

MARCH 1955

RADIO - ELECTRONICS

TELEVISION • SERVICING • HIGH FIDELITY

HUGO GERNSBACH, Editor

In this issue:

Transistorized
R-C Bridge

Variable Damping
Amplifiers

Emerson 14-Inch
Portable TV

A Capaswitch
Photo-Relay

Probes for Profits

35¢

U. S. and
CANADA

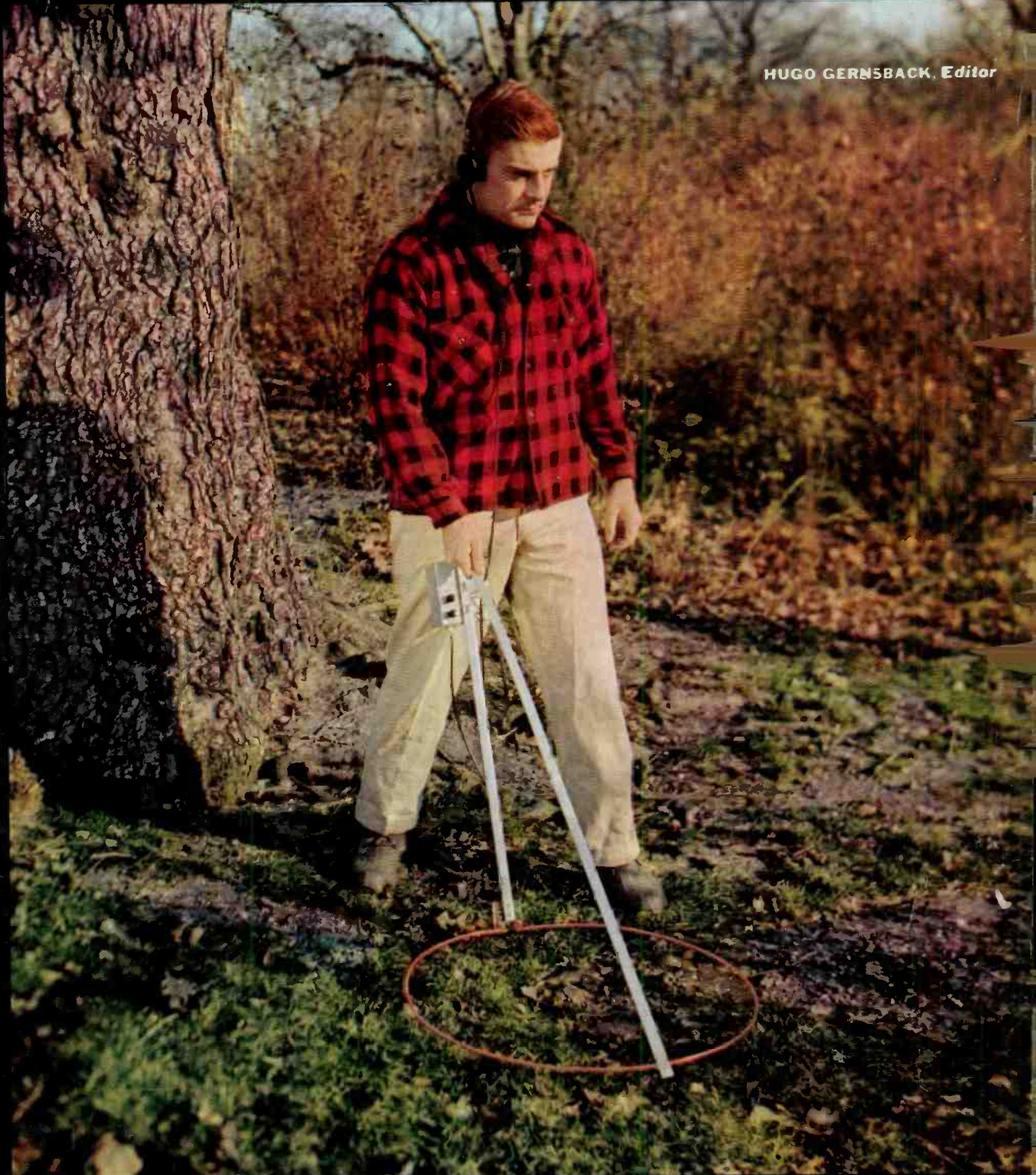

Building Metal Locators
(See page 4)

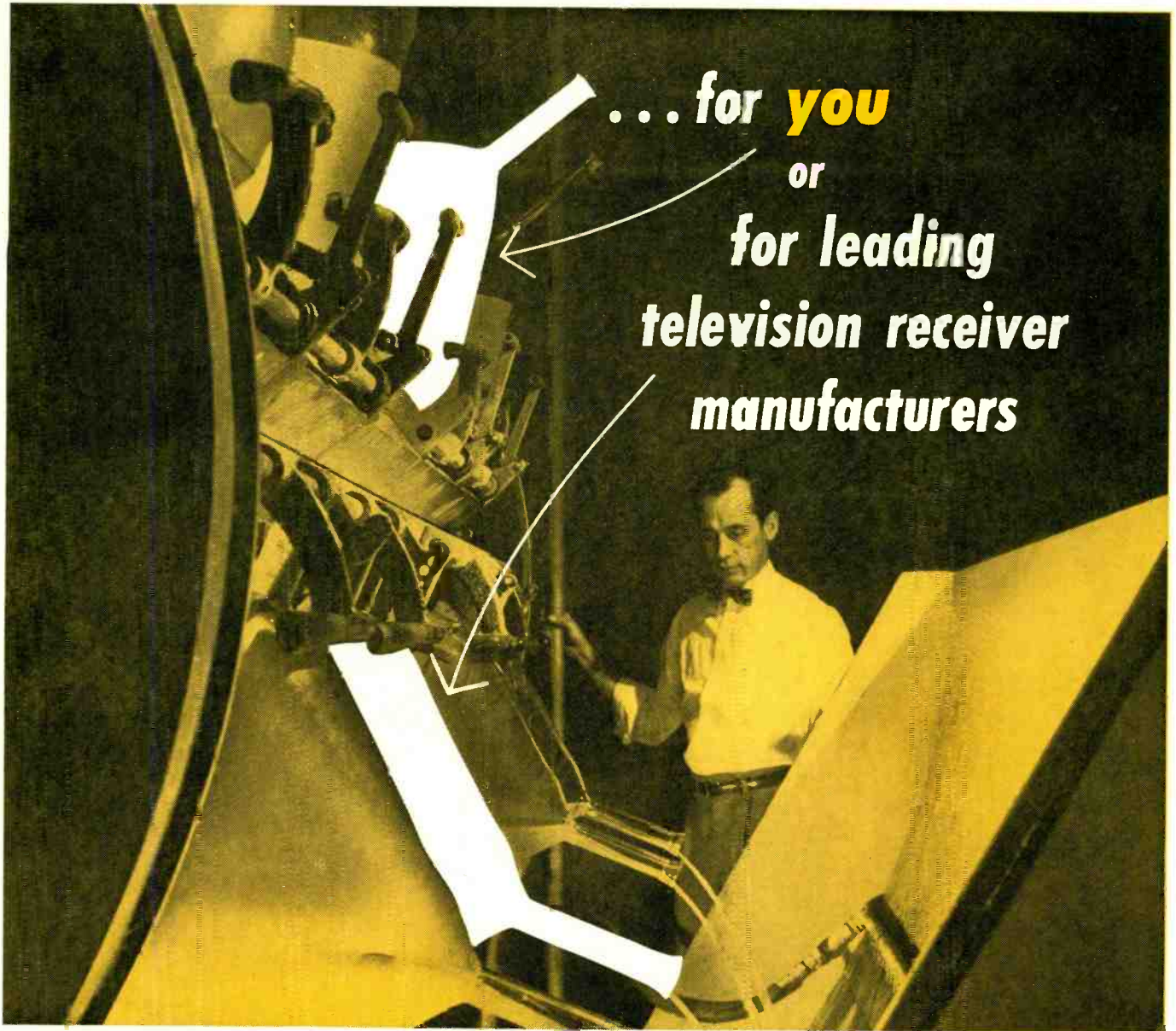

... for **you**
or
for leading
television receiver
manufacturers

At Du Mont there is only one

Standard of Quality...



* Trade Mark

All Du Mont picture tubes are built to the highest standards of quality – whether for leading TV receiver manufacturers as initial equipment, or for the individual serviceman. The same careful assembly, processing and inspection is done on *every* picture tube bearing the Du Mont name.

Do as leading TV receiver manufacturers do – choose Du Mont initial quality picture tubes for new set performance.

CATHODE-RAY TUBE DIVISION
ALLEN B. DU MONT LABORATORIES, INC.
CLIFTON, N. J.

I WILL TRAIN YOU AT HOME FOR GOOD PAY JOBS IN RADIO-TELEVISION

J. E. SMITH has trained more men for Radio-Television than any other man. OUR 40TH YEAR.





America's Fast Growing Industry Offers You Good Pay—Bright Future—Security

I TRAINED THESE MEN

 "Started to repair sets six months after enrolling. Earned \$12 to \$15 a week in spare time."—Adam Kramlik, Jr., Sunnyside, Pennsylvania.

 "Up to our necks in Radio-Television work. Four other NRI men work here. Am happy with my work."—Glen Peterson, Bradford, Ont., Canada.

 "Am doing Radio and Television Servicing full time. Now have my own shop. I owe my success to N.R.I."—Curtis Stath, Ft. Madison, Iowa.

 "Am with WCOC. NRI course can't be beat. No trouble passing 1st class Radio-phone license exam."—Jesse W. Parker, Meridian, Mississippi.

 "By the time I graduated I had paid for my course, a car and testing equipment. Can service toughest jobs."—E. J. Streitenberger, New Boston, Ohio.

AVAILABLE TO VETERANS UNDER G.I. BILLS

You Learn by Practicing with Parts I Send



Nothing takes the place of PRACTICAL EXPERIENCE. That's why NRI training is based on LEARNING BY DOING. You use parts I furnish to build many circuits common to Radio and Television. As part of my Communications Course, you build many things, including low power transmitter shown at left. You put it "on the air," perform procedures required of broadcasting operators. With my Servicing Course you build modern Radio, etc. Use Multimeter you build to make money fixing sets. Many students make \$10, \$15 week extra fixing neighbors' sets in spare time while training. Coupon below will bring book showing other equipment you build. It's all yours to keep.

The Tested Way To Better Pay!

Training plus opportunity is the PERFECT COMBINATION for job security, good pay, advancement. In good times, the trained man makes the BETTER PAY, GETS PROMOTED. When jobs are scarce, the trained man enjoys GREATER SECURITY. NRI training can help assure you more of the better things of life.

Start Soon to Make \$10, \$15 a Week Extra Fixing Sets

Keep your job while training. I start sending you special booklets that show you how to fix sets the day you enroll. Multimeter built with parts I send helps you make \$10, \$15 a week extra fixing sets while training. Many start their own Radio-Television business with spare time earnings.

My Training Is Up-To-Date

You benefit by my 40 years' experience training men at home. Well illustrated lessons give you basic principles you need. Skillfully developed kits of parts I send (see below) "bring to life" things you learn from lessons.



Television Making Good Jobs, Prosperity—Even without Television, Radio is bigger than ever. 115 million home and auto Radios to be serviced. Over 3000 Radio broadcasting stations use operators, technicians, engineers. Government, Aviation, Police, Ship, Micro-wave Relay, Two-Way Radio Communications for buses, taxis, trucks, etc., are important and growing fields. Television is moving ahead fast.

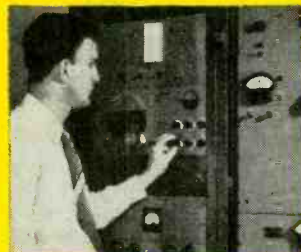

About 200 Television stations are now on the air. Hundreds of others being built. Good TV jobs opening up for Technicians, Operators, etc.

25 million homes now have Television sets. Thousands more are being sold every week. Get a job or have your own business selling, installing, servicing.

Radio-TV Needs Men of Action—Mail Coupon

Act now to get more of the good things of life. Actual lesson proves my training is practical, thorough. 64-page book shows good job opportunities for you in many fields. Take NRI training for as little as \$5 a month. Many graduates make more than total cost of training in two weeks. Mail coupon now. J. E. SMITH, President, National Radio Institute, Dept. 5CF, Washington 9, D. C. OUR 40TH YEAR.

Good for Both—FREE

MR. J. E. SMITH, President, Dept. 5CF, National Radio Institute, Washington 9, D. C. Mail me Sample Lesson and 64-page Book, FREE. (No salesman will call. Please write plainly.)

Name..... Age.....
 Address.....
 City..... Zone..... State.....
VETS write in date of discharge.....

The ABC's of SERVICING

How to Be a Success in RADIO-TELEVISION

RADIO - ELECTRONICS

Formerly RADIO CRAFT • Incorporating SHORT WAVE CRAFT • TELEVISION NEWS • RADIO & TELEVISION*

Hugo Gernsback
Editor and Publisher
M. Harvey Gernsback
Editorial Director
Fred Shunaman
Managing Editor
Robert F. Scott
W2PWG, Technical Editor
Jerome Kass
Associate Editor
I. Queen
Editorial Associate
Matthew Mandl
Television Consultant
Angie Pascale
Editorial Production
Wm. Lyon McLaughlin
Tech. Illustration Director
Sol Ehrlich
Art Director

Lee Robinson
General Manager
John J. Lamson
Sales Manager
G. Aliquo
Circulation Manager
Adam J. Smith
Director, Newsstand Sales
Robert Fallath
Promotion Manager
Seymour Schwartz
Advertising Production

GERNSBACK PUBLICATIONS, INC.

Executive, Editorial and Advertising Offices, 25 West Broadway, New York 7, N. Y. Telephone REctor 2-8630.

Hugo Gernsback
Chairman of the Board
M. Harvey Gernsback
President
G. Aliquo
Secretary

ON THE COVER

(Story on page 54) Our electronic prospector seems to think "three paces from the old oak tree" a logical place to seek indications of buried treasure.

Color original by
Daniel R. Rubin



MARCH 1955

Vol. XXVI, No. 3

Editorial (Page 31)

De Forest Nobel Prize Overdue.....by Hugo Gernsback 31

Television (Pages 32-53)

Emerson 14-Inch Portable.....by Robert F. Scott 32
What! No High Voltage?.....by Charles R. Wheeler 36
Foldover.....by Matthew Mandl 38
Television—It's a Cinch (Fifteenth conversation, second part:
Pentode separators, d.c. level problems, differentiator and
integrator circuits).....by E. Aisberg 41
U.H.F. Alignment.....by Robert G. Middleton 44
The Callback Scourge.....by Art Margolis 46
The Synchroguide Circuit.....by E. R. Gunny 48
Check the Picture Tube.....by J. Dubinsky 49
TV Service Clinic.....by Jerry Kass 50
Color TV Circuits, Part X—Isolating defective circuits in color
TV receivers.....by Ken Kleidon and Phil Steinberg 52

Electronics (Pages 54-58)

Two Transistorized Metal Locators (Cover Feature).....by Edwin Bohr 54
The Capaswitch Photorelay.....by Irving Gottlieb 58

Radio (Pages 59-61)

Mobile Radio Shop.....by Charles E. Holman 59
Beating the Service Technician.....by George D. Philpott 60

Audio—High Fidelity (Pages 62-94)

Transistor-Varistor Modulator for Low-Level Audio.....by Albert H. Taylor 62
Variable Damping in Audio Amplifiers.....by Robert F. Scott 64
For Golden Ears Only: G-E Baton arm and cartridge; Martin
model 352 amplifier and preamp; new records review.....by Monitor 66
High-Fidelity Dictionary, Part II.....by Ed Bukstein 76
Magnetic Tape Erasure.....by David Gnessin 86

Test Instruments (Pages 96-110)

Probes for Profits.....by John W. Sherman 96
Simple Frequency Meter.....by George Fletcher Cooper 98
Wide-Range Transistorized Bridge.....by I. Queen 106

New Design (Pages 114-117)

What's New in Test Equipment, Television and High Fidelity....by Sol Heller 114

DEPARTMENTS

Books.....	155	Question Box.....	136
Business.....	147	The Radio Month.....	8
Correspondence.....	18	Radio-Electronic Circuits.....	132
Miscellany.....	130	Technical Literature.....	153
New Devices.....	118	Technicians' News.....	123
New Tubes and Transistors.....	112	Technotes.....	128
Patents.....	141	Try This One.....	144
People.....	150		

Average Paid Circulation over 180,000

RADIO-ELECTRONICS, March, 1955, Vol. XXVI, No. 3. Published monthly at Mt. Morris, Illinois. By Gernsback Publications, Inc. Second Class mail privileges authorized at Mt. Morris, Ill. Copyright 1955 by Gernsback Publications, Inc. Text and Illustrations must not be reproduced without permission of copyright owners. SUBSCRIPTIONS: Address correspondence to Radio-Electronics, Subscription Dept., 404 N. Wesley Ave., Mt. Morris, Ill., or 25 West Broadway, New York 7, N. Y. When ordering a change please furnish an address stencil impression from a recent wrapper. Allow one month for change of address. SUBSCRIPTION RATES: U. S., U. S. possessions and Canada, \$3.50 for one year; \$6.00 for two years; \$8.00 for three years; single copies 35c. All other countries \$4.50 a year; \$8.00 for two years; \$11.00 for three years. BRANCH ADVERTISING OFFICES: Chicago: 7522 North Sheridan Road, Tel. ROGers Park 4-8000. Los Angeles: Ralph W. Harker and Associates, 600 South New Hampshire, Tel. DUnkirk 7-2328. San Francisco: Ralph W. Harker and Associates, 582 Market St., Tel. GARfield 1-2481. FOREIGN AGENTS: Great Britain: Atlas Publishing and Distributing Co., Ltd., London E.C. 4. Australia: McGill's Agency, Melbourne. France: Brentano's, Paris 2e. Belgium: Agence et Messageries de la Presse, Brussels. Holland: Trilectron, Heemstede. Greece: International Book & News Agency, Athens. So. Africa: Central News Agency Ltd., Johannesburg. Durban, Natal: Universal Book Agency, Johannesburg. Middle East: Steimatzy Middle East Agency, Jerusalem. India: Broadway News Centre, Dadar, Bombay #14. Pakistan: Paradise Book Stall, Karachi 3. POSTMASTER: If undeliverable send form 3578 to: RADIO-ELECTRONICS, 25 West Broadway, New York 7, N. Y. *Trademark registered U.S. Patent Office.



National Schools brings you a new dimension in training for TELEVISION-RADIO-ELECTRONICS

YOU CAN LEARN BY HOME STUDY, IF—

- you are ambitious to increase your earning power.
- you want to broaden your knowledge and skill.
- you choose the school with the most complete training and service.

50 Years of Successful Training

National Schools has been training men for success since 1905. Our graduates are located around the globe, in good-paying jobs in servicing, installation and manufacturing... in public and private industry, or in their own businesses. All this experience and background are your assurance of success.

What This New Dimension in Home Study Means to You

As a National Schools student, with Shop Method Home Training, you master *all phases* of the industry—TV, Radio, Electronics—theory and practice. You learn HOW and WHY, in one complete course at one low tuition.

Because National Schools' world headquarters are in Los Angeles—"capital city" of TV-Radio-Electronics—our staff is in close touch with industry. Our lessons and manuals are constantly revised to keep you up-to-the-minute on latest developments. We show you how to make spare time earnings as you learn, and we give you free placement assistance upon graduation. National Schools is approved for G. I. Training. Both Resident and Home Study courses are offered. If you are of draft age, our training helps you achieve specialized ratings and higher pay grades.

This *new dimension* enables us to train you as you should be trained at home, regardless of your age or previous education.

Your Course Includes Valuable Units

We send you important equipment, including a commercial, pro-

fessional Multitester... plus parts to build Receivers, Oscillators, Signal Generator, Continuity Checker, other units, and Short Wave and Standard Broadcast Superhet Receiver.

Mail Coupon for Complete Information

Get these two free books about this new dimension in Home Training. A comprehensive, illustrated fact-book and a sample National Schools lesson. No obligation, so mail coupon today.

NATIONAL SCHOOLS

TECHNICAL TRADE TRAINING SINCE 1905
Los Angeles 37, Calif. • Chicago: 323 W. Polk St.
In Canada: 811 W. Hastings St., Vancouver, B.C.



MAIL NOW TO OFFICE NEAREST YOU!

(mail in envelope or paste on postal card)

NATIONAL SCHOOLS, Dept. RG-35

4000 S. FIGUEROA STREET OR 323 W. POLK STREET
LOS ANGELES 37, CALIF., CHICAGO 7, ILL.

Rush FREE BOOK, "Your Future in Radio-TV-Electronics," and FREE LESSON. No obligation, no salesman will call.

NAME _____ BIRTHDAY _____ 19__

ADDRESS _____

CITY _____ ZONE _____ STATE _____

Check if Interested ONLY in Resident Training at Los Angeles.

VETERANS: Give date of discharge _____

Confidentially



... installing Astron "SM"* electrolytics is the secret of profitable capacitor servicing

Be sure to see us
at Booth #368
March IRE Show.

BECAUSE exclusive "SM"* safety margin construction gives you the *extra* protection needed in an electrolytic... the stamina to withstand surge voltages and momentary overloads without permanent damage. Installing Astron "SM"* electrolytics insures "No callback" servicing... more profits and greater consumer satisfaction for you.

Actually there's no secret about how Astron does it... they simply maintain meticulous care when assembling the high purity foil and other quality parts used in "SM" electrolytics. Astron foil is subjected to high-gain etching and other special electrochemical treatments utilizing creative formulas developed after extensive research and testing. These carefully controlled processes form the vital anodic film governing the "SM" electrolytics' superior service and extended life... Astron control assures the utmost performance and satisfaction. Add to this a "regulated" electrolyte to effectively cope with every operating condition, a wide choice of exact replacement styles, long shelf life, and amazing self restoration properties... to know the complete story. See your favorite jobber for Astron "SM" electrolytics... he's proud to carry them.

ASTRON "SM" MINIMITE*

- Miniature, hermetically sealed metal-cased tubulars.
- Conservatively rated for stable, dependable operation.
- Easily mounted.
- Individually tested and guaranteed.

ASTRON "SM" TWIST-PRONG

- Consistent 85°C operation.
- Wide range of hermetically sealed styles.
- Clearly stamped terminal codings for rapid installation.
- Individually tested and guaranteed.

*TRADEMARK

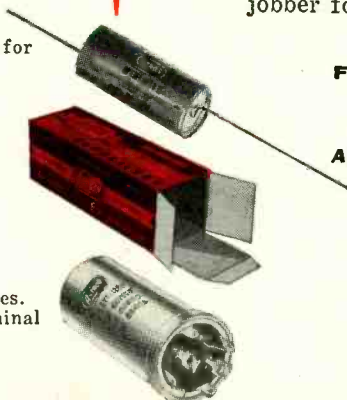

FREE SERVICING AID New "Customer Estimating and Pricing Guide for Service Technicians" now available — *write for your copy today!*

AVAILABLE NATIONALLY THROUGH AUTHORIZED DISTRIBUTORS

ASTRON

CORPORATION

255 GRANT AVENUE
EAST NEWARK, N. J.



Export Division: Rocke International Corp., 13 East 40th St., N. Y., N. Y. In Canada: Charles W. Pointon, 6 Altona Ave., Toronto 10, Ontario

All Electronic Parts
YOURS TO KEEP!

Now!
Work over
300
practical projects
WITH THESE
PARTS...

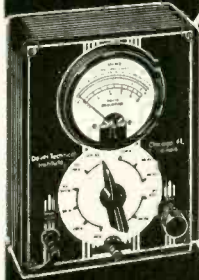

MULTIMETER

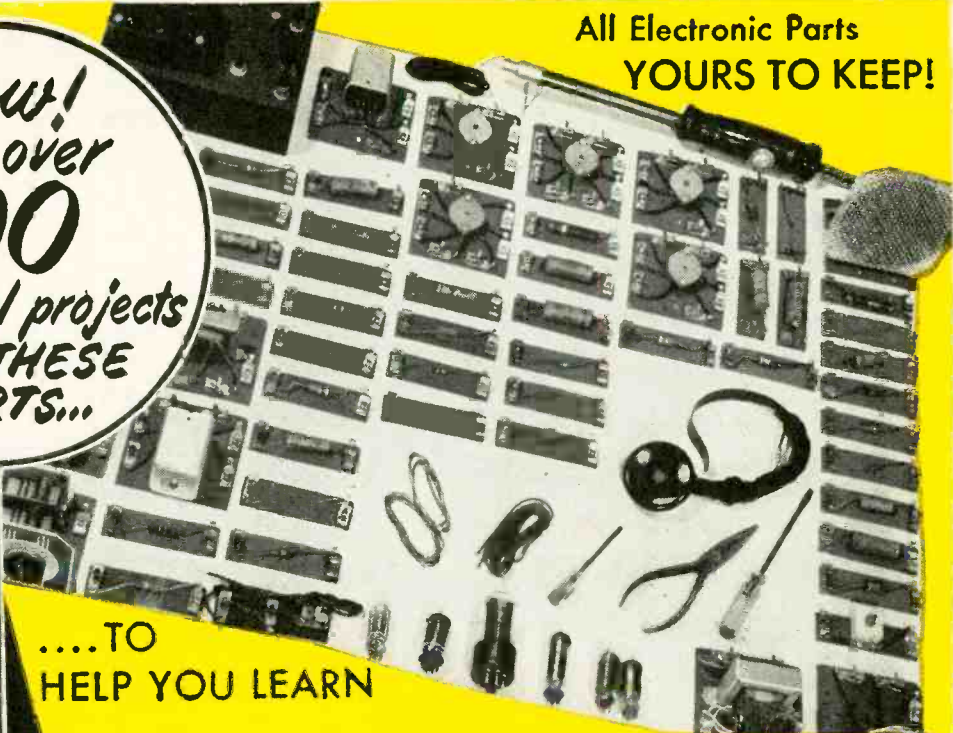

....TO
HELP YOU LEARN

TELEVISION

RADIO-ELECTRONICS Now... at home in spare time you can get BOTH the very training and subsequent Employment Service you need to help you start earning real money in America's thrilling, multi-billion dollar opportunity field of Television-Radio-Electronics. Now that Television is coming to almost every community, here is a chance of a lifetime to prepare to cash in on one of Television's great expansions.

D.T.I.'s amazingly practical home method enables you to set up your own HOME LABORATORY. You get many Electronic parts which you mount on individual bases with spring clip connectors. Tops for experimenting! Add or remove parts in a jiffy. No wasted hours of soldering and unsoldering for each project. You spend *minimum* time to get *maximum* knowledge of important circuits that really work. In fact, you get exactly the same type of basic training equipment used in our Chicago training laboratory—one of the nation's finest.

Build and KEEP This VALUABLE TEST EQUIPMENT

Your home laboratory projects also include building and keeping a versatile 5 inch Oscilloscope and precision Jewel Bearing Multi-Meter. These quality commercial test instruments help you **EARN WHILE YOU LEARN** and will prove mighty valuable, should you later decide to start your own full time TV-Radio service business. You also build and keep a quality 21 inch TV SET.

D.T.I. Provides EVERYTHING YOU NEED to master TELEVISION

In addition to your home laboratory and easy-to-read lessons, you even use HOME MOVIES—a wonderfully effective and exclusive D.T.I. training advantage. You watch hidden actions... see electrons on the march. Important fundamentals... become "movie clear," helping you learn faster... easier... better.

Full time Residential training in D.T.I.'s great Chicago laboratories also available. MAIL COUPON TODAY for all facts. (If subject to Military Service, you'll especially welcome the information we have for you.)
D.T.I.'s Training is available in Canada



HOME MOVIES

89 WAYS TO EARN MONEY

MAIL COUPON TODAY!



5 INCH
"SCOPE"



21 INCH

Build and keep this BIG DTI Engineered TV set—easily converted to U.H.F. (DTI offers another home training, but without the TV set.)

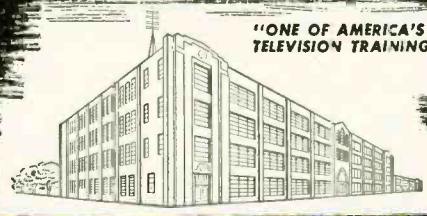

"ONE OF AMERICA'S FOREMOST TELEVISION TRAINING CENTERS"

DEVRY TECHNICAL INSTITUTE

AFFILIATED WITH
DEFORREST'S TRAINING, INC.
CHICAGO 41, ILLINOIS

DEVRY TECHNICAL INSTITUTE
4141 BELMONT AVE., CHICAGO 41, ILL. DEPT. RE-3L

I would like your valuable information-packed publication showing how I can get started toward a good job or my own business in Television-Radio-Electronics.

Name _____ Age _____
Street _____ Apt. _____
City _____ Zone _____ State _____

You can build a reputation on Tung-Sol® Quality

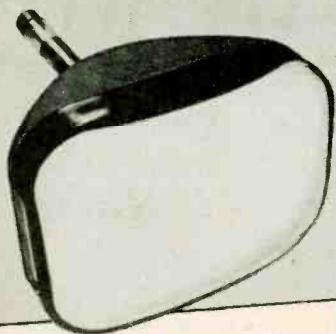

TUNG-SOL makes
 All-Glass Sealed Beam Lamps,
 Miniature Lamps,
 Signal Flashers,
 Picture Tubes, Radio, TV,
 Special Purpose Electron Tubes,
 Semiconductor Products.

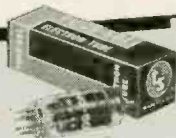

TUNG-SOL ELECTRIC INC.
 Newark 4, New Jersey

Sales Offices: Atlanta, Chicago, Columbus, Culver City (Los Angeles), Dallas, Denver, Detroit, Newark, Seattle

the Radio month



FOUR NEW U. S. TV STATIONS

have gone on the air since our last report:

KTVK	Phoenix, Ariz.	3
WEAT-TV	West Palm Beach, Fla.	12
WUNC-TV	Chapel Hill, N. C.	4
KEPR-TV	Pasco, Wash.	19

Two stations have gone off the air:

WPMT	Portland, Me.	53
WBTM-TV	Danville, Va.	24

CKWS-TV, channel 11, Kingston, Ont., Canada, has also started broadcasting.

CLOSED CIRCUIT TV may take on the task of observing general port operations at the New York Port of Embarkation, the largest Army Transportation Corps installation in the country.

In response to a request by the NYPE Provost Marshal and G-2 for an electronic device capable of furnishing identification at the approaches to the piers at the Brooklyn Army Base, the Signal Corps mounted a TV camera atop a convenient water tower. It was able to pick up the activities of vessels in the pier area and relay the image to a monitor in a jeep near by (see photo). By changing lenses, normal, wide-angle and close-up pictures of harbor craft maneuvers were viewed. The results of the test were highly satisfactory despite the test being made under adverse weather conditions.

It would be possible for strategically located cameras to cover the entire base in fixed positions or attached to automatic panning devices which would permit continuous scanning of large

areas. The cameras could also be used for security, fire detection and pilferage control.

COMMUNITY TV SYSTEMS in Casper and Laramie, Wyo., and Sterling, Colo., have come under attack regarding the contents of their programming. Station KOA-TV, Denver, has requested the community systems to sign "affiliation" contracts. This action is being fought by the National Community Television Association. At the same time station KFBC-TV Cheyenne, Wyo., has requested the three wired-TV organizations to cease picking up its signals.

The KOA-TV note to the three systems asked for an agreement which would permit the station's signals to be picked up for distribution to subscribers provided that no commercial announcements were deleted. It also suggested that the community TV systems pick up and relay to subscribers a weekly minimum of 25 hours, of which at least 14 hours must be after 6 pm. There was no mention of payment in the proposed agreement.

Don Searle, executive vice president of KOA-TV, said: "Our primary interest is that viewers of our stations have a fair opportunity to watch representative portions of our programming and that the advertising messages which accompany programs not be deleted, since in the final analysis it is the advertisers who bear the cost of producing and broadcasting the programs."

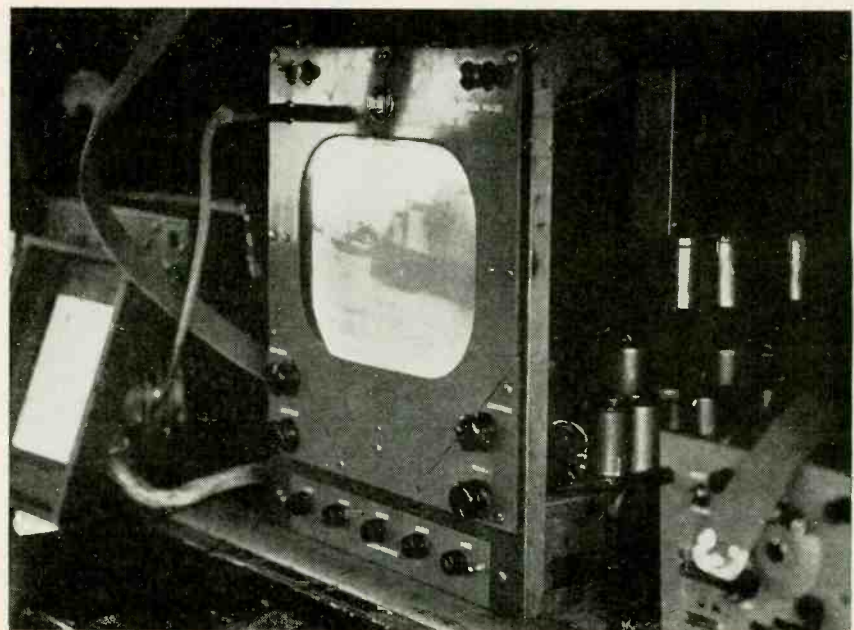

FREE

MONEY MAKING
FCC
 Commercial-Radio Operator
LICENSE
 INFORMATION

TELLS HOW -

WE GUARANTEE
 TO TRAIN AND COACH YOU AT HOME IN SPARE TIME UNTIL YOU GET
YOUR FCC
LICENSE

If you have had any practical experience—Amateur, Army, Navy, radio, repair, or experimenting.

Here is your guarantee

If you fail to pass your Commercial License exam after completing our course, we guarantee to continue your training without additional cost of any kind, until you successfully obtain your Commercial license, provided you first sit for this examination within 90 days after completing your course.

TV Engineering

INCLUDED IN OUR
 TRAINING AND
 COACHING

TELLS HOW -

OUR AMAZINGLY EFFECTIVE JOB-FINDING SERVICE HELPS CIRE STUDENTS GET BETTER JOBS. HERE ARE JUST A FEW RECENT EXAMPLES OF JOB-FINDING RESULTS:

GETS CIVIL SERVICE JOB

"Thanks to your course I obtained my 2nd phone license, and am now employed by Civil Service at Great Lakes Naval Training Station as an Equipment Specialist."
 Kenneth R. Leiser, Fair Oaks, Md., Del., McHenry, Ill.

GETS STATE POLICE JOB

"I have obtained my 1st class ticket (thanks to your school) and since receiving same I have held good jobs at all times. I am now Chief Radio Operator with the Kentucky State Police." Edwin Healy, 264 E. 3rd St., London, Ky.

GETS BROADCAST JOB

"I wish to thank your Job-Finding Service for the help in securing for me the position of transmitter operator here at WCAE, in Pittsburgh."
 Walter Koschik, 1442 Ridge Ave., N. Braddock, Pa.

GETS AIRLINES JOB

"Due to your Job-Finding Service, I have been getting many offers from all over the country, and I have taken a job with Capital Airlines in Chicago, as a Radio Mechanic."
 Harry Clare, 4537 S. Drexel Blvd., Chicago, Ill.

HERE'S PROOF FCC LICENSES ARE OFTEN SECURED IN A FEW HOURS OF STUDY WITH OUR COACHING AT HOME IN SPARE TIME:

Name and Address	License	Time
Harry G. Frame, Box 429, Charlestown, W. Va.	2nd Class	13 Weeks
Charles Ellis, Box 449, Charles City, Iowa.	1st Class	28 Weeks
Omar Bibbs, 1320 E. 27th St., Kansas City, Mo.	1st Class	34 Weeks
Kenneth Rue, Dresser, Wisconsin	2nd Class	20 Weeks
B. L. Jordan, Seattle, Washington	1st Class	20 Weeks

CARL E. SMITH, E.E. Consulting Engineering, President
CLEVELAND INSTITUTE OF RADIO ELECTRONICS
 Desk RE-74, 4900 Euclid Bldg., Cleveland 3, Ohio

TELLS HOW -

EMPLOYERS MAKE JOB OFFERS LIKE THESE TO OUR GRADUATES EVERY MONTH!

Letter from nationally-known Airlines: "Radio Operators and Radio Mechanics are needed for our company. Periodic wage increase with opportunity for advancement. Both positions include many company benefits such as paid vacations, free flight mileage allowance and group insurance."

Letter from nationally-known manufacturer: "We have a very great need at the present time for radio-electronics technicians and would appreciate any helpful suggestions that you may be able to offer."

These are just a few of the examples of the job offers that come to our office periodically. Some licensed radioman filled each of these jobs; it might have been you!

Ours is the only home study course which supplies FCC-type examinations with all lessons and final tests.

An Approved Member



ACT NOW!

Get
ALL 3
FREE

Your FCC Ticket is recognized by most employers in the electronic field as proof of your technical ability.

MAIL COUPON NOW!



Cleveland Institute of Radio Electronics
 Desk RE-74—4900 Euclid Bldg., Cleveland 3, Ohio
 (Address to Desk No. to avoid delay)

I want to know how I can get my FCC Ticket in a minimum of time. Send me your FREE booklet, "How to Pass FCC License Examinations" (does not cover exams for Amateur License), as well as a sample FCC-type exam and the amazing new booklet, "Money-Making FCC License Information." Be sure to tell me about your Television Engineering Course.

Name _____
 Address _____
 City _____ Zone _____ State _____

FOR PROMPT RESULTS, SEND AIR MAIL
 Special tuition rates to member of the U.S. Armed Forces

PERMOFLUX ANNOUNCES

The NEW

Largo-12

Big brother to the famous "Largo 8"

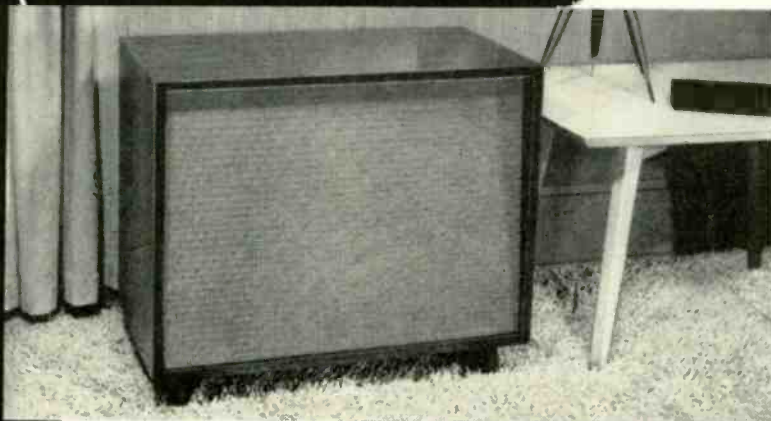

New, complete two-way speaker system —
with all the time-tested, proven features of the "Largo 8"
plus:

- More powerful Super Royal 12" Speaker
- New, larger, back-loaded horn enclosure
- Full 20-watt power-handling capacity
- Smooth peak-free response . . . 30 to 16,000 cycles

Combined with: • Scientifically matched 32KTR Super Tweeter • Slanted speaker panel for proper sound focusing
• High-frequency balance control • Horn loading of back wave thru unique cabinet base. The Largo 12 is precision-constructed of beautiful $\frac{3}{4}$ " Mahogany or Korina Blonde cabinet woods. Impedance, 8 ohms.
Size: 23 $\frac{1}{8}$ " H, 27 $\frac{1}{2}$ " W, 15 $\frac{1}{2}$ " D.

Audiophile NET.....\$149.50
(Also available in Walnut at slightly higher price.)

H.T.P.

The Largo 12 is available under the exclusive Permoflux insured Home Trial Plan (H.T.P.). Try it in the comfort and quiet of your own home for 15 days—with your own records and associated equipment. For a limited time only, each H.T.P. participant will receive—absolutely FREE—the new Permoflux "Maestro" speaker-Headset Control Box (\$10.00 value). Also available under H.T.P.: the Diminutive (\$49.50); the Largo 8 (\$99.75).

Only Permoflux gives you all the features you should have in a 2-way high-fidelity speaker system. See and hear the Largo 12 and other Permoflux systems at your hi-fi dealer today. Also ask him about H.T.P.—or write:

Permoflux CORPORATION

Dept. RE, 4912 West Grand Avenue • Chicago 39, Illinois
West Coast Plant • 4101 San Fernando Road • Glendale 4, California
Canadian Licensee • Campbell Manufacturing Co., Ltd., Toronto, Canada

THE RADIO MONTH

(Continued)

TV TECHNICIANS' WEEK, March 7 to 12, to salute the thousands of service dealers and technicians who install and maintain home TV receivers, has been announced by Douglas Y. Smith, vice president and general manager of the RCA Tube Division. The *National Television Servicemen's Week* program includes prizes totaling more than \$10,000 to be awarded to radio-TV service deal-



ers creating the most effective National Week promotions at the neighborhood level.

A complete set of five RCA test instruments for color TV servicing, valued at \$1,337, will be awarded in each of RCA's eight sales regions. Service dealers will qualify for the competition simply by describing in 50 words or less their efforts to publicize and promote *National Television Servicemen's Week*.

The week, registered with the U. S. Chamber of Commerce, will be symbolized by an RCA Electronic Statuette (see photo) which has been popularized in advertising and will be displayed by service dealers from coast to coast. Smith said that it is RCA's hope that during this period those who make, sell and enjoy home television equipment will give thought to the local service technician and his invaluable contributions to its efficient performance.

The campaign opens with a full-page ad in the March 7 issue of *Life* magazine. This will be followed by concentrated newspaper, radio and TV publicity.

FLAT PICTURE TUBE is about 3 inches thick (see photo) and consists of a phosphor screen placed between glass plates. Still classified as experimental, the new tube was developed by Willys Motors. It functions by exciting selected areas on the phosphor screen. This is done by injecting an electronic beam along a horizontal edge, in a field free region of the tube. The beam flows along this edge and adjacent to a row of transverse deflection plates. By controlling the deflection plate voltages, the beam is bent vertically at any place
(Continued on page 14)



What did Beethoven WANT you to hear in his Fifth Symphony?

You have listened to this great work countless times... what have you heard in it? And what may you have failed to hear? An original plan of at-home music education now enables you to appreciate fully all of the great orchestral music you hear

HIGH-FIDELITY MUSIC-APPRECIATION RECORDS



ON ONE SIDE there is a full performance of a great musical work, just as on the ordinary record you buy. The records feature orchestras and soloists of recognized distinction. You listen to the performance first, or afterward, and then...



ON THE OTHER SIDE is an illuminating analysis of the music, with the various themes and other main features of the work played separately with running explanatory comment, so that you can learn *what to listen for*.

THIS NEW IDEA is sponsored by the Book-of-the-Month Club and is designed for those who enjoy good music but who are aware that, too often, they do not listen to it with complete understanding and appreciation. Their minds wander and they realize afterward that they have missed most of the beauties of the work. There is no doubt about the reason: most of us are not primed in advance about *what to listen for*. MUSIC-APPRECIATION RECORDS meet this need, for a fuller understanding of music, better than any means ever devised. They do it, sensibly, by auditory demonstration.

YOU HEAR MUSIC AS THE GREAT CONDUCTORS HEAR IT... On the podium they have in mind at every moment the various themes of the work, their interplay and development, and the main architectural features of the composition. This combined aesthetic and intellectual pleasure is what every music-lover can now acquire through MUSIC-APPRECIATION RECORDS. After hearing several of these

records, all the music you listen to is transformed, because you learn in general what to listen for. This enjoyable form of self-education can be as thorough as the Music Appreciation courses given in many universities.

YOU SUBSCRIBE BUT TAKE ONLY RECORDS YOU WANT... A new MUSIC-APPRECIATION RECORD will be issued - for subscribers only - every month. The announcement about each forthcoming record will be written by Deems Taylor. After reading this descriptive essay you may take the record or not, as you decide at the time. *You are not obligated as a subscriber to take any specified number of records.* And, of course, you may stop the subscription at your pleasure - at any time!

TWO TYPES OF RECORDS AT A RELATIVELY LOW COST... All MUSIC-APPRECIATION RECORDS will be high-fidelity, long-playing records of the highest quality - 33 1/3 R.P.M. on Vinylite. They

will be of two kinds: first, a so-called Standard Record - a *twelve-inch* disc - which will present the performance on one side, the analysis on the other. This will be sold at \$3.60, to subscribers only. The other will be an Analysis-Only Record - a *ten-inch* disc - priced at \$2.40. The latter will be made available each month for any subscriber who may already have a satisfactory long-playing record of the work being presented. (A small charge will be added to the prices above to cover postage and handling.)

TRY A ONE-MONTH SUBSCRIPTION - WITH NO OBLIGATION TO CONTINUE... Why not make a simple trial, to see if these records are as pleasurable and as enlightening as you may anticipate? The first record, BEETHOVEN'S FIFTH SYMPHONY, will be sent to you at once - at no charge. You may end this subscription immediately after hearing this record - and keep it with our compliments - or you may cancel any time thereafter if you are not completely satisfied with the plan.

As a demonstration

WILL YOU ACCEPT WITHOUT CHARGE



Beethoven's Fifth Symphony

A NEW HIGH-FIDELITY RECORDING BY THE LONDON SYMPHONY ORCHESTRA

Norman Del Mar, Conductor

Analysis by Thomas Scherman

YOU WILL also receive a **DESCRIPTIVE ESSAY** about the work by the noted composer and music commentator Deems Taylor, as well as a **GLOSSARY OF MUSICAL TERMS COMMONLY USED**.

PLEASE RETURN ONLY IF YOU HAVE A RECORD PLAYER WHICH CAN PLAY 33 1/3 R. P. M. LONG-PLAYING RECORDS

MUSIC-APPRECIATION RECORDS
c/o Book-of-the-Month Club, Inc.
345 Hudson Street, New York 14, N. Y.

R39-3

Please send me at once the first MUSIC-APPRECIATION RECORD, Beethoven's Fifth Symphony, without charge, and enter my name in a Trial Subscription to MUSIC-APPRECIATION RECORDS, under the conditions stated above. It is understood that, as a subscriber, I am not obligated to buy any specified number of records, but may take only those I want. Also, I may cancel my subscription after hearing this first record, or any time thereafter at my pleasure, but the introductory record is free in any case.

Mr. }
Mrs. }
Miss } (Please Print)
Address.....

City..... Zone..... State.....

MAR 8

Depend on the COMPLETE line of ROHN

"SUPERIOR DESIGN" towers and accessories

for **LARGER PROFITS** **MORE SATISFACTION** **GREATER EASE IN HANDLING**

3 added towers to solve ALL your needs

also



no. 6 tower

"All-Purpose" tower.

Fulfills 75% of your general tower needs—is structurally as sturdy—yet costs less than the well-known Rohn No. 10 Tower. Ideal for home and industrial installations, communication requirements... eliminates stocking many different tower models. Self-supporting to 50 ft. or guyed to 120 ft. Easy to climb for fast, efficient servicing. Utilizes "Magic Triangle" which insures far greater strength and stability. Permanent hot-dipped galvanized coating. Dependability—a feature customers demand—is assured with the Rohn No. 6 Tower... designed to "stand up" for years to the rigors of weather and climatic conditions.

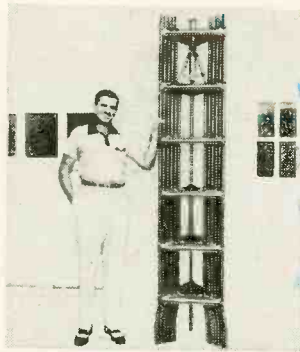

Package Tower

"Space Saver"—cuts storage space 300% or more!

Popular PT-48 has almost 50' of sturdy tower within a compact 8' x 20" package! "Magic Triangle" design is adapted to a pyramid shape using a wide 19" base with progressively decreasing size upward. Decreases your overhead... easy to transport and assemble—cuts shipping costs. Galvanized throughout. Available in heights of 24, 32, 40, 48, 50 and 64 feet!



no. 30 tower

Heights up to 200' or more when guyed
Self-supporting up to 60'

Sturdy communication or TV tower that "stands up" to all the stresses of weather and climatic conditions... will withstand heavy wind and ice loading. Heavy gauge tubular steel, electrically welded throughout. Weather resistant, non-corrosive double coating provides durable finish. All sections in 10' lengths. Only 2-4 manhours required for installing 50' tower!

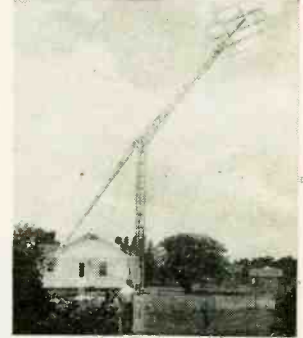

ROHN Fold-over tower

For experimenters, TV service departments and retailers. Use this kit with regular Rohn tower sections. Simple and easy to use.

ROHN Telescoping Masts

Heavy-duty hot-dipped galvanized steel tubing and rigid joints give extraordinary strength. Quick installation... mast attached to base—antenna fixed, then mast hoisted quickly to desired height. Utilizes special clamp and guy ring arrangement. Flanged interior section; crimped exterior section gives most stability that can't be beat. Complete with guy rings and necessary erection parts. In 20, 30, 40 and 50 ft. sizes. Bases and ground mounts available.



Both Towers Feature

THE ROHN MAGIC TRIANGLE

For structural superiority, famed wrap-around "magic triangle" design is featured in these all-steel towers. Towers have full 2 1/2" wide corrugated cross-bracing welded to tubular steel legs. The exclusive design assures dependable strength and permanence.

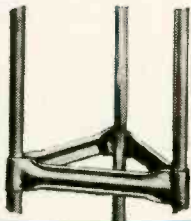

and a complete line of ROHN accessories—all galvanized



PEAK ROOF MOUNT

Heavy duty for quick, secure mounting of tower to top of peak roof. Flanges hinged, fastened to roof with 2 lag screws in each flange.

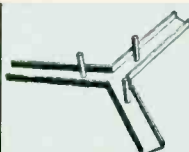

FLAT ROOF MOUNT

For all types flat surfaces. 3-1" solid steel projections permit first section of tower to be mounted directly on roof mount by inserting usual 3/8" bolts.

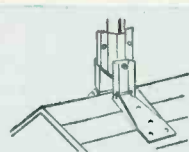

MAST BASES

Complete line of telescoping mast bases for every requirement, accommodating masts from 1"-2 1/4" diameter. Also available—drive-in mast bases.

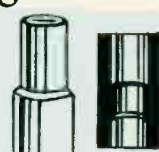

MAST 'N' TV TUBING

Heavy-duty, hot-dipped galvanized steel tubing. Machined to perfection. Extra sturdy joints slotted for full, perfect coupling.



PEAK and WALL MOUNTS

For mounting of mast or pole to roof or wall. Heavy-duty steel. Variable sizes. Models for most every need.

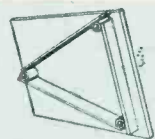

DRIVE-IN BASE

Set on top of ground... 3-4' drive rods driven through base into ground. First tower section secured to rods with single bolt in each leg. Instant erection.



SERVICE TABLE

Perfect answer for television servicing, display and storage. Truly one of the finest of its kind in economy price range.

ALSO AVAILABLE

Rotator posts for mounting rotator to tower; House Brackets; Guying Brackets; UHF Side Arm Mounts; Mounts for Additional Antennae on a Tower; Erection Fixtures; Guy Rings; Installation Accessories; and dozens of other items!

For complete catalog and prices, see your authorized Rohn Representative or Distributor; or write or wire direct.

Designed and Manufactured Exclusively by **ROHN Manufacturing Company**

Dept. RE 116 Limestone, Bellevue Peoria, Illinois

ATTENTION SERVICEMEN

Have all of your ambitions for Greater Earning Power and Security been satisfied?



SERVICE MANAGER

If You Answer "No" or "Not Quite" We Invite You to Investigate this New All-Practice Television Training

Has your income been increasing each year? America's total bill for servicing has been going up fast. Can you look forward to a secure future? UHF, Color Television, other Electronic developments will pay off for men who keep up with the field.

The most foolproof, sure-fire way ever discovered for reaching greater success— independence—security—is to keep on learning more!

Not for Beginners

NRI's new Professional Television Servicing course can train you to go places in TV servicing. This course is for men who know basic theory, either from Radio or TV Servicing experience or planned training but realize the need for more knowledge to be able to forge ahead.

UHF and Color TV Making New Boom

Installing front-end channel selector strips in modern UHF-VHF Television receivers and learning UHF servicing problems and their solution is part of the practice you get if you live in a UHF area. To cash in on the coming color TV boom you'll need the experience this training gives.

Get Details FREE

Find out what you get, what you learn from NRI's new course in Professional Television Servicing. See pictures of equipment supplied, read what you practice. Judge for yourself whether this training will further your ambition to reach the top in TV servicing. Mailing the coupon involves no obligation. Address National Radio Institute, Dept. 5CFT, 16 & U Sts., N.W., Washington 9, D.C.

Priced under \$200. Equipment supplied includes 17" Picture Tube, Components for TV Receiver, Scope, Signal Generator, HF Probe. LOW MONTHLY PAYMENTS

You learn by doing. This is 100% practical training. We supply all the components, all tubes, including a 17-inch picture tube, and comprehensive manuals covering a thoroughly planned program of practice. You see how various defects affect the performance of a TV receiver—learn to know the causes of defects accurately, easily, and how to fix them. You do more than just build circuits. You get practice recognizing and fixing innumerable TV receiver troubles. You get actual experience aligning TV receivers, diagnosing the causes of complaints from scope patterns, eliminating interference, using germanium crystals to rectify the TV picture signal, and much more service experience too expensive to list.



Coupon Brings Important MAIL BOOK FREE NOW

National Radio Institute, Dept. 5CFT
16th and U Sts., N.W., Washington 9, D.C.
Please send my FREE copy of "How to Reach the Top in TV Servicing." I understand no salesman will call.



Name..... Age.....
Address

City..... Zone..... State.....
Approved Member, National Home Study Council

HERE'S Fast, Easy Picture Tube and Receiver Testing

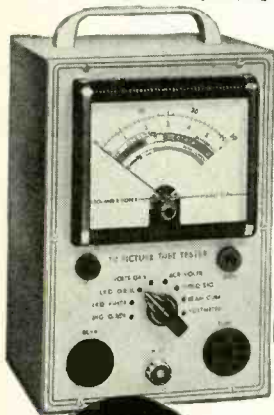

**FOR ALL
BLACK AND
WHITE SETS
ADAPTABLE
TO COLOR**



Take the guesswork out of C-R tube testing and TV troubleshooting! New Boland & Boyce C-R Tube Tester tests all magnetic picture tubes *dynamically*—under the receiver's own power. Tells instantly whether tube or set is at fault. 600 V. d-c range extends to 30 or 60 KV by HV Probe.

Separate plug-in power supply available for in-carton tube testing. Prices include 2 cabled leads and instruction manual. **KIT—\$29.85. FACTORY WIRED & TESTED—\$39.95.** Sold by leading distributors.

B&B BIAS BOX—Speeds Alignment and AGC Troubleshooting



Supplies steady, accurately adjustable bias voltages from 0 to 17 volts d-c to substitute for receivers' normal automatic-gain- or automatic-volume-control circuits. A "must" for radio and TV alignment. Clips and grounds to chassis apron; powered by receiver's 6.3 v. heater supply. **KIT—only \$6.95. FACTORY WIRED & TESTED—\$9.95.**

UNIVERSAL HV PROBE for ALL meters, ALL ranges



Extends range of any VTVM, or any multimeter or voltmeter having sensitivity of 10,000 ohms-per-volt or more. Supplied with complete set of plug-match any meter... any range—10KV, 30KV, 60KV, and others. Clear, high-dielectric probe body shows resistors in use. Includes shielded cable with Amphenol connectors and phone tips. \$13.95 net.

Write for Brochure Describing B&B Products

BOLAND & BOYCE, INC.
Dept. RE-35, 236 Washington Avenue
Belleville 9, N. J.

THE RADIO MONTH (Continued)
along the edge of the tube. The beam then flows vertically between a series of transparent deflection plates and the electrically charged phosphor screen.



Official U.S. Navy Photo

The tube is controlled by changing the voltage on horizontal or vertical deflection plates in a sequential manner—all plates are at a high voltage except those plates opposite the position at which it is desired to bend the beam.

1955 IRE CONVENTION will be held March 21 to 24 at the Waldorf-Astoria Hotel and Kingsbridge Armory in New York City. The national convention will feature over 250 technical papers and 700 engineering exhibits. The papers cover virtually every phase of the electronic art. During the four days of the convention the distaff side will be entertained with a social program.

RADIO-ELECTRONICS will occupy Booth 452 at Kingsbridge Armory.

HEARING AID operates without a cord and looks like an ordinary pair of horn-rimmed eyeglasses.

All the parts found in a conventional hearing aid—about 200—are assembled in a standard width and weight eyeglass frame. All wiring is invisible.

A thin, colorless and flexible tube, about 1 inch long, leads from the bow directly to the ear and conducts sound. The microphone is in the frame directly behind the ear. The hearing aid is powered by a tiny dime-size battery, which lasts 180 hours. The unit is made by Otariion, Inc., Dobbs Ferry, N. Y.

FM LITIGATION between RCA and the late Maj. Edwin H. Armstrong has been settled with the payment of approximately \$1,000,000 by RCA to the estate of Major Armstrong.

The Armstrong claims were instituted in 1948, accusing RCA and NBC of infringement on five of his basic patents on FM. He alleged that RCA tried to maintain a monopoly of the business of granting licenses under radio patents in the U. S. and "deliberately set out to oppose and impair the value" of his FM patents.

Armstrong's complaint also charged that RCA had refused to take out a license under his patents and that it falsely represented that it had developed a set that did not infringe on his system.

(Continued on page 16)

typical TURNER VALUE

in a slender
modern
dynamic

Applications from
commercial
broadcasting
to tape recording

MODEL 95D DYNAMIC

Excellent sensitivity
to voice and music

Response: 100-10,000
c.p.s.

Level: -58 db

Impedance: High impedance wired single ended (single conductor shielded 20 ft. cable). 50, 200, or 500 ohms wired for balanced line (two conductor shielded 20 ft. cable).

Case: available in satin chrome or satin black.

List Price **\$35⁰⁰**

S-95D with on-off slide switch **\$38⁵⁰**

Also available with crystal or ceramic interior at \$10.75 off above prices.

THE TURNER COMPANY

933 17th Street, N.E.

Cedar Rapids, Iowa

Gentlemen: Send complete information on Model 95 microphones.

Name _____

Address _____

City _____

State _____

MAIL COUPON TODAY!



9½ OUT OF EVERY 10 BONDED DEALERS* SAY



**THE RAYTHEON BONDED PROGRAM
HELPS THEM MAKE MORE MONEY**

And chances are that the other half isn't half trying.

We say that because there's definite proof that wherever service dealers take full advantage of the Raytheon Bond — publicize the fact that their work and parts guarantee is bonded through one of America's largest insurance companies — they are making more money.

They tell customers about their bonded way of doing business with free displays, identification cards, ad mats, decals, etc. supplied by Raytheon — all de-

signed to create customer confidence in their shops and their men. And here's the most important fact of all. This Raytheon Bond that builds their business costs them *not one penny*.

If you can qualify for it, it won't cost you one cent, either. For further information on the Raytheon Bonded Electronic Technician Program, see your sponsoring Raytheon Tube Distributor or write direct to Department F, Raytheon Manufacturing Co., Receiving and Cathode Ray Tube Operations, 55 Chapel St., Newton 58, Mass.

*Based on a recent survey



RAYTHEON MANUFACTURING COMPANY

Receiving and Cathode Ray Tube Operations

Newton, Mass. • Chicago • Atlanta, Ga. • Los Angeles, Calif.

Raytheon makes all these:

Receiving and Picture Tubes • Reliable Subminiature and Miniature Tubes
Semiconductor Diodes and Transistors • Nucleonic Tubes • Microwave Tubes



Excellence in Electronics.

LONG-PLAYING 33 $\frac{1}{3}$ R. P. M. HIGH-FIDELITY

10 MASTERPIECES

FREE!

Complete to the last note!



NO STRINGS ATTACHED!

No obligation to buy any other records—now or later.

NOW YOU can get a real start on a complete record collection. You get ALL TEN masterpieces—complete to the last note—and pay NOTHING but the cost of postage.

Of course, this sensational Free Offer bears no relation to the value of the recordings. These ten masterpieces would cost you many dollars at retail prices, in recordings of equal quality.

Why We Make This Amazing Offer

We were FORCED to make this "give-away" offer . . . for only by putting our recordings in your hands can we convince you how extraordinary their tonal quality is. Performed by internationally-renowned orchestras, conductors, and soloists. Custom-pressed on the purest vinyl plastic. Reproduced with a fidelity of tone which encompasses the entire range of human hearing . . . 50 to 15,000 cycles!

HOW CLUB OPERATES: As a trial member, you are not obligated ever to buy any recordings from us. You do, however, have the right to try—free of charge—any of the Society's monthly selections which interest you. You receive prior notice of these. You pay nothing in advance. And you are not obligated to keep those you try . . . even after you have played them and read the interesting music notes which accompany each selection. You pay only for those which—after having tried them—you decide you really want to own. And for these, you pay only the low member's price of \$1.65 per long-playing disc, embodying on the average about 40 minutes of music by the great masters. A saving of about $\frac{2}{3}$ off the usual retail price!

Think how much beauty and serenity these recordings will add to your life—at a trifling cost. Think what a cultural advantage your children will gain by having great music as an everyday inspiration.

Mail Coupon Now

We obviously cannot keep "handing out" such magnificent long-playing recordings indefinitely. Production capacity limits the membership rolls; once filled, the offer has to be withdrawn. So avoid disappointment. Mail coupon with only 25¢ to help cover postage—today! The Musical Masterpiece Society, Inc., Dept. 52-3 43 West 61st Street, New York 23, N. Y.

- MOZART**
Symphony No. 26 in E Flat, K. 184
Netherlands Philharmonic Orch.,
Otto Ackermann, Conducting
- BEETHOVEN**
Piano Sonata No. 24 in F Sharp,
Opus 78
Grant Johannesen, Pianist
- BRAHMS**
The Academic Festival
Utrecht Symphony,
Paul Hupperts, Conducting
- BERLIOZ**
The Roman Carnival
Netherlands Philharmonic Orch.,
Walter Goehr, Conducting
- VIVALDI**
Concerto in C for
Two Trumpets and Orchestra
Netherlands Philharmonic Orch.,
H. Sevensteyn and F. Hausdoerfer,
Trumpeters, O. Ackermann, Cond.
- WAGNER**
Die Meistersinger, Prelude, Act 1
Zurich Tonhalle Orch.,
Otto Ackermann, Conducting
- BACH**
Tocatta and Fugue in D Minor
Alexander Schreiner at the Organ
of the Tabernacle, Salt Lake City
- DUKAS**
Sorcerer's Apprentice
Utrecht Symphony,
Paul Hupperts, Conducting
- MOUSSORGSKY**
Night on Bald Mountain
Netherlands Philharmonic Orch.,
Walter Goehr, Conducting
- CHOPIN**
Fantaisie-Impromptu, Opus 66
Robert Goldsand, Pianist

Internationally Acclaimed!
"The recording is of such perfection it seems to bring the artists into your living room"
—Glorious Sounds, Amsterdam, Holland.
"Excellent series of records"
—The Saturday Review, New York.

The Musical Masterpiece Society, Inc. Dept. 52-3
43 West 61st Street, New York 23, N. Y.

ALL 10 MASTERPIECES—FREE!

I enclose 25¢ to help cover cost of postage. Please send me ALL 10 of the masterpieces listed above and enroll me as a trial member. Send me notice of future selections which I may try for 5 days without cost or obligation. For those future l.p. discs I decide to keep after I have tried them, I will pay only the special member's price of \$1.65 each, plus few cents shipping. I may cancel my trial membership at any time. This offer restricted to new Trial Memberships—only one samale package per family.

Name.....
Address.....
City.....State.....
In Canada address: 686 Bathurst St., Toronto 4, Ont.

COLOR TV MICROSCOPE capable of projecting an image of the specimen on a 6-foot screen has been demonstrated by CBS. The chief use of the device will be in the education of physicians, biologists and chemists.

The unit consists of an ordinary optical microscope, a color television camera which picks up the image from the eyepiece and a color television projection system.

According to Dr. Peter Goldmark, president of the CBS laboratories, the equipment can enlarge a specimen 15,000 times. However, it does not provide an increase in resolution over the optical system which can magnify 2,000 times. A feature of the microscope lies in the small amount of light necessary on the specimen. Ordinary optical methods require such great intensities that live specimens are boiled by the heat generated.

Dr. Goldmark said that the television system achieves almost exactly what photography plus microscopy does, except that it eliminates film processes. Screen projections from a microscope have been demonstrated previously, but with less amplification.

NEW ELECTRONIC DEVICE, the "maser," may provide an entirely new method of amplifying signals and producing electronic oscillations, as well as an electronic clock with an accuracy greater than any now in existence.

The name "maser" is short for "microwave amplification by stimulated emission of radiation." It was invented by Prof. Charles Townes, executive officer of the Physics Department of Columbia University, and developed into practical form by Drs. H. J. Zeiger and J. P. Gordon.

The new device uses the molecular energy of ammonia gas to produce oscillations. Gas injected into a low-vacuum chamber flows between cylindrical electrodes in such a manner that the higher-energy molecules are focused into a resonant cavity and the lower-energy ones are bent out of the beam. Some of the molecules give up tiny quanta of energy, dropping to a lower-energy state in doing so. The released energy quanta trigger other molecules, causing a chain reaction which starts oscillation in the resonant cavity if enough molecules are present. If not, the maser acts as an amplifier. The chamber is pumped continuously to maintain vacuum and remove the gas.

The oscillating maser maintains a more constant frequency than any device yet discovered. Operated as an amplifier just below the point of oscillation, it is extremely sensitive. Much more important, it is virtually noise-free. Thus signals not strong enough to be amplified by a vacuum tube may be increased in strength to a point where vacuum-tube amplification may be used.

Further information on the maser is in preparation and will appear as an article in an early issue. END

FREE

1955 ALLIED 308-PAGE CATALOG

the only COMPLETE catalog
for everything in TV, Radio
and Industrial Electronics

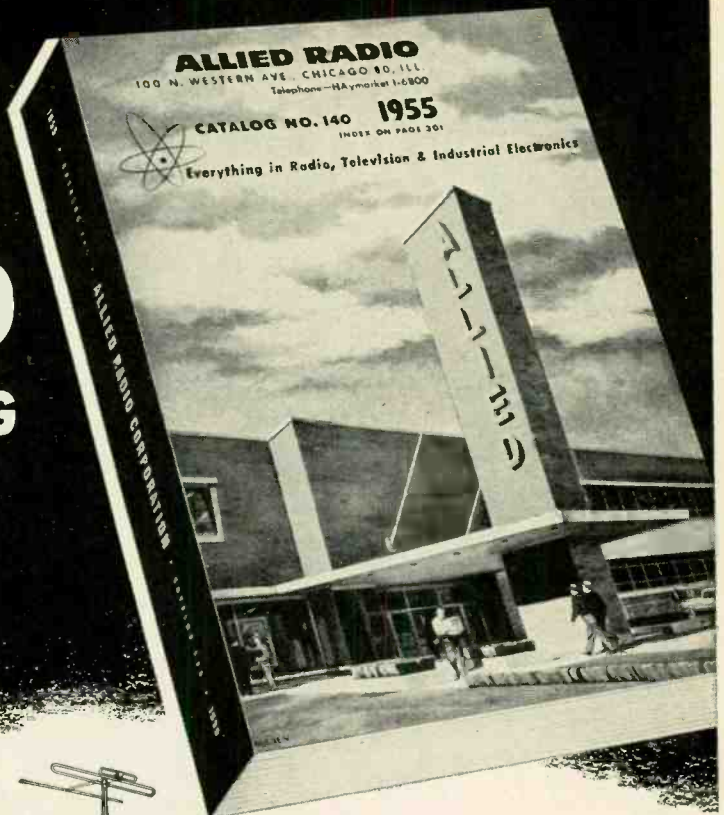

World's Largest Stocks

- All TV and Radio Parts
- All Electron Tube Types
- Test and Lab Instruments
- High Fidelity Equipment
- Custom TV Chassis
- AM, FM Receiving Equipment
- Recorders and Supplies
- P.A. Systems, Accessories
- Amateur Station Gear
- Builders' Kits, Supplies
- Equipment for Industry



ultra-modern facilities for the
FASTEST SERVICE IN ELECTRONIC SUPPLY

SEND FOR IT TODAY!

Get ALLIED's 1955 Catalog—308 pages packed with the world's largest selection of quality electronic equipment at lowest, money-saving prices. Select from the latest in High Fidelity systems and components; custom TV chassis, TV antennas and accessories; AM and FM receiving equipment; P. A. systems and accessories; recorders and supplies; Amateur receivers, transmitters and station gear; specialized industrial electronic equipment; test instruments; builders' kits; huge listings of parts, tubes, tools, books—the world's *most complete* stocks of quality equipment. ALLIED gives you *every* buying advantage: fastest shipment, expert personal help, lowest prices, assured satisfaction. Get the big 1955 ALLIED Catalog. Keep it handy. Send for your FREE copy today.

**IT'S VALUE PACKED... SAVE ON
EVERYTHING IN ELECTRONICS**

**SEND FOR THE LEADING
ELECTRONIC SUPPLY GUIDE**

FREE →



ALLIED RADIO
world's largest Electronic Supply House

EASY-PAY TERMS
Use ALLIED'S liberal Easy Payment Plan—only 10% down, 12 months to pay—no carrying charges if you pay in 60 days. Available on Hi-Fi and P.A. units, recorders, TV chassis, test instruments, Amateur gear, etc.

HI-FI SPECIALISTS
To keep up with the latest and best in High Fidelity, look to ALLIED. Count on us for all the latest releases and largest stocks of Hi-Fi equipment. We specialize, too, in TV supply, and are foremost in the field of Builders' Kits.

ALLIED RADIO CORP., Dept. 2-C-5
100 N. Western Ave., Chicago 80, Illinois

Send FREE 308-Page 1955 ALLIED Catalog.

Name _____

Address _____

City _____ Zone _____ State _____

Simpson...the most Complete Line of VOM's

Select the one that fits your needs!

MODEL
260
world's most popular!

Over half a million Model 260's have been sold to date! 20,000 Ohms per volt. You'll find it wherever quick, accurate, electrical checks are needed. It's so handy, so dependable, so sensibly priced! Ask your jobber. Price, including Adjust-A-Vue Handle, only ... **\$38.95**

Carrying Cases from **\$6.75**

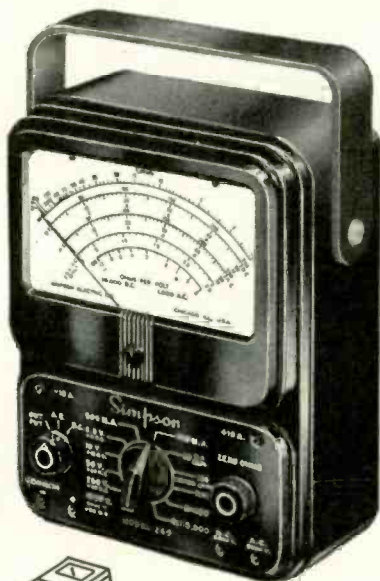

MODEL **262**

Deluxe!



the new VOM with a 7" meter

20,000 Ohms per volt DC and 5,000 Ohms per volt AC sensitivity ... 33 ranges ... compact 7" case with Adjust-A-Vue Handle ...

\$59.50

Carrying Case ... **\$ 9.95**

MODEL **269**

100,000 Ohms per volt!



Most sensitive VOM

available! A Volt-Ohm-Microammeter with a big 7" meter in a compact 7" case ... 33 ranges ... Adjust-A-Vue Handle ...

\$88.00

Carrying Case ... **\$ 9.95**

NEW!

- ▶ **MIDGETESTER** Model 355—New shirt-pocket size Volt-Ohmmeter **\$29.95**
- MODEL 240**—Small VOM; 14 ranges; up to 3000 volts AC or DC **\$26.35**
- MODEL 230**—Small VOM; 12 ranges; up to 1000 volts AC or DC **\$24.95**
- ROTO RANGER** Model 221—25 Separate meters at turn of a switch **\$75.00**
- LABORATORY STANDARD**—For instrument calibration. Price on application.

Simpson ELECTRIC COMPANY

World's Largest Manufacturer of Electronic Test Equipment

5203 W. Kinzie St., Chicago 44, Ill. • EStebrook 9-1121
In Canada: Bach-Simpson, Ltd., London, Ontario

Correspondence

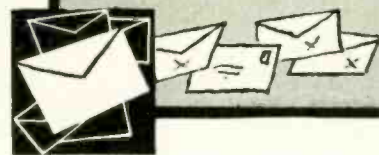

WHERE DOES JOE LIVE?

Dear Editor:

I was very interested in Mr. Henry Farad's little fictional tale (January 1955). I don't say it's not true, but being an American, it's difficult to understand the troubles many people of some countries have to go through. The story is easy to read because it is written in American terms.

We Americans know Joe Doaks as an average citizen, but in his native land he would probably be known as Josep Doakski. Although there was no mention of the city where Joe Doaks lives, it is obvious that he lives under a government ruled by a dictator. (Still, there is the possibility that in our great country, some state or city may have fallen prey to a ruthless ruler.)

There is one thing to be learned from reading this story: If you happen to live where the conditions are as stated in Mr. Henry Farad's article, move your business to a state or city where Democracy still recognizes you as a free American.

CARL SPLINTER

Aberdeen, Wash.

(The author of the article referred to above—"Joe Doaks, TV Repairman" in the January issue—lives in California, and presumably the laws described are those of one of the municipalities of that state.—Editor)

JOE NOT MISTREATED

Dear Editor:

I don't get the idea of a Joe Doaks. Does the medical, legal or any other profession have its Joe Doakses? Why does he kick around the very thing he expects to make a success of? Why can't he get started by working for a reliable firm, learn his trade, and then go in business for himself?

No, I am not in favor of back-door selling or servicing. Let Joe go in business right, or else stay out!

His kind hurts the profession; he works for less pay, cuts prices, no overhead, does bum jobs, makes "dog" sets for the regular shops.

Joe has no kick coming. He is bucking an organized society founded on sound business practices. If he and people like him were let do everything they wanted, regular service organizations would have to go out of business.

To curb this kind of unfair competition, we have to give up some of our privileges and make laws.

J. M. McCAN

Mac's Electric Shop
West Pensacola, Fla.

Home Study Courses in TELEVISION SERVICING offered by RCA INSTITUTES



Study Television Servicing—from the very source of the latest, up-to-the-minute TV and Color TV developments. Train under the direction of men who are experts in this field. Take advantage of this opportunity to place yourself on the road to success in television. RCA Institutes, Inc. (A Service of Radio Corporation of America), thoroughly trains you in the "why" as well as the "how" of servicing television receivers.

FIRST HOME STUDY COURSE IN COLOR TV SERVICING

Now you can train yourself to take advantage of the big future in Color TV. RCA Institutes Home Study Course covers all phases of Color TV Servicing. It is a practical down-to-earth course in basic color theory as well as how-to-do-it servicing techniques.

This color television course was planned and developed through the combined efforts of instructors of RCA Institutes, engineers of RCA Laboratories, and training specialists of RCA Service Company. You get the benefit of years of RCA research and development in color television.

Because of its highly specialized nature, this course is offered only to those already experienced in radio-television servicing. Color TV Servicing will open the door to the big opportunity you've always hoped for. Find out how easy it is to cash in on Color TV. *Mail coupon today.*

SEND FOR FREE BOOKLET

Mail coupon in envelope or paste on postal card. Check course you are interested in. We will send you a booklet that gives you complete information. No salesman will call.



RCA INSTITUTES, INC.
A SERVICE OF RADIO CORPORATION OF AMERICA
350 WEST FOURTH STREET, NEW YORK 14, N. Y.

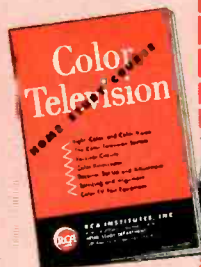

HOME STUDY COURSE IN BLACK-AND-WHITE TV SERVICING

Thousands of men in the radio-electronics industry have successfully trained themselves as qualified specialists for a good job or a business of their own—servicing television receivers. You can do this too.

This RCA Institutes TV Servicing course gives you up-to-the-minute training and information on the very latest developments in black-and-white television.

As you study at home, in your spare time, you progress rapidly. Hundreds of pictures and diagrams, easy-to-understand lessons help you to quickly become a qualified TV serviceman.

There are ample opportunities in TV, for radio servicemen who have expert training. Mail coupon today. Start on the road to success in TV Servicing.

MAIL COUPON NOW

RCA INSTITUTES, INC.
Home Study Dept. RE-3-55
350 West Fourth Street, New York 14, N. Y.

Without obligation on my part, please send me copy of booklet on:

- Home Study Course in TELEVISION SERVICING.
 Home Study Course in COLOR TV SERVICING.

Name _____ (please print)

Address _____

City _____ Zone _____ State _____

the fabulous VHF-UHF antenna that actually sells itself with performance!



RAINBOW*

What do America's servicemen think of Channel Master's RAINBOW antenna? Here are their very words†:

"The RAINBOW brings metropolitan reception to isolated areas."

"Gets more stations in this fringe area than any other antenna made."

"Just what our customers have been waiting for -- a powerful, sturdy, economical antenna."

†Just a few of the many letters of praise we receive daily.

LOOK at the RAINBOW'S unique design, so deceptively simple, yet so unbelievably efficient. **LOOK** at its advanced features: New Spacing Formula, new Triple-Section High Band elements, new full-efficiency Intermix Design, and the brilliant triple-power TRI-POLE! **LOOK** at its remarkable Yagi performance on every channel, its sharp single lobe. **LOOK** at its rugged, durable 100% aluminum construction, reinforced at all stress points. **LOOK** at its trigger-fast "Snap-Lock" Action, Channel Master's fabulous preassembly that snaps open, locks open, without hardware or tightening.

With every installation, Channel Master's RAINBOW again proves itself the most powerful TV antenna yet developed by modern science. Buy for bay, it out-performs every all-channel antenna on the market today!

Get In On This High-Powered Advertising Deal

Your Channel Master distributor offers you a hard-hitting promotion program which includes TV spot films, newspaper mat ads, radio ads, full-color display material, and consumer literature. Advertise and install America's best known, most wanted antenna.

Here's how the RAINBOW out-performs the famous Champion:

Gain Over	1-Bay Champion	CHANNEL												
		1	2	3	4	5	6	7	8	9	10	11	12	13
1-Bay RAINBOW	0	0	0	+1	+2	+3	+2.5	+1	+5	+5	+1.5	+2.5	DB	
Stacked RAINBOW	DB	DB	DB	DB	DB	DB	DB	DB	DB	DB	DB	DB	DB	
1-Bay SUPER RAINBOW	+1	+1	+1.5	+2.5	+3.5	+3.5	+3	+2	+1.5	+2	+3.5	+4.5	DB	
Stacked SUPER RAINBOW	DB	DB	DB	DB	DB	DB	DB	DB	DB	DB	DB	DB	DB	

Gain Over	Stacked Champion	CHANNEL												
		1	2	3	4	5	6	7	8	9	10	11	12	13
Stacked RAINBOW	+1.5	+2	+1.5	+1.5	+2	+5	+3.5	+0	+0	+0	+1	+1.5	DB	
Stacked SUPER RAINBOW	+2	+2.5	+3	+3	+4	+5	+1	+1	+2	+2	+2.5	+3.5	DB	

There's a RAINBOW model for every area . . . for every purse!

For fringe and super-fringe areas:

Super RAINBOW model no. 331, \$37⁵⁰ list

stacked Super RAINBOW model no. 331-2, \$75⁷⁰ list

For suburban and near-fringe areas:

Champion RAINBOW model no. 330, \$23⁶⁰ list

stacked Champion RAINBOW model no. 330-2, \$48⁶⁰ list

For economy installations:

(featuring butted tubing)

Challenger RAINBOW model no. 332, \$18⁰⁶ list

stacked Challenger RAINBOW model no. 332-2, \$37⁵⁰ list

don't kid me!

NOTHING outperforms

CHANNEL MASTER

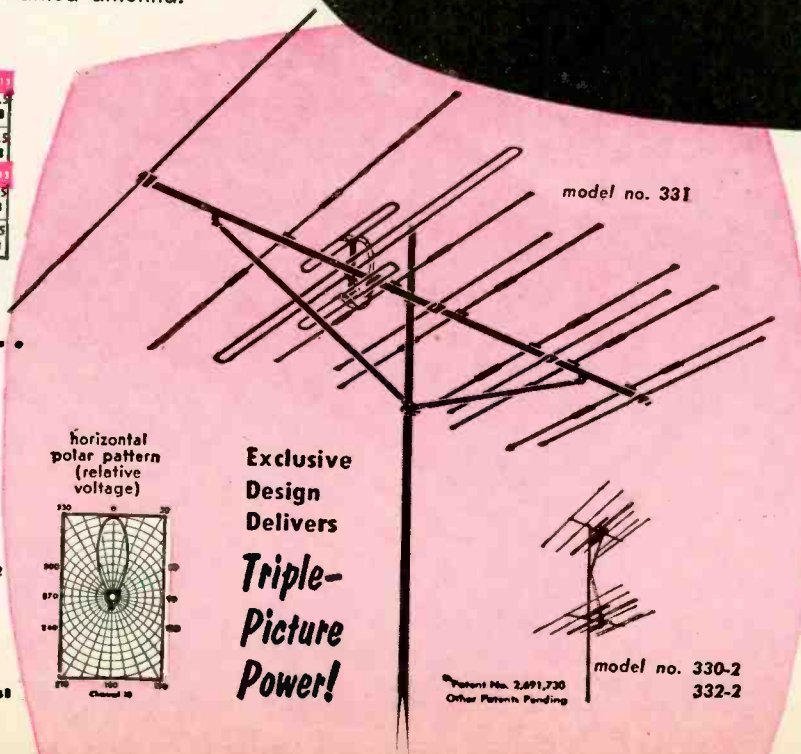

horizontal polar pattern (relative voltage)

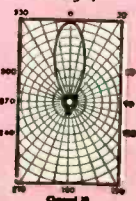

Exclusive Design Delivers Triple-Picture Power!

Patent No. 2,691,730 Other Patents Pending

a major step forward
in installation procedures —

CHANNEL
MASTER'S

SELECTENNA

coupling system

the great Channel Master development
that permits *unlimited antenna combinations*
with only *one* transmission line to the set!

the NEW WAY, the BEST WAY,
the only AUTOMATIC WAY to get
all-channel, all-direction reception . . .

● **Without rotators!**

Selectenna means: no extra control unit on the set; no moving parts to get out of order; antennas are always in perfect orientation.

● **Without switches!**

Selectenna means: no manual switches to bother with; better performance because couplers have less insertion loss than switches.

● **Without multiple lead-in wires!**

Selectenna means: neater, more professional installations, because no complicated wiring enters the home. Only one lead connects to the set.

This modern way to obtain multi-directional reception — with its individual band-pass filter networks — offers the consumer great convenience advantages possible in no other system. There's never been anything like it! The Selectenna System is rapidly replacing all older methods. Use it on your next "multi-direction" installation!

**FREE TECHNICAL
ADVISORY SERVICE**

Our engineers will tell you the correct hook-up for your area. Merely list the channels you expect to receive, as well as the different antennas you would like to hook up. No charge or obligation.

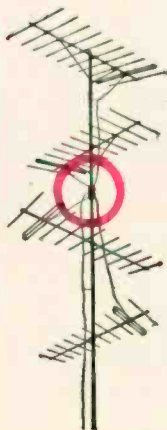

Simple as:



Simply select your
channel on the set---
the right signal is
always there!

list price:
\$5.42
each

Including mounting
hardware and
connecting wire.

Couplers snap together. This particular interlocked stack consists of four Antenna Couplers and one Hi-Lo Coupler, for joining two High Band and two Low Band antennas.



CHANNEL MASTER CORP. ELLENVILLE, N. Y.
The World's Largest Manufacturer of Television Antennas and Accessories.

Copyright 1954, Channel Master Corp.

the **one** line
 that has **everything**
C·D·R ROTORS

a model for
 every need

Powerful beyond any need!



featuring the
**SHARPEST TUNING
 AUTOMATIC ROTOR**

model AR-2 ... complete, automatic rotor with thrust bearing. Handsome modern design cabinet, uses 4 wire cable.

model AR-1 ... same as AR-2 without thrust bearing.

model TR-12

... a special combination value consisting of complete rotor, including thrust bearing. Handsome, modern cabinet with meter control dial, uses 4 wire cable.

model TR-11

... same as TR-12 without thrust bearing.

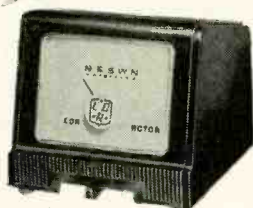
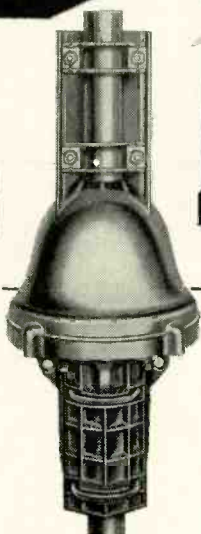
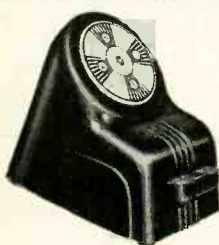
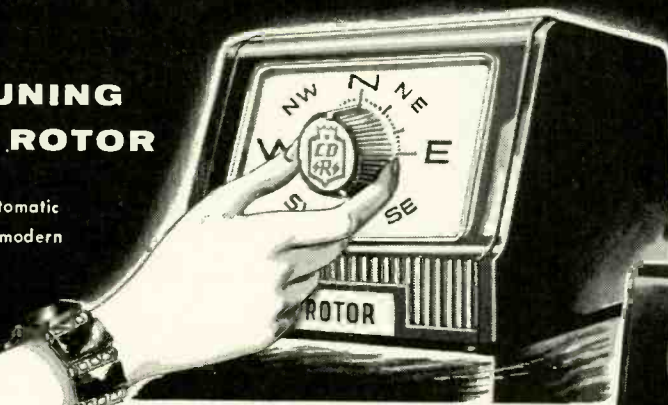

model TR-2

... the heavy-duty rotor, with plastic cabinet featuring "Compass Control" illuminated perfect pattern dial, uses 8 wire cable.

model TR-4

... the heavy-duty rotor complete with handsome, new, modern cabinet with METER control dial, uses 4 wire cable.

Here is the one **COMPLETE** line of rotors ... everything you need because there is a CDR rotor for every need! **SIX** skillfully engineered models... **ALL FIELD TESTED AND PROVEN** by thousands and thousands of satisfied users from coast to coast.



Pre-Sold to millions every week on TV stations across the nation.



CORNELL-DUBILIER
 SOUTH PLAINFIELD, N. J.



THE RADIART CORP.
 CLEVELAND 13, OHIO

Mr. Ray Snyder
General Manager
Educ. Book
Division

You Get
This Valuable Book

FREE

Just for Examining
COYNE'S NEW 6-VOLUME SET

"Applied Practical Radio-Television"
ON 7 DAYS FREE TRIAL!



Now! The most liberal "get-acquainted" offer you've ever seen! Think of it—Coyne gives you this big, new 1955 Edition of book, "150 Radio-Television Picture Patterns and Diagrams Explained", ABSOLUTELY FREE. This up-to-the-minute, practical book gives you complete 11 x 22" Schematic Diagrams covering 170 models Radio and Television Sets. Also analysis of TV Servicing with picture tube patterns including many actual trouble-shooting patterns. Large 8½ x 11" pages. Full instructions show you how to read and use the diagrams. *This valuable book is a FREE GIFT to you*, for just asking to see the great new Coyne 6-book set, "Applied Practical Radio-Television"!

AT LAST! MONEY-MAKING "KNOW-HOW" ON TRANSISTORS, COLOR TV AND SERVICING

You get all the right answers to today's TELEVISION-RADIO servicing problems—and get them quickly—in Coyne's great new 6-volume set. Right at your fingertips is the TV-Radio knowledge that makes you worth more money! Over 5,000 practical facts and data are fully covered in easy-to-understand fashion in volumes 1 through 5. Every step is completely explained—from principles of radio and television to installing, servicing, troubleshooting and aligning including full facts on COLOR TV and UHF, adapters and converters. Also includes latest information on TRANSISTORS. Hundreds of photos, illustrations, charts and diagrams help you understand quicker. For speedy on-the-job use, I'll also include the famous 762 page Coyne TELEVISION SERVICING CYCLOPEDIA—covering today's television problems in easy-to-find alphabetical order. Use this complete 6 volume TV-RADIO LIBRARY FREE for 7 days. Get the valuable Picture Pattern-Diagram Book ABSOLUTELY FREE!

ACT NOW—SEND NO MONEY!

Just mail the coupon for Coyne's 6 volume set on 7 days free trial. I'll include the book of 150 TV-RADIO Patterns & Diagrams. If you keep the set, pay \$2 in 7 days and \$2 per month until \$22.50 plus postage is paid. (Cash price, \$29.95.) Or you can return the library at our expense in 7 days and owe nothing. *Either way, the book of TV-Radio Patterns is yours to keep FREE!* Take advantage of this offer AT ONCE!

2500 PAGES OF PRACTICAL RADIO AND TELEVISION FACTS AT YOUR FINGER TIPS!

- Vol. 1. APPLICATION OF TELEVISION-RADIO PRINCIPLES:** 300 pages, covers resonance & tuning, amplifiers, oscillators, etc.
- Vol. 2. RADIO, TELEVISION & FM RECEIVERS:** 403 pages, covers rectifiers, high frequency, short wave, FM, antennas, etc.
- Vol. 3. RADIO-TELEVISION CIRCUITS:** 356 pages, covers power tubes, de-coupling, distortion, photo-tubes, phase inverters, etc.
- Vol. 4. LATEST INSTRUMENTS FOR SERVICING RADIO-TELEVISION:** 343 pages, covers all types of testing instruments, their use in service work.
- Vol. 5. TELEVISION SERVICING & TROUBLE-SHOOTING MANUAL:** 400 pages, practical servicing of all types of TV sets, UHF, boosters, color TV printed in 4 colors, etc.

★ PLUS TV CYCLOPEDIA!

A "must" for the TV serviceman. Quick answers to all TV problems in A-B-C order, cross-indexed. 762 pages, fully illustrated; covers hundreds of facts on servicing, installation, alignment, UHF, transistors, much more.

MAIL COUPON TODAY

FREE BOOK—FREE TRIAL COUPON!

Mr. Ray Snyder, Technical Book Manager
COYNE ELECTRICAL SCHOOL
500 S. Paulina St., Dept. 35-T1, Chicago 12, Ill.

O.K., Mr. Snyder! I'll take advantage of your Get-Acquainted Offer! Send new, 6-book set, "Applied Practical Radio-Television" for 7 days FREE TRIAL per your offer. Include TV-RADIO Patterns & Diagrams Book FREE!

Name.....

Address.....

City..... Age.....

Where Employed..... Zone..... State.....

Check here if you want library sent C.O.D. You pay postman \$20.95 plus C.O.D. postage on delivery. 7-day Money Back Guarantee.

COYNE ELECTRICAL SCHOOL

500 So. Paulina St., Dept. 35-T1, Chicago 12, Ill.



PHILEAS FOGG, MEET NELLIE BLY!

ENGINE 93 streaked through Arizona, its eight steel wheels flailing the track. And when the young lady at the controls thought the engineer wasn't looking, she opened up the throttle another notch.

She was Nellie Bly, reporter for the New York World. And she was in a big hurry to reach Jersey City and beat a fictional man in a trip around the globe. The man's name was Phileas Fogg, phlegmatic English hero of a popular novel by M. Jules Verne: *Around The World In 80 Days*.

And beat him she did—in just over 72 days—with only one dangerous incident. A “titled cad” tried to flirt with her in the middle of the Indian Ocean, but even he subsided when she threatened to signal the nearest U. S. man-of-war.

M. Verne cried “bravo!” when he heard her triumph. And all 1890 America cheered. For hers was the authentic American spirit that translates dreams into practical realities.

It's the same spirit that lives in today's 160 million Americans, who—far from incidentally—are the real assets making U. S. Series E Savings Bonds one of the world's finest investments.

Why not profit by your faith in your fellow Americans and yourself? Guard your future, and your country's, by buying Bonds regularly!

★ ★ ★

It's actually easy to save money—when you buy United States Series E Savings Bonds through the automatic Payroll Savings Plan where you work! You just sign an application at your pay office; after that your saving is done *for* you. And the Bonds you receive will pay you interest at the rate of 3% per year, compounded semiannually, for as long as 19 years and 8 months if you wish! Sign up today! Or, if you're self-employed, invest in Bonds regularly where you bank.

**SAFE AS AMERICA—
U. S. SAVINGS BONDS**

The U.S. Government does not pay for this advertisement. It is donated by this publication in cooperation with the Advertising Council and the Magazine Publishers of America.



GET IN ON THE BOOM!



L. C. Lane, B.S., M.A.
President, Radio-Television Training Association. Executive Director, Pierce School of Radio & Television.

TRAIN FOR A HIGH PAYING JOB AS A TELEVISION TECHNICIAN
NO PREVIOUS EXPERIENCE NEEDED — study AT HOME in your SPARE TIME

Next to the atom and hydrogen bombs, the biggest noise being made today is by the booming radio-television-electronics industry.

Now, while the boom is on in full force, is the time for you to think about how you can share in the high pay and good job security that this ever-expanding field offers to trained technicians.

Just figure it out for yourself. There are more than 400 television broadcasting stations operating right now

and hundreds more to be built; more than 30 million sets in the country and sales increasing daily. By 1955 moderately priced color television sets will be on the market and the color stampede will be on.

All these facts mean that good jobs will be looking for good men. You can be one of those men if you take advantage of my training now — the same training that has already prepared hundreds of men for successful careers in the radio-television-electronics field.



No experience necessary! You learn by practicing with professional equipment I send you. Many of my graduates who now hold down good paying technician jobs started with only grammar school training.

If you have previous Armed Forces or civilian radio experience you can finish your training several months earlier by taking my FM-TV Technician Course. Train at home with kits of parts, plus equipment to build BIG SCREEN TV RECEIVER. ALL FURNISHED AT NO EXTRA COST!

After you finish your home study training in the Radio-FM-TV Technician Course or the FM-TV Technician Course you get two weeks, 50 hours, of intensive Laboratory work on modern electronic equipment at our associate school in New York City, Pierce School of Radio & Television.

THIS EXTRA TRAINING IS YOURS AT NO EXTRA COST WHATSOEVER. My courses are complete without this extra training, however. It is just an added opportunity for review and practice.

- RADIO-FM-TV TECHNICIAN TRAINING**
- FM-TV TECHNICIAN TRAINING**
- EXTRA LABORATORY TRAINING IN NEW YORK CITY AT NO EXTRA COST!**

VETERANS!

My School fully approved to train veterans under new Korean G.I. Bill. Write discharge date on coupon.

YOU GET THESE FOUR
free!



MAIL THIS COUPON TODAY!
no salesman will call!

Mr. Leonard C. Lane, President
RADIO-TELEVISION TRAINING ASSOCIATION
52 East 19th Street, New York 3, N. Y. DEPT. R-3

Dear Mr. Lane: Mail me your NEW FREE BOOK, FREE SAMPLE LESSON, and FREE aids that will show me how I can make BIG MONEY IN TELEVISION. I understand I am under no obligation and no salesman will call.

(PLEASE PRINT PLAINLY)

Name _____ Age _____
Address _____
City _____ Zone _____ State _____

I AM INTERESTED IN:

- Radio-FM-TV Technician Course
- FM-TV Technician Course
- TV Cameraman & Studio Technician Course

VETERANS!
Give date of discharge _____

LEARN BY DOING As part of your training, I give you enough equipment to set up your own home laboratory and prepare for a BETTER PAY TV job. You build and keep a professional GIANT SCREEN TV RECEIVER complete with big picture tube (designed and engineered to take any size up to 21-inch) . . . also a Super-Het Radio Receiver, RF Signal Generator, Combination Voltmeter-Ammeter-Ohmmeter, C-W Telephone Transmitter, Public Address System, AC-DC Power Supply. Everything supplied, including all tubes.

EARN WHILE YOU LEARN Almost from the very start you can earn extra money while learning by repairing radio-TV sets for friends and neighbors. Many of my students earn up to \$25 a week . . . pay for their entire training from spare time earnings . . . start their own profitable service business.

FREE FCC COACHING COURSE Qualifies you for Higher Pay! Given to all my students AT NO EXTRA COST. Helps you qualify for the TOP JOBS in Radio-TV that demand an FCC license! Full training and preparation at home for your FCC license.

Radio Television Training Association
52 EAST 19th STREET • NEW YORK 3, N. Y.

Licensed by the State of New York • Approved for Veteran Training
MARCH, 1955

the KEY to your problem

phastron

the NEW LOOK in "555" metal-cased MULTIMETERS

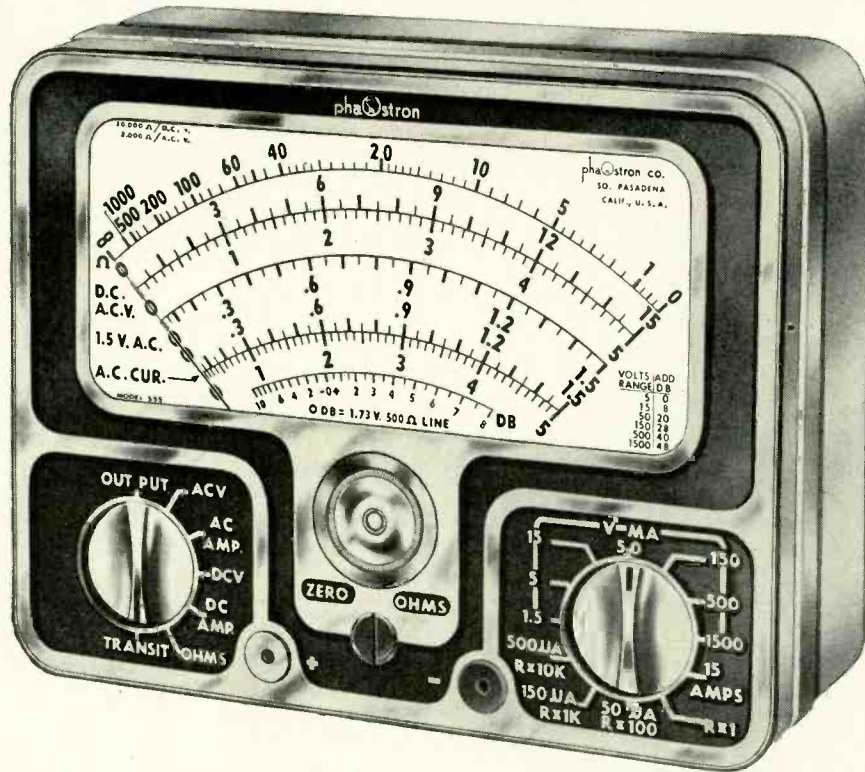

POCKET SIZE WITH A 4 7/8" LENGTH SCALE

WE LEAVE IT TO YOU

WOULD YOU BUY A PLASTIC-CASED WRIST WATCH . . .

if you could buy the finest movement in a magnetically shielded metal case?

Phastron, world famous manufacturer of ENVIRONMENT FREE PRECISION AIRCRAFT EQUIPMENT for Military and Industrial uses introduces a new concept in Multimeters. This magnetically shielded, metal-cased "555" compares with plastic-cased multimeters as a fine watch in a precious metal case would compare with a plastic wrist watch.

The shielded, shatterproof and anti-magnetic case insures continued accuracy and integrity of this instrument for years to come.

Phastron "555" Multimeter incorporates more ranges, including AC current, greater visibility, simplified and functional controls and the greatest value offered to date.

See the Phastron "555", note its many outstanding features, its beautiful satin chrome case, its compactness and light weight, and you will know why

"YOU CANNOT BUY BETTER"

AC CURRENT RANGES
SEPARATE RANGE & FUNCTION SWITCHES
ONLY 2 JACKS

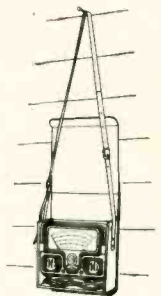
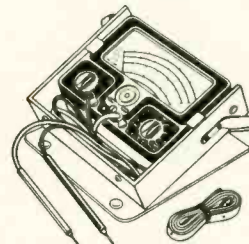

COLOR CODED SCALES ARE RED, GREEN, BLUE & BLACK
ACCURACY 3% DC, 4% AC

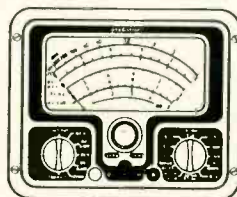

PANEL MOUNTING ADAPTER \$1.50

GENUINE LEATHER CARRYING CASE
\$5.95

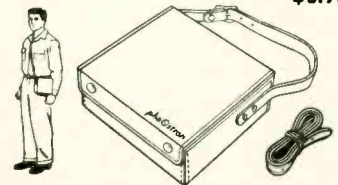

"555" MULTIMETER
complete with probes and batteries
at your PARTS DISTRIBUTOR

\$39.95

Manufactured by PHAOSTRON COMPANY • 151 Pasadena Avenue • South Pasadena, Calif., U.S.A.

8 ENGINEERING EXCLUSIVES... REASONS WHY...



1 STOP WATCH TUNING ACCURACY

Pinpoint control system is unsurpassed in consistent accuracy of indication. Stops antenna instantly within 1/2 degree of desired position. No drift or ambiguity.

2 SMARTLY STYLED CONSOLE WITH PIANO TUNING

The striking control console is designed for beauty of design as well as ease of operation. Actuates the rotator with the slightest touch. Available in mahogany or ivory cabinet.

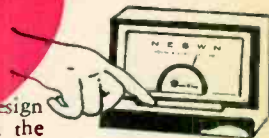

3 REPLACEABLE FACTORY SEALED CARTRIDGE UNIT

Sealed power drive unit eliminates the former need of dismantling the antenna when servicing. Simply loosen 3 screws to remove the sealed unit.



4 POWERFUL INLINE DESIGN

Supports direct dead weight load of largest stacked array. Resists downthrust and bending moment. Built-in thrust bearings. No extra parts to buy. No breakable offset bearings.

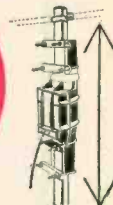

5 COLORFUL "CARRY-ALL" CARTON

Safely protects Roto-King en route... eases on-the-job carrying of units... comes in handy in the shop or around the home. A JFD merchandising extra at no extra cost.



The only rotator with these EXTRAS to sell!

6 AUTOMATIC VOLTAGE COMPENSATION

Advanced circuitry achieves automatic voltage compensation for stability and exactness of indication despite line voltage fluctuations.

7 BALANCED POWER

Close tolerance 3200:1 reverted gear drive (within .002 in. tolerance) efficiently transmits 100% of developed power. No inherently weak worm gears.

8 390 DEGREE ROTATION

390 degrees — the broadest traverse range now in use — speeds and simplifies station selection beyond standard 360 degree revolution.



Roto King

is rocking the rotator market!

Model	Style	List
RT100-M	Mahogany	\$44.95
RT100-IV	Ivory	\$44.95

Write for 8-page Roto-King engineering brochure No. 288.

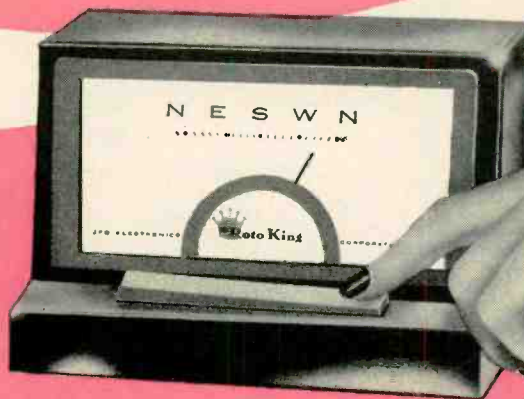

Look to JFD for Engineering Leadership!
MANUFACTURING CO., INC.

6101 16th AVENUE, BROOKLYN 4, N. Y.
INTERNATIONAL DIVISION: 15 Moore Street, New York 4, U.S.A.

OUR HATS

ARE OFF TO YOU...

MR. SERVICEMAN



On the occasion of National Television Servicemen's Week, Chicago Standard Transformer Corporation pays tribute to you. You have done a magnificent job in maintaining the more than 30,000,000 television sets in the nation today.

In a highly technical area, which almost daily grows more and more complex, you have kept up with the new developments, and have serviced a rapidly increasing number of sets. We salute you for the noteworthy job you have done.

Chicago Standard is proud to have played a small part in your accomplishment. We pledge our continuing efforts to make your work easier and more profitable. You can depend on us to keep supplying you with STANCOR exact replacement components and accurate replacement information.

CHICAGO STANDARD TRANSFORMER CORPORATION

3592 ELSTON AVENUE
CHICAGO 18, ILLINOIS



The practical experience you already have—PLUS the advanced technical training we offer you—can assure you of excellent pay, a bright future and job security in all electronic fields, including—

- BROADCASTING (AM & FM)
- TELEVISION
- MANUFACTURING
- COMMUNICATIONS
- SERVICING
- AERONAUTICS
- ARMY, NAVY, AIR FORCE AND COAST GUARD ELECTRONICS

The data that launched thousands of careers is yours FREE—Send For It NOW!

This FREE BOOK...

tells you how CREI helps you get the best jobs in the booming world of RADIO-TV-ELECTRONICS

AVAILABLE TO VETERANS UNDER GI BILL



THE BETTER TRAINED MAN WRITES HIS OWN TICKET

CREI specializes in helping you cash in on THE BEST OPPORTUNITIES available to electronic engineering technicians. Opportunities pass by the partially or poorly trained man. But in today's booming world of electronics, the technician with CREI's advanced training can bank on good pay, a bright future, job security. Our formula for your success: We give you the BEST in training. You, in turn, use this training to win the BEST career opportunities—in telecasting, AM and FM broadcasting, TV manufacturing, radio-tv servicing, research, 2-way mobile radio, aviation electronics, industrial electronics, sound motion pictures, and many other electronic fields. Proof that CREI's training is BEST . . .

CREI TRAINING PRODUCES PROMOTION, PAY INCREASES—WITHIN A SHORT TIME

Here are but a few letters received from CREI students, reporting what benefits their training has brought them:

"In this time of less than two years, I have almost doubled my salary and have gone from wireman, to engineering assistant and now to junior engineer. I have CREI to thank."—Frank A. Eckert, 22 Clover Lane, Levittown, Pa.

"I chose CREI training upon recommendation of two top engineers. Before I completed the course I became transmitter chief of a 5KW station. I am now employed as a technician at a 100 KW TV station, and in spare time have a good TV sales and service business."—Artie D. Patton, 203 Burke Ave., San Antonio, Tex.

"I have the greatest regard and the highest respect for your courses. I advanced to U.S.N. Chief Aviation Technician a year ago solely on the strength of these courses."—E. E. Gorig, 3077 Fireside Road, South Norfolk, Va.

CAPITOL RADIO ENGINEERING INSTITUTE

Accredited Technical Institute Curricula
DEPT. 143-B 3324 16th St., N.W., Washington 10, D.C.

CREI STUDIES BEST GEARED TO NEEDS OF EMPLOYERS

CREI has been a leader in technical education since 1927. We stay abreast of industry developments (we were working on color TV courses, for example, long before color TV was commercially available). Our courses are thorough, practical, up-to-date. Many of America's largest companies prove the superiority of CREI's instruction methods by choosing and paying CREI to train their own technical staffs. Among them: United Air Lines, Canadian Broadcasting Corporation, Sears, Roebuck and Co., Bendix Products Division, All America Cables and Radio, Inc., Radio Corporation of America.

CREI GRADS ARE IN DEMAND

CREI graduates have a reputation for being well-trained. They are successful because they're taught what they need to know. They're able to get top jobs as electronic engineering technicians. Employers contact us regularly, wanting to hire our graduates for good jobs. In fact, our Placement Bureau can't keep up with demands. Typical requests, received recently:

"Openings will occur in the GS-10 grade, starting salary \$5500 per year, for men who can qualify for the servicing of 35mm motion picture sound and projection equipment. Although some previous experience in this field is desirable, it is not essential if the individual has sufficient training in radio . . ."—Departments of the Army and Air Force, St. Louis, Mo.

"Just about four months have passed since I made my first recruiting trip to CREI. As a result of that visit Messrs. Kohs, Plante and Wenger are now members of the Laboratories and Mr. Kresge soon will be . . . we have some openings now and will have others . . ."—Bell Telephone Laboratories, Murray Hill, N.J.

PASS FCC EXAMS EASILY

CREI training equips you to pass FCC commercial license exams; qualify for top jobs.

START YOUR OWN BUSINESS

Our training also has launched many a graduate on a successful, self-owned business career in an electronics field.

CREI RESIDENCE SCHOOL

also offers instruction at same high technical level in Washington, D. C. Classes start at regular intervals. Qualified residence school graduates earn degree: Associate In Applied Science. Check coupon if you prefer residence study.

ACT NOW! FILL OUT COUPON TODAY

You owe it to yourself to investigate our proven career preparation plan. No obligation. You'll receive our book, "Your Future in The New World of Electronics" right away. Send for your free copy today!

Mail This Coupon Today for Your FREE BOOK

To help us answer your request intelligently, please give the following information:

EMPLOYED BY

TYPE OF PRESENT WORK

SCHOOL BACKGROUND

ELECTRONICS EXPERIENCE

IN WHAT BRANCH OF ELECTRONICS ARE YOU MOST INTERESTED?

CAPITOL RADIO ENGINEERING INSTITUTE
Accredited Technical Institute Curricula
DEPT. 143-B, 3324 16th St., N.W., Washington 10, D.C.

Please send me your course outline and FREE Illustrated Booklet "Your Future in the New World of Electronics" . . . describing opportunities and CREI home study courses in Practical Electronics Engineering.

- CHECK FIELD OF GREATEST INTEREST
- Practical Radio Engineering
 - Broadcast Radio Engineering (AM, FM, TV)
 - Practical Television Engineering
 - Aeronautical Electronics Engineering
 - TV, FM & Advanced AM Servicing

Name

Street

City..... Zone..... State.....

CHECK: Residence School Veteran

**FREE 1955
EICO CATALOG!**
Tells you how to **SAVE 50%** on
your test equipment costs!

EICO
THE LARGEST MANUFACTURER OF ITS KIND IN THE WORLD

**KITS
INSTRUMENTS**

THE INDUSTRY'S MOST COMPLETE LINE OF KITS & INSTRUMENTS
1/3 MILLION EICO INSTRUMENTS IN USE THE WORLD OVER —
SAVE 50% — BUILD 'EM IN ONE EVENING... THEY LAST A LIFETIME

the Exclusive **EICO** Make-Good
GUARANTEE
Each EICO Kit and Instrument is doubly guaranteed by EICO and your jobber. In our own only selected quality instruments. EICO guarantees to replace any component which might become defective in normal use if returned to the factory within 90 days of purchase. EICO guarantees all Kits assembled according to EICO's simplified instructions will operate as specified therein. EICO guarantees service and calibration of every EICO Kit and Instrument at the nominal charge as stated in the instructions.

ELECTRONIC INSTRUMENT CO., INC.
Test Equipment Manufacturers
84 WITHERS STREET, BROOKLYN 11, N. Y.
See Our IRE
Booths 209-211

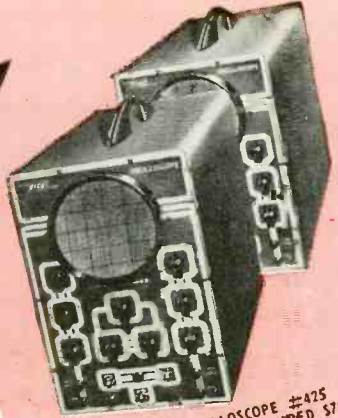

5" PUSH-PULL OSCILLOSCOPE #425
KIT \$44.95 WIRE \$79.95
NEW! #470 7" PUSH-PULL OSCILLOSCOPE
KIT \$79.95 WIRE \$129.50

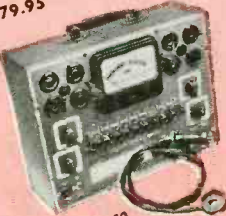

CRA TUBE TESTER #425
KIT \$34.95 WIRE \$49.95



20,000 Ohms/Volt
MULTIMETER #565
KIT \$24.95
WIRE \$29.95



1,000 Ohms/Volt
MULTIMETER #536
KIT \$12.90
WIRE \$14.90



NEW! #232 PEAK-TO-PEAK
VTVM with DUAL-PURPOSE
AC/DC UNI-PROBE (pat. pend.)
KIT \$29.95 WIRE \$49.95
NEW! #249 DELUXE
PEAK-TO-PEAK VTVM with 7 1/2"
METER & UNI-PROBE (pat. pend.)
KIT \$39.95 WIRE \$59.95



VACUUM TUBE VOLTMETER #221
KIT \$25.95 WIRE \$39.95
DELUXE VTVM (with 7 1/2" METER) #214
KIT \$34.95 WIRE \$54.95

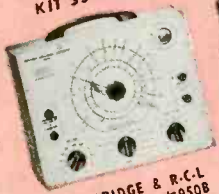

R-C BRIDGE & R-C-L
COMPARATOR #950B
KIT \$19.95 WIRE \$29.95



MULTI-SIGNAL
TRACER #145
KIT \$19.95
WIRE \$28.95



DELUXE RF SIGNAL
GENERATOR #315
KIT \$39.95 WIRE \$59.95

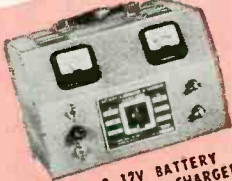

6V & 12V BATTERY
ELIMINATOR & CHARGER
#1050
KIT \$29.95 WIRE \$38.95



NEW! #944 FLYBACK
TRANSFORMER & YOKER
TESTER
KIT \$23.95
WIRE \$34.95

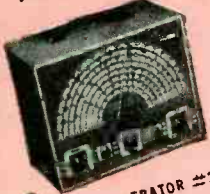

RF SIGNAL GENERATOR #320
KIT \$19.95 WIRE \$29.95



TV/FM SWEEP GENERATOR #360
KIT \$34.95 WIRE \$49.95



A PROBE FOR EVERY PURPOSE

SMC-4.5MC CRYSTAL
\$3.95 ea.

EICO

See the famous EICO line at your jobber today
SEND FOR FREE CATALOG C-3
ELECTRONIC INSTRUMENT CO., Inc.
84 Withers Street • Brooklyn 11, N. Y.
Prices 5% higher on West Coast

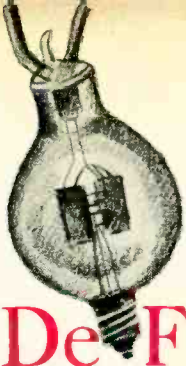

De Forest Nobel Prize Overdue

DR. LEE DE FOREST, Father of Radio, now in his 82nd year, needs no introduction to the knowing citizens of the world. Indeed his name has been a household term for more than a generation, wherever the wonders of radioelectronics have penetrated. The patentee of over 300 inventions, de Forest is of course best known for his discovery of the three-element electronic tube which made possible modern radio, electronics and television. Even more important than the radio tube itself was de Forest's discovery of the tube's magical powers as a radio detector, radio and audio amplifier and as an oscillator in "feedback" or regeneration circuits. The patents on these historic inventions were twice sustained by the U. S. Supreme Court.

De Forest, a prolific inventor, also invented the first practical radiophone, which soon became modern broadcasting. Electronic sound-on-film was still another of his outstanding contributions, making possible our modern talking motion pictures.

These and hundreds of other inventions earned him the richly deserved title of "Father of Radio." Honored in the U. S. and in many foreign countries, where his genius has been recognized for decades, he was the recipient of numerous medals and awards, only a few of which will be mentioned here: Gold Medal, World's Fair, St. Louis, 1904; Panama Pacific Exposition, San Francisco, 1915; Medal of Honor, Institute of Radio Engineers; Elliot Cresson Medal, Franklin Institute; John Scott Medal, City of Philadelphia; Prix La Tour, Institute of France; Cross of the Legion of Honor, France; Edison Medal, 1946. In addition to the 1899 Ph. D. Degree from Yale and the honorary D. Sc. Degrees from Syracuse in 1919 and Yale in 1926, he was given the Degree of D. Eng. from Lewis Institute in 1937; LL. D. from Talladega College and Beloit College in 1951; and the honorary Degree of D. Sc. from the College of Osteopathic Surgery in 1951.

Yet the greatest accolade of all, the Nobel Prize for Physics, for some unknown reason was never awarded. This seems all the more strange in view of the fact that the Swedish Academy of Science, the donor of the awards, gave the 1909 Nobel Prize to Marconi, for his great contribution to wireless telegraphy.

Can there be any reasonable doubt that Dr. de Forest's radioelectronic accomplishments far overshadow those of Marconi's? If we measure Marconi's gifts to humanity against those of de Forest, it will be acknowledged by most qualified judges that despite the admittedly great treasures which Marconi left to us, the Father of Radio outranks him decisively. De Forest has enriched our lives to an astonishing degree—in the arts, in entertainment, in progress and in industry, in the betterment of our health, and in the saving of countless lives due to the radiophone, broadcasting, and faster

communication to the ends of the earth.

If ever there was a great world-wide benefactor of humanity, that man is de Forest. Yet he has been treated rather shabbily by his fellowmen—particularly in worldly rewards. At 82 he still must earn his living.

We would like to repeat a statement made by the present writer in our January 1947, de Forest Anniversary Number (40 years of the Vacuum Tube): "VERILY"—to paraphrase Winston Churchill: 'NEVER IN THE HISTORY OF THE WORLD HAS SO MUCH BEEN OWED, BY SO MANY TO ONE MAN—LEE DE FOREST.'

Never too affluent, de Forest could not afford, even in his most prosperous days, the luxury of a publicity or public relations counsel. In consequence he never did have a continuing favorable press in the land of his birth. Therefore others must try and do for him what obviously should have been done years ago.

For that reason this publication has undertaken to address the Swedish Academy of Science in the hope of securing the coveted award for the Father of Radio in his lifetime.

This will consist largely of letters from scientists, engineers, bodies of learning, industrial leaders and similar figures. RADIO-ELECTRONICS therefore appeals to all such persons in its readership to write a letter, stating why, in their opinion, Dr. de Forest is entitled to the Nobel Prize in Physics—which also carries a cash award of over \$33,000.

Please proceed as follows:

1. Write letters on *two* of your standard letter-heads, 8½ x 11 inches, *typewritten only*. (One letter to be an original, the other a duplicate.)

2. Address your letter to: Board of Directors, The Nobel Fund, Swedish Academy of Science, Stockholm, Sweden. Forward *both* copies to:

De Forest Nobel Prize Committee, c/o RADIO-ELECTRONICS, 25 West Broadway, New York 7, N. Y.

The original letters will be bound into a volume (or volumes) for presentation to the Academy. The duplicates will be bound similarly and presented to Dr. de Forest.

3. The closing date for receipt of all letter-petitions has been set for April 30, 1955. *Kindly observe this date.*

4. RADIO-ELECTRONICS will bear all costs and expenses of this project, presentation to the Academy, circularization to various bodies of learning, etc.

FINALLY—PLEASE DO NOT DELAY YOUR LETTERS—AND KINDLY NOTIFY INTERESTED FRIENDS. AT DR. DE FOREST'S ADVANCED AGE, TIME IS OF THE ESSENCE—IT IS LATE—EXCEEDINGLY LATE...

—H. Gernsback



Circuit tracing a new design in TV receivers

Emerson 14-Inch Portable

By ROBERT F. SCOTT
TECHNICAL EDITOR



External view shows portable feature.

THE vertical type of TV chassis construction introduced recently has led to the development of more compact TV receivers and paved the way for the reintroduction of portable TV receivers. One of the latest of these is the Emerson model 1030D 14-inch set.

The receiver (Fig. 1) has 18 tubes (including picture tube) and a pair of selenium rectifiers in the power supply. The tuner, not shown in detail, is a Standard Coil series 6500 v.h.f. turret type with a 6BZ7 cascode r.f. amplifier and a 6U8 triode oscillator and pentode mixer. The antenna input circuit has two fixed i.f. traps that reduce interference in the 40-mc i.f. range and one tunable trap that can be adjusted in the field to reduce interference further in the i.f. range.

Mixer stability is obtained by reducing the screen bypass capacitor from .0015 to 220 μf . Degeneration thus produced cancels the regeneration caused by interelectrode and stray capacitances.

Some of the early-production sets use a tuner with a 6J6 mixer-oscillator. In these, a small coil is connected between the mixer grid and plate to form a parallel-resonant circuit with the tube's grid-to-plate capacitance and prevent feedback of the 40-mc i.f. signal from the mixer plate to grid. A capacitor in series with this coil blocks the flow of d.c. from plate to grid.

The 41-45-mc output of the mixer is coupled to the first i.f. amplifier through low-impedance link coupling network T1-C1-L3. The 15-ohm resistor in the grid return of V1 couples T1 and L3 so they appear as a tuned transformer whose windings can be peaked to the same frequency. The i.f. input circuit response is not affected by lead dress and lead length because the coupling im-

pedance is low—about 15 ohms.

Series-tuned circuits L1-C2 and L2-C3 in the low-impedance link are adjacent-channel sound and accompanying sound traps tuned to 47.25 and 41.25 mc, respectively. The composite (sound and video) i.f. signal is amplified by V1, V2 and V3 connected in stagger-tuned circuits using bifilar type transformers. Lead lengths, lead dress and stray coupling through tube capacitances make it necessary to neutralize the 40-mc i.f. amplifiers.

This is done by using smaller-than-normal screen bypass capacitors. The portion of the signal voltage that remains on the screen grids causes degenerative feedback. This cancels the regeneration caused by signal-voltage feedback through the plate-to-grid capacitance of the tubes. The neutralization prevents oscillation in the individual stages.

Since the screen capacitors are used for bypassing as well as neutralization, their values are critical and replacements must be of the same value and type and must be placed in the same physical locations with leads cut as short as possible.

The response of the i.f. amplifier strip is adjusted so just enough sound carrier signal passes through to heterodyne with the video carrier in the video detector to produce the 4.5-mc intercarrier sound i.f. signal. The sound i.f. signal is obtained from T5, the combination 4.5-mc sound trap-sound i.f. transformer and fed back into the grid circuit of V2, the second video i.f. and sound i.f. amplifier. The secondary of T5 appears as a 4.5-mc tuned circuit in series with the 40-mc i.f. transformer T2. The amplified 4.5-mc signal is developed across L5 in series with the 40-mc i.f. transformer T3 in the plate circuit of V2. The 4.5-mc signal is fed

to the grid of the 6AU6 sound limiter.

Although V2 operates as a reflex amplifier with 40- and 4.5-mc resonant networks in the plate and grid circuits, the resonant networks do not interact because the impedance of each is negligible at the resonant frequency of the other.

The a.g.c. system

The a.g.c. detector uses half (pins 2 and 5) of the 6AL5 (V4). It rectifies the positive half of the modulation envelope and develops a negative voltage across R14. This voltage is added to the negative d.c. voltage that the video detector (pins 1 and 7 of V4) develops across R18 to produce an a.g.c. voltage approximately equal to the peak-to-peak carrier voltage of the incoming signal.

The noise factor of the cascode r.f. amplifier is lowest when gain is maximum. Thus the a.g.c. voltage is delayed and is not applied to the tuner until the incoming signal is strong enough to overload the i.f. amplifier. A positive bucking voltage is tapped off the screen of the 6AU6 sound limiter and fed through a 10-megohm resistor to the tuner a.g.c. line. The grid-cathode circuit of the input section of the cascode r.f. amplifier acts as a clamping diode to hold the tuner a.g.c. line at contact potential—about -0.7 volt—until the incoming signal is strong enough to develop sufficient a.g.c. voltage to overcome the positive delay voltage.

The video amplifier

The primary of T5 in the video detector output circuit functions as a 4.5-mc trap to prevent the sound i.f. signal from reaching the 6CB6 video amplifier. The 440- μh r.f. choke in the amplifier grid circuit further isolates the i.f. signal from the video amplifier circuit.

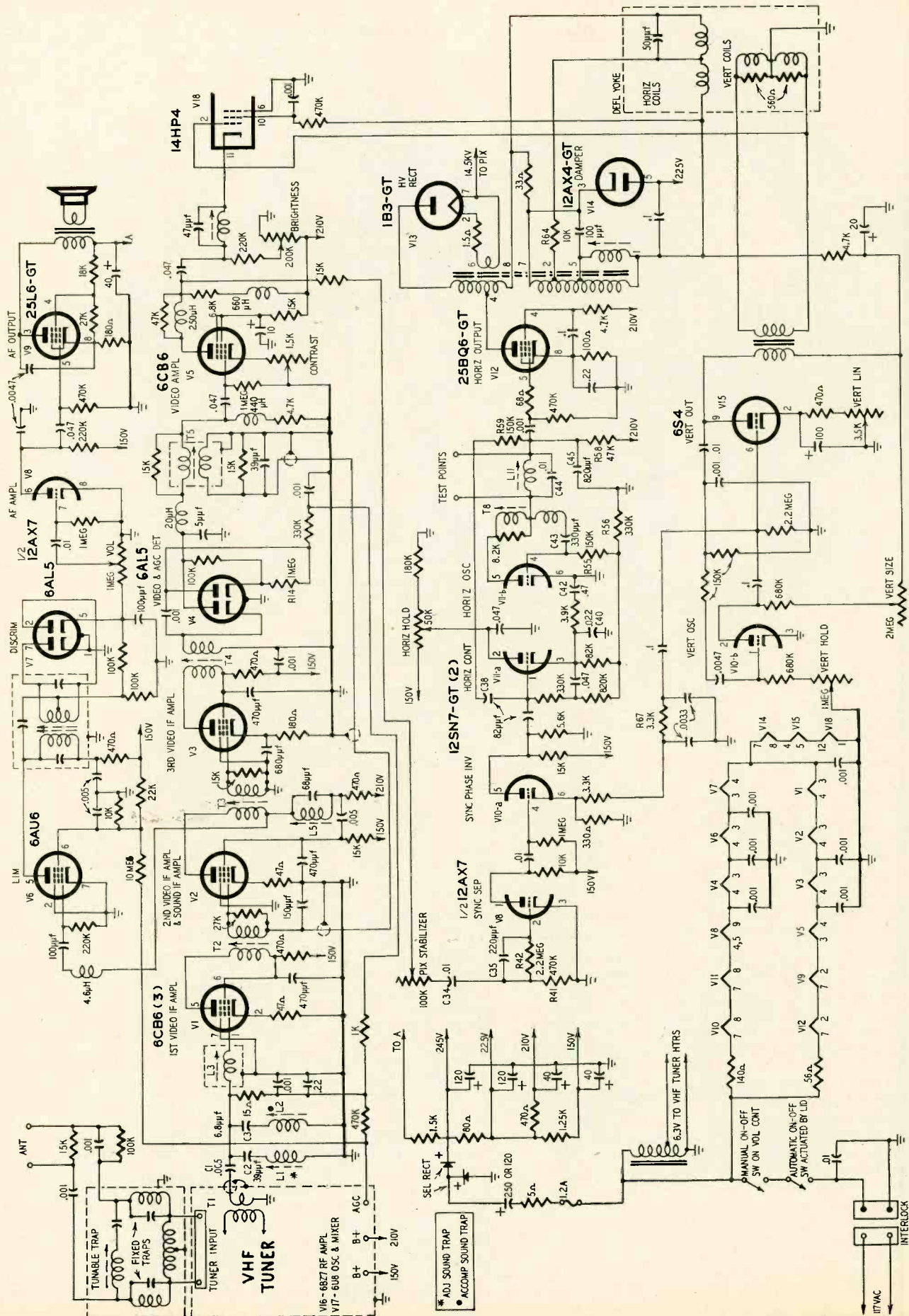
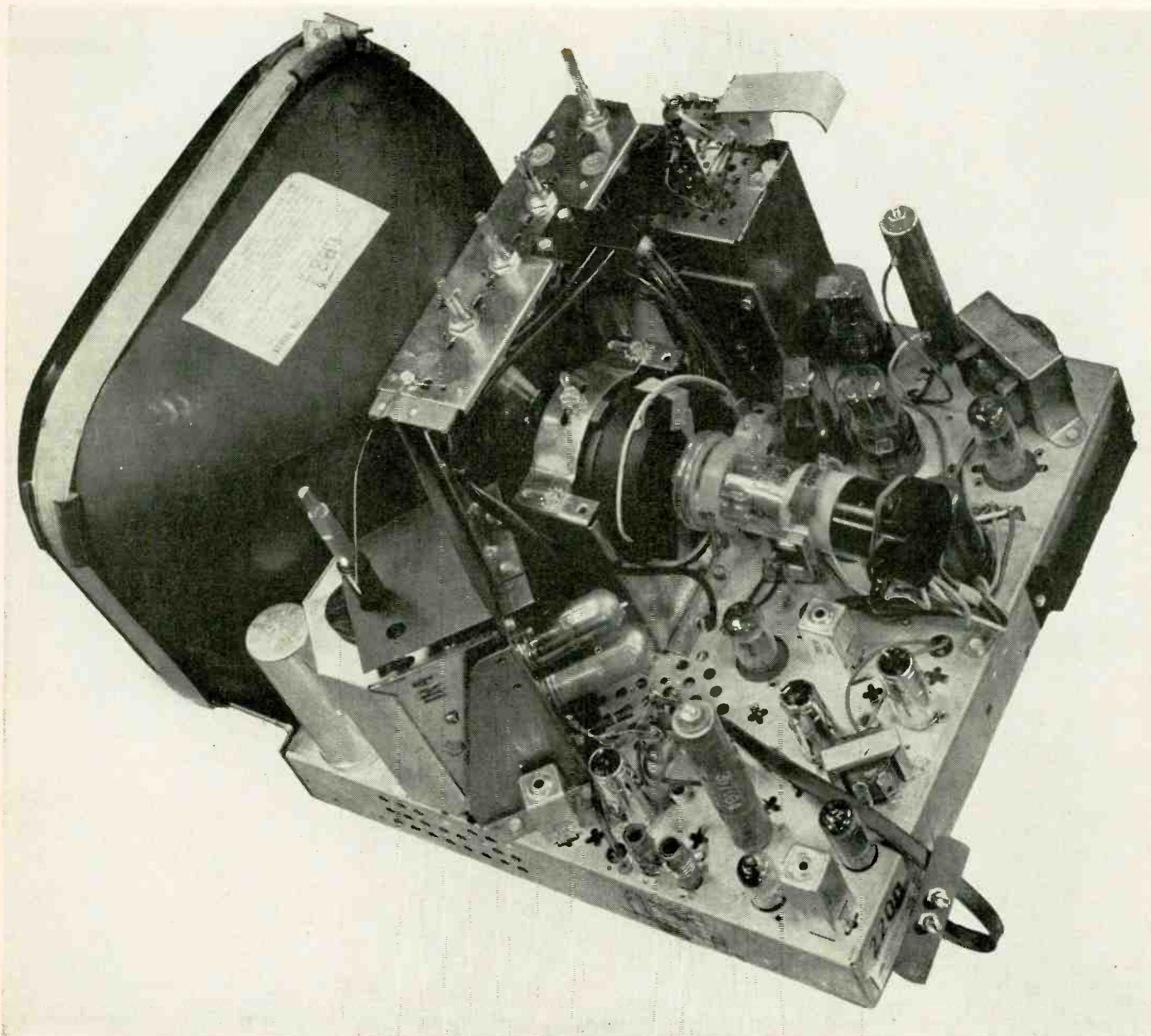

Fig. 1—Schematic diagram of the Emerson model 1030D 14-inch portable. Set uses a Standard Coil series 6500 v.h.f. tuner.



The Emerson model 1030D 14-inch chassis.

The single-stage video amplifier inverts the video signal so it appears with positive sync on the cathode of the 14HP4 picture tube. A combination of series-shunt peaking and low plate load resistance (6,800 ohms) shapes the response of the video amplifier for good picture quality. Contrast is controlled by the 1,500-ohm potentiometer in the cathode circuit.

The video amplifier is connected as a tetrode with the screen and suppressor grids tied together. Wide variations in 6CB6 characteristics cause some tubes to draw grid current when driven hard (with contrast control set to maximum) in normal service as pentode amplifiers. Grid-current flow causes clipping of the positive (white) peaks and results in *white overload* appearing as muddy whites and highlights. The tetrode operation, tube characteristics are less critical and grid-current flow is minimized.

The sync circuit

Composite video is fed to the video amplifier with sync negative. The amplifier is adjusted so that noise pulses of greater amplitude than the sync tips drive the tube to cutoff and are clipped at sync-tip level in the plate circuit. The composite video is fed from the plate circuit to the grid of the sync separator through the picture stabilizer control. Noise clipping in the video amplifier improves sync stability.

The amplified video with sync positive is fed to the sync separator through a double time-constant network C34-R41 and C35-R42 further to improve sync stability against impulse type noise. The large grid-leak resistor and low plate resistor assure that the sync separator will conduct only during sync pulses so blanking and video information cannot pass through and disturb the sweep oscillators.

Phase inverter V10-a follows the sync separator to provide positive-going sync pulses needed for syncing the horizontal oscillator. Negative-going sync pulses are tapped off the cathode of V10-a and fed to the vertical integrator consisting of two series 3,300-ohm resistors and two shunt .0033- μ f capacitors. This R-C network forms a low-pass filter that removes the horizontal sync pulses and passes the vertical pulses to the vertical oscillator.

Vertical deflection

The vertical oscillator is a free-running multivibrator using half of a 12SN7 (V10-b) and a 6S4. Sync pulses are fed to the grid of the 6S4 to control the operating frequency. Picture height is controlled by varying the plate voltage to V10-b with a 2-megohm variable resistor. Linearity is controlled by the variable 6S4 cathode resistor that sets the operating point for the tube. Line-

arity, height and hold control settings interact to some extent so the hold control should be adjusted for good stability and then touched up slightly after the size and linearity controls have been set.

Horizontal deflection

The horizontal oscillator and a.f.c. circuit is an improved version of the Synchroguide. V11-a is the a.f.c. tube and V11-b the free-running blocking oscillator whose frequency is controlled by its grid bias. In this circuit parallel-resonant network L11-C44 has been added between B plus and the tap on blocking transformer T8.

When voltage is applied to the circuit, plate current gradually increases through the upper half of T8 and induces a voltage in the lower half that drives the grid positive.

The positive grid voltage increases the plate current and the process is cumulative until plate saturation occurs. At this point the positive voltage disappears from the grid.

The positive grid voltage results in grid-current flow that charges grid capacitor C43 with its grid side negative. This capacitor discharges through R55 and R56, developing a negative voltage that drives the oscillator to cutoff. The tube remains cut off until C43 discharges to the cutoff bias level.

Fig. 2-a shows the voltage waveform on the grid of the oscillator due to the discharge of C43. Note how the curve tapers off and begins to parallel the cutoff-bias line as the charge decreases. A positive pulse—sync or noise—arriving at the grid before the capacitor voltage drops to cutoff would drive the tube into conduction and increase its operating frequency.

Parallel-resonant circuit L11-C44 helps prevent premature triggering of the oscillator by noise pulses. When the blocking oscillator cuts off, the sudden drop in plate current shocks the resonant circuits into oscillation at the horizontal sweep frequency. The sine-wave voltage developed across this circuit is shown in Fig. 2-b. This voltage combines with the voltage across C43 to

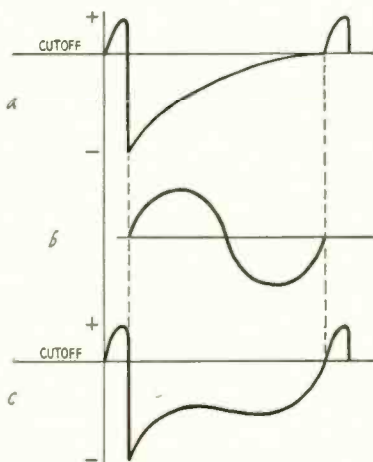
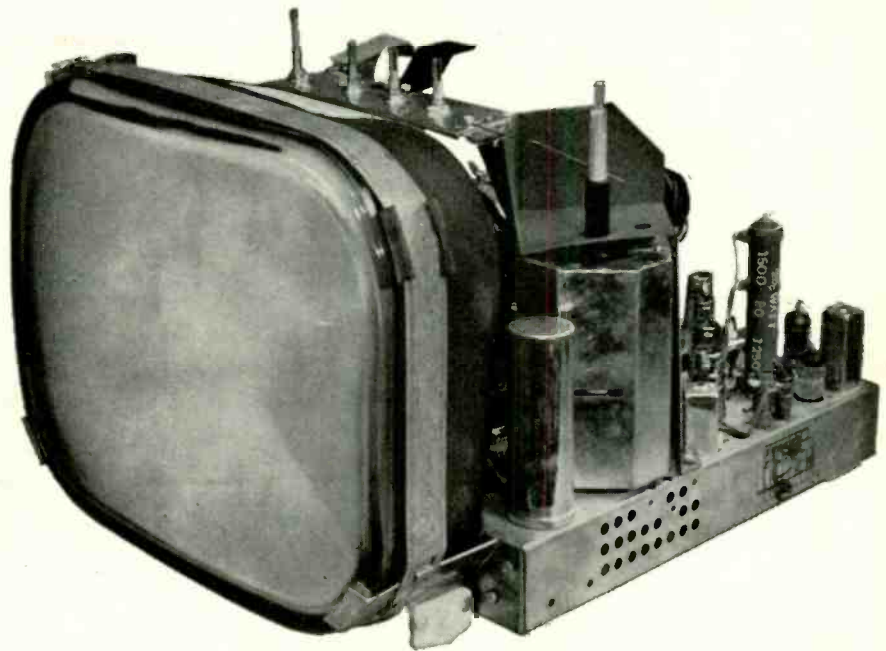

Fig. 2—Waveforms at various points in horizontal oscillator and a.f.c. circuits.



Front-chassis view of 14-inch receiver. Note the vertically positioned controls.

produce the resultant waveform of Fig. 2-c on the grid of the oscillator. In this case, the voltage on the grid is well below cutoff until just before the end of the normal grid R-C time constant.

Blocking oscillator V11-b is cut off during the forward horizontal sweep and conducts heavily during retrace. When it is cut off, C45 charges through R58, developing a positive exponential voltage on the horizontal output grid. This voltage causes the beam to sweep forward. When V11-b conducts, it discharges C45 and develops the retrace portion of the deflection sawtooth.

Pulse-width a.f.c.

Sync pulses are not applied directly to the oscillator as in the vertical deflection circuit. Instead, the a.f.c. tube (V11-a) compares the frequencies of the oscillator and the sync voltages and develops a correction voltage on its cathode (and on the oscillator grid that is direct-coupled to it).

The grid of the a.f.c. tube is direct-coupled to the oscillator grid through an R-C network that provides the necessary filtering and decoupling. Since the oscillator is free-running, its grid is negative for a large portion of the time. This negative voltage biases V11-a to cutoff when the horizontal hold control is set properly.

The sine-wave voltage across L11-C44 and the sawtooth across C45 are fed to the grid of V11-a through R59 and C38 where they appear as a positive pulse with sharp leading and trailing edges. The peak amplitude of this pulse is not high enough to cause conduction; but, if it occurs simultaneously with the arrival of the horizontal sync pulse, their combined amplitudes cause the a.f.c. tube to conduct. The phase and frequency of the two signals determine the point at which the a.f.c. tube begins to

conduct and the length of time that it passes current. Capacitors C40 and C42 charge to a d.c. voltage that is proportional to the length of time that V11-a conducts. This voltage is applied to the grid of V11-b to control its frequency and hold it in sync. The oscillator frequency varies directly with the positive control voltage.

Horizontal output circuit

The sawtooth voltage developed across C45 is fed to the grid of the 25BQ6-GT horizontal output stage. The output transformer matches the plate circuit to the low-impedance deflection coils in the yoke and raises the horizontal retrace pulse to around 15,000 volts by autotransformer action. The 1B3-GT rectifies this pulse voltage and produces a d.c. voltage used on the second anode of the picture tube.

The 12AX4-GT damper loads the horizontal output transformer and horizontal deflection coils, preventing spurious oscillations (ringing) that would normally occur in the output circuit during the sweep cycle. The energy absorbed by the damper tube provides the boosted B plus voltage. The 50- μ f capacitor across half of the horizontal deflection winding equalizes the electrical characteristics of the two halves and combines with series resistor R64 to prevent ringing in the yoke.

The low-voltage supply

A pair of selenium rectifiers in a voltage-doubler circuit supply the B plus voltage. The tube heaters are connected in two series-parallel strings (See "Series Heater Strings for TV Receivers" in the August, 1954, issue of *Electronics* magazine) arranged so the warmup times are balanced to minimize voltage surges and momentary overloads that cause premature tube failures. **END**

What! No High Voltage?

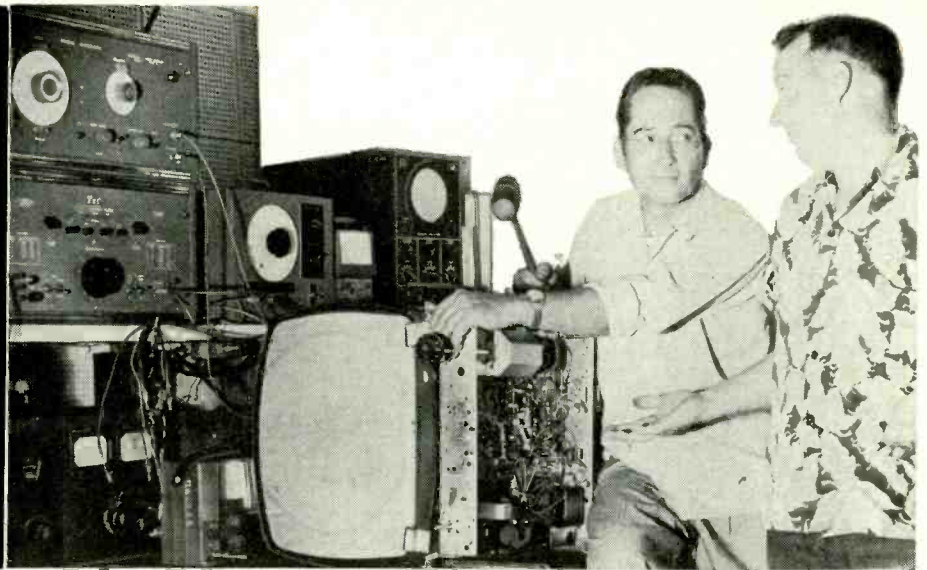

"It was O.K. when it left my booth."

By CHARLES R. WHEELER

COME along on a short trip through the scan-analyze lines in a television plant. Chassis pour from the production lines along a conveyor into the tracking department. Twenty-five scan-analyze booths are lined up along the conveyor. Scanners dart from their booths, grabbing sets on the run. The sets are benched, scanned and passed to i.f. trackers in a smooth, continuous flow.

But what is this? Who is this knight of the rueful countenance squatting so glumly on his stool uttering muffled curses? His v.t.v.m. and scope leads fly from one reading to another but nothing happens. Production is clearly stalled in this booth: the odds are three to one that the problem involves high voltage or the lack of it.

If he is a top-notch analyzer, the correct solution will soon be found. If he is not and the problem is difficult, he may make a quick guess that is likely wrong.

This is costly not only in scrapped parts but in repair time.

From the standpoint of analyzing and repair cost, the horizontal output and high voltage stage is the most expensive circuit to analyze in production. Time is limited, but the penalties of misanalyzing are severe. Lost time, expensive repair parts, repair handling, and nervous wear and tear add up to an impressive total.

The generation of high voltage in a television receiver starts at the horizontal oscillator. However, since this circuit is relatively easy to service, we will consider the control grid of the horizontal output tube as the starting point of our analysis. A typical output stage is that in the Admiral 19B1 chassis (see diagram) and we will use it as the basis of discussion.

It is assumed that few or no high-voltage a.c. pulses appear at the plate

cap of the high-voltage rectifier. Should there be a normal a.c. voltage at the plate of the 1B3 and no high voltage at the second anode of the picture tube, the high-voltage circuit would be checked (see TV Clinic, January, 1955).

Horizontal output circuit

The first information we must have when analyzing a high-voltage problem involves the 6BQ6-GT. Is the horizontal output tube functioning normally? We know, or can get from a schematic, the normal operating voltages. Any deviation from the normal on the control grid, cathode, screen or plate will tell its own tale concerning what is wrong. (In the 19B1 chassis the normal voltages are: control grid, -24; cathode, 5; screen grid, 150, and plate, 250.)

Suppose the drive trimmer shorts, removing the negative 24-volt bias from the grid of the 6BQ6. The grid is now positive with respect to its normal operating point and the tube is driven to saturation. The plate runs red hot. The cathode will go 8 or 9 volts positive instead of the normal 5, due to the heavy plate current. Screen voltage is normal. This combination of voltages points to trouble at the tube grid or horizontal oscillator failure.

Scope and resistance checks will quickly localize the trouble. Of course, it could be a faulty 6BQ6 which can be checked by substitution. Other abnormal voltage combinations are also helpful. No cathode or screen voltage with a burning 8,200-ohm screen grid dropping resistor, coupled with an abnormally high control grid voltage (-35), indicates a shorted screen grid within the tube or at the tube socket.

Cathode voltage running 2 volts high (7), with no voltage drop across the 8,200-ohm screen grid dropping resistor, indicates an open 82-ohm screen grid resistor, bad screen grid connection or

open within the 6BQ6 output tube. An open cathode resistor will produce 120 volts on the cathode. Screen grid voltage will read 300 and control grid voltage zero.

Failure of the plate B plus supply to the 6BQ6 plate cap from the horizontal output transformer will cause the 8,200-ohm screen grid dropping resistor to burn. The screen will show 50 or 100 volts instead of 150. The cathode voltage will read 1 instead of 5. And the control grid drive will increase to -35 volts instead of 24. When this combination of voltages is found, always remove the plate cap from the tube before measuring, to protect the meter.

Thus, by making three or four quick voltage checks on the 6BQ6 we can determine whether the horizontal output tube is functioning. If it isn't, the trouble has been located.

If the 6BQ6 is working properly but there is still no high voltage, we must turn our attention to the horizontal output transformer and yoke circuits. The most useful check point for analyzing these circuits will be the cathode of the 6AX4 damper.

The bootstrap circuit

The boost voltage in a television set performs several important functions. It is a means of cutting down on power transformer and filter capacitor costs. By using a B plus of 250 volts, a lower-voltage power transformer and filter capacitors can be used. However, this voltage is too low for use in the sweep circuits. To obtain the higher values needed at these points the horizontal output circuit is designed to boost the sweep voltages to 450 a.c. In addition to its damper action, the 6AX4 also rectifies this a.c. The frequency being high, very little filtering is required to make it suitable for use in the vertical sweep circuit. Filtering is supplied by

a 20- μ f electrolytic capacitor in the vertical sweep B plus. Little filtering is needed for the horizontal sweep as any ripple is in phase with the sweep pulses that generate the boost.

A little thought will explain why this boost circuit is often called the *bootstrap*. Starting with an original B plus of 250 volts, a 15,750-cycle sweep is generated. After the sweep operates for a few cycles, it produces a d.c. boost voltage of 450. This 450-volt boost then becomes the operating B plus in the horizontal and vertical sweep circuits. The original 250-volt B plus has thus raised itself by its own bootstraps to 450 and will remain at that level as long as the output circuit functions.

Due to this rather complicated action, almost any trouble in the horizontal or vertical sweep circuits will affect the boost voltage. Also any shorts or defects in the high-voltage section of the horizontal output transformer will be reflected in the boost, usually cutting it down from the optimum value of 450 volts. This makes the cathode of the 6AX4 such a desirable check point in cases of high-voltage failure.

A word of caution: It is not good analyzing practice to make voltage measurements at the damper cathode unless the high voltage is weak or non-existent. There is a high pulsed voltage at this point when the circuit is operating properly. However, with a good vacuum-tube voltmeter, little trouble will be experienced if the technician makes sure that the high voltage is definitely weak or dead.

To avoid even a remote possibility of meter damage the technician can open-circuit the 0.1- μ f, 600-volt capacitor coupling the flyback pulse from the yoke to the horizontal output transformer. This disables the high voltage but all boost sections work normally. Any shorts in inductive components will still affect the boost as described and analyzing procedures will be the same.

Three main circuits are fed from the cathode of the 6AX4. These are the horizontal sweep, vertical sweep and high-voltage windings of the horizontal output transformer. As the trouble can lie in any one of these circuits the next step is to localize it. Change the 1B3 high-voltage rectifier and the 6AX4 damper. Also replace the 6S4 vertical output tube. If changing these tubes does little toward raising the boost to normal, make a resistance check of all components, looking out for usual causes of trouble as shorted capacitors, off-value resistors, grounded wires, solder shorts to ground and open inductive components like the yoke or horizontal output windings.

If the trouble is not found at this point, there is usually only one possibility left—shorted turns in the horizontal output transformer, yoke, vertical output transformer or width coil. These components, when defective, will usually check good when the windings are measured with an ohmmeter.

Only indirect methods of checking

will be of any value. The best method is to remove the inductive loads one at a time until the offending part loading down the circuit is found.

Isolating circuits

Other than tubes, capacitors and resistors, there are five main loads to be checked at this point: the horizontal output transformer, width coil, horizontal and vertical deflection coils and vertical output transformer. If any of these develop shorted turns, the excessive current drain through the defective component will increase the circuit load and decrease the boost voltage.

Since a component with shorted turns will decrease the boost voltage, if we remove the units from the circuit one at a time, the boost voltage will rise to its full value when we remove the defective part. The horizontal output transformer is the source of the boost voltage so it cannot be checked this way and must be left to the last. (If a flyback checker is available, the transformer can be checked immediately.) However, a number of short cuts can be used to expedite matters.

For example, suppose we have checked all components and circuits thoroughly and have narrowed the trouble down to an excessive inductive load in the circuits fed from the 6AX4. We measure the boost and find it 300 volts instead of the normal 450. The boost is working because the voltage measured is higher than the B plus voltage. What is the defective component loading the high-voltage circuit?

Feel the width coil. A coil with shorted turns will get extremely hot. If it is hot, clip it loose and check for high voltage. If it is not hot, determine whether the heavy loading is in the horizontal or vertical circuits.

The vertical-output plate circuit is fed through a 1,200-ohm resistor from the boost circuit. By disconnecting the 1,200-ohm load resistor any inductive loads in the vertical output circuit will be removed. If the defective load is anywhere in the vertical output, the boost and high voltages will return to

their normal values. If high voltage appears, we have narrowed the trouble to the vertical yoke or vertical output transformer. Connect the clipped resistor and make further checks in the vertical circuit.

Disconnect the vertical yoke at both ends. If this unit is defective, the boost voltage will rise and high voltage will appear. If this does not happen, nothing is left but the vertical output transformer and upon disconnecting it high voltage will appear.

Suppose that clipping the 1,200-ohm vertical supply resistor did not raise the boost voltage. This localizes the trouble in the horizontal circuit. Connect the clipped resistor and turn to the horizontal yoke. If it is defective, clipping one end loose from the 6AX4 cathode will remove the load and the boost will rise. *But there will be no high voltage.* High voltage is dependent on the flyback pulse from the horizontal yoke, so the boost must be used as the sole indicator. If the boost does not rise, all that remains to be checked is the horizontal output transformer itself.

Usually a transformer shorted this badly will heat up by the time this stage of checking has been reached. The wax covering the secondary winding will get warm and soft. This condition is a positive indication of a defective unit, and it should be replaced.

There is one special exception to the rule that weak or no high voltage is always accompanied by a reduction in boost voltage. Consider a set in which all boost-voltage points check and all other requirements are met for the generation of high voltage, but none is present. This trouble will usually trace directly to an open capacitor that couples the flyback pulse from the yoke to the horizontal output transformer. In the 19B1 chassis this is a 0.1- μ f 600-volt tubular. Occasionally this capacitor will open, blocking the flyback pulse from the yoke, resulting in no high voltage. If all circuits check out with normal boost voltages, bridging the open capacitor with a good one will restore high voltage. END

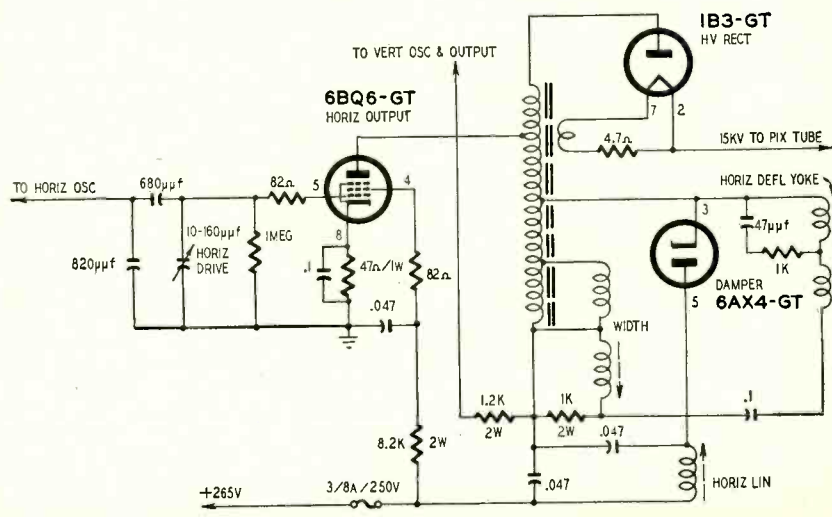

Schematic diagram of the Admiral model 19B1 sweep and high-voltage circuits.

FOLD OVER

The cause and cure of vertical and horizontal overlap

By MATTHEW MANDL*

VERTICAL or horizontal fold-over occurs in a television receiver when the timing between the sync pulses and the blanking is upset because of circuit faults. At this time a portion of the visible retrace contains signal information which appears on the screen inverted with respect to the primary image. Fig. 1 is a typical indication of foldover at the bottom of the picture tube. The bottom of the station pattern appears upside down along the lower margin of the picture. This is sometimes referred to as overlap, since there is an overlapping of one image with respect to another.

Overlap or foldover along a *horizontal* plane at either the top or bottom of the picture indicates a fault in the *vertical* sweep system of the receiver. Overlap along a *vertical* plane on either side of the picture indicates a defect in the *horizontal* sweep system of the receiver. Thus, the appearance of the foldover gives an immediate clue as to which sweep system is affected. Knowing the underlying causes of foldover will usually enable the technician to localize the condition more exactly in either the sweep oscillator or sweep output stage.

Indirect sync

The sync pulses of the transmitted signal are mounted on the blanking pedestal. At the receiver, they are

*Author: Mandl's Television Servicing.

stripped from the blanking level and used to synchronize the vertical and horizontal oscillator stages *indirectly*. In the vertical circuit, successive vertical pulses build up a charge on the resistor-capacitor (integrator) network which precedes the oscillator. When the charge is sufficient to overcome the grid bias, the tube conducts and the oscillator is synchronized with the incoming signal.

The horizontal sync pulses are fed to a phase discriminator or other control tube which generates a correction voltage for the horizontal oscillator. In neither the vertical nor the horizontal system are the sync pulses used to synchronize the sweep oscillators directly. Thus, circuit defects can upset the timing relationship between the sync and the blanking pulses.

Fig. 2 illustrates what occurs when the timing between sync and blanking is disturbed. At *a* of Fig. 2, normal operation is shown. This can represent either the vertical or the horizontal sweep, since foldover in each case is caused by a disturbance of the timing. (For the purposes of this discussion, assume that Fig. 2 illustrates horizontal sweep.) The sawtooth of current in the deflection coil which sweeps the beam across the screen is shown with the composite video signal to illustrate the timing sequence. When horizontal blanking begins, the beam is still swept across the screen for a short distance since the sawtooth has

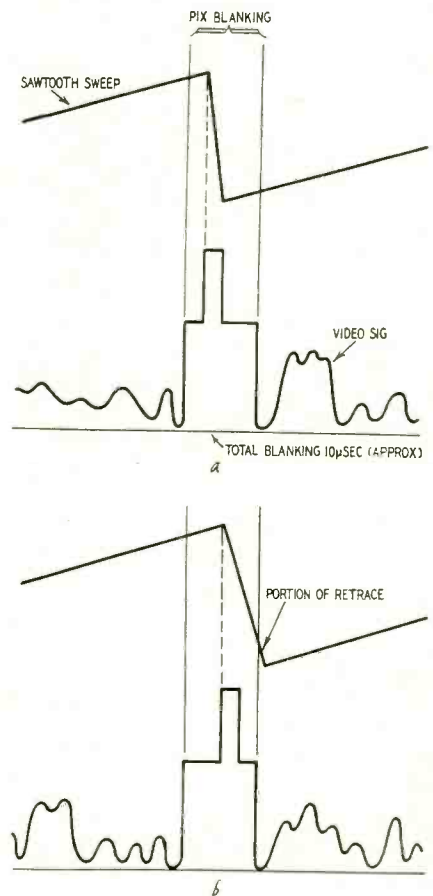

Fig. 2—Sync and sweep relationships.

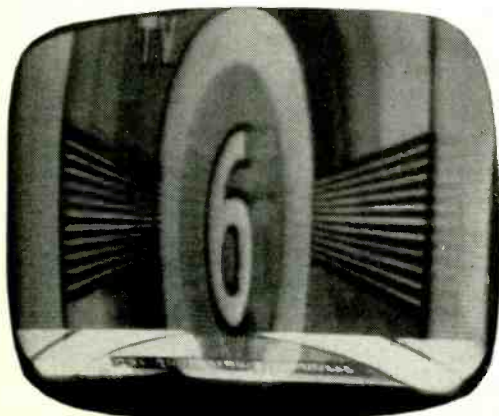

Fig. 1 (left)—Foldover at bottom of picture.



Fig. 3 (right)—Slight horizontal foldover.

not reached the peak of its incline. When the leading edge of the horizontal sync pulse occurs, it triggers the sawtooth oscillator. The decline of the sawtooth wave indicates the retrace sweep of the beam across the face of the picture tube. After the sawtooth waveform has swept the beam back to the left side of the screen, it starts to sweep forward again. The blanking level is maintained for a portion of this forward sweep. Thus, the retrace portion of the beam is blanked out as well as a slight portion of the beginning and ending trace.

If the horizontal sync pulse is delayed with respect to blanking (Fig. 2-b), the sawtooth retrace occurs too near the end of the blanking period

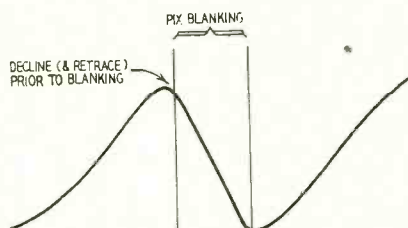

Fig. 4—Defective sawtooth waveshape.

and a portion of the retrace occurs after blanking. Under this condition, the beam will be blanked out for most of its retrace from right to left. But as it nears the left edge, the blanking ends and the retrace portion, which is visible, scans some of the video information. Thus, video information is traced backward along the screen during the last portion of the retrace and forward during the normal sweep of the beam. The retrace video information therefore overlaps the forward trace video information.

The forward trace of the beam along the face of a picture tube takes approximately 53 μ sec. The retrace is completed in less than 10 μ sec, since some forward trace occurs during the initial part of blanking. Thus, the video information picked up during the horizontal retrace will not appear as vivid as the forward trace which occurs at a slower sweep rate. The overlap may be a faint haze. Fig. 3 shows such a condition. The outer white circle of the station pattern can be seen bending in from the left side of the screen.

Another cause of foldover is a circuit defect that disturbs the waveshape of the sawtooth (Fig. 4). The sharp point at the peak of the sawtooth has been rounded off by a loss of high-frequency response. In this case, the peak of the sawtooth declines before blanking because of the distortion of the waveshape. The decline from the peak sawtooth value means that retrace starts before blanking. Thus, a portion of the initial return trace contains video information. This causes an overlap similar to that of Fig. 3, except that now the foldover occurs at the right (Fig. 5). Because the retrace time is so much faster than the forward time, the retrace image appears as a faint white haze.

If the vertical system is involved, the Fig. 2-b defect would cause foldover at the top of the screen, since retrace is from bottom to top. The condition shown in Fig. 4—the initial portion of retrace is not blanked out—would cause foldover at the bottom of the screen as shown in Fig. 1.

The degree of overlap along either

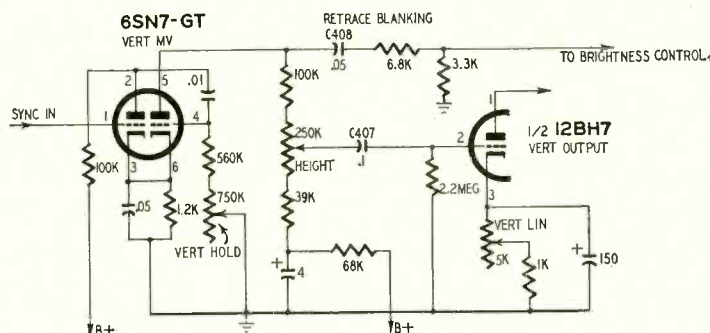

Fig. 7—Vertical multivibrator and output circuits in a Westinghouse V-2313.

the horizontal or vertical plane depends on how much of the retrace is not blanked out. For instance, a defect in the sawtooth-forming circuit can obliterate a sufficient amount of the high-frequency components of the sawtooth waveform so that it begins to look like a sine wave. That would cause severe foldover.

Vertical system foldover

Foldover in the vertical sweep system which caused the Fig. 1 condition occurred in the circuit shown in Fig. 6

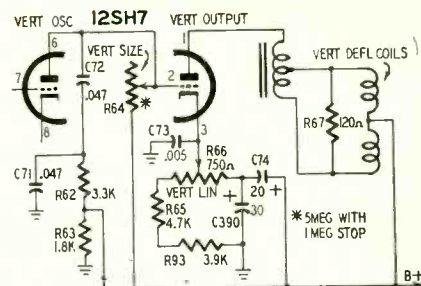

Fig. 6—Diagram of the vertical oscillator and output circuit of Motorola 17T13.

(Motorola 17T13). A short in the vertical size (height) control placed a high d.c. potential on the grid of the vertical output tube and on the oscillator plate. Adjusting the vertical linearity control reduced the amount of foldover but could not obliterate it entirely. The excessive voltage upset the linearity of the sawtooth developed across discharge sawtooth-forming circuit C71-C72-R62-R63.

A more common cause of foldover in the vertical system is a leaky coupling capacitor such as C407 in the West-

inghouse V-2313 in Fig. 7. This produced the type foldover shown in Fig. 8. The top portion of the picture, while elongated, has not been lost in Fig. 1. This condition can be localized by a voltage check with a v.t.v.m. from the grid of the vertical output tube to the cathode. There should be a negative bias at the grid: the lack of such bias, or a positive reading, indicates a leaky capacitor, which permits some of the B plus voltage from the oscillator plate to appear at the grid of the output tube.



Fig. 5 (left)—Overlap at right side of picture.

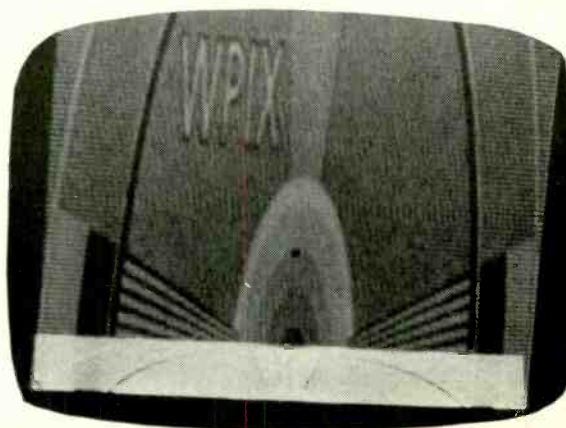

Fig. 8 (right)—Foldover caused by leaky coupling capacitor to grid of vertical output.

TELEVISION

An additional check can also be made by disconnecting one side of the capacitor and checking it with a capacitor checker. Replacement should have a 600-volt rating, using the same capacitance as the original. A lower capacitance than the original will insert a high series capacitive reactance to the low-frequency vertical sweep signals, reducing the drive to the output tube and therefore the height.

When troubles occur in the resistor-capacitor network which precedes the vertical oscillator, the sync can be delayed sufficiently to cause foldover at the top of the picture. By far the most common symptom, however, is foldover along the bottom, caused by either a leaky coupling capacitor or an abnormal increase in the voltage applied to one of the vertical output tube elements. On occasion a faulty tube will contribute to foldover and it is a good idea to check tubes first. After this, check all voltages and components in the output stage.

Horizontal system foldover

Foldover caused by defects in the horizontal sweep system (Figs. 3, 5) is also a symptom of horizontal instability. If the horizontal hold control is misadjusted to the point just before sync loss, foldover symptoms will appear in many receivers. If the hori-

zontal hold control cannot be adjusted to eliminate the foldover, the horizontal oscillator circuit should be checked. The most simple check consists of tube replacement and readjustment of the horizontal frequency control. If this fails to correct the trouble, component parts associated with the horizontal hold control should be tested. Check replacement parts against service notes for the receiver, since some are temperature-compensated and close-tolerance.

The horizontal oscillator section should also be readjusted completely, because aging of the oscillator tube and component parts may make operation more critical than when the set was new. Tube replacement usually calls for readjustment also. Again check the service notes. Some systems (such as the Synchronguide) require a complex step-by-step procedure to get best stability, sync pull-in and noise immunity. If several 6SN7-GT tubes are on hand, try each to see which gives best results. Some tube types require less readjustment and provide more stability than others.

Matched parts

The trouble illustrated in Fig. 2-b—a portion of the retrace is beyond blanking—can also occur in a receiver which has too long a retrace interval. In such

a case foldover will occur even though there is good timing between the sync pulse and the blanking interval. Proper retrace speed in the horizontal sweep system can be disturbed by a mismatch between the yoke and the horizontal output transformer. A mismatch can increase the flyback time and cause foldover which cannot be eliminated by horizontal oscillator adjustments. Thus, it is important to use the proper yoke or horizontal output transformer replacement when either of these units is found defective.

Components must also be matched carefully in the vertical sweep system. It may be necessary to readjust the controls for good linearity, picture positioning and full screen masking, after replacing either the output transformer or the yoke. Foldover can occur in the vertical system of some receivers when both height and vertical linearity controls are considerably misadjusted.

Retrace blanking

As shown in Fig. 7, some receivers place the retrace blanking circuit after the vertical oscillator instead of at the vertical output. When this is done, the capacitors and resistors in the retrace blanking circuit should also be checked if it becomes difficult to eliminate foldover. Defective parts in the retrace eliminating circuit are not a direct cause for foldover, but they can alter circuit characteristics to the point where it is necessary to misadjust the height and linearity controls to mask the picture properly. These misadjustments often cause foldover.

Defective capacitors (such as C408 in Fig. 7) are the usual offenders and the best method for localizing them is to disconnect one side of the capacitor and use a capacitor checker which can indicate leakage (power factor). If the resistors beyond C408 short or change value, they will have no effect on the d.c. potentials at the oscillator plate, providing C408 has no leakage. Shorted resistors can, however, affect the signal voltages between the oscillator and the grid of the vertical output tube because of the low-reactance path provided by the capacitance of C408 which is usually large (.05 μ f in Fig. 7). Thus, even though C408 seems to appear as a blocking factor, all components in the retrace blanking circuit should be tested when trouble occurs.

The retrace blanking circuit could be removed from the oscillator circuit by disconnecting C408 from the oscillator plate lead. This will indicate what effect, if any, the circuit has on troubles in the vertical sweep system. Disconnecting the retrace blanking coupling capacitor may save time tracing the various other parts of this circuit through the chassis wiring. If disconnecting the retrace circuit has no effect on vertical oscillator performance, it can be reconnected and the time spent checking the parts associated directly with the vertical oscillator and vertical output stages. END

OLD-TIME RADIOMAN CARRIES ON

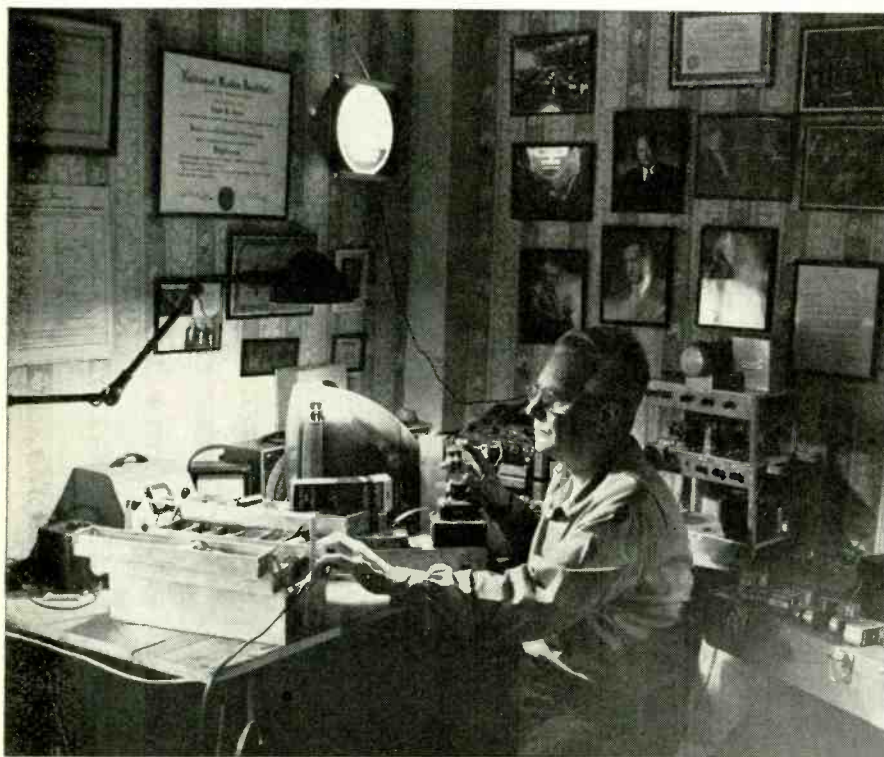

Edgar K. James, who is now in his 60's, is the proprietor of a thriving little TV repair business in Chesham, N. H. His present work culminates a lifetime devoted to electronics. James became interested in this field in 1906 and is a member of the Quarter Century Wireless Association and the de Forest Pioneers.

TELEVISION...it's a cinch

*Fifteenth conversation, second part:
Pentode separators, d.c. level
problems, differentiator and
integrator circuits*

By E. AISBERG

WILL—I suppose all pentode separators are hooked up so the sync pulses fall in the part where the current varies—the so-called rising part of the characteristic curve. Then the picture part of the composite video signal will disappear completely—it will be in the area of no plate current or that of the flat top. In either case a change of grid voltage would have no effect whatever on the plate current.

KEN—You've outlined the principles underlying sync separators completely! And I don't think you'll have any trouble analyzing the circuits in detail. Let's take a case of positive-going video signals. Here's a pentode hooked up across a voltage divider so the plate has a low voltage, the screen a higher one and the cathode is at a considerably higher voltage than the grid, due to the voltage drop across R1. So the grid is biased negative.

WILL—I see. And this bias is to . . . ?

KEN— . . . bring the grid to the point where plate current just begins when the signal reaches the black level. Then the pulses extend out into the region where the tube amplifiers (the rising part of the characteristic). It's a good idea to bias the grid far enough that the pulses start in the region of no plate current. Then you're sure all parts of the picture signal are cut off and only sync pulses are amplified.

WILL—Wonderful! Now what's the hookup for a negative-going signal?

KEN—Exactly the same! Only the connections to the voltage divider are changed to make the grid a few volts more positive than the cathode, so that all the picture signal is buried in the region of maximum plate current, and only the sync pulses are negative enough to reach what from this end you might call the falling part of the tube's characteristic curve. This drawing shows how a negative-going signal would look.

WILL—It seems we'll get a positive output signal anyway. We're taking the signal off the plate; and since the drop in plate current means a lot less drop across the load resistor R, each pulse should drive the plate voltage up practically to the supply voltage as the plate current approaches zero. Consequently we get positive sync pulses from the output instead of the negative ones applied.

KEN—That shouldn't surprise you—in fact you mentioned not so long ago that the diode *didn't* invert the signal, as if you expected that any other tube would. And you may have noticed that I drew input and output pulses for the positive-going signal. But I've bad news for you again. The separator that we've just drawn can't possibly work right!

From the original "La Télévision? . . . Mais c'est très simple!" Translated from the French by Fred Shunaman. All North American rights reserved. No extract may be printed without the permission of RADIO-ELECTRONICS and the author.

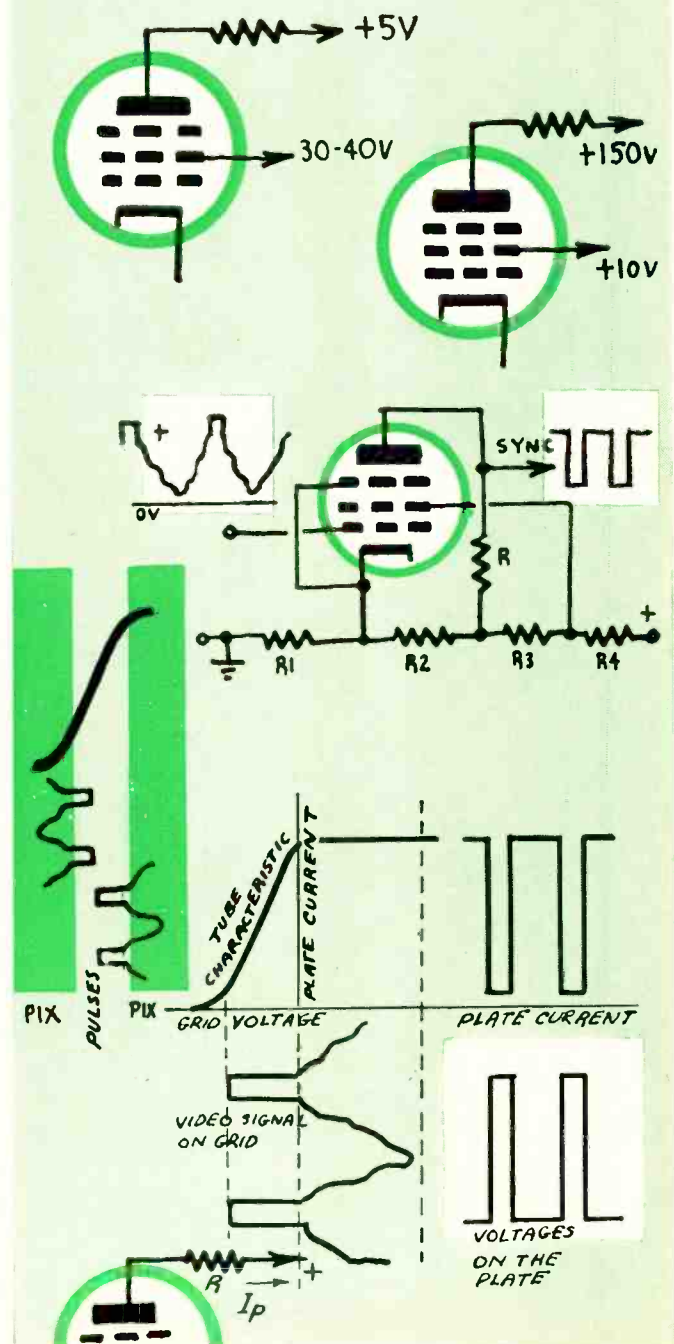

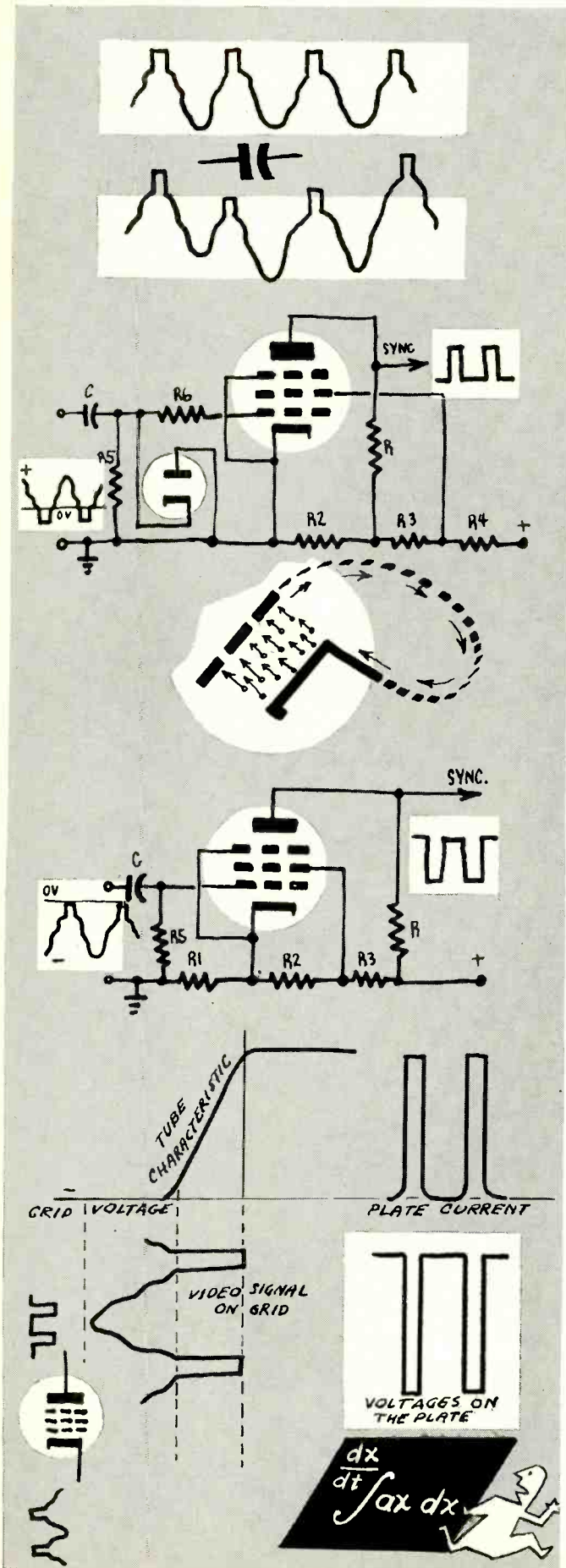

WILL—What, down a wrong trail again? What's wrong with the circuit? It looks almost foolproof!

KEN—First of all, our separator is most likely to be connected to the stage which supplies its signal through a coupling capacitor. And when you say "capacitor" you say good-by to the direct-current component of the signal.

WILL—I think we've already had enough of that! But just how does it bother us in this case?

KEN—Doesn't it hit you right between the eyes? The whole operation of this separator depends on the black level being lined up properly with the grid voltage point where the plate starts to draw current. So, without the d.c. level, your pulse tops will look like a rough mountain range, each peak at a different height than the others. With this synthetic mountain range controlling the plate current, you can't expect correct syncing. Some of the pulses won't have enough effect. In other lines parts of the video signal, or maybe noise pulses, would trigger your sync circuits.

WILL—Can't we save the situation again by putting in a grid resistor (R5 in this diagram) and putting a diode across it? This looks like a good d.c. restorer circuit now.

KEN—You have the solution. Now everything falls into order—or almost, for we still have disturbances due to grid current . . .

WILL—And just how bad is that?

KEN—Well, you can see that you're going to have some fairly high signal voltages on the grid, especially with negative-going signals, where the black level is roughly at zero volt and the picture signal takes the grid far positive. Under these conditions it becomes an anode and captures electrons, which have to follow the external path from grid to cathode. You can help the situation by putting R6 in series with the grid. Now any grid current produces a voltage drop that keeps the grid a little negative and prevents it from reaching high positive potentials.

WILL—And from what you've just said, I suppose a positive-going signal gives a lot less trouble?

KEN—Yes. Everything happens in the region of negative grid voltage, so you don't have to worry about grid current.

WILL—Now I'm beginning to get this for the first time. I can see that only the sync pulses can possibly affect the plate current and that picture signals will be rejected absolutely, since they are all in the region below plate current cutoff.

KEN—Before you dismiss it from your mind, remember once again that the output signals are opposite in phase to those at the input. The sync signals produce increases in the plate current and because of the voltage drop across the load resistor, they are transformed into negative voltage pulses.

WILL—Just one more thing, Ken. You said something about noise pulses triggering the sync. Wouldn't electrical interference be strong enough in a lot of places to make trouble? And if so, what's the use of all our careful separating?

KEN—You're right, Ken, and in many modern televisers the sync signal is "keyed" or "gated" which means that the sync separator is switched into the circuit only for a short interval around the time the sync signals are due to come in. Then it doesn't work during the rest of the scan.

The jolly capacitor and the mean resistor

WILL—And now that we're able to extract good pulses with either diodes or pentodes, how are we going to pick out the vertical field pulses from the horizontal ones?

KEN—You know that one is much longer than the other. The principle of selection is to change duration into amplitude.

WILL—How perfectly clear! Almost like a political commentator before a close election!

KEN—It's really simple enough. The usual method is to use differentiation and integration.

WILL—Better and better! Excuse me while I run out and take a couple of calculus courses before you go on with the explanation!

KEN—It won't be necessary! The terms that impress you

so much refer to voltages in the most simple circuit you could design: a resistor and capacitor connected in series! Now suppose you figure out what happens if we suddenly apply a voltage E across this circuit, maintain the voltage for a given time T , then cut it off just as suddenly.

WILL—I've learned a lot of things in the time we've known each other, but nothing better than to know when you've a sneak ball coming. This voltage that we start and stop so suddenly, isn't it a horizontal or line pulse if T is short, and a vertical or field pulse if T is long?

KEN—You're getting good, Will! Now what we want to study is the form of voltages E_r and E_c that appear across the resistor and capacitor.

WILL—But we've already gone through this before (in our fifth conversation, when we started with time bases). When you apply voltage E , you start to charge capacitor C through resistor R . Voltage E_c rises along an exponential curve more or less according to the time constant of the circuit, the product $R-C$ that is.

KEN—Your good memory makes things easier for me as well as yourself. Now, depending on whether R and C have high or low values (let's draw graphs for both), the capacitor will charge rapidly or slowly. Can you tell me what happens in resistor R during this time?

WILL—Certainly. At the beginning of the charge, it carries maximum current, which makes voltage drop E_r large. As the charge continues the current diminishes, and with it voltage E_r , also according to an exponential curve.

KEN—Has it occurred to you that the sum of the two voltages E_r and E_c would be equal to the total voltage E at each instant?

WILL—I took that for granted! Obviously, then, if you know how, you can calculate the form of curve E_r from that of E_c and *vice versa*, since their sum will give you E .

KEN—I've drawn the voltage curves for a rectangular pulse with a duration T for both a long and short time constant. In the first case, we can consider the charge practically completed during the time T . In the second, it finishes much more rapidly, so voltages E_r and E_c rise very quickly and are prolonged at level E , the voltage of the flat top of the rectangular pulse. Now, what happens when the applied voltage drops to zero?

WILL—Capacitor C starts to discharge across the resistor and through the original voltage source. So E_c starts to drop (I guess I don't have to say according to the exponential rule) with the same time constant. And if that is long enough, we find our old friend the sawtooth wave we got so well acquainted with when we were studying time bases.

KEN—Our present sawtooth is a little different from those earlier ones. Here charge and discharge follow the same law, while in the time base the discharge circuit had very little resistance and so had a very short time constant. Now what becomes of E_r across our resistance?

WILL—It reverses itself! We have a negative voltage drop across the resistor. And the current—and therefore the voltage—is high at the beginning of the discharge this time too, then diminishes according to that exponential rule which seems to be the supreme law of radio.

KEN—Don't be too surprised at the change in direction of the voltage on R . With a little thinking you'd have seen it already. Since E_r plus E_c equals E , and now that E has dropped to zero, E_r will have to be negative if their sum is to be zero.

WILL—Sounds reasonable—but don't confuse me with mathematics. Can you drop the calculus and come out with a good physical explanation? That's what I understand.

KEN—Don't get so scared! The voltage E is *integrated* when you take E_c as your output. Its form is different from E —it's been rounded off—the sharp corners have been rubbed down. On the other hand, those changes are accentuated in the *differentiated* voltage E_r you take from across the resistor.

WILL—In other words, the capacitor is a jolly fat fellow who takes everything in good humor, and the resistor is an acid old hag with a sour face, jerky movements and a sharp tongue.

(TO BE CONTINUED)

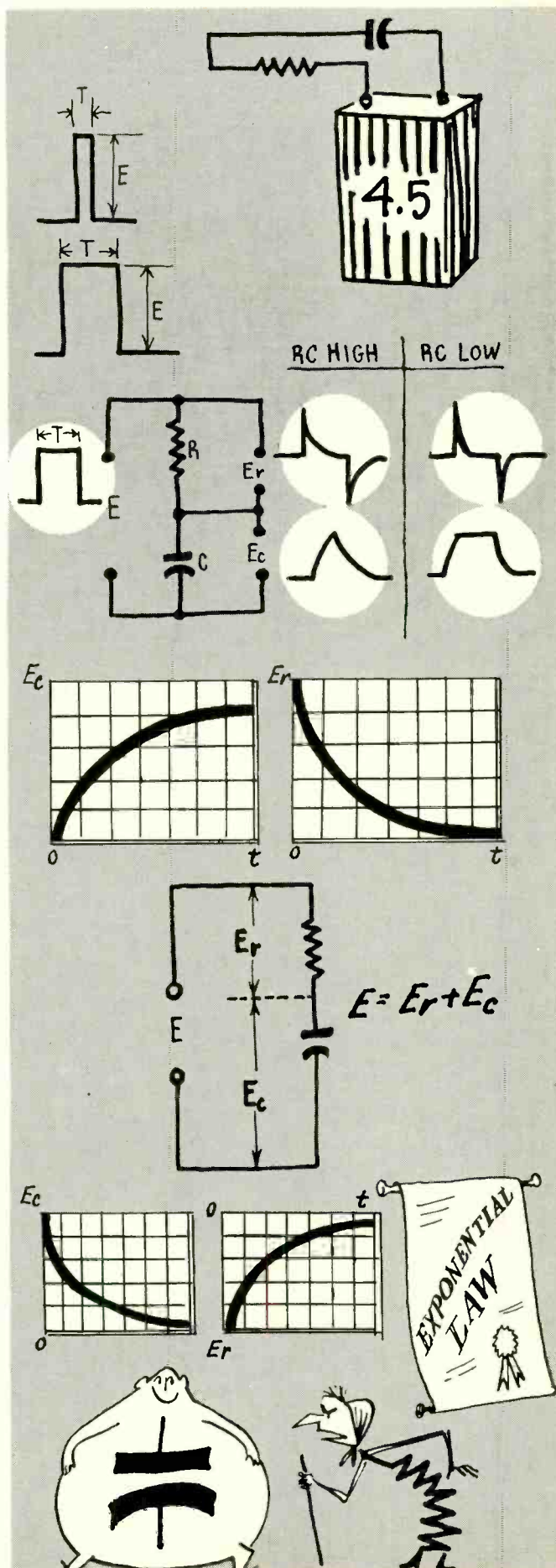

U.H.F. ALIGNMENT

Using markers and harmonic sweeps; checking tracking

By ROBERT G. MIDDLETON*

SIGNAL-GENERATING equipment used in u.h.f. servicing consists of generators designed originally for v.h.f., but which can be adapted to u.h.f.; auxiliary heterodyne units that operate in conjunction with v.h.f. generators and make it possible to obtain relatively strong u.h.f. test signals at minimum cost, and generators specifically designed for u.h.f. that operate independently of a v.h.f. generator and usually develop the purest output.

The first group of generators operates on harmonics, the second on beat fundamentals, and the third on true fundamentals.

Three principal types of u.h.f. circuit arrangements (Fig. 1) are used at present in TV receiver design.

Fig. 1-a shows a u.h.f. converter that works into the front end of a v.h.f. receiver. Since the converter energizes a front-end channel not used for v.h.f. reception, the probability is that this channel will not be in good alignment when the converter is installed. Accordingly, the first requirement in such an installation is to check the response of the front end on the channel to be used with the converter; this may be channel 5 or 6, or, in some cases, an otherwise unused channel from 7 through 13.

The arrangement shown in Fig. 1-b consists of a u.h.f. "strip" in which both the fundamental and a higher harmonic of the local oscillator are used. No additional tubes are used in strip operation; however, the use of both fundamental and harmonic output from the local oscillator makes this adjustment critical. Harmonics, up to the eighth, are commonly used in the design of strips.

One of the most satisfactory methods of setting the local oscillator to the correct frequency is to determine the proper operating frequency for the local oscillator, and then zero-beat the oscillator against a calibrated marker generator. This will be discussed later.

Fig. 1-c is similar to that of the more familiar v.h.f. front-end systems. An important difference that the technician encounters occasionally is the use of oscillator harmonic operation. Unless this possibility is kept in mind, confusion may result during alignment.

Tracking problems at u.h.f.

This refers to the closeness with which the u.h.f. tuned circuits resonate

to the same frequency as the tuning dial of the converter is turned through its range. Tracking also refers to the closeness with which the local oscillator in the converter maintains a fixed difference between its own frequency and the frequency of the u.h.f. preselector circuits as the tuning dial of the converter is turned.

Tracking can be checked using the test setup shown in Fig. 2. The output from the sweep generator is applied to the u.h.f. antenna-input terminals, while the scope is connected at the output of the video detector. This particular test setup is especially useful when harmonics of the sweep-generator output are used to check u.h.f. circuits; harmonics in general have less voltage than the fundamentals from which they are derived, and the higher-order harmonics have the least voltage. Hence it is advantageous to utilize the gain of the i.f. amplifier in the receiver, under such conditions, to obtain a substantial deflection on the scope screen.

To check tracking, note the amount of deflection obtained on the scope screen when sweeping channel 14; then vary the tuning of the u.h.f. circuits and the tuning of the sweep generator simultaneously so as to keep the response curve centered on the scope screen. When tracking is good, the response curve appears at maximum height on the scope screen; when tracking is poor, the response curve drops. Shop practice varies concerning correction of poor tracking. Most service shops do not attempt it and return the unit to the factory for exchange.

But poor tracking does not necessarily justify rejection of a u.h.f. converter; the region of poor tracking may not fall in active local channels. For example, if reception is available only on channel 23, poor tracking on channel 14 would not be a matter for concern, but poor tracking on channel 23 would.

Harmonic sweeps

The technician who uses harmonic sweeps for the first time may be surprised to find that the response curves appear very narrow on the scope screen. The reason for this narrowing is that the deviation of the sweep signal is multiplied by the order of harmonic being utilized; for example, when the third harmonic of a generator is used, the sweep width will actually be three

times as great as indicated by the sweep-width control, and the technician must back off considerably on the sweep-width control setting to obtain a conventional scope display.

Another technical point concerns progression from one band of the sweep generator to another. In a practical situation, for example, the technician will be able to check tracking from channel 14 to channel 21 on one generator band, but will find it necessary to use another band to check from channel 22 up. The order of harmonics used is now changed, i.e., from second to third in the example cited, and the new display appears reduced both in height and width. This situation is corrected by advancing the attenuator setting of the sweep generator to restore the height of the response curve, and by reducing the sweep-width setting of the sweep generator to restore the width of the response curve.

The necessity for using a "flat" sweep generator in tracking tests is obvious. If the output from the sweep generator varies substantially from one frequency to another, the receiver may be unjustly blamed for the generator deficiency. It is a good plan to undertake this type of service work only with generators having a satisfactory rating on flatness of output. When harmonics are to be used for u.h.f. tests, the flatness of output on harmonic operation should be determined. This is desirable because it is possible for the generator to have a good flatness figure on fundamental operation (v.h.f.) such as 0.2 db per mc of sweep width, but to have a very poor flatness figure on harmonic operation. The required information can be obtained from the manufacturer of the generator. In some cases, the manufacturer will recommend a special output cable for u.h.f. applications that avoids the development of standing waves on u.h.f.

The response curve obtained with the arrangement shown in Fig. 2 is an "over-all" curve. It shows the shape and bandwidth of the response of the tuned signal circuits as a whole. This is a very important determination, because the quality of the reproduced image depends to a large extent upon the bandwidth and shape of the tuned-circuit response. This curve should have the same shape as an ideal i.f. response curve that is generally specified in the service manual for the receiver.

*Field Engineer, Simpson Electric Co.

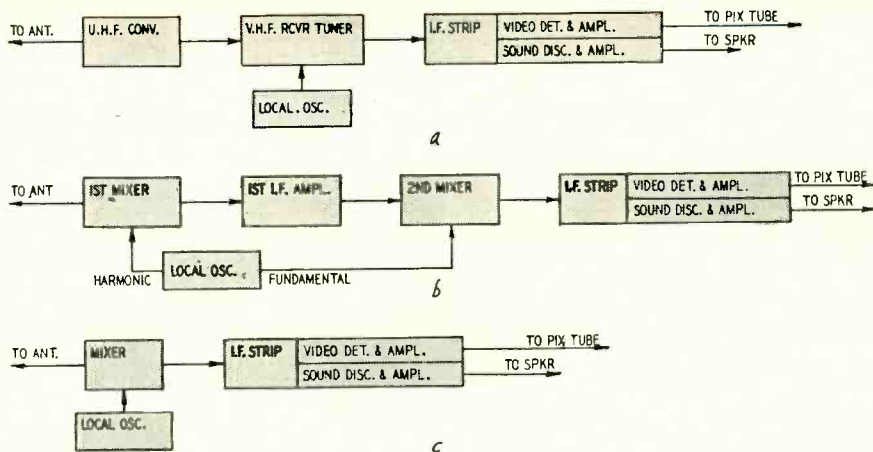

Courtesy Simpson Electric Co.

Fig. 1—Typical u.h.f. circuit arrangements: 1-a—Converter is external to v.h.f. receiver; 1-b—U.h.f. strip is used in v.h.f. turret tuner; 1-c—Single-conversion type u.h.f.-v.h.f. front end.

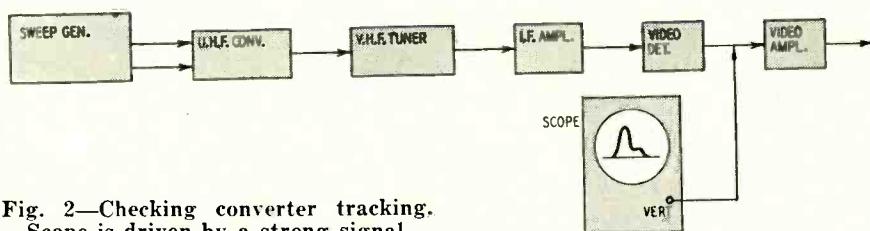

Fig. 2—Checking converter tracking. Scope is driven by a strong signal.

Such an over-all response curve can be marked in many cases with the harmonic output from v.h.f. marker generator. In such cases, the dial indication of the marker generator is multiplied by the order of harmonic being used in the alignment procedure; for example, if the eighth harmonic of the generator is being used and the dial indication is 109 mc, the marker frequency will be 8×109 , or 872 mc (channel 81). If the technician does not know which harmonic is actually indicated by the marker "bug," the best procedure is to sweep and mark a u.h.f. converter known to be in good operating condition. By setting this "control" unit to a given channel such as channel 81, the dial setting can be noted at the picture-carrier and sound-carrier positions (873.25 mc and 877.75 mc respectively). This setting will then serve as a guide to harmonic operation when a faulty unit is being checked.

Bugs derived from higher harmonics in the output of the marker generator will travel much faster on the curve than those derived from lower harmonics in the output of the marker generator. The reason for this is that the dial indication (for fundamental output is multiplied in each case by the order of the harmonic.

Markers

A u.h.f. station signal may often be used as a marker. When the lead-in from the u.h.f. antenna is connected to the input terminals of the converter through a pair of isolating resistors (Fig. 3), a marker is developed at the picture-carrier and sound-carrier points on the response curve. Try using 10,000-

ohm isolating resistors; vary this value up or down as required to obtain conventionally sized markers on the response curve.

The question sometimes arises whether a station-signal marker is a picture-carrier or a sound-carrier marker. This is quickly answered by tuning the converter to run one marker on top of the response curve, and then to run the other marker on top of the response curve. When the picture-carrier marker is on top of the curve, a sync pulse will be visible somewhere in the pattern. When the sound carrier is on top of the curve, a small wiggle will appear in the base line, due to slope-detected audio signal mixing with the scope signal.

When u.h.f. markers can be obtained both from a station signal and from a marker generator, the station-signal markers will be very useful to check the calibration of the generator. When a generator marker is "run over" a station-signal marker, the base line of the display will wiggle. The rate of the wiggle will decrease to zero at the zero-beat point. The generator frequency is then equal to the station-carrier frequency.

Spurious markers may appear on the response curve at times, whether or not a marker generator is being used. Of course, the possibility of cross-beats is greatly increased when a marker generator is used. True and false markers can be distinguished. If the u.h.f. station signal is used for marking, these markers will run along the response curve as the converter dial is turned. Also, these markers will become very large when the value of the isolating resistors is reduced. The picture-carrier

marker develops a maximum of sync-pulse display when placed on top of the curve, and the sound-carrier marker develops a maximum of audio wiggle in the base line when on top of the curve.

When a marker generator is used, three tests can be made that are helpful in distinguishing between true and false markers. These tests are shown in Fig. 4. First, rock the dial of the marker generator back and forth, watching the marker on the response curve; a true marker moves on the response curve toward the sound-carrier end of the curve as the generator frequency is increased. A marker that stands still on the curve, or runs backward on the curve, is spurious.

Second, rock the dial of the sweep generator back and forth, watching the curve and marker; a true marker moves with the response curve. A spurious marker runs on the curve.

Third, rock the u.h.f. tuning control of the converter or receiver; a true marker moves with the response curve. A marker that runs on the response curve is spurious. END

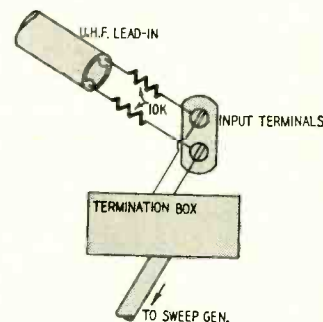

Fig. 3—Connecting u.h.f. lead-in.

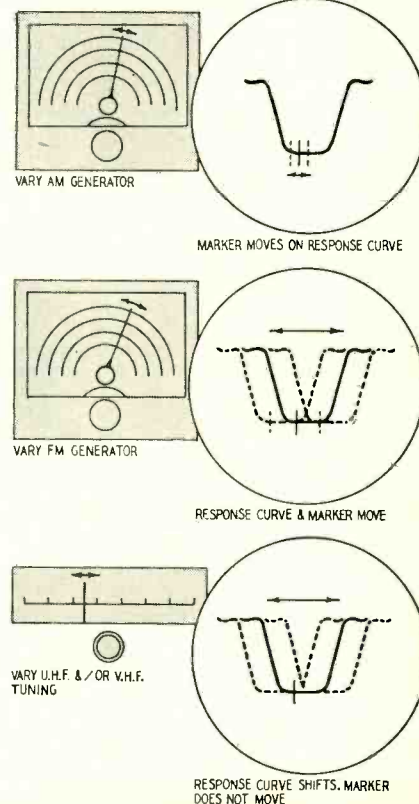
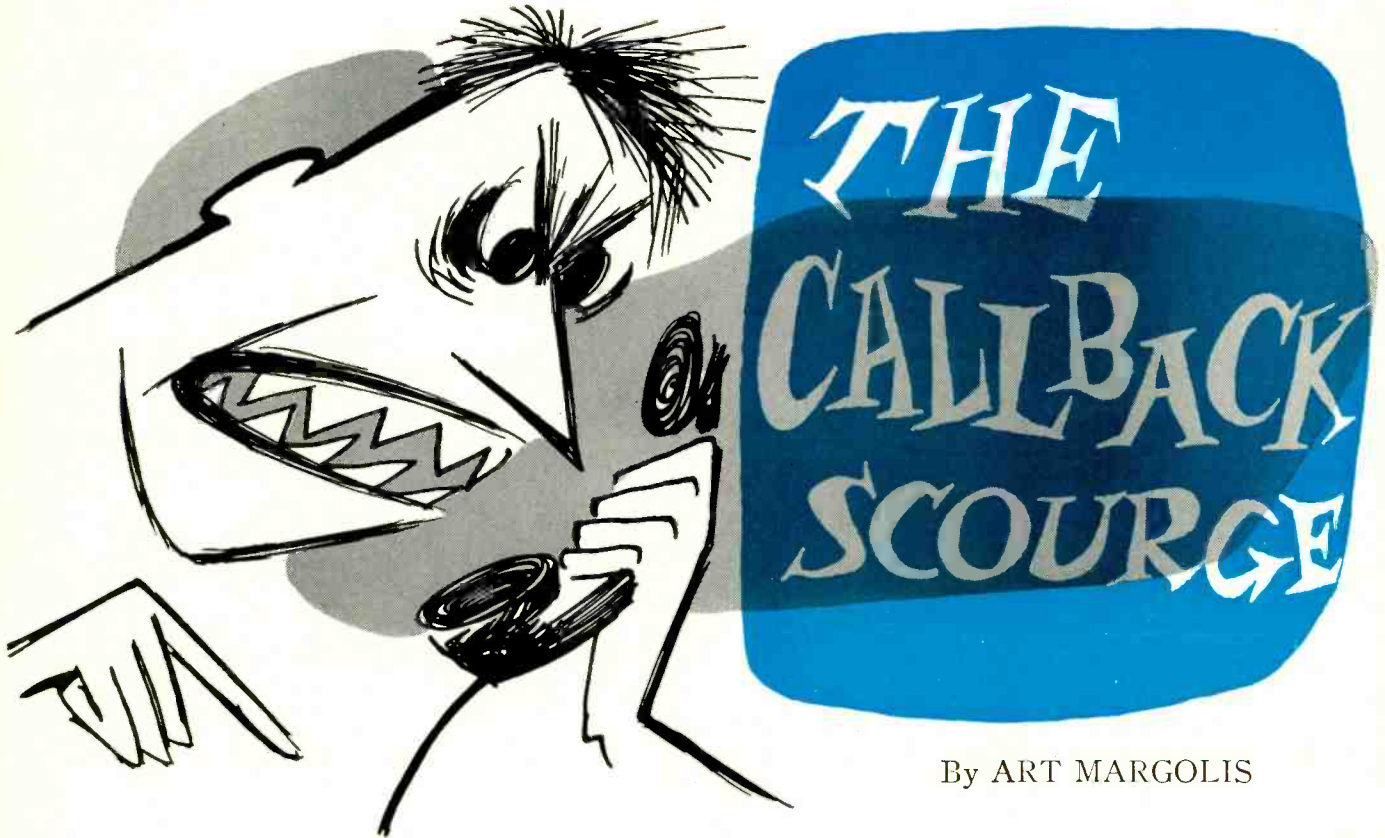

Fig. 4—Three spurious-marker tests.

Courtesy Simpson Electric Co.



By ART MARGOLIS

ARE callbacks a nuisance? Are they aggravating? What dire thoughts of mayhem run through your mind when you pick up your telephone and a sweet voice says, "Three weeks ago you people repaired my television set. I still have the same trouble. I would have called right away, but I've been away."

You pull out your file card and note that you changed a .002- μ f capacitor in the integrator. The bottom of the picture had been locking in about $\frac{1}{2}$ -inch off the bottom of the screen. You say, "Yes ma'am, what seems to be the trouble now?" The overpolite answer is, "Oh, it's the same thing, no sound."

This is not an extreme case. Callbacks in general occur often enough to be a major threat to the solvency of TV service shops, large or small. They skim the cream right off the top of the profit. What can be done?

I was out on a call the other day—weak picture on all channels. It was a clear-cut case of antenna trouble. After showing the customer a much-improved picture by removing her antenna and installing my rabbit ears, I hopped outside for a look around. The stacked conical looked fine. Following the 300-ohm lead-in down the side of the house, I noticed a break. It was about 4 feet off the ground, where it entered the window sill. I spliced the lead—under constant threat of a menacing Great

Dane; the picture returned to its original beauty and the people were happy.

Exactly 22 hours and 31 minutes later I received a callback—same trouble. I explained to the man of the house in great detail how to splice the wire and informed him that, if his prize-winning hound continued to break the lead-in, he would have to just keep splicing it.

Numerous callbacks require simple adjustments which, following your instructions, the customer can clear up without your personal appearance. A telephone call plus a little common sense can save you many dollars.

Paul, our North Philly service technician, made a call recently. The customer phoned 3 hours later, full of complaints. "The picture is out of focus and when the people stand up their heads are chopped off." Although decapitation was a serious thing during the French Revolution, it is an easily corrected condition in television. The service manager called the customer and got the man of the house on the phone. A few simple instructions on vertical linearity and the customer was a proud adjuster of his own TV set.

Each case is individual, but taking advantage of all possible factors, money can be saved. We replaced a few tubes in a 16-inch Admiral the other day. One of them was a 6AL5 ratio detector. After a few days the sound became garbled. Knowing that the owner was

an auto mechanic I gave him explicit instructions: "Remove the knobs, the back and the packing bolts. Pull the chassis halfway out. With a long, thin screwdriver, turn the under-side adjustment on the ratio detector transformer 180° clockwise." This in his own language "ungarbled the sound" and left the customer glowing with achievement. This case is unusual but you can get people to make vertical sweep, horizontal frequency and numerous other little adjustments.

(This practice could prove extremely costly. The various coils and i.f. transformers generally look alike to people not acquainted with radio or TV chassis, and an incorrect adjustment could mean that the set would have to be returned to the shop for realignment.—*Editor*)

Make callbacks fast

What about callbacks you must make? These (unfortunately) are in the majority. If you must make the call, do it promptly.

A customer of ours had an exceptionally bad streak of luck. She called on a Tuesday and I handled the call. It was a 14-inch Westinghouse with not enough high voltage. The grid capacitor of the horizontal output tube had a high-resistance short. I replaced it, collected for the job and left. Two days later the customer called again. This time the horizontal tube was dead. Three days

later she called again. This time it was an open filament on the picture tube. A week later she called again. I went grimly determined this time. It was a fight to the death—the TV set or me. I found an open damper tube.

Now the point is this: There was recurrent trouble. Parts and labor were paid for every time and the customer, though miserable with her set, was not unhappy with us because we came promptly each and every time.

Callback treatment

Callbacks are usually shabbily handled. While the original call is made in a matter of hours, the repeat call sometimes takes days and constant hounding by the customer.

A few years ago Harold, working South Philly, stumbled on a sweet morsel of business. He received a service call on a large three-way 16-inch Admiral, one of those old jobs with separate chassis, picture tube and power supply. The chassis is a side mount, hanging by four bolts. If you have never tried balancing the chassis with one hand and inserting the bolts with the other, consider yourself fortunate.

He fixed the set *muy pronto*. The thrilled owner happened to be the proprietor of a prosperous meat store. In no time at all his clientele was ours. This joyful situation continued for 6 months, until the butcher's set went haywire again. Our new South Philly man did not take too kindly to this aging TV monster. The set was pulled into the shop and given extensive repairs. With crossed fingers, we sent the set back with our best technician. Three hours later a bedraggled service technician returned to the shop with a victorious smile.

How dismal life appeared when a callback to Max the Butcher appeared on the docket a few days later! Naturally, it was dragged out. Who would want to stake his reputation on an old beat-up chassis? As a result we lost the butcher and, subsequently, all his customers. While the original call created confidence, the callback created ill will; and in this case a sizable loss of income.

I did a house call a few months ago. There was horizontal sync trouble in a 16-inch Motorola. I changed the horizontal oscillator and horizontal phase detector tubes. This seemed clear-cut and the customer was very pleased. She was a 60-year-old widow, living with her 90-year-old mother. They were two sweet old ladies and very dependent on their television set. Two days later, she called in again with the same trouble. I knew I had a dreaded intermittent horizontal sync on my hands. Did you ever try to explain to two lemonade-offering ladies that their set had to go to the shop, with no definite cost estimate and no promise of delivery?

The set was ready in about 5 days. A leaky bypass capacitor in the plate of the horizontal oscillator was shifting the horizontal oscillator frequency. Fearing arsenic, I was relieved there

was no offer of soft drink upon the chassis' return. No longer sweet to me, the two ladies would have rather put a garrote around my neck instead of the money in my hand. They had spent their usual viewing time the past five nights discussing our television service. We did everything possible for a satisfactory repair, and they spent the repair time working themselves into a frenzy over the delay.

In cases of this type, the only thing one can do is loan out a spare set. The empty hours must be filled. It's costly, true, but consider what value a loan-out would have had in this particular case.

One day I was sent on a recall to a fairly rough section of Philadelphia and I was glad it was early afternoon. The woman of the house seemed frantically glad to see me. I didn't think too much of it at the time, but after inspection of the set (I found insufficient high voltage and routine checks did not reveal the trouble) I informed her that I would have to pull the chassis into the shop. She burst into tears. She told me her concern was with her husband. He had instructions from his parole officer to stay home after 7 pm. The last two nights, because the TV set was inoperative, he had gone out in violation of this order. He had stayed home all the while the television set worked. The wife pleaded with me to get the set back as soon as possible.

The high-voltage transformer was replaced and the set was ready in about two days. I called the woman and told her she could expect the set in a few hours. She told me not to rush. Her husband had gone out the night before

—he was caught with three others hijacking a truck.

Possible solution

How can we stop callbacks from draining our profits? A good way to attack the problem is to figure out how many callbacks you have on how many calls. For instance, pick out 100 original calls. On these calls, see how many callbacks you have (you probably will be amazed at the number). Find the average number of callbacks per call, and add the cost of this average figure to the amount you charge on service calls. It will probably come to a dollar or two depending on how you have been operating. If you raise your prices by this figure, you are then being paid for all callbacks before you receive them.

The human frailty of the intelligent service technician is a major obstacle. He takes pride in his work. He strongly dislikes returning to a place where he might receive a blow to his pride. There is even a certain amount of fear in facing the customer, the person who might now have a tainted opinion of his ability. However, the technician must realize that his customer, whether doctor or laborer, has very little knowledge of TV. How many times have you been told, "There is definitely a shortage in my set"? Have a little patience and understanding for the knowledge people do not possess and often envy you for having. In this way it is much easier to face and handle a person whom you might feel thinks little of your ability. I'll never forget the carpenter who brought out an expensive bubble level and said, "This time I want that picture straight!"

END



THE

SYNCHROGUIDE

CIRCUIT

By E. R. GUNNY

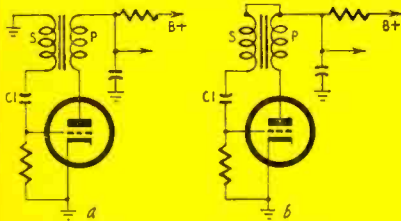

Fig. 1—Basic blocking oscillators.

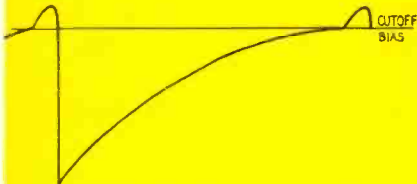

Fig. 2—The oscillator grid voltage.



Fig. 3—Ideal grid-voltage waveform.

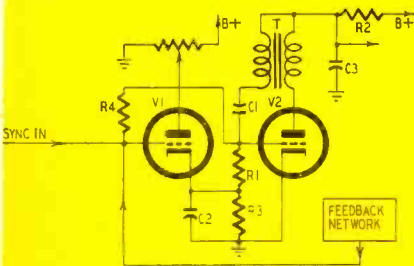

Fig. 4—Improved blocking oscillator.

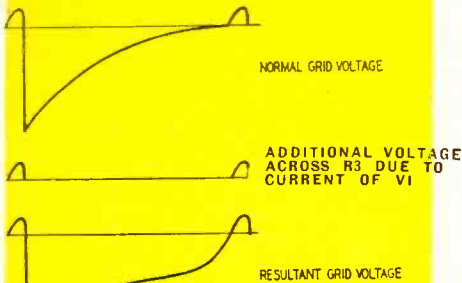

Fig. 5—Obtaining desired waveform.

Analyzing the famous RCA horizontal a.f.c. network

TELEVISION sweep generators today use two basic circuits: the multivibrator and blocking oscillator. Each has certain advantages. The blocking oscillator requires one tube and a transformer in addition to other components; the multivibrator usually needs two tubes and no transformer. Thus, from a standpoint of number of parts, there is little difference. Power-wise, the picture is different.

In a multivibrator, one of the two tubes is always conducting fully. In the blocking oscillator, plate current flows only during the period of conduction, or flyback time. On this basis, the blocking oscillator appears a better choice where power conservation is desired. However, the ordinary blocking oscillator circuit is susceptible to noise-pulse triggering, resulting in horizontal tearing or vertical rolling. To overcome this characteristic of the blocking oscillator and permit its use as a horizontal sweep generator, the Synchroguide circuit was developed.

To understand the Synchroguide circuit one must understand the basic blocking oscillator (Fig. 1-a). A variation of this circuit is shown in Fig. 1-b. The blocking oscillator operates as follows:

1. When plate and heater voltages are applied, plate current flows through the transformer primary.
2. The plate-current flow induces a

voltage in the grid winding (secondary) of the transformer, driving the grid positive.

3. Plate current flow increases, causing a still more positive grid voltage. This condition continues until the plate current reaches a maximum, determined by the tube and circuit values, and can increase no further. At this time no voltage is induced across the grid winding of the transformer.
4. While the grid was positive, it attracted electrons from the cathode, which charged capacitor C1 and made the grid side of it negative. Thus when the transformer secondary voltage drops to zero, the released electrons drive the grid far negative, and the tube is cut off.
5. The tube remains cut off until the charge on C1 can leak off through the grid resistor to a point where the grid voltage will once again permit the tube to conduct. Then the process is repeated.

During this cycle the grid voltage, viewed on a scope, appears as shown in Fig. 2.

The tube can be made to conduct earlier than normal by inserting a positive voltage pulse near the end of the cycle. Notice that the grid voltage levels off as it approaches the point of conduction. It is this characteristic that makes the circuit respond to noise. If the grid rise could be altered as shown

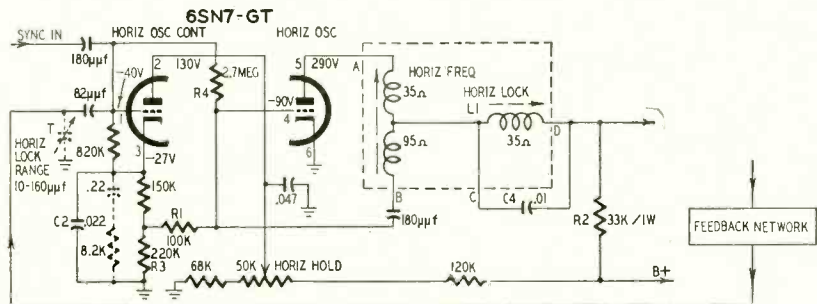

Fig. 6—Schematic diagram of the Synchroguide circuit showing all values.

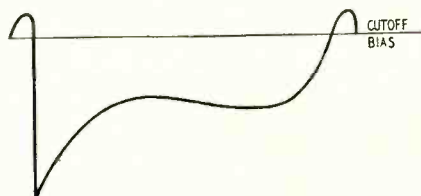

Fig. 7—Grid voltage in Synchroguide.

in Fig. 3, noise pulses would have less effect. With just this in mind, the circuit shown in Fig. 4 was designed.

The operation of this circuit is as follows:

1. Components V2, T, C1, R1, C3 and R2 operate as a conventional blocking oscillator.
2. Some of the output is fed back to V1, which is held at cutoff by the oscillator grid voltage coupled through R4 and by the cathode voltage across R3 until near the end of a cycle.
3. The feedback is arranged to provide for a fast rise of current through V1 near the end of the cycle to modify the grid voltage rise on V2 (Fig. 5). As might be expected, with the addition of V1, component values have to be changed to maintain the correct frequency.

Thus this circuit keeps the grid voltage of the blocking oscillator away

from the conduction point until the proper sync time is near. This insures a more noise-free condition. Sync is introduced directly on the grid of V1, keeping the grid of V2 free of direct connection with possible sources of noise. While V1 is cut off, noise pulses cannot have any effect unless they exceed the cutoff bias. The plate voltage of V1 is made variable. This controls the amount of current flow during the conduction period, thus affecting the average voltage across R3. The voltage across R3 controls to a limited extent the free-running frequency of the blocking oscillator.

The incoming sync signal also affects the conduction of V1. If the oscillator is running slow, the sync pulse will tend to increase V1 current flow, thus raising the voltage across R3, which in turn, speeds up the oscillator. If the oscillator frequency is too high, V1 may be driven to cutoff before the sync pulse can add to the current of V1, permitting the average voltage across R3 to drop. In normal operation the oscillator conducts during the sync period, permitting only part of the sync pulse to contribute to control of the V1 current. For this reason the circuit is termed a pulse-width a.f.c. system. In the commercial version C2 is shunted by a series R-C circuit to improve long-time frequency

stability and prevent a "hunting" action of the control tube.

The circuit described was modified again to arrive at the final Synchroguide circuit as we know it today (Fig. 6). The added modifications include L1 and C4 which constitute a parallel resonant circuit tuned close to the horizontal scanning frequency. Some of the voltage developed across this tank circuit is coupled back to the blocking oscillator grid to change further its waveform, as shown in Fig. 7.

Some versions of the Synchroguide circuit include a frequency locking range trimmer across the grid of the control tube. This trimmer serves as a voltage divider for the input signals. As its capacitance is increased, the noise immunity of the system improves but the pull-in range narrows down.

Occasionally if component values change, or the frequency of the resonant circuit is too far off, the oscillator may double-trigger erratically, causing a ragged appearance on the raster, with one or more jagged vertical lines. To correct this, a jumper lead should be used across transformer terminals C and D to short out the resonant circuit. Now steps can be taken to correct the frequency of the circuit. Once normal operation is attained, the jumper can be removed and L1 adjusted. END

CHECK THE PICTURE TUBE

By J. DUBINSKY

MOST service technicians are aware of the many difficulties caused by defective picture tubes. Probably millions of man-hours have been lost by members of the servicing fraternity before discovering the fault was in the picture tube.

One of the most common defects in these tubes is an intermittent heater, caused by bad or corroded connections to the heater at the base of the tube. Soldering these connections is difficult and usually results in the pins becoming loose when too much heat is applied. A technique I have found successful is to set the tube down on its face, heat the pin and then insert a length of stiff tinned wire into the opening, at the same time applying fresh solder. Usually this makes a good tight joint.

Another common source of trouble—one that sometimes can be corrected—is a cathode-heater short. I was called on recently to repair a TV receiver that was cutting out completely after a half hour of operation. This set—a 12-inch Admiral—had been serviced many times and would have been heaved out if it hadn't been a gift. This C-R tube cathode was the control element rather than the grid. Thus the cathode-heater short cut out both picture and brightness, giving the effect of loss of high voltage.

I installed a small 6-volt transformer, connecting its output to the heater of the picture tube. With the

heater isolated from ground, the cathode-heater short made no difference. This was a permanent cure.

The most common cause of picture-tube difficulties is weak or low emission. All sorts of devices have been put on the market for boosting or reactivating the cathode emission of picture tubes. These range from short bursts of high heater voltage to raising the heater voltage slightly (to about 9 volts) with a small autotransformer. Either method brightens the picture for a while but should be used only when it is certain that the trouble is low cathode emission.

In one case, the owner of a 21-inch RCA receiver found himself with a weak picture. Instead of calling a competent service technician, he bought and installed a booster. The picture brightened a bit but it was out of focus.

Examination showed that the tube used electrostatic focusing, which was cut out when the booster was installed. To top it off, the dim picture was not caused by a defective tube, but by a defective capacitor and resistor in the screen-grid supply to the picture tube.

Using a transformer for isolating the heater of a picture tube can often cure another condition—an ineffective brightness control. If the isolation transformer doesn't cure the trouble, you will probably have to replace the tube (assuming the circuitry is O.K.).

I had one case—a Hallcrafters 17-

inch receiver—where I couldn't reduce the brightness but did get a good picture and sound. This condition was traced to a defective coupling capacitor. Replacing this unit in the cathode circuit of the picture tube brought the picture back to normal.

A bad case of horizontal tear in a 30-tube 630 chassis was finally traced to the picture tube. If the brightness control affects picture stability, probably there is gas in the picture tube.

I once spent many hours on a Transvision set that had a very critical vertical hold. Practically everything possible was done to stabilize the vertical circuits. It finally dawned on me that the only thing I had not tried was a new picture tube. The 12-inch tube was replaced and sure enough that was it.

In another case, a 17-inch RCA developed a very bad vertical jitter. It was almost impossible to get the picture to stay steady. Strangely enough the horizontal hold was solid and the picture was very good. Yes, you guessed it—the picture tube.

A lot of your troubles can be and often are in the picture tube. A weak washed-out picture can stem from troubles in the tuner, i.f. or video output circuits. But it can also be caused by the picture tube.

In a case of intermittent brightness, try tapping the neck of the tube. If the picture jumps in bright or if multiple horizontal bars are seen, the tube is N.G. END

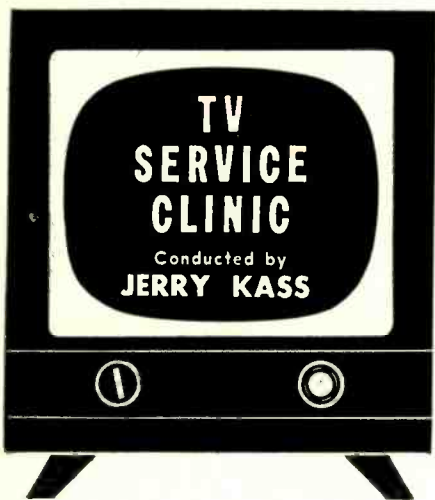

IN last month's discussion of sync separation we assumed that the incoming signal is reasonably free from noise. Unfortunately this is too often not the case. There are many sources of noise. It can be created by any arc-producing electrical equipment such as automobile ignition systems and motors, by atmospheric conditions or by arcing within the TV receiver. In each case noise impulses may be induced in the antenna or transmission line by direct radiation from the source of arcing and become part of the incoming signal. Many recent questions have dealt with points falling in this area, and the following is an attempt to answer all these as well as other inquirers who have the same questions in mind.

Noise affects the deflection circuits more than any other part of the TV receiver, so circuits have been developed to eliminate or attenuate it in the sync separator before it has a chance to disturb the action of the sweep generators.

Noise pulses are generally of short duration. However, when fed into the vertical oscillator's integrating network, they can charge the capacitor to a point of normal synchronizing amplitude. This triggers the vertical deflection oscillator before its normal time and the picture rolls vertically. To the horizontal sweep system noise pulses often appear as horizontal synchronizing pulses and cause false triggering that results in tearing.

The solution to this problem could lie in the use of shorter time constants in the grid-leak circuits of the sync separator. But this is not practical since a grid-leak time constant in this circuit must be long enough to maintain bias between horizontal lines and during the vertical pulses. Otherwise the clipping level will change. Also, noise pulses in the sync circuit increase the grid bias and reduce the sync gain. Some TV receivers have separate vertical and horizontal sync separator stages. In this way the time constants of each circuit are designed for maximum noise rejection.

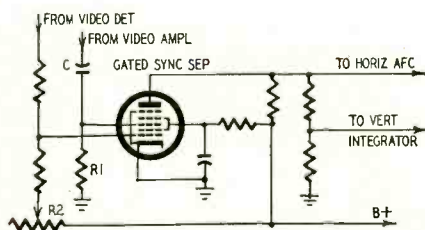

Fig. 1—Basic gated sync separator.

Gated sync separator

Becoming extremely popular is a circuit combining sync separation and noise cancellation, using a single pentode tube (Fig. 1). The circuit operates as a gated amplifier that separates the sync pulses from the composite video signal and removes all noise pulses that are of greater amplitude than the incoming sync pulses.

Grid 3 of the sync separator, usually a 6BE6 or a 6CS6, receives a portion of the composite video signal from the plate circuit of the video amplifier. The signal is of positive polarity and fed through C. The plate and screen voltages of the tube are kept low (20 to 30 volts) and the signal on grid 3 causes grid current to flow, charging C to the level of the sync pulse. Between sync pulses, C discharges through R1 and develops on grid 3 a bias approximately equal to the incoming signal's blanking level. Thus grid 3 holds the tube in cutoff except during the peak amplitude of the sync pulses, removing the video content and permitting only horizontal and vertical pulses (gated output) to appear in the plate circuit. This is essentially the same operation we observed in the conventional triode sync separator.

Noise pulses in the video amplifier plate circuit below the level of the sync pulses are not passed by the sync separator because the tube is cut off for all signals more negative than the bias on grid 3. However, noise pulses greater in amplitude than the bias level would make the horizontal and vertical synchronization extremely unstable by excessively biasing grid 3 and blocking its normal operation, possibly during several consecutive sync pulses. These noise pulses are prevented from affecting sync stability by the action of grid 1.

Grid 1 is biased slightly positive by connecting it to a low-voltage point on a voltage divider that extends from the video detector to B plus. The bias voltage on grid 1 is varied by potentiometer R2. The composite video signal, with sync pulses negative (180° out of phase with the signal on grid 3), is fed to grid 1 from the video detector. The bias on grid 1 is set so that the sync tips of the composite video signal are near cutoff.

As long as noise pulses are not

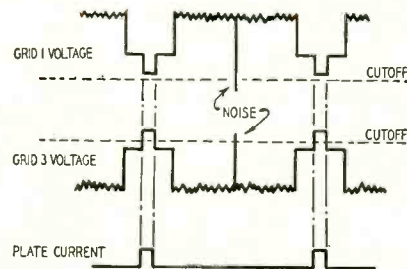

Fig. 2—Operation of the noise gate.

greater in amplitude than the sync tips, the positive bias on grid 1 is not overcome. Each sync pulse appearing at grid 3 drives that grid sufficiently positive to overcome its bias, permitting plate current to flow. When noise pulses greater in amplitude than the sync peaks appear, they drive grid 1 beyond cutoff, halting the flow of plate current and preventing the tube from passing the noise on to the sync circuits (Fig. 2). The tube remains cut off only for the duration of the noise.

Any noise pulses occurring at the same time as the sync pulses cut off the tube and sync pulses may be lost. Since the noise pulses are of much shorter duration than the sync pulses, the stability of the horizontal and vertical oscillators will not be affected. Besides, even if some sync pulses are lost, the flywheel effect of the oscillators will keep them synchronized until the next sync pulse arrives. For maximum noise rejection R2 should be set so that the tube cuts off slightly above the tips of the sync pulses. No effect will be noticed in the picture unless the noise burst is unusually long. One further point, the noise elimination circuit does not remove visible noise from the picture; it only isolates the sweep circuits from the effects of noise.

Making the bias on grid 1 less positive provides better noise immunity with weak signals, permitting noise pulses to drive the grid negative enough to cut off plate current. Insufficient positive bias lowers the gain of the tube, causing weak vertical and horizontal hold. Too much positive bias results in greater sync output but less noise immunity.

Zenith circuit

Fig. 3 is a schematic of a sync separator and noise eliminator circuit used in Zenith chassis. The composite video signal is taken from the 12BY7 video amplifier and fed through R1 to grid 1 of the 6BE6. Potentiometer R3 (7.5 megohms), connected in series with R2, to the 250-volt line adjusts the bias on G1. The potentiometer is called the *fringe lock* (other manufacturers refer to this adjustment as the noise gate, electronic stabilizer, sync control).

The positive-polarity composite signal from the 12BY7 plate is applied to grid 3 of the 6BE6 and establishes a bias as a result of grid-leak components C1-

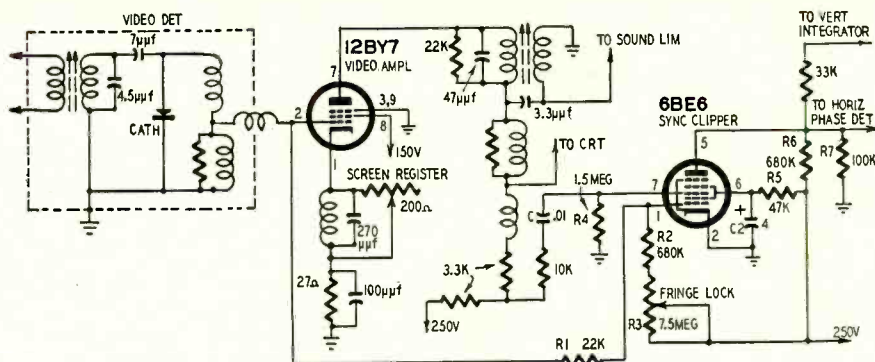

Fig. 3—Zenith's fringe-lock circuit—sync separation and noise elimination.

R4. The bias is just above the signal's blanking level. The positive sync peaks, because of the low plate voltage (30), drive the plate current into saturation. Thus the signal at the plate circuit consists of clean, clipped sync waveforms which are then fed to the vertical and horizontal sync circuits.

The cathode of the 6BE6 is grounded and so does not contribute cathode bias to the tube. The bias on grid 3 is provided by time constant C1-R4 from grid current drawn during sync peaks. The plate is maintained at a fixed positive voltage by voltage divider R6-R7. The screen is bypassed to ground through C2, a 4- μ f electrolytic capacitor, and connected to B plus through R5.

Fringe-lock adjustment

This circuit is of particular value in weak-signal areas where noise is present, especially for increasing the stability of the vertical oscillator. Turn the fringe lock counterclockwise and adjust the vertical hold control for maximum stability. Then advance the fringe lock until a noticeable improvement in sync stability is obtained. In strong signal areas the fringe lock must be more carefully adjusted. Select the strongest channel and, as before, stabilize the vertical oscillator. Advance the fringe-lock control until the picture begins to shift slightly in a horizontal direction, then turn it slowly back just below this point. Check this setting on other channels and readjust the control if necessary. If both strong and weak signals are present, adjust the control for best overall performance.

Service notes

In general, our discussion last month on servicing sync circuits applies here. The main difference is the noise cancellation circuit. The plate and screen of the pentagrid tube are generally operated at a low voltage and circuit operation will not be critical to changes in this voltage. Thus, in cases of poor vertical and horizontal sync, first check the plate circuit with an oscilloscope. If the pulse amplitude is below manufacturer's specifications, carefully check the noise cancellation circuit. A slight variation in the bias voltage on grid 1 controls greatly the amplitude of the sync pulses in the plate circuit. Since

the grid-1 circuit originates in the video detector, improper action of the grid-1 circuit should be checked back to its source.

Sync compression

If the sync level is reduced as compared to the level of the rest of the video signal components, the condition is referred to as sync compression. This could be caused in the video amplifier, prior to the sync takeoff, by insufficient grid bias or excessive signal input overloading the stage.

Besides causing unstable synchronization, sync compression is usually accompanied by excessive picture contrast. When these symptoms occur, check the output of the video detector with a scope because the overloading could be taking place in the i.f. amplifier. Check the grid bias on the i.f. amplifier tubes. If it measures low, check all components in the a.g.c. system, especially the delay capacitor. It is usually well to replace this unit—it often becomes leaky and causes this condition. If compression is the result of excessive signal, insert an attenuator such as an H pad in the antenna. If the receiver has an a.g.c. threshold control, try adjusting it.

Sync compression is also caused by poor low-frequency response as a result of poor tuning or misalignment. The improper sync action caused by this will often cause horizontal picture pulling.

Still another cause of sync compression is the overloading of i.f. and video amplifiers by strong audio signals, causing an almost total loss of sync and a negative picture. This situation can best be handled by correcting the local oscillator frequency to bring the sound carrier down from the top of the response curve.

Correction

The December, 1954, installment of the TV Clinic had a photo showing Barkhausen oscillations appearing on the right side of the screen. This, after we had gone to great length to explain why they appear at the left side. The error was due to the photo being turned over during printing. Latest reports indicate that Barkhausen oscillations are still in business at the left side of the screen.

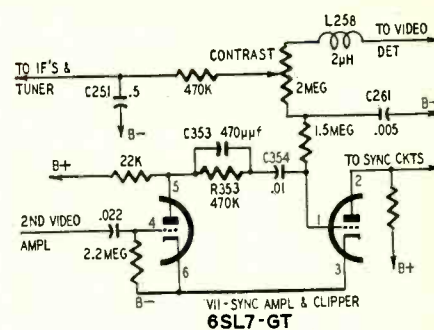

Fig. 4—Contrast circuit in G-E 17C105.

Excessive contrast

A G-E model 17C105 came in with excessive contrast and no control of contrast after 10 minutes of operation. There were other defects in the set but after they were cleared up the contrast trouble remained. To correct this condition I checked all coupling capacitors in the video i.f. section. I also checked many associated components with no success. It looks very much like the video amplifier is overloaded by the input from the i.f. amplifier.

All tubes in the front end, video i.f. and video amplifier were replaced. I have not replaced the 1N64 crystal. I am at a loss as to what to do next. Any information you could give would be deeply appreciated.—S. J. S., Cleveland, Ohio.

Before any circuit checks are made, investigate the possibility of excessive signal input to the receiver—place an attenuator pad in the antenna input circuit. Should the defective contrast condition exist under normal signal conditions, replace the 2-megohm contrast control (Fig. 4). Check for a shorted or leaky coupling capacitor C354 or for an open circuit in capacitor C353. Also, check for a short in C251, the a.g.c. bypass capacitor.

Since the picture control is ineffective, check C261. A defect in this capacitor would cause extremely erratic operation of the contrast circuit—even make the contrast control work backward. There is the possibility of an open circuit in choke L258. Finally, check the waveform at pin 4 of V11, the sync amplifier and clipper. You should read approximately 45 volts peak to peak.

Hot transformer

The low-voltage power transformer in a Stromberg-Carlson model TC19 television receiver is running extremely hot. There is nothing wrong with the picture and all controls appear to be operating normally. I have checked the power supply for shorts, including the filament windings, but could find nothing wrong.—J. M., Durham, N. C.

There is nothing wrong with the power transformer other than the primary being wired with a No. 22 conductor. Some production runs used a heavier No. 16 wire. Unless the heat is affecting other components or insulation do not change the transformer. END

COLOR TV CIRCUITS

Part X—Isolating defective circuits in color TV receivers

By KEN KLEIDON* and PHIL STEINBERG*

THIS, the final article of this series, will review the servicing points covered in previous articles and present the servicing aspects of a color receiver from a practical viewpoint.

The NTSC color transmitting standards being compatible, a color television receiver is capable of receiving black-and-white signals. Thus, a color receiver can be considered as nothing more than a black-and-white receiver with the additional circuitry required for color and a different type picture tube. Any color receiver on the market at the present time—regardless of make or manufacturer—can be divided into three basic sections: black-and-white circuitry; additional circuitry required for color; color picture tube and associated circuitry. Fig. 1 illustrates the three-part division of a color receiver and the circuits contained in each part.

Most later-model color receivers use basically the same type of circuitry and a three-gun color picture tube. We will therefore use Raytheon's 19-inch color receiver as a basis for analysis. This receiver has 39 tubes plus a three-gun picture tube. The circuit breakdown, following the block diagram of Fig. 1, is: black-and-white section, 40% of the circuits; picture tube and associated circuitry, another 40% of the circuits; color circuits, the remaining

20%. The percentage figures were determined by the number of tubes in each section.

When servicing monochrome receivers, the service technician learned to use the face of the picture tube as an indicator to determine which section of the receiver is defective. Each section of the receiver contributes to the picture, and the picture tube shows what is lacking. The technician can then go to the section that controls the defective portion of the picture and make the repair. Since this servicing method is effective for monochrome, there is no reason why it will not also apply to color servicing.

Isolating defective sections

By analyzing the face of the picture tube when trouble occurs in a color receiver, and using the tuning control, you can easily determine which of the three sections of the receiver is defective. If, when tuned between channels (no video information present), the picture tube shows a raster which fills the screen horizontally and vertically, has adequate brightness and appears black-and-white, that large portion of the color receiver consisting of the picture tube and its circuitry is functioning normally. This circuitry, as indicated in Fig. 1, includes the picture tube, low-voltage, convergence, high-voltage, horizontal and vertical deflection circuits. Each of these must be functioning properly to display a black-

and-white raster. Therefore, by observing the face of the picture tube and tuning between channels, you can determine whether 40% of the receiver's circuits are in good order.

Because the NTSC system is compatible, a color receiver is capable of receiving and reproducing a black-and-white signal. Thus the picture tube and tuning control can again be used to isolate trouble in a color receiver. When tuned to a monochrome station, the picture tube should show a black-and-white picture if it and associated circuitry along with the tuner, i.f. amplifiers, a.g.c., sync, d.c. restorers and Y channel circuits are functioning properly. This simple check will determine whether another 30% of the receiver's circuits—in addition to the picture tube and associated circuitry—are in working order. The sound section of the receiver can also be checked when tuned to a monochrome station. If the sound is acceptable, then an additional 10% of the receiver's circuits are normal.

The sound section (10%), black-and-white circuits (30%) and the picture tube and associated circuits (40%) constitute 80% of the circuits in a color receiver. This leaves only 20% of the receiver to be checked. This 20% consists of the color circuits: chrominance bandpass channel, color oscillator and control circuits, color demodulators, color video amplifiers and associated

*Raytheon Manufacturing Company, Television and Radio Division.

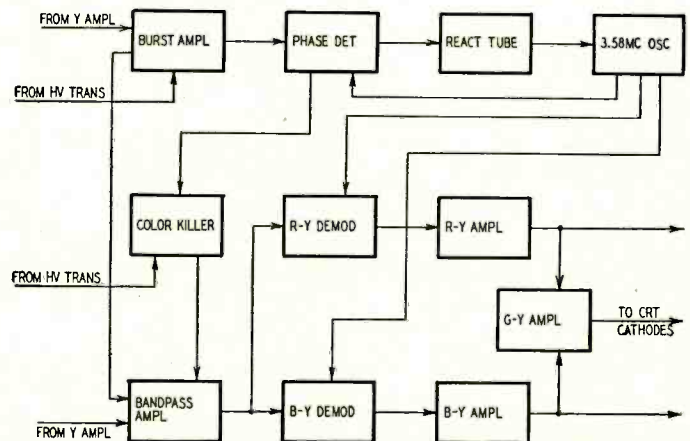
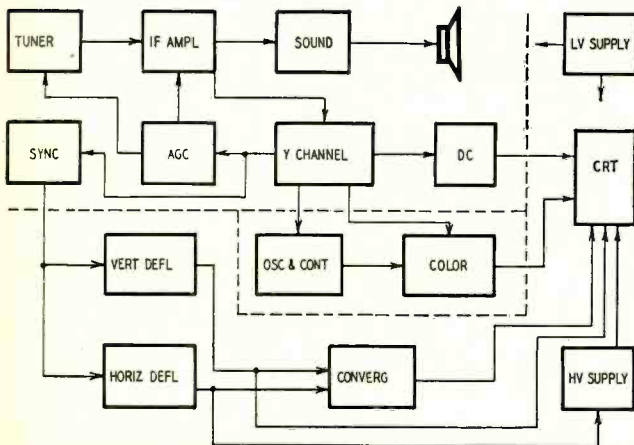

Fig. 1 (left)—Division of a color receiver. Fig. 2 (right)—Expanded block diagram of the color and oscillator control circuits.

circuitry. By observing the face of the picture tube and tuning to a color telecast you can determine whether the color circuits of the receiver are operating normally.

Isolating defective stages

When the defective section of the receiver is located, the picture tube can be used to further isolate the defective stage in that section.

When a black-and-white raster is not obtained between stations, the trouble will be in the picture tube or associated circuitry. The appearance of the raster will indicate which stage of the picture tube circuitry is defective.

Insufficient or no vertical sweep would be caused by a defect in the vertical deflection circuit. A failure in the high-voltage, horizontal deflection or low-voltage circuit would cause almost the identical appearance on a color picture tube as on a monochrome tube. If trouble occurs in either the cathode, grid or screen circuit of the picture tube, the servicing procedure would be similar to that used for a monochrome tube because a three-gun color tube can be considered as three separate tubes in one glass envelope. Since each of the three guns has an individual cathode, control grid, and screen grid, the only difference between them is the color of each electron gun's phosphor-dot screen. Therefore, if a component is defective in one of the three cathode circuits, for example, its effect on one color is easily noticed.

When tuned to a black-and-white transmission, the picture tube should show a black-and-white picture. If a normal picture is not obtained, the cause of the trouble would be located in either the black-and-white circuits or the picture tube and its circuits. Color fringing due to a convergence-circuit control misadjustment or circuit failure would be evident only with video information. If a black-and-white raster is obtained by tuning between stations, you can feel reasonably sure that the cause of the trouble is located in the black-and-white circuits. In a color receiver these are almost identical to those of a monochrome receiver and can be serviced similarly.

If trouble occurs when tuned to a color program, check the picture with a monochrome signal. If the same defect is noticed on both color and monochrome, the black-and-white circuits are at fault. However, if the trouble disappears when tuned to a monochrome program, look for trouble in the color circuits. These consist of the chrominance bandpass amplifier, oscillator and control circuitry, color demodulators and amplifiers as shown in Fig. 2. A block diagram of the color and oscillator control circuitry is expanded from Fig. 1.

The bandpass amplifier, burst amplifier, color killer, and the color oscillator and control circuits are the only

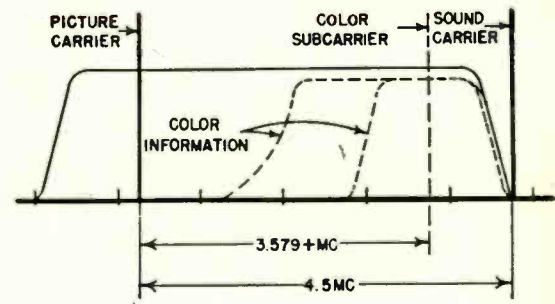
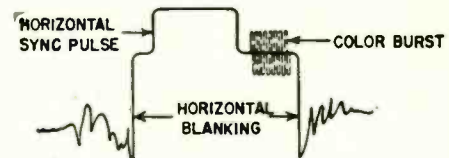

Fig. 3 — The complete color signal. Dotted lines indicate the additions made to the black-and-white signal



stages that could cause a complete loss of color and result in a monochrome picture when tuned to a color program. If the color oscillator is slightly off frequency, the color information will not be synchronized with the black-and-white information and the picture tube will display a stationary black-and-white picture with color bars running diagonally. If a particular color is missing or lacking detail, the corresponding color-difference amplifier circuitry (R - Y, B - Y and G - Y) should be checked. This service procedure is based on the assumption that the receiver was once functioning normally and is applicable approximately 95% of the time. There are other possibilities of receiving a monochrome picture when tuned to a color program. Defects in the antenna, tuner, i.f. amplifier or Y channel amplifier could also cause this condition but these are the exceptions rather than the rule.

Color TV signals

When dealing with a monochrome receiver, the service technician has three separate signals to work with: sound, video and sync. With a color receiver two additional signals (Fig. 3) are available, making servicing that much easier. These two signals are the color information and the color burst. Fig. 3 shows, by dotted lines, the additional information added to the monochrome signal (the area in solid lines) to make up a complete color signal. The area within the dotted lines, labeled color information, is the chrominance signal. The color burst, shown in dotted lines on the blanking pedestal, is nothing more than a synchronizing signal to control the phase and frequency of the color oscillator. It can be considered as an additional sync pulse similar to the horizontal sync pulse. Therefore, in a color receiver, there are five separate signals that can be used to help identify troubles.

Referring to Fig. 1, the composite color signal consisting of sound, sync,

video (Y signal), color and burst is fed through the tuner and i.f. amplifiers. The sound signal is separated and applied to a sound detector and then coupled to the remaining sound circuits. The four other signals are passed to the video detector and then to the first video amplifier in the Y channel. At the first video amplifier, the four signals are separated and fed to their respective circuits. The sync signal is coupled to the sync separator for vertical and horizontal oscillator synchronization. The video signal is coupled to the second video amplifier and then through the d.c. restorers to the picture tube. The color signal is coupled to a bandpass amplifier, then to the demodulators and on to color amplifiers. The burst signal is coupled to a burst amplifier and then to the color oscillator for synchronization.

If any of the five signals is either lost or changed in shape or amplitude, the effect on the face of the picture tube or sound coming from the speaker will be noticed quickly. It then becomes a matter of tracing that signal through the receiver to the circuit at fault.

By using the tuning control and observing the face of the picture tube, you can determine which section of the receiver is defective or is causing a particular trouble. To repeat: a color receiver is nothing more than a black-and-white receiver with additional circuitry necessary for color reception and a color picture tube. The additional circuitry (color, oscillator-control and convergence circuits) and color picture tubes were thoroughly covered in this series and constitute only 20% of a color receiver. Therefore, 80% of the circuits in a color receiver are identical to those in a black-and-white set. The familiar servicing techniques used for black-and-white can also be applied to color.

END

A complete book entitled "Color TV Circuits" containing more detailed information is being prepared by the authors of this series and will be available in a few months through the publishers of RADIO-ELECTRONICS.

ELECTRONICS

TWO TRANSISTORIZED METAL LOCATORS

By EDWIN BOHR

Two lightweight units—one small and one large—feature stable oscillators, simple construction and low cost

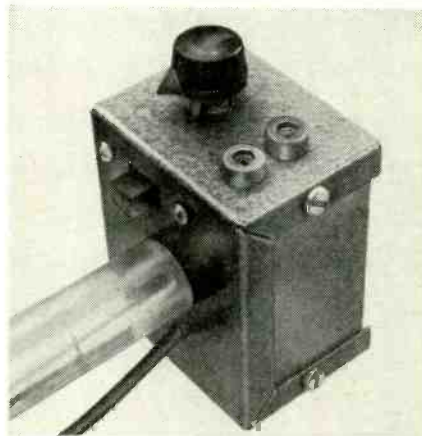

Chassis of the large metal detector.

Chassis of the small metal locator.

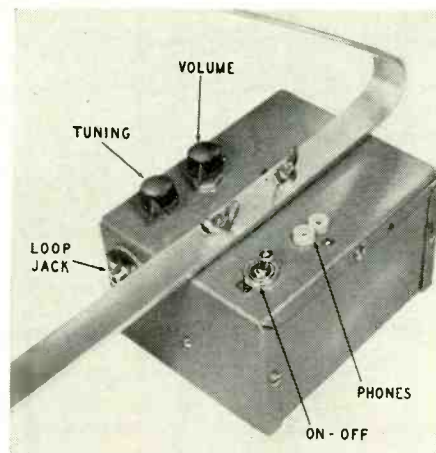

THESE two metal locators are built with the available low-cost transistors. The larger locator contains four CK722 transistors, the smaller unit two.

Each locator, although the two circuits are very much alike, serves a different purpose. The smaller locator is suitable for finding small objects, such as plastered-over conduit boxes; the larger locator is designed to detect larger masses of metal at greater depth.

As metal locators go, both units are small; in fact, the smaller one is truly miniature and, complete with batteries, weighs only 8½ ounces. As shown in the photos, each locator can be carried with one hand.

Both transistorized r.f. and audio circuits are used. The oscillators are extremely stable, using a separate-battery bias form of resistance stabiliza-

tion. Battery life is long and standard easily obtained components are used throughout.

Circuit description

Small circulating eddy currents are generated in metals placed in a radio-frequency field. These currents oppose the back e.m.f. of the coil producing the field, lowering its inductance. If the coil is part of an oscillator circuit, the frequency of oscillation is *increased* as metals are approached.

Of several ways for detecting metals, this *inductance change* method is the most simple and requires very little in the way of complicated circuits.

The change in inductance must be translated into some sort of signal that can be detected by the human mechanism. This might seem difficult, since the change in inductance is small. But, the problem is easily solved by beating two oscillators, producing an audible indication.

Parts for small metal locator

Capacitors: 2—390 μf , tubular ceramic; 2—.002 μf , disc ceramic; 3—.01 μf , metallized paper (Aerovox P83Z).

Miscellaneous: 2—CK722 transistors; 2—5-prong hearing-aid tube sockets; 2—1,000-ohm ½-watt resistors; 1—adjustable Ferri-Loopstick; 1—broadcast-band loop antenna; 4—mercury cells (Mallory RM625RT); 1—d.p.s.t. switch; 1—aluminum case, 1½ x 2½ x 2¾ inches; 1—knob; 2—pin jacks; 1—Lucite rod, ¾-inch diameter, 9 inches long; 1—sheet Lucite.

Parts for large metal locator

Resistors: 4—1,000 ohms; 1—4,700 ohms; 1—250 ohms, variable (1RC Q11-201).

Capacitors: 2—200 μf , ceramic or mica; 2—.001 μf , ceramic or mica; 1—.01 μf , paper; 1—0.1 μf , paper; 3—25 μf , 3 volts, electrolytic.

Miscellaneous: 4—CK722 transistors; 4—5-pin hearing-aid tube sockets; 2—4.5-volt BC batteries (RCA V50-28); 1—mercury cell (Mallory RM-401R); 1—adjustable Vari-Loopstick; 1—audio interstage transformer, plate-to-line 50:1 impedance ratio (UTC SO-3, S50-3 or equivalent); 1—d.p.s.t. switch; 2—pin jacks; 1—3 x 4 x 5-inch aluminum box; 1—2-foot length of RG-58A/U (50 ohms) coaxial cable; 1—length of litz wire (see text); 1—phono plug and jack; 1—length of ¼-inch diameter copper tubing; 1—length of ¾ x 1/8-inch aluminum; 1—insulating board; 2—knobs.

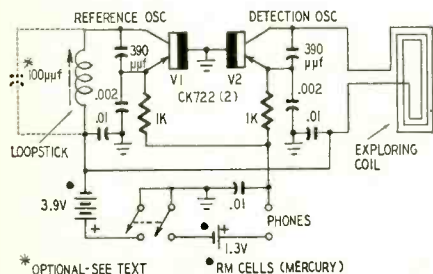

Fig. 1—The transistorized metal detector uses two beat-frequency oscillators.

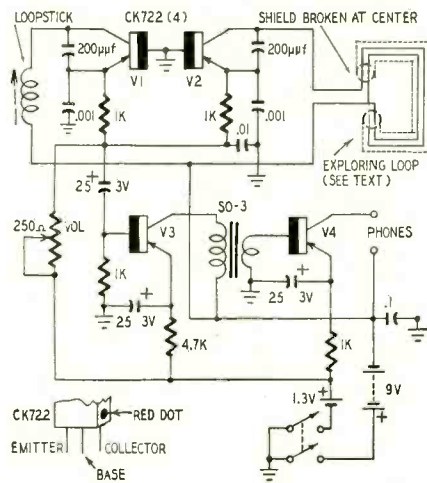
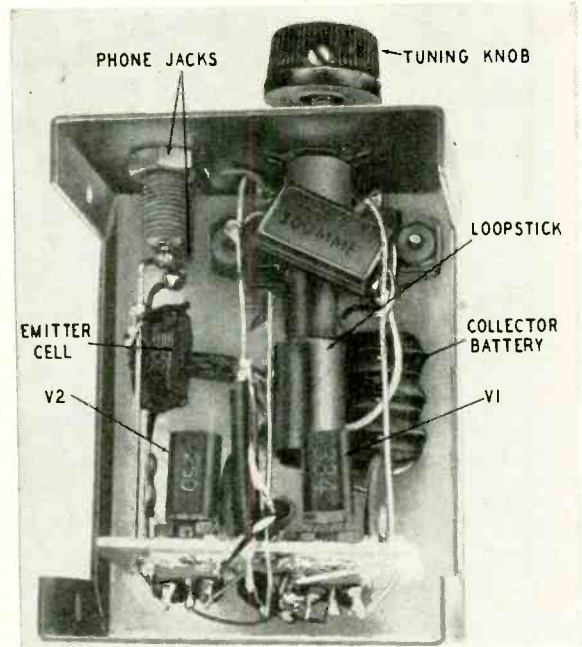
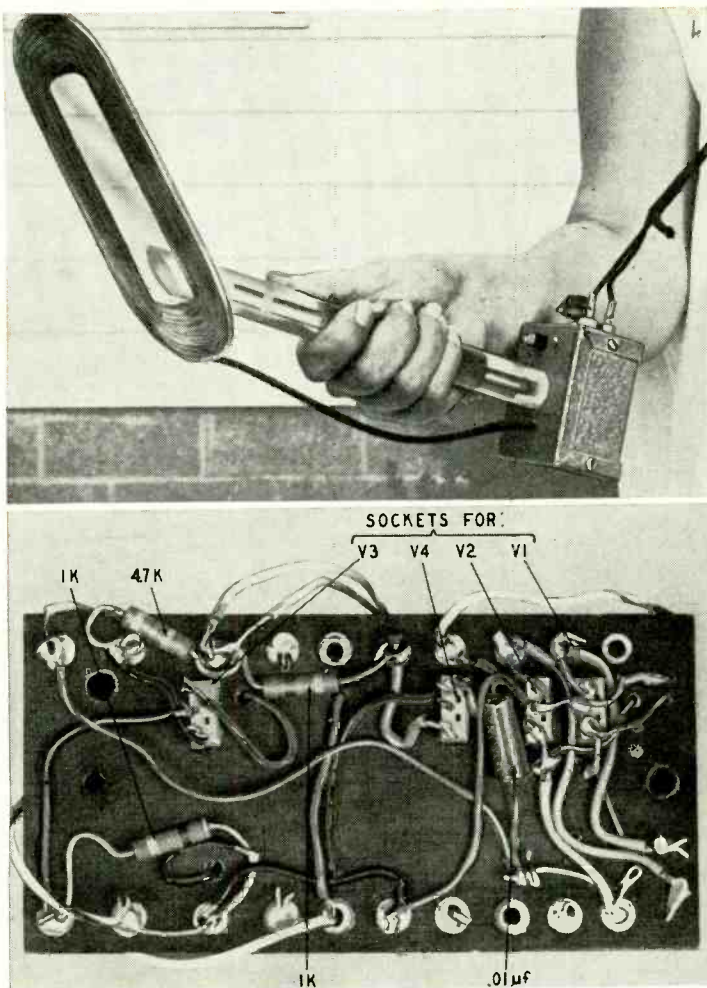

Fig. 2—Schematic of metal detector using additional two-stage amplifier.



Underchassis view of the small metal locator, showing major components. Photo at upper left illustrates carrying and operating positions of small locator. Photo at lower left shows underside of mounting board in large model.

The two oscillators, in Fig. 1, are labeled REFERENCE and DETECTION. The reference oscillator operates at a fixed frequency, adjustable by an iron core. However, the detection oscillator changes frequency when the exploring coil comes near metals. The oscillators are coupled to headphones where their outputs combine to form a different beat. The locator in Fig. 2 has an additional two-stage amplifier between the oscillators and the headphones. This requires very stable oscillators.

Two features increase the stability of the transistorized circuit. First, the oscillators are similar electrically. Thus, their drift rates are similar—the beat note change is not so pronounced if there is a shift in the oscillator frequencies. Second, the separate-battery bias stabilization reduces—as much as possible—the drift troubles produced by the transistors.

Why bias stabilization is necessary may not be too clear. The problem is unique with the transistor and very interesting. To clear up the picture, special characteristics of semiconductors must be known.

Stabilization

Germanium diodes and transistors do not perform well at high temperatures. Neither should allow current to flow in the reverse direction; but they do, and that is a fact we have to live with.

The amount of back current increases with junction temperature and, in the case of transistors at a given temperature, may vary from one unit to the next by a factor of 10.

Because there is resistance within the transistor base, part of the back current takes a path to ground through the emitter, generating positive emitter bias. The "hole" current thus generated causes a further increase in collector current. The resistance within the transistor base, alone, causes instability. But, many of the published circuits add fuel to the fire by placing large biasing resistances (perhaps a megohm) in the base circuit.

With very high performance transistors, high resistance in the base can cause this temperature plus back current plus bias effect to become cumulative and destroy the transistor. For standard-gain transistors, however, resistance in the base usually does not produce anything as drastic. But, it does result in a circuit undesirably sensitive to transistor variations and temperature changes.

Stabilization is obtained by putting as much resistance as possible in the emitter circuit and as little as possible in the base circuit. One way to do this is to place a voltage divider across the collector supply. The base is then returned to the divider, and enough

resistance inserted in the emitter circuit to bring the bias current to the correct value.

A better way, and the one used in the locator, returns the base directly to ground. The bias, then, is supplied by a separate emitter battery and resistor.

The small locator

A capacitance type dividing network across the tuning coil provides the feedback and proper impedance match between the collector and emitter. There is a further advantage in that a simple two-terminal coil, without taps or tickler winding, can be used. The value of the capacitor for the emitter tap in Fig. 1 (.002 μf) may seem extremely large by vacuum-tube standards, but it is correct for the low emitter impedance of the transistor.

Positive emitter bias flows through the headphones and the 1,000-ohm emitter resistances. This current is necessary to start the transistors into oscillation. After the oscillations have begun, the emitters are self-biased, class C.

The values of the components are rather delicately balanced. For example, two .01- μf capacitors bypass the collector supply. More capacitance than this will reduce pulling between the oscillators, but will also reduce the loudness of the beat note. Less capacitance produces

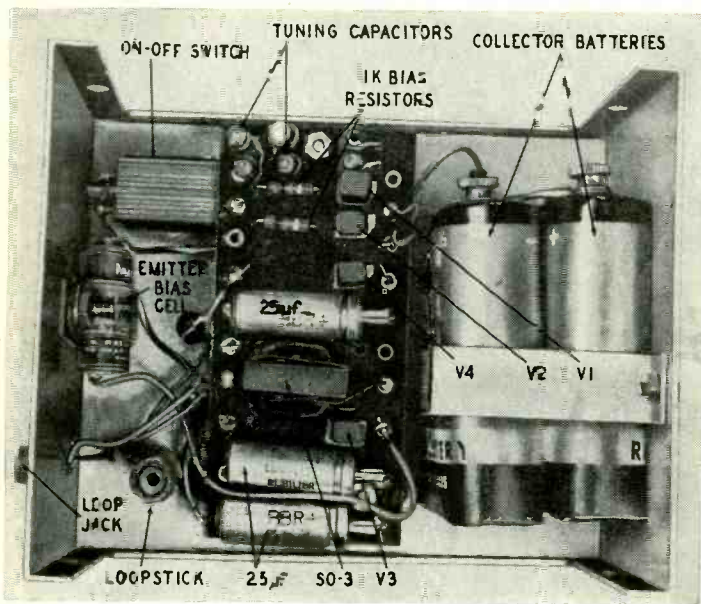

Underchassis of the oscillator—amplifier model.

severe pulling. If the headphones have too much internal resistance, the oscillators will not start. The headphone resistance should be limited to 1,000 ohms. For higher resistances an extra emitter bias cell, connected in series, could be used, but the oscillators may lock together more readily.

The oscillators operate at about 500 kc. Most transistors will operate to this frequency with 4 volts of collector supply. The poorest transistor tested in the circuit was able to make it to 600 kc before it quit oscillating.

Also, at this frequency an ordinary radio can be used to check the locator. And the frequency is low enough for the locator coil to be used without a Faraday shield being absolutely necessary.

Small locator construction

The exploring coil for Fig. 1 is an ordinary loop antenna salvaged from an abandoned portable radio. The loop is cemented, with polystyrene coil dope, to a Lucite panel.

Saw off one end of a 9-inch length of Lucite rod, at a 60° angle, and weld it to the Lucite loop panel. A 75% ethylene dichloride, 25% acetic acid solution is excellent for welding plastic surfaces. Cover each surface with the solution and press them together, pushing out all air bubbles. The resulting weld will be almost as strong as the plastic material.

Tap the other end of the rod for two 6-32 screws, which mount the aluminum case. The switch, coil, and headphone

jacks are mounted on the case. The transistor chassis and other parts are mounted by support leads to these three components.

The transistor chassis is a section of plastic from the lid of a small radio-hardware assortment box. Rectangular holes for hearing-aid sockets are made with the end of an instant-heat soldering iron. While the plastic is still warm and soft, the sockets are pushed into place. Support and connection wires to the chassis are treated in the same way. The wire is heated and pushed through the chassis.

Mercury cells, type RM625RT, power the locator. Because of their long life, they are wired into the circuit. Three cells are wired in series to form the collector battery. The tab is bent upward at a right angle, near its tip, and soldered to the side of the next cell. Tin each surface first, and be quick with the soldering iron. The cell is small and quickly becomes overheated, with possible damage from an internal short.

After the cells are soldered together, give them several coats of TV corona dope for insulation. A small piece of cloth, pressed into the wet dope, improves the insulation.

To fit a knob to the variable loopstick, wind a single piece of solid hookup wire, in two layers, near the end of the adjusting screw. The solder is then flowed into the wire and screw for a solid mass.

The two leads from the loop run through flexible spaghetti into the case.

Small locator operation

Turn on the power switch and rotate the tuning knob until an audio signal is heard in the phones. If no audio signal is detected, either or both of the oscillators are not operating; or, they are too far out of tune to be brought to zero beat.

A few tests will indicate what is happening. Short out the earphone terminals and bring the locator near a radio tuned to the low end of the broadcast band. At some point on the radio dial a strong carrier from the detection oscillator should be received. The reference oscillator should also be received, but it will be weaker. It can be identified since its frequency changes when the locator tuning knob is turned.

If the loopstick can not bring the reference oscillator to the same frequency as the detector oscillator, it may be necessary to add capacitance across either the loop or loopstick. I had to add a 100- μ f mica capacitor across the loopstick. It can be seen in the photograph.

Plug the phones in again. This may shift the frequency slightly, but the oscillators should continue to work. If they do not, the headphone resistance is too high. I used a single phone and had no trouble. If high-resistance phones must be used, short out the regular headphone terminals and connect the phones in series with the collector bat-

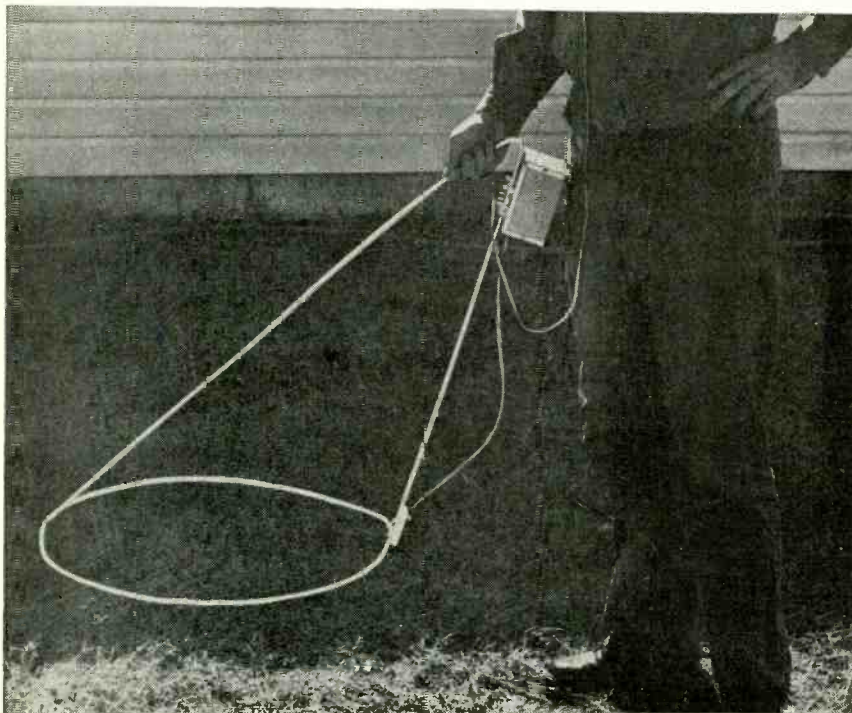

Large metal detector in operation. Low weight increases its portability.

tery. An alternative is to use an additional emitter bias cell. But, to repeat, the oscillator should give no trouble with 1,000 ohms in the headphone circuit.

Best performance is attained with the reference oscillator tuned to the lowest possible beat note, just before the oscillators lock together. When the exploring coil comes near metals, the pitch will rise. The reference oscillator can be set for a constant high pitch note that goes down to zero beat as metal is approached, but the sensitivity is less.

The operator must practice with the locator until the "feel" of operation is acquired. Practice first with objects that can be seen.

Maximum range for the locator is about a foot in the case of relatively large-surfaced metals. The boundaries of large objects are easily determined within an inch at a distance of 6 inches. Retune the beat note to its lowest value each time the object is approached closer; otherwise, the note will be too high for the ear to easily distinguish small pitch variations.

Large locator

The larger locator varies in several respects with the smaller locator. The oscillator frequency is 1 mc and the search coil is electrostatically shielded and of much larger diameter. Also, a two-stage a.f. amplifier is included. These modifications to the r.f. circuits tend to increase the range of the locator. Larger search coils spread out the magnetic lines of force (the range varies roughly as the radius of the coil) and the higher operating frequency gives an increased frequency change for a given inductance change of the search coil.

When a coil approaches a large mass of metal, the eddy currents tend to reduce the inductance of the coil and increase the oscillation frequency. But, the increased circuit capacitance, caused by the nearness of the metal, tends to reduce the frequency. (The capacitance effect is more pronounced at higher frequencies.) This opposing capacitance effect is removed by shielding the coil with an open loop of copper or aluminum tubing called a Faraday shield.

Without the shield—because of the increased capacitance—the beat note goes down as nonmetals are approached. The shield almost completely eliminates this and the locator responds only to metals.

Large locator construction

Assemble the locator circuit on a strip of insulating board. Use a No. 26 drill to cut out holes for the transistor sockets. Just drill two of these holes side by side and square them to fit, with a small file. The SO-3 transformer is held down with a solid wire harness that is pulled through and soldered to the terminal board eyelets.

Take care in soldering to the negative center pole of the mercury cell.

It is more delicate than the cell used in the small locator, since it has no metal tab. Check the cell with a voltmeter after the leads have been soldered.

The entire loop-and-handle assembly is detachable. Wing nuts hold the handle to the locator box and a small phonograph jack is used as a disconnect to the loop coil. Both leads to the coil are above ground. Thus, the jack must not be mounted directly to the box. Cut out a plastic washer and place it between the outside of the box and the jack. The connecting cable to the loop consists of a small length of coax. The coax shield should be used as the coil lead to the collector batteries.

A 2-foot loop of ¼-inch copper tubing encloses the exploring coil. This tubing is grounded at its midpoint to the aluminum handle. The two free ends of the tube are left floating electrically and clamped mechanically to a Lucite insulating block. If the loop ends were brought together, they would form a shorted turn in the r.f. field.

The coil is made by pulling six strands of wire through the tubing. The ends are then soldered together to form a single six-turn loop. I used litz wire (Belden 8817), but almost any small size wire will do.

Other size coils can be built by winding 38 feet of wire into the loop. For this length of wire the smaller loops will have larger inductance, but this can be adjusted by decreasing the tuning capacitance slightly. Use the same methods of checking the oscillators as outlined for the smaller locator.

Try all four transistors in the oscillator circuits. The most active transistor should be used in the detection oscillator, the second most active in the reference oscillator, and the other two in the audio amplifiers. If there is any trouble in obtaining oscillation (if none of the transistors have good r.f. characteristics), the collector supply can be increased to 15 volts.

The small-locator operating procedure is used with the larger locator, with one exception. The variable 250-ohm resistor can be used as a combination volume control and fine frequency adjustment. The bias current varies the collector capacitance, changing the oscillator frequency. There is plenty of audio gain and power output—enough for the signal to be heard with the headphones hanging about the operator's neck. The range of detection is around 3 feet.

Metal locators in many ways are very limited. They do not tell what has been detected or located, how deep it lies, or very much about its exact size—if it is very small or deeply buried. Most metal-locator operators are surprised at first by the amount of trash material that has been dug up before they find the item in which they are interested. The locator has gloved feeling, but it certainly does not have eyes.

To go beyond 3 feet in detection depth will require different techniques and more elaborate equipment. A few of these have been outlined in the *Handbook of Industrial Electronic Circuits* (McGraw-Hill). END

RADIO-TV SUPERMARKET



Fashioned after the popular self-service style of operation used by many food stores, the new Frank Gerry & Co. Appliance Distributing Center recently opened in London, Ontario, Canada, features a supermarket layout. Items such as vacuum tubes, resistors, capacitors, batteries and hardware are neatly laid out and carefully identified for the customers' convenience.

THE CAPASWITCH PHOTO- RELAY

By IRVING GOTTLIEB

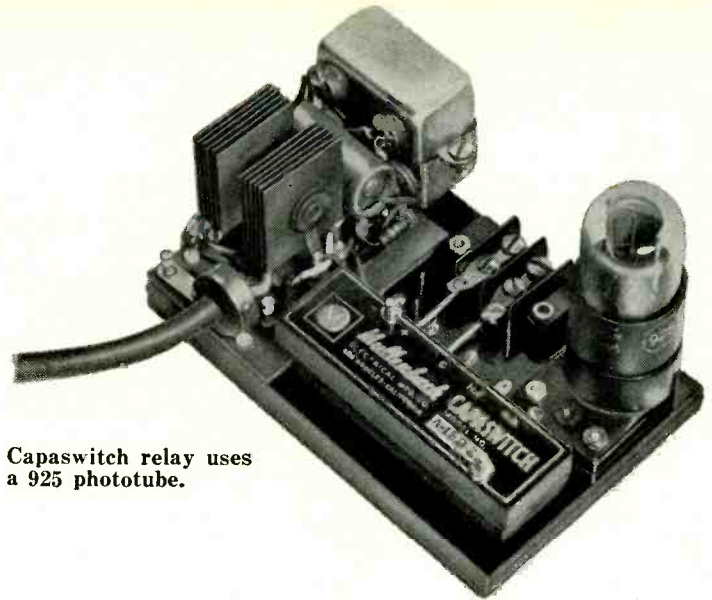

Capaswitch relay uses a 925 phototube.

THE venerable vacuum tube, long accepted as monarch of the electronic domain, is reluctantly giving way to the transistor. Now it appears that another old-timer, the electromagnetic relay, can also expect healthy competition from a rival device. This, the Capaswitch, is a relay of unusually high sensitivity and power gain.

The transformation of electrical energy to mechanical motion is not a new concept. We have electrostatic voltmeters and capacitive loudspeakers in which attraction and repulsion of charges displace a charged plate. The piezoelectric effect is also familiar. Quartz and other crystals change dimensionally when a voltage is applied to them. Similar to the piezoelectric effect is the phenomenon of electrostriction—basically a piezoelectric effect. The essential difference is that the effect is termed piezoelectric when it occurs in a substance composed of one or perhaps a few crystals, whereas electrostriction includes substances composed of many crystals. Electrostriction is the electric counterpart of the more familiar magnetostriction, in which magnetism produces a dimensional change in magnetic material.

In general, electrostriction results in a greater dimensional change than does piezoelectricity. This is fortunate, for it makes it possible to actuate a contact by the mechanical displacement of an electrostrictive material when it is subjected to the stress of an electric field. Barium titanate is one substance suitable for this purpose. However, it must be processed differently than when used in conventional ceramic capacitors.

A feature of the Capaswitch is its small power demand. About 50 microwatts are required to hold the contacts closed, about one-hundredth the holding power needed for a comparable electromagnetic relay. Thus, it can be used in a photoelectric relay, with the Capaswitch actuated directly from the photosensitive element.

The Capaswitch photorelay (Fig. 1) consists of a voltage-doubling rectifier, a 925 phototube and the Capaswitch relay. The electrostrictive element of the Capaswitch is polarized, as are also the selenium rectifiers and the electrolytic capacitor.

The d.c. voltage output of the rectifier, measured across the 4- μ f capacitor, should be about 260. The 925 is sensitive to radiation from incandescent lamps as its response is peaked in the red and infra-red regions. It is always desirable in devices of this kind to use a parabolic reflector behind the light source. Otherwise much of the usable light is emitted at various angles and never reaches the photoelectric cell. Another useful optical technique is to use a shield that blocks off ambient light while allowing direct rays from the source to reach the cathode of the phototube.

If the application is such that the distance between light source and photo-

tube is constant, the potential developed across the electrostrictive element should not exceed about 160 volts as measured with a v.t.v.m. at the moment of contact by the meter probe. The voltage can be limited to this value by controlling the intensity of the light source. Conversely, the d.c. output voltage of the power supply can be reduced by shunting a resistance across the 4- μ f output capacitor. If, however, the photorelay is used in a garage door opening mechanism, maximum sensitivity is needed. And it does not matter if the potential across the electrostrictive element exceeds 160 volts, because transient or momentary overloads as great as 100% will not damage the relay.

The actuating element of the Capaswitch, besides having an electrostrictive dielectric, is a capacitor (approximately 0.1 μ f). This places a limitation on the release speed when the polarizing voltage is removed, the actual time delay being determined by this capacitance and the 22-megohm photocell load resistor. The pull-in time, however, is much faster—about 10 milliseconds after applying 150 volts. The time required for closing the contacts in this application of the Capaswitch depends upon the intensity and duration of the light reaching the photocell. Due to the ability of the actuating element to accumulate a charge, several short bursts of light spaced by long dark intervals will ultimately trip the relay. The only requirement for this application is that the intensity of the individual burst of light must be such that, if continued, a potential of 150 volts would be developed across the plates of the Capaswitch element.

The high sensitivity of the Capaswitch permits its use in many unique circuits. A typical application is shown in Fig. 2. When the voltage across the Capaswitch becomes high enough to close the neon lamp circuit, the lamp will flash, removing the voltage. This causes the relay to return to its original position. The cycle will repeat until the battery voltage is removed. END

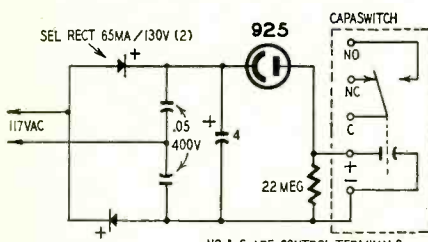

Fig. 1—The Capaswitch photorelay.

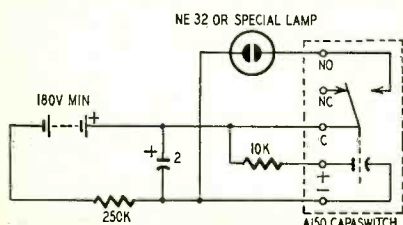

Fig. 2—Capaswitch used in a flasher.

Parts for Capaswitch photorelay

1—Capaswitch or electrostrictive relay, 150 volts for actuation, s.p.d.f. contacts, 1-ampere rating at 125 volts a.c. with resistive load (Mullenbach Electrical Mfg. Co., Los Angeles); 2—selenium rectifiers, 65 ma, 117 volts; 2—0.5- μ f 400-volt bathtub capacitors, 1—4- μ f 450-volt electrolytic capacitor; 1—22-megohm $\frac{1}{2}$ -watt composition resistor; 1—type 925 photoelectric cell; 1—chassis; 1—socket for 925.

MOBILE RADIO SHOP

By CHARLES E. HOLMAN



◀ Interior view shows efficiency of layout.

▶ The self-contained two-way radioshop.

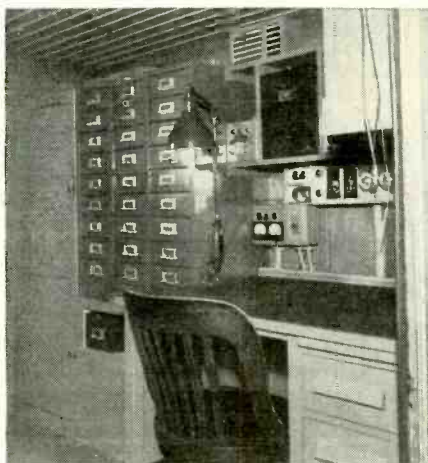

WE have what we think is one of the best and most complete mobile two-way radio shops with all the necessary test equipment, antennas and wiring to service two-way radio equipment any place at any time.

We purchased a 3/4-ton 1953 Chevrolet chassis with a Car-O-Van walk-in type body having inside dimensions of 70 inches high, 74 inches wide and 98 inches long from bulkhead to rear doors. We installed an 80-amp Leece-Neville alternator to keep the battery fully charged and to supply power for lights, test equipment, soldering iron, drill and other electrical devices in the field. The 7 volts a.c. from the alternator is stepped up with two 20-amp 6-volt filament transformers to put out 115 volts a.c. with a capacity of 300 watts on each phase. Being a 3-phase alternator, it would be possible to get a total of 900 watts. However, we need only 600 watts.

There are separate outlets for each phase on the work bench and an electric soldering iron, tube checker and bench light can be operated from one phase, while an electric drill is operated from the other—all this with the truck motor running at normal idling speed.

At the rear of the truck we have mounted a 50-foot spring type extension cord reel. Through a switching arrange-

ment we can use the reel to deliver 115 volts a.c. 50 feet from the truck if needed or to bring 115 volts a.c. into the truck from the customer's outlet. All circuits are fused with circuit breakers and all voltages are metered along with the 6-volt d.c. current drain.

All instruments are located on a panel above the work bench in the left front corner of the truck. A coaxial patchboard permits us to connect any antenna or piece of equipment together or to various locations in the truck. Armored flexible conduit (1 1/2 inches) is used under the truck to the driver's position with outlets for a.c., d.c., No. 26 pair cable and 52- and 72-ohm coax from the patchboard. On the right side of the truck is a rack with amateur equipment which is also connected to power and coax panels.

Our test facilities are complete with cable mockup for all model Motorola sets, with plug-in provisions for positive or negative grounds. Test equipment includes one each of the following: P8501A and P8500 Motorola test sets, v.t.v.m., BC-221 frequency meter, field-strength meter, mike checker, Triplett VOM (portable), Lampkin 205 modulation monitor, Hickok 600A tube checker.

We installed a metal bulkhead behind the driver to protect him in case of a sudden stop and to permit us to lock the contents of the shop without having to lock the driver's doors each time he left the truck.

At the left of the work bench, an oak desk 30 x 40 inches with three drawers on the right side, we installed a metal cabinet 30 inches wide, 37 1/2 inches tall and containing three rows of nine metal drawers, 9 inches wide, 15 inches deep and 3 1/2 inches high, giving us a total of 27 drawers for our tubes and various repair parts. Wooden dividers in 10 of the drawers make divisions for our various tubes and vibrators. We also made partitions in the rest of the drawers so the various

parts would not shift and could be quickly found. The metal cabinet has a device that locks all drawers so they will not slide out when you go around a corner. In fact all instruments, test equipment, tools and other necessary items for a repair shop are firmly anchored so they will keep their place.

Several wooden cabinets were built between the parts cabinet and the rear doors. In these we carry our gas torch, rope and other large items.

With this layout we can roll up to our customer's door or drive out to an oil drilling rig in the field and have his equipment working in short order, for we have our parts, tools, test equipment and power with us at all times. We have had the truck working for the past year and it comes up to all of our expectations. END

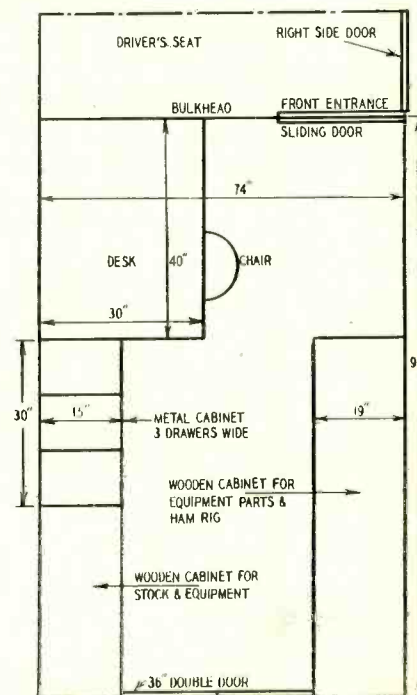

Floor plan of mobile radio shop.



Beating the Service Technician

By GEORGE D. PHILPOTT

ONCE upon a time there was a man named Arthur Squat and he owned a radio named *Whizzer*. It was a *Whizzer 6*. Now Arthur Squat's radio played and played, until one day it got tired of playing, so it quit. You would quit too if you had played for 10 straight years. This was a tragic thing, because Arthur valued his radio more than his watch, or his automobile, or even his wife, Sussy; for his watch wouldn't tick but half the time, his automobile wouldn't run when he needed it most, and Sussy did nothing but run. Yes, Arthur had learned to love his *Whizzer 6* more than these other worldly things.

Arthur Squat thought and thought about how the radio had failed him and he knew one thing—no incompetent radio service technician would ever get his hands on *Whizzer*; Arthur, himself, would do the work. He would remove his precious possession from its dusty corner and find out what was wrong with it.

Arthur's workbench was the kitchen table—good solid aluminum. His tools were not radiomen's tools, but they were pretty good tools; slightly rusty and from bygone days when he was a thrifty little soul struggling for his existence in the mattress factory. He smiled to himself as he placed the tongs, Stilson wrench, and screwdriver, which in his fair youth he had pilfered from the locomotive works, on the table. Those were the days when he really lived it up. Yes, those were the days...

"Blip-blip-blip," said the speaker of the *Whizzer 6*, after Arthur plugged in

the power cord. "Blip-blip-blip." Arthur carefully removed the chassis from the shine-gone cabinet and looked things over closely. My, my, the dirt... the *Whizzer* was cloudy with dirt and fuzz. Sussy must have swept all the dirt into the *Whizzer* instead of under the rug, he thought. At least it certainly looked like it.

"Ah—perhaps here is the troublesome little rascal," Arthur chuckled out loud, wiggling an awful-loose-looking aluminum can. "Blat-blat-b-l-l-at!" echoed the speaker. Arthur tightened every loose screw in every loose-looking i.f. can. How in heaven's name had these screws got so loose, he wondered. "Flut-flut," said the speaker. Arthur hardly recognized the unmusical notes as that of a radio in good order. My, it is so strange, he thought. The *Whizzer* had never let him down for 10 straight years... and then out of a clear sky, this. Arthur tapped very gently on a tube.

It was a sad day, this day, after he had examined the innermost mysteries of the 5-inch speaker. With trembling fingers he managed to work the pieces of the speaker together again. Goodness, what a mess... The coil seemed all unwound and ill-fit somehow. One washer just wouldn't go any place in the speaker. And it scraped and scratched as he tried his very best to adjust what was left. At last no "blat-blat," he thought, dejectedly.

Much of the wiring seemed out of order to Arthur, so naturally he did his slight bit in this direction. Before very long a sticky, tar smell ventured

forth from a corner of the *Whizzer* chassis and Arthur got worried terribly—and not without reason. Sussy wouldn't stand for hot tar in the curtains. This odor must be originating from the power phaser, he thought. Or could it be the transformer? Arthur wasn't positive he knew a power phaser from an apple cart, but he was sort of good on transformers. He was good enough on them to realize transformers are anything but duck soup to fiddle with. He listened as the transformer hummed along and certainly it sounded to him as not being very contented. Yes, under the transformer's black cover was—certainly must be—the trouble.

Arthur Squat had one fault that often caused him grief: a short memory. Under the circumstances, his short memory was too closely coupled with something more serious—short knowledge—and so he did not bother to unjuice the juicy portion of the *Whizzer* before diving into the power supply. Now, let it be known here and now that if the *Whizzer* lacked in many things desirable in a radio, it lacked not in the voltage of the power supply. *Whizzer* was action packed. Ten whirling minutes and countless powerful cycles later Arthur again could see where he was located—on top, or nearly on top, of the gas range. His breath came in short pants. His toes seemed to be spinning in his socks. The third digit of his left hand felt like it had been used as one element of carbon in the arc of a motion picture projector. Blinking, he looked for the man with the baseball bat. Somebody must have hit him, he

hot. He placed Whizzer 6 back down and scratched his head. The radio was proving to be a problem . . .

The Whizzer slowly built up to the task. Arthur twisted and Stilson-wrenched the aluminum can. "There, that's better," he murmured to himself, sweat now standing out in great beads on his brow. Having finished tightening, he knew of nothing better than to wipe the perspiration and gaze at his work. It seemed as if the Whizzer was readying itself in some way and getting set to do a bit of responding to the loving hands. Arthur thought about this and raked in the mess of tools; he needed one small tool for making the final adjustment. A faint cooking sound warned that the Whizzer was upon the throes of a great undertaking. Arthur Squat adjusted his spectacles. The Whizzer broke into a meaningful hiss . . . Arthur looked close.

With the hidden energies of a demented shotgun the Whizzer explosion raked through the house. Over the chair went Arthur Squat, Whizzer, and all. Unfortunately the cord had been snaking his leg. Electrolytically speaking, Whizzer's No. 1 filter capacitor had discharged for the last time—all over the place.

Well, to make a long thing just a little longer, in the midst of a sale at Lindberger's Radio Parlor, on State Street, a man with splotched glasses interrupted the scene, demanding in a voice reserved for those who have re-

tried to think. His second thought was slightly better and it was concerning the fact that nothing was wrong with the Whizzer power supply.

Arthur Squat waited, not daring to forget what he had forgot. He wondered about the Whizzer "firecrackers" (capacitors, to those who are not familiar with highly technical jargon). Perhaps, just maybe, one of the firecrackers was not resisting . . . It was worth looking into . . . if, he thought, he ever got able so he could look into anything, again.

Six times he removed capacitors from here, put them there, then did the same with other parts. The 400-watt plumber's soldering iron scorched a black path among the Whizzer's valuables; but so what, he thought. Everything else was charred, dirty, or inoperative. Something had to be done. Arthur Squat rested the mighty iron and plugged in the wall plug again.

With a mighty scraping screech the Whizzer came to life. It began low and worked up to the sound of a midnight owl calling its mate. Arthur cranked around on the control. He couldn't remember if it was the volume or tone control, but it changed the vile sounds in the Whizzer speaker to the splashing noises of a waterfall. The shortwave bandswitch operated the dial light in a most rare manner, each position proving more brilliant than the last. Through channels through which the good i.f. transformers had never been made to eject their output came signals of a ready and waiting airplane beacon, or else it was a tone of a standby fire station . . . something like that. FM from a local transmitter splattered through the reluctant mess, and electrical sparks slithered from chassis to tabletop. And the radio, to Arthur Squat, looked slightly irrigated now . . .

Arthur watched apprehensively as a droll-looking fluid eased out from some-

where under the cocked-up chassis of the Whizzer 6. Something was leaking! Where could it be coming from, he asked himself. With caution to the winds, Arthur snatched his Whizzer 6 from the tabletop and began the official and final examination. The tall aluminum can with the tinge to it seemed to be doing the dripping. Since when did radios have fluid in the tall cans? And the can was warm? Closer observation

showed the 80 power tube to be hot as an old coal stove—and the tube's plates just as red. Cherry, he thought. Arthur Squat smiled, slightly relieved . . . After all, it was a powerful radio. Most likely the Whizzer was supposed to be

cently suffered many close calls, "I—I want one 450 fahrenheit, with a capacitance of 10 volts working watts. And don't try to overcharge me on it, because I'm a service technician and everyone knows I fix radios." **END**

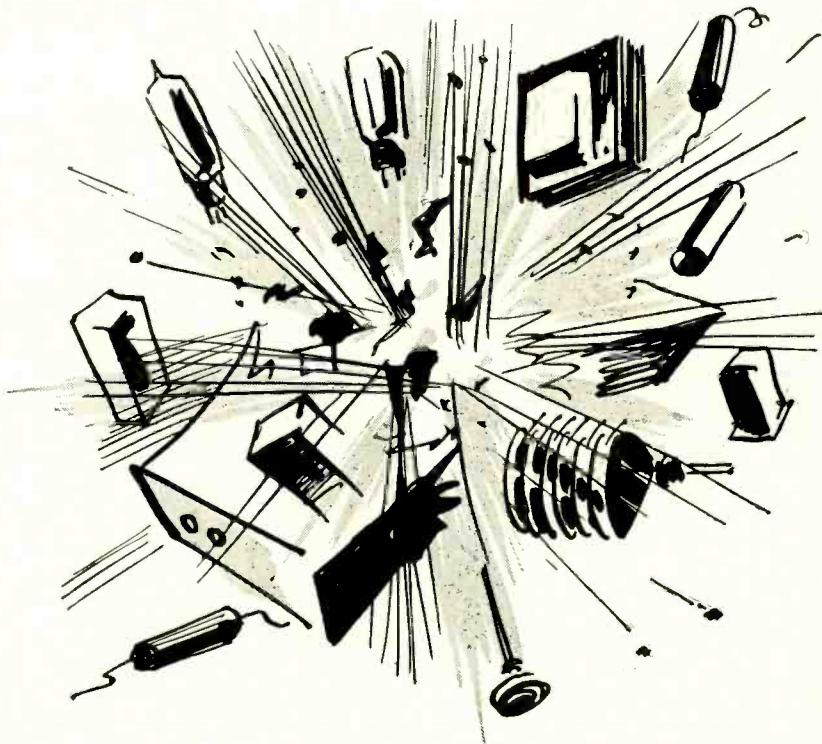
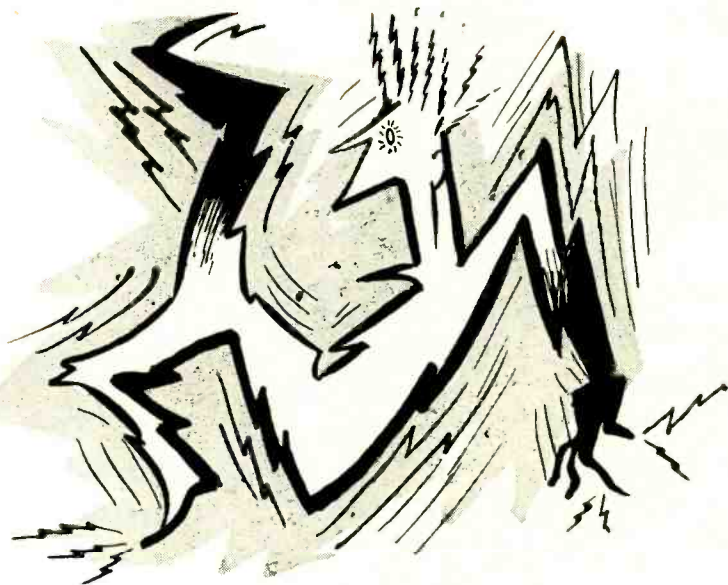

Transistor—Varistor Modulator

for low-level audio

Semiconductor unit gives excellent results

By ALBERT H. TAYLOR

A UNIT, based on the principles and applications of Balanced Modulators for Low-Level Audio (December, 1954) and using a transistorized carrier oscillator and a varistor modulator containing two germanium diodes, is described in this article.

The transistor oscillator is essentially that published by Bohr¹. It contains a Ferri-Loopstick coil with the core fixed symmetrically and ceramic tuning capacitors. My transistor self-excited r.f. oscillators sound doleful against a receiver heterodyne, and I would use a crystal in a modification of Queen's circuit² if I had one in a small holder like his LM crystal. Fortunately the quavering r.f. doesn't seem to hurt the audio quality and the stability is not bad.

The modulator (Fig. 1) is, from the balancing standpoint, a mutual inductance bridge like those commonly used in metal detectors. Two identical secondaries (L2 and L3) are moved to adjust their relative couplings to the oscillator coil (L1) for balance. They should by rights be electrostatically shielded from it, but I haven't yet made a shield that doesn't kill the oscillator. Fortunately the amount of unbalanceable carrier that gets through—even with no attempt at capacitance balance—is so little that the Pickering pickup overmodulates it and the coils must be moved off center to increase the unbalance for better quality. For still weaker audio sources, shunt the 1N34 rectifiers with small capacitors and adjust the coil and the variable trimmer alternately until the balance is as fine as you like. In this, as in the tube circuit ("Balanced Modulators," December, 1954), even harmonics are not balanced.

The pickup is applied in push-pull between the two secondaries and bypassed for r.f. The bypass capacitors are essential to carry the r.f. current of the rectifiers. If they reduce the audio fidelity, try in their place series-resonant circuits with smaller capacitors, tuned to the carrier frequency.

To provide the necessary d.c. path for the rectifiers, the primary of an Ouncer type push-pull output transformer from a BC-347-A interphone amplifier serves as a center-tapped audio choke. It has a resistance of 500 ohms. A pair of resistors would probably do if they did not load the pickup nor throttle the rectifiers. The output load resistor is not critical and satisfactory modulation with little change in level takes place with anything from wide open to a direct short through the receiver's antenna coil or an r.f. choke. Too low a resistance probably loads the pickup but I can't say I missed any highs in a broadcast receiver.

I generally use a 10,000-ohm resistor and a 200- μ f coupling capacitor to avoid misalignment. A d.c. voltmeter across the output conveniently indicates oscillation and reads about 0.5 volt with the coil turns I am using. The output impedance is so low that if I make another unit I shall use more turns on the twin secondaries for a higher carrier-to-audio ratio in the diodes.

Construction

Any small metal box will make a good chassis—I found that of the BC-347-A ideal. Simple filtering keeps the transistor oscillator signal where it belongs and no shielding is necessary between oscillator and modulator sections.

The only critical job is making and

mounting the r.f. transformer, but it can be done very neatly even without special tools. If you are afraid of it, try Fig. 2 instead of Fig. 1. You may get away with using an unshielded, stock receiver antenna transformer if you use trimmers from the bridge corners to the live side of the secondary.

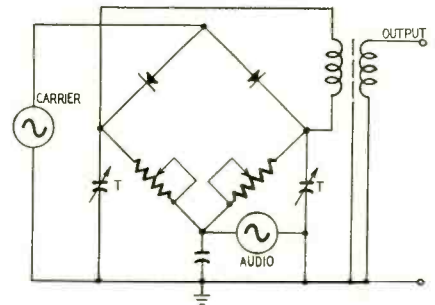

Fig. 2—Diagram of another varistor bridge; has grounded input, balanced output.

Fig. 3 shows my transformer in cross-section. The form for the secondaries is a paper tube that just slips over the waxed-paper cover of the Ferri-Loopstick primary. I made it by wrapping two layers of drawing paper onto the end of a dowel and binding tightly with tape and thread. I dropped this into a can of hot coil wax and cooked it till it quit bubbling. A piece of dowel necked-down to plug into the foot of the Loopstick cooked at the same time. When the waxed paper form had cooled and stiffened, I mounted it and the Loopstick on their brackets, set them side by side in the positions they would occupy in mid-setting, and marked the secondary form with a pencil opposite the center of the Loopstick coil.

The narrow secondary coils are 0.5-inch apart and are symmetrically

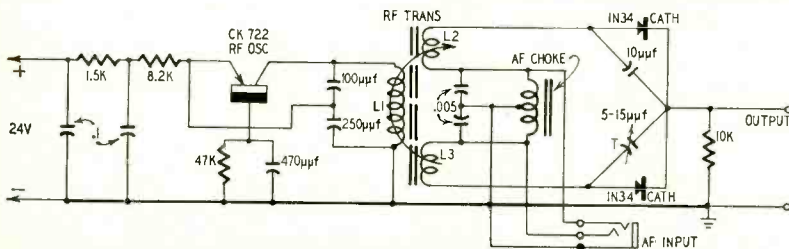

Fig. 1—The varistor modulator—a balanced bridge to cancel the carrier.

Parts list for modulator

Resistors: 1—1,500; 1—8,200; 1—10,000, 1—47,000 ohms, 1/2 watt.

Capacitors: 1—10, 1—100, 1—250, 1—470 μ f; 2—.005, 2—0.1 μ f; 1—5—15 μ f, trimmer.

Miscellaneous: 1—CK722 transistor and holder; 2—1N34; 1—Ferri-Loopstick; 1—center-tapped audio choke (see text); 1—chassis; 1—2-circuit jack; 1—rubber band; 1—22.5-volt battery; 1—1.5-volt cell; 1—r.f. transformer (see text); hardware.

spaced from this mark. They are wound with the Litz wire that comes with the Loopstick, which is just enough for the two 5-turn coils with a little over for leads. I wove them as Turk's heads² to hold them in place till they could be dipped. Then I plugged the open end of the form with a wad of cotton and flash-dipped the completed coils into the wax, also dipping the butt of the Loopstick to hold it onto its dowel.

The Loopstick primary L1 and the twin secondaries are held to their brackets at identical heights by wood screws in the dowels. They must fit accurately and squarely so as not to bind when the secondaries travel back and forth.

In the assembled modulator (see photo) the transformer takes up a great deal of room because the Loopstick must be kept away from large pieces of metal. If it gets too close, the oscillator quits. A single screw holds the bracket of the Loopstick at one end of the case, while the long-footed bracket of the secondaries at the other end has two 10/32 screws tapped into it which travel in slots in the case, parallel to the axis of the coils. A 1-inch 10/32 adjusting screw through the end of the case is tapped into the moving bracket and is turned from the outside to move the secondaries gradually. A rubber band between the brackets pulls against the screw to take up backlash, and the moving bracket may have to be grounded by a pigtail unless the guide screws are set up hard after it has been set. The oscillator stops and starts if the bracket makes intermittent contact. Tie the coil leads to convenient points and leave slack for motion. Watch the polarity.

Band Conversion

This modulator can be used as a frequency changer or converter if the r.f. input, suitably filtered against spurious responses, is applied in place of the audio. The bypasses would then be tuned to the local oscillator frequency. Fig. 2 appears a little better suited for this job.

Both this and the tube modulator save tuning elements and radiation worries by connecting directly to receivers. But they can be used remotely by tuning the outputs. The low-impedance transistor-varistor modulator should be tapped down on the tank circuit. In the tube modulator the tank circuit would replace the plate load resistor, with small r.f. chokes in place of the extra resistors if finer balance is needed. But be careful! My father worked New Zealand from Washington, D.C., 'way back then, with just two 201-A's. END

References

- ¹Edwin Bohr, "Transistor Phono Oscillator," *RADIO-ELECTRONICS*, p. 74, May, 1954.
- ²I. Queen, "I.F.-R.F. Crystal Oscillator Uses Junction Transistor," *RADIO-ELECTRONICS*, p. 92, May, 1954.
- ³Garaumont and Hensel, *Encyclopedia of Knots and Fancy Rope Work*, Cornell Maritime Press, 1945.

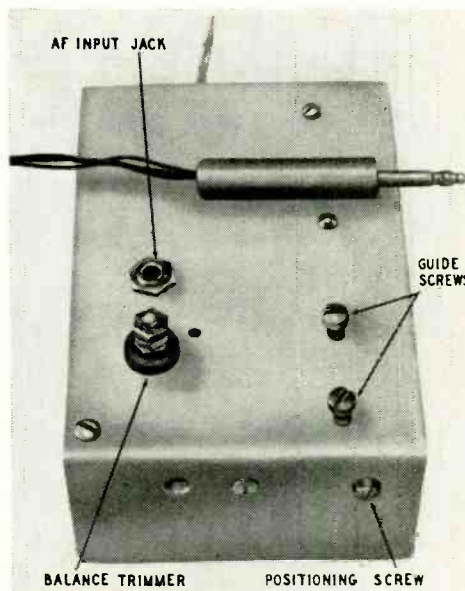

Top view shows external connections.

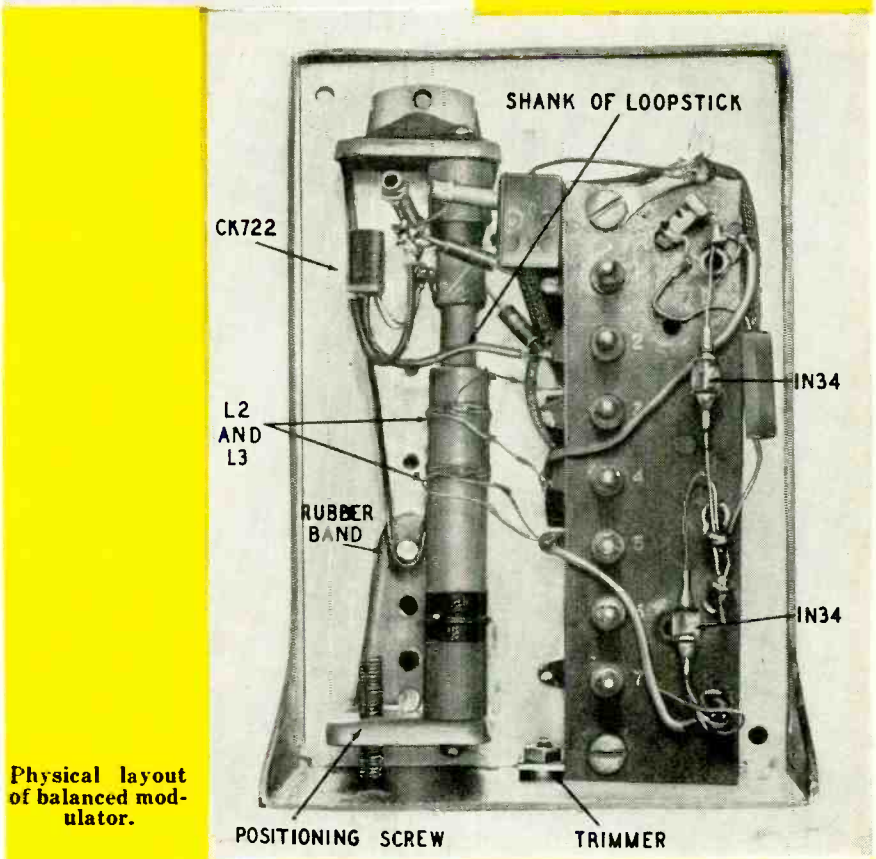

Physical layout of balanced modulator.

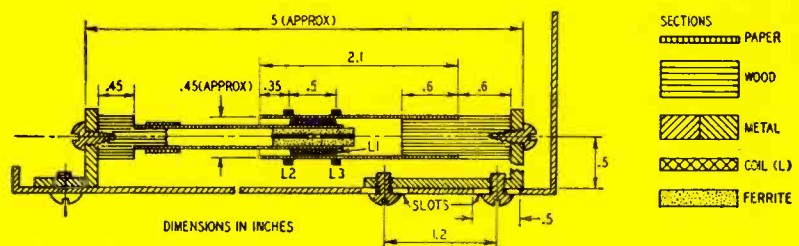

Fig. 3—Cross-section of transformer.

VARIABLE DAMPING IN AUDIO AMPLIFIERS

By ROBERT F. SCOTT

Technical Editor

Obtaining an ideal match between amplifier and speaker



The Scott model 265-A audio amplifier.



The Bogen model DB20DF—damping factor circuit is similar to model DO30A.

proportional to its resistance. The feedback voltage across the series string is positive with respect to ground at one end and negative with respect to ground at the other.

When the control is at its extreme counterclockwise position (X) a ganged switch shorts the series resistors, removing the current feedback. Turning the control clockwise opens the switch so the voltage across the 0.27-ohm resistor is applied to the cathode of the 12AT7 as *negative* current feedback to increase the output impedance and lower the damping factor. Continuing the clockwise rotation of the control, the damping factor rises gradually until a point is reached where the arm is at ground potential, there is no current feedback, and the damping factor is the same as when the switch is closed. Continued rotation of the control applies positive current feedback to the 12AT7, causing the amplifier output impedance and damping factor to become *negative*. The voltage across the voice coil now varies *inversely* as the voice-coil impedance.

The low-pass filter in the current feedback loop is designed for a cutoff around 300 cycles to limit the damping to the low-frequency end of the spectrum where it is most effective. One author¹ suggests making the filter network frequency sensitive to compensate for reduction in low-frequency response when some speakers are provided with optimum damping. In this case, the values of R1 and C1 can be determined

¹"A New Approach to Loudspeaker Damping." Clements, *The 2nd Audio Anthology*.

If I'm ever in the mood for an argument I'll simply make a few categorical remarks about damping factor in amplifiers and then sit back and await the howls of anguish and indignation from those who do not agree. Rather than chance this, I'll let other authors explain all about damping factor and its effects on speaker performance (see bibliography) and just stick to discussing the various circuits amplifier manufacturers are using to obtain an ideal match between amplifier and speaker system. Circuits for varying the damping factor are comparatively simple and are easily adapted to existing amplifiers.

The Bogen damping control

The variable damping factor control used in Bogen amplifiers is perhaps the

most easily adapted to existing equipment. Fig. 1 shows the circuit of the Bogen DO30A amplifier. Two small resistors, 0.27 and 0.47 ohm, are connected in series with the common side of the voice coil circuit. Since they are in *series* with the load (voice coil) the voltage drop across them is proportional to the load current and may be tapped off and used as *current* feedback. (Negative *voltage* feedback is taken from *across* the load and applied separately to the cathode of the first a.f. amplifier.)

A 25-ohm potentiometer shunts the resistors in the output circuit, with its center arm connected to the bottom of the cathode resistor through a low-pass filter consisting of R1 and C1. When the junction of the series resistors is grounded, the voltage across each is

from the formula $R1 = 1/6.28 \times f \times C1$, where f is the turnover frequency and may be made equal to the resonant frequency of the speaker.

It is normal for some amplifiers to oscillate when the damping factor is carried into the negative region. So when the speaker-amplifier combination requires a negative damping factor, most satisfactory performance may be found with the damping factor control set just below the point of oscillation.

The Scott and Electro-Voice circuits

In the Bogen circuit (Fig. 1), loudspeaker damping is controlled electronically by using a fixed amount of negative voltage feedback and varying the amplitude and phase of the current feedback applied to the input circuit. The Electro-Voice and Scott circuits use combinations of negative voltage and negative current feedback only; so they do not provide for varying the damping factor into the negative range as in the Bogen circuit. They are not frequency selective, either.

Fig. 2 shows the variable damping control circuit in the H. H. Scott model 265-A amplifier. The 16-ohm output tap is shunted with a voltage divider consisting of a 500-ohm potentiometer in series with a 1,200-ohm resistor. The negative voltage feedback signal at the arm of the control is applied to the cathode of the input section of the phase inverter. A negative current feedback voltage proportional to the voice-coil current is developed across a 0.19-ohm resistor in parallel with a second 500-ohm potentiometer. The current feedback voltage at the arm of this potentiometer is applied to the cathode of the input stage.

The potentiometers are ganged and the voltages are phased so that when the controls are at one end of their range the negative current feedback loop is grounded and the phase inverter gets the full negative voltage feedback. Rotating the controls toward the other end of their range gradually increases the amount of current feedback and decreases the voltage feedback. The circuit constants are proportioned so the circuit gain and the total amount of feedback are constant for all positions of the damping factor control. The damping factor is variable between 1 and 30.

Fig. 3 is the basic damping control circuit used by Electro-Voice in the Circlotron series of amplifiers. A negative voltage feedback signal is taken from the secondary of the output transformer and fed to the arm of an 1,800-ohm resistor in the cathode circuit of the first voltage amplifier stage. The amount of voltage feedback is determined by the values of the cathode resistor and series resistor, and is maximum when the arm of the control is at the cathode end of its range.

The bottom end of the cathode resistor is a 1-ohm potentiometer in series with the common side of the voice coil

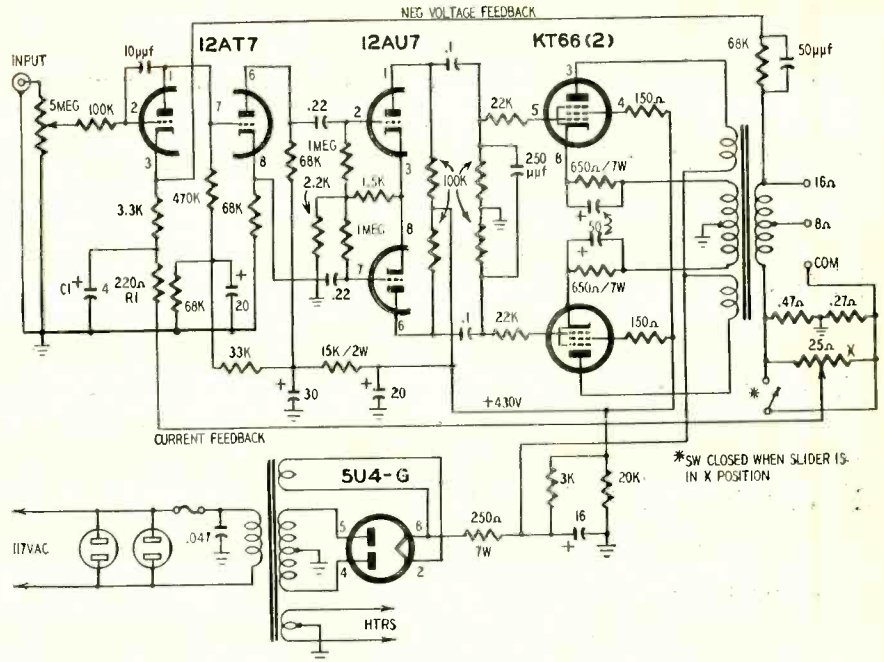

Fig. 1—Diagram of the Bogen DO30A—unit features variable damping factor control.

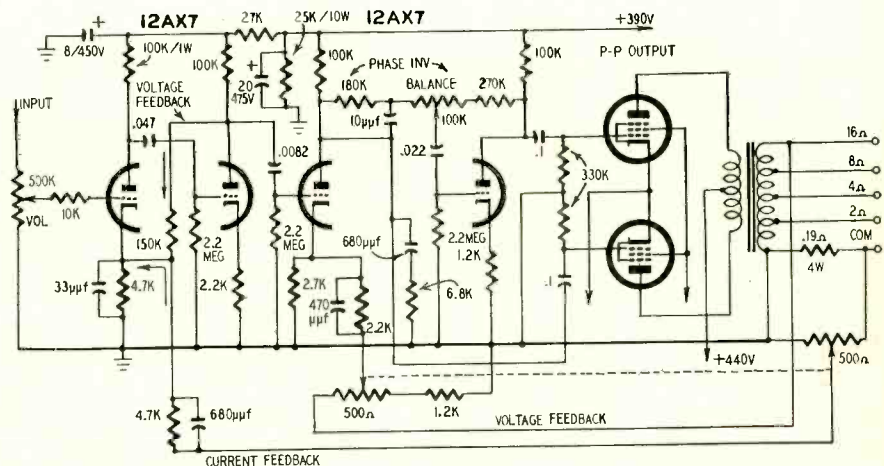

Fig. 2—Diagram of the Scott 265-A amplifier—feedback circuits are indicated.

circuit. The two potentiometers are ganged as in Fig. 2. When the control is set for maximum damping factor, the arm of the 1,800-ohm potentiometer is at the cathode end for maximum voltage feedback and the 1-ohm potentiometer is shorted out so no current feedback voltage is developed. Turning the control toward minimum gradually decreases the amount of negative voltage feedback, while the negative current feedback increases as the resistance in series with the voice coil is increased. The damping factor is variable in this circuit from 0.1 to 15.

The new Bogen, Electro-Voice and Scott amplifiers discussed here have a number of additional interesting features that we hope to discuss in an early issue. END

Bibliography

- "Loudspeaker Damping as a Function of the Plate Resistance of the Power Output Tube". Geppert, *The 2nd Audio Anthology*.
- "It's Positive Feedback". Clements, *The 2nd Audio Anthology*.

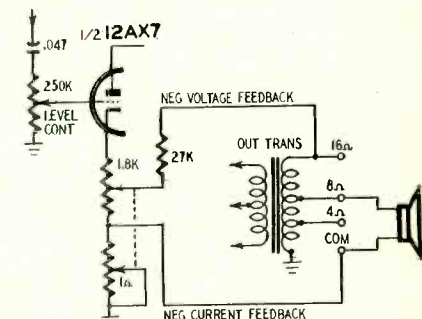

Fig. 3—Electro-Voice feedback circuit.

- "Output Impedance Control". Roddam, *Wireless World*, February, 1950.
- "Transients and Loudspeaker Damping". Moir, *Wireless World*, May, 1950.
- "More About Positive Feedback". Roddam, *Wireless World*, July, 1950.
- "Audio Amplifier Damping". Mitchell, *Electronics*, September, 1951.
- "Combining Positive and Negative Feedback". Miller, *Electronics*, March, 1950.
- "Improving Loudspeaker Response with Motional Feedback". Tanner, *Electronics*, March, 1951.
- "Missing Link in Speaker Operation". Tomcik, *RADIO-ELECTRONICS*, December 1954, January 1955.

FOR GOLDEN EARS ONLY

*The G-E Baton tone arm and cartridge,
Martin model 352 amplifier and pre-
amp; new records review*

By MONITOR

THE pickup arm of a high-fidelity system may have a greater influence on over-all quality than many realize. It determines needle pressure, needle alignment, tracking and, to a marked extent, groove loading, all of which play a very important part in faithful, low-distortion performance.

In testing the G-E Baton tone arm and cartridge (see photo) I measured the IM of the cartridge in the G-E arm, in an inexpensive arm and in a well known changer, using the IM bands of the Cook series 10LP test record as a signal source and my Heathkit IM analyzer for the meter. The average total IM in the G-E arm was 5%, in the inexpensive arm 7% and in the changer 8%. I estimate that the IM on the record at the time amounted to around 4%, so the difference represents the contribution of arm, cartridge, turntable and preamp.

The difference is quite understandable when the G-E arm is examined and analyzed. Both the vertical and lateral friction are extremely low—certainly not over 2 grams. Ball race bearings are used in both the vertical and horizontal pivots and are entirely enclosed and lifetime lubricated. This means that both are dust-free and will not deteriorate with use. Furthermore the vertical bearing can be adjusted to compensate for wear. This results in very low friction and the drag of the tone arm is inconsequential, with very little effect on tracking or groove loading.

Although the arm itself is massive and heavy, the vertical mass so far as the needle is concerned is very low. This condition is obtained by placing the vertical bearing just beyond the head and coupling the counterweight only to the head. Thus only the head and not the entire arm moves vertically. Furthermore, this division and the looseness of the coupling of head to the rest of the arm dampens the head from the rest of the arm so that the important resonance is that of the short head,

rather than the long tubes. I could find no trace of resonance.

A clever method is used to obtain mounting flexibility and cartridge alignment adjustment. The bottom of the base is spherically convex and is fastened to the table with three screws which go into a flat base plate underneath the table. By adjusting the pressure on the three mounting screws it is possible to change the angle of the arm to the plane of the record in both directions. Thus it is possible to obtain perfect alignment of the needle to the record grooves. This is very important for lowest distortion. Moreover, the angle of the base can also be adjusted in this way to obtain perfect balance over the playing arc of the record and so to compensate for slight departure of the table from absolute level.

The vertical height of the arm above the record can be adjusted precisely. The stylus pressure is also adjustable over a range of 3 to 15 grams or so. The counterweight is calibrated in grams for the G-E cartridges. The calibrations do not hold for heavier or lighter cartridges, but a new scale can be added following calibration with a needle pressure gauge. I obtained 100% tracking with a needle pressure of only 3 grams. I do not recommend so low a pressure for normal use, but successful operation with so low a pressure indicates the fine tracking ability and low friction of the arm.

Cartridges are mounted on a quick change slide, removable in a few sec-

onds, which accommodates all G-E and most other cartridges with ½-inch mounting centers. (The G-E Triple Play cartridge cannot be quick-changed because the "turnaround" knob prevents this.) The cartridge mount and head tilts 90° so that the needle can be adjusted and examined easily.

The only adjustment the arm does not have is for tracking angle when different cartridges are used. The correct overhang for the arm is 17/32 inch. This can be established for any given cartridge when the arm is mounted originally. However, the distance of needle from mounting center differs from cartridge to cartridge and when it does, the tracking angle will be slightly off. I know of no arm which provides this adjustment, so this limitation is not peculiar to the G-E. In short the Baton is a very fine pickup arm for highest fidelity and I recommend it highly.

Martin 352 amplifier and preamp

Amplifier design has become fairly standardized in the past few years. More than 90% of the commercial high-fidelity amplifiers use the Williamson circuit in whole or with some modifications. It is not surprising, therefore, that the performance has also become somewhat standardized. When, therefore, an amplifier comes along which stands out from others, it is a real event for the man who, like myself, tests and listens to many amplifiers. The Martin 352A and its companion preamplifier

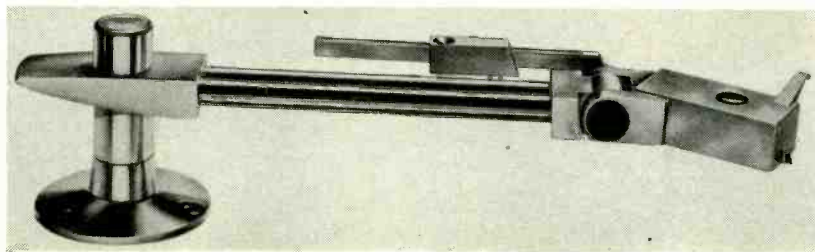

The G-E Baton tone arm and cartridge.

**It's New! 3 Years in Development
-NOW READY FOR YOU!**

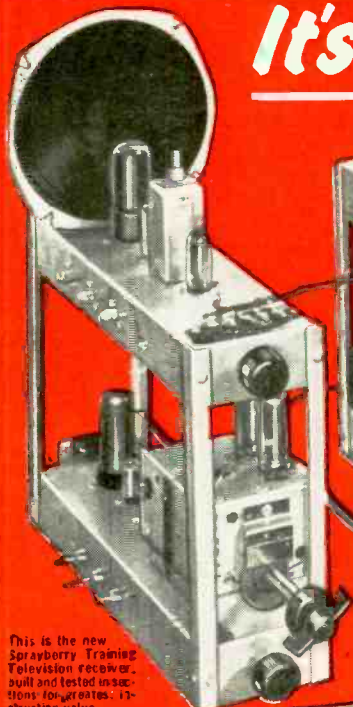

This is the new Sprayberry Training Television receiver, built and tested instructions for greatest instruction value.

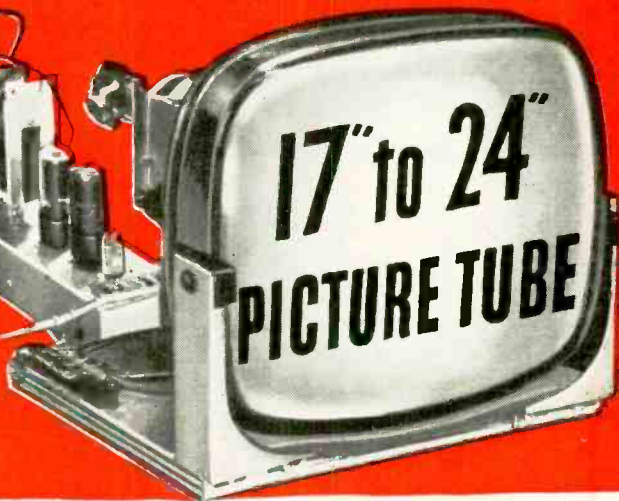
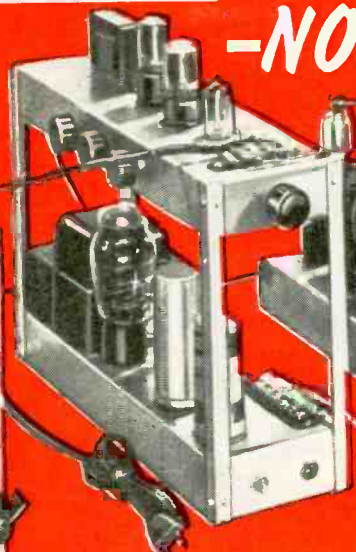

**17" to 24"
PICTURE TUBE**

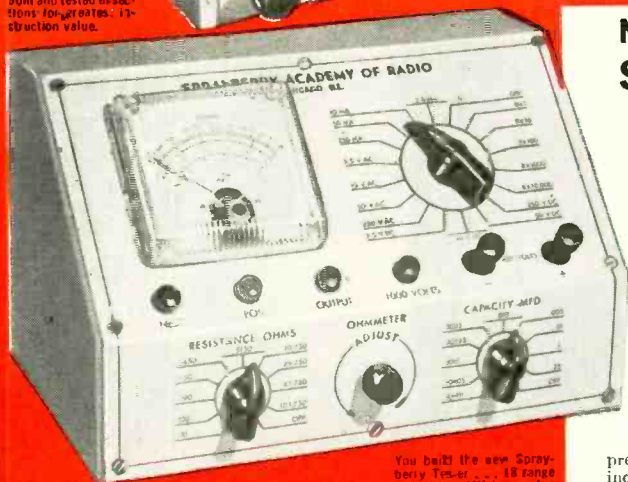

These photos show only a small part of the training equipment I send my students.

You built the new Sprayberry Tester... 18 range Volt (1000-1000000) meter readings plug output meter and condenser and resistor substitution selector.

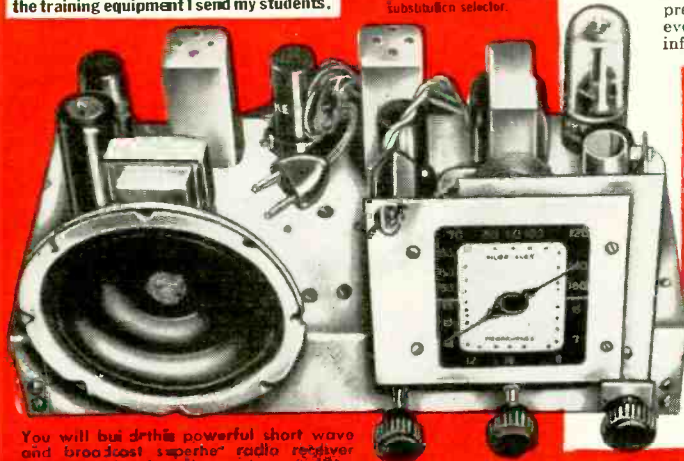

You will buy this powerful short wave and broadcast superhet radio receiver for valuable shop instruction practice.

New Equipment! New Lessons! Enlarged Course!
SPRAYBERRY PRACTICAL TRAINING IN
RADIO-TELEVISION
3 NO OBLIGATION TRAINING PLANS



Frank L. Sprayberry
President, Sprayberry
Academy of Radio

You have NO MONTHLY PAYMENT CONTRACT to sign ... pay for this outstanding training as you learn!

The complete facts are so big and so important to any man seeking training in Radio-Television that I urge you to mail the coupon below at once for my big all-new 56 page FREE CATALOG and FREE Sample Lesson. Get the full story of this remarkable new and up-to-the-second Training Plan. You'll read about my 3 NO OBLIGATION PLANS or "packaged unit" instruction for both beginners and the experienced man. You'll learn how I can now prepare you in as little as 10 MONTHS to take your place in this fast moving big money industry as a Trained Radio-Television Technician. You'll see that you take no risk in enrolling for my Training because you DO NOT SIGN A BINDING TIME PAYMENT CONTRACT. I have been training successful Radio-TV technicians for 22 years ... I can prepare you, too, to get into your own profitable Service Shop or a good paying job, even if you have no knowledge of Radio-Television. Mail the coupon ... I rush full information FREE and without obligation. (No salesman will call.)

NEWEST DEVELOPMENTS

Your training covers U H F, Color Television, F.M., Oscilloscope Servicing, High Fidelity Sound and Transistors.

PRACTICE AND TRAIN AT HOME WITH 25 NEW KITS OF EQUIPMENT

You get valuable practical experience in construction, testing and shop practice. You build a powerful 2 band superhet radio, the all-new 18 range Sprayberry multimeter, the new Sprayberry Training Television receiver, signal generator, signal tracer and many other projects. All equipment is yours to use and keep ... and you have practically everything needed to set up a Radio-Television Service Shop.

All your training is IN YOUR HOME in spare hours. Keep on with your present job and income while learning. I help you earn extra spare time money while you learn. If you expect to be in the armed forces later, there is no better preparation than practical Sprayberry Radio-Television training. Rush coupon below for all the facts—FREE!

SPRAYBERRY ACADEMY OF RADIO
111 NORTH CANAL STREET, DEPT. 20-W, CHICAGO 6, ILLINOIS

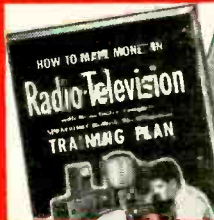

FREE CATALOG AND SAMPLE LESSON

Rush coupon for my catalog "How to Make Money in Radio-Television". PLUS an actual sample Sprayberry Lesson without obligation—ALL FREE. Mail coupon NOW!

SPRAYBERRY ACADEMY OF RADIO MAIL THIS COUPON FOR FREE
Dept. 20-W, 111 N. Canal St., Chicago 6, Ill. FACTS AND SAMPLE LESSON

Please rush all information on your ALL-NEW Radio-Television Training Plan. I understand this does not obligate me and that no salesman will call upon me. Include New Catalog and Sample Lesson FREE.

Name _____ Age _____

Address _____

City _____ Zone _____ State _____

NEW 1955

Heathkit

Engineering Features

New PRINTED CIRCUITS

One of the many tremendous improvements in the new 1955 Heathkits is the use of an etched metal process printed circuit board. Printed circuits will be used in Heathkits whenever they will affect construction simplification, and lend themselves to stabilization, and lend themselves to stabilization, and lend themselves to stabilization. Now for the first time a kit instrument company offers the advantages of modern printed circuit instrument construction technique. For the first time consideration has been given toward reducing the kit assembly time. Also this is the first time that printed circuit boards have been hand soldered on a volume basis. Offered only by Heathkit, the pioneer and leader in kit instrument design.

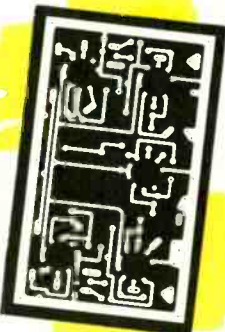

New PEAK-TO-PEAK VTVM CIRCUIT

New 6AL5 full wave rectifier in AC input circuit permits full scale peak-to-peak measurements. Seven ranges — upper limits 4000 volts peak-to-peak. Just the thing you TV servicemen have needed in making TV circuit voltage checks. Precision resistor voltage divider limits AC RMS level to 150 volts. Prevents over-loading the rectifier — extends upper limit AC RMS ranges to 1500 volts — further protects meter and circuitry against AC flash-over or arcing. Another definite example of continuing Heathkit design leadership in the kit instrument field.

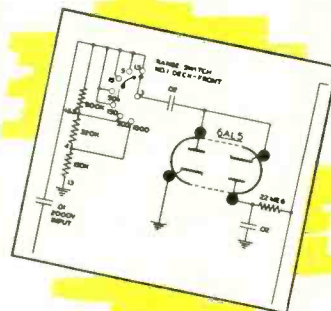

New HIGH READABILITY PANELS

New 1955 Heathkits feature complete panel redesign. Sharp white lettering applied to the beautiful charcoal gray panels, provide a new high in readability. Lettering is easy-to-read open style and panel calibrations are vividly clear against the pleasing soft gray background. New knobs of exclusive Heathkit design.



New 3" UTILITY SCOPE

The new 3" Scope is a "natural" for the well rounded line of Heathkit instruments. Small in size, 11 3/4" deep, 6 1/2" wide, 9 1/2" high, yet big in performance. Just think of the value. An Oscilloscope for \$29.50. Brilliant intensity, sharp focusing, wide positioning range. An ideal portable Scope for the TV serviceman — a second shop scope — modulation monitor for you hams (deflection plate terminals in rear of cabinet). Performance to spare for all general scope applications. See specifications on following page.

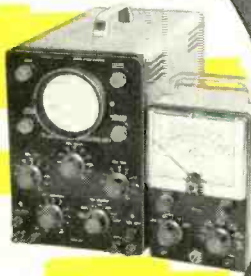

New STYLING New COLOR

New styling and coloring is responsible for tremendous improvement in Heathkit appearance. The new instrument panel color combination is high definition white lettering in a soft charcoal gray panel. Cabinet color is a lighter feather gray. The satin gold baked enamel cabinet for the WA-12 Preamplifier is further indicative of the modern pacemaking trend in Heathkit styling.



New SCOPE SWEEP CIRCUIT 10 CYCLES — 500 KC

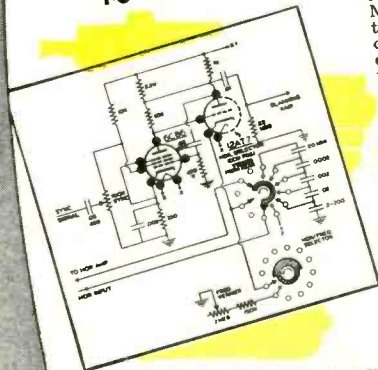

New 1955 Heathkit Model 0-1C Scope features a new wide frequency range sweep generator covering 10 cycles to 500,000 cycles. This coverage is available in five virtually decade sweep ranges and is five times greater than the frequency range usually available. Excellent retrace time characteristics, actually less than 20% at 500 KC. Use of the free running Heath circuit provides a larger margin of stability and a new high in Heathkit Scope performance.

Continuing PROGRESS FUTURE LINE EXPANSION



The outstanding improvements featured in the 1955 Heathkit line are representative of the progress characterized by the Heath Company operation. Long range planning will provide a continuing succession of new kit releases to further expand the Heathkit line which already represents the world's greatest selection of electronic kits. The innovations in the 1955 line, are representative of additional new models scheduled for release for the coming years.

SEE THE INSTRUMENTS ON THE FOLLOWING PAGES

HEATH COMPANY • • Benton Harbor 20, Mich.

Heathkit ELECTRONIC SWITCH KIT

The basic function of the Heathkit Electronic Switch Kit is to permit simultaneous oscilloscope observation of two separate traces which can be either separated or superimposed for individual study. This is accomplished through the use of two individually controlled inputs working through amplifier, multi-vibrator, and blocking stages. The output of the Electronic Switch is connected directly to the vertical input of the Oscilloscope. A typical example of usefulness would be simultaneous observation of a signal or waveform as it appears at both the input and output stages of an amplifier.

APPLICATIONS

An Electronic Switch has many applications to increase the over-all operating versatility of your oscilloscope. It can be used to check amplifier distortion—audio crossover networks—phase inverter circuits—to measure phase shift—special waveform study, etc. The instrument can also be conveniently used as a square wave generator over the range of switching frequencies, often providing the necessary wave form response information without incurring the expense of an additional instrument. Ownership of this instrument will reveal many entirely new fields of oscilloscope application and will quickly justify the modest cost of the Electronic Switch Kit.

Individual input gain controls, position control, coarse frequency control, and fine frequency control

Transformer operated for safety when used in conjunction with other equipment.

Tube complement:
2—6X4, 2—6SN7,
1—6X5

Continuously variable switching rates in three ranges from less than 10 CPS to over 2000 CPS.



MODEL S-2

\$23.50

Shpg. Wt.
8 lbs.

Heathkit VOLTAGE CALIBRATOR KIT



MODEL VC-2

\$11.50

Shpg. Wt. 4 lbs.

Another useful oscilloscope accessory particularly in circuit development work and in TV and radio service work. The Voltage Calibrator provides a convenient method for making peak-to-peak voltage measurements with an oscilloscope, by establishing a relationship on a comparison basis between the amplitude of an unknown wave shape and a known output of the voltage calibrator. Peak-to-peak voltage values are read directly from a calibrated panel scale without recourse to involved calculations.

FEATURES:

To off-set line voltage supply irregularities, the instrument features a voltage regulator tube. A convenient "signal" position on the panel switch by-passes the calibrator completely and the signal is applied through the oscilloscope vertical input, thereby eliminating the necessity for constantly transferring test leads.

RANGES:

With the Heathkit Voltage Calibrator it is possible to measure all types of complex waveforms within a voltage range of .01 to 100 volts peak-to-peak. Build this instrument in a few hours and enjoy the added benefits offered only through combination use of test equipment.

Heathkit LOW CAPACITY PROBE KIT



No. 342

\$3.50

Shpg. Wt. 1 lb.

An oscilloscope accessory, the 342 Low Capacity Probe permits observation of complex TV waveforms without distortion. An adjustable trimmer provides proper matching to any conventional scope input circuit. Excellent for high frequency, high impedance, or broad bandwidth circuits. The attenuation ratio can be varied to meet individual requirements.

Heathkit SCOPE DEMODULATOR PROBE KIT



No. 337-C

\$3.50

Shpg. Wt. 1 lb.

Extend the usefulness of your oscilloscope by observing modulation envelopes of RF or IF carriers found in TV and radio receivers. The Heathkit Demodulator Probe will be helpful in alignment work, as a gain analyzer and a signal tracer. Easy construction with the new modern printed circuit board. Voltage limits are 30 volts RMS and 500 volts D.C.

HEATH company

A SUBSIDIARY OF DAYSTROM, INC.

BENTON HARBOR 20,
MICHIGAN

AUDIO—HIGH FIDELITY

large feedback possible without instability.

Hum level is unusually low. The elaborate decoupling measures (plus no fewer than four filter chokes) improve the power supply filtering. In addition, the two single-ended stages of the main amplifier and the entire preamp are furnished with a d.c. filament supply. This is particularly helpful in the split-load inverter whose high cathode resistor increases heater-cathode leakage and accounts for most of the residual hum in Williamson amplifiers. The input tube of the main amplifier, as well as the amplifier tubes in the control unit, are low-noise 12AY7's—three of them. Finally, no a.c. of any kind goes into the preamp; the on-off switch and the pilot light, with their cables, are entirely outside the tight metal case which shields it.

As a result you literally have to stick your head inside a Karlson enclosure or a horn, with the bass and loudness control full on and treble normal, to hear any noise whatever, and what you hear is not line hum, but various tube noises. The total noise is completely inaudible as close as 1 foot from a Karlson enclosure with an RCA LC1A ("For Golden Ears Only," February 1955) speaker. The total noise is somewhat higher in the phono position but is still more than 60 db down. It is a good thing that both amplifier and preamp have bright pilot lights; you'll need them to remember to shut the outfit off.

The preamp offers a choice of magnetic phono and two other inputs. The load of the phono channel is 100,000 ohms; the equalizer is of the 2-stage feedback type. I would personally like to have more exact equalization than provided by the three curves (AES, NAB and EUROPEAN). True, given a turntable with very low hum and rumble, most systems can stand the bass boost on ORTHO, LP and NARTB records; but a system as fine as this ought to be equally good in this respect, too. And, with average changers and turntables, the rumble and hum when using the loudness control are likely to be a bit heavy.

There is a high-impedance output channel ahead of the loudness control but after the tone controls for a recorder. The loudness control is of the three-potentiometer type and very pleasant; a switch can throw it out. The bass control provides about 16 db of boost, no attenuation; the treble gives about 16 db boost or attenuation. Preamp output is through a cathode follower and any reasonable amount of cable can be used between the preamp and the main amplifier. The on-off switch on the preamp controls the amplifier, too; and there is a receptacle on the main chassis for another a.c. plug.

As there is no skimping in circuit details, there is also no skimping in quality of components or construction. Some of the plate resistors are rated at 10 watts and almost all resistors are 2 watts or better; those in push-pull

NEW *Heathkit* 5" PUSH-PULL OSCILLOSCOPE KIT FOR COLOR TV

BRAND NEW DESIGN: The new Heathkit Model O-10 Oscilloscope would be something special at any price, but is almost unbelievable at \$69.50. Completely re-designed scope has broadband amplifiers for color TV work and offers brilliant overall performance. Vertical frequency response within 5 db from 5 cps to 5 mc. Even more astounding, the response is down less than 1½ db at 3.58 mc. the color TV sync burst frequency. It is essential that scopes for color work have these broadband characteristics.

PRINTED CIRCUITS: Two printed circuit boards used in this fine instrument to insure stable, consistent performance. Problems solved by pre-engineering of boards, and their use guarantees completed unit that will have same characteristics as lab development model. Printed circuits simplify construction and save labor.

NEW SWEEP CIRCUIT: Sweep circuit operates with exceptionally good linearity from 20 eps to over 500,000 eps. 5 times the usual range for scopes in this price range. An entirely new circuit introduced for the first time in any Heathkit.

FEATURES: Other outstanding characteristics of this professional oscilloscope are: Built-in 1V peak-to-peak reference for calibration of plastic CRT face-plate; 5" 5U1 CRT; push-pull hor. and vert. deflection amplifiers; hor. trace width expandable to 3 times diameter of CR tube to allow inspection of any small portion of the signal; deflection sensitivity, .025 volts per inch; wiring harness pre-formed and cabled to save construction time and insure professional appearance and operation. Incorporates efficient retrace blanking. Frequency compensated step attenuator at the vertical input. Entire tube face useable. No foldover on vertical over-load. Performance obtainable only in much more expensive laboratory models.

Uses 5U1, 6AB4, 6B07, 12BH7, 6CB6, 12AT7, 2-12AU7, 6X4, 1V2, and 6C4. Quality components used throughout so that outstanding performance characteristics may be maintained for years to come. Plastic molded condensers are used in all coupling and by-pass applications. The "new-look" in Heathkit styling produces professional appearance in keeping with the professional performance of this instrument.

First color television service Oscilloscope with necessary high sensitivity and full 5 megacycle bandwidth.

New printed circuit construction, all components mounted on high insulation surface resulting in uniformly low circuit capacitance.

New type wide frequency range Heath sweep generator, 10 cycles to 500,000

New electronic positioning controls for instantaneous, definite positioning without bounce or overshoot.

New 5U1 CR tube



New cabinet styling and color harmony—charcoal gray panel with high readability white lettering.

MODEL O-10

\$69⁵⁰

Shpg. Wt. 27 lbs.

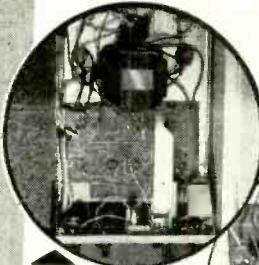

Clean, open, under chassis construction and wiring. Possible only through use of pre-cabled wiring harness, and simplified printed circuit boards.

Simplified, standardized construction technique of vertical and horizontal amplifier construction made possible through the use of a single printed circuit board.

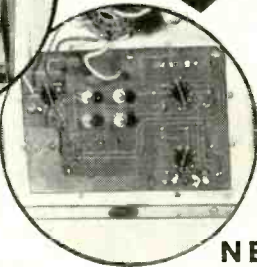

NEW

Heathkit

3" PRINTED CIRCUIT

OSCILLOSCOPE KIT

MODEL OL-1

\$29⁵⁰

Shpg. Wt. 15 lbs.

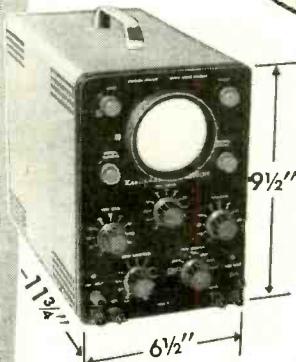

3GP1 CR TUBE

New compact utility Scope—light-weight—portable for service work.

Deflection plate terminals—ideal for ham transmitter modulation monitoring.

EXCEPTIONAL VALUE: The brand new Model OL-1 Utility Oscilloscope is designed especially for portable applications so that outside servicemen or persons performing field tests can have the advantages of a scope available. Then too, it is ideal for home workshop, the ham-shack, or as an "extra" scope for the service shop. It is compact, light in weight, and surprisingly versatile in operation. An outstanding instrument for the price.

Front panel controls are "bench-tested" for ease of operation and convenience. Printed circuit board used for constant circuit performance. Assembly time cut in half!

SPECIFICATIONS: Vertical amplifiers feature frequency response within 1 db from 10 cps to 100 kc, and within 5 db from 5 cps to 500 kc. Vertical sensitivity .2 volts per inch at 1 kc, with input impedance of 12 mfd shunting 10 megohms.

Horizontal response within 1 db from 10 cps to 200 kc. and within 5 db from 5 cps to 500 kc. Hor. sensitivity .25 volts per inch at 1 kc, input impedance of 15 mfd shunting 10 megohms. Sweep generator covers 10 cps to 100,000 cps with stable positive lock-in circuit. Cathode follower input in both vert. and hor. amplifiers; push-pull vertical and horizontal deflection amplifiers; 3" CRT; electronic positioning controls for wide range of vertical and horizontal spot deflection; provision for internal and external sync; 60 cycle line sweep. New modern color styling and unusual performance make this instrument an outstanding value.

New easy-to-build printed circuit board with high insulation factor.

New Heathkit Instrument styling—charcoal gray panel with high readability white lettering.

New Heath twin triode sweep generator 15-100,000 cycle sweep.

NEW

Heathkit

5" PRINTED CIRCUIT

OSCILLOSCOPE KIT

MODEL OM-1

\$39⁵⁰

Shpg. Wt. 24 lbs.

5B1 CR TUBE



VERSATILE INSTRUMENT: The new Model OM-1 general purpose Oscilloscope represents an outstanding dollar value in reliable test equipment. Full 5 inch CRT. Printed circuit boards for ease of assembly, constant circuit characteristics, and rugged component mounting. Includes all the design features necessary for servicemen, students, experimenters, radio amateurs, etc. Frequency response of amplifiers flat within 1 db from 10 cps to 100 kc, and down only 7 db from 10 cps to 500 kc. Sweep generator range from 20 cps to 100,000 cps. Also features new Heathkit color styling with charcoal gray panel and high definition white lettering for readability even under subdued lighting conditions.

DESIGN FEATURES: A full-size, versatile oscilloscope at a price you can afford. Other features are: adjustable spot shape control; RF connections to deflection plates; direct coupled centering controls; external and internal sweep and sync; 60 cycle line sync; built in 1 volt peak-to-peak panel terminal reference voltage; professional appearance of cabinet, panel, and knob styling.

HEATH company

A SUBSIDIARY OF DAYSTROM, INC.

BENTON HARBOR 20,
MICHIGAN

Heathkit MULTIMETER KIT

The new Heathkit Multimeter is a "must" to complete the instrument lineup of any well equipped service shop. Here is an instrument packed with every desirable service feature, many of which are not found in other Multimeters. All of the measurement ranges you need or want. High sensitivity 20,000 ohms per volt DC; 5,000 ohms per volt AC.

★ ADVANTAGES

Complete portability through freedom from AC line power operation—provides service ranges of direct current measurements from 150 microamps up to 15 amperes—can be safely operated in RF fields without impairing accuracy of measurement.

★ RANGES

Full scale AC and DC voltage ranges are 0-1.5, 5, 50, 150, 500, 1500 and 5,000 volts. Direct current ranges are 150 microamps, 15, 150 and 500 milliamperes and 15 amperes. Resistances are measured from .2 ohms to 20 megohms in 3 ranges and db range from -10 to +65 db.

★ CONSTRUCTION

The Heathkit MM-1 features a unique resistor ring switch mounting assembly procedure. With this method of assembly the precision resistors are wired to the rings and range switch before actual mounting of the switch to the instrument panel. This procedure affords the advantage of simpler construction yet complete accessibility of precision resistors in event replacement is ever required. Ohmmeter batteries were selected for convenience of replacement and only standard commercially available types are used. Batteries consist of 1 type C flashlight cell and 4 Penlite cells. All batteries and necessary test leads are furnished with the kit.

20,000 ohms per volt sensitivity DC; 5,000 ohms per volt AC.

Polarity reversal switch eliminates transferring of test leads.

All 1% precision multiplier resistors—sensitive 50 microamp 4 1/2 Simpson meter.

Total of 35 meter ranges on two color scale.

New modern cabinet styling—attractive appearance.

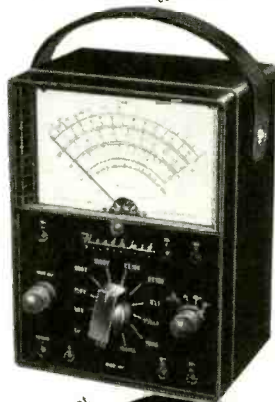

MODEL MM-1

\$26.50

Shpg. Wt. 6 lbs.

Heathkit HANDITESTER KIT



MODEL M-1

\$14.50

Shpg. Wt. 3 lbs.

The Heathkit Model M-1 Handitester readily fulfills major requirements for

a compact, portable volt-ohm milliammeter. The small size of the smooth gleaming molded bakelite case permits the instrument to be tucked into your coat pocket, toolbox or glove compartment of your car. Always the "Handitester" for those simple repair jobs.

RANGES:

Despite its compact size, the Handitester is packed with every desirable feature required in an instrument of this type. AC or DC voltage ranges, full scale, 10, 30, 300, 1,000 and 5,000 volts. 2 convenient ohmmeter ranges 0-3,000 ohms and 0-300,000 ohms. 2 DC milliammeter ranges 0-10 milliamperes and 0-100 milliamperes.

CONSTRUCTION

The instrument uses a 400 microampere meter movement which is shunted with resistors to provide a uniform 1 milliamper load in both AC and DC ranges. This design allows the use of but 1 set of 1% precision divider resistors on both AC and DC and provides a simplicity of switching. A small hearing aid type ohms adjust control provides the necessary zero adjust function on the ohmmeter range. The AC rectifier circuit uses a high quality Bradley rectifier and a dual half wave hookup. Necessary test leads and battery are included in the price of this popular kit.

Heathkit RESISTANCE SUBSTITUTION BOX KIT

MODEL RS-1

\$5.50



Shpg. Wt. 2 lbs.

36 standard RTMA 1 watt resistor values between 15 ohms and 10 megohms with an accuracy of 10% are at your fingertips in the Model RS-1 Resistance Substitution Box kit. This sturdy and attractive accessory will easily prove its worth many times over as a time saving device. Order several today.

Heathkit CONDENSER SUBSTITUTION BOX KIT

MODEL CS-1



\$5.50

Shpg. Wt. 2 lbs.

18 standard RTMA values are available from .0001 mfd to .22 mfd. An 18 position switch set in the panel of an attractive bakelite case allows quick changes without touching the test leads. Invest a few minutes of your time now and save hours of work later on.

HEATH company

A SUBSIDIARY OF DAYSTROM, INC.

BENTON HARBOR 20,
MICHIGAN

AUDIO—HIGH FIDELITY

stages are matched to 2% or better. The output stage not only has the usual balancing control, but also a bias-setting control. Instead of a single 6SN7 for the drivers, two 6J5's are used to keep the tubes well within dissipation ratings.

No effort has been made to save space. The amplifier is really big—it occupies a space 21 inches long and 11 inches wide. The main amplifier is as handsome underneath as a fine schematic diagram. Obviously, the Martin is not an assembly-line product. There is no evidence here of compromises for the sake of cost saving, space saving, production tolerances, or what not; but on every hand, evidence of an effort to build in maximum performance and maximum quality.

New Records

Note: Records are 12-inch LP and play back with RIAA curve unless otherwise indicated.

GOULD: Latin American Symphonette
BARBER: School for Scandal. Adagio for Strings, Essay for Orchestra.
Howard Hanson conducting the Eastman-Rochester Orchestra

Mercury MG 4002

If, God forbid, I had to get along with only one record for testing, demonstrating or showing off hi-fi equipment, I do believe at the moment I would choose this. The Gould *Symphonette* has just about everything needed to test almost any audio quality, once you have become familiar with it; and it makes a spectacular sound for pure show-off.

If Gould overlooked any instrument of the orchestra somebody else will have to catch the oversight; and he has combined them in a large representation of all possible combinations, from solo, choir to counterpoint. The music, once you start getting the hang of it, is amusing and pleasant and certainly shouldn't feeze anyone who listens to progressive jazz.

The percussives and drums are remarkably sharp: the bass drums very big. Most of the other percussives, including cowbells, take a turn at one point or another; there are very nice pizzicato double basses as well as legato, interesting contrasts of both legato and pizzicato in the Tango movement. The Rhumba and Guaracha are spectacular. Mercury does full justice to all this in an outstanding recording. The transient response is especially notable, and the entire record very clean except in the finale. But that is not surprising—when we reach a state when we can record a climax like this one, and on the innermost grooves at that, the millennium will have arrived.

The Barber works on the other side are not of the same type and by no means so useful, but they have their interest and hi-fi usefulness which nicely complements the Gould extravaganza. The Allegro of the *Essay* has very interesting variations of string tone, with a fine double-bass passage. The instrumentation of the *School for Scandal* is nicely complicated and offers a good measure of definition. There are some triangles buried in the crescendos, which will be quite audible on a system with zood definition. The record plays back clean with AES equalization and can stand the treble boost of a steep loudness control.

GUSTAV HOLST: The Planets
Philharmonic Promenade Orchestra,
London Philharmonic Choir,
Sir Adrian Boult, conducting.
Westminster 5235

High-fidelity record listening is producing a new type of connoisseur—the connoisseur of sound rather than music. For such a connoisseur this record offers a couple of very tasty dishes. *The Planets* is a cycle of tone poems indicat-

NEW *Heathkit* VACUUM TUBE VOLTMETER KIT PRINTED CIRCUIT DESIGN

Another outstanding example of continuing Heath Company pioneering and leadership in the kit instrument field. A new **printed circuit** VTVM. New peak-to-peak circuit—new styling and new panel design. A prewired, prefabricated printed circuit board eliminates chassis wiring, cuts assembly time in half, assures duplication of Engineering pilot model specifications, and virtually eliminates possibility of construction error.

CIRCUIT:

A 6AL5 tube operated as a full wave AC input rectifier permits seven peak-to-peak voltage ranges with upper limits of 4000 volts P-P. Just the ticket for you TV servicemen. Voltage divider in the 6AL5 input circuit limits applied AC input to a safe level. This circuitry and the isolation of the meter in the cathode of the 12AU7 bridge circuit affords a high degree of protection to the sensitive 200 microampere meter.

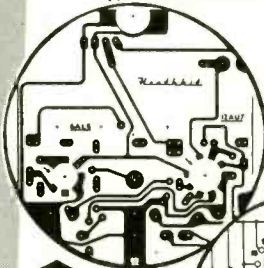

The first kit instrument to offer a labor-saving, error-free **printed circuit board**. Your instrument an exact wiring replica of Engineering development model.

Full wave rectifier in AC input circuit. Read peak-to-peak and RMS volts with upper limit of 4000 P-P and 1500 volts RMS. Voltage divider input circuit.

RANGES:

Seven voltage ranges. 1.5, 5, 15, 50, 150, 500 and 1,500 volts DC and AC RMS. Peak-to-peak ranges 4, 14, 40, 140, 400, 1,400, 4000. Ohmmeter ranges X1, X10, X100, X1000, X10K, X100K, X1 meg. Additional features are a db scale, a center scale zero position, and a polarity reversal switch.

IMPORTANT FEATURES:

High impedance 11 megohm input—transformer operated—1% precision resistors. 6AL5 and 12AU7 tube—selenium power rectifier—individual AC and DC calibrations—smoother improved zero adjust control action—new panel styling and color—new placement of pilot light—new positive contact battery mounting—new knobs—test leads included.

The new V-7 also sets the pace as a kit instrument style leader. Smart, good-looking charcoal gray panel and soft feather gray cabinet. High readability panel with sharply contrasting white calibrations. The pleasing, eye catching, modern styling is in harmonious balance with the outstanding circuit design improvements. Easily the best buy in kit instruments.

New charcoal gray baked enamel panel with high readability, white lettering, soft feather gray cabinet, subdual pilot light indicator.

New printed circuit board for faster, easier construction—exact duplication of Lab development model.



New easy-to-read open panel lay-out. Off-on switch now incorporated in the selector switch.

MODEL V-7

\$24.50

Shpg. Wt. 7 lbs.

New peak-to-peak meter scale—new color harmony—new knobs.

Heathkit AC VACUUM TUBE VOLTMETER KIT MODEL AV-2

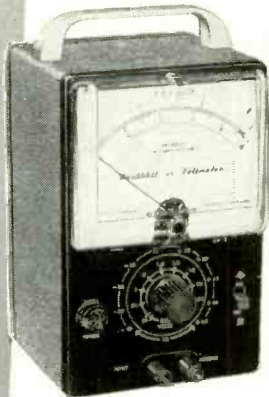

\$29.50

Shpg. Wt. 5 lbs.

Extreme sensitivity has been emphasized in the design of the Heathkit AC VTVM. Ten full scale RMS ranges are .01, .03, .1, .3, 1, 3, 10, 30, 100, and 300 volts. Frequency response is substantially flat from 10 cycles per second to 50 KC with input impedance of 1 megohm at 1 KC. Will accurately measure as low as 1 millivolt at high impedance. Total db range is -52 db to +52 db. An excellent kit for measuring

the output of phono cartridges and the gain of amplifier stages. Use it also to check power supply ripple, as a sensitive null detector, and for compiling frequency response data. Features one knob operation, 200 microampere Simpson meter and precision resistors.

Heathkit 30,000 VOLTS DC PROBE KIT

Measure up to 30,000 volts DC with the Heathkit VTVM and the 336 high voltage Probe. Precision resistor provides multiplication factor of 100. Can be used with any 11 megohm input VTVM. Housed in a Polystyrene two color sleek plastic probe body for safety of operation.



No. 336
\$4.50
Shpg. Wt. 1 lb.

Heathkit PEAK-TO-PEAK PROBE KIT



No. 338-C
\$5.50

Shpg. Wt. 2 lbs.

Peak-to-peak values not exceeding 80 volts at a DC level of not more than 600 volts, can now be read directly by using 338-C Probe with previous model Heathkit VTVM's or any VTVM with 11 megohm input resistance. Probe construction features a modern printed circuit board for easy assembly. Frequency range 5 KC to 5 MC.

Heathkit RF PROBE KIT

The Heathkit RF Probe will permit the measurement of RF voltages up to 250 MC with an accuracy of ±10%. The limits are 30 volts AC and a DC level of 500 volts. Designed for any 11 megohm input VTVM. Modern styling, Polystyrene aluminum housing, Polystyrene insulation, and printed circuit board for easy assembly.



No. 309-C
\$3.50 Shpg. Wt. 1 lb.

Heathkit AUDIO WATTMETER KIT

Read audio power output directly without using external load resistors with the new Heathkit Audio Wattmeter. Built-in non-inductive load resistors provide impedances of 4, 8, 16, and 600 ohms. Flat response from 10 CPS to 250 KC. Full scale power ranges are 0-5 MW, 0-50 MW, 0-500 MW, 0-5 W and 0-50 W. Model AW-1 will operate continuously at 25 watts and has a duty cycle of 3 minutes at 50 watts. Total db range in five positions is -50 db to +48 db, using the standard 1 milliwatt 600 ohms.



MODEL AW-1

\$29.50

Shpg. Wt. 6 lbs.

HEATH company

A SUBSIDIARY OF DAYSTROM, INC.

BENTON HARBOR 20,
MICHIGAN

Heathkit 6-12 VOLT BATTERY ELIMINATOR KIT

Here is the new 12 volt Heathkit Battery Eliminator so necessary for modern up-to-date operation of your Service Shop. Furnishes either 6 or 12 volt output which can be selected at the flick of a panel switch. Use the BE-4 to service all of the new 12 volt car radios in addition to the conventional 6 volt models.

RANGES:

This new Battery Eliminator provides two continuously variable output voltage ranges. 0-6 volts D.C. at 10 amperes continuously or 15 amperes maximum intermittent and 0-12 volts D.C. at 5 amperes continuously or 7.5 amperes maximum intermittent. The output voltage is clean and well filtered, as the circuit uses two 10,000 mfd condensers.

The continuously variable output feature is of definite aid in determining the starting point of vibrators, the voltage operating range of oscillator circuits, etc.

OTHER USES:

The controllable low voltage DC supply has many other applications besides primary use in car radio service work. Can be nicely used as a battery charger, or low voltage DC supply for electric trains. Has applications in high gain audio work requiring clean DC filament supply. Can be used for low power electro-plating or as a power supply for battery powered intercommunication systems.

Automatic overload relay—self resetting—fuse protected.

New 18 plate split liner unit.



Continuously variable output voltage, either 6 or 12 volt operation.

Constant ammeter and voltmeter monitoring.

MODEL BE-4

\$31.50

Shpg. Wt. 17 lbs.

Heathkit VIBRATOR TESTER KIT



MODEL VT-1

\$14.50

Shpg. Wt. 6 lbs.

This time-saving device will quickly pay for itself in your auto radio service shop. 6 volt vibrators can be checked instantly on the Good-Bad type meter scale. Operation requires only a variable DC voltage from 4 to 6 volts at 4 amperes. Model BE-4 Battery Eliminator is recommended for this application.

Five test sockets provide for the testing of hundreds of interrupter and self-rectifier types. Proper starting voltage is determined easily and accurately. Over-all quality is then unmistakably indicated on the panel mounted meter.

Heathkit IMPEDANCE BRIDGE KIT

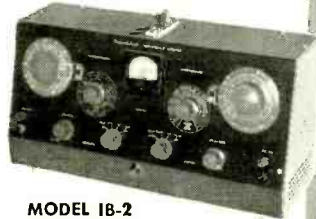

MODEL IB-2

\$59.50

Shpg. Wt. 12 lbs.

The new Heathkit Impedance Bridge features built-in adjustable phase shift oscillator and amplifier. This instrument actually represents four instruments in one compact unit. The Wheatstone bridge for resistance measurements, the Capacity Comparison bridge for capacity measurements, Maxwell bridge for low Q, and Hay bridge for high Q measurements.

DESIGN:

Panel provisions for external generator use. A new two section CRL dial, provides ten separate "units." Ten separate units switch settings and fractions of units are read on a continuously variable calibrated control. A special minimum capacity shielded and balanced impedance matching transformer between the generator and bridge circuit is automatically switched to provide correct load operation of the generator circuit. The instrument uses 1/2% precision resistors and condensers in all measurements circuits.

Heathkit VARIABLE VOLTAGE ISOLATION TRANSFORMER KIT

Variable output voltage between 90 and 130 volts AC. Rated at 100 volt-amperes continuously and 200 volt-amperes intermittently. The principle function of the Heathkit Isolation Transformer is to isolate the circuit being tested from line interference being caused by motors, appliances, etc. It works backward too by isolating such devices from the line.

Many other uses, especially with AC-DC type circuits. Do not confuse the Heathkit Isolation Transformer with the hazardous auto transformer type line voltage boosters.



MODEL IT-1

\$16.50

Shpg. Wt. 10 lbs.

HEATH company

A SUBSIDIARY OF DAYSTROM, INC.

BENTON HARBOR 20,
MICHIGAN

AUDIO—HIGH FIDELITY

ing the characters of the planets, and since they—from a horoscopic point of view—run the gamut from martial to coy, the music does also. The orchestra is one of the largest ever assembled and includes just about every instrument you can think of, not overlooking the full assemblage of percussives so beloved by the hi-fi people, plus a choir of voices for the final movement.

The music is most notable for the extraordinary variety of orchestral tone, exceptional definition and dynamic range, and the number of instruments which can be picked out clearly, even in the crescendos. Once you become acquainted with the music (and that will take several playings) the recording also makes a first class test record. The subtler nuances and tones, so well recorded, will be evident most on the better systems, and obscured on the poorer ones.

It would be impossible, short of several thousand words, to note the many sound values of the disc. There is, for instance, a very deep, very low pitched drum whose size must be as prodigious as its note. About two-thirds through the first movement this drum—whether alone or possibly backed by the organ pedal—produces the lowest musical tone I can think of. There are bells, not only struck, but apparently brushed as well; a lovely percussive harp; plenty of glockenspiel; interesting choirs of instruments playing arpeggios; strange effects such as that of bells, plucked harp and organ; a very dry (as opposed to mellow) xylophone; an occasional touch of the organ pedal. Musically interesting is the drum-beat rhythm of the first movement which will remind you of Ravel's *Bolero* but was written 10 years earlier.

RESPIGHI: *The Fountains of Rome* *The Pines of Rome* Orchestra of the Vienna State Opera, Argeo Quadri conducting. Westminster WL-5167

This was one of the first really spectacular hi-fi recordings; and will still hold its own with the very best.

The music is deliberately written for the sound coloring, not the melody; indeed, there is practically no melody aside from that supplied by the genuine nightingale. The tonal color of the orchestra covers a very wide spectrum.

We have a tremendously augmented orchestra and a variety of riches beyond my capacity to cover in so short a space. I quote some of my notes: the interesting wind sound in the opening of the *Fountains*; the tremendous horns and crescendos of the second movement; the ingenious variety of ways Respighi finds to express vividly the tinkle, roar, lapping, sparkling, gushing and rushing of water; the very big double basses and drums; the second movement is one of the loudest ever recorded with cleanliness and clarity; the bells in the final of the *Fountains* with their individual vibrato. The very sharp, strident opening of the *Pines*; the curious and individual tonal effect produced by the strangely assorted choirs of many instruments; the organ-like legato quality of the second movement with its tremendous bass; the very deep drums and close-up horns of the fourth; and finally, the use of an actual recording of a nightingale in the third movement, as per specifications by the composer on the score.

IBERT: *Concertina da Camera For Saxophone and Orchestra*

DEBUSSY: *Rhapsodie for Sax and Orchestra.*

Marcel Mule, soloist, with the Paris Philharmonic Orchestra conducted by Manuel Rosenthal.

Capitol L 8231

This is strictly for the collector of Debussy and modern music in general, as well as the specialist in instruments. Excellent but not brilliant sax tone, with a typically Debussy orchestral coloration behind it. A tambourine, for some reason or other, is prominent. The piece offers excellent opportunity for contrasting the sax with various other wind instruments, for often it is backed by, or plays tag with, horns and woodwinds.

The Ibert is more modern and the sax more brilliant and jazzy. People who like the progressive jazz of Stan Kenton should have no difficulty enjoying this. Marcel Mule is one of the outstanding virtuosi of the saxophone. END

NEW *Heathkit* TV ALIGNMENT GENERATOR KIT

Here is the most radically improved Sweep Generator in the history of the TV service industry. The basic design follows latest high frequency techniques which result in a combination of performance features not found in any other sweep generator.

SWEEP:

Sweep action is obtained electronically through the use of a newly developed controllable inductor, thereby eliminating all moving parts with their resultant hum, vibration, fatigue, etc. Frequency coverage entirely on fundamentals, is continuous from 4 MC to 220 MC at an output level well over a measurable .1 volt.

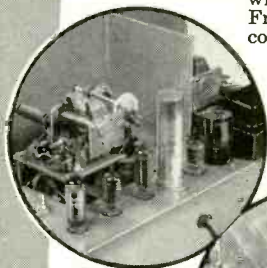

Triple marker system, 4.5 MC crystal controlled marker—continuously variable marker—provisions for external marker.

Automatic amplitude control circuit—constant output voltage regulated power supply.

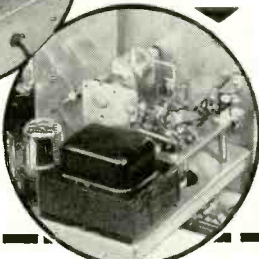

Controllable inductor sweep oscillator with output entirely on fundamentals.

Triple marker system 4.5 MC crystal controlled—3 sets of cables included.

Electronically operated, smoothly continuous variable sweep circuit. No vibration, hum or noise.



Frequency coverage: 4 MC—220 MC continuous including FM spectrum. RF output well over .1 volt.

MODEL TS-3

\$44.50

Shpg. Wt. 18 lbs.

MARKER:

The same instrument incorporates a triple marker system with a crystal controlled reference. A variable marker provides accurate coverage from 19 to 60 MC on fundamentals, and 57 to 180 MC on calibrated harmonics. A separate fixed crystal controlled 4.5 MC marker can be used for checking IF, band-pass, calibration, reference, etc. Provisions are also made for external marker use. A 4.5 MC crystal is supplied with the kit.

POWER SUPPLY:

The transformer operated Power Supply features voltage regulation for stable oscillator operation. Three sets of shielded cables are furnished with the kit. Sweep range is completely and smoothly controllable from zero up to a maximum of 50 MC, depending upon base frequency.

Here is a TV Sweep Generator that truly no serviceman can afford to be without for rapid, accurate, TV alignment work.

NEW *Heathkit* SIGNAL GENERATOR KIT



MODEL SG-8

\$19.50 Shpg. Wt. 8 lbs.

The new Heathkit service type Signal Generator, Model SG-8 incorporates many design features not usually found in this instrument price range. Frequency coverage

is from 160 KC to 110 MC in five ranges, all on fundamentals, with useful calibrated harmonics up to 220 MC. The RF output level is well in excess of 100,000 microvolts throughout the frequency range. The oscillator circuit consists of a twin triode tube, one-half used as a Colpitts oscillator, and the other half as a cathode follower output which acts as a buffer between the oscillator and external load, thereby eliminating oscillator frequency shift usually caused by external loading.

All coils are factory wound and adjusted, thereby completely eliminating the need for individual calibration and the use of additional calibrating equipment. The stable, low impedance output, features step and variable attenuation for complete control of RF level. A separate 6C4 triode acts as a 400 cycle sine wave oscillator, and a panel mounted switching system permits choice of either external or internal modulation.

Heathkit LABORATORY GENERATOR KIT



MODEL LG-1

\$39.50

Shpg. Wt. 16 lbs.

The new Heathkit Laboratory type Signal Generator definitely establishes a new performance standard for a kit instrument. An outstanding feature involves the use of a panel mounted 200 microampere meter calibrated both in microvolts and percent modulation, thereby providing a definite reference level for using the Signal Generator in design work, gain measurements, selectivity, frequency response checks.

DESIGN:

Additional design features are copper plated shield enclosure for oscillator and buffer stages resulting in effective double shielding. Fibre panel control shaft extensions in RF carrying circuits, thorough AC line filtering, careful shielding of the attenuator network, voltage regulated B plus supply, selenium rectifier, etc.

RANGES:

Frequency coverage from 150 KC to 30 MC all on fundamentals in five separate ranges. Output voltage .1 volt with provisions for metered external or internal modulation. Output impedance termination 50 ohms. Transformer operated power supply.

Investigate the many dollar stretching features offered by the LG-1 before investing in any generator for Laboratory or Service work

NEW *Heathkit* BAR GENERATOR KIT



MODEL BG-1

\$14.50 Shpg. Wt. 4 lbs.

The Heathkit BG-1 produces a series of horizontal or vertical bars on a TV screen. Since these bars are equally spaced, they will quickly indicate picture linearity of the receiver under test without waiting for transmitted test patterns. Panel switch provides "standby—horizontal and vertical position." The oscillator unit uses a 12AT7 twin triode for the RF oscillator and video carrier frequencies. A neon relaxation oscillator provides low frequency for vertical linearity tests. The instrument will also provide an indication of horizontal and vertical sync circuit stability as well as overall picture size. Operation is simple and merely requires connection to the TV receiver antenna terminal. Transformer operated for safety.

HEATH company

A SUBSIDIARY OF DAYSTROM, INC.

BENTON HARBOR 20,
MICHIGAN

Heathkit
VISUAL-AURAL
**SIGNAL-TRACER
KIT**

The new Heathkit Visual-Aural Signal Tracer features a special high gain RF input channel used in conjunction with a newly designed wide frequency range demodulator probe. High RF sensitivity permits signal tracing from the receiver antenna input. Separate low gain channel and probe available for audio circuit exploration. Both input channels are constantly monitored by an electron ray beam indicator so that visual as well as aural indications may be obtained.

NOISE LOCATOR:

A decidedly unusual feature is a noise locator circuit used in conjunction with the audio probe. With this system, a DC potential is applied to a suspected circuit component and the action of the voltage in the component can be seen as well as heard. Invaluable for ferreting out noisy or intermittent condensers, noisy resistors, controls, IF and power transformers, etc.

WATTMETER:

Built-in calibrated wattmeter circuit will prove useful for quick preliminary check of total wattage consumption of equipment under test. Separate panel terminals provide external use of the speaker or output transformer for substitution purposes. Saves valuable service time by eliminating the necessity for speaker removal on every service job. The same panel terminals also provide easy access to a well filtered B plus supply for external use. Don't overlook the many interesting service possibilities provided through the use of this instrument, and let the Signal Tracer work for you by saving time and money.

RF and audio probes supplied along with necessary test leads.

Visual and aural signal tracing.

Substitution test speaker—utility amplifier.
Noise locator circuit—calibrated wattmeter.



MODEL T-3
\$23⁵⁰

Shpg. Wt. 9 lbs.

Heathkit **CONDENSER CHECKER KIT**



MODEL C-3

\$19⁵⁰ Shpg. Wt. 7 lbs.

Here is a handy test instrument for any Service Shop. Unknown values of capacity and resistance are quickly determined on the direct reading condenser checker dial. Capacity is measured in four ranges from .001 mfd to 1000 mfd. Resistance in the range from 100 ohms to 5 megohms.

DC polarizing voltages of 25, 150, 250, 350, and 450 volts are available for leakage tests on all types of condensers. For electrolytics, a power factor control is provided to balance out inherent leakage and to indicate directly the power factor of a condenser under test. Proper balancing of the AC bridge is reflected in the degree of closure of an electron beam indicator tube.

Model C-3 uses a transformer operated power supply, spring return leakage test switch, and a convenient combination of panel scales for all readings. Test leads are furnished in addition to precision components for calibrating purposes. Quick and easy to operate, the Heathkit Condenser Checker will save valuable time and increase your Shop efficiency.

Heathkit **"Q" METER KIT**

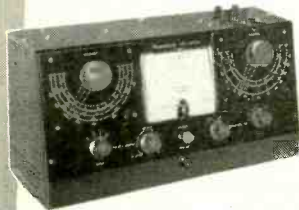

MODEL QM-1

\$44⁵⁰

Shpg. Wt. 14 lbs.

The Heathkit QM-1 represents the first practical popular priced Q meter available within the price range of schools, laboratories, TV service men, and experimenters. This instrument will enable the operator to simulate conditions encountered in practical circuits and to measure the performance of coils or condensers at the operating frequencies actually encountered. All indications of value are read directly on the 4 1/2" 50 microampere Simpson calibrated-meter scale. Measures Q of condensers, RF resistance, and the distributed capacity of coils. Oscillator section supplies RF frequencies 150 KC to 18 MC in four ranges. Calibrate capacity with range of 40 MMF to 450 MMF with vernier of ±3 MMF. Investigate the many services this instrument can perform for you.

Heathkit

AUDIO OSCILLATOR KIT

MODEL AO-1

\$24⁵⁰

Shpg. Wt. 10 lbs.



The Heathkit Audio Oscillator will produce both sine and square waves within the frequency range from 20 CPS to 20 KC in three ranges. Thermistor controlled linearity results in a variation of no more than ±1 db in a 10 volt (no load) variable output level. There will be less than .6% distortion from 100 CPS throughout the audible range. Low impedance 600 ohm output. Precision 1% resistors, used in the range multiplier circuits to provide accurate calibration.

HEATH company

A SUBSIDIARY OF DAYSTROM, INC.

BENTON HARBOR 20,
MICHIGAN

AUDIO—HIGH FIDELITY

**HIGH-FIDELITY
DICTIONARY**

Part II

A compilation of commonly used audio terminology

By ED BUKSTEIN*

Constant-velocity recording

A disc recording technique in which, for equal signal voltages, the amount of lateral movement of the cutting stylus is inversely proportional to the frequency. Since the lateral swing of the stylus is greater for low frequencies and smaller for high frequencies, the velocity of the stylus remains constant. This system has two fundamental disadvantages. During the recording of low frequencies, the lateral swing may be so great as to cause the stylus to cut into adjacent grooves. During the recording of high frequencies, the lateral swing of the stylus may be so small that the signal-to-noise ratio becomes excessively small. These disadvantages may be overcome by using constant-amplitude recording at the low frequencies and pre-emphasis of the high frequencies (Fig. 4).

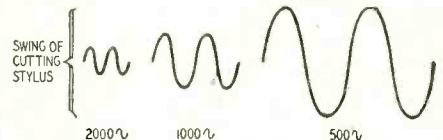

Fig. 4—Constant-velocity recording.

Corner enclosure

A loudspeaker enclosure designed to be used in the corner of a room. In some designs, the walls of the room serve as an extension of the enclosure.

Crossover frequency

The frequency at which equal power is applied to both loudspeakers of a two-loudspeaker system. One of the loudspeakers is designed to handle frequencies above crossover; the other, frequencies below. In a three-loudspeaker system, the audio spectrum is divided into three sections (high, low and mid-range) and there are two crossover frequencies. The term crossover frequency is sometimes used to describe the frequency above which

(Continued on page 81)

*Northwestern Television and Electronics Institute, Minneapolis, Minn.

Heathkit TUBE CHECKER KIT

The Heathkit TC-2 Tube Checker was primarily designed for the convenience of radio and TV servicemen and will check the operating quality of tubes commonly encountered in this type of work. Test set-up procedure is simplified, rapid, and flexible. Panel sockets accommodate 4, 5, 6, and 7 pin tubes, octal and loctal, 7 and 9 pin miniatures, 5 pin Hytron, and a blank socket for new tubes. Built-in neon short indicator, individual 3-position lever switch for each tube element, spring return test switch, 14 filament voltage ranges, and line-set control to compensate for supply voltage variations, all represent features of the TC-2.

Illuminated reading and quick identification of chart reference.

Improved smooth running roll chart mechanical action.

Simplified construction—new harness type wiring—closer tolerance resistors.

Smart, professional appearance—available in computer or portable models.

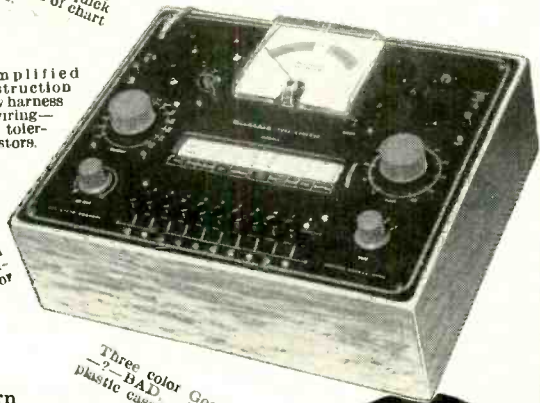

Three color Good 4 1/2" Simpson meter.

MODEL TC-2

\$29.50

Shpg. Wt. 12 lbs.

Results of tube tests are read directly from the large 4 1/2" Simpson 3-color meter. Checks emission, shorted elements, open elements, and continuity. Wiring procedure has been simplified through the use of multi-wired color coded cable providing a harness type installation between tube sockets and lever switches. This procedure insures standard assembly and imparts a "factory built" appearance to the instrument. New Construction Manual furnishes detailed information regarding tube set-up procedure for testing of new or unlisted tube types. No delay necessary for release of factory data.

Heathkit PORTABLE TUBE CHECKER KIT

The portable model is supplied with a strikingly attractive two-tone cabinet finished in rich maroon proxylin impregnated fabric covering with a contrasting gray on the inside of the detachable cover.

MODEL TC-2P

\$34.50

Shpg. Wt. 15 lbs.



Heathkit REGULATED POWER SUPPLY KIT



MODEL PS-2

\$33.50

Shpg. Wt. 15 lbs.

Here is a source of regulated D.C. voltage for circuit development work. Power supply voltage and current drain to the circuit under test are constantly monitored by the 4 1/2" panel mounted meter. Separate 6.3 volt at 4 ampere A.C. filament source available. The regulated and variable output voltage will be constant over wide load variations, and hum ripple will not exceed .012% at 250 volts under a 50 MA load. Completely isolated circuit, standby switch, and other desirable features, make the Model PS-2 extremely useful in a wide variety of applications.

Heathkit TV PICTURE TUBE TEST ADAPTER

The Heathkit TV Picture Tube Test Adapter used with the Heathkit Tube Checker Kit, will quickly check picture tubes for emission, shorts, etc. and determine tube quality. Consists of standard 12-pin TV tube socket, four feet of cable, octal socket connector, and data sheet.



No. 355

\$4.50 Shpg. Wt. 1 lb.

Heathkit DECADE RESISTANCE KIT



MODEL DR-1

\$19.50

Shpg. Wt. 4 lbs.

Twenty 1% resistors are decade in 1 ohm steps to provide any value between 1 ohm and 99,999 ohms. Sturdy ceramic switches with silver plated contacts insure reliable service. Use the Decade Resistance in bridge circuits, meter multipliers, calibrations, or any application requiring a wide range of precision resistance values.

Heathkit AUDIO GENERATOR KIT

Here is an Audio Generator with features generally found only in the most expensive instruments. Sine wave coverage from 20 cycles to 1 Megacycle—response flat ± 1 db from 20 cycles to 400 Kc—continuously variable and step attenuated output. Because the output voltage is relatively constant over wide frequency ranges, the AG-8 is ideal for running frequency response curves in audio circuits. Once set by means of the attenuator, this voltage may be relied upon for accuracy within ± 1 db. Instrument features low impedance 600 ohm output circuit and distortion less than .4 of 1% from 100 CPS through audible range.



MODEL AG-8

\$29.50

Shpg. Wt. 11 lbs.

Heathkit DECADE CONDENSER KIT

The Heathkit Decade Condenser provides a ready source of capacity values from 100 mmf to .111 mfd inclusive in capacity steps of 100 mmf. Silver plated contacts on husky ceramic switches, assure positive contact for each switch position. Precision silver mica condensers $\pm 1\%$ accuracy for close tolerance accurate work.

MODEL DC-1

\$16.50

Shpg. Wt. 3 lbs.



HEATH company

A SUBSIDIARY OF DAYSTROM, INC.

BENTON HARBOR 20,
MICHIGAN

NEW *Heathkit* HIGH FIDELITY PREAMPLIFIER KIT

Here is the exciting new Heathkit Preamplifier with all of the features you Audiophiles have asked for and at a down-to-earth price level. Beautiful satin gold baked enamel finish, striking control knobs and arrangement, attractive custom appearance and entirely functional design.

DESIGN:

Uses three twin triode tubes in a shock mounted chassis, 2-12AX7 and 1-12AU7. Features tube shielding, plastic sealed color coded capacitors, smooth acting controls, good filtering, excellent decoupling, low hum and noise level, and all aluminum cabinet. Special balancing control for absolute minimum hum level. Cathode follower, low impedance output circuit for complete installation flexibility.

SPECIFICATIONS:

Provides five switch selected inputs, 3 high level, and two low level, each with individual level controls—4 position LP, RIAA, AES, and early 78 equalization switch—4 position roll-off switch, 8, 12, 16 with one flat position. Separate tone controls, bass 18 db boost and 12 db cut at 50 CPS, treble 15 db boost, and 20 db cut at 15,000 CPS. Power re-

Equalization for LP, RIAA, AES, and early 78.

Separate bass and treble tone controls—special hum control.



Cathode follower low impedance output circuit.

Beautiful, modern appearance, blends with any interior or color scheme.

Five switch selected inputs with individual level controls.

requirements from Heathkit Williamson Type Amplifier power supply 6.3 volts AC at 1 ampere, and 300 volts DC at 10 MA. Over-all dimensions 12%¹/₂" wide x 5%¹/₂" deep x 3%¹/₂" high.

APPLICATION:

The new Heathkit WA-P2 Preamplifier has been designed to operate with any of the Heathkit Williamson Type Amplifiers and is directly interchangeable with the previous Model WA-P1 Preamplifier unit. Order your kit today and enjoy completely smooth control over the operation of your Hi-Fi system. Obtain the exact tonal balance of bass and treble with the precise degree of equalization you want. Note that the design of the WA-P2 accommodates the newly established RIAA curve.

MODEL WA-P2

\$19.75

Shpg. Wt. 7 lbs.

HAM EQUIPMENT

Single knob band switching—prewound coils.



Crystal or VFO excitation—metered operation.

52 Ohm coaxial output—built-in power supply.

MODEL AT-1

\$29.50

Shpg. Wt. 16 lbs.

filter, good shielding and a 52 ohm coaxial output. The 425 volt, 100 milliamperere power supply and 5U4 rectifier are more than adequate for the 6AG7 oscillator multiplier and 6L6 amplifier doubler.

Heathkit

AMATEUR

TRANSMITTER KIT

The Heathkit AT-1 Transmitter has established a high reputation and has been enthusiastically accepted by hundreds of experienced operators as well as beginners. Power input up to 35 watts for the novice and suitable as a standby exciter for your higher powered rig later on.

Model AT-1 can be crystal or VFO excited and operates on 80, 40, 20, 15, 11 and 10 meters. The prewound coils with the oscillator and amplifier are switched simultaneously by the rugged band switch. Meter switch allows a reading of the final grid and plate current on the panel mounted meter. Modulator input and VFO power sockets are provided as well as a key jack for CW operation. Other features include a crystal socket, standby switch, key click filter, AC line

Brand NEW

HEATHKIT VFO KIT

The new Heathkit VFO is the perfect companion to the Heathkit Model AT-1 Transmitter and it has sufficient output to drive any multi-stage transmitter of modern design. Good mechanical and electrical design insures operating stability. Coils are wound on stable, heavy duty, ceramic forms using Litz or double cellulose wire coated with Polystyrene cement and baked for humidity protection. Variable capacitor of differential type construction, especially designed for maximum bandwidth. Kit is furnished with a carefully precalibrated scale which provides well over two feet of scale length. Smooth acting vernier reduction drive and illuminated dial provides easy tuning and zero beating.

Power requirements 6.3 volts AC at .45 amperes, and 250 volts DC at 15 mls. Just plug it into the power receptacle provided on the rear of the AT-1 Transmitter. Seven band coverage 160 through 10 meters with 10 volt average RF output. Uses 6AU6 electron coupled Clapp oscillator and OA2 voltage regulator.

Copper plated chassis—aluminum cabinet—easy to build.



Smooth acting illuminated and dial.

Seven band coverage 160 through 10 meters at 10 volt RF output.

6AU6 electron coupled Clapp oscillator and OA2 voltage regulator.

MODEL VF-1

\$19.50

Shpg. Wt. 7 lbs.

Heathkit

GRID DIP METER KIT

The invaluable instrument for Hams, servicemen and experimenters. Useful in TV service work, for alignment of traps, filters, IF stages, peaking compensation networks, etc. Locates spurious oscillation, provides a relative indication of power in transmitter stages. Use it for neutralization, locating parasitics, correcting TVI, measuring CL and Q of components, and determining RF circuit resonant frequencies. The variable meter sensitivity control, headphone jack, 500 microampere Simpson meter, continuous frequency coverage from 2 MC to 250 MC. Prewound coil kit and rack included.

LOW FREQUENCY COILS:

Low frequency range extended to 355 KC by the use of two additional coils. Complete with dial correlation curves. Set 341-A for GD-1B and set 341 for GD-1A. Shpg. wt. 1 lb. Price \$3.00



MODEL GD-1B

\$19.50 Shpg. Wt. 4 lbs.

Heathkit ANTENNA

IMPEDANCE METER KIT

MODEL AM-1

\$14.50

Shpg. Wt. 2 lbs.

Determine antenna resonance and resistance, transmission line surge impedance, and receiver input impedance. Works with one-half and one-quarter wave lines, half wave and folded dipoles, harmonic mobile and beam antennas. Resistance type SWR bridge—100 microampere meter—frequency range 0-150 MC—impedance range 0-600 ohms.



MODEL AC-1

\$14.50

Shpg. Wt. 4 lbs.

ANTENNA COUPLER KIT

For the Heathkit AT-1 Transmitter or any comparable Amateur Transmitter. Will handle power up to 75 watts at its 52 ohm coaxial input. Matches a wide range of antenna impedances with its L type tuning network and neon indicator. A tapped inductance provides coarse adjustment and a transmitting type variable condenser sets it "right on the nose." Will operate on the 10 through 80 meter bands.

HEATH company

A SUBSIDIARY OF DAYSTROM, INC.

BENTON HARBOR 20,
MICHIGAN

New LOW PRICED HEATHKIT SINGLE UNIT Williamson Type High Fidelity AMPLIFIER KIT

Here is the newest Heathkit Hi-Fi Amplifier at the lowest price ever quoted for a complete Williamson Type Amplifier circuit. The W-4 Model has been designed for single chassis construction, and only for the new Chicago Transformer Company Model BO-13 "super range" high fidelity output transformer. This transformer, a new development in the Hi-Fi field, is being offered at substantial saving over transformers of comparable quality. It is outstanding in performance and on the basis of our tests, we find it equal in every respect to transformers used in the W-2 and W-3 Heathkit series.

LOW PRICES:

Through utilization of a single chassis with resultant economy obtained through elimination of duplicate sheet metal fabrication, connecting cables, plugs, sockets, and a new Chicago "super range" output transformer, a 20% price reduction has been made possible without sacrificing kit quality.

COMPONENTS:

The new Heathkit W-4 uses the same heavy duty power transformer and choke. It has all of the features of previous models including individual jacks and a wire wound control to balance the output tubes—plastic high quality capacitors and the exact circuitry previously utilized in Williamson Type Amplifiers. Intermodulation distortion and harmonic distortion are both at the same low level as in the W-2 and W-3 models.

CONSTRUCTION:

Here is the opportunity for even the economy minded Hi-Fi enthusiast to enjoy all of the advantages offered through Hi-Fi reproduction of fine recorded music. Simplified step-by-step Construction Manual completely eliminates necessity of electronic knowledge or special equipment. Assemble this Amplifier in a few pleasant hours.

Rugged, heavy duty,
single chassis con-
struction.

Output Impedances
4, 8, and 16 ohms.



Standard
brand com-
ponents used,
no sacrifice of
quality.

Lowest price high quality
Williamson Type Ampli-
fier ever offered.

Send for
free booklet
"High
Fidelity
Especially
For You."

COMBINATIONS AVAILABLE

W-4M with Chicago "super-range" trans-
former only. Single chassis main amplifier
and power supply. Shipping **\$39.75**
weight 28 lbs. Express only

COMBINATION W-4 with Chicago
"super-range" transformer only includes
single chassis main amplifier and power sup-
ply with WA-P2 preamplifier **\$59.50**
kit. Shpg. wt. 35 lbs. Express only

NEW Heathkit 20 WATT High Fidelity AMPLIFIER KIT

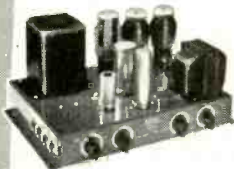

MODEL A-9B

\$35⁵⁰

Shpg. Wt. 24 lbs.

In keeping with the progressive policy of the Heath Company, further improvement has been made in the already famous Heathkit High Fidelity 20 Watt Amplifier. Additional reserve power has been obtained by using a heavier power transformer. A new output transformer designed and manufactured especially for the Heath Company, now provides output impedances of 4, 8, 16 and 500 ohms. The harmonic distortion level will not exceed 1% at the rated output.

FEATURES:

Outstanding features of the Heathkit 20 watt Amplifier include frequency response of ± 1 db from 20 CPS to 20 KC. Separate (boost and cut) bass and treble tone controls. Four switch selected input jacks and a special hum balancing control. Flexibility is emphasized in the in-

put circuits and proper equalization for all input devices is incorporated.

TUBE LINEUP:

12AX7 magnetic preamplifier and first audio amplifier. 12AU7 two stage amplifier with tone controls. 12AU7 voltage amplifier and phase splitter. Two 6L6 push-pull beam power output and 5U4G rectifier.

The Heathkit Model A-9B is excellent for custom installation and is designed for outstanding service at a very reasonable cost.

Heathkit SIX WATT AMPLIFIER KIT



MODEL A-7B

\$15⁵⁰

Shpg. Wt. 10 lbs.

An outstanding value, this econom-
ically priced 5 watt Amplifier is
capable of performance expected
only in much more expensive units.
Only 2 or 3 watts output will ever
be used in normal home applications
and Model A-7B will be more than
adequate for this purpose.

SPECIFICATIONS:

Two switch selected inputs are avail-
able for crystal and ceramic phono
pickups, tuner, TV audio, tape re-
corder, and carbon type microphone.
Model A-7B features separate bass
and treble tone controls, push-pull
balanced output stages, output im-
pedances of 4, 8, and 15 ohms, and extremely wide frequency
range $\pm 1\frac{1}{2}$ db from 20 CPS to 20 KC. Not just a souped up AC-
DC job. Full wave rectification, transformer operated power
supply and good filtering, result in exceptionally low hum level.

MODEL A-7C

Provides a preamplifier stage and proper compensation for the
variable reluctance cartridge and low level microphone. \$17.50

Heathkit WILLIAMSON TYPE AMPLIFIER KIT

Here is the famous kit form Williamson Type high fidelity Amplifier that has de-
servedly earned highest praise from every strata of Hi-Fi music lovers. Virtually
distortionless, clean musical reproduction, full range frequency response, and more
than adequate power reserve.

OUTPUT TRANSFORMERS:

This outstanding Williamson Type Hi-Fidelity Amplifier is supplied with the famous
Acrosound TO-300 output transformer. This quality transformer features the pop-
ular "ultra-linear" output circuit for clean maximum power level. Separate chassis for amplifier
and power supply.

SPECIFICATIONS:

Frequency response within 1 db from 10 cycles to 100,000 cycles. Harmonic distortion at 5 watt
output less than .5% between 20 cycles and 20,000 cycles. 1M distortion at 5 watts equivalent
output .5% using 60 and 3,000 cycles. Output impedances of 4, 8, or 16 ohms. Overall dimensions
for each unit 7" high x 5½" wide x 11½" long.

CONSTRUCTION MANUAL:

This fine kit is supplied with a completely detailed step-by-step Construction Manual and the
only effort required is the assembly and wiring of the pre-engineered kit. Even the complete
novice can successfully construct this Amplifier and have fun building it.

COMBINATIONS AVAILABLE:

W-3 Amplifier Kit (Includes Main Ampli-
fier with Acrosound Output Transformer,
Power Supply and WA-P2 Preamplifier.)
Shipping weight 37 lbs. **\$69.50**
Shipped express only

W-3M Amplifier Kit (Includes Main Am-
plifier with Acrosound Output Transformer
and Power Supply.) Shipping **\$49.75**
weight 29 lbs. Express only



HEATH company

A SUBSIDIARY OF DAYSTROM, INC.

BENTON HARBOR 20,
MICHIGAN

AUDIO—HIGH FIDELITY

constant-velocity recording is used and below which constant-amplitude recording is employed. This technique is known as modified constant-velocity recording. The switchover is usually made at about 500 cycles.

Crossover network

The filter circuits used to separate the audio signal according to frequency and to feed the separated frequencies to two or more loudspeakers, each designed to operate in a specific portion of the audio spectrum.

Crystal

The material, usually Rochelle salt, used as the pickup element in some cartridges. The crystal is piezoelectric and generates voltages in accordance with the movement of the stylus.

Crystal cutter

A cutting head in which the stylus is caused to move by a piezoelectric crystal.

Cutting head

The stylus (and its actuating mechanism) used to cut the grooves on a disc recording.

Decibel

The decibel is a unit of relative power, either acoustical or electrical, and is numerically equal to 10 times the logarithm of the ratio of the two powers. Equipment is often rated in decibels with respect to some established reference level, commonly 6 milliwatts across 600 ohms.

De-emphasis

The process and result of correcting the frequency response of a playback amplifier to compensate for the high-frequency boost (pre-emphasis) during recording. Pre-emphasis is used to prevent a low signal-to-noise ratio which might otherwise result from the small lateral swing of the cutting stylus at high frequencies (see constant-velocity recording).

Driver

A stage which supplies the input power of a following stage. For example, the output stage of an audio amplifier is often so designed that the grid or grids draw current thereby consuming power. The preceding stage must supply this power and is, for this reason, referred to as a driver.

Dual-track recording

A tape recording technique that doubles the playing time of a given length of tape. As the tape passes through the recording head, the magnetic patterns are recorded on only half of the tape width. The tape may then be reversed and the recording continued on the unused half-width.

Dynamic noise suppression

A system of noise reduction in which the bandpass (frequency response) of an amplifier is varied in accordance

with the frequencies present in the signal. When there are no high-frequency components in the signal, the high-frequency response of the amplifier is reduced. High-frequency noise is therefore not reproduced except when a high-frequency signal (of sufficient amplitude to mask the noise) is present. The low-frequency response of the amplifier is similarly altered.

Dynamic pickup

A type of pickup cartridge containing a coil and a magnet. Movements of the stylus cause the coil to move in the magnetic field. The voltage thus induced in the coil is the cartridge output.

Equalization

The process and result of designing an amplifier that will compensate for nonlinearities introduced by other components of a sound-reproducing system. For example, high-frequency signals are boosted during disc recording to increase the signal-to-noise ratio. The playback amplifier must therefore have a frequency characteristic that will reduce the high-frequency signal to its correct relative amplitude.

Erasing head

The coil used to remove magnetic patterns previously recorded on a tape or wire.

Exponential horn

A loudspeaker horn whose flare is such that the cross-sectional area increases exponentially with the distance from the throat. This is a mathematical way of saying that the horn flares out like a bell rather than being straight-sided like a cone.

Feedback

The process of returning a portion of the signal voltage to a preceding point of the circuit. The signal so returned may be either in phase or out of phase; that is, it may either reinforce or oppose the signal at the point of feedback. Aiding the feedback is said to be positive or regenerative; opposing, it is negative or degenerative. Negative feedback is often used in audio circuits since it improves frequency response, reduces harmonic distortion and improves the stability of the amplifier.

Fidelity

Exact acoustic duplication of the original voice, music or other sound.

Fletcher-Munson curves

A group of curves showing the frequency response of the human ear at different levels of sound intensity.

Flutter

Frequency variations in the reproduced sound caused by nonuniform speed of the turntable either during recording or playback.

(Continued on page 83)

SHURE NEW

crystal pickup cartridges replace 210!

AT A TOTAL COST OF ONLY \$18.00 LIST



The MODEL W68 replaces 41 Crystal Cartridges made by the five leading manufacturers.

The W68 is a "Muted Stylus" type, Dual-Weight Cartridge. The dual weight makes it possible to replace either aluminum or steel case cartridges—without adjusting tone-arm balance. With weight slug net weight is 25 grams; without weight slug net weight is 12 grams. The W68 is equipped with the famous A62A silent-tracking, "Muted Stylus" needle. Model W68—List price. \$7.50

The MODEL W78 replaces 149 Cartridges made by the five leading manufacturers.



Model W78 is a Dual-Volt, Dual-Weight Cartridge—so versatile it replaces 149 other cartridges! This cartridge alone will become a sensation overnight—because it replaces steel or aluminum case cartridges, of either high or low output! The W78 provides the broadest coverage at the lowest investment—only \$5.55 list.

General Information: With weight slug, net weight is 25 grams; without weight slug, net weight is 12 grams. In addition, Model W78 has a capacitor, furnished as an accessory. Without capacitor, output is 4.0 volts; with capacitor, output is 2.0 volts.



The MODEL W70 replaces 20 "Special" Cartridges.

Model W70 is a completely new cartridge in the Shure line. It replaces all the Webster "CX" and "C" Series Cartridges, comes equipped with all the necessary accessories. The W70 is more than an adequate replacement: it is an improvement, because it uses pin jacks—doing away with laborious "threading" of leads through the tone-arm. Model W70—List price. \$4.95



The Mark of Quality

craftsmen GOES DIRECT!

Bringing these Savings to You . . .

Effective March 1, Radio Craftsmen will begin a new policy—
"Selling directly to you."

The same fine Craftsmen Components that have previously been sold only through High Fidelity Dealers and Radio Parts Distributors can now be purchased direct from the factory—at tremendous savings. This new sales policy is designed to offer you the finest High Fidelity Equipment at the lowest possible price.



CRAFTSMEN *Solitaire*

Here is the finest, most flexible unit offered by any manufacturer. All you need for a professional home music system is the Solitaire, a fine record player and speaker. This exceptional new unit contains a full 20 watt power amplifier, a preamplifier and an exclusive sharp cut-off filter, housed in an attractive cabinet of leather etched steel. Inputs for magnetic phono cartridge, FM-AM tuner, tape recorder and TV receiver. Six record equalization positions. Contour type loudness control, and separate bass and treble tone controls giving 15 db boost and 13 db attenuation. Sharp cut-off filter system removes both high and low frequency noises. Basic amplifier is based on Williamson Ultra-linear design. Frequency response: ± 0.5 db, 20-20,000 cycles. IM distortion less than 2% at 20 watts. Size: 4 x 14½ x 11½", Weight 25 lbs.
Price was \$113.50 **NOW ONLY \$86.50**

C10 FM-AM Tuner

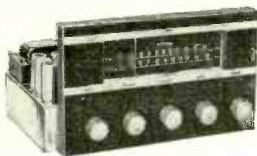

There are more C10 tuners now in use than any other FM-AM tuners ever made. The proof of its exceptional performance and durability is in the thousands of installations in homes, leading radio and TV stations, schools and hospitals. Has independent, continuously variable tone controls, built-in preamplifier, and two cathode follower outputs. Frequency Response: 20 to 20,000 cps. Sensitivity less than 5 microvolts. AFC for simplified, "no-drift" tuning. 12 tubes including rectifier. Weight—17 lbs.
Was \$131.50 **NOW ONLY \$107.50**

C1000 FM-AM Tuner

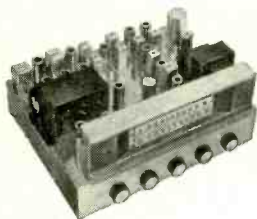

Far more than just a tuner, the C1000 is a complete control center for your Hi-Fi system. Here is a superior FM-AM tuner, a complete preamplifier with 4 positions of record equalization and input circuits for TV, tape recorder and phono. Has two AM bandwidths; broad for local Hi-Fi and sharp for distant or noisy stations. FM sensitivity; 2 mv for 30 db quieting. AFC and 2 cathode follower outputs. Wt. 25 lbs.
Was \$179.50 **NOW ONLY \$161.00**

C900 Basic FM Tuner



For use with Solitaire or C350 Preamplifier. Designed for broadcast monitoring where low distortion, ultimate stability, and high sensitivity are needed. Exclusive printed IF coils (20.6 mc); variable amplified AFC and lower over-all distortion than any station. Frequency response $\pm 1/2$ db 20-20,000 cycles. Overall IM distortion for 100% modulation less than .05%. Sensitivity, 2 microvolts for 30 db quieting. Weight 17 lbs.
Was \$119.50 **NOW ONLY \$99.50**

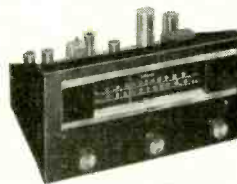

C810 Basic FM-AM Tuner

For use with the Solitaire or C350 preamplifier. Does not have built in preamplifier or tone controls. Exceptional FM sensitivity (4 mv. for 30 db of quieting) and wide band AM for true high fidelity performance. Frequency response ± 1 db 20-20,000 cps. Weight 21 lbs.
Price was \$134.50 **NOW ONLY \$97.50**

C550 30 Watt Amplifier



Here is maximum ruggedness, dependability and flawless reproduction at any volume level. Thirty full watts of audio power with only 0.1% harmonic and 0.5% IM distortion. Frequency response is far beyond the audible range (± 1 db 10-100,000 cps.) Special thermal time delay protects circuit. KT66 output tubes used exclusively for maximum efficiency. Wt. 33 lbs.
Was \$109.50 **NOW ONLY \$89.50**

C400 Audio Amplifier



Exceptional performance at low cost. Streamlined narrow chassis for ease of installation. Push-pull 6V6 beam-tetrode tubes plus 13.5 db negative feed back provide 10 watts output with frequency response of 15 to 20,000 cps. (± 1 db). Harmonic distortion less than 1%; hum and noise level 70 db below rated output. Five tubes including rectifier. Weight 13 lbs.
Was \$42.90 **NOW ONLY \$29.50**

C450 Audio Amplifier

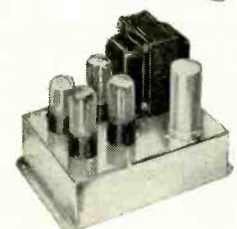

Ideal for budget Hi-Fi systems. Has same high quality craftsmanship as other Craftsmen amplifiers but with lower output of 6 watts. Frequency response: 20 to 20,000 cps. (± 1 db) with only one percent harmonic distortion. Push-pull 6W6GT beam-tetrode output tubes. Only 6 x 8½ x 6 inches. Weight 10 lbs.
Was \$29.50 **NOW ONLY \$19.50**

Order direct from factory and save. Only by selling direct can Craftsmen offer you these exceptional units at so low a price. Don't delay—Order by Mail Today.

The Radio Craftsmen Inc. Dept. G3 4403 N. Ravenswood Ave. Chicago 40, Illinois

World's Largest Exclusive Makers of High Fidelity Equipment

AUDIO—HIGH FIDELITY

Frequency response

The output of a pickup, amplifier, speaker or other component or combination of components expressed as a function of frequency. This expression usually takes the form of a graph showing response values plotted against frequency. Ideally, the curve should be flat; that is, the system should reproduce all frequency components in the same proportions as they are present in the original sound.

Guard circle

The closed, innermost groove of a disc recording. The guard circle prevents the pickup arm from swinging into the center of the record.

Harmonic distortion

A type of distortion introduced by an amplifier whose gain is nonlinear with respect to signal amplitude. (See Amplitude distortion.)

Hill-and-dale recording

A disc recording technique in which the applied signal controls the depth of the cut made by the stylus. The recorded signal therefore consists of a groove of varying depth. This system is also known as *vertical recording*.

IM

Abbreviation of intermodulation (See Intermodulation distortion).

Infinite baffle

A loudspeaker enclosure having no openings other than the one behind which the speaker is mounted. Originally applied to very large baffle areas—such as when speaker is mounted in the wall of a room—it is now often used to describe a relatively small, tightly closed box.

Intermodulation distortion

A type of distortion resulting from nonlinearity in an audio system. As a consequence of this nonlinearity, the frequency components of the signal are beat together and produce sum and difference frequencies. Since these frequencies were not present in the original sound, they constitute distortion.

I.p.s.

An abbreviation of inches per second, used in reference to the speed of tape or wire recordings.

Labyrinth enclosure

See Acoustical labyrinth enclosure.

Lead-in groove

The unmodulated spiral groove at the beginning of a disc recording. This groove leads the stylus into the recorded grooves.

Lead-out groove

The unmodulated groove at the end of a disc recording. This groove leads the stylus into the guard circle.

Locked groove

A closed groove on a disc recording. (See Guard circle.)

BUY DIRECT and SAVE!

Order by mail direct from factory, the finest equipment in high fidelity.

The best known name in high fidelity

craftsmen

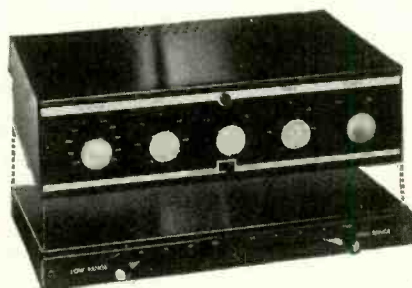

C350 Equalizer Preamplifier

New audio control system designed for exceptional flexibility and low distortion. Has exclusive "Hinged tone control circuit"—eliminates honk and rasp typical of conventional tone controls. Seven accurate record equalization positions. New British Z729 preamplifier tube results in a new low in noise, hum and distortion. New compensated Loudness Control reinforces highs and lows at soft volume settings. Has 4 input circuits for FM-AM tuner, TV, tape recorder and magnetic cartridge. Two cathode follower outputs for amplifier and recording systems. All-triode circuitry reduces distortion to vanishing point. Wt. 11 lbs. **Was \$129.50 NOW ONLY \$89.50**

C375 Sharp Cut-Off Filter System

Eliminates distortion present at the extremes of frequency range. Invaluable in obtaining maximum enjoyment from records, tape or FM broadcasts. Low frequency cut-off points: Flat, 40, 70, 120 and 200 cycles, reducing hum or turntable rumble. High frequency cut-off points: Flat, 9KC, 6KC, 4KC and 2.8KC. In flat position frequency response is ± 0.5 db, 20-20,000 cycles. Weight 8 lbs. **Was \$39.50 NOW ONLY \$33.50**

Save by mail. Order today direct from Craftsmen.

Now you can have the finest High Fidelity equipment made . . . at the lowest prices ever offered.

All equipment fully guaranteed and covered by Craftsmen Factory Warranty.

THE RADIO craftsmen INC.

Dept. G3, 4403 Ravenswood Avenue, Chicago 40, Illinois

Order Blank

Send me complete Craftsmen Catalog SHIP VIA
 Name _____ Express
 Address _____ Freight
 _____ Best Way

Uptown 8-4000

Quantity	Model No.	Item	Price

Check or M.O. enclosed
 Send COD. (25% prepayment enclosed)
 Orders from Canada and APO's must include full remittance.

On Express orders do not include transportation charges—they will be collected by the express agency at time of delivery.
 All Orders F.O.B. Chicago

World's Largest Exclusive Makers of High Fidelity Equipment

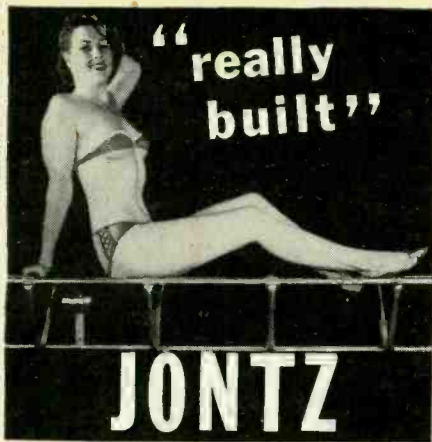

JONTZ TV TOWERS

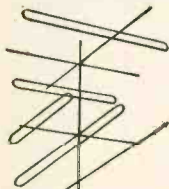

✓ **Safe**

✓ **Long
Lasting**

✓ **Easy to
Install**

Carry and sell the line that is really built to do the job. JONTZ TOWERS have everything . . . fine 14 gauge tubular steel; simplicity of erecting; easier to climb; guarantee maximum safety; self-supporting; withstand wind load up to 100 m.p.h.

Sell the line that is . . .
"Really Built"
to do the job.



AVAILABLE
at better jobbers . . .
EVERYWHERE

JONTZ
MANUFACTURING
COMPANY

1101 East McKinley,
Mishawaka, Indiana.

Model 400...

AUDIO—HIGH FIDELITY

Longitudinal magnetization

A tape recording technique in which the tape is magnetized in a direction parallel to its travel (Fig. 5).

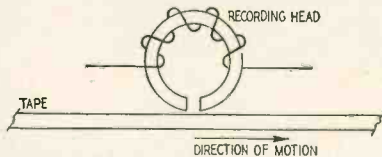

Fig. 5—Longitudinal tape magnetization.

Loudness control

A frequency-compensated volume control. Such controls vary the frequency response of an amplifier when the volume level is changed. This control compensates for the change in frequency response of the human ear at different levels of sound intensity.

LP records

Long-playing records. The increased playing time is obtained by a reduction of groove pitch. The LP record therefore has a greater number of grooves per inch than the standard record. A typical value for a standard disc is 100 grooves per inch, while an LP record may have from 225 to 300 grooves per inch. The grooves of an LP record are only about one-third as wide as those of a standard record and are known as microgrooves. LP records are made of vinylite and therefore have an extremely low noise level.

Magnetic bias

In tape recording, an alternating current (other than the signal current) is fed through the recording coil. This additional current is known as magnetic bias and serves a purpose similar to the bias applied to an amplifier tube. Fig. 6 shows a curve in which magnetic flux (B) is plotted as a function of magnetizing force (H). If signal current only were fed through the recording head, the operating point would be at O. Since the lower portion of

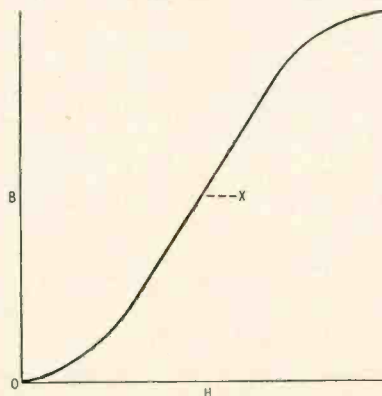

Fig. 6—Plot of a simple B-H curve.

the curve is nonlinear, operation in this region would lead to distortion. If a direct current is fed simultaneously with the signal through the recording head, the operating point is moved to X. Since operation now takes place over the linear portion of the curve, the fidelity is much improved. But d.c.

biasing of a magnetic tape has the disadvantage of magnetizing the tape even in the absence of signal. Since such magnetization increases the noise level of the recording, a.c. bias is commonly used. This leaves the tape unmagnetized when no signal is present.

Magnetic pickup

A pickup cartridge using a magnetic field. (See Dynamic pickup and Variable-reluctance pickup.)

Magnetic recording

A system of recording in which the audio signal is translated into corresponding magnetic patterns on a magnetic tape or wire.

Microgroove records

(See LP Records.)

Microphonics

Vibration of loose elements in a tube changes its characteristics and modulates its plate current. In effect, the tube acts as a microphone, hence the name microphonics. Sound from the loudspeaker may vibrate a microphonic tube, resulting in uncontrolled feedback and producing howls and squeals in the loudspeaker.

Modified constant-velocity recording

A disc recording technique that combines constant-amplitude and constant-velocity recording. Below a certain frequency (known as the turnover frequency) constant-amplitude recording is used. Above the turnover frequency, constant-velocity recording is employed.

Noise

Sound, other than the desired signal, produced by a record player, radio receiver or other sound-reproducing device. Noise is characterized by its random nature. This feature distinguishes it from hum, oscillation, wow and other undesirable sounds of a periodic nature. Three common sources of noise voltages are thermal noise, shot effect and record noise. Thermal noise is produced by the random motion of free electrons, particularly in carbon resistors. Such noise may be minimized by using wirewound resistors in critical parts of the circuit. Shot-effect noise is the result of random emission of electrons from the cathodes of the tubes, that is, the number of electrons emitted per unit time is not constant. Record noise results from the movement of the stylus over the granular structure of the record surface.

Noise suppressor circuit

A circuit designed to reduce the noise level of a sound reproducing system. An example of this type of circuit is the dynamic noise suppressor. This circuit varies the frequency response of an amplifier in accordance with the signal frequency. By reducing the band-pass of the amplifier when a wider range is not required, the circuit reduces the noise level. (See Dynamic noise suppression.) TO BE CONTINUED



TRANSFORMERS

from the pen of

Arnold Lichten

Dear Bill,

This page is the reason more and more servicemen and jobbers are concentrating on Merit for their

Single source

NO OTHER MANUFACTURER CAN SUPPLY THIS COMPLETE LINE OF COILS AND TRANSFORMERS.

Reply Sales Manager • Merit Coil and Transform. Co., Chicago 40

C-2981	3	A-3124	8	★MF-3	7	BC-351	12	BC-543	14
C-2985	3	A-3125	8	★MF-4	7	BC-350	12	BC-544	14
C-2987	3	A-3126	8	★MF-5	7	BC-352	12	BC-545	14
C-2990	3	A-3127	2	★MWC-1	7	BC-353	12	BC-546	14
★C-2991	3	A-3128	2	★MWC-2	7	BC-354	12	BC-547	14
C-2993	3	A-3129	2	★MWC-3	7	BC-355	12	BC-548	14
★C-2994	3	A-3130	2	★MWC-4	7	BC-360	12	BC-549	14
★C-2995	3	A-3131	2	★MWC-5	7	BC-361	12	BC-550	14
★C-2996	3	A-3132	2	★MWC-6	7	BC-362	12	SW-600	14
A-2998	2	A-3133	2			BC-363	12	SW-601	14
A-2999	2	★P-3138	7			BC-364	12	SW-602	14
★A-3000	6	★P-3139	7			BC-365	12	SW-603	14
★A-3001	6	P-3143	5			BC-366	12	SW-604	14
★A-3002	6	P-3145	5			BC-367	12	SW-605	14
★A-3003	6	P-3146	5			BC-368	12	SW-606	14
★A-3005	2	P-3147	5			BC-369	12	SW-607	14
A-3008	8	P-3148	5			BC-370	12	SW-620	14
A-3013	2	P-3149	5			BC-371	12	SW-621	14
A-3014	2	P-3150	5			BC-372	12	SW-622	14
A-3015	2	P-3151	5			BC-375	12	SW-630	14

COILS

★TV-100	10
★TV-101	10
★TV-102	10

GENERAL INDEX	PAGES
TRANSFORMERS	
★BLOCK OSC.....	6
CHOKES—REPLACEMENT.....	3
SPECIAL AND HAM.....	9
DRIVERS.....	8
FILAMENTS.....	4-5
INPUT.....	3
INTERSTAGE.....	3
ISOLATION.....	9
MODULATION—SPECIAL.....	8
UNIVERSAL.....	8
OUTPUTS—DUAL PRIMARY.....	2
FILTER TAPPED.....	1
HEAVY DUTY.....	2
SINGLE.....	1
SPECIAL.....	1
UNIVERSAL.....	2
★VERTICAL.....	1
PLATE.....	8
POWER—★REPLACEMENT.....	4-5
PHOTOFLASH.....	9
SELENIUM RECTIFIERS.....	6
STEPDOWN AUTO TRANSFORMERS.....	9
TV COMPONENTS.....	6-7
TUBE TO LINE.....	3
UNIVERSAL LINE—70.7V.....	2
OUTDOOR WEATHER PROOFED.....	8
VIBRATOR—DC.....	6
AC-DC.....	9
COILS	
★TELEVISION—IF.....	10
TRAPS.....	10-11
HORIZ. SYNC.....	10
ANT. COUPL.....	10
PEAKING.....	10
HI-PASS FILTER.....	10
HI-VOLT OSC.....	11
REQUENCY MODULATION (FM)—IF.....	11
RF-ANT-OSC.....	11
BROADCAST—STD.-IF.....	11-12
RF-ANT-OSC.....	12
BFO.....	13
TRF.....	13
PHONO-OSC.....	13
FILTERS.....	13
CHOKES—UNSHIELDED AIRCORE.....	13
SHIELDED AIRCORE.....	13
RF TYPE.....	14
UNSHIELDED IRON CORE.....	14
SHIELDED IRON CORE.....	14
FILAMENT.....	14
SHORT-WAVE—IF.....	14
S.W. CHOKES.....	14
RF-ANT-OSC.....	14
★TELEVISION REPLACEMENTS.	
Prices effective September 1, 1953. All prices subject to trade discount, and change without notice.	
DETAILED SPECIFICATIONS AND SCHEMATICS, ETC., SUPPLIED WITH EACH UNIT.	

MAGNETIC TAPE ERASURE

By DAVID GNESSIN

ON the face of it, magnetic tape erasure is simply the inverse of magnetic tape recording. It is not as simple as that. Operating some tape recorders in record position, with the volume control turned down, automatically erases the tape. In others, erasure is possible only with an a.c. bulk eraser, a few passes of which remove the recording on the entire reel without even unwinding it. Virgin tape, never used before, operates better if erased before its initial recording. To better understand magnetic tape erasure, let us review the process of recording on magnetic tape.

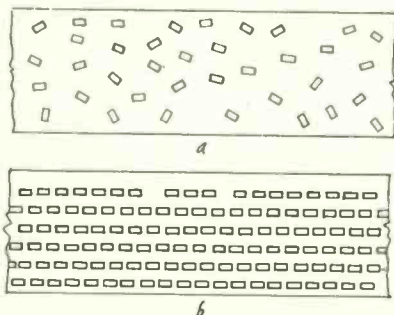

Fig. 1—Molecular structure of tape in a magnetized and unmagnetized position.

Fig. 1-a shows an unmagnetized strip of magnetic tape (plastic base covered with a film of iron oxide) with individual iron molecules having random positions. In Fig. 1-b the molecules are aligned, the result of a magnetizing force passing through the tape. The little rectangles (molecules) may be considered as tiny bundles of magnetic energy that can be oriented by external magnetizing force.

Fig. 2 shows a laminated iron core with a small gap touching a moving tape. The winding around the core goes to a transformer leading to a PM speaker, used as a microphone. Sound, picked up by the speaker, will generate a weak electrical current in the winding, producing a magnetic field across the gap. As the tape passes the gap, the originating sound is recorded on the tape.

If the magnetized tape is again drawn past the laminated core gap, the moving magnetic field provided by the tape will induce voltages in the winding. These will be heard as a replica of the original recording. In practice an amplifier, properly compensated, amplifies the weak signals both in recording and playback.

A portion of magnetic tape is shown enlarged in Fig. 3, with flux lines of a constant a.c. tone made visible by a laboratory carbonyl iron process. The photo shows ordinary 1/4-inch tape viewed right to left as it would pass the recording head.

Virgin tape may be considered as recorded tape, since the magnetic "bundles" (Fig. 1-a) carry an audible, if random, message. When played back this appears as tape noise. In Fig. 1-b the tape has been magnetized in a single direction. This condition, known as *d.c. erasure*, plays back as a hiss, a special form of tape noise. Uniform magnetization of the tape can magnetize the recording head and tape guides as it passes in close contact, causing these components to distort even good tape in later use. Magnetized tape transport components alter the bias point, producing nonsymmetric recording with second- and higher even-order harmonic distortion.

The causes of even-order harmonic distortion in the recording process have one thing in common—d.c. component or magnetization which prevents the heads from properly modulating the tape about the ideal point of symmetry. This lack of symmetry is usually noticed at the recording head; but if the erasure head leaves the tape heavily magnetized, the same results occur.

Yet, d.c. erasure is used in some recorders because it takes little space

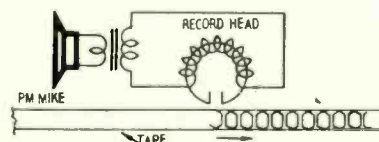

Fig. 2—Diagram of basic tape recorder.

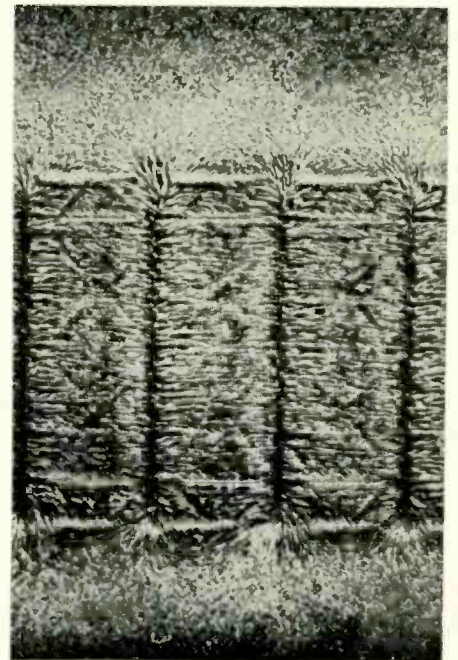

Fig. 3—Recording on magnetic tape.

and weight and does not introduce enough distortion to render the recording unpleasant.

Erasure heads

There are two typical types of permanent-magnet erase heads. One swings on a pivot and may be swung out of the way when not erasing. The other is a combination tape-guide eraser that is bolted onto the tape transport panel, replacing a tape guide. A mark on the face of the guide shows whether the magnet face or the back side is against the tape. A ratchet permits this unit to be rotated in or out of the circuit as desired, without disturbing its tape-guide action.

In some units d.c. bias is used for recording. Under these conditions the PM eraser simply saturates the tape in the opposite direction to the d.c. bias. The only difficulty with this is the residual noise level due to the saturation

Fabulous..Revolutionary.. Completely New..

MIGHTY MO*

*Pat. No. 2680196, others pending.

**the most powerful antenna
ever built, featuring TESCON'S
NEW exclusive DDP*** (Double Diamond Phasing)

Tescon's miraculous Mighty Mo will make prime signal areas out of even the deepest fringe sections of the country.

Mighty Mo... complete with DDP, an entirely new and revolutionary concept of phasing, will trap even the weakest signal and perk it up to a clear, brilliantly sharp, deep-toned picture. Tescon absolutely guarantees that each and every Mighty Mo will perform where other antennas have actually failed!

Theoretical ratings will never pay off. Rely on tested results... that's your real proof, that's your money in the bank.

**Here's Mighty Mo's proof
...the results of ACTUAL
FIELD TESTS.**

- On channels 2 to 13, Mighty Mo outperforms every other antenna manufactured today.
- Higher uniform gain over all channels. Does not vary more than 1 1/2 D.B. on any channel across band. Perfect on color TV.
- Clearer, sharper, deeper pictures on all channels.
- Higher average gain than 6 of the most advertised antennas.

MIGHTY MO'S FEATURES

- DDP (Double Diamond Phasing) precision-timed phasing regulator enables the weakest of signals to be trapped and then boosted to a clear, magnificently sharp, photo-like picture.
- Flat response... a must for color reception.
- Largest screen area... over 70 sq. ft. Screen elements spaced less than 1/10 wave length apart for maximum reflector efficiency. Highest front to back ratio ever achieved.
- Absolutely no rear pick up or co-channel interference... no "venetian blinds."
- 1/2 wave element spacing on all channels for super-gain.
- Completely preassembled... not an erector set type antenna.
- Uniform gain response... no erratic audio and video patterns.
- Thoroughly tested for mechanical stress and strain... exceptionally rugged.
- Guaranteed to perform where other antennas fail.

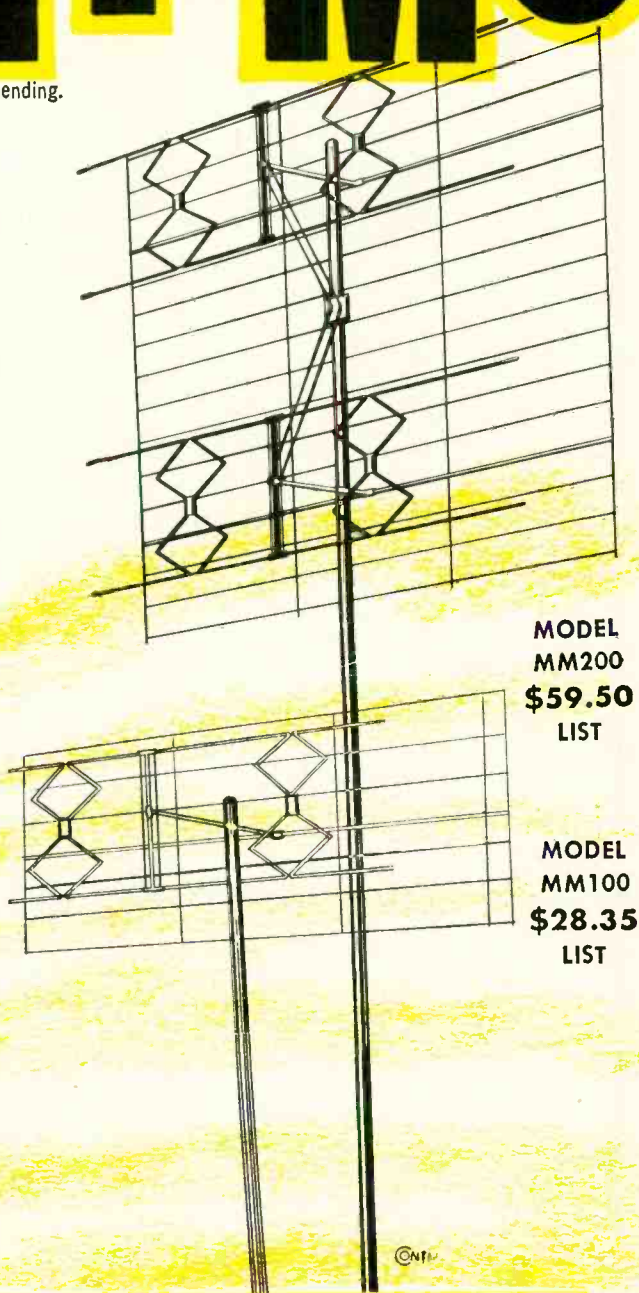

**MODEL
MM200
\$59.50
LIST**

**MODEL
MM100
\$28.35
LIST**

TESCON

**TV PRODUCTS COMPANY
SPRINGFIELD GARDENS 13, NEW YORK**



when it's a
QUAM
Adjust-a-Cone[®]
SPEAKER

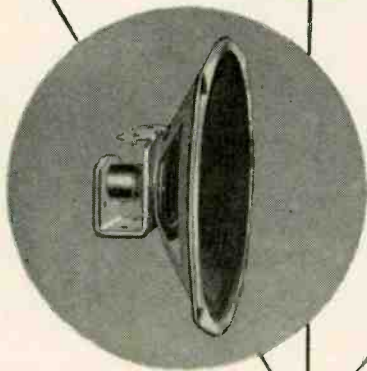

you can
SELL IT
and
FORGET IT!

Quam Speakers just don't come back. Ask any serviceman or distributor who handles them. The patented Adjust-a-Cone suspension and the patented U-shaped coil pot, combined with Quam's advanced production and inspection procedures, are your assurance that every Quam Speaker is a trouble-free speaker.

A FREE copy of the latest Quam Catalog, listing over 100 replacement speakers, is available from your distributor, or from the Quam-Nichols Company.

ask for **QUAM** the quality line for all your speaker needs

QUAM-NICHOLS COMPANY

236 EAST MARQUETTE RD. • CHICAGO 37, ILLINOIS

OVER 97,000 TECHNICIANS HAVE LEARNED
HOW TO GET THE MOST OUT OF ↓ **for AM**
BASIC TEST EQUIPMENT **FM-TV**

'Servicing by Signal Substitution'

A BEST SELLER FOR OVER 13 YEARS!
(NEW, UP-TO-DATE, 14th EDITION)

The Modern, Simplified, Dynamic Approach to
all Receiver Adjustment & Alignment Problems

- ★ Nothing complicated to learn
- ★ No extra equipment to purchase
- ★ Universal . . . non-obsolete
- ★ Employs only basic test instruments

Ask for "S.S.S." at your local Radio
Parts jobber or remit 40¢ in small
stamps or coin directly to factory.



ONLY 40¢
103 pages.
Invaluable
information
that will help
you redouble
the value of
your basic test
equipment.

PRECISION APPARATUS COMPANY, INC.
70-31 84th STREET, GLENDALE 27, L. I., N. Y.

AUDIO—HIGH FIDELITY

hiss. Where this hiss can be tolerated the recorder may use a d.c. electromagnet for erasing.

Where electromagnets are used, a slight extra expense in the design permits d.c. pulse erasure, an improvement over the d.c. saturation technique. The improvement uses the first d.c. pulse to saturate the tape, followed by a second d.c. pulse of opposite polarity and of such strength as to leave the tape with zero magnetization after its removal. While lacking the gradually decreasing cyclic demagnetization of the ideal a.c. erasure, an average of zero magnetization can be approached.

The simplicity and economy of a small PM eraser are a strong temptation to design engineers. Since the single pole of a magnet will leave the tape magnetized to saturation, one system uses more than one PM pole, leaving the tape in a nearly demagnetized condition. A very large number of poles of successively opposite polarity and gradually decreasing strength is equivalent to an a.c. erase. Practical design, however, limits the use to a small number of poles.

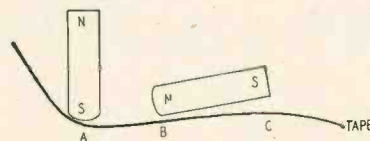

Fig. 4—Diagram shows PM pulse erasure.

Fig. 4 shows the setup in the Brush "Soundmirror" and Wilcox-Gay "Recordio." Two magnets are arranged to give essentially three-pulse erasure.

The two magnets laid at almost right angles to each other magnetize the tape at points A, B and C with alternating polarity. At A the first magnet saturates the tape, removing the previous recording. As the saturated tape reaches B, the weak reversed polarity tends to demagnetize the tape, leaving point C with a reversed (even weaker) field to average out the magnetic alignment of the tape. The two magnets are adjusted to give the optimum magnetic field for erasure.

Since, as shown in Fig. 5, an airspace is left between portions of the second magnet and the tape, it may be expected that *tape weave* will vary the magnetic effect upon the magnetic alignment of the tape. Thus, the space between magnet and tape is filled with nonmagnetic material permitting the tape to rub against the surface. The nonmagnetic shim material must be thin, since the space may be measured in hundredths of an inch. (Scotch tape has been used with success.)

Where batteries or a well-filtered B supply is available, both bias and erase voltages can be taken from the d.c. supply (Fig. 5). The potentiometer adjusts for optimum d.c. bias. The erase coil has a switch built in to cut out erasure when not required. As in all d.c. circuits, the polarity of the recording head is important and should be

NEW Capacitor Resistor-Analyzer AND Quick Capacitor Checker

another
Pyramid
first

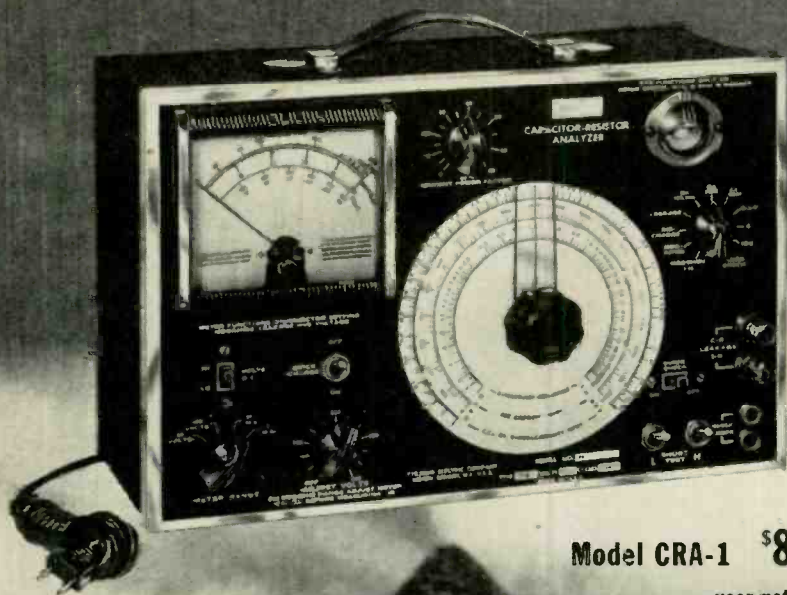

Model CRA-1 \$82⁹⁵
user net price

This fine double duty instrument provides you not only with the complete setup for checking and analyzing all types of capacitors and resistors, but also the "Quick Check" feature enables you to test capacitors while they are wired in a set.

With the Pyramid analyzer there is no need to remove capacitors from the circuit to determine if they are open, shorted or intermittent.

This new development that saves time in servicing and production testing serves the function that required two instruments previously, actually costs less than the older type analyzer plus a separate "quick" capacitor checker.

PYRAMID ELECTRIC CO.

1445 Hudson Blvd., North Bergen, N. J.

2 in 1

BURTON BROWN ADVERTISING

PYRAMID

DON'T THROW OLD RADIOS AWAY!

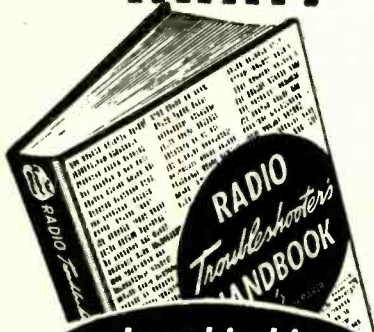

Let this big handbook show you EXACTLY HOW TO FIX THEM fast and r-i-g-h-t!



THE ONLY GUIDE OF ITS KIND!

A. A. GHIRARDI

Covers every model made by 202 mfrs. from 1925 to 1942

- Airline
- Apex
- Arvin
- Atwater Kent
- Belmont
- Bosch
- Brunswick
- Clarion
- Crosley
- Emerson
- Fada
- G.-E.
- Kolster
- Majestic
- Motorola
- Philco
- Pilot
- RCA
- Silvertone
- Sparton
- Stromberg

... and over a hundred more!

PRACTICE 10 DAYS FREE.

Dept. RE-35, RINEHART & CO., INC.,
232 Madison Ave., New York 16, N.Y.
Send Ghirardi's RADIO TROUBLESHOOTERS HANDBOOK for 10-day free examination. If I decide to keep book, I will then send \$6.50 (plus postage) in full payment. Otherwise, I will return book postpaid and owe you nothing.

Name.....

Address.....

City, Zone, State.....

OUTSIDE U.S.A. \$7.00 cash only. Money back if book is returned in 10 days.

AUDIO—HIGH FIDELITY

carefully noted in hooking up this circuit; otherwise, the output will be low in amplitude and high in distortion.

Alternating-current erasure

The best magnetic erasure is a.c. This is because of the nature of erase requirements. The ideal erase technique saturates the tape in a strong magnetic field, aligning the magnetic bundles. This effectively destroys the tape's previous magnetic history without giving it a new magnetic pattern. To avoid magnetizing the tape anew, the

μf trimmer adjusts the bias current fed to the record-playback head (Shure TR-16).

Only ultrasonic frequencies are used in a.c. erasure when built into the tape-transport mechanism. Sixty cycles (line frequency) is never used in this arrangement, since it would magnetize the tape with a pronounced 60-cycle hum. As a matter of fact, hum in the vicinity of the recording or erase head, due to leaky capacitors, induction by improper lead dress and faulty components, acts to limit complete erasure of signal from the tape.

The alignment of the erase head with respect to the recording head determines the erase efficiency. A properly aligned head using high-frequency energy directed along the longitudinal axis of the tape can effect erasure with field intensities of from 1,000 to 1,500 gauss. Improper alignment may require more energy to do the same job.

Extraordinary problems of alignment may arise where the system is incompatible, such as attempting to erase a dual-track recording on a single-track machine, or vice versa. Similarly, if an erase head meant for dual-track operation erases one track at a time, it is necessary that the erase head coincide with the recorded track erased. Some machines record and erase the top track, others the bottom. Some machines feed left to right, others right to left. Where the erasing head covers the entire width of the tape these confusions are eliminated.

Occasionally complete erasure is not obtained with an ultrasonic system due to strange regeneration effects taking place just after the tape passes the erase gap. As the tape leaves the saturation field, entering the fringe field, it may welcome the weaker ultrasonic energy as normal ultrasonic bias. This permits re-recording of the weak tape field from proximity to the fully magnetized tape entering the gap a short distance before. The effect is most prominently felt when the erase head gap is small. Thus, the bad effect cannot be eliminated by increasing the erase current.

One way to cure this ill is to make a second pass by the erase head, where the residual signal is quickly removed since the heavily recorded signal was wiped off by the first pass. This second pass may be made upon the very same machine with good results, and used as a test to distinguish this regeneration trouble from another faulty condition— inadequate erase field intensity. Some

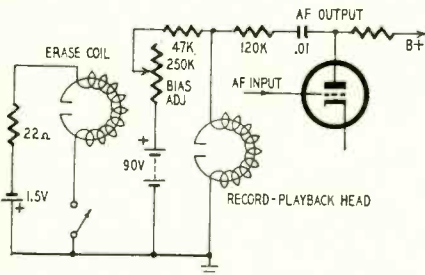

Fig. 5—B supply for bias and erase.

magnetic field must diminish in amplitude at a rate no greater than 10% per cycle. This limitation causes greatest concern in design of a.c. erasers.

In practice, where an a.c. erase head is mounted on the tape transport panel, an optimum ratio of erase frequency versus tape speed provides the gradually diminishing amplitude required in the fringing fields as the tape leaves the magnet, traveling at normal tape speed.

In practice, energy may be taken from the ultrasonic bias oscillator for the erase field. This is applied to a head much like the recording head. Fig. 6 shows a typical circuit using ultrasonic bias and erase. Oscillator coil L is wound on a powdered iron core $\frac{1}{4}$ inch in diameter and 1-1/16 inches long. It has 750 turns of No. 25 Formex or enamel wire, tapped at 150 and 250 turns. (If you're going to experiment, better include an additional tap or two to provide a variable voltage.) The triode-connected 6V6 oscillates at 25 kc, chosen to be about five times the highest audio frequency to be recorded or erased. (A low frequency—some of the best recorders erase at nearly 100 kc.—Editor) Coil L is tuned by the .003- μf capacitor, which may be changed to alter the ultrasonic frequency.

The oscillator output is fed to the erase head (such as the Shure TE-2 erase head), and the adjustable 500-

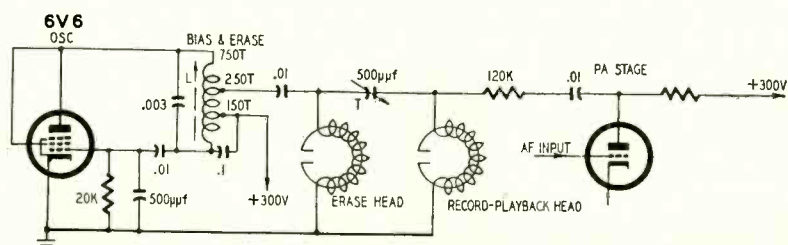

Fig. 6—Schematic diagram of circuit supplying an ultrasonic bias and erase.

150 field tests have proved to
WARD jobbers:

- * Good VHF picture at as far as 200 miles on several channels
- * Excellent results at 100 miles
- * Good results in areas where no other antenna was able to bring in a picture
- * More compact—25%-75% less stacking distance
- * Channel 2-13 response as much as 40% better than any comparable antenna
- * Unique superior snap-lock bracket
- * Original WARD design all aluminum supplemented spring pressure bracket—eliminates possibility of intermittent contact

TRY ONE—you'll find why the Invader is superseding all fringe and super-fringe antennas.

WARD Model TVS 356 2 bay and stacking harness \$39.95 list

WARD Model TVS 357 4 bay stacking kit (feed harness only) \$3.95

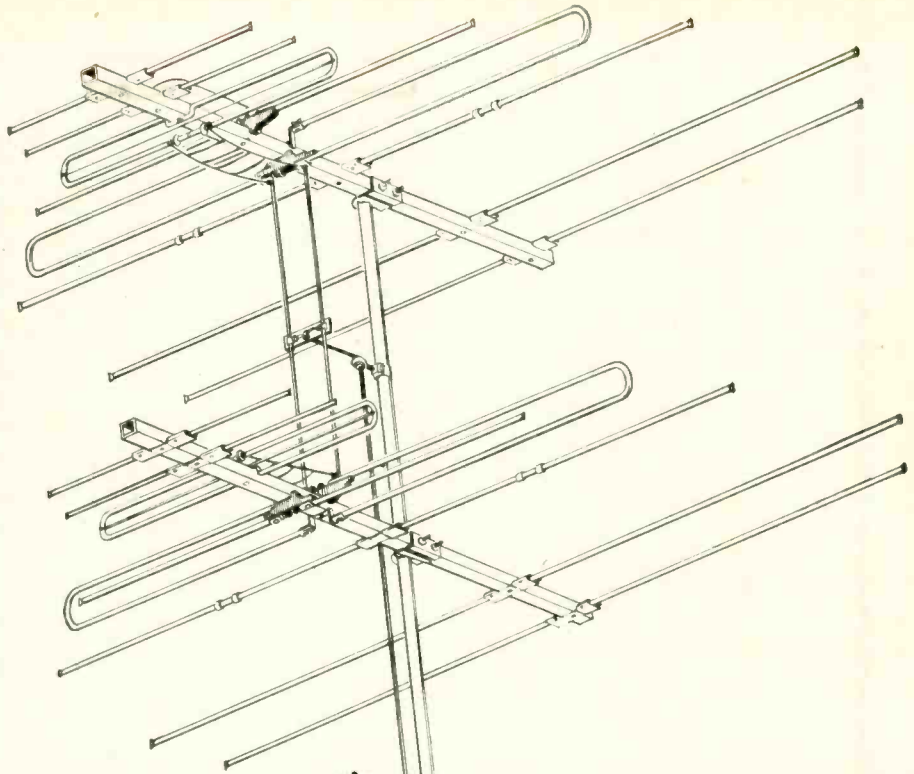

THE INVADER* CONQUERS

sweeps all other fringe and super-fringe antennas before it

*an original WARD design



flat type Uni-plane Yagi for fringe area VHF and primary signal area UHF.

*Documental testimonials in our files



WARD

Products Corp., Cleveland 15, Ohio

THERE ARE 3

New
REK-O-KUT
Rondine
TURNTABLES

The Rondine Deluxe

3-speed with hysteresis motor..... **\$119⁹⁵**

The Rondine

3-speed with 4-pole induction motor..... **69⁹⁵**

The Rondine Jr.

2-speed with 4-pole induction motor..... **49⁹⁵**

*Each is the Finest
of its kind*

Which one belongs in
your home music system?

Mail this coupon
today!

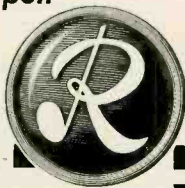

REK-O-KUT Company
Dept. WC-13 38-01 Queens Blvd.
Long Island City 1, N. Y.

I would like to know how the Rek-O-Kut
Rondine Turntables can fit into my high
fidelity plans. Also send me FREE Strobe
Disc to check my present equipment.

Name _____

Address _____

City _____ Zone _____ State _____

My dealer is _____

AUDIO—HIGH FIDELITY

recorders have dual-erase head gaps to eliminate this regenerative difficulty.

Magnetic air gap

The gap in the erase head (Fig. 7) is a compromise. When a signal equal to the wavelength of the gap is applied to the erase head, the gap sets up two magnetic flux fields of opposite polarity. Their average is zero. When the frequency is doubled, or when the gap is halved at the same frequency, maximum magnetic action (erasure) will take place.

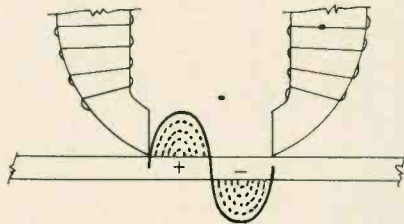

Fig. 7—Construction of erase head gap.

Since the frequency is determined by the highest audio frequency to be erased, the gap is made small to approach half-wavelength at the erase frequency. As the gap becomes smaller, the erase field becomes shallower. Carried to the extreme, the magnetic separation between pole pieces will decrease to a point where a *magnetic short circuit* exists between them, leaving no erase energy to be fed to the tape. The compromise in design provides for an adequately small gap (somewhat larger than record-playback gap) with adequate magnetic penetration supplied by the ultrasonic erase oscillator.

Since the erase head is similar to the recording head, but using an ultrasonic frequency, it would seem that the recording head could be used for erasing. Indeed it can! Simply feed in an ultrasonic frequency of proper amplitude to the recording head with the machine set to *record*, and it will erase. It is not good engineering practice since the recording head function should be reserved for recording and playback. Combination heads, combining erase gap and recording gap in a single head, make a satisfactory compromise.

The laminated core structure of the

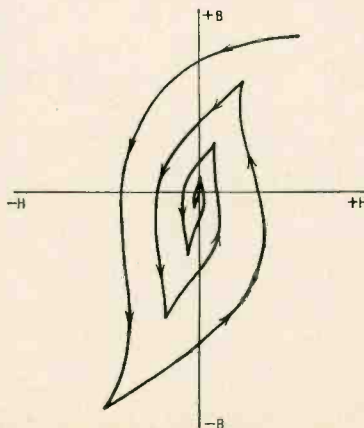
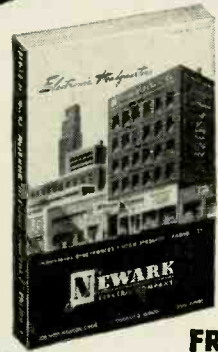

Fig. 8—Decreasing hysteresis curve.

SEE THE LATEST IN
Electronics
EQUIPMENT



FREE

Send for

Newark's 1955 Catalog

Select the fast, easy, dependable way from the New Electronics Reference Book — full of the latest releases and largest selections of High Fidelity, Radio, TV, Amateur and Electronics equipment.



Dept. RE-3 223 W. Madison, Chicago 6, Ill.



Need a Tube Tester?

FOLLOW THE LEADER...

Buy **EICO**

© 1955

TUBE TESTER #625
KIT \$34.95 Wired \$49.95



More Servicemen buy EICO TUBE TESTERS — in KIT and wired form — than any others sold through distributors. Why? Because EICO gives you the MOST value at LOW-EST cost.

- Test all conventional & TV tubes and pilot lights.
- 10 individual lever-type element switches.
- Illuminated anti-backlash rollchart kept up-to-date by EICO's Engineering Dept.
- 4½" meter, 3-color "Good-Bad" scale.
- Line-adjust control. Blank socket for new tubes. Protective overload bulb.

In stock at your local jobber. Write for free Catalog. CT-3 Prices 5% higher on West Coast.

ELECTRONIC INSTRUMENT CO., INC.
84 Withers Street • Brooklyn 11, N. Y.

AUDIO—HIGH FIDELITY

erase head is subject to the same core losses as is a transformer. The core may become heated. If the heat dissipation is not reasonably controlled by design, the plastic tape or the coating binder may soften or tend to stick to the heads. A solution to this problem is to avoid stopping the tape for any appreciable length of time while the circuit is set up for erasing.

A heavy magnetizing field is required to remove the original recording from the tape, followed by a gradual cyclical reduction of the magnetizing field as it reverses. This amounts to a decreasing series of hysteresis loops, approaching a point of zero induction as shown in Fig. 8.

The a.c. bulk eraser

For ease in erasing an entire reel of tape at a time an a.c. bulk eraser has been developed, giving excellent results. The reel of tape is held in one hand, while the bulk eraser (Fig. 9) is held about 3 feet away (at arm's length). Depress the push-button switch. (Keep it depressed until the entire erasing process has been completed.) Slowly bring the eraser in close contact with the flat side of the reel.



Courtesy Amplifier Corp. of America

Fig. 9—Ampliorp bulk a.c. erasure.

Start from the center of the reel and rotate outward. Move the eraser slowly around the reel. If the linear speed of the eraser is kept down to 1 or 2 inches per second the cyclical magnetic field decreases until the average of these fields for any given length of tape is equal to zero and the tape may be considered unmagnetized.

The tape would have to move too slowly at an erase frequency of 60 cycles if an attempt were made to build 60-cycle erasure into the tape transport mechanism. Out of the recorder, the operator can take his time, finishing the entire reel in less than a minute. This will reduce noise, even in virgin tape, several db below the original level.

Erasure is relative! Erasing signals down as much as 50 or 60 db is a practical extreme. Yet there are cases where a residual signal of even 60 db below normal levels may be troublesome. Most erase systems simply remove signals to below the tape noise. This does not assure that a heavily recorded signal pulse, such as a switching transient,

MAKE MORE MONEY ON SERVICE!

TELEVISION • RADIO • ELECTRONIC



Learn to handle ANY job easier, better and lots FASTER this modern professional way!

ONLY \$12 FOR THE COMPLETE TRAINING *You Save \$125*

THESE two big fact-packed Ghirardi training books make it easy for you to become expert on all types of home radio and television receiver service—at absolute minimum cost!

Ask the men who already have good-pay jobs! They'll tell you that Ghirardi training is the finest — AT ANY PRICE — because it is so outstandingly complete, and because it makes even the

toughest subjects so easy to understand.

Each of these two books is entirely new, completely modern in every respect—NOT a re-hash of old, outmoded material. Together, they form a complete service library written so you can easily understand every word—and designed to serve either as a complete training course or as a handy reference for experienced servicemen who want to look up puzzling jobs or develop new and faster methods.

Learn all about Circuits . . . AND WATCH SERVICE "HEADACHES" DISAPPEAR

Years of experience plus hundreds of talks with service technicians proved to Mr. Ghirardi the need for a book that got right down to earth in explaining the basic circuits and operation of modern radio and television receivers. Radio & Television Receiver Circuitry and Operation is the result. Backed by what you can learn from it, you'll find that 9 out of 10 service jobs are tremendously simplified. You'll work faster with less testing—and make more money in the bargain! Guesswork is eliminated.

Starting with AM and FM proc-

esses and characteristics, the book progresses to a complete understanding of basic circuits, how they operate, how to recognize them quickly and what is likely to go wrong with them. By making it easy for you to understand each circuit and its relation to other circuits, the book helps you go right to the seat of trouble in far less time. You'll know what different trouble symptoms mean — and you'll know how to repair troubles lots faster and more efficiently.

Sold separately for \$6.50. Try it for 10 days on our FREE examination offer.

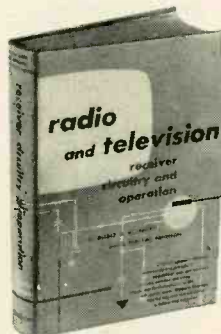

Radio and Television Receiver CIRCUITRY AND OPERATION

By Ghirardi and Johnson
669 pages, 417 helpful illustrations; Price \$6.50

Complete Training in MODERN, PROFESSIONAL SERVICE METHODS

This big book makes the tough service jobs easy, makes the easy ones a cinch!

Actually, Radio & Television Receiver TROUBLESHOOTING AND REPAIR is a complete guide to modern professional methods.

First you get a full analysis of components, their functions, their troubles and their remedies. Next you learn modern troubleshooting methods from "static tests to dynamic signal tracing and injection techniques. You learn basic procedures and how to interpret performance data. Four big chapters show how to realign Television, FM and AM receivers in less time. You'll learn how a glance at a TV set may quickly tell you what is wrong. Special hard-to-fix service problems are explained. Puzzling "intermittent" troubles and their remedies are clearly outlined. Step-by-step service procedure charts

demonstrate many operations almost at a glance. In short, from the simplest troubles to the most difficult ones, nothing has been omitted—nothing has been condensed. Everything is carefully explained—and the entire book is fully indexed so you can find exactly what you want in a jiffy.

Read it 10 days FREE! See for yourself how this great book can pave your way for bigger pay. Sold separately for \$6.75. Save money by ordering special combination offer.

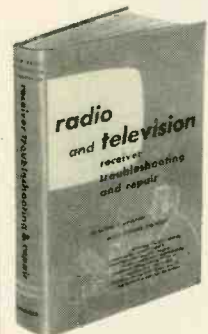

Radio and Television Receiver TROUBLESHOOTING AND REPAIR

By Ghirardi and Johnson
822 pages, 417 clear illustrations; Price \$6.75

PRACTICE 10 DAYS FREE!

SPECIAL money-saving OFFER!

Save \$1.25 by ordering both of the above big books. Make your service library complete!

Dept. RE-35, RINEHART & CO., INC.,
232 Madison Ave., New York 16, N.Y.

Send books below for 10-day FREE EXAMINATION. In 10 days, I will either remit price as indicated (plus a few cents postage) or return books postpaid and owe you nothing.

Check here to order books singly:

Radio & TV Receiver CIRCUITRY & OPERATION (Price \$6.50 separately)

Radio & TV Receiver TROUBLESHOOTING & REPAIR (Price \$6.75 separately)

Check here for MONEY SAVING COMBINATION . . . SAVE \$1.25!

Both of the above big books at the special price of only \$12.00 for the two. (Regular price \$13.25—you save \$1.25.) Payable at the rate of \$3 after 10 days if you decide to keep books and \$3 a month thereafter until the total of \$12 plus postage has been paid.

Name

Address

City, Zone, State.....

OUTSIDE U.S.A.—\$7.25 for TROUBLESHOOTING & REPAIR book; \$7.00 for CIRCUITRY & OPERATION; \$13.00 for both books. Cash with order only. Money refunded if you return books in 10 days.

precise

says: Ask ANY

Engineer or Serviceman,

"WHAT'S THE TOUGHEST TEST OF ALL?"

YOUR test . . . the way the equipment works in actual use . . . under actual conditions. PRECISE test equipment has passed that test countless times . . . every instrument fully proven. That is why YOU and thousands like you have made PRECISE the fastest growing line of test instruments in America today!

Remember, too, PRECISE uses no surplus. See the complete line of PRECISE quality instruments at your jobber now—and save!

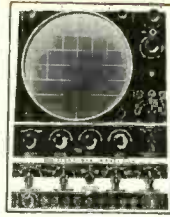

EXCLUSIVE PRECISE 8 1/2" OSCILLOSCOPE
#308K kit form \$129.50
#308W factory wired \$229.50

PRECISE 7" OSCILLOSCOPE
#300K kit form \$94.95
#300W factory wired \$199.50

precise ★ precise ★



EXCLUSIVE PRECISE VOLT. REG. V.T.V.M.
#9071K kit form \$35.95
#9071W factory wired \$49.95

precise ★ precise ★ precise

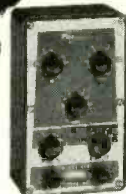

PRECISE RESISTANCE DECADE BOX
#468K kit form \$18.95
#468W factory wired \$24.95
PRECISE CAPACITY DECADE BOX
#478K kit form \$18.95
#478W factory wired \$24.95

Model SWK Custom Switch Kit

Contains all necessary parts and special tools to make production switches. The rotors may be cut to designers' specifications. Short and Long Clips may be placed as desired. Saves weeks of waiting for samples or replacement parts since it duplicates factory switch. Also usable for modifying and repairing other switches. \$29.95

Note: Replacement part Kits also available without tools.

precise ★ precise ★ precise ★ precise ★ precise



PRECISE TV RE-MO TUNER
Allows finest alignments—vertical, horizontal, etc.—with greatest of ease. NO STRETCHING . . . NO STRAINING . . . NO MIRROR NEEDED. Fits compactly into any tool box.
#SMK wired only \$2.95

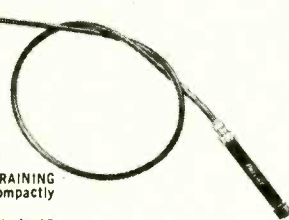

NEW PRECISE VACUUM TUBE VOLTMETER
#909K kit form \$25.98
#909W factory wired \$37.50

★ precise ★ precise ★ precise ★ precise ★ pr



PRECISE RF-AF-TV & MARKER GENERATOR
#630K kit form \$33.95
#630KA pre-assembled head \$38.95
#630W factory wired \$53.95



PRECISE RF SIGNAL GENERATOR
#610K kit form \$23.95
#610KA pre-assembled head \$28.95
#610W factory wired \$39.95



NEW PRECISE Em. & MUT. CONO. TUBE TESTER
#111K kit form \$69.95
#111W factory wired \$139.95

precise ★ precise

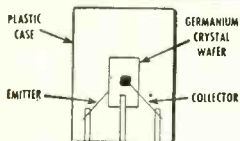

PRECISE NEW T1 TRANSISTOR KIT

PRECISE offers a simple and direct approach to the understanding of transistors. The instruction book covers the physics and practical applications in simple and non-mathematical terms. Two transistors, one germanium diode, transformer, electrolytics, coils, resistors, condensers, chassis, etc. are supplied.
Model T1 kit only \$17.95

precise

DEVELOPMENT CORP.
OCEANSIDE, NEW YORK

Prices slightly higher in the West. Prices and specifications subject to change without notice.

SEND FOR NEWEST PRECISE CATALOG—DEPT. RE-3

AUDIO—HIGH FIDELITY

will be completely erased. The very act of erasing, if suddenly stopped, will modulate the tape with a switching pulse. That's why in bulk erasure it is necessary when removing the eraser to slide it carefully away from the reel, avoiding an abrupt *breakaway* from the field, continuing to draw the eraser away to arm's length, when the current may be shut off.

It must not be thought that heavily recorded signals are unerasureable. All that is required is a more intense erase. In the case of metallic reels (as compared to plastic reels) of tape being erased with a bulk eraser, the shielding action of the metal reels is ineffective.

Curious effects occur after tape is stored for some time. A pronounced signal which can be easily erased immediately after recording may become so much harder to erase after several months of storage that two or three times as much erase energy is required. In extreme cases, where it is found that an ordinary erase head cannot be excited sufficiently to get rid of the loud signal, the bulk eraser may be used. In rare cases the loud signal is slightly revived later under normal recording excitation, as a case of *magnetic memory*. This unusual condition is hardly feared as a normal tape recording hazard.

For efficient erasure these three hints by the Minnesota Mining & Mfg. Co. may be of assistance:

1. Store tapes in erased rather than recorded condition, when the recording is no longer needed.
2. A tape having a background signal which cannot be completely erased should be stored for a few days in the erased condition, preferably in a warm place.
3. Store recorded rolls in a cool location. This is also advisable for long tape life and freedom from layer-to-layer signal transfer.

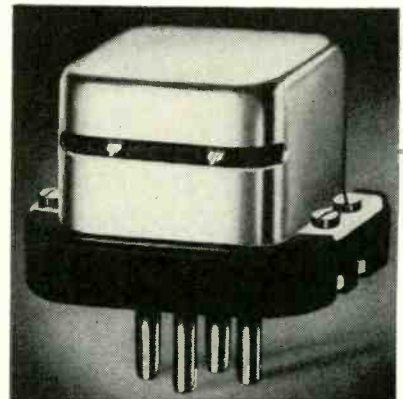

Courtesy Shure Bros. Inc.

Fig. 10—Erase head for recording wire.

The same erase problems exist in magnetic recording wire. A popular plug-in type wire-recording-erasing head is shown in Fig. 10 with the wire slot clearly visible. The fidelity of wire is lower than that of tape and its popularity is therefore below tape in common use.

END



NEW 12AU7A

- shorter construction reduces intermittent scan and heater cathode failures.
- completely interchangeable with Type 12AU7.



NEW 5U4GB

- twin-wing plates provide greater heat dissipation.
- wafer stem strengthens construction. Increases ratings to 275 Ma at 44V drop with 1.0 amp. peak plate current.

Sylvania makes important NEW advances in

WAR ON CALL-BACKS

Six "double-duty" tubes designed to lick TV service's costliest problems. More to come!

Sylvania's war against callbacks began with the highly improved 5U4GB tube. Now Sylvania continues its fight against profit-grabbing callbacks and offers five more improved types for TV service.

These tubes score a direct hit on the most common "quick failures." Stronger winged-plate design and wafer-stem construction—sturdier welds and glass-to-metal seals; these plus a score of other mechanical and electrical improvements are incorporated to give trouble-free service.

Join the battle against callbacks! Use only Sylvania "double-duty" types! They're designed for servicing old as well as new sets.

NEW 1X2B

- all-nickel plates reduce electrolysis. Lower gas level results in higher breakdown voltage.
- longer life-test under conditions well above ratings.



NEW 6BQ6GTA

- folded-edge plate design avoids bulb bombardment.
- double-clearance between mount and bulb top eliminates the "pigtail" to grid shorts. Avoids bulb-puncturing electron bombardment.

NEW 1B3GT

- electrostatic shield-ring protects filament during high-voltage operation.
- Sylvania-developed top-cap alloy produces positive glass-to-metal seal.
- high-voltage base makes tube interchangeable with coated types.



NEW 6SN7GTB

- oblique orientation of sections reduces microphonism.
- direct weld between stem pins and plates strengthens mount.



Look for the new "double-duty" types in this yellow-and-black carton. It's your calling card of quality.

SYLVANIA

Sylvania Electric Products Inc.
1740 Broadway, New York 19, N.Y.

In Canada: Sylvania Electric (Canada) Ltd.
University Tower Bldg., St. Catherine Street
Montreal, P. Q.

LIGHTING • RADIO • ELECTRONICS • TELEVISION • ATOMIC ENERGY

PROBES for PROFITS

By JOHN W. SHERMAN

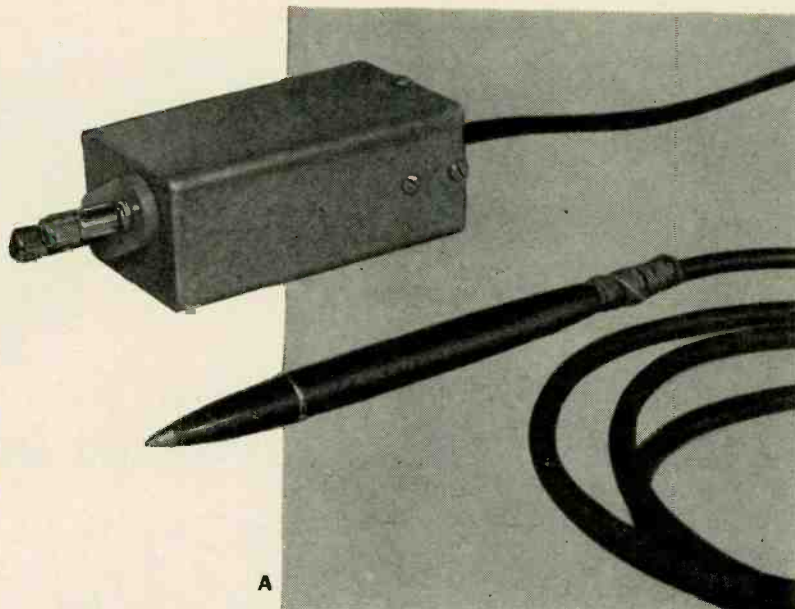

A—Top, the peak-to-peak probe. Bottom, r.f. probe housed in ballpoint pen.

PROFIT in radio and TV servicing is inversely related to the time consumed in repair. The more rapidly we can analyze the source of trouble and correct it, the greater the financial return. To make repairs we use whatever test instruments we have that are best suited to the task.

Not always, however, do we use our instruments to full advantage. Much of our equipment may be adapted to do specific jobs more rapidly and effectively through the use of easily built probes.

These accessory probes may be classified into three main groups: voltmeter probes, oscilloscope probes, signal tracer and others.

Voltmeter probes

The d.c. isolating probe (Fig. 1) is probably the best known and most used of all probes. Most vacuum-tube voltmeters are sold with it as included



Fig. 1—Diagram of d.c. isolating probe.

equipment. The probe is merely a test prod with a built-in 1-megohm resistor, which, together with the shielded cable, isolates the test prod and the meter input from stray capacitive effects. The resistor will have some effect on the reading of the meter, but this is generally taken into account in the calibration adjustment of the instrument.

R.f. probe: Voltage readings up to about 200 mc may be made on a v.t.v.m. by using the shunt crystal diode r.f. probe (Fig. 2). Voltages up to about 20 r.m.s. may be safely applied directly to the crystal. The probe generally in-

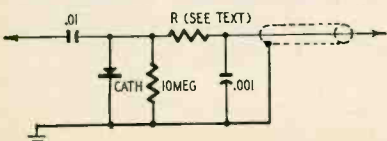

Fig. 2—Shunt crystal diode r.f. probe.

dicates the negative peak value of the wave though the r.m.s. value is generally desired. This may be compensated for by recalibrating the meter scale or using a simple voltage divider R so that the r.m.s. voltage is applied to the voltmeter input. For r.m.s. readings on standard d.c. scales, R must equal 1.414 times the input resistance of the meter. For example, an 11-megohm input meter would require a 15.5-megohm resistance.

While crystals are somewhat non-linear at low voltage levels, readings made with this probe will be accurate enough for most service work. If higher accuracy is desired or needed, the probe may be checked and calibrated with a known voltage source. The entire probe can be housed in a ballpoint pen by using ceramic capacitors, 1/2- or 1/4-watt resistors and small crystal diodes.

Peak-to-peak probe: Some of the most necessary, and often difficult, measurements in TV servicing are peak-to-peak voltages of complex waveforms. This job is made simple with a v.t.v.m. and a special peak-to-peak probe (Fig. 3).

The circuit consists of two shunt diode rectifiers with their inputs in parallel and their outputs in series.

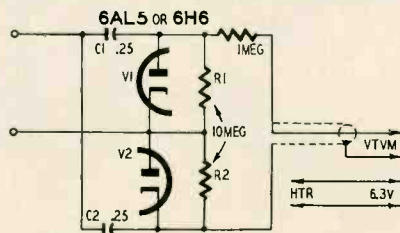

Fig. 3—Diagram of peak-to-peak probe.

Thus, it becomes in effect a voltage doubler. Tube V1 conducts when its plate is positive and charges capacitor C1 to the peak value of the signal voltage. A d.c. voltage equal to this peak a.c. signal is then developed across R1. When the plate of V2 is positive, it

charges capacitor C2 to the peak value of the applied a.c. signal and a d.c. voltage of like magnitude appears across R2. Since R1 and R2 are in series, the d.c. voltages are added. This d.c. voltage is then applied to the meter and is equal to the peak-to-peak value of the original a.c. signal.

High-voltage probe: Measuring high voltage in a television set presents a problem to the service technician—a high-voltage probe is the answer. Building such a probe should be left to manufacturers. The series resistance is usually several hundred megohms—which manufacturers obtain with special materials. In addition, the housing is usually of special plastics or other material that can withstand the high second-anode voltages and is shaped with safety flanges to form a high-resistance leakage path. None of these items is easily obtained on the retail market, and the penalty for using stuff

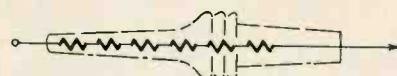

Fig. 4—Layout of a high-voltage probe.

that is approximately as good is too high to make it worth while to take a chance. See Fig. 4 and photo E.

Oscilloscope probes

TV pulse probe: To best display TV pulse patterns, it is necessary to have a wide-band oscilloscope and a properly terminated transmission line or cable to conduct the signal from the receiver to the scope. This termination is a simple, but vital, TV pulse probe (Fig. 5). The probe termination is adjusted with

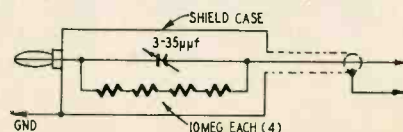

Fig. 5—Diagram of the TV pulse probe.

B—Top, the demodulation probe. Bottom, TV pulse probe—the metallic shield is not a necessity.

C—Construction of the crystal diode demodulation probe.

D—Internal view peak-to-peak probe

E—A commercial high-voltage probe.

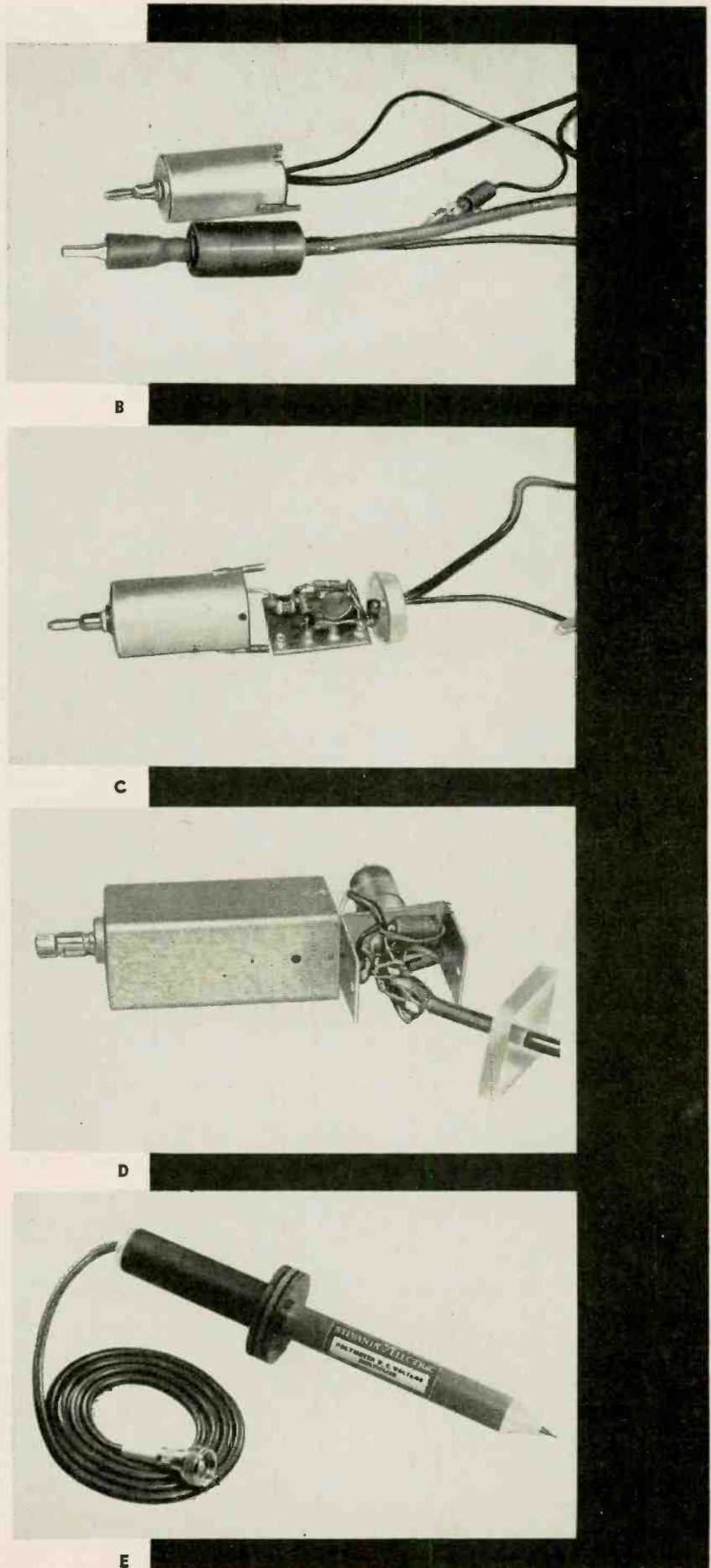

the trimmer capacitor to a value equal to the shunt capacitance of the cable and the vertical input circuit of the oscilloscope. This may be done by actually measuring the line and scope capacitance and adjusting the trimmer capacitor to suit or by trial and error while observing a known pulse pattern on the face of the scope. This second method is good enough for all TV functions. The complete unit may be housed in a small tube or container. The cable should not be over 3 feet in length.

Demodulation Probe: A demodulation probe (Fig. 6) supplies a video-frequency voltage for the vertical deflection plates of an oscilloscope pro-

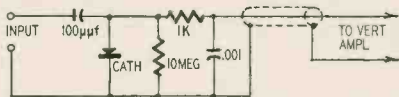

Fig. 6—Diagram of demodulation probe.

portional to the instantaneous value of the signal from the TV sweep generator or the transmitter acting upon the circuit to be checked. This probe is a simple crystal unit. It is shown in a shield can, but shielding is not necessary and any convenient mount can be used. The leads from the probe to the TV set should be as short as possible to minimize stray pickup.

Signal tracer probes

R.f.-a.f. probe. A very practical and useful device for rapid servicing is an inexpensive, high-gain audio amplifier with an a.f.-r.f. probe (Fig. 7).

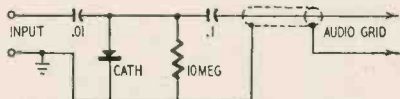
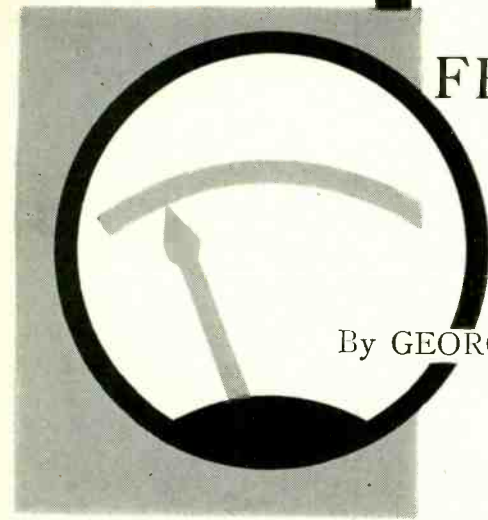

Fig. 7—Schematic of a.f.-r.f. probe.

This probe is similar to some of the others with the exception that the rectified d.c. is not used. The audio component of the signal is applied to the grid of an amplifier or to headphones. The unit is then primarily a detector. When used with a good amplifier, it will trace a signal from the antenna to the speaker, revealing signal loss, hum, distortion and other faults. END

SIMPLE FREQUENCY METER

By GEORGE FLETCHER COOPER



WHEN I started to design amplifiers and oscillators, oscilloscopes apparently weren't used very much. Not because they hadn't been invented—it was not so long ago—but rather, I suspect, because it was considered rather unfair—as the British say, not cricket.

I hope this introduction will not mislead you into expecting to read about oscilloscopes. The article is a description of a rather simple and attractive frequency meter. You might think a frequency meter a rather special device that you personally don't need. That is the way we used to consider the oscilloscope; now no home is complete without one. A frequency meter is a pretty useful instrument to have sitting on one corner of the bench.

Without straining, I can remember five kinds of frequency meters. There's the latest cycle-counting type, which is expensive but tells you exactly how many cycles occurred in 10 seconds. For research on oscillators these are wonderful devices. Then there is the old bridge type in which an R-C bridge is adjusted to give a balance: the bridge is calibrated in frequency. The reed type can still be seen on some power boards, and there's a crossed-coil system for power frequencies which is still used. Finally, there is the capacitor-charging type, very widely used for audio-frequency work. It is the latter meter which I will describe.

Circuit theory

The frequency-measuring circuit (Fig. 1) of a capacitor-charging frequency meter consists of a small capacitor, a rectifier bridge and a milliammeter. When we apply a.c. to these components, which are connected in series, the current through a milliammeter is equal to $\frac{V}{Z}$, where Z is the capacitor impedance. This assumes that the rectifier and meter resistance

can be neglected, compared with Z. For the capacitor $Z = \frac{1}{2\pi fC}$ so that $I = 2\pi fCV$ and the current is directly proportional to frequency.

The current is also proportional to the voltage so we must keep this voltage constant. Here the designer can start to amuse himself with new circuits. One possible approach would be to use an amplifier fitted with good a.v.c. But this is not a satisfactory solution, because it would make the final reading depend on the waveform of the input signal. In all the circuits I have ever seen the input signal is converted into a square wave, so that the voltage applied to the capacitor-meter system is of standard amplitude and shape. I have used a rather simple double triode as my limiter for developing square waves.

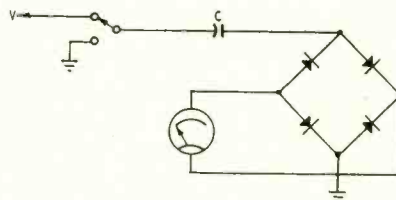

Fig. 1—The basic frequency meter.

Before we get on to the circuit itself, we must check on one detail. Two paragraphs back I said that current was proportional to frequency. If we leave matters there, I know from experience that sometime in 1957 a reader will write sharply to me and ask what I meant by "frequency." He will then define a square wave, quoting *Reference Data for Radio Engineers* and a lot of mathematics. And if I have a square wave, what do I mean by the impedance of a capacitor? I don't really mind these letters: they show the editor that I have a reader.

The proper way of calculating the behavior of the circuit is easy, and it confirms the expression we obtained above. The limiter circuit can be re-

garded as a switch which moves one terminal of the capacitor (Fig. 1) from ground to V and then back to ground every cycle. When the switch is moved to V, the capacitor is charged, through the meter, to the full value of V. A charge of CV coulombs must pass through the meter. When the switch returns to ground, the charge flows away from the capacitor; again CV coulombs must pass through the meter. Therefore, each full cycle from 0 to V and back causes a total of 2CV coulombs to pass through the meter. In 1 second, a charge of 2CVf coulombs will pass through the meter. But 2CVf coulombs per second is exactly the same thing as 2CVf amperes: the meter current will be 2CVf.

In this expression V is the peak-to-peak square-wave voltage. A sinusoidal wave having the same peak-to-peak amplitude will have a root-mean-square voltage of $\frac{V}{2\sqrt{2}}$ and an average value of $\frac{V}{\pi}$. Writing $\frac{V}{\pi} = V_{ave}$ we see that the

meter current is $\frac{2\pi f CV_{ave}}{2\pi}$. This is the form that we derived previously, except that we did not know that we must use V_{ave} instead of the usual sine-wave amplitude.

We have now got ourselves onto a fairly sound theoretical base. The circuit will give us a reading directly proportional to frequency, provided that we can get the capacitor charged and discharged completely each half-cycle. Let us consider what this means. We can choose a maximum frequency for one range of our frequency meter and do a little arithmetic. Let us take 1,000 cycles as a full-scale reading, using a 100- μ f meter. For a supply voltage we can have $V = 100$ volts. Then

$$100 \times 10^{-6} = 2C \times 100 \times 1,000$$

$$C = 500 \mu\text{f}$$

We want a 500- μ f capacitor to be completely charged or discharged in 1/2,000 second. The resistance in series should then be not more than will give $C-R = 1/5$ t, or 1/10,000 second. Therefore, we can have $R = 200,000$ ohms. The total resistance in the circuit is not likely to be anything near this if we are using a triode. However, if we had used a 1-ma meter, we would have found $C = 5,000 \mu\text{f}$. Then the maximum value of resistance is only 20,000 ohms. This is getting near the danger region; and although a 1-ma meter can

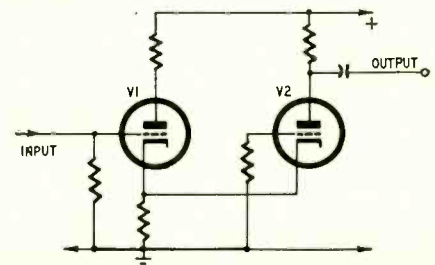
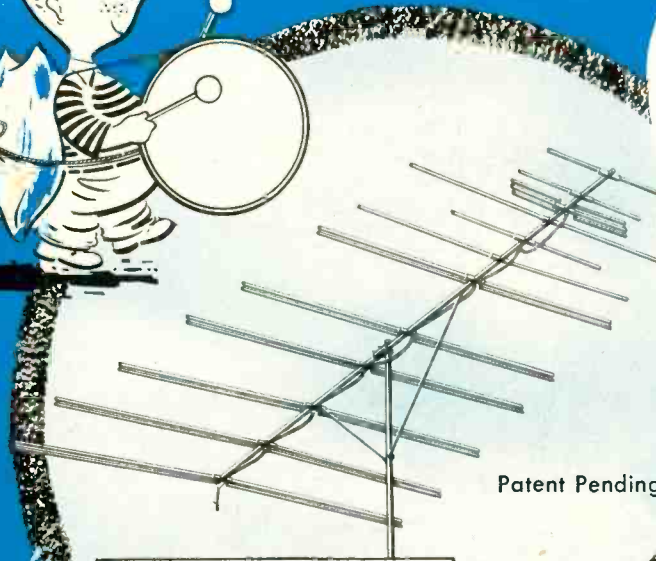

Fig. 2—The basic electronic switch.

from
KAY-TOWNES
 comes
 America's

**LEADING
 ANTENNAS**



Patent Pending

REAR GUARD
 For Pin Point
 Reception

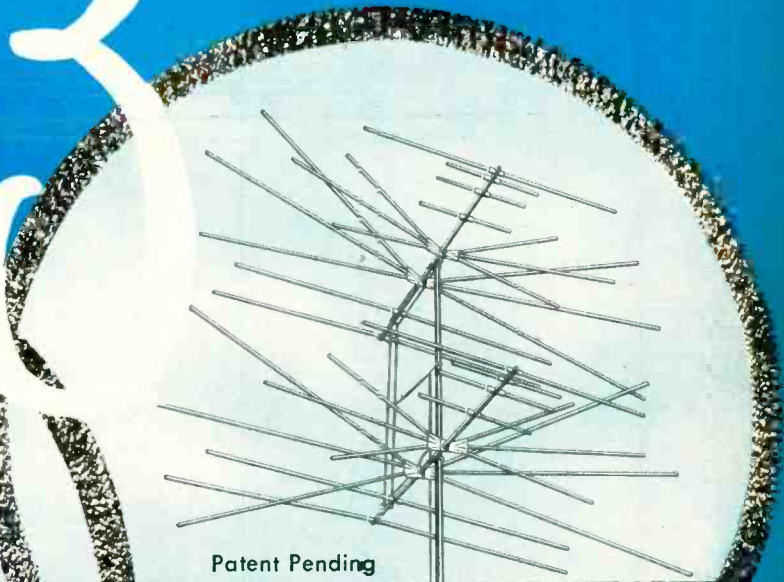

Patent Pending

SUPER KATY
 A Proven
 Performer

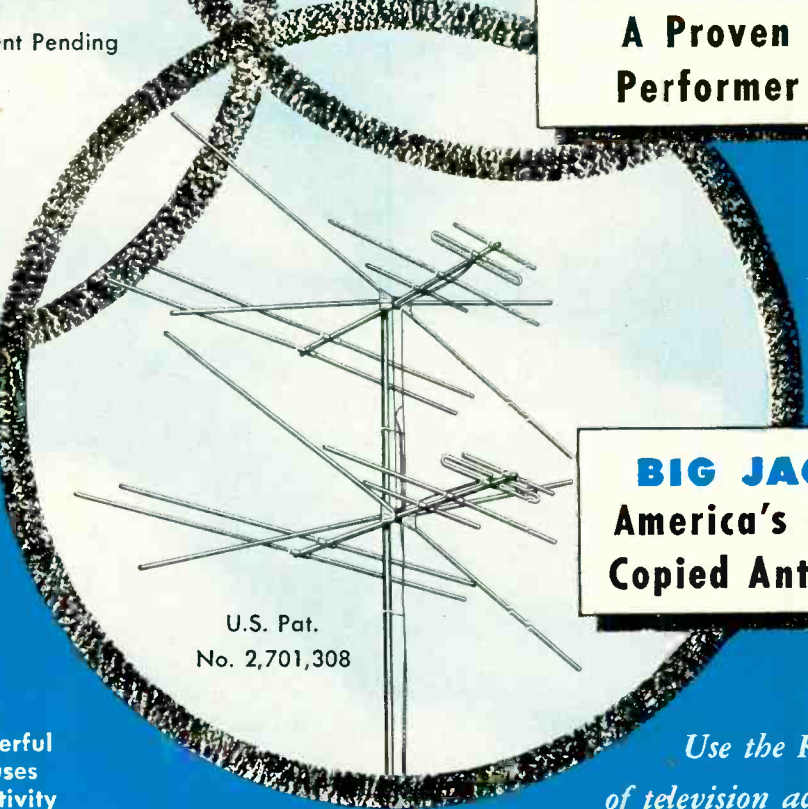

U.S. Pat.
 No. 2,701,308

BIG JACK
 America's Most
 Copied Antenna

For the best in televising pleasure America's TV audience looks to Kay-Townes Antennas. The pace-setting **BIG JACK**, originated and patented by Kay-Townes, leads in sales across the nation. In fringe and problem areas the **SUPER KATY** has become a "proven performer" giving top-quality pictures where good reception had been next to impossible without it.

And now Kay-Townes is first again with the answer for TV fans living between two powerful stations. The Kay-Townes **REAR GUARD** refuses signals from the rear to give pin-point directivity and photo-clear reception in areas where reception has been practically impossible because of interference from near-by stations.

*Use the K-T line
 of television accessories*

THE FIRST NAME IN TV ANTENNAS

KAY-TOWNES
ANTENNA COMPANY
BOX 593A • ROME, GEORGIA

Manufactured and
 Distributed in CANADA by
 DELHI METAL PRODUCTS, LTD.
 DELHI, ONTARIO

COPYRIGHT 1955

TESTED AND PROVEN E-Z WAY TILT OVER TOWERS



E-Z Way TV Towers crank up and down. Can be easily lowered and the antenna tilted over to a height of only six feet above the ground and made absolutely hurricane proof!

- CRANKS UP AND DOWN ● TILTS OVER
- NO GUY WIRES—NO CONCRETE
- NO ROOF DAMAGE
- NO LIGHTNING RISK ● HURRICANE PROOF
- GREATER DISTANCES—BETTER PICTURES

The only practical free-standing tower is one that can be lowered in case of strong winds. E-Z Way Tower is the sturdiest, most unique and versatile tower in the industry. High-test steel construction. Electric Arc welded. Each section completely immersed in Pliotite S-5 (rubber base) aluminum enamel for long-lasting weather resistance. Most economical. Easiest to install. Easiest to service and add antennas. Twelve tilt-over types from 30' to 85' VHF heights. Fifteen building-attached crank-up types of towers. Each tower specifically designed for a particular use.

E-Z WAY DEMONSTRATION TRAILER

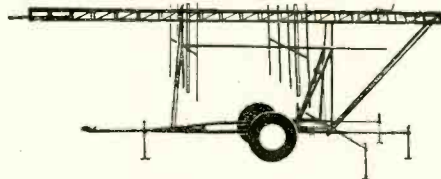

One-man operation. Light weight. Saves time and money. Carries antenna completely assembled—no guy wires necessary. Five types with towers 40' to 85' as low as \$149.95 to dealers.

DISTRIBUTOR INQUIRIES INVITED

FOR FREE CATALOGUE AND INFORMATION WRITE:

E-Z WAY TOWERS, Inc.
5901 E. BROADWAY • P. O. BOX 5491 • TAMPA, FLORIDA

NEW! For the First Time!

CHECK CAPACITORS UNDER WORKING CONDITIONS!
TEST CONDENSERS IN THE SET!



ment is a new, compact checker that does a giant job to save you time and money. It will check condensers at 150 Volts, which is approximately the working voltage in a radio or TV set. Meters will not give this type of check since the applied voltage is 20 Volts or less. Avoid call-backs by using CAPACITEST. Accurately, quickly, it shows open, shorted, or intermittent capacitors and leaky electrolytics. Compact: 4"x4"x2"—lightweight, for bench or tool kit.

SATISFACTION
GUARANTEED
OR RETURN WITHIN
TEN DAYS FOR REFUND

CAPACITEST the result of months of development in development

CAPACITEST

Quickly, Accurately checks:

- PAPER, MICA, CERAMIC CAPACITORS
- ELECTROLYTICS
- CONTINUITY
- AC/DC VOLTAGES
- FLASHBULBS

\$9.95 postpaid Dir. Net complete, ready for operation

NOT A KIT

FREE Special Introductory Offer for limited time only: Set of test leads Free with each CAPACITEST. Order direct from manufacturer —include \$3 deposit with C.O.D.'s. Save PP & COD fees, send \$9.95 & we'll pay postage.

TEST INSTRUMENTS

be used, it is better to use a more sensitive one.

This calculation was for a maximum frequency of 1,000 cycles. It turns out that the same calculation for 10,000 cycles gives the same value of R, although $C = 50 \mu\text{f}$.

The basic circuit is shown in Fig. 2. Triode V1 is coupled to V2 by a fairly large cathode resistor. This circuit is the "long-tailed pair" I described in an article on push-pull drivers recently (March, 1953). The input is applied to the grid of V1 and the output is taken from the plate of V2. To keep the circuit symmetrical the two tubes have equal plate loads. As the grid of V1 is driven positive, the cathodes go positive, reducing the current flow through V2. The plates of V1 and V2 move approximately in push-pull. The exact behavior does not matter, for reasons to be explained.

The mathematics of the previous article on this circuit assumed that it was not overloaded. Suppose now we apply a really large input signal to V1. For half of the input cycle the grid of V1 will be driven negative and V1 will be cut off. The cathodes will settle at a value determined solely by the characteristics of V2 and the two circuit resistors. For the other half-cycle, as the grid of V1 is driven positive, the cathodes will tend to go positive until V2 is cut off. As soon as this happens, the cathode load of V1 increases from a value of a few hundred ohms, the impedance looking in at the cathode of V2, to the few thousand ohms of the actual cathode resistor. Tube V1 thus has a lot of negative feedback switched into the circuit and can draw grid current only with a very large drive. Meanwhile the plate of V2 is at the plate supply voltage.

The result of this action is that the plate of V2 gives a very good square wave, both top and bottom being limited by tube cutoffs. The waveform at the plate of V1 is not nearly so good. Although it is well squared at the cutoff, it does not square properly with grid current.

The circuit was tried first in the general form of Fig. 2 and behaved in the way predicted. When a signal was applied to the grid and increased slowly, the meter reading increased steadily until an input of some 4-5 volts was reached. The meter reading remained absolutely steady for higher inputs, up to at least 20 volts. And the reading

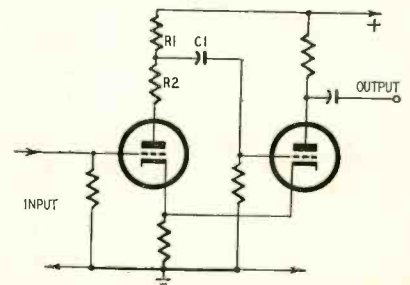
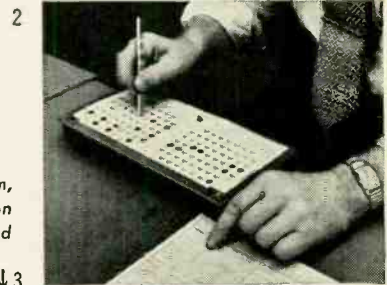
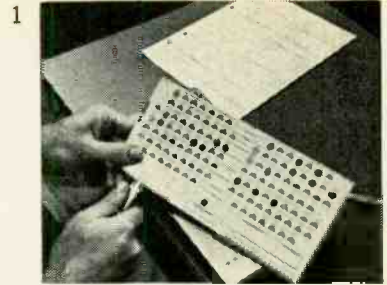

Fig. 3—Cross-coupling added to switch.

How your telephone call asks directions... and gets quick answers

Perforated steel cards, which give directions to the Long Distance dial telephone system, are easy to keep up to date. New information is clipped (1) and punched (2) by hand on a cardboard template. This guides the punch-press that perforates a steel card (3), and the two are checked (4). The new card is put into service in the card translator (5).



↓3

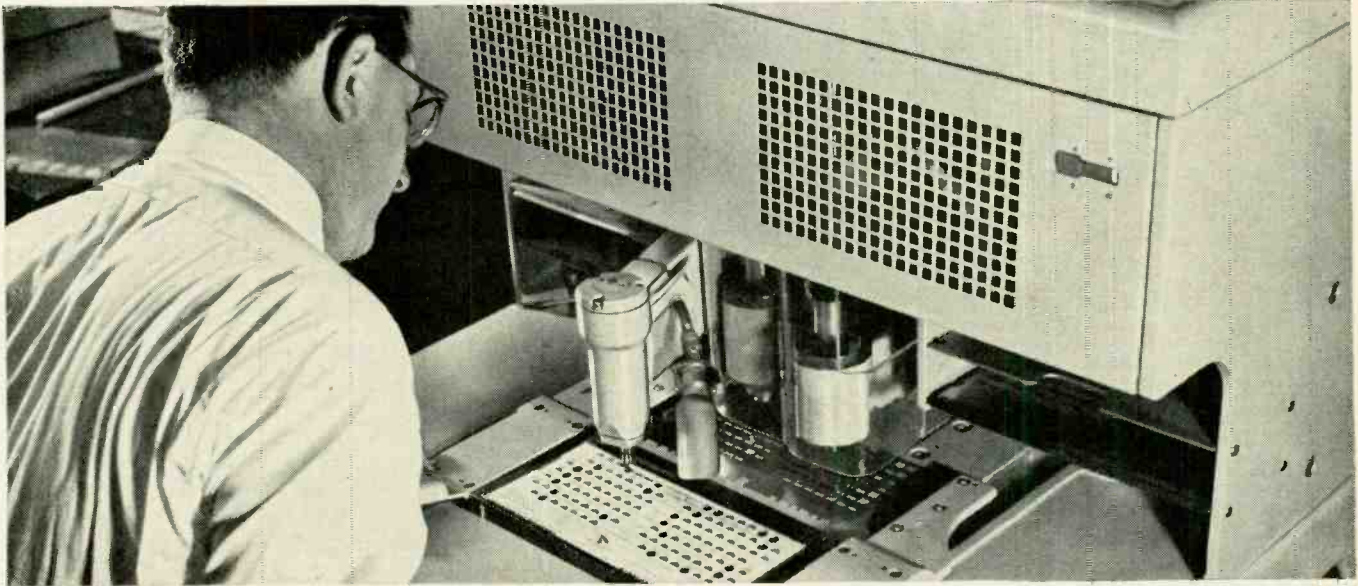

When the Bell System's latest dial equipment receives orders to connect your telephone with another in a distant city, it must find—quickly and automatically—the best route.

Route information is supplied in code—as holes punched on steel cards. When a call comes in, the dial system selects the appropriate card, then reads it by means of light beams and photo-transistors. Should the preferred route be in use the system looks up an alternate route.

It is a simple matter to keep thousands of cards up to date when new switching points are added or routing patterns are changed to improve service. New cards are quickly and easily punched with the latest information to replace out-of-date cards.

This efficient, flexible way of keeping your dial system up to the minute was devised by switching engineers of Bell Telephone Laboratories, who are continually searching for ways to improve service and to lower costs. Right now most of the Long Distance dialing is done by operators, but research is hastening the day when you will be able to dial directly to other telephones all over the nation.

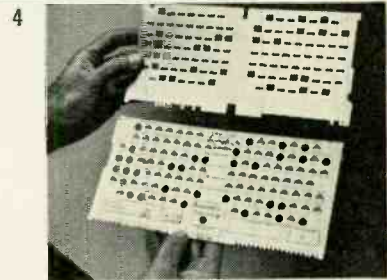

BELL TELEPHONE LABORATORIES

Improving telephone service for America provides careers for creative men in scientific and technical fields.



HERE IS TELEVISION FOR YOUR HIGH FIDELITY SOUND SYSTEM

Designed and custom-built to operate through your high fidelity amplifier and speaker system (or independently, if you wish). In this way, you enjoy the VIDEO quality of Tech-Master's advanced 630-type design and the AUDIO quality of your own high fidelity system.

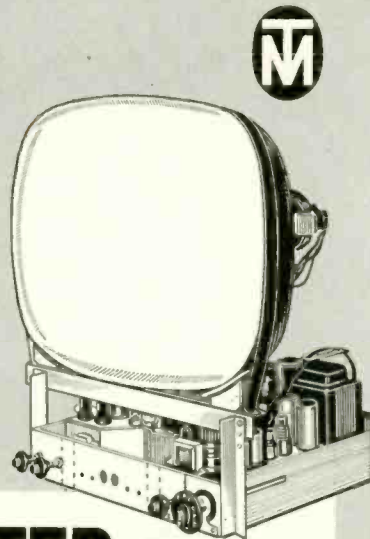

TECH-MASTER GOLD MEDAL TV CHASSIS

Designed for use with Home High Fidelity Systems

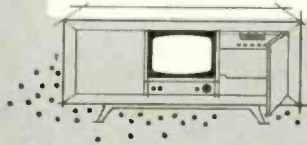

Illustrated Brochure Upon Request
TECH-MASTER CORPORATION
75 Front Street, Brooklyn 1, N. Y.

AUDELS TV-RADIO SERVICE LIBRARY

HERE IS LATE INFORMATION IN A HANDY FORM FOR RADIO AND TELEVISION REPAIRMEN, SERVICEMEN AND STUDENTS



2 VOLS. \$6 COMPLETE \$1 A MO. PAY ONLY 1 MO.
AUDELS TV-RADIO SERVICE LIBRARY—Highly Endorsed—1001 Facts—Over 1552 Pages—625 Illustrations, Diagrams of Parts, Presents Important Subjects of Modern Radio, Television, Industrial Electronics, F.M., Public Address Systems, Auto, Marine & Aircraft Radio, Phonograph Pick-Ups, etc.

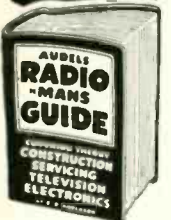

IT PAYS TO KNOW!
The Basic Principles—Construction—Installation—Operation—Repairs—Trouble Shooting. Shows How to get Sharp, Clear T.V. Pictures. Install Aerials—How to Test. Explains Color Systems, Methods of Conversion, Terms, etc. Includes Ultra High Frequency (U.H.F.)—Valuable for Quick Ready Reference & Home Study. Tells How to Solve T.V. & Radio Troubles—Answers Your Questions.

Get this Information for Yourself.
7 DAY TEST-ASK TO SEE IT!

MAIL ORDER

AUDELS Publishers, 49 W. 23 St., N.Y. 10, N.Y.
Mail AUDELS T.V. RADIO SERVICE LIBRARY 2 Vols. \$6 on 7 days free trial. If O. K. I will remit \$1 in 7 days and \$1 monthly until \$6 is paid. Otherwise I will return them.

Name _____
Address _____
Occupation _____
Employed by _____ RE

102

CORNISH

countersign of superior wires.....

Famous for Quality and Performance since the very beginning of commercial radio! CORNISH TV Antenna Cables and Tubular Twin-lead are packaged now so you just can't miss 'em. Look for these orange-and-black display cartons, at all good dealers.

CORNISH WIRE CO., INC.
50 Church Street New York 7, N. Y.



TEST INSTRUMENTS

was directly proportional to frequency, just as expected. However, for my purposes this is not sufficiently sensitive.

The circuit was therefore modified to look like Fig. 3, in which R1 and C1 have been added. Instead of the grid of V2 being grounded, it is now connected, for a.c., to a tap on the plate load of V1. There are two ways of looking at the circuit. When I designed it, I thought of it as a method of driving the grid of V2 harder and thus, because of the cathode coupling, also driving V1 harder for the same input signal. The other way of looking at the circuit is to say that we have a two-stage amplifier with positive feedback added, from the cathode of V2 to the cathode of V1, giving much more gain and therefore bringing overload much nearer.

It is important to notice that the connection between the plate of V1 and the grid of V2 does not spoil the square wave at the plate of V2. Nothing can go wrong with the squaring when V2 is cut off: nothing can be passed into V2 once V1 cuts off. This means that we do not need to consider this circuit modification as a danger spot, so far as squaring is concerned. We must, however, make sure that we do not try to get too much sensitivity. The circuit can easily become a multivibrator and produce its own frequency. In my own circuit I have fixed the sensitivity at a convenient value; but for general use it is probably better to

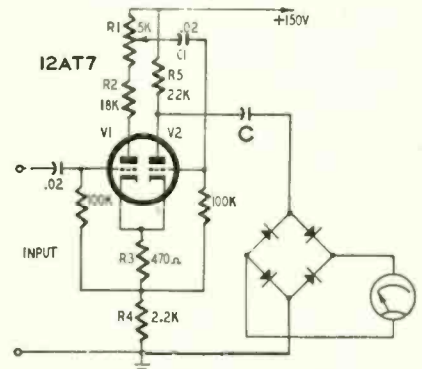

Fig. 4—The complete frequency meter.

provide variable sensitivity, and this is shown in the full circuit (Fig. 4).

The a.f. meter circuit

The cathode resistor is now divided into two parts, R3 providing the necessary bias for the tubes and R4 the main coupling resistance. Components R1, R2 and C1 are used to keep the operating conditions correct. The plate coupling resistor R1-R2 is shown with a variable tapping point for the coupling capacitor to V2.

How many ranges do you want? An earlier, similar design of mine operated reliably up to 100 kc. This present design has not been tested above 10 kc—there just hasn't been time—but the appearance of the square wave at 10 kc suggests that it should work up

NOW

New

SPRAGUE CERAMIKITS

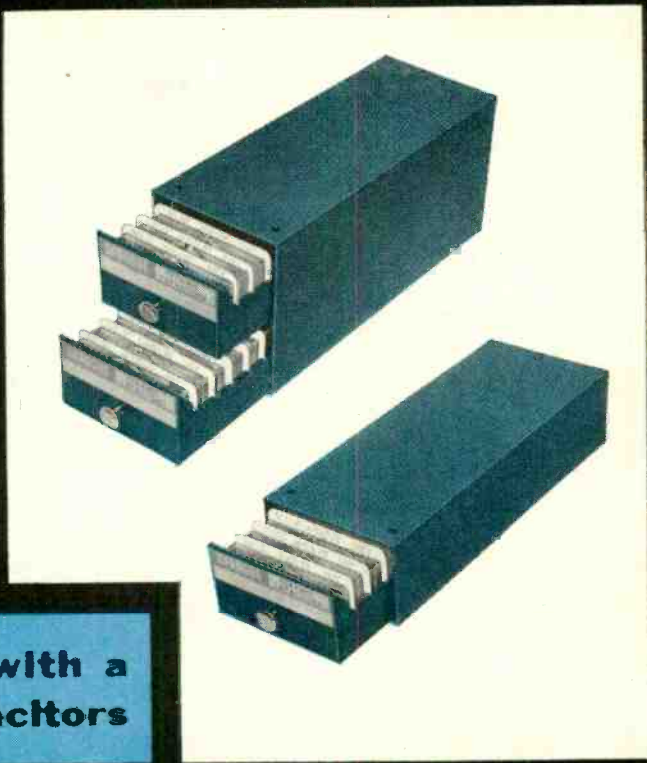

Get these cabinets **FREE** with a basic order of ceramic capacitors

● NOW . . . stock ceramics so you can find 'em when you want 'em . . . have your own neat and complete cabinet . . . at the cost of the capacitors alone.

● Sprague has pre-stocked these handsome, blue, heavy-gauge steel CERAMIKIT cabinets with its famous Ceramite capacitors. Ratings and quantities are based on popularity. No dogs! Stand-up indexes separate reusable plastic boxes. Catalog numbers and ratings can be seen at a glance.

● Whether you use many ceramics, or just a few, there's a Ceramikit sized and priced just right for you. Kit CK-2 is a two-drawer model holding 150 capacitors in 27 different ratings. Kit CK-3 is a single-drawer unit holding 75 capacitors in 12 different ratings. Remember there's not a dog in either Ceramikit.

● Kits inter-lock so You Can Build With Sprague as you buy your Ceramikits. Use the extra cabinets for handy indexed stocking of all your small parts.

● See your distributor *now* about Ceramikits, or request complete facts in Sheet M-711 from Sprague Products Co., 81 Marshall St., North Adams, Massachusetts.

CERAMIKIT CK-3

CONTENTS

3 1/2" x 9 1/4" x 2"

\$19.25 List

Quan.	Cat. No.	Quan.	Cat. No.
5	5GA-Q1	5	5GA-T47
5	5GA-Q22	5	5GA-T5
5	5GA-Q5	10	5GA-D1
10	5GA-T1	5	5GA-D2
5	5GA-T15	5	5HK-D5
5	5GA-T22	10	5HK-S1

CERAMIKIT CK-2

CONTENTS

3 1/2" x 9 1/4" x 4"

\$38.00 List

Quan.	Cat. No.	Quan.	Cat. No.
5	5GA-V5	5	5GA-T27
5	5GA-Q1	5	5GA-T33
5	5GA-Q15	5	5GA-T39
5	5GA-Q22	5	5GA-T47
5	5GA-Q33	5	5GA-T5
5	5GA-Q39	5	5GA-T68
5	5GA-Q47	10	5GA-D1
5	5GA-Q5	5	5GA-D15
5	5GA-Q68	5	5GA-D2
5	5GA-Q82	5	5GA-D33
10	5GA-T1	5	5GA-D4
5	5GA-T12	5	5HK-D5
5	5GA-T15	10	5HK-S1
5	5GA-T22		

don't be vague . . . major in

SPRAGUE®

YOU CAN BUILD WITH SPRAGUE

Sprague Products Co. is the Distributors' Division of the Sprague Electric Co.

TWO NEW COLOR BAR GENERATORS



*For All Color
Circuit Checks in
Color TV Receivers*

"Ideal for
COLOR"

Specifications—Model 700

Signal Outputs

1. Composite video of either polarity, adjustable amplitude to 1-volt across 90 ohms. Either luminance or chrominance can be eliminated from the composite signal.
2. Modulated R.F., channels 3, 4, or 5 of .1 volt across 300 ohms.
3. Horizontal sync., positive polarity, 1 volt across 200 ohms.
4. Crystal controlled color subcarrier (3.5795 MC), 40 Millivolts across 200 ohms at burst phase.

Synchronizing Signals

1. Color burst, crystal controlled (NTSC standards).
2. Standard horizontal sync. and blanking signals.

Color Bar Signals

1. Simultaneous bar display with luminance and chrominance levels held to plus or minus 10 percent, phase angles to plus or minus 5 degrees as follows:

Color	Relative Luminance	Chrominance
White	1.0	0
Yellow	0.89	0.44
Cyan	0.70	0.63
Green	0.59	0.59
Magenta	0.41	0.59
Red	0.30	0.63
Blue	0.11	0.44
Black	0	0

2. Color Difference Displays. Bars of zero luminance selectivity available as follows: (Phase angles within plus or minus 2 degrees):

Signal	Type of Display	Relative Chrominance
I	single bar	0.25
Q	single bar	0.25
I & Q	simultaneously	0.25
R-Y	single bar	0.25
B-Y	single bar	0.25
R-Y & B-Y	simultaneously	0.25

(Background for all color difference bars in black—relative chrominance zero)

3. Single Bars — Primary colors — red, green and blue—selectively available. Each bar is approximately 60% of screen width. Luminance 0.3, chrominance 0.5.

Crystal Controlled Sound Carrier—approximately 25% of peak picture carrier, placed 4.5 megacycles from picture carrier. Sound carrier may be turned off or on by panel control switch.

Panel Controls

1. R.F. Carrier Tuning—channels 3, 4 or 5.
2. Video Output Amplitude.
3. Horizontal Lock.
4. Sound On—Sound Off Switch.
5. Video Output Polarity Switch.
6. Power Switch.
7. Color Bar Selector Switch.
8. Horizontal Centering Control.
9. R.F. Attenuator.
10. Luminance-Chrominance Selector.

Internal Adjustments

1. Burst amplitude.
2. Color Sub-Carrier.
3. Modulation percentage.

Circuit Operation

1. Color sub-carrier and sound frequencies are determined by crystal oscillators.
2. All six color bars—yellow, cyan, green, magenta, red, blue, plus black and white are independently generated. No color mixing or matrixing is required.
3. Color phase angles are determined by an accurate, low impedance delay line.
4. Direct gating of proper chrominance phase is employed for each color bar to attain maximum stability and reliability rather than the usual methods which utilize quadrature encoders.
5. Luminance and Chrominance levels are reliable and stable. No multi-vibrators are employed in generating any bars.
6. No internal or external adjustments are required for proper phase angles, bar widths, luminance, or chrominance levels.

Specifications—Model 712

Provides similar signal outputs and Color Selection to model 700. Also includes crosshatch and white dot generators for convergence checks on 3-gun tubes. Cross-hatch pattern may also be used for linarity and tilt adjustments. Small dot size—about 1/4" on a 19" tube permits more positive convergence adjustment.

Accessories

Model 75C—Attractive Leatherette Covered Carrying Case with Velvet interior lining. For either Model 700 or 712.

Model 700—Shipping weight
30 pounds\$295.00 net

Model 712—Shipping weight
32 pounds\$395.00 net

Model 75C—Carrying Case—Shipping weight
12 pounds\$24.95 net

TEST INSTRUMENTS

to 100 kc. So you can have 0-100, 0-1,000 or 0-10,000 and 0-100,000 cycles. Or you could insert 0-300 cycle, etc. as well, if you use an 8-position switch. The extreme ranges are useful when you have an unstable amplifier and want to know if it is oscillating at 30,000 or 60,000 cycles. In any case, let us calculate the capacitance values.

The resistance through which the capacitor charge must pass when V2 is cut off is R5—22,000 ohms. As we have already seen, a 1-ma meter can be used if the resistance does not exceed about 20,000 ohms. The choice of a meter is thus free: anything more sensitive than 1 ma full scale will do.

Having decided what meter to use, you may have some special ideas on supply voltage. You can use 150 volts and put in a voltage stabilizer tube, or you can use an unregulated supply with a series resistor. The trick then is to provide a switch position which connects the meter as a voltmeter and to adjust the series resistor to give a standard reading, the one you calibrated the meter with. But in any case you will have to calibrate the meter to suit your particular tube (I used a 12AT7). Approximate values for C are given in the table (capacitance is in μf).

Meter Sensitivity (ma)	FULL-SCALE FREQUENCY					
	100	300	1 KC	3 KC	10 KC	30 100 KC
1	100,000	33,000	10,000	3,300	1,000	330 100
0.5	50,000	16,700	5,000	1,670	500	167 50
0.2	20,000	6,700	2,000	670	200	67 20
0.1	10,000	3,300	1,000	330	100	33 10

Each range must be checked at one point, which can be rather a tedious operation. Luckily, I have available standard frequency supplies at 100, 1,000 and 10,000 cycles, so that it is just a question of using the oscilloscope and any convenient oscillator. Your best plan might be to settle down to frequency checking first, with WWV acting as standard, and get oscillators, frequency meter and anything else with a frequency scale recalibrated. For the frequency meter, of course, it is a question, not of recalibration, but of

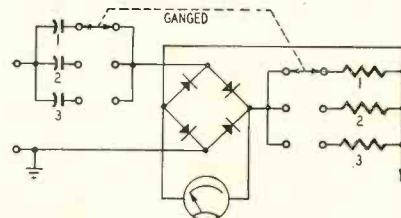

Fig. 5—Range switch with meter shunts.

adjusting the capacitor on each range.

You might prefer using a slightly more complicated switch and taking the capacitors straight out of the box. Take a switch with an extra bank, use the capacitor values shown for 1 ma with a 0.5-ma meter (or for 200 μa with a 100- μa meter) and connect a shunt across the meter to reduce the reading to the current value. By padding the meter in this way we eliminate the

"Service Engineered"
Test Equipment



TEST INSTRUMENTS

need for precision capacitors. The shunts can be used for the calibration trim. The circuit arrangement is shown in Fig. 5. The resistance values are all about the same, and all about equal to the resistance of the meter.

We have not discussed the rectifier. This depends on the frequency range you wish to cover. For frequencies up to 10 kc ordinary copper-oxide rectifiers are perfectly suitable. But if you want to extend up to 100 kc, it is best to use crystals, such as the 1N34. A small economy can be practiced here by con-

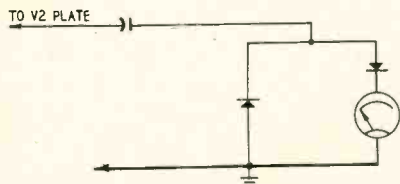

Fig. 6—Simplifying the meter circuit.

necting the circuit as in Fig. 6. This takes only two diodes instead of four, but it gives only one-half the current compared with the full bridge rectifier.

Meter operation

How do you use the frequency meter? Switch it on, let it warm up, check the voltage, connect an input signal, vary the sensitivity until the meter reading is steady and read the frequency. Then turn the range switch back to the maximum frequency range. This helps prevent overloading the meter. In using the frequency meter, be sure to check that there is enough input to drive the circuit to the cutoff level: if the meter reading does not change as the sensitivity control is moved a little, the input level is enough.

What can you use a frequency meter for? You can measure frequency, of course. You can use this circuit as a square-wave generator, too, if you connect a cathode follower to the plate of V2. A square-wave generator is always useful for testing the transient behavior of audio amplifiers. An oscillator must be used to drive the circuit, but that is always easy to arrange. And then there are the special jobs. You can work out some of these for yourself, but here is an example:

I have some rather complex R-C networks in production, and I wanted a quick cheap way of checking them. An ohmmeter will check that most of the resistors are wired correctly. A more general check is provided by connecting an amplifier between the output terminals of the network and the input terminals. The circuit is arranged so that it oscillates for a known gain setting of the amplifier, and the frequency is measured with the frequency meter. I can set tolerances to the gain and frequency, so that the networks can be completely tested at the rate of about six a minute.

That is just one special application. I'm sure that there are others. Why not build yourself a frequency meter, and find new uses for it? **END**

what you want
when you want it... use

ERIE

RESISTOR CORP.

ERIE CERAMICON and TUBULAR TRIMMERS 		ERIE UNIVERSAL 20KV CERAMICONS 	ERIE DISC and PLATE CERAMICONS
ERIE CERAMICONS 		ERIE BUTTON SILVER MICA CAPACITORS 	ERIE FEED-THRU CERAMICONS
ERIE CERAMICONS 		ERIE STAND-OFF CERAMICONS 	ERIE SWITCHES

the most complete line of
Ceramic Replacement Capacitors

Leading builders of radio and TV sets and electronic equipment have approved ERIE components and have used them for many years.

Your requirements can be met without delay from your ERIE Distributors' vast and varied stock.

Most ERIE Distributors have in stock from 25,000 to 75,000 ERIE Ceramicons of various styles, types, and values.

Write for latest catalog and the name of your nearest ERIE Distributor.

ERIE RESISTOR CORPORATION
ELECTRONICS DISTRIBUTOR DIVISION
Main Offices: ERIE, PA.
Factories: ERIE, PA. • LONDON, ENGLAND • TRENTON, ONTARIO

NOW! Service Dealers can offer the finest in

HI-FI

on an investment of only
\$495**

TRANSVISION Lifetime MATCHED HI-FI UNITS enable you to undersell ALL competition at a good profit! You get **full Dealer Price Protection**—and more!

**How? Rush coupon for full details about our great "Dealer Hi-Fi Program."

FOR
The Finest
MASTER AMPLIFIED AND COMMUNITY TV ANTENNA SYSTEMS-

— Send Us Your Problem for FREE Engineering Advice.

FREE: Important Technical Manual for Community and Master TV Systems

RUSH THIS COUPON NOW
TRANSVISION, INC., NEW ROCHELLE, N. Y. E-3

Rush details on Hi-Fi Dealer Program;
 FREE Manual for Master Antenna Systems

Name _____
Address _____
City _____ State _____



"He goes into such ecstasies since we're using **JENSEN NEEDLES**, there's no holding him."

WIDE-RANGE

TRANSISTORIZED BRIDGE

*Simple instrument makes
precision measurements*

By I. QUEEN

EDITORIAL ASSOCIATE

MOST technicians acknowledge the advantages of a bridge over an ohmmeter. (It is far more accurate and is easily adapted to measure capacitance as well as resistance.) But few ever attempt to build one. They feel that a bridge is a complicated instrument, while an ohmmeter consists merely of a few resistors, a battery and an added scale on a meter that also measures ma and volts.

The bridge described here should appeal to these technicians and experimenters. It is easy to construct and convenient to use. Its scale length is over 10 inches, as against about 4 for a 4-inch ohmmeter. The same instrument measures resistance and capacitance, divides voltage and can be used as a substitute resistor.

Fig. 1 shows the basic circuit of a bridge for measuring resistance. Resistor R_s is a standard whose value should be known accurately. The unknown resistance is connected across X. A voltage, a.c. or d.c., is fed to terminals T. The variable arm of potentiometer AB is adjusted for balance (no output

at the detector). Then $X = \frac{AR_s}{B}$.

The resistance of A and B need not be known separately. Their ratio gives sufficient information to insert into the equation. This ratio may be determined at various points along the potentiometer dial by using known resistors at X and R_s . A small value R_s permits measuring low resistance at X. A large R_s should be used to measure a large X, etc. The ratio $\frac{A}{B}$ is not affected by any change at R_s or X.

To measure capacitance, the circuit of Fig. 2 is used. Note that the standard and unknown have been interchanged. This is because voltage or capacitive reactance is being measured, and X varies *inversely* with capacitance. If the unknown is properly chosen, the same calibration holds whether resistance or capacitance (Fig. 1 or Fig. 2) is being measured.

The complete wide-range bridge is shown in Fig. 3. With the switch in the position shown we have the equivalent of Fig. 1, the circuit for measuring

resistance. The unknown is connected across R and the switch is thrown to RES.

With the switch thrown to CAP, the circuit is like Fig. 2. The unknown capacitor is placed across c.

There is a third position, x. This eliminates both standards, so any desired *external* standard may be used. For example, to measure very high resistance, a 100,000-ohm standard may be plugged into the c terminals. The unknown is connected across R as usual. Of course, the calibrations are now 100 times larger than those obtained with the internal 1,000-ohm standard. If an external capacitor standard is to be used, plug it in at r. The unknown goes across c.

This bridge uses a General Radio type 371-T potentiometer. It has a square-law taper when advanced clockwise. This provides well-spaced readings and a wide range. It has 1,100 turns to permit fine, accurate balance settings; dissipates up to 8 watts and can be rotated through 303° . The table shows a typical calibration obtained with the switch thrown to RES. The dial

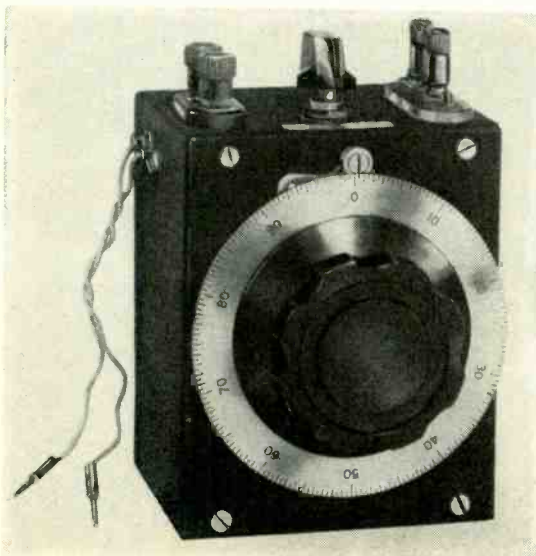
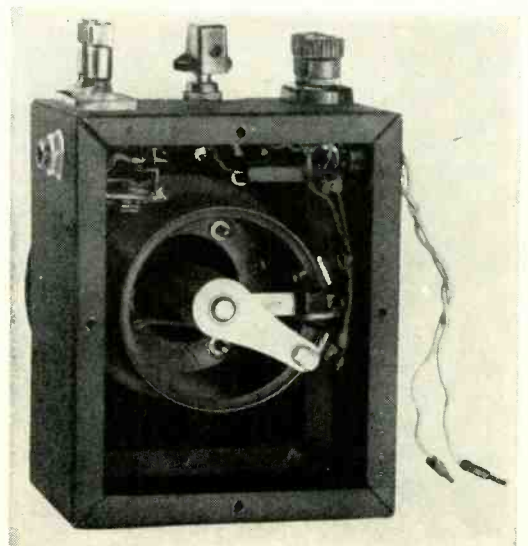

Photo at left shows front view of the versatile bridge. The precision dial assures high accuracy.



Simplicity of this bridge is seen in this rear-view photo and in the schematic diagram in Fig. 3. Oscillator and amplifier are separate units that can be used for other servicing applications.

start right . . . in **COLOR** with RCA field-proved instruments!



**WR-61A
COLOR-BAR
GENERATOR**



**WR-36A
DOT-BAR
GENERATOR**

If you want to get off to the right start in color-television servicing, add the RCA WR-61A Color-Bar Generator and RCA WR-36A Dot-Bar Generator to your present black-and-white equipment. These two units, used with proper test facilities for servicing black-and-white receivers, give you complete test equipment for trouble-shooting and servicing color-TV receivers.

Lightweight, compact and portable, both instruments are designed for accuracy and stability. See your local RCA Distributor for complete details.

The WR-61A Color-Bar Generator generates signals for producing 10 different color bars simultaneously—including bars corresponding to the R-Y, B-Y, G-Y, I, and Q signals for checking and adjusting phasing and matrixing in all makes of color sets. Crystal-controlled oscillators insure accuracy and stability. Luminance signals at bar edges facilitate checking color "fit" or registration. Adjustable sub-carrier amplitude permits checking color-sync action. The WR-61A which was designed for color servicing is now accepted as the standard for color-phasing accuracy in many TV stations and network operations. Suggested User Price **\$247.50**

The WR-36A Dot-Bar Generator provides a pattern of small-size dots for adjusting convergence in color receivers and H- and V-bars and crosshatch patterns for precise adjustment of linearity in both color and black-and-white TV sets. RF output on channels 2-6. High-impedance video output (plus and minus polarities). Choice of internal 60-cps vertical sync or external sync. The number of vertical and horizontal dots and bars is adjustable. Suggested User Price **\$147.50**

New—Small Dots Current production WR-36A Generators produce small-dot and fine-line crosshatch patterns for convergence adjustments in large-screen color receivers. (Small-dot modification kits are being supplied at no charge to registered owners of earlier models of the WR-36A. Send in YOUR registration card if you have not already done so.)

Special Porta-Rack offer expires April 30, 1955!

This valuable service aid is yours FREE with your purchases of RCA Test Equipment. An RCA exclusive, tailor-made for the busy technician, this sturdy, mobile RCA PORTA-RACK can carry a full complement of RCA Test Equipment, right to the shop job . . . saves time, saves precious bench space . . . increases your operating efficiency. See your RCA Distributor for details.

ANNOUNCING THE RCA PORTA-RACK



**FREE
OF EXTRA COST
FOR A
LIMITED
TIME ONLY!**



RADIO CORPORATION of AMERICA
TEST EQUIPMENT
HARRISON, N. J.

New TUBE TESTER

Exclusive
HICKOK
Dynamic
Mutual Conductance

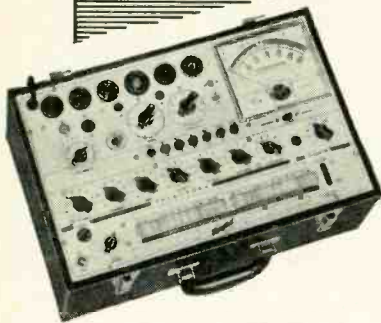

MODEL 600A

This fine tube tester is a lightweight portable. Popularly priced, the 600A is the Radio-TV serviceman and Industrial Technician's favorite. Backed by the HICKOK guarantee and built to the high HICKOK standard, this equipment will provide the necessary completeness and accuracy of tube testing required in the professional maintenance of radio-TV and industrial electronic equipment. HICKOK Dynamic Mutual Conductance circuits permit accurate tube evaluation. AC signal 2.5 volts: 0-3000, 6000, 15000 micromhos. Large, easy-to-read 5" HICKOK-built internal pivot meter. Tests all tubes including, Color TV under simulated operating conditions. Includes the HICKOK bias potentiometer. Contains all the latest tube sockets and complete built-in tube reference chart.

This instrument is the lowest priced dependable quality tube tester available. Through increased accuracy and time saving completeness, the 600A will pay for itself in the shortest possible time.

Write today . . . for full details on the world's most complete line of quality vacuum tube testers.

THE HICKOK ELECTRICAL INSTRUMENT CO.
10531 Dupont Avenue • Cleveland 8, Ohio

TEST INSTRUMENTS

used is 4 inches in diameter and calibrated 0-100 over a full 360°. Only the numbers 0-84 are effective since the potentiometer can be rotated only 303°. The calibrations of this particular dial increase in a counterclockwise direction. In the table most of the values are given to the nearest whole number for convenience. However, the dial is marked in half-units and can be easily estimated to tenths of a division.

When measuring capacitance, the table calibrations must be multiplied by 10. This is because the capacitance standard 10,000 μmf is 10 times larger than the resistance standard. For measuring very low capacitance, an external standard of 100 μmf was made up. This permits measuring small, air variable capacitors down to their minimum values.

In all measurements a very sharp null point should be obtained. If a capacitor produces a broad balance, it is because of its high internal resistance. Thus the quality of a capacitor may be estimated by the sharpness of balance. It should balance to an almost complete null.

(Electrolytic capacitors often have enough internal resistance to make it difficult to get a clear reading. An external standard, consisting of a 1- μf capacitor in series with a 1,000-ohm potentiometer, may be used for measuring them. If it is hard to obtain a null, the resistance is increased a little and the bridge rebalanced, the procedure being repeated till the sharpest null is obtained.—Editor)

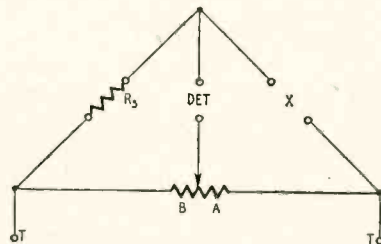

Fig. 1—Circuit for measuring resistance.

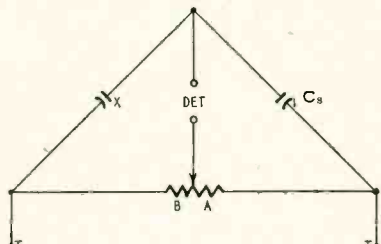

Fig. 2—Circuit for measuring capacitance.

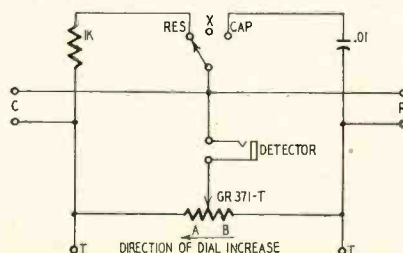

Fig. 3—Schematic of wide-range bridge.

EDLIE for TOP VALUES

Newest & Best "Fix-It-Yourself" Aid Larrel's E-Z TV REPAIR GUIDE

The Only **FIX-IT-YOURSELF** Guide Made expressly for **YOUR TV Set!**
Now you can save costly TV repairs with this new, simplified method which includes all necessary data for just **YOUR** set. No confusing, unimportant information applicable to hundreds of other makes. Simplifies detection of faulty tubes in your TV receiver quickly, accurately.
It's a terrific idea—It's a terrific guide! Order today and have your set back in perfect condition at once. Be sure to send us make and model of your TV when ordering. **50¢**

New CODE KEYS, J-38

Brand new! Signal Corp., U.S. Army, black bakelite base, 3" x 3/4", brass jumper, strip, & binding posts. Circuit closing switch. Completely adjustable. **79¢**
Special ea.

Save! HIGH PASS FILTER

Input impedance: 600 ohms; output impedance 5,000 ohms. 300 cycles cut off frequency at 3,500 cycles attenuates at 2 db.; at 120 cycles attenuates at 20 db.; at 60 cycles attenuates at 45 db. 2" x 3 1/2" x 2". Original cost: \$20. **\$1 35**
Reduced to

Save! LOW PASS FILTER

At 3,500 cy. attenuates at less than 0.2 db.; at 8,000 cy. attenuates at greater than 60.0 db.; at 6,000 cy. attenuates at greater than 50.0 db. Input impedance: 5,000 ohms. Original cost: \$15. **\$1 45**
Reduced to

SAVINGS ON KITS INSULATED RESISTOR KIT

100 INSULATED RESISTORS. RMA code marked all 1/2 watt varying in ohmage from 1 ohm to 10 megohms and tolerance of 5%, 10% & 20% of standard makes. RMA color code chart included FREE. Special! **95¢**

DeLuxe Insulated Resistor Kit

Includes: 15-2 watt, 35-1 watt and 50-1/2 watt values up to 20 megs. Housed in a transparent plastic box, 4 3/8" x 2 3/4" x 1", 4-compartments. Reduced to **\$225**

FLEXIBLE W. W. PIGTAIL RESISTOR KIT

100 Resistors of asst. ohmages and wattage. **\$165**

CANDOHM W. W. metal clad

25 Resistors of asst. ohmages and wattage. **95¢**

WIRE WOUND RESISTOR KIT

25 Wire Wound Resistors up to 50-1/2 ohms, 5, 10, 20, 30, 50, and 100 watt resistors. **\$195**

PRECISION CARBOFILM RESISTOR KIT

1% tolerance in ohmages from 5 to 2.2 megohm. \$25 value. **\$245**

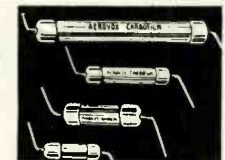

Terrific Buy! PRECISION WIRE WOUND RESISTOR KIT

20 Precision W.W. resistors. 1% tolerance. 20 different ohmages ranging up to 1/2 megohm, 1/2 & 1 watt. \$25 value. **\$245**



Disc Condenser Kit

50 Disc condensers—.001, .0015, 2X0015, 2X004, 0047, .005, .01, 2X01, & 0000 10/2kV mfd. of equal amounts. Now! **\$195**

CERAMIC CONDENSER KIT

50 Tubular ceramic (solid and hollow) ranging in capacity from 1 to 4700 mfd. Special! **\$175**

Write today for FREE Catalog. All mdse. shipped F.O.B. New York City, prices subject to change without notice. Include 20% deposit with C.O.D.'s.

EDLIE ELECTRONICS
154 Greenwich St. New York 6, N.Y.
DI. 9-3143

P. R. MALLORY & CO. INC.
MALLORY
APPROVED PRECISION PRODUCTS

P. R. MALLORY & CO. INC.
MALLORY
APPROVED PRECISION PRODUCTS

P. R. MALLORY & CO. INC.
MALLORY
APPROVED PRECISION PRODUCTS

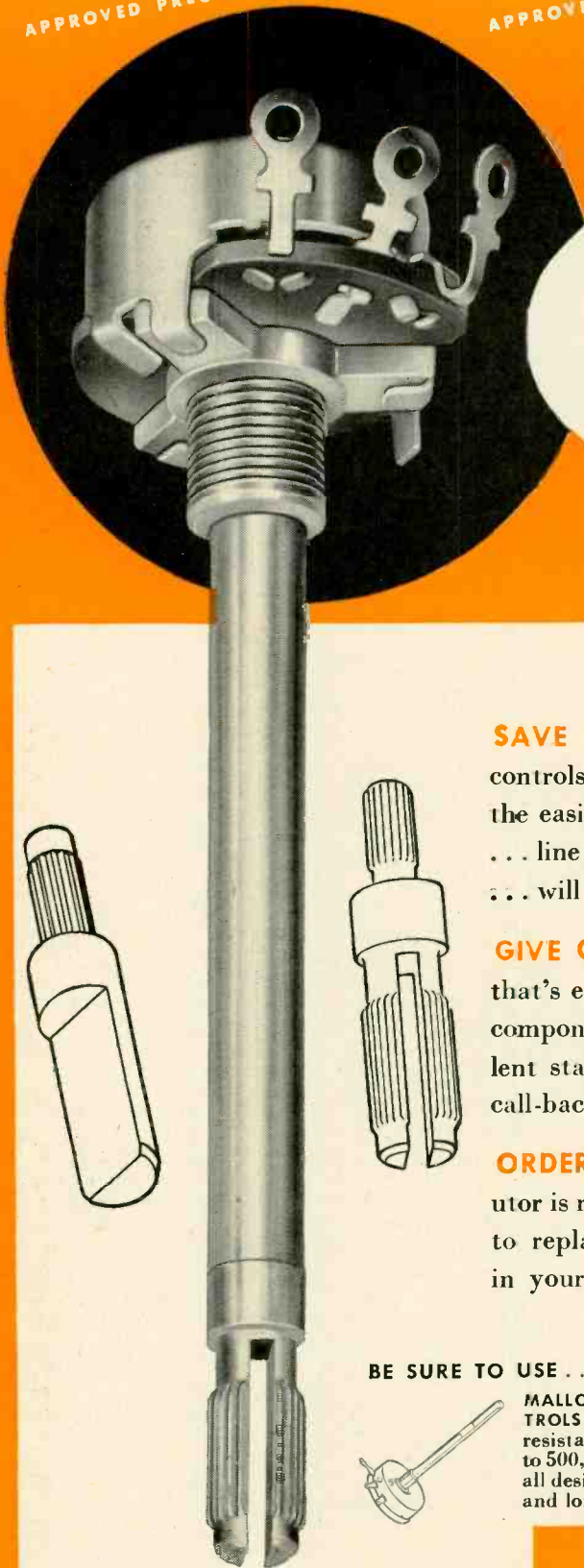

The simplest – and best – control replacements you can install

SAVE YOURSELF TIME with Mallory Midgetrols®—the carbon controls designed for *both* you and your customers. Features like the easily-cut tubular shaft that fits split-knurl or flatted knobs . . . line switches that you attach without disassembling the unit . . . will save valuable minutes of your shop work.

GIVE CUSTOMERS THE BEST with Midgetrols—the control that's engineered to equal or exceed the performance of original components. Their precise tapers, noise-free operation and excellent stability add up to the kind of performance that prevents call-backs . . . builds customer good-will.

ORDER YOUR STOCK TODAY. Your nearby Mallory distributor is ready to supply you with a Control Kit that will equip you to replace controls in 90 per cent of the radio and TV sets in your area.

BE SURE TO USE . . .

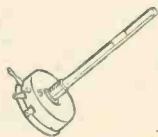

MALLORY WIRE WOUND CONTROLS . . . a wide selection of resistance, wattages from 2 to 500, and variety of tapers . . . all designed for cool operation and long life.

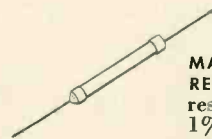

MALLORY DEPOSITED CARBON RESISTORS . . . high stability resistors with tolerances of 1% or 10% . . . at cost substantially lower than wire wounds.

P. R. MALLORY & CO. INC.
MALLORY

CAPACITORS • CONTROLS • VIBRATORS • SWITCHES • RESISTORS
RECTIFIERS • POWER SUPPLIES • FILTERS • MERCURY BATTERIES
APPROVED PRECISION PRODUCTS

P. R. MALLORY & CO., Inc., INDIANAPOLIS 6, INDIANA

P. R. MALLORY & CO. INC.
MALLORY
APPROVED PRECISION PRODUCTS

P. R. MALLORY & CO. INC.
MALLORY
APPROVED PRECISION PRODUCTS

P. R. MALLORY & CO. INC.
MALLORY
APPROVED PRECISION PRODUCTS

'SCOPES ARE "GOLD MINES"

... when you know how
to use them fully on all
types of service jobs

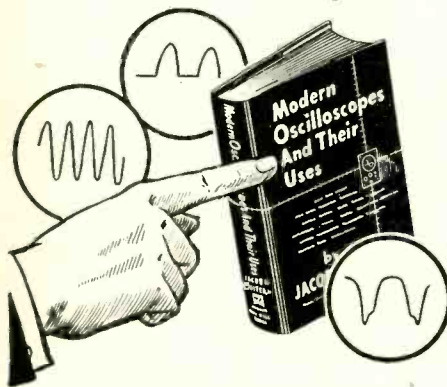

... AND THIS BOOK
MAKES IT EASY TO LEARN
ALL ABOUT THEM!

No question about it! The cathode ray oscilloscope is the handiest, most useful instrument in radio-TV servicing today. Servicemen who master it get the best jobs—make the most money—work lots faster—and are headed for even bigger things in the future!

MODERN OSCILLOSCOPES AND THEIR USES

By Jacob H. Ruiters, Jr.
of Allen B. DuMont Laboratories, Inc.
326 pages, 370 illustrations, \$6.00

- ✓ When, where, why and how to use oscilloscopes
- ✓ How to interpret patterns
- ✓ How to handle tough jobs easier and faster

Now the oscilloscope won't "stump" you—not when you have the clear explanations given by this famous book! It contains no involved mathematics—no puzzling and complicated discussions. Instead, it goes right to work explaining oscilloscopes fully and showing you exactly how to use them in lab work and on AM-PM and TV service work—from locating troubles to handling tough realignment jobs. Each operation is carefully explained, including determining where and how to use the 'scope; making connections, adjusting circuit components, setting the controls and analyzing patterns fast and accurately. About 370 illustrations including dozens of typical pattern photos make things doubly clear.

No other type of specific service method training can mean so much to you in terms of efficiency and greater earning power! Send for it today. See for yourself how this book can help you—before you buy!

READ IT 10 DAYS . . . at our risk!

Dept. RE-35, RINEHART & CO., Inc.
232 Madison Ave., New York 16, N.Y.

Send MODERN OSCILLOSCOPES AND THEIR USES for 10-DAY EXAMINATION. If I decide to keep the book, I will then remit \$6.00 plus a few cents postage in full payment. If not, I will return book postpaid and owe you nothing.

Name

Address

City, Zone, State

OUTSIDE U. S. A.—Price \$6.50 cash only.
Money back in 10 days if book is returned.

TEST INSTRUMENTS

The source of power for a bridge may be either a.c. or d.c. for measuring resistance. For capacitance it *must* be a.c.

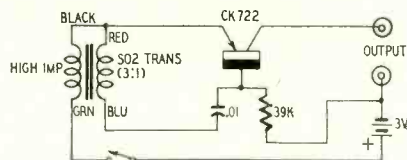

Fig. 4—Diagram of transistor oscillator.

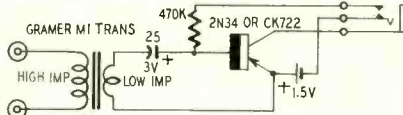

Fig. 5—Amplifier for the oscillator.

The transistor oscillator

The oscillator was not combined with the bridge. It is more convenient to have it separate, so it can be used for other purposes (signal generator, continuity tester, etc.) while the bridge is idle. Many users will no doubt have their own source of audio-frequency a.c. in the form of an audio oscillator or an r.f. generator with provision for audio output.

Those who have no audio source can find plenty of circuits for simple audio generators. The writer's own miniature a.f. test oscillator, which appeared in this magazine in August, 1954, on page 38, will do the job, as will Bohr's AM test oscillator (September, 1954, page 52). Both are transistor devices. A 1-tube oscillator is described in the October, 1954, issue on page 37. Use a transistor oscillator to provide the audio tone for both resistance and capacitance measurements. A pair of headphones is used as the detector.

This transistor circuit is housed in a plastic box, 2½ x 1¼ x ⅞ inch, of the type (with hinged cover) used to package screws and small radio parts.

The oscillator (Fig. 4) does not have a switch. Its battery circuit is closed only when a load (in this case, the bridge) is connected across its output.

This oscillator gives ample output for bridge measurements under normal conditions. However, in a noisy room or for measuring a very high resistance, an

amplifier is desirable. Such a circuit is shown in Fig. 5.

All parts except the phone jack are assembled on a plastic sheet 1¼ x 2 inches. This sheet is wedged into a plastic box approximately 3 x 2 x 1 inch.

For convenience the bridge uses dual binding posts for R and C. These posts, which take either wires, phone tips or banana plugs, are available from General Radio, National and others. The posts also fit a dual banana-plug unit. The external standards are mounted directly on these double plugs.

Bridge applications

Besides ordinary measurements this bridge is suitable for matching resistors (or capacitors) to better than 1%. Special circuits like phase inverters often require such pairing. In these cases the actual values of the resistors don't matter, but they must be equal. For example, if 10,000 ohms is specified, it could just as well be 9,950 ohms or some similar value. However, the resistors (or capacitors) must be within 1% of each other.

Parts for bridge

1—1,000-ohm precision resistor; 1—potentiometer (see text); 1—.01-µf capacitor, precision (1%); 1—single-pole 3-position switch; 1—phone jack; 2—binding posts; 1—chassis; 1—dial (4-inch diameter).

Parts for oscillator

1—CK722; socket for CK722; 2—penlight cells; 1—39,000-ohm resistor; 1—.01-µf disc capacitor; 1—audio transformer, 1:3, primary impedance 10,000 ohms, secondary impedance 90,000 ohms (UTC SO-2 or equivalent); 2—pin jacks; 1—plastic box.

Parts for amplifier

1—470,000-ohm resistor; 1—25-µf 3-volt electrolytic capacitor; 1—audio transformer (Gramer M1 or equivalent); 1—2N34 or CK722 transistor; 1—socket for transistor; 1—circuit-closing phone jack; 1—penlight cell; 1—plastic box; 2—pin jacks.

To match resistors, switch to x and connect one resistor as the standard and the other as the unknown. Exact equality is indicated at 30.2 on the dial on my particular bridge. Each percent of error produces a change of 0.1 of a dial division. For example, if the bridge indicates 30.3 or 30.1, the resistors are unequal by 1%. If desired, a reading may be taken and the resistors then interchanged. For example, if they are out by 1%, we will read 30.3 in one position and 30.1 in the second. This makes it easier to read small errors since the difference in reading is *doubled*.

To use this bridge as a voltage divider, short-circuit R. The output appears across the detector jack. This setup is suitable for experiments, meter calibration, etc. The output may be calibrated either in percentage or in db.

When terminals T are left open and R is shorted, a variable resistance appears at the detector jack as the dial is rotated. Up to 28 ma can be passed safely through this resistance, which can be used as a temporary substitute for a defective resistor to determine optimum conditions in an experimental circuit.

END

TYPICAL CALIBRATION TABLE

Ohms	Dial
10	1.3
27	2
56	3.5
150	8
250	12
500	18
1,000	30
2,000	45
4,000	56
8,000	68
16,000	74
32,000	78
60,000	81.2
150,000	82.8
500,000	83.6
1 megohm	84



G-C RADIO-TELEVISION CHEMICAL LAB
Save time and money, with this complete lab of 20 2-oz. G-C chemicals. Do all repairs to speakers, coils, dials, etc. Free metal rack included.
NO. 997 NET \$7.65



G-C ROOF-SEEL COMPOUND
Seal holes in roofs on roof-top antenna installations. Stop call-backs.
NO. 18-16 Pint can NET \$0.60



G-C LENS-TUBE CLEANER
Specially prepared to remove finger marks and spots on picture tube and lens.
NO. 216-2 2-oz. bottle NET \$0.36



G-C DE-OX-ID
Cleans and prevents oxidation on all sensitive circuit contacts, switches, etc.
NO. 19-2 2-oz. bottle NET \$0.96



G-C INSULATION AND DIPPING VARNISH
Treat field coils, chokes, noisy or buzzing transformers.
NO. 56-2 2-oz. bottle NET \$0.39



G-C SCRATCH REMOVER
Dark shade covers hairline scratches, renews appearance of TV set, furniture.
NO. 92-2 2-oz. bottle NET \$0.30

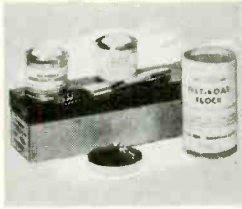

G-C DELUXE FELT-KOAT KIT
Complete flock finishing kit for applying to turntables, grilles, cabinets, etc.
NO. 180-0 NET \$2.25



G-C DIAL CORD DRESSING
Prevents dial cord slipping. Simply rub dressing stock on cord. Long lasting.
NO. 1212 NET \$0.15



G-C RADIO KNOB KIT
Kit contains 35 assorted walnut and ivory replacement knobs. Includes springs.
NO. 1140 NET \$2.82

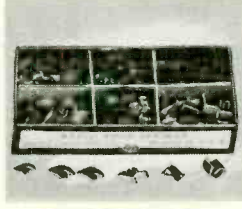

G-C KNOB SPRING KIT
Kit of 100 knob springs in 12 different styles. Tempered spring steel.
NO. 1051 NET \$1.17



G-C TURNTABLE SPRING KIT
Kit of 50 assorted turntable springs for replacement on RCA, Philco, Zenith, etc.
NO. 6478 NET \$1.65



G-C WOOD CABINET GLUE
Repair TV and radio cabinets, furniture, etc. Fasten grill cloth, labels.
NO. 39-2 2-oz. bottle NET \$0.39

GENERAL

CEMENT

Ask For These
RADIO-TV SERVICE AIDS
... at Your Jobber



G-C RADIO-TV SPAGHETTI
Best grade varnished tubing in 20-ft. lengths. Fit No. 12- No. 18 wire. Five colors.
NO. 499 NET \$1.11

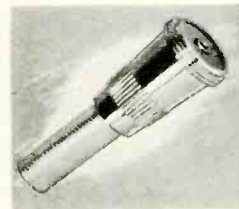

G-C MIKE CONNECTOR
Single contact male type, completely shielded. Brass, bright chrome plated.
NO. 7940 NET \$0.30



G-C PHONO PLUG
Phono connector for RCA, Philco, Zenith and others. Use also for auto radio.
NO. 1742 NET \$0.06

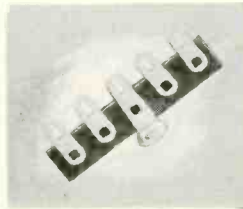

G-C STO. TERMINAL STRIPS
Bakelite insulation 1/16" thick. 3/8" spacing. Five lugs, others 1 to 12.
NO. 8785 NET \$0.072

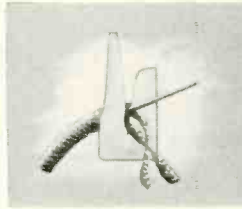

G-C POCKET WIRE STRIPPER
Popular wire stripper is also scraper, cutter, screwdriver and wire winder.
NO. 757 NET \$0.30

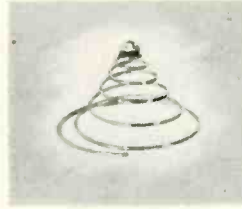

G-C STATIC SPRING
Eliminates auto front wheel static noise. Riveted metal points for firm contact.
NO. 1058 NET \$0.03

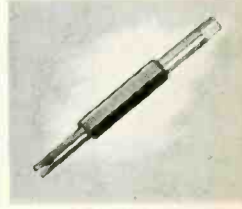

G-C AUTO RADIO TUNER
Handy tuner tool for adjusting auto radio when chassis and cables are removed.
NO. 8285 NET \$0.27



G-C FAHNESTOCK CLIPS
Spring brass, 3/4" long x 3/16" wide. No. 6 mtg. hole. Box of 144. Medium Size.
NO. 6302-G NET \$2.46



G-C BANANA JACK
Standard jack, insulated 3/16" head. Mounts in 3/16" hole. NO. 7741 Color Red NET \$0.132 NO. 7742 Color Black NET \$0.132

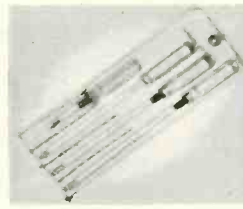

G-C TV ALIGNMENT KIT
Handy versatile alignment tool kit in plastic holder. Four basic tools.
NO. 8457 NET \$1.77



G-C HANDLE INSULATORS
Envelope of assorted sizes to insulate handles on pliers, cutters, etc. Neat appearing.
NO. 8118-E NET \$0.27



G-C 6-PIECE "SLIP-ON" SET
Friction handle holds 5 plated hex sockets. Sizes: 1/4", 3/16", 1/8", 3/8", 7/16".
NO. 715 NET \$1.35

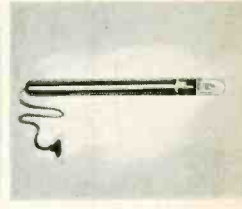

G-C INSPECTION LIGHT
Service light where you want it. Ideal for production inspection. 110 v. AC-DC.
NO. 705 NET \$1.35



G-C PIN STRAIGHTENER
Straightens both miniature and jumbo-miniature tubes of both 7- and 9-pin types.
NO. 8655 NET \$1.50



G-C LIGHTNING ARRESTOR
Underwriters' approved, for all types of UHF-VHF lead-in lines. Easy to use.
NO. 8642 NET \$0.75

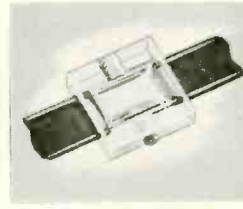

G-C 300-OHM CONNECTOR
Screw-type connector to splice 300-ohm twin line. Retains wire characteristics.
NO. 8095-E Env. of 2 NET \$0.27

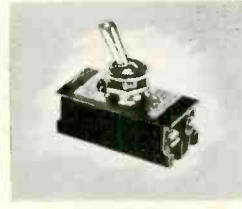

G-C H. D. POWER SWITCH
D.P.S.T. toggle switch. Rated 12 amp. at 125 volts. For motors, appliances, etc.
NO. 1350 NET \$1.32



FREE!
Send postage for your illustrated G-C Catalog.



GENERAL CEMENT MFG. CO.

910 Taylor Avenue • Rockford, Illinois

ASK YOUR JOBBER FOR THE

SPECIALS OF THE MONTH

 G-C "KLEER LENS" LENS CLEANER NO. 9081 NET \$0.75	 G-C 3-WAY TV LINE KLIP NO. 9015 NET \$0.12	 G-C UNIV. UHF-VHF LIGHTNING ARRESTOR NO. 8642 NET \$0.75	 "MITY-V" ADJUSTABLE UHF-VHF ANTENNA NO. A-9098 NET \$2.25
---	--	--	---

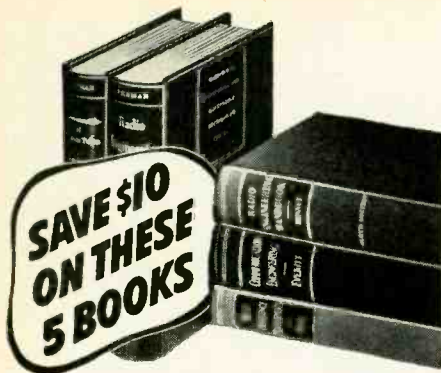

Special Offer On This Complete RADIO ENGINEERING LIBRARY

The Famous Library that Brings High-powered Help on the Whole Field of Radio Engineering. Places Authoritative Facts, Standards, Data, Practice, and Theory At Your Fingertips.

Now offered at a special low price, the Radio Engineering Library brings you almost 4000 pages of tested methods, standards, data and accepted practice. This Library will help solve hundreds of problems for designers, researchers, engineers, and students in any field based on radio.

Written by leading radio engineers, these books cover circuit phenomena, networks, tube theory, vacuum tubes, amplification, measurements, etc.—give specialized treatment of all fields of practical design and application. They provide you with a complete and dependable encyclopedia of facts.

5 volumes, 3872 pages, 2770 illustrations

- Eastman's FUNDAMENTALS OF VACUUM TUBES, 3rd Edition
- Terman's RADIO ENGINEERING, 3rd Edition
- Everitt's COMMUNICATION ENGINEERING, 2nd Edition
- Hund's HIGH FREQUENCY MEASUREMENTS, 2nd Edition
- Henny's RADIO ENGINEERING HANDBOOK, 4th Edition

SEND NO MONEY
Special Low Price—Easy Terms

On this special offer you get this Library for \$38.00, instead of \$48.00. You save \$10 and may pay on easy terms. Mail coupon below to examine the Library FREE for 10 days. No obligation. These books are recognized as standard works; you are bound to need them. So take advantage of this special money-saving offer. Mail coupon at once!

McGraw-Hill Book Co., Dept. RE-3
327 West 41st St., New York 36, N. Y.

Send for 10 days' FREE trial, the RADIO ENGINEERING LIBRARY. If not satisfied I will return books. Otherwise I will send \$8.00 plus delivery charges then; and \$6 a month for 5 months. (Reg. price \$48.00, you save \$10.00.)

Name

Home Address

City & State

Employed by

We'll pay Delivery Charges if you enclose \$8.00 first payment WITH coupon. Same return privilege for full refund.

For prices and terms outside U.S. write McGraw-Hill Int'l., NYC RE-3

new Tubes & Transistors

Silicon junction diodes

A new line of silicon junction diodes has been announced by the Hughes Aircraft Co., Culver City, Calif. The devices have a high forward conductance and an extremely high back resistance—some units, approximately 10,000 megohms. In most applications this represents an open circuit. Made of silicon, these diodes may be used in many high-temperature circuits in



which germanium units cannot be used.

The announcement includes 8 types—the HD6001 through HD6009. All of these have an ambient operating temperature range of from -80 to 200° C.

The diodes are fusion-sealed in a one-piece glass body (see photo), with the diode envelope coated with black silicone enamel to shield the crystal from light. Physical dimensions are 0.265 x 0.103 inch, maximum.

6472 phototube

A small, rugged multiplier phototube of the 9-stage type has been developed by RCA. It is intended especially for automobile headlight-dimming service, and features instantaneous response to meet the critical timing requirements of that application.

The high luminous sensitivity of the 6472 makes it possible to use it with a relatively low-impedance input amplifier and fewer stages than required by a less sensitive tube. The phototube has a low electrode dark current, which permits the use of high-resistance voltage-divider networks to minimize power requirements and to improve operating stability.

Hearing-aid transistors

Transistors approximately the size of the head of a wooden match are being produced by CBS-Hytron. They are apparently the smallest hearing-aid transistors to be manufactured commercially up to this time.

The miniature units, the HA-8, HA-9 and HA-10, are smaller versions of the HA-1, HA-2 and HA-3 described in this column June 1954. They are hermetically sealed in a cylindrical metal case 0.25 inch long and 0.13 inch in diameter. Three of these tiny transistors,

Famous Weller Soldering Gun

7 NEW FEATURES TO SOLDER FASTER, BETTER!



1. Streamlined, compact
2. Over 100 watts
3. Heats in 5 seconds
4. Trigger switch
5. Two spot lights
6. Replaceable tips
7. Guaranteed 1 year

\$5.95

MODEL 8100

3 or more \$5.30 ea.
12 or more \$5.04 ea.

HI-GAIN CONICAL ARRAY XA-44

8 hi-tensil 3/4" aluminum elements, dowel reinforced. Heavy duty bakelite insulator. Universal U-clip. Weighs 4 lbs. Easy to install; gives trouble free performance. Real buy!

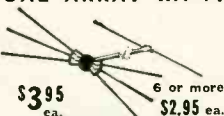

No Motors! No Electricity! ROTATES ELECTRONICALLY

360° Reception VHF-UHF Channels 2-83

Snyder Super-Directronic Exclusive AX-524 \$24.95 design cuts costs to

Powerful, 24 element 2 bay Directronic antenna is electronically beamed to any transmitter in fringe area by 8-position selector sw. No motors or electricity. Extremely high gain. COMPLETE WITH 8-POSITION DIRECTRONIC BEAM SELECTOR. 100' TUBULAR TRI-X CABLE. UNIVERSAL U CLAMPS. Order Model AX-524.

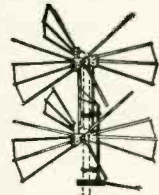

BARGAIN SCOOPS!

- Full Range Plastic Recording Tape, 1200' \$1.95 ea.
- Your Choice: Alnico V PM Speakers—4" square or 5" round. Lowest prices ever! Only 95c each.
- Pic Tube Booster Scoop! Vu-Brite C-401 now only 95c ea.

Write for FREE FYI Bulletin 214

WHOLESALE RADIO PARTS CO., Inc.

311 W. Baltimore St. • Baltimore 1, Md.

F. C. C.

1st Phone LICENSE

in only

2

MONTHS!

Correspondence

or

Resident Training

MAIL COUPON FOR FREE BOOKLET

Grantham School of Electronics
Dept. 101-RF
6064 Hollywood Blvd.
Hollywood 28, Calif.

Send me your FREE booklet, telling how I can get my commercial FCC operator license quickly and what job opportunities are available to licensed technicians.

NAME _____

ADDRESS _____

CITY _____ STATE _____

NEW TUBES & TRANSISTORS (Continued)
with a total weight of less than a penny,
are used in hearing aids.

Guaranteed-life tubes

Amperex has announced the addition of seven "premium quality" types to their line of tubes. They carry a minimum guaranteed life of 10,000 hours, and are designed for use in equipment where unsupervised, uninterrupted operation is required.

The 6085 medium-mu dual triode, 6084 sharp-cutoff pentode amplifier and 6277 power pentode are particularly suited to withstand severe shock and vibration. The E83F wide-band pentode amplifier and E81L power pentode are internally screened and especially designed for use in telephone equipment and instruments. The 5920 and E92CC double triodes are designed for use in flip-flop circuits in computers, business machines, etc. In the field these tubes showed only small variations in characteristics during a series of 10,000-hour life tests.

5915-A, 6211

G-E has announced two new additions to its line of tubes designed especially for computer applications.

The 5915-A is a dual-control heptode, for use as a coincidence-gating tube. Each of the two independent control grids has a sharp-cutoff characteristic. Electrically and physically, the 5915-A may be used as a replacement for the older 5915 tube.

The 6211 is a nine-pin medium-mu twin triode for binary-counter or amplifier applications. Its electrical characteristics are equivalent to those of the 5844, except that each section of the new type has a separate cathode connection.

Electrical characteristics of the 5915-A are: maximum cathode current, 20 ma; maximum plate dissipation, 1 watt; typical plate current in gating service ("on" condition), 5.8 ma. Electrical characteristics of the 6211 are: maximum cathode current per section, 14 ma; maximum plate dissipation (per plate), 1 watt; grid voltage required to cut off plate current, -10. **END**

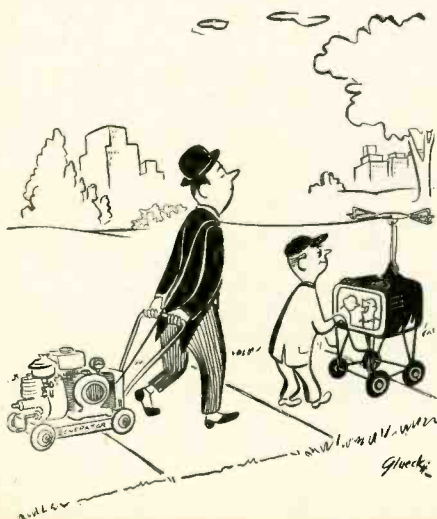

MARCH, 1955

**March
21-24**

The
Radio - Electronic
SPECTACULAR
of 1955!

**See!
Hear!**

**IRE
National Convention**



At both the Waldorf-Astoria (convention headquarters) and Kingsbridge Armory, you'll attend what actually amounts to 22 conventions fused into one. Hundreds of scientific and engineering papers will be presented during the many technical sessions, a large number of which are organized by IRE professional groups. You'll meet with the industry's leaders—enjoy the finest meeting and recreational facilities in New York.

and

**Radio
Engineering Show**



At the Kingsbridge Armory and Kingsbridge Palace, you'll walk through a vast panorama of over 700 exhibits, displaying the latest and the newest in radio-electronics. You'll talk shop with the industry's top manufacturers—enjoy the conveniences provided for you in the world's finest exhibition halls, easily reached by subway and special bus service.

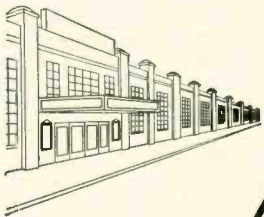

Admission by registration only. \$1.00 for IRE members, \$3.00 for non-members. Social events priced extra.

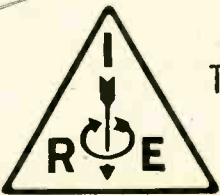

The Institute of Radio Engineers
1 East 79 Street, New York



Newcomb 20-watt Classic 1500 amplifier.

WHAT'S NEW

In Test Equipment, Television and High Fidelity

Reviewing some recent TV and audio developments

By SOL HELLER

A FLYBACK tester needing no reference flyback transformer for comparison purposes is being manufactured by TeleTest Instrument Corp., Flushing, N. Y. With some flyback checkers it is necessary to obtain a flyback transformer similar to the one under suspicion, make checks on both units and compare results. TeleTest's unit makes these time-consuming preliminaries unnecessary. Deflection yokes and linearity coils, as

well as flyback transformers, are tested by this instrument. The operation of this instrument is based on the following theory.

A resonant circuit (Fig. 1) tends to oscillate when it is shock-excited by a voltage pulse. If the circuit contained no resistance, the tank would oscillate forever, even though the exciting pulse was of only momentary duration. The coil and capacitor would deliver energy to each other in constant succession and the absence of energy losses would keep the sine-wave voltage appearing across the tank—at a constant amplitude.

Since a coil must have some resistance, a circuit resembling actual conditions is shown in Fig. 2. The resistance of the coil, represented by R , will now dissipate energy rapidly. Every half-cycle of oscillation will be smaller than the one before it.

The rate at which the oscillatory voltage decays to zero depends on the Q of the coil. The Q , in turn, depends on the ratio of the coil's inductive reactance to the coil's resistance. The larger the resistance, the lower the Q , the faster the oscillatory decay.

A circuit similar to the flyback network is shown in Fig. 3. The secondary reflects an impedance (R_x) back into the tuned primary. This impedance acts like a resistance in series with the primary, and decreases the Q . The smaller the value of R_x , the greater the reflected impedance. This lowers the Q of the primary and lowers the voltage output across it. When the primary is shock-excited and R_x is relatively low, the voltage appearing across the primary will be highly damped—it will decay rapidly to zero,

and there will be a large difference in the amplitude of successive half-cycles.

Let's now consider a simplified schematic of the FT100 Flyback Tester (Fig. 4). There are two basic sections—an exciter and an indicating unit. The exciter consists of a single-turn coil or loop coupled to the windings of the flyback transformer under test. In operation, C , which has been charged, is switched across the single-turn coil into which it discharges. The discharge current through this coil induces a voltage into *all* the windings on the flyback, shock-exciting them into oscillation.

When momentary switch $S1$ is released, C again charges. After a short wait, $S1$ may be depressed again and the flyback excited once more—as often as necessary. The pulse applied by the exciter to the flyback induces voltages across its various windings comparable to those developed during normal receiver operation. A partial or complete short circuit in the flyback, only when it is in operation, will show up during this interval.

The indicator is a peak-reading voltmeter. It measures the amplitude of the damped waves. At one setting of

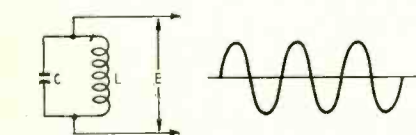

Fig. 1—Basic L-C circuit and waveform.

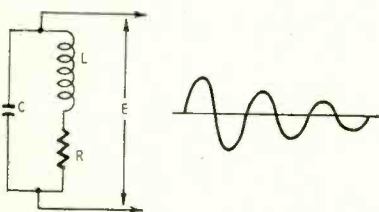

Fig. 2—Tank circuit having resistance.

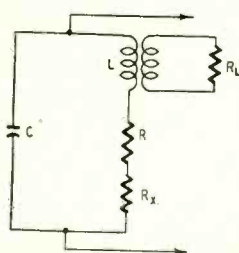

Fig. 3—A transformer-coupled circuit.

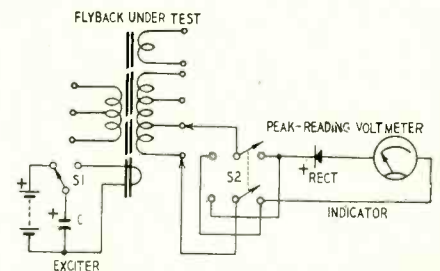

Fig. 4—Basic diagram of flyback tester.

NEW DESIGN

reduces the degenerative feedback from the voice coil. On TV setting the bypassing is eliminated.

The feedback is varied because more audio signal is available for the TV sound system than for the phono amplifier. If the same amount of degeneration were used at both settings, the phono output would be very low.

In the 19R series receivers, width is varied by adjusting a brass sleeve on the neck of the picture tube (Fig. 8). The sleeve is slid up and back and rotated until proper width and linearity are obtained. This control operates by varying the strength of the magnetic field around the deflection coils.

Metal-wrapped resistors will be found in several circuits of the Zenith '55 receivers. The metal wrapping consists of a tight 1/2-inch band around a standard 2-watt resistor. The band is fastened to the chassis by means of a self-tapping screw. By carrying heat away from the resistor, the band enables it to carry 4 watts safely.

When replacing resistors of this type, mount the replacement the same way as the original unit. If the metal mounting clamp is not used, a resistor of twice the wattage rating must be installed.

Minimizing push-pull distortion

The unbalance introduced by push-pull output tubes due to their non-uniform aging is a major cause of distortion in audio amplifiers. However, tube aging is not the only way such mismatching may occur. When a weak or otherwise defective push-pull tube

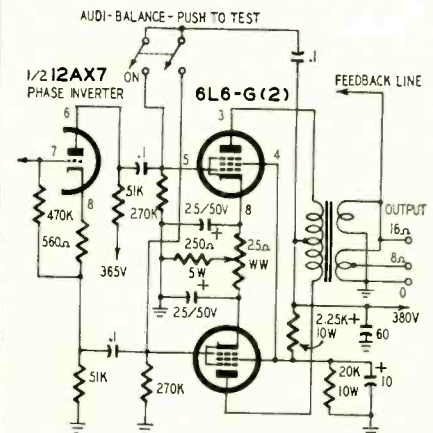
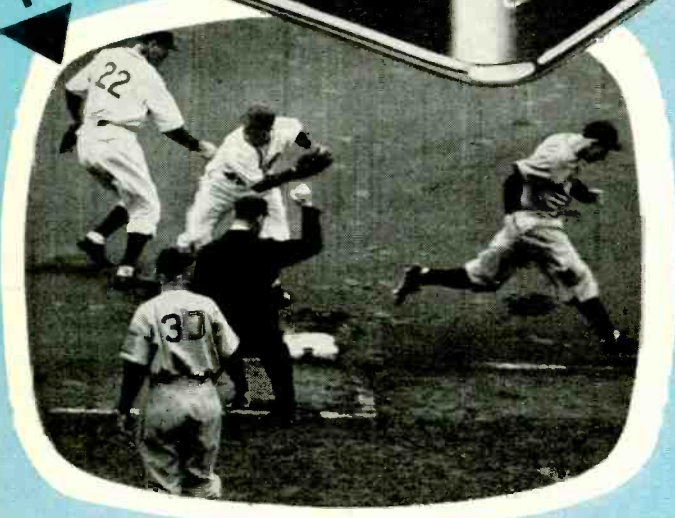
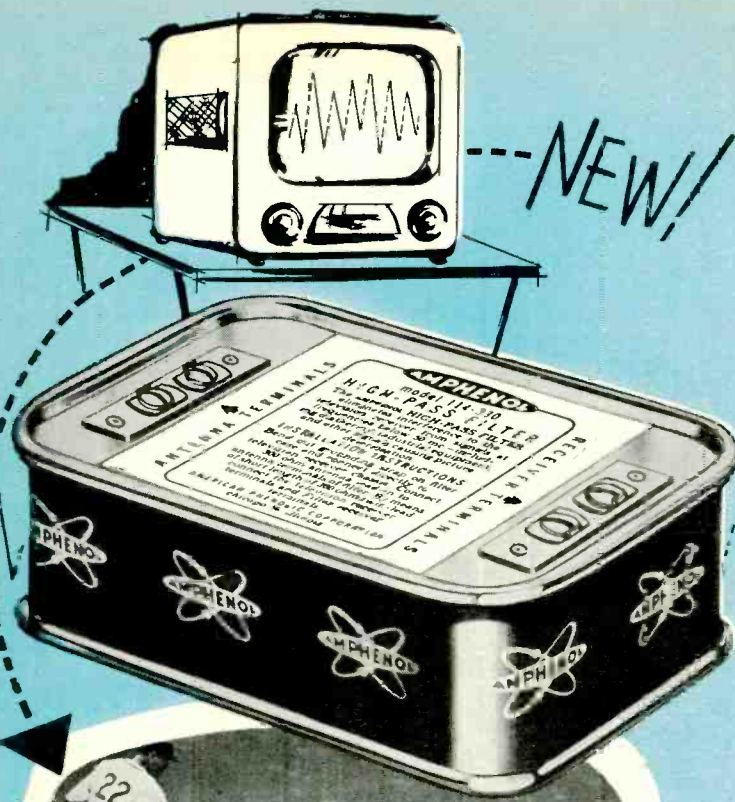

Fig. 9—Circuit for testing output tube matching in the Newcomb Classic 1500. is replaced, an unbalance is likely to be created since a new tube is being put into double harness with an old one. Even when both tubes are replaced, it is not always simple to obtain two tubes whose emission under load is even approximately equal. (Matched tubes may sometimes be available at an increased cost.)

Some hi-fi aficionados to whom money or time is no object connect one or two meters into the push-pull circuit, mounting them on the amplifier cabinet. When a switch is thrown, the matching can be checked quickly.



HIGH PASS FILTER eliminates TV interference

The model 114-330 High Pass Filter is an inexpensive accessory providing clearer, sharper pictures for any tv set.

It effectively rejects all signals at frequencies below 50 mc, including communication-type, diathermy and heat-transmitting interference, and industrial or ignition interference • Circuits are double-shielded in the 114-330 to prevent pick-ups of signals by the Filter itself. Mounting/grounding strap bleeds off rf interference direct to chassis ground.

Easily attached to chassis of any tv set.

Lists at only \$5.45!

AMERICAN PHENOLIC CORPORATION

chicago 50, illinois

In Canada: AMPHENOL CANADA LIMITED, Toronto

AMPHENOL

NEW DESIGN

A much simpler method of testing output tube matching has been built into a commercial hi-fi amplifier and deserves honorable mention. The circuit is used in the 20-watt Ultra Fidelity Classic 1500 amplifier (Fig. 9) manufactured by the Newcomb Audio Products Co. The method has been described to constructors in the past, but this is the first time I have seen it in a commercial amplifier. Possibly some readers remember otherwise?

A double-pole single-throw switch, known as the AUDI-BALANCE, in conjunction with a potentiometer used as a distortion control make up the necessary components. The switch is connected between the two grids of the push-pull tubes. The potentiometer is in the cathode circuit of one of these tubes.

When the hi-fi system owner—or service technician—wishes to test the output tube matching, he simply pushes the AUDI-BALANCE switch to its ON setting, shorting the grids of the two output tubes to each other. This eliminates the audio signal input to the speaker and permits only residual power-supply hum to be heard. When mismatching is present, this hum will be much louder than usual. If a signal is applied to the two grids, the balance point is the one at which the output reaches a minimum.

To test for, as well as correct, any mismatch, rotate the distortion control to the point where minimum hum is heard in the speaker. The adjustment sets the cathode bias of one tube to the point where that tube's plate current is equal or nearly equal to the plate current of the other tube. Since minimum hum as well as minimum distortion occur at this setting, the tubes are easily balanced. END

Radio Thirty-Five Years Ago

In Gernsback Publications

HUGO GERNSBACK Founder

Modern Electrics	1908
Wireless Association of America	1908
Electrical Experimenter	1913
Radio News	1919
Science & Invention	1920
Television	1927
Radio-Craft	1929
Short-Wave Craft	1930
Television News	1931

Some of the larger libraries still have copies of ELECTRICAL EXPERIMENTER on file for interested readers.

In March, 1921 Science and Invention (formerly Electrical Experimenter)

Radiophone on Motor Car
Radio Aids to Navigation
New Danish Radio Invention
The Edison Effect and the Audion, by Donald McNicol
Concerts Via Radiophone [birth of the disk jockey]
Building a 150 to 20,000 Meter Radio Receiver, by Bertram C. Rogers

MARCH, 1955

STAY AHEAD IN TV!

these SAMS books show you how

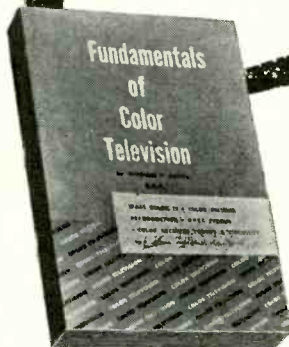

"Fundamentals of Color Television"

Written by William F. Boyce. A complete explanation of Color TV written so you can understand it. Tells you all you want to know in 5 great chapters: 1. What You Need to Know About Color TV (explains principles and terms); 2. Color Picture Reproduction (describes picture tube types and function); 3. Principles of NTSC Color System (describes color signal, methods of transmission and reception); 4. Color Receivers (theory of operation); 5. Circuit Analysis of Color Receivers (full description of circuits and special components). Complete, authoritative, fully illustrated. 224 pages. 5½ x 8½". Order BA-1, only. \$2.00

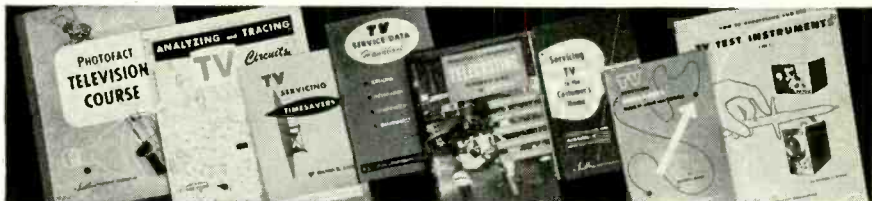

"Photofact Television Course"

A complete, simple explanation of modern Television principles, operation and practice. Covers Cathode Beam Formation and Control; Beam Deflection Systems; Beam Modulation and Synchronization. Includes analysis of CR tube construction, camera tubes, voltage supplies, saw-tooth generators, sync circuits, control functions, receiving antenna circuits, RF input tuning systems, IF systems, AGC, etc. Fully illustrated. 208 pages, 8½ x 11".

Order TV-1, only. \$3.00

"Analyzing & Tracing TV Circuits"

Milton S. Kiver's new approach to television servicing. Shows you how to best utilize the data included on the schematic, so that you can speed up repairs and earn more. Shows how to trace specific sections of a TV receiver. The importance of properly analyzing voltages on the tube elements is stressed. Helps you solve the toughest TV service problems in the shortest time. Fully illustrated. 168 pages, 8½ x 11".

Order JA-1, only. \$3.00

"TV Servicing Time-Savers"

A new, extremely helpful book by Milton S. Kiver. Prepared in 5 sections presenting 51 "Time-saver Tips" showing causes and cures of common TV troubles. Shows how to improve reception; includes practical time-saving tips; covers alignment problems, etc. Any one of the 51 "tips" may save you more than the low cost of this book. 124 pages; illustrated, 5½ x 8½".

Order JC-1, only. \$1.50

"TV Service Data Handbook"

A compilation by Milton S. Kiver of the most frequently needed charts, tables and formulas required in TV servicing and installation. Includes charts and tables on fuses, color codes, attenuator pads. A section on trouble shooting lists nearly all TV trouble symptoms along with suggestions for locating the defective component. Includes valuable mathematical constants and electrical formulas. 112 pages, 5½ x 8½".

Order JB-1, only. \$1.50

"Teletesting Operations"

Here, in one complete, easy-to-understand volume, Harold E. Ennes tells the whole fascinating story of the equipment and techniques used in Teletesting. Covers such subjects as: The TV Camera; The TV Control Room; Fundamentals of Studio Lighting; Network Program Relay Systems; Maintenance Practices; Technical Production; Field Equipment and Microwave Relays, plus hundreds of other subjects. 600 pages; fully illustrated; 6 x 9".

Order OH-1, only. \$7.95

"Servicing TV in the Customer's Home"

Provides practical, proved help for technicians and outside TV service calls. (New enlarged edition, including advance data on Color TV receivers.) Saves time, work and chassis hauling — shows how to make successful repairs on the spot by using a VTVM and capacitor probe to trace trouble; by "tube-pulling" to diagnose audio and picture trouble; by performance tests through analysis of the picture test pattern; etc. 128 pages; illustrated; 5½ x 8½".

Order TC-1, only. \$1.75

"TV Servicing Short-Cuts"

This helpful book describes a series of actual TV service case histories, each presenting a specific problem about a specific receiver. The symptoms of the trouble are outlined and then followed by a step-by-step explanation of how to solve it. Finally there is a discussion of how this particular trouble can be tracked down and solved in any TV set. 98 pages; 5½ x 8½".

Order TK-1, only. \$1.50

"TV Test Instruments"

Provides basic explanations of how each test instrument operates; describes functions of each control and shows their proper adjustment. Covers: Vacuum Tube Voltmeters, AM Signal Generators, Sweep Signal Generators, Oscilloscopes, Video Signal Generators, Field Intensity Meters, Voltage Calibrators. Describes use in actual servicing. 180 pages; illus.; 8½ x 11".

Order TN-1, only. \$3.00

Look for the SAMS "BOOK TREE" at your Parts Distributor



Make it a habit to browse at the "Book Tree." It's loaded with the time-saving, profit-building books you want and need to keep ahead in every phase of Radio and TV servicing. Get these and other Howard W. Sams Publications at your Electronic Parts Distributor.

HOWARD W. SAMS & CO., INC.

Order from your Parts Jobber today, or write to Howard W. Sams & Co., Inc., 2205 East 46th St., Indianapolis 5, Ind.

My (check) (money order) for \$ _____ enclosed.

Send following books: _____

Name _____

Address _____

City _____ Zone _____ State _____
(outside U. S. A. priced slightly higher)



new Devices

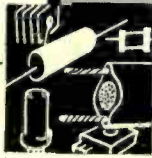

TV ANTENNA, Brach *Colorcon 5403* conical type for black-and-white and color reception. Center elements prevent spikes on color TV subcarriers. Adjustable reflector acts as corrective peaking filter on many TV channels. Brach Manufacturing Co., 200 Central Ave., Newark, N. J.

BROAD-BAND ANTENNA, JFD *Fireball*, for deep fringe v.h.f.-u.h.f. areas. Available in single-bay model *FB500* and stacked model *FB500S*. Elements are snapped into brackets without screws or bolts. Has high directivity, 11.5 db gain and high front-to-back and front-to-side rejection of unwanted signals. Uses reverse-phase multiplex di-pole system which gives dual-band operation of all elements for channels 2 through 13.

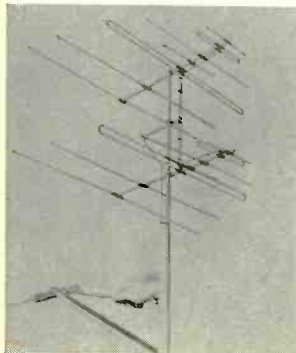

Wide-spaced booster and parasitic elements give maximum signal pickup on all channels. —JFD Mfg. Co., Inc., 6101 16th Ave., Brooklyn 4, N. Y.

INDOOR ANTENNA, Walsco *Star*, designed for metropolitan and suburban areas. Has built-in electronic rotating and tuning control. Turning control changes directivity by automatically selecting correct combination of elements for each channel.



Three different size receiving elements are tuned to pick up v.h.f. or u.h.f. stations in opposite directions and on widely separated channels.

Similar in appearance is the *Starlet* model, without the electronic tuning.—Walsco Electronics Corp., 3602 Crenshaw Blvd., Los Angeles 16, Calif.

REAR SPEAKER Baffle KIT, General Cement Nos. *9180* bronze and *9181* gray. Has perforated metal grille and 3-position switch, permitting a choice of either speaker or both simultaneously. — General Cement Mfg. Co., 919 Taylor Ave., Rockford, Ill.

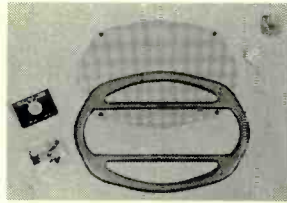

MINIATURE LOUDSPEAKER, Jensen *P275-Y*. Designed for use in very small radios—such as the TR-1 transistorized pocket radio recently intro-

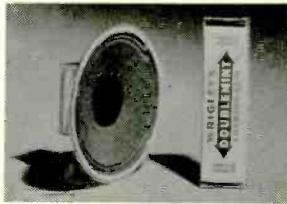

duced by Regency in which it made its first appearance—or in transreceivers, paging units and other equipment of similar size and weight. Is 2 1/4 inches in diameter and 1-3/32 inches in depth; weighs less than 2 1/4 ounces. Nominal voice coil impedance 16 ohms at 1,000 cycles. —Jensen Mfg. Co., 6601 S. Laramie, Chicago, Ill.

LOUDSPEAKER, Quam-Nichols *Little Four 4A06*, 4-inch permanent magnet speaker. Its shallow construction facilitates in-

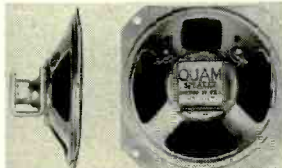

stallation in any radio or TV set. Has rim mounting holes. Alnico-V magnet with U-shaped pot. Maximum watts input is 2.5; voice coil impedance 3.2 ohms.—Quam-Nichols Co., 236 E. Marquette Rd., Chicago 37, Ill.

SUBMINIATURE RECEIVER, Telasco *Telecommander 951B*, for radio control on the Citizens band (27.255 mc). Light weight, has high sensitivity, shock stability and reliability. The 3Q4 circuit and the self-contained P-100 subminiature relay are housed in a Bakelite

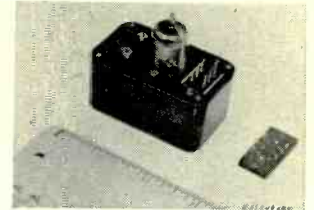

case. Built-in 6-pin plug accommodates all external connections to antenna, batteries and escapement.

Frequency 27.255 mc; low voltage, 1.5; high voltage 67.5. Weight 3 ounces, dimensions 1 1/2 x 2 1/2 x 1 1/4 inches.—American Telasco Ltd., Huntington, N. Y.

CATHODE REJUVENATOR TESTER, B & K model *350*, enables TV service technician to check and repair weak and inoperative TV picture tubes without removal from TV set. Unit tests for emission, inter-

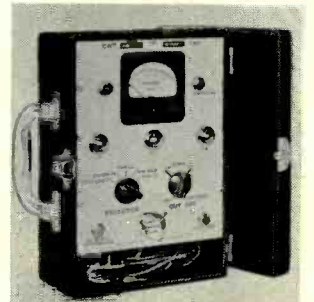

Regency

Day by day more and more people are making High Fidelity a part of their everyday life. These handsome River Edge cabinets have been designed to make it effortless to assimilate High Fidelity equipment into any home decor.

RIVER EDGE CABINETS DESIGNED EXPRESSLY FOR REGENCY HIGH FIDELITY COMPONENTS



MODEL TM—Table model cabinet for HF-80 or HF-150 amplifiers or any Regency tuner.

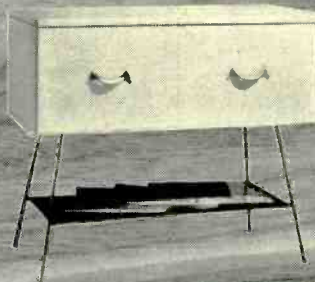

MODEL CTC—Console cabinet for combination of changer, AF-220 tuner and HF-80 or HF-150 amplifiers.

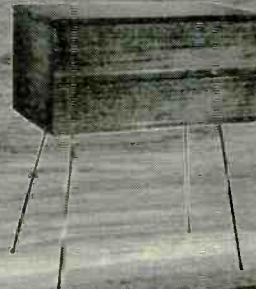

MODEL TMC—Table model or a chairside console for changer and HF-80 or HF-150 amplifiers or AF-220 tuner.

River Edge cabinets are priced from \$17.50 to \$85.55. Pre-cut, pre-drilled panels are available to specifications at nominal charge.

REGENCY DIVISION, I.D.E.A., Inc., 7900 Pendleton Pike, Indianapolis 26, Indiana

NEW DEVICES

element shorts, leakage, open circuits, grid cutoff, gas content, and probable useful life; restores emission and brightness, removes shorts, repairs open circuits. Weighs 5 pounds and is 11 x 7½ x 5 inches.—**B & K Manufacturing Co.**, 3731 N. Southport Ave., Chicago 13, Ill.

CAPACITANCE SUBSTITUTION BOX, Eico model 1120K (kit) and model 1120 (factory wired) enables rapid substitution of a wide range of RETMA capacitance values. Helps find the value of badly damaged or otherwise illegible capacitors by substitution.

Range: .001 to 0.22 µf; minimum accuracy ± 10%. Most capacitors rated 600 volts, lowest rating 400. Eighteen-position switch selects any value rapidly; 5-way jack-top binding posts connect practically any type of test lead; equipped with silver-mica and molded plastic tubular capacitors.—**Electronic Instrument Co., Inc.**, 84 Withers St., Brooklyn 11, N. Y.

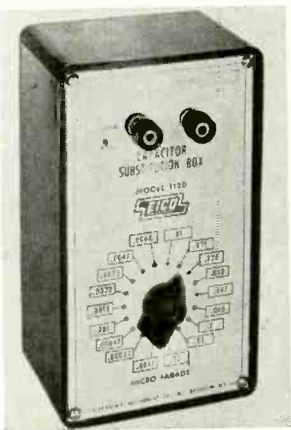

CABLE, Belden No. 8275 Cellulose. Inner core new type polyethylene expanded 100% to density of 0.47, forming millions of tiny unconnected cells, each filled with inert gas. Approximately 50% of internal area inert gas, making it waterproof. Dielectric constant 1.5. Does not kink or crush in installation. Nominal impedance 300 ohms, nominal velocity of propagation 80%, nominal capacitance per foot 4.6 µµf.—**Belden Manufacturing Co.**, 4647 W. Van Buren St., Chicago 44, Ill.

TV SWEEP GENERATOR KIT, Heath TS-4, provides significant improvements over previous Heathkit models in linearity, better oscillator and automatic gain circuitry, higher r.f. output, and new controllable inductor for center-sweep operation. All-electronic sweep. Deviation controllable from 0 to 40 mc, depending on base frequency.

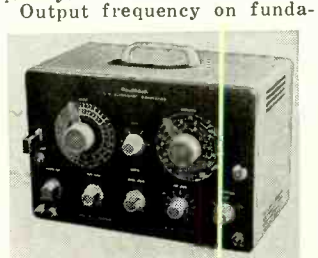

mentals from 3.6 to 220 mc in

(Continued)

four bands. Output impedance 50 ohms, terminated at both ends of cable. Markers available from 3 sources. Crystal oscillator provides 4.5 mc and multiples thereof. Variable oscillator covers 19 mc to 60 mc on fundamentals, up to 180 mc on harmonics. Provision for use of external marker. Effective 2-way blanking eliminates return trace; phasing control is available also. Calibrated for all v.h.f. and u.h.f. channels, this model covers all frequencies encountered in monochrome TV, color TV, and FM.—**Heath Co.**, Benton Harbor, 20, Mich.

RACK-MOUNTED OSCILLOSCOPE, Hickok 670R, has d.c. amplifiers for good square-wave response, even down to d.c.

Sensitivity 18 mv per inch. Demodulator circuit for viewing modulation on r.f. signal.



Recurrent linear sweep: 3 to 50,000 cycles. Reversing switches for both horizontal and vertical deflection. Fixed sweep frequency for horizontal and vertical waveforms to TV receivers. Both negative and positive synchronizing. Line phasing control approximately 180°. Wide-band vertical amplifier useful beyond 2 mc. Direct-coupled, balanced push-pull amplifiers for both vertical and horizontal deflection. Provision for Z-axis modulation. Three-step attenuator in horizontal amplifier, plus vernier attenuator control.—**The Hickok Electrical Instrument Co.**, 10531 Dupont Ave., Cleveland 8, Ohio.

CAPACITOR CHECKER, Instruments for Service Cap-Check, checks capacitors while in circuit.

An a.c. ohmmeter method is used, showing total impedance of circuit containing capacitor



being tested. Provision is made for supplying external a.c. voltage of higher frequency than the internal 60-cycle normally used, making instrument useful for smaller capacitors. Charge-discharge tests are also provided for, and instrument has built-in voltmeter and ohmmeter—all using one master function switch. **Instruments for Service, Inc.**, 96 S. Grand Ave., Baldwin, L. I., N. Y.

professional tube testers by EMC

featuring...

**Lowest Prices
Precision Construction
Widest Instrument Choice
Advance-designs**



EMC MODEL 204

Tube — Battery — Ohm Capacity Tester

Easy, direct readings for all tubes from .75 to 117 filament volts • Flexible four-position lever-type switches positively protect against obsolescence • Large, 4½" three-color, "reject-good" scale meter • Checks batteries under rated load • Uses emission test • Checks continuity, shorts, opens and leakages • Line voltage control for variations from 105 to 135V • Checks resistance to 4 meg. ohms, capacity to 1 mfd., leakage to 1 meg. ohm • Easy-to-use roll chart • Handsome, hand-rubbed oak carrying case with removable cover.

MODEL 204P (ill.) \$55.90
MODEL 204C (counter case) \$54.90
MODEL 207, 204 Tester with extra large 7½" meter for counter use. \$65.90



EMC MODEL 205 Emission Tube Tester

Standard emission method accurately checks all tubes (with filament volts between .75 to 117V.) • Individual sockets • Compensates for line variations between 105-135V. • Flexible four-position lever-type switches positively protect against obsolescence • Checks continuity, shorts, opens and leakages • Large, clear, 4½" three-color, "reject-good" scale meter • Handsome, hand-rubbed oak carrying case with removable cover • Easy-to-use roll chart

MODEL 205P (ill.) \$47.50
MODEL 205C (counter-case) \$46.50



EMC MODEL 206 Mutual Conductance Tube Tester

4½" three-color meter with calibrated micromho and "reject-good" scale checks mutual conductance and gas content • Plate current sufficient to check emission and mutual conductance • Flexible four-position lever-type switches positively protect against obsolescence • Easy, direct, readings for all tube types • Individual sockets • Instrument fuse replaced from panel front • Easy-to-use roll chart • Handsome, hand-rubbed oak carrying case with removable cover

MODEL 206P (ill.) \$83.50
MODEL 206C (counter case) \$79.50



New EMC MODEL 208 Portable Tube Tester

Requires no supplementary equipment • Completely tests all tube types for quality, shorts, leakages, filament continuity and opens between any two tube elements • Adjustable line voltage visually assures accurate quality testing • Space saving, portable case, 5½" x 6¾" x 2¾", fits serviceman's "caddy case" • Individual sockets • Matches Hi-Fi tubes • Comes with detailed instruction book and tube listings.

MODEL 208 (ill.) \$24.90
MODEL 208P (Oak carrying case) \$27.90
MODEL CRA (pic-ture tube adapter for 204, 205, 208) \$4.50 (CTA for 206) \$6.50

Free... write Dept RE-3 for your copy of complete catalog TODAY!

EMC

ELECTRONIC MEASUREMENTS CORP.
280 LAFAYETTE STREET NEW YORK 12, N. Y.
EXPORT DEPT.— 136 LIBERTY ST. N. Y.

MAIL TODAY. LEARN RADIO AT HOME WITH THE PROGRESSIVE RADIO "EDU-KIT".

BUILD 15 RADIOS

ONLY

AT HOME

\$19.95
Complete

With the New Improved 1955

Progressive Radio "EDU-KIT"

NOW INCLUDES
HIGH FIDELITY,
SIGNAL TRACER, and
CODE OSCILLATOR

- ATTRACTIVELY GIFT PACKED
- FREE SOLDERING IRON
- NO ADDITIONAL PARTS NEEDED
- EXCELLENT BACKGROUND FOR TV
- 30 DAY MONEY-BACK GUARANTEE
- SCHOOL INQUIRIES INVITED
- ABSOLUTELY NO KNOWLEDGE OF RADIO NECESSARY



WHAT THE PROGRESSIVE RADIO "EDU-KIT" OFFERS YOU

Our Kit is designed to provide a fundamental background in radio, with the basic facts of Radio Theory and Construction Practice expressed simply and clearly. You will gain a knowledge of basic Radio Principles involved in Radio Reception, Radio Transmission and Radio Amplification. You will learn how to identify Radio Symbols and Diagrams; how to build radios, using regular radio circuit schematics; how to mount various radio parts; how to wire and solder in a professional manner. You will learn how to service and trouble-shoot radios. You will learn code. You will receive training for F.C.C. Novice License. You will learn High Fidelity. In brief, you will receive a practical basic education in Radio, worth many times the small price you pay.

THE KIT FOR EVERYONE

The Progressive Radio "Edu-Kit" was specifically prepared for any person who has a desire to learn Radio. The Kit has been used successfully by young and old in all parts of the world. It is not necessary that you have even the slightest background in science or radio.

The Progressive Radio "Edu-Kit" is used by many Radio Schools and Clubs in this country and abroad. It is used by Armed Forces Personnel and Veterans throughout the world.

The Progressive Radio "Edu-Kit" requires no instructor. All instructions are included. All parts are individually boxed, and identified by name, illustration and diagram. Every step involved in building these sets is carefully explained.

PROGRESSIVE TEACHING METHOD

The Progressive Radio "Edu-Kit" comes complete with instructions. These instructions are arranged in a clear, simple and progressive manner. The theory of Radio Transmission, Radio Reception, Audio Amplification and servicing by Signal Tracing is clearly explained. Every part is identified by illustration and diagram. You will learn the function and theory of every part used.

The Progressive Radio "Edu-Kit" is designed to be "Learn by Doing". Therefore you will build radios, perform jobs, and conduct experiments to illustrate the principles which you learn. These radios are designed in a modern manner, according to the best principles of present-day educational practice. You begin by building a simple radio. The next set that you build is slightly more advanced. Gradually, in a progressive manner, you will find yourself constructing still more advanced multi-tube radio sets, and doing work like a professional Radio Technician. Altogether you will build fifteen radio circuits, including Receivers, Transmitter, Code Oscillator and Signal Tracer. These sets operate on 105-125 V. AC/DC. An Adaptor for 210-250 V. AC/DC operation is available.

THE PROGRESSIVE RADIO "EDU-KIT" IS COMPLETE

You will receive every part necessary to build 15 different radio circuits. Our "Edu-Kit" contains tubes, tube sockets, chassis, variable condensers, electrolytic condensers, paper condensers, resistors, line cord, selenium rectifier, tie strips, coils, hardware, tubing, etc. No solder or hook-up wire included.

Every part that you need is included. These parts are individually packaged, so that you can easily identify every item. A soldering iron is included, as well as an Electrical and Radio Tester. Complete, easy-to-follow instructions are provided. All parts are guaranteed, brand new, carefully selected and matched.

In addition, the "Edu-Kit" now contains lessons for servicing with the Progressive Signal Tracer, F.C.C. instructions, quizzes, high fidelity instructions.

TROUBLE-SHOOTING LESSONS

Trouble-shooting and servicing are included. You will be taught to recognize and repair troubles. You will build and learn to operate a professional Signal Tracer. You receive an Electrical and Radio Tester, and learn to use it for radio repairs. While you are learning in this practical way, you will be able to do many a repair job for your neighbors and friends, and charge fees which will far exceed the cost of the "Edu-Kit". Here is your opportunity to learn radio quickly and easily, and have others pay for it.

FREE EXTRAS

- ELECTRICAL & RADIO TESTER
- ELECTRIC SOLDERING IRON
- TV BOOK
- QUIZZES

Progressive "Edu-Kits" Inc. 497 Union Ave., Brooklyn 11, N.Y.

MAIL TODAY—Order shipped same day received.

30-Day Money-Back Guarantee. Include ALL FREE EXTRAS.

- Send "Edu-Kit" Postpaid. I enclose full payment of \$19.95 (U.S.A. only).
- Send "Edu-Kit" Postpaid. I enclose full payment of \$20.95 (Outside U.S.A.).
- 210-250 V. Adapter for "Edu-Kit"—\$2.50.
- Send "Edu-Kit" C.O.D. I will pay \$19.95 plus postage (U.S.A. only).
- I wish additional information describing "Edu-Kit". No Obligation.
- Send me FREE Radio-TV Servicing Literature. No Obligation.

Name.....

Address.....

PROGRESSIVE "EDU-KITS" INC.

497 UNION AVE., RM. 102 G, PROGRESSIVE BLDG., BROOKLYN 11, N.Y.
On Shipment to a New York City Address, add 60c sales tax

NEW DEVICES

CAPACITOR-RESISTOR ANALYZER, Pyramid model *CRA-1*, has built-in quick-check unit that permits testing suspected capacitors, in circuit without disconnecting capacitor or disturbing the circuit.

Tests for shorts, opens and intermittents, leakage current



and insulation resistance, as well as measures capacitance, resistance and power factor. Equipped with quick-charge switch to decrease charging time constant when testing high-capacitance paper capacitors. For safety, discharge feature is provided, permitting capacitor to be discharged before being removed from the test.—Pyramid Electric Co., 1445 Hudson Blvd., North Bergen, N. J.

VIDEO SWEEP GENERATOR, Tel-Instrument 1106. Has frequency sweep of 50 kc to 6 mc, with uniform output adjustable from 1 mv to 2 volts peak-to-peak into a 750-ohm load from



source impedance of 75 ohms. Front panel switches control maximum of 10 optional crystal markers, furnished to customer specifications.

Attenuation from 0 to 63 db by a pushbutton attenuator with 20 db, 10 db, and 3 db steps, in addition to a continuously variable 0-10 db attenuator.—Tel-Instrument Co., Carlstadt, N. J.

5 IN 1 TUBE BRIGHTENER, Tele-Matic model *CR-70*, improves reception of all types of cathode-ray tubes through use of its five positions—series, parallel, electrostatic, electromagnetic and isolation.—Tele-Matic Industries, Inc., 16 Howard Ave., Brooklyn, N. Y.



PREAMPLIFIER - EQUALIZER Webster model *97-O* control unit



(Continued)

can be used to control tone and volume of radio, tape recorder, TV set or phonograph, and provide equalization for all types of phono records.

Two equalizer selectors—one for high-frequency rolloff and one for low-frequency turnover provide total of 25 combinations of settings. Has 6-position input selector for tuner, TV set, tape recorder, microphone, magnetic and ceramic cartridges. Variable bass and treble tone controls with boost and cut of 15 db as well as master gain control and loudness control. Filter control with two cutoffs of 5,000 and 7,000 cycles cuts off scratch on old or worn records. Frequency response 20 to 20,000 cycles ± 1 db. Dimensions 4 x 15 x 9 inches.—Webster Electric Co., 1900 Clark St., Racine, Wis.

REJUVA-TESTER, TeleTest, model *FT100*, combines cathode-ray tube testing and rejuvenating. Portable and checks cathode-ray tubes for interelement shorts in both hot and cold conditions. Rejuvenates by removing contamination from cathode surface.—TeleTest Instrument Corp., 31-01 Linden Pl., Flushing, N. Y.



PANEL METER, Triplett model *420-P1*, a 4-inch meter with plastic case and molded base. Case front projects over rim of the instrument giving longer scale length. Mounts on studs inserted through the panel, and is available in two basic types—d.c. permanent-magnet moving coil and a.c. iron vane.—Triplett Electrical Instrument Co., Bluffton, Ohio.

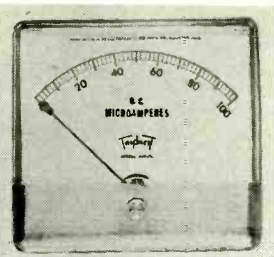

PULSE TRANSFORMERS, Acme, available in a series of metal case design with glass-seal terminal header plates,

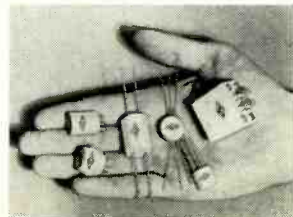

NEW DEVICES

also encapsulated in molded epoxy resin with several types of terminal connections. Developed for triggering and counting circuits, and for d.c. isolation, inversion, pulse shaping and pulse transmission circuits.—Acme Electric Corp., 1375 W. Jefferson Blvd., Los Angeles, Calif.

SERIES HEATER CHECKER, G-E, for series-string tubes in TV sets, a.c.-d.c. radios, and portable radios. Service technician need only insert tube in one of four sockets available. If tube heater is satisfactory, a



small lightbulb in the checker lights immediately, no warm-up time needed. Heater (battery powered) has sockets for picture tubes, octal, 7- and 9-pin miniature tubes.—General Electric, Electronics Park, Syracuse, N. Y.

REPLACEMENT UNITS. Merit models HVO-28, HVO-29, HVO-30, flybacks designed to cover a number of Motorola units, will also cover Crosley, Hallicraft-

ers and Hoffman replacements. HVO-33, 34 and 35 are designed to replace RCA units in 135 models.

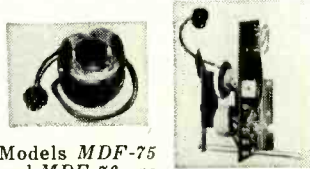

Models MDF-75 and MDF-76 are deflection yokes for Motorola and RCA sets, respectively.

Models TV-125, 126, 127, 128 and 129 are video i.f. transformers covering a large percentage of all replacements in the 40-46-mc band.—Merit Transformer Corp., 4427 N. Clark St., Chicago, Ill.

SIX ELECTRONIC COMPONENTS, RCA, for use with 21-inch color TV tube. Deflecting yoke (230D1) provides full 70° deflection. Converging magnet assembly (231D1) has three pairs of horizontal and vertical coils and three ferrite magnets. Dynamic convergence inductor pack 223R1 contains six coils with two each used in red, blue and green convergence circuits; 224R1 pack is assembly of three coils, one for each of the three—red, green, blue—convergence circuits.

Horizontal output and high-voltage transformer (246T1) for use with the 230D1 deflecting yoke is capable in a suitable regulated voltage-adder circuit of supplying up to 25 kv to the focusing electrode.

Vertical deflection output transformer (247T1) operates with parallel-connected 6BL7-GT twin triode as driver tube to provide ample deflection with good sweep linearity.—Radio Corporation of America, Tube Division, Harrison, N. J.

FLYBACK TRANSFORMERS, Ram models X070 and X116 for replacement in Zenith receivers. These horizontal output transformers have special terminal lead distribution, high-voltage stand-off construction, and anti-corona spray feature.—Ram Electronics Sales Co., Irvington-On-Hudson, N. Y.

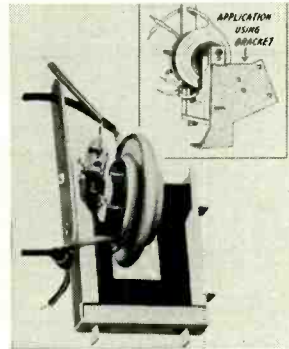

CRYSTAL CARTRIDGES, Shure models W78, W68 and W70, replace 210 of the most commonly used cartridges.

Model W78—dual-volt, dual-weight—replaces 149 and also steel or aluminum case car-

tridges with either high or low output.

Model W68—dual weight—also replaces either steel or aluminum case cartridges without adjusting tone arm balance. Equipped with A62A silent-tracking muted-stylus needle.

Model W70 replaces 20 Webster CX and C series. Equipped with all necessary accessories. Uses pin jacks to eliminate threading of leads through tone arm.—Shure Brothers, Inc., 225 W. Huron St., Chicago 10, Ill.

HI-FI CARTRIDGE, Sonotone 1P, features high compliance and extended frequency response. Available in two versions—one for 33's and 45's and the other for 78's. Requires

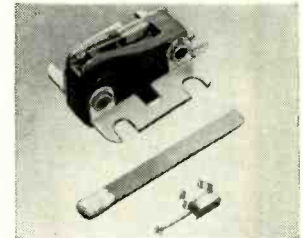

neither equalizer nor preamplifiers, and is unaffected by moisture or temperature. Small—will fit into a large number of tone arms. The replacement needle NIP snaps into place and is available with either diamond or sapphire tip.—Sonotone Corp., Elmsford, N. Y. END All specifications given on these pages are from manufacturer's data.

Just Out

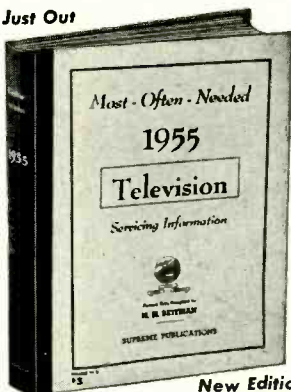

New Edition
Covers all important 1955 Sets

New SUPREME 1955 TV Manual

AMAZING BARGAIN

The new 1955 TV manual is the scoop of the year. Covers all important sets of all makes in one giant volume. Your price for this mammoth manual is only \$3. This super-value defies all competition. Other volumes at only \$3 and \$2 each. Each manual has a whole year of service material. Includes all data needed for quicker TV repairs. Practically tells you how to find each fault and make the repair. More pages, more diagrams, more service data per dollar of cost. Get SUPREME.

COVERS ALL POPULAR SETS

Supreme TV manuals have all needed service material on every popular TV set of every important manufacturer. Here is helpful, practical, factory-prepared data that will really make TV servicing and adjustment easy for you. Benefit and save with these amazing values in service manuals. These giant TV manuals have complete circuits, alignment facts, test patterns, response curves, service hints, all recommended changes, voltage charts, waveforms, and many double-page diagram blueprints. Here is your TV service material to help you do more expert work quicker; and priced at only \$3 and \$2 per manual covering a full year of material. Be ready to repair any model by having in your shop all nine TV volumes listed in coupon below. Or try the new 1955 TV manual to see what an amazing bargain you get for only \$3. Send trial coupon for prompt shipment, or ask your jobber.

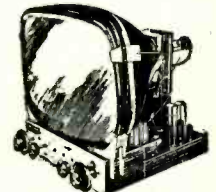

The repair of any television set is really simple with Supreme TV service manuals. Every set is covered in a practical manner that will simplify trouble-shooting and repair. This is the help you need to find toughest faults in a jiffy. Each \$3 TV volume covers a whole year of service material. New Television Servicing Course will aid you in learning TV. Be wise, buy Supreme Manuals only once each year instead of spending dollars every week for not needed data.

TELEVISION SERVICING COURSE

Let this new course help you in TV servicing. Amazing bargain, complete, only \$3, full price for all lessons. Giant in size, mammoth in scope, topics just like a \$200.00 correspondence course. Lessons on picture faults, circuits, adjustments, short-cuts, UHF, alignment facts, hints, antenna problems, trouble-shooting, test equipment, picture analysis. Special, only **\$3**

RADIO DIAGRAMS

Here is your complete source of all needed RADIO diagrams and service data. Covers everything from most recent radios to pre-war old-timers; home radios, auto sets, combinations, changers, and portables. Sensational values. Still sold at pre-Korean prices. Only \$2 for most volumes. Every Radio manual contains large schematics, all needed alignment facts, parts lists, voltage values, trimmers, dial stringing, and helpful service hints. All volumes are large in size, 8½x11 inches, about 192 pages. See coupon at right for a complete list of these low-priced manuals.

NO-RISK TRIAL ORDER COUPON

SUPREME PUBLICATIONS, 1760 Balsam, Highland Park, ILL.

Radio Diagram Manuals

Most-Often-Needed Series (See full description at left.)

- 1954 Radio Manual, \$2.50
- 1953 Diagrams
- 1952 Radio
- 1951 Diagrams
- 1950 Manual
- 1949 Radio
- 1948
- 1947
- 1946
- 1942
- 1941
- 1940
- 1939
- 1926, 1938 Manual, \$2.50
- Master INDEX only 25¢

EACH \$2.50

PRICED AT ONLY \$2 EACH

- Rush today Radio manuals checked at left and TV manuals below. Satisfaction guaranteed.
- New 1955 Television Manual, \$3.
- 1954 TV, \$3.
- 1953 TV Manual, \$3.
- UHF Manual, \$1.50
- 1952 Television Manual, \$3.
- 1951 TV, \$3.
- 1950 Television Manual, \$3.
- 1949 TV, \$3.
- 1948 TV, \$3.
- 1947 TV & FM, only \$2.
- Television Servicing Course, complete, only \$3.

I am enclosing \$..... Send postpaid.

Send C.O.D. I am enclosing \$..... deposit.

Name:

Address:

Newest



Supreme Publications
Sold by All Leading Parts Jobbers

MINIMUM CIRCUIT LOADING...

peak to peak
measurement
with input
impedance of
10 megohms shunted
by a capacitance
of only
15 micromicrofarads!

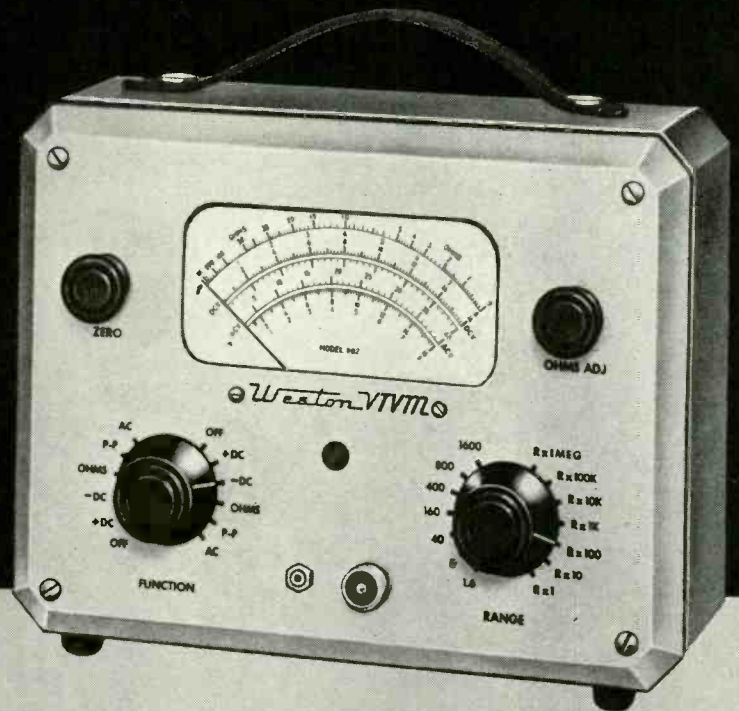

the 980 line

VACUUM TUBE VOLTMETER

Model 982

Other 980 Line Instruments

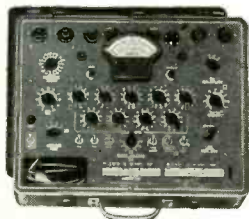

Model 981
Tube checker



Model 980
Analyzer



Model 983
Oscilloscope

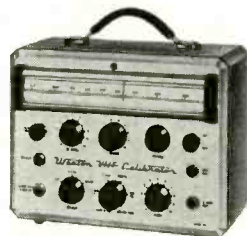

Model 985
Calibrator



Model 984
Sweep Generator

Here is the most convenient, most versatile and portable VTVM available. Battery operated, it is completely isolated from spurious response due to stray a-c fields and circulating ground currents. Accuracy is $\pm 3\%$ d-c, $\pm 5\%$ a-c RMS, sinusoidal wave form. Impedance 10 megohms d-c; 2.8 megs a-c RMS; 1 meg a-c at 130 mmf peak to peak; 10 megs at 15 mmf peak to peak with LC probe.

RANGES:

D-C and Peak to Peak Volts	1.6	8	40	160	400	800	1600
A-C Volts	1.6	8	40	160	400	800	1200
Low-C Peak to Peak Volts	16	80	400	1600			
Ohms	X1Meg	X100K	X10K	X1K	X100	X10	X1 (10 ohms center)

Frequency Response—to 300 KC on peak to peak; to 2 KC on AC rms; to 300 MC with RF probe, (available as accessory).

Battery Life—Battery A, Approx. 90 days, 8 hours, easily replaceable. Battery B, Approx. 1 year, 8 hours per day.

For complete details see your distributor, or write for literature . . . WESTON Electrical Instrument Corp., 614 Frelinghuysen Avenue, Newark 5, New Jersey.

WESTON

980 line test equipment

Technicians' News



ATTACKS BAIT ADS

In a drive against unscrupulous operators in the Buffalo area, the Radio Television Service Association of Western New York has launched an advertising campaign directed at set owners and inviting them to report all instances of service abuses to the association.

The campaign points out that advertisers offering service or merchandise at unreasonably low prices cover their losses by adding charges to the advertised minimum. In such cases the total bill is often much larger than what a reputable service company would charge. The public is urged to read a Better Business Bureau booklet on the subject.

RTSA reports in its ads that several hundred complaints on TV service were referred to it in 1954, the vast majority being handled to the complete satisfac-

tion of the customer. Those that were not so concluded were against non-members of the association, since RTSA as a group is responsible for and guarantees the service work of its members.

BARLOWE ELECTED

The Radio Television Guild of Long Island chose Murray Barlowe, president; Jim Lyons, vice president; Chris Stratigos, corresponding secretary; Bob Henderson, recording secretary; Jim Thornton, treasurer, and George Volkens, Sergeant-at-Arms, for 1955. Trustees for Nassau, Queens and Suffolk Counties were also elected.

The guild is very much interested in the subject of licensing. The December, 1954, issue of *The Guild News* printed a detailed story of the New York City license hearing, attended by a number of members, and also printed in full the

text of the license law proposed for N. Y. C. It was announced that Max Liebowitz, president of NETSDA, would discuss the subject at a coming meeting.

FRSAP ELECTS

The Federation of Radio Service Men's Associations of Pennsylvania elected Bert Bregenzer (RTSA, Pittsburgh) as chairman for the 1955 term. Charles Knoell (TSA, Philadelphia) was elected vice president; Leon J. Helk (LRTA, Carbondale), corresponding secretary; William Lansberry (BCARTSE, Hollidaysburg), recording secretary, and L. B. Smith (MRSA, Hershey), treasurer.

RTTG NEWS

A new service association newspaper, the *Radio Television Technicians Guild* (of New England) *News*, has appeared. Volume I, No. I is dated December, 1954. The larger part of the editorial space is devoted to an introductory Guild Message, but there is enough news scattered throughout the issue to indicate that active guild chapters exist in New Bedford and Fall River, Mass., as well as Boston.

The new paper is printed—on excellent paper—and contains six pages. The center page carries a short technical item on color TV by the veteran instructor A. C. W. Saunders and is removable
(Continued on page 126)

**COYNE offers
LOW COST**

**TELEVISION
RADIO-ELECTRONICS**

Training in
Spare Time **AT HOME**



The future is **YOURS** in TV-RADIO!

A fabulous field—good pay—fascinating work—a prosperous future! Good jobs galore, or independence in your own business!

Coyne brings you the first *truly lower cost*, MODERN—QUALITY Television Home Training; training designed to meet Coyne standards. Not an old Radio Course with Television "tacked on". Here is MODERN TELEVISION TRAINING including working knowledge of Radio. Includes **UHF AND COLOR TV**. No Radio background or previous experience needed. Personal guidance by Coyne Staff. **Practical Job Guides** to show you how to do actual servicing jobs—**make money early in course**.

With Coyne Television Home Training you pay only for your training, **No Costly "Put together kits"**.

**COYNE
ELECTRICAL SCHOOL**

A TECHNICAL TRADE INSTITUTE OPERATED
NOT FOR PROFIT

500 S. Paulina Street, Chicago 12, Dept. 35-TR4

B. W. COOKE,
President



Coyne—the Institution behind this training... the largest, oldest, best equipped residential school of its kind. Established 1899. Send coupon for details.

MAIL COUPON FOR FREE DETAILS

including information about easy Payment Plan.
No obligation, no salesman will call.



COYNE ELECTRICAL SCHOOL
Television Home Training Div.
500 S. Paulina St., Chicago 12, Ill.,
Dept. 35-TR4

Send Free Picture Folder and details on Television Home Training. This does not obligate me and no salesman will call.

Name _____
Address _____
City _____ State _____

Check here if interested in Resident School Training in Chicago.



Measures 6 1/4" x 9 1/2" x 4 1/2"

Superior's new
Model 670-A

SUPER METER

A COMBINATION VOLT-OHM MILLIAMMETER PLUS
CAPACITY REACTANCE INDUCTANCE AND DECIBEL MEASUREMENTS

SPECIFICATIONS:

D.C. VOLTS: 0 to 7.5/15/75/150/750/1,500/7,500 Volts
 A.C. VOLTS: 0 to 15/30/150/300/1,500/3,000 Volts
 OUTPUT VOLTS: 0 to 15/30/150/300/1,500/3,000 Volts
 D.C. CURRENT: 0 to 1.5/15/150 Ma. 0 to 1.5/15 Amperes
 RESISTANCE: 0 to 1,000/100,000 Ohms 0 to 10 Megohms
 CAPACITY: .001 to 1 Mfd. 1 to 50 Mfd. (Good-Bad scale for checking quality of electrolytic condensers.)
 REACTANCE: 50 to 2,500 Ohms 2,500 Ohms to 2.5 Megohms
 INDUCTANCE: .15 to 7 Henrys 7 to 7,000 Henrys
 DECIBELS: -6 to +18 +14 to +38 +34 to +58

ADDED FEATURE:

Built-in ISOLATION TRANSFORMER
reduces possibility of burning out
meter through misuse.

The Model 670-A comes housed, in a rugged crackle-finished steel cabinet complete with test leads and operating instructions.

\$2840
NET



Superior's new
Model TV-11

TUBE TESTER

SPECIFICATIONS:

- ★ Tests all tubes including 4, 5, 6, 7, Octal, Lock-in, Peanut, Bantam, Hearing Aid, Thyratron Miniatures, Sub-miniatures, Novals, Sub-minars, Proximity fuse types, etc.
- ★ Uses the new self-cleaning Lever Action Switches for individual element testing. Because all elements are numbered according to pin-number in the RMA base numbering system, the user can instantly identify which element is under test. Tubes having tapped filaments and tubes with filaments terminating in more than one pin are truly tested with the Model TV-11 as any of the pins may be placed in the neutral position when necessary.
- ★ The Model TV-11 does not use any combination type sockets. Instead individual sockets are used for each type of tube. Thus it is impossible

to damage a tube by inserting it in the wrong socket.

- ★ Free-moving built-in roll chart provides complete data for all tubes.
- ★ Newly designed Line Voltage Control compensates for variation of any Line Voltage between 105 Volts and 130 Volts.
- ★ NOISE TEST: Phono-jack on front panel for plugging in either phones or external amplifier will detect microphonic tubes or noise due to faulty elements and loose internal connections.

The model TV-11 operates on 105-130 Volt 60 Cycles A.C. Comes housed in a beautiful hand-rubbed oak cabinet complete with portable cover

EXTRA SERVICE — The Model TV-11 may be used as an extremely sensitive Condenser Leakage Checker. A relaxation

type oscillator incorporated in this model will detect leakages even when the frequency is one per minute.

\$4750
NET



SUPERIOR'S NEW MODEL TV-40

C.R.T. TUBE TESTER

A complete picture tube tester
★ for little more than the price of a "make-shift" adapter!!

★ Tests all magnetically deflected tubes . . . in the set . . . out of the set . . . in the carton!!

The Model TV-40 is absolutely complete! Self-contained, including built-in power supply, it tests picture tubes in the only practical way to efficiently test such tubes: that is by the use of a separate instrument which is designed exclusively to test the ever increasing number of picture tubes!

EASY TO USE:

Simply insert line cord into any 110 volt A.C. outlet, then attach tester socket to tube base (on Trap Need Not Be on Tube). Throw switch up for quality test . . . read direct on Good-Bad scale. Throw switch down for all leakage tests.

SPECIFICATIONS:

- Tests ALL magnetically deflected picture tubes from 7 inch to 30 inch types.
- Tests for quality by the well established emission method. All readings on "Good-Bad" scale.
- Tests for inter-element shorts and leakages up to 5 megohms.
- Tests for open elements.

Model TV-40 C.R.T. Tube Tester comes absolutely complete—nothing else to buy. Housed in round cornered, molded bakelite case. Only.....

\$1585
NET

**SHIPPED ON APPROVAL
NO MONEY WITH ORDER — NO C.O.D.**

Try any of the above instruments for 10 days before you buy. If completely satisfied then send down payment and pay balance as indicated on coupon. No Interest or Finance Charges Added! If not completely satisfied return unit to us, no explanation necessary.

MOSS ELECTRONIC DISTRIBUTING CO., INC.
Dept. D-109, 3849 Tenth Ave., New York 34, N.Y.

Please send me the units checked. I agree to pay down payment within 10 days and to pay the monthly balance as shown. It is understood there will be no finance, interest or any other charges, provided I send my monthly payments when due. It is further understood that should I fail to make payment when due, the full unpaid balance shall become immediately due and payable.

Model 670-A.....Total Price \$28.40
\$7.40 within 10 days. Balance \$3.50 monthly for 6 months. Model TV-11.....Total Price \$47.50
\$11.50 within 10 days. Balance \$6.00 monthly for 6 months. Model TV-40.....Total Price \$15.85
\$3.85 within 10 days. Balance \$4.00 monthly for 3 months.

Name

Address

City..... Zone..... State.....

The Model
TV-50

GENOMETER

A versatile all-inclusive GENERATOR which provides ALL the outputs for servicing:

A. M. Radio F. M. Radio Amplifiers Black and White TV Color TV

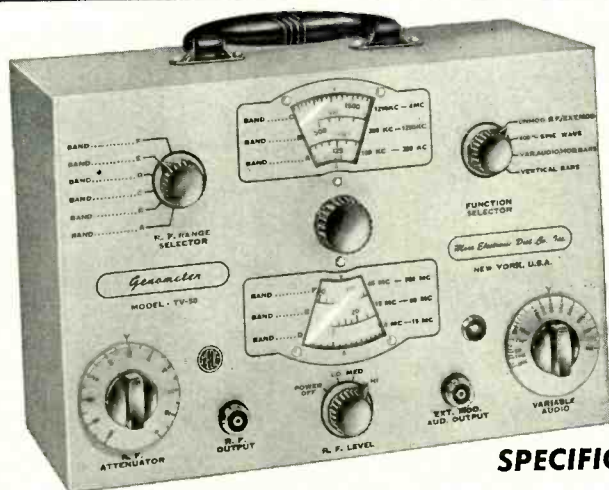

7 Signal Generators in One!

- ✓ R. F. Signal Generator for A.M.
- ✓ R. F. Signal Generator for F.M.
- ✓ Audio Frequency Generator
- ✓ Bar Generator
- ✓ Cross Hatch Generator
- ✓ Color Dot Pattern Generator
- ✓ Marker Generator

SPECIFICATIONS:

R. F. SIGNAL GENERATOR:

The Model TV-50 Genometer provides complete coverage for A.M. and F.M. alignment. Generates Radio Frequencies from 100 Kilocycles to 60 Megacycles on fundamentals and from 60 Megacycles to 180 Megacycles on powerful harmonics. Accuracy and stability are assured by use of permeability trimmed Hi-Q coils. R.F. is available separately, modulated by the fixed 400 cycle sine-wave audio or modulated by the variable 300 cycle to 20,000 cycle variable audio. Provision has also been made for injection of any external modulating source.

VARIABLE AUDIO FREQUENCY GENERATOR:

In addition to a fixed 400 cycle sine-wave audio, the Model TV-50 Genometer provides a variable 300 cycle to 20,000 cycle peaked wave audio signal. This service is used for checking distortion in amplifiers, measuring amplifier gain, trouble shooting hearing aids, etc.

BAR GENERATOR:

This feature of the Model TV-50 Genometer will permit you to throw an actual Bar Pattern on any TV Receiver Screen. Pattern will consist of 4 to 16 horizontal bars or 7 to 20 vertical bars. A Bar Generator is acknowledged to provide the quickest and most efficient way of adjusting TV linearity controls. The Model TV-50 employs a recently improved Bar Generator circuit which assures stable never-shifting vertical and horizontal bars.

CROSS HATCH GENERATOR:

The Model TV-50 Genometer will project a cross-hatch pattern on any TV picture tube. The pattern will consist of non-shifting, horizontal and vertical lines interlaced to provide a stable cross-hatch effect. This service is used primarily for correct ion trap positioning and for adjustment of linearity.

DOT PATTERN GENERATOR (For Color TV)

Although you will be able to use most of your regular standard equipment for servicing Color TV, the one addition which is a "must" is a Dot Pattern Generator. The Dot Pattern projected on any color TV Receiver tube by the Model TV-50 will enable you to adjust for proper color convergence. When all controls and circuits are in proper alignment, the resulting pattern will consist of a sharp white dot pattern on a black background. One or more circuit or control deviations will result in a dot pattern out of convergence, with the blue, red and green dots in overlapping dot patterns.

MARKER GENERATOR:

The Model TV-50 includes all the most frequently needed marker points. Because of the ever-changing and ever-increasing number of such points required, we decided against using crystal holders. We instead adjust each marker point against precise laboratory standards. The following markers are provided: 189 Kc., 262.5 Kc., 456 Kc., 600 Kc., 1000 Kc., 1400 Kc., 1600 Kc., 2000 Kc., 2500 Kc., 3579 Kc., 4.5 Mc., 5 Mc., 10.7 Mc. (3579 Kc. is the color burst frequency.)

The Model TV-50 comes absolutely complete with shielded leads and operating instructions.
Only

\$47⁵⁰
NET

SHIPPED ON APPROVAL
NO MONEY WITH ORDER — NO C.O.D.

Try it for 10 days before you buy. If completely satisfied then send \$11.50 and pay balance at rate of \$6.00 per month for 6 months. No Interest or Finance Charges Added! If not completely satisfied return unit to us, no explanation necessary.

MOSS ELECTRONIC DISTRIBUTING CO., INC.
Dept. D-109, 3849 Tenth Ave., New York 34, N.Y.

Please rush one Model TV-50. I agree to pay \$11.50 within 10 days and to pay \$6.00 per month thereafter. It is understood there will be no finance, interest or any other charges, provided I send my monthly payments when due. It is further understood that should I fail to make payment when due, the full unpaid balance shall become immediately due and payable.

Name

Address

City.....Zone.....State.....

the demand
keeps going...

UP, UP, UP, UP

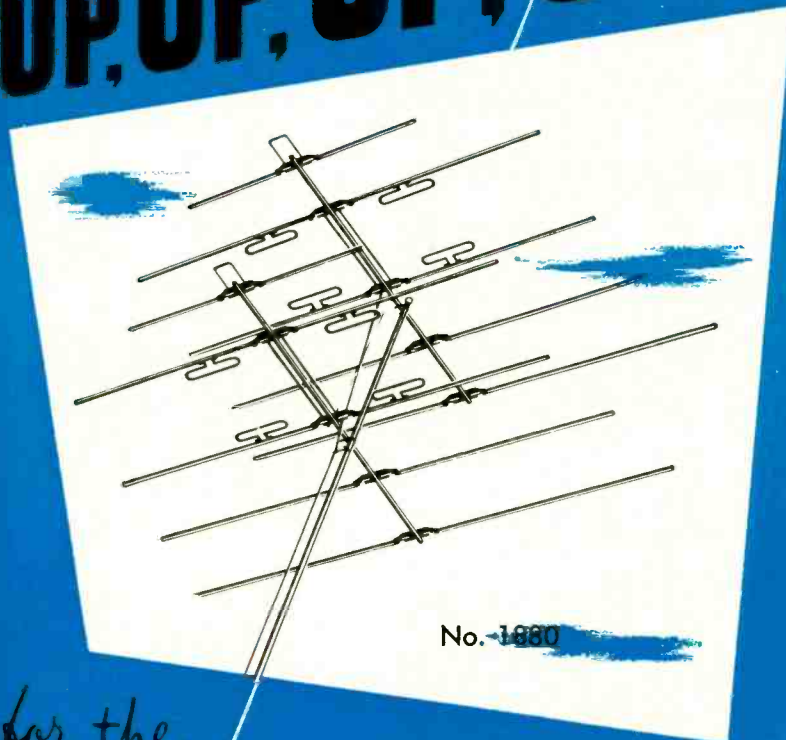

for the

**TANCO
TRAPPER**

THE BEST SELLING TV ANTENNA!

- No. 1 in performance ...
- No. 1 in appearance ...
- No. 1 in convenience ...

TECHNICAL APPLIANCE CORPORATION
Sherburne, N. Y.

In Canada: Hackbusch Electronics, Ltd., Toronto (4)

TECHNICIANS' NEWS (Continued)

for filing. Saunders, who founded the Boston Guild many years ago, is also the technical editor of the paper.

ANOTHER SET ALL SHOT

The Western "technician" who used a rifle to release a jammed picture tube from its yoke (see "Sure-Fire Service," page 144, RADIO-ELECTRONICS, January, 1955) has a parallel in a Philadelphia customer. According to *P.R.S.M.A. News*, a man came into Kinney's Radio and TV Repair Shop and asked for his TV set. The owner told him to drop back in a couple of days and he'd have it fixed. This was not good enough for the customer. After an argument, he drew a revolver and shot one bullet into the picture tube and two into the chassis. "Now you can have the set," he told the startled shop owner and walked out.

100K SERVICE TECHNICIANS?

Tremendous gains in TV service and installation business were predicted by J. A. Milling, vice president of Howard Sams Co., in a recent talk to the company's sales representatives. Stating that the number of service technicians was 70,000 in 1950, he said that the number has now grown to over 90,000. By 1959, the number should increase to 130,000. Sales and installation business in 1954 totaled \$1.5 billions and in 1959 would be over \$3 billions, he estimated.

An even larger estimate of the number of service technicians was made recently by Charles M. Odorizzi, RCA vice president, who believes that the industry is already employing "nearly 100,000" service technicians and sees \$2.7 billion service business in 1957 (RADIO-ELECTRONICS, February, 1955, pages 117 and 120).

NEW GROUP EXHIBITS

The Northern Lancaster County Electronic Service Association, called by the Pennsylvania *Federation News* one of the newest groups in the state, exhibited at the recent fair held in Ephrata. The main attraction at the association's booth was an RCA TV Eye, connected to several sets displayed throughout the fair. Over 20,000 people visited the display and filled in cards to win one of the 10 prizes given by the organization.

ARTSD 1955 OFFICERS

Dave Arick is president of the Associated Radio-Television Service Dealers Association of Columbus, Ohio, with Paul Herman as vice president, Dick Dewitt, secretary, and Jim Cumbow, treasurer.

NEW TV ANTENNA USE

The Leach family of Newman Grove, Neb., owe their lives to an efficient TV antenna installation. When fire broke out in the Leach farmhouse recently, Mr. and Mrs. Leach and their two teenage children were trapped on the second floor by the flames. Using the well-installed antenna mast as a slide, the entire family escaped. END

*Hughes, pioneer developer of
airborne digital computers, and
leader in radar fire control,
now enters the field
of ground radar and data
processing systems.*

Important new programs are under way in the Radar Research and Development Division for the development of ground radar and data processing networks. In these projects, Hughes engineers are drawing on their extensive experience in the successful development of radar fire control systems and airborne computers.

The data gathering for these ground networks will be performed by very high power radar using advanced high-speed scanning techniques developed by Hughes under sponsorship of the U. S. Navy. The processing, transmission, and correlation of the great mass of data involved will be handled by large-scale digital systems. This equipment must be designed to meet stringent tactical requirements for reliability and maintainability.

Visit the
HUGHES EXHIBITS

Booths 753 • 755 • 757

I. R. E.

NATIONAL CONVENTION
and
RADIO ENGINEERING SHOW

New York City, March 21, 22, 23, 24
Headquarters, Waldorf-Astoria Hotel
Exhibits, Kingsbridge Armory

**SCANNING
A NEW
HORIZON**

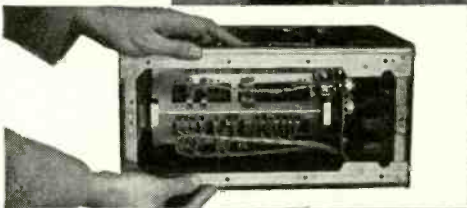

Shown here is a new magnetic drum memory for the Hughes airborne digital computer. Many of the techniques it employs will be used in the ground radar data processing systems.

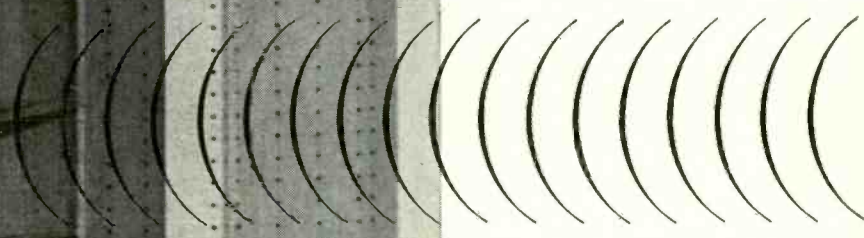

Here are some of the types of work included:

- TRANSISTOR CIRCUITS
- DIGITAL CIRCUITS
- MAGNETIC DRUM AND CORE MEMORIES
- LOGICAL DESIGN
- PROGRAMMING
- ADVANCED RADAR TECHNIQUES

*Engineers
and Physicists*

Application of the techniques, special knowledges and individual talents indicated here is creating positions at all levels in the Ground Systems Department. Engineers and physicists with experience in the fields listed, or those with exceptional ability in these directions, are invited to consider joining our Staff.

*Scientific
and
Engineering
Staff*

HUGHES

RESEARCH
AND DEVELOPMENT
LABORATORIES

Culver City, Los Angeles County,
California

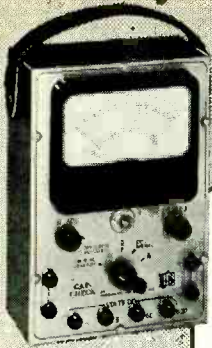

CAP-CHECK!

the only precision instrument that checks condensers WHILE IN THE CIRCUIT!

WITH CARRYING STRAP AND TEST LEADS COMPLETELY WIRED AND TESTED.

- Checks condensers in the circuit and eliminates the time consuming need of unsoldering and resoldering.
- The only direct reading microfarad meter.
- Convenient jacks for using CAP-CHECK with frequencies from audio generator or RF generator.
- Large easy-to-read dial. A flip of the switch instantly gives the condition of the capacitor without removing it from the circuit.
- Eliminates the need for carrying multiple units. Has built in voltmeter, an ohmmeter, plus the capacity meter — All using one master function selector switch.
- Uses a 4 1/2" precision microammeter.
- Engineered and precision made to give dependable and accurate service.
- Each instrument backed by written registered warranty and conforms to standard RTMA guarantee.

AC only **\$495**

CAP-CHECK gives High Performance at Low Low Cost!!

See your local jobber or write for full information.

IIS Instruments for Service Inc. 96 SOUTH GRAND AVENUE, BALDWIN, LONG ISLAND, N. Y.

OPPORTUNITY ADLETS

Rates—45c per word (including name, address and initials). Minimum ad 10 words. Cash must accompany all ads except those placed by accredited agencies. Discount, 10% for 12 consecutive issues. Misleading or objectionable ads not accepted. Copy for May issue must reach us before March 15, 1955.

Radio-Electronics

25 W. Broadway, New York 7, N. Y.

REPAIRS ON ALL MAKES OF HIGH-FIDELITY SPEAKERS, Amprite Speaker Service, 70 Vesey St., New York 7, N. Y.

FIFTY assorted new resistors—\$1.00. Postpaid. Test equipment repaired—Kits constructed. Free list. Bigelow Electronics, Pioneer Road, Beulah, Michigan.

"Buy Surplus Radio. Electronic Equipment direct from Government. List \$1.00. Box 169AK, East Hfd 8, Conn."

SPEAKER RECONING: Guaranteed workmanship. C&M Recone Co., 255 Tioga St., Trenton 9, N.J.

TUBES—70% to 90% DISCOUNT. Government, manufacturers, jobbers, etc. surplus. Guaranteed 1 year. Free catalog on request. Cadillac Trading, Dept. AA, 231-07 Linden Blvd., Jamaica 11, N. Y.

DIAGRAMS FOR REPAIRING RADIOS \$1.00. Television \$2.00. Give Make, Model, Diagram Service, Box 672-RE, Hartford 1, Conn.

HI-FIDELITY BARGAINS—Brand new, factory packed Collaro RC-54, dual sapphires, 45 spindle—\$38.75. Fenton (English) Hi-Fidelity Basic 7 1/2 IPS tape recorder with three 4-pole motors, push button controls and head—\$49.85. ALL ITEMS PREPAID. Tuners, Amplifiers, Speakers, Baffles, Turntables, etc. ALL LOW PRICED. NEW, PREPAID—WRITE TODAY. FIDELITY UNLIMITED, 63-03 39th Ave., Woodside 77, N. Y.

TELEVISION JOBS—Names and addresses of companies to contact. \$1.00 Fitzgerald, Dept. A-23, 815 Countryside Drive, Wheaton, Illinois.

Used Correspondence Courses, Books, Bought, Sold, Rented, Catalog Free. Educational Exchange, Summer-ville, Ga.

TUBES—TV, RADIO, TRANSMITTING, AND SPECIAL PURPOSE TYPES BOUGHT, SOLD AND EXCHANGED. Send details to B. N. Gensler W2LN1, 512 Broadway, N. Y. 12, N. Y.

TEST EQUIPMENT REPAIRED—New modern lab equipped to handle all makes and types of meters and testers. Free estimates. Catalogue available. General Electronic Dist. Co., 100 Park Place, N. Y. 7, N. Y.

ALL MAKES OF ELECTRICAL INSTRUMENTS AND TESTING equipment repaired. Write for free catalogue on new and used instruments at a savings. Hazelton Instrument Co., 128 Liberty Street, New York, N. Y.

MODEL 480 SIMPSON GENESCOPE like new in original carton, \$225.00. Tom Kane, 1221 Crater, Dover, Ohio.

24 PAGES PLANS "1-tube Receiver" (record 12,000 miles) with 6 Issues "Radiobuilder" \$1.00. Laboratories, 328-B Fuller, Redwood City, California.

WANTED: AN/APR-4, other "APR", "TS", "IE", "ARC-1, ARC-3, ART-13, BC-348, etc. Microwave Equipment. Everything Surplus. Special tubes. Tec Manuals, Lab Quality Equipment, Meters, Fast Action, Fair Treatment. Top Dollar Littell, Fairhills Box 26, Dayton 9, Ohio.

BUY WHOLESALE—25,000 items—Catalog 25c. Matthews, 1472-P-5, Broadway, NYC 36.

SPEAKER RECONING: 25 years experience. Michigan Speaker Reconing Service, 930 Metropolis, Marine City, Michigan.

WANTED—Pre-1920 wireless equipment, books, etc. W6GH 1010 Monte Drive, Santa Barbara, California.

ALUMINUM TUBING, Angle and Channel, Plain and Perforated Sheet, Willard Badeliff, Fostoria, Ohio.

RECORDISTS! Exchange talking and musical tapes internationally! Box 1404-W, San Francisco 1.

Power Transformers Rebuilt: all makes, Victor R32—\$12.95. Red Arrow Radio, 924 Metropolis, Marine City, Michigan.

25-50% DISCOUNT, guaranteed. Factory Fresh LP records: 6pc and up; Pre-recorded tapes. Send 20c for catalogue. SOUTHWEST RECORDS, 4710 Caroline, Houston 4, Texas.

TELEVISIONS, WORKINGS, \$30 UP, WAAP, 1420 South Randolph, Arlington 4, Virginia.

INCREDIBLE! ONE TUBE radio receives television, FM broadcast, CAP and amateurs. Special tube and diagram only \$2.00. Wired assembly \$2.00. Springfield Enterprises, Box 54-F2, Springfield Gardens 13, New York.

Thousand "QUALITY" Business Cards \$3.95. Stickers \$2.95. Postpaid. Trowbridge, 312-B West 75th, Chicago 21.

Transistor Geiger Counter Kit Diagram, instructions \$3.50 kit from \$29.95 up. Free information. J. Young Co., 800 Stockton St., San Francisco 8, Calif.

TV FM ANTENNAS, ALL TYPES INCLUDING UHF. Mounts, accessories. Lowest prices. Wholesale Supply Co., Lunenburg 2, Mass.

Technotes



PRINTED ERROR IN MOTOROLA 53R

Complaints of hum have been received on early-run sets of the Motorola 53R series. The trouble has been traced to an error in the printed circuit which leaves the lower end of the .047- μ f a.c. line bypass capacitor (C3) floating. This should have been returned to ground, which is the outer edge of the etched, printed surface.

This is visible from the rear of the receiver with the cover removed. To correct the trouble, bend the capacitor pigtail so it touches the outer edge of the printed plate, and solder in place. This error has been corrected in later production runs.—*Motorola Service News*

BENDIX AUTO RADIOS

Fuse blowing is a frequent occurrence in Bendix auto radios in late-model Fords. The lead to the radio switch grounds to the chassis when the supporting brackets of the radio case are tightened. Tape the wire and move it sufficiently to prevent contact with the chassis.—*Edgar B. Kastelberg*

PHILCO MODEL 46-1209

If noise in this receiver is traced to a defective converter tube, or if this tube becomes defective frequently, future difficulty can be eliminated by replacing the 4,000-ohm resistor in the plate circuit with a 47,000-ohm unit. The 100,000-ohm resistor between B plus and cathode of the 7F8 must be removed when this is done.—*George Anglado*

MOTOROLA 21T3

The trouble was intermittent audible clicks accompanied by a flicker in screen brightness. All indications pointed to arcing in the high-voltage supply. All tests and observations in total darkness failed to reveal the trouble. Finally, a simple trick located the trouble.

I used a long piece of varnished spaghetti as a stethoscope and soon located the trouble in the high-voltage capacitor. In this model the source of the arc is so close to the flyback transformer that you are very likely to jump to the wrong conclusion as I did. The intermittent disappeared when the capacitor was replaced.

Shorts in the low-voltage supply of this set are often traced to a gob of solder on the selenium rectifier connection next to the chassis. Shorts at this point ruined rectifiers in two of these sets.—*Fred E. Kelley*

TV GLO-TEST

Replaces \$279 in TESTING EQUIPMENT

This sensational new all-purpose tester does the work of equipment costing nearly 12 1/2 times as much. Recently featured in RADIO-ELECTRONICS and other publications, the GLO-TEST has been bought and used enthusiastically by hundreds of TV and Radio Servicemen, Sound Technicians, Amateurs, Experimenters and Electricians.

More than 50 uses: Pixtube Tester—AC-DC; Measures Voltage to 50 KV; Signal Generator; Signal Tracer; Tube Tester; Resistor and Capacitor Measurements; Checks Distortion, Linearity. Accuracy is comparable to VTVM. GLO-TEST complete with test leads and instruction booklet, postpaid.....only \$14.50

Send check or money order. Satisfaction guaranteed. Free literature on request. Dealer Inquiries Invited.

V. A. ENTERPRISES, Dept. AA, 608 E. Rosecrans Blvd., Compton, Calif.



FULLY GUARANTEED

UNUSUAL SOLDER JOB

This was another of those sets the customer brought to the shop. I couldn't help noticing how well he had cleaned off the top of that 12½-inch Magnavox TV chassis.

"She just won't play," explained the owner. "I'm in a hurry—look it over and I'll be back later."

Sure enough. Nothing. I turned the chassis over on its side and took a quick preliminary look. Everything seemed normal. Nice soldering. But how come some of those joints have a peculiar off-color look?

Well, there's one needs resoldering. Might as well get it now. So I put the iron on it. With a quick puff of smoke, the solder disappeared!

After-resoldering about 45 connections, on which Mr. X had used Liquid Solder, I had that little Magnavox happy once again. Liquid Solder, incidentally, is a plastic cement and a very fine insulator!—*W. C. Collins*

"RABBIT EARS"

When signals are weak on TV sets using "rabbit ears," check the lead-in where it comes out of the plastic bottom of the antenna. I have seen several of these antennas that had been moved around on the top of sets to such an extent that one of the lead-in wires broke where it enters the base. If one of the wires is broken, open the base and splice the wires.—*B. W. Welz*

SPEAKER REPAIRS

Frequently a service technician finds the voice coil off center after using radio cement for a minor repair on a small speaker. The cement contracts while drying and pulls the cone with it.

In many such cases, the voice coil can be recentered by applying cement to an area approximately equal to that of the repair and diametrically opposite it.—*Ralph Bennett* END

CONTROL SNAPS ON

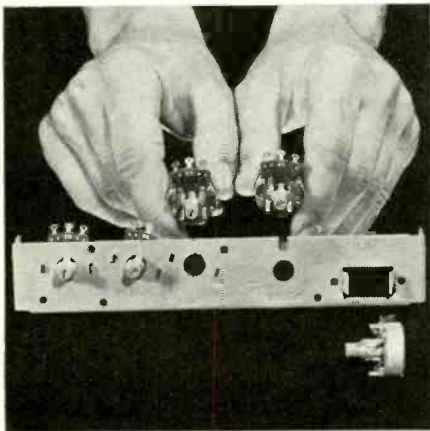

New quickly installed controls announced by Centralab should be a real timesaver for the technician. They are mounted by simply pushing them into the mounting hole where they are held firmly by six spring clips on the control. They are being made available in values which will replace about 75% of the usual TV rear-end short-shaft controls.

FOR SERVICE DEALERS, from **TRANSVISION-**
8 MONEY-MAKERS

THESE FINE, LOW COST INSTRUMENTS PAY FOR THEMSELVES QUICKLY!
Necessities for black-and-white TV, a MUST for COLOR TV!

1 TV Component Tester
PERFORMS 6 VITAL FUNCTIONS



You get \$176 worth of Testing and Repair Instrumentation in 1 efficient unit for the amazing low price of only

The industry's biggest value! **SIX** instruments in one compact unit—terrific as a **PICTURE TUBE TESTER... FLYBACK & YOKE TESTER... SELENIUM RECTIFIER TESTER... CONDENSER TESTER... CONTINUITY TESTER... PICTURE TUBE REACTIVATOR.**

\$49⁹⁵

5 Field Strength Meter
For Battery Operation and 110 V AC



Model FSM-5B, for Battery Operation and 110V AC. Weight 22 lbs. net

Saves 50% of installation cost... Measures pic signal strength directly from antenna... Identifies TV, FM, TVI signals... Has 12 channel selector; multiplier switch for weak signal areas... Range is 10-50,000 microvolts... A must in fringe areas, UHF or VHF.

\$89

2 Make Big Profits with this Tester-Reactivator Sparker

A complete picture tube testing and repair unit. It **TESTS** picture tubes—measures Cathode emission, locates shorts between elements; locates high resistance shorts or leakage as high as 3 megohms. **REACTIVATES** dim tubes without removal from set. **SPARKS OUT** high resistance shorts in CRT'S and other tubes.



\$34⁹⁵

3 CRT TESTER—REACTIVATOR
Same as Tester-Reactivator-Sparker, but without Sparker, only **\$19.95**

4 CRT SPARKER
SPARKS OUT high resistance shorts in CRT's and other tubes by application of 15,000 volts of RF.only **\$19.95**

6 Flyback—Yoke—Continuity Tester . . . in 1 low cost unit

Checks low and high impedance Yokes and Flybacks... Detects even one shorted turn... An improved Continuity Checker: Checks condensers for opens, electrical shorts, or leakage. (Ordinary continuity testers will not do this).

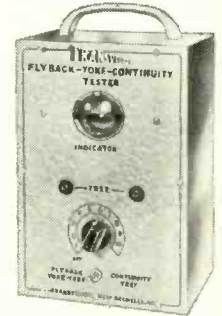

A \$59 value for **\$24⁹⁵**

Complete line of COIN TV SETS

Also COIN BOXES for operating any TV set. Many unusual, profit-making features; only \$14.95. Ask for complete details—today.

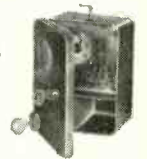

8 Install the Finest MASTER AMPLIFIED and COMMUNITY TV ANTENNA SYSTEMS

Let Transvision help solve your problem with FREE engineering advice. Also write for—

FREE Technical Manual for Community and Master TV Systems. Write for it now.

TRANSVISION, INC., NEW ROCHELLE, N. Y. Dept. E3

Send me.....
 Enclosed find \$.....deposit. Balance C.O.D.
 My JOBBER is.....
 Name.....
 Address.....
 City.....State.....

WRITE FOR CATALOGS
JOBBER INQUIRIES INVITED



IT'S BIGGER AND BETTER THAN EVER!

**B-A's NEW 1955
FREE CATALOG**

**164 BIG PAGES
LOADED WITH SAVINGS
AND NEW ITEMS IN
RADIO, TV, ELECTRONICS**



**INCLUDES 23 PAGES
OF AMAZING
BARGAINS NOT FOUND
IN ANY OTHER CATALOG**

BURSTEIN-APPLEBEE CO.

BURSTEIN-APPLEBEE CO. Dept. S,
1012-14 McGee St., Kansas City 6, Mo.

Send Free B-A Catalog No. 551.

Name.....
Address.....
City..... State.....



SEND FOR IT TODAY!

MISCELLANY

**THE FUND REACHES
\$11,573.86**



**HELP -
FREDDIE-WALK
FUND**

AS we go to press, Christmas is still fresh in our memories, and we here at RADIO-ELECTRONICS would like to say a word of thanks to all the many people who were kind enough to remember with special greetings little Freddie Thomason, armless and legless son of Herschel Thomason, radio technician of Magnolia, Ark.

Although we have no recent news of Freddie to report, we know from his father's last letter that he has been progressing steadily. He has a fine time exploring the house and immediate neighborhood on his new legs and, except for an occasional tumble or two, he manages to get around almost as well as any normal youngster. In the near future he will be fitted with his first pair of artificial arms, an event both he and his parents, as well as everyone here, are looking forward to with a keen sense of anticipation.

Freddie is growing fast, just as fast as any normal child his age. Therefore, from here on in almost constant adjustments of the mechanical limbs on which he depends, and upon which he will depend for the rest of his life, will have to be made. New arms and legs will have to be fitted periodically.

The Help-Freddie-Walk Fund is thus working on a long-range basis, and we sincerely hope that our readers will see the necessity for such planning and cooperate to the fullest extent of their capabilities. Thousands and thousands of dollars are still needed to see Freddie through to maturity, and we are counting on *you* to help out whenever you can.

Please send your contributions in as often as you can. No amount is too small to receive our sincerest thanks and appreciation, and every donation is acknowledged by letter. *Make all money orders, checks, etc., payable to Herschel Thomason.* Address all letters to:

Help-Freddie-Walk Fund
c/o RADIO-ELECTRONICS Magazine
25 West Broadway
New York 7, N. Y.

FAMILY CIRCLE Contributions.....	\$ 602.50
RADIO-ELECTRONICS Contributions as of Oct. 15, 1954.....	10,890.11
Anonymous, Scott Air Force Base, Ill.....	2.00
Anonymous, Minneapolis, Minn.....	5.00
Mrs. Helene Buckby, Honolulu, Hawaii.....	10.00
George H. Critz, Mandeville, La.....	1.00
Van H. Ferguson, Tallahassee, Fla.....	5.00
June O. Fischer, Los Angeles, Calif.....	10.00
H. Goldstein, White Plains, N. Y.....	1.00
Catherine T. Haley, Chicago, Ill.....	1.00
E. T. Jones, R.C.A., Camden, N. J.....	2.00
Just a Friend, Worcester, Mass.....	2.00
Mary Krull, Passaic, N. J.....	10.00
Michael Krull, Jr., Passaic, N. J.....	5.00
Mrs. Stella C. Pencosky, Bridgeville, Pa.....	1.00
F. C. Purkeyville, Corvallis, Ore.....	20.00
Alexander Rys, Minneapolis, Minn.....	.25
Joseph R. Sorger and Co., Morton, Pa.....	1.00
A. Tiefenbruner, Bronx, N. Y.....	1.00

**TOTAL CONTRIBUTIONS as of
Jan. 17, 1955.....\$11,573.86**

NEW! **completely assembled
6 and 12 VOLT
DC POWER SUPPLY**



Model
D-612

**ONLY
\$3995**

at a comparable KIT PRICE

0 to 8, 0 to 16v. completely variable; 0 to 10 amps. at 12v. continuous. Operates all auto radios. For relays, low voltage devices, battery charging, etc. Less than 5% ripple over rated ranges. Withstands high voltages.

**MODEL "B" FILTERED DC
POWER SUPPLY**

For testing, servicing, operating low power 2-way mobile auto radios. 1 Model "B" delivers 6v. at 20 amps. 2 Model "B's" in parallel deliver 6v. at 40 amps. **\$49.80**

**MODEL "S" Converts Battery Radios
to AC ALL-Electric**

Assures hum-free reception from any 1 1/2 v., 4 to 6-tube battery radio using 115-volt, 50-60 cycle source. Fits battery space. Guaranteed three years. **\$11.10**
See Your Parts Distributor or Write for Bulletin

ELECTRO PRODUCTS LABORATORIES
4501-Ra N. Ravenswood Ave., Chicago 40, Ill.
Canada: Atlas Radio Corp., Ltd., Toronto

**Easier,
Faster**

INSTALLATIONS WITH THE

**New LA-75
ARRESTER**



ANOTHER
Radion

FIRST

ANOTHER
Radion

FIRST

ANOTHER
Radion

FIRST

New twin-lead grip speeds connections.

Flame-proof, waterproof. All hardware included. UL Approved indoors or out. Carry one arrester to fit all needs. Ask your distributor now.

Dept. G

THE RADION CORP.

1130 W. Wisconsin Ave.,
Chicago 14, Ill.



Effective Distribution

with Masterline[★] TV TAP-OFFS



**Type MTO-11
for Outdoors**

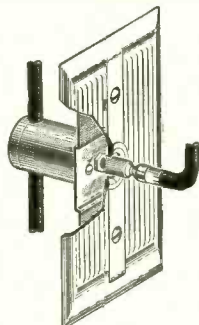

**Type MTO-59
for Indoors**

TV set connections to the line have been the most critical and troublesome points in distribution systems. This is no longer the case. B-T Tap-Offs are the simplest means ever devised for connecting TV receivers to a feeder line or riser. Installation is practically automatic. There is no break made in the line and no splices are required. Precise impedance match is assured, and because the line is not damaged, B-T Tap-Offs may be removed at any time without affecting continued performance.

These ingenious, low-cost compact connectors have a flat response across the entire TV band. Shunted capacitance is less than 1 mmf, thereby virtually eliminating the cause for ghost reflections, picture smear and loss of signal strength. Insertion loss is less than 1/2 db, permitting their use in many instances without preamplification. A built-in network gives 17 db inverse isolation (34 db set-to-set) which may be increased where required.

Type MTO-11 is completely weatherproofed and is designed for outdoor applications in connecting 59/U cables to RG-11/U lines. A messenger cable clamp is built on for added convenience in installation and for additional strain relief.

Type MTO-59 is intended for indoor applications in connecting 59/U receiver leads to 59/U riser cables. Unit is designed to provide a wall outlet, and is furnished with a flush wall plate.

Type MTO-11.....each \$7.00 list
Type MTO-59.....each 7.00 list

Packed 6 to the carton

For complete specifications and installation data, write to Dept. CC-3

BLONDER-TONGUE LABORATORIES, INC., WESTFIELD, NEW JERSEY



Manufacturers of TV Amplifiers, Boosters, Converters, Accessories, and Originators of the B-T Masterline and 'Add-A-Unit' Master TV Systems

RADIO-ELECTRONIC CIRCUITS (Continued)

to discharge C1. At the same time, the negative pulse from V2's screen reaches the grid of V7 but has no effect. The control grid of V8 goes positive with the cathode of V2.

When light is restored to the phototube supplying V1, V1 cuts off, producing a negative pulse on its cathode and a positive pulse on its screen. The positive voltage from the screen of V1 is applied to the shield grid of V8 where it acts with the positive voltage already on the control grid to fire the tube and discharge C2 through the coil of the addition counter, causing it to register. The subtraction counter does not operate when light again strikes the phototube of V2 because C1 has just been short-circuited by V5. An object moving through the beams in the opposite direction produces a similar chain reaction that causes the subtraction register to operate.

AUDIO SWITCHING

The problem of connecting an FM tuner, TV receiver and phono input to the same audio amplifier system without adding a number of unsightly switches is a fairly difficult one. My solution is to use a system of relays that require no additional controls on the set or tuner. The on-off switches in the tuner and TV receiver were replaced with double-pole types and the phono preamp switch by a 3-circuit unit. All were rewired so a.c. is supplied to the power amplifier whenever the tuner, phonograph or TV set is turned on. The relays automatically connect the audio input of the amplifier to the output terminals of the equipment being used. The diagram is shown in Fig. 1.

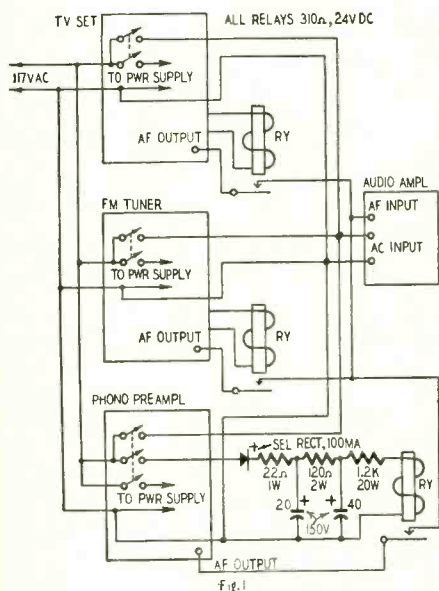

One of the advantages of this setup is that hum pickup is minimized by using d.c. to excite the relay coils. The tuner and TV receiver supply excitation current for their respective relays. The 1,000-ohm filter resistor in the FM tuner was replaced by a 680-ohm

HERSHEL RADIO CO. BIGGEST BUYS!

<p>KIT 1. HARDWARE Over 1,000 pieces, 2 1/2 lbs. of assorted RADIO & TV HARDWARE. \$149</p>	<p>KIT 4. Rotary Switches 25 ASSORTED TYPES. A Real Buy at only... \$475</p>	<p>KIT 7. TOGGLE & SLIDE SWITCHES 25 ASSORTED. DPST, DPDT, SPST, etc. \$495</p>
<p>KIT 2. CERAMICONS 100 ASSORTED. Range from .75 mmfd. to 6,000 mmfd. \$350</p>	<p>KIT 5. RESISTORS 100 ASSORTED TYPES. Range from 1 ohm to 15 meg. 1/2 to 5 watt. \$198</p>	<p>KIT 8. PAPER & CAN CONDENSERS 25 ASSORTED. Range from 4 mfd. 150 v. to 80 mfd. 450 v. \$350</p>
<p>KIT 3. Volume Controls 25 ASSORTED. Range from 2 ohm to 3 meg. Some with switch. \$475</p>	<p>KIT 6. R.F. CHOKES 25 ASSORTED. Range from .5 mh. to 25 mh. \$195</p>	<p>HI GAIN DYNAMIC MIKE KIT Uses UTC Transformer and Western Electric Mike. Ideal for Hams, PA, CAP, Recording, Mobile Equip. —50 DB/80-7500 CPS. Diagram Furnished. \$195</p>

<p>TRANSFORMER Pri. 110VAC 60cy. SEC. 6.3V 1A...95c TRANSFORMER Pri. 110VAC 60 cy. Sec. 400VCT. 6.3V 1A, 5V 2A, 70 MA...\$1.49 SCOPE TRANSFORMER Pri. 110VAC 60 cy. Sec. 400V 10MA...\$2.95 TRANSFORMER Pri. 110VAC. 60 cy. 600VCT. 6.3V 2A, 5V 2A, 70 MA...\$2.35 RELAY D.P.D.T. 110VAC 8 Amp. Contacts...\$1.69 RELAY D.P.D.T. 3VDC 11 ohm coil cont. 1.5A...\$1.50 KEY J38 Telegraph Key...95c LIP MIKE With Head Band Cord and Switch...\$1.29 CHOKE 2.5MH, 125MA...15c CHOKE 1.5 MH, 100MA...49c COIL Plug in Type 4, 5, 6, Prong Type...29c OUTPUT TRANSFORMER 6V6 TO 3.2 Voice Coil...39c OUTPUT TRANSFORMER P.P. 6V6 TO 3.2 Voice Coil...59c OUTPUT TRANSFORMER 50L6 TO 3.2 Voice Coil...35c COIL Ignition Type Pri. 3V Sec. 15,000VDC. Ideal for Photo Flash Triggering...\$1.29 GLOW-LITE 2 1/2 Watt Argon Lite 110VAC Will Run On MOTOR From Gun Camera 24VDC...95c 110VAC...95c CABINET RCA Speaker Cabinet Plastic For 8 inch Round Spk...\$1.95 RHEOSTAT 30 ohm 50 Watt...95c</p>	<p>RCA PLATE TRANS. only PRI. 90 v 60 cy. 3 amp. Sec. 4400 v. 1 amp. 6 1/2 x 5 1/4 x 6 1/4 H. \$1.95</p>	<p>TELEGRAPH SOUNDER Main Line 150 ohms. Attn. C.A.P. \$195</p>
<p>TRANSFORMER P.P. 6L6'S 25 watt PRI 5000 Ohms output. Sec. #1 500 Ohms. Sec. #2 600 Ohms. Sidetone 15 to 15,000 cy. flat.</p>	<p>MODULATION and DRIVER TRANSFORMERS Modulation trans. 815 Class AB2 56 Watt DRIVER, 6SN7 to Modulator. \$495 for Both</p>	

<p>MYSTERY PACKAGE ELECTRONIC PARTS The Surprise of Your Life 25 pounds of Worth \$50. BRAND NEW USABLE GOODS S.U.R.P.L.U.S. Ideal gift for the ham, etc. \$495</p>	<p>HERSHEL RADIO CO. 5245 GRAND RIVER AVE. DETROIT 8, MICHIGAN TERMS: Cash with order or 25% DOWN — BALANCE C.O.D. NET 10 DAYS RATED ACCOUNTS ALL PRICES NET F.O.B. DETROIT Merchandise Subject to Prior Sale</p>	<p>ALL-PURPOSE FIL. TRANSFORMER For Model Trains, Welding, Transmitters, etc. PRI 117 v. 60 cyc. sec. 6.4 v. 12A 6.4 v. 10A 5 v. 3A 5 v. 3A 5 v. 3A 2.5 v. 1.75A \$495</p>
---	--	--

HERE'S HOW TO GET YOUR START IN RADIO ELECTRONICS

More experts got their basic training from this big book than any other of its type!

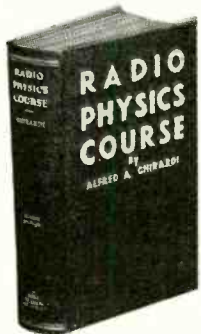

Here's basic training you can really understand... training that can help fit you for a good pay radio-television-electronic career!

Ghirardi's RADIO PHYSICS COURSE is the oldest book of its kind... and still a best seller because it is so amazingly clear and complete. Thousands now in electronics got their start from this great book—and they'll recommend it to you today!

RADIO PHYSICS COURSE
by A. A. Ghirardi
Complete, basic training for beginners

Starts with Basic Electricity (over 300 pages) then takes you step by step through the entire radio-electronics field. Covers principles, theories and practices that are basic to even the most modern equipment. 972 pages; 508 pictures; 858 helpful self-review test questions. Price only \$6.50.

STUDY 10 DAYS FREE!

Dept. RE-35, RINEHART & CO., INC., 232 Madison Ave., New York 16, N.Y.

Send Ghirardi's RADIO PHYSICS COURSE home-training book for 10 days free examination. I will then either return book promptly or send you \$6.50 plus postage in full payment.

Name

Address

City, Zone, State.....

OUTSIDE U.S.A.—\$7.25 cash only. Money back if book is returned in 10 days.

FREE ALLIED'S SPECIAL 64-PAGE HI-FI CATALOG

Your guide to an easy understanding of Hi-Fi—plus the world's largest selection of Hi-Fi systems and components

send for it

This 64-page book shows you how to select a Hi-Fi music system at lowest cost. Tells you what to look for in each unit and shows many handsome, practical installation ideas. Offers you the world's largest selection of complete systems and individual units from which to make your money-saving choice. To understand Hi-Fi, to own the best for less, you'll want this Free book. Write for it today.

ALLIED RADIO
America's Hi-Fi Center

ALLIED RADIO CORP., Dept. C-35
100 N. Western Ave., Chicago 80, Ill.

Send FREE High Fidelity Catalog

Name

Address

City, Zone, State.....

**BUY DIRECT...
SAVE MONEY!**

**HI-FI and
Binaural units...
wired or kits!**

New Imperial V-12-tube AM-FM Tuner Kit

- Band width—200 kc • Tuned RF stage • Tuning Range 88-108 mc • Sensitivity 5-10 u/v, 20-30 db
- Iron core tuned I.F. disc. trans. • 6CB6 RF amplifier • 6AB4 mixer • 6AB4 oscillator • 6AU6 1st I.F. amplifier • 6AU6 2nd I.F. amplifier • 6AU6 1st limiter • 6AU6 2nd limiter • 6AL5 detector • 6C4 cathode follower output • AM tuning range 530-1650 kc • 6BA6 RF amplifier • 6BE6 converter • 6BA6 1st I.F. amplifier • 1N34 or 1N60 crystal diode detector • Tuned RF stage • Chassis dimensions: 9 3/4" long, 5" high, 8" W.

Complete kit of parts including tubes, pictorial and schematic diagrams. **\$37.50**

Frequency Response (FM) 20 — 20,000 CPS \pm .5 DB
Frequency Response (AM) 20 — 7,500 CPS \pm 3 DB

New V-9 FM Receiver Kit

- Self-contained AC Power Supply
- 3 section variable condensers • Tuning range 88-108 mc • Band width 200 kc • Sensitivity 10 microvolts 20 db • Tuned RF stage • Iron core tuned I.F.—disc. trans. • 6CB6 R.F. amplifier • 6AB4 mixer • 6AB4 oscillator (temp. compensated) • 6AU6 1st I.F. amplifier • 6AU6 2nd I.F. amplifier • 6AU6 1st limiter • 6AU6 2nd limiter • 6AL5 detector • 6C4 cathode follower output • #65 selenium rectifier • Dimensions 9 3/4" x 5" x 5 7/8"

Complete kit of parts including AC power supply, tubes, pictorial and schematic diagrams **\$29.50**

Frequency response 20—20,000 CPS \pm .5 DB
Wired & Tested extra \$5.00

New V-5 AM Receiver Kit

- Self-contained AC power supply
- Tuning range 530-1650 kc • 6BA6 RF Amplifier • 6BE6 converter • 6BA6 1st I.F. amplifier • 6AL5 detector • 6C4 cathode follower output • #65 selenium rectifier
- 3 section variable cond. • Tuned RF stage • Sensitivity 5 microvolts • Iron core tuned coils throughout • Dimensions 9 3/4" x 5" x 5 7/8"

Complete kit of parts, including AC power supply, tubes, pictorial and schematic diagrams **\$24.50**

Frequency Response 20—7,500 CPS \pm 3 db
Wired & Tested extra \$4.25

FREE CATALOG OFFER!

Write Dept. RE-E today for free complete Approved catalog!

ORDER DIRECT FROM

APPROVED

ELECTRONIC INSTRUMENT CORP.

928 BROADWAY NEW YORK 10, N. Y.

RADIO-ELECTRONIC CIRCUITS (Continued)

unit in series with the relay coil. The relay in the TV set (a 630 type) is inserted in a section of the voltage divider. Fig. 2 shows how two 1,500-ohm resistors and the relay are connected

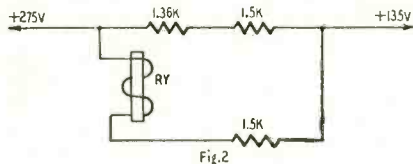

between the 135- and 275-volt points (100- and 250-volt points in some sets). The phono changeover relay is powered by a 24-volt d.c. supply using a selenium rectifier to minimize hum. This may not be required with some types of relays.—George J. Hausmann

SUBHARMONIC OSCILLATOR

An interesting frequency-dividing circuit is the crystal-controlled transistor oscillator (see "Transistor Oscillator Produces Subharmonics," RADIO-ELECTRONICS, April, 1954). Another is described in a technical report of the National Bureau of Standards. This circuit, shown in the diagram, is capable of frequency division ratios as great as 10,000 to 1.

The divider is essentially a triode blocking oscillator synchronized with the subharmonic of a crystal connected across a third winding on the oscillator transformer. The crystal may also be connected across either the grid or plate winding or directly between plate and grid of the tube. The circuit shown is preferable because it removes d.c. from the crystal and permits grounding the trimmer across it.

The suddenness of plate-current cut-off induces a voltage pulse that shock-excites the crystal into producing the necessary synchronizing pulses. Frequencies as low as 1/10,000 of the crys-

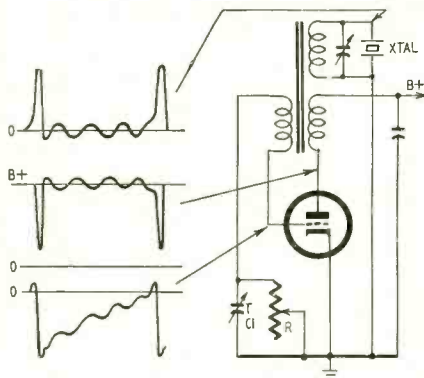

tal frequency are possible and division by factors up to several hundreds is readily obtained. Using a 1-mc crystal, the oscillator locks in readily at 1 kc and produces useful harmonics up to 20 mc and higher. The frequency of the submultiple is controlled by the settings of R and C1. The upper limit of the blocking oscillator frequency—usually around 200 kc—is determined by the characteristics of the oscillator transformer.

END

TELEVISION

Big demand for graduates

B.S. DEGREE IN 27 MONTHS in radio including TV engineering—VHF, UHF, AM and FM. Students use over \$100,000 worth of equipment including 2 large commercial type transmitters in new TV lab. Intense specialized course includes strong basis in mathematics, science and advanced design in radio and TV. Hundreds of young men each year are earning engineering degrees in this recognized institution. Start any quarter. Many earn a major part of expense in this industrial center. Low tuition. Competent instruction. Thorough, intense, practical program. Also **B.S. DEGREE IN 27 MO.** in Aeronautical, Chemical, Civil, Electrical and Mechanical Engineering. G. I. Gov't approved. Enter March, June, Sept., Dec. Free catalog. **ENROLL NOW.**

INDIANA TECHNICAL COLLEGE
1735 E. Washington Blvd., Fort Wayne 2, Indiana

TV TUNER REPAIRS

48-HOUR SERVICE

Defective tuners rebuilt to factory standards. New tuner guarantee. Ship prepaid.

RADIO PRODUCTS CO.

College Point 56 New York
We carry a full stock of
Replacement Tuners for all makes of T.V.

New Gernsback Books

**RADIO-CONTROL HANDBOOK—
No. 53**

R/C expert Howard G. McEntee, W2SI, gives you all the necessary practical details on how to build R/C systems and mechanical components to control model planes, boats, etc. 192 Pages. 175 Illustrations.



\$2.25

THE OSCILLOSCOPE—No. 52

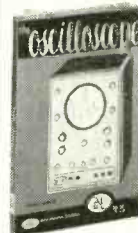

A practical book that tells you how to use the scope to best advantage in all types of servicing. Gives you tips on use and warns about pitfalls to avoid. 192 Pages. Over 100 illustrations.

\$2.25

TRANSISTORS—THEORY AND PRACTICE—No. 51

Rufus P. Turner explains transistors for the practical man. Gives applications in well-known circuits. Contains guide to characteristics of commercial transistors. 144 Pages.

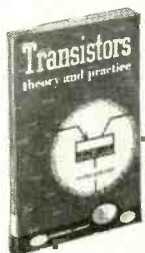

\$2.00

TV REPAIR TECHNIQUES—No. 50



Top technician-writers tell you how to recognize and correct quickly the tough servicing problems which stump even the experts. Will help you do a better job faster. 128 Pages.

\$1.50

See coupon on page 156
Gernsback Publications, Inc.

Publishers of RADIO-ELECTRONICS
25 West Broadway New York, N.Y.

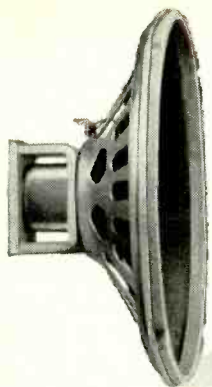

It's here... It's terrific...

a great HI-FI speaker

by Delco Radio

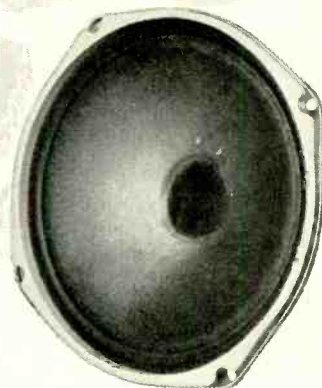

MODEL 8007—The Speaker with Thousands of Replacement Applications!

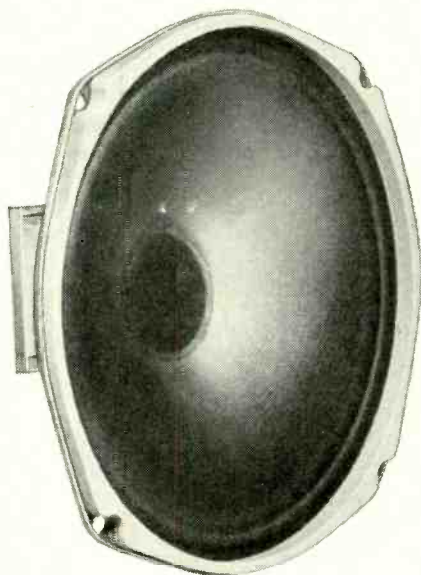

Here is a sensational performer in the big Delco Radio line of speakers . . . a *Hi-Fi* replacement speaker for AM, FM, and TV receivers and phonographs that matches their service requirements with a *voice coil impedance of 4.1 ohms*—not too high, not too low, but just right! And it's ideal, too, for custom-built high-fidelity systems. Wherever installed, the model 8007 Delco Hi-Fi speaker will give new sparkle and life over the full tonal range.

Here are some of the reasons why:

- Its 8-inch curvilinear cone extends the Highs, gives maximum performance over a range of 50 to 12,500 cycles per second
- A heavy Alnico-5 magnet provides peak damping action, high output with clean performance, light highs, heavy lows
- Power rating of 10 watts
- Input impedance of 4.1 ohms
- A 1 $\frac{3}{8}$ -inch voice coil for excellent damping effect, high efficiency, minimum distortion
- Total these features, add a rugged, zinc-plated, attractively painted basket, and you have the outstanding speaker in its price range . . . the Delco model 8007!

DELCO RADIO'S Model 8007
A Terrific Value at Moderate Cost

*The Most Highs . . . the Most Lows . . . the Most Watts . . .
in a Medium-Priced Speaker*

A GENERAL MOTORS PRODUCT   A UNITED MOTORS LINE

DISTRIBUTED BY ELECTRONICS WHOLESALERS EVERYWHERE



DELCO RADIO

DIVISION OF GENERAL MOTORS, KOKOMO, INDIANA

**LEARN basic electricity
electronics**
THE EASY "PICTURE BOOK" WAY!



The fabulous new **ILLUSTRATED Training Course** now used by the U. S. Navy!

You Learn by Pictures

Over 25,000 Navy trainees have already learned Basic Electricity and Basic Electronics this easy, "Picture Book" way! Now, for the first time, YOU can master the basics of Electricity and Electronics with this same "Learn-by-Pictures" training course! Over 1,700 simple, easy-to-understand drawings explain every section—these "teaching" pictures actually make up more than half the entire course! No other Basic Electricity or Basic Electronics course in America uses this revolutionary illustrative technique! You learn faster and easier than you'd ever dream possible!

A Complete Idea on Every Page

Here's how this easy, illustrated course works: every page covers one complete idea! There's at least one big illustration on that same page to explain it! What's more, an imaginary instructor stands figuratively at your elbow, doing "demonstrations" that make it even easier for you to understand. Then, at the end of every section, you'll find review pages that highlight the important topics you've just covered. You build a thorough, step-by-step knowledge at your own pace — as fast or as slow as you yourself want to go!

Everyday English—A Course Anyone Can Understand

Sponsored by the Navy to turn out trained technicians in record time, this modern course presents Basic Electricity and Basic Electronics in a simple way that everyone can grasp—regardless of previous education! Every phase is made instantly clear—explained in plain, down to earth English—with hundreds of easy-to-understand illustrations to help you!

10 Complete Volumes

Vols. 1 and 2 of "Basic Electricity" cover DC components and circuits; Volumes 3 and 4 cover AC components and circuits; Volume 5 covers AC and DC motors and machinery.

Volume 1 of "Basic Electronics" covers Diodes & Power Supplies; Vols. 2 and 3 cover Amplifiers & Oscillators; Vols. 4 and 5 cover Transmitters & Receivers.

Home Study Without Correspondence

This course is so different, so complete—there's no need for the usual letter writing, question and answer correspondence! You learn at home—at your own pace!

10 Day Examination — Money Back Guarantee

Send today for these exciting new training courses—you risk nothing! When you receive the volumes, examine them in your own home for 10 days. If, at the end of that time, you're not completely satisfied, simply return the books to us and we'll gladly refund your full purchase price! Total cost for either 5-volume course is only \$9.00! In Canada, prices approx. 5% more.

ORDER TODAY!

These books are sold by electronics parts jobbers and book stores. If YOUR dealer doesn't have these books, mail this coupon!

JOHN F. RIDER PUBLISHER, INC.
480 Canal Street, N.Y.C.

Please RUSH me _____ sets of "Basic Electricity" @ \$9.00 per set, and _____ sets of "Basic Electronics" @ \$9.00 per set. I understand that I may return the books within 10 days and receive a complete refund of my full purchase price.

Name _____

Address _____

City & State _____ E

**Question
Box**



500-WATT FINAL AMPLIFIER

I have a small transmitter with an output of 75 watts on CW and 65 watts on AM phone on all bands. I would like the diagram of an r.f. amplifier to boost the output to 200-500 watts. I have a power supply delivering 1,120 volts at 500 ma. I'd like to use 811's.—
J. W., Greybull, Wyo.

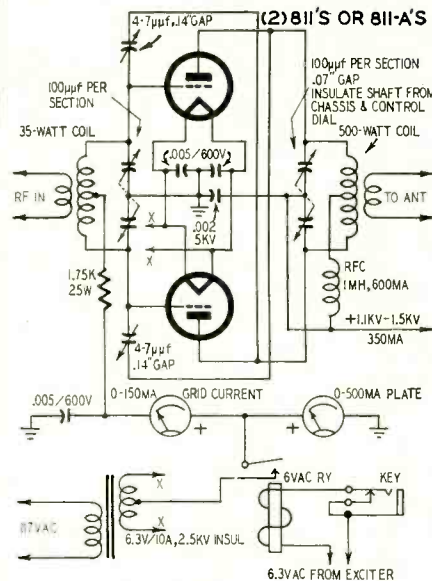

The circuit of a push-pull r.f. amplifier suitable for 811's, 811-A's, 812's, T-55's, 35-T's, and similar medium-power transmitting triodes is shown. The grid resistor value is for 811's and 811-A's. Use a 3,500-ohm, 25-watt unit of 812's and 812-A's. For other types, vary the value to give the required operating grid bias at the grid current recommended by the tube manufacturer. Select the proper filament transformer for the tubes used.

If you key the exciter, provide a means of automatically protecting the final if excitation fails. You can use fixed grid bias or grid-leak bias with enough fixed grid or cathode bias to limit the plate current to a safe level. Another method is to insert the coil of an overload relay in the center tap of the filament circuit. The relay contacts should be wired to open the final plate supply when plate current exceeds a safe level.

Your present modulator may be used as a driver for a 250-watt modulator by replacing its modulation transformer with a driver-type unit.

WANT POWER & VERSATILITY?

FOLLOW THE LEADER...



6V and 12V BATTERY ELIMINATOR and CHARGER #1050.
KIT \$29.95. Wired \$38.95.

- operates 6V and 12V auto radios for servicing and sales demonstration.
- charges 6V and 12V storage and Edison Batteries.
- operates mobile and marine receivers, transmitters, boat lights, electric trains, projection and other equipment.

SPECIFICATIONS

- 6-Volt range: 0-8V (up to 20 Amp.)
- 12-Volt range: 0-16V (up to 10 Amp.)
- variac-type transformer for continuously variable voltage adjustment.
- reads volts and amperes at same time on 2 separate meters.
- Transformer primary and secondary fully protected.

In stock at local jobbers throughout the world. Write for free Catalog CB-3
Prices 5% higher on West Coast



84 Withers Street
Brooklyn 11, N. Y.

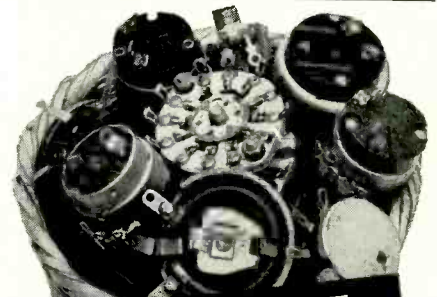

QUIETROLE

Reg. U. S. Pat. Off.

The ORIGINAL
NON-INFLAMMABLE
NON-CONDUCTIVE
LUBRICANT CLEANER



CONTROLS & SWITCHES like new by the BASKETFUL for only a few PENNIES . . . that's what QUIETROLE can do for you, and only QUIETROLE will give that long lasting smooth, quiet operation . . . even new controls last longer and operate quieter when treated with QUIETROLE . . . the original and most reliable product of its kind.

THE CHOICE OF BETTER SERVICEMEN "EVERYWHERE"
Supplied in 2, 4, and 8 oz. sizes. Ask for it at your distributor.

manufactured by

QUIETROLE COMPANY

Spartanburg, South Carolina

RADIO-ELECTRONICS

These are franchised *Fen-tone* Hi-Fi
Audio Equipment Distributors:

CANADA

Dominion Electrohome, 39 Edward Street, Kitchener, Ontario

CALIFORNIA

Thomas Tenney, 2984 College Avenue, Berkeley
Jack Schiefer, 2121 Blackstone Ave., Fresno
Guphill High Fidelity, 22 S. School St., Lodi
Electronic Sales, 1433 W. Pico Blvd., Los Angeles
Pacific TV Supply, 4032 S. Figueroa St., Los Angeles
True Tone Electronics, 812-14 N. Highland Ave., Los Angeles
Macdonalds Radio & Sound, 35 N. Santa Cruz, Los Gatos
Madera Music Co., 114 E. Yosemite, Madera
Griffin Furniture Co., 25 N. Knoll Rd., Mill Valley
Olin S. Grove, 2904 Telegraph Ave., Oakland
The Service Shop, 1553 Pine St., Redding
The Hi-Fi Shop, 3525 California St., San Francisco
Market Radio Sound Dept., 1240 Market St., San Francisco
San Francisco Radio & Supply Co., 1284 Market St., San Francisco
Television Radio Supply Co., 408 Market St., San Francisco
West Coast Electronics, 409 Market St., San Francisco
Allens Sight & Sound, 856 Monterey St., San Luis Obispo
High Fidelity Unlimited, 211 S. San Mateo Drive, San Mateo

FLORIDA

Flagler Radio, 1058 W. Flagler St., Miami
Southeast Audio Co., 930 West Adams St., Jacksonville

ILLINOIS

Electronic Expeditors, 2909 W. Devon Ave., Chicago
Lowe's Radio, 1217 E. 55th St., Chicago
Malone Electronics, 123 Addison St., Elmhurst

IOWA

Gifford Brown Inc., Box 1668, Cedar Rapids
Iowa Radio Supply, 508 Third Ave., Cedar Rapids

KANSAS

Western Distributors, 227 N. Santa Fe, Salinas
McClelland Sound Equipment Co., 229 W. William St., Wichita
Radio Supply Company, Inc., 115 Laura St., Wichita

KENTUCKY

Universal Radio Supply, 533 S. 7th St., Louisville

LOUISIANA

New Iberia Cart & Trailer Co., New Iberia
Electronic Parts Corp., 223-225 N. Broad St., New Orleans

MARYLAND

Fan Electronics, 4220 Dresden St., Kensington

MASSACHUSETTS

Bond Electronics, 42 Cornhill St., Boston
Electro Sound, 15 Halleck St., Boston
Lincoln Electronic Supply, 790 Commonwealth Ave., Boston
Radio Wire & TV, 110 Federal St., Boston
The Radio Shack, 167 Washington St., Boston
Hi-Fi Electronic Supply, 1077 Massachusetts Ave., Cambridge
Young and Young of Lawrence, 262 Lowell St., Lawrence
Radio Electronic Sales Company, 52 Chandler St., Worcester

MINNESOTA

Northwest Radio, 123 E. First St., Duluth
General Supply Co., 201 W. Lincoln Ave., Ferguson Falls
Ecklen Radio & Sound Co., 114 Lyndale Ave., Minneapolis

MISSOURI

Ebinger Radio & Supply Co., 2501-3 Jefferson St., St. Louis

NEBRASKA

J. B. Distributors, 1616 Case St., Omaha

NEW JERSEY

Magnetic Recording, 344 Main St., Patterson
Chas. Sparger, 34 E. Main St., Pennsgrove

NEW YORK

Adirondaek Radio Supply, 185-191 W. Main St., Amsterdam
Dares Radio, 22 E. Genesee St., Auburn
Radio Equipment Co., 312 Elm St., Buffalo
John L. Reusch, 169 Landon St., Buffalo
Island Radio Distributors, 412 Fulton Ave., Hempstead
Standard Parts Corp., 277 N. Franklin St., Hempstead
The Audio Exchange, 159-19 Hillside Ave., Jamaica
Arrow Electronics, 65 Cortland St., New York City
Goody Audio Centre, 235 W. 49th St., New York City
Harvey Radio Corp., 103 W. 43rd St., New York City
Heins & Bolet, 68 Cortland St., New York City
International Audio Exchange, 1101 Lexington Ave., New York City
Leonard Radio Corp., 69 Cortland St., New York City
Lyric Hi-Fi Workshop, 1332 Third Ave., New York City
Radio Wire & TV, 100 Sixth Ave., New York City
Sonscraft, 115 W. 45th St., New York City
Terminal Radio Corp., 85 Cortland St., New York City
Ravel TV, 204 Long Beach Road, Oceanside
Electronics TV Corp., 2 Purchase St., Rye
Stewart W. Smith, 325 E. Water St., Syracuse
Electronics Labs & Supply, 1415 Oriskany St., White Plains
High Fidelity Center, 367 Mamaroneck Ave., White Plains
Stentor Recording Machine Co., 469 Fourth Ave., New York City

NEVADA

Art Rembels Sound Supply, 460 Wells Ave., Reno

NORTH CAROLINA

Wemaek Electric Supply, W. Walnut Street, Goldsborough

MARCH, 1955

Imagine!

FOR THE BARGAIN PRICE

OF ONLY **\$154¹⁵**



You Get

TPR-1 TAPE PREAMP

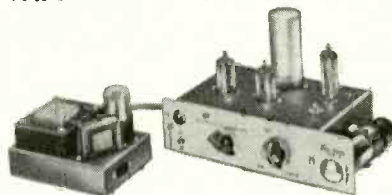

2 Fen-tone TPR-1 TAPE PREAMP

- Bias Frequency 45-55 Kc
- Signal-to-noise ratio 55 db
- Separate Power Supply and Hum-Balance Control
- One mike, One high level input
- High impedance (1 volt) output
- Tubes: 6X5GTA, 6AQ5, 12AT7, 5879, 6E5.

1 Fen-tone MOTEK TRANSPORT MECHANISM

- Driven by three individual AC motors.
- Speed 7 1/2 I.P.S., dual tracks.
- All electrical push button switching and braking.
- Hi-Fi record/playback and erase heads.
- Frequency response better than 50 - 10,000 C.P.S.
- WOW and FLUTTER less than .3%
- Accommodates 7" reels (1200").

3 Fen-tone PE REX CHANGER

- The only truly automatic and foolproof changer (patented), playing ten inter-mixed records, without pre-setting, in any odd size between 6" and 12".
- Precision built: free from rumble and acoustic feedback.
- Automatic muting switch. Automatic shut-off. Built in 3-stage tone filter. Spring mounted chassis.
- Price includes famous PE8 dual cartridge with sapphire stylus.

OR YOU CAN OWN A COMPLETE AUDIO SYSTEM* FOR ONLY \$173.90

1. Fen-Tone Motek Transport Mechanism
2. Fen-Tone PE Rex Changer
3. Fen-Tone TAP-2 complete Tape and Audio Amplifier
(*Less speaker).

FENTON COMPANY

15 MOORE STREET • NEW YORK 4, N. Y.

OHIO

Dillman Radio Supply, 389 W. Center St., Marion
Warren Radio Co., 1002 Adams St., Toledo

OREGON

Carlson, Hatton & Hay, 96 E. 10th Ave., Eugene
Northwest Radio, 110 S.E. Ave., Portland
Television & Radio Supply Co., 720 S.E. Alder St., Portland

PENNSYLVANIA

Air Tone Sound & Recording, 1527 Chestnut St., Philadelphia
Magnetic Recorder & Reproducer, 1533 Cherry St., Philadelphia
Sid Washers Electronic Supply, 522 W. Wyoming Ave., Philadelphia
Schuykill Electric Distributors, P.O. Box #656, Pottsville
Grove Enterprises, 1373-83 Easton Rd., Roslyn
Consolidated Distributors, 842-44 Capouse Ave., Scranton
Electronic Sales & Service, 734 Market St., Sunbury
West Hazelton Electronic Supply, 120-22 N. Broad St., West Hazelton
C. B. Minnich, 624 W. Market St., York

SOUTH CAROLINA

High Fidelity, 728 Saluda Ave., Columbia
The 59 Line, 209 W. Washington St., Greenville

TEXAS

Gulf Coast Electronics, 1110 Winbern St., Houston

VIRGINIA

Radio Parts Distributors, 128 W. Olney Road, Norfolk

WASHINGTON

Pacific Electronic Sales, 1209 First Ave., Seattle
Seattle Radio Supply, 2117 Second Ave., Seattle
Twentieth Century Sales, W. 1021 First Ave., Spokane
Kar Radio & Electric, Walla Walla

WEST VIRGINIA

James M. Black & Sons, 952 Market St., Wheeling

or at your nearest Hi-Fi center.

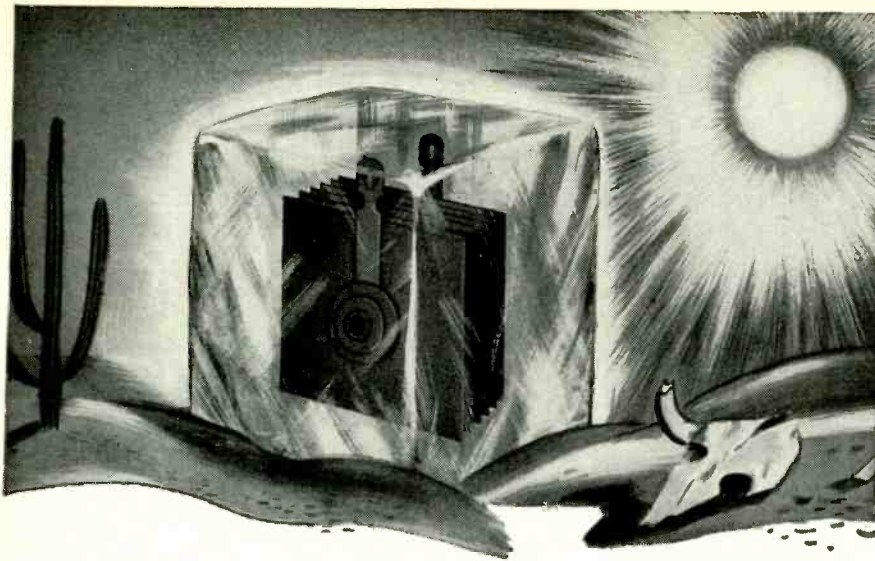

**They beat the heat in the
sizzling southwest!**

RADIO RECEPTOR

**selenium rectifiers with
"safe centers"**

Intense heat, humidity and blazing sunshine down in south Texas are *murder* on ordinary rectifiers. That's what servicemen at J. B. Penny Co., Inc., of Houston find every day when they check over ailing radio and TV sets. There's a simple solution, though. Replacements are invariably Radio Receptor rectifiers with the famous "Safe Centers."

"We've been using Radio Receptor rectifiers for over two years," says Mr. Penny, "because they take our extremes of temperature and humidity in stride, where other brands won't stand up. In our shop, selenium rectifiers are always replaced with Radio Receptor units."

The "Safe Center" feature in RRco. rectifiers means cool January performance right through the hottest months of summer. It eliminates arc-over danger, short circuits and heating at the center contact point — Complete protection during mounting and when in use.

You can bet on those bright green RRco. rectifiers for a sure thing, next time you need replacements. Insist on them when you order from your jobber.

Other Radio Receptor products: Germanium and Silicon Diodes, Germanium Transistors, Thermatron Dielectric Heating Generators and Presses, Communications, Radar and Navigation Equipment.



Semi-Conductor Division
RADIO RECEPTOR COMPANY, INC.

In Radio and Electronics Since 1922

SALES OFFICE: 251 WEST 19th STREET, NEW YORK 11
WATKINS 4-3633 • Factories in Brooklyn, N. Y.

QUESTION BOX

(Continued)

SELENIUM RECTIFIER QUERY

Selenium rectifiers are comparatively short lived in the bridge type low-voltage supply in my Radio Craftsmen TV receiver. After about a year of use, the output of the rectifiers drops about 10% and causes a noticeable reduction in high voltage. I've consistently replaced the original rectifiers with higher-current types but the output still drops in about a year. What causes this condition? Is there any way that I can eliminate it without constantly replacing the rectifiers?—J. L. J., Highland Falls, N. Y.

The condition is probably caused by normal aging of the rectifiers. It is characteristic for the forward and reverse resistances of a selenium rectifier to increase gradually over a period of time before stabilizing. The output voltage stabilizes at a value 5 to 10% lower than that of the new rectifier. In many applications the voltage drop is not noticeable. In others, it is necessary to compensate.

You can compensate in your set by reducing the value of the screen dropping resistor in the horizontal output stage until the screen and high voltages are approximately normal. This change may make the output stage harder to drive so you may have to apply the boosted B plus voltage to the horizontal oscillator tube.

XTAL CONTROL FOR S-82

My Hallicrafters S-82 Civic Patrol receiver drifts badly during and after the warmup so I would like a diagram showing how the oscillator can be converted for crystal-controlled reception on 42.62 mc. Can you help me?—T. A. R., Lincolnton, N. C.

The diagram at *a* shows the original variable-frequency oscillator circuit and the diagram at *b* shows the same circuit modified for optional crystal control on a single frequency in the set's 30-50-mc range. The dashed lines show the switches and components that are added. The switches are shown in the position for crystal control. The crystal

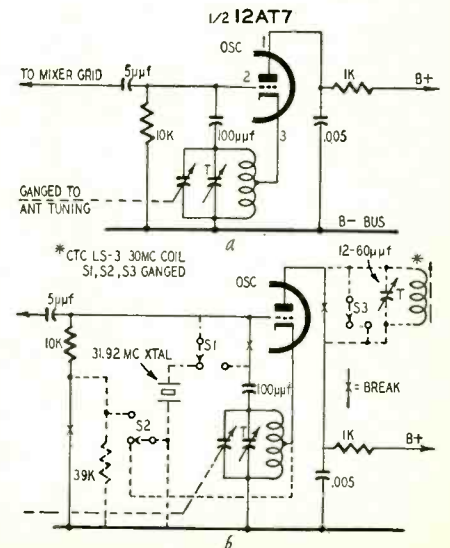

OUTSTANDING for HIGH FIDELITY!

**BUY DIRECT
AND SAVE**

**'PRE-FAB' COLLINS TUNERS
and RECEIVERS**
AUDIO PRODUCTS CO.

NOW! . . .
with AFC

Collins Audio Products Co. is an equal opportunity employer with Collins Radio Co.

Each Collins Tuner Kit is complete with punched chassis, tubes, power transformer, power supply components, hardware, dial assembly, tuning eye, knobs, wire, etc., as well as the completed sub-assemblies: FM tuning units, AM tuning units, IF amplifiers, etc., where applicable. All sub-assemblies wired, tested and aligned at the factory make Collins Pre-Fab Kits easy to assemble even without technical knowledge. The end result is a fine, high quality, high fidelity instrument at often less than half the cost—because you helped make it and bought it direct from the factory.

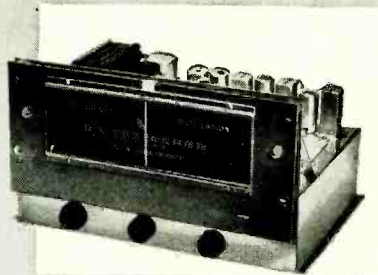

FM Tuner Kit

\$55

with AFC \$58.50

The FM-11 tuner is available in kit form with the IF Amplifier mounted in the chassis, wired and tested by us. You mount the completed RF Tuning Unit and power supply, then after some simple wiring, it's all set to operate. 11 tubes: 6J6 RF amp, 6AG5 converter, 6C4 oscillator, 6BA6 1st IF, (2) 6AU6 2nd and 3rd IF, (2) 6AU6 limiters, 6AL5 discriminator, 6AL7-GT double tuning eye, 5Y3-GT rectifier. Sensitivity 6 to 10 microvolts, less than 1/2 of 1% distortion, 20 to 20,000 cycle response with 2DB variation. Chassis dimensions: 12 1/2" wide, 8" deep, 7" high. Illustrated manual supplied. Shipping weight 14 lbs.

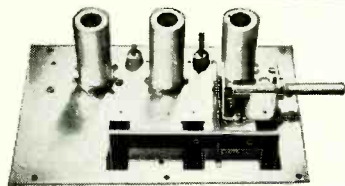

FMF-3 Tuning Unit

\$15²⁵

with AFC \$18.75

The best for FM. The most sensitive and most selective type of "front end" on the market. 6 to 10 microvolts sensitivity. Image ratio 500 to 1. 6J6 tuned RF stage, 6AG5 converter, 6C4 oscillator. Permeability tuned, stable and drift-free. Chassis plate measures 6 1/2" x 4 1/2". In combination with the IF-6 amplifier, the highest order of sensitivity on FM can be attained. Tubes included as well as schematic and instructions. Draws 30 ma. Shipping weight FMF-3: 2 1/2 lbs. Dial available @ \$3.85.

IF-6 Amplifier

\$19⁷⁵

6 Tubes. Shipping Wgt. 3 lbs.

FOR USERS OF COLLINS TUNERS:

Receive \$5.00 credit toward the new FMF-3A front end! Mail us your old front end with \$13.75 and we will send you the new, improved FMF-3A with AFC, or, remit the full amount of \$18.75 and when we receive your old unit in return a check will be mailed you for \$5.00.



AM-4 Tuning Unit

\$24⁵⁰

Tops in AM superhet performance! A 3-gang tuning condenser gives 3 tuned stages with high sensitivity and selectivity. Assembly is completely wired, tested and aligned ready for immediate use. Frequency coverage 540 KC to 1650 KC at a sensitivity of 5 microvolts. Tubes 6BA6 RF amplifier; 6BE6 converter; 6BA6 IF amplifier and 6AT6 detector. Draws 30 ma @ 220 volts. Mounts on a chassis plate measuring 4" x 7 7/8". Shipping weight 2 1/2 lbs. Dial available at \$3.85.



FM/AM Tuner Kit

\$77⁵⁰

with AFC \$81.00

The original 15 tube deluxe FM/AM pre-fab kit redesigned on a smaller chassis. The tuner now measures 14" wide by 12" deep by 7 1/2" high. This attractive new front and dial assembly opens up new applications where space is at a premium. Kit includes everything necessary to put it into operation—punched chassis, tubes, wired and aligned components, power supply, hardware, etc. Kit comprises FMF-3 tuning unit, IF-6 amplifier, AM-4 AM tuning unit, magic eye assembly and complete instructions. All tubes included. Shipping weight 19 lbs.



To: Collins Audio Products Co. Inc. RE-3
P.O. Box 348, Westfield, N. J.
Tel. WE8field 2-4390

- FM Tuner Kit FM/AM Tuner Kit FMF-3 Tuning Unit
- with AFC with AFC with AFC
- IF-6 Amplifier AM-4 Tuning Unit

NAME

ADDRESS

CITY STATE

Amount for Kit \$ See weights, add shipping cost \$

Total amount enclosed \$ Check Money Order

QUESTION BOX

(Continued)

operates 10.7 mc lower than the desired signal frequency so you can use James Knights H-173 or Bliley BH-6 types.

Section S1 of the changeover switch disconnects the oscillator coil and connects the crystal in the grid circuit. S2 grounds the cathode and connects the 39,000-ohm resistor into the grid circuit. S3 connects the plate coil (a CTC type LS-3 30-mc inductor) into the plate circuit.

Adjust the plate-coil slug and trimmer capacitor for minimum plate current in the oscillator when set for crystal operation. Set the receiver's tuning dial to the frequency to be received. A number of crystal-controlled spot frequencies can be received by using a 3-circuit switch having one more position than there are crystal-controlled frequencies. S1 selects the desired crystal, S2 is connected to ground the cathode in all crystal-controlled positions and S3 switches in trimmer capacitors as needed. In this case, the plate-circuit trimmer capacitor shown connects to the contact that is shown open on the diagram.

WHY A DOUBLE SUPERHET?

I am planning to purchase a new communications receiver but am at a loss as to what type or make to choose. Does a double-conversion superhet receiver have greater selectivity than a conventional circuit with a crystal filter?—S. H., Forest Hills, N. Y.

Image interference becomes a problem at frequencies above around 10 mc when the incoming r.f. signal is converted to an i.f. of about 450 kc. Raising the i.f. to 1.5 mc or higher greatly improves the signal-to-image ratio but results in lower gain and selectivity per stage. The double-conversion superhet is the solution to the problem of providing good image rejection without greatly increasing the number of tuned circuits in the front end. In the double superhet, the incoming r.f. signal is converted to some suitable frequency—not in the tuning range of the receiver—between around 1600 kc and 10 mc. This signal, the first i.f., is amplified and then passed to a second converter stage that changes it to a lower (second) i.f. usually between 150 and 50 kc. The second i.f. provides the required gain and adjacent-channel selectivity while the first provides the image rejection.

Using a specified number of tubes and tuned circuits in a receiver, it is generally possible to obtain greater sensitivity, selectivity and image rejection than from a single-conversion receiver with a 465-kc i.f.

Crystal filters are usually used to increase the selectivity of i.f. circuits operating at 450 kc or higher. At lower i.f.'s, adequate selectivity can be obtained by using variable-selectivity transformers, by connecting transformers back-to-back, and by using Wein bridge networks, bridged and parallel T's, and other types of filter arrangements.

END

WHEN YOU THINK OF TUNERS, THINK OF COLLINS AUDIO PRODUCTS

Patents

ACOUSTIC LENS AND WAVEGUIDE

Patent Nos. 2,684,724 and 2,684,725

Winston E. Kock, Basking Ridge, N. J. (Assigned to Bell Telephone Laboratories, Inc.)

Everyone knows that sound reflects from an obstacle. These inventions (described in RADIO-ELECTRONICS, July, 1950) show that sound may be focused and refracted as well. In Fig. 1 the solid, rigid disc D (shaded) is in the path of

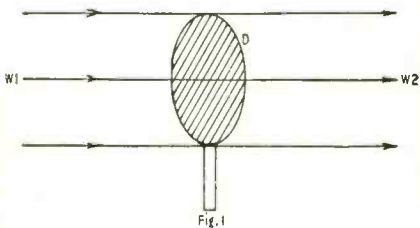

an advancing wave W1. The disc reflects some of the energy, creating a secondary wave of the same frequency as W1 but opposite in phase. These two waves combine to form a third wave W2 with the same frequency as its components. Its phase is intermediate between that of W1 and the reflected wave, so the phase of W2 lags that of W1. Thus, D slows the original wave and slightly weakens it.

A number of discs may be arranged in the form of a lens (Fig. 2). As with an optical lens, the wave slows down most where the lens is thickest. Thus the sound wave converges to a

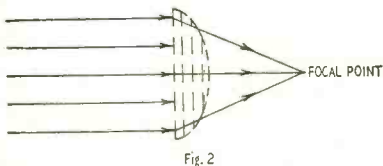

focal point. Such a lens may be used to improve hi-fi installations and public address systems. Normally, high-frequency energy concentrates in a narrow beam along the speaker axis. With a lens, the high-frequency energy may be dispersed over a wide area for more uniform coverage.

The discs or obstacles that make up an acoustic lens must be very small compared with the wavelength of the sound energy. In addition, the spacing between discs must be small. Instead of using separate discs, a lens can be made of perforated plates. The solid areas slow down the wave just as discs do.

Fig. 3 shows a series of discs mounted on a rod; M is a microphone. Normally, sound tends

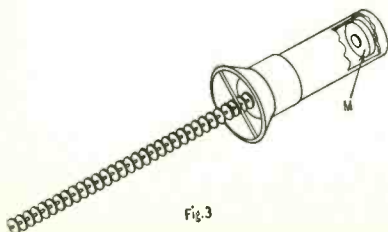

Here's why PERMA-TUBE backs up quality service:

1. **PERMA-TUBE IS CORROSION-PROOF** . . . it's treated with vinylsynite—then coated *inside and outside* with a metallic vinyl resin base. It's guaranteed to be free from rust in a salt spray test of 500 hours minimum: to an American Society of Testing Materials Specification B117-49T. This assures long life.
2. **PERMA-TUBE IS STURDY** . . . it's made of special, high-strength J&L Steel.
3. **PERMA-TUBE IS EASILY INSTALLED** . . . it's the only mast with *both ends* of the joint machine fitted.

Here's proof of how PERMA-TUBE resists corrosion:

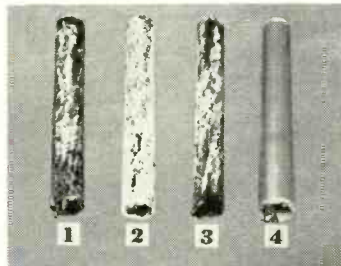

Test samples after 1440 hours
ASTM salt spray test

1. Coated Mechanical Tubing . . . note that galvanized coating is gone and underlying steel is severely corroded.
2. Coated Mechanical Tubing . . . note that paint coating is nearly destroyed and zinc coating is corroded.
3. Galvanized Mechanical Tubing . . . note zinc and steel are corroded.
4. PERMA-TUBE . . . note that Perma-Tube is relatively unharmed.

J&L STEEL

For further details on product and installation, write for a copy of the Perma-Tube booklet. Jones & Laughlin Steel Corporation, Dept. 495, 3 Gateway Center, Pittsburgh 30, Pa.

Jones & Laughlin

STEEL CORPORATION — Pittsburgh

arkay KITS

value unsurpassed

world's finest radio TV, and test kits

10-watt hi-fi amplifier kit



arkay kit model A-12: Top quality kit for home and industry with built-in pre-amp, for magnetic pickup, built-in equalizer networks, true bass and treble boost circuit controls and push-pull output with inverse feedback. Freq. resp.: 20-20,000 cps. — 1 db; hum: —70 db. below rated output. 5 tubes, 70 watts. Includes input selector switch front panel and elaborate instruction book. Complete with tubes.

\$22.95

hi-fi impedance baffle (knockdown form) for 12" speaker

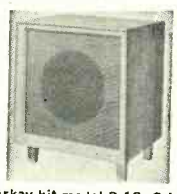

Arkay kit model B-12: Cabinet replica of a very expensive sound chamber, and constructed of sturdy, specially treated lumber; acoustically balanced. Front baffle plate of 1/2" thick sound absorbent material; reduces echo and eliminates cabinet resonance. Extended bass response possible. For use also (without legs) inside bar, credenza. Includes attractive grill cloth. Comes completely knocked down, easy assembling instructions anyone can follow.

\$9.95

hi-fi ac/dc amplifier kit



arkay kit model A-5: A high-fidelity AC/DC amplifier kit featuring a new, improved push-pull output circuit plus a specially designed output transformer utilizing 2 speakers for the new 3d-dimensional qualities of audio reproduction. New engineering developments give your hi-fi at the lowest possible price. Kit is complete, except for speakers.

\$9.95

hi-fi amplifier with built-in pre-amp



arkay kit model FL-10: A striking new design with physical dimensions and style for use on a shelf or corner without elaborate or expensive enclosures. Specifications: same as model A-12.

\$27.95

ac/dc radio kit

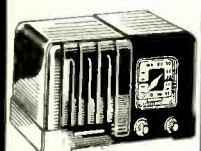

arkay kit model S-5E: New, 5-tube superhet. kit designed for radio students and hobbyists. Includes new 3D color instruction book, 550-1600 kc, complete with glistening walnut bakelite cabinet.

\$14.95

3-way portable radio kit

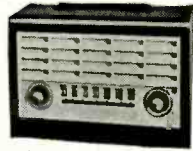

arkay kit model 3W10-P: A smartly styled portable radio kit that operates on AC/DC or self contained batteries. Has 4 tubes and selenium rectifier with a fine quality Alnico V speaker, built-in loop antenna and hi-gain coils. Includes pictorial and schematic diagrams that are easy to follow. Colorful plastic cabinet.

\$18.95

Write today for new catalog including complete arkay line of radio, TV, phonograph, amplifier and test equipment kits. Prices F.O.B. N.Y.

the world's finest kits
arkay RADIO KITS, INC.
120 Cedar Street
Bekman 3-6686 New York 6, N. Y.

PATENTS

to spread over an ever-widening area, but these discs keep it focused near the axis of the rod. This is an end-fire radiator. The longer the rod (with its spaced discs), the narrower the projected beam. The rod may be curved slightly without defocusing the beam, and if made long enough, may become a waveguide.

One radiator designed for 14.3 kc had the following dimensions: rod, 10 inches long, .093 inch diameter; discs, 0.35 inch diameter, .032 inch thick, 0.25 inch apart. The beam had a total spread of only 19° between the half-power points.

COLD GENERATOR

Patent No. 2,685,608
Eduard Justi, Braunschweig, Germany

When a thermocouple junction is heated, a voltage is generated. If the junction is cooled, a voltage of opposite polarity appears. This process is reversible. Current flow through the junction can be made to increase or decrease the temperature. Generally the temperature change is so small that it is of no practical value.

This inventor has discovered thermoelements

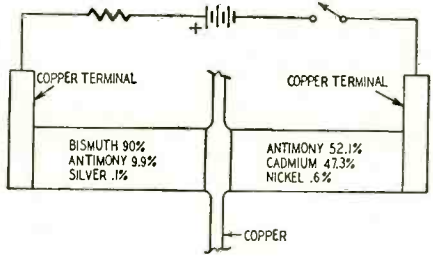

that produce considerable loss of heat. A drop of 27°C (48.6°F) has been observed. The thermoelements are joined by a strip of copper (see diagram). The copper has little thermal effect but it receives the cold and helps to spread it to adjacent areas.

The secret of this invention is the small percentage of iron, nickel or a similar metal alloyed with the thermoelements.

PROTECTIVE FLAME CONTROL

Patent No. 2,685,645

William H. Wannamaker, Jr., Flourtown, Pa. (Assigned to Minneapolis-Honeywell Regulator Co.)

Any fuel burner becomes a hazard when its flame dies out or becomes abnormal. This device automatically shuts off the flow of fuel under these circumstances.

A normal flame produces ionized gases, with positive ions moving toward the burner. Electrons flow toward the tip. This ionization furnishes positive grid bias to V2. Normally, there-

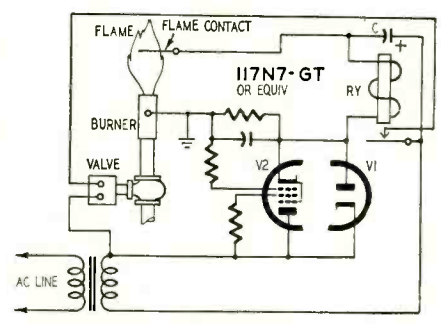

fore, the pentode has a low resistance. The d.c. output of V1 flows through V2 and the relay is not energized.

When the flame goes out or behaves abnormally, ionization ceases. The bias on V2 disappears and the tube resistance becomes high. This leaves the relay coil as the only effective load for V1. The diode conducts (during alternate half-cycles) through the coil. When the relay contacts close, they connect a valve mechanism across the a.c. power. The valve opens and removes the hazard.

(Continued)

PRINTED BATTERY

Patent No. 2,688,649

Johan Bjorksten, Madison, Wis. (Assigned to Bjorksten Research Laboratories for Electrochemistry, Inc.)

Transistors require very little power. Batteries now available for their operation are too large (in comparison with other transistor circuit components) and inefficient. They are required to supply so little current that they deteriorate from age rather than use. This patent shows how to make small batteries by a printing process.

An ink is made of fine iron particles suspended in an electrolyte and moistening chemi-

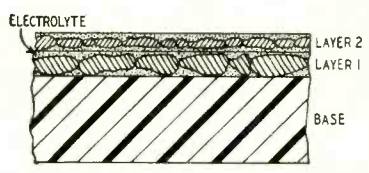

cal. It is deposited on a paper or plastic base by any standard printing method. While wet, the ink is subjected to a powerful magnetic field which aligns the metal particles so they contact each other. When this layer of ink is dry, a second layer is printed over the first. The second ink uses a different metal, for example, nickel instead of iron. Again a magnetic field aligns the metal particles so they touch. The iron and nickel act as "plates" of the cell. They are insulated by the electrolyte.

Any desired voltage can be generated by printing alternate ink layers one over the other. The first and last layers are provided with terminals for connection to the external circuit.

REGULATED ALPHA COUNTER

Patent No. 2,689,309

John R. Mahoney, Oak Ridge, Tenn. (Assigned to United States of America as represented by the U. S. Atomic Energy Commission)

An alpha counter is essentially a tube containing two electrodes and a gas atmosphere. Radioactivity ionizes the gas and initiates the flow of charged particles. The sensitivity of a counter depends upon the voltage between electrodes. There is an optimum region (Fig. 1) where sensitivity is high, yet the voltage is not sufficient to sustain a continuous discharge.

The optimum region varies with gas temperature and pressure. In this counter a control tube

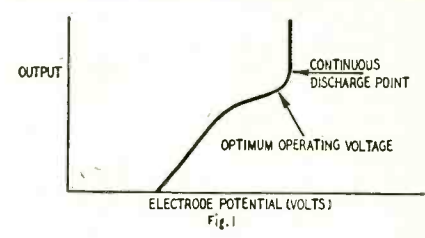

regulates the voltage applied to the probe. The control unit and the probe may be similar to each other, and both are vented to the same gas atmosphere.

Fig. 2 shows control unit P1 and probe P2. Due to changes in temperature, the optimum

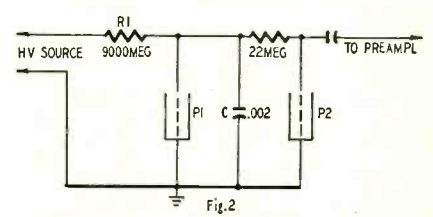

operating point may be displaced, for example to the right. This increases the current through P1 and R1. The high voltage is dropped until P2 receives the correct potential required.

NOTHING LIKE THIS
IN BASS BEFORE!

University WOOFERS



MODEL C8W
8"

LOW FREQUENCY
REPRODUCER

Ideal for assembling a compact, limited space, high quality system . . . perfect too, as mid-range unit in low cost three-way system. Can also be used in multiples as expanding woofer. Eight ohms impedance, 25 watts power capacity.



MODEL C12W
12"

ADJUSTABLE
RESPONSE
WOOFER

Contains exclusive built-in facilities for limiting high end response to 700, 2000 or 5000 cycles, thus suiting crossover requirements of most tweeters. Overall response 40-6000 cycles. Handles 30 watts, impedance 8 ohms.



MODEL C15W
15"

DUAL
IMPEDANCE RANGE
SUPER WOOFER

Acme of attainable perfection in the specific reproduction of low frequencies. Two spiders for positive piston action. Greatest axial voice coil depth and excursion—Six lb. Alnico 5 magnet. Die-cast girder construction for lifetime trouble-free operation. Adjustable voice coil permits match to 4-8 ohms and 10-16 ohms. Defies obsolescence. For 50 watt systems.

For descriptive literature write desk 59

Another engineering achievement of

University
LOUDSPEAKERS, INC.



80 SOUTH KENSICO AVENUE, WHITE PLAINS, N. Y.
Ask For Progressive Speaker Expansion

MARCH, 1955

PATENTS

(Continued)

HIGH-POWER TRANSISTOR

Patent No. 2,689,930

Robert N. Hall, Schenectady, N. Y.
(Assigned to General Electric Co.)

This method of transistor-making results in a semiconductor that passes considerable current and withstands high inverse voltages. The center of the crystal is pure germanium. Acceptor material (like aluminum) is diffused into the crystal. This absorbs electrons and makes a rich p type region. Donor material (like antimony) is diffused into the crystal on the other side. This results in an extremely rich n type layer.

The high-resistivity pure germanium can withstand 500 volts or more. The high-conductivity n and p layers are capable of passing considerable current.

Fig. 1 shows an excellent high-power rectifier.

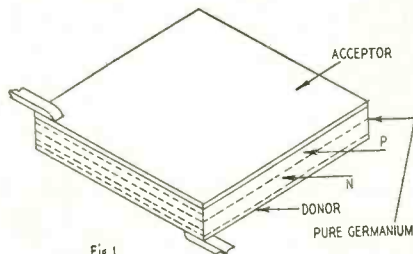

Fig. 1

To make a transistor, grooves are ground into the crystal (Fig. 2). Alternate n areas are connected together to act as emitter and collector. The p area becomes the base of the n-p-n junction transistor.

A semiconductor of this type may be used as a current control device. Being a p-n junction unit which has both the high reverse voltage characteristic of previous high-voltage types and the high forward current characteristic of previous high-current types, this device makes an unusually efficient high-power rectifier or transistor.

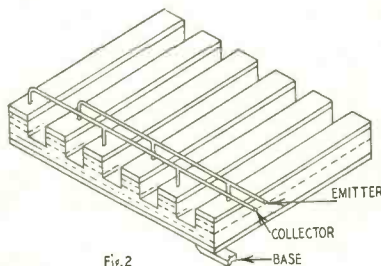

Fig. 2

TV FILTER

Patent No. 2,688,119

Ansel J. Gere, Norwood, Mass.
(Assigned to Gabriel Co., Cleveland, Ohio)

This crossover network for video signals permits the use of a single antenna (or combination of antennas) and a single transmission line for all channels. The u.h.f. is separated from the v.h.f. at the end of the line, each being fed to its own receiver (see diagram). Circuit components are printed for compactness and efficiency at high frequencies. A low-pass network

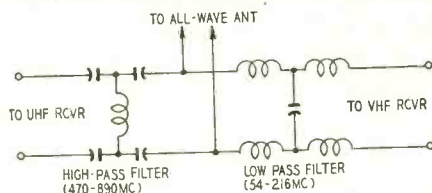

is at the right and a high-pass filter at the left.

Using printed-circuit techniques, a strip of high-dielectric plastic holds all components. Capacitors are formed by metallic strips printed on opposite sides of the plastic. Coils are printed spirals. Eyelets pass through the plastic, making connections to both surfaces. The high-pass filter uses split capacitors in both leads, adding to the unit's compactness. END

THE ANSWER IS University TWEETERS

WHATEVER
THE PROBLEM . . .

- Crossover
- Power Capacity
- Impedance
- Dispersion
- Response
- Cost

NEW!

MODEL HF-206
SUPER TWEETER

High frequency response far beyond audibility. Super-efficient high output driver and horn assembly using "reciprocating flares" principle. Suitable for crossover 3500 cycles or above. Dispersion 120° x 60°, eight ohms impedance.



MODEL 4401
TWEETER

Uses "reciprocating flares" wide angle horn and bina fide compression driver. Exceptional performance at modest cost. Eight ohms impedance, suitable for crossover down to 2000 cps.



MODEL 4402
WIDE ANGLE DUAL TWEETER

Electrical and acoustical characteristics make it the most versatile high frequency tweeter available. Driver can be connected for use in 4-8 and 10-16 ohm systems. Dispersion pattern variable with interconnection of drivers. High power capacity. For 200G cycle crossover or above.



MODEL 4408

For wide range reproduction in moderate power systems requiring a crossover down to as low as 600 cycles. Heavy, resonant-free horn casting. Dispersion 120° x 60°. Eight ohms impedance.

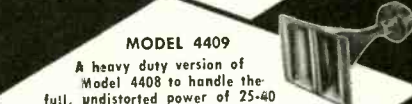

MODEL 4409

A heavy duty version of Model 4408 to handle the full, undistorted power of 25-40 watt amplifiers in 2-way systems, and 50 watts in 3-way systems.



MODEL COBREFLEX/T-30

For use in 2- or 3-way systems when crossover as low as 350 cycles is desired. Exclusive die-cast dual wide angle horn. Eight ohms impedance. Will handle high power.

For descriptive literature, write Desk 58

Another engineering achievement of

University
LOUDSPEAKERS, INC.



80 SOUTH KENSICO AVENUE, WHITE PLAINS, N. Y.
Ask For Progressive Speaker Expansion

Leading a brand new line...
1000°
OF CALIBRATED BANDSPREAD!

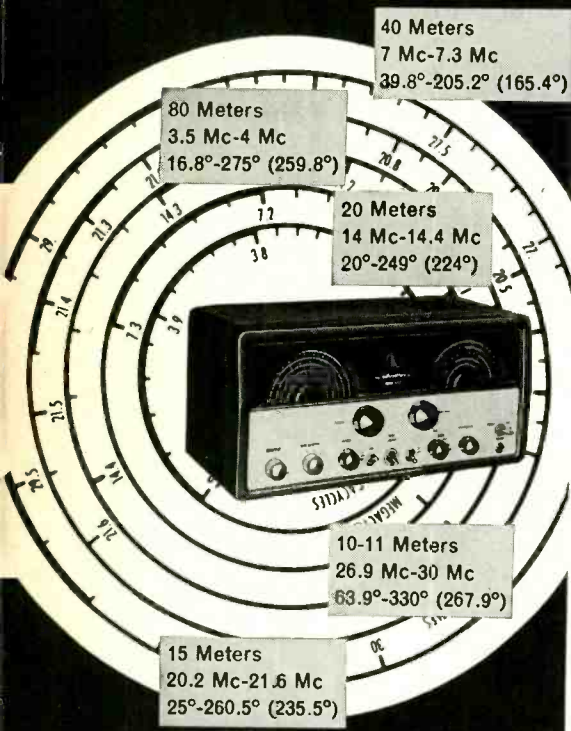

MODEL S85
S-85 Receiver (AC)
S-86 Receiver (AC-DC)
105/125 V. 50/60 cycle
Either \$119.95

We here at Hallicrafters are proud of our new communications line, especially the new S-85 receiver with over 1000° of calibrated bandspread. Broadcast band 540-1680 Kc and three short-wave bands 1680 Kc—34 Mc on large easy to read dial. Separate bandspread tuning condenser and built-in speaker. Seven tubes plus rectifier. Coupon below brings complete specifications.

*Used by 33 governments,
Sold in 89 countries.*

hallicrafters
Chicago 24, Illinois



MAIL THIS COUPON

FREE World-wide time converter
Specification sheet S-85(S-86)
 S-95(S-94) S-38D
Name _____
Address _____
City _____ Zone _____ State _____
 Ham (call letters _____) Listener
Occupation _____

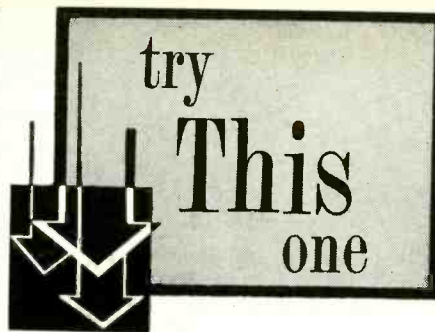

SPEAKER CONE REPAIRS

I use ordinary rubber cement to repair damaged loudspeaker cones. A toothpick is used as the applicator. Rubber cement is flexible when dry and does not cause tinny reproduction and crackling as hard-drying cements are likely to do.—*James J. Maroney*

(Mr. Maroney sent us a section of a speaker cone that had a long rip along the edge and a 1/2-inch square cut out about half way down the flare. The repairs were neat and only slightly less flexible than the rest of the specimen of the cone.—*Editor*)

CLEANING A TV MASK

Technicians who have been stymied by blemishes on plastic TV masks and safety glass often can get perfect results by using Johnson's Car Plate polish. Apply the polish with a damp cloth, allow it to dry a few minutes and then buff lightly. Excessive rubbing or too much pressure may mar the plastic finish. This polish is also excellent for cleaning the area around the anode cap on the picture tube when arcing is troublesome.—*Clifford Lessig*

PROTECTING GLASS VIALS

You can minimize breakage of bottles of coil dope, service cement, contact cleaner and other service chemicals in your tool kit by removing the sponge rubber sleeves from defective vibrators and slipping them over the bottles.—*Kai Klemm*

STOP TV TAMPERING

Perchance other TV service technicians have encountered the same trouble I have. How many times I have been called to repair a TV set only to find that the owner has tampered with the set's service controls.

Here is a simple trick I use to deter set owners from tampering with the controls: I have added a roll of extra-wide adhesive tape to my tool kit. I cut it into strips and place it directly over the service controls of every set I install or service. With the tape in place, I locate the screwdriver slot in the control by indenting the tape with my fingernail and mark the direction of the slot with a pen. When I suspect that someone has meddled with the service controls of a set, all I have to do is note whether or not the pen marks on the tape are parallel with the screwdriver slots in the controls. If they are not I know that someone has been experimenting.—*John A. Comstock*

STAN-BURN E-D-A-R-K-E

GATHODE RAY TUBE SPECIALS

ONE YEAR GUARANTEE

G. E.		STAN-BURN	
* 10BP4A	\$14.95	10BP4	\$10.20
10FP4A	21.10	12LP4	11.90
* 12KP4A	24.45	12P4A	13.95
* 12LP4A	18.75	12QP4	11.90
12QP4A/B1014	21.00	12JP4	14.50
* 12UP4B	28.75	12UP4A	15.50
14CP4	24.50	14CP4	17.50
15DP4/B1014	23.75	15DP4	17.50
* Dumont	30.95	16KP4 or A	17.50
16AP4A	25.25	16JP4 or A	17.50
16DP4A (N.U.)	31.25	16CP4 or A	17.50
* 16GP4 or B	24.20	16FP4	17.50
16KP4/16RP4	28.35	16WP4	17.50
* 16RP4A (Aluminum)	25.25	16AP4	23.00
16JP4A (N.U.)	28.50	16AP4A	23.00
16LP4A	26.50	16EP4	23.50
* 16WP4A	31.25	16EP4A	21.00
16GP4B	34.50	16GP4 or A	18.50
* 17BP4B	35.75	17BP4	22.50
17CP4	34.00	17CP4A	22.60
* 17GP4B (Aluminum)	38.50	19FP4	23.00
19AP4A	41.50	19FP4A	24.00
* 20CP4	30.00	19AP4	23.90
20LP4	37.50	19AP4A	24.90
* 21AP4	42.00	20CP4	23.95
21EP4	32.80	21EP4	25.50
* 21EP4A	37.35	21AP4	26.50
24AP4	78.50	24AP4	49.00

PRICES SUBJECT TO
CHANGE WITHOUT NOTICE

AUTHORIZED DISTRIBUTORS for: General Electric, Kenrad, Tung-Sol, National Union, De Wald, Regal, Automatic and General Motors.

AUTOMATIC CUSTOM-BUILT RADIOS for Plymouth, Ford, Chevrolet and many others, always in stock. We carry a complete stock of HI-FIDELITY and SOUND EQUIPMENT. Send us your requests. We also carry a complete line of popular makes of Radio parts and transmitting types, and all electronic parts and equipment at lowest prices. Send us your requirements for prompt quotations. Terms: 20% with order, Balance C.O.D. All prices FOB, NEW YORK Warehouse. Minimum order \$5.00. Write for our latest price list and Hi-Fi Catalog to Dept. RE-3

STAN-BURN RADIO and ELECTRONICS CO.
1697 BROADWAY • NEW YORK 19, N.Y.

INTERCOM SPECIAL!

STEVE-EL
(House of Bargains)
HAS DONE IT AGAIN!

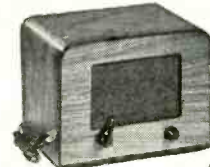

Now you can own an intercom that has a thousand uses at a price you would normally pay for a kit.

This intercom comes housed in wooden cabinets completely wired and ready to operate. Outfit consists of one master, one sub station and fifty feet of two wire cable. Ideal for home as baby sitter. Perfect for office or factory. Order now as quantities are limited.



YOUR COST COMPLETE, **\$15⁹⁵** only

FREE BARGAIN CATALOG • WRITE DEPT. RE-3

STEVE-EL Electronics Corp.
61 Reade St. New York 7, N. Y.

New VU Magnemite*



Spring-Motor Battery-Operated Portable Tape Recorder

Now you can consistently make professional recordings under the most gruelling field conditions. Tapes will faultlessly play back on all professional and home recorders. Ruggedly designed for maximum dependability and top-notch efficiency. Combines unlimited versatility of performance with extreme simplicity of operation. Choice of fourteen models available for every conceivable application.

Incorporates a multi-purpose VU monitoring meter for precise setting of recording level without earphone monitoring. Meter also accurately indicates condition of "A" and "B" batteries. Five single speeds as well as two, three and 4-speed models available. Units weigh only 19 lbs. with batteries and measure 6½" x 9½" x 14¼". Higher speed models meet NARTB standards. All recorders are guaranteed for One Full Year.

Write for complete technical specifications and direct factory prices to Dept. RE:

AMPLIFIER CORP. of AMERICA
398 Broadway, N. Y. 13, N. Y.

INSIST ON
THE GENUINE

NEW INCA

Quickie #2

the 10 WAY WRENCH

WITH 1,001 USES!

ONLY **98¢** Slightly higher
W. of Miss.

Small head for hard-to-reach places... Fits all hex nuts & bolts from ¼" to ¾", plus ¼" sq. Finest made, rugged, alloy construction, hard chrome finish.



AT YOUR JOBBER
If he cannot supply, write to

J.E.S. CO.

111-47 Lefferts Blvd.
S. Ozone Park 20, L. I., N. Y.

OSCIL-O-PEN

Extremely convenient test oscillator for all radio servicing: alignment • Small as a pen • Self powered • Range from 700 cycles audio to over 600 megacycles u.h.f. • Output from zero to 125 v. • Low in cost • Used by Signal Corps. • Write for information.

GENERAL TEST EQUIPMENT
38 Argyle Ave. Buffalo 9, N. Y.

TRY THIS ONE

(Continued)

FERRITE-ROD ANTENNAS

Portables and older a.c.-d.c. receivers with loop antennas wound around and cemented to the inside of the case are very difficult to realign. You can't reach the trimmers when the set is in the cabinet. To work on the chassis outside the cabinet you have to unsolder the antenna leads and then resolder them. Even then, you can't do a good alignment job. Tracking will be off when you reinstall the chassis because it changes the inductance of the loop.

My solution to this problem is to remove the loop and replace it with a ferrite-rod antenna. The cost is low and the customer will usually agree to the change when you explain that performance is likely to improve considerably with the new antenna and that future repair bills will be lower because of the time saved in removing and replacing the chassis.—*Milan Rafayko*

OPEN HEATER WINDINGS

Now and then small four- and five-tube transformer type sets come into the shop with open or intermittently open heater windings. Often it is impossible to find direct replacements for these transformers because of their size or odd mountings, and because of the compactness of these receivers there is no place to put a small filament transformer.

Quite often these sets can be saved for the customer by changing the rectifier tube. For example, if you have a four-tube set with an open 5-volt winding and a 5Y3 rectifier, cut the 5-volt winding and replace the 5Y3 with a 6X5, hooking its heater in the 6-volt string. Usually the transformer's 6-volt winding will be sturdy enough to handle the extra 0.5-ampere drain.

If you have an open 6-volt winding and a 5Y3 or similar tube you can change the 5Y3 for a 6X5 and use the rectifier winding to light all 6-volt heaters. The slightly lower heater voltage quite often is unnoticed. (A lightly loaded 5-volt winding designed for a 2- or 3-ampere drain will often supply as much as 6 volts.—*Editor*) But remember, the heater amperage should not exceed the rated amperage of the rectifier tube, which for a 5Y3, 80, or 5Y4 is 2.—*B. W. Welz*

BURNED-OUT YOKES

If you have to replace a burned-out yoke in a TV set and it won't come past the base of the picture tube, cut through the yoke parallel to the neck of the tube. You can then pull it apart and easily remove it. This doesn't take long and it will prevent damage to the base that might result from forceful removal.

In cases where a sufficient number of turns remain to permit current to pass through the coil, it may help appreciably to "soften" the yoke by applying d.c. across the yoke terminals and letting the yoke heat up.—*Sim S. Eagleson, Sr.*

no matter
how you look
at it...

INTERNATIONAL'S
Replacement
Rectifier...

is the
Replacement Rectifier
that's Right!

all types available from
your parts distributor

**INTERNATIONAL
RECTIFIER
CORPORATION**

El Segundo, Calif. ORego 8-6281

NEW YORK

CHICAGO

World's Largest Supplier of
Quality Industrial Rectifiers

*W9WJV beats
last year's
Field Day record
with hallicrafters*



Lawrence T. Fadner, team captain in Chicago's 1954 North Suburban Ham Club ARRL 40 meter CW Field Day bettered the club's last year record by nearly 30%.

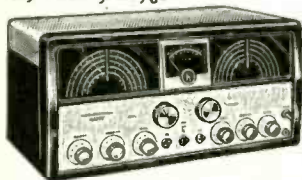

and Hallicrafters SX-96 is hot news too. More hams are telling each other about this new receiver than about any equipment in years.

*Used by 33 governments,
sold in 89 countries*

hallicrafters
CHICAGO 24, ILLINOIS

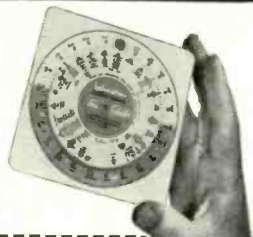

MAIL THIS COUPON
FREE—Send me World-wide Time Conversion Dial Calculator and all band frequency allocation chart plus a fund of other handy data.

Name _____
Address _____
City _____ State _____
 Ham (call letters _____) Listener
Occupation _____
Hallicrafter equipment I would like to know about: _____

TRY THIS ONE (Continued)
CODING CABLED LEADS

In emergencies we sometimes use wire of a single color to make up long multiconductor cables for intercoms, remote controls and other applications. A problem arises when we try to identify quickly the ends of the various conductors. Our solution is to apply different voltages to each of the conductors and then measure the voltages that appear at the far end of the cable.

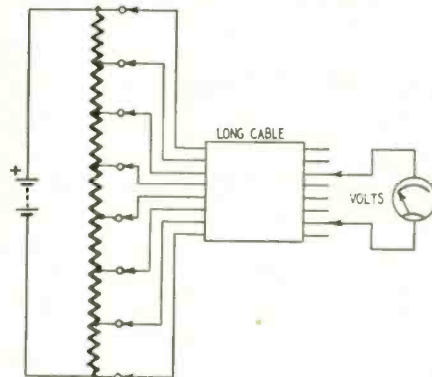

Connect a tapped resistor (or a string of resistors in series) across a battery or other power supply delivering a conveniently low voltage. Mark or code the leads and connect them to points on the voltage divider. Record the voltage on each lead. You can identify the leads at the far end in the shortest possible time by measuring the voltages across them as shown in the drawing. —Wu Hing Chang

RECEIVER ALIGNMENT

When aligning a set with a signal generator, wedge a piece of solder lightly between the plates of the oscillator tuning capacitor. You will find that it will effectively prevent interference from the set's oscillator as well as protect the plates from becoming bent. This method is much better than wedging a screwdriver, wire or some other hard material between the plates. —Sim S. Eagleson, Sr.

(This method is usually very effective. But a few sets have been manufactured which have high voltage on the oscillator capacitor stator. If one of these old-timers comes into the shop, look out!—Editor) **END**

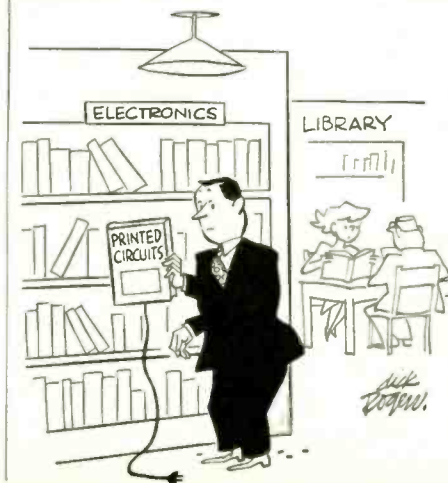

**NEW! ATLAS CJ-30
COBRA-JECTOR**
INDESTRUCTIBLE FIBER-GLASS
ALL WEATHER
WIDE ANGLE DISPERSION



List \$40.00
NET \$24.00
Complete with Driver.

Weatherproof Line Matching Transformer as shown, Net \$5.10.

New versatile all-purpose projector—excellent for paging & talk-back, intercom, marine, and industrial voice & music systems. Penetrating articulation assures wide angle intelligible coverage even under adverse sound conditions. "ALNICO-V-PLUS" magnetic assembly. Double-sealed against all weather. Omni-directional mounting bracket. Quick, easy installation. An amazing "power package"—Specify the CJ-30 for the "tough" jobs!

Input Power (continuous)	15 watts
Input Impedance	8 ohms
Response	250-9000 cps
Dispersion	120° x 60°
Dimensions:	Opening, 14" x 6"
	Overall Length, 14"



WRITE FOR COMPLETE CATALOG
ATLAS SOUND CORP.
1443—39 St., Bklyn. 18, N. Y.
In Canada: Atlas Radio Corp., Ltd., Toronto, Ont.

**FOR MAXIMUM ALL-CHANNEL
FRINGE AREA PERFORMANCE**

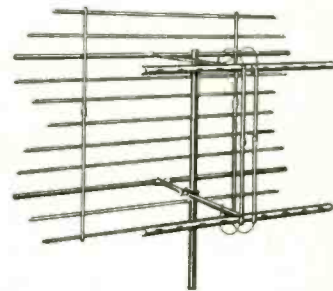

"TARGET 88"

With highest front-to-back ratio and minimum side pick-up.

\$34⁹⁵ List

Also conical, Yagi-type and corner reflector antennas. First to use Fibreglas insulators. Write for information on open territories.

S & A ELECTRONICS
1025 Nevada Avenue, Toledo 5, Ohio



Merchandising and Promotion
Ward Products Corp., a division of the Gabriel Co., Cleveland, designed a



new mobile TV antenna display which may be hung from the ceiling or fixtures.

Allied Radio Corp., Chicago, sponsored the "Fine Arts Quartet" in the first of a series of 13 chamber music concerts presented at Kimball Hall, Chicago. The concerts are being broadcast over radio station WFMT, Chicago.

Electronic Measurements Corp., New York City, is promoting its test equipment with a special "Basic Service Shop" introductory offer, through which purchasers may buy a v.t.v.m., signal generator, and tube tester at a special price. They also receive a picture tube adapter and two instrument stands as premiums. The offer is good for a limited time only.

Belden Manufacturing Co., Chicago wire manufacturer, is now packaging



its TV antenna cable in an attractive package designed to eliminate stocking problems and to serve as a counter display.

MARCH, 1955

GREATEST TUBE BUYS

EVERY TUBE GUARANTEED A FULL YEAR

Branded—Bulk Packed in Original Mfr's. Nested Cartons or Individually Boxed
JOBBERS! DISTRIBUTORS! We have a Wonderful Deal For You. Write—Wire—Phone!

0A2	5.87	1U4	46	6AT6	36	6N7	95	7F7	64	125F5	48	35Z3	40
0A3 VRT5	37	1U5	40	6AU6	40	6Q7	40	7F8	90	125F7GT	68	35Z5GT	35
0A4G	60	1X2	55	6AV5GT	79	6R7	49	7G7	80	125G7	70	37	35
0B2 VRS	74	2A3	90	6AV6	36	6S4	39	7K7	80	25H7	70	39-44	35
0B3 VR105	90	2A5	49	6AX4GT	57	6S7G	55	7L7	77	125J7	55	42	40
0C3 VR105	95	2A6	49	6B7	93	6SA7	40	7M7	57	125K7GT	49	45	53
0D3 VR150	85	2A7	60	6B8G	29	6SC7	75	7Q7	57	125L7GT	50	45Z3	40
0E4	40	2A8	52	6B8G	38	6SD7GT	38	7R7	59	125M7GT	50	46	45
1A4P	35	2X2	39	6B7A	55	6SF5GT	45	7S7	83	125Q7GT	53	46	85
1A5GT	40	2X2A	114	6BC5	49	6SF7	58	7T7	85	125R7	59	49	38
1A7GT	45	3A4	44	6BE6	37	6SG7	40	7W7	85	1223	39	50L6GT	61
1A85	38	3A5	90	6BF5	69	6SH7	60	7X6	57	14A4	65	50K6	62
1B3GT	57	3ABGT	59	6BG6G	115	6SH7GT	50	7Z4	45	14A7	55	50Y6GT	57
1C5GT	40	3A7	39	6BG6	45	6S7	54	7Z4	45	14A7	59	56	47
1C7C	37	3D6	38	6BJ6	41	6SK7	39	12A6	49	14F7	59	56	45
1D7GT	75	3LF4	71	6BK7	89	6SL7GT	49	12A7	49	14F7	59	56	45
1E7GT	35	3Q1	48	6BL7GT	65	6SN7GT	48	12A7	49	14F7	59	56	45
1F4	40	3Q5GT	48	6BN6	89	6SQ7	49	12A7	49	14F7	59	56	45
1F5G	44	3S4	46	6BQ6GT	75	6SR7	45	12AT6	35	14C7	65	71A	1.00
1H4G	40	3V4	50	6BQ7	88	6ST7	59	12AV6	44	14E6	65	71A	1.00
1H5GT	38	3TR	1.25	6C4	35	6TB	57	12AU6	36	14E7	80	77	53
1J6G	59	5U4G	49	6C5	39	6U7G	45	12AU7	59	14F7	65	75	43
1L4	45	5V4G	76	6C6	54	6V6	48	12AV7	64	14M7	57	82	67
1L6	85	6A4	85	6G6G	74	6V7	59	12AX4GT	55	14N7	67	83	52
1LA4	59	5Z3	33	6C8B6	42	6W4GT	41	12AX4GT	55	14Y4	67	85	57
1LA6	75	6A6	45	6C8B6G	1.05	6W6GT	35	12AY7	72	19	45	85	57
1L84	77	6A7	80	6D8	95	6X5	35	128A6	47	19B6G	1.15	89Y	25
1LCS	59	6A8	65	6D8G	95	6X5	35	128A7	59	19T8	75	117L7GT	1.17
1LC6	75	6A8A	42	6E5	76	6X8	70	12B6	46	22	40	117Z3	38
1LD5	49	6A87	41	6E7	74	6Y4	45	12B6G	46	25AV5GT	80	117Z4GT	73
1LDS	75	6AC5GT	95	6F7	90	7A5	55	12B6E	45	25AV5GT	75	117Z6GT	70
1LG5	75	6AC7	68	6F8G	69	7A6	65	12B7	34	25L6GT	40	2051	93
1LN4	75	6AF4	85	6G6G	65	7A7	65	12B7G	34	25W4GT	45	803	2.95
1LN4	55	6AF6G	75	6H6	49	7A7	65	12F5GT	35	25Z6GT	45	803	2.95
1NSGT	51	6A65	47	6J5	38	7AG7	55	12H6	45	25Z6GT	45	814	3.50
1P5GT	56	6A7	89	6J5	38	7AH7	49	12I7	49	25Z6GT	45	832A	5.95
1Q5GT	55	6AH6	98	6J7	49	7B4	44	12J7GT	57	26	42	866A	1.45
1R4	81	6AK5	59	6J8G	90	7B5	55	12K7	53	27	37		
1R5	47	6AL5	39	6K7GT	45	7C4	55	12L7	57	32L7GT	95		
1S4	55	6AQ5	39	6K7G	38	7C4	55	12Q7G	57	35C5	37		
1S5	40	6AQ6	36	6K8G	64	7C7	65	12SRGT	60	35L6GT	45		
1S6	48	6AQ7GT	68	6L6G	62	7E6	60	12S7GT	62	35W4	52		
1T4	46	6A55	62	6L6GA	99	7E6	65	12SC7	68	35Y4	44		

Our Tubes are of Excellent Quality Because—

1. We've specialized in selling vacuum tubes exclusively for many years.
 2. All tubes offered herein are obtained from Receiver Manufacturers' surplus, various gov't. agencies and other surplus sources. Most of these tubes are brand new and the balance is removed from gov't. and other equipment.
 3. WE UNCONDITIONALLY GUARANTEE EVERY TUBE YOU BUY.
- Our modern, completely equipped laboratories check every tube received. You are invited to see this special equipment in operation.
- Even though our inventories include almost every tube type made over the past 20 years—in quantities of more than a million assorted types—it is impossible to list every type. You are, therefore, urged to include any additional types required in your order.
- Minimum Order: \$10.00. Terms: 25% with order, balance C.O.D. Please include postage. All prices subject to change without notice.

TRANSAMERICA ELECTRONICS CORP.

115 LIBERTY ST., NEW YORK 6, NEW YORK

OUR GREATEST BARGAIN

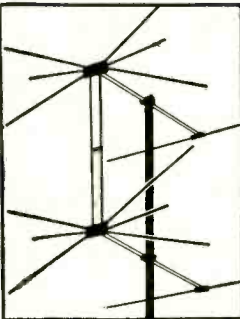

**2-BAY
16-ELEMENT
CONICAL ARRAY
With Hi-Band
Adapters
Sturdy 3/8" Ele-
ments**

\$4.99 IN LOTS
OF
EACH THREE
SINGLE LOTS \$5.30

Never before has National Electronics had a BARGAIN like this. We made a special purchase in order to get these sensational prices. And this array has everything. This included 2-bay 16-element array provides

ultra-fine fringe reception. Includes sixteen 3/8 inch air-plane type aluminum elements, including hi-band adapters for greater gain on the high channels and is complete with one pair of stacking bars to each array. These are packed in cartons of three 16-element arrays per carton, with tie rods at \$14.95 per carton. Money back if not satisfied.

- When purchased in single 16-element arrays, separately boxed—your cost is... \$ 5.30 each
- 3 Two-Bay Arrays per carton without Tie Rods.....\$13.50 carton
- 4 Bay Ultra-Fringe Stacking Assembly for Above—Model 4B.....\$1.95 set

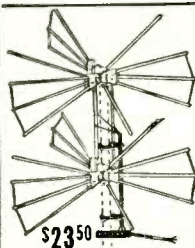

**360° Super Directronic
Electronically Rotates
in All Directions VHF-
UHF CHANNELS 2-83**

Powerful, 24 element 2 bay Directronic antenna is electronically beamed to any transmitter in fringe area by 6-position selector switch. No motors or electricity. Extremely high gain. COMPLETE WITH 6-POSITION DIRECTRONIC BEAM SECTOR TUNING TABLE. TRI-X CABLE. UNIVERSAL U-CLAMPS. Order model AX-524. Money back if not satisfied.

NEW CATALOG AVAILABLE

National Electronics
OF CLEVELAND
THE HOUSE OF TV VALUES
6608 Euclid Ave. Dept. E-3 Cleveland 3, Ohio

SHOOT TV TROUBLE FAST!

With H. G. Cisin's Copyrighted RAPID "TV TROUBLE SHOOTING METHOD"

Without experience or knowledge, this guaranteed new method of servicing TV sets enables you to DIAGNOSE TV troubles as rapidly as an expert. NO THEORY—NO MATH—you can locate all faults in record-breaking time, regardless of make or model. "TV TROUBLE SHOOTING METHOD" is the most valuable aid to TV servicing ever written. Be a TV Trouble Diagnostician. Increase your present earnings. Open your own Profitable Business or get a high-paying skilled job.

It's all in this book... Nothing more to Pay—Nothing else to Buy. Alphabetically listed there are 85 picture troubles, over 58 raster and 17 sound troubles and by this unique copyrighted method you know EXACTLY WHERE the trouble is; plus step-by-step instructions, including 69 RAPID CHECKS, enabling you to find the faulty part.

13 IMPORTANT PRELIMINARY CHECKS NEED NO INSTRUMENTS! Of the 69 Rapid Checks, OVER 65 ALSO REQUIRE NO INSTRUMENTS! Rapid checks include emergency checks for distorted pictures, defective tubes including PIX tube, plus 57 others. ALL EXPLAINED IN SIMPLE LANGUAGE. PERFORMED WITHOUT INSTRUMENTS MANY CHECKS USE THE PICTURE TUBE AS A GUIDE. H. G. Cisin, the author, is the inventor of the AC/DC midjet radio. He licenses RCA, AT&T, etc. He has also trained thousands of technicians now owning their own prosperous TV service organizations or holding highly paid TV positions. His years of experience are embodied in this remarkable new TV TROUBLE SHOOTING METHOD.

Guaranteed. Money Back in 5 Days if Not Satisfied!

Send coupon & receive ABSOLUTELY FREE a copy of H. G. Cisin's book "TV TUBE LOCATOR" with Trouble Indicating charts of 3000 TV models, selling for \$1. ACT NOW—get both books postpaid at cost of only one!

RUSH COUPON NOW!

H. G. CISIN, CONSULTING ENGINEER,
Amagansett, N.Y. Dept. E-32
Enclosed find \$1. Rush both books.

Name.....
Address.....
City.....Zone.....State.....

NEW AGAIN, FIRST WITH THE LATEST! What's a reputation worth?

It's priceless since Hallicrafters' reputation, firmly built on over twenty years of electronic leadership reflects our precision-built products, our craftsmanship and our future. These new models, in keeping with Hallicrafters' high standards, uphold this tradition of quality.

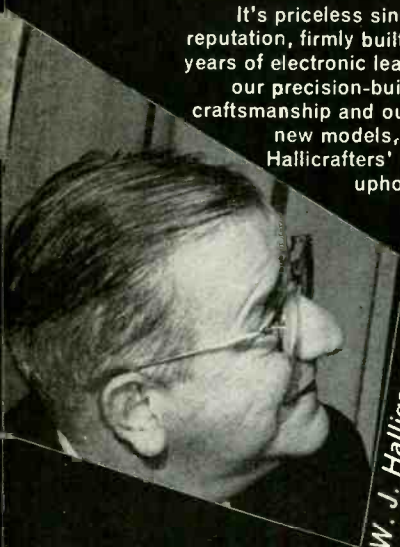

W. J. Halligan

Low cost unit with high priced performance over Broadcast Band 540-1650 kc plus three short-wave bands from 1650 kc-32 Mc. Electrical band-spread operates over large easy-to-read dial. Headphone tip jacks on rear and powerful built-in PM speaker. Oscillator for reception of code signals. Four tubes plus rectifier. 105/125 V. 50/60 cycle AC/DC \$49.95

Model S-38D



Bill Halligan, Jr.

These two new Civic Patrol receivers are over 10 times as sensitive as previous models, greater increased audio power output and built-in relay squelch system. Perfect for monitoring, police, fire, taxicab, telephone-mobile, forestry, Civil Defense. The S-94 covers 30-50 Mc and the S-95 150-173 Mc. Built-in speaker and provisions for headphones. Eight tubes plus rectifier. 105/125 V. 50/60 cycle AC/DC \$59.95

Write for complete specifications.

Model S-94 (S-95)



hallicrafters
CHICAGO 24, ILLINOIS

BUSINESS

Production and Sales

RETMA reported the production of 6,513,292 TV sets and 9,138,955 radios for the first 11 months of 1954. This compares with 6,766,040 TV sets and 12,267,441 radios for the 1953 period. The association noted that TV set production of 858,501 units for November set a record for that month.

RETMA reported the retail sale of 6,223,332 TV sets and 5,272,155 radios, exclusive of automobile sets, during the first 11 months of 1954. These figures compare with 5,600,423 TV and 5,608,477 radios sold during the 1953 period.

RETMA announced that cumulative sales of cathode-ray tubes for the first 11 months of 1954 were 8,904,106 units valued at \$188,660,782 compared with 9,194,851 tubes worth \$219,922,667 for the 1953 period. Manufacturers' sales of receiving tubes for the first 11 month of 1954 were 347,180,564 as against 413,687,529 in 1953.

Calendar of Events

1955 Joint Western Computer Conference and Exhibit, March 1-3, Statler Hotel, Los Angeles.

1955 IRE Show, March 21-24, Kingsbridge Armory, Bronx, N.Y.

Fourth Regional Seminar for Parts Distributors, April 1-2, Paxton Hotel, Omaha, Nebr.

Spring Assembly Meeting of the Radio Technical Commission for Aeronautics, April 5-7, Los Angeles.

Ninth Annual Spring Technical Conference of the Cincinnati Section of the IRE, April 15-16, Engineering Society of Cincinnati Building, Cincinnati, Ohio.

New Plants and Expansions

General Instrument Corp., Elizabeth, N.J., is completing a five-point program for the expansion of its Canadian operation now based on Kitchener, Ont. The plan includes the new plant which was recently opened in Waterloo, Ont.

RCA Engineering Products Division, Camden, N.J., opened an engineering laboratory in Waltham, Mass., for the development of specialized electronic fire-control systems for military aircraft. Dr. Robert C. Seamans, Jr., well known authority on airborne electronics, was named manager of the new laboratory.

Northwest Radio & Television School, Portland, Ore. and Hollywood, Cal., opened a new resident training school unit in Chicago.

Heppner Manufacturing Co., Round Lake, Ill., is building a 10,000 square foot addition to its present plant.

Motorola's Communications and Electronics Division established a new research and development laboratory in Riverside, Cal.

Magnecraft Electric Co., Chicago, moved to larger quarters which triples the space of its former quarters.

Show Notes

The 1955 Western Electronic Show and Convention will be held August 24-26 in San Francisco, Cal. Management

(Continued)

of the 1954 WESCON announced that that show had broken all previous records for attendance and exhibits. The Board of Directors issued a refund of 5% to all exhibitors.

Audiorama 1955, sponsored by the Audio Engineering Society in conjunction with Audio Fairs, will be held October 13-16 in New York.

RADIO-ELECTRONICS will exhibit in Booth 452 in the Kingsbridge Armory at the IRE Show in New York, March 21-24.

Business Briefs

... General Electric Tube Department general manager J. Milton Lang, predicted that about one out of every six TV sets would need a new picture tube during 1955, creating a need for over 5½ million new TV picture tubes.

... RETMA released a report "Unit Territory Plan—to Serve the Jobber Better" which was based on an 18-month study by its Jobber Relations Committee.

... Daystrom, Inc., Elizabeth, N.J., purchased the Heath Co., Benton Harbor, Mich., manufacturers of the Heathkit electronic instrument kits. The Heath Co. has an annual sales volume of \$6,000,000. It will be operated as a subsidiary of Daystrom. Robert Erickson, a vice-president of Daystrom, was elected president of Heath and will continue as an officer of the parent corporation. The purchase was made from Helen C. Anthony, widow of Howard Anthony, late president and founder of the Heath Co.

... United Motors Service, Division of General Motors Co., Detroit, Mich., has set up a Distribution Council to foster closer relations with its distributors. It is made up of 15 distributor members who will meet with top United Motors executives three times during the year to discuss problems of marketing, advertising, sales, etc. The first meeting will be held this month in Detroit.

... Telrex Corp., Asbury Park, N.J. and Channel Master Corp., Ellenville, N.Y., concluded a licensing agreement under a Telrex patent covering conical antennas. The agreement settles a litigation between the two companies.

... RETMA announced the establishment of an Automation Committee and an Industrial Relations Department. Walter Hausz of General Electric is chairman of the Automation Committee and Robert C. Sprague, Jr., Sprague Electric, will head the Industrial Relations Department.

... Equipto Division of Aurora Equipment Co., Aurora, Ill., is making available free the services of its engineers to help its clients in arranging their stock room layouts.

... Du Kane Corp., St. Charles, Ill., has established a new purchasing set-up which in addition to normal procurement for established production, includes a specialized office for exploring new materials and sources of supply. Edwin E. Swick, formerly purchasing agent, has been reassigned as purchase manager of the new operation. END



So much is happening in electronics today, that if you don't want to end up on the shelf with the coherer, or other "new developments" of yesterday, you need a steady source of reliable information on everything new or current in the field. Only RADIO-ELECTRONICS gives you so much timely, readable, and valuable information on TV, radio, audio-high fidelity and other phases of electronics. Here is a glimpse of just a few of the features in store for regular readers in the months ahead.

Some Aspects of Intercarrier Buzz

Causes and elimination—by the popular engineer-author, Bob Middleton.

Servicing Dog TV Receivers

More in this series on how to solve the troublesome problems which beset the service technician.

New Ideas in Horn-Type Speaker Systems

A careful review of a subject of great importance in high-fidelity work.

Test Capacitors with Your Ohmmeter

A gadget that makes a good capacitor checker from your regular bench multimeter.

Electronics Searches for Oil

Techniques and equipment used in this branch of electronic prospecting.

You gain by subscribing now

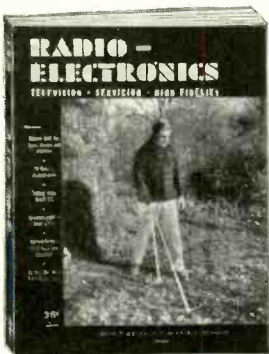

First of all you save considerably over the newsstand price—up to \$5.05 on a three year subscription—and secondly, you are sure of getting RADIO-ELECTRONICS every month without interruption. That way you won't miss even one important feature.

THREE YEARS—\$8.00

You save \$5.05 over the newsstand price

TWO YEARS—\$6.00

You save \$2.70 over the newsstand price

ONE YEAR—\$3.50

You save 85c over the newsstand price

START YOUR SUBSCRIPTION NOW

RADIO-ELECTRONICS, Dept. 35
25 West Broadway
New York 7, N.Y.

Please enter my subscription as indicated

- 3 Years—\$8.00 2 Years—\$6.00 1 Year—\$3.50
 Remittance enclosed I'll pay when billed.

NAME _____ Please print
STREET _____
CITY _____ ZONE _____ STATE _____

Rad-Tel for I FULL YEAR Guaranteed Tubes

70% to 90% off • SAME DAY SERVICE • ALL TUBES INDIVIDUALLY BOXED • 400 TYPES ALWAYS IN STOCKS

For Quality—Performance—Dependability

Type	Price	Type	Price	Type	Price
OZ4M	.65	6AU6	.46	7C6	.59
1AX2	.62	6AV5GT	.83	7F7	.79
1B3GT	.73	6AV6	.40	7H7	.59
1E7	.29	6AX4GT	.65	7N7	.69
1H4	.30	6BA6	.49	7Q7	.66
1LA6	.69	6BC5	.54	7Y4	.69
1LH4	.69	6BC7	.82	12A4	.60
1LN5	.59	6BE6	.51	12AL5	.37
1R5	.62	6BG6G	1.25	12AT6	.41
1S5	.51	6BH6	.53	12AT7	.72
1U4	.57	6BJ6	.49	12AU6	.46
1U5	.50	6BK5	.80	12AU7	.60
1X2A	.63	6BK7	.80	12AV6	.39
3A3	.80	6BL7GT	.83	12AV7	.73
3AU6	.46	6BN6	.74	12AX4	.67
3BC5	.54	6BQ6GT	.98	12AX7	.63
3BN6	.74	6BQ7	.90	12B4	.60
3CB6	.54	6BZ7	.90	12BA6	.49
3Q4	.59	6C4	.40	12BE6	.51
3Q5GT	.69	6CB6	.54	12BF6	.39
3S4	.58	6CD6	1.11	12BH7	.63
3V4	.58	6CF6	.64	12BY7	.65
4BQ7	.90	6CS6	.51	12CU6	.98
4BZ7	.96	6H6GT	.41	12SA7GT	.65
5AW4	.59	6J5GT	.48	12SJ7M	.67
5J6	.64	6J6	.52	12SK7GT	.63
5T4	.79	6K6GT	.45	12SL7GT	.57
5U4G	.55	6L6	.84	12SN7GT	.52
5U8	.75	6Q7	.45	12SQ7GT	.56
5V4	.71	6S4	.48	12V6GT	.46
5Y3GT	.37	6SA7GT	.55	12X4	.38
6AB4	.44	6SH7GT	.49	14A7	.63
6AC7M	.86	6SJ7GT	.41	14B6	.63
6AF4	.90	6SK7GT	.53	14R7	.79
6AG5	.56	6SL7GT	.48	19B6G	1.39
6AG7M	.99	6SN7GT	.59	19T8	.69
6AH4	.57	6SQ7GT	.46	25AV5GT	.83
6AH6	.73	6T4	.99	25BQ6GT	.98
6AK5	.75	6T8	.80	25L6GT	.51
6AK6	.59	6U8	.78	35B5	.52
6AL5	.42	6V6GT	.50	35C5	.51
6AM8	.78	6V8	.86	35L6GT	.51
6AN8	.78	6W4GT	.47	35W4	.47
6AQ5	.50	6W6GT	.57	35Y4	.54
6AQ6	.37	6X4	.37	35Z3	.59
6AQ7	.70	6X5GT	.37	35Z5GT	.47
6AR5	.45	6X8	.75	50A5	.55
6AS5	.50	6X8	.69	50B5	.52
6AS6	1.49	7A7	.75	50C5	.51
6AT6	.41	7A8	.68	50L6GT	.61
6AU4GT	.68	7B7	.49	80	.43
6AU5GT	.82	7C5	.69	117Z3	.37

Send for Free List of Over 400 Tubes and Parts Catalog



SELENIUM RECTIFIERS Mfd. by FEDERAL

65 DC-Ma.	each .59	250 DC-Ma.	each 1.39
75 DC-Ma.	each .69	300 DC-Ma.	each 1.49
100 DC-Ma.	each .79	350 DC-Ma.	each 1.59
150 DC-Ma.	each .84	400 DC-Ma.	each 1.69
200 DC-Ma.	each 1.25	500 DC-Ma.	each 1.79

TERMS: A 25% deposit must accompany all orders—balance C.O.D. All shipments F.O.B. Irvington warehouse. **ORDERS UNDER \$10—\$1.00 HANDLING CHARGE** . . . Subject to prior sale.

PLEASE: Send full remittance . . . allow for postage and save C.O.D. charges! We refund all unused money.

Rad-Tel TUBE CO.

'Integrity Is Our Chief Asset'
115 COIT ST., IRVINGTON II, N. J.



LEARN COLOR UHF, MONOCHROME TELEVISION



Edward M. Noll

nationally known TV consultant, teacher and writer **MAKES IT EASY**

in the new revised edition of his famous **TELEVISION for RADIOMEN**

Complete course in one volume

All in one book—at much less cost than the average course of lessons—you'll get **THOROUGH**, practical training for the best jobs in TV. You'll know the fundamentals of both transmission and receiving; the practical techniques of installation, alignment, adjustment, trouble-shooting; the latest improvements, transistor circuits, UHF, color.

You'll **UNDERSTAND TV**; be able to handle service work expertly, efficiently; be well qualified for the hundreds of high-paid technical openings in TV today.

Easy to learn

Each step in theory is explained in clear non-mathematical terms and is applied to circuit set-up and operation so you see exactly how to use theory in practical work. Many schematics and how-to-do-it examples help you learn both theory and practical techniques easily and thoroughly. Study questions insure your understanding.

Prepares you fully for work on color TV, UHF

You'll learn each detail of the NTSC color system; the function of each circuit, the special installation and adjustment techniques, the service problems and how to handle them. You'll know the principles and all practical details of the intercarrier I-F system, the best antenna installations for UHF.

There is no better, more up-to-date, or more thorough book on television fundamentals.

HERE is your ticket to the best TV technical jobs today!



THE MACMILLAN CO.,
60 Fifth Avenue, New York 11, N. Y.

RE-6

Please send me a copy of *Noll's Television for Radiomen, Revised*. I will either remit the full price of \$10.00 plus a few cents delivery charge, or return the book in ten days. (SAVE: Send check or money order and we pay delivery charge.)

Signed _____

Address _____

This offer good only within continental limits of U.S.A.

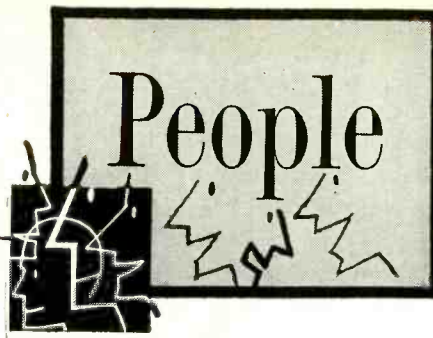

William H. Kelley was elected vice president and general manager of all manufacturing and sales divisions of Allen B. Du Mont Laboratories, Clifton, N. J.



W. H. Kelley



W. C. Scales

William C. Scales was appointed manager of the Receiver Sales Division. Kelley was formerly vice president, marketing, and Scales, sales manager of the Cathode-Ray Tube Division.

Harold F. Bersche was promoted to the new position of manager, Marketing Services Department, of the RCA Tube Division, Harrison, N.J. He has held



H. F. Bersche



D. M. Branigan

executive sales and merchandising positions with the company for the past 10 years. Durward M. (Max) Branigan, former promotion manager for the division's Receiving Tube and Transistor Marketing Department, succeeds Bersche as manager, Distributor Sales. Branigan will supervise the Tube Division's distributor field sales force and have responsibility for sales of division products handled by distributors.

Marion Pettegrew was promoted to general manager of the Sylvania Parts Division in Warren, Pa. He was formerly general manufacturing manager and acting general manager of the division. In his new position he will be in charge of the division's four plants at Warren and York, Pa., and Nelsonville and Cleveland, Ohio.



Thomas Roy Jones, president of Daystrom Inc., Elizabeth, N. J., was elected a director of Western Electric, Newark, N. J.



Lawrence E. Kearney was appointed sales manager of LaPointe Electronics, Rockville, Conn. He has been with the company since 1950 as a design and sales engineer. For the past six months he has assumed the responsibility of sales manager.

Herb Cornelius was promoted to sales manager of Littelfuse Inc., Des Plaines, Ill. He was formerly assistant sales manager.



Personnel Notes

... Raymond W. Durst, executive vice president of Hallicrafters, Chicago, was elected president, succeeding William J. Halligan who was elected to the newly created post of chairman of the board. Other executive personnel changes include the promotion of Michael D. Kelly, television sales manager, to director of marketing for television and home radio; William J. Halligan, Jr., communications sales manager, to director of marketing for the division, and Caleb A. Shera, district sales manager, to director of distribution for television and home radio.

... Myles M. Walker was promoted to manager of marketing research of Raytheon Manufacturing Co., Waltham, Mass. He was formerly a marketing analyst. A. E. Keleher, Jr. is the new product manager of Raytheon's communications equipment. He will also continue as staff assistant on the company's product planning committee.

... David Wadrow, manager of the Quality Control Department of Shure Brothers, Chicago, was appointed Membership Chairman of the Chicago Section of the American Society for Quality Control.

... Edward Berliant who has been asso-

LAFAYETTE'S SPECTACULAR MULTITESTER VALUES

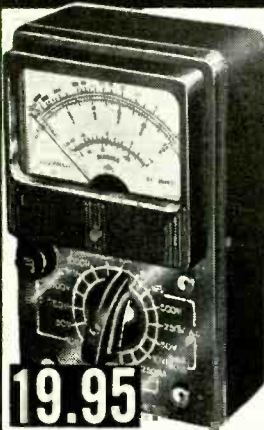

HIGH SENSITIVITY AC-DC MULTITESTER 20,000 ohms per Volt

The new Lafayette High Sensitivity Multitester is a complete instrument (not a kit). Here is an instrument packed with every desirable feature found only in instruments costing twice as much. One of the most sensitive multitesters ever offered. 20,000 ohms per volt DC; 8,000 ohms AC, having a high sensitivity 45 microamps meter. Full scale AC-DC voltage ranges are 0-10V, 0-50V, 0-250V, 0-500V, 0-1000V; DC current ranges 50 microamps, 2.5 ma, 25 ma, 250 ma. Resistance: 0-5K ohms, 0-50K ohms, 0-500K and 0-5 megohms. Decibel range: -20 +5 db; +5 +22 db (0 db - 0.775V - 600 ohms). Extreme versatility and accuracy. 1% precision resistors; 3" meter; beautiful plastic front, with metal bottom for ruggedness. Size: 3 3/4" x 5 3/4" x 2 3/4". Complete with batteries and leads. Shpg. Wt. 4 lbs.

19.95

MODEL RW-30G NET **19.95**
In lots of 3 **19.25**

NEW POCKET AC-DC VOM MULTITESTER 1,000 ohms per Volt

9.95

This instrument is one of the best buys that Lafayette has ever offered in a Wide Range AC-DC MULTITESTER. An ideal portable unit that meets the need for a compact, yet rugged test instrument. Has ease of operation usually FOUND ONLY IN MORE EXPENSIVE INSTRUMENTS. Has 1000 ohms/volt sensitivity on both AC or DC. Uses full 3" rectangular meter with large easy to read scale. Uses 1% precision resistors, jeweled D'Arsonval microamp meter movement. Ranges: AC-DC and output volts 0-5, 0-25, 0-250, 0-1000V; DC current 0-1, 0-10, 0-100. MA: Resistance 0-10K and 0-100K ohms. In handsome sturdy bakelite case. Size: 4 3/4" x 3 3/4" x 1 3/4". Supplied Complete with test leads and batteries. A Must for every serviceman shop, Laboratory or experimenter—and at Lafayette's Price you can afford to own one. Shpg. Wt. 2 1/2 lbs.



MODEL RW-27C—Complete | In Lots of 3 **9.45**
Single, ea. **9.95**

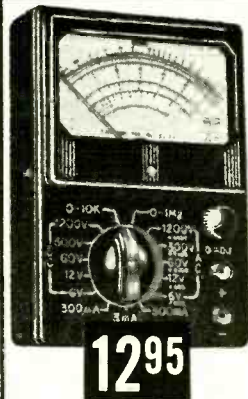

SENSITIVE AND ACCURATE AC-DC MULTITESTER 2000 OHMS PER VOLT ON BOTH DC AND AC

An unusual buy in a very accurate and sensitive VOM. Features single selector switch for all ranges. Has 3", sensitive 140 microamp meter, 2000 ohms per volt on both AC and DC, 21 full scale ranges, consisting of AC-DC Voltage Ranges: 0-6; 0-12; 0-60; 0-300; 0-1200 Volts; DC Current Ranges: 0-300 ua; 0-3 MA; 0-300 MA; Resistance Ranges: 0-20 K ohms; 0-2 Meg-ohms; Decibels: 0 db +6 db; +20 db; +34 db; +46 db (0 db - 0.774V).

12.95

Extreme versatility and accuracy. 1% precision resistors; beautiful plastic front with metal bottom for ruggedness and shielding. Size 3 3/4" x 5 3/4" x 1 3/4". Shpg. Wt. 3 lbs.

MODEL RW-360 Complete
In lots of 3 **12.45**
Singly, ea. **12.95**

NOW!—A ROTATOR AT A BUDGET PRICE ROTOR QUEEN

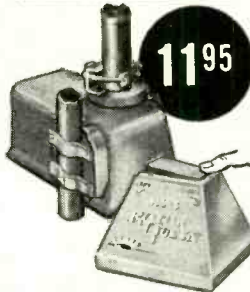

11.95

Here is a rotator that is engineered with outstanding quality features, but without any fancy doodad to add to cost. Weather sealed all aluminum housing with maximum mast support—antenna sets 3" into drive unit. Full 370° rotation in each direction with instant braking for pinpoint accuracy. Direct gear drive for high torque—no worm gears. Lifetime oilite bronze side thrust bearing, rustproof parts. Guy wire supports and flagpole type base for easy installation. Control unit of mahogany polystyrene only 3 3/4" x 3 3/4" x 3 3/8". Fingertip control. Shpg. Wt. 7 lbs.

RMS R-55 Rotator.....Net **11.95**

ACCESSORIES

Thrust bearing for above
RMS TB-2.....Net **2.91**
3-wire cable for above per hundred ft. **1.50**
WR-49.....per ft.....**.02**

COMPENSATOR

for G. E. CARTRIDGE
Designed for use with G.E. reluctance cartridges and preamplifiers. Five settings include LP, AES, Flat, Good 78 and Poor 78. No circuit loss is produced by use of equalizer. A must where greater bass and treble response is desired. Flat position gives maximum high frequency response. No wiring required—just plug in. With lead and plug. 2 1/2" x 2" x 2"—Max. depth 4". Stock No. PK-61.....NET **4.95**



DUAL STYLUS — TRIPLE PLAY



DIAMOND and SAPPHIRE

(LP) (70)
LIST \$34.00

Replacement for All G.E. RPX-050 Triple-Play Cartridges!
Stock No. PK-29 Net **11.95**

Lafayette Greatest Tape Buy Ever!



\$1.89 per roll plus postage (C.O.D. accepted)

1200 FT. REEL
Genuine Plastic Base
RECORDING TAPE
Shpg. Wt. 14 oz.

LAFAYETTE made a terrific deal with one of the leading manufacturers of recording tape to supply us with their regular tape which sells for almost twice our price. WE GUARANTEE ABSOLUTE SATISFACTION OR YOUR MONEY BACK. The finest, professional quality recording tape obtainable. Highest performance for thousands of playings. Red Oxide Base in a smooth, uniform coating; greater signal strength; with maximum fidelity; uniform frequency response from 40-15,000 cps. In lots of 10 rolls - **1.75 ea.**

LAFAYETTE EXCLUSIVE! DYNAMIC EAR PHONE

A new lightweight plastic ear phone especially imported by Lafayette to bring you the high quality of a dynamic ear phone with the ease and comfort of an almost weightless unit—at a price less than half that of any comparable unit. Fits right into ear. Excellent sensitivity of 85 db. Ideal for use with miniature sets, hearing aids, transcribing, etc. DC resistance 2000 ohms, impedance 5000 ohms at 1000 cycles. Complete with 3 ft. plastic covered cord. MS-72.....Net **1.95**

RCA 807 TUBES

QUANTITY LIMITED
BRAND NEW JAN. SPECS. **1.29**
STOCK NO. SP-70

BINOCULARS NEVER BEFORE AT THIS PRICE

IMPORTED DIRECT
Prism-Coated Lenses
● All-Metal Construction
● Individual Construction
● Leather Case & Straps

F-105, 8 x 30 with case.....NET **1.8.25**
F-15, 7 x 35 with case.....NET **1.95**
F-103, 7 x 50 with case.....NET **21.95**
F-104, 12 x 50 with case.....NET **32.50**

} with order, Add 10%
} Fed. Tax

High Output Dynamic Microphone

Worth Many Times Its Price



SALE \$14.95 List Price **\$47.00**

AT LAST! A Hi-Fi Dynamic Mike for Public Address etc. at a price you'd expect to pay for a good crystal mike!

Lafayette went abroad to obtain a high quality DYNAMIC MICROPHONE at a price that is 70% less than any comparable dynamic microphone on the market today. Exceptionally fine for public address, recording and other general purpose use. Substantially flat response, 60-10,000 cps. assures faithful reproduction of speech and music. Impedance 4,000 ohms ±15% at 1000 cps. Output Level—55 db. Die cast metal case finished in light grey and fine chromium. Compact and light weight. Net Wt. 1 lb. Head at fixed tilt of 15°, equipped with 6 ft. well shielded low-loss special vinyl-jacketed cord. Standard 5/8"-27 thread. Dimensions 1-23/32" high, 2" wide, 3 3/8" deep. Shpg. Wt. 3 lbs.

PA-19.....Singly, ea. **14.95**... In lots of 3 **14.45**

CROSLLEY UHF FRONT END

● Mallory 3 Gang Inductuner
● 6AF4 — 6BZ7 and IN72
● Parts Alone Worth Twice the Price

UHF front end covers all channels 14 through 82, using the famous Mallory continuous tuning inductor. Original replacement for Crosley part 154698-1-1 used in Crosley series EU chassis 393 and 394. Ideal for building UHF converters, etc. Output feeds into channel 5 I.F. Concentric shaft includes fine tuning. Built-in antenna switch operates off tuning shaft. Comes complete with IN72 diode, 6BZ7 and shock mounted 6AP4 tubes. Size: 8 x 5 x 3 1/2. Shpg. Wt. 5 lbs. Quantity limited.

TL-25.....Lots of 3, ea. **4.45**
Singly, ea. **4.95**

Masco

CASCADIAN TV BOOSTER

List Price **\$42.50**

SALE 9.95



Biggest Booster Buy Ever! Famous Masco Cascade Booster!!

- Three tuned circuits—cascode!
- Golden Grid 6BZ7 Plus 6J6 Plus rectifier!
- 35 db gain (56 times!) average on all channels!

A sensational new tunable VHF booster utilizing a special low-noise circuit. Employs the new Golden Grid 6BZ7 tube so well known for its use in cascode circuits. Field pioneer and specifically designed for new low noise-high gain front ends. Brings superior reception to older type receivers. Single knob control for utmost simplicity of operation. Signal strength is increased at least 56 times—35 db!—average on all channels. Rack and pinion permeability for precision stability. Automatically switched on and off by TV set. Uses cross-neutralized 6J6 and 6BZ7 tubes for maximum gain and bandwidth. U/L approved. For 110 volts AC. Wt. 5 lbs.

Masco TVB-53: in lots of 3, Net **9.45** Singly, ea. **9.95**

Lafayette Radio
DEPT. JC
NEW YORK, N.Y. 100 Sixth Ave.
BRONX, N.Y. 542 E. Fordham Rd
NEWARK, N.J. 24 Central Ave.
PLAINFIELD, N.J. 139 West 2nd St.
BOSTON, MASS. 110 Federal St.
Include postage with order.
Write or FREE Bargain Packed Catalog!

BUILD *the New* TRANSVISION TV KIT

ONLY \$15⁰⁰ gets you started*

Designed so that COLOR can be added

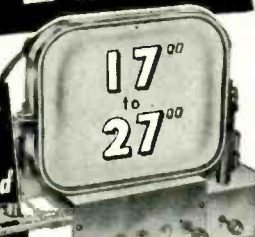

* THIS MODEST INVESTMENT gets you started on a most fascinating project — assembling the new "E" type Transvision TV Kit in easy stages. For \$15 you get PACKAGE #1 (standard first package for all new "E" kits). This package gives you the BASIC CHASSIS and required first-stage TV COMPONENTS, with complete instructions. When ready, you order the next stage (pkg. #2), etc. All stages (or packages) are low priced, making your complete kit the best buy in TV.

YOU PROFIT 3 WAYS:

1 Learn TV

You learn TV the practical way — by doing. No previous technical knowledge is required. With Package #1 you get a complete Instruction Book; a 95-page Book of interesting, educational facts and explanation about TV, servicing, etc.; over 200 drawings and diagrams; and a 16-page booklet on Hi-Fidelity.

2 Save up to 50%

You build a TV set worth up to double your cost of the parts; and you learn how to save on servicing, too.

3 Prepare for COLOR TV

By assembling your own TV Kit, you will learn enough about TV to be able to make the necessary modification to add color. Transvision will supply the required components to make change over to COLOR practical and inexpensive.



FREE CATALOG Shows 8 Great TV Kits: EXCLUSIVE: Only Transvision TV Kits are adaptable to UHF. Ideal for FRINGE AREAS. No Previous Technical Knowledge Required. Write now!

TRANSVISION
THE OLDEST NAME IN TV KITS
NEW ROCHELLE, N. Y.

MAIL THIS COUPON TODAY

Educational Director
TRANSVISION, INC., NEW ROCHELLE, N. Y. Dept. E-3

I'm enclosing \$ _____ deposit. Send standard kit PACKAGE #1, with all Instruction Material. Balance C.O.D.

Send FREE copy of your new TV Kit Catalog.

Name _____
Address _____
City _____ State _____

PEOPLE

(Continued)

ciated with the radio-electronics field for 25 years, acquired control of Instruments For Service, Baldwin, N.Y. The firm manufactures the Cap-Check capacitor checker. Edward Bluestone, formerly with RCA and International Electronics Laboratories, joined the company as chief engineer.

... Kenneth Brock was named advertising and promotion manager of Brown Laboratories, Winchester, Mass. Prior to service in the U.S. Army he was advertising manager of Ward Products.

... Victor Le Gendre joined Haydu Brothers Division of Burroughs Corp. as chief engineer of the Plainfield, N. J., plant. He was formerly with Chatham Electronics Corp.

... Philip J. McFarland joined CBS-Hytron, Danvers, Mass., as assistant patent counsel. He has a background in law and engineering.

... Philip F. LaFollette was elected president of Hazeltine Electronics Corp., a subsidiary of Hazeltine Corp., Little Neck, N. Y. He succeeds Fielding S. Robinson, who resigned.

... Frank F. Neuner was appointed to the newly created post of manager, Semi-Conductor Marketing, of the RCA Tube Division, Harrison, N. J. He had been planning administrator in charge of coordinating the Tube Division's over-all long-range marketing operations for the past year.

... Robert G. Scott was promoted to the position of general sales manager of the Cathode-Ray Tube Division of Allen B. Du Mont Laboratories, Clifton, N. J. He was formerly assistant sales manager for the division.

... William Platt joined Winston Electronics, Philadelphia, as vice president in charge of sales. He was formerly electronics product manager of a Philadelphia appliance distributor.

... Edward M. Cappucci was appointed director of sales of Radio Merchandise Sales Inc., New York. He was formerly general manager.

... Anthony G. Schifino, former general manager of the Stromberg-Carlson Sound Division, Rochester, N.Y., was elected vice president of the division.

... Nello Coda was promoted to chief engineer of the Electronics Division of Erie Resistor Corp., Erie, Pa. He was formerly chief electrical engineer.

... Edward S. Miller joined Sherwood Electronic Laboratories, Chicago high-fidelity equipment manufacturer, as general manager. He was formerly with Radio Craftsmen. Sherwood recently introduced its line through radio and TV parts distributors.

... Peter J. Reuter was appointed to the new position of manager of Contract Relations for Government Operations of CBS-Columbia and CBS Laboratories, Long Island City, N.Y. He was formerly with Polarad Electronics. END

!! TELEPHONE HANDSETS !!

PRESS-TO-TALK... Perfect for Fixed or Mobile rigs, reg. telephone or intercom systems. S.B. Carbon mike, magnetic phone: 19 ft. 4 wire cable & plug. Rugged, moulded bakelite. (Navy #CYR-101B) ea. \$6.95; Pair \$12.95

HG-8 U CO-AXIAL CABLE (52 ohm) .20 ft. lgth... 1.69
RG-54A U (58 ohm) CO-AX-25 ft. lgth... 1.49
MC-211A ANGLE DRIVE (ARC-5) ea. 39c... 12 3.98
HS-30 HEADSET—with matching cable... 2.49
HB-30 HEADBANDS for HS30—ea. 19c... 12 1.98
HS-30 MATCHING XFMR ea. 59c... 10 5.00
CD-820E DBLE. PHONE CORDS (HS30) ea. 29c... 10 2.49

!! A BARGAIN FOR SURE !!

"Jumbo Radio-Electronics Parts Kit"

We clear our shelves of odds & ends of regular & surplus stock YOU SAVE \$\$\$; USEFUL ITEMS! VALUABLE ITEMS! HARD-TO-GET ITEMS! 17 FULL LBS. OF: COILS, SOCKETS, WIRES, SPEAKERS, ACCESSORIES, HARDWARE, RESISTORS, CONN. CHASSIS, PLUS DOZEN S.O.F. ITEMS! (shpg. wt. 20 lbs) **\$3.95**

And Here Are More Kit Values!

MOULDED PLASTIC CONDENSERS .50 mmf—50 asstd. \$1.98
.2mf. 200-800 V. Pigtail leads... 100 asstd. \$2.98

RELAYS incl. multi-contact & midjet keying types. Kit of 8 assorted... 2.49

ROTARY SELECTOR SWITCHES incl. multi-deck, 1/4" shafts. Kit of 6 assorted... \$1.75

RADIO-TV BUILDERS LIBRARY for Students, Hams, Servicers, TV & Radio schematics, including Photofacts. Kit of 25 asstd... 98

RF-ANT-OSCILLATOR COILS std. b'cast & S.W. incl. shielded. Kit of 10 asstd... 98

TUBE SOCKETS wafer: 4 to 8 pin. 12 asstd... 49

KNOBS wood & plastic. Kit of 25 asstd... 98

WIRE-WOUND RESISTORS 5 to 25 watts, including tapped. Kit of 12 asstd... 98

CARBON RESISTORS 1/4-2W. 100 asstd... 1.95

DIAL WINDOWS acetate & glass. 12 asstd... 1.29

RADIO HARDWARE TREASURE FULL LB. CAN of: Nuts, Screws, Washers, Lugs, etc... 89c

POTENTIOMETERS 1/4" shafts. Kit of 6 asstd... 1.49

ALNICO MAGNETS Powerful Bar, lock, "U", Rod, etc. Kit of 10 asstd... 1.98

(WRITE FOR FREE "ALNICO MAGNET" SUPPLEMENT)

Min. Orders \$3.00—20% Dep. On All C.O.D.'s.

LEOTONE RADIO CORP.
67 Day Street
New York 7, N. Y.

GET INTO ONE OF THESE GREATER OPPORTUNITY FIELDS

Electricity or Radio-Television

TRAIN IN THE GREAT SHOPS OF COYNE

OLDEST, BEST EQUIPPED SCHOOL OF ITS KIND IN U. S.

Prepare for your future NOW. Get practical training in TELEVISION—RADIO—ELECTRICITY—ELECTRONICS—all vital in Industry. Prepare now for a better job that also offers a real future in the years ahead. Learn on real equipment at Coyne—no advanced education or previous experience needed.

Approved for Veterans—finance plan—enroll now, pay most of tuition later. Part time employment service while training if needed.

FREE BOOK Clip coupon for Big Free Illustrated Book. No salesman will call. Act NOW.

B. W. COOKE President **COYNE ELECTRICAL SCHOOL** FOUNDED 1899

A TECHNICAL TRADE INSTITUTE CHARTERED NOT FOR PROFIT,
500 S. Paulina St., Chicago, Dept. 35-81H
ELECTRICITY • TELEVISION • RADIO • REFRIGERATION • ELECTRONICS

B. W. COOKE, Pres.
COYNE ELECTRICAL School
500 S. Paulina St., Chicago 12, Ill. Dept. 35-81H
Send FREE BOOK and details on:

RADIO-TELEVISION ELECTRICITY

NAME.....
ADDRESS.....
CITY..... STATE.....

technical Literature

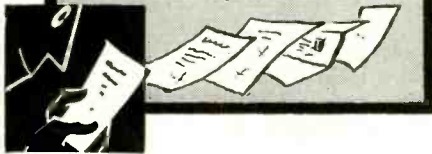

SERVICING

A 40-page booklet, *Master Index to Most-Often-Needed Television and Radio Servicing Information*, cross-indexes all material in 9 TV volumes and 14 radio manuals.

Available for 25 cents from *Supreme Publications*, 1760 Balsam Rd., Highland Park, Ill.

TUBE CATALOG

A 13-page catalog contains technical data on pentodes, triodes, rectifiers, vacuum capacitors, etc.

Eitel-McCullough, Inc., San Bruno, Calif.

HIGH FIDELITY

A 16-page two-color booklet, *This Is HIGH FIDELITY*, explains reproduction of voice and music. The functions of the basic units used in home hi-fi music systems are also discussed, as well as what percentage of the hi-fi dollar should be appropriated for each component. Booklet includes tips for the budget-minded on how to save money. Many installations are illustrated. A separate section shows ways of modernizing existing equipment.

Allied Radio Corp., 100 N. Western Ave., Chicago 80, Ill.

Any or all of these catalogs, bulletins, or periodicals are available to you on request direct to the manufacturers, whose addresses are listed at the end of each item. Use your letterhead—do not use postcards. To facilitate identification, mention the issue and page of RADIO-ELECTRONICS on which the item appears. UNLESS OTHERWISE STATED, ALL ITEMS ARE GRATIS. ALL LITERATURE OFFERS ARE VOID AFTER SIX MONTHS.

HI-FI BUYER'S GUIDE

A 5-page hi-fi buyer's guide in multi-graph. Gives points to look for in buying a hi-fi system. Discusses the pickup cartridge and stylus, record player, tuner, power amplifier, speakers, and enclosures.

The Magnavox Co., Fort Wayne 4, Ind.

TRANSISTOR DESIGN SHEETS

A 10-page set of design sheets describes several Westinghouse transistors and their application. Among those described are p-n-p junction types 2N54, 2N55, 2N56. General semiconductor theory is discussed, and equivalent circuits and equations are derived for grounded-base, grounded-emitter, and grounded-collector connections.

Circuits for a phonograph pream-

LABORATORY DESIGNED for UHF and VHF! ... It's NEW!

MOSLEY

2-WAY TV ANTENNA SWITCH



Cat. No. F-40
List Price
\$1.95

- Extremely low Standing Wave Ratio — by actual test!
- Positive rotary action!
- Silver-to-silver contacts!
- Compact size!
- Solderless — easy to install!
- Low cost!

Another PREMIUM QUALITY MOSLEY Accessory for BETTER TV INSTALLATIONS!

Mosley
Electronics, Inc.
8622 ST. CHARLES ROCK ROAD
ST. LOUIS 14, MISSOURI

New PORTABLE DOUBLE-DUTY Money-Maker

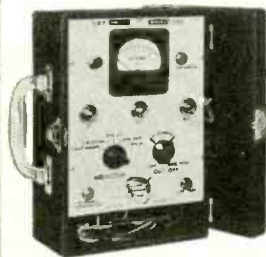

B&K CATHODE REJUVENATOR TESTER
TESTS and REPAIRS TV PICTURE TUBES

SPOTS THE TROUBLE AND QUICKLY CORRECTS IT—WITHOUT REMOVING TUBE FROM SET

AMAZING LOW PRICE \$54⁹⁵
SIZE 11" x 7 1/2" x 5"

No Extra Accessories Necessary

Now it's easy to save thousands of weak and inoperative TV picture tubes. As much as 80% of the troubles which arise in picture tubes may easily be repaired with the CRT. This portable instrument creates new profitable picture tube repair business. Saves servicing time, speeds work. Eliminates tube transportation. Saves money on trade-in reconditioning. The CRT quickly pays for itself—and continues to make profits for TV service dealers.

DOES ALL THIS
Tests for Emission, Inter-Element Shorts, Leakage, Open Circuits, Grid Cut-Off, Gas Content, Probable Useful Life.

RESTORES—Emission and Brightness
REMOVES—Shorts
REPAIRS—Open Circuits

10% REQUIRED WHEN ORDERING

Almo RADIO CO.
MAIN STORE: 509 ARCH ST., PHILA., PENNA.

BRANCHES: NORRISTOWN, PA. CAMDEN, N.J. ATLANTIC CITY, N.J. WILMINGTON, DEL. SALISBURY, MD.

RADIO CONTROLLED Garage Door Operating Mechanism \$24.50

Write for Information

P. E. HAWKINS CO.

631 Prospect

Kansas City 24, Mo.

SOUND-OFF!

Build fully automatic electronic brain. The MUSICON cuts out commercials. Lets any radio, TV play only music! Priceless possession for home, business office. Work, study, read, relax with music. Simple, low-cost construction. 2-tubes. Booklet, full instructions, schematic PLUS special component, \$3.50 with order. Free literature.

NORMAN ELECTRONICS COMPANY
P.O. Box 733 Brooklyn 1, N.Y.

EXCITING HIGH FIDELITY

From your HOME TAPE RECORDER

FROM \$19.95 COMPLETE



20 thru 15,000 cycles at 7.5 I.P.S. to Input of Home Music System

DYNAMU

CONVERSION KIT

FOR YOUR Pentron, Revere, RCA, Wilcox Gay, Knight, Concertone, etc.

Write: DYNAMU, Maico Bldg., Minneapolis, Minn.

XCELITE Hand Tools
PREFERRED BY THE EXPERTS

**JUST A
SAMPLE of the
complete choice of fine
XCELITE TOOLS**

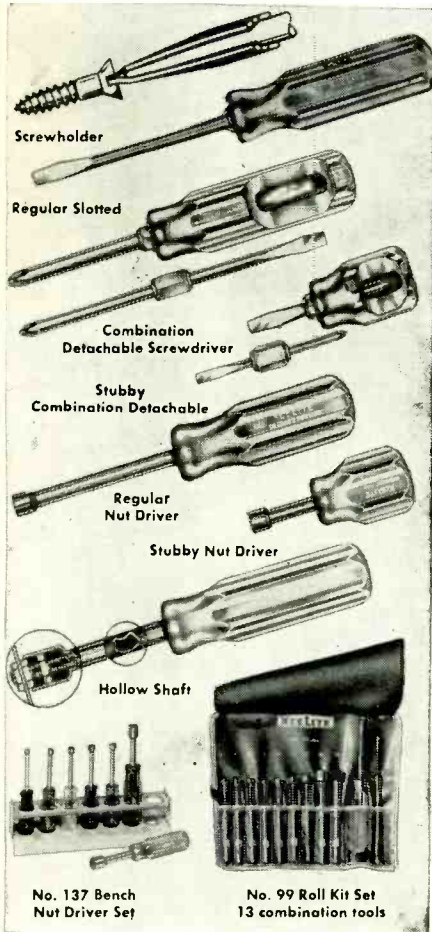

- screwdrivers
- screwholders
- nut drivers with handles color-coded-to-size
- pliers
- electricians' knives
- reamers
- tool kits

**READY TO MAKE
LIFE EASIER FOR YOU!**

(Why be without 'em? Check with your supplier soon and see the **WHOLE** line!)

XCELITE, INCORPORATED
(formerly Park Metalware Co., Inc.)

Dept. J Orchard Park, N. Y.

For Originality
LOOK TO XCELITE

TECHNICAL LITERATURE (Continued)

plifier and an audio oscillator are shown to illustrate typical transistor applications.

Westinghouse Electronic Tube Div., Commercial Engineering Dept., P. O. Box 285, Elmira, N.Y.

LOUDSPEAKERS

An 8-page catalog illustrates various speakers and includes complete data on each type of speaker.

Oxford Electric Corp., 3911 S. Michigan Ave., Chicago, Ill.

BUSINESS BUILDERS CATALOG

CBS-Hytron's *Business Builders Catalog PA-37* lists a supply of promotional material, technical literature and service tools for the service shop owner.

CBS-Hytron, Danvers, Mass.

KITS AND INSTRUMENTS

Eico's 14-page 1955 catalog *C-3* describes and illustrates 38 kits and 42 factory-wired instruments. Prices, specifications and applications are given.

Electronic Instrument Co., Inc., 84 Withers St., Brooklyn 11, N. Y.

TUBE CHARACTERISTICS

Raytheon's booklet on industrial tube characteristics contains technical information on subminiature tubes, radiation-counter tubes, germanium crystal diodes, transistors, thyratron tubes, rectifier tubes, etc. It also contains three pages of basing diagrams.

Raytheon Manufacturing Co., 55 Chapel St., Newton 58, Mass.

PRINTED CIRCUITS

A 6-page manual on printed circuits service and repair has data on replacing components, coils, ratio detector i.f. transformers, tube sockets mounted either on wiring or component side of board.

Admiral Corp., 3800 Cortland St., Chicago 47, Ill.

TAPE RECORDERS

Amplex's *Bulletin AB3-1-4* describes two- and three-channel audio tape recorders. Console, rack-mounted and portable types are also described.

Amplex Electric Corp., 934 Charter St., Redwood City, Calif.

HI-FI EQUIPMENT

Langevin's 4-page brochure describes their equalizer-preamplifier and hi-fi amplifier. Illustrations, characteristics and technical data on the equipment are given.

Langevin Manufacturing Corp., 37 W. 65 St., New York 23, N. Y.

TV MICROWAVE

An 8-page brochure *3-110* describes KTR-100 television microwave relay equipment. Specifications, applications, and general performance are discussed.

May be obtained by interested parties by writing Raytheon Manufacturing Co., Dept. 6130, 100 River St., Waltham 54, Mass.

END

**6 VOLT BATTERY SOLDERING
IRON AND WELDER**

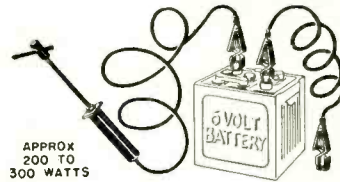

U.S. Army release. Brand New—Never Used. Fully Guaranteed. This soldering iron can be used to solder or weld when connected to any six-volt storage battery. Uses approximately 200 to 300 watts. The high intensity arc created between the metal to be soldered and the carbon electrode (carbons supplied free with iron) can be used to heat tin or aluminum solder. Suitable also for light brazing and spot welding. Arc can be used for melting metals, cutting holes and soldering seams in chassis. Also useful for analyzing metals and minerals.

Battery soldering iron outfit includes 2 carbons, 3 heavy duty spring clips, 2 pieces 5 ft. heavy duty wire cable. (Battery not included.)

Ideal for use where current is not available. Ship wt. 4 lbs.

\$1.95
ITEM NO. 126
UNUSUAL BUY (Shp. Chgs. 40c)

POWERFUL ALL PURPOSE MOTOR



Sturdy shaded pole A.C. induction motor. 15 watts, 3000 rpm. 3 1/2" x 2 1/4"; 4 mounting studs; 3/8" shaft, 3/16" diameter; 110-120 volts, 50-60 cycles. A.C. only. When geared down, this unit can operate an 18" turntable with a 200 lb. dead weight. Use it for fans, displays, timers and other purposes. Ship wt. 2 lbs.

\$2.45
ITEM NO. 147
UNUSUAL BUY (Shp. Chgs. 35c)

WATTHOUR METER

Leading makes—reconditioned. Ideal for trailer parks. 100-110 volts, 60 cycles. 2-wire A.C. 5 amp. Heavy metal case 8 1/2" x 6 1/4" x 5". Easy to install. Ship. wt. 14 lbs.



\$4.50
ITEM NO. 33
NOW ONLY (Shp. Chgs. \$1.25)

WESTERN ELECTRIC BREAST MIKE

Lightweight 1 lb. carbon microphone. Aircraft type. Breastplate mounting, adjustable 2-way swivel. Easily fastened straps. For home broadcasts, communications etc. Complete with 6 foot cord, hard rubber plug. Shaded plate, non-rusting finish. Ship. wt. 2 lbs.



\$1.98
ITEM NO. 132
NEW LOW PRICE (Shp. Chgs. 32c)

AMAZING BLACK LIGHT



250-watt ultra-violet light source. Makes fluorescent articles glow in the dark. Fits any lamp socket. For experimenting, entertaining, unusual lighting effects.

Ship. wt. 2 lbs. **\$2.45**
ITEM NO. 27
A SAVING AT (Shp. Chgs. 35c)

250 POWER TELESCOPE LENS KIT

Make your own high powered 6 ft. telescope! Kit contains 2" diam., 75" focal length, ground and polished objective lens and necessary eye pieces. Magnifies 50x to 250x. Full instructions. Ship. wt. 1 lb.



\$2.95
ITEM NO. 123
YOU SAVE AT (Shp. Chgs. 10c)

HUDSON SPECIALTIES CO.
25 West Broadway, Dept. RE-3-55
New York 7, N. Y.

I am enclosing full remittance for items circled below. (Be sure to include shipping charges.)

OR, my deposit of \$..... SHIP balance C.O.D.

MINIMUM C.O.D. ORDER \$5.00.

C.O.D. ORDERS ACCEPTED ONLY WITH 20% DEPOSIT

INCLUDE SHIPPING CHARGES.

Circle Items Wanted

87 147 33 152 126 123

Name Please Print Clearly

Address

City Zone State

Books

ELECTRONICS, by George F. Corcoran and Henry W. Price. John Wiley & Sons, New York. 459 pages, \$7.00.

A modern introduction to electronics including complete chapters on graphical methods, vacuum tubes, feedback, oscillators, and transistors for the engineering student or practicing electrical engineer with little or no knowledge of electron tubes and transistors. Problems and questions at the end of each chapter guide the reader in evaluating his progress and the soundness of his interpretations.

SINGLE SIDEBAND FOR THE RADIO AMATEUR. Compiled and published by The American Radio Relay League, West Hartford, Conn. 176 pages, \$1.50.

This worthwhile book is a compilation of articles on single sideband published in QST magazine between about April 1948 and November 1954. Articles selected are by such recognized authorities on SSB as applied to amateur transmissions as Goodman, Norgaard, Wright, Villard, Edmunds, Brown, Reque, and Webb. Must reading for all advanced amateurs and others interested in this mode of radiotelephone communication.

THE OSCILLOSCOPE AT WORK, by A. Haas and R. W. Hallows. Published for Wireless World by Iliffe & Sons, Ltd., Dorset House, Stamford St., London, S.E. 1, England. 5½ x 8½ inches, 172 pages. 15 shillings.

In the hands of a competent user an oscilloscope can produce stupendous results. The instrument gives us an extension of one of our senses that is far beyond nature's original provision. However, to take advantage of the scope calls for skill (acquired by practice) and knowledge (which can be obtained by reading this book).

The Oscilloscope at Work helps solidify your grip on radio theory by discussing electrical measurements, a.f. and r.f. amplifiers, oscillators, rectifiers, detectors, modulators. An unusual feature is the large number of waveshapes photographed directly from the screen of the scope. These waveshapes (often misinterpreted, misunderstood, and maligned) are analyzed and explained in detail. Once generally understood, they can then be applied to specific interpretations.

The authors—one from France, the other from England—are both known to our readers through their articles in this magazine.—MC

MARCH, 1955

in ceramics

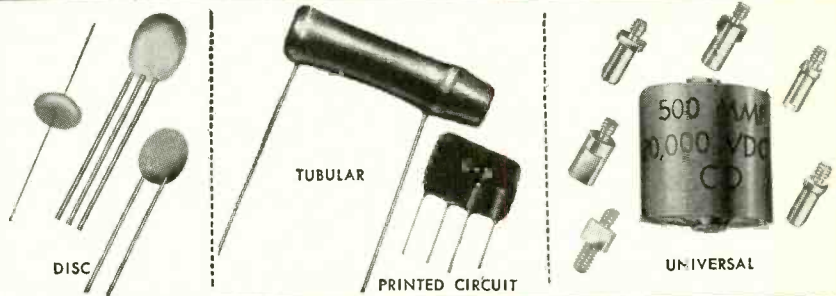

you can see why C-D is always the leader

THE ONLY CERAMIC WITH THE MILLION-DOLLAR BODY

C-D Ceramic Capacitors are made from beginning to end under one roof in a huge plant devoted completely to ceramic capacitor production. Every process... every ingredient is under constant control. You can see the reasons for C-D's outstanding superior quality.

And to help you, C-D Ceramic Capacitors are packaged in compact, crystal-clear, easy to handle and always usable plastic boxes (no extra charge). That's why Distributors *who know* carry the complete C-D line. See your C-D Distributor today. He's listed in your local Classified Telephone Directory.

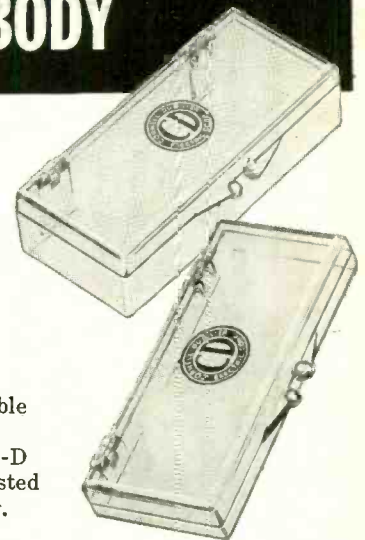

There are more C-D capacitors in use today than any other make.



CONSISTENTLY DEPENDABLE CORNELL-DUBILIER CAPACITORS

PLANTS IN SOUTH PLAINFIELD, N. J.; NEW BEDFORD, WORCESTER AND CAMBRIDGE, MASS.; PROVIDENCE AND HOPE VALLEY, R. I.; INDIANAPOLIS, IND.; SANFORD AND FUQUAY SPRINGS, N. C.; SUBSIDIARY: THE RADIART CORPORATION, CLEVELAND, O.

10 Element DELCO Yagi

- with All-Aluminum Elements!!

Available for Channels 4, 5, and 6 only

Please Specify Channel when Ordering

Outstanding performance under the most adverse receiving conditions is a characteristic of this amazing antenna. Extra-wide spacing of elements assures maximum gain and razor sharp directional characteristics. Very high front-to-back ratio reduces annoying "ghost" signals. New 10 element inline design produces more than twice as much gain as conventional double-stacked 5 element yagis and yet is much lower in cost, easier to install, and has a better rooftop appearance. All elements are made of heavy gauge aircraft aluminum and the crossbar of triple-galvanized 12 gauge steel tubing for added structural strength. Twin "V" brace gives added support to crossbar—eliminates needless worry whenever the wind begins to blow.

Stock No. 88-B-BD610..... Reg. \$34.95..... \$7.50

Reg. \$34.95

\$6.95 ea. Lots of 3

\$7.50 ea.

CONCORD RADIO 54 Vesey St., N. Y. 7.
Dept. C3 MINIMUM ORDER \$5.00
20% deposit with C.C.D.
 Please send NEW 1955 CONCORD Catalog!
NAME _____
ADDRESS _____
CITY _____ ZONE _____ STATE _____

CONCORD RADIO • 54 VESEY ST. • NEW YORK 7, N. Y. • Digby 9-1132

The Gernsback Library

An up-to-the minute library of low-cost technical books which gives you complete and valuable information on every phase of practical electronics in a readable and understandable way.

BOOKS ON TV-RADIO-AUDIO SERVICING



The Oscilloscope—No. 52. 192 Pages. \$2.25

Gives details on how to use the scope for more efficient TV, radio, or audio servicing. Will open many new scope applications to the practicing service technician.



TV Repair Techniques—No. 50. \$1.50

Top technician-writers give you the benefit of their experience in finding and correcting tricky TV servicing problems. Will save you hours of servicing time.



Radio & TV Test Instruments—No. 49. \$1.50

How to build the instruments required for modern TV-radio-audio servicing, plus chapters on constructing a bench and carrying case. Each instrument tested by the authors.



Television Technicians—No. 46. \$1.50

Symptoms, causes, and cures of over 600 TV troubles which occur in scores of sets made by leading manufacturers. Will help cut trouble-shooting time to the bone in TV servicing.

HIGH FIDELITY

High-Fidelity — Design, Construction, Measurements—No. 48. \$1.50

New 3-way approach to top hi-fi performance.



High-Fidelity Techniques—No. 42. \$1.00
James R. Langham's humorous, common-sense guide to high fidelity.

FUNDAMENTALS

Basic Radio Course—No. 44 Cloth cover \$2.25

John T. Frye teaches you theory from Ohm's Law to advanced techniques, in an entertaining way.



Radio Tube Fundamentals—No. 45. \$1.00

Theory of tubes from the technician's viewpoint.

RADIO CONTROL

Radio-Control Handbook—No. 53. \$2.25

R/C expert, Howard G. McEntee, W2SI, tells you how to build R/C systems and the mechanical components to control model planes, boats, etc.



Model Control By Radio
No. 43. 112 Pages. \$1.00

A wonderful companion volume for book 53. For both beginner and expert. Covers theory and practical construction.

TRANSISTORS

Transistors — Theory and Practice—No. 51. \$2.00

Rufus P. Turner writes about transistors for the practical man, in a down-to-earth way. Transistor applications in well known circuits. First complete guide to commercial transistors.

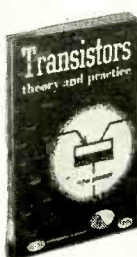

See your distributor—or mail this coupon

GERNSBACK PUBLICATIONS, INC., Dept. 35
25 West Broadway
New York 7, N.Y.

Enclosed is my remittance of \$.....

Please send me the following books postpaid.

- 39 41 42 43 44 45 46
 47 48 49 50 51 52 53

Name
(Please print clearly)

Street

City Zone State

MISCELLANEOUS

Radio & TV Hints—No. 47. \$1.00

300 hints, gimmicks and short cuts on TV, radio, audio.

Public-Address Guide—No. 41. 75c

How to make extra money in PA work.

Practical Disc Recording—No. 39. 75c

Theory and techniques.

A DICTIONARY OF ELECTRONIC TERMS. Compiled and published by Allied Radio Corp., Chicago 80, Ill. 72 pages. 25c.

Here you have evidence that radio and TV have a language all their own. Contains over 2,500 definitions and 125 illustrations. Many new color TV terms are included. Very readable, informative and worth while.—MC

ACOUSTICS, by Leo L. Beranek. McGraw-Hill Book Co., 330 West 42 St., New York, N. Y. 6 x 9½ inches, 481 pages. \$9.00.

Written as a complete text for the engineer, this is an unusually complete work from the electroacoustic or audio viewpoint. Facility in calculus is necessary for complete understanding of some (but not all) the chapters, and the treatment is mathematical throughout. However, examples and problems with numerical solutions appear throughout the book, making it easier for the book's user to gear his mathematics to what may be to him an unfamiliar field.

One chapter each is devoted to microphones, direct-radiator loudspeakers, loudspeaker enclosures and horn loudspeakers, and sound in enclosures. Subjects appear to be rated in importance in direct ratio to their importance in the electronic field. Thus, architectural acoustics is not treated (though there is a chapter on noise control) and such subjects as hearing and intelligibility are handled from the audio engineer's viewpoint.—FS

HOW TO SERVICE TAPE RECORDERS, by C. A. Tuthill. John F. Rider Publisher, Inc., 480 Canal St., New York, N. Y. 5½ x 8½ inches, 154 pages. \$2.90.

The first three chapters of this book introduce magnetic recording to the reader and discuss basic magnetic theory and tape recording fundamentals. The fourth discusses tape recording mechanisms, giving a number of examples of both professional and home type recorders. There are a number of complete circuits in this chapter. The fifth chapter covers tape recording circuitry, also with a number of examples from common equipment.

The sixth and last chapter is devoted to maintenance and repair. As might be expected, greatest attention is given to mechanical features, which might be expected to be less familiar than the electronic circuitry to most service technicians. The example method is again followed, with a number of recorders being considered from the service viewpoint.

Besides the schematics, the book also contains a number of good halftones, with important components called out.—FS

TV DOCTOR (1955 Edition), by Harry G. Cisin. H. G. Cisin, Amagansett, N. Y. 8½ x 11 inches, 37 pages. \$1.

Intended for the beginner in TV servicing or for the set owner with an

RADIO SCHOOL DIRECTORY

TELEVISION

PREPARE FOR A GOOD JOB!

BROADCAST ENGINEER
ELECTRONICS
RADIO SERVICING

Television Servicing

(Approved for Veterans)

SEND FOR FREE LITERATURE

BALTIMORE TECHNICAL INSTITUTE
1425 EUTAW PLACE, BALTIMORE 17, MD.

Get Your **F.C.C. LICENSE** Quickly!

Correspondence or residence preparation for F.C.C. examinations. Results guaranteed.

An FCC commercial operator license means greater opportunities and higher pay. We are specialists in preparing you, in a MINIMUM OF TIME, to pass FCC examinations for all classes of licenses. Beginners get 2nd class license in 5 weeks and 1st class in 3 additional weeks. Write for our FREE booklet with complete details.

GRANTHAM School of Electronics
Dept. 101-F, 6064 Hollywood Blvd., Hollywood 28, Calif.

LEARN TV AT HOME

Here is your opportunity to learn TV servicing at home... a simple 14-week course written so you can understand it, priced so you can afford it.

This well-established, reputable TV and electronics school will send you complete lessons, tests and give you individual consultation, by correspondence.

The complete course costs only \$25.00. This is a limited offer so write today for information to:

VIDEO SPECIALTIES, INC., Dept. 616A
4508 E. Firestone Blvd., South Gate, Calif.

GET INTO ELECTRONICS

You can enter this uncrowded, interesting field. Defense expansion, new developments demand trained specialists. Study all phases: radio & electronics theory and practice; TV; FM; broadcast; servicing; aviation, marine, police radio. 18-month course. Graduates in demand by major companies. H.S. or equivalent required. Begin Jan., March, June, Sept. Campus life. Write for catalog.
VALPARAISO TECHNICAL INSTITUTE
Dept. C, Valparaiso, Ind.

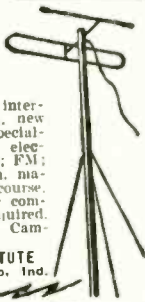

CODE SENDING RECEIVING SPEED

Be a "key" man. Learn how to send and receive messages in code by telegraph and radio. Commerce needs thousands of men for jobs. Good pay, adventure, interesting work. Learn at home quickly through famous Candler System. Quality for Amateur or Commercial License. Write for FREE BOOK.
RADIO SYSTEM CO.
Dept. 3C, Box 928, Denver 1, Colo., U.S.A.



RCA INSTITUTES, INC.

A service of Radio Corporation of America
350 West 4th St., New York 14, N. Y.

OFFERS COURSES IN ALL TECHNICAL PHASES OF RADIO, TELEVISION, ELECTRONICS

Approved for Veterans
Write Dept. RE-55 for Catalog

RADIO-TV ELECTRONICS



CREI graduates in big demand. ECPD-Accredited Technical Institute Curricula. New classes start monthly. Free placement service for grads. Courses: Radio Engineering, Broadcast or TV Engineering; TV, FM, AM Servicing; resident studies leading to "Associate in Applied Science" degree. Write for free catalog. Approved for vets.

CAPITOL RADIO ENGINEERING INSTITUTE
Dept. RE, 3224-16th St., N.W., Washington 10, D. C.

MARCH, 1955

MORE JOBS

than graduates

Demand for our engineering graduates exceeds supply. Effective placement. Study in this world-famed college established 1884. Quarters start March, June, September, January.

Bach. Sc. degree in 27 months

Complete Radio Eng. courses... TV, UHF and FM. Also Mech., Civil, Elec., Chem., Aero. and Adm. Eng.; Bus. Adm., Acct. Small classes. Well-equipped labs. Modest costs. Prep. courses. Write
Jean McCarthy, Director of Admissions,
for Catalog and Campus View Book.

TRI-STATE COLLEGE
2435 College Avenue, Angola, Indiana



TV REPAIRMEN EARN TOP MONEY!

IN JUST 12 MONTHS, COMPLETE TV SERVICE TRAINING, INCLUDING COLOR TV. Streamlined course gives you all essentials for a good job as service technician. Graduates in great demand; jobs are plentiful in this growing field. Other electronic courses in radio operation and maintenance. Day or evening classes. Opportunity for employment in local industry. Approved for Korean veterans.

Write for Catalog 111 Today

INDIANAPOLIS ELECTRONIC SCHOOL
312 E. Washington, Indianapolis 4, Ind.

RADIO ENGINEERING DEGREE IN 27 MONTHS

Intensive, specialized course including strong basis in mathematics and electrical engineering, advanced radio theory and design, television. Modern lab. Low tuition. Self-help opportunities. Also B.S. degree in 27 months in Aeronautical, Chemical, Civil, Electrical, and Mechanical Engineering. U.S. Gov't approved. Enter March, June, September, December. Catalog.

INDIANA TECHNICAL COLLEGE
1535 E. Washington Blvd., Fort Wayne 2, Indiana

EARN MORE MONEY— BE A PROFESSIONAL TELEVISION SERVICE TECHNICIAN

GET DOWN-TO-EARTH PRACTICAL TV TRAINING WITH WTI EXPERTS FOR THE TOP PAYING \$5,000-\$10,000 PER YEAR JOBS.

UHF—COLOR—VHF

Master the latest, up-to-the-minute TV and Color TV developments QUICKLY.

SEND FOR FREE BOOK TODAY!

WESTERN TV offers real experience on live equipment in our BIG SHOPS and LABORATORIES in the shortest practical time under expert instructors. Graduates are in big demand because they have the "field experience" necessary for immediate "bench" or supervisory positions. You learn every phase of Radio and TV servicing (AM, FM, VHF, UHF). WTI men win fast promotion... can demand better pay... develop highly profitable businesses of their own with the latest and most PRACTICAL PERSONALIZED TRAINING BEHIND THEM. You concentrate all your time on being a PROFESSIONAL TV SERVICE TECHNICIAN—non-essential math and engineering theory omitted. YOU CAN EARN WHILE YOU LEARN. Special Finance Plan.

APPROVED FOR VETERANS. Find out how you can get into the TOP PAY GROUP—Send for this fact-packed book NOW!

WESTERN TELEVISION INSTITUTE

America's Leading Television Servicing School

Western Television Institute Dept. E-3-55
341 W. 18th St., Los Angeles 15, Calif.
Without obligation, please send FREE fully illustrated booklet. (No salesman will call.)

NAME _____ AGE _____
ADDRESS _____
CITY _____ ZONE _____ STATE _____

Become an

ELECTRICAL ENGINEER

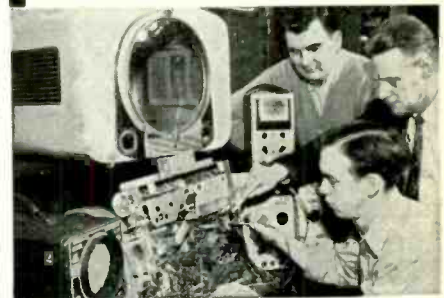

Major in Electronics or Power BS Degree in 36 months

Prepare now for a career as an electrical engineer or engineering technician—and take advantage of the many opportunities in these expanding fields.

You can save a year by optional year-round study. Previous military, academic, or practical training may be evaluated for advanced credit.

Enter Radio and Television — courses 12 to 18 months

You can be a radio technician in 12 months. In an additional 6-months you can become a radio-television technician with Associate in Applied Science degree. Color television instruction is included in this program.

These technician courses may form the first third of the program leading to a degree in Electrical Engineering. Twenty-one subjects in electronics, electronic engineering and electronic design are included in these courses.

Courses also offered: radio-television service (12 mos.); electrical service (6 mos.); general preparatory (3 mos.).

Terms — April, July, September, January

Faculty of specialists. 50,000 former students—annual enrolment from 48 states, 23 foreign countries. Non-profit institution. 52nd year. Courses approved for veterans. Residence courses only.

MS-6A

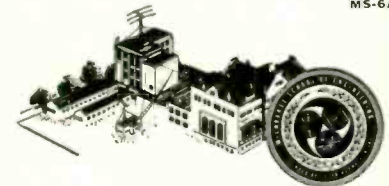

MILWAUKEE SCHOOL OF ENGINEERING

MILWAUKEE SCHOOL OF ENGINEERING
Dept. RE-355, 1025 N. Milwaukee Street
Milwaukee 1, Wisconsin

Send FREE illustrated booklets
 Career in Electrical Engineering,
 Career in Radio-Television.

I am interested in _____ (name of course)

Name _____ Age _____

Address _____

City _____ Zone _____ State _____

If veteran, indicate date of discharge _____

NEW STOCK OF FIRST QUALITY TELTRON TUBES GUARANTEED! . . . LOWEST PRICES EVER!

All tubes individually boxed . . . unconditionally guaranteed for one year.

GIFT OFFER!
One 6BG6G tube will be shipped FREE with any order accompanying this ad.

FREE Bonus Offer!

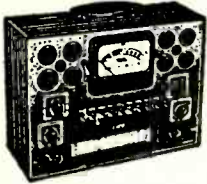

Model 625K

- Illum. gear-driven "Speed Rollchart"
- New lever-action switches for individual testing of every element
- Tests all conventional and TV tubes

May be bought outright from Teltron for \$34.95

This Eico Tube Tester is yours FREE when you buy \$199 worth of tubes or more within 60 days at Teltron.

Type	Price	Type	Price	Type	Price
1A7GT	.53	6BE6	.46	12AT6	.37
1H5GT	.51	6BF5	.48	12AU6	.43
1L4	.51	6BF6	.48	12AV6	.42
1L6	.51	6BG6G	1.18	12AV7	.73
1LC6	.49	6BK5	.75	12AX4GT	.60
1N5GT	.51	6BJ6	.51	12AX7	.61
1U4	.51	6BH6	.51	12AZ7	.65
1U5	.43	6BK7	.78	12B4	.72
1X2	.65	6BL7GT	.78	12BA6	.46
2A3	.35	6BN6	.90	12BE6	.46
2A7	.35	6BQ7	.85	12BA7	.58
3Q4	.53	6BY5G	.60	12BH7	.61
3Q5GT	.61	6BZ7	.95	12BY7	.65
3S4	.48	6C4	.41	12BZ7	.63
3V4	.48	6CO6G	1.63	12SA7	.45
5V4G	.49	6CU6	.95	12SK7	.45
5Y3GT	.30	6F6	.42	12SL7GT	.60
5Y4G	.40	6F5GT	.44	12SN7GT	.56
5Z3	.42	6H6	.50	12SQ7	.38
6A8	.40	6J5GT	.49	19BG6G	1.48
6K7	.40	6J6	.61	19T8	.71
6AB4	.43	6L6	.78	25BQ6GT	.82
6AF4	1.02	6Q7	.40	25CU6	1.09
6AG5	.52	6S4	.41	25Z5	.55
6AH4GT	.65	6S8GT	.65	25Z6GT	.36
6AK5	.96	6SA7	.45	35A5	.48
6AL5	.43	6SK7	.45	35B5	.48
6AQ5	.48	6SL7GT	.60	35C5	.48
6AR5	.48	6SN7GT	.60	35L6GT	.41
6AT6	.37	6T8	.71	35W4	.33
6AU5GT	.60	6V3	.80	35Y4	.42
6AV5GT	.60	6V6GT	.48	35Z5GT	.33
6AV6	.37	6W6GT	.53	50A5	.49
6AX5GT	.60	6X4	.37	50B5	.48
6BA6	.56	6X5GT	.38	50C5	.48
6BA7	.58	6X8	.80	TYPE 80	.40
6BC5	.48	7F8	.49	117L7GT	1.20
		12AL5	.43	117Z3	.33
				117Z6GT	.65

FREE \$7.20 list value Bonus Box of three 6SN7 tubes and 25 assorted resistors with each order of \$25 or more.

SAME DAY SERVICE

48 Hour Postal Delivery To West Coast

TERMS: Save all freight and postage charges. All orders accompanied by full remittance will be shipped POSTAGE PAID anywhere in the continental U.S.A. 25% deposit required on C.O.D.'s. Minimum order \$10.00. Open accounts to rated firms only.

All Teltron tubes are obtained from top surplus sources such as government agencies, receiver manufacturers, etc. Most of them are brand new and the remainder are from government and other equipment. ALL TUBES UNCONDITIONALLY GUARANTEED FOR ONE YEAR.

SPECIALS—THRU APRIL 1

Type	Price	Type	Price
1B3GT	.55	65Q7	.35
1T4	.47	6U8	.69
5U4G	.38	6W4GT	.35
6AC7	.59	7N7	.48
6AU6	.34	12AT7	.67
6AX4GT	.54	12AU7	.52
6BQ6GT	.73	25L6GT	.37
6CB6	.47	50L6GT	.44
6K6GT	.35	80	.36

TELTRON ELECTRIC COMPANY

428 Harrison Ave.,

Harrison, N. J.

Dept. RE-3

Send for Free complete tube listing and monthly specials! Get on our mailing list.

Phone HUmboldt 4-9848

ENJOY 3 COLOR TELEVISION FILTER SCREEN NOW

Changes dull eye-straining black and white pictures into beautiful color tones. Seconds to attach. No tools used. Helps eliminate glare and snow in fringe areas. Order direct. Send \$1 for screen size up to 16", \$1.25 size 17", \$1.50 size 20", \$2 size 21", \$2.50 size 24", \$3 size 27". We pay postage except on C.O.D. orders. Satisfaction guaranteed. Inquiries from dealers also welcomed.

Zingo Products, Johnstown 13, New York

FREE!

REQUEST PORTFOLIO 200

TO EVERY TV
SERVICEMAN

TV accessories and parts
— catalogs, literature,
data sheets, etc. Yours
for the asking!



Vidaire

ELECTRONICS MFG. CORP

Main Office & Plant

576 WEST MERRICK ROAD LYNBROOK, N.Y.

EASY TO LEARN CODE

It is easy to learn or increase speed with an Instructograph Code Teacher. Affords the quickest and most practical method yet developed. For beginners or advanced students. Available tapes from beginner's alphabet to typical messages on all subjects. Speed range 5 to 40 WPM. Always ready—no QRM.



ENDORSED BY THOUSANDS!

The Instructograph Code Teacher literally takes the place of an operator-instructor and enables anyone to learn and master code without further assistance. Thousands of successful operators have "acquired the code" with the Instructograph System. Write today for convenient rental and purchase plans.

INSTRUCTOGRAPH COMPANY

4701 Sheridan Rd., Dept. RC, Chicago 40, Ill.

BOOKS

(Continued)

experimenter's knowledge of radio and TV, explanations are clear, but the language is that of the person who understands the technical terms used in television.

Cisin's coded TV Trouble Locator technique, in which observed conditions are translated into number-letter combinations and checked against a list, is confined to one chapter in this edition. Other chapters are: Valuable Information About TV Receivers, How to Recognize and Replace Defective tubes, Easy Trouble Checks, Antenna Know-How, and Color Television.—*FS*

HANDBOOK OF MICROWAVE MEASUREMENTS (Volumes I and II), by Moe Wind and Harold Rapaport. Polytechnic Institute of Brooklyn, 55 Johnson Street, Brooklyn 1, N. Y. Over 1,000 pages, 8 1/2 x 11 inches. \$12.00.

This publication (Volume I text and Volume II over 500 illustrations) is specifically prepared to meet the needs of the engineer, student, and laboratory technician engaged in microwave research, development and production. During the comparatively few years that we have known microwave engineering, a number of different techniques and procedures have been developed for making the various measurements required in practice. In many instances these have been described in lectures and papers which were available to only a few of the thousands actively engaged in this work.

This handbook is a collation of much of the material on measurement techniques which, until now, has been unavailable to many of those who have the greatest need for it. It is divided into 20 sections, each covering in detail the various procedures and techniques that have been developed to measure such quantities as frequency, wavelength, voltage standing-wave ratio, attenuation, power, Q, dielectric constant and noise factor.

Placing the illustrations in a separate volume may seem a bit clumsy, but since the authors refer frequently to the many diagrams, photos, and charts, this reviewer feels that the present arrangement is advantageous. It permits the reader to glance from text to illustration and back again without wasting time continuously flipping pages.—*RFS*

DIELECTRIC AERIALS, by D. G. Kiely. John Wiley & Sons, New York. 132 pages, \$2.00.

A critical review of existing work and a highly mathematical compilation of design data on dielectric antennas—the most recently developed of all microwave types.

The five chapters of the book are "Introduction" (a historical sketch of the field and scope of the book), "Wave Propagation Along a Dielectric Rod", "Dielectric Rod Aerials", "Dielectric Tube Aerials", and "Other Dielectric Aerials".

END

The Magnificence of FM

at a price everyone can afford!

Granco "Music Hall" FM RECEIVER

FM reception — for every home, room, taste, pocketbook! The "Music Hall" offers superlative radio entertainment at a popular price. In many cities, no other radio is necessary, since fine AM programs are simultaneously broadcast on FM—plus the wonderful high-fidelity music exclusively on FM.

- * Powerful six-tube chassis for high sensitivity and drift-free performance.
- * Exclusive coaxial tuning—outstanding stability, selectivity, sensitivity.
- * Amazing volume. Only table radio in its price class with a big, oval, 6" speaker.
- * With built-in antenna. No installation required.
- * Smart paragrid styling. Fits anywhere. Available in three colors. Blends with any decor.

Model 610E, Ebony . . . \$29.95

Grained walnut or ivory, slightly higher.
Prices slightly higher on the West Coast.



Granco
PRODUCTS INC.
36-17 20th Avenue, Long Island City 5, N. Y.

A TOWER OF STRENGTH

- Safe in gales up to 80 m.p.h. without ugly, hazardous guy wires
- Free-standing to 50 feet high
- No rusting, ripping or weakened holes
- Big, safe, steel gird-around ties
- Easy installation and dismantling
- Sturdy, safe . . . on roof or ground
- Thick, baked-on-steel aluminum finish

Kuehne*

TELEVISION TOWERS

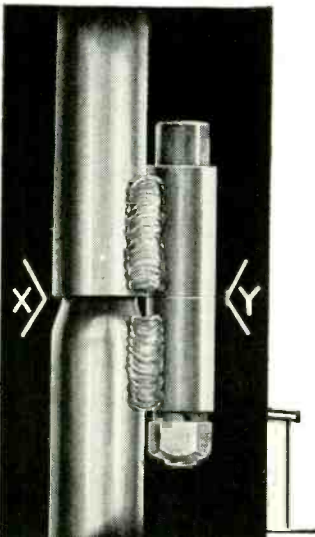

Exclusive! LATERAL LOAD-BEARING JOINTS

No dangerous rust. Arrow "X" shows open-joint section. Moisture cannot get in tubing to cause interior rust.

No hazardous holes. Arrow "Y" shows lateral load bearers lifetime welded to side of each section leg with twin 1 1/8" fillets. Sections are bolted vertically. Bear 100% of load! No load on joints. No horizontal bolts to tear through. Nothing stronger or safer. Only Kuehne has it!

KUEHNE MFG. CO.
TV TOWER DIVISION
MATTOON, ILLINOIS

* Say "Kee Nee"

For catalog sheets, see your "Kee Nee" Man or write direct.

ADVERTISING INDEX

Radio-Electronics does not assume responsibility for any errors appearing in the index below.

Allied Radio Corp.	17, 133
Almo Radio Co.	118
American Phenolic Corp.	145
Amplifier Corporation of America	134
Approved Electronic Instrument Corp.	142
Arky Radio Kits, Inc.	6
Astron Corp.	146
Atlas Sound Corp.	102
Audel Publishing Co.	100
Barjay Co., The	160
Barry Electronics Corp.	101
Bell Telephone Labs.	131
Blonder Tongue Labs.	14
Boland & Boyce, Inc.	11
Book of the Month Club, Inc.	139
Brooks Radio & TV Corp.	130
Burstein Applebee Co.	29
Capitol Radio Engineering Institute	20, 28
Channel Master Corp.	147
Chicago Standard Transformer Corp.	9
Cisin, H. G.	140
Cleveland Institute of Radio Electronics	155
Collins Audio Products Co.	22, 105
Concord Radio Electric Corp.	102
Cornell Dubilier Electric Corp.	23, 123, 152
Cornish Wire Co.	135
Coyne Electrical & TV Radio School	Inside Front Cover
Delco Radio (Div. of General Motors Corp.)	153
DeVry Technical Institute	108
DeMont, Allen B., Labs.	130
Dynamo Magnetics Corp.	Third Cover
Eddie Electronics	159
Electro Products Laboratories	119
Electro-Voice, Inc.	105
Electronic Instrument Co. (EICO)	100
Electronic Measurements Corp.	137
Erie Resistor Corp.	111
E-Z Way Towers, Inc.	145
Fenton Company	148
General Cement Mfg. Co.	153
General Test Equipment	69-80
Granco Products Co.	123
Grantham School of Electronics	108
Hallcrafters Co.	154
Hawkins, P. E., Co.	127
Heath Co.	134
Hershel Radio Co.	137
Hickok Electrical Instrument Co.	145
Hudson Specialties Co.	27
Hughes Research & Development Labs.	104
Indiana Technical College	105
Institute of Radio Engineers	84
Instructograph Co.	99
Instruments for Service, Inc.	160
International Rectifier Corp.	151
J. E. S. Co.	152
JFD Mfg. Co., Inc.	151
Jackson Electrical Instrument Co.	152
Jensen Industries	150
Jones & Laughlin Steel Corp.	109
Jontz Manufacturing Co.	112
Kay-Townes Antenna Corp.	85
Kuehne Mfg. Co.	153
Lafayette Radio Corp.	124, 16
Leotone Radio Corp.	147
Macmillan Co., The	13
Mallory, P. R. & Co., Inc.	5
McGraw-Hill Book Co.	90
Merit Coil and Transformer Co.	153
Mosley Electronics	153
Moss Electronic Distributing Co.	124, 16
Musical Masterpiece Society, The	147
National Electronics of Cleveland	13
National Radio Institute	3, 13
National Schools	5
Newark Electric Co.	90
Norman Electronics	153
Opportunity Adlets	128
Perma-Power Co.	132
Permotlux Corp.	10
Phaotron Co.	26
Precise Development Corp.	94
Precision Apparatus Co., Inc.	141
Progressive "Edu-Kits", Inc.	120
Pyramid Electric Co.	89
Quam Nichols Co.	88
Quietrol Co.	136
RCA Institutes, Inc.	19
RCA Tube Div. (Radio Corp. of America)	107, Back
Rad-Tel Tube Co.	149
Radiart Corp.	22
Radio Craftsmen, Inc., The	82, 123
Radio Products Co.	134
Radio Receptor, Inc.	138

RADIO SCHOOL DIRECTORY PAGE 157

Baltimore Technical Institute	25
Candler System Co.	130
Capitol Radio Engineering Institute	15
Grantham School of Electronics	118
Indiana Technical College	92
Indianapolis Electronic School	136
Milwaukee Schol of Engineering	90, 93, 110, 133
RCA Institutes, Inc.	12
Tri-State College	146
Valparaiso Technical Institute	81
Video Specialties Co.	137
Western Television Institute	103
Radio Television Training Association	67
Radion Corporation	144
Raytheon Mfg. Co.	144
Regency Division (I.D.E.A.)	121
Rek-O-Kut Co.	121
Rider, John F., Inc.	87
Rinehart & Co., Inc.	144
Rohn Mfg. Co.	144
S & A Electronics	121
Sams, Howard W. & Co., Inc.	95
Shure Brothers, Inc.	87
Simpson Electric Co.	162
Sprague Products Co.	102
Sprayberry Academy of Radio	126
Stan-Burn Radio & Electronics	158
Steve-El Electronics Corp.	147
Supreme Publications	105, 129, 147
Sylvania Electric Products, Inc.	161
T. V. Products Co.	8
Tab	14
Technaster Corp.	143
Technical Appliance Corp.	128
Teltron Electric Co.	128
Transamerica Electronics	128
Transvision, Inc.	105, 129, 147
Trio Mfg. Co.	161
Tung-Sol Electric Co.	8
Turner Co.	14
University Loud Speakers, Inc.	143
V.A. Enterprises	128
Vidair Electronics Mfg. Corp.	158
Ward Products Corp.	91
Weston Electrical Instrument Co.	112
Wholesale Radio Parts Company	112
Winston Electronics, Inc.	24
Xcelite	154
Zingo Products	158

STANDARD BRAND TUBES

Now Geared for Same-Day Shipment

- Individually boxed. • Only 1st quality.
- Latest Dating—
- No private label, electrical or mechanical rejects.
- No rebrands or "reworked" "bargains."

Write for Free 1955 New Air-Mail Handy-Order Blank.

- Lists ALL Popular TV & Radio Types.
- Makes Mail-Order a Pleasure.
- All Tube Orders Over \$25.00 (with Remittance) Postpaid.

SPECIAL-PURPOSE TUBES

Write for our complete listing on XMTG, Industrial, Special-Purpose and Crystal Diodes. We stock over 2,000 types at excellent prices.

METEOROLOGICAL TRANSMITTER

Type T-49C. Uses RCA 3AB. Complete with tube, antenna, battery harness. Brand Only \$1.75

SUPER SPECIAL! 3000 Volts DC—330 Ma.

BASIC COMPONENT KW POWER SUPPLY KIT
Contains:
• 350C V. AC. XFMR @ 400 MA. Primary—115 V., 60 cy.
• 400 MA. Matched Smoothing Choke.
• 115 Volts Primary Bridge Filament for Four 866-A's.
Complete only \$39.95

3,000 VOLT POCKET MULTITESTER

AC: 0-15, 150, 750, 3000 volts.
DC: 0-15, 75, 300, 750, 3000 volts.
DC MA: 0-15, 150, 750 ma.
Resistance: 0-10,000, 100,000 ohms.
Complete with battery, test leads. Only 3 1/2" W x 4 1/4" H x 1 3/4" deep. Brand New @ only \$9.95.

TWO-COLORED TUBE CARTONS, with new Safety Partitions. Prevents Tube Breakage. This Super-Gloss Red and Black Carton is the Most Distinctive Box Available Today! Minimum: 100 any one size. Quantity prices on request. Boxes F.O.B., N.Y., N.Y.
SIZE EACH
Miniature.....(6AU6, 6AL5, etc.).....\$.01
GT.....(6SN7, 6W4, etc.)......0125
LARGE GT.....(183, 6BQ6GT, etc.)......015
LARGE G.....(5U4G, 6BG6G, etc.)......02

Terms: 25% with order, balance C.O.D. All merchandise guaranteed. F.O.B., N.Y.C.
New phone and address Phone: Walker 5-7000.

BARRY ELECTRONICS CORP.
512 Broadway N.Y. 12, N.Y.

NEW EICO PROBES*

SCOPE PROBES



- SCOPE DEMODULATOR PROBE
KIT \$3.75 WIRED \$5.75
- LOW CAPACITY PROBE
KIT \$3.75 WIRED \$5.75
- DIRECT PROBE
KIT \$2.75 WIRED \$3.95

SPECIAL . . . All 3 Scope Probes
KIT \$9.95 WIRED \$14.95

VTVM PROBES

- VTVM RF PROBES
KIT \$3.75 WIRED \$4.95
- PEAK-TO-PEAK PROBES
KIT \$4.95 WIRED \$6.95



Sensational High Voltage Probe

Model HVP-2 . . . ONLY \$4.95

© 54 Extends range of VTVMs & VOMs to 30 KV *pat. pend.



Write for FREE Catalog CP-3

ELECTRONIC INSTRUMENT CO., INC.
84 Withers Street • Brooklyn 11, N.Y.

TRIO

America's Top Quality Line...
is the Best Buy for the Money!

Behind every TRIO antenna is the RESEARCH—ENGINEERING—EXPERIENCE and CRAFTSMANSHIP that has made TRIO the leader in antenna development.

TRIO — THE COMPLETE LINE

YAGIS
RADAR SCREEN TYPES
UHF & REFLECTOR TYPES

CONICALS
COLINEAR ARRAYS
CONICAL — YAGIS

NEWEST ADDITIONS TO THE TRIO LINE

The TRIO "99"

CHANNELS 2-13

A well-known broad band Yagi type featuring sturdier construction, higher quality materials and faster assembly. Improved forward gain with reduced side and rear pick-up as a result of TRIO engineering and research. Uses famous "Insta-Lok" clamps and all riveted construction as originally introduced by TRIO.

The TRIO "77"

CHANNELS 2-13

High gain, broad band type now greatly improved as a result of TRIO engineering. Highest quality Alcoa elements and boom. Exclusive "Insta-Lok" clamps for easy fast assembly. Designed for low wind resistance and balanced for rotator operation.



America's No. 1 Choice

The TRIO "88"

More DB gain per dollar cost. Completely pre-assembled, ready to unfold and install. New Mycastyrene insulators for greater strength and insulating qualities. Highest quality Alcoa aluminum elements and extra sturdy boom. Exclusive, sensational TRIO Jr. & Sr. "Insta-Lok" clamps combined with famous "Vari-Con" head gives the "88" all the plus features everyone wants. Rugged construction, completely pre-assembled, superior performance and low unit cost. The best buy on the market today! Available in single or two bay models.

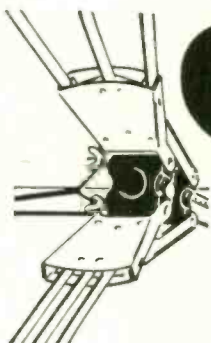

New "Vari-Con" Head

Four hi strength aluminum adjusting arms. Interlocking butterfly sections. Heavier snap-action spring assembly. Spring dampers lessen vibration and breakage. Mycastyrene insulators. Used on the popular TRIO "88" and "Vari-Con" antennas.



Sensational "INSTA-LOK" CLAMP

(Goodbye Nuts)

Revolutionary TRIO clamp employed on all TRIO antennas with parasitic elements. Permits instant flip-out assembly — permanent alignment and ultra-strength. Nothing stronger! Nothing faster!

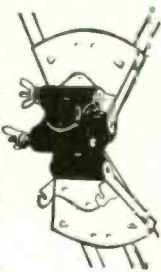

New Mini-Up Conical Head

Superior strength — with the new modern riveted construction. No shedding of elements as with doweled, friction held elements.



Heaviest Booms!

Thick-wall, extra sturdy 1 1/4" diameter booms used on ALL low band Yagis. Highest grade Alcoa aluminum for added strength.

COMPARE THESE FEATURES!

THE TRIO "ARISTOCRAT"

America's Most Dependable Rotator Is Also America's Most Beautiful

Control unit available in four glorious colors.

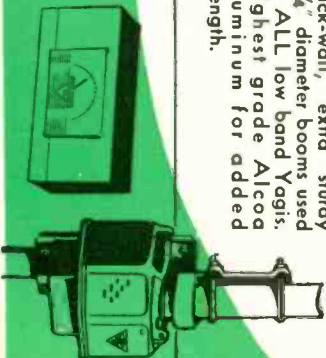

TRIO MANUFACTURING COMPANY · GRIGGSVILLE, ILLINOIS
TRIO Leader in Antenna Development

Copyright 1955 by TRIO MANUFACTURING CO.

PROVEN FINEST IN PA

CDP[®]

COMPOUND DIFFRACTION PROJECTOR*

Public Address Loudspeaker System

Sets new standards
for voice penetration
and musicasting

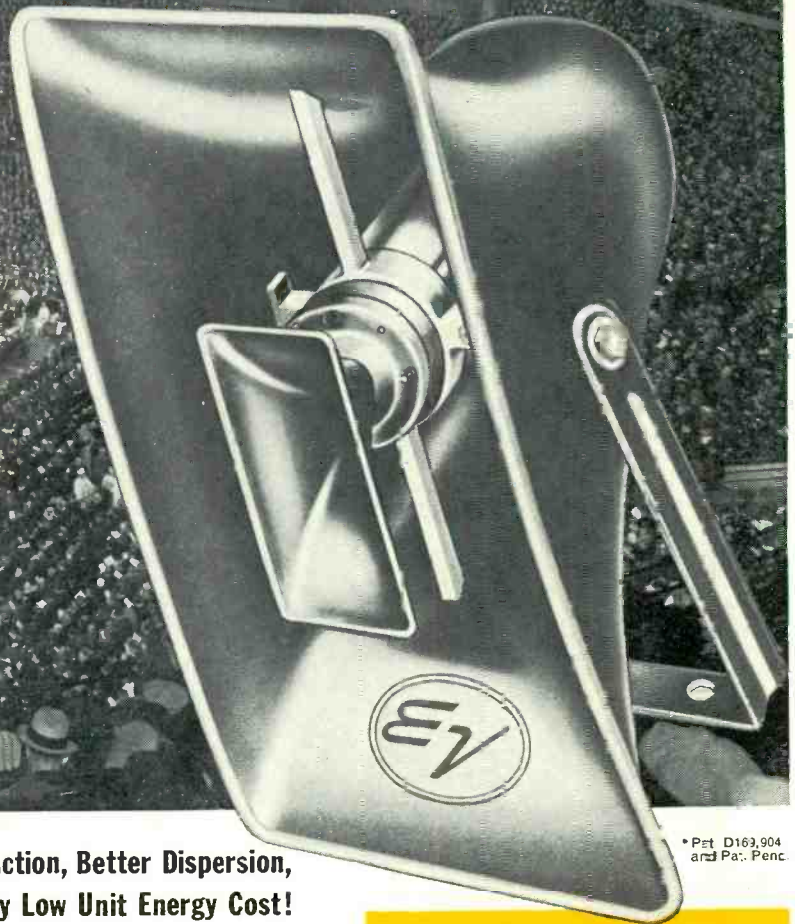

* Pat. D163,904
and Pat. Penc.

Gives Clearer, Cleaner, Wider-Range Reproduction, Better Dispersion, Greater Penetration and Coverage... at Very Low Unit Energy Cost!

Results are so amazing that the "CDP" is outmoding and rapidly replacing conventional PA re-entrant horns. Exclusive E-V "CDP" utilizes two coaxially mounted diffraction horns working from both sides of a single diaphragm. Each horn is designed for optimum air loading and reproduction within its own range. Also uses the new acoustic application of optical slit diffraction for perfected smooth sound dispersion virtually independent of frequency. Permits use of fewer units at far less cost. Greatly improves public address—in all types of applications—indoors and outdoors. *One test will convince you!*

Model 848 CDP. 25 watts. 16 ohms.
10½" wide, 20½" high, 20" deep over-all.
List Price \$69.50. Net \$41.70

Acclaimed by Sound Experts Everywhere

- Peak-free response 175-10,000 cps.
- Delivers 2½ octaves more musical range than units of similar size or price.
- Speech articulation index greatly improved.
- Weather-proof, blast-proof, splash-proof. Virtually indestructible.
- Small Size—about ½ the width of re-entrant PA horns of similar power rating. Ideal shape for stacking.
- Provides augmented bass response when stacked in adjacent positions or when mounted singly against wall, in corners or where ceiling joins wall.
- Permits various polar patterns for most effective use.
- Molded of glass fibers for extra strength and improved acoustic properties.

Send Now for Helpful
Bulletin No. 197



Gives complete and helpful information about the performance and application of the "CDP."

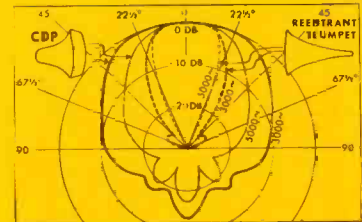

COMPARE POLAR PATTERN

Sound distribution of the E-V "CDP" exceeds 120° at all frequencies up to 10,000 cps.

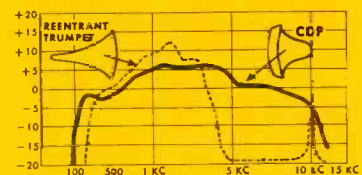

COMPARE RESPONSE AND EFFICIENCY

Note extended high frequency range of the "CDP." Response is smooth, peak-free 175-10,000 cps.

NO FINER CHOICE THAN

Electro-Voice

ELECTRO-VOICE, INC. • BUCHANAN, MICHIGAN

FULTON T V 3-57
 % PAUL S BOLLARO
 434 FULTON ST
 ELIZABETH 1 N J

READY FOR . . .

NATIONAL TELEVISION SERVICEMEN'S WEEK MARCH 7-12

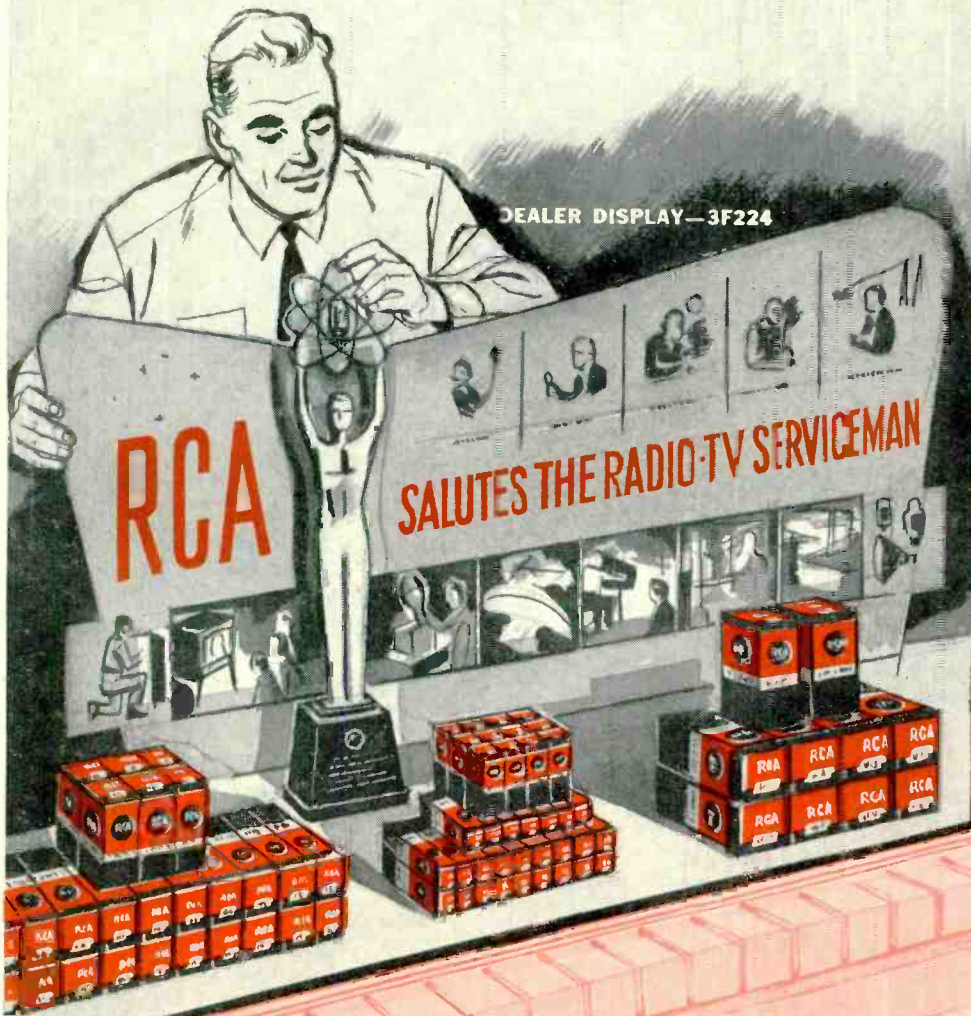

Television dealers and service technicians all over the country are preparing to tie-in with a great promotional event. It's National Television Servicemen's Week, March 7-12, sponsored by the RCA Tube Division and registered officially with the Chamber of Commerce of the United States.

You can use this unique merchandising plan right in your own neighborhood to meet and sell more television service prospects than ever before. Your RCA Tube Distributor offers you excellent promotional materials to help you identify yourself and your store with this nationwide consumer promotion.

Plan an active participation in National Television Servicemen's Week now. Act today! See your RCA Tube Distributor for full details.



RADIO CORPORATION of AMERICA
 ELECTRON TUBES
 HARRISON, N.J.

Use These Promotional
 Materials

