

JUNE 1954

# RADIO - ELECTRONICS

TELEVISION • SERVICING • HIGH FIDELITY

In this issue:

Preamplifier  
for the  
Golden Ear



Color TV  
Circuits



A Versatile  
Electronic  
Control



What's New  
in  
Transistors

**35¢**

U. S. and  
CANADA



HUGO GERNSBACK, Editor

**Servicing High-Fidelity Audio in the Home**  
(See page 4)

# Right now

..... IS THE TIME TO  
**REPLACE** THAT OUT-MODED  
AND WORN OUT TV ANTENNA

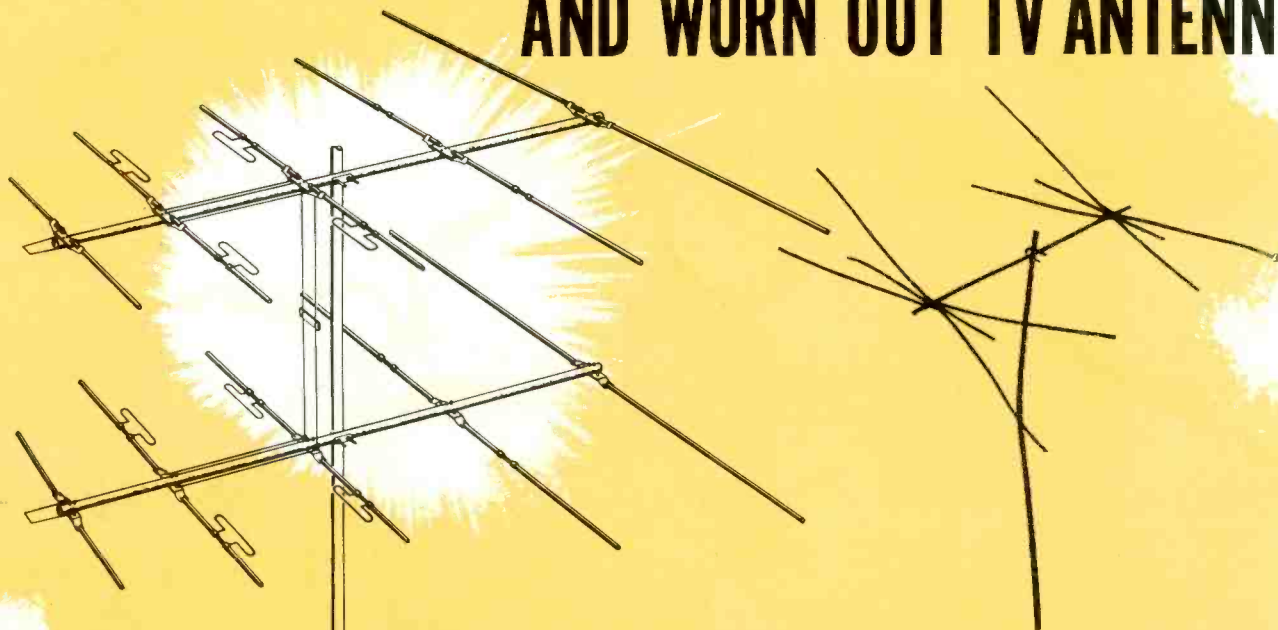

Your customers can enjoy better TV reception with their present receiver  
WITH  
**BRIGHTER, CLEARER, SHARPER PICTURES**

Provide your customer with greater enjoyment with his present TV receiver—put new life into the pictures on the screen—supply him with the equipment necessary to bring in all the available channels better, clearer...with the installation of a new Taco antenna.

We all know that there is a tremendous amount of replacement antenna and installation business to be had. The next few months will have a great effect on your overall business for the year.

**SEE YOUR TACO DISTRIBUTOR—HE WILL  
TELL YOU WHAT TACO IS DOING FOR YOU.**

**Mr. Serviceman:**

Postcards with your message directed to your customers and bearing your imprint and telephone number are available through your Taco distributor. Your customers will thank you for sending him this reminder that he needs television antenna service.



ESPECIALLY WITH A GENUINE

# TACO

**HIGH-GAIN ANTENNA**

Technical Appliance Corporation, Sherburne, N. Y.

In Canada: Hackbusch Electronics, Ltd., Toronto 4, Ontario



# I Will Send You BOTH FREE

J. E. SMITH, President  
National Radio Institute  
Washington 9, D. C.

**ACTUAL LESSON**

**The ABC's of SERVICING**

**How to be a SUCCESS in RADIO-TELEVISION**

**64 PAGE BOOK**

## See How I Train You at Home in Spare Time for Good Pay Jobs in RADIO-TELEVISION

### You Practice Broadcasting with Equipment I Send



As part of my Communications Course I send you kits of parts to build the low-power Broadcasting Transmitter shown at left. You use it to get practical experience putting this station "on the air," to perform procedures required of broadcasting station operators. An FCC Commercial Operator's license can be your ticket to a better job and a bright future. My course gives you the training you need to get your license. Mail coupon below. See in my book other valuable equipment you build and keep.

### You Practice Servicing with Equipment I Send

Nothing takes the place of PRACTICAL EXPERIENCE. That's why NRI training is based on LEARNING BY DOING. You use kits of parts I furnish to build many circuits common to both Radio and Television. With my Servicing Course you build the modern receiver shown at right. You also build an Electronic Multimeter which you can use to help fix sets while training at home. Many students make \$10, \$15 a week extra fixing neighbors' sets in spare time, starting soon after enrolling. I send you special booklets that show you how to fix sets. Mail coupon for 64-page book and actual Servicing Lesson, both FREE.



TRAINING plus OPPORTUNITY is the PERFECT combination. The sample lesson I send will prove to you that it is practical to keep your job while TRAINING right in your own home for better pay and a brighter future. My 64-page book should convince you that Radio-Television is truly today's field of OPPORTUNITY.

### TELEVISION MAKING JOBS, PROSPERITY

Radio, even without Television, is bigger than ever. 115 million home and auto Radios create steady demand for service. 3000 Radio stations give interesting, good pay jobs to operators, technicians. NOW ADD TELEVISION. 25 million Television homes and the total growing rapidly. 200 Television stations on the air and hundreds more under construction. Color Television soon to be a reality. Government, Aviation, Police, Ship, Micro-wave Relay, Two-way Communications for buses, taxis, trucks, railroads are growing fields providing good jobs for men who know Radio-Television. All this adds up to good pay now, a bright future later for men who qualify.



### START SOON TO MAKE \$10, \$15 A WEEK EXTRA

An important benefit of Radio-Television training is that you can start to cash in fast. Many men I train fix neighbors' sets, make extra money, starting soon after they enroll. Multimeter built with parts I send helps locate and correct set troubles. Read at left how you build actual equipment that gives you practical experience, brings to life what you learn from my lessons.



### MEN OF ACTION NEEDED MAIL COUPON TODAY

Act now to enjoy more good things of life. Get the benefit of my 40 years' experience training men at home. Take NRI training for as little as \$5 a month. Many NRI graduates (some with only a grammar school education) make more in two weeks than the total cost of training. Find out about this tested way to better pay. Mail coupon below today for Actual Lesson and 64-page Book — BOTH FREE. J. E. SMITH, President, National Radio Institute, Dept. 4Ft., Washington 9, D. C. OUR 40TH YEAR.

### I TRAINED THESE MEN AT HOME



"Started repairing Radios six months after enrolling. Earned \$12 to \$15 a week, spare time." — ADAM KRAMLIK, JR., Sumneytown, Pennsylvania.



"I've come a long way in Radio and Television since graduating. Have my own business on Main Street." — JOE TRAVERS, Asbury Park, New Jersey.



"Answered ad for Radio and Phone Serviceman. Got the job. Within a year my pay increased 50%." — CHURCH-ILL CARTER, San Bernardino, California.



"Am with WCCO. NRI course can't be beat. Passed exam for first class Radio-telephone license with no trouble at all." — JESSE W. PARKEE, Meridian, Miss.



"Am with WNBT as video control engineer on RCA color project. Owe a lot of my success to your textbooks." — WARREN DEEM, Malverne, N. Y.

**AVAILABLE TO VETERANS UNDER GI BILLS**

### Good for Both - FREE

Mr. J. E. SMITH, President, Dept. 4FF  
National Radio Institute, Washington 9, D. C.

Mail me Sample Lesson and 64-page Book, FREE. (No salesman will call. Please write plainly.)

Name \_\_\_\_\_ Age \_\_\_\_\_

Address \_\_\_\_\_

City \_\_\_\_\_ Zone \_\_\_\_\_ State \_\_\_\_\_

**VETS** write in date of discharge \_\_\_\_\_



# RADIO - ELECTRONICS

Formerly RADIO-CRAFT • Incorporating SHORT WAVE CRAFT • TELEVISION NEWS • RADIO & TELEVISION

**Hugo Gernsback**  
Editor and Publisher

**M. Harvey Gernsback**  
Editorial Director

**Fred Shunaman**  
Managing Editor

**Robert F. Scott**  
W2PWG, Technical Editor

**Jerome Kass**  
Associate Editor

**I. Queen**  
Editorial Associate

**Matthew Mandl**  
Television Consultant

**Charles A. Phelps**  
Copy Editor

**Angie Pascale**  
Editorial Production

**Wm. Lyon McLaughlin**  
Tech. Illustration Director

**Sol Ehrlich**  
Art Director

**Lee Robinson**  
General Manager

**John J. Lamson**  
Sales Manager

**G. Aliquo**  
Circulation Manager

**Adam J. Smith**  
Director, Newsstand Sales

**Robert Fallath**  
Promotion Manager

**Seymour Schwartz**  
Advertising Production



Member  
Magazine Publishers  
Association

ON THE COVER (See article  
on page 37)

A typical service job on the  
audio amplifier in one of Sigma  
Electric's custom installations.  
It combines an AM and FM  
radio, a television receiver and  
a high-fidelity phonograph.

(Color original by Avery Slack)

## CONTENTS

JUNE 1954

### Editorial (Page 31)

Age of Decomplexity .....by Hugo Gernsback 31

### Audio—High Fidelity (Pages 32-46)

Phono Preamp for Golden Ears .....by Joseph Marshall 32

High-Fidelity Servicing (Cover Feature)  
by Wilfred Goldstick and Arthur Peikes 37

Tuning Electronic Organs .....by Richard H. Dorf 40

High-Fidelity Loudspeakers, Part III—Horns and multiple-unit speaker  
systems .....by H. A. Hartley 42

High-Quality Audio, Part X—Circuits and characteristics of the cathode  
follower .....by Richard H. Dorf 45

### Electronics (Pages 47-52)

I. R. E. Shows Electronic Progress .....by Fred Shunaman 47

A Digital NIM Computer .....by Arthur Schlang 49

Versatile Control Unit .....by R. J. Sandretta 51

### Television (Pages 53-65)

Color TV Circuits .....by Ken Kleidon and Phil Steinberg 53

Noise Immunity and Other Circuits .....by Robert F. Scott 56

Television—It's a Cinch (Tenth Conversation, 2nd half—vertical sync and  
blanking signals, bandwidth considerations, TV sound) ...by E. Aisberg 58

U.H.F. Lines and Converters .....by Matthew Mandl and Ed Nail 60

A Very Loose Vertical Hold .....by Wayne E. Lemois 61

TV Service Clinic .....conducted by Matthew Mandl 62

Yankee Repairman in England .....by John D. Burke 64

### Test Instruments (Pages 66-70)

Tube Checker for A.C.-D.C. Sets .....by Alvin B. Kaufman 66

Simple Capacimeter .....by Kai M. Klömm 67

Novel Grid-Dip Oscillator Uses 6E5 .....by Elliott A. McCready 68

Tech-Tricks .....by Harry E. Leeper 70

### Radio (Pages 75-92)

What's New in Transistors? .....by I. Queen 75

Ceramic Capacitors .....by Jesse Dines 78

Watch that Signal! .....by William H. Minor 83

### New Design (Pages 94-97)

New Tubes ..... 94

### Departments

The Radio Month 6 New Devices .. 107 Technotes ..... 119

Correspondence 14 Radio-Electronic Miscellany ..... 121

Business 20 Circuits ..... 111 People ..... 122

New Patents 98 Try This One 115 Electronic ..... 125

With the Question Box .. 117 Literature ... 125

Technician ... 105 Book Reviews .. 126



MEMBER Audit Bureau of Circulations

Vol. XXV, No. 6

Average Paid Circulation over 171,000

RADIO-ELECTRONICS, June, 1954, Vol. XXV, No. 6. Published monthly at Erie Ave., F to G Sts., Philadelphia 32, Pa. Gernsback Publications, Inc. Entered as Second Class matter September 27, 1948, at the Post Office at Philadelphia, Pa., under the Act of March 3, 1879. Copyright 1954 by Gernsback Publications, Inc. Text and Illustrations must not be reproduced without permission of copyright owners.

EXECUTIVE, EDITORIAL and ADVERTISING OFFICES: 25 West Broadway, New York 7, N. Y. Telephone REctor 2-8830. Gernsback Publications, Inc. Hugo Gernsback, President; M. Harvey Gernsback, Vice-President; G. Aliquo, Secretary.

SUBSCRIPTIONS: Address correspondence to Radio-Electronics, Subscription Dept., Erie Avenue, F to G Sts., Philadelphia 32, Pa., or 25 West Broadway, New York 7, N. Y. When ordering a change please furnish an address stencil impression from a recent wrapper. Allow one month for change of address.

SUBSCRIPTION RATES: In U. S. and Canada, and in U. S. possessions, \$3.50 for one year; \$6.00 for two years; \$8.00 for three years; single copies 35¢. All other foreign countries \$4.50 a year; \$8.00 for two years; \$11.00 for three years.

BRANCH ADVERTISING OFFICES: Chicago: 7522 North Sheridan Road, Tel. Rogers Park 4-8000. Los Angeles: Ralph W. Harker and Associates, 1127 Wilshire Blvd., Tel. Madison 6-1271. San Francisco: Ralph W. Harker and Associates, 582 Market St., Tel. GARfield 1-2481. FOREIGN AGENTS: Great Britain: Atlas Publishing and Distributing Co., Ltd., London E.C.4. Australia: McGill's Agency, Melbourne. France: Brentano's, Paris 2e. Belgium: Agence et Messageries de la Presse, Brussels. Holland: Trilectron, Heemstede. Greece: International Book & News Agency, Athens. So. Africa: Central News Agency Ltd., Johannesburg. Capetown, Durban, Natal. Universal Book Agency, Johannesburg. Middle East: Steimatzky Middle East Agency, Jerusalem. India: Broadway News Centre, Dadar, Bombay #14. Pakistan: Paradise Book Stall, Karachi 3. POSTMASTER:

If undeliverable send form 3578 to: RADIO-ELECTRONICS, 25 West Broadway, New York 7, N. Y. \*Trademark registered U.S. Patent Office.

RADIO-ELECTRONICS

# ADVANCE! Raise your earning power—learn RADIO-TELEVISION-ELECTRONICS by SHOP-METHOD HOME TRAINING

## GOOD JOBS AWAIT THE TRAINED RADIO-TV TECHNICIAN

There is a place for you in the great Radio-Television-Electronics industry when you are trained as National Schools will train you at home!

Trained technicians are in growing demand at good pay—in manufacturing, broadcasting, television, communications, radar, research laboratories, home Radio-TV service, and other branches of the field. National Schools Master Shop-Method Home Training, with newly added lessons and equipment, trains you in your spare time, right in your own home, for these fascinating opportunities. OUR METHOD IS PROVED BY THE SUCCESS OF NATIONAL SCHOOLS TRAINED MEN, ALL OVER THE WORLD, SINCE 1905.

## EARN WHILE YOU LEARN

Many National students pay for all or part of their training with spare time earnings. We'll show you how you can do the same! Early in your training, you receive "Spare-time Work" Lessons which will enable you to earn extra money servicing neighbors' and friends' Radio and Television receivers, appliances, etc.



Signal Generator



T. R. F. Receiver

Audio Oscillator

## National Schools Training is All-Embracing

National Schools prepares you for your choice of many job opportunities. Thousands of home, portable, and auto radios are being sold daily—more than ever before. Television is sweeping the country, too. Co-axial cables are now bringing Television to more cities, towns, and farms every day! National Schools' complete training program qualifies you in all fields. Read this partial list of opportunities for trained technicians:

- Business of Your Own • Broadcasting
- Radio Manufacturing, Sales, Service • Telecasting
- Television Manufacturing, Sales, Service
- Laboratories: Installation, Maintenance of Electronic Equipment
- Electrolysis, Call Systems
- Garages: Auto Radio Sales, Service
- Sound Systems and Telephone Companies, Engineering Firms
- Theatre Sound Systems, Police Radio
- And scores of other good jobs in many related fields.

## TELEVISION TRAINING

You get a complete series of up-to-the-minute lessons covering all phases of repairing, servicing and construction. The same lesson texts used by resident students in our modern and complete Television broadcast studios, laboratories and classrooms!



## MASTER ALL PHASES!

Get Master Shop-Method Home Training from an Established Practical Resident School with its own Training Shops, Laboratories, Studios — almost 50 Years of Successful Experience in Training Ambitious Men.

**We Bring National Schools To You!**



Superheterodyne Receiver

You also receive this Multitester

## LEARN BY DOING

You receive and keep all the modern equipment shown above, including tubes and valuable, professional quality Multitester. No extra charges.

## FREE! RADIO-TV BOOK AND SAMPLE LESSON!

Send today for National Schools' new, illustrated Book of Opportunity in Radio-Television-Electronics, and an actual Sample Lesson. No cost—no obligation. Use the coupon now—we'll answer by return airmail.

**APPROVED FOR VETERANS AND NON-VETERANS**  
Check coupon below

Both Resident and Home Study Courses Offered!

## NATIONAL SCHOOLS

LOS ANGELES 37, CALIFORNIA • ESTABLISHED 1905  
IN CANADA: 811 W. HASTINGS STREET, VANCOUVER, B.C.

## GET FACTS FASTEST! MAIL TO OFFICE NEAREST YOU!

(mail in envelope or paste on postal card)

**NATIONAL SCHOOLS, Dept. RG-64**  
4000 S. Figueroa Street or 323 West Polk Street  
Los Angeles 37, Calif. Chicago 7, Ill.

Send FREE Radio-TV Electronics book and FREE sample lesson. No obligation, no salesman will call.

NAME \_\_\_\_\_ BIRTHDAY \_\_\_\_\_ 19 \_\_\_\_\_

ADDRESS \_\_\_\_\_

CITY \_\_\_\_\_ ZONE \_\_\_\_\_ STATE \_\_\_\_\_

Check if interested **ONLY** in Resident Training at Los Angeles. **VETERANS:** Give Date of Discharge \_\_\_\_\_



# Quality Features OF TUNG-SOL PICTURE TUBES

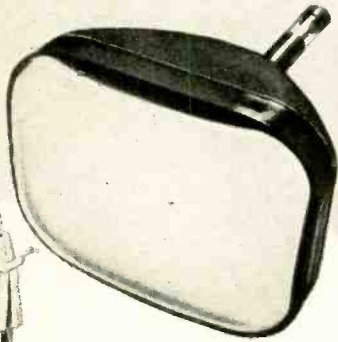

**Gun** made of best grade non-magnetic steel.

**Glass bead** type assembly is stronger both mechanically and electrically—gives greater protection against electrical leakage.

**Rolled edges** in gun minimize corona.

**Custom built stem** with greater spacing between leads assures minimum leakage.

**Low resistance** of outside conductive coating minimizes radiation of horizontal oscillator sweep frequency.

**Double cathode tab** provides double protection against cathode circuit failure.

**Selected screen composition** resists burning (X pattern).

**Rigid control** of internal conductive coating provides utmost service reliability.

**Designed** for use with single or double field ion trap designs.

**One-piece construction** of parts assures better alignment.

**Maximum dispersion** of screen coating assures uniform screen distribution.

Tung-Sol makes All-Glass Sealed Beam Lamps, Miniature Lamps, Signal Flashers, Picture Tubes, Radio, TV and Special Purpose Electron Tubes and Semiconductor Products.

TUNG-SOL ELECTRIC INC., Newark 4, N. J. Sales Offices: Atlanta, Chicago, Columbus, Culver City (Los Angeles), Dallas, Denver, Detroit, Newark, Seattle.

## TUNG-SOL®

RADIO AND TV TUBES



You Can Build A Reputation On Tung-Sol Quality

**COLOR TV CLINICS** have attracted more than 27,000 television service technicians in the first 35 sessions of a nationwide series of lectures and demonstrations sponsored by RCA and its distributors.

E. C. Cahill, president of the RCA Service Co. which is conducting the clinics, stated that the enthusiastic response by the nation's TV service technicians shows they are aware of the need for advance preparation to meet future demand for color TV service.

**COLOR STRIPE GENERATOR** for television stations, developed by RCA, will permit installation and performance checks of color television receivers in homes while black-and-white programs are on the air. The color stripe, practically unnoticeable on black-and-white receivers, will enable the service technician to determine whether the stations' color signal reaches the set.

The color generator is inserted in

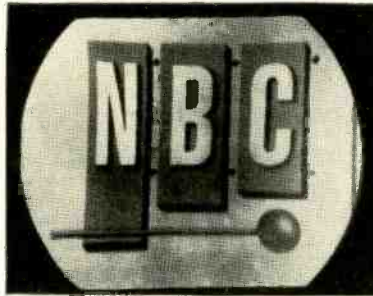

the video line feeding the television transmitter in such a way that normal operation is not changed. The generator adds a small amount of color information to the composite video signal. This information consists of a color sync burst signal which appears on the back porch of the regular monochrome sync pulse, and a short test burst of color signal which is superimposed on the monochrome video signal at the right side of the raster (see photo). The signal would be transmitted for brief periods at station breaks.

Monochrome receivers are relatively "blind" to these added signal components because most receivers have relatively low response at 3.6 mc. In a color receiver, however, the color sync signal and color test burst signal generate a single greenish-yellow bar  $\frac{1}{4}$  to  $\frac{3}{8}$ -inch wide (on a 15-inch kinescope).

**POWER FROM THE SUN**—in appreciable quantities—was shown to be a possibility by scientists of the Bell Telephone Laboratories in a demonstration at Murray Hill, N. J., April 23. Ordinary sunlight, subdued skylight, and electric lights were directed on batteries made of flat silicon plates to power radio transmitters, line telephone repeaters, and even a toy Ferris Wheel.

The silicon solar cell is a highly refined piece of that metal, into the surface of which minute traces of impurities have been introduced under carefully controlled conditions. These impurities, penetrating less than .0001 inch, form a p-n junction covering the face of the plate. Photoelectric action

at this junction is responsible for its action as a generator.

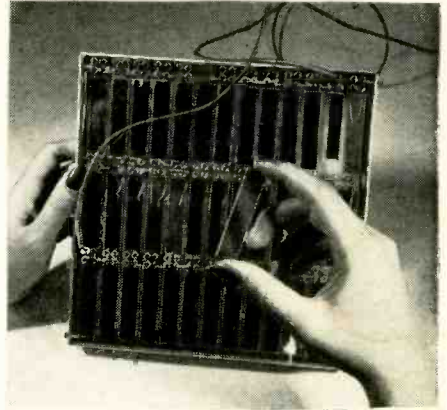

One of the silicon solar batteries and a closeup of one of the component cells.

Photoelectric devices are old, but this is the first one to obtain any significant quantity of power from light. According to figures given by the Laboratories, a square yard of surface will produce more than 50 watts of power. Open-circuit voltage of a cell is said to be 0.5—under load it drops to about 0.3 volts. Efficiency of the demonstrated battery was 69%.

**McCARTHY FCC PETITION** would require all radio stations—including amateurs—to record all their programs and broadcasts. As an outgrowth of his pressing for "free time" legislation, the Senator stated that according to some intelligence agencies, the hams are a tremendous potential for passing out improper information for espionage.

**19-INCH COLOR TV TUBE**, first demonstrated to the press by Du Mont Laboratories April 28, may provide the public with a TV picture large enough to have entertainment value at a reasonable price. This was the opinion of Dr. Allen B. Du Mont, who discussed the technical and economic aspects of the new tube in detail.

The new tube is a curved shadow-mask type with phosphors applied directly to the correspondingly curved faceplate by a photographic process. A new type of three-beam electron gun has a beam spacing only 70% as great as that in other color tubes. Electron beam deflection can therefore be increased to 60 degrees and the length of the tube reduced. The close spacing also makes it possible to have uniform-sized holes over the whole picture mask, with resultant greater brightness and decrease in distortion. Dr. Du Mont told his interviewers.

The picture covers the whole face of the tube. Thus the 19-inch tube provides a 19-inch picture of 185 square inches. This compares with 160 square inches for the planar-mask 19-inch tube, 155 square inches for the 21-inch Lawrence-type tube, and 88.5 square inches for the planar-mask 15-inch tube. It is 25% inches long, as compared with 26% inches for the 15-inch planar-mask type. Quantity production is expected by fall.

All Electronic Parts  
YOURS TO KEEP!

Now!  
Work over  
**300**  
practical projects  
WITH THESE  
PARTS...

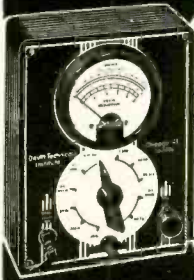

MULTIMETER

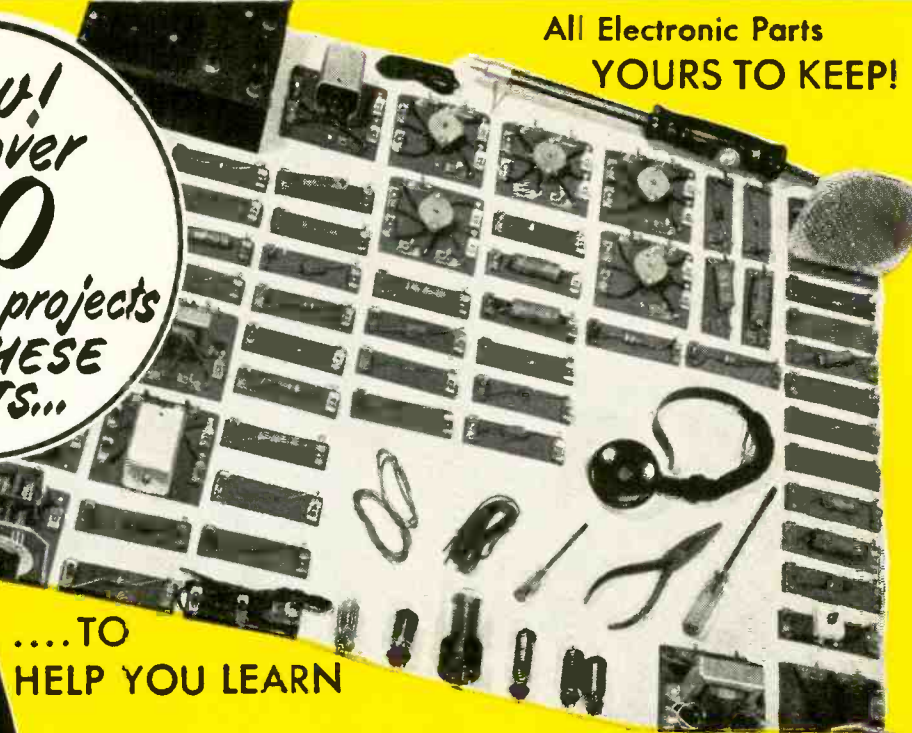

...TO  
HELP YOU LEARN

# TELEVISION

**RADIO-ELECTRONICS** Now... at home in spare time you can get BOTH the very training and subsequent Employment Service you need to help you start earning real money in America's thrilling, multi-billion dollar opportunity field of Television-Radio-Electronics. Now that Television is coming to almost every community, here is a chance of a lifetime to prepare to cash in on one of Television's great expansions.

D.T.I.'s amazingly practical home method enables you to set up your own HOME LABORATORY. You get many Electronic parts which you mount on individual bases with spring clip connectors. Tops for experimenting! Add or remove parts in a jiffy. No wasted hours of soldering and unsoldering for each project. You spend minimum time to get maximum knowledge of important circuits that really work. In fact, you get exactly the same type of basic training equipment used in our Chicago training laboratory—one of the nation's finest.

### Build and KEEP This VALUABLE TEST EQUIPMENT

Your home laboratory projects also include building and keeping a versatile 5 inch Oscilloscope and precision Jewel Bearing Multi-Meter. These quality commercial test instruments help you EARN WHILE YOU LEARN and will prove mighty valuable, should you later decide to start your own full time TV-Radio service business. You also build and keep a quality 21 inch TV SET.

### D.T.I. Provides EVERYTHING YOU NEED to master TELEVISION

In addition to your home laboratory and easy-to-read lessons, you even use HOME MOVIES—a wonderfully effective and exclusive D.T.I. training advantage. You watch hidden actions... see electrons on the march. Important fundamentals... become "movie clear," helping you learn faster... easier... better.

Full time Residential training in D.T.I.'s great Chicago laboratories also available. MAIL COUPON TODAY for all facts. (If subject to Military Service, you'll especially welcome the information we have for you.)



HOME MOVIES

**89 WAYS TO EARN MONEY**

**MAIL COUPON TODAY!**



Build and keep this BIG DTI Engineered TV set—easily converted to U.H.F. (DTI offers another home training, but without the TV set.)

"ONE OF AMERICA'S FOREMOST TELEVISION TRAINING CENTERS"



**DEVRY TECHNICAL INSTITUTE**

AFFILIATED WITH  
**DEFOREST'S TRAINING, INC.**  
CHICAGO 41, ILLINOIS

**DEVRY TECHNICAL INSTITUTE**

4141 BELMONT AVE., CHICAGO 41, ILL. DEPT. RE-6-K

I would like your valuable information-packed publication showing how I can get started toward a good job or my own business in Television-Radio-Electronics.

Name \_\_\_\_\_ Age \_\_\_\_\_

Street \_\_\_\_\_ Apt. \_\_\_\_\_

City \_\_\_\_\_ Zone \_\_\_\_\_ State \_\_\_\_\_

# PROVEN FINEST IN PA

# CDP<sup>®</sup>

## COMPOUND DIFFRACTION PROJECTOR\*

Public Address Loudspeaker System

Sets new standards  
for voice penetration  
and musicasting



\* Pat. D169,904  
and Pat. Pend.

**Gives Clearer, Cleaner, Wider-Range Reproduction, Better Dispersion,  
Greater Penetration and Coverage... at Very Low Unit Energy Cost!**

Results are so amazing that the "CDP" is outmoding and rapidly replacing conventional PA re-entrant horns. Exclusive E-V "CDP" utilizes two coaxially mounted diffraction horns working from both sides of a single diaphragm. Each horn is designed for optimum air loading and reproduction within its own range. Also uses the new acoustic application of optical slit diffraction for perfected smooth sound dispersion virtually independent of frequency. Permits use of fewer units at far less cost. Greatly improves public address—in all types of applications—indoors and outdoors. *One test will convince you!*

Model 848 CDP. 25 watts. 16 ohms.  
10½" wide, 20½" high, 20" deep over-all.  
List Price \$65.00. Net \$39.00

### Acclaimed by Sound Experts Everywhere

- Peak-free response 175-10,000 cps.
- Delivers 2½ octaves more musical range than units of similar size or price.
- Speech articulation index greatly improved.
- Weather-proof, blast-proof, splash-proof. Virtually indestructible.
- Small Size—about ½ the width of re-entrant PA horns of similar power rating. Ideal shape for stacking.
- Provides augmented bass response when stacked in adjacent positions or when mounted singly against wall, in corners or where ceiling joins wall.
- Permits various polar patterns for most effective use.
- Molded of glass fibers for extra strength and improved acoustic properties.

### Send Now for Helpful Bulletin No. 197



Gives complete and helpful information about the performance and application of the "CDP."

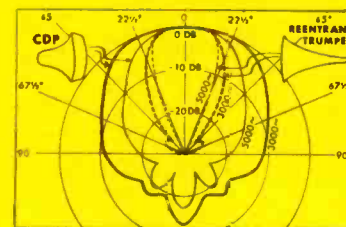

### COMPARE POLAR PATTERN

Sound distribution of the E-V "CDP" exceeds 120° at all frequencies up to 10,000 cps.

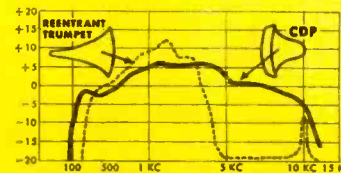

**COMPARE RESPONSE AND EFFICIENCY**  
Note extended high-frequency range of the "CDP." Response is smooth, peak-free 175-10,000 cps.

NO FINER CHOICE THAN

# Electro-Voice

ELECTRO-VOICE, INC. • BUCHANAN, MICHIGAN

RADIO-ELECTRONICS





Carl E. Smith, E.E.  
President

# Want To DOUBLE YOUR PAY?

## How To Pass **FCC** **COMMERCIAL** **RADIO OPERATOR** **LICENSE** **EXAMINATIONS**

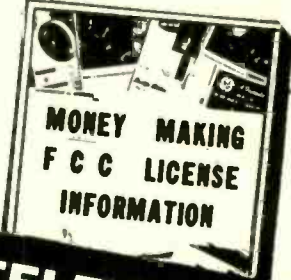

**TELEVISION ENGINEERING**  
Included in our  
Training and coaching

**GET THIS AMAZING NEW BOOKLET FREE!**

TELLS HOW...

HERE IS YOUR GUARANTEE

TELLS HOW...

### WE GUARANTEE

TO TRAIN AND COACH YOU AT  
HOME IN SPARE TIME UNTIL YOU GET  
**YOUR FCC LICENSE**

If you have had any practical experience—Amateur, Army, Navy, radio repair, or experimenting.

If you fail to pass your Commercial License exam after completing our course, we guarantee to continue your training without additional cost of any kind, until you successfully obtain your Commercial license, provided you first sit for this examination within 90 days after completing your course.

### Our Amazingly Effective JOB-FINDING SERVICE

Helps CIRE Students Get Better Jobs

Here are a few recent examples of Job-Finding results:

#### GETS CIVIL SERVICE JOB

"Thanks to your course I obtained my 2nd phone license, and am now employed by Civil Service at Great Lakes Naval Training Station as an Equipment Specialist." Kenneth B. Leiser, Fair Oaks, Md. Del., Mettigny, Ill.

#### GETS STATE POLICE JOB

"I have obtained my 1st class ticket (thanks to your school) and since receiving same I have held good jobs at all times. I am now Chief Radio Operator with the Kentucky State Police."

Edwin P. Healy, 264 E. 3rd St., London, Ky.

#### GETS BROADCAST JOB

"I wish to thank your Job-Finding Service for the help in securing for me the position of transmitter operator here at WCAE in Pittsburgh." Walter Koschik, 1442 Ridge Ave., N. Braddock, Pa.

#### GETS AIRLINES JOB

"Due to your Job-Finding Service, I have been getting many offers from all over the country, and I have taken a job with Capital Airlines in Chicago, as a Radio Mechanic." Harry Clare, 4537 S. Drexel Blvd., Chicago, Ill.

TELLS HOW...

### Employers Make JOB OFFERS Like These to Our Graduates Every Month!

Letter from nationally-known Airlines, "We would also appreciate if you would place the following additional advertisement in your bulletin—Wanted—Superintendent of Communications . . . Salary \$666.66 per month."

Letter from nationally known airplane manufacturer, "We need men with electronic training or experience in radar maintenance to perform operational check-out of radar and other electronics systems . . . starting salary . . . amounting to \$329.33 per month."

Letter from nationally-known Airlines, "We are contemplating placing . . . an Airline Ground Radio Engineer." Starting salary \$385 per month.

These are just a few examples of the job offers that come to our office periodically. Some licensed radioman filled each of these jobs . . . It might have been you!

### HERE'S PROOF FCC LICENSES ARE OFTEN SECURED IN A FEW HOURS OF STUDY WITH OUR COACHING AT HOME IN SPARE TIME

Name and Address	License	Lessons
Lee Worthy 2210 1/2 Wilshire St., Bakersfield, Calif.	2nd Phone	16
Clifford E. Vogt Box 1016, Danla, Fla.	1st Phone	20
Francis X. Foerch 38 Beucher Pl., Bergenfield, N. J.	1st Phone	38
S/Sgt. Ben H. Davis 317 North Roosevelt, Lebanon, Ill.	1st Phone	28
Albert Schoell 110 West 11th St., Escondido, Calif.	2nd Phone	23

**CLEVELAND INSTITUTE OF RADIO ELECTRONICS**  
Carl E. Smith, E. E., Consulting Engineer, President  
Desk RE-65, 4900 Euclid Bldg., Cleveland 3, Ohio

OURS IS THE ONLY HOME STUDY COURSE WHICH SUPPLIES FCC-TYPE EXAMINATIONS WITH ALL LESSONS AND FINAL TESTS.

Your FCC Ticket is recognized in all radio fields as proof of your technical ability.

### MAIL COUPON NOW

**CLEVELAND INSTITUTE OF RADIO ELECTRONICS**  
Desk RE-65—4900 Euclid Bldg.  
Cleveland 3, Ohio  
(Address to Desk No. to avoid delay.)

**B**

I want to know how I can get my FCC ticket in a minimum of time. Send me your FREE booklet "How to Pass FCC License Examinations" (does not cover exams, for Amateur License), as well as a sample FCC-type exam and the amazing new booklet, "Money-Making FCC License Information. Be sure to tell me about your Television Engineering Course."

Name .....  
Address .....  
City ..... Zone ..... State .....  
Paste on two cent postcard or send air mail.

# NEW HALLDORSON

Specific Replacements



FB414  
FB415  
FLYBACKS

for

# EMERSON TV

SERVICE OVER 100  
MODELS AND CHASSIS

You're money ahead when you use these exact Emerson replacements... they install quickly and "stay put."

FB414 and FB415 are so carefully designed that they service well over one hundred Emerson models and chassis. They are typical of Halldorson's long line of *specific* TV replacements, engineered to provide the broadest possible service coverage.

Now available at your Halldorson distributor. FB414 and FB415—\$6.30 each, Dealer's Net.

Descriptive Bulletin 117 Lists 112  
Emerson Models and Chassis

HALLDORSON REPLACEMENTS NOW  
BEING LISTED IN PHOTOFACTS  
AND COUNTER FACTS



Halldorson Transformer Co.  
4500 N. Ravenswood Ave.  
Chicago 40, Illinois

**Halldorson**  
QUALITY Transformers SINCE 1913

## FOURTEEN NEW TV STATIONS

have gone on the air since our last report. These are:

KARK-TV	Little Rock, Ark. ...	4
KQED	San Francisco, Calif. ...	9
WALB-TV	Albany, Ga. ....	10
KULA-TV	Honolulu, T. H. ....	4
WHO-TV	Des Moines, Ia. ....	13
WSJV	Elkhart, Indiana ...	52
WSLI-TV	Jackson, Miss. ....	12
KFBB-TV	Great Falls, Mont. ...	5
WMFD-TV	Wilmington, N. C. ...	6
KVAL-TV	Eugene, Ore. ....	13
WQED	Pittsburgh, Pa. ....	12
WNET	Providence, R. I. ....	16
WDEF-TV	Chattanooga, Tenn. ...	12
KBMT	Beaumont, Texas ...	31
KRGV-TV	Weslaco, Texas ....	5
WJPB-TV	Fairmont, W. Va. ...	35
WHA-TV	Madison, Wisc. ....	21

Four stations have gone off the air: KRTV, Little Rock, Ark., channel 17; KETX, Tyler, Texas, channel 19; WACH, Newport News, Va., channel 33; WOSH-TV, Oshkosh, Wisc., channel 48. Canada has one new station this month, CHSJ-TV, St. John, New Brunswick, channel 4.

**RADIATION CONTROL** proposal made by the FCC covers all devices which radiate radio-frequency energy as well as those which are specifically designed to generate radio-frequency energy, whether or not they are intended to be used for communications purposes.

Incidental radiation devices in which the generation of r.f. energy is unintentional are specially mentioned in the broad proposal.

The most severe restriction of all would be applied to community TV antenna systems. They are limited to a radiation of 10  $\mu$ v per meter at 10 feet. All existing systems would have until June 30, 1955 to comply. The Federal Communications Commission stand is predicated on the right of people living near the cables to protection from cable interference.

Included in the FCC proposal was the requirement that TV and FM receivers obtain certification that their spurious emissions do not radiate beyond certain limits, depending upon their frequency. The requirement would be effective as soon as the FCC made the proposal final. The Commission said that it hopes certification would be done by the manufacturers. RETMA has suggested establishing an industry laboratory to do the work.

Two sets of field intensity limitations are involved: one to be effective immediately to frequency modulation and television receivers, and the other, to all receivers manufactured after January 30, 1956.

The Federal Communications Commission warned that still stricter limits may later have to be set because of new developments in the rapidly expanding electronics field.

**C-BAND RADAR** has been found to be a very useful device for safer and smoother navigation of thunderstorm

and precipitation areas. In a lengthy series of tests with C-band (5.5-cm) airborne weather radar by United Air Lines, C-band radar showed itself capable of terrain mapping; penetrating 15 miles or more of heavy rain; avoiding collisions with terrain; using a 22-inch antenna for obtaining good definition, justifying the installation of radar in aircraft which cannot accommodate a larger antenna. It was, however, of little use in the avoidance of other planes.

**RENE BARTHELEMY**, pioneer of French television, died February 12, the same day upon which he had been made a Commander of the Legion of Honor.

Barthelemy played a part in French television similar to Baird's in England, and comparable to a composite of that played in the United States by Jenkins, Zworykin and Baker.

Though best known for his work in television—which dates back to 1925—he was famous also for radio work in the '20's, especially for his *Isodyne* circuit and his contributions toward solving the problems of developing all-electric receivers.

**HIGH FIDELITY INSTITUTE** will create standards of measurement for products connected with sound reproduction. These standards will be in terms the public can readily recognize and understand.

Jerome J. Kahn, of Chicago, Commissioner of the Institute, said that when the claims of manufacturers have been certified by a qualified independent testing laboratory, the High Fidelity Institute will issue its seal of approval, certifying the accuracy of the manufacturer's claims. These measurements will go a long way toward dispelling public confusion about high-fidelity, and will give the buyer a basis of comparison between products.

Operating as a non-profit organization with headquarters at 1 North La-Salle St., Chicago, the Institute will designate an all-industry committee to outline the measurement standards for each product.

**SUPER V BATTLE** centering around the compact, vertically-planned-chassis Crosley TV receiver broke out in April. The receiver, Underwriters Laboratories approved, was placed on the market in February and has since been manufactured by other companies.

While not calling it by name, one leading competitor said the Super V had a "lethally 'hot' chassis". Other charges leveled at the receiver called it a stripped-down 15-tube chassis with a cheaply circuited selenium rectifier, obsolescent 21-mc system, non-immune circuitry, and old-style intercarrier sound with the tendency to buzz and hum.

Crosley pointed out that other manufacturers were seeking licenses to reproduce the set, and that it was currently turning out more than 2,500 Super V receivers a day. **END**

# Get yourself on the beam to the BIG MONEY in RADIO and TV

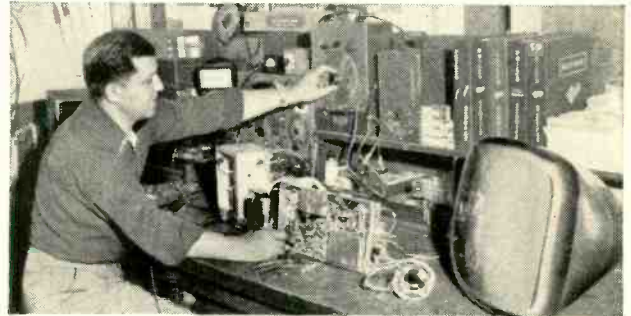
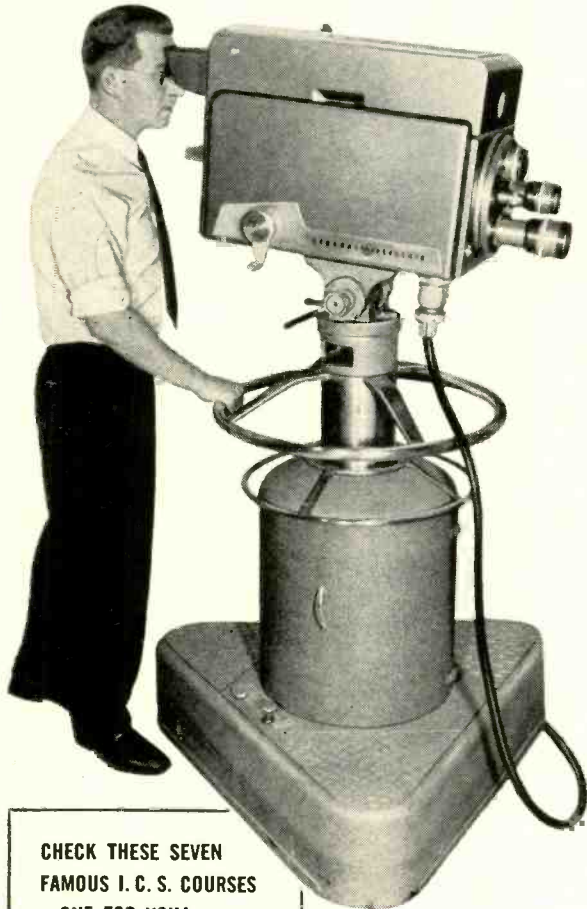

That's the way to become an expert Radio or Television service man. Study the bedrock theories and principles. These are vitally important. Nothing can take their place.

### No royal road to learning

Listen to what radioman R. G. Hamlin of Bay City, Michigan, says. "There's no royal road to learning. I am convinced more than ever after examining the lessons of friends who were lured by short-cut methods . . . 'understandability' and 'rememberability' are of utmost importance and I.C.S. lessons qualify on both counts."

### New I.C.S. Courses

I.C.S. offers you two new courses in radio and television servicing—one for beginners, the other for the more experienced. Also courses in Industrial Electronics, Television Technician, Practical Radio-Television Engineering.

All are sound, practical, extremely thorough. You learn by doing—the world-famous I.C.S. way. Completely modern. Success proved. Endorsed by employers. Low in cost. And no interference with business and social life.

### Send for 2 FREE Books

Mark and mail the coupon. It brings you by return mail the 36-page gold-mine of tips on "How to Succeed." Also the 1954 catalog outlining the opportunities in the field you check—whether it's Radio-Television or one of the other 276 I.C.S. Courses. Absolutely no obligation!

CHECK THESE SEVEN  
FAMOUS I. C. S. COURSES  
—ONE FOR YOU!

- PRACTICAL RADIO-TELEVISION ENGINEERING**—Foundation course for radio-television career. Basic principles plus advanced training. Radio, Sound, TV.
- TELEVISION TECHNICIAN**—To qualify you for high-level technical positions in television. Camera, studio, transmitter techniques. Manufacture, sale and installation of TV equipment.
- TELEVISION RECEIVER SERVICING**—Installation, servicing, conversion. Dealership. For the man who knows about radio and wants TV training.
- RADIO & TELEVISION SERVICING**—Designed to start you repairing, installing and servicing radio and television receivers soon after starting the course.
- RADIO & TELEVISION SERVICING WITH TRAINING EQUIPMENT**—Same as above but with addition of high-grade radio servicing equipment and tools.
- RADIO OPERATING COURSE**—Special course to help you pass the Government examination for operator's licenses. Code. TV, FM. Radioregulations.
- INDUSTRIAL ELECTRONICS**—Broad, solid background course devoted to the electron tube and to its many applications.

For Real Job Security — Get I. C. S. Training!

I. C. S., Scranton 9, Penna.

## INTERNATIONAL CORRESPONDENCE SCHOOLS



BOX 2882-K, SCRANTON 9, PENNA.

(Partial list of 277 courses)

Without cost or obligation, send me "HOW TO SUCCEED" and the opportunity booklet about the field BEFORE which I have marked X:

### ARCHITECTURE and BUILDING CONSTRUCTION

- Air Conditioning—Refrig.
- Architecture
- Building Contractor
- Building Maintenance
- Carpenter and Mill Work
- Estimating
- Heating
- Painting Contractor
- Plumbing
- Reading Arch. Blueprints
- Steamfitting

### ART

- Cartooning
- Commercial Art
- Fashion Illustrating
- Magazine Illustrating
- Show Card and Sign Lettering
- Sketching and Painting

### AUTOMOTIVE

- Auto Body Rebuilding
- Auto Elec. Technician
- Auto-Engine Tune Up
- Automobile Mechanic

### AVIATION

- Aeronautical Engineering Jr.
- Aircraft & Engine Mechanic

### BUSINESS

- Advertising
- Bookkeeping and Accounting
- Business Administration
- Business Correspondence
- Certified Public Accounting
- Creative Salesmanship
- Federal Tax
- Letter-writing Improvement
- Managing Small Business
- Office Management
- Retail Business Management
- Sales Management
- Stenographic-Secretarial
- Traffic Management

### CHEMISTRY

- Analytical Chemistry
- Chemical Engineering
- Chem. Lab. Technician
- General Chemistry
- Natural Gas Prod. & Trans.
- Petroleum Engineering
- Plastics
- Pulp and Paper Making

### CIVIL, STRUCTURAL ENGINEERING

- Civil Engineering
- Construction Engineering
- Highway Engineering
- Reading Struct. Blueprints
- Sanitary Engineering
- Structural Engineering
- Surveying and Mapping

### DRAFTING

- Aircraft Drafting
- Architectural Drafting
- Mechanical Drafting
- Mine Surveying and Mapping
- Ship Drafting
- Structural Drafting

### ELECTRICAL

- Electrical Engineering
- Electrical Maintenance
- Electrician  Contracting
- Lineman

### HIGH SCHOOL

- Commercial
- Good English
- High School Subjects
- Mathematics

### LEADERSHIP

- Foremanship
- Industrial Supervision
- Leadership and Organization
- Personnel-Labor Relations

### MECHANICAL AND SHOP

- Gas—Electric Welding
- Heat Treatment  Metallurgy
- Industrial Engineering
- Industrial Instrumentation
- Industrial Supervision
- Machine Design-Drafting
- Machine Shop Inspection
- Machine Shop Practice
- Mechanical Engineering
- Quality Control
- Reading Shop Blueprints
- Refrigeration
- Sheet Metal Worker
- Tool Design  Toolmaking

### RADIO, TELEVISION

- Electronics
- Practical Radio—TV Eng'ng
- Radio and TV Servicing
- Radio Operating
- Television—Technician

### RAILROAD

- Air Brakes  Car Inspector
- Diesel Locomotive
- Locomotive Engineer
- Section Foreman

### STEAM AND DIESEL POWER

- Combustion Engineering
- Diesel—Elec.  Diesel Eng's
- Electric Light and Power
- Stationary Fireman
- Stationary Steam Engineering

### TEXTILE

- Carding and Spinning
- Cotton, Rayon, Woolen Mfg.
- Finishing and Dyeing
- Loom Fixing
- Textile Designing
- Textile Eng'ng  Throwing
- Warping and Weaving

### MISCELLANEOUS

- Domestic Refrigeration
- Marine Engineering
- Ocean Navigation
- Shipfitting
- Short Story Writing
- Telephony

Name \_\_\_\_\_ Age \_\_\_\_\_ Home Address \_\_\_\_\_

City \_\_\_\_\_ Zone \_\_\_\_\_ State \_\_\_\_\_ Working Hours \_\_\_\_\_ A.M. to P.M. \_\_\_\_\_

Occupation \_\_\_\_\_

Canadian residents send coupon to International Correspondence Schools, Canadian, Ltd., Montreal, Canada. . . . Special tuition rates to members of the U. S. Armed Forces.

# SPLITTING HAIRS

# TO SPEED CALLS

To triple the voice-carrying capacity of coaxial cable, Bell Laboratories engineers had to create new amplifying tubes with the grid placed only two-thirds of a hair's breadth from the cathode. Furthermore, the grid wires had to be held rigidly in position; one-quarter of a hair's shifting would cut amplification in half.

Working with their Bell System manufacturing partners at Western Electric, the engineers developed precise optical means for measuring critical spacing insulators. On a rigid molybdenum grid frame they wound tungsten wire three ten-thousandths of an inch thick. To prevent the slightest movement they stretched the wire under more tension for its size than suspension bridge cables, then bonded it to the frame by a new process.

The resulting tube increases coaxial's capacity from 600 to 1800 simultaneous voices—another example of how Bell Telephone Laboratories research helps keep your telephone system growing at the lowest possible cost.



*This coaxial system electron tube amplifies more voices at the same time because of wider frequency band—made possible by bringing grid and cathode closer together.*

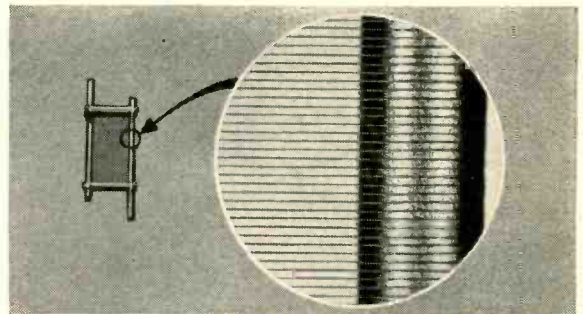

*Grid is shown above left, actual size. Picture at right, enlarged 15 times, shows how wires are anchored by glass bond. They will not sag despite nearness of red-hot cathode.*

## BELL TELEPHONE LABORATORIES

IMPROVING TELEPHONE SERVICE FOR AMERICA PROVIDES CAREERS  
FOR CREATIVE MEN IN SCIENTIFIC AND TECHNICAL FIELDS



RADIO-ELECTRONICS



# NO EXPERIENCE NECESSARY! LEARN TELEVISION AT HOME IN YOUR SPARE TIME!

L. C. Lane, B.S., M.A.  
President: Radio-Television Training Association  
Executive Director: Pierce School of Radio & Television

Super-Hot Radio Receiver



Giant Screen TV Receiver

Combination Voltmeter-Ammeter-Ohmmeter



You build all this equipment and more! Everything yours to keep

## VETERANS! CIVILIANS!

### BE A SUCCESS AS A TRAINED TV TECHNICIAN!

Keep your present job while I prepare you AT HOME, using the same successful methods that have helped hundreds of men—many with no more than grammar school training—master television!

## WARNING!

ALL VETERANS DISCHARGED BEFORE AUGUST 20, 1952 must be enrolled and IN TRAINING by August 20, 1954. Otherwise you lose your G.I. rights to a free education under NEW G.I. BILL! Don't put it off... time is short! RJSH COUPON BELOW. Tell your ex-G.I. friends!

## VETERANS!

MY SCHOOLS FULLY APPROVED TO TRAIN VETERANS UNDER NEW G.I. BILL! If discharged after June 27, 1950 —CHECK COUPON! Also approved for RESIDENT TRAINING in New York City... qualifies you for full subsistence allowance up to \$160 per month.

### EXPERT FM-TV TECHNICIAN TRAINING!

My FM-TV Technician Course can save you months of training if you have previous Armed Forces or civilian radio experience! Train at home with kits of parts, plus equipment to build BIG SCREEN TV RECEIVER, and FREE FCC Coaching Course! ALL FURNISHED AT NO EXTRA COST!

### NEW! PRACTICAL TV CAMERAMAN & STUDIO COURSE!



(For men with previous radio & TV training) I train you **at home** for an exciting big pay job as the man behind the TV camera. Work with TV stars in TV studios or "on location" at remote pick-ups! A special one-week course of practical work on TV studio equipment at Pierce School of Radio & TV, our associated resident school in New York City, is offered upon your graduation.

### FREE FCC COACHING COURSE!

QUALIFIES YOU FOR HIGHER PAY! Given to all my students AT NO EXTRA COST after TV Theory and Practice is completed. Helps you qualify for the TOP JOBS in Radio-TV that demand an FCC License! Full training and preparation at home for your FCC License.

### OPTIONAL: TWO WEEKS TRAINING IN NEW YORK CITY AT NO EXTRA COST

You get two weeks, 50 hours, of intensive Laboratory work on modern electronic equipment at our associated school in New York City—Pierce School of Radio and Television. And I give you all this AT NO EXTRA COST whatsoever, after you finish your home study training in the Radio-FM-TV Technician course and FM-TV Technician Course.

## RADIO-TELEVISION TRAINING ASSOCIATION

52 East 19th Street, New York 3, N. Y.

Licensed by the State of New York

Approved by the VA

### ENOUGH EQUIPMENT TO SET UP YOUR HOME LABORATORY!

As part of your training, I give you ALL the equipment you need to prepare for a BETTER PAY TV job. You build and keep a professional GIANT SCREEN TV RECEIVER complete with big picture tube (designed and engineered to take any size up to 21-inch)...also a Super-Hot Radio Receiver, RF Signal Generator, Combination Voltmeter-Ammeter-Ohmmeter, C-W Telephone Transmitter, Public Address System, AC-DC Power Supply. Everything supplied including all tubes.

### GOOD SPARE TIME EARNINGS!

Almost from the very start you can earn extra money while learning, repairing Radio-TV sets for friends and neighbors. Many of my students earn up to \$25 a week... pay their entire training from spare time earnings... start their own profitable service business. Act now! Mail coupon and find out for yourself what a TV career can do for you!

### MAIL COUPON TODAY!

MY 4 FREE AIDS SHOW YOU HOW AND WHERE TO GET A BETTER PAY JOB IN TELEVISION! See for yourself how my simple, practical methods make success easy.



### NO SALESMAN WILL CALL!

Mr. Leonard C. Lane, President  
RADIO-TELEVISION TRAINING ASSOCIATION  
52 East 19th St., New York 3, N. Y. Dept. R-6B  
Dear Mr. Lane: Mail me your NEW FREE BOOK, FREE SAMPLE LESSON, and FREE aids that will show me how I can make BIG MONEY IN TELEVISION. I understand I am under no obligation and no salesman will call.  
(PLEASE PRINT PLAINLY)

NAME \_\_\_\_\_ AGE \_\_\_\_\_  
ADDRESS \_\_\_\_\_  
CITY \_\_\_\_\_ ZONE \_\_\_\_\_ STATE \_\_\_\_\_

#### I AM INTERESTED IN:

- Radio-FM-TV Technician Course
- FM-TV Technician Course
- TV Cameraman & Studio Course

VETERANS! Check here for Training under NEW G.I. Bill

# Two Recognized Masters

Combined in perfect performance for the ultimate in

high-fidelity  
reproduction



## ASTATIC MODEL CAC-D-J CRYSTAL TURNOVER CARTRIDGE

THE MOST MASTERFUL performer among single needle, high fidelity crystal cartridges is Astatic's Model CAC-J, a result of collaboration between engineers of Astatic and Columbia Records Inc. How to project these same complete tonal values and absolute purity of reproduction into the design of a double needle, crystal turnover cartridge—without loss of perfection—seemed an insolvable engineering problem. But, pioneering in modern, high fidelity equipment proved as natural for Astatic engineers as their work in developing the first commercially produced crystal cartridges and microphones. The revolutionary new design of the Model CAC-D-J was the result. Combining two complete CAC-J Crystal Cartridge assemblies back to back, on a common plate, this unparalleled turnover unit eliminates interaction between needles and permits ideal output and response characteristics for each record type. Free of the limitations encountered in ordinary cartridge designs, the CAC-D-J has proved to be the most logical partner of the finest in high fidelity amplifiers, speakers and related equipment. When you want the very best, be sure to check this master of crystal cartridges.

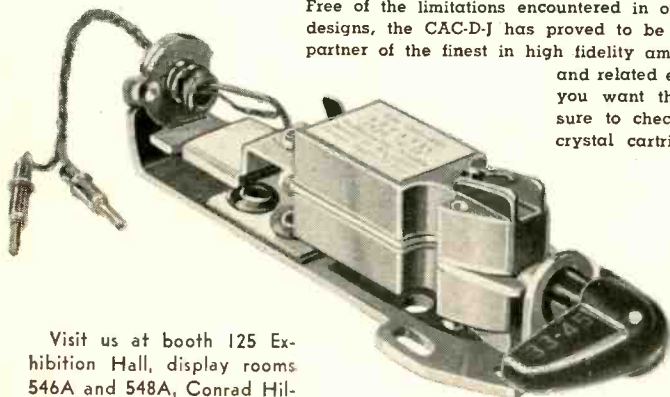
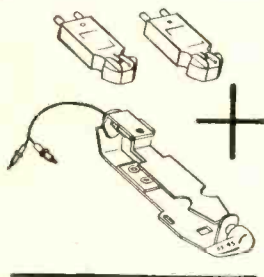

Visit us at booth 125 Exhibition Hall, display rooms 546A and 548A, Conrad Hilton Hotel, The 1954 Electronic Parts Show.

KNOWN THE WORLD OVER  
FOR HIGHEST QUALITY  
AT LOWEST POSSIBLE COST

THE  
**Astatic**  
CORPORATION  
ASTATIC  
CONNEAUT, OHIO  
IN CANADA CANADIAN ASTATIC LTD. TORONTO, ONTARIO

EXPORT  
REPRESENTATIVE: 401 Broadway, New York, N. Y. Cable Address: ASTATIC, New York

## A CLINICAL ERROR

Dear Editor:

In your April 1954 issue, Matthew Mandl's "Television Service Clinic" quotes a correspondent's suggestion that video i.f. amplifiers not be aligned until after replacement of all tubes which check even slightly weak. Mr. Mandl goes on to explain that such replacement is particularly necessary in a stagger-tuned amplifier, because the presence of one weak tube would make it impossible to align the amplifier to give the proper overall frequency response. I assume that both Mr. Mandl's correspondent and Mr. Mandl himself use the expression "weak tube" to designate lower than normal transconductance.

Mr. Mandl could not have had the time to examine his correspondent's suggestion thoroughly or he would not have seconded it. I am sure that he knows better and that he would not wish to encourage an increase in the number of unnecessary tube replacements. There is nothing wrong with replacing a weak video i.f. tube if the resultant increase in sensitivity justifies the cost of the tube and the time which may have to be spent in realignment. However, if realignment is required to improve definition, but the sensitivity is satisfactory, presumably no tubes need be replaced.

The presence of one or more low-gain tubes will *not* make it impossible to align a stagger-tuned amplifier for the proper response. I have demonstrated this fact, both theoretically and practically, to numerous students. For others, I can offer an explanation, and suggest a test requiring no equipment, which can be made on any stagger-tuned receivers.

In a video i.f. amplifier, stagger-tuned or otherwise, there is only one signal path; every frequency component of the signal which arrives at the second detector must have passed through *every one* of the amplifier stages. The overall gain at any frequency is the product of all the individual stage gains at that particular frequency.

Within the frequency range where the gain is uniform, if one stage has a relatively high gain at a certain frequency, the combined gain of the other stages must be proportionately low at the same frequency. To cite a numerical example:

Freq.	Gain, first stage	Gain, other stages	Total gain
22 mc	27	1,000	27,000
23 mc	9	3,000	27,000
24 mc	3	9,000	27,000
25 mc	1	27,000	27,000
25.75 mc	0.4	33,750	13,500

If the first tube is replaced by one which has one-third as much transconductance, but the tuning remains the same, the gain of that stage will decrease by a factor of three at every frequency. We then have:

RADIO-ELECTRONICS

WHEN THE  
**RAYTHEON**  
 BONDED  
 ELECTRONIC TECHNICIAN  
 PROGRAM  
 REMOVES  
 THIS  
 CHIP...



*You're in the chips!*

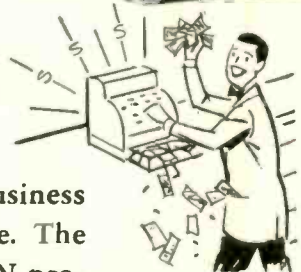

Customer confidence in you and your way of doing business is the greatest single business asset you can have. The RAYTHEON Bonded ELECTRONIC TECHNICIAN program, now in its 10th year, has helped and continues to help many thousands of Radio and Television service dealers break down the barrier of public mistrust. And in so doing increases the volume and profit of these Raytheon Bonded Technicians.

Ask your Raytheon Tube Distributor if you can qualify for this priceless sales asset. If you can, the program costs you not one cent, it's Raytheon's investment in *your* future.



**RAYTHEON MANUFACTURING COMPANY**

Receiving Tube Division  
 Newton, Mass., Chicago, Ill., Atlanta, Ga., Los Angeles, Cal.

*Excellence in Electronics*

RECEIVING AND PICTURE TUBES • RELIABLE SUBMINIATURE AND MINIATURE TUBES • SEMICONDUCTOR DIODES AND TRANSISTORS • ENCLICORIC TUBES • MICROPHONE TUBES

**OUTSTANDING for HIGH FIDELITY!**

**BUY DIRECT AND SAVE**

**'PRE-FAB' COLLINS TUNERS and RECEIVERS**  
AUDIO PRODUCTS CO.

**NOW!**

with AFC

Collins Audio Products Co. is an equal opportunity employer with Collins Audio Co.

Each Collins Tuner Kit is complete with punched chassis, tubes, power transformer, power supply components, hardware, dial assembly, tuning eye, knobs, wire, etc., as well as the completed sub-assemblies: FM tuning units, AM tuning units, IF amplifiers, etc., where applicable. All sub-assemblies wired, tested and aligned at the factory make Collins Pre-Fab Kits easy to assemble even without technical knowledge. The end result is a fine, high quality, high fidelity instrument at often less than half the cost—because you helped make it and bought it direct from the factory.

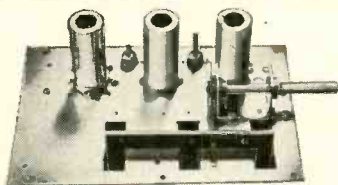

**FMF-3 Tuning Unit**

**\$15<sup>25</sup>**

with AFC \$18.75

The best for FM. The most sensitive and most selective type of "front end" on the market. 6 to 10 microvolts sensitivity. Image ratio 500 to 1. 6J6 tuned RF stage, 6AG5 converter, 6C4 oscillator. Permeability tuned, stable and drift-free. Chassis plate measures 6 1/2" x 4 1/2". In combination with the IF-6 amplifier, the highest order of sensitivity on FM can be attained. Tubes included as well as schematic and instructions. Draws 30 ma. Shipping weight FMF-3: 2 1/2 lbs. Dial available @ \$3.85.

**IF-6 Amplifier**

**\$19<sup>75</sup>**

6 Tubes, Shipping Wgt. 3 lbs.

**FOR USERS OF COLLINS TUNERS:**

Receive \$5.00 credit toward the new FMF-3A front end! Mail us your old front end with \$13.75 and we will send you the new, improved FMF-3A with AFC., or, remit the full amount of \$18.75 and when we receive your old unit in return a check will be mailed you for \$5.00.

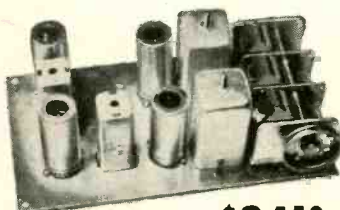

**AM-4 Tuning Unit**

**\$24<sup>50</sup>**

Taps in AM superhet performance! A 3-gang tuning condenser gives 3 tuned stages with high sensitivity and selectivity. Assembly is completely wired, tested and aligned ready for immediate use. Frequency coverage 540 KC to 1650 KC at a sensitivity of 5 microvolts. Tubes 6BA6 RF amplifier; 6BE6 converter; 6BA6 IF amplifier and 6AT6 detector. Draws 30 ma @ 220 volts. Mounts on a chassis plate measuring 4" x 7 3/8". Shipping weight 2 1/2 lbs. Dial available at \$3.85.

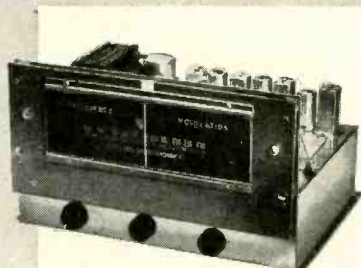

**FM Tuner Kit**

**\$55**

with AFC \$58.50

The FM-11 tuner is available in kit form with the IF Amplifier mounted in the chassis, wired and tested by us. You mount the completed RF Tuning Unit and power supply, then after some simple wiring, it's all set to operate. 11 tubes: 6J6 RF amp, 6AG5 converter, 6C4 oscillator, 6BA6 1st IF, (2) 6AU6 2nd and 3rd IF, (2) 6AU6 limiters, 6AL5 discriminator, 6AL7-GT double tuning eye, 5Y3-GT rectifier. Sensitivity 6 to 10 microvolts, less than 1/2 of 1% distortion, 20 to 20,000 cycle response with 2DB variation. Chassis dimensions: 12 1/2" wide, 8" deep, 7" high. Illustrated manual supplied. Shipping weight 14 lbs.



**FM/AM Tuner Kit**

**\$77<sup>50</sup>**

with AFC \$81.00

The original 15 tube deluxe FM/AM pre-fab kit redesigned on a smaller chassis. The tuner now measures 14" wide by 12" deep by 7 1/2" high. This attractive new front and dial assembly opens up new applications where space is at a premium. Kit includes everything necessary to put it into operation—punched chassis, tubes, wired and aligned components, power supply, hardware, etc. Kit comprises FMF-3 tuning unit, IF-6 amplifier, AM-4 AM tuning unit, magic eye assembly and complete instructions. All tubes included. Shipping weight 19 lbs.

**MAIL COUPON TODAY**

To: Collins Audio Products Co. Inc. RE-6  
P.O. Box 348, Westfield, N. J.  
Tel. Westfield 2-4390

FM Tuner Kit  FM/AM Tuner Kit  FMF-3 Tuning Unit  
 with AFC  with AFC  with AFC  
 IF-6 Amplifier  AM-4 Tuning Unit

NAME .....

ADDRESS .....

CITY..... STATE.....

Amount for Kit \$..... See weights, add shipping cost \$.....

Total amount enclosed \$..... Check  Money Order

Freq.	Gain, first stage	Gain, other stages	Total gain
22 mc	9	1,000	9,000
23 mc	3	3,000	9,000
24 mc	1	9,000	9,000
25 mc	0.333	27,000	9,000
25.75 mc	0.133	33,750	4,500

The overall gain still is uniform from 22 to 25 mc and still drops to 50% of its maximum value at 25.75 mc.

The gain of any individual stage at its peak frequency depends on the transconductance of the tube and the impedance of the load. Relative gain off resonance depends on the relative decrease of load impedance and therefore on the Q of the tuned circuit which forms the load; the transconductance of the tube is constant throughout the pass-band. As long as all of the stagger-tuned stages are tuned to the proper peak frequencies, improper relative overall response can be due only to improper tuned-circuit Q.

In the service data for the RCA Victor model 630TS, pages 5 and 6, the following paragraphs occur:

"In such a stagger-tuned system variations of individual i.f. amplifier tube gain do not affect the shape of the overall i.f. response curve if the Q and center frequency of the stages remain unchanged. This means that the i.f. amplifier tubes are non-critical in replacement.

"To align the i.f. system, the transformers are peaked to the specified frequencies with a signal generator. The overall i.f. response is then observed by the use of a sweep generator and oscilloscope. Slight deviations from standard circuit Q are compensated for with slight shifts in transformer center frequency until the desired response curve is obtained. If this response cannot be obtained, the difficulty is likely to be in a location that affects either the frequency or Q of one or more of the i.f. transformers."

These quotations suggest a simple test. If a reduction in gain of a stage in a stagger-tuned amplifier would reduce the relative overall response only in the vicinity of that stage's peak frequency, then turning down the contrast control of an RCA Victor model 630TS or other similar receiver would result in reduced response only near the frequencies the gain-controlled stages (the first three i.f. stages) are peaked to. These frequencies are 25.3 mc, 22.3 mc, and 25.2 mc. The remaining response would be due largely to the 21.8 mc circuit (circuit A in Mr. Mandl's diagram) in the plate circuit of the mixer and the 23.4 mc circuit in the plate circuit of the fourth stage. Because of the sharply peaked circuit A, a great excess of high video-frequency response would result. It doesn't happen, because reducing the gain of the first three stages reduces the response not only in the vicinity of 25.3 mc, 22.3 mc, and 25.2 mc, but also throughout the entire pass-band. Try it!

JOHN K. FRIEBORN

Jersey City, N. J.

RADIO-ELECTRONICS

**WHEN YOU THINK OF TUNERS, THINK OF COLLINS AUDIO PRODUCTS**



**big values  
new releases**

send for **ALLIED'S  
Latest Free Supplement**

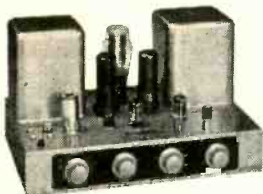

**"Golden Knight"  
24-Watt High Fidelity Amplifier**

A standout choice for limited-budget home music systems. Features  $\pm 0.75$  db, 20 to 40,000 cps response; harmonic distortion less than 1% at rated output; I. M. less than 0.5% at normal listening level; low hum (83 db below rated output); switch for proper loading of G. E., Pickering or Audak cartridges; 3-position record equalizer; bass and treble controls; inputs for magnetic phono, mike, tuner and auxiliary. Finished in satin-gold. 8 x 14 x 9" deep. With connectors, shaft extenders and separate panel for cabinet mounting. For 110-130 v., 50-60 cy. A.C. Shpg. wt., 30 lbs. Guaranteed for one full year. 93 SX 321. Net, only ..... \$79.50

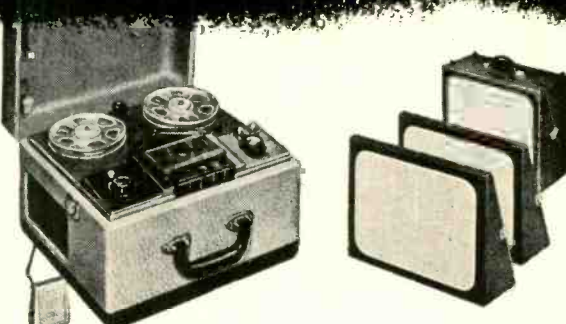

**New Knight Combination Tape Recorder and 8-Watt P. A. System**

Amazing value in a versatile Hi-Fi recorder and powerful P.A. System. Records simultaneously during P.A. use. Outstanding features: quality push-pull 8-watt amplifier; 2 built-in oval speakers for play-back and P. A.; jacks for external speakers (below); push-button control of recording and playback functions; 2 inputs for recording from mike, radio, phono, TV, etc.; recording time scale. Exceptional response: 7.5" speed,  $\pm 3$  db from 65-10,000 cps; 3.75" speed,  $\pm 3$  db from 75-7500 cps. Recording time (1200 ft. reel): 7.5" speed, 1/2 hour continuously, one hour overall; 3.75" speed, one hour continuously, two hours overall. Maroon and gray luggage-type case, 9 1/2 x 17 1/4 x 14 1/4". With crystal mike, 600 ft. reel of tape and take-up reel. 110-120 v., 60 cycle AC. 32 lbs. 96 RX 635. Net, only ..... \$129.50

Accessory Speakers: Two 12" speakers in 2-section case. With 25 ft. cables and plugs. 20 x 9 x 16". Shpg. wt., 21 lbs. 96 RX 637. Net ..... \$43.00

Remote Control: For starting and stopping recorder. 15 ft. cable and plug. 2 x 3 x 3". 3 lbs. 96 R 636. Net ..... \$6.64



**"Golden Knight" Hi-Fi Music Systems**

**Phono System:** A super value, true hi-fi phono system, with prepared cables and color-coded plugs for easy custom installation. Includes: "Golden Knight" Amplifier; Electro-Voice SP-12B 12" Radax Speaker; famous Garrard RC-80 3-speed record changer, and G. E. RPX-050 triple-play cartridge with dual-tip sapphire stylus. Shpg. wt., 60 lbs. 94 SX 127. Net, only ..... \$161.75

**FM-AM Phono System:** As above, but includes new Knight 727 FM-AM Tuner. Shpg. wt., 76 lbs. 94 SX 128. Net, only ..... \$214.50



**Knight VT Volt-Ohm-Milliammeter Kit**

Terrific Value! Response to 2.5 mc. Bridge-type circuit; 1% resistors. Input res.: DC, 20 megohms; AC, 1.5 megohms. 4 1/2" meter. Ranges: AC p-to-p volts, 0-8-28-84-280-840-2800; AC rms & DC volts, 0-3-10-30-100-300-1000; DC ma. 0-3-10-30-100-300-1000; res. 0-1000-10K-100K ohms & 0-1-10-1000 megohms; cap., .005-.5, .05-.5, .5-50, 5-500, 50-5000 mfd. With tubes, leads, case, instructions. For 110-120 v. DC or 60 cy. AC. Shpg. wt., 6 1/2 lbs. 83 F 120. Net, only ..... \$24.95

83 N 121. Hi-V Probe; extends DC range to 30 KV .. \$6.95

83 N 122. Hi-Frequency Probe for AC range to 200 mc \$5.95



**Wall "Trig-R-Heat" Soldering Gun**

New transformerless quick-heat gun—very lightweight; perfect balance. Squeeze the trigger—you're ready to solder in 3 seconds. Long, narrow 6 1/2" barrel. Features thermostatic action "brain"—automatically regulates gun wattage from 150 to 400 watts to meet needs of the job. Built-in light; iron-clad 1/4" tip. U.L. Approved. For 110-120 v., AC or DC. Shpg. wt., 2 lbs. 46 N 850. Net, only ..... \$7.85

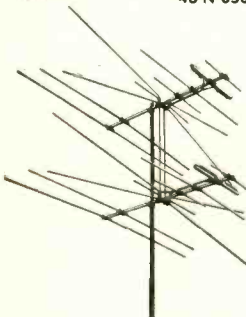

**JFD Super-Jet VHF Fringe Antenna**

Model 2135. New, 2-bay all-channel VHF stacked array for fringe areas. Dual reflectors provide flat response on low channels. Conical-type driven elements for broad band-width. High band sections consist of 2 driven elements and 2 directors each—spaced and phased for peak performance. With half-wave stacking bars. Entirely pre-assembled for easy installation. 1" square aluminum boom. Less mast and 300 ohm line. Shpg. wt., 18 lbs. 98 CX 465. Net ..... \$22.55

JET 213. As above, but single-bay array. Shpg. wt., 8 1/2 lbs. 98 CX 464. Net ..... \$11.00

**Knight Crystal Mike Value.** A real buy in a moisture-sealed crystal mike for recording or Amateur use. Response, 60-7500 cycles. Output level, -50 db. High impedance. Insulated inner elements for safe AC-DC use. With 5-ft. shielded cable. Shpg. wt., 1 lb. 99 S 599. Net, only ..... \$3.25



**Special Value Knight Recording Tape**

Top quality 1/4" tape at very low cost. Plastic base smoothly coated with red oxide. Features low noise level and uniform output. Type "A". 96 R 698. 600 feet. Net each, \$1.37. 5 or more, each ..... \$1.24

96 R 699. 1200 feet. Net each, \$2.10. 5 or more, each ..... \$1.89



**Servicemen's Carry-All Case**  
Quantities Limited

Worth twice this price! All-steel tool and service case. Each half of case is compartmented. One half has 12 compartments and 6 transparent plastic boxes for small parts and tools. Other half has 2 compartments for larger tools and instruments. 7 compartments are in removable tray. Internal plate divides and protects each half of case. With carrying handle. 21 1/4 x 7 1/4 x 12 1/4". A truly remarkable value. Shpg. wt., 14 lbs. 86 NX 084. Quantity limited. Net, while they last ..... \$7.95



**U-C Lite "Big Beam" Hand Lamp**

A "powerhouse" of brilliant portable light. Features 4" lamphead with parabolic reflector, double-strength lens and long-life bulb; focuses for wide or narrow beam. Separate switches for flashing beacon and headlight. Beacon flashes 112 times per min. Head bracket adjustable 95° in vertical plane. Lamp, beacon arm and handle chrome-plated; battery case in red enamel. Uses one 6-v. battery (not supplied). Shpg. wt., 3 1/4 lbs. 78 J 250. Net, only ..... \$6.63

53J028. Burgess F4H Battery. Net 67c

**New Rider Books on Color TV**

"Highlights of Color TV." Makes color TV understandable to everyone. Covers principles of color TV receiver circuitry. 48 pages. 37 K 937. Postpaid, only ..... 97c

"Introduction to Color TV." Covers color wave lengths and frequencies; primary color meaning; color production by reflection and projection; explains various color systems, brightness, hue, saturation, etc.; describes Color TV receiver circuits. 140 pages. 37 K 938. Postpaid, only ..... \$2.06



**ALLIED RADIO CORP., Dept. 2-F-4  
100 N. Western Ave., Chicago 80, Ill.**

**FREE Supplement**

Send FREE ALLIED Supplement No. 139.

Enter order for..... enclosed.

Name.....

Address.....

City..... Zone..... State.....

**ALLIED RADIO**

Exciting New Performance . . . Superb Cabinet Craftsmanship

THE PERMOFLUX

*Fortissimo*

2-Way Speaker System with "DUAL DRIVING POINT" Horn Design

Now Brings You

**FULL RANGE HIGH FIDELITY**  
At Either Low or High Volume Level

Perfection  
in Cabinetry  
by  
*Contemporary  
American  
Furniture*  
in  
Mahogany or  
Korina Blonde.

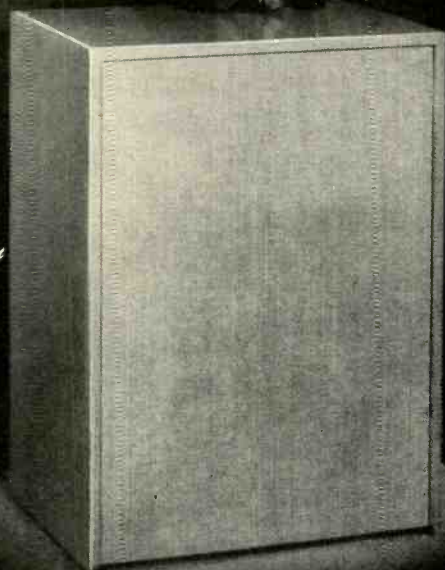

Unique "New Dual Driving Point" Enclosure Design, employing Dual Eight inch woofer system, surpasses bass and mid-range performance of finest conventional 12 and 15 inch systems. Satin smooth highs are added by specially designed Super Tweeter. Beautiful modern cabinet styling . . . precision constructed of carefully selected veneers . . . hand rubbed to a lustrous enduring finish . . .

New . . . Diminutive 2-Way Speaker System

THE PERMOFLUX

*Diminutive*

Exclusive New Design . . . combines full high fidelity performance with minimum cabinet size and low cost. Angled speaker mounting assures correct distribution of sound regardless of placement. Perfect for Binaural when used in pairs.

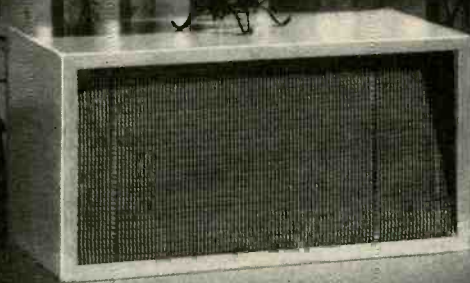

Two Royal 6 inch  
Speakers and Super Tweeter  
housed in choice of Mahogany or  
Blonde enclosure.

See your Hi-Fi dealer for demonstration; also hear the New Super Royal Speakers (8, 12 and 15 inch sizes).

For complete descriptive literature write to . . .

*Permoflux* CORPORATION

4912 West Grand Avenue • Chicago 39, Illinois

West Coast Plant

4101 San Fernando Road • Glendale 4, California

## TUBE FAILURES

Dear Editor:

I should like to thank H. A. Highstone for his comprehensive addition (page 186, January, 1954, RADIO-ELECTRONICS) to information contained in "Tube Failures In TV Receivers," November, 1953, issue.

I believe, however, that if Mr. Highstone will re-examine the article, he will find less inaccuracy than he at first presumes. In section 1, for example, the 5U4-G is listed among tubes "most likely to burn out." However, in the next sentence it is also listed for weak emission. This is in direct agreement with Mr. Highstone's own notes. Also in agreement are the 6SN7-GT, 6BG6-G, and 6CD6-G listed in section 2 under "weak tubes". (No effort was made to list these tubes in the order of their popularity or tendency to fail). In my experience, the majority of 6SN7-GT's have checked slightly weak in one triode section and very weak in the other one.

Conversely, my experiences over the past three years with 1B3-GT's, 1X2-A's, and similar rectifiers does not agree with Mr. Highstone's. I have seen few of these tubes burned out—99% being low-emission and a few gassy (this includes brand-new tubes). Also, most of the 6AU6's I have replaced have been low-emission or shorted, not burned out. Most 6AL5's have also been low-emission or gassy.

As mentioned in the article, the list was by no means complete and was intended primarily as a basic list or example of how actual failures could be compiled and analyzed. It would be interesting to hear similar reports from other service technicians in various parts of the country.

JOHN B. LEDBETTER

Claremont, California

## DEFECTIVE MATERIAL

Dear Editor:

The letter of Joseph Amorose in your February issue is absolutely right. Something should be done about parts jobbers who sell seconds, rejects, and otherwise defective material with no indication of their condition other than price.

Here in Memphis, radio men refer to them as the "gyp houses", and kid the unfortunate who succumbs to a "bargain" and gets tubes with broken pins, or dried-out electrolytics.

Your flip answer that a capacitor, with 200,000 ohms resistance might be used to bypass 10,000 ohms doesn't show much thinking. If a .02- $\mu$ f capacitor is bought for coupling purposes it not only is unfit for that use if it has a 200,000-ohm short, but also is usually of too low capacitance to bypass 10,000 ohms.

A radio man has enough worries without having undependable capacitors mixed in his parts bin. And anyone who knowingly uses such junk in servicing sets is only trying to give himself a black eye.

HORACE COLBY

Memphis, Tennessee

RADIO-ELECTRONICS

“Not in 55,973 years

have I had an imp that operated so efficiently in such high temperatures,” says L. (Lucifer) Satan, Hades strong man. “What’s more, the improved Jet Imps are tough and won’t scar under heat.”

Burton broome advertising



**Jet Imps** are designed to operate at 100° Centigrade (212° F.—boiling point) 15° higher operating temperature than most molded capacitors available today. This means that Jet Imps not only withstand emergency conditions but also under normal operating temperatures, such as the high temperatures under a TV chassis, Jet Imps have a real safety margin for long trouble-free service.

The rugged low loss thermosetting plastic case of the Jet Imps enables them to pass the RETMA Humidity test. Jet Imps are small too, built to the sizes which conform to the requisite design factors for the finest capacitors.

See your Pyramid jobber for the new Imp.



**PYRAMID ELECTRIC COMPANY,** 1445 Hudson Blvd., North Bergen, New Jersey

TO THE

**E. E.**

OR

**PHYSICS  
GRADUATE**

WITH EXPERIENCE IN

**RADAR**

OR

**ELECTRONICS**

HUGHES RESEARCH AND DEVELOPMENT LABORATORIES ARE ENGAGED IN A CONTINUING PROGRAM FOR DESIGN AND MANUFACTURE OF ADVANCED RADAR AND FIRE CONTROL SYSTEMS IN MILITARY ALL-WEATHER FIGHTERS AND INTERCEPTORS.

THE GREATEST advancements in electronics are being made in this sphere because of military emphasis. Men now under 35 years of age will find this activity can fit them for future application of highly advanced electronic equipment.

YOU WILL serve as technical advisor in the field to companies and government agencies using Hughes equipment.

TO BROADEN your field of experience in radar and electronics you will receive additional training at full pay in the Laboratories to become thoroughly familiar with Hughes radar and fire control equipment.

AFTER TRAINING you will be the Hughes representative at a company where our equipment is installed; or you will advise in the operation of Hughes equipment at a military base. (Overseas assignments, single men only.)

**HUGHES**RESEARCH AND DEVELOPMENT  
LABORATORIESSCIENTIFIC AND  
ENGINEERING STAFF

Culver City, Los Angeles County, Calif.

Assurance is required that relocation of the applicant will not cause disruption of an urgent military project.

**Merchandising and Promotions**

Quam-Nichols Co., Chicago loudspeaker and TV components manufacturer, announced a stepped-up advertising program including advertisements in leading trade magazines.

Allen B. Du Mont Laboratories, Cathode-ray Tube Division, Clifton, N. J., designed a new counter display to promote replacement sales. The point-



of-sale display features an actual electron gun mounted on it.

Hickok Electrical Instrument Co., Cleveland, Ohio, has been sponsoring a series of test equipment demonstrations and TV service clinics conducted by its engineers in leading distributor establishments.

Raytheon Mfg. Co., Receiving Tube Division, Newton, Mass., reported excellent attendance at its Service Saver and color TV meetings for service technicians held in selected cities in Ohio and in Fargo, N. D., and Minneapolis, Minn., early this spring.

Simpson Electric Co., Chicago, held a service meeting at Wichita Falls, Texas, earlier this spring. Closed-circuit television was used as a unique method of instruction by Bob Middleton, Simpson



field engineer. A demonstration of antenna impedance measurements by means of a new invention, the *traveling injector*, was one of the highlights of the forum.

Technical Appliance Corp., Sherburne, N. Y., manufacturer of Taco antennas, has designed a new two-color printed carton for its Trapper antenna.

Javex, Redlands, Calif., manufacturer of TV, radio, and electronic devices, is featuring a new counter display on which is mounted one of its custom TV wall outlet plates complete with plug and lead.

Krylon, Inc., Philadelphia, manufacturer of acrylic spray coatings, has launched the most aggressive advertising and merchandising program in its history. The campaign will include advertising in consumer and trade magazines plus some TV advertising. A sales contest is tied in with the program. The company also announced six new colors to its line of spray coatings.

Westinghouse Electric Tube Division, sent out mailing pieces containing the necessary information and an entry blank on its \$8,000 League Leaders tube contest.

Finney Co., Cleveland, Ohio, announced that its Finco 400-A fringe-area antenna was being awarded to winning contestants on TV quiz shows on WAVE-TV, Louisville, Ky., and WHIO-TV, Dayton, Ohio. The company backed up this promotion with attractive and informative mailing pieces to its distributors and dealers. The Finney Company also announced that it had expanded its TV advertising by sponsoring several leading shows, including Inner Sanctum, Amos and Andy, Liberace, and others, with the commercials, in each case, supporting local distributors.

RCA Tube Division, Harrison, N. J., launched a promotion campaign designed to increase the use of RCA factory replacement parts in servicing RCA television receivers and phonographs.

National Carbon Co., New York City, manufacturer of *Eveready* portable radio batteries, is promoting the year-round sale of portable radios with a



complete point-of-sale kit featuring a new motion display. A bonus offer of *Eveready* batteries was also made to dealers who placed pre-season orders totaling \$50 or more.

Radio Merchandise Sales (RMS), New York City, conducted another in its series of TV antenna forums in Providence, R. I., to welcome Station WNET to the u.h.f. airwaves.

Copperweld Steel Co., Special Products Department, Glassport, Pa., designed a new octagon-shaped carton containing its 3/18 Guy Strand for radio and television masts in 500- or 1,000-ft. coils.

Philco Corp., Philadelphia, which for the past eight-and-a-half years has been a sponsor of the Don McNeill Breakfast Club over the ABC radio network, is now also sponsoring the TV simulcast.

Hallcrafters, Chicago, was awarded a bronze plaque for the most distinguished use of match-book advertising in the radio and TV field in 1953. Northern Electric Co. Ltd., Montreal, Canada, and Allen B. Du Mont Laboratories, Clifton, N. J., were voted award certificates.

V-M Corp., Benton Harbor, Mich.,

RADIO-ELECTRONICS

# Home Study Courses in TELEVISION SERVICING offered by RCA INSTITUTES



Study Television Servicing—from the very source of the latest, up-to-the-minute TV and Color TV developments. Train under the direction of men who are experts in this field. Take advantage of this opportunity to place yourself on the road to success in television. RCA Institutes, Inc. (A Service of Radio Corporation of America), thoroughly trains you in the "why" as well as the "how" of servicing television receivers.

## FIRST HOME STUDY COURSE IN COLOR TV SERVICING

Now you can train yourself to take advantage of the big future in Color TV. RCA Institutes Home Study Course covers all phases of Color TV Servicing. It is a practical down-to-earth course in basic color theory as well as how-to-do-it servicing techniques.

This color television course was planned and developed through the combined efforts of instructors of RCA Institutes, engineers of RCA Laboratories, and training specialists of RCA Service Company. You get the benefit of years of RCA research and development in color television.

Because of its highly specialized nature, this course is offered only to those already experienced in radio-television servicing. Color TV Servicing will open the door to the big opportunity you've always hoped for. Find out how easy it is to cash in on color TV. *Mail coupon today.*

### SEND FOR FREE BOOKLET

Mail coupon in envelope or paste on postal card. Check course you are interested in. We will send you a booklet that gives you complete information. No salesman will call.



**RCA INSTITUTES, INC.**  
A SERVICE OF RADIO CORPORATION of AMERICA  
350 WEST FOURTH STREET, NEW YORK 14, N.Y.

## HOME STUDY COURSE IN BLACK-AND-WHITE TV SERVICING

Thousands of men in the radio-electronics industry have successfully trained themselves as qualified specialists for a good job or a business of their own—servicing television receivers. You can do this too.

This RCA Institutes TV Servicing course gives you up-to-the-minute training and information on the very latest developments in black-and-white television.

As you study at home, in your spare time, you progress rapidly. Hundreds of pictures and diagrams, easy-to-understand lessons help you to quickly become a qualified TV serviceman.

There are ample opportunities in TV, for radio servicemen who have expert training. Mail coupon today. Start on the road to success in TV Servicing.

### MAIL COUPON NOW

RCA INSTITUTES, INC.  
Home Study Dept. RE 654  
350 West Fourth Street, New York 14, N. Y.  
Without obligation on my part, please send me copy of booklet on:

- Home Study Course in TELEVISION SERVICING.  
 Home Study Course in COLOR TV SERVICING.

Name \_\_\_\_\_ (please print)  
Address \_\_\_\_\_  
City \_\_\_\_\_ Zone \_\_\_\_\_ State \_\_\_\_\_

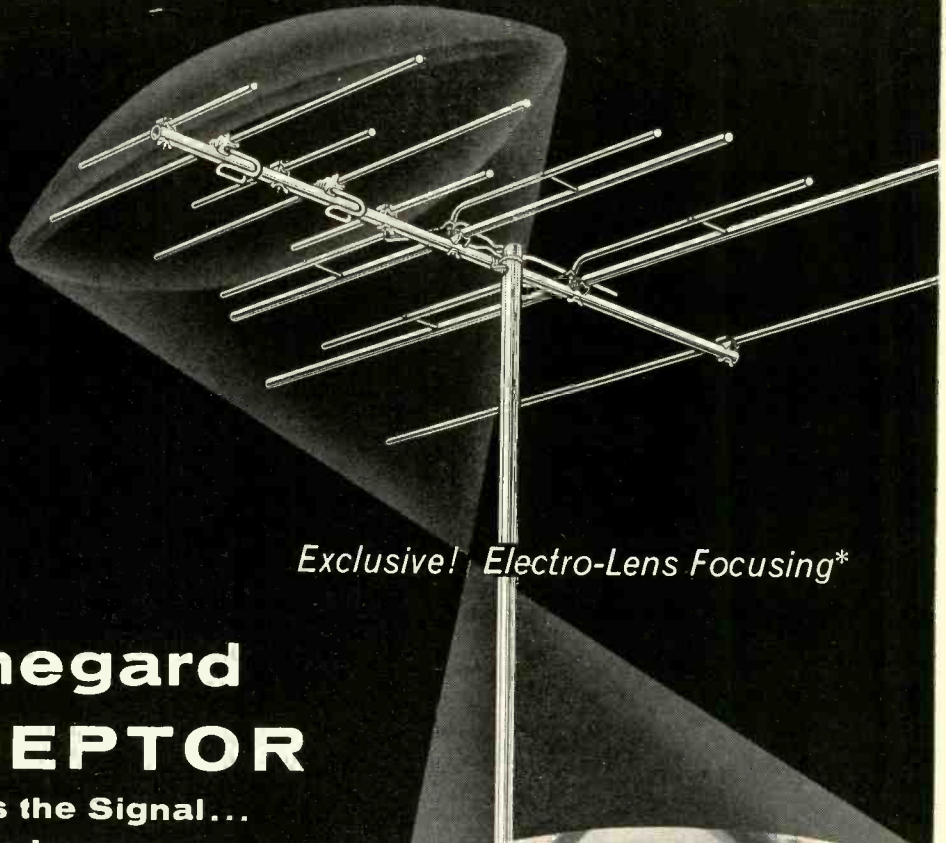

*Exclusive! Electro-Lens Focusing\**

## New Winegard INTERCEPTOR

**Grabs and Boosts the Signal...  
Focuses It...like a Lens**

● Completely new in appearance. Completely new in electrical design. Sensational in results! The new INTERCEPTOR antenna now combines the famous Winegard Multi-Resonant Dipole with the most sensational electronic design of the decade... *Electro-Lens Focusing.\** This exclusive Winegard feature literally grabs the signal out of the air and focuses it on the driven element the same as an ordinary lens focuses light. The result... a picture gloriously brilliant... sharp and clear. A picture up until now unobtainable!

● Never before has one antenna incorporated so many outstanding and exclusive features. The INTERCEPTOR gives highest possible gain and still maintains rejection from the back and sides that really shuts out co-channel interference. Its *Electro-Lens Focusing* makes it an ideal fringe area antenna without the bulk required by present fringe antennas. Small, light-weight and compact, the INTERCEPTOR's neat appearance will be appreciated by owners of the finest homes.

Attention: Servicemen! You will notice we show no charts trying to establish fabulous claims. We suggest you order a Winegard INTERCEPTOR today. If your regular jobber does not have it, please contact us. Test it for yourself. The INTERCEPTOR is its own best salesman!

- A Winegard Exclusive... *Electro-Lens Focusing*.
- All channels (2-13).
- Light, rigid, quick to assemble, easy to install.
- Low wind resistance.
- Designed for color reception.

For complete information on the Winegard INTERCEPTOR VHF antenna with exclusive *Electro-Lens Focusing*, send for Bulletin No. L-4.



# WINEGARD COMPANY

3000 Scotten Boulevard, Burlington, Iowa

\*Patent Pending

RADIO-ELECTRONICS

Here's the most terrific Time and  
Trouble saver you've ever seen  
the **CLASSY CHASSIS CARRIER!**



Carries up to 27" tube  
and chassis easily!

**\$19.95**  
A VALUE...  
YOURS FREE WHEN  
YOU BUY SYLVANIA  
TUBES

### SEE HOW IT SAVES!

1. Saves effort and energy... a breeze to wheel... a snap to carry!
2. Saves extra steps and extra labor. Carries your TNT Kit... everything all at once.
3. Saves valuable service time... permits more calls per day... you make more money.
4. Prevents damage to tubes, wiring and set.
5. Prevents damage to customers' furniture, woodwork and floors.

You'll say it's stupendous... the greatest and most valuable helper a TV Serviceman ever had!

An easy-wheeling, aluminum carrier that lets you move a heavy TV chassis (up to 27-inch tube) anywhere... with no lugging, no straining, no bumping. And no risk to tubes, floors, or polished surfaces. You save time, save money, save effort, and win renewed confidence from your customers.

### Yours FREE!

This sensational work-saver now yours FREE with your purchases of Sylvania Tubes.

But don't delay! Offer expires August 31st. So, order your Sylvania Tubes and get your carrier reservation in NOW! Call your Sylvania Distributor for full details *today!*

SYLVANIA ELECTRIC  
PRODUCTS INC.  
1740 BROADWAY  
NEW YORK 19, N. Y.

# SYLVANIA



In Canada:  
Sylvania Electric  
(Canada) Ltd.  
University Tower Bldg.  
St. Catherine St.  
Montreal, P. Q.

LIGHTING • RADIO • ELECTRONICS • TELEVISION

JUNE, 1954

Cut  
control-  
replacement  
time and cost

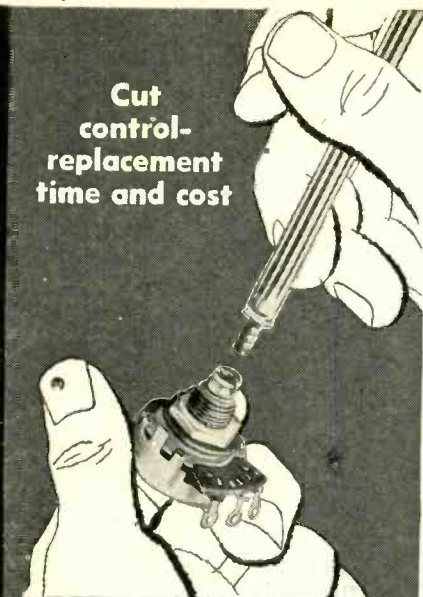

**Centralab**  
**Adashaft Radiahms**

**12 basic shaft types available from 3/8" to 10" in length, including auto types, insulating nylon, many others**

Centralab's patented Adashaft design lets you (1) speed service; (2) give your customer both control and shaft for no more than the cost of an ordinary control.

The basic Adashaft control has a stub shaft you can use "as is" as a short, screwdriver-slotted unit. Or you can easily attach any of 12 basic shafts. Thus, you can have any resistance you want, including dual-tapped types — with any shaft. An instant, positive lock gives you a solid, well-aligned unit every time.

After adding the shaft you need, you can convert the unit to a switch type, with Centralab "Fastatch" type KB line switches.

Your Centralab distributor has Adashaft Controls in the popular model "B", 15/16" construction. Order from him.

Send coupon for bulletin 42-199 with complete Adashaft information.



**Adashaft**  
**Kit No. AB-100**  
An assortment of 39 most popular controls, switches, shafts, shaft extensions, and couplers. In hinged lid plastic box. \$13.38 net.

**Centralab**

CENTRALAB, A Division of Globe-Union Inc.  
444-F E. Keefe Ave., Milwaukee 2, Wisconsin  
Send me Centralab bulletin 42-199.

Name.....  
Company.....  
Address.....  
City..... Zone..... State.....

sponsored a consumer promotion introducing the new 4-speed feature of its V-M 121-A *Jewel Case* portable phonograph. A 16 2/3-r.p.m. "Talking Bible" record was given as a gift to each purchaser.

M. A. Miller Manufacturing Co., Libertyville, Ill., developed a new *Pres-Test* card for testing a phonograph needle without removing it from the instrument.

#### New Plants and Expansions

Aerovox Corp., New Bedford, Mass., formally opened two new plants in California. One, in Burbank, houses Cinema Engineering Co., Division of Aerovox, and the other in Monrovia, houses both Acme Electronics, a subsidiary, and the Pacific Coast Division of Aerovox.

Sylvania Electric Products, New York City, established a new Missile Systems Laboratory in Queens County, N. Y., for analyzing and evaluating engineering problems associated with guided missiles. The company has also begun manufacturing operations in its 422,000 square foot set-assembly plant in Batavia, N. Y. Sylvania's Canadian subsidiary announced plans for construction of a new TV manufacturing plant in Dunnville, Ontario.

Buxton Industries, Pasadena, Calif., manufacturer of TV antennas, moved into a new plant which more than triples its old plant area.

Condenser Manufacturers Inc., Nashville, Tenn., was established as a new firm for the manufacture of etched-foil electrolytic capacitors. Principals include: Hampton Lackey, president; Howard W. Gates, vice president and chief engineer; J. C. Carlin, director of research; and Howard A. Gates, consultant.

Precision Apparatus Co., manufacturer of radio, TV, and electronic test equipment, expects to move from its present plant in Elmhurst, N. Y., to new larger quarters in Glendale, N. Y., by the middle of the summer.

World Radio Laboratories, one of the country's largest distributors, held formal open house in its new plant April 9-11. The new air-conditioned, fireproof building occupies 30,000 square feet at 3415-27 West Broadway, Council Bluffs, Iowa.

Wilrite Products Inc., Cleveland, Ohio, was established as a new resistor manufacturing firm. W. M. Kohring, former owner of Wilkor Products, is the founder of the new company.

DeVry Technical Institute, Chicago, is now located in a large modern building which it purchased at 4141 Belmont Ave.

Rhein Sound Systems, Inc., a new audio amplifier manufacturing company, was established in Orlando, Fla., by G. W. (Gene) Rhein and W. L. Pedersen.

Precision Potentiometer Corp., Los Angeles, was established as a majority-owned subsidiary of Master Mobile Mounts. Samuel E. Goldstein is president of both companies. Walter H. Donaldson and Karl A. Kopetzky are associated with him as officers of the Precision Potentiometer Corp.

# Mr. Serviceman

**OXFORD'S**

**NEW**

**REAR DECK  
SPEAKERS**

mean **MORE**  
**PROFITABLE**  
**AUTO RADIO**  
**WORK for**  
**YOU!**

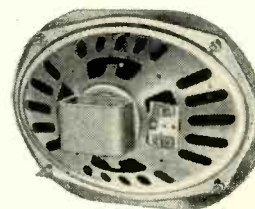

**Model**  
**RD-69**  
**6" x 9"**  
**\$13.40**

Suggested list price:

**Preferred for**  
**Original**  
**Equipment —**  
**Proven for**  
**Replacement**



**Model**  
**RD-57**  
**5" x 7"**  
**\$12.15**

Suggested list price:

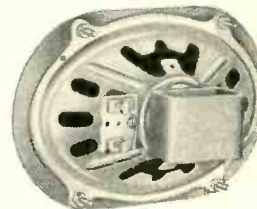

**Sold Through Recognized Jobbers Only!**

**OXFORD**  
**ELECTRIC**  
**CORPORATION**



3911 SOUTH MICHIGAN AVENUE  
CHICAGO 15, ILLINOIS

EXPORT — ROBURN AGENCIES, NEW YORK CITY  
IN CANADA — ATLAS RADIO CORP. LTD., TORONTO

RADIO-ELECTRONICS





# "Here's proof the CQS Plan can really help your business"

"SEE HOW IT WORKS FOR ME . . ."

**WILLIAM SCHOOLEY, owner**  
SCHOOLEY TELEVISION SALES & SERVICE  
3019 W. 111th Street  
Chicago, Illinois



"CBS-Hytron is running advertisements like these in LIFE. Maybe you've seen them and noticed they really do a selling job for us service-dealers. Well, I'm one service-dealer who is cashing in on a plan that's tailor-made for me."



"So, I'm using the CQS Tags on every job. Many of my customers now ask for them. They like the Tag's lay-it-on-the-line certification. Since December, I've ordered three lots of Tags . . . 500, 1000 and 2000."



"I like my customers to know I'm the dependable CQS service-dealer they read about in the big magazines like LIFE and the POST. So I make sure they do . . . by using the CQS Clocks, Signs, Decals, etc., available to any service-dealer."



"Take my word for it. Here's a plan that's so simple . . . so sound that any service-dealer is missing a real bet, if he doesn't tie in . . . and cash in. The boost that CQS has given my business proves it."



"Look at the 'sell' of these new CQS Streamers! Get aboard this CQS plan. It can do just as fine a job for you as it is doing for me. Take a tip. Find out today the facts about CQS. Prove to yourself that CQS can build up your business, too."

**GET YOUR Certified QUALITY SERVICE TAGS** . . . imprinted with your name and address. Use them on every job. Get your big, new CQS CBS-Star Kit. It contains:

- A.** Six smashing, colorful CBS-Star streamers. Each features a different CBS-TV star: Benny . . . Burns and Allen . . . Gleason . . . Godfrey . . . Murrow . . . and Marie Wilson. Each streamer is a different size and shape. Each one sells the Star Performance of your Certified Quality Service.
  - B.** New colorful inside/outside CQS decal.
  - C.** Business Builders Catalog showing the many hard-hitting sales aids available to you.
- CBS-STAR KIT IS FREE** with your order for CQS Tags . . . Kit alone, 25¢.

Ask your distributor salesman for special offer. Or use coupon:



Manufacturers of Receiving Tubes Since 1921

**CBS-HYTRON** Main Office: Danvers, Mass.

A Division of Columbia Broadcasting System, Inc.

A member of the CBS family: CBS Radio • CBS Television  
Columbia Records, Inc. • CBS Laboratories • CBS-Columbia • and CBS-Hytron

### CBS-HYTRON, Danvers, Mass.

Please rush me:  
 A CBS-Star Kit free with . . . . . CQS Tags  
 (quantity)  
 @ \$2.25, 250; \$3.50, 500; \$6.00, 1000  
 A CBS-Star Kit only  
 @ 25¢ (for handling and mailing)  
 I enclose \$ . . . . . to cover Tags and/or Kit.  
 (Please send cash, check, m.o. . . . no C.O.D.'s.)  
 HERE IS MY 3-LINE IMPRINT FOR TAGS  
 (please print name and address)

Name . . . . .  
 Street . . . . .  
 City . . . . . State . . . . .  
 Signed . . . . .

# Trav-Electric

DC to AC

**CURRENT CONVERTERS**  
for Land...Sea...Air

JUST PLUG INTO CIGAR LIGHTER ON DASH

Change 6 or 12 Volt D. C.  
to 110 Volt A. C. - 60 cycle



Operates Test Equipment,  
All Electric Shavers

SIZE: 2"x2"x3 1/2"

**Trav-Electric MIDGET**

\$11<sup>95</sup>  
List

Model 6-11160, 60 Cycle, 10-15 Watts

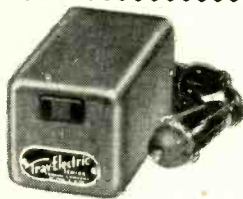

- OPERATES
- Test Equipment
  - Turntables
  - Lights
  - Short, Long Wave Radios
  - Portable Phonographs
  - Electric Shavers, etc.

SIZE: 2 1/2"x2 1/2"x4 1/2"

**Trav-Electric SENIOR**

\$15<sup>95</sup>  
List

Model 6-1160, 60 Cycle, 35-40 Watts



- OPERATES
- Curling Irons
  - Radios
  - Turntables
  - Small Dictating Machines
  - Test Equipment,
  - Electric Shaver
  - Portable Phonographs

SIZE: 4"x5"x6"

**Trav-Electric MASTER**

\$24<sup>95</sup>  
List

Model 6-51160, 60 Cycle, 40-50 Watts



- OPERATES
- Wire Recorders
  - Amplifiers
  - Soldering Iron
  - Radios
  - Dictating Machines
  - Turntables
  - Small Electric Drill
  - Electric Shaver

SIZE: 4"x5"x6"

**Trav-Electric SUPER**

\$37<sup>95</sup>  
List

Model 6-71160, 60 Cycle, 60-75 Watts

**FULLY GUARANTEED**

See your Jobber or Dealer

# Terado COMPANY

1057 Raymond Ave.  
ST. PAUL 14, MINNESOTA

In Canada Write: Atlas Radio Corp., Ltd.  
560 King St. West, Toronto 28, Ont.

Export Sales Division: Scheel International, Inc.  
4237 N. Lincoln Ave., Chicago 18, Ill. U.S.A.

Cable Address—Harshell

## Show Notes

Management of the Western Electronic Show and Convention will be held in the Los Angeles Pan-Pacific Auditorium under the joint sponsorship of the West Coast Electronic Manufacturers Association and the San Francisco and Los Angeles sections of the IRE. The management announced that over 465 booths would be occupied, nearly 100 more than last year. A record attendance of 20,000 is anticipated.

The Audio Engineering Society will continue to sponsor the Audio Fair for 1954 and 1955. The 1954 Fair will be held in the Hotel New Yorker, New York City, October 14-16.

## Business Briefs

... Winegard Company, which is now under the sole ownership of John R. Winegard, one of the former partners of the predecessor company, Wells and Winegard, moved into a new factory in Burlington, Iowa. The TV antenna and accessories manufacturer is now operating as an Iowa corporation.

... Clarostat Manufacturing Co., Dover, N. H., at its spring sales meeting awarded diplomas to a select group of engineers and production supervisors upon their completion of a Work Factor Training Course in labor-time study and evaluation. Clarostat also announced that its Midwest plant in North Aurora, Ill., now entering its third year of operation, is in full production on power resistors, rheostats, and controls.

... Triplett Electrical Instrument Co., Bluffton, Ohio, celebrated its 50th anniversary at its annual sales meeting in Bluffton, May 14 and 15.

... RETMA reported the production of 847,504 TV sets and 1,641,213 radios during the first two months of 1954. This is down considerably from the 1953 period but at about the same level as in 1952.

... Granco Products, Long Island City, tuner manufacturer, held a spring sales meeting at its plant at which salesmen and engineers exchanged ideas on the u.h.f. situation.

... RCA and General Electric entered an agreement under which RCA's right to grant certain sub-licenses in the radio and TV fields, under G-E patents, will terminate December 31, 1962.

... Howard W. Sams & Co., Indianapolis, announced that CBS-Hytron, Federal Telephone and Radio Corp., and International Rectifier Corp. had become participants in its services.

... Telrex, Inc., Asbury Park, N. J., antenna manufacturer, announced that basic patent application on its conical antennas had been granted by the Patent Office of Canada. The company also announced that it had greatly expanded its facilities to meet the demand for its *Beamed Power—Perfect Match* rotaries.

... Technical Appliance Corp., Sherburne, N. Y., announced that an exclusive new development which it calls a *Tension Booster* is being incorporated in its new all-channel Trapper antenna.

# The First Practical, Understandable Book About TRANSISTORS

distributed by  
**HOWARD W. SAMS & CO., INC.**

NEW COYNE PUBLICATION

## "TRANSISTORS AND THEIR APPLICATIONS IN TELEVISION-RADIO-ELECTRONICS"

by Louis E. Garner, Jr.

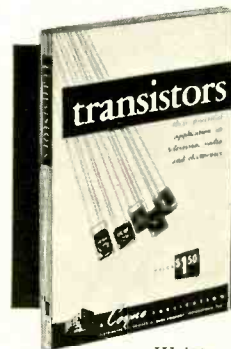

The "inside story" of Transistors for Servicemen, Engineers, Amateurs and Experimenters

Written by an authority on the subject. Explains in easy-to-understand language the theory and practical applications of Transistors. Clears up common misconceptions; clarifies Transistor circuitry, installation, testing techniques, theory and servicing. An important book for everyone in Electronics.

### CONTENTS

Chapt. 1: History of Transistor development and its implications for the electronic industry. Chapt. 2: Non-mathematical explanation of how Transistors work; description of basic types. Chapt. 3: Physical and electrical properties of transistors. Chapt. 4: Transistor amplifier circuits. Chapt. 5: Transistor oscillator circuits. Chapt. 6: Special Transistor circuits (D.C. amp., R.F. det., Clippers, Phase Inverters, etc.). Chapt. 7: Transistor Components (sub-miniature parts and power supplies). Chapt. 8: Care and servicing of Transistors. Chapt. 9: Practical Transistor circuits (experimental circuits with parts values; audio and r.f. circuits). Chapt. 10: Reference data; commercially available Transistors and their characteristics, etc.

Have ALL the latest information on Transistors in this authoritative, low cost book—it's a "must" for your library.

100 PAGES. 5 1/2" x 8 1/2" \$150

ORDER CTB-7. Only...

ORDER TODAY

### HOWARD W. SAMS & CO., INC.

Order from your Parts Jobber today, or write direct to Howard W. Sams & Co., Inc. 2205 East 46th St., Indianapolis 5, Ind.

My (check) (money order) for \$..... enclosed. Send..... copy(ies) of "Transistors" (CTB-7) at \$1.50 per copy.

Name.....

Address.....

City.....Zone.....State.....

# MORE DEALERS ARE INSTALLING

## CHANNEL MASTER'S CHAMPION THAN ANY OTHER ANTENNA IN TELEVISION HISTORY!

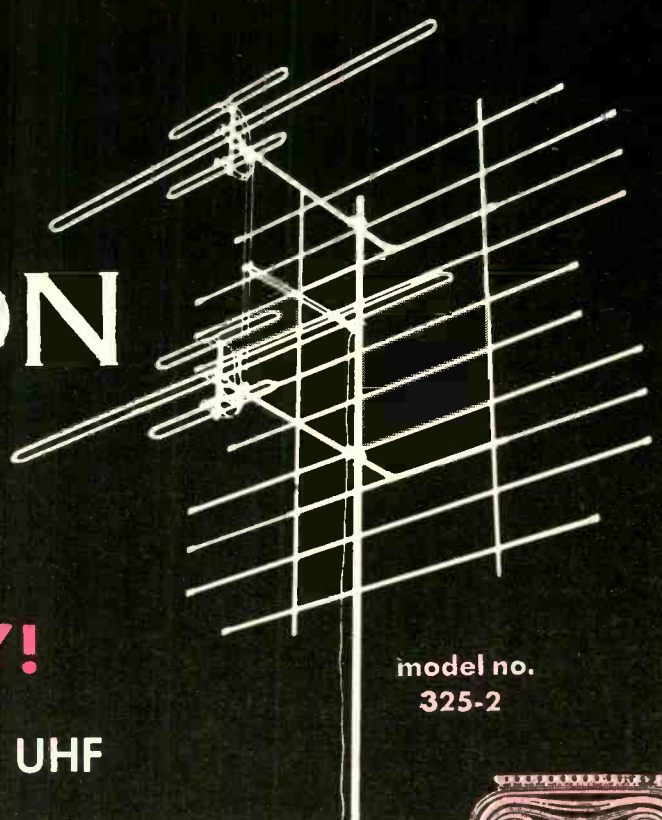

model no.  
325-2

All-channel reception: VHF & UHF

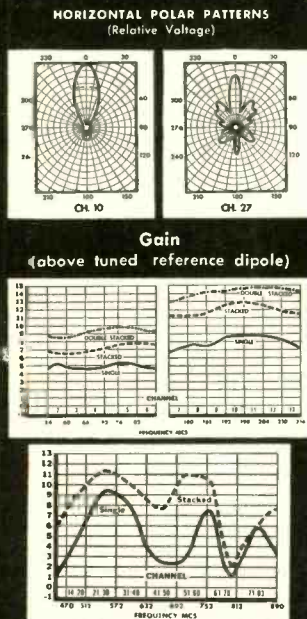

**ONLY THE CHAMPION** enjoys this overwhelming acceptance: over 300,000 already sold!

**ONLY THE CHAMPION** is powered by the unique "Tri-Pole," the triple-powered dipole system that provides fabulous VHF-UHF fringe area performance. 100% aluminum; rugged, exclusive alloy. Installs in a flash!

**ONLY THE CHAMPION** gives you this four-star promotion program:

- ★ **FREE newspaper ads**
- ★ **FREE TV film commercials**
- ★ **FREE colorful display material**
- ★ **FREE consumer literature**

See your Channel Master distributor for full details.

### The antenna America knows best!

Introduced to millions through the editorial pages of their favorite magazines and newspapers, and on TV.

**DON'T BE MISLED BY "LOOK-ALIKES" . . .  
THERE'S ONLY ONE REAL CHAMPION!**

Model no. 325, Single bay; Model no. 325-4, Four bay; Model no. 325-6, Super Champ



**CHANNEL MASTER CORP.**

The World's Largest Manufacturer of Television Antennas

Copyright 1954 Channel Master Corp.

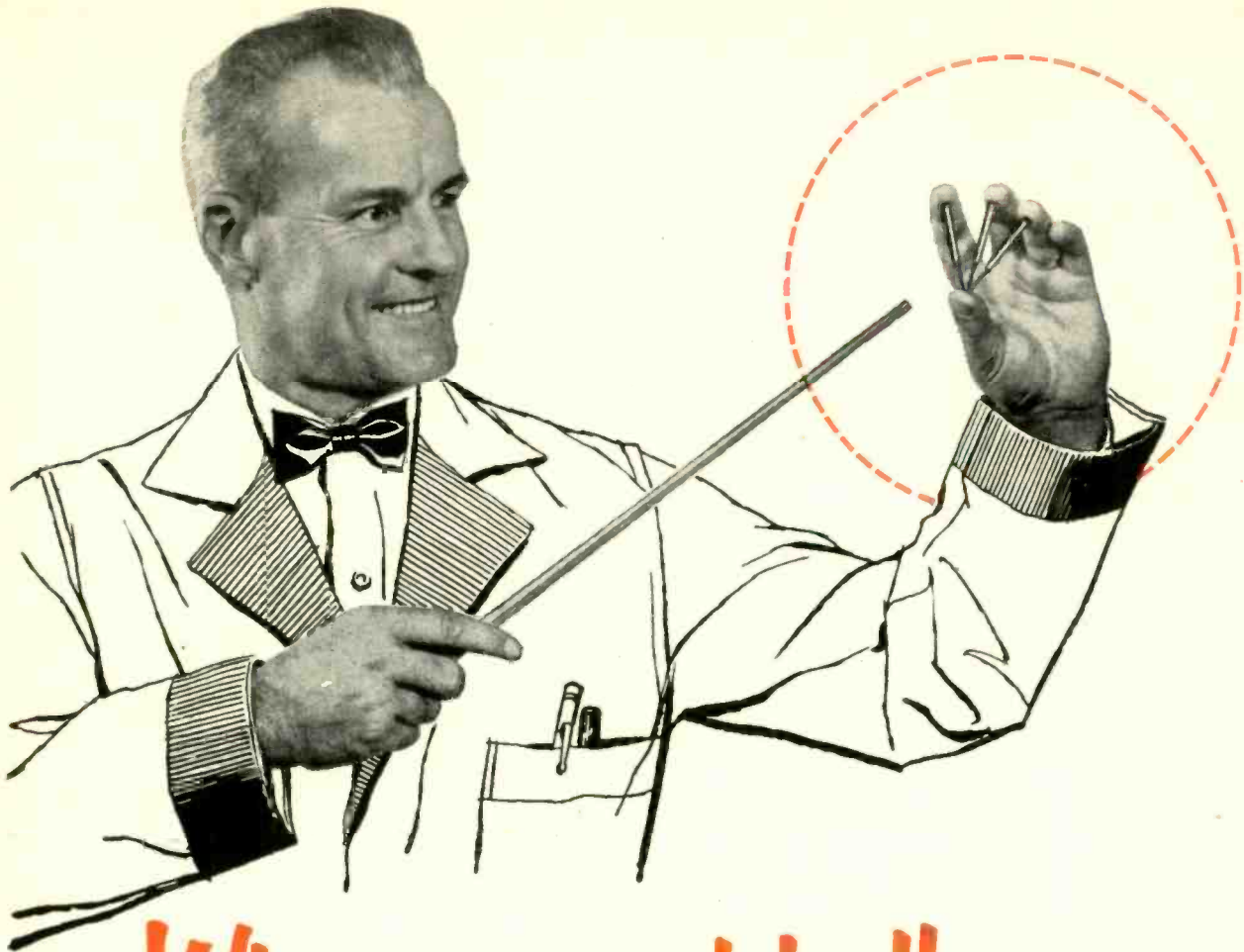

# When you get to the core...

**DELCO RADIO MAKES ITS OWN OF POWDERED IRON FOR HIGH-QUALITY PERMEABILITY-TUNED COILS!**



*FINAL TEST ON IRON CORE ASSEMBLIES AT DELCO RADIO. Here, all iron core assemblies are carefully checked for permeability and separated into very narrow tolerance permeability groups.*



To insure quality performance, Delco Radio exercises rigid control over the components used for both original equipment and service parts in its auto radios.

For example, the powdered-iron cores of Delco Radio's RF, IF, or tuning coil assemblies are made to exacting specifications at the Delco Radio plant. Powdered iron is treated with a binding agent and then compressed into shape by a special machine. Skilled craftsmen attach the connector, and the head end of the core is notched for the tuning tool blade. The core is now ready to be inspected and sent to the tuner department.

This careful manufacturing results in greater customer satisfaction—always. Delco Radio service parts, made by the world's largest manufacturer of auto radios, are available through your UMS Delco Electronic Parts Distributors.

## **DELCO RADIO**

DIVISION, GENERAL MOTORS CORPORATION, KOKOMO, INDIANA

DISTRIBUTED BY ELECTRONICS WHOLESALERS EVERYWHERE

A GENERAL MOTORS PRODUCT  A UNITED MOTORS LINE

RADIO-ELECTRONICS

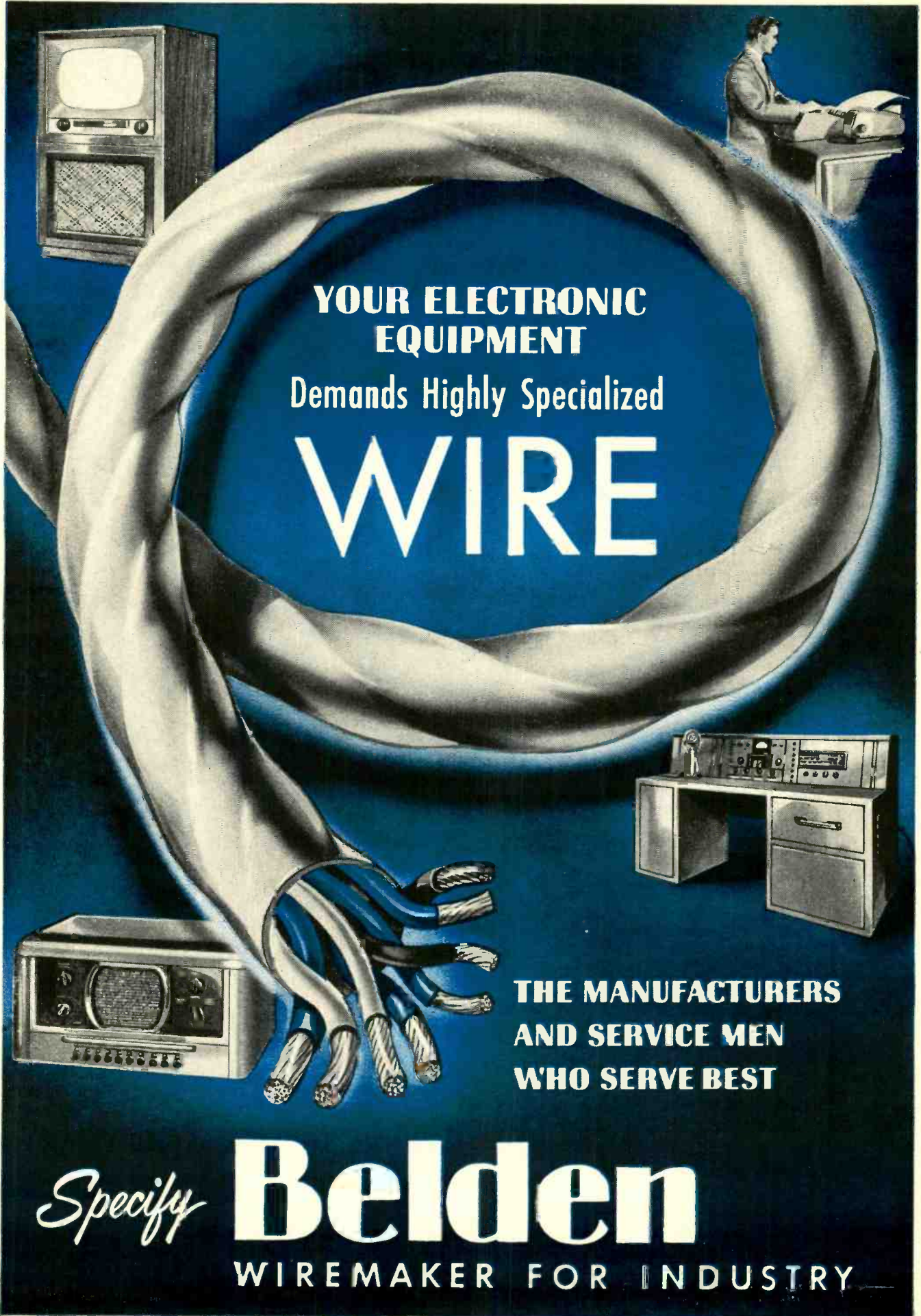

**YOUR ELECTRONIC  
EQUIPMENT**  
 Demands Highly Specialized  
**WIRE**

**THE MANUFACTURERS  
AND SERVICE MEN  
WHO SERVE BEST**

*Specify* **Belden**

**WIREMAKER FOR INDUSTRY**

# NOW... 2 SENSATIONAL EICO SCOPE VALUES!

NEW AMAZING FEATURE PACKED  
7" PUSH-PULL OSCILLOSCOPE

Only EICO Has All These Features:

- VERTICAL FREQ. RESPONSE: flat  $\pm 2$  db 10 cps - 1 mc
- VERTICAL SENS.: .01 volts rms/inch
- HOR. FREQ. RESP.: flat  $\pm 0$  db 10 cps - 200 kc, -4 db at 500 kc
- HOR. SENS.: .3 volts rms/inch
- SWEEP RANGE: 15 cps-100 kc
- 3-STEP FREQ.-COMPENSATED ATTENUATOR eliminates freq. distortion, overloading.
- CATHODE FOLLOWER inputs to both amplifiers
- PUSH-PULL outputs in both amplifiers
- RETURN TRACE BLANKING
- INT. VOLTAGE CALIBRATOR
- V & H TRACE EXPANSION & CENTERING: 1.5X full screen without distortion.
- DIRECT CONNECTION to vert. CRT plates.
- PHASING CONTROL of internal 60 cps sine wave sweep.
- AT FRONT PANEL: intensity mod. input; 60 cps, sawtooth outputs.

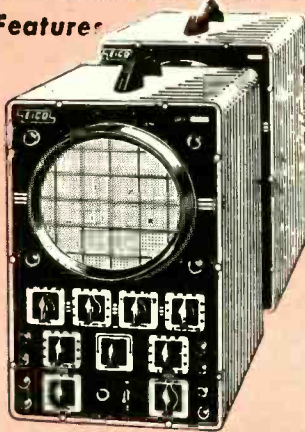

MODEL 470K  
KIT \$79.95. WIRED \$129.50.

EICO EXCLUSIVE! 5" PUSH-PULL SCOPE, 425K,  
Amazing feature-packed economy-priced  
Wired, \$79.95. KIT, \$44.95.

- PUSH-PULL V & H amplifiers. Sens: 0.5-1 rms v/in. Useful to 2.5 mc.
- SWEEP, 15 cps-76 kc, 2-axis intensity modulation. Dual trace positioning controls.



SCOPE VOLTAGE CALIBRATOR KIT  
495K KIT \$12.95. WIRED \$17.95.

- Sq. wave output at power-line freq. with full-scale readings of .1, 1, 10 or 100 V. peak-to-peak
- Accuracy  $\pm 5\%$  of full-scale on each range.

8V & 12V BATTERY ELIMINATOR KIT  
1050K KIT \$29.95. WIRED \$38.95.

- DC output: 0-8 V or 0-16 V.
- Continuous current rating: 10 A at 6 V, 6 A at 12 V.
- Intermittent current rating: 20 A at 6 V, 12 A at 12 V.
- Separate Voltmeter & Ammeter.



- AC & DC volts: 0-5, 10, 100, 500, 1000 V (30 KV with HVP-1 probe).
- 5 ohm ranges from .2 ohm to 1000 megs.
- DC input Z 26 megs.
- 4 1/2" meter movement in can't-burn-out circuit.
- 1% mult. resistors.



HIGH VOLTAGE PROBE \$6.95  
● Extends range of VTVMs & voltmeters to 30 KV.

CATHODE RAY TUBE CHECKER  
630K, WIRED \$24.95 KIT \$17.95



- Checks all types of TV picture and C.R. tubes in the set or carton. Bridge measurement of peak beam current (proportional to screen brightness).
- Detects shorted & open elements.

625K TUBE TESTER KIT \$34.95. WIRED \$49.95.

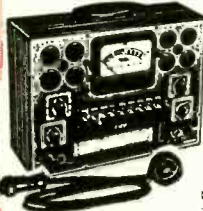

- Illum. gear-driven "Speed Rolchart."
  - New lever-action switches for individual testing of every element.
  - Tests all conventional & TV tubes.
- PIX TUBE ADAPTER for Tube Testers \$4.50. Checks TV picture tubes while in set.

360K SWEEP GEN. KIT \$34.95. WIRED \$46.95.

- Continuous coverage of all TV & FM freqs. from 500 kc to 228 mc.
- Sweep width variable 0-30 mc.
- Crystal marker oscillator, variable amplitude.



214K VTVM KIT \$34.95. WIRED \$54.95.  
249 K P-P KIT \$39.95. WIRED \$59.95

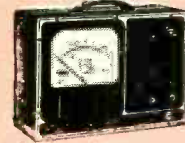

- Large 7 1/2" meter, can't-burn-out circuit.
- AC/DC volts: 0-5, 10, 100, 500, 1000 (30 KV with HV Probe).
- 5 ohms ranges from .2 ohm to 1000 megs.
- DC input Z 26 megs.
- 1% mult. resistors.

Large 7 1/2" meter

950A-K R-C BRIDGE & R-C-L COMP. KIT \$119.95. WIRED \$29.95.

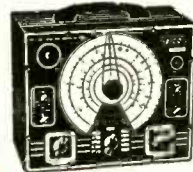

- Measures & tests all resistors; .5 ohm to 500 megohms.
- Every type condenser, 10 mmf to 5000 mfd.
- 0-500 DC voltage source for capacitor leakage testing.

NOW! ONLY EICO KITS & WIRED INSTRUMENTS Gives You LIFETIME SERVICE & CALIBRATION GUARANTEE\*

\*at less than our cost of handling (See EICO Guarantee Card enclosed with each Kit & Instrument).

BAR GENERATOR 352K, WIRED \$19.95 KIT, \$14.95

- Enables rapid adjustment of TV picture V & H linearity without hard-to-find station transmitted test pattern.
- Produces 16 V or 12 H bars. Operates on TV channels 3, 4, or 5.

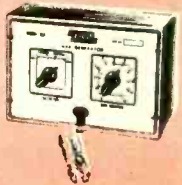

Prices 5% higher on West Coast. Specifications and prices subject to change without notice.

## New! EICO SCOOPS!

232K PEAK-to-PEAK VTVM with DUAL-PURPOSE AC/DC Uni-Probe\*  
KIT \$29.95 WIRED \$49.95



Measures directly p-p voltage of complex and sine waves: 0-4, 14, 42, 420, 1400, 4200 Vp-p. DC/RMS sine voltage range: 0-1.5, 5, 15, 50, 150, 500, 1500 v. Ohms: 0-1000 megs. 7 non-skip ranges on every function. Calibration without removing from cabinet. Zero center. Freq. Resp. 30 cps-3mc. 1% precision ceramic multipliers. Exceptional stability and accuracy. Compact, portable, (8 1/2 x 5 x 5"), smart, rugged.

NEW! UNI-PROBE! Terrific time-saver! Only 1 probe for all functions—a half-turn of probe-tip selects DC or AC-OHMS!

249 K PEAK-to-PEAK VTVM with 7 1/2" METER KIT \$39.95, WIRED \$59.95

944 K FLYBACK TRANSFORMER AND YOKE TESTER  
KIT \$23.95 WIRED \$34.95

Tests all flybacks and yokes, in or out of TV set—in just seconds! Detects even 1 shorted turn! Exclusive separate calibration for air- and iron-core flybacks assures utmost accuracy. Large 4 1/2" meter, 3 colored scales. Compact, portable (8 1/2 x 5 x 5"), smart, rugged.



315K DELUXE SIG. GEN. KIT \$39.95. WIRED \$59.95.

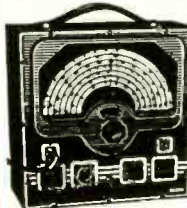

- Covers range of 75 kc to 150 mc.
- 7 calibrated scales: accuracy better than 1%.
- Bandsread vernier tuning.
- 4-step RF shielded output multiplier: constant output Z.

377K SINE & SQUARE WAVE AUDIO GEN. KIT \$31.95. WIRED \$49.95.



- Complete sine wave coverage, 20-200,000 cps in 4 direct-reading ranges.
- Complete square wave coverage, 60-50,000 cps.
- Cathode follower output circuit.

536K MULTIMETER KIT \$12.90. WIRED \$14.90.  
826K MULTIMETER KIT \$13.90. WIRED \$16.90.



- 1000  $\Omega/V$ ; 31 ranges
- DC/AC volts: Zero to 1, 5, 10, 50, 100, 500, 5000.
- DC/AC Current: 0-1, 10 ma; 0.1, 1 A.
- Ohms: 0-500, 100 K, 1 meg.

565K MULTIMETER KIT \$24.95 WIRED \$29.95.

555K MULTIMETER KIT \$29.95. WIRED \$34.95. (1% precision resistors)



- 20,000  $\Omega/V$ ; 31 ranges.
- DC/AC/Output volts: 0-2.5, 10, 50, 250, 1000, 5000.
- DC Current: 0-100 ua; 10, 100, 500 ma; 10 A.
- Ohms: 0-2K, 200K, 20 meg.

145K SIG. TRACER KIT \$19.95. WIRED \$28.95.



- Audibly signal traces all IF, RF, Video & Audio circuits from ANT to SPKR or CRT in all TV, FM, AM, etc. without switching.
- Germanium crystal diode probe responsive to over 200 mc.
- Inter... test speaker.

326K SIG. GEN. KIT \$19.95. WIRED \$29.95.  
822K SIG. GEN. KIT \$23.95. WIRED \$34.95.



- Fundamentals 150 kc to 34 mc, harmonics to 102 mc.
- 5-step band switching.
- Colpitts audio oscillator generates 400 cps pure sine wave voltage.
- Permits pure RF, modulated RF, or pure AF.

Write NOW for FREE latest Catalog C-6

Ask your jobber for FREE EICO business building decals.

Separate Assembly & Operating Manuals supplied with each EICO KIT!

You build EICO Kits in one evening, but... they last a lifetime!

SAVE OVER 50%! See the famous EICO line TODAY, at your local jobber.

ELECTRONIC INSTRUMENT CO., Inc., 84 Withers Street, Brooklyn 11, N. Y.

www.americanradiohistory.com

# AGE OF DECOMPLEXITY

. . . *Simplification in radio-electronics is vital today* . . .

By HUGO GERNSBACK

**W**HEN radio left its crystal days behind and the vacuum tube age arrived, an age of complexity developed, the like of which had never been known to technicians of any art.

With the advent of the television receiver, the complexity of the radio set was multiplied manyfold. Now with the coming of color television, that complexity begins to border on the fantastic. Hundreds of separate components, nearly a thousand connecting wires, and as many soldered connections are constantly inviting set failure. It is a wonder—and a testimonial to our receiver manufacturers—that radio and television sets stand up as well as they do.

In addition to breakdowns, the present high complexity of our receivers and of other radio-electronic devices such as the even more intricate electronic computers makes them very costly, as well as liable to failure. This high cost is due not only to the price of components and wiring, but to a far greater degree to tedious labor and other assembling costs.

With present-day techniques there will always be a high percentage of future failure no matter how careful the manufacturing supervision and the final testing of a receiver may be. The reasons for such failure are legion and would fill a good-sized book, so we will touch only upon the most frequent ones: Bad tubes, poor tube-to-socket contacts, punctured capacitors, burned-out (crystallized) resistors. But most of all, there is *contact failure*, either due to mechanical reasons such as screwed connections or soldered ones. Heat, cold, and jarring during transportation add further to possibilities of future failure.

Contact failure is also the chief reason for *intermittents*—the nightmare of all service technicians. Usually the intermittent trouble appears only when the receiver has warmed up, but not always. The set may work well for hours or days, then go bad for a long period, only to “make” once more and repeat the same erratic performance. Even taking such a receiver to the shop may be of little avail. The set may be returned to the owner with the service technician in the belief that he has located the trouble—but the old difficulty may reappear. We know of an intermittent set that was twice returned to the set manufacturer, who pronounced it perfect—having given it a two-day time test. Nevertheless, in a few days, the old failure reappeared anew. The manufacturer finally gave up and exchanged the set for a new one—a rare procedure, due only to the prominence of the owner, a Very Important Person in the radio field.

The cost of servicing such intermittents is frequently incredible. The average owner just will not pay the cost, or if he does, the service technician will often be shunned for good. The public simply cannot understand the complex reasons for such failures, and naturally enough blames the repair industry.

What then is the answer to the problem? The radio-electronic industry certainly cannot go on forever piling complexity upon complexity. In the average television receiver there are probably over one thousand junctions where failure or partial failure may occur. *In the new color receivers, these potential failure points may be twice as numerous.*

Manufacturers inevitably must—if they are to stay in business—reorient their entire thinking about the subject of receiver building. Even now, the servicing industry can no longer cope successfully with the problem. What will happen when an avalanche of color sets swamps the country during the next few years is anyone's guess. One thing appears certain: *the service technicians will be slowly strangled.* Even now the field no longer attracts as many

as it did a few years ago—the endeavor has become too difficult, too hectic, too unattractive economically.

First of all, the manufacturers—component makers and set makers alike—must do away with much of the high present-day complexity. There are far too many separate components and entirely too much wiring. As for the myriads of soldered connections, the less said the better! A *partial* answer may be found in the appliqué (the so-called printed) circuit idea, although actual *printed* circuits are long out of use. But attractive as the idea is—doing away with nearly all wiring—the old contact bugaboo still remains. It is difficult, often impossible, to solder components to appliqué circuits. The use of spring or screwed contacts is not reliable over long periods of time. *They invite intermittents.*

New research will probably overcome this difficulty in time. Most urgent is the plea to component manufacturers who must redesign and modernize many receiver components, for the future—and coming—decomplexed receiver.

Let us make only a single suggestion here. At frequent points in all receivers we have an inductor, a capacitor, and a resistor closely connected together. Often there is a multiplicity of these components. *Why not make a single multi-component—a “block” in one unit—with only two or three leads extending from such a combination?* This can be done, if engineered correctly. If failure occurs, the entire block can be replaced. (One manufacturer, Centralab, with its “Printed Electronic Circuit” units has made a good beginning in this direction.)

As mass production of transistors is now assured for the immediate future, there is then no reason why the transistor should not be added to a number of multicomponent blocks. Such an internally connected block would still have only two or three leads, *not wires*, but flat metal strips extending from the block. These strips would then be *spot-welded* to the strips of adjacent other blocks. Thus, instead of a thousand soldered junctions, we would only have a few dozen spot-welds. The number of separate components would be reduced over two-thirds. The labor cost per set would be sharply reduced, as would receiver failure.

Instead of a confusing helter-skelter mess of wires and a crazy quilt pattern of components, we would have an orderly array of blocks taking up half the former space. This would in turn make for nearly perfect servicing accessibility. Every block, too, would be labeled or printed or embossed with its circuit and the values of the separate internal components.

Servicing such a true wireless set would become a pleasure rather than the constant irritant we find in so many present-day receivers.

Let us now listen to an undisputed expert on this and parallel ideas. Dr. W. R. G. Baker, vice-president and general manager of General Electric's Electronics Division, in a talk he delivered recently before the Meeting of the Radio Technical Commission for Aeronautics in Washington, D.C., said:

“There is no doubt that many of the criticisms of electronics on the basis of complexity and unreliability have a basis in fact, and to some extent I believe the electronics industry must bear the blame. The electronics engineers and scientists, who have been so quick to grasp the potentialities of the science, have been notably unimaginative in devising new methods of producing the same results that can be obtained from the wiring of standard components into a circuit. It may be possible—in effect—to grow capacitors, resistors, as well as transistors into a single crystal.”

# PHONO PREAMP FOR

# GOLDEN EARS

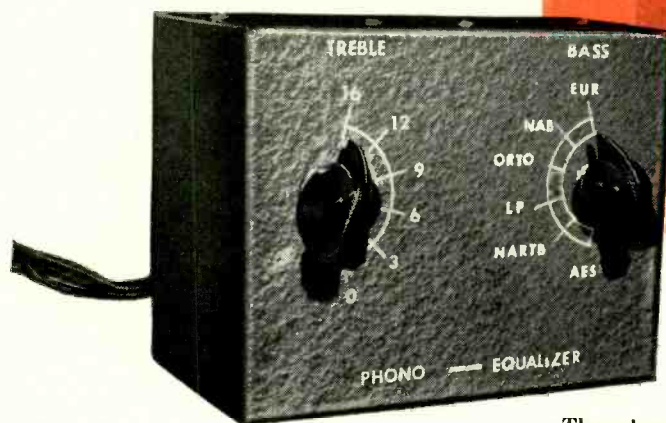

By JOSEPH MARSHALL

The phono preamp—a wide range of treble and bass control is provided.

**F**OR faithful reproduction of today's remarkably good recordings the phonograph preamplifier-equalizer should meet the following specifications:

1. **Good frequency response.** It should be reasonably flat (after equalization) between 20 and 20,000 cycles or better. We have some high-fidelity recordings today which include this range, and many of the purely commercial discs cover the spectrum between 30 and 15,000 cycles.

2. **Extremely low noise level.** The output of some magnetic pickups is under 10 millivolts for the average peaks above the turnover; but the lowest bass tones may be well under 1 millivolt. Some of the softer passages and the various delicate harmonics may have a level at the preamp input of less than 100 microvolts. Obviously only a little noise in the preamplifier, especially the input stage, will mask these subtle components of music and there is nothing we can do in the following stages to repair the damage.

The noise component in a preamp is due to a combination of hum, tube noise, and resistor noise. If possible, the total of all this noise should be held down to a level of 60 db below the maximum output of the preamp. This would be worse than marginal in a power amplifier but is about the limit in preamps with today's tubes. Hum presents a particularly trying problem. Not only is it an evil in itself, but also it tends to increase intermodulation distortion.

3. **Adequate equalizers.** It is debatable whether there is any justification for the many varieties of recording and playback curves used today. A long step forward was the recent adoption of a standard curve by the AES and the RIAA (RADIO-ELECTRONICS, May 1954, p. 63) as a new industry standard in

the U.S.A. The old curves will remain for many years even if everybody standardizes at once for the simple reason that they will still be necessary to play today's and yesterday's records. Six equalizers represent about the minimum for the music lover who mixes his record brands, and even these require compromises. The critical listener needs many times more than this.

4. **Low distortion.** Distortion, by high-fidelity standards, is already high, even in the best of recordings. An IM distortion level of 2% is very seldom improved upon. Moreover, pickups and turntables with hum and rumble will add 1 or 2% at least and may multiply this. If the over-all distortion is to be held down to a nonirritating level, it is clear that very little distortion can be added by the preamplifier. Certainly we should add not more than 1% at the top 3 db of the dynamic range and it should be inconsequential at more normal levels.

5. **Adequate gain.** Gain is not an important consideration provided there is enough of it for complete equalization, and output is sufficient to override the noise of succeeding stages. To provide full bass compensation down to 20 cycles, a bass boost of over 24 db is necessary. Moreover, some curves call for treble attenuation of up to 16 db at 10,000 cycles. A rule-of-thumb minimum over-all gain of 40 db is therefore necessary to take care of the equalization range. Most high-fidelity systems follow the preamp with a control unit which will provide a gain of at least 10 and a maximum output of at least 5 volts. An output of ½ volt or more from the preamp-equalizer should therefore be sufficient.

6. **Size and form.** This is a marginal consideration, but well worth some thought. These factors should permit

some flexibility in positioning and mounting. Personally, I like to have the preamp-equalizer next to the turntable or changer so the equalization can be selected when the record is placed on the turntable.

The response of this unit (Fig. 1-a) embraces the entire audible range from 16 to beyond 20,000 cycles. There is a boost of between 3 and 6 db below 50 cycles on all curves. The response above 10,000 cycles will depend on the pickup and the condition of the needle; the circuit provides a means of compensating for pickup and line losses in this region. The net gain is around 100. The output voltage is up to 1.5 volts for 78-r.p.m. recordings and half that for LP's with a G-E pickup. The distortion is less than 1% IM. The total noise at the output depends to some degree on the filtering of the power supply which feeds the preamp. With the control unit for Golden Ears and Milady's Golden Ear, the noise varies at the output between 0.6 and 3.5 millivolts, depending on the tube. This represents a level between 46 and 60 db down.

A choice of two equalizers is provided. The simpler one (Fig. 1-b) uses one switch and provides 6 playback curves—3 for 78's and 3 for LP's. The more elaborate version (Fig. 1-c) uses separate bass and treble equalizers with a choice of 6 slopes in each, or a total of 36 possible combinations. This takes care of every curve in use today and should be adequate to deal with anything the engineers may dream up in the future. The simpler version is recommended for everybody except the cranks.

## The circuit

The primary consideration in this design was low noise. This requires a careful choice of tubes and circuits. In



the past I have gone to such extremes as using battery tubes with battery filament supplies. Here, however, I have achieved a noise level as good as I ever had before, with a.c. on the filaments.

The 12AY7 is the outstanding tube from a low-noise point of view; but it costs \$3.50. Fortunately, the much cheaper and more easily available 12AT7 is capable of just about as good a noise figure in the proper circuit. A small portion of the run of 12AT7's is microphonic and perhaps 20% is excessively (for this purpose) noisy; but about 80% can be used in this circuit with results which very closely approach those with the 12AY7. Incidentally, the 12AY7 can be used in the circuit with no changes whatever and will provide a very slight improvement in noise. The prototype was tried with both types.

For minimum hum, the cathodes of both sections are grounded, bias being obtained by grid leaks. The heater line should be balanced at the power supply (Fig. 2) and the mid-tap should be connected to a positive voltage of between 30 and 50 volts. (All Golden Ear amplifiers provide such a biased filament voltage and this preamp may be fed directly from one.)

To reduce resistor noise it is best to use deposited-carbon resistors for the two grid leaks and the plate loads. If economy is essential, a good grade of carbon resistor could be used for the grid leaks, but the low-noise resistors are essential for the plate loads if noise is to be held down to the specified level. A 0B2 voltage regulator is used for hum filtering and decoupling.

The final reduction of hum is achieved by the rather novel construction which encloses the entire preamp in an aluminum case. The tube itself has a shield and is therefore doubly shielded. Attempts to do without the tube shield might result in instability since the bass equalizer is very close to the tube.

The total effect of all these measures is the remarkably small noise level at the output, of between 0.5 and 0.6 millivolts (depending on the tube), which would indicate a first-tube noise of considerably less than 10 microvolts.

The unit can be mounted within a few inches of a phonograph motor and on the same baseboard with no significant increase in hum level. The pickup will pick up some hum, but the preamp is so thoroughly shielded that even the meter shows no significant increase as the case is placed adjacent to a motor.

The Vector turret socket, mounted on an insulated nonconducting base, greatly reduces stray and wiring capacitances with the very happy result that despite the very high grid leaks, the response does not begin to slope off until around or beyond 20,000 cycles.

**Power supply**

The unit requires an external power supply. Most amplifiers can supply the 10 ma plate current and 150 ma fila-

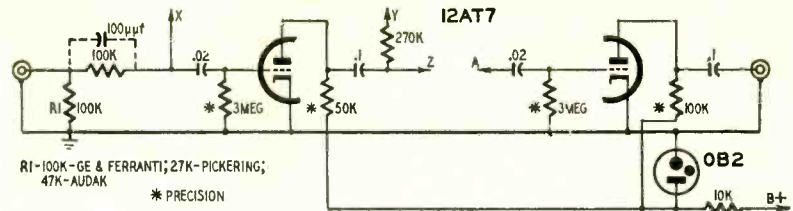

Fig. 1-a—Skeleton diagram of phono preamp. Unit features less than 1% IM.

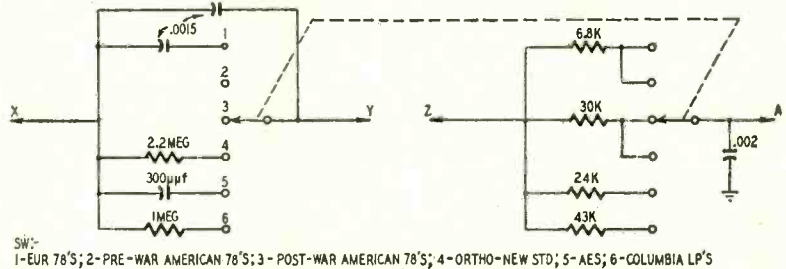

Fig. 1-b—Simple equalizer; it uses one switch and provides 6 playback curves.

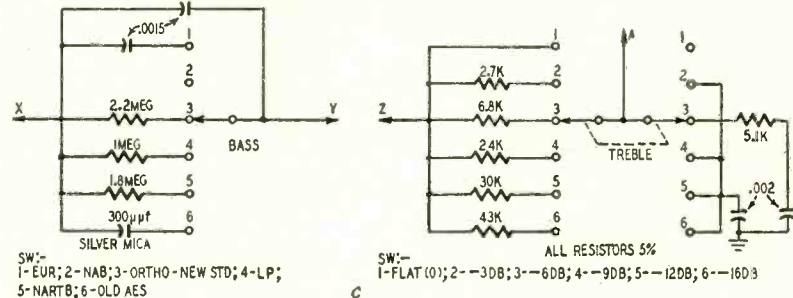
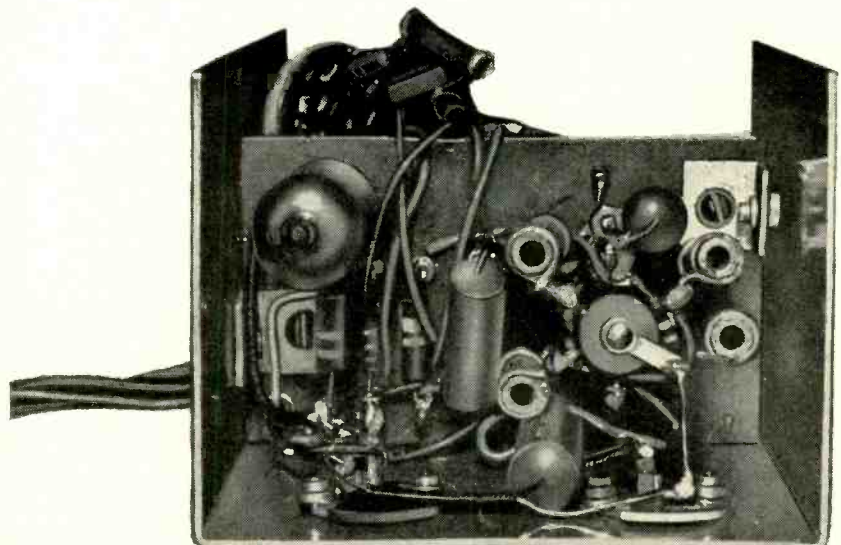

Fig. 1-c—Separate bass and treble equalizers; each provides 6 slopes.

ment current with no danger of overload. If the filament supply is not balanced and biased, the hum level will rise slightly but not very significantly. Any attempt to include a power supply in this preamp will seriously increase the hum level despite the most heroic measures. If possible, it is better to supply the preamp from an FM tuner, or unit other than the amplifier and control unit to which it will be con-

nected. This will increase the decoupling and stability. However, my preamp is in use with the combination of the control unit for Golden Ears, and Milady's Golden Ear, using power from Milady, with excellent results. And this despite the fact that the control unit loudness control provides up to 20 db of bass boost. However, if you like, you can construct a separate supply (Fig. 3) in another case.



The turret socket adds compactness and helps reduce wiring capacitances.

This view of phono preamp gives closeup of underchassis and equalizer wiring.

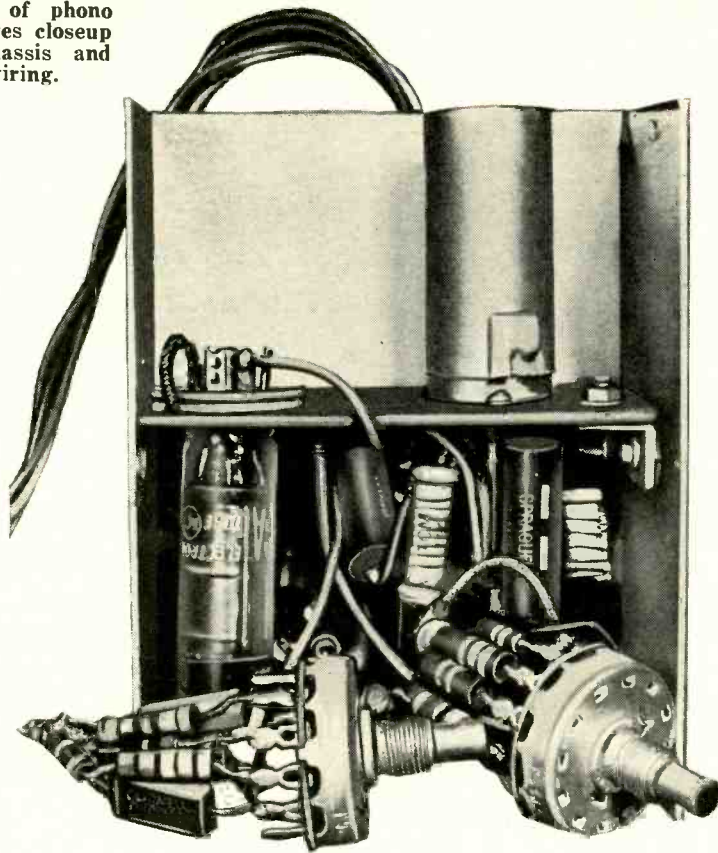

A feedback loop from the plate of the input section to the pickup provides bass equalization. This has many advantages over more conventional methods. First, it makes it possible for the cathode of the input tube to be grounded, thus greatly reducing the hum level. Second, it removes all high impedances from the direct signal path and thereby reduces susceptibility to hum pickup. Third, the equalizer permits the use of small, compact capacitors. Fourth, it offers an extremely simple and convenient means of compensating the pickup response at high fre-

test record. However, the 100  $\mu\text{f}$  specified will be quite right with most G-E pickups.

With the parameters specified the circuit yields a bass slope flat within 2 db to 50 cycles for all curves, and a rise below 50 cycles which will depend on the pickup cartridge. The Ferranti, for instance, yields a boost of up to 6 db at 20 cycles and up to 3 or 4 db at 15,000 or 20,000 cycles, depending on cable losses. Incidentally, the transformer of the Ferranti (or a low-impedance G-E) may be connected directly to the input with the 100,000-ohm load, and will be very nicely equalized for all curves up to and beyond the audible limits.

### The equalizers

The more elaborate version provides 6 bass slopes: 1—European (and Columbia 78-r.p.m.) which has turnover between 250 and 300 cycles and a 6 db-per-octave slope below turnover all the way down to 16 cycles; 2—the old NAB slope which uses a 500-cycle turnover and a 6 db-per-octave slope below that (here, as in all curves, the slope continues down to 16 cycles); 3—the RCA Ortho (now also RIAA standard) slope with a 500-cycle turnover but with modifications of the 6-db slope to limit the bass boost below 100 cycles; 4—Columbia LP, which is similar but has a slightly different limiting of the bass boost; 5—the new NARTB which is also similar to the above but levels the boost out below 60 cycles; 6—the old AES which is a 6-db-per-octave slope with a turnover around 400 cycles.

The small capacitors used in this and

the treble equalizer can be 10% mica and silver-mica types. One-third watt resistors of 5% tolerance will do very nicely and will also provide a more compact assembly than the prototype model pictured here. The equalizer components are soldered directly to the switches for greatest compactness and to obtain the lowest possible stray capacitance.

The treble equalizer is of the inter-stage bypass type. The more elaborate version provides a choice of 6 slopes: 1—flat or unequalized; C1 can be adjusted to provide a flat curve to 15,000 cycles with the G-E and to 20,000 cycles with other pickups. Once this flatness is obtained the other curves will follow with an accuracy of plus or minus 2 db; 2—a slope of 3 db at 10,000 cycles; this is the slope for the old London (78 r.p.m.) frr records and is also useful for some old American 78's; 3—minus about 6 db at 10,000 cycles—this is the slope now used on British HMV records and other foreign 78's, and works well with old 78's in good shape; 4—down about 11 db at 10,000 cycles—the old AES treble slope; this also works well with the London frr LP recordings; 5—down around 14 db at 10,000 cycles—the Ortho-RIAA slope; and 6—down about 16 db at 10,000 cycles which is the LP and new NARTB curve. (Note: on the model illustrated, the treble slopes are labeled for convenience in 3-db steps, but the 9-db position is actually the 11-db AES curve, and the 12-db is actually the 14-db Ortho curve.)

The simpler version uses a single 2-pole, 6-position switch for both treble and bass equalization and provides the following curves: 1—European 78's—250-cycle turnover and 6-db slope below that, also used for Columbia 78's; 2—prewar American 78's—500-cycle turnover, 6-db slope, and minus 6 db at 10,000 cycles; 3—modern American 78's—the NAB bass and Ortho treble, which yields a pleasing quality with most modern 78's; 4—RCA Ortho; 5—old AES curve for those LP's which do not use either the Ortho-RIAA or Columbia LP curve; 6—the Columbia LP and NARTB curve.

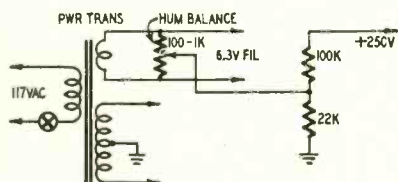

Fig. 2—Balancing the filament line.

quencies: connecting C1 across the 100,000-ohm resistor in series with the input. This is the resistor across which feedback is applied. A small capacitor will reduce the feedback at very high frequencies. Not all pickups require this and it should be used only when necessary. But many pickups have a droop from 10,000 cycles up which is accentuated by losses in cables. The G-E cartridge, for instance, usually has a 3 or 6 db slope between 9 kc and 15 kc; a capacitor of between 50 and 150  $\mu\text{f}$  will compensate for this nicely. The value ought to be chosen by trial and error with the aid of a frequency

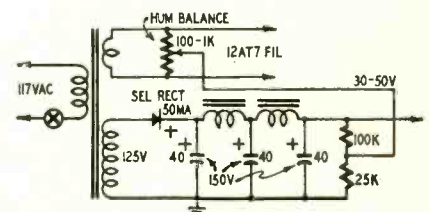

Fig. 3—Power supply for phono preamp.

The Table lists the records most commonly used today. The final two columns give the bass and treble slopes which most closely follow the playback curves; the figure in parentheses in the first column gives the position on the simpler one-switch equalizer which comes closest to fitting the playback curve. Where two numbers are given, both should be tried and the one which suits the individual taste best used. I

suggest that the Table be cut out, sprayed with clear plastic or lacquer, and tacked or pasted somewhere near the record player for ready reference.

As mentioned previously, the Record Industry Association of America has adopted a standard curve which it recommends to the industry. The new RIAA curve is the same as the new RCA Orthophonic recording characteristic listed as ORTHO in the table. Since most of the larger record manufacturers are members of the RIAA, it is probable that a majority of future recordings will follow that curve.

Many recording companies are presently changing from one curve to another.

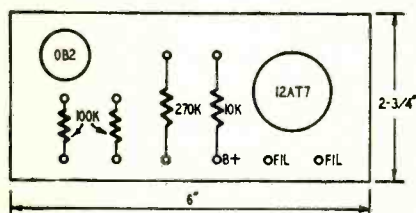

Fig. 4—Mountings on terminal board.

other. So far as I can determine, the Table is reasonably accurate. Many companies now include equalization instructions on the jacket—look for it.

The two-switch equalizer leaves plenty of room for individual taste and for compensating local conditions. Thus, for instance, the NAB bass can be used with LP records to provide some boosting of speaker response below 70 cycles, while the treble switch could be set 3 or even 6 db higher or lower to make up for line losses, to reduce noise in noisy records or to increase tweeter output. If the switches are operated gently there will be only a very slight, barely audible click, as the position of the equalizers is changed—if the amplifier, like the Golden Ears, has a good transient response and cannot be thrown into motorboating.

The compact, shorting type Mallory switches of the 3100 series should be used; this permits compactness and also simplifies the construction. The equalizers are wired separately, right on the switches, and connected to the rest of the circuit on final assembly.

**Construction**

The construction should duplicate as exactly as possible that shown in the photos. Instead of a metal subchassis, a terminal board is used. The board should be 2 3/4 inches wide and cut to a length just 1/16 inch or so shorter than the width of the cover of the Fleximount case. (Burstein-Applebee of Kansas City has a suitable board, No. 17B138, for 25¢.) A 3/4-inch hole is cut or punched 1 3/4 inches from one end of the terminal board for the turret socket. All the resistors and capacitors associated with the two tube circuits are mounted on the turret, from socket terminal to the ring of terminals on the other end. Only the input and output capacitors are left free at one end, for wiring at final assembly. The two feed-

back resistors, the input shunting resistor, and the power supply filtering resistor are mounted on the terminal strip. The layout of Fig. 4 is highly recommended.

The following routine will save time and trouble:

1. Cut the terminal board to fit the cover of the case with a leeway of about 1/16 inch. This leeway is tolerance for mounting brackets and for squaring the cover on final assembly. Cut the holes for the two sockets. Mount the resistors on the board.

2. Wire the turret socket carefully, before attaching it to terminal board. Be sure all joints are good—there is no tolerance in a preamp for noisy connections. The two cathodes are grounded directly to the adjacent ground lugs on the socket by bending the terminals over the lugs and soldering tight. A common-ground bus runs from one of these lugs to the lug at the center of

the turret, and from there to other points in the circuit.

3. Now assemble the turret to the terminal board. Position it so that the two resistors and the output capacitor in the output section will be in the corner of the box when the assembly is completed. Note that the OB2 is mounted opposite to that of the amplifier tube and is so positioned that it fits in the corner diagonal to that of the turret. Complete wiring of turret and terminal board components. Solder 6-inch leads to points X, Y, A, and Z. The leads should be of very flexible stranded wire. Before mounting the terminal board on case, drill the holes for the two jacks and the power cable. Position the output jack so that it is in the corner adjacent to the turret and so that the output capacitor will connect to it with a very short lead. Position the input jack on the opposite end where it will be adjacent to the 100,000-ohm input loading resistor and require a lead only an inch or two long to connect to the circuit. Fasten the jacks in place; thread through and knot the cable and solder its ends to appropriate points on the terminal board.

4. Now the terminal board mounts to the case with two small brackets. I made mine out of a pair of large cable clamps, flattened out. In mounting the board you'll probably have to shim up one of the screws so that the cover is spread exactly right to fit the other part of the case without warping.

5. Drill the panel section of the box for the switches. If one switch is used, it should go on the side of the 12AT7.

**RECORDING CURVES**

COMPANY	Position of One-Switch Equalizer	Two-Switch Equalizer	
		BASS	TREBLE
Artist	5	NARTB	-16 db
Angel	6	NAB	-11 db
Audiophile	2	NAB	-6 db
Bach Guild	6	LP	-16 db
Banner	6	LP	-16 db
British 78-r.p.m.	1	EUR	0 or -6 db
British Columbia I	1	EUR	0 or -6 db
Blue Note	5	AES	-11 db
Capitol	5	AES	-11 db
Capitol-Telefunken	2	NAB	-6 db
Cetra-Soria 78's I	1	EUR	0 or -6 db
Cetra-Soria 33's 6	6	LP	-16 db
Capitol-Soria	5	AES	-11 db
Coliseum	6	LP	-16 db
Columbia 78's, new	6	NAB or AES	-16 db
Columbia 78's, old	3	NAB	-6 db
Columbia 33's	6	LP	-16 db
Coral	5	AES	-11 db
Cook	5	AES or NAB	-11 db
Old Concert Hall 78's and 33's	2	NAB	-6 db
New Concert Hall 33's	6	LP	-16 db
Decca (American)	5	AES	-11 db
Decca frr 78	3 or 5	AES	-3 db
Dial	6	LP	-16 db
Handel Society	6	LP	-16 db
Haydn Society	6	LP	-16 db
HMV (released by RCA)	4	ORTHO	-14 db
HMV 78's (British)	1	EUR	-6 db
HMV 33's (British)	6	NAB	-11 db
London frr	4-5	LP	-11 db
Mercury	5	AES	-11 db
MGM	4	NARTB	-16 db
Montilla	5	ORTHO	-14 db
RCA—older 78's and 45's	3	NAB	-14 db
RCA—new Ortho, all speeds	4	ORTHO	-14 db
Remington	6	NARTB	-16 db
Tempo	6	NARTB	-16 db
Urania	4-5	NAB	-14 db
Vanguard	6	LP	-16 db
Vox	5-6	NAB	-16 db
Westminster	6	NARTB	-16 db
Westminster also		AES	-11 db

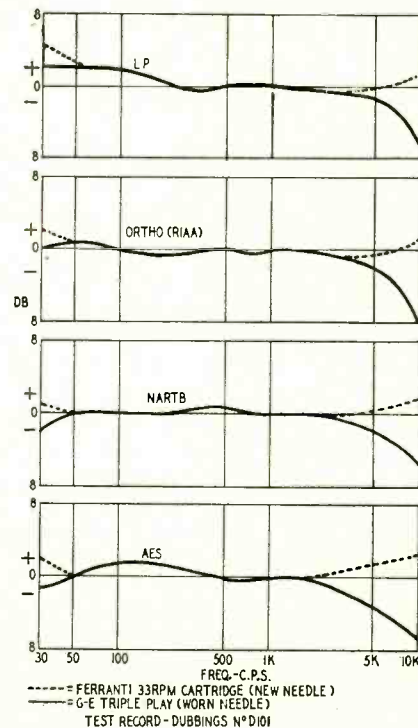

Response curves. Preamp is not compensated for G-E pickup. About 100 μμf across 100,000-ohm feedback resistor corrects slope above 5 kc to about 7 db for AES position and about 5 db in other positions.

terminal board; if two are used, the bass switch should go on the 12AT7 side. This is important: putting the bass assembly on the other side may result in oscillation or instability. Note that the switches are mounted off-center. If you duplicate the arrangement you can drill the two holes  $1\frac{1}{4}$  inches from the top and  $\frac{7}{8}$  inch from the sides. Check to see that with the switches mounted the whole assembly fits together nicely. Be sure that the equalizer resistors and capacitors do not short to ground or to other portions of the circuit.

#### Parts list for phono preamp

- 1—10,000-ohm resistor
- 2—100,000-ohm resistor
- 1—50,000-ohm resistor, precision, Aerovox or Continental
- 1—100,000-ohm resistor, precision, Aerovox or Continental
- 1—270,000-ohm resistor, carbon, 5%
- 2—3 megohm precision resistor, Aerovox
- 2—.02- $\mu$ f capacitor, 200 volts, paper
- 2—.01- $\mu$ f capacitor, 200 volts, paper
- 1—12AT7 tube
- 1—0B2 tube
- 1—Naval Vector turret socket
- 1—Shield and base for Vector socket
- 1—7-pin miniature socket
- 1—Flexi-mount 3 x 4 x 5-inch aluminum case
- 1—Terminal board, 6x2 $\frac{3}{4}$  inches (Burststein-Applebee No. 17B138)
- 2—Phone jacks
- 1—Power supply cable (10 feet)
- 1—4-contact plug (Jones)
- 1—Decals, audio

#### Parts for one-switch equalizer

- 1—6,800-ohm resistor, carbon, 5%
- 1—24,000-ohm resistor, carbon, 5%
- 1—30,000-ohm resistor, carbon, 5%
- 1—43,000-ohm resistor, carbon, 5%
- 1—1-megohm resistor, carbon, 5%
- 1—2.2-megohm resistor, carbon, 5%
- 1—300- $\mu$ mf capacitor, silver mica, 5%
- 2—.0015- $\mu$ f capacitor, mica, Sangamo type C, 10%
- 1—.002- $\mu$ f capacitor, mica, Sangamo type C, 10%
- 1—1-pole 6-position switch (Mallory 300 series)

#### Parts for two-switch equalizer

- 1—2,700-ohm resistor, carbon, 5%
- 1—5,100-ohm resistor, carbon, 5%
- 1—6,800-ohm resistor, carbon, 5%
- 1—24,000-ohm resistor, carbon, 5%
- 1—30,000-ohm resistor, carbon, 5%
- 1—43,000-ohm resistor, carbon, 5%
- 1—1-megohm resistor, carbon, 5%
- 1—1.8-megohm resistor, carbon, 5%
- 1—2.2-megohm resistor, carbon, 5%
- 1—300- $\mu$ mf capacitor, silver mica, 5%
- 2—.0015- $\mu$ f capacitor, mica, Sangamo type C, 10%
- 2—.002- $\mu$ f capacitor, mica, Sangamo type C, 10%
- 1—2-pole 6-position switch (Mallory 300 series)

6. Remove the switches and apply the decals—if the unit is to be used in plain sight. The fifth edition of Audio decals has most of the legends, although some may have to be made up letter by letter. Follow the instructions carefully. Give the decals at least overnight to dry. Apply the lacquer sparingly with a brush to remove the lacquer film. This is likely to leave the panel somewhat dirty looking, so moisten a cloth in the lacquer thinner and rub it *lightly* over the panel surface, over and around the letters and lines. This will remove the scum and leave a nice smooth finish.

7. Now wire the switches into the circuit. The leads should be long enough so you can fasten the switches to the panel with the two halves of the box at least half-open. Close the box. Check each power supply terminal, also the input and output jacks, with an ohmmeter to check for accidental grounds and shorts. If it tests O.K., put in the screws and test the unit with a frequency test record if you have one.

#### Troubles

There is always some danger—in a

compact assembly like this—of instability. To insure against it, duplicate the layout and follow the instructions exactly. Be especially careful to keep the output capacitor, jack, and the lead between them, in the corner of the case, well isolated from the rest of the circuit. If you get high-frequency oscillation, try repositioning the treble equalizer assembly, by turning it around. If necessary, leads Z and A can be shielded. The simplest and safest way to do this is to take another piece of hookup wire and coil it around the Z and A conductors, grounding one end. This is better than shielded cable because there is no danger of producing a short by contact of the shield and some B plus point on the turret.

Because of the length of this article, we have been forced to omit the regular installment of Marshall's "Servicing High-Fidelity Equipment." Part V will appear in the July issue.

Because the boost in this circuit continues down to 16 cycles and below, there is some danger of motorboating in the NAB and AES positions when a common power supply is used for the preamp and the amplifier to which it is connected. Actually, this is likely to happen only if the values of the components in the bass equalizer section are considerably off. Watch especially the value of the 270,000-ohm feedback resistor. The one used in the original turned out to have an actual value of only 200,000 ohms and produced trouble; replaced with one of 270,000 ohms, the preamp was completely stable. The boost at the lowest frequencies increases

very fast as the value of this resistor is lowered. The bass equalizer switch is placed on the side of the terminal board on which the tube is mounted; placing it on the other side, adjacent to the turret and the 0B2, may cause instability.

As I have indicated, the boost below 50 cycles will vary with the pickup used. This boost can be reduced or eliminated by connecting a resistor of about 4 megohms across the .0015- $\mu$ f bass-boosting capacitor, which will have the effect of limiting the boost below 50 cycles. By proportioning this resistor exactly with the help of test records it is possible to produce a response which is very flat all the way down. This single resistor will operate in all equalizer positions and produce a complementary effect on all curves. I prefer the boost below 50 cycles.

You will find this circuit less critical in respect to stability than the common one using a two-stage feedback loop. Indeed, you are unlikely to have any trouble at all unless the following control unit has a loudness control which produces a large amount of bass boost. On the other hand, the high degree of bass equalization provided by this circuit all the way down to 20 cycles or below will result in exceptionally satisfying reproduction of modern recordings.

#### Conclusion

The difference a low-noise, wide-range, properly equalized preamp can make is really amazing. To fully appreciate it, you need a rumble- and hum-free turntable and one of the really wide-range pickups. With these, the complete absence of noise produces a startling feeling of presence and realism. Even very old shellac recordings sound good. It is a revelation to discover how much there is not only on the new recordings but also on the old shellacs.

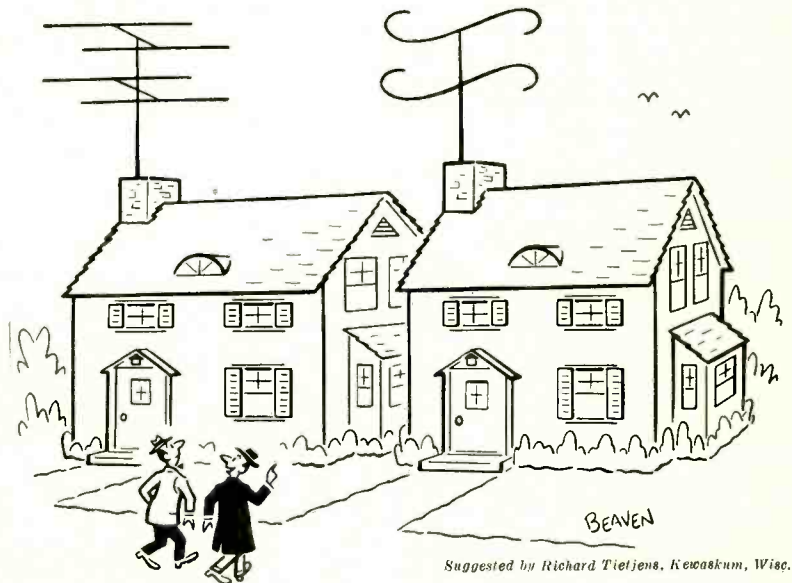

Suggested by Richard Tietjens, Kewaskum, Wis.

"This is the Smith's antenna; the other is the Harrison's antenna to avoid confusion."

# HIGH-FIDELITY SERVICING

*Old principles and new techniques bring success in this newest type of service*

By **WILFRED GOLDSTICK**  
and  
**ARTHUR PEIKES\***

**K**EEPING up with high-fidelity equipment presents some new problems for the radio service organization. These arise not so much because of actual electronic differences between high-fidelity and conventional equipment (although differences certainly do exist) but rather because of the way high-fidelity components are sold and the attitude of the owner toward his equipment.

The owner perhaps has purchased what he believes to be the very best components available, has spent from \$200 to \$500 or more, and is not willing to make any compromise with quality as he understands it. Reversing the procedure commonly followed by a purchaser of a standard radio-phono combination, he selects the individual components first, and only then chooses the cabinet—if any.

Typically, the purchaser of a hi-fi rig has never actually heard *his* set operating until the moment when he finally completes the installation in his home. Only then does he have an opportunity to compare its performance with what he remembers having heard in the demonstration room of the audio center that sold him his units. Very often the hi-fi service technician may be called in at this early stage—called in to service brand-new equipment—to remedy what the customer may only describe as “not sounding quite right.”

This is not to imply that most calls are unwarranted, but rather that many of them come about just because of the manner in which high-fidelity equipment is purchased. Frequently troubles are caused by improper installation—missing grounds on interconnecting cables, poor placement of components relative to one another, improper impedance matching, poor antenna, or similar faults that an experienced technician can readily correct. Actual circuit component failures are comparatively rare in high-fidelity equipment, because it is generally designed with performance rather than cost in mind, and tends to allow large safety margins compared with standard mass-produced items.

\*Proprietors, Sigma Electric Co., New York, N. Y.

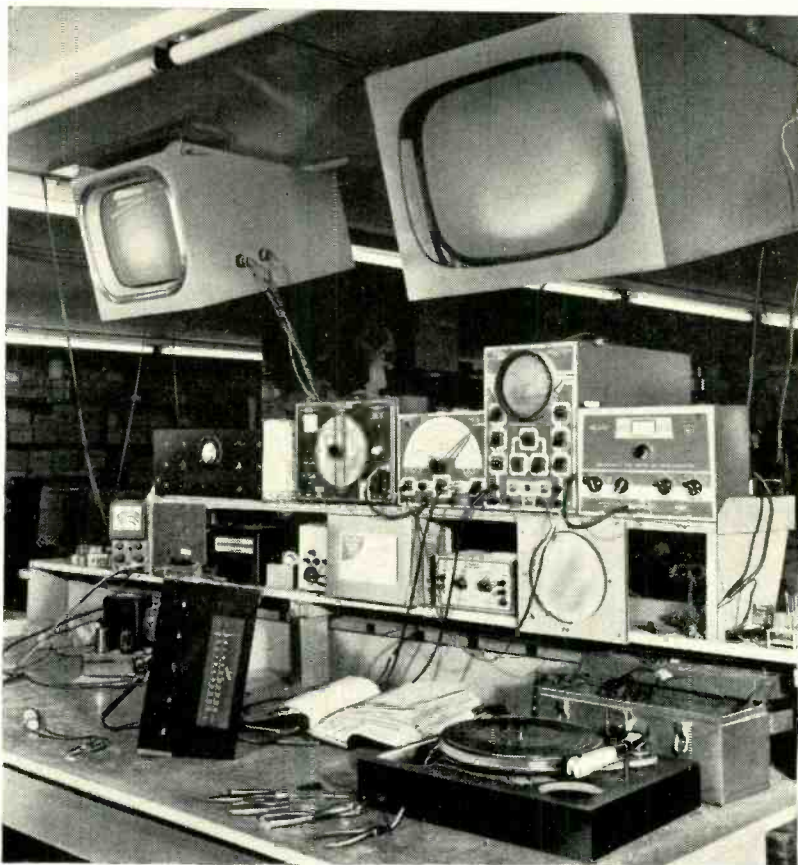

One of the benches, used for FM alignment and the often necessary TV work.

The common complaints for which a hi-fi service technician is called in would be passed over by most listeners, and would require much more careful servicing than is required in normal electronic work. It follows that servicing this equipment is exacting and relatively expensive. The final problem of servicing such units is to develop a routine that—while being thorough enough to locate the troubles complained of—does not involve the service shop in measurements that properly belong to a design and testing laboratory and that would make repairs prohibitively expensive.

## System and equipment

The procedure in our shop is to attempt to relieve the skilled service technician of as much routine work as possible by making a helper and a wireman available for setting equipment up, making tube checks, and changing major components, leaving highly trained personnel for actual diagnosis and adjustment. In addition, we have found it necessary to keep the service technician from contact with the customer (to prevent excessive loss of working time) and to use experienced countermen to discuss the customer's problems.

Special benches are provided for alignment of FM and AM receivers (with sweep generator, marker generator, oscilloscope, and necessary in-

terconnecting cables installed), and for making complete audio measurements (audio oscillators, oscilloscope, distortion meter, electronic switch, voltage calibrator, voltage-regulated power supplies).

Each service bench affords a working area of approximately 3 x 8 feet and is provided with the following: a.c. outlet strip (outlets 6 inches apart) and an audio source strip (cathode follower from FM tuner, outlets 6 inches apart); high-fidelity audio amplifier (panel-mounted, with phono preamplifier, equalizer, voltage amplifier, power amplifier, and output transformer available at tip jacks); loudspeaker in wall baffle; phono turntable with plug-in cartridges (crystal and VR); and vacuum-tube voltmeter.

To obviate delays this concern maintains a large stock of exact duplicate replacement parts and a stock of tubes much larger than usually required in service work (to allow for selection of tubes for low noise, hum, microphonics, or drift).

## Test equipment

The close attention to many details that must be paid to hi-fi repairs can be very time-consuming, and it is essential that test equipment be purchased or constructed wherever its use can conceivably cut down the labor that must be spent on servicing. In addition to the normal complement of test equip-

ment, we consider the following to be absolutely necessary:

1. A good-quality narrow-band sweep generator suitable for FM and AM alignment, such as the Sylvania 216 or Hickok 288X.

2. Crystal-controlled markers to accurately align bandpass on high-fidelity receivers.

3. Stable audio oscillator, capable of producing sine and square waves over a wide range.

4. High-fidelity amplifier.

5. A 12-inch, or preferably 15-inch, loudspeaker mounted in at least a bass-reflex speaker enclosure.

6. FM tuner, preferably piped over the service areas.

7. Phonograph turntable equipped with VR and crystal arms.

8. Frequency-test records for checking over-all response.

9. Other test instruments which are very desirable, but of fairly limited usefulness, because the service shop generally does not have sufficient information about the design of the equipment under test to correctly interpret measurements like total harmonic distortion, over-all gain, intermodulation distortion, and similar characteristics. Although manufacturers' specifications are usually available, they generally do not give any indication of how much a given unit may deviate from the specifications without being rejected, or of the exact conditions under which the manufacturer's measurements were made. It is our opinion that tests of

performance of this sort should be made only when the customer specifically requests them.

### Repair procedure

In the following example, a Radio Craftsmen Model C-10 AM-FM tuner with phonograph preamplifier is being worked on (see specimen worksheet). Complaints indicated are:

- a. Noise on AM.
- b. FM not clear; difficult to tune; does not receive all stations, as formerly.
- c. Phonograph noisy, bad crackle.

1. Helper checks all tubes on a mutual-conductance tube checker, coding all tubes as to their condition, but replacing them in their original sockets.

2. Helper sets up tuner to play through the test amplifier and speaker in the service bench and the service technician checks performance to confirm that customer's complaints actually *do* occur in the shop. He finds that the FM lacks sensitivity and tunes badly (4 FM tubes are marked defective), the phone preamplifier tube is noisy, but the AM radio behaves normally. Before proceeding with the repair the customer is contacted.

3. The counterman explains to the customer that, although we can remedy two of his complaints, the difficulty with AM reception is due principally to local interference at his home, and he cannot expect any great improvement on AM after repair. If customer O.K.'s the work on this basis, the

repair is continued; if not, a nominal inspection charge is made to cover the work already performed. *Unless this procedure is followed, the set may subsequently be returned for a no-charge repair on a complaint that cannot be remedied in the tuner itself.*

4. Service technician substitutes new tubes, coded so that they can be identified in case the customer later requests replacement under our warranty. (We use a drop of green lacquer on customer's tubes, red on shop tubes.)

5. Technician makes several spot checks of voltage and resistance and of the condition of electrolytic and paper capacitors. If these seem in order, he proceeds with the next step.

6. The set is aligned in accordance with the manufacturer's instructions. *It is absolutely essential that a sweep generator, oscilloscope, and marker generator be used to ensure proper bandwidth and symmetrical response curves.* Attempting to align by peaking with a vacuum-tube voltmeter as an output indicator can result in too narrow a bandpass with consequent loss of fidelity. In the absence of proper markers during sweep alignment, the bandpass may be made too wide with consequent loss of selectivity and sensitivity.

7. Helper removes equipment to check-out bench where it is allowed to play for several hours while being periodically inspected by the service technician.

8. Supervisor (one of the proprietors) checks over-all performance of

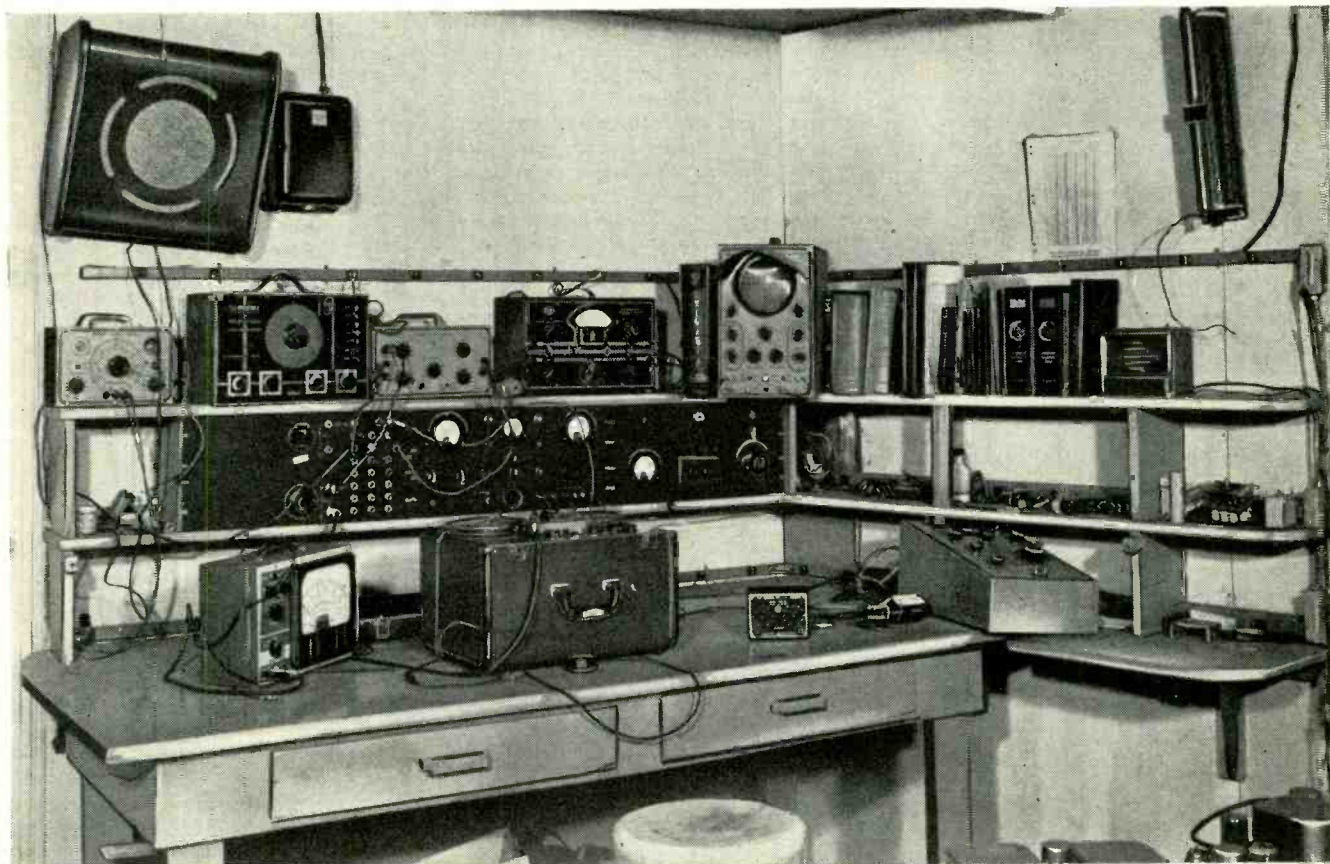

This "problem bench" is used for work on amplifiers and other equipment whose defects may require special skills or special audio testing equipment, or both.

the tuner, with particular attention to FM reception and quietness of phono preamplifier. We have found it very important that all work be rechecked by someone other than the man actually performing the work, to hold reworks to a minimum.

9. Set is disassembled by helper and placed on a finished work shelf to await pickup by customer.

**Billing and customer's check**

The completed worksheet (see specimen) initialed by the service technician and by the supervisor who passed the repair, is then used to prepare an itemized typewritten bill for the customer's information, showing all repairs and adjustments made and parts replaced, and on which our guarantee is clearly printed. The invoice number is recorded on the worksheet, in case any later cross-check must be made.

Wherever possible, we try to have the customer listen to his equipment in operation before it leaves our shop. This may forestall recriminations where customer has difficulty reinstalling his apparatus. To prevent this last check from being too time-consuming, we have equipped our front counter very much as the individual service benches—with amplifier, tuner, phonograph, bass-reflex-mounted speaker, and FM antenna. The customer can then, within reasonable limitations, listen to his equipment as it will sound in his home.

**Guarantee, records**

The standard guarantee clause printed on our invoice reads: "We warrant all our workmanship and material to be free from defects under normal use and service. Our obligation is limited to repairing or exchanging any defective parts returned, within 90 days, transportation prepaid. The warranty is void on any unit which has been tampered with or subjected to misuse, negligence, or accident."

On equipment which we have completely overhauled we make no further charge for labor in the event of failure during the warranty period, but if the failure requires additional parts they are charged for. Where a limited repair has been made, only the parts and labor for which we have been paid are guaranteed.

Each piece of equipment entering our shop for service is written up on the prenumbered service sheet and marked with a self-adhesive label indicating customer's name and worksheet number. The customer receives a printed receipt on which the worksheet number is written.

The worksheet is a letter-size form containing spaces for all information concerning the equipment and for subsequent billing. All work done, time spent, and parts used are recorded by the service technician on the body of this form.

The completed worksheet is filed alphabetically by customer's name, and if the unit returns at a later date for

additional work, the old and new sheets are stapled together so we have a complete case history.

**Outside service**

Outside calls are a much greater problem than repairs made in the shop:

1. Only an unusually well-qualified man can be sent into the customer's home. He must be familiar with all components that may be found in a hi-fi installation, including tape recorders, record changers, and TV sets, which are often part of a combined installation. Obviously, it is not practicable to send a different specialist to repair each item of the owner's setup.

2. Repairs must be made without the assistance of adequate test equipment—solely by the relatively crude methods of voltage and resistance readings and tube substitution.

3. When the repair is finally completed, the service technician often must convince the customer that his equipment is actually operating as its manufacturer intended. His success in this

will depend to a very large extent on his intimate knowledge of hi-fi systems.

4. The cost of outside work is always very much more than that of a similar shop repair because the time lost in travel and the cost of making good on warranty repairs must be included in the repair charges.

5. Intermittent troubles can cause repeated callbacks, with corresponding loss of customer good-will and of working time that cannot generally be charged for.

For these reasons, we attempt to avoid outside calls (except to repair obvious installation defects). We either have the customer bring the equipment in to us or have a helper pick it up.

For all its complexities and annoyances, hi-fi servicing is in fact one of the most rewarding tasks that a well-trained service technician can work at. The equipment is soundly engineered, made of the finest components, and at its best can reproduce sounds with a realism that can be a genuine source of pride to the technician. END

Sigma Electric Co. 11 EAST 16th STREET NEW YORK CITY

ORD. No.	REF.	WARRANTY	DATE 4-9-54
CUSTOMER		EQPT.	
MR. JOHN DOE		RADIO CRAFTSMEN TUNER	
ADDRESS 854 W 57 ST.		MODEL RC-10	
NEW YORK, N.Y.		SERIAL NO J308762	
PHONE HY 7-6943			
COMPLAINT			
1. NOISE ON AM			
2. FM NOT CLEAR, DIFFICULT TO TUNE, DOES NOT GET STATIONS THAT USED TO COME IN			
3. PHONO NOISY			
SVCE CALL <input type="checkbox"/>		C. P. U. <input checked="" type="checkbox"/>	SHIP VIA
		PROMISED 4-16-54	
REPAIRS	LAB. HRS.	MATERIAL	CHARGE
CHECKED TUBES	MM. 1/4	6CB6	
CHECKED PERFORMANCE		12AT7	
FM N/G		6AU6	
PHONO PREAMP TUBE N/G.		6AU6	
AM SEEMS OK	L.L. 1/4	12AX7	
ALIGNED COMPLETELY AM-FM		6X5	
FM DISC. WAY OFF			
CHECKED OUT			
FM, AM, PHONO -OK.	1 1/2		
PARTS			
NET			
TAX			
LABOR		2	
TOTAL			
OPEN <input type="checkbox"/>	PD. CASH <input type="checkbox"/>	PD. CHECK <input type="checkbox"/>	
BILL TO			
REP. BY L.L.	APP'D. W.	DATE 4/15	RATE
INV. NO. 83964	INV. BY M	WARRANTY	
REC. BY	DATE		
REMARKS:			
HOLD FOR REPAIR - OK			

No 7595

Specimen worksheet carries complete case history of repair job.

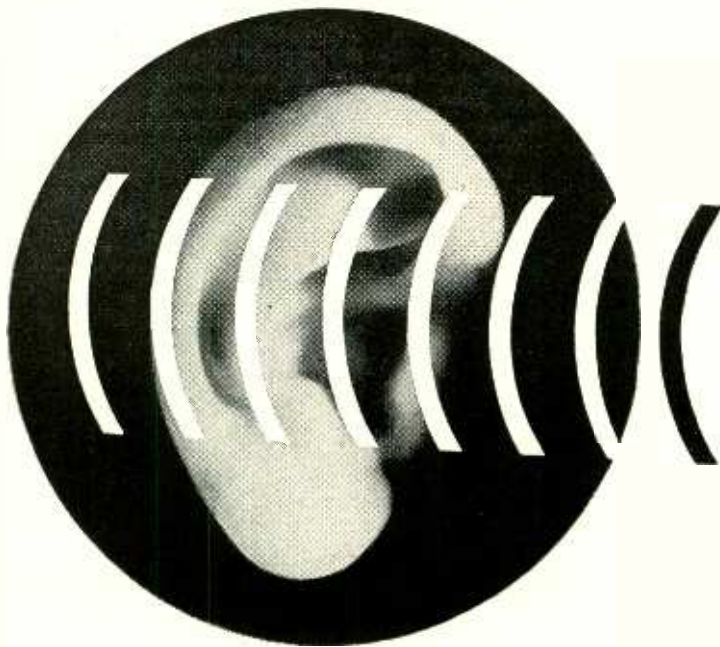

# TUNING ELECTRONIC ORGANS

*A complete repair job on an electronic organ includes tuning*

By RICHARD H. DORF

IT MAY seem that an article on tuning musical instruments ought to appear in a music magazine. But it appears in an electronics magazine instead because electronic engineers, technicians, and hobbyists need it the most. These are the people who design, build, and service electronic musical instruments but who do not have the training to tune the instruments they work on. There is certainly nothing to be ashamed of in that, for most professional musicians do not know how to tune their instruments either, especially pianists and organists.

A great many electronic organs and neo-organs are in the hands of the public today—Baldwins, Minshalls, Low-

reys, Consonatas, Wurlitzers, Allens, and so on. Articles on building organs and organ-like instruments, such as my recent series, spark construction projects. But when the builder is finished, he is often forced to try to tune by zero-beating each note with a piano. Even when the piano is itself in good tune (which is less often than most people think), beating organ tones with it is no easy job. When, as is usual, there is no piano handy, the normal situation finds neither the repair technician nor the organist able to tune the instrument and put it back into service. This is especially true after a period long enough to cause oscillators to drift.

This article, with the accompanying

specially computed Tuning Table, will make a good enough electronic organ tuner out of anyone who is not absolutely tone deaf. All that is necessary is a little care.

These instructions are applicable to any electronic organ. The types which use 12 master oscillators, with all lower octaves locked in to them are easiest and quickest, since only 12 notes need to be tuned. However, organs with separate oscillators, such as the Consonata, Allen, and Wurlitzer, can also be tuned.

## Hearing beats

The first step is to understand and hear *beat notes*. To do this quickly, hold down middle C and the G directly above it by putting a pair of C-clamps on the keys or having an assistant do the holding. Pull a stop or tonal combination without too much harmonic content, such as a flute or diapason, not a reed or string tone. Slowly vary the tuning of either note. Notice that at just one setting only, the two notes are heard. Varying frequency slightly up or down will cause a sort of pulsation, beginning at zero frequency and continuing to a rate faster than can be counted, as raising or lowering of frequency is continued.

If the beginner has difficulty noting this by ear, do the same thing, but this time place the vertical input of an oscilloscope across the audio output of the organ. Bring the horizontal gain down to zero and open the vertical gain control enough to get a vertical line of good size when the notes are sounding. Now notice that as tuning is varied the height of the line on the scope screen will vary at a rate depending on how the frequency of either note is set. Listen carefully at the same time and you cannot fail to note the pulsations that coincide with the variations in the line height.

TUNING TABLE

Tune	Sound	Beat Freq.	Beats in 10 sec.	Should be	Will be	Error
A	A	0	Zero-beat with tuning fork at 440 c.p.s.			0
E	A & E	1.5 c.p.s.	15	329.628 c.p.s.	329.625 c.p.s.	.0009%
B	E & B	1.1 c.p.s.	11	493.883 c.p.s.	493.888 c.p.s.	.001%
F#	B & F#	1.7 c.p.s.	17	369.994 c.p.s.	369.991 c.p.s.	.0008%
C#	F# & C#	1.2 c.p.s.	12	277.183 c.p.s.	277.193 c.p.s.	.004%
G#	C# & G#	1.0 c.p.s.	10	415.305 c.p.s.	415.290 c.p.s.	.004%
D#	G# & D#	1.4 c.p.s.	14	311.127 c.p.s.	311.118 c.p.s.	.003%
A#	D# & A#	1.0 c.p.s.	10	466.164 c.p.s.	466.177 c.p.s.	.003%
F	A# & F	1.6 c.p.s.	16	349.228 c.p.s.	349.233 c.p.s.	.001%
C	F & C	1.2 c.p.s.	12	261.626 c.p.s.	261.625 c.p.s.	.0004%
G	C & G	0.9 c.p.s.	9	391.995 c.p.s.	391.988 c.p.s.	.002%
D	G & D	1.3 c.p.s.	13	293.665 c.p.s.	293.666 c.p.s.	.0003%
A*	D & A	1.0 c.p.s.	10	440.000 c.p.s.	439.999 c.p.s.	.0002%

## NOTES:

Strike only notes between middle C and B just above it.

Final A\* is for checking only. Do not retune it. Look for errors in preceding notes.



These pulsations are the *beats* between the third harmonic of the C and the second harmonic of the G. Because of the way our "well-tempered" scale is constructed these harmonics must not coincide; the second harmonic of the G (783.991 c.p.s.) must be about 0.9 cycle-per-second less than the third harmonic of the C (784.878 c.p.s.). We can achieve this (assuming the C has first been tuned to the correct frequency) by first tuning for zero-beat, then *lowering* the frequency of the G until we hear the 0.9-cycle beat. We can check the beat frequency by counting to see that there are 9 beats in 10 seconds. When this has been done, we have tuned the G.

The Tuning Table gives all the necessary information for tuning each of the 12 notes between middle C and the B just above it. Two additional pieces of equipment are needed (discard the oscilloscope after using it to instruct yourself in listening to beats). These are a 440-cycle tuning fork, available for a couple of dollars at any store selling musical instruments, and a watch with a second hand. A big sweep hand is desirable and a stopwatch with 1 revolution per 10 seconds is especially good.

First practice with the tuning fork for a minute. Hold it by the handle, as

far to the end as possible. Strike the end of one tine sharply against a piece of wood and find the position near your ear where you can hear the tone best.

### Tuning the organ

In the following tuning procedure, sound only the notes between middle C and the B just above it. When A and E are called for, for instance, sound the A above middle C and the E below the A, in the same octave.

Now refer to the table. First tune the A. Hold down the A key and strike the tuning fork. Tune the A both up and down, noting the beat pulsations in each case. Then choose the setting just in the middle, where no beat is heard. The A should now be at 440 cycles. Check it again in a minute or two just to make sure the instrument has warmed up enough to stop drifting.

Next, tune the E. Sound both A and E continuously. Adjust the tuning of the E *only* for zero beat. Now very carefully *lower* the frequency of the E until there are 1.5 beat pulsations per second. Check this with the watch by counting the number of beats in 10 seconds. There should be 15. If there are more, you have lowered frequency too much, so raise it very slightly and count again. If there are fewer than 15 beats in 10 seconds, you must lower the

frequency more.

Now the B and the other notes are tuned in just the same way. In each case the steps are as follows:

1. Hold down the two notes given in the "Sound" column.
2. Tune the oscillator of the note in the "Tune" column for zero-beat.
3. Lower the frequency of this note until there are as many beats as shown in 10 seconds.
4. Do not again touch the tuning of this note.

The reason for step 2 is that a similar beat can be obtained when the frequency is high. In each case the second or fourth harmonic of the note tuned must be *lower* in frequency than the third harmonic of the other note.

This is basically the same system of progressive tuning used by professional tuners. If precisely done, it is actually subject to somewhat less error than when tuning is done by an average tuner, since the latter uses no watch and relies on his memory and feeling for identification of the beat rate. A really good tuner can do as well as with the counting method. In any case, as the "Error" column shows, the maximum error is only .004%, which no ear can detect. The actual error will be greater because of human fallibility and oscillator instability. **END**

## VISUAL VOLUME INDICATOR AIDS HARD-OF-HEARING CHILDREN

A new electronic device called a visual volume indicator has been developed to assist hard-of-hearing children in learning proper speech habits. Normally, the development of hard-of-hearing children is limited by hearing defects, difficult speech, and a sharply limited vocabulary. Since hearing is not clear, their speech is usually too loud or too soft.

The visual volume indicator is a device which causes lights to blink and follow the rhythm and volume of sounds picked up by a microphone. The student hears these sounds through headphones and watches the blinking lights on a panel. Thus, by imitating the teacher and making the light patterns correspond to hers, the student learns proper speech patterns, accentuation of syllables, breath control, and rhythm.

The device was developed by Ra-Tone Electronic Co., Phoenix, Arizona, at the

request of Mr. George L. Campbell, executive director of the Maricopa County Society for Crippled Children. A block diagram is shown in Fig. 1 and the schematic in Fig. 2.

The amplifier is a modified Stromberg-Carlson AU-34. Speech is picked up by a crystal microphone (Astatic 200-S) and, after amplification, is fed to a selenium rectifier and filter circuit connected across the 250-ohm output tap on the amplifier. The anode side of the rectifier is biased 22.5 volts positive by returning the common end of the output winding to ground through the cathode resistor for the output stage. This prevents the rectifier from conducting until positive peaks of the signal voltage exceed 22.5 volts.

The output of the rectifier is filtered and fed to the paralleled coils of nine 12-volt telephone-type d.c. relays with 2,500-ohm coils. There is a 10,000-ohm

potentiometer in series with each relay coil so the successive relays can be adjusted to close as the volume level increases in 3-5-db steps.

The normally open s.p.s.t. contacts of the 12-volt relays are placed in series with the coils of 115-volt telephone-type a.c. relays that control the indicator lamps. A nine-position s.p.s.t. switch is connected to the 115-volt relay coils so that when the switch is closed each locks in through its own contacts when its coil is first energized through the contacts of the corresponding d.c. relay. Thus, instead of flickering, each lamp can be made to stay on until the circuit is opened manually. **THE END**

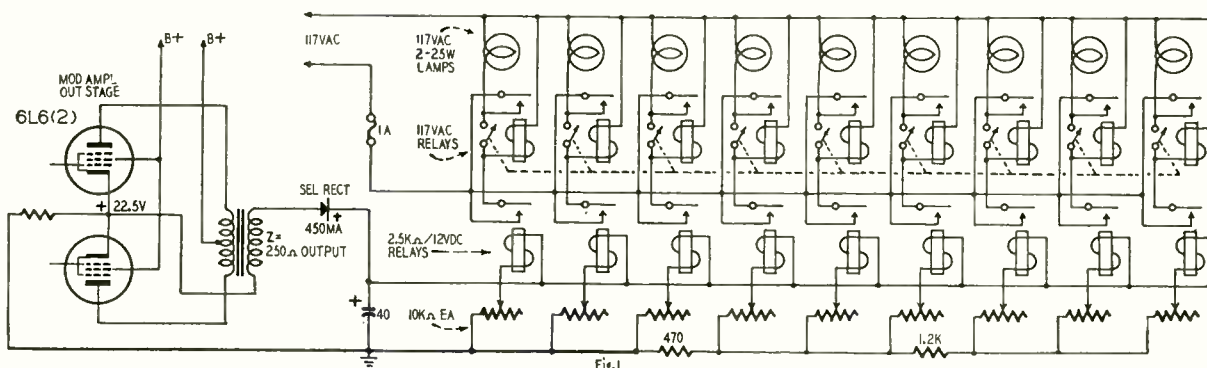

Fig. 1

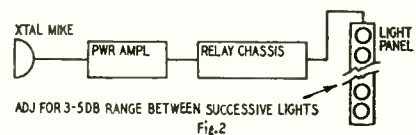

Fig. 2

# K HIGH-FIDELITY LOUDSPEAKERS

By H. A. HARTLEY\*

## Part III—Horns and multiple-unit speaker systems

THE prime object in fitting a horn to a speaker is to increase its electro-acoustic efficiency. A horn increases the acoustical loading on the diaphragm and requires less movement of the diaphragm for a given acoustical output. Thus nonlinear distortion is reduced, and a smaller amplifier can be used. However, these benefits are not obtained without cost. Horn speakers have defects not found in direct radiators. In horn speakers the horn is the housing or cabinet and cannot be considered apart from the unit. Certain types of folded horns and corner horns are offered for sale to be used with direct radiators; this appli-

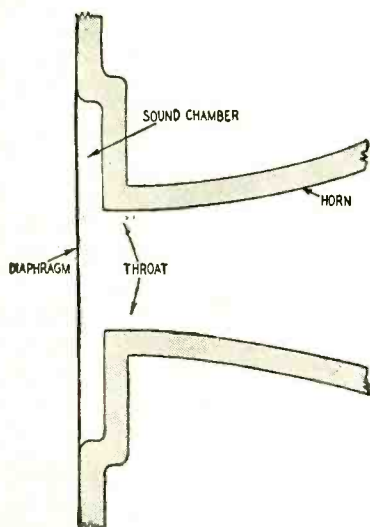

Fig. 1—The diagram shows a simple sound chamber in horn-loaded speaker.

cation will be considered in the section dealing with enclosures.

The performance of a horn-loaded speaker is determined not only by the shape of the horn but also by its length. The most efficient shape is one showing a true exponential increase; formulas and calculations can be found in any radio engineering handbook. If the horn is circular it can be spun out of metal or molded from papier-maché, but when the horn is long the circular shape becomes too unwieldy to make. Measure-

ment shows there is little difference in performance between a circular and a square horn, and if square, it can be made out of fairly thin wood. Unfortunately both metal and thin wood resonate strongly, and a wooden horn should be well glued and taped at the corners, strongly braced at fairly short intervals, and the intervening panels should be damped by cementing thick felt all over the exterior surfaces. The inside of the horn should be as smooth as possible to reduce air friction. Horns of rectangular section seem to set up undesirable reflections within the body of the contained air.

To give good bass reproduction the horn must be long (the Swiss alpenhorns run to over 16 feet). This is seen in the bass brass instruments of an orchestra, such as the tuba and sousaphone. For compactness these long horns have a twisted form and are carefully calculated. Similar long folded horns are found in the better theater installations. A horn to reproduce a 50-cycle note needs to be about 22 feet long with a flare circumference of about 24 feet. Such a horn is difficult to accommodate in an ordinary apartment, folded or straight.

More recent work has shown that the hyperbolic exponential horn can be shorter than the ordinary exponential type for a given bass cutoff, but the flare must be as large, and lower frequencies than this cannot be reproduced without distortion unless the back of the speaker works into an enclosed air chamber which provides a capacitive reactance equal to and replacing the inductive reactance of the horn when it ceases to be effective. An example of this is the Klipsch speaker, and the calculations must be made with an exact idea of the effect desired. Any old speaker mounted in something resembling a Klipsch enclosure will not produce a high-fidelity woofer.

### The throat problem

It has been stated many times that large throats are necessary for good bass reproduction and small ones for good treble. Without qualification this statement is not necessarily correct. If

the throat (the small end of the horn) is designed to suit the driving unit, then it can be small for good bass if the horn is long enough. In domestic installations, however, the long horn is ruled out, and, as an exponential horn increases very gradually in cross-section in the course of the first few feet, this part of the horn can be removed if the driving unit is large enough to cover the enlarged throat. Such a truncated assembly is not efficient for high frequencies, whereas a small driver working into a small throat is. The statement above therefore is true only if the listening conditions are such that a long horn cannot be used. One long horn speaker can reproduce a wide range of frequencies, but if a long horn cannot be used, separate bass and treble speakers are necessary for reasonable efficiency.

Some speakers have the throat area the same as the diaphragm, but better acoustical loading is obtained by having a smaller throat (Fig. 1). The space between the diaphragm and the throat is called the sound chamber. The mere presence of the sound chamber will cause distortion, which increases with lower frequencies. In the interests of good fidelity it is therefore desirable not to use a sound chamber for a low-frequency horn speaker even if some efficiency is sacrificed. For a horn-loaded tweeter the sound chamber must be designed with some care. To avoid distortion all parts of the diaphragm should be equally distant from the throat opening (Fig. 2). If the diaphragm is flat this is impossible. However, if the diaphragm is made concave and the sound chamber conical, the condition can be met.

Tweeter diaphragms can be small and there is a temptation to use thin, light aluminum which can easily be spun to the desired shape. Earlier remarks on coloration of the reproduction by metallic diaphragms should be borne in mind, and for best results the diaphragm should be molded from some relatively inert material.

A simple horn on a tweeter focuses the highs acutely. This can be overcome to some degree by using several

\* H. A. Hartley Co., Inc.

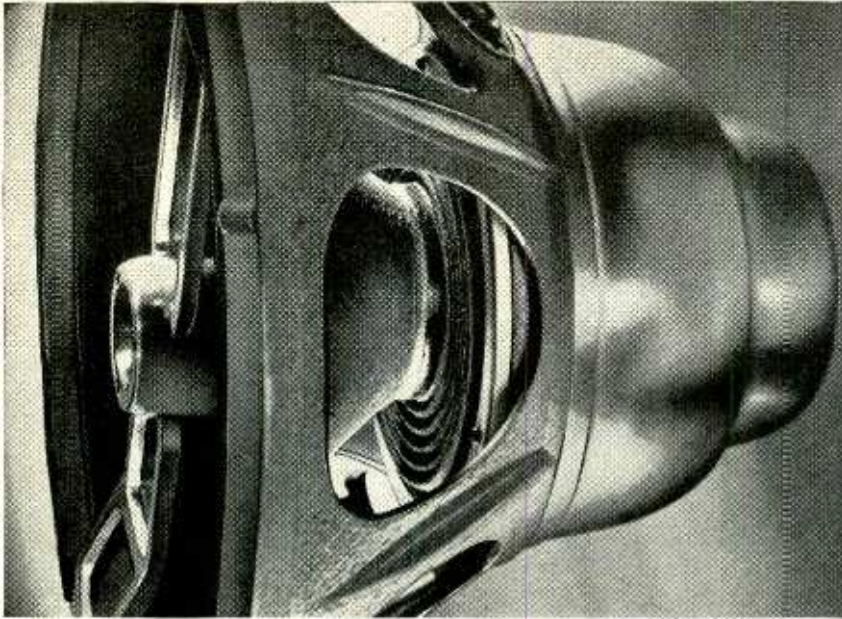

horns driven by the one unit, by a multicellular horn, or by a diffusion lens. The latter has been reported as increasing the cone of propagation from 20° to over 50° at a frequency of 8,000 c.p.s., a substantial enough increase—but not impressive in view of the fact that a direct radiator can show a spread of 160° at the same frequency.

The design features to be looked for in horn speakers include many of those listed under direct radiators if ordinary diaphragm types are used as driving units. Because of the better loading of the horn the speaker does not need to be driven so hard, but distortion due to nodding, cone material, insufficiently free suspension, and nonlinear suspension all apply, particularly in a bass speaker. The horn should not add any coloration to the reproduction, and as a counsel of perfection it should be made of brick or concrete, with a smooth internal finish. If made of some more convenient material it must be strongly braced, and deadened by the application of absorbent material, and attention must be paid to the smoothness of the inside, particularly in the corners. Folded horns, when made up of screens and internal baffle plates, should have all edges well rounded and all corners filled with plastic wood or putty, to provide a smooth transition from one plane to another. Sharp corners cause reflection of the sound waves, introducing harmonic distortion. Tweeter horns should be nonmetallic and designed to give good forward radiation. Also the tweeter diaphragm should be nonmetallic and concave.

### Multiple-unit systems

My somewhat lengthy discussion of direct-radiator speakers supplemented by notes on horn speakers makes the approach to the modern multiple speaker a fairly simple matter, since these two types of units are used almost exclusively, the exceptions being those using a ribbon type of tweeter. The advantages and disadvantages of

both types are inherent in multiple systems which have peculiarities of their own. These special points call for separate treatment.

It is somewhat difficult to decide whether multiple speakers created a demand for high-fidelity reproduction (involving better records, pickups, and amplifiers) or whether high fidelity created a demand for better speakers. The hoariest cliché in audio is that the speaker is the weakest link in the chain, but as a speaker designer myself I insist that it need not be so. It is really a question of an aesthetic approach to the problem. I may be accused of undue partisanship toward my own ideas on the subject, but this I shall try to avoid. I said earlier that, so far as I knew, I produced the first tweeter-woofer combination, back in 1929, and subsequently discontinued it because I didn't like it. I freely admit that the tweeter-woofers of today are far better than my pioneer efforts, but to me they still contain something which I didn't like in 1930 and don't like today. What that something is I will explain. You can then disregard my personal likes or dislikes and form your opinion from the facts.

The development of multiple-speaker systems has come about because the ordinary single unit has limitations, particularly in the way of frequency response. In the case of direct radiators I have shown that the mass of a large diaphragm restricts its output of high frequencies, yet a large diaphragm seems necessary for adequate power-handling capacity in the bass. On the other hand, a small diaphragm can give good treble response, but will be hopelessly overloaded by large bass inputs because the cone cannot move sufficiently freely. It seems obvious that the way out of the dilemma should be to have a small speaker for the treble and a large one for the bass. Clearly, the bass must be kept out of the treble speaker, to prevent damage and distortion, and the treble must be kept out

Jensen's model G-610 system consists of 3 independently driven reproducing elements and a crossover network.

the unreproduced power at high frequencies. These functions are carried out by the crossover network.

If the system is to work properly the two speakers should have identical inherent acoustical characteristics. The perfect speaker would have no individuality, but no speakers are perfect, and each has its own characteristic. Therefore, apart from frequency response, the tweeter output should have the same sort of quality as that of the woofer, and this requires that if the woofer is a baffle-mounted cone speaker then the tweeter also should be a baffle speaker, with a cone having the same material characteristics as the woofer. It may be argued that distortion due to cone material would show up on the response curve, but this I do not believe. No speaker response curve is a smooth line; it is full of tiny peaks and valleys, and it is impossible to say which of these is due to cone material. But a trained musical ear can detect coloration, and using the same cone material for tweeter and woofer is the safe way out.

There must be a frequency overlap in the two speakers, each extending at least half an octave into the range of the other as a minimum; the amount of overlap depends on the design of the frequency-dividing network. Above and below the crossover frequency both speakers will be working within a minimum limit of an octave, and phase distortion will occur because the speakers themselves will not be in phase and because there will be phase shift in the dividing network. This will cause pronounced peaks and dips in the response curve. Moreover, if the speakers are not coaxial the listener may be at different distances from the two speakers and this will cause further phase distortion. The distortion due to the frequency overlap will be reduced with lower crossover frequency, but this may be so low that the tweeter unit cannot

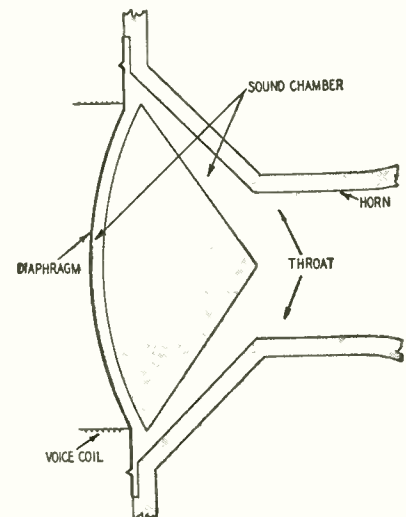
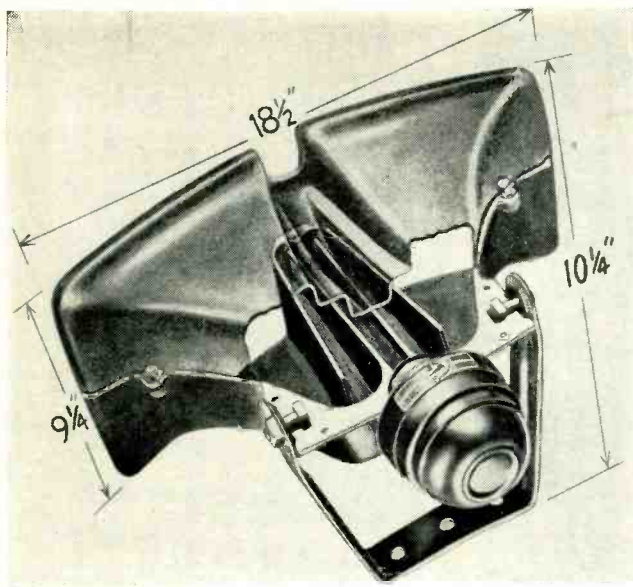

Fig. 2—All parts of the concave diaphragm are equidistant from the throat.



A cutaway view of a heavy-duty wide-angle high-frequency folding horn, the University Cobreflex.

handle it; in such case there is no alternative except to include a third or middle range speaker, and that will require a three-channel dividing network.

Phase distortion can occur in transient reproduction. Generally the woofer has a large cone, so that it can handle the bass with ease. But I have shown that a large cone will cause phase shift of the low-frequency components of a transient through wave-motion in the cone itself. The mass of a large cone also prevents its instantaneous reaction to a transient pulse. In a dual system the tweeter has much better "attack" than the woofer, because the moving part is small and light. This means that when a transient is reproduced by a dual speaker the higher harmonics will be propagated by the tweeter sooner than the lower harmonics and fundamental through the woofer, and the higher components will decay sooner than the lower components.

Actually this phenomenon occurs with all types of complex waves but is particularly noticeable with transients and cannot be overcome in a multi-channel system. A very good speaker must have excellent attack, a property rarely mentioned in speaker specifications. I am not sure what one can say of a speaker system that has good attack over part of the frequency range and not in the rest.

As mentioned, coaxial units are desirable if only to maintain equal distances of the parts from the listener's

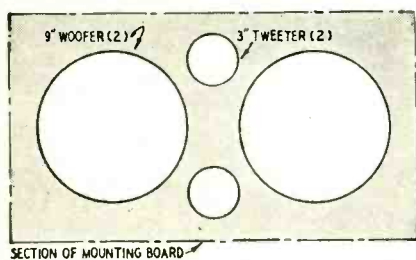

Fig. 3—Speaker array avoids the disadvantage of using a large woofer cone.

ear; they are also desirable because the sound is better mixed over the whole frequency range. Coaxial direct radiators can be made, but this calls for rather delicate design of the magnet system. On the other hand, if the separate magnet system is located behind the main magnet, the woofer center-pole can be bored out to provide the throat and first few inches of the tweeter horn. This horn can then be extended in a flared projection, and the familiar woofer-cone tweeter-horn speaker results. But this combination is difficult to match acoustically, so the advantages of a coaxial system are somewhat neutralized.

Combined speakers having a horn tweeter and a cone woofer mounted in a so-called infinite baffle, or in a bass-reflex or acoustic-labyrinth cabinet, lose the benefits of coaxiality while retaining the disadvantages of differing types of speakers. It seems to me that such designs display a lack of appreciation of what is involved in designing a true high-fidelity speaker. A tweeter-woofer combination is not by its very nature high fidelity; it must be made so.

If a horn tweeter is used, then it is only rational to use a horn-loaded woofer, and the better designs do this. Horn-loading the woofer gets rid of some of the disadvantages of using large cones and certainly reduces non-linear distortion; but there is a dangerous trap in such an arrangement which a slipshod designer may completely overlook. If the bass horn is folded, the acoustical paths of the air in tweeter and woofer are very different.

At the crossover frequency there will be a considerable departure from amplitude linearity, giving rise to harsh and edgy reproduction. With a direct radiator system the dividing network rolloff of the two channels can be as gentle as 6 db per octave. But the irregularities in the response of a two-channel horn system can be brought within reasonable limits only by having

a much sharper rolloff, perhaps as much as 18 db per octave, so that the overlap is made as narrow as possible. It follows that the separate speaker units must be designed so that they do truly cover their respective frequency ranges without distortion.

Finally, all multiple-speaker systems using networks have an uncertain impedance value at crossover frequency. Even at other frequencies the impedance varies widely because of the presence of inductors and capacitors in the network, but at crossover frequency conditions are very complicated because of the partly reactive load. This mismatching is very serious in pentode and tetrode output stages, which require a fairly close approximation to their ideal load. In a carefully designed system beam-power tetrodes properly operated can give at least as good results as triodes and sometimes even better, but it is advisable to stick to triodes with multiple-speaker systems.

Those, then, are the facts, and it may be gathered that I am not very partial to the tweeter-woofer idea—I said that at the beginning of this article. Yet I maintain that the idea is fundamentally a good one, and, apart from the last-mentioned impedance complication, all difficulties can be swept away by making a very simple decision.

If it is possible to make a single speaker to cover the whole frequency range—and I believe it is—then the disadvantage of not having a large cone is overcome by using several small speakers of identical characteristics. The size of a baffle determines the bass response of the speaker, but even if mounted in a large wall, a small speaker cannot move enough air to give adequate bass in a very large room or auditorium. Two or more speakers, wired in series or parallel, will give all the bass needed, while offering the advantage of a large frontal presentation. On the other hand if it is categorically denied that a single speaker will cover the whole range, the desired goal can be reached simply and satisfactorily by using a divided system, the bass unit consisting of two or more 8- or 9-inch speakers, and the treble unit of one or two 3- or 4-inch speakers *designed on exactly the same lines and of exactly the same materials*, the whole being arranged in a compact array, so that the bass and treble are well mixed at source (Fig. 3). For purposes of housing design, the array can be considered one large speaker.

It may well be asked why no one ever thought of this before. Actually it has been thought of over and over again. Many current designs of systems can be shown to have a valid genealogical descent from certain basic assumptions, but you have no guarantee that those original assumptions were correct.

A speaker depends on its mounting. Therefore we will consider loud speaker mountings, enclosures and cabinets in the next installment.

(TO BE CONTINUED IN AUGUST ISSUE)

RADIO-ELECTRONICS

# HIGH-QUALITY AUDIO

By RICHARD H. DORF\*

## Part X—Circuits and characteristics of the increasingly popular cathode follower

VOLTAGE-AMPLIFIER stages, especially those which operate at fairly low levels, are responsible for some of the noise in an audio system. Much of this noise comes from what is known as *shot effect* and is caused by the impact of electrons striking the plate. Some of it of course comes from hum, but we will discuss that in a later article.

An easily eliminated source of noise is thermal, coming from temperature variations in the plate-load resistor. This noise can be eliminated by substituting a wire-wound resistor for the usual carbon-composition type. It is unnecessary to use the precision types with resistances correct to 2%; they are too expensive. Low-cost wire-wounds work just as well. Theoretically plate-load resistors should be noninductively wound, but in practice it is almost impossible to detect any bad effects from use of ordinary units.

\*Audio Consultant, New York City

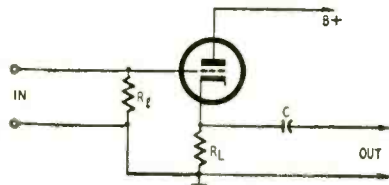

Fig. 1—The basic cathode follower.

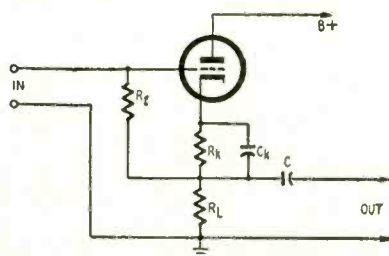

Fig. 2—Improved cathode follower.

Net distortion in voltage amplifiers depends on the B supply voltage, the impedance of the tube load, and the audio voltage level. It is interesting to notice a few typical distortion figures in the Radiotron Designer's Handbook, fourth edition, published by RCA. For a 6SJ7 operating at 250 supply volts with a plate-load resistor of 100,000 ohms, intermodulation at a 10-volt output level is 1% when the following grid resistor is 100,000 ohms and 0.8% when it is 400,000. With both resistors at 100,000 ohms, the IM is 1% at 10 volts output, 2.9% at 19 volts, and 12% at 37 volts. For home music systems these distortion figures are astronomical; yet the resistance-coupled amplifier tables in the tube manual list possible output for a stage like this at 72 volts peak, corresponding to slightly over 50 volts r.m.s. (the figures above are r.m.s.).

This points out the error in a common statement that distortion in voltage amplifiers is negligible. Naturally, it is very small when the tubes are used in preamplifiers because the voltage level is very low. Distortion rises to importance, however, in the first stage of a main amplifier where its input may be 1 volt and its output perhaps 10 to 12 if it is a triode. There is no doubt that the voltage amplifier in a central amplifier ought to be included in the nega-

tive feedback loop. And those preamplifiers which incorporate negative feedback with a frequency-selective loop for equalization have definite distortion-reducing advantages. Keep in mind that, when we are all through with the amplifier and preamplifier, the over-all distortion ought not to exceed 1% at ordinary listening levels. It often is much less. In the ordinary department-store radio-phonograph console, voltage amplifiers have been used to the utmost of their capabilities for gain and output; it is not surprising that even a moderately priced "high-fidelity" amplifier sounds so much better!

### Cathode followers

One more type of voltage "amplifier" ought to be covered here—the highly useful cathode follower. The word amplifier is in quotes because the cathode follower does not amplify. Cathode followers are being used more and more in high-quality equipment as sending-end impedance transformers for long lines, in phase splitters, as isolation networks, as drivers for power stages, and so on.

Fig. 1 shows the basic cathode-follower circuit. The input signal is applied to the grid, as with ordinary stages, but output is taken from an unbypassed cathode. The circuit has

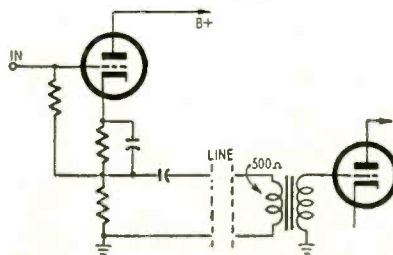

Fig. 3—Low-impedance termination.

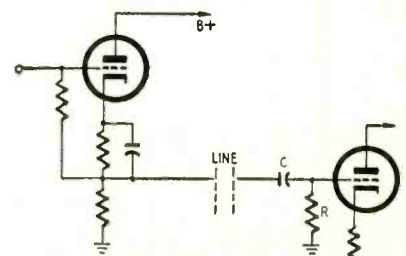

Fig. 4—Cathode-follower application.



McIntosh C104 equalizer-preamplifier uses cathode follower output.

many interesting aspects, but its chief reason for use in audio is that the output is at low impedance—300 to 600 ohms, ordinarily—so that the output signal may be run for some distance without much danger of hum or noise pickup. This same thing could be accomplished with a transformer, but the cathode follower is cheaper than a good-quality transformer and has no frequency discrimination over the audio range; in fact it is extensively used in video systems where smooth response from d.c. up to several megacycles is needed. The cathode follower also has an extremely high input impedance; it may be many times greater than for the same tube in another circuit. (This of course does not apply to circuits like Fig. 1, where the input is shunted by  $R_k$ .)

In Fig. 1,  $R_L$  acts both as load and cathode-bias resistors. The circuit in Fig. 2 is more versatile because a higher-value load resistor can be used, while the bias can be set separately. In Fig. 2,  $R_k$  is chosen as desired for bias, with  $C_k$  as the bypass capacitor.  $R_L$  is then chosen, higher values making for higher gain (actually smaller loss, since the output is always less than the input). Gains as high as 0.9 and more are possible, but never as much as 1.0.  $R_k$  is returned to the lower end of  $R_L$  so that the grid receives the correct bias. The signal, however, is applied between grid and ground.

The low impedance of the output is not due to a low-value cathode resistor (which may be as much as 10,000 ohms or more). It is due to the degeneration in the cathode circuit which results in two out-of-phase voltages, the resultant of which is a single low voltage. Let us assume for Fig. 1 that on one input alternation the grid is positive with respect to ground. This causes increased tube conduction, making the cathode go more positive because of increased current through  $R_k$ . But if the top of  $R_L$  is more positive, its bottom (ground) must be more negative with respect to cathode. This negativeness is applied to the grid through the grid resistor, and tends to cancel the positiveness of the input signal. For a given grid-driving voltage, therefore, the re-

sulting cathode output voltage is very low compared to the plate voltage of a conventional amplifier.

Since the net audio voltage appearing between cathode and ground is low—in fact, lower than the input signal—the impedance between cathode and ground is also very low. This is true no matter what the value of  $R_L$ . Thus,  $R_k$  may be considered as a resistance in shunt with the cathode-ground circuit, making the cathode-ground impedance equal to the parallel value of two resistances, one of which is the cathode circuit and the other  $R_L$ .

Therefore it follows that the lower the value of  $R_L$ , the lower the sending impedance of the cathode follower, simply because a source of perhaps 400 to 600 ohms (the cathode) is being shunted by a resistor. As is true when  $R_L$  is in the plate circuit, lower values mean lower gain and lower available output voltage for a given distortion percentage.

If the cathode follower is used like a transformer and is terminated with a low-impedance input (Fig. 3), two difficulties appear. First, the low-impedance termination is an additional impedance in shunt with the cathode resistance; this limits both gain and output to very low values, perhaps 0.5 volts or less, with substantial distortion even at this value. Second, the capacitor and transformer primary make up a high-pass filter, so that to pass low frequencies the capacitor must be perhaps 50 to 100  $\mu$ f. Electrolytics are not very suitable for this service (though they can be used). The difficulty of using cathode followers with low-impedance loads is primarily responsible for their scarcity in broadcast and recording systems.

Typical use of a cathode follower is shown in Fig. 4. Its output is connected directly to the grid of the following stage, with  $R$  being a standard high-resistance grid leak.  $C$  is chosen as it would be for a plate-loaded source, as discussed in last month's article. There is no need to terminate its output in its own impedance; in fact, as we have shown, that is undesirable. The low impedance of the line is maintained right up to the grid of the following stage.

Cathode followers are useful, not only for long-line sources—for instance between preamplifier or tuner and main amplifier—but also as low-impedance sources for equalizers and tone controls. These are dependent to some extent on source impedance, many operating ideally from zero-impedance sources. When correctly designed they are useful also as low-impedance sources for power stages which draw grid current and for which step-down transformers between driver and final ordinarily would be used. Some circuits even use cathode-follower output stages, with the output transformer primary in the cathode circuit rather than the plate circuit. The loss in voltage gain is not important in such cases because power is desired rather than voltage and the cathode follower can have power gain.

## Phase splitters

In practically every home music system the signal applied to the input of the main amplifier is single-ended; it consists of a single-wire-and-shield line with the signal between the wire and the grounded shield. The output stage of the amplifier is push-pull and requires two signals for its grids; the two signals must be identical but exactly opposite in phase. Phase splitters transform the single-ended input signal into push-pull phase-opposed signals.

Fig. 5 shows a phase splitter consisting of V1 and V2. V3 and V4 are the push-pull power-output tubes of the amplifier. This circuit is excellent for illustrating the basic function of a phase splitter. In practice, triodes V1 and V2 are usually contained in a single envelope.

The single-ended input signal is applied to the grid of V1, a triode voltage amplifier. Its output is coupled to the grid of V3. The grid leak resistor for V3 is composed of R2 and R3 connected in series.

V2 is another voltage amplifier which may be similar to V1 (it usually is). Its grid signal is taken from the junction of R2 and R3; this is a portion of the signal supplied by V1. The output of V2 is applied to the grid of V4 through C2. R5 is the grid leak for V4, usually equal to the series value of R2 and R3.

Two out-of-phase signals have been produced because the input signal has passed only through V1 to reach the grid of V3, but has passed through both V1 and V2 before reaching the grid of V4. Each tube inverts phase so that the same positive half-cycle of input signal on V1 that produced a negative half-cycle at V3 produces a positive half-cycle at V4. The values of R2 and R3 are adjusted so that the output of V2 is equal to that of V1; in other words, R2-R3 is simply a voltage divider.

The circuit of Fig. 5, while often used, has some defects when we are looking for the highest-quality results. Any voltage amplifier contributes some harmonic and intermodulation distortion and often has some frequency discrimination at the highs. Lows are affected by the coupling and cathode-bypass capacitors. In Fig. 5, the signal to V3 has gone through only one tube and one blocking capacitor; the signal to V4 has gone through two. It is therefore extremely likely that the signals on V3 and V4 will not be identical, especially at the extremes of the range. But the essence of distortion reduction in a push-pull power stage is cancellation between identical signals. If the signals are not identical, further distortion will be generated in the power stage.

There is no doubt that using low-gain circuitry for the splitter reduces unbalance to a minimum. The circuit is not considered ideal, however, and next month we shall investigate some more recent and better-designed phase splitters.

(TO BE CONTINUED)

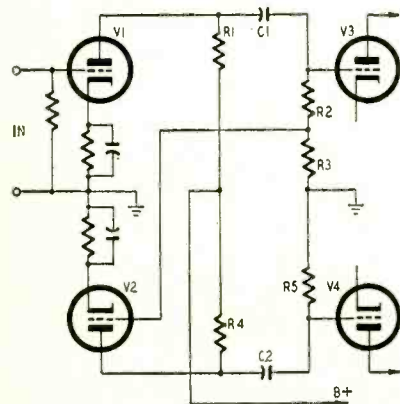
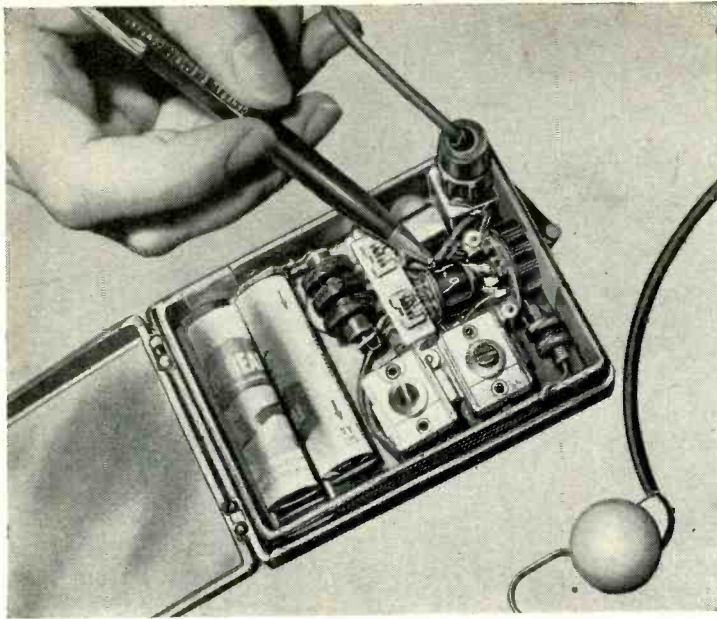
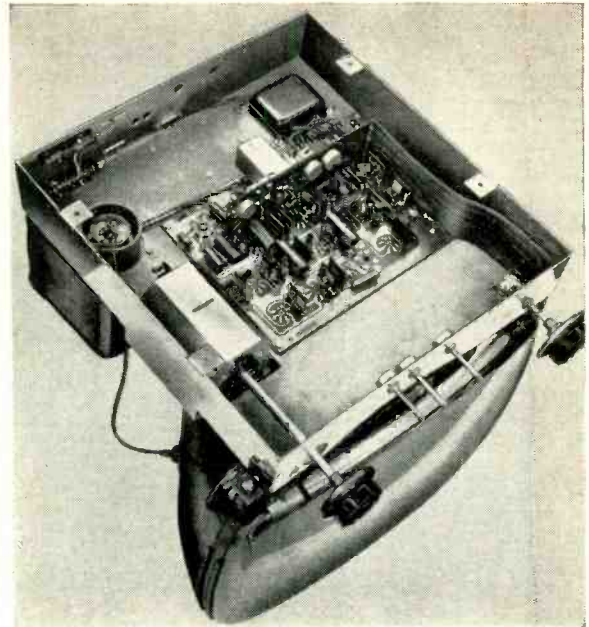

Fig. 5—Phase-splitter circuit.



Left—G-E's transistorized vest-pocket civil defense radio. Right—A TV receiver wired with Reliaplates.



# IRE SHOWS ELECTRONIC PROGRESS

By FRED SHUNAMAN

MANAGING EDITOR

THE 1954 convention of the Institute of Radio Engineers presented a story of steady progress rather than one of new discoveries and new departures like some conventions of the not distant past. There were new developments aplenty, ranging from little blowers scarce a cubic inch in dimension and minute variable capacitors of great stability—with cylindrical quartz dielectrics and plates of Invar metal—all the way to giant u.h.f. transmitting tubes. But new principles and new discoveries were by no means conspicuous.

Striking new developments of preceding years were matter-of-course at this convention and its accompanying exhibition of electronic equipment and parts. The transistor was treated as a standard component, and transistorized pieces of equipment—including an auto headlight dimmer—were on view in the most matter-of-fact manner. A transistorized portable receiver, as well as a vest-pocket type, were on view.

U.h.f. was another subject taken as a matter of course, and a transmitting tube designed for the requirements of color TV but equally suited for black-and-white was announced to have a power output of 12,000 watts at 900 mc.

Color TV was similarly treated, though in the domain of color TV tubes one had the sensation of skirting unexplored territory. Several as large as

21 inches were displayed (though it was rumored that they were not all guaranteed to work) and reports of even larger and more remarkable types were circulated. Several types of test equipment for color TV were also on display.

Sound has also settled down. Sound equipment appeared in larger quantities and with less fanfare than at any of the recent conventions. High fidelity was taken for granted; and an amplifier flat within 0.5 db from 0.5 cycle to 30 kilocycles attracted only a normal amount of attention. Among the interesting devices in the field of sound was an instantaneous spectrum analyzer exhibited by Raytheon. Composed of 420 narrow-band filters, it is especially useful in analyzing transients and noises of too short duration to be studied with ordinary spectrum analyzers.

Printed circuits and improved wiring methods were also in evidence, possibly the most striking being the "Reliaplate" system shown by Sanders Associates. Printed-circuit conductors, adhesive-tape resistors, and flat ceramic capacitors on small plates mounted at right angles to the chassis reduce the ordinary TV underchassis wiring jumble to almost unbelievable simplicity.

The important position conceded to ultrasonics was perhaps the most novel feature of the convention. A new type of intruder alarm was the prime

attention-getter in that field. The device—described by S. Bagno of the Alertronic Corporation—not only will detect anything moving in the area it protects, but is also an efficient fire alarm. The main components of the system are two ultrasonic transducer units. One is an ultrasonic transmitter sending out waves at approximately 19 kc; the other a magnetostriction pickup which detects these ultrasonic waves—as they

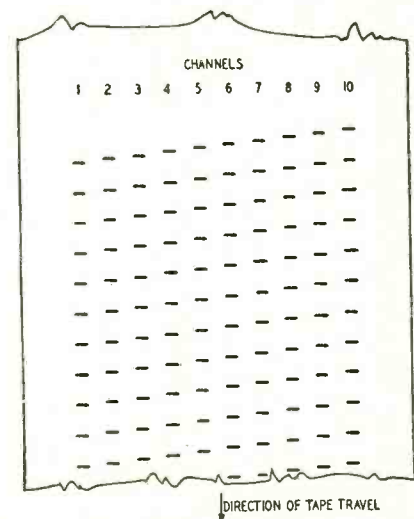
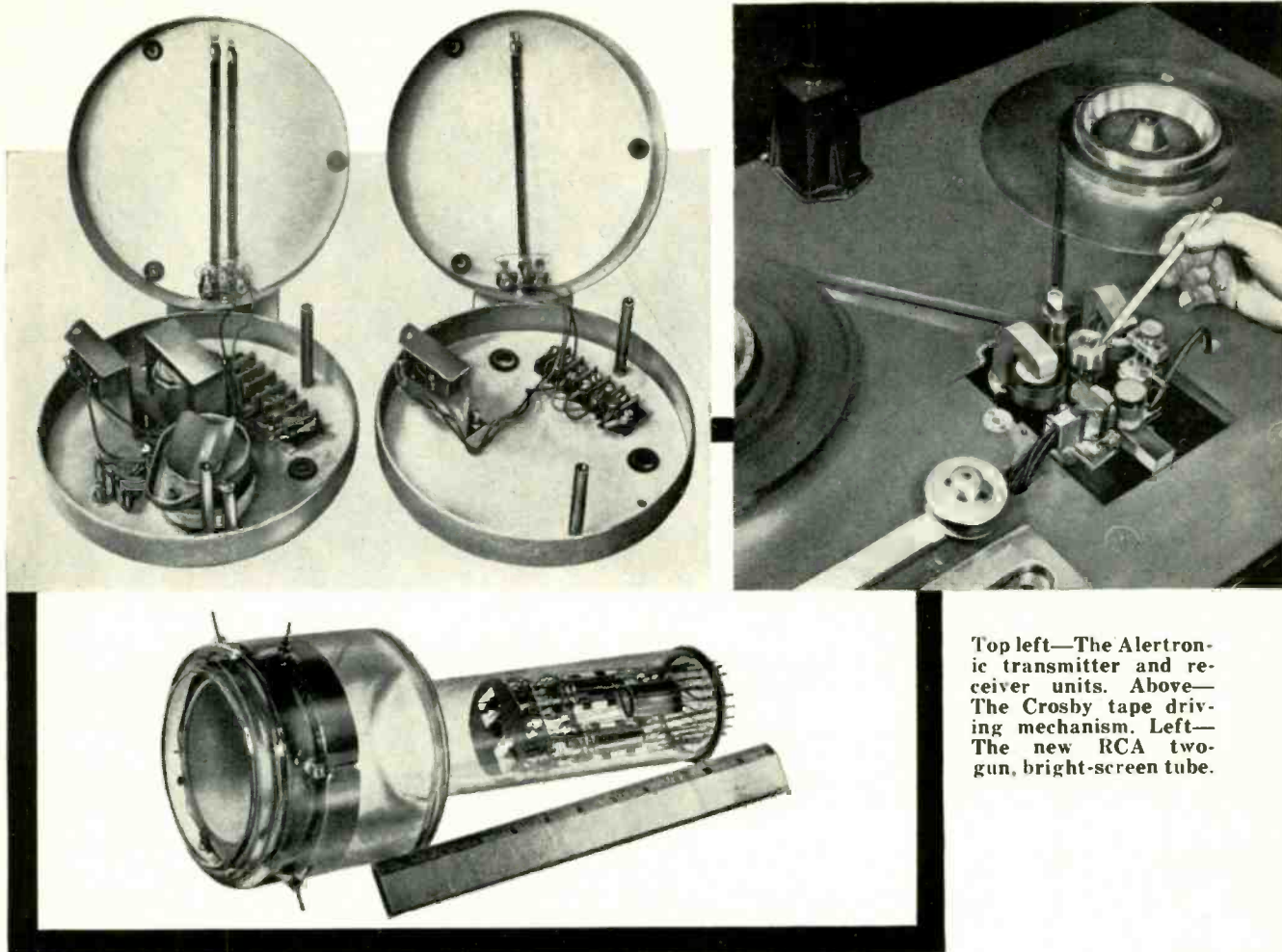

Fig. 1—Recording diagonal traces.



Top left—The Alertronic transmitter and receiver units. Above—The Crosby tape driving mechanism. Left—The new RCA two-gun, bright-screen tube.

bounce off objects in the protected area—and turns them back into electrical signals. If any object in the area moves, a Doppler effect is created and the pitch of the resulting signal changes. The receiving equipment notes the change and immediately sounds an alarm. Since columns of hot air from a fire also reflect these ultrasonic waves, movement of heated air from a fire also sets off the alarm.

Dr. P. Lindstrom, of the Veterans Administration Hospital of Pittsburgh, and others described biological applications of ultrasonics. By subjecting the brain to ultrasonic waves of moderate intensity, Dr. Lindstrom reported, results similar to those produced by frontal lobotomies or electrical or chemical shock could be achieved, without the danger and undesirable after-effects of lobotomy or shock. Dr. Fry of the University of Illinois described an ultrasonic "surgeon's knife" which could be used to destroy a small area of deep tissue without affecting the layers above it. This is done by focusing a number of ultrasonic beams to converge at the desired point. Only the tissue at the focal point is destroyed.

Large cancerous areas were destroyed by high-intensity ultrasonic vibrations, reported Earl H. Newcomer of the University of Connecticut. The experiments were performed on mice, and resulted in a high fatality rate, but indicated definitely that there is a wide field for

research in that direction.

X-ray pictures in color—described by Dr. Mackay of the University of California—were another contribution of electronics to biology and medicine. Different portions of the X-ray spectrum, said Dr. Mackay, vary in their penetration patterns. This difference often does not show up in the black-gray-white pictures taken by "white" X-rays. But if three negatives are taken—each with a definite portion of the X-ray spectrum—and printed in the three color primaries, the resulting color picture gives very fine indications of difference in tissue texture. The colors have no resemblance to the colors of the bones and tissues photographed, of course, but they vary according to their density. Therefore unhealthy tissue which differs so slightly from surrounding healthy tissue as to be practically indistinguishable in a black-and-white X-ray may show up in a clearly visible different shade in the color X-ray picture.

Video tape recording—both the RCA and Bing Crosby types—were described completely at the convention. Dr. Harry F. Olson explained the RCA system, which had already been demonstrated at Princeton last December. The less familiar Crosby system was discussed by J. T. Mullin. Unlike the continuous recording technique of RCA, the Crosby method uses a sampling approach, which makes it possible to scan across

the tape, in effect.

There are 10 video channels (plus a sound and a sync channel) on the half-inch tape. Three very short (0.15  $\mu$ sec) samples are taken every microsecond. The first of these is recorded in channel 1, the second in channel 2, and so on till the tenth sample has been taken. Now the tape has moved far enough ahead to permit another sample to be recorded in channel 1. Thus a large number of diagonal traces is recorded (as seen in the simplified diagram, Fig. 1). This method of recording makes it possible to run the tape at moderate speed (100 inches per second) and to record more than 15 minutes on a single reel of tape.

A radar tube developed by RCA for use in bright light introduced a new principle. Two guns are used to produce a very bright image. One gun produces a "flood" of electrons which sweeps toward the screen, but is held back by a grid just before it, except in those portions swept by the beam from a second "writing" gun which produces the desired pattern. The action is actually modulation of the "flood" of electrons by the writing beam. The phosphor persistence is long—images remain on the screen 30 seconds without fading, and may remain useful for five minutes, or until swept off the screen by a third "erasing" gun. The image is so bright it can be viewed in direct sunlight—an important feature in radar work. END



# A DIGITAL NIM COMPUTER

By ARTHUR SCHLANG

"NIM" is an ancient game of wits whose beginning is unknown. The significance of the title, "Nim" is not entirely clear, though it may have meant "take" in Anglo-Saxon times. In spite of these historical drawbacks, we may still enjoy many interesting hours playing this game.

To play Nim, get a number of matches, paper clips, or any other small objects. Make any number of piles of these objects with any number of objects in each pile. Next, find an opponent. Either of you may go first, taking any number of objects from one pile only. An entire pile may be removed. The next player may then remove, in a similar manner, any number of objects from any remaining pile. This process continues until the last object is picked up. The unfortunate player who picks up the last object loses.

The amazing thing about this game is that it can be played according to a mathematical system regardless of the number of piles, or objects in each pile. Because a system does exist, any initial setup has a predetermined winner. Assuming both opponents know the mathematical system, the one who goes first may win or lose depending how the piles are initially arranged. If only one opponent knows the system, he will probably win even if the initial setup is pre-determined against him. This is so because his opponent will probably make a wrong move, permitting the informed player to gain an advantage he cannot lose.

A mathematical computer to play Nim based upon the system described at the end of this article is shown in Fig. 1 and 2. It is built to accommodate a maximum of five piles with a maximum of ten objects per pile in the initial setup. The computer then replaces one opponent, and it is up to the remaining human to beat the machine.

To operate the computer, someone must act as a visual aide since the machine cannot see how the objects are set up. The computer is informed of the initial setup by assigning each of its five dials to a particular pile, and then turning each dial until its pointer indicates the number of objects in its pile. At all times during the game, after each move, the positions of the switches must correspond to the number of objects in each assigned pile.

Watch the computer indicator light. If this light is blinking and it is the computer's turn to go, it definitely wins the game. If the light is out, and it is the computer's turn to go, and its opponent knows the system, the computer loses. If the light is out, and its opponent does not know the system, and it is the computer's turn to go, it probably will win. This is so because the probability of the human making

only one error (all that is necessary) is large. Even one who knows the system cannot recapture the advantage from the machine.

Assume the indicator light is out and it is the computer's turn to go. The absence of the light indicates the game is predetermined against the computer. The move the computer must make is to remove one object from the largest pile. This provides the maximum probability the computer's opponent will make an error. The dial of the computer corresponding to the pile operated on is then set to the new number of objects in that pile. The indicator light is now blinking. The computer's opponent then makes his move, and the corresponding dial is moved to coincide to the new number of objects in that pile. If the unknowing human opponent inadvertently makes the correct move, the light goes out, and the machine again must take one object from the largest pile to put the greatest probability of error in its favor. The light will now be blinking when the game is turned back to the human. If the human ever makes a move where the game is turned over to the computer with the light flashing, the computer has the edge and cannot lose.

When it is the computer's turn to go with the light flashing, one of its dials is moved toward zero until the light goes out. If the dial goes to zero, and the light continues to flash, turn the dial back to its former setting. Go to another dial and repeat the preceding process until a position is found on one dial where the light goes out. There will always be at least one such dial if the light is flashing when it is the computer's turn to go. Remove objects in the pile corresponding to the dial that put the indicator light out. Make the number of remaining objects in that pile equal to the dial reading. This is the computer's move.

When the computer's opponent goes after the computer has made a move to put the light out, the opponent cannot make a move which when set up on the dials can hand the game back to the computer with the light out. It must flash.

Again at the computer's turn, the computer's aide moves one dial toward zero until the light goes out. If the light does not go out, return the dial to its initial setting before moving. Go to another dial and repeat the preceding process until a position is found on one

dial where the light goes out. And so on the game progresses, where the computer, once it has the advantage, cannot lose it. And if it does not have the advantage, it seeks it by relying on a probability of error. More involved machines have been built where the computer automatically searches through each dial until it finds a solution, thus making it unnecessary for someone to move the dials. However, such an automatic device would be too expensive for the average home experimenter to construct.

## The circuit

The wiring diagram for the computer is shown in Fig. 3. There are three types of wired switches. It does not matter which type is assigned what pile of objects. Switch A is a 10-pole 11-throw rotary switch wired as shown. Only one switch of this kind is needed in the Nim computer. Switch B is a 10-pole 11-throw rotary switch wired as shown. Three switches of this type are used in the computer shown in Fig. 3. Only one is shown in the circuit diagram. Any number of this type of switch may be added to increase the computer's capabilities to more piles of objects.

Dotted lines are shown from the contact arms of switch A to the fixed contacts (labeled zero) of switch B. Similarly, dotted lines are shown from the contact arms of switch B to contacts zero on switch C. This is the manner in which additional switches of type B may be added.

The third type of switch is switch C. Only one of this type is needed in any computer. It is a 6-pole 11-throw device, wired as shown. Its contact arms provide the excitation for the neon bulb relaxation oscillator which consists of an NE51 neon bulb in parallel with a 0.1  $\mu$ f capacitor, the whole combination in series with a 680,000-ohm resistor. The power source is any small 90-volt battery. The drain on the battery is negligible and its life in use should approximate the life it would have on the shelf. Since the light intensity of the neon bulb is small, use a clear jewel in the bulb holder. In selecting switches for the computer, it is best to use the shorting contact type since less contact failure will be experienced. Considering the number of contacts used, contact reliability is important. Mallory switches number 1261L are used in the model.

Fig. 1—A worthy opponent—the Nim computer.



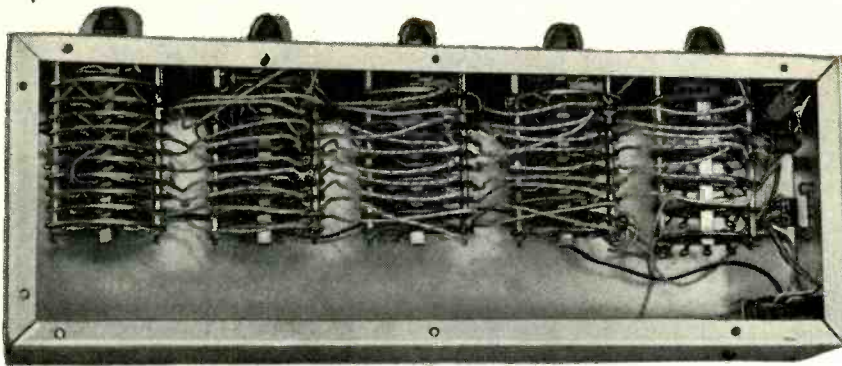

Fig. 2—Small spacers permit compactness.

These switches are 6-pole devices, modified for switches A and B by disassembling them and sawing the switch section spacers in half. The switches are then reassembled with four additional sections from a cannibalized switch using the halved spacers. The modified version has proven very reliable. With 10 poles on switches A and B and 6 poles on switch C, the capabilities of each switch indicates a theoretical maximum of 15 objects per pile. This maximum capability is not realized because commercially available switches only have 11 fixed contacts. This limits the computer's capabilities to a maximum of 10 objects per pile.

If the experimenter should desire to build a simpler device, he may reduce the computer's capabilities to a maximum of seven objects per pile by eliminating switch sections numbers 3 and 4 with all associated wiring in each switch. In addition, only 8 throw switches are needed on the remaining sections. Thus all wiring on contacts 8, 9, and 10 of each of the remaining switch sections is eliminated. When wiring the computer, it is easier to wire each switch before mounting it.

**Mathematical system**

The mathematical system for playing Nim is based upon binary numbers. The binary system of numbers uses the com-

bination of only two symbols to represent any quantity. These symbols are 1 and 0. The disadvantage of the binary system is that it does not lend itself to a compact form of notation.

To illustrate this, the binary equivalences are listed in the Table. Thus to represent a simple Arabic number like 6, in the binary system, three digits must be used. Number systems can be devised with any number of symbols; the greater the number of symbols, the more compact the notation. However, the greater the number of symbols, generally, the more difficult the arithmetic. Since machines are very stupid, we

CONVERTING TO BINARY SYSTEM			
Arabic Number	Binary Equivalent	Arabic Number	Binary Equivalent
0	0	6	110
1	1	7	111
2	10	8	1,000
3	11	9	1,001
4	100	10	1,010
5	101	11	1,011

must provide them with the simplest number system to work with—the binary system. The symbol 1 is represented by a closed switch and 0 by an open switch as done in the computer.

To use the system, write down in a column the number of objects in each pile expressed in binary form. Align the first digits of each binary number vertically. Add each column independently of the others using the Arabic system of numbers. Then examine each Arabic sum. You must hand the game back to your opponent with each Arabic number an even one. If the game has been handed to you in this state, there is nothing you can do to hand it back in the same state. You merely rely on the probability of error on your opponent's part by removing one object from the largest pile. With practice, you can quickly determine what pile to operate on, and the number of objects to remove to make each Arabic sum even. The computer does not actually add the columns—it merely determines whether or not each sum is even or odd. The actual Arabic number is of no importance.

There is an exception to the system. When a move reduces the number of objects in each pile to one, then the system should be discarded even though the even criteria is satisfied. In this in-

**Parts for Nim computer**

4—10-pole 11-throw, 1—6-pole 11-throw, switches (constructed from Mallory type 1261L); 1—680,000-ohm resistor; 1—0.1- $\mu$ f capacitor; 1—NE-51; 1—90-volt battery; 1—socket for NE-51; 1—chassis.

stance, the player should hand the game back to his opponent with a total of an odd number of single objects added from pile to pile. If a player has the upper hand all through the game, he can always retain the upper hand if the exception is reached. The computer takes into account the exceptions, with sections 1 and 2 of each switch which overrule the actions of all the other sections when the number of objects in each pile is reduced to one or zero. END

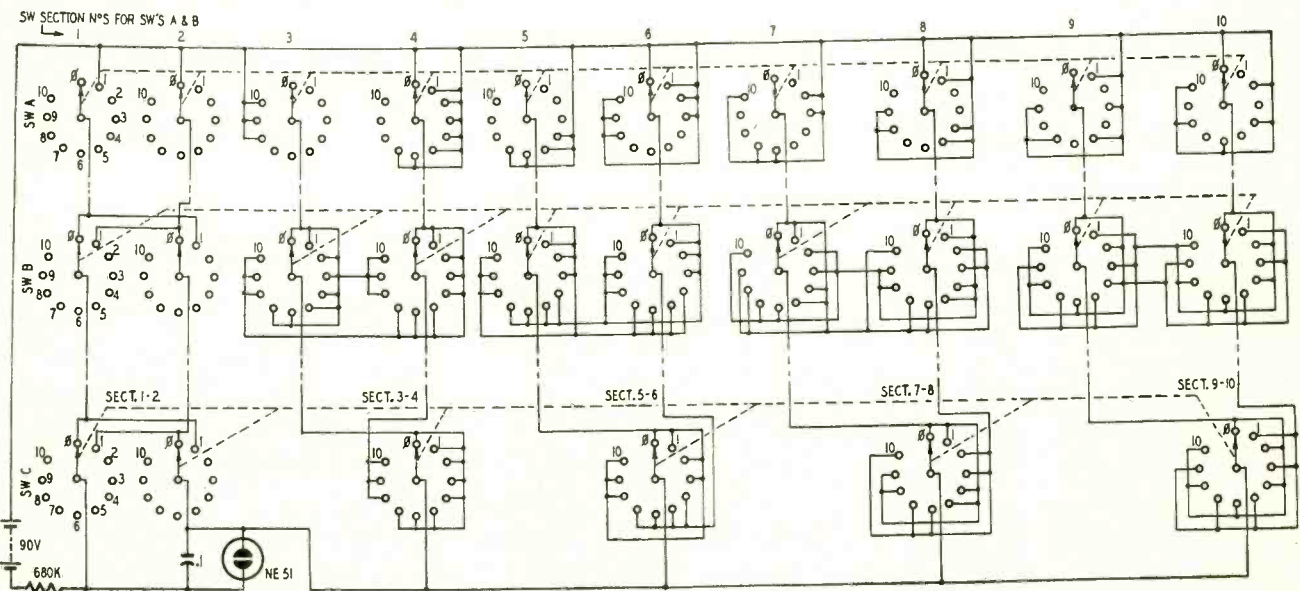
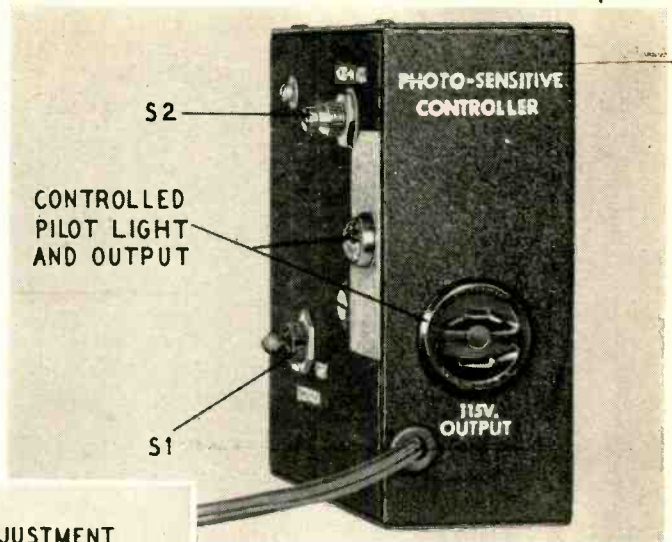
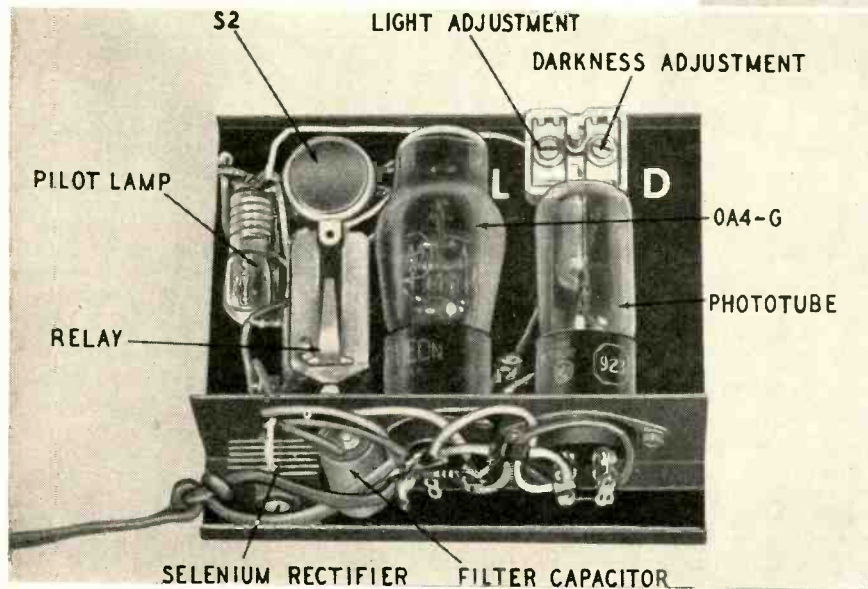

Fig. 3—Wiring diagram. More B switches may be inserted by duplicating switch B wiring shown between dotted lines.

# Versatile Control Unit

By R. J. SANDRETTO



Above, photorelay shown in Fig. 4.

Left, view of chassis shows parts layout of the general-purpose relay.

tentials.

Fig. 1 shows a circuit that may be used for a burglar alarm or to turn on a sign, or garage or poultry-house lights when darkness falls. When the phototube is darkened, the 0A4-G fires and the relay closes. The 0A4-G continues to conduct, thereby keeping the external circuit positively closed until the source of power is momentarily cut off by opening the s.p.s.t. switch.

The 923 phototube is a gas-filled type, and for this reason has greater sensitivity than most vacuum types. (The manufacturer lists the 923 for renewal use only. For new equipment, the 1P40 and 930 types are recommended. These are octal-based equivalents of the 923.)

An illuminated phototube is the equivalent of a rather low resistance, but when darkened its resistance increases greatly, depending upon the change in light intensity. The variable resistance characteristic of the tube is used as one leg of a voltage divider in the 0A4-G starter-anode circuit.

A small value of capacitance is used as the other leg of the voltage divider. Its impedance is in series with the resistance of the phototube.

In this voltage-dividing circuit a dark tube will have a greater voltage across it than a lighted one, and a small capacitance will have a higher voltage across it than will a bigger one. Increasing the voltage sufficiently between the 0A4-G cathode and its starter-anode causes the tube to fire. Hence, in Fig. 1, lowering the intensity of the light falling on the phototube causes its resistance to increase and thereby causes the tube to fire.

An extremely high-value resistor (many megohms) may be used instead of the small variable capacitor. The capacitor was chosen because it could be adjusted over a wide range, takes up less space than the type for which substituted; it can be more easily obtained and costs less. A resistance type of voltage-dividing circuit may be placed across the B supply. If such

**T**HE 0A4-G cold cathode, glow-discharge, gas-triode control tube was designed primarily for calculating machines and carrier-current relay systems but also is ideally suited for many other electronic-control applications. It operates without a filament or a heater, so power consumption is greatly reduced, and no filament-dropping resistors or transformer are needed. This results in lower cost, less wiring, smaller space requirements, and elimination of ventilation problems.

## Description of the 0A4-G

The 0A4-G gas triode elements are plate, cathode, and starter-anode. The glass envelope is filled with argon, a gas which behaves like neon. The three elements inside the tube act toward each other like the two neon-surrounded elements in a common neon bulb. In a conventional glow-lamp, nothing happens as long as the potential between the two electrodes is lower than the ionization potential of the gas. But when the voltage reaches or exceeds that point an electric discharge occurs. This discharge is accompanied by a light whose color is characteristic of the gas used.

When the 0A4-G is used in a circuit, the voltage between its plate and its

cathode is slightly lower than the ionizing—or firing—potential. If an extremely slight discharge is then created between the starter-anode and the cathode, a discharge suddenly occurs between the plate and the cathode. The potential between the starter-anode and the cathode therefore controls the main discharge, which continues until the plate supply is interrupted momentarily.

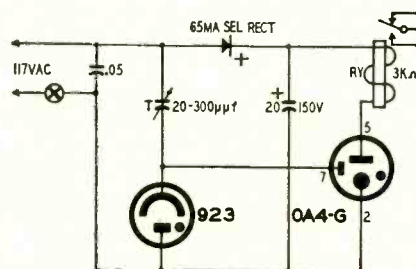

Fig. 1—Photoelectric relay diagram.

## The 0A4-G in photoelectric relays

The thyatron-like action of the 0A4-G makes it ideal for energizing relays in photoelectric circuits. By combining it with a sensitive phototube, power consumption can be held to that required to obtain proper operating po-

experimenting is done, make sure that the phototube is operated with no more

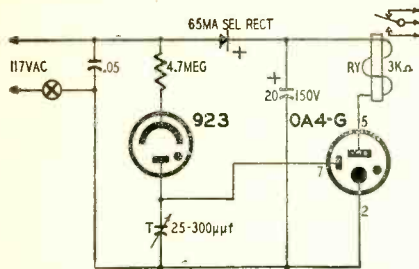

Fig. 2—Increased light trips relay and locks it in until plate is opened.

than 90 volts between its electrodes. A higher voltage ionizes the gas in the tube and a harmful glow discharge takes place independently of the cathode illumination. Such a discharge is indicated by a faint pale blue glow inside the cell.

Fig 2 shows a circuit similar to the one described above except that it provides for control by increasing the light intensity. The 4.7-megohm resistor supplies the phototube with a safe operating voltage in the light-activated circuit.

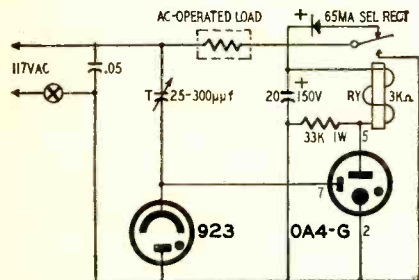

Fig. 3—A darkness-activated reset or blinking photoelectric control circuit.

**A photoelectric blinker**

A circuit which will automatically reset itself after the tube is fired is shown in Fig. 3. In this circuit large values of filter capacitance will give long relay hold-in periods. If the cell is darkened for a long period of time the unit will fire and reset itself repeatedly, until the light source is restored. Therefore this circuit can be used to automatically turn on and flash a lighted sign after darkness has fallen. The action is stopped by the approach of dawn. Unless the sign presents a very light load, use a second relay to carry the heavy current that a plate relay is not capable of carrying.

**A versatile control unit**

Fig. 4 is the diagram for a general-purpose photoelectric control unit. This is the one shown in the photographs. It covers all the above-mentioned uses. Switch S1 selects the type of activation desired, in either light or darkness. S2 changes the circuit from automatic resetting to lock-in operation.

Any reasonable component values will work in these circuits, except for the tube-shunting resistor needed in Figs. 3 and 4. Its value will vary with different plate relays and has to be determined experimentally. It must not be

so low as to cause the relay armature to be pulled in during stand-by periods, nor so high that it will not allow the tube to reset itself properly after being fired. A resistance substitution box is helpful in selecting the proper value.

Filter capacitors of about 20- $\mu$ f and working voltage ratings of at least 150 are used for the non-reset circuits. For

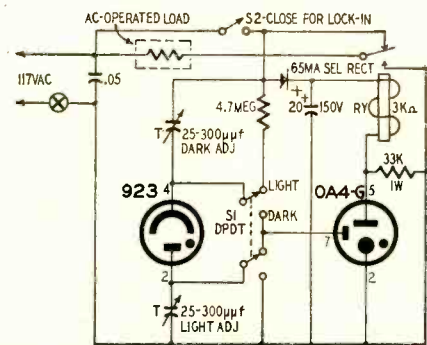

Fig. 4—General-purpose relay combining features of the preceding figures.

**Materials for Fig. 4**

**Capacitors:** 2—25-300- $\mu$ f mica or ceramic trimmers; 1—.05- $\mu$ f, 600-volt paper; 1—20- $\mu$ f, 150-volt electrolytic.  
**Miscellaneous:** 1—65-ma selenium rectifier (see text). 1—4.7-megohm, 1/2-watt, 1—33,000-ohm, 1-watt resistor. 2—s.p.s.f., 1—d.p.d.t. toggle or rotary switch. 1—OA4-G gas triode tube, 1—923, 930, or 1P40 phototube. 2—sockets, 1—chassis type a.c. receptacle, 1—s.p.d.t., 3,000-ohm plate relay. Chassis, cabinet, hookup wire, hardware.

the other circuits one may wish to use a higher capacitance if a longer relay hold-in period is desired.

If the relay used has a resistance higher than 5,000 ohms, a 35-ma selenium rectifier will be sufficient. Otherwise this rectifier should have a rating of 65 or 100 ma.

A capacitor may be necessary across the power-line connections to bypass r.f. pulses that tend to fire the unit. In some circumstances it may not be needed, and in others you may require a slightly higher value of capacitance. This component can be left out until the need for it has been determined.

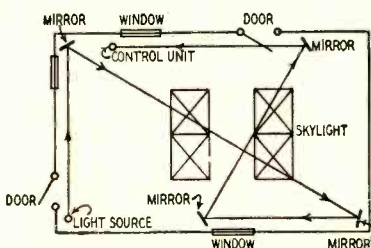

Fig. 5—Typical installation for photoelectric intruder alarm system.

Since only three pins of the OA4-G are used for connections to the tube, the remaining five pins on the octal socket may be used as wiring terminals.

A fuse may be placed in one side of the line if desired. No part of the circuit should be connected to the case housing the unit, because of possible shock hazard.

The small 115-volt pilot lamp shown in the photographs of the general purpose unit is useful, but not necessary.

After the unit has been wired, the small mica trimmer capacitor in the

photocell voltage-dividing circuit is adjusted for the desired operation.

**Adjustments**

A high-voltage probe and a vacuum-tube voltmeter should be used to measure d.c. voltage across the phototube. The resistances in the circuit must be extremely high to take fullest advantage of the phototube. An 11-megohm vacuum-tube voltmeter alone will change the voltages and give false indications. A probe increasing the input resistance of the meter to about 1,100

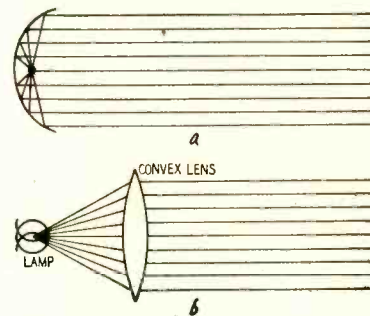

Fig. 6—Two methods of concentrating light into narrow beams—by parabolic reflector at a and convex lens at b.

megohms will allow accurate voltage readings. Switch to a low scale and multiply the meter reading by the multiplication factor of the probe to get the voltage on the phototube.

**The light source**

A separate light source will be needed unless the control unit is to be activated by either sunlight, darkness, or ambient light. Either a small 115-volt lamp or an automobile type bulb supplied by a 6.3-volt transformer is used as the light source, which is housed in a light-tight box.

In an intruder alarm, one might want to bend the beam around corners and criss-cross an area with the use of mirrors as indicated in Fig. 5. Here, the beam is likely to travel a long distance. Its intensity decreases inversely as the square of the distance, so the efficiency of the light source should be increased by concentrating its rays. Figs. 6-a and 6-b show two methods of concentrating light into a narrow beam. The first uses a parabolic reflector such as may be found in a common flashlight, and the other uses a convex lens. In the latter case the lamp is placed at the focal point of the lens, which is easily determined experimentally.

To further increase the efficiency of the light source, you may use a second lens to concentrate the light on the cathode of the phototube. Place the lens so the cathode is at its focal point. This lens will also help to eliminate interference from stray light.

In intruder alarms, it may be desirable to make the beam invisible. Do this by placing an infrared filter in front of the light source. This will reduce the intensity of the beam so a stronger light source will be needed to compensate for losses in the filter.

END

# COLOR TV CIRCUITS

Part I—Proper reception of color TV will require modifications in antenna, tuner, and i.f. amplifier

By KEN KLEIDON and PHIL STEINBERG\*

EVER since the NTSC (National Television System Committee) completed their transmission specifications for color television, many articles have appeared explaining the color standards and how they differ from monochrome (black-and-white) transmission. These articles presented information concerning the theory of color TV, and were of value as background data. Since the theoretical aspects and composition of the NTSC color signal were thoroughly explained in previous issues of this magazine, we will deal with the problems the service technician may expect to face when servicing a color receiver.

Servicing a color television receiver will not require the theoretical knowledge of a design engineer, but simply an understanding of the basic function and operation of the various circuits in monochrome receivers and plain common sense in applying this knowledge to the additional circuits added for color. A color receiver contains approximately 50% monochrome circuits, 30% monochrome circuits with slight modification, and only 20% new circuits. We will begin this series by dealing with circuits similar to those in monochrome receivers and will work toward circuits which differ considerably. We are attempting to present only the information that is practical, down to earth, and of value to the color television service technician.

The difference between a monochrome and color signal arriving at the antenna can best be explained by referring to Fig. 1. The two drawings were selected because they clearly illustrate, by dotted lines, the additional information which is added to the present monochrome signal (the area in solid lines) to comprise a complete color signal. The area denoted by dotted lines and labeled color information is actually two signals which are amplitude-modulated and out of phase with each other by 90°.

This is illustrated in Fig. 2 where the two signals are shown as sine waves and separated in time by a quarter of a cycle, or 90°. The first signal is re-

\* Raytheon Manufacturing Company, Television and Radio Division.

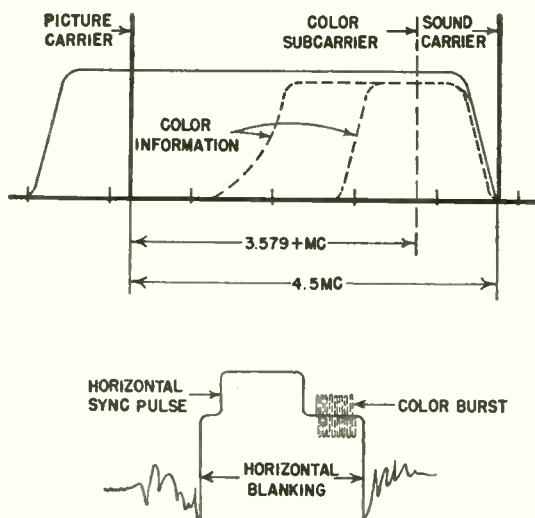

Fig. 1—The complete color signal. Dotted lines indicate the additions made to the black-and-white signal.

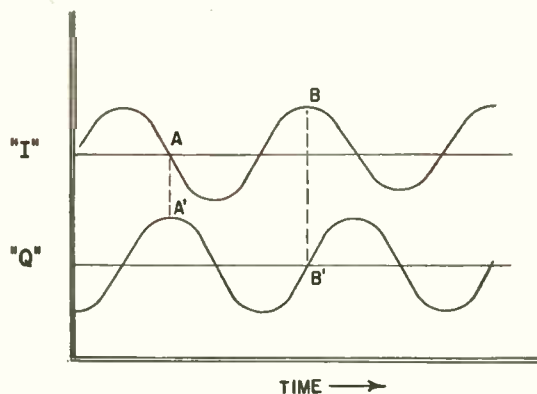

Fig. 2—I and Q phase relationship.

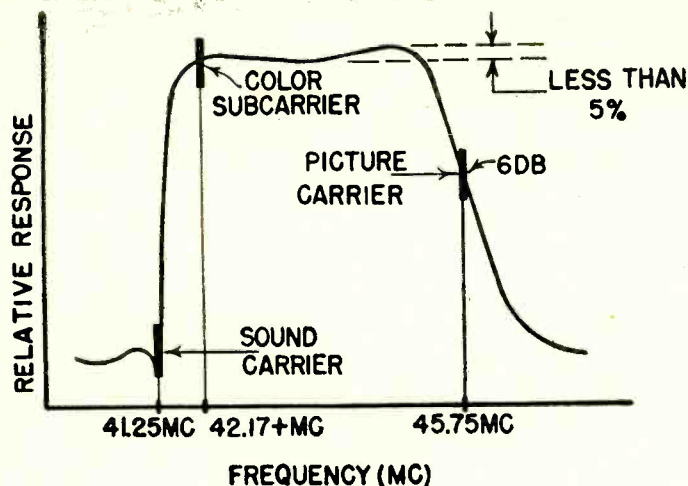

Fig. 3—Color i.f. response curve.

ferred to as the in-phase or "I" signal and the second as the out-of-phase quadrature or "Q" signal. When the I signal is at zero (A) the Q signal is at maximum (A') and when the I signal is at maximum (B) the Q signal is at zero (B'). Together with the monochrome or luminance signal, three color signals (red, blue, and green) are obtained by special circuitry in the receiver. For simplicity, however, keep in mind that while the area within the dotted lines is the color or chrominance signal whose carrier is 3.58 mc (exactly 3.579545 mc) above the picture carrier, this added information is only additional amplitude-modulation on the picture carrier. The horizontal blanking pedestal shown in Fig. 1 shows the position of the color burst in dotted lines. The color burst is nothing more than a synchronizing signal provided to control the phase and frequency of the color-subcarrier reference oscillator in the receiver. It can be considered as an additional sync pulse similar to the horizontal sync pulse but whose frequency (3.58 mc) and phase is accurately controlled at the transmitter.

Since the color subcarrier is located 3.58 mc above the picture carrier (see Fig. 1) slight design revisions are necessary in the monochrome tuner, i.f. amplifier, and method of sound take-off, used in a color receiver. These revisions, though slight, should be carefully studied by the service technician. The overall tolerances in a monochrome receiver for response-curve tilt and valley-to-peak flatness, considering the antenna, tuner, and i.f. amplifier, is a voltage ratio of approximately 2 to 1 (6 db). For a color receiver much closer tolerances are required. The i.f. response curve in Fig. 3 shows that no more than 5% tolerance on tilt between peaks and between peaks and valley is permissible. This is indicated in specifications of a major TV manufacturer. Due to the frequency conversion in the first detector or mixer (tuner) which produces the i.f., the position of the carriers are inverted and the color subcarrier is then 3.58 mc below the picture i.f. carrier. Since the color burst

is at the same frequency as the color subcarrier, any appreciable tilt may result in a considerable reduction in burst amplitude and possibly cause a loss of color sync. Thus, the antenna, tuner, and i.f. amplifiers are each discussed, as they could present difficulty.

### Antennas

An antenna used for monochrome reception may not necessarily provide acceptable results for color. Fig. 4 is an antenna response curve recently published by a leading manufacturer. It can be seen that for a given channel the gain can vary almost  $1\frac{1}{2}$  times (3 db). Using this particular antenna or any narrow-band type, such as the multi-element Yagi could, under certain circumstances, produce undesirable color reception. Therefore, it may be advantageous, where practical, to select an antenna with flat response rather than high gain. One antenna manufacturer recently announced that an antenna with a maximum of 15% variation per channel is available and advertised it as suitable for color. It appears likely that the majority of antennas which have been installed for monochrome reception will be acceptable for color. Even the narrow-band types might give good reception if the tuner and i.f. amplifier are sufficiently flat. What effect an antenna will have on color television reception can be determined only after a number of color receivers have been installed in consumers' homes.

### Tuners

A tuner used in a color television receiver, whether u.h.f. or v.h.f., is almost identical, electrically and mechanically, to one used for monochrome reception. The only differences are the design changes necessary to insure the flattest response curve possible. Production tolerances on the order of 1 db are required for tilt and valley-to-peak specifications. Thus, a little more care must be taken during alignment, but this should not be a problem if the manufacturer's procedure is carefully followed. Servicing the tuner will also

require care so as not to move or rearrange leads or components; this may change the distributed capacities and inductances and thereby offset the alignment. Also, when a part replacement is necessary, the same lead lengths should be maintained and the part must be replaced in the same physical location. The part should be an exact replacement.

Tuning a color receiver will require a little more skill and patience on the part of both the receiver owner and the service technician. The fine-tuning control on snap type tuners, which was seldom used for monochrome reception, will require careful manipulation when receiving color. This can be seen by referring to Fig. 3. If the receiver is tuned so that the picture carrier is below the 6-db point of the i.f. response curve, the sound carrier will ride up on the curve and a 920-kc beat pattern will result, due to the heterodyning action in the second detector between the sound carrier and the color subcarrier. If tuned so that the picture carrier is above the 6-db point, the color subcarrier will ride over or down on the curve and result in a partial or complete loss of color information. It will be the responsibility of the service technician to properly instruct the color TV owner that a compromise is necessary, and to adjust the tuning control for the best color effect obtainable with sufficient sound and a minimum of 920-kc beat in the picture.

### I.f. amplifiers

The i.f. amplifiers in a color receiver undergo many more changes than the tuner. This is because the color subcarrier is 3.58 mc below the picture carrier in the i.f., and, because of the color sidebands, the i.f. amplifier must be capable of a minimum pass-band of about 4.1 mc at the 6-db point. One other important consideration is the heterodyne action between the sound carrier and color subcarrier, which requires sufficient sound carrier (41.25 mc) attenuation to reduce the 920-kc beat to a negligible level in the picture. This requires the video-to-sound ratio to be considerably higher, and necessitates additional trapping and detecting the sound information separately from the video as shown in Fig. 5. The sound is usually separated by an additional detector before the last sound trap in the i.f. amplifier and applied to the 4.5 mc sound i.f. All these points are important to the service technician, as i.f. alignment and servicing will be a little more precise for color. As with the tuner, alignment of the color i.f. amplifier will be similar to its monochrome counterpart and should not present difficulty if the manufacturer's procedure is followed carefully.

Monochrome receivers using the FCC approved 40-mc i.f. have been in the field for some time and the service technician should be familiar with the slightly different problems involved with this increase in frequency. There are a few points, however, that are

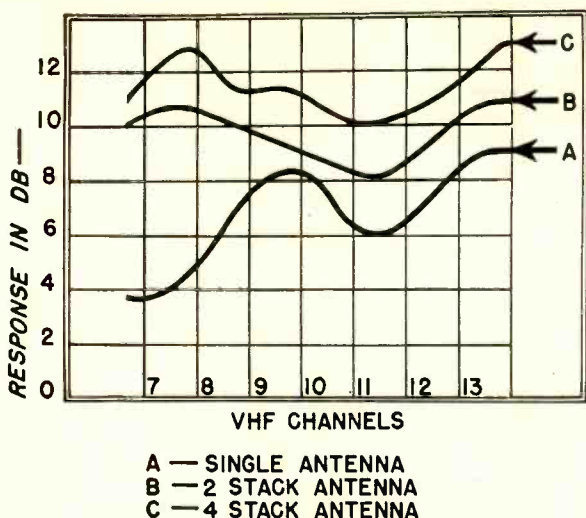

Fig. 4—Antenna response curve.

usually overlooked and are worth mentioning.

Any rearrangement of parts and leads should be done with caution and the tolerances of replacement parts should be kept in mind. A number of 5% resistors are used in color i.f. amplifiers and the value of capacitors are critical in some locations. Tube substitution in the i.f. amplifier strip, especially in the customer's home, should not be attempted indiscriminately. If an i.f. amplifier tube is suspected, each tube should be substituted until the defective one is found, but, if a tube is changed and does not cure the trouble at hand, the original tube should be returned to its socket. If this procedure is not followed, the alignment may be affected due to varying tube characteristics of different manufacturers.

**Sound section**

The sound section in a color receiver serves the same function as in a monochrome receiver and has essentially the same circuits. The only difference is an added detector, as mentioned previously, at the input of the first 4.5-mc sound i.f. stage. Some receivers may differ in that the sound take-off point is located before the last i.f. stage and uses an auxiliary 40-mc i.f. amplifier before

coupling to the separate sound detector. In either case, these additional circuits are not in any way new, as they have been used in the past in various monochrome receivers.

**Sync and sweep circuits**

The sync, a.g.c., and horizontal and vertical oscillator circuits in a color receiver perform the same function and are almost identical to those in a monochrome receiver (see Fig. 5). The manufacturer will probably use the same circuits as in their monochrome receivers; therefore, the service problems will be identical. The slight change in horizontal (from 15,750 to 15,734 cycles) and vertical (from 60 to 59.94 cycles) scanning frequencies used for color will not in any way affect circuit designs or servicing. One point, however, that may be of interest, concerns a monochrome receiver tuned to a color transmission. This is the slight change in horizontal scanning frequency required, which may create a difficulty if the customer's horizontal hold control is set near its lowest frequency position. This of course can easily be rectified by readjusting the horizontal hold coil usually found at the rear of the set.

(TO BE CONTINUED)

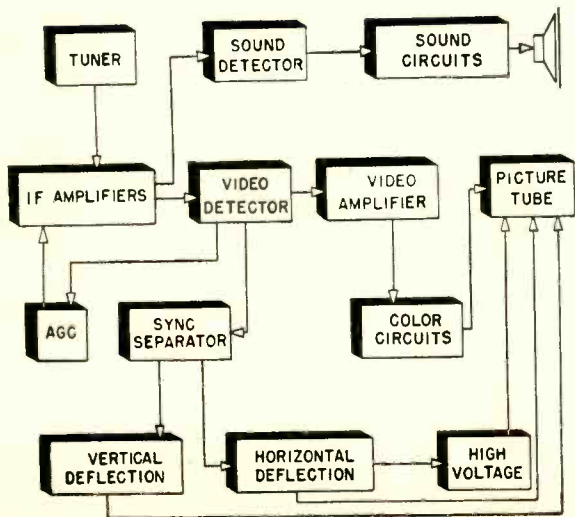

Fig. 5—Block diagram shows basic layout of color television receiver.

**NEW TV SERVICE AIDS**

In many areas of the country, away from cities and large towns, a trained TV service technician is not always available when a set is in need of repair. Often the set must be shipped or a technician must travel as far as 70 to 100 miles to repair it. This causes long delays and greatly increases the service cost of a minor repair job.

Since the most common TV receiver troubles are caused by defective tubes or misadjusted controls, Du Mont is distributing its new *Fix-Faster* service data sheet to its dealers and sales personnel to enable them to correct many of these troubles when a trained TV service technician is temporarily unavailable.

The *Fix-Faster* is a 19 x 24-inch service sheet covering one particular chassis. The first issue is on the RA-166/171 chassis. Subsequent issues will cover later chassis.

The front of the sheet shows test patterns resulting from misadjustment of one or more controls, with complete step-by-step instructions for proper adjustment. Diagrams show the chassis location of the control to be readjusted. The other side shows a large number of test patterns that are the result of defective tubes. Next to each pattern is a legend indicating which tube or tubes may be causing the trouble. A tube location chart assists in finding the tubes involved.

**TV COVERS THE EARTH**

World TV survey compiled by UNESCO shows that television is making headway in 45 countries and territories. In 20 countries, public broadcasts are on the air; eight countries are carrying out technical broadcast experiments; and in the other 17, governments or private organizations are taking steps to introduce television.

The report, called "Television, A World Survey," states there is one TV set for every 7 persons in the U. S., one for every 24 persons in the United Kingdom, one for every 55 Cubans, one for every 704 Frenchmen, one for every 2,400 in the Soviet Union, and one for every 8,000 persons in the German Federal Republic.

Since the report was completed, an entirely new continent has been heard from, with the establishment of a permanent television broadcast station at Casablanca, Africa. While no reports are on hand as to the number of receivers within range of the new station, it points out that Africa is now going to be a factor in the TV field. Neither were there any reports as to the number of persons per TV set in Asia, where the number is no doubt still very small, though several stations are in operation on that continent.

That Cuba, a country which does not manufacture any TV equipment, ranks so high among the TV countries is indicative of a trend which is noticeable elsewhere in Latin America and promises to make itself felt in Asia and Africa.







# TELEVISION . . . it's a cinch

By E. AISBERG

## Tenth conversation, second half: vertical sync and blanking signals, bandwidth considerations. TV sound

From the original "La Télévision? . . . Mais c'est très simple!" Translated from the French by Fred Shunaman. All North American rights reserved. No extract may be printed without the permission of RADIO-ELECTRONICS and the author.

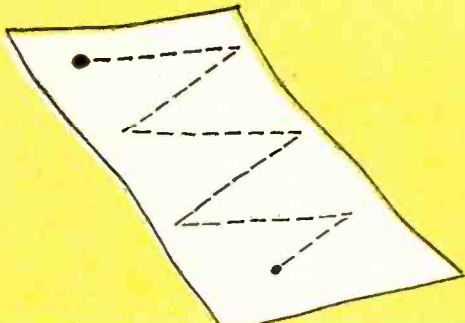
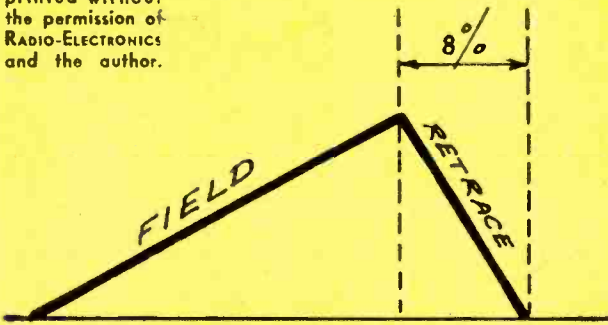

WILL—And are the signals at the end of each field like the horizontal sync signals?

KEN—Yes and no. The principle is the same, but the pulses are quite a bit different. They have to be, so the receiver can pick them out from among the horizontal sync signals.

WILL—The vertical time-base has a lot longer period than the horizontal one, so I suppose the sync signals have to be longer, too?

KEN—It comes to that. We again have to blank out the spot during the whole time it is returning to the top of the picture. That time is about 20 lines, or more than 8% of the entire time spent in scanning the field.

WILL—What happens to the horizontal sync signals during that time. Are they blanked out, too?

KEN—Why should they be? You know already that the receiver is synchronized by a free-running oscillator and that the oscillator's frequency is controlled by the sync pulses. Starting and stopping it 60 times a second wouldn't help synchronization much! And there's nothing wrong in having the spot swing across the screen a few times on its way to the top (something like a souse coming home late at night) so long as the signal is up above the 75% level, so the spot stays blanked out.

WILL—But doesn't our free-running horizontal sync oscillator get out of step a little during the long vertical pulse?

KEN—No. The vertical sync signal still has to keep the horizontal sweep circuit in sync. Otherwise it would oscillate at its own frequency, which—if you remember—is a little lower than the correct line frequency.

WILL—But how can you keep control?

KEN—Can't you guess?

WILL—About the only way would be to keep on transmitting the horizontal sync signals during the vertical one.

KEN—That's just what is done, at least in principle. The vertical sync pulse is split up into a great many smaller ones, some of which act as horizontal sync pulses. The complete vertical sync pulse looks just about like this sketch. You will see a couple of horizontal pulses after the video signal ends, followed by a number of equalizing pulses, then the broad pulses that trigger the vertical oscillator, another group of equalizing pulses, then a number of horizontal pulses before the video starts again. We'll find out more about equalizing pulses and just *how* the vertical pulses are applied to the vertical sync circuits of the receiver when you are a little more advanced in the art of television.

Different TV systems use signals that look quite a bit different, but they all work on the same principle. (In color TV, for example, we're going to have a little burst of 8 or more pulses during the time after the line sync signal has ended and before the video signal starts—on the "back porch" of the synchronizing pulse.) You might as well take a look at these vertical signal patterns, used by the French and the British television systems, too. You can see that the horizontal pulses are much the same in all of them. And while you're looking, notice that the vertical sync signals have to provide for interlacing. One field starts at the upper left corner of the picture and ends at the middle of the bottom. The next one starts at the middle of the top and ends at the lower right corner.

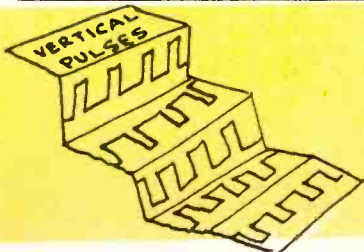
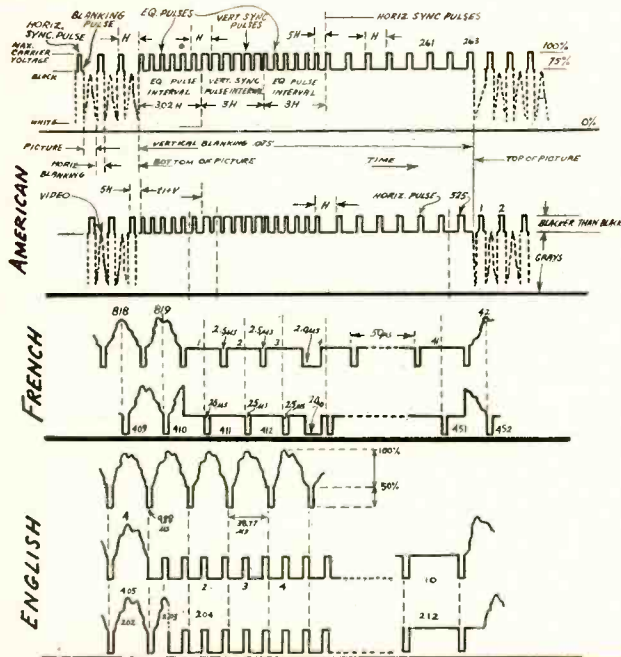

### A "programmed" jigsaw puzzle

WILL—It's crazy, the number of things you can get

together in this composite television signal. It reminds me of the jigsaw puzzles I used to play with as a boy. You had to get all those little pieces together in just the right way to get a picture!

**KEN**—The TV signal is a lot more complete than your puzzles were! For not only does it carry all the pieces needed for a perfect picture—it also carries the complete instructions on how to put them together to get the perfect picture. The sync signals give those instructions. They remind me of the “taping” or programming of an electronic computer, that tells the machine what to do with the numbers fed to it to get the right result.

**WILL**—And this whole combination of complexities is packaged so that it can be shipped out on the high-frequency wave of a television carrier! I think you pointed out a long time ago that the video signal spreads itself out over such a large band of frequencies that it can be carried only by a very high-frequency wave?

**KEN**—That's right. You need a video signal of about 4 megacycles for a 525-line system. In higher-definition systems, like the French 819-line standard—the band is much wider.

**WILL**—I'm beginning to get dizzy. When I remember that a modulating signal creates *two* sidebands of its own width—one above and one below the carrier—I wonder how you can build equipment to send or receive such wide bands of signals.

**KEN**—A TV signal certainly is wide if you compare it with an AM signal—or even with the entire broadcast band! But we don't have to go quite as far as two sidebands.

**WILL**—What? Can you do without one of the sidebands?

**KEN**—Not quite, unless you're willing to put up with a lot of distortion. But we can cut off the greater part of one sideband. Have you ever heard of *vestigial sideband* transmission?

**WILL**—Yes, but I never knew what it meant. So they trim off a lot of one sideband, and so reduce the frequency band you need to transmit the signal. But just what frequencies are used on TV? These channel numbers don't give you much of an idea about where the bands are or how much space a channel takes up.

**KEN**—In this country there are three TV bands. Two of them—from 54 to 88 mc and from 174 to 216 mc—are in the so-called very high frequencies, and one—from 470 to 890 mc—is in the ultra-high-frequency spectrum. Channels are 6 mc wide. The widest channel is the French high-definition 819-line system, which has a width of nearly 14 mc. These drawings will give you an idea.

**WILL**—From anything I've learned yet, our images are still dumb. But I know they do speak on the real television screen. I suppose we add a narrow band of frequencies to our video signals to carry the sound?

**KEN**—There are some ways of carrying the sound on the same carrier as the video signals. But the practical way of doing it seems to be to use a separate transmitter for the sound.

**WILL**—I suppose the sound is kept on a frequency well away from the video signals, to keep interference down?

**KEN**—On the contrary. The sound is as close to the composite TV signal as possible without letting the sound and video signals overlap. There is less than a megacycle between the two signals.

**WILL**—Doesn't sound like a very healthy condition. Why do they have to be so close together?

**KEN**—There are several reasons. One is to keep the signals close enough together so that you can use one antenna for both sound and picture signals.

**WILL**—And this sound signal—how wide is it? Do they keep it down to a theoretical 10,000 cycles or so, like an AM broadcast, or does it get a 200-kc channel like an FM signal?

**KEN**—In the first place, it is an FM signal—at least in American television. And it is permitted a deviation of 25 kc each side of the carrier.

**WILL**—FM, eh? Then could you call television sound “high fidelity?”

**KEN**—Reasonably high—if the sound part of your receiver is designed for high-fidelity reception and reproduction.

(TO BE CONTINUED)

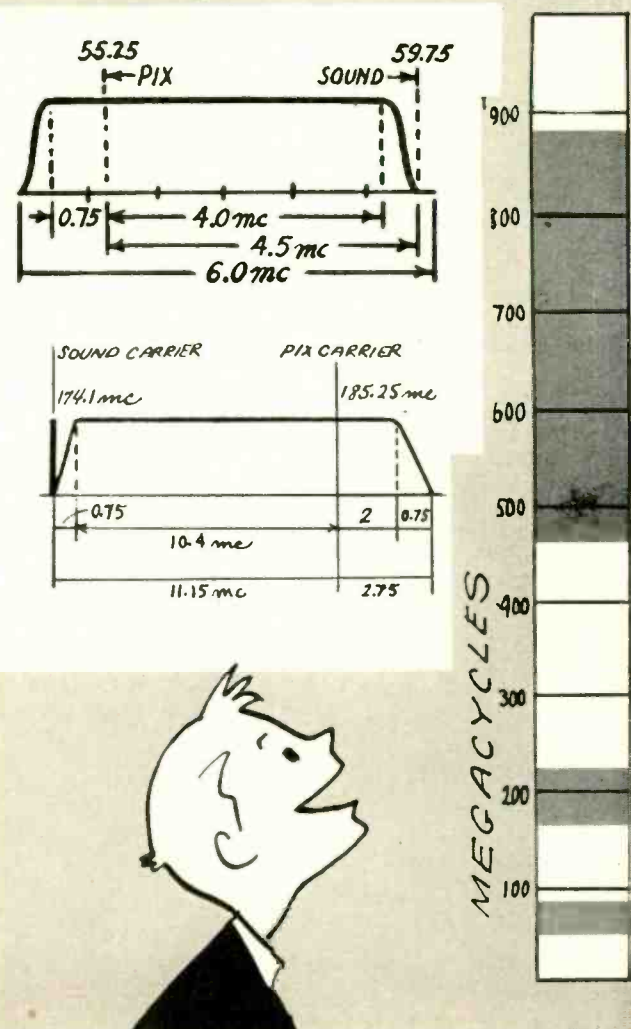
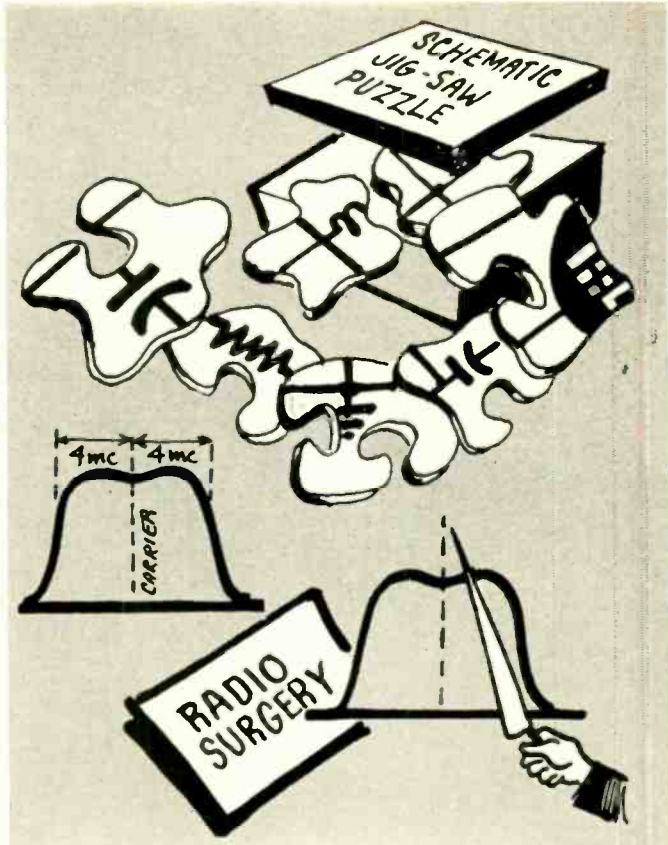

# U. H. F. LINES and CONVERTERS

*Pointers on using these elements to improve performance*

By **MATTHEW MANDL** and **EDWARD NOLL**

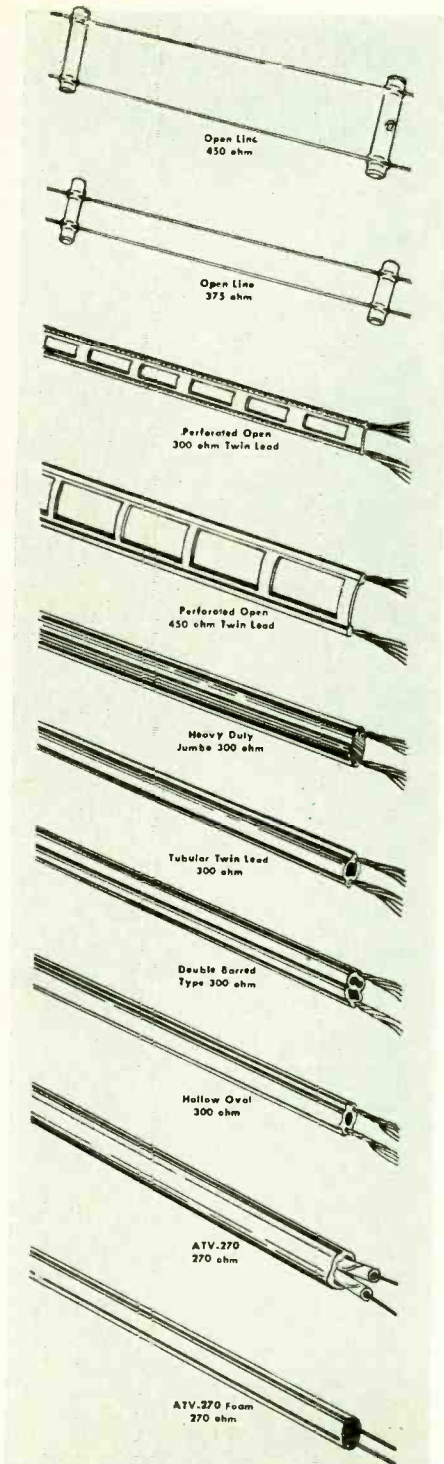

Several popular types of transmission lines used in u.h.f. installations.

*courtesy G-B Techni-talk*



A standard u.h.f. television converter.

**T**HE proper type of transmission line and its installation are important factors in getting the most from a u.h.f. installation. Capacitance losses are greater at u.h.f. Therefore the transmission line should be spaced at least six inches or more from the mast or other metal objects. Even with a wide spacing it is best not to run the line parallel to rain pipes or other metal conduit for any great distance. The line should be as short as possible, and sharp bends should be avoided.

Line having the least loss should be used, though installation factors may alter such a choice. The open-wire line, for instance, has much lower losses than other types, but is most difficult to install, particularly where it enters the home. The new Gonset u.h.f. open-wire line has an impedance of 375 ohms with a 2-db loss at 500 mc. Imperial has a 250-275-ohm open-wire line which matches 300-ohm loads and has a loss of about 0.8 db per 100 feet at 500 mc when dry. As shown in the table on page 39 of the January issue, other lines have a greater loss for this frequency. Since losses are calculated on the basis of 100-foot lengths, the other lines can be used for ease of installation, provided too great a length is not required.

Losses increase for the higher u.h.f. channels and too lengthy a run will cut down the signal appreciably. Thus, if the antenna is raised by 100 feet the additional length of the ribbon lead would introduce over 3 db loss around channel 19 and almost 5 db for channel 83. A 5-db loss is greater than the gain realized by stacking an antenna (3 db for each bay added to an existing antenna). The tubular type line is preferable over the flat because of its lower loss, but precautions must be taken to seal the ends of the line to keep out moisture. Some technicians form a reverse loop in the tubular lead-in at the antenna to keep out moisture, and also provide a drain hole by cutting a slot in the bottom of the line where it enters the home. When the top is sealed, however, a loop is avoided and a neater installation results.

The American Phenolic Corp. manufactures a polyethylene end seal plug

which provides a quick and positive closure for tubular lead-in. It seals the inside of the tubular lead and also provides a protective cap and seal for the outside. (Amphenol, 66-213 Twin-Lead and seal.)

The shielded wire lines are not recommended for u.h.f. installations. Their excessive losses more than overcome their advantages—low noise (shielding), plus unchanging impedance in wet weather.

### U.H.F. TRANSMISSION LINES

TYPE	AD-VANTAGES	DISAD-VANTAGES
Open-wire line	Low loss Less effect when wet	More costly More difficult to install and route Higher impedance than 300 ohm standard
Ribbon line	Inexpensive Easy to install	Higher loss than open or tubular line Loss increase when wet
Tubular line	Less loss than flat line Less affected by weather	More costly than flat line Requires sealing of ends
Coaxial lines	Less noise pickup Not affected by weather	More costly Greater db loss than other types Unbalanced for TV Impedance mismatch

The table lists the common advantages and disadvantages for various types of u.h.f. transmission lines.

### Uhf converters

Many u.h.f. converters have a gain of 1 and therefore do not increase the signal strength during the conversion process. Thus it is essential that the converter operate at peak efficiency. Otherwise signal strength will decline during the conversion process. When there is reason to doubt the performance of a converter, the tubes should be checked and the mixer crystal changed. It is also a good idea to try several local-oscillator tubes as well as mixer crystals, because certain combinations deliver greater signal output.

Some converters have provisions for

both the v.h.f. and u.h.f. antennas. The respective transmission lines are attached to the terminals and automati-

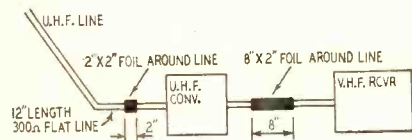
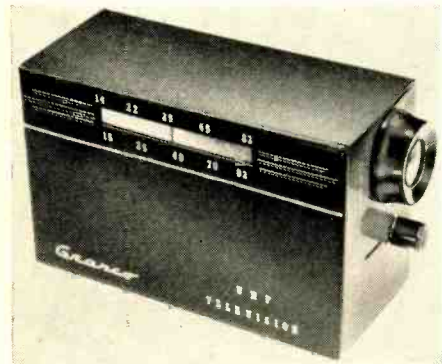

Fig. 1—Using two sections of tin foil to minimize effects of standing waves.

cally switched into position as the selector knob is turned to either u.h.f. or v.h.f. In some converters such switches introduce capacitive losses. In weak-signal areas such losses can be severe enough to degrade picture quality considerably. A simple check consists of setting the converter for v.h.f. reception and tuning in a weaker station. Remove the v.h.f. antenna transmission line from the converter and attach it directly to the antenna terminals of the receiver. If there is an increase in picture quality and contrast, the converter is introducing losses. In such an instance it would be preferable to install a separate d.p.d.t. switch. The switch within the converter can also be removed and the u.h.f. antenna coupled directly to the input terminals, thus bypassing the switch losses.

Reception can be improved considerably by using tin foil on the transmission line. This has always been helpful



A compact type of u.h.f. converter.

on the upper v.h.f. channels to minimize the effects of standing waves and antenna mismatching. Results for u.h.f. are also excellent. Best results are obtained if two sections of foil are used, as shown in Fig. 1. Such foil is not as effective on the tubular or heavier insulated transmission lines. For best results with such types, add 12 inches of ordinary flat line between the u.h.f. antenna terminals and the u.h.f. transmission line.

A 2-inch section of line works well prior to the converter, while a section from 6 to 8 inches should be used on the line that runs between the converter output and the antenna terminals of the receiver. A slight adjustment of each section of foil for the weakest u.h.f. stations will make a considerable difference in reception. END

## A VERY LOOSE VERTICAL HOLD

PERHAPS, now that I know better, this service job would not seem so unusual to me, but then again I don't know. You be the judge.

A TV dealer called on me to install a new set for a good customer. After plugging in the set, attaching the antenna, and adjusting the controls, we sat back to watch the picture a few minutes. It rolled slightly so I hastened to adjust the vertical hold control. I had just got comfortable when again the picture started rolling. I jumped up to adjust the control, muttering something about the tubes aging fast. I set it again but in 15 seconds the picture was off and rolling again. This continued until I got to the end of rotation and the picture was still rolling and getting faster as time progressed.

Little did I realize that this would be the beginning of a job I wouldn't soon forget.

Explaining to the customer that it's probably a tube, I jerk the back off the set and replace the vertical blocking oscillator tube, a 6SN7, and using my cheater cord, plug in the set, turn it on, and watch for the results. The results are different! Now I am able to stop the picture at the very end of the control range and the picture remains locked in. Not being satisfied with this I put the original tube back and now the picture locks in almost at the same place.

At this point I can hear all the experts say, "It's the heat!" Well I consider myself an expert, so I tell the lady customer that it must be the heat causing some component to change value. She wishes to be very helpful and suggests that it's probably the hold control causing the trouble. So I explain to her very nicely that it is *not* the control because of "the way they're made," and besides, the picture rolls with the control in the maximum clockwise position and keeps rolling faster when the back is on the set.

I also intimate that if she understood blocking oscillators, sync separators, and generally the way a TV set is made she would understand why it couldn't possibly be the hold control.

After promising the customer that it wouldn't take long to repair the set, I rush it off to the shop.

At the shop I pull the chassis and hook it up. The picture starts rolling. I turn the control back to mid-range and the picture stops, but in no less than 30 seconds the picture is rolling again, and again the same process continues until I've twisted the control's tail as far as it will go. The picture still rolls and I'm beginning to wonder about the heat angle. As a matter of fact, I'm desperate, disgusted, and worried. I get out the schematic. A Raytheon 17AY212.

The schematic shows a 470,000-ohm

resistor in series with the hold control from B plus. I decide that probably it's changing value and besides that if I change it to a somewhat smaller value I can get the hold control to stop the picture nearer the center of its range. So I change it to 390,000 ohms and check the results. Sure enough, I can stop the picture very near the mid-range point and it stays put.

I still have not forgotten about the heat business, so I turn the set off for an hour. When I turn it back on I can't stop the picture at all. I finally get it settled down again after about two or three minutes.

I start using resistors, capacitors, and a soldering iron. I replace the 1.5-megohm grid resistor, the 220,000-ohm resistor feeding the boost voltage to the blocking oscillator, the capacitor feeding the sync to the oscillator, but all to no avail.

I study the circuit and decide that maybe the damper tube is warming up slow, I replace it, and also the oscillator transformer, but still the trouble persists. Any attempt to measure voltages so upsets the circuit that interpretation is impossible to my befuddled mind.

The dealer suggests I write the factory and ask their opinion. I agree that it is a fine idea.

The factory writes that it may be the decoupling filter C116, an 8- $\mu$ f unit. "Why didn't I think of that?" I say to myself, as I hurriedly put it in. I turn on the set and find that it's just another new part I'll have to take out and replace with the old one.

By this time the dealer is anxious to sell the set and has a customer who'll buy the culprit at a substantial reduction.

Well, my resistance is gone (as well as my capacitance), so I put the set back together and let him sell it. I'm relieved but somewhat chagrined. I don't like to give up on a set.

This might have been the end of the story if the set had never given any other trouble. Some time later the dealer brought it back with trouble in another circuit. He said also that the new owner was complaining that the vertical hold control was extremely critical. I put in a new hold control, suspecting the old one to be worn out with much use.

Yes, maybe some of you guessed it! The old trouble disappeared. And that, my dear fellow experts, is how I learned . . . "The customer is *always* right" . . . "Don't argue with a woman" . . . and that a radio service expert may not necessarily be a TV expert (because—let's face it—an expert is someone with experience). Another thing, don't let me ever hear anyone say that it can't be the vertical hold control!—

Wayne E. Lemons

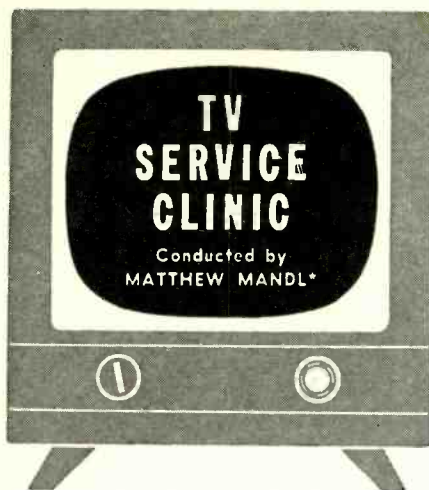

**E**SPECIALLY disliked by service technicians are two types of troubles: Intermittents and those defects which occur infrequently and take considerable time to localize.

Technicians resort to various means to localize intermittents. Among them is placing the receiver in a carton so that the parts will overheat. This often hastens the breakdown and helps locate the defect. On other occasions—if the symptoms localize the intermittent component to a particular stage—they replace all the components in that stage rather than spend hours trying to localize the intermittent one.

Defective paper capacitors contribute to intermittent troubles more than any other circuit component. Thus, time can be saved by making a thorough check of all capacitors which may be responsible for any particular symptom. Some technicians have difficulty in localizing the intermittent capacitor because they make only a routine check, taking a resistive reading of the suspected units. While the  $R \times 1$  megohm scale of a v.t.v.m. is useful for checking leakage resistance, it does not subject the capacitor to its actual working voltage. So it often fails to disclose an intermittent capacitor which may act up only when operating with the proper voltages and while warm.

A capacitor checker should be employed which not only reads the value of the capacitor, but also indicates the leakage at its actual voltage in the receiver. Capacitors should be checked after the set has played a while in the cabinet or in a closed carton. The set is then shut off and one side of the suspected capacitors are disconnected and checked immediately with the capacitor checker. Move the leads going into the capacitor slightly with insulated pliers to determine whether contacts to the capacitor foil are loose.

How a capacitor can contribute to multiple trouble in one stage can be seen from Fig. 1. This is a typical high-efficiency vertical output amplifier as used in the Admiral chassis 20A2. Simi-

\* Author: Mandl's Television Servicing.

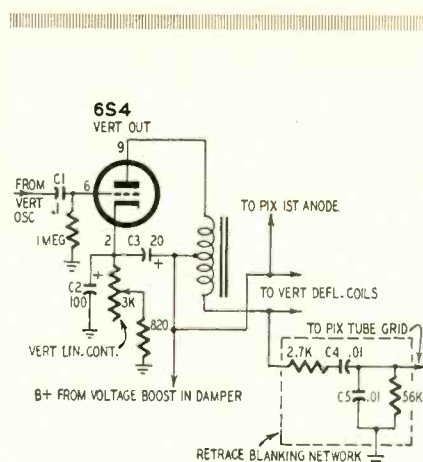

Fig. 1—Admiral 20A2 vertical output.

lar systems are in a number of other receivers. If coupling capacitor C1 becomes intermittent and opens on occasion, it will cause loss of height. If this capacitor becomes leaky it upsets the bias on the 6S4 grid and causes excessive current flow and repeated tube failure.

If cathode bypass capacitor C2 develops leakage, it decreases the voltage drop across the cathode resistive network and again causes excessive current flow through the tube because bias is reduced. When replacing C2, make sure the same value is used. A lower value will not have enough shunt reactance for the 60-cycle sweep frequency and cause degeneration. This will again result in loss of height. The 100- $\mu$ f capacitor shown has a shunt reactance of approximately 26 ohms for the 60-cycle signal.

Leakage of C3 will short some of the B voltage which will then overload the low-voltage rectifier and drop the plate voltage of the 6S4. This will also affect brilliancy because it decreases the voltage applied to the first anode of the picture tube. Leakage in C4, in the retrace blanking circuit, will permit some of the B plus from the vertical output circuit to be applied to the grid of the picture tube. This will cause excessive brilliancy which cannot be controlled by the brilliancy control and can damage the picture tube because it will cause excessive cathode emission. Leakage in C5 will have the effect of shorting the picture-tube grid to ground and eliminating the retrace blanking feature.

Besides intermittent capacitors in this stage, performance will be affected if troubles in the damper circuit occur. This would cause a decline in the B plus fed to the vertical output tube from the voltage boost system of the damper. Thus, an intermittent condition in the horizontal output circuit can also affect the vertical circuit because of the B plus produced in the damper system.

### Pincushion

I recently converted a Transvision model A from a 16-inch tube to a 21-

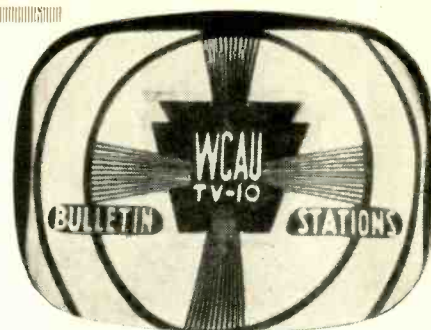

Fig. 2—Pincushion distortion.

inch tube. I get some pincushion effect on all channels and I understand that the cosine yoke has something to do with this. How can this be corrected? S. F., Brooklyn, N. Y.

When a cosine yoke is used with a cylindrical faced picture tube (such as a 21EP4A) the raster will have a pincushion effect which can be eliminated by using two corrector magnets. The corrector magnets extend from the yoke housing bracket and are adjusted on each side of the picture tube to eliminate the pincushion effect. Raster size should be reduced while making the correction, so all edges can be seen. Without the corrector magnets, some picture distortion results even though the picture is expanded so the edges do not show. Fig. 2 illustrates test-pattern distortion in a receiver where the pincushion magnets have not been adjusted properly. The width has been reduced slightly to show the curved sides indicative of pincushioning.

### Cascade tuner troubles

I have an Admiral model 520M16 for repair in which the 6BQ7 has to be replaced approximately every 8 weeks. At one time resistor R104 (see Fig. 3) burned out and I replaced it and capacitor C105. This resistor is again overheating and I would appreciate your advice as to the cause. H. W. E., Milwaukee, Wis.

Since you had trouble with resistor R104 originally, as well as capacitor C105, you should check these units again, particularly since the resistor is again overheating. If bypass capacitor C105 is leaky or shorted, it will cause the resistor to overheat and burn out. A gassy tube could also cause the resistor to overheat. Tubes become gassy when excessive current flows through them. This could be caused by improper bias, so check resistors R111 and R112 in the grid circuit of the second section of the 6BQ7. Also check resistor R110 to see if it is off value.

### Overheated flyback

In a Trav-ler A-16GT receiver, there is unusual heating of the flyback transformer and loss of high voltage. I have replaced tubes in the high-voltage section with no change. Also, what is the

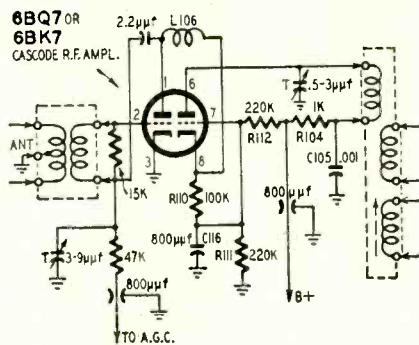

Fig. 3—Admiral 520M16 r.f. amplifier.

value of the video-amplifier plate resistor in this receiver? This went defective prior to high-voltage loss and gave a poor picture. L. R., Cincinnati, Ohio.

This indicates lack of horizontal sweep, which, in turn, would cause high-voltage failure. With loss of sweep the bias on the horizontal output tube decreases and its plate current runs high. This draws excessive current through the flyback transformer, with consequent overheating. Besides a new horizontal output tube and damper, you should also replace the horizontal oscillator tube. If this doesn't help, check the voltages and parts in the horizontal oscillator. A scope test of the signal on the grid of the horizontal output tube will show if the signal from the oscillator is insufficient or totally absent.

The plate resistor you inquired about is 6,800 ohms, 5 watts. Factory recommendation, however, is for a 10-watt rating whenever replacement may be necessary.

#### Intermittent sync

In a Motorola TS410A, horizontal sync is lost after a half hour of operation. I had it in the shop for 11 hours and it stayed in sync. I put a Variac on it and varied the voltage from 90 to 125, and it still stayed in sync. I then reduced the antenna signal and it would not go out of sync.

I've replaced the horizontal oscillator and some components, but when the set is placed in the home, sync instability returns. J. T., Taftville, Conn.

It seems likely that conditions in the home are such that the receiver is subjected to excessive warmth or humidity which is causing an intermittent condition in one of the components of the horizontal oscillator circuit. Another possibility is that the antenna in use at the home is misoriented or is clipping some sideband components near the carrier which would reduce sync amplitude.

First try the receiver in a better ventilated section of the house, or with an electric fan blowing on the rear. This will establish whether or not poor ventilation is causing the intermittent. The antenna should also be checked for ori-

entation, loose connections, or shorts. If the antenna is not the cause, the intermittent component will have to be found by a check of parts in the horizontal a.f.c. and oscillator circuits.

#### Buzz in Crosley

In a Crosley 11-442 I cannot eliminate the intercarrier buzz. I've tried sound i.f. alignment without reducing the noise.

I'm also having trouble with an RCA 21T176 receiver. When the set is first turned on the picture is not sharp and the horizontal line structure seems coarse. There are highlights around images and white lettering is blurry. After a couple of hours brightness is adequate and the picture clears up. Could this be a problem of poor interlace? The vertical hold control doesn't affect the poor quality. I've checked the video amplifier and replaced the 6AG7 as well as the germanium diode. C. S. W., S. Berwick, Me.

For the buzz in the Crosley, adjust the ratio-detector transformer slug. Only a slight adjustment need be made in most cases. If too great an adjustment is made, sound will suffer. If this does not help, make sure all capacitors in the sound section have good ground. Shield the back of the contrast control if it has no shield already. Check lead dress in the sound take-off circuits and keep coupling capacitors well away from other parts. If this doesn't help, align the picture i.f. stages.

In the RCA receiver, the picture tube may be defective. A defective kinescope often produces a silvery appearance of objects with some distortion. The silvery effect increases as the brilliancy or contrast is advanced.

Try a new 6CB6 a.g.c. tube, as well as a 6AV6 first audio amplifier. The latter is also a diode clamp for the a.g.c. system, and troubles here could affect contrast levels and picture quality. Also check the 6BQ7 r.f. amplifier as well as the 6X8 mixer and oscillator. If any one of these tubes is a slow heater it may cause the symptoms you described. Also check to see that the low-voltage power supply delivers adequate voltage after the first minute of warmup. It is unlikely that the lack of

interlace would cause the troubles you detailed. If the foregoing does not help, you will have to check the picture tube.

#### Cascode tuner alignment

In a Tech-Master model 2430 using the Standard cascode tuner, we have tried aligning the set-screws. So far we have succeeded only in decreasing the efficiency of the receiver. Could you please give instructions on how to realign the tuner? A. W., Las Cruces, N. M.

The tuner is normally set at the factory and no tracking should be necessary except for adjustment of the output frequency slug, which is the screw set on a bias on top. The following are the alignment steps:

1. Set the station selector to channel 12.

2. Connect an oscilloscope through a 10,000-ohm resistor to the test point on top of the tuner (small wire loop).

3. Connect a minus 3-volt d.c. battery to the a.g.c. lead of the tuner.

4. Apply a sweep generator to the antenna terminals, sweeping channel 12.

5. Adjust the upright screws on top of the tuner for a flat top response curve and maximum gain.

6. Connect a marker generator (or use the internal marker of the sweep if it has one) and check markers on all channels. They should fall automatically on all channels.

7. Connect a v.t.v.m. in series with the 10,000-ohm resistor to the second detector video output on the main chassis. Remove the tube shield on the 6J6 in the tuner. Couple an AM signal generator to the 6J6, using an ungrounded shield over the tube. Set the frequency of the generator to the video i.f. and tune the screw set on a bias on top of the tuner for maximum voltage on the v.t.v.m.

8. Set the fine-tuning control and adjust the oscillator for best picture and sound for each station. Apply a non-inductive screwdriver into the opening in the front.

#### Uhf converter trouble

We have two Mallory u.h.f. converters in the shop. After five minutes or more the picture becomes snowy and the noise increases. The trouble does not clear up again unless the converter is switched off for a short period. J. McM., Bristol, Conn.

Since the picture becomes snowy and the noise increases intermittently, you should employ the same servicing procedures on the converter as you would with the tuner of a television receiver. First, try new tubes, and if this does not help you will have to make a check of all components. The trouble you described is usually caused by an open capacitor. If the capacitors check all right the fault may be a defective resistor, or a cold-soldered joint. Since temperature-compensated components and critical parts are used in u.h.f. converters, make sure exact replacements are used for any defective resistors or capacitors. END

# YANKEE REPAIRMAN in ENGLAND

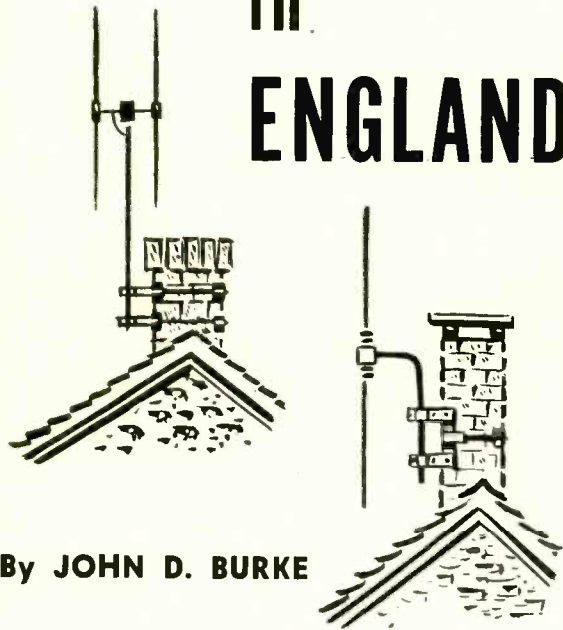

By JOHN D. BURKE

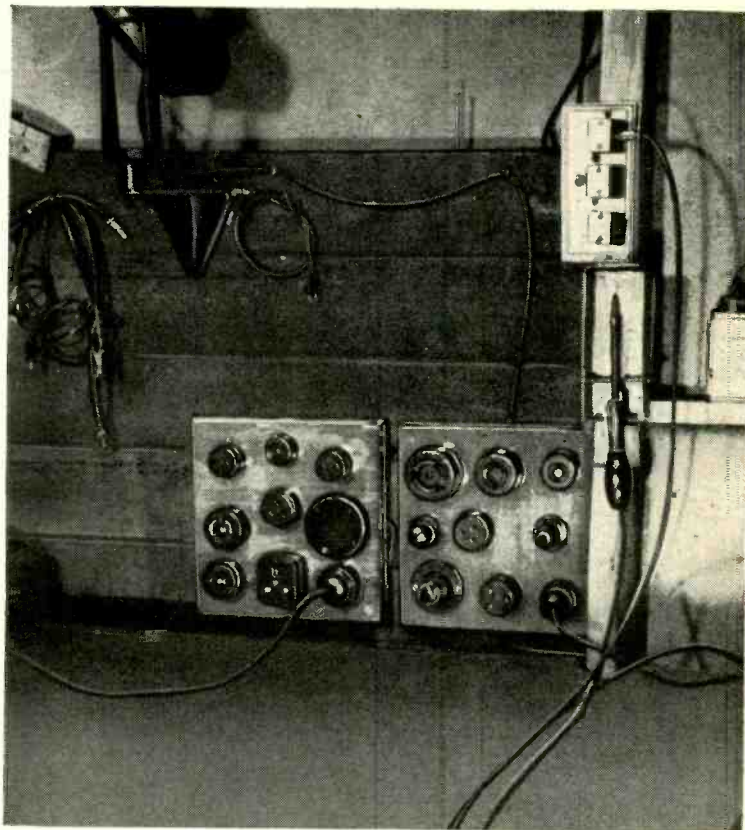

This group of receptacles is needed on every service bench in England, because of non-standardization of electric fixtures.

ACCORDING to the editor of *Wireless World*, H. F. Smith, I have done an original thing in coming to England from the United States to make my living as a TV service technician.

At any rate, he asked for a story on my reactions to British TV. That article appeared in their February, 1953, issue. The title "Fugitive from Pandemonium" gives a good idea of how I feel about the headaches confronting American repairmen. *British Radio and Television* also asked for an article. This latter magazine is limited in circulation to professional repairmen.

To my friends, the readers of *RADIO-ELECTRONICS*, there are a number of interesting things about British television, and also a few ideas for future use.

There is a shortage here of top skilled men. Frequent ads appear, and I was at work within less than two weeks after landing.

After a few weeks on the job, and many hours spent in servicing and discussions on the servicing field, I have come to some very definite conclusions which I believe will be extremely interesting to service technicians in the U.S.:

The pay: Somewhat lower than in the U.S. However, in keeping with the general cost of living, wages are sufficient to live on quite comfortably.

The hours: General average is 44. All shops close at 6 p.m. (However, just as in the U.S., many small shops and individuals work all sorts of hours.)

Working conditions: Good. The several shops I have visited, and the one in which I work, have a very congenial atmosphere.

To give you a picture of the situation, let me list certain facts.

1. While there are now eight TV stations transmitting in Britain, all carry the same program (most of the time). Most operate on different channels, to prevent interference. However, the repairman needs to give the customer satisfactory reception on only *one* channel.

2. The signals are transmitted with vertical polarization. Antennas are oriented vertically, and, in most cases, do not need to be directional. Antenna installation is generally much simpler than in the U. S.

3. TV signals have *positive* modulation. The sync pulses are located *under* the video level, rather than over. Severe noise has no effect on picture lock. Thus, very simple sync circuits can be used.

4. Pictures are transmitted at 25 frames per second (interlaced) and 405 lines. A bandwidth of only 3 megacycles is sufficient. Thus, there is very little problem of alignment; and there are fewer stages of i.f.

5. Sound is transmitted in the AM

form, rather than FM. Thus, simpler sound detection. Actual audio reproduction is high-fidelity.

6. Due to all the above, TV sets are generally much simpler than American sets; no headaches are created by having to satisfy users who expect good reception on many different channels. And antennas do not get out of orientation as a result of wind.

7. The hours of transmission are only half of what many stations in the U. S. operate. Thus, breakdowns occur less frequently; picture tubes last longer; there is less pressure on the repairmen as to speed of service.

8. Because of the comparatively low group of frequencies for TV, the English sets do not even have to have a fine-tuning control (on the front of the set) to take care of oscillator drift. The oscillators hold frequency over long periods.

9. Amazingly enough, my shopmates say that 30% of the sets sold by this concern have not required *any* service at all for the past three years!

10. Small-tube failures are quite as common as in the U. S. except for heater burnouts. Actually heaters burn out rarely! One reason is the common use of series heaters, with the *globar* type of heat-compensating series resistors.

11. Other components are well in-

RADIO-ELECTRONICS



sulated. In particular, the paper capacitors. I have not yet seen a leaky coupling capacitor.

12. A rather high percentage of high-voltage transformers break down. Possibly due to the humid climate. My shop places all finished repair jobs in a temperature-controlled drying room. There is another such room for new sets in reserve stock.

13. Having to operate on only one channel; using vertical polarization

17. Prices for new TV sets are *not* cut. No *discount selling*. All dealers get list price. Only franchised dealers, prepared to render service on the sets they sell, are able to get sets from the manufacturers.

18. No TV fix-it books have been sold to the British public. (Many books are sold telling how to build your own radio or TV.)

19. I have seen only a few ads offering cut-rate repair service; and these

at least four times as difficult here as in the U. S.

We experience such things as a radio set having two diodes in its audio output tube. (Just as if a 50L6 had the detector and AVC diodes included in its structure.)

Lest I be misunderstood, let me make it clear that the English 405-line picture lacks the definition of the American 525-line system. As a TV viewer, I feel the loss of those hundred lines.

But, as a repairman; the problems of 405-line television are much less troublesome.

Furthermore, as Mr. Gernsback said in one of his editorials, by speeding up motion picture film from 24 frames per second to 25, the English are getting excellent *film reproduction* on TV.

Now, of what use is it to tell you all these differences? I believe that certain objectives can be set for our trade in the U. S. The main one should be to reduce some of the more chaotic aspects of the situation: Less frequent changes of models; less recklessness in design; more thought given by the manufacturers to the problem of how their sets are to be repaired.

As long as wide-open competition prevails, little can be hoped for in the way of assuring the small-set-selling dealer a margin of profit, and thereby a chance to render service to customers as a matter of course.

Used TV sets are *not* taken in on the purchase of new sets, here in England. Rather, the tendency is to keep on repairing the old sets, and they retain usefulness and value. I have seen a number of prewar sets still giving good service!

This situation helps the repairmen very much.

The repairmen in the U. S. can register their feelings to a certain extent, and effect some changes.

If this report from England suggests some ideas on how to simplify the problem of servicing TV in the U. S., this writer will feel that his efforts have been well spent. END



The British "Service Engineer" is a dignified individual, who wears a white coat at his occupation.

(and thus reducing airplane flutter)—the typical TV set always receives about the same strength of signal. Thus, there is no need for automatic gain control. Most sets have only manual control. I find this rather hard to get used to. However, one manufacturer (anticipating multiple-channel operation, in part, and mainly seeking to overcome fading in fringe areas) has just announced a.g.c. on his new models, and expects other manufacturers to follow.

14. For various reasons, some of them economic, the rebuilt picture tube is not being used in England. Picture tubes still carry only a 6-month guarantee, and are sold with a heavy purchase tax added. Still—the public pays quite readily.

15. All the above help to explain why such a shop as the one I work for has a very long list of regular patrons for their service contracts. Picture tubes are extra—and both the customers and the shop are quite satisfied with the annual maintenance system. The amount charged is low in proportion to the list price of the set, yet the shop makes a profit on contracts. Work by the job is also done.

16. A much higher percentage of repair jobs go into the shop than in the U. S. Very often the whole cabinet is taken. Incidentally, many of the small consoles are fitted with casters!

were nothing like the "Dollar plus parts" so common in the United States.

20. You may not agree with the idea, but I am beginning to like it! Here in England a person able to repair radio or television sets is called a "Service Engineer." A certain respect goes with the title, and I find the situation better than the pushing around we repairmen often get in the States.

21. It is amazing how many differences are possible in the design of electronic equipment. For example, the triode cathode-ray tube. Hardly used in the U. S., many British picture tubes are triodes!

Another surprise—the use, in some sets, of metallic rectifiers for dampers. A set I saw yesterday used no damper at all, yet linearity was good.

There are a large number of sets using the horizontal sweep-amplifier tube as the horizontal oscillator. (I recall seeing that arrangement in one U. S. set—a Muntz.)

There is a much lower rate of failures in the high-voltage rectifiers than I have been accustomed to seeing.

The general practice comprises only one video-amplifier stage.

There is a huge number of tubes (valves, they say here) of all different sizes, shapes, and characteristics which now must be learned by me. The job of keeping a stock of tubes on hand is

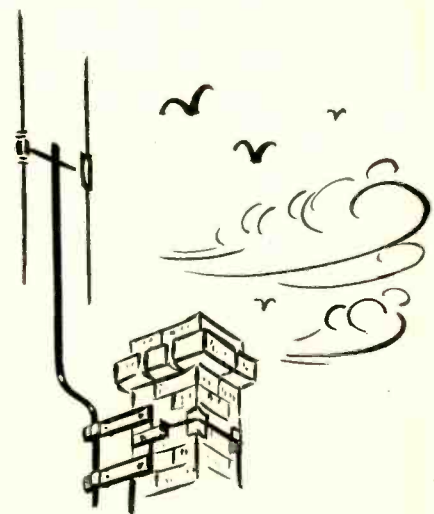

# TUBE CHECKER for A.C. D.C. SETS

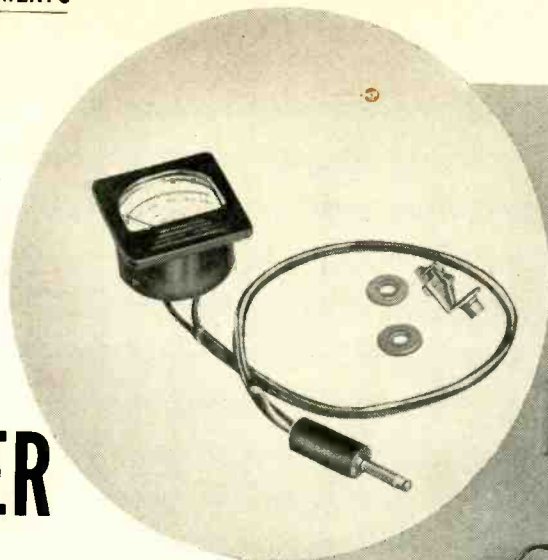

*Series-connected tubes  
require special testing*

By ALVIN B. KAUFMAN

Using ammeter and checker to measure filament current. Components for modification are shown.

**M**ORE than once the service technician will complain that a used tube tests good in his tube tester, but fails to work in the receiver. In the case of tubes coming out of an a.c.-d.c. receiver, the complaint is more than justified.

The tube tester manufacturers answer this complaint with: "Tubes are built to specifications. Our tube testers are designed to test tubes in conformity with these specifications." Unfortunately, this sort of answer does nothing to correct the design of the tester to indicate a bad tube which may be—in the tester at least—inside these specifications.

The reason for the tube failing to perform in the receiver is often that it is not receiving its specified filament voltage. A new tube will generally perform because of its initial high emission. There are two conditions that may cause the difference between the tube tester and actual practice. In battery-a.c. sets, low filament voltage generally results from aging of the battery or line-operated rectifier and associated components. Test these 1.4-volt battery tubes at 1.2 volts to see if the emission is high enough for satisfactory operation with low battery or line-supplied filament voltage. Needless to say, any defective components should be repaired or replaced. Filament voltage is often low because of corroded spring battery clips; in other cases it may be poor set design. In many cases the tube-tester

manufacturer's equipment is quite right in indicating that the tube is good, because it is—when operated within specifications.

With the 117-volt a.c.-d.c. line operated receiver there is another reason for tester's failure to indicate a defective tube. In this type of set the tubes are connected with their heaters or filaments in series. Sometimes—even though the power-line voltage is normal—a series tube with an abnormal filament resistance may appear to be the only one lit brightly (if its resistance is high) or the only cold one (if its resistance is low). Yet—within certain limits—both types may test good on the tube tester.

The reason for this apparently strange action is fairly simple. The current through the string of filaments is regulated by the total series resistance. If the resistance of one filament is low (generally an internal short) it still receives almost the same current, but will not heat up. Placed in a tube tester it draws an abnormally high current, not indicated by the tester, and lights up and performs like a normal tube. If the tube has a high filament resistance, it lights up in the set, robbing its companion tube or tubes, making them appear defective. In the tester, however, the "good" tube (as shown by "set-testing") fails to light, or gives a low gm reading. In this case the tube checker is valuable and gives a meaningful indication.

There are two simple methods which may be used to indicate the acceptability of a tube for series-filament operation. One is to actually measure the filament current drawn by the tube when operated at its specified voltage in a tube tester. The current drawn should be within 10% of the rated tube characteristic. Tubes falling out of this range should not be discarded; they are usable in parallel-heater operation providing emission or gm is satisfactory.

An external a.c. milliammeter jack may easily be added to the average tube tester as shown in Fig. 1. It

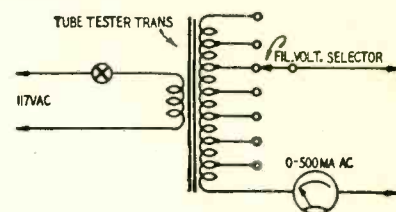

Fig. 1—External a.c. milliammeter is inserted in the filament return lead.

should break the common filament return lead from the tube-tester multi-filament transformer.

An alternate method is to operate the tube heater in series with a dropping resistance from the 117-volt line (Fig. 2). With this method, the voltage across the heater must be measured and be within the 10% tolerance established by the tube manual. This method

# SIMPLE CAPACIMETER

By KAI M. KLEMM

requires many high-wattage tapped resistors and is more complicated than it first appears. With 6-volt heaters, currents range from .15 to 0.9 ampere. With little exception, however, all 6-volt tubes series connected draw either .15 or .30 ampere. The 12-, 35-, 50- and 70-volt series of tubes likewise draw .15 ampere, except for some special types. Assuming the two current values for the 6-volt tubes, and the lower current value for the 12 and higher-voltage tubes, seven resistors (or a tapped bleeder) and a rheostat would be required. The resistors are in series with the tube filament and thus simulate actual use. An external volt-ohmmeter or a standard built-in a.c. voltmeter is used to read the voltage. The rheostat adjusts the supply voltage to exactly 110 volts, then the voltage across the tube is measured.

With both systems the meter can be *red-lined* to indicate the satisfactory range of operation for each series type of tube.

A quick check in receivers where the socket heater terminals are accessible is simply to check the voltage across each tube filament with an a.c. voltmeter. A tube with abnormally high or low resistance will show up immediately. Voltage can be down to 3 volts on a 6.3-volt tube or up to nearly 50 volts on a 35-volt tube in sets that are still working—after a fashion.

Filament voltage checks are fairly easy on any radios in which the socket terminals are visible from the bottom. Simply turn the set upside down, turn it on and measure the voltage across each filament in turn. This procedure should be followed whenever a set has been used with an improper ballast, been subjected to high voltages, possibly affected by lightning, and in all other cases where there is a possibility that the filaments may have been overloaded or abused.

A time-saving method is to build one of these circuits up into a permanent or semipermanent instrument.

With the two or three standard tube

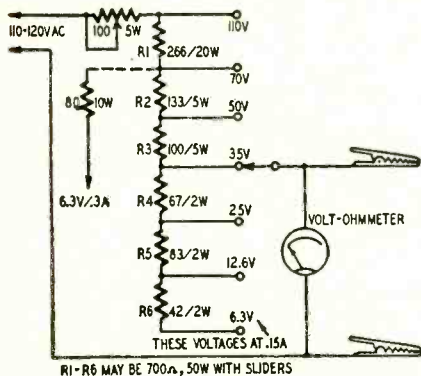

Fig. 2—Circuit for testing tubes by measuring the filament voltage drop.

bases used for the a.c.-d.c. series of tubes, sockets may be permanently wired up to facilitate rapid checking, or small battery clips may be used for connection to the tube under test. END

EQUIPMENT for measuring capacitance is welcome on any experimenter's or service technician's workbench. Such devices are usually expensive impedance or capacitance bridges using one or more tubes and a meter or tuning eye as a null indicator. For a few dollars you can construct this little instrument that measures capacitance over the range of approximately 15  $\mu\text{f}$  to 0.5  $\mu\text{f}$ .

The instrument operates by comparing the frequency of two oscillators. The frequency of one is controlled by a dial and a range switch calibrated in capacitance units. The frequency of the other is controlled by the value of the unknown capacitor connected across the test terminals.

Fig. 1 shows a typical relaxation oscillator consisting of a neon lamp, resistor R, and capacitor C connected to a d.c. supply. The tone in the phones will increase or decrease as the capacitance of C is varied.

Fig. 2-a is the diagram of the capacitance checker. In it, we have two neon-tube oscillators. One has a variable capacitor and a bank of capacitors which may be switched in to vary the pitch. The frequency of the other is determined by the capacitance of the unknown capacitor connected across the

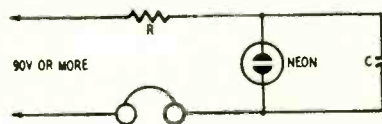

Fig. 1—A simple relaxation oscillator.

test terminals. The outputs of the two oscillators are fed to the phones through the halves of the center-tapped secondary of an audio interstage transformer. Two tones will be heard in the phones when the oscillator frequencies differ. When they are the same, the signals cancel in the center-tapped winding and a null appears in the output. Thus, the value of a capacitor can be determined by adjusting the variable capacitor and the setting of the range switch to produce a null in the phones.

The maximum capacitance that can be measured with the variable capacitor

alone—with the range switch at OFF—depends on its maximum capacitance. It is a 2-gang variable with a maximum capacitance of 1,000  $\mu\text{f}$  with both sections wired in parallel. To measure higher capacitance values, known capacitors are connected across the variable.

The variable capacitor has little effect on the higher ranges—its capacitance is only 2% of the total on the .05- $\mu\text{f}$  range. Therefore, best results on the high ranges are obtained by comparing the tones produced by known and unknown values.

The complete capacitance checker can be constructed in a small metal utility box with the dial of the variable capacitor in the center of the front panel. A pair of binding posts is provided for the unknown capacitor. The neon lamps may be mounted wherever convenient. I mounted one in each of the upper corners of the panel. Operating power is easily obtained. You can use a pair of worn-out 67.5-volt batteries in series, or a simple a.c. supply like that shown at b in Fig. 2.

### Materials for capacitance checker

**Miscellaneous:** 2—1-megohm, 1/2-watt resistors, 1—2.5-megohm linear potentiometer; 1—0.1, 1—.05, 1—.01, 1—.005, 1—.001- $\mu\text{f}$ , 400-volt capacitor, 1—2-gang, 500- $\mu\text{f}$  or 3-gang, 365- $\mu\text{f}$  variable capacitor, 2—NE51 neon lamps, 1—audio interstage transformer with center-tapped secondary, 1—single-pole, 6-position rotary switch, Binding posts, dial, cabinet, and hookup wire.

### Materials for power supply

**Miscellaneous:** 2—33-ohm, 2-watt resistors, 1—40- $\mu\text{f}$ , 150-volt electrolytic capacitor, 1—line switch, s.p.s.t. toggle or rotary; 1—half-wave power transformer, 117-125-volt, 15 ma secondary.

To calibrate the instrument, first determine the maximum capacitance of the variable capacitor, from the manufacturer's data or by comparing it with one of known capacitance. With the range switch in the OFF position turn the capacitor to maximum capacitance and connect a fixed capacitor of the same capacitance across the terminals. Two tones should now be heard in the phones. Adjust the potentiometer for best null. Now connect various other capacitors across the terminals, rotate the variable till a null is heard, then mark the spot on the dial. END

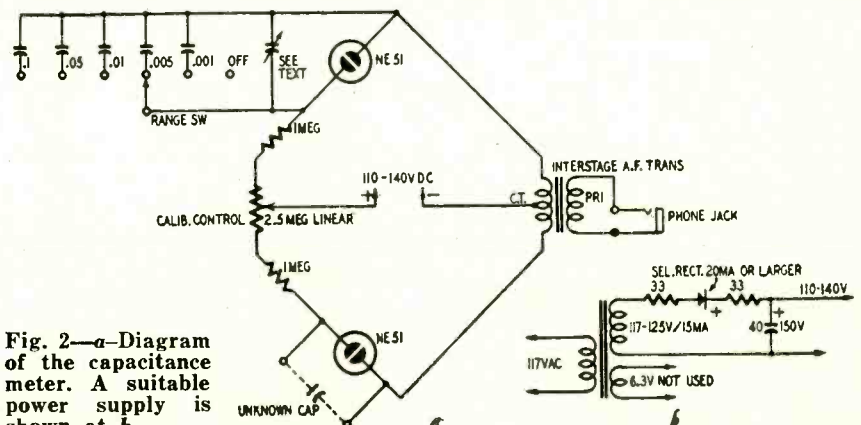

Fig. 2-a—Diagram of the capacitance meter. A suitable power supply is shown at b.

# NOVEL GRID-DIP OSCILLATOR USES 6E5

By ELLIOTT A. McCREADY

THE grid-dip oscillator seems to be one of the most highly publicized pieces of test equipment on the market today. Almost every technical magazine has published construction articles on these little gadgets in the last several months. The relatively simple circuit and small size of this highly versatile instrument make it a must for every service or experimental bench.

To date, however, all of these instruments use a meter as a grid current indicator—usually a 0-100 microammeter. This is not a very large component, but it still adds to the parts list, and meters are expensive regardless of size or range.

Probably the other logical indicating device, an electron-ray tube, has not been used because, among other things, it would add a bulky extra tube to an otherwise compact layout.

The construction and operation of the electron-ray tube seem to have been largely taken for granted, and it has been used strictly, as far as I know, for the purpose for which it was designed—namely, a visual-tuning indicator tube. The 6E5 contains a sharp cutoff triode. This triode makes an excellent amplifier—both a.c. and d.c. Why not use it as an oscillator and let the variation in grid current produced by coupling to an external resonant circuit actuate the self-contained meter, i.e., the shadow

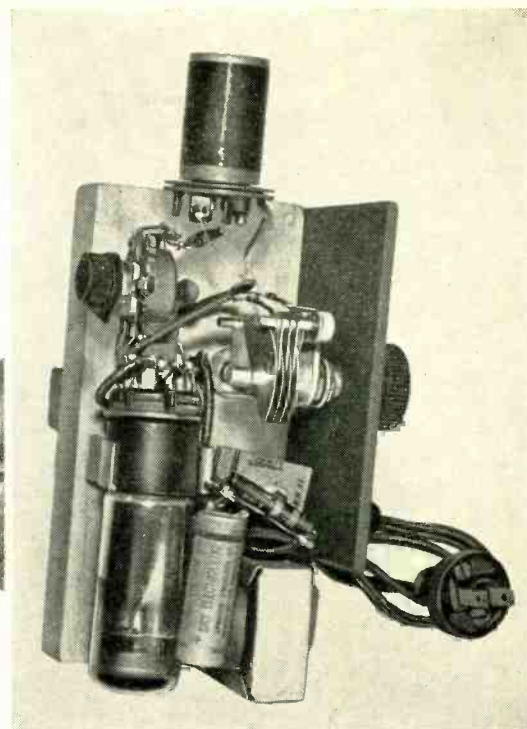
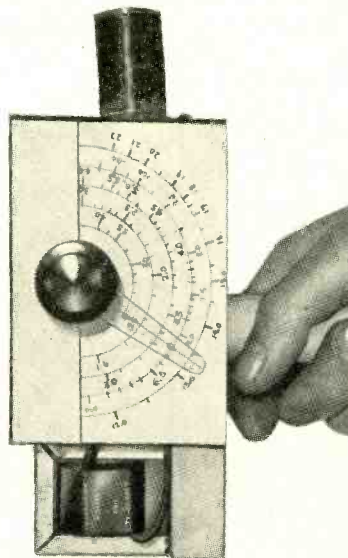

Top and under-chassis views of the grid-dip oscillator. Chassis is made of wood.

This circuit oscillates extremely well at frequencies up to 40 megacycles, and indications are that it will oscillate at much higher frequencies. Coupling of an inch or so to a resonant circuit will produce a decided spread on the "eye" of the 6E5. Readable indications can be obtained at a much greater distance.

The 4.7-megohm resistor in the grid circuit of the 6E5 produced a maximum reading with minimum fuzziness of the shadow. The 1-megohm potentiometer in the plate circuit controls the strength of oscillation to the particular coil in use. The remainder of the oscillator circuit is conventional except for the 100,000-ohm plate resistor which is much lower than the 1 megohm called for in the tube manual for indicator use.

A midget power transformer isolates the instrument from the a.c. line, and a voltage-doubling power supply provides adequate operating voltage for the 6E5. Two 65-ma selenium rectifiers conserve space. No filtering is necessary as the oscillator is not modulated. If the instrument is to be used as a signal generator, an R-C filter should be added to the power supply.

## Construction

The unit was constructed breadboard style. The base is a 3 x 6-inch piece of white pine screwed to a 4-inch wooden handle. The chassis was given 3 coats of shellac and a 1/4-inch hole drilled in the handle to accommodate the line cord. If the unit is constructed in a metal case care must be taken as the tuning capacitor is hot with respect to chassis ground. The photos show a Thordarson filament transformer which was later replaced by a Stancor PS-8415 half-wave power transformer. The two transformers are the same size, so

no alteration in chassis size was necessary.

The instrument was calibrated with a signal generator. The case of the signal generator was removed and the coil of the grid dip oscillator was coupled to the signal generator. Over-coupling will produce an erratic indication of the eye. At higher frequencies there is a slight hand-capacitance effect but this is harmless, as the instrument is always used with the hand on the tuning control. If the instrument is enclosed in a metal case this effect could probably be reduced.

The coils for the grid-dip oscillator were wound with materials at hand and are not critical (see Coil Table). I

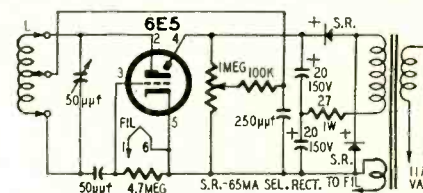

Fig. 1—Schematic of the oscillator.

found that high-Q coils produced a better indication but even this is not too critical. Coils for lower and higher frequencies may be wound experimentally.

## Parts for grid-dip oscillator

Resistors: 1—100,000, 1—4.7 megohm, 1/2 watt; 1—27 ohm, 1 watt; 1—1 megohm, potentiometer.  
Capacitors: 1—50 µuf, 1—250 µuf, ceramic; 2—20 uf, 150 volts, electrolytic; 1—50 µuf, midget variable.  
Miscellaneous: 1—power transformer, 125 volts, 15 ma, 6.3 volts, 0.6 amperes; 2—65-ma selenium rectifiers, 1—6E5 tube; 1—socket for 6E5; 5—coil forms; 1—3 x 6-inch chassis base; 1—4-inch wooden handle; 1—coil-form socket; 1—line cord; 1—scale for calibrating coils; wire.

This instrument has certainly come up to all my expectations and was well worth the time and energy spent in construction. END

COIL TABLE				
Range	Diameter	Wire		Spacing
		Turns	Size	
1.6-3.0 mc	1 inch	114	30	close-wound
3.0-6.0 mc	1 inch	44	30	close-wound
6.0-11.5 mc	1 1/2 inches	21	25	close-wound
11.5-22 mc	1 3/4 inches	9	20	spaced to 1/2 inch
22-40 mc	1 3/4 inches	5	20	spaced to 1/8 inch
All coils center-tapped.				

angle on the 6E5 target?

That which will amplify will oscillate, they tell us; so I decided to see if—and how well—the triode section of the 6E5 would oscillate. It did so, extremely well.

## Circuit

The main problem then remaining was to determine which circuit would provide maximum grid current (and hence grid voltage) variation when the oscillator was coupled to an external resonant circuit. The Hartley circuit was found to be by far the best; and experimental variation of components resulted in the circuit shown in Fig. 1.



**I Send You  
18 BIG  
KITS  
OF RADIO-  
TELEVISION  
EQUIPMENT**

**I'll Train YOU at Home in Your Spare Hours for Big  
Pay Job • Your Own Business • Exceptional Opportunity in**

# **RADIO-TELEVISION**

**ON *New* NO-OBLIGATION PLAN!**

**You Have NO MONTHLY  
PAYMENT CONTRACT**

**to sign . . . you pay for your training  
as you learn and earn... ENROLL NOW!  
Be Ready in Little as 10 MONTHS!**

Now you can get into Radio-Television, today's fastest growing big money opportunity field, in months instead of years! My completely new "package unit" training plan prepares you to qualify as a Radio-Television Technician in as short a time as 10 months, or even less! I offer you my training with no monthly payment contract to sign—thus NO RISK and NO OBLIGATION for you! This is America's finest, most modern and really practical training. Includes FM . . . UHF Television and all the most recent developments. My training gets you ready to handle any practical job in the booming Radio-Television industry. Start your own profitable Radio-Television Service Shop . . . or accept a fine paying job. I have trained hundreds of successful Radio-Television technicians—and I can train you regardless of lack of previous experience. Mail coupon and get all the facts—FREE!

### **VALUABLE EQUIPMENT INCLUDED WITH TRAINING**

Much of your Sprayberry Training is actual construction, demonstration and experimentation. You get priceless practical experience this way. You build the 6 tube Sprayberry Short Wave and Broadcast Training Radio Receiver, the Sprayberry Television set, multi-range test meter, signal generator, signal tracer, cathode ray oscilloscope and many other projects. All this equipment is yours to keep. You have practically everything you need to set up your own profitable Radio-Television shop. All lessons and books I send you remain your own property.

### **OUR 21st YEAR TRAINING MEN FOR RADIO-TELEVISION**

#### **Earn Extra Money While You Learn**

All your Sprayberry Training is given IN YOUR OWN HOME during your free time. Keep on with your present job and income while learning Radio-Television. With each Sprayberry "Package Training Unit" I include money-making plans and special "Business Builders" for spare time Radio-Television service jobs. New Television stations opening everywhere open big money opportunity for men to install UHF antennas—I tell you how! If you expect to be in the Armed Forces later, there is no better preparation than Radio-Television. Mail coupon below . . . get facts FREE. *No salesman will call.*

## **FREE TO YOU 3 BIG RADIO- TELEVISION BOOKS**

**I invite you to get all the facts—**

I want you to have ALL the facts—without cost! Rush coupon for my three big Radio-Television books! "How to Make Money in Radio-Television" PLUS my new illustrated Television Bulletin PLUS an actual sample Sprayberry Lesson—ALL FREE. No obligation and no salesman will call. Mail coupon NOW!

### **SPRAYBERRY ACADEMY OF RADIO**

111 NORTH CANAL STREET, DEPT. 20-K  
CHICAGO 6, ILLINOIS

**Mail  
Coupon  
Today!**

**SPRAYBERRY ACADEMY OF RADIO, Dept. 20-K  
111 North Canal St., Chicago 6, Illinois**

Please rush to me all information on your 10-MONTH Radio-Television Training Plan. I understand this does not obligate me and that no salesman will call upon me. Be sure to include 3 books FREE.

Name.....Age.....

Address.....

City.....Zone.....State.....

Are you Experienced?  No Experience

**TRAIN AT  
HOME IN  
SPARE HOURS**

**IF YOU ARE  
EXPERIENCED IN RADIO**

Men already in Radio who seek a short intensive 100% TELEVISION Training with FULL EQUIPMENT INCLUDED are invited to check and mail the coupon at the right.

# TECH-TRICKS

By HARRY LEEPER

Technicians frequently waste several hours a week due to the lack of certain special tools or devices. Either they don't know that such exist, or their price makes purchase impractical. It is very satisfy-

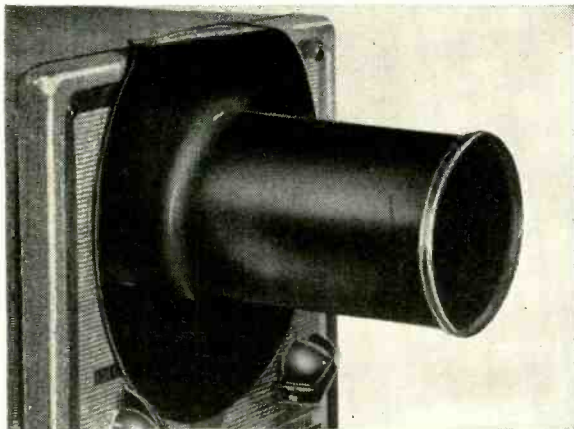

Photo A—A hood for your oscilloscope may be quickly assembled from a couple of tin cans. One can having a diameter somewhat greater than that of the scope tube is opened at both ends. The top or bottom from a larger tin is cut in the center with a circular opening equal to the opening in the first tin. The two parts are then soldered as shown, and painted black. Bending the larger section may be all that is required to attach to some scopes. Drilling and tapping for one or more small screws will hold the hood on all scopes.

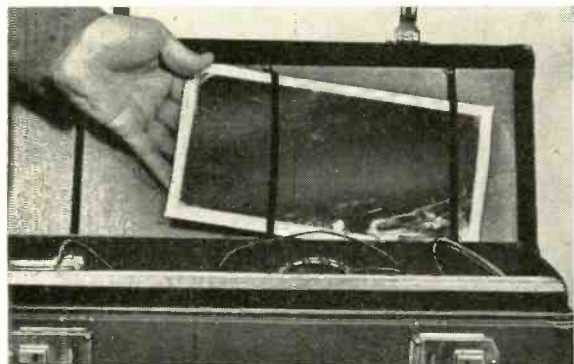

Photo B—A mirror is essential in adjusting TV receivers. Try a piece of mirror glass cut to fit your tool kit. Tape applied around the mirror edges will protect the hands as well as the glass.

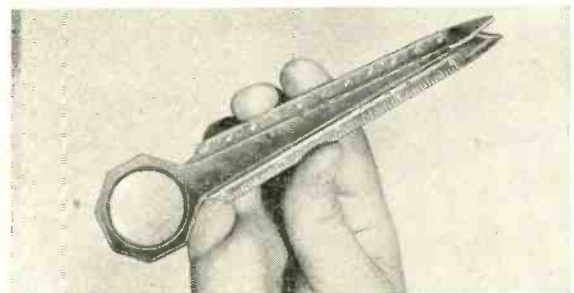
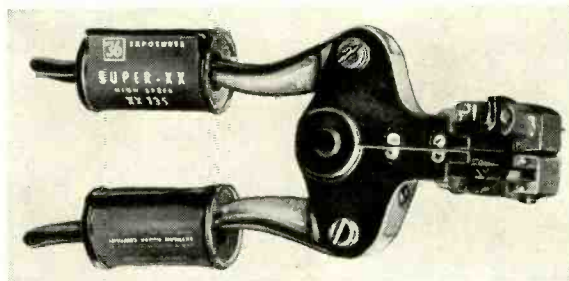

Photo C—A small magnifier with a 6-inch fiber or plastic handle is convenient for checking values marked on capacitors and other radio and TV parts. By cutting a notch in the one end of the handle, such a magnifier may be used as a tool for twisting capacitor or resistor pig tails, or moving wiring.



ing when a technician can contrive a time-saving tool or device from material, perhaps lying around his shop, which up to that time he considered useless. The following ideas may save valuable time:

Photo D—For the mechanic who likes to have his tools neatly arranged around the workbench, wire strippers are difficult to handle. A couple of 35-mm film spools mounted as illustrated will solve this problem. The empty metal spools may be drilled and screwed to the bench or nearby wall with a thin screwdriver, then the top and bottom caps of the spools forced into normal position. When spaced at the proper distance, the handles of the tool will slip through these spools and will be held as shown.



Photo E—In some TV receivers, filament wires or other wires are found shaped around certain tubes as the one shown. To avoid oscillations, noise, or other troubles when replacing or removing a tube for test, make sure the wires are formed around the tube just as you found them.

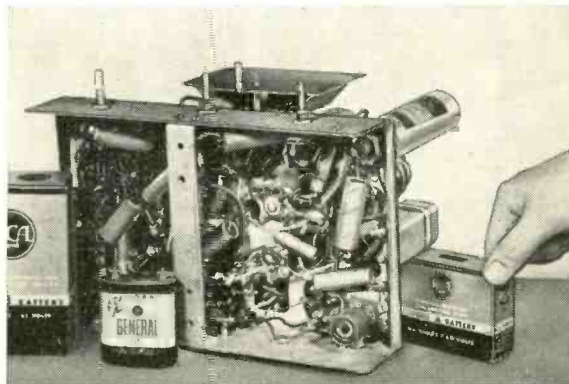
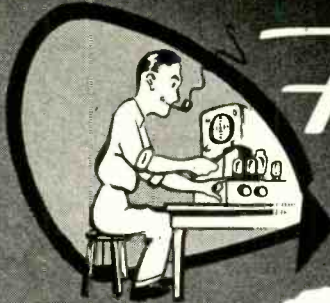

Photo F—Worn-out dry batteries removed from portable radios may be used as supports for a radio chassis. Since batteries of various dimensions can be found, there are usually one or two of the proper size to support a chassis by placing them under some substantial part.

END

BUILD YOUR OWN  
**Heathkits**



- TEST INSTRUMENTS
- AMPLIFIERS
- RECEIVERS, etc.

- ① Save by ordering direct from manufacturer.
- ② All high quality standard brand components.
- ③ Increased knowledge through actual construction.
- ④ Sound engineering insures excellent performance.
- ⑤ Kit construction is fascinating and enjoyable.



**MODEL O-9**  
**\$59.50**  
 Shipping Wt. 28 lbs.

*Heathkit* MODEL O-9  
**OSCILLOSCOPE KIT**

New features unheard of in a kit oscilloscope have been added to the already popular Heathkit series. All top quality components are used including a brand new RCA 5UP1 CRT. Ten other first line tubes complete the lineup. Voltage regulation provides a rock steady pattern regardless of normal line voltage variations. A built-in blanking amplifier eliminates the retrace line entirely. Other important advantages are a phasing control, Z axis input, direct connections to the deflection plates, 1 volt peak-to-peak calibration voltage and a calibrated grid screen.

Wiring is simplified by the use of the harness technique which also results in a neat professional appearance. Extremely wide vertical bandwidth allows accurate reproduction of even a 500 KC square wave. Excellent focusing characteristics are made possible by the use of the new RCA 5UP1 CRT and a spot shape control. One of the most versatile of test instruments, the Heathkit O-9 Oscilloscope will be invaluable in the radio and TV service shop, as a work project in schools and for all types of circuit investigation work in the laboratory. Its new features make Model O-9 comparable in every way to many commercially built oscilloscopes selling for as much as \$400. Don't pass up this opportunity to add a really fine instrument to your service or experimental lab.

*Heathkit*  
**VOLTAGE CALIBRATOR KIT**

The use of a Voltage Calibrator will greatly increase oscilloscope usefulness. Provides a convenient method of making peak to peak voltage measurements by establishing a relationship between the unknown wave shape and the Voltage Calibrator. Voltage ranges .01-100 volts peak to peak. The Voltage Calibrator features direct reading scales and a regulated power supply system.



**MODEL VC-2**  
**\$11.50**  
 Shipping Wt. 4 lbs.

*Heathkit*  
**ELECTRONIC SWITCH KIT**

The Heathkit Electronic Switch Kit will further extend scope usefulness by permitting simultaneous observation of two individually controlled traces. Continuously variable switching rates 10 cps to 2,000 cps in three ranges. Will also serve as a square wave generator over the range of switching frequencies.



**MODEL S-2**  
**\$23.50**  
 Shipping Wt. 11 lbs.

*Heathkit* VACUUM TUBE  
**VOLTMETER KIT**

The beautiful new 1953 Heathkit Model V-6 VTVM, the world's most popular kit instrument, now offers many outstanding new features in addition to retaining all of the refinements developed and proven through the production of over 70,000 VTVM kits. The Heathkit VTVM now features extended voltage ranges with 50% greater coverage on the DC range. New 1 1/2 volt low scale provides well over 2 1/2 inches of scale length per volt permitting faster measurements with greater accuracy. AC and DC ranges are 0-1.5-5-15-50-150-500-1500 volts (1,000 volts maximum on AC). Ohmmeter ranges are X1, X10, X100, X1,000, X10K, X100K X1 meg. Measures .1 ohm to 1,000 megohms. Other features are db scale, center scale zero adjust and polarity reversal switch. High 11 megohm input resistance virtually eliminates circuit loading.

The low anti-inflation price of this tremendously popular kit includes all tubes, necessary constructional material, test leads and the construction manual.

**MODEL V-6**  
**\$24.50**  
 Shipping Wt. 6 lbs.



*Heathkit* AC VACUUM TUBE  
**VOLTMETER KIT**

**MODEL AV-2**  
**\$29.50**  
 Shipping Wt. 5 lbs.

A new amplifier type AC VTVM that makes possible those sensitive measurements so essential in laboratory or audio work. Ten voltage ranges covering from .01 RMS full scale to 300 volts RMS full scale. Input impedance 1 megohm with frequency response 20-50,000 cycles. Ten DB ranges from -52 to +52 DB. Four diodes in meter bridge circuit for maximum linearity.



*Heathkit*  
**HANDITESTER KIT**

**MODEL M-1**  
**\$14.50**  
 Shipping Wt. 3 lbs.

The ever popular Handitester is now supplied with a Simpson 400 microampere meter movement. Provides AC and DC voltage ranges 0-10-30-300-1,000-5,000 volts. Ohmmeter ranges 0-3,000 and 0-300,000 ohms. DC current measurements 0-10 and 0-100 milliamperes. A completely self contained portable instrument.

**HEATH COMPANY • Benton Harbor 20, Mich.**

# HEATHKITS for the ENGINEER

## Heathkit VISUAL AURAL SIGNAL TRACER KIT



MODEL T-3 \$23<sup>50</sup>

Shipping  
Wt. 10 lbs.

Designed especially for service applications in AM-SW-FM-TV repair work. RF and audio two channel input. More than adequate sensitivity—new noise locator circuit—calibrated wattmeter—substitution speaker—visual signal indication. Can be used with scope and VTVM, checks phono cartridges, phono mechanisms, microphones, tuners, etc. Let the Heathkit Visual Aural Signal Tracer help you.

## Heathkit CONDENSER CHECKER KIT

An instrument designed solely for its particular job. Not a "sideline" or a multiple function instrument. Measures value and quality of unknown condensers and resistors. Capacity range .00001 mfd to 1,000 mfd. Resistance range 100 ohms to 5 megohms. Sensitive electron beam indicator—five polarizing test voltages—safety spring return leakage test switch. An amazingly accurate instrument at this low price.



MODEL C-3  
\$19<sup>50</sup> Shipping  
Wt. 8 lbs.

## Heathkit SIGNAL GENERATOR KIT



MODEL SG-8  
\$19<sup>50</sup>

Ship. Wt. 8 lbs.

The standard service instrument for alignment work. .1 volts output from 160 KC to 110 MC. Calibrated harmonics up to 220 MC. Internal (400 CPS) and external modulation. Pre-calibrated coils for all 5 bands. Good stability and accuracy. All test leads included.

## Heathkit GRID DIP METER KIT

One hand operation. 5 pre-wound coils cover 2—250 MC. Controlled sensitivity. Usable as an oscillator or an absorption wave meter. Extra low frequency coils available.



MODEL GD-1B  
\$19<sup>50</sup>  
Ship. Wt. 4 lbs.

## Heathkit LABORATORY REGULATED POWER SUPPLY KIT



MODEL PS-2  
\$33<sup>50</sup>

Ship. Wt. 20 lbs.

A regulated variable 160-450 volt DC output power supply for the lab or service shop. Accurate voltage and current measurements with large Simpson meter. AC supply 6.3 volts at 4 amperes—standby switch eliminates warmup time. Low hum content—5 tube circuit. AC and DC output voltages isolated from panel for maximum operational flexibility.

## Heathkit RESISTANCE SUBSTITUTION BOX KIT

MODEL RS-1

Ship. Wt. \$5<sup>50</sup>  
2 lbs.



Choice of 36 switch selected resistance values 15 ohms to 10 megohms. All standard RTMA 1 watt 10% resistors. Buy several for those lab and service applications.

## NEW Heathkit 20,000 OHMS PER VOLT MULTIMETER KIT

Here is the solution to all service problems requiring a portable measuring device of high accuracy. 20,000 ohms/volt sensitivity on DC and 5000 ohms/volt on AC. Full scale voltage ranges of 1.5, 5, 50, 150, 500, 1500 and 5000. DC current ranges of 150 microamperes; 15, 150 and 500 milliamperes; and 15 amperes. Resistances are measured from .2 ohms to 20 megohms in 3 ranges and decibels from -10 to +65 db.

Model MM-1 uses standard commercially available batteries and is not affected by strong RF fields as encountered in and near transmitting equipment. 1% precision resistors on a very easily wired ring type range switch and a highly accurate Simpson 50 microampere meter fully qualifies the Heathkit Multimeter for close tolerance laboratory and service work. The meter movement is placed in a recessed position for maximum non-glare readability. The kit includes the attractive black bakelite cabinet, 2 color meter scales, test leads, batteries and all other necessary components. Overall cabinet size is 5 1/4" wide x 4" deep x 7 1/4" high.



MODEL MM-1  
\$26<sup>50</sup>  
Ship. Wt. 6 lbs.

## Heathkit TUBE CHECKER KIT

Checks overall tube quality, filament continuity, and individual elements for shorts and opens. Features chart illumination, harness type wiring, and large 3-color meter scale.

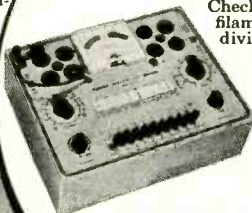

MODEL TC-2  
\$29<sup>50</sup>

Shipping Wt. 12 lbs.

Portable Model TC-2P at \$34.50. Wt. 14 lbs. No. 91-8 Cabinet only at \$7.50. Wt. 7 lbs. No. 355 TV Picture Tube Adapter at \$4.50. Wt. 1 lb.

## Heathkit LABORATORY GENERATOR KIT



MODEL LG-1  
Ship. Wt. \$39<sup>50</sup>  
16 lbs.

A professional laboratory instrument designed for extreme accuracy in frequency and output level. Colpitts oscillator operates in 5 ranges from 150 KC to 30 MC. Panel meter calibrated in output voltage and percent of modulation. Output in excess of .1 volts. Features complete shielding of oscillator, buffer and attenuator sections; regulated power supply and 50 ohm output cable. Comparable instruments priced many times higher than the cost of this new kit.

## Heathkit AUDIO WATTMETER KIT



MODEL AW-1  
Ship. Wt. \$29<sup>50</sup>  
6 lbs.

Measure output power levels directly with the Heathkit Audio Wattmeter. Flat response to frequencies from 10 CPS to 250 KC. Full scale ranges of 5 MW, 50 MW, 500 MW, 5 W and 50 W. Db calibration from -10 to +48. Uses non-inductive built-in load resistors providing impedances of 4, 8, 16 and 600 ohms. Meter bridge uses 4 germanium diodes.

HEATH COMPANY • Benton Harbor 20, Mich.



# SERVICEMAN · AMATEUR · STUDENT

**Heathkit**  
**IMPEDANCE BRIDGE KIT**



Modern design with built-in 1 KC generator for AC measurements. A choice of the Wheatstone, Maxwell, Hay or capacitance comparison bridges for measuring resistance, capacitance, inductance, dissipation factor and storage factor. 1/2% resistors and precision mica condensers provide maximum accuracy. Completely AC operated.

**MODEL IB-2**  
**\$59.50**  
Ship. Wt. 15 lbs.

**Heathkit**  
**COMMUNICATIONS RECEIVER KIT**



Full coverage from 550 KC to 35 MC on 4 bands, with good sensitivity and selectivity. Features electrical bandspread, BFO, headphone jack, slide rule dial with ham band identification, RF gain control, noise limiter and phone standby-CW switch. Top quality, high gain components used throughout. Pre-wound coils in a shielded turret assembly and a transformer operated power supply assure trouble-free performance.

**MODEL AR-2**  
**\$25.50**  
Ship. Wt. 12 lbs. (Less Cabinet)

**Heathkit**  
**AUDIO OSCILLATOR KIT**



Features sine or square wave coverage from 20-20,000 cycles in 3 ranges. Variable 10 volt output level at 600 ohms impedance. Thermistor controlled linearity—precision multiplier resistors—distortion less than .6%. An outstanding instrument value at this amazing low price.

**MODEL AO-1**  
**\$24.50**  
Ship. Wt. 11 lbs.

**Heathkit**  
**DECADE RESISTANCE KIT**



Individual switch selection of twenty 1% precision resistors in 1 ohm steps from 1 to 99,999 ohms. Sturdy ceramic wafer switches featuring silver plated contacts and smooth, positive detent action.

**MODEL DR-1**  
**\$19.50**  
Ship. Wt. 4 lbs.

**Heathkit**  
**Q METER KIT**



A typical Heathkit invasion of the laboratory instrument field. Here is the first successful low priced Q meter ever offered in kit form. Oscillator supplies RF in the range of 150 KC to 18 mc. Reads Q directly on calibrated meter scales. Measures Q of condensers, RF resistance and distributed capacity of coils. Calibrate capacitor with range of 40 mmf to 450 mmf with vernier ±3 mmf. All measurements made at the operating frequency.

**MODEL QM-1**  
**\$44.50** Ship. Wt. 14 lbs.

**Heathkit**  
**AMATEUR TRANSMITTER KIT**



Power input up to 35 watts on 80, 40, 20, 15, 11 and 10 meters. Can be crystal or VFO excited. Complete with modulator input socket and VFO power output provisions. Other desirable features are good shielding, AC line filter, key click filter, standby switch and a 52 ohm coaxial output. Model AT-1 is AC operated and is suitable as an exciter for a higher powered rig. Complete with full instructions for construction and use.

**MODEL AT-1**  
**\$29.50**  
Ship. Wt. 16 lbs.

**Heathkit**  
**TELEVISION SWEEP GENERATOR KIT**



Simplify your TV alignment jobs with the new Heathkit TS-3. Full coverage on fundamentals from 4 MC to 220 MC at an output of well over 100,000 microvolts . . . Automatic blanking and wide range phasing. A triple marker system ranges from 19 MC to 180 MC using a Colpitts oscillator plus the 4.5 MC crystal controlled oscillator for check points (crystal furnished). Provisions are also made for using an external marker. Featured is the new sweep system, using an \*INCREDUCTOR controllable inductor. Sweep width is variable from 0 to 12 MC at the lower RF frequencies and increases to 0-50 MC at the highest . . . Other advantages are power supply regulation, constant RF output level, independent marker and RF output control circuits, low impedance output and properly terminated output cables. The construction manual is complete in all detail and with a reasonable amount of care, Model TS-3 will serve faithfully for many years to come.

**MODEL TS-3**  
**\$44.50**  
Ship. Wt. 18 lbs.

**Heathkit**  
**DECADE CONDENSER KIT**



Switch selected 1% silver mica precision condensers providing capacity range of 100 mmf. to 0.111 mfd. in steps of 100 mmf.

**MODEL DC-1**  
**\$16.50**  
Shipping Wt. 4 lbs.

**Heathkit**  
**AUDIO GENERATOR KIT**



A new extended range 18 cycles —1 megacycle audio instrument at a remarkably low price. Five continuously variable output ranges—600 ohm output impedance—low distortion figure, less than .4% from 100 cps through audible range.

**MODEL AG-8**  
**\$29.50**  
Ship. Wt. 11 lbs.

**Heathkit**  
**BAR GENERATOR KIT**



Small, compact and easy to use, Model BG-1 supplies horizontal or vertical bars for TV linearity adjustments. Output cable clips directly to the TV receiver antenna terminals.

**MODEL BG-1**  
Ship. Wt. **\$14.50**  
6 lbs.

**Heathkit**  
**BATTERY ELIMINATOR KIT**



6 or 12 volt operation with current and voltage constantly monitored. Double protection with a fused transformer and automatic overload relay. Well filtered output and all heavy duty components. Designed for auto radio repair and as a storage battery charger.

**MODEL BE-4**  
Ship. Wt. **\$31.50**  
18 lbs.

**WRITE FOR Free CATALOG**

New 40 page 1954 Catalog lists all kits, specifications, schematics and latest price information.

\*Trademark, C.G.S. Laboratories, Stamford, Connecticut

## HEATH COMPANY · Benton Harbor 20, Mich.



# What's new in...

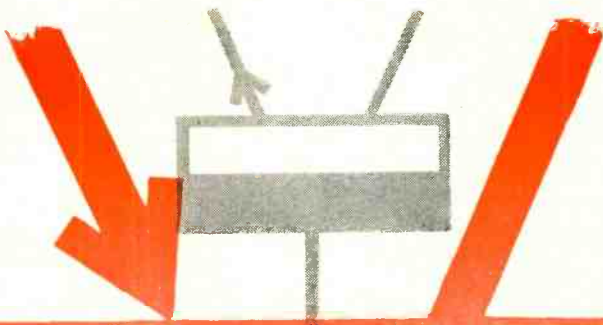

# TRANSISTORS

*Improvements in circuits and in the units themselves accelerate the progress of these newest and "hottest" things in electronics*

**By I. QUEEN**

**T**RANSISTORS remain the hottest thing in electronics, new applications being continually brought forward. Transistors themselves as well as circuits for them are being improved. Recent developments include higher gain, lower noise, and greater stability. Transistors of the future may possibly be grouped or combined without need for transformers or coupling components. Grouping is possible because crystals may be N or P type, and thus complement each other.

William Shockley of the Bell Laboratories, famous for his work on transistors, has designed a bi-stable circuit (Fig. 1). It is assigned patent No. 2,655,609. NPN and PNP junction types are paired. R1 is the circuit load. Resistors R2 and R3, which may be 100 ohms, aid in providing a trigger action. Ordinarily we associate a trigger effect with point-contact transistors. Shockley has obtained the same result with the less expensive junction types.

A positive signal is applied. When

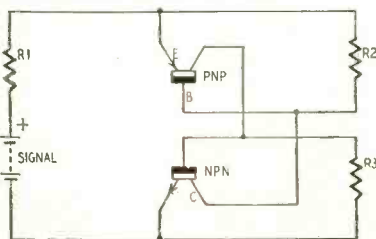

Fig. 1—Bi-stable transistor circuit.

it is low, current through load resistor R1 is small. The voltage drop across R2 and R3 is nearly zero. Since this drop determines the emitter bias for each transistor, each works near cutoff.

If the positive input voltage is increased, more current flows through the circuit. Resistors R2 and R3 produce a greater bias between emitter and base of each semiconductor. The bias is always in the forward direction for each transistor. More bias means more collector flow, and in turn, the emitter bias is increased still further. Soon, each transistor current reaches its saturation value where it remains, and the load current through R1 is maximum. The trigger returns to low conduction when the input voltage is lowered to near zero.

The crystal pair shown in Fig. 1 is equivalent to a single transistor with a current gain  $A/1-A$  where A is the gain of each individual unit. For example, if each has a gain of 0.9 then the equivalent transistor has a total

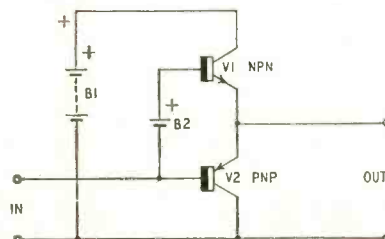

Fig. 2—A transistor amplifier.

gain of 9. The emitter of the equivalent transistor is E, its base is B, and its collector is C.

Another patent (No. 2,666,818) recently credited to Shockley is illustrated in Fig. 2. Again he pairs an NPN and PNP to obtain special effects. The result is a circuit that can handle relatively large amounts of power. As before, we show an arrow (in the emitter lead) pointing *outward* to indicate a NPN unit. The arrow pointing *toward* the crystal indicates a PNP. The two transistors V1 and V2 form a voltage divider across battery B1. Auxiliary battery B2 biases each transistor in the forward direction, that is, toward lower impedance.

When the input signal is zero, the transistors conduct equally. The output voltage is one-half of B1. Electrons flow out of the collector of V1, equal in amount to the holes drawn from the collector of V2. The same number of electrons are injected into the emitter of V1 as holes injected into the emit-

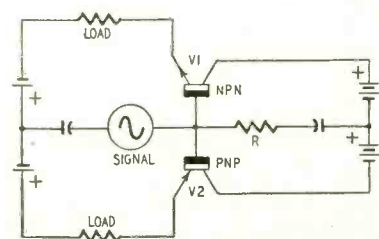

Fig. 3—PNP-NPN balanced amplifier.

# 4 NEW RIDER BOOKS for JUNE

## ADVANCED TELEVISION SERVICING TECHNIQUES

written by the RETMA (Radio Electronic Television Manufacturers' Association) Pilot Training School Teaching Staff

A completely NEW approach to books for TV service technicians. Written by experts who are teaching every day.—The contents have been tried and proven to be the finest ever written. Completely practical. A step-by-step approach to how to service every section of a TV receiver with every kind of test equipment—by resistance measurement, by voltage measurement, by means of the scope. It explains the uses of test equipment of all kinds in connection with TV receiver servicing, such as sweep generators—signal generators—vacuum tube voltmeters—scopes, ohmmeters!

This is not a theory book! It is a book which every technician can use on the bench—and every student in a TV school can use, because it tells what-to-do and how-to-do-it.

Never a book like this. Words alone cannot describe it. You have to see it to believe it! Approx 175 (8½ x 11") pages.

Attention teachers:—the main book above and a laboratory manual for it as well as The Teacher's Guide also are available. Write for details.

## SPECIALIZED AUTO RADIO MANUALS

Cover 5 years production (1950 thru 1954) of factory installed car radios. Identical data from other sources is just not available! Each volume contains: Parts list, Schematics, Tube layout, Voltages, Trimmer Location, Chassis Views, Chassis pictures, Dial stringing and complete installation and removal information.

**VOL 2-A**  
Buick . . . Cadillac . . . Oldsmobile  
200 (8½ x 11") pages, illus. . . . \$3.00

**VOL 3-A**  
Chevrolet, Pontiac, GMC Trucks, Chevrolet Trucks—128 (8½ x 11") pages, illus. . . . \$1.80

## COLOR TV DICTIONARY

by J. R. Johnson

First complete explanation of new color TV terms with their definitions that everyone—service technicians, students, engineers, amateurs—interested in color television must be familiar with. This is more than a dictionary! Over 50 illustrations.

Approx 72 (5½ x 8½") pages

## R-C & R-L TIME CONSTANT

edited by Alexander Schure, Ph.D., Ed.D.

FIRST IN A SERIES of review books written expressly for the student who is studying electronics or the technician who has studied electronics and wishes to understand Time Constant (R-C and R-L) more clearly. It supplements the contents of courses in text books which are on a technical institute level. Covers practical applications of Time Constant and how it effects circuit operation.

About 48 (5½ x 8½") pages

write for complete 32 page  
NEW RIDER CATALOG

Buy these books now from your jobber, bookstore—if not available from these sources, write to:

**JOHN F. RIDER**

PUBLISHER, INC.  
480 Canal Street, New York 13, N. Y.

In Canada  
Mr. Charles W. Panton  
1926 Gerrard Street, East  
Toronto 4, Ontario

Export Agents  
Roburn Agencies, Inc.  
39 Warren Street  
New York 7, New York

West Coast Office  
4218 20th St. Hollywood Blvd.  
Los Angeles, California

Circle address  
February 1954

ter of V2. Thus there is no need for a direct return path for each element.

When the input goes positive, each base receives the positive potential. V1 conductivity increases. At the same time V2 decreases in conductivity. The output voltage is decreased during this time. During the other half-cycle, this process reverses and the output voltage rises. Each transistor contributes toward the power output, yet the circuit needs no transformers, capacitors, or resistors.

Another NPN-PNP balanced pair appears in Fig. 3. It was invented by Gordon Raisbeck who assigned his patent (2,666,819) to the Bell Telephone Laboratories. As before, we indicate the

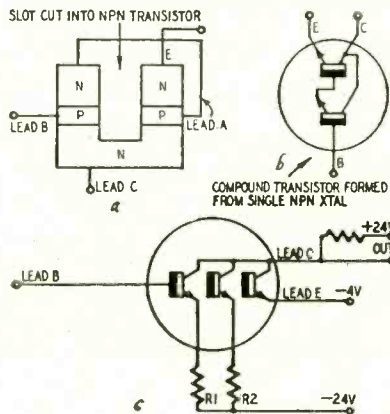

Fig. 4-a—Slotted NPN transistor.  
Fig. 4-b—A compound transistor  
Fig. 4-c—Triple compound transistor.

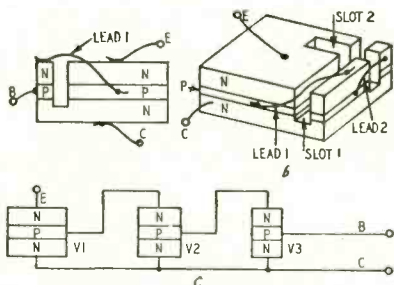

Fig. 5-a—Emitter areas are unequal.  
Fig. 5-b—Slotted compound transistor.  
Fig. 5-c—Analog of Fig. 5-b transistor.

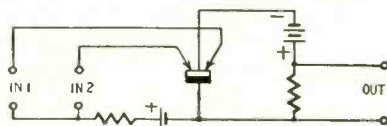

Fig. 6—Transistor tetrode mixer.

NPN junction transistor by an emitter arrow pointing outward. The other transistor, V2 is a PNP type.

The circuit provides push-pull output without a transformer, and the input signal does not have to be balanced to ground. When the a.c. signal goes positive, the same bias is fed to both emitters. V1 conduction is lowered, while V2 is increased. The load receives power from each transistor. As in any push-pull arrangement, even harmonics are canceled out.

There is no d.c. return to the base. It is not necessary. At any given in-

stant there are as many charges withdrawn from one base as are fed into the other. Base current is always zero. Fig. 3 is an amplifier, but may be connected to modulate, detect, or oscillate.

A single junction transistor may be slotted as shown in Fig. 4-a to form a compound unit. It is equivalent to a pair of transistors, yet formed from a single NPN junction crystal. This unit has a common collector, but separate emitters and bases. A Lead A connects one emitter (upper N region at the left) with the other base. Leads E, B, and C are connected to the terminals of the equivalent transistor.

The equivalent transistor (Fig. 4-b) has an unusually high *alpha* or current-gain factor. It is equal to  $1 - (1 - A)^2$ . For example, if an unslotted transistor has an *alpha* of 0.9 the compound unit has an *alpha* of 0.99. Theoretical maximum for a junction crystal is unity.

With suitable slotting, the single NPN semiconductor can be made equivalent to a triple compound transistor, as shown in Fig. 4-c. In addition to the leads E, B, and C, two others are brought out for biasing purposes. R1, R2 are chosen for optimum gain and low idling current.

This compound transistor is credited to Sidney Darlington (Patent No. 2,663,806) and is assigned to Bell Labs.

One disadvantage of the previous transistor is its high collector current when emitter bias is zero. This represents a power loss and may be highly undesirable in some circuits. Bernard M. Oliver has discovered a means of solving the problem. It is disclosed in patent No. 2,663,830, assigned to Bell Telephone Laboratories. He finds that the idling current is minimized if the slots are cut as described here.

Fig. 5-a shows a double compound unit suitably slotted. The areas of the emitters (and bases) are unequal. The ratio should be 1 : 1-A, where A is the current gain of the unslotted semiconductor. If A is 0.9, the slotted areas should have a 10:1 ratio. Fig. 5-b illustrates a triple compound transistor slotted in accordance with this patent. Slot 1 is the first slot which gives the equivalent of two transistors. A second slot makes the unit equivalent to three separate transistors with a common collector C. Lead 1 connects the base of the first transistor with the emitter of the second. Lead 2 connects the base of the second transistor with the emitter of the third. The analog of this compound transistor is shown in Fig. 5-c. The area of V2 is smaller than that of V1. V3 is still smaller.

Other inventors have added to the usefulness of a point-contact transistor by using more than one emitter or base contact. A crystal tetrode has been invented by Robert T. Blakely, patent No. 2,666,150, and assigned to International Business Machines Corp. of New York (Fig. 6).

This tetrode gives the same effect as two separate transistors. Each emitter is fed from an input source, and each provides gain. Thus it is useful as a mixer.

END

**RADIART**  
**Seal-Vent**  
**VIBRATORS**

are **TOPS**

The complete rugged service line of vibrators that has dominated the field for years. Exclusive design plus controlled manufacture guarantees long-life performance! Built to "take it", they work under the most adverse conditions. You too will agree RADIART VIBRATORS are the STANDARD of COMPARISON!

the Complete  
 Replacement Line

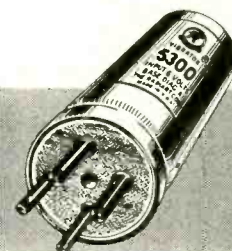

THE **RADIART** CORPORATION  
 CLEVELAND 13, OHIO

TV ANTENNAS • AUTO AERIALS • VIBRATORS • ROTORS • POWER SUPPLIES

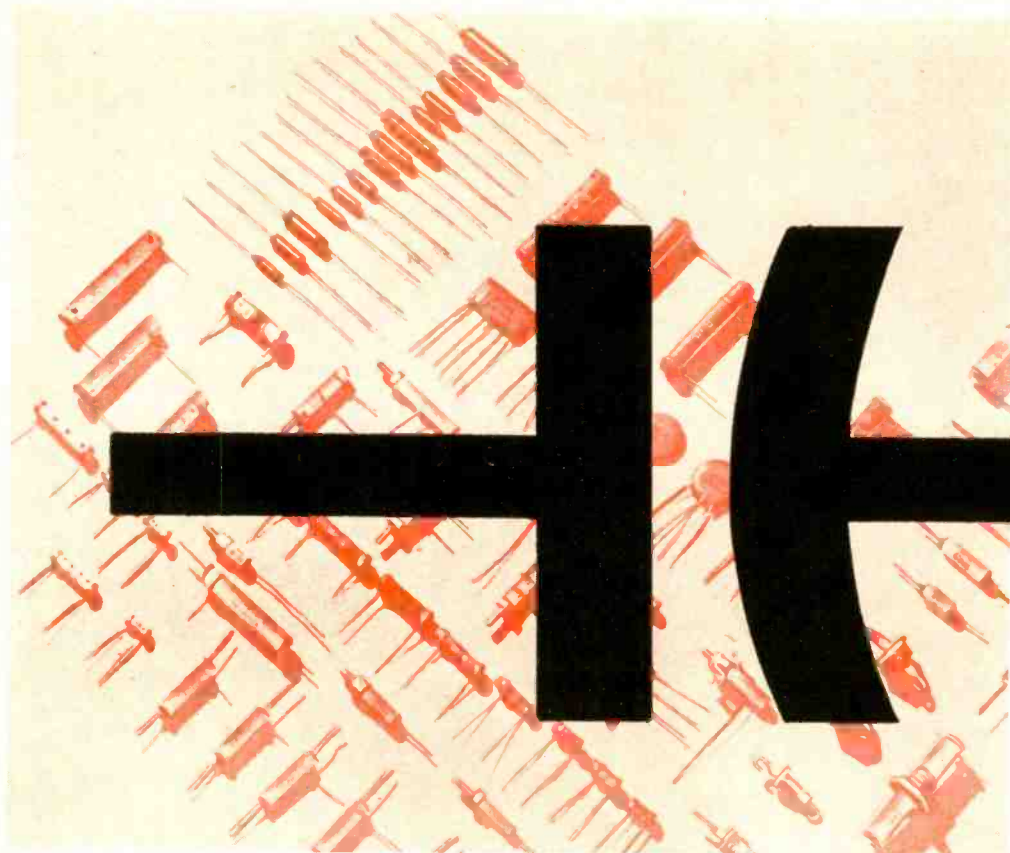

*Composition of the ceramic capacitor; temperature coefficients*

Eric Resistor Co. Photo

# CERAMIC CAPACITORS

By JESSE DINES\*

**N**OT too long ago, in the days when television was still a cloud on the horizon, replacing a capacitor was no problem to the service technician. He determined the capacitance of the defective unit and ordered a new one of the same value, specifying a voltage rating high enough to make sure that it would stand up under normal and abnormal voltages in the circuit where it was intended to work.

The problem which faces the service technician who replaces a capacitor today is a very different one. He has to know about a number of characteristics of capacitors beside the capacitance value, tolerance, and voltage rating. TV and FM circuits are more critical, and the wrong capacitor can produce serious results—or no results at all.

For example, yesterday's technician would not hesitate to replace a faulty .05- $\mu$ f blocking capacitor with any type of .05- $\mu$ f unit, whether mica, paper, or ceramic. If today's repairman tried to replace a defective capacitor in a TV set with the first one of the same capacitance picked up around the shop, he would be courting trouble. For instance, a TV receiver is brought into a service shop. There is no video—everything else

is normal. After trouble-shooting the video detector bypass capacitor—a 5- $\mu$ f N100 ceramic with a tolerance of  $\pm 0.5$   $\mu$ f—is found to be faulty. The service technician replaces it with a 5- $\mu$ f mica capacitor with a tolerance of  $\pm 20\%$ . Although present, the video is now *weak* in spite of complete realignment and several tube replacements.

What is the explanation? The replacement capacitor could have had any value from 4.0 to 6.0  $\mu$ f. But the set was so designed that the value should lie between 4.5 and 5.5  $\mu$ f. Perhaps this alone would not have made that much difference, but what about the N100 ceramic? What does N100 signify? Must a ceramic be replaced with only a ceramic? These are questions that this article will answer.

## Ceramic capacitors

Of the three major types of capacitors used in receivers today—ceramic, paper, and mica—ceramics are the most extensively used.

The years preceding television saw the predominant use of paper capacitors. Mica capacitors were used only in special applications, such as tuned and critical time-constant circuits. Ceramic capacitors were not used to any great extent until recently. Their increasing

popularity stems from their newly discovered advantages over the other types. Ceramic capacitors have a low power factor, high dielectric and high mechanical strength; they are impervious to moisture (0.007% or less); they are easily fabricated in a multitude of shapes (discs, plates, and tubes); they can be made durable; and they are relatively small (many are one-seventh the size of the other types of capacitors). Unlike other types, the ceramic body itself will stand temperatures exceeding those found in electronic apparatus, without causing any changes in capacitance. Also, ceramics permit capacitances of unusually close tolerance at modest costs.

To illustrate the widespread use of ceramic capacitors, Fig. 1 shows the tuner and video i.f. amplifier of Philco chassis 84, H-4 code 103, as well as a table giving the capacitance, capacitance tolerance, purpose, and type of capacitors used. All capacitors shown are ceramics. An analysis of the schematic of the entire television chassis reveals that only a small percentage of paper and mica capacitors are used throughout. The predominance of ceramic capacitors in this chassis is typical of the majority of newly released TV receivers.

Ceramics are composed of the natural  
RADIO-ELECTRONICS

\* Educational Director, Ram Electronics Sales Co., Irvington, N. Y.

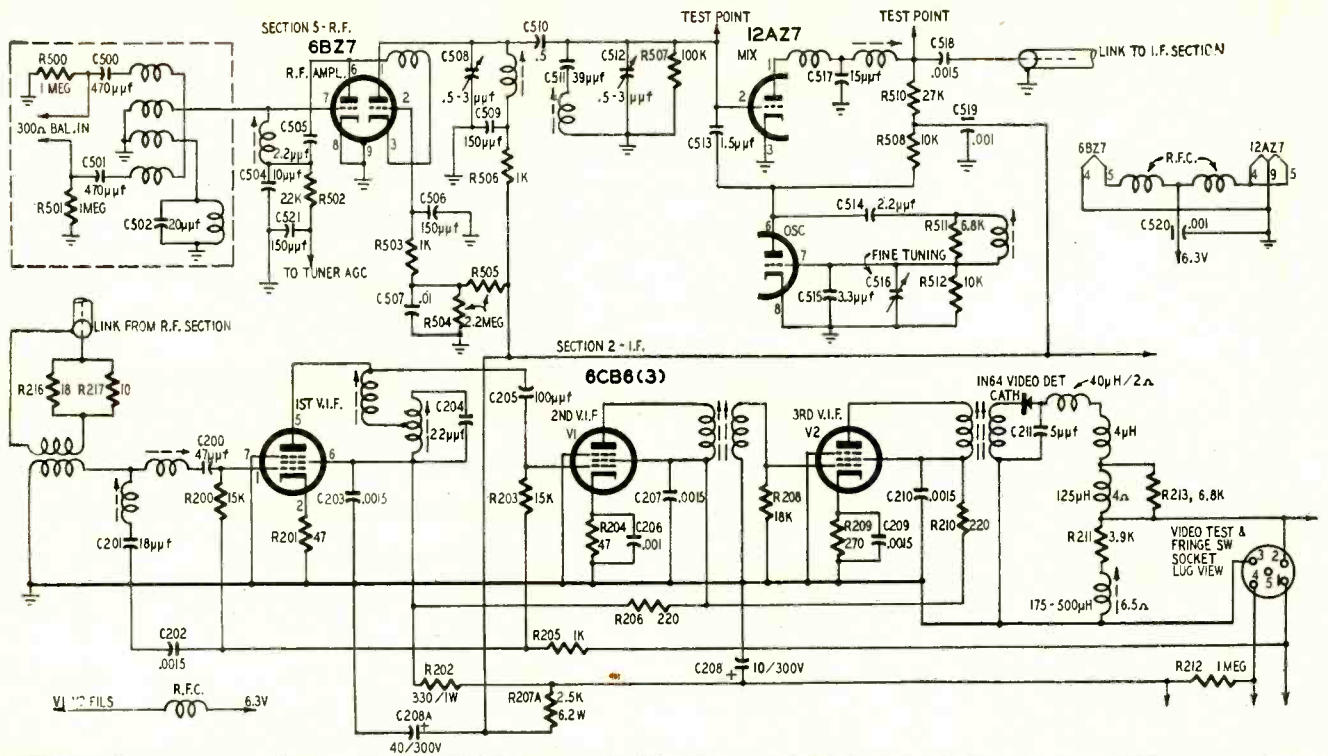

Symbol No.	Capacitance Tolerance*	Purpose	Type Capacitor	Symbol No.	Capacitance Tolerance*	Purpose	Type Capacitor
C200	±5%	D.c. blocking	G.P.** ceramic	C508	±10%	R.f. plate trimmer	G.M.V.*** ceramic
C201	±10%	Trap	NPO ceramic	C510	±10%	Coupling	G.P. ceramic
C205	±10%	D.c. blocking	N330 ±550 ceramic	C511	±10%	Coupling	N330 ±550 ceramic
C211	±5µmf	Detector bypass	N100 ceramic	C512	±10%	Mixer grid trimmer	.....
C500, C501	.....	Antenna isolating	G.P. ceramic	C514	.....	Oscillator Coupling	G.P. ceramic
C502	±5%	FM trap	N330 ±550 ceramic	C515	.....	Grid blocking	G.P. ceramic
C503, C522, C523	.....	Coupling	G.P. ceramic	C515, C517, C204	.....	Fixed trimmer	G.P. ceramic
C504	±1µmf	Bypass	N330 ±550 ceramic	C516	.....	Fine tuning	Ceramic tube
C505	±10%	Neutralizing	G.P. ceramic	C519	.....	Feed-through	G.P. ceramic
C505, C509, C521	.....	Bypass	G.P. ceramic	C520	.....	Feed-through	G.P. ceramic
C507	.....	Decoupling	G.P. ceramic				

\* Tolerance is ±20% when not listed  
 \*\* General purpose  
 \*\*\* Guaranteed minimum value.

Fig. 1—The schematic and table below it illustrate the widespread use of ceramic capacitors in modern equipment.

ural mineral, *rutile*, which has a very high dielectric constant. In the past decade, titanate bodies, made from rutile, were mixed experimentally with oxides of barium, calcium, and magnesium; ceramics with varying characteristics were obtained. From these groups, dielectric constants from 18 to 12,000 (there are indications that 12,000 is not the maximum value) have been obtained. The higher the dielectric constant, the smaller will be the resulting capacitor for a given capacitance.

Ceramic capacitors are made in various forms, such as tubulars, discs, and plates; each manufacturer builds capacitors in his own way, yet all are basically of the same construction. Two cross-sectional views of typical tubular type ceramic capacitors are shown in Fig. 2.

A capacitor consists of two conducting surfaces separated by a dielectric material. This condition is met in Fig. 2 where the dielectric material is a ceramic and the conducting surfaces are homogeneous silver plates. The style CN capacitor has radial leads and is coated with a moistureproof, nonhydro-

scopic plastic. The CI style is insulated with a special end seal compound which allows the wax impregnant to enter and thoroughly fill all the voids inside the steatite tube.

Ceramics serve the same purposes as paper and mica capacitors, such as coupling, bypassing, and d.c. blocking. Table I gives the characteristics and

functions of these three types. However, ceramics have an exclusive function as temperature-compensating capacitors. Noticeable changes in temperature produce changes in capacitance. The amount of capacitance is dependent upon the actual composition of the capacitor: that is, whether titanium dioxide, barium titanate, or any

TABLE I—CHARACTERISTICS OF PAPER, MICA, AND CERAMIC CAPACITORS

TYPE	RANGE (Approx.)	VOLT-AGE	SIZE	RESIST-ANCE	TOLERANCES	FUNCTIONS
Paper	.001 µf to 4 µf	100-1,600	Medium and large	Medium to high	+10-10 +40-40 +20-10 +50-25 +20-20 +60-20 +30-10 +60 25 +40-10 +80-10 +40-20 +80 20 +40-15 (%)	Bypass-.001 µf to 4 µf Coupling-.001 µf to 1 µf D.c. isolating-.001 to .1 µf
Mica	10 µmf to .005 µf	400-30,000	Small	High	General purpose- 2, 5, 10, 20% Silver mica- 1, 2, 3, 5%	Bypass-100 µmf to .005 µmf Coupling-10 µmf to 500 µmf Tuned circuit- 10 µmf to 500 µmf
Ceramic	1 µmf to .1 µf	500-20,000	Small and medium	High	General purpose- 10, 20% Critical Toler- ances- ±.1, .25, .5, 1, 2 µmf Others-1, 2, 2.5, 5, 10, 20%	Bypass-100 µmf to .01 µf Coupling-1 µmf to 500 µmf Tuned circuit- 1 µmf to 500 µmf

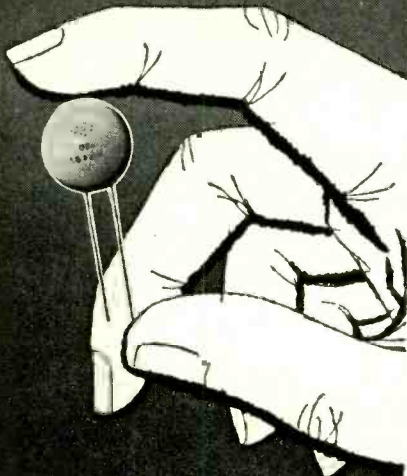

**Centralab**  
1600 V.D.C.W. Ceramic Disc  
**BUFFERS**

combine high capacity in minimum space with a high safety factor

**Totally unaffected by heat, humidity, or vibration**

Talk about ceramic capacitors being made to order for mobile applications—Centralab DD16's fill the bill on every count.

First of all, they're just right for size. They were originally designed for use in electric shavers, so you know they're small. And that's one reason why they're so widely used as buffers in auto radios.

There are other reasons, also. Though DD16's are small in size, they're big in efficiency. They're 100% inspected and tested at twice rated working voltages. And they maintain high capacity and performance up to + 85° C. operation.

Yet, with all this, Centralab DD16's cost less than ordinary paper or mica capacitors of equal rating (35¢ list).

DD16's are conveniently packaged five per envelope, 25 units per carton. Keep a supply on hand for all your mobile needs. See your Centralab distributor.

Send coupon for bulletin 42-202.



CENTRALAB, A Division of Globe-Union Inc.  
922F E. Keefe Avenue, Milwaukee 1, Wis.

Send me bulletin 42-202 on Centralab Ceramic Disc Buffers

Name.....

Address.....

City.....(.....) State.....

D-3054A

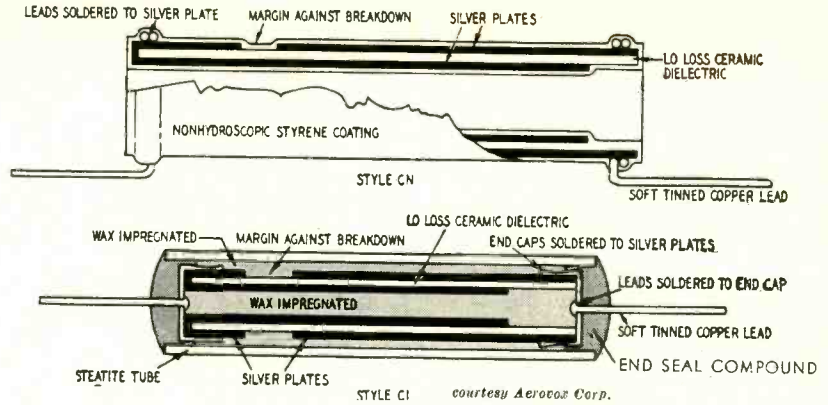

Fig. 2—The cross-section drawings show how tubular ceramic capacitors are made.

other compound is combined with rutile. A temperature-compensating capacitor may serve its normal function in a circuit, or it may have a dual purpose. For example, it may be used for d.c. coupling and at the same time for temperature compensation.

**Temperature compensation**

Changes in capacitance due to temperature changes can be detrimental since they can cause changes in frequency. A tank circuit should be designed so that its natural resonant frequency does not change with temperature changes. As you can imagine, if the tank circuit of the r.f. oscillator

a negative temperature coefficient (TCN) capacitor across the inductive circuit. TCN indicates that temperature and capacitance vary inversely; that is, an increase in temperature causes a decrease in capacitance. In the case of the positive temperature coefficient (TCP), the temperature and capacitance vary directly—an increase in temperature causes an increase in capacitance.

The resultant temperature coefficient (TC) of all the component parts, leads, and connections, etc., of conventional electronic equipment is positive. To counterbalance this effect, a TCN of equal magnitude must be inserted in the circuit, leaving a zero temperature coefficient (TCZ). It is difficult to pre-determine the positive temperature coefficient of a circuit. In most cases, a circuit is first built, then TCN type ceramics with different coefficients are inserted in the circuit. Only through trial and error is the point of best frequency stability reached. It has been found that positive temperature coefficients are fairly constant and uniform in television sets of similar design. This enables the design engineer to approximate beforehand the amount of TCN capacitance necessary. The compensating capacitor is placed at that point in the circuit where maximum compensation is needed.

There are several sections in a television receiver where compensation is necessary; they are, mainly, the r.f., oscillator, and i.f. sections. Either the oscillator or the i.f. circuit may be compensated for, since both circuits work hand-in-hand and thus the compensating of one will take care of the other. If possible, the oscillator is compensated for, since it offers less engineering difficulty. Sufficient compensation can usually be obtained by the addition of one ceramic capacitor to the oscillator circuit. A separate compensating capacitor must be used in the r.f. section as well.

Ceramic coupling capacitors, generally NPO's (N—negative, P—positive, and O—zero, which means that they have neither a negative nor a positive temperature coefficient) are used from the audio frequencies through the ultra-high frequency range. These ca-

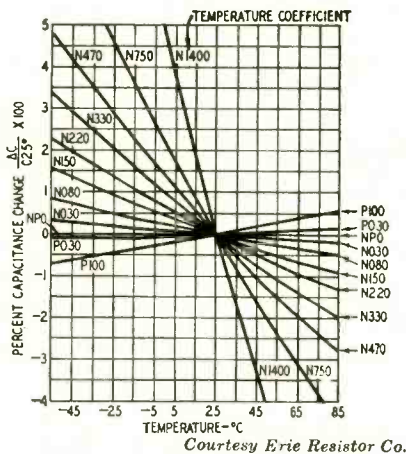

Fig. 3—Capacitance change vs. temperature.

in a television receiver drifted, both sound and video reception would be impaired. While a small amount of drift can be tolerated in intercarrier-type television receivers, it still must be kept within certain limits. Reception will be impaired also by the detuning of any of the several traps, and the circuits associated with the horizontal automatic frequency control.

Transformers, coils, wires, sockets, component leads, etc., increase in inductance as the ambient temperature increases, lowering the natural resonant frequency. This undesirable effect may be minimized, or even eliminated, by using coils of special construction, such as hermetically sealed ones. However, the most economical method is to insert



capacitors are also finding increasing use in test equipment, where careful shielding frequently causes frequency drift through overheating.

**The temperature coefficient**

Temperature coefficient is expressed in parts per million per degree C (p/m/°C). It is written as a number which is preceded by the letters N (negative) or P (positive) in order to indicate whether it has a negative or positive coefficient. Thus N750 has a negative temperature coefficient and P100 has a positive one. Let us analyze the expression *N080 ceramic*. This means that the capacitor has a negative temperature coefficient whose capacitance changes 80 parts (out of every million parts) for every degree (C) change in temperature.

For a better understanding, consider a 1,000-μf capacitor which has a temperature coefficient of N1,400. The 1,400 indicates that it changes 1,400 p/m/°C or 1,400/1,000,000 or 0.0014. Thus every time the ambient temperature increases 1°C, the capacitance decreases 0.0014 × 1,000 μf or 1.4 μf.

**TABLE II  
TEMPERATURE COEFFICIENT TOLERANCES**

Nominal Temperature Coefficient	Tolerance in P/M/°C. on temperature coefficient as determined by measurement at 25°C. and 85°C.			
	Capacitance 0.5 to 2 μf	Capacitance 2.1 to 3.9 μf	Capacitance 4 to 9.9 μf	Capacitance 10 μf and Over
P100	±250	±120	±60	±30
P030	±250	±120	±60	±30
NP0	±250	±120	±60	±30
N030	±250	±120	±60	±30
N080	±250	±120	±60	±30
N150	±250	±120	±60	±30
N220	±250	±120	±60	±30
N330	±250	±120	±60	±60
N470	±250	±120	±120	±60
N750	±250	±120	±120	±120
N1400	±250	±250	±250	±250

Courtesy Erie Resistor Corp.

To illustrate this effect on circuit capacitance, consider the case where the temperature rises to 31° C, only 6° above room temperature (25° C). The total decrease in capacitance is 1.4 × 6, or 8.4 μf. This amounts to an 8.4/1,000 or 0.84% change. Note that it is common for temperatures to rise as high as 85° C in standard electronic equipment.

To illustrate the seriousness of an 8.4-μf change, take the case of an i.f. circuit operating at a center frequency of 40 mc. Using the relationship

$$F_2 = \frac{F_1 \times C_1}{C_2}$$

where F1 = frequency at room temperature,

F2 = frequency at any other temperature,

C1 = capacitance at room temperature,

C2 = capacitance at any other temperature,

F1 = 40 mc, C1 = 1,000 μf, and C2 = 1,000 - 8.4 or 991.6 μf (at 31° C). Therefore at 31° C,

$$F_2 = \frac{40 \times 1,000}{991.6} = 40.33 \text{ mc.}$$

**NEW** 

completely assembled

# 6 and 12 volt DC POWER SUPPLY

## at a comparable KIT PRICE

only **\$39<sup>95</sup>** Net

**MODEL D-612**

**UNMATCHED PERFORMANCE**

0 to 8, 0 to 16v. completely variable.  
0 to 10 amps at 12 v. continuous.

This unbeatable combination of unequalled performance, low price and quality makes the D-612 a must for service technicians. Backed by Electro's reputation for high quality products.

**CHECK! COMPARE! More uses for you!**

- Operates all auto radios. For relays, phone circuits, low voltage devices, electroplating and battery charging.
- Less than 5% ripple over rated ranges.
- Patented EPL conduction cooling.
- Withstands high overloads for long service.
- Same top quality as other EPL models.

**See Your Jobber**

... or contact factory for details and literature. You can't afford to be without the D-612, it's everything you need in a DC Power Supply.

Rush FREE Bulletin DCS-123, giving detailed specifications

**ELECTRO PRODUCTS LABORATORIES**  
4501-Ra North Ravenswood Avenue—Chicago 40, Illinois

Manufacturers of Battery Eliminators and Power Supplies Since 1936

RECEIVING

# TUBES

**THREE TOP BRANDS ONLY!**  
AT TREMENDOUS SAVINGS OVER  
REGULAR WHOLESALE

**OTHER TUBES AVAILABLE AT SAME LOW, LOW PRICES**

Latest Code Dates	Boxed	Fully RTMA Guaranteed	Brand New Pix Tubes Full One Year Guarantee
024 .62	6AK5 1.30	6BQ7 1.42	12AU7 .85
1B3 .95	6AL5 .63	6BZ7 1.52	12BA6 .73
1X2 1.06	6AQ5 .75	6CB6 .76	12BE6 .78
5U4 .63	6AV6 .67	6J6 .92	12SA7 .80
5Y3 .48	6AV6 .60	6K6 .65	12SK7 .77
6AB4 .80	6BA6 .71	6SN7 .85	12SQ7 .67
6AC7 1.25	6BG6 1.98	6V6GT .75	35W4 .49
6AG5 .83	6BK7 1.28	6W4 .70	35Z5 .51
6AH6 1.40	6BQ6 1.42	12AT7 1.05	50L6 .75

Send for FREE catalog of additional tubes and parts

**STUART ELECTRONICS DISTRIBUTORS** 149-09 Union Turnpike  
Dept.—E-6 Minimum Order \$10.00 Flushing 67, N. Y.  
TERMS: 25% Check or Money Order, Balance C.O.D., F.O.B. New York. Satisfaction Guaranteed or money back in 10 days. Olympia 8-3553, 4352

# "COLOR TV TRAINING SERIES" now appearing in PF INDEX the Monthly REPORTER for the Electronic Service Industry

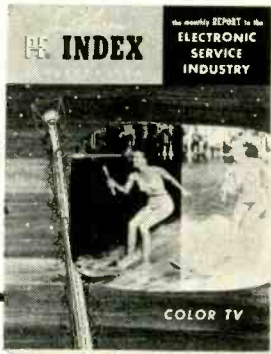

brings you a complete education in COLOR TV based on practical experience with actual receivers, and first-hand data developed exclusively by the editorial staff of PF INDEX . . . appearing month after month. You won't want to miss a single issue . . . so get

## PF INDEX

AT YOUR PARTS DISTRIBUTOR

**get it each month  
only 25¢**

Undoubtedly, a 0.33-mc (the difference between 40.33 mc and 40 mc) change will seriously impair the video of the television receiver.

The temperature coefficient of capacitors on the market today varies from about P120 to N4,700, but there is actually no limit to how high or low it may go. A set of curves showing percentage capacitance change vs temperature for coefficients, ranging from P100 to N1,400 is shown in Fig. 3. The NPO curve has a zero percentage capacitance change; that is, the capacitance of an NPO ceramic does not change with variations in temperature. The higher the temperature coefficient, the greater the percentage capacitance change. To illustrate the use of a curve, take the case of an N150. At minus 55° C the percentage capacitance change is only slightly more than 1.5%; at 25° C (room temperature) its capacitance change is zero; and at 85° C its capacitance change is slightly less than minus 1.0%.

Although the curves are illustrated as straight lines, there is a slight curvature which manufacturers consider negligible and therefore choose to ignore.

Temperature coefficients of ceramic capacitors have a tolerance which is also expressed in p/m/°C. Thus an N1,400 with a tolerance of  $\pm 250$  p/m/°C may range anywhere from N1,150 to N1,650. The tolerance is dependent upon not only the coefficient but also the capacitance. The greater the coefficient, the greater the tolerance; the larger the capacitance, the closer the tolerance. The specific tolerances for different coefficients vary from one manufacturer to another.

Table II (page 81) indicates the tolerances of different capacitance ranges for various temperature coefficients. An N030, for example, changes plus or minus 250 p/m/°C when its capacitance is from 0.5 to 2  $\mu$ f but changes only plus or minus 30 p/m/°C when it is over 10  $\mu$ f. This indicates that closer tolerances and therefore more reliable capacitances can be realized for relatively higher capacitance values.

A capacitance cannot always be obtained at a desired coefficient. The range of capacitances given for any coefficient varies with different manufacturers. Generally, the larger the coefficient, the greater the availability of capacitances.

In many cases, a capacitor is known as a general-purpose ceramic. Such a capacitor can have any TC within the temperature range shown in Fig. 4. These capacitors are used in circuits where changes in capacitance, due to changes in temperature, are insignificant.

An N330  $\pm 500$  p/m/°C capacitor is a general-purpose ceramic, although it appears to be a TCN. The set manufacturers generally use that designation when referring to general-purpose ceramics; this is shown in Fig. 1. Such capacitors are commonly known as SL types and may be replaced with general-purpose ceramics. END

## TAKE IT FROM EDWIN SCHAFFER:

"KRYLON TV Acrylic Spray cuts down contract calls, and spreads the word about my servicing reliability!"



Edwin G. Schaffer, President, Edwin G. Schaffer Co., 7920 Frankford Avenue, Phila., sprays hi-dielectric strength KRYLON on the high voltage sections of TV receivers to prevent corona . . . and he also sprays KRYLON on antennas to weather-proof them. KRYLON TV Acrylic Spray is crystal clear . . . gives lasting protection. It's the push-button spray coating that's become the TV industry's most useful right-hand man!



## KRYLON, INC.

2038 Washington Ave., Phila 46, Pa.

*Krylon also available in Bright Aluminum, Flat Black, Glossy Black, Touch-up White, and Bright Gold.*

AT TV JOBBERS EVERYWHERE

## RADIO • TELEVISION SERVICEMEN!

HERE IS YOUR 1934 OPPORTUNITY  
TO DEVELOP A PROFITABLE  
SMALL APPLIANCE REPAIR SERVICE  
WITH PRESENT SHOP EQUIPMENT

We supply a complete program designed to maintain you in the highly profitable traffic appliance repair field.

**ELECTRIC SWEEPER SERVICE CO.**

"The House of **ESSCO** 100,000 Parts"

2034 EUCLID AVE. • CLEVELAND 15, OHIO

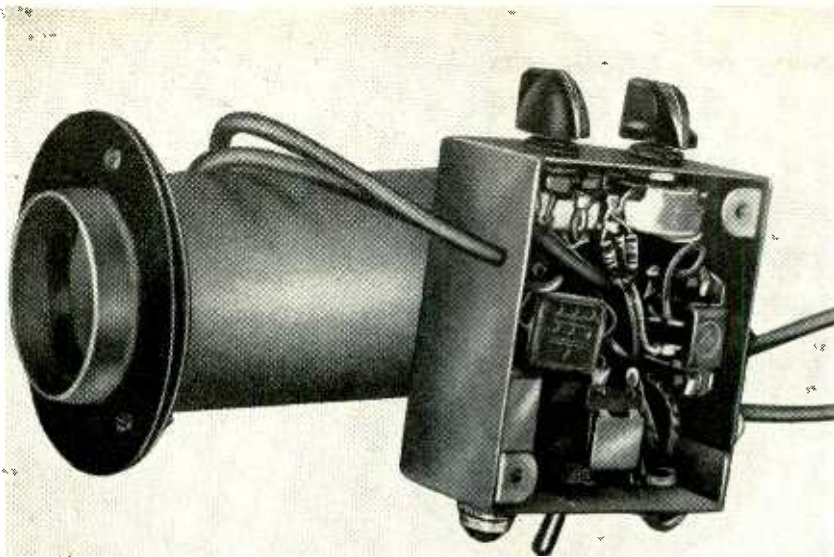

A simple modulation monitor—built at very low cost from surplus parts.

**C**OSTS of cathode-ray tubes and oscilloscopes have dropped constantly until they are now at a level within easy reach of nearly every amateur radio operator. The basic C-R tube indicator in the photo and Fig. 1, was constructed of surplus parts costing less than \$3.00; yet it fully satisfied the need for which it was designed.

Almost every amateur has seen the cathode-ray tube displays of transmitter signals. Still the equipment is not in extremely wide use. At the same time, many who are operating on crowded amateur bands realize the need for greater knowledge and control of emitted signals and so have turned to the oscilloscope as an aid. This discussion describes a simple C-R tube indicator and reviews some old and useful ideas on using cathode-ray equipment around a ham shack.

The basic scope unit in Fig. 1 was designed particularly to be used in a mobile station installation. A few minor changes were made in the usual basic cathode-ray tube circuit. Spot-positioning controls were eliminated, since only a.c. voltages without d.c. components were to be observed. The ground potential was shifted to the tube control grid end of the voltage divider so tube potentials might be furnished by any available high-voltage supply. The C-R tube must be one in which the

cathode and heater are *not* internally connected.

The recommended accelerating potential for most cathode-ray tubes ranges between 500 and 1,500 volts. These tubes will work quite satisfactorily at much lower potentials with some sacrifice of definition. This may be as low as 250 volts. Voltages lower than 500, however, may require a little juggling of the resistor values of the divider to insure control of intensity and focus.

This simple circuit will permit the amateur to make most of the important measurements he finds necessary. The circuit can be built and made a permanent part of the transmitter, using existing supplies or—as the author chose—can be part of a mobile transmitter installation.

**Checking modulation**

There are three principal methods of modulation measurement which suit amateur applications. The pattern traced on the tube screen classifies the method. These are the elliptical trace, the trapezoidal trace, and the wave-envelope trace. Each of these has disadvantages, as well as advantages. Which method the amateur uses remains an individual selection. The methods are discussed in turn.

The elliptical trace is the simplest to produce, yet it is the least known and least used method of modulation measurement. It is simple because it requires only one deflection voltage from the transmitter. That voltage can be taken from an easily placed pickup loop. The connections for this display are shown in Fig. 2.

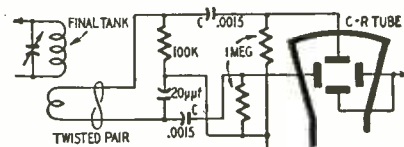

Fig. 2—This connection produces an elliptical modulation pattern on tube.

# WATCH THAT SIGNAL!

By WILLIAM H. MINOR

A loop of 1 or 2 turns of wire with enough lead to reach from the final tank coil to the indicator is connected across a resistance-capacitance phase-shift network. The two out-of-phase voltages developed across the resistance and capacitance are applied to the deflection plates through blocking capacitors.

The 100,000-ohm resistor and the 20- $\mu$ f capacitor may not be the exact values needed for all situations. The trace formed depends upon the frequency of the signal and upon these values—which may have to be changed to obtain a desired shape.

After constructing the circuit, place the pickup loop in the vicinity of the final tank coil. Turn on the unmodulated carrier. The trace which appears on the screen will be a dot, a straight line, an ellipse, or a circle. The dot indicates that there is little or no deflection voltage getting to the plates.

Adjust the pickup loop until a convenient size trace is formed. Now, if there is a straight line or if the ellipse is too narrow, change the 100,000-ohm or 20- $\mu$ f values to make the trace more

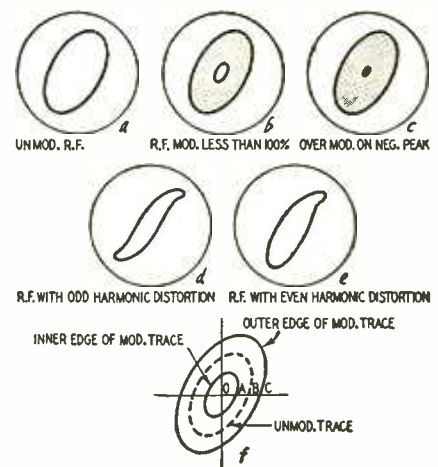
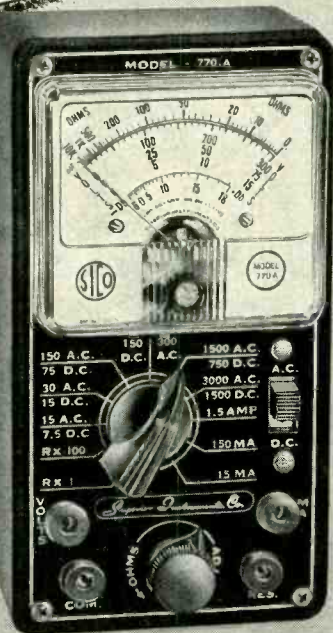

Fig. 3—Patterns obtained with circuit connections in Fig. 2. Points O, A, B, and C in pattern f are used to measure the percentage of amplitude modulation.

**SUPERIORS**  
New Model 770-A

*The first Pocket-Sized*  
**volt-ohm**  
**milliammeter**  
using the new  
**"full-view" meter**



**71% More Scale Area!**

Yes, although our new FULL-VIEW D'Arsonval type meter occupies exactly the same space used by the older standard 2 1/2" Meters, it provides 71% more scale area. As a result, *all* calibrations are printed in large easy-to-read type and for the first time it is now possible to obtain measurements instead of approximations on a popular priced pocket-sized V.O.M.

**Specifications**

- 6 A.C. VOLTAGE RANGES:  
0-15/30/150/300/1500/3000 Volts
- 6 D.C. VOLTAGE RANGES:  
0-7.5/15/75/150/750/1500 Volts
- 2 RESISTANCE RANGES:  
0-10,000 Ohms 0-1 Megohm
- 3 D.C. CURRENT RANGES:  
0-15/150 Ma. 0-1.5 Amps.
- 3 DECIBEL RANGES:  
-6 db to +18 db +34 db to +58 db  
+14 db to +38 db

The Model 770-A comes complete with self-contained batteries, test leads and all operating instructions **\$15<sup>85</sup>**

Write Dept. RC-6 for catalog of complete line.

Manufactured and Guaranteed by



**SUPERIOR INSTRUMENTS CO.**  
2435 White Plains Road New York 67, N. Y.

AT YOUR  
RADIO PARTS  
JOBBER

**OSCILLOSCOPES**  
**ARE**  
**"GOLD**  
**MINES"!**

... if you learn how to use them fully on all types of service jobs!

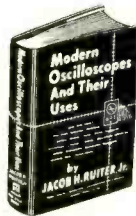

Learn to handle the oscilloscope fully on all types of AM, FM and TV service work—and watch your efficiency and earnings soar!

**MODERN OSCILLOSCOPES AND THEIR USES**, a fact-jammed 326-page book by Jacob H. Ruiter, Jr., of the Allen B. DuMont Laboratories, contains exactly the help you need—written in a way you can clearly understand. It shows you how to use your "scope for fast accurate work on all types of jobs from troubleshooting to realigning; how to make connections; how to adjust circuit components; how to set controls and how to analyze patterns fast and accurately. 370 helpful illustrations including dozens of pattern photos make things doubly clear.

No other type of specific service training stands to mean so much to you in terms of being able to do better, faster, and more profitable work!

- ✓ When, where, why and exactly how to use oscilloscopes
- ✓ How to interpret oscilloscope patterns
- ✓ How to handle tough jobs in less time

**MAIL ORDER 10-DAY FREE EXAMINATION**

Dept. RE-64, Rinehart & Co., Inc., 232 Madison Ave., New York 16, N. Y.

Send MODERN OSCILLOSCOPES AND THEIR USES for 10-DAY EXAMINATION. If I decide to keep the book, I will then remit \$6.00 plus a few cents postage in full payment. If not, I will return book postpaid and owe you nothing.

Name.....  
Address.....  
City, Zone, State.....

Employer's Name & Address.....  
OUTSIDE U.S.A.—Price \$6.50 cash only. Money back in 10 days if book is returned.

**Concord Radio**  
**60% 90% OFF LIST**

**TUBES** • New, Boxed  
**STANDARD BRAND** • Guaranteed

5BP1A	4.95	803	3.50	814	3.95
5CP1	4.95	805	3.50	815	4.95
100TH	5.95	807	1.45	826	.49
304TH	4.95	810	9.95	866A	1.25
304TL	5.95	811	2.95	872A	2.50

TUBE	NET	TUBE	NET	TUBE	NET
1B3GT	1.06	6AL5	.73	6C4	.68
1L4	.70	6AQ5	.90	6CS	.78
1R5	.94	6AG5	.90	6CD6G	.84
1S4	.98	6AU6	.66	6D6G	2.38
1S5	.82	6AV6	.74	6H6	.80
1T4	.90	6AV6	.66	6J5GT	.72
1U4	.90	6BA6	1.28	6J6	1.00
1U5	.80	6EA0	.78	6K6GT	.72
1X2A	1.06	6BC5	.80	6N7GT	.94
3Q5GT	1.12	6BE6	.82	6P8	1.16
3S4	.88	6BG6	2.10	6V6GT	.80
3V4	.88	6BH6	.92	6WAGT	.78
3V4	.70	6B7A	.84	6W6GT	.88
5U4G	1.50	6B7B	1.16	6X4	.66
5Y3GT	.82	6B7C	1.40	6Y4	.66
6AC7	1.34	6BQ7A	1.40	12AT6	1.16
6AH6	1.56	6BQ7B	1.40	12AT7	1.16
6AK5	1.74	6BK7	1.28	12AU6	.74
				50L6GT	.78

**FREE! NEW 1954 CATALOG!**

A complete, comprehensive listing of all your electronic requirements. Bursting with SPECIAL VALUES

Terms: 20% with order. Balance COD. All prices FOB. NEW YORK Warehouse. Minimum order \$5.00.

**CONCORD RADIO** Dept  
53 Vesey St., N. Y. 7. N6

Send new 1954 CONCORD CATALOG!

NAME.....  
ADDRESS.....  
CITY..... ZONE..... STATE.....

**CONCORD RADIO • 53 VESEY ST.**  
**NEW YORK 7, N. Y. • Dlgy 9-1132**

circular as in Fig. 3-a. Patterns *d* and *e* indicate r.f. distortion.

Modulate the carrier to cause the elliptical trace to expand inward and outward, forming a band. See Fig. 3-b. If the modulation is a single tone obtained from a generator or by whistling a sustained note into the microphone, the band will remain stationary. Speech patterns cause the band to shift at an irregular rate.

The eye of the ellipse just closes at 100% modulation. Set the transmitter gain control to the point where normal speaking will almost—but not quite—close the trace on modulation peaks. A bright spot in the center as in Fig. 3-c indicates overmodulation.

A rather crude but fairly accurate way to determine the percentage of modulation is to make the measurements shown in Fig. 3-f. Measure the distances along a horizontal line. Measure from the center of the ellipse to the unmodulated trace. Call this distance OB. Measure the distance from the unmodulated trace to the inner and outer edges of the modulated band. Call these AB and BC respectively. Now compute the modulation percentage:

$$\% \text{ modulation (negative peaks)} = \frac{AB}{OB} \times 100$$

$$\frac{AB}{OB} \times 100$$

$$\% \text{ modulation (positive peaks)} = \frac{BC}{OB} \times 100$$

$$\frac{BC}{OB} \times 100$$

The advantage of this method is its extreme simplicity. It does have some disadvantages. Distortion and carrier shift are not as readily apparent as with other techniques. Distortion in the audio is not easily seen.

Use this method if the particular interest is in modulation peaks or static changes in transmitter output.

**The trapezoidal pattern**

This is the most frequently used trace for observing transmitted signals.

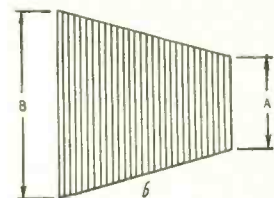
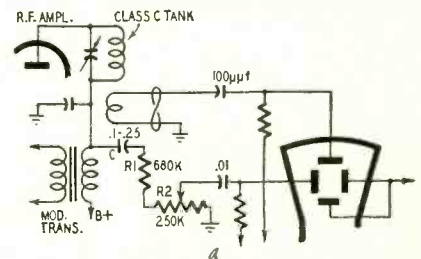
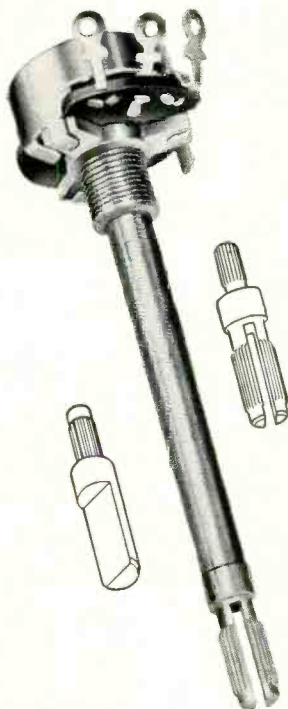

Fig. 4—Make connections shown at *a* to get trapezoidal pattern like *b* on the face of the C-R tube. The trapezoidal pattern may slope to left on some scopes.

The easy way  
is the right way . . .

when you use *Mallory Midgetrols*®



*Easy*

because the round, tubular shaft of the Mallory Midgetrol can be cut accurately and quickly. Easily adapted to split-knurl, flatted, or set screw type knobs. And you save additional time because AC switches can be attached instantly without control disassembly.

*Right*

because Mallory Midgetrols are engineered to match the electrical characteristics of original equipment of any radio or TV set . . . give equal, often better, performance than the original control.

*For Jobs*

done right the easy way, always use Mallory Midgetrols. You'll save time and trouble. And, equally important, you can depend on Mallory Midgetrols for performance that makes satisfied customers.

To make your auto radio repair work easier . . .



The new Mallory Auto Radio Control Guide speeds selection of the proper control for every job that comes your way. Ask your Mallory Distributor for a copy . . . or write to P. O. Box 1558, Indianapolis, Ind.

P. R. MALLORY & CO. Inc.  
**MALLORY**

CAPACITORS • CONTROLS • VIBRATORS • SWITCHES • RESISTORS  
RECTIFIERS • POWER SUPPLIES • CONVERTERS • MERCURY BATTERIES  
**APPROVED PRECISION PRODUCTS**

**P. R. MALLORY & CO. Inc., INDIANAPOLIS 6, INDIANA**

# Build Your Own Interior-Styled Cabinets

## KITS

by **Cabinart**

presenting the

### paul klipsch-designed REBEL IV . . .

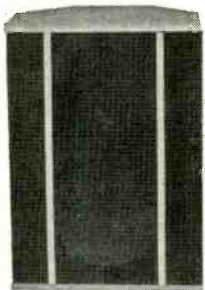

Now you can build your own Klipsch Corner Horn Enclosure and save money — identical in acoustic design to assembled units and easily put together with a minimum of tools. Priced for the home-builder in unfinished birch.

**\$36.00\*** Net for 12" model  
**\$42.00\*** Net for 15" model

### BASS REFLEX and EQUIPMENT CABINETS

Ideal housing for hi-fi components — removable panels make future changes easier. Loudspeaker cabinet acoustically designed for either 12" or 15" speaker.

Overall dimensions: 33 1/2" x 23" x 16 1/2".  
 Tuner Compartment: 20" H., 21 3/4" W. (inside dimensions), 15 1/4" Deep.  
 Baffle volume: 6 cubic feet.



All kits include 5/8" white pine plywood cut to size, baffle pre-cut for 12" or 15" speaker, Saran Plastic Acoustcloth, Kimsut Acoustic Insulation, Assembly and finishing instructions, hardware, plastic wood, sandpaper and glue.

**No. 80 . . \$27.00\***  
 (Equipment Kit)

**No. 8112 . \$18.00\***  
 (12" speaker)

**No. 8115 . \$18.00\***  
 (15" speaker)

### CORNER FOLDED HORN ENCLOSURES

Reproduces a quality of bass heretofore only possible through the use of far more expensive designs.

**No. 61 (12" speaker) . . \$19.95\***

**No. 63 (15" speaker) . . \$23.95\***

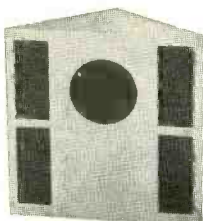

Write for free catalog and nearest distributor  
 \* Prices higher West and South.

**G & H WOOD PRODUCTS COMPANY**  
 75 NORTH 11th STREET  
 BROOKLYN 11, N. Y.

Though it is not so simple to connect as the equipment for elliptical traces, it is easier to adjust and to read. The patterns give a clear indication of modulation and of many transmitter faults as they occur.

A pickup loop as previously described is connected to one of the deflection plates. The vertical plate is usually chosen for this connection, but there is no reason why the horizontal plate should not be used instead.

The other deflection voltage is taken from the modulation transformer. Ordinarily the a.c. voltage at the transformer is high enough to drive the spot off the tube screen. Fig. 4-a shows the connections. R1 and R2 serve as a voltage divider from which just enough voltage is tapped to give the desired deflection. No exact values are given, for they depend upon the available voltage and that necessary for the particular cathode-ray tube. The peak voltage at the junction of R1 and R2 should be about 150 for a 2-inch tube. The d.c. voltage on the secondary of the modulation transformer is blocked from the voltage-divider network and the deflection-plates by a 0.1- or 0.25- $\mu$ f capacitor, C, which must be rated for at least twice the r.f. amplifier plate voltage.

To use this circuit fix the pickup loop in the vicinity of the final tank coil and turn on the unmodulated carrier. A vertical line should be formed. Adjust the loop until this line is about one-quarter the screen diameter. This line should be thin like a pencil mark. If it

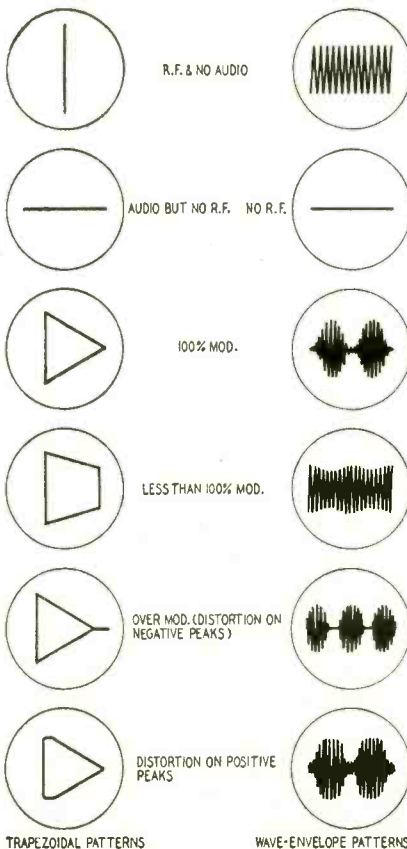
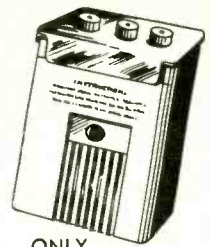

Fig. 5—Typical oscilloscope patterns for checking amplitude modulation.

## HERE AT LAST!

### VEST POCKET TESTER

A mighty might. It virtually replaces the VTVM. Excellent sensitivity. Checks leakage beyond the range of most meters. Checks AC or DC Voltages. Checks presence of RF and High Voltages up to 30 KV. Tests and Quality checks all types of Condensers. Checks tubes, transformers and many other important applications!



ONLY **\$8.95**

Complete Postpaid with leads and interlock cord.

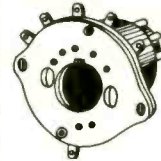

Horizontal Bar Generator  
**\$1.95**  
 Postpaid

NEW! IMPROVED! H.B.G. with CRT TEST ADAPTER

Checks CRT and Yoke setting, height, linearity and alignment. Can be used with vest pocket tester to check equality of CRT and operating voltages.

SAVE MONEY ON COMBINATION OFFER!  
 BOTH UNITS FOR **\$9.95**

Send Check or Money Order with order. Save C.O.D. and Postage Charges.

**BRUNO-NEW JERSEY, INC.**  
 12 HENNION PLACE  
 BLOOMINGDALE, N. J. DEPT. B

## precise TRANSISTOR KIT

Here is the unique PRECISE TRANSISTOR KIT that supplies you with all the components necessary to perform innumerable experiments . . . along with many prepared experiments including audio one stage amplifiers through transformer-coupled amplifiers . . . and into special circuits. Instruction book teaches you the theory of transistors in simple non-mathematical terms.

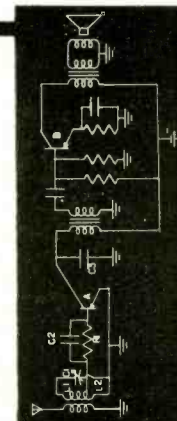

- ★ Audio oscillator
- ★ RF oscillator
- ★ Signal tracer
- ★ Tuned signal tracer (TRF type receiver), etc.

TI . . . Kit **\$17.95**

WRITE FOR 1954 CATALOG INCLUDING NEW HIGH FIDELITY INSTRUMENTS IN KIT & WIRED FORM

**PRECISE DEVELOPMENT CORP.**  
 Oceanside, New York



**IF** You have never ordered by mail because you did not want to buy anything "sight unseen" or —  
 You have ordered by mail but with disappointing results or —  
 You have never purchased anything on time payments because of excessive finance charges, then —

— **HERE** —

is your opportunity to examine what you want under our "Seller not Buyer, takes" all the risk" plan. We invite you to order any item on this page and examine it in the privacy of your own home. If you decide to keep it, you

can then pay the balance in easy monthly payments with no interest or finance charges added. Otherwise, you may return the merchandise for prompt refund of your down-payment.



Superior's new  
Model 670-A

# SUPER METER

A COMBINATION VOLT-OHM MILLIAMMETER PLUS  
CAPACITY REACTANCE INDUCTANCE AND DECIBEL MEASUREMENTS

**SPECIFICATIONS:**

D.C. VOLTS: 0 to 7.5/15/75/150/750/1,500/7,500 Volts  
 A.C. VOLTS: 0 to 15/30/150/300/1,500/3,000 Volts  
 OUTPUT VOLTS: 0 to 15/30/150/300/1,500/3,000 Volts  
 D.C. CURRENT: 0 to 1.5/15/150 Ma. 0 to 1.5/15 Amperes  
 RESISTANCE: 0 to 1,000/100,000 Ohms 0 to 10 Megohms  
 CAPACITY: .001 to 1 Mfd. 1 to 50 Mfd. (Quality test for electrolytics)  
 REACTANCE: 50 to 2,500 Ohms 2,500 Ohms to 2.5 Megohms  
 INDUCTANCE: .15 to 7 Henries 7 to 7,000 Henries  
 DECIBELS: -6 to +18 +14 to +38 +34 to +58

**ADDED FEATURE:**

The Model 670-A includes a special **GOOD-BAD** scale for checking the quality of electrolytic condensers at a test potential of 150 Volts.

The Model 670-A comes housed in a rugged, crackle-finished steel cabinet complete with test leads and operating instructions.

**\$28<sup>40</sup>**  
NET



Superior's new  
Model TV-11

# TUBE TESTER

**SPECIFICATIONS:**

- ★ Tests all tubes including 4, 5, 6, 7, Octal, Lock-in, Peanut, Bantam, Hearing Aid, Thyatron, Miniatures, Sub-miniatures, Novals, Sub-minars, Proximity fuse types, etc.
- ★ Uses the new self-cleaning Lever Action Switches for individual element testing. Because all elements are numbered according to pin-number in the RMA base numbering system, the user can instantly identify which element is under test. Tubes having topped filaments and tubes with filaments terminating in more than one pin are truly tested with the Model TV-11 as any of the pins may be placed in the neutral position when necessary.
- ★ The Model TV-11 does not use any combination type sockets. Instead individual sockets are used for each type of tube. Thus it is impossible

to damage a tube by inserting it in the wrong socket.

- ★ Free-moving built-in roll chart provides complete data for all tubes.
- ★ Newly designed Line Voltage Control compensates for variation of any Line Voltage between 105 Volts and 130 Volts.
- ★ **NOISE TEST:** Phono-jack on front panel for plugging in either phones or external amplifier will detect microphonic tubes or noise due to faulty elements and loose internal connections.

The model TV-11 operates on 105-130 Volt 60 Cycles A.C. Comes housed in a beautiful hand-rubbed oak cabinet complete with portable cover

**\$47<sup>50</sup>**  
NET

**EXTRA SERVICE** — The Model TV-11 may be used as an extremely sensitive Condenser Leakage Checker. A relaxation

type oscillator incorporated in this model will detect leakages even when the frequency is one per minute.



Superior's New Model 660-A AN AC OPERATED

# SIGNAL GENERATOR

PROVIDES COMPLETE COVERAGE for AM-FM & TV Alignment

**SPECIFICATIONS:**

• Generates Radio Frequencies from 100 Kilocycles to 60 Megacycles on fundamentals and from 60 Megacycles to 220 Megacycles on powerful harmonics. • Accuracy and Stability are assured by the use of permeability trimmed Hi-Q coils. • R.F. available separately or modulated by the internal audio oscillator. — Built in 400 cycle sine wave audio oscillator used to modulate the R.F. signal also available separately for audio testing of receivers, amplifiers, hard of hearing aids, etc. • R.F. Oscillator Circuit: A high transconductance hep-

tope is used as an R.F. oscillator, mixer and amplifier. Modulation is effected by electron coupling in the mixer section thus isolating the oscillator from load changes and affording high stability. • A.F. Oscillator Circuit: A high trans-conductance heptode connected as a high-mu triode is used as an audio oscillator in a High-C Colpitts Circuit. The output (over 1 Volt) is nearly pure sine wave. • Attenuator: A 5 step ladder type of attenuator is used.

**TUBES USED:**

- 1—6BE6 as R.F. Oscillator, mixer and amplifier.
- 1—6BE6 as Audio Oscillator.
- 1—6H6 as Power Rectifier.

The Model 660-A comes complete with coaxial cable test lead and instructions.

**\$42<sup>95</sup>**  
NET

**MOSS ELECTRONIC DISTRIBUTING CO., INC.**  
Dept. B-103, 3849 Tenth Ave., New York 34, N. Y.

Please send me the units checked. I am enclosing the down payment with order and agree to pay the monthly balance as shown. It is understood there will be no carrying, interest or any other charges, provided I send my monthly payments when due. It is further understood that should I fail to make payment when due, the full unpaid balance shall become immediately due and payable.

Name.....  
 Address.....  
 City.....Zone.....State.....

- MODEL 670-A ..... Total Price \$28.40 \$7.40 down payment. Balance \$3.50 monthly for 6 months.
- MODEL TV-11 ..... Total Price \$47.50 \$11.50 down payment. Balance \$6.00 monthly for 8 months.
- MODEL 660-A ..... Total Price \$42.95 \$12.95 down payment. Balance \$5.00 monthly for 6 months.
- I enclose \$..... as down payment.
- Ship C.O.D. for the down payment.

RADIO-ELECTRONICS



**NO INTEREST!!**

Buy on our radically new  
**Time Payment Plan**

**NO CARRYING CHARGES!!**

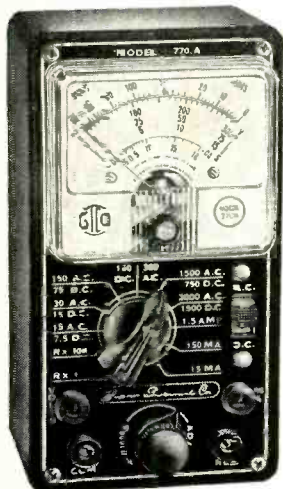

Superior's New Model 770-A The FIRST Pocket-Sized

**VOLT-OHM MILLIAMMETER**  
USING THE NEW "FULL-VIEW" METER

71% MORE SCALE AREA!!

Yes, although our new FULL-VIEW D'Arsonval type meter occupies exactly the same space used by the older standard 2 1/2" Meters, it provides 71% more scale area. As a result, all calibrations are printed in large easy-to-read type and for the first time it is now possible to obtain measurements instead of approximations on a popular priced pocket-sized V.O.M.

- Features**
- ★ Compact—measures 3 1/8" x 5 7/8" x 2 1/4"
  - ★ Uses "Full View" 2% accurate, 850 Microampere D'Arsonval type meter
  - ★ Housed in round-cornered, molded case
  - ★ Beautiful black etched panel. Depressed letters filled with permanent white, insures long-life even with constant use.

- Specifications**
- 6 A.C. VOLTAGE RANGES: 0-15/30/-150/300/1500/3000 Volts. 6 D.C. VOLTAGE RANGES: 0-7.5/15/75/150/-750/1500 Volts. 2 RESISTANCE RANGES: 0-10,000 Ohms, 0-1 Megohm.
  - 3 D.C. CURRENT RANGES: 0-15/150 Ma., 0-1.5 Amps. 3 DECIBEL RANGES: -6 db to +18 db, +14 db to +38 db, +34 db to +58 db.

THE MODEL 770-A COMES COMPLETE WITH SELF-CONTAINED BATTERIES, TEST LEADS AND ALL OPERATING INSTRUCTIONS. ONLY

**\$15.85**  
NET



Superior's New Model 70 UTILITY TESTER

**FOR REPAIRING ALL ELECTRICAL APPLIANCES • MOTORS • AUTOS**

As an electrical trouble shooter the Model 70:

- Measures A.C. and D.C. Voltages, A.C. and D.C. Current, Resistances, Leakage, etc.
- Will measure current consumption while the appliance under test is in operation.
- Incorporates a sensitive direct-reading resistance range which will measure all resistances commonly used in electrical appliances, motors, etc.
- Leakage detecting circuit will indicate continuity from zero ohms to 5 megohms (5,000,000 ohms).
- Will test toasters, Irons, Broilers, Heating Pads, Clocks, Fans, Vacuum Cleaners, Refrigerators, Lamps, Fluorescents, Switches, Thermostats, etc.

As an Automotive Tester the Model 70 will test:

- Both 6 Volt and 12 Volt Storage Batteries • Generators • Starters • Distributors • Ignition Coils • Regulators • Relays • Circuit Breakers • Cigarette Lighters • Stop Lights • Condensers • Directional Signal Systems • All Lamps and Bulbs • Fuses • Heating Systems • Horns • Also will locate poor grounds, breaks in wiring, poor connections, etc.

Handsome round-cornered molded bakelite case, 3 1/8" x 5 1/8" x 2 1/4". Complete with all test leads. Also included is a 64 page book giving detailed instructions for testing all electrical appliances, automotive equipment, etc.

**\$15.85**  
NET

SUPERIOR'S NEW MODEL TV-40

**C.R.T. TUBE TESTER**

A complete picture tube tester  
★ for little more than the price of a "make-shift" adapter!!

★ Tests all magnetically deflected tubes . . . in the set . . . out of the set . . . in the carton!!



The Model TV-40 is absolutely complete! Self-contained, including built-in power supply, it tests picture tubes in the only practical way to efficiently test such tubes; that is by the use of a separate instrument which is designed exclusively to test the ever increasing number of picture tubes!

**EASY TO USE:**

Simply insert line cord into any 110 volt A.C. outlet, then attach tester socket to tube base (Ion trap need not be on tube). Throw switch up for quality test . . . read direct on Good-Bad scale. Throw switch down for all leakage tests.

**SPECIFICATIONS:**

- Tests all magnetically deflected picture tubes from 7 inch to 30 inch types.
- Tests for quality by the well established emission method. All readings on "Good-Bad" scale.
- Tests for inter-element shorts and leakages up to 5 megohms.
- Test for open elements.

Model TV-40 C.R.T. Tube Tester comes absolutely complete—nothing else to buy. Housed in round cornered, molded bakelite case. Only . . . . .

**\$15.85**  
NET

MOSS ELECTRONIC DISTRIBUTING CO. INC.  
Dept. B-103, 3849 Tenth Ave., New York 34, N. Y.

Please send me the units checked. I am enclosing the down payment with order and agree to pay the monthly balance as shown. It is understood there will be no carrying interest or any other charges, provided I send my monthly payments when due. It is further understood that should I fail to make payment when due, the full unpaid balance shall become immediately due and payable.

Name.....

Address.....

City..... Zone..... State.....

- Model 770-A . . . . . Total Price \$15.85 \$3.85 down payment. Balance \$4.00 monthly for 3 months.
- Model 70 . . . . . Total Price \$15.85 \$3.85 down payment. Balance \$4.00 monthly for 3 months.
- Model TV-40 . . . . . Total Price \$15.85 \$3.85 down payment. Balance \$4.00 monthly for 3 months.
- I enclose \$..... as down payment.
- Ship C.O.D. for the down payment.



## FIRST CHOICE of America's Leading Record-Changer Makers

There are good reasons why America's leading record-changer manufacturers rely on General Industries to furnish their phonomotor requirements. Engineering . . . design . . . manufacturing skill . . . dependable, trouble-free performance . . . all contribute to the high quality of GI *Smooth Power* products.

Each of the above 3-speed record-changer phonomotors was designed and engineered by General Industries to meet the specific requirements of a leading national manufacturer.

For complete information about General Industries phonomotors—for both record-changer and manual application—write to:



**THE GENERAL INDUSTRIES CO.**  
DEPARTMENT ME • ELYRIA, OHIO

OVER 50,000  
TECHNICIANS  
HAVE LEARNED

HOW TO GET  
THE MOST OUT  
OF BASIC TEST  
EQUIPMENT

for A.M. - F.M. - TV

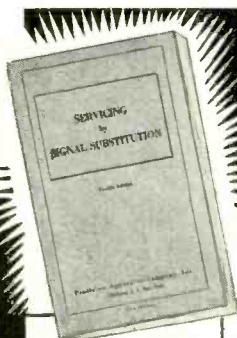

**ONLY 40¢**  
103 pages. Invaluable information that will help you re-double the value of your basic test equipment.

**'SERVICING BY  
SIGNAL SUBSTITUTION'**  
A BEST SELLER FOR OVER 12 YEARS!  
(NEW, UP-TO-DATE, 12th EDITION)

The Modern, Simplified, Dynamic Approach to Receiver Adjustment & Alignment Problems.

- ★ Nothing complicated to learn
- ★ No extra equipment to purchase
- ★ Universal . . . non-obsolete
- ★ Employs only Basic Test Instruments

Ask for "S.S.S." at your local Radio Parts Jobber or remit 40¢ in small stamps or coin directly to factory.

**PRECISION APPARATUS COMPANY, INC.**  
92-27 HORACE HARDING BLVD., ELMHURST 4, N. Y.

two-thirds the screen diameter.

Next, turn on the unmodulated carrier. The line should broaden into a wide horizontal band. Adjust the pickup to provide a vertical deflection of about one-quarter the screen diameter.

The upper and lower edges of this bright band should be straight. Bright lines through the band parallel to the horizontal axis indicate carrier distortion (harmonics) or parasitic oscillations.

To make the pattern stationary on the screen as shown in Fig. 5, two things must be done. First, the modulating voltage must be a sinusoid—or at least a single modulating frequency. Second, the horizontal sweep generator must be carefully adjusted to a sub-multiple of the modulating frequency.

Once a stationary pattern is obtained, the trace on the screen indicates modulation and will show any distortion.

Most measurements are made while using voice modulation. The usual practice is to set the sweep generator to some fairly low frequency—say 40 to 50 cycles—and leave it there. Although the modulating pattern will shift constantly across the screen, the resultant pattern is such that the troughs and peaks can be examined readily for distortion or overmodulation.

### Measurements at the receiver

Amateurs rarely use a scope to measure modulation percentage and distortion at the receiver position, though any one of the three methods of measurement can be used to check incoming signals. Before looking at the circuit and method, let's consider some of the limitations.

1. Circuits require electrical connection to the receiver.
2. Voltages available from a receiver are low and require considerable amplification before use as deflection potentials.
3. Oscilloscope input circuits, particularly those carrying the intermediate frequency, must be high-impedance to prevent loading the receiver circuits.
4. Distortion in the receiver can be interpreted as transmitter faults.
5. Selective fading, cross-modulation, and interference can make evaluation difficult.

Fig. 7 shows the connections which can be made to the receiver. The vertical input is connected to the plate circuit of the last i.f. stage which must be

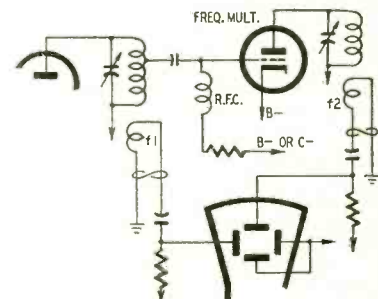

Fig. 8—Using scope as frequency comparator to tune frequency-multiplier stages.

**TRIO, LEADER IN ANTENNA DEVELOPMENT  
NOW PRESENTS**

**most complete line in the industry!**

No matter what antenna type is your favorite, TRIO now makes it—in better quality construction and at lower cost!

This is possible because TRIO has installed its own tube mill, added the most modern tool and die department, built a new production plant—and manufactures its own components. TRIO can thus control production and offer higher quality and better performance at *substantially lower prices.*

You are assured of fast delivery too, because TRIO now owns and operates its own trailer trucks, the most modern fleet in the industry.

See your jobber or write for the new TRIO catalog. It describes the most complete line available.

*Illustrated below is only part of the TRIO line*



Available in Blonde  
or Mahogany

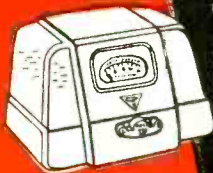

**ONLY TRIO HAS THESE FEATURES:**

- Now available pre-wired with either 65' or 90' of control cable for the most rapid installation. Merely connect spade lugs to control case terminals.
- Each rotator checked with its cable, eliminates defective cable and wiring faults.
- Not a single rotator returned since this feature added.
- Only rotator that receives a two hour bench test.
- Only rotator with two year guarantee.

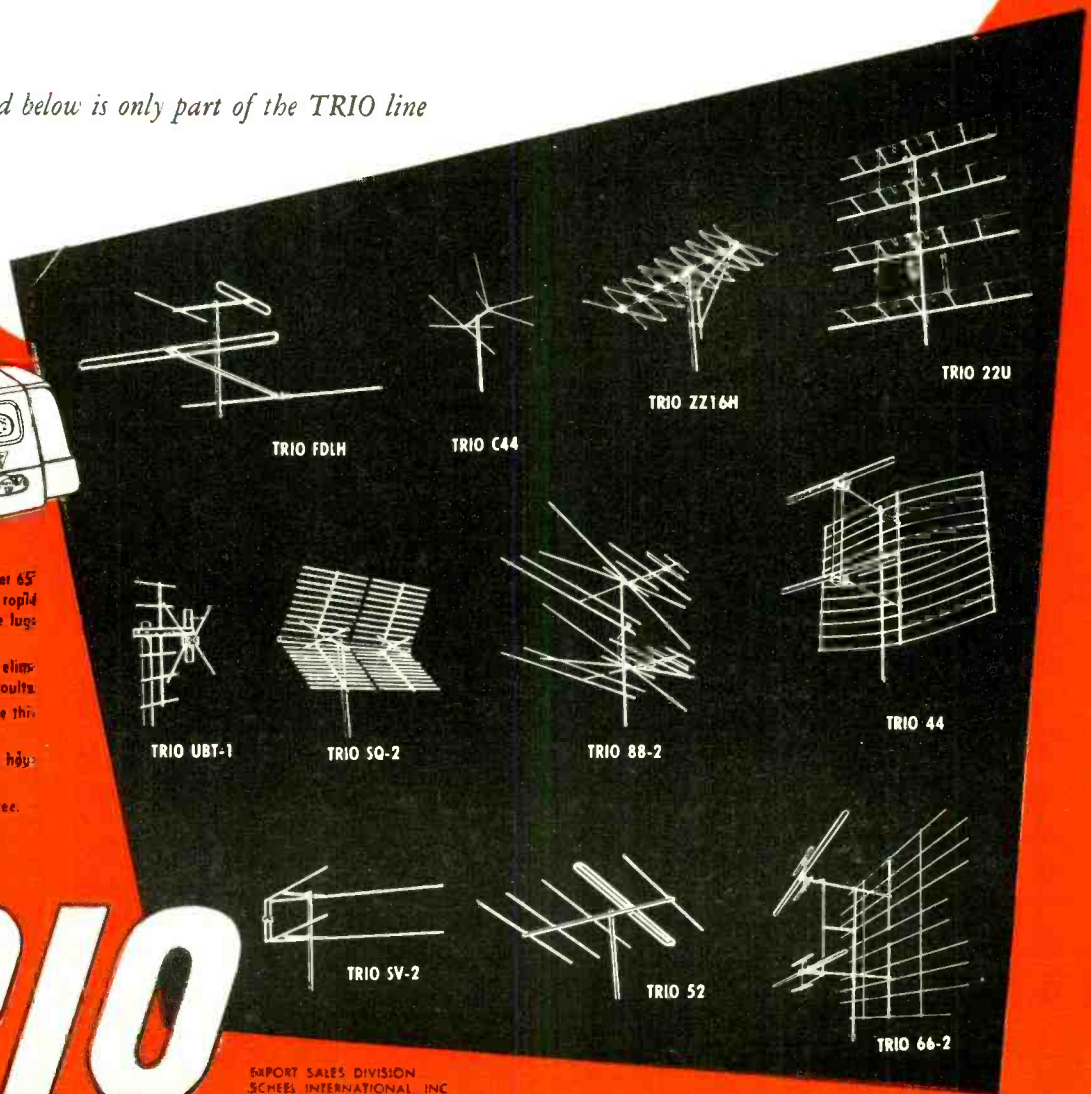

**TRIO**

EXPORT SALES DIVISION  
SCHEEBS INTERNATIONAL INC  
4237 N. Lincoln Ave. Chicago, U.S.A.  
Cable Address: MARSCHKEE

**TRIO MANUFACTURING CO. • GRIGGSVILLE, ILLINOIS**

# TELTRON TUBES

**GUARANTEED! . . . LOWEST PRICES EVER!**

All tubes individually boxed . . . unconditionally guaranteed for one year.

TYPE	PRICE	TYPE	PRICE	TYPE	PRICE	TYPE	PRICE	TYPE	PRICE
024	.45	6K7	.40	6BK5	.75	6T8	.71	12BZ7	.63
1A7GT	.53	6Q7	.40	6BK7	.78	6U8	.76	12K7	.40
1B2GT	.52	6AR4	.43	6BL7GT	.78	6V3	.80	12SA7GT	.45
1H5GT	.51	6AC7	.65	6BN6	.90	6V6GT	.48	12SK7GT	.45
1L4	.51	6AG5	.52	6BQ6GT	.83	6W4GT	.43	12SL7GT	.60
1L6	.51	6AH4CT	.65	6BQ7	.85	6W6GT	.53	12SN7GT	.56
1LC6	.49	6AJ5	.96	6BY5G	.60	6X4	.37	12SQ7GT	.38
1N5GT	.51	6AK5	.96	6BZ7	.95	6X5GT	.38	19B6GG	1.48
1RS	.51	6AL5	.43	6C4	.41	6X8	.80	19T8	.71
1S5	.43	6AQ5	.48	6C6	.49	7F8	.49	25B06GT	.82
1T4	.51	6AR5	.48	6C6GG	1.63	7N7	.49	25L6GT	.41
1U4	.51	6AT6	.37	6CUG	.95	12AL5	.43	25W4GT	.43
1U5	.43	6AUSGT	.60	6F6	.42	12AT6	.37	25Y5	.55
1X2	.65	6AV6	.43	6F5GT	.40	12AT7	.71	25Z6GT	.36
2A3	.35	6AV5GT	.60	6H6	.50	12AUG	.43	35B5	.48
2A7	.35	6AV6	.37	6H7	.50	12AUI7	.58	35C5	.48
304	.53	6AX4GT	.60	6J6	.61	12AV6	.42	35L6GT	.41
3Q5GT	.61	6AX5GT	.60	6J6GT	.38	12AV7	.73	35W4	.33
354	.48	6BA6	.56	6K6GT	.60	12AX4GT	.60	35Y4	.40
3V4	.48	6BA7	.58	6L6	.78	12AX7	.61	35Z5GT	.33
5U4G	.43	6BC5	.48	6S4	.41	12AZ7	.65	50A5	.49
5V4G	.49	6BE6	.46	6S8GT	.65	12B4	.72	50B5	.48
5Y3GT	.30	6BF5	.48	6SA7GT	.45	12BA6	.46	50C5	.48
5Y4G	.40	6BF6	.48	6SK7GT	.45	12BA7	.58	50L6GT	.50
5Z3	.42	6BG6G	1.18	6SL7GT	.60	12BE6	.46	Type 80	.40
6A8	.40	6BH6	.51	6SN7GT	.60	12B7	.65	117Z3	.33
		6BJ6	.51	6SQ7GT	.38	12BH7	.61	117L7GT	1.20
								117Z6GT	.65

**FREE** \$5.00 list value Bonus Box of Radio & TV components including resistors, condensers—controls, and many other items with each order of \$25.00 or more.

**FREE GIFT OFFER** One 6BG6G tube will be shipped FREE with any order accompanying this ad.

We now have a complete line of special purpose and transmitting tubes in stock.  
Write for quotations on your requirements—Dept. T.  
**We guarantee your orders to be shipped the same day they are received!**  
Minimum order \$10.00. 25% deposit on C.O.D. orders—save parcel post charges. Orders accompanied with full remittance will be shipped prepaid anywhere in continental U.S.A. All orders subject to prior sale.  
*Send for Free complete tube listing*

**SPECIAL!**  
while they last **39¢** each 10 for **\$3.50**  
Type Type Type Type Type  
1A4P 1F7GT 19 34 Type  
1C6 1F4 1629 35 39/44  
1C7C 1H4G 22 35/51 46  
1D5GP 2A7 33 36 1F5G  
1D7G 36 1F5G  
These specials are new, famous make, individually boxed. Order now.

## TELTRON ELECTRIC COMPANY

428 Harrison Ave., Dept. RE6, Harrison, N. J. Phone HUmboldt 4-9848

**New EICO PROBES**



**SCOPE PROBES**

SCOPE DEMODULATOR PROBE  
KIT \$3.75 WIRED \$5.75

LOW CAPACITY PROBE  
KIT \$3.75 WIRED \$5.75

DIRECT PROBE  
KIT \$2.75 WIRED \$3.95

**VTVM PROBES**

VTVM RF PROBES  
KIT \$3.75 WIRED \$4.95

PEAK-TO-PEAK PROBES  
KIT \$4.95 WIRED \$6.95



**SENSATIONAL HIGH VOLTAGE PROBE**  
Model HVP-2  
ONLY . . . \$4.95

**SPECIAL**  
ALL 3 SCOPE PROBES  
Kit . . . \$9.95  
Wired \$14.95

See these amazing probe values at your jobber today. Write now for FREE catalog CP-6. Read EICO's other ads in this issue—turn to Advertisers Index!

**EICO** PAT. APP. FOR  
ELECTRONIC INSTRUMENT CO., Inc.  
84 WITHERS STREET, BROOKLYN, NEW YORK

**AUDELS TV-RADIO SERVICE LIBRARY**

HERE IS LATE INFORMATION IN A HANDY FORM FOR RADIO AND TELEVISION REPAIRMEN, SERVICEMEN AND STUDENTS

**2 VOLS. \$6 COMPLETE \$11 A MONTH**

AUDELS T.V.-RADIO SERVICE LIBRARY—Highly Endorsed—1001 Facts—Over 1552 Pages—625 Illustrations, Diagrams of Parts. Presents Important Subjects of Modern Radio, Television, Industrial Electronics, F.M., Public Address Systems, Auto, Marine & Aircraft Radio, Phonograph Pick-Ups, etc.

**IT PAYS TO KNOW!**  
The Basic Principles—Construction—Installation—Operation—Repairs—Trouble Shooting. Shows How to get Sharp, Clear T.V. Pictures. Install Aerials—How to Test. Explains Color Systems, Methods of Conversion, Terms, etc. Includes Ultra High Frequency (U.H.F.)—Valuable for Quick Ready Reference & Home Study. Tells How to Solve T.V. & Radio Troubles—Answers Your Questions.

Get this Information for Yourself.  
**7 DAY TEST—ASK TO SEE IT!**

**MAIL ORDER**

AUDEL Publishers, 49 W. 23 St. N.Y. 10, N.Y.  
Mail AUDELS T.V. RADIO SERVICE LIBRARY 2 Vols. \$6 on 7 days free trial. If O. K. I will remit \$1 in 7 days and \$1 monthly until \$6 is paid. Otherwise I will return them.

Name \_\_\_\_\_  
Address \_\_\_\_\_  
Occupation \_\_\_\_\_  
Employed by \_\_\_\_\_

retuned when the scope lead is connected. If the scope's input capacitance is too great this stage may not retune to the intermediate frequency. Horizontal deflection voltage may be taken from any point in the receiver after detection. The connection shown is to the plate of the first audio amplifier. However, for greater deflection voltage, a later stage can be used.

Tune in a clear signal, free of interference, and study the trapezoidal modulation pattern. Distortion or overmodulation will be indicated as shown in Fig. 5. Several good signals should be watched in turn. Any distortion that is common to all the signals is probably caused by the receiver rather than the transmitter. Study especially the peculiar patterns caused by signals and interference.

The wave-envelope pattern is available with the same connections as shown in Fig. 7. All that is necessary is to set the horizontal selector switch to the internal sweep generator for a time-base representation.

**Tuning frequency multipliers**  
The indicator has many uses, but one of particular interest to amateurs is the measurement of frequency. Multipliers are frequently used to go from a low-frequency crystal to a higher-frequency output. When the multiplier stages are tuned initially, the proper harmonic may be hard to locate. For example, in going from 7 to 28 megacycles it is as easy to hit the unwanted third or fifth harmonic as the desired fourth.

By using the connections shown in Fig. 8 a Lissajous figure will be formed. This figure will tell immediately the relationship of the input and output frequencies. For the patterns to be expected, see Fig. 9. By simply counting the number of loops, the harmonic can be determined.

**The mobile installation**  
The circuit in Fig. 1 was connected to a mobile rig to provide a trapezoidal modulation pattern. An interesting variation was made by installing the tube

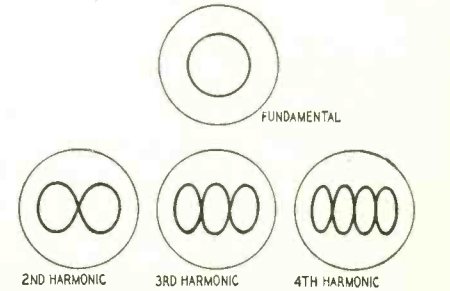
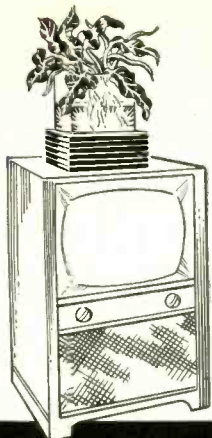

Fig. 9—Traces resulting when frequency-multiplier stage is tuned to the fundamental or 2nd, 3rd, or the 4th harmonic.

in a vertical position on the steering column. In this position a dim but easily discernible reflection appeared in the car windshield. It was possible, then, to follow the modulation pattern constantly without removing the eyes from the road while driving. One merely looks through the image to the highway. END



Look what happened to the  
"ugly duckling" of the TV industry!  
At long last . . . a converter  
nobody wants to hide.  
The new FEN·TONE design gives  
your home that "Woman's Touch"  
everybody admires.

The Beautiful New

**Fen·tone**

MODEL C1

**UHF CONVERTER**

Here is the breath-taking sensation  
that "stole the show" at the  
Chicago Electronic Parts Exhibition.

Besides being a high per-  
formance converter, it is  
a lamp! An illuminated  
aquarium! An illuminated  
plant vase!

A trend-setting innovation—  
truly "fit for a Queen"—  
The American Housewife.

Fen-tone Model C1  
UHF CONVERTER

List Price \$29.95

Fen-tone Model B1  
VHF BOOSTER

(Same beauty of design  
as above.) List Price \$29.95

Place your order now  
with your nearest jobber.

**FENTON COMPANY — 15 MOORE STREET, NEW YORK 4, N. Y.**

Creators of FENTUBE-AIRSPACED • TWISTUBE • TUF-GUY "TEN-SPOT"  
AND OTHER TREND-SETTING INDUSTRIAL FIRSTS

PATENT  
PENDING



# everything needed...

## FOR THE QUALITY INSTALLATION

### antennas

A complete line of VHF and UHF antennas, designed for high gain and top performance, is made by the antenna-wise craftsmen of AMPHENOL. The *color-tested* INLINE\* and its new partner the Conical are superior VHF antennas. The Corner Reflector, Yagi, Rhombic and re-designed Bo-Ty are the sturdiest, most efficient UHF antennas offered today. For VHF, UHF or combined VHF/UHF installations the AMPHENOL Stacked-V is the first choice of distributors, dealers and the public.

\*Reissue U.S. Patent 23,273

### accessories

AMPHENOL accessories for the quality tv installation include Stand-off Insulators, mast sections and hardware, the UHF/VHF ISONET, new UHF/VHF Lightning Arrestor with *lowest measurable loss*, and the new TELE-COUPLEERS for effective coupling of two to four television sets to one antenna. The TRISONET couples high and low band VHF antennas and UHF antenna to one TV set.

### lead-in

Unique AIR-CORE Tubular Twin-Lead (U.S. Pat. No. 2,543,696) is a truly efficient transmission line with lowest signal loss of any lead-in. AIR-CORE is a must for UHF television. AMPHENOL Flat Twin-Lead has been proved through years of effective transmission as a superior VHF lead-in.

the famous trade mark

**AMPHENOL**

AMERICAN PHENOLIC CORPORATION

www.americanradiohistory.com

### NEW DESIGN

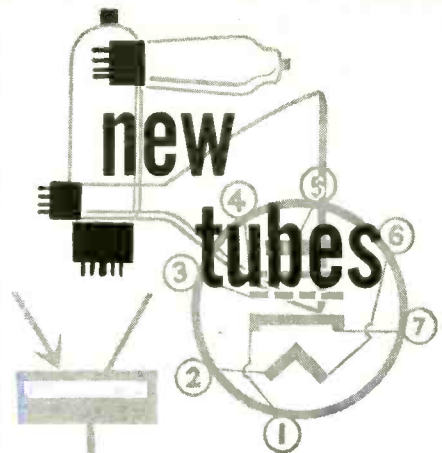

### and Transistors

FOLLOWING close on the heels of its announcement of the 6BD4, RCA has released a superseding version, the



6BD4-A (see photo). The new tube is a low-current beam triode of the sharp-cutoff type designed specifically for the voltage regulation of high-voltage, low-current d.c. power supplies, such as are used for picture tubes in color TV receivers.

The 6BD4-A has a maximum d.c. plate-voltage rating of 27,000 instead of the 6BD4's 20,000; a maximum unregulated d.c. supply-voltage rating of 55,000 instead of 40,000; and a maximum plate-dissipation rating of 25 watts instead of 20 watts. Other maximum ratings are unchanged.

The 6BD4-A may show a blue glow on the upper half of the inner surface of the bulb wall under normal operating conditions. This is caused by fluorescence and should not be mistaken for gas.

Another RCA release, the 6BC4 is a medium- $\mu$  triode of the 9-pin miniature type, designed for use as a cathode-driven r.f. amplifier in u.h.f. TV tuners covering the frequency range of 470 to 890 mc.

Having a transconductance of 10,000 micromhos, the 6BC4 permits circuit design for high gain and reduced equivalent noise resistance. Other design features of the 6BC4 include silver-plated base pins to reduce losses due to skin effect at u.h.f., four grid terminals to permit reduced lead inductance and resistance in circuit arrangements, an electrode structure for good isolation

RADIO-ELECTRONICS

**BLAK-RAY SELF-FILTERING ULTRA-VIOLET LAMP**



BLAK-RAY 4-watt lamp, model X-4, complete with U-V tube. This lamp gives long-wave ultra-violet radiation having a wave-length of 3654 to 4000 angstrom units. Some of the substances made to fluoresce visibly when illuminated by U-V light are certain woods, oils, minerals, milkstone, cloth, paints, plastics, yarn, drugs, crayons, etc. This lamp is self-filtering and the invisible U-V rays are harmless to the eyes and skin. Equipped with spectral-finish aluminum reflector. Consumes only 4 watts and can be plugged into any 110 volt 50-60 cycle A.C. outlet. Will give 2000 to 3000 hours of service. It weighs but 1 3/4 lbs. Approved by the Underwriters Laboratories and has a built-in transformer so that it may be safely used for long periods when necessary. Extra U-V tubes are available.

Ship wt. 4 lbs.  
ITEM NO. 125  
UNUSUAL BUY ..... (Shp. Chgs. 70c)

**\$16.75**

**POWERFUL ALL PURPOSE MOTOR**



Sturdy shaded pole A.C. induction motor. 15 watts, 3000 rpm. 3"x2"x1 3/4"; 4 mounting studs; 7/8" shaft, 3/16" diameter; 110-120 volts, 50-60 cycles. A.C. only. When geared down, this unit can operate an 18" turntable with a 200 lb. dead weight. Use it for fans, displays, timers and other purposes. Ship wt. 2 lbs.

ITEM NO. 147  
UNUSUAL BUY (Shp. Chgs. 35c)

**\$2.45**

**WATTHOUR METER**

Leading makes—reconditioned. Ideal for trailer parks. 100-110 volts, 60 cycles, 2-wire A.C. 5 amp. Heavy metal case 8 1/2" x 6 1/4" x 5". Easy to install. Ship. wt. 14 lbs.

ITEM NO. 33  
NOW ONLY (Shp. Chgs. \$1.25)

**\$4.50**



**WESTERN ELECTRIC BREAST MIKE**

Lightweight 1 lb. carbon microphone. Aircraft type. Breastplate mounting, adjustable 2-way swivel. Easily fastened straps. For home broadcasts, communications etc. Complete with 6 foot cord, hard rubber plug. Sheradized plate, non-rusting finish. Ship. wt. 2 lbs.

ITEM NO. 152  
NEW LOW PRICE (Shp. Chgs. 35c)

**\$2.25**

**AMAZING BLACK LIGHT**



250-watt ultra-violet light source. Makes fluorescent articles glow in the dark. Fits any lamp socket. For experimenting, entertaining, unusual lighting effects.

Ship. wt. 2 lbs.  
ITEM NO. 87  
A SAVING AT (Shp. Chgs. 35c)

**\$2.45**

**250 POWER TELESCOPE LENS KIT**

Make your own high powered 6 ft. telescope! Kit contains 2" diam., 75" focal length, ground and polished objective lens and necessary eye pieces. Magnifies 50x to 250x. Full instructions. Ship. wt. 1 lb.

ITEM NO. 123  
YOU SAVE AT (Shp. Chgs. 10c)

**\$2.95**

HUDSON SPECIALTIES CO.  
25 West Broadway, Dept. RE-6-54  
New York 7, N. Y.

I am enclosing full remittance for items circled below. (Be sure to include shipping charges.)  
OR, my deposit of \$..... Ship balance C.O.D.  
MINIMUM C.O.D. ORDER \$5.00.  
C.O.D. ORDERS ACCEPTED ONLY WITH 20% DEPOSIT  
INCLUDE SHIPPING CHARGES.

Circle Items Wanted  
87 147 33 152 125 123

Name ..... Please Print Clearly  
Address .....  
City ..... Zone ..... State .....

between the load circuit and the input circuit, and low interelectrode capacitances.

For use in compact, low-power mobile transmitters and in emergency communications equipment operating from 12-volt storage batteries, RCA has announced the 6417, a 9-pin miniature beam-power tube. With an ICAS plate-dissipation rating of 13.5 watts, the 6417 can be operated with full input up to 50 mc and with reduced input to 175 mc.

The high transconductance, high perveance, and high power sensitivity make the 6417 particularly useful as an r.f. power amplifier, frequency multiplier, oscillator (v.f.o. or crystal), and driver tube for larger tube types. Because of its high perveance, the 6417 can supply high power output at relatively low supply voltages. Its plate characteristic is favorable to the generation of a high harmonic output, so the 6417 is especially useful in the doubler and tripler stages of transmitters.

The 6417 is a 12.6-volt version of the 5763.

A new pentode amplifier tube, type 6DB6, designed for use as a color demodulator synchronous detector in color television circuits, has been announced by Westinghouse. The new tube is capable of being driven harder and giving greater output than tubes currently being used as color demodulators.

The 6DB6 is a sharp-cutoff pentode amplifier of the 7-pin miniature type. Grids 1 and 3 are control grids for color demodulator use. The chromatic signal is applied to grid 1, and the output of the 3.58-mc oscillator is applied to grid 3. When used as a color demodulator, the tube's output is linear for high levels of grid 3 drive.

The 6DB6 may be used also as a sync separator with the usual advantages of a pentode-type tube. It can be used in black-and-white television circuits as a mixer.

G-E has announced a new line of "service designed" TV receiving tubes to overcome the problem of varying operating conditions found in different makes and models of TV receivers. The first tube types released in the line are the 5U4-GA, the 6BQ6-GA, the 6SN7-GTA, and the 26BQ6-GA. All directly replace their prototypes.

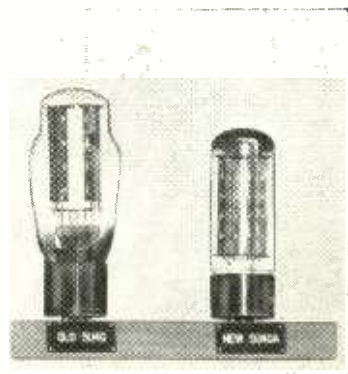

The 5U4-GA has a straight-side envelope (see photo) permitting use of

**ATTENTION!!**  
Executives and Salesmen!  
*Shave in the Comfort of Your Own Car, Boat or Plane!*

WITH **ATR**

**SHAV-PAK**



Specially Designed for Operating Standard A.C. Electric Shavers in Automobiles, Buses, Trucks, Boats, and Planes.

Keep in Glove Compartment



PLUGS INTO CIGARETTE LIGHTER RECEPTACLE ON DASH

**\$12.95**

LIST PRICE

TYPE	INPUT D.C. VOLTS	A.C. OUTPUT 60 CYCLES	OUTPUT WATTAGE	LIST PRICE
6-SPB	6	115 volts	15	12.95
12-SPB	12	115	15	12.95

**DICTATE REPORTS ACCURATELY-PROMPTLY!**  
*make your car, boat or plane a "rolling office"*

WITH **ATR**

**INVERTERS**



for changing your storage battery current to A. C.

Household ELECTRICITY

Anywhere in your own car!

Plugs into Cigarette Lighter Receptacle on Dash

**\$2250**

AND UP LIST PRICE



ATR INVERTERS . . . especially designed for operating standard 110 volt A. C. . . .

- TAPE RECORDER
- WIRE RECORDERS
- DICTATING MACHINES
- ELECTRIC RAZORS

See your jobber or write factory today for complete information



**AMERICAN TELEVISION & RADIO CO.**  
Quality Products Since 1927  
SAINT PAUL 1, MINNESOTA—U. S. A.

*"In America even the workers can buy JENSEN NEEDLES"*

mica supports at both the top and bottom of the tube structure. A double-fin plate construction improves heat dissipation.

The 6BQ6-GA and 25BQ6-GA have a larger envelope to allow better heat dissipation; new mica design and special processing to reduce internal tube arcing; and a peak-pulse plate voltage rating of 6,000 instead of the 5,500 for the 6BQ6-GT and the 25BQ6-GT. In addition, grid drive requirements for full sweep are considerably reduced.

The 6SN7-GTA enjoys improved ratings over the 6SN7-GT, such as maximum plate voltage, 500, as against 300; maximum heat dissipation per plate, 5 watts, as against 2½ watts.

Design of new aircraft or mobile receivers using their "Five-Star" ruggedized tubes in every socket is now possible, announced G-E, with the development of tube type 6265. The tube is a sharp-cutoff pentode designed for wide-band high-frequency amplifiers. Its standard prototype is the 6BH6.

Typical operating conditions of the 6265 as a class A-1 amplifier are: plate voltage, 250; cathode-bias resistor, 100 ohms; plate resistance, approximate, 1.0 megohm; transconductance, 4,600 micromhos; plate current, 7.4 ma.

CBS-Hytron has developed three new junction transistors, the HA-1, HA-2, and HA-3, especially designed for use in hearing aids. The transistors meet the specialized requirements of all three stages of hearing-aid amplifiers.

The HA-1 and HA-2 are low-level, high-gain units in which restrictive limits have been set for the current amplification factor. The HA-3 is designed for the power output stage. Maximum ratings are: d.c. collector voltage, -20; d.c. collector current, 68 ma; collector dissipation, 50 mw. All three transistors meet the very-low noise requirement of hearing-aid amplifiers.

RCA has announced the most powerful beam-power tube so far developed

**IT IMPROVES THE PICTURE**



list \$750

**T-V CLARIFIER**

Removes annoying signals that cause picture distortion in TV sets due to FM, amateurs, shortwave, diathermy, ignition and adjacent channels. Ghosts, lines, herringbone patterns, tears and wavy effects are eliminated or reduced simply by turning the two control knobs on this new type interference eliminator.

- No technical knowledge needed
- Traps unwanted signals
- Fastens to screws on back of set
- Easy to tune. Stable
- Small, mechanically rugged
- Necessary with every TV installation

**PRECISION ELECTRONICS, INC.**  
9101-Ev King St. • Franklin Park, Ill.

Please rush Free Bulletin on T-V Clarifier

Name .....  
Address .....  
City ..... Zone ..... State .....

**GET INTO ONE OF THESE GREATER OPPORTUNITY FIELDS**

**Electricity or Radio-Television**

**TRAIN IN THE GREAT SHOPS OF COYNE** OLDEST, BEST EQUIPPED SCHOOL OF ITS KIND IN U. S.

Prepare for your future NOW. Get practical training in TELEVISION—RADIO—ELECTRICITY—ELECTRONICS—all vital in Industry. Prepare now for a better job that also offers a real future in the years ahead. Learn on real equipment at Coyne—no advanced education or previous experience needed.

Approved for Veterans—finance plan—enroll now, pay most of tuition later. Part time employment service while training if needed.

**FREE BOOK** Clip coupon for Big Free Illustrated Book. No salesman will call. Act NOW.

B. W. COOKE President **COYNE** FOUNDED 1899  
**ELECTRICAL SCHOOL**  
A TECHNICAL TRADE INSTITUTE CHARTERED NOT FOR PROFIT  
500 S. Paulina St., Chicago, Dept. A4-81H  
ELECTRICITY • TELEVISION • RADIO • REFRIGERATION • ELECTRONICS

B. W. COOKE, Pres.  
COYNE ELECTRICAL School  
500 S. Paulina St., Chicago 12, Ill. Dept. A4-81H  
Send FREE BOOK and details on:  
 RADIO-TELEVISION  ELECTRICITY

NAME .....  
ADDRESS .....  
CITY ..... STATE .....



RCA's 6448—powerful u.h.f. tetrode. for u.h.f. television broadcasting, the 6448, capable of 12,000 watts of power output at 900 mc. It is the first trans-

**GREATEST TUBE SALE ON EARTH** Colossal VALUES GIGANTIC SAVINGS

1B3 .....	\$ .53	6SN7 .....	\$ .42
5U4G .....	.39	6V6 .....	.38
6AK5 .....	.49	6W4 .....	.39
6AX4GT .....	.49	6W6 .....	.39
6BG6GT .....	.99	6X5 .....	.35
6BQ6GT .....	.59	6BL7 .....	.69
6C4 .....	.33	12AX7 .....	.59
6J6 .....	.49	25BQ6 .....	.79

METER and SET TESTED  
INDIVIDUALLY GUARANTEED 90 DAYS BOXED  
BRANDED: MAXIM  
Minimum order: \$5. Include postage, excess refunded. 25% deposit with C.O.D.'s.

**Maxim** Jack Goldman  
RADIO SALES and SERVICE Co., Inc.  
170 Greenwich St. New York 7, N. Y.  
WO. 2-0671



mitting tube with tetrode construction ever developed for high-power, u.h.f. television service.

Previously, u.h.f. TV transmitters with power output above 5,000 watts required large, costly tubes of complex design. A comparative midget in size, the 12,000-watt 6448 measures only 7 3/4 inches in height and 1 1/8 inches in diameter.

In color or black-and-white TV service, the 6448 can deliver a synchronizing-level power output of 15,000 watts at 500 mc. As a continuous wave (cw) amplifier in class C telegraphy, it can generate useful power output of 14,000 watts at 400 mc or 11,000 watts at 900 mc.

G-E has announced development of a new metal-and-ceramic v.h.f.-u.h.f. "lighthouse" transmitting tube, type 2C39-B, a high-mu triode that can be used in grounded-grid, class-C power amplifier, oscillator, or frequency-multiplier circuits up to 2,500 mc.

Features of the new tube are an oxide-coated indirectly heated cathode and an anode capable of dissipating 100 watts with forced-air cooling.

Maximum ratings for the tube, in class C telegraphy as an r.f. amplifier and oscillator (key-down conditions per tube without amplitude modulation) are: d.c. plate voltage, 1,000; d.c. cathode current, 125 ma; d.c. grid voltage, minus 150; d.c. grid current, 50 ma; peak positive r.f. grid voltage, 30; peak negative r.f. grid voltage, minus 400; plate dissipation, 100 watts; grid dissipation, 2 watts. END

**CORRECTION**

The series resistors in the grid circuits of the 1614's in Milady's Golden Ear Amplifier (page 50 of the April, 1954, issue) should be 1,200 ohms instead of 12,000 ohms as shown in the diagram. The values are not critical, however, and it is possible that the higher values will work as well as the lower ones. The parts list specifies one 20-μf, 150-volt capacitor. This capacitor should be rated at 450 volts.

Although no ratings other than resistance were given for the balance and bias control potentiometers in the amplifier, we recommend that wire-wound units with ratings of at least 2 watts be used.

We thank L. Gancher, of New York, N. Y. for these corrections. END

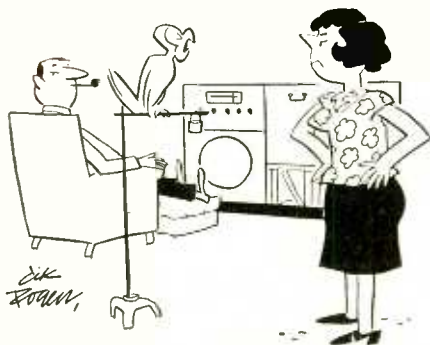

"One thousand cycles to set level—awk. One thousand cycles to set level."

JUNE, 1954



**irish** OFFERS YOU A **SOUND RECORDING TAPE TO FIT THE PERFORMANCE REQUIREMENTS OF YOUR TAPE RECORDER . . . . .**

Not all tape recorders are alike. A professional instrument intended for high quality music reproduction will perform differently than a portable unit intended for home or office use. Whereas one will record and reproduce from 30 to beyond 15,000 cycles per second, the less costly unit may be limited to a range from 100 to 7000 cps. or less. Obviously, there is no advantage in using a wide response tape with a limited-response recorder! And there is a definite disadvantage...

**WHY PAY MORE FOR WIDER RESPONSE WITHOUT GETTING ANYTHING IN RETURN?**

Until the development of IRISH Brown Band, users of sub-professional tape recorders had no choice! But IRISH Brown Band was designed specifically for such recorders. THERE HAS BEEN NO SACRIFICE IN QUALITY... IRISH Brown Band has been specially developed to reproduce with true fidelity the frequency range between 100 and 8000 cycles.

The considerable savings in production costs now enables you to buy high quality, plastic tape at a price, which up to now, could only buy ordinary paper tape!

1200 feet, plastic tape, on plastic reel **\$2.50 NET**

For professional recording on equipment with wide frequency response, your best tape buy is IRISH GREEN BAND NO. 211, the professional super-sensitive, wide-range recording tape that is used in broadcast stations and recording studios throughout the industry.

1200 feet on plastic reel **\$3.30 NET**  
2400 feet on metal reel **\$7.71 NET**

One day you will surely use IRISH... write direct to factory for a free sample test reel today.



At all leading radio parts distributors

**ORRADIO INDUSTRIES, INC.**

**OPELIKA 5, ALABAMA**

EXPORT DIVISION: Morhan Exporting Corp., New York, N. Y.

**TRAIN AT HOME FOR COLOR-TV and**

**TELEVISION SERVICING**

Learn practical, professional type TV Servicing without leaving your present job. Included are money-making extras, such as set conversion, master antenna installation, UHF-TV, NTSC Color System, field servicing short cuts. You can start earning Television money after first few lessons. You learn to test, trouble shoot and repair all types of TV sets.

**HERE'S HOW YOU GET EXPERIENCE!**

You train on a large screen, modern TV receiver, furnished with the course and yours to keep! As an optional feature you can get two weeks actual experience with Chicago's largest independent servicing organization. You learn by doing! Age is no barrier. Many students are over 40! Beginner's Course available. Send for FREE Catalog and SAMPLE LESSON today!

**TV COMMUNICATIONS INST.**  
605 W. Washington Blvd., Dept. RE-30  
Chicago 6, Ill.

**VETERANS!**  
T.C.I. is approved for G.I. training. Under Public Law 550. Check coupon.

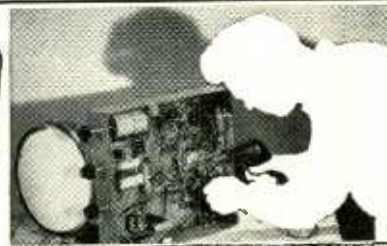

**MAIL NOW FOR FREE BOOKLET**

MILTON S. KIVER, President  
TELEVISION COMMUNICATIONS INST.  
605 W. Washington Blvd., Dept. RE-30, Chicago 6, Ill.  
Rush FREE Catalog and Sample Lesson. I am not obligated. Salesman will not call.

Name.....  Veterans: Check here  
Address.....  
City..... Zone..... State.....  
 BEGINNERS check here for Basic TV Course.

# THE American IDEA

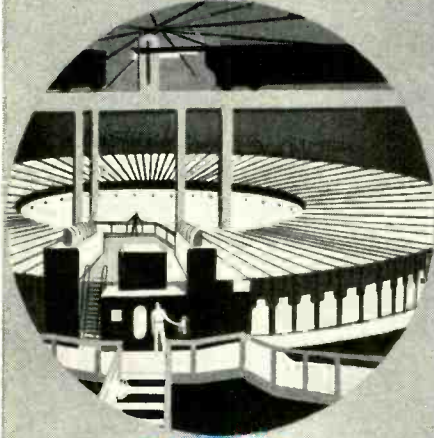

"To find and follow the better way"... Gigantic offspring of the cyclotron, the Bevatron—world's greatest magnet—can send masses of protons hurtling around its 135'-diameter race track at almost the speed of light. "Idea", to penetrate deep into the atomic nucleus, where lie secrets of matter and energy.

With us, the "American Idea" is, by directed effort and applied know-how, to continue to lead in bringing you electronic products of the highest quality.

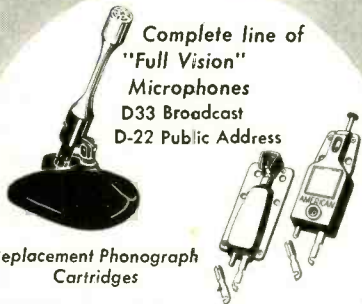

Replacement Phonograph Cartridges

INSIST ON AMERICAN FOR QUALITY  
Send for FREE Catalog 47

American microphone co.

370 South Fair Oaks Ave. • Pasadena, 1, Calif.

## SELECTIVE AUDIO GATE

Patent No. 2,666,848

Thomas E. Goodwin, Hempstead, N. Y.  
(Assigned to Erco Radio Laboratories, Inc.)

This invention increases the reliability of communication. Several antennas are placed at different locations and each feeds into its own r.f. amplifier. Should one signal fade out or become too weak, the others may still provide satisfactory communication. This gate selects the stronger of two audio signals (from the output of a diversity radiotelegraph receiver), completely suppressing the weaker one. This is important, because a

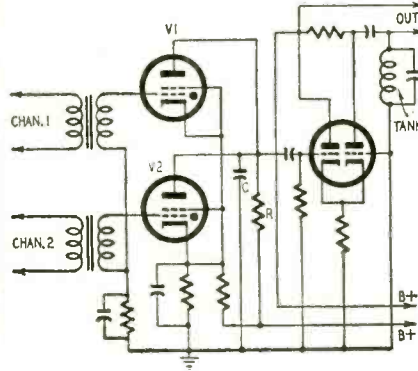

weak signal may arrive out of phase with the stronger one. If they are combined directly, less than optimum output would be obtained.

Each audio channel is fed to its own thyatron as shown. One tube only can conduct at any time. For example, if this should be V1, current flowing through the common grid return will bias V2 negatively and block it.

A tube can conduct only if C is charged to the value of the B supply. With signals fed to both channels, the tube receiving the stronger signal will fire first. When it does, the other tube blocks. Conduction permits C to discharge through the tube that ignites. It requires approximately one complete cycle for C to charge again through R. When C is charged again, the thyatrons are ready for the next audio cycle. Thus we have cycle-to-cycle sensitivity. The stronger signal always takes control for the next cycle.

Of course the thyatron output is a sawtooth wave. It is fed to a duo-triode limiter which squares off the top. A tuned tank converts this flat-top to a sine wave (flywheel action).

Both cathodes are biased by a positive voltage tapped off the B supply. This prevents the tubes from "taking off" or going into self-oscillation.

## CONTROLLED TRANSISTOR OSCILLATOR

Patent No. 2,663,800

Gerald B. Herzog, New Brunswick, N. J.  
(Assigned to Radio Corporation of America)

Controlled oscillators are used in TV sync networks, a.f.c., and similar applications. In each case the oscillator frequency is determined by its own circuit constants until it deviates from some incoming signal frequency. When it does, a control voltage shifts the oscillator frequency until it is in step with the signal. This circuit uses a local sawtooth generator which is to be synchronized with a signal (for example, a deflection pulse).

The sawtooth generator is an N-type point-contact transistor shown in the upper portion of the diagram. (Fig. 1). Its collector is biased negative by a battery, whose positive terminal (not shown) is grounded. A base resistor provides regeneration. It drives the transistor either to cutoff or to full conduction. There is no in-between condition.

Initially, C charges through R1, R2. Current

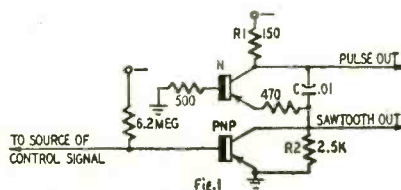

## FIND THE RIGHT TV Yoke Capacitor IN A JIFFY!



Just try the different ceramics in this Sprague TV Yoke Capacitor Replacement Kit until you get a good picture. That's all there is to it! 36 famous Sprague Cera-Mite® Capacitors, in eight different values selected and proportioned on the basis of actual need, providing complete coverage of fractional values between 33 mmf and 82 mmf. The tiny ceramic discs fit any yoke assembly . . . stand up under the toughest service . . . are excellent replacements for any 2000 volt capacitor which may appear in original equipment. Complete instructions are on the face of the tough, paper-board card, conveniently punched for hanging over the service bench. Get yours now! Ask your distributor for Sprague Kit CK-1. Only \$12.60 List!

**SPRAGUE PRODUCTS COMPANY**  
Distributors' Division of the Sprague Electric Co.  
NORTH ADAMS, MASS.



Solve poor TV reception with a HI-Gain Booster. Banish weak fringe areas, reduce snow. This unit comes to you as a highly serviceable High-Gain Tuner. Uses 6J6 Tubes in very efficient HI-Q Circuit. Has 8 tuned circuits using pure silver inductances and individual compensation providing high gain on all channels. Built in 5:1 Vernier Drive.  
All necessary parts and Instr. included makes highest gain booster on the market reg. of price.

**100 ASSORTED RESISTORS**  
Carbon insulated. New in current RMA Values 5%, 10% and 20% in 1/2, 1 and 2 watt . . . . . **\$1.00**

Shipments sent postpaid when full payment is enclosed. 25% deposit on C.O.D. Send for our new bulletin. NO C.O.D.'S TO CANADA.  
**FRANK W. DECRAZ & ASSOC.**  
11842 W. Jefferson Blvd. Culver City, Calif.

**CERAMIC 100 ONLY \$1 CONDENSERS**  
Complete kit of assorted Postpaid standard brands. All new, \$10 value!  
**HARJO SALES CO. Dept. E1**  
4109 Burbank Blvd., Burbank, Calif.

Watch for the July Issue of **RADIO-ELECTRONICS**  
At Your Dealers June 26

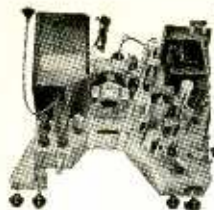

Build your own

## #630 Super Deluxe TV CHASSIS

with . . . U. H. F.

With a #630 SUPER DELUXE 31-TUBE TV KIT

including your assigned U.H.F. Station • OPERATES 16" TO 24" PICTURE TUBES • Engineered in strict adherence to the genuine RCA #630 plus added features • FULL 4MC BANDWIDTH • CASCADE TUNER • COSINE DEFLECTION YOKE • LARGER POWER TRANSFORMER • KEYED AGC • 12" SPEAKER • UNIVERSAL MOUNTING BRACKETS • CONDENSERS and RESISTORS at rated capacities and tolerances. You receive a COMPLETE SET OF PARTS and TUBES, everything needed is included (less wire & solder). All I.F. Coils and Transformers are factory pre-aligned and tuned. You will enjoy building it with "LIFE-SIZE" easy to follow step-by-step ASSEMBLING INSTRUCTIONS" included with each KIT.

NOTHING BETTER AT ANY PRICE!

only . . . **\$119.44** (less CRT)

## #630 SUPER DELUXE TV CHASSIS

with U.H.F.—Licensed under RCA patents  
**COMPLETE READY TO PLUG IN AND PLAY**—Similar in characteristics and features to the TV KIT at left • Manufactured especially for us by Regal Electronics Corporation • No efforts or expense have been spared in workmanship or materials, to make this #630 SUPER DELUXE TV CHASSIS the best obtainable for fringe areas, clarity and all-around performance, regardless of price. Customers report reception better than 200 miles • Each Set is factory aligned and air-tested • All parts carry the RMA three month guarantee • Our mass volume of business on this CHASSIS (numbering thousands of pleased customers) now makes it possible for us to reduce the price to . . . . .

only **\$157.97** (less CRT)

## 27" #630 CHASSIS TECH-MASTER

TECH-MASTER Gold Medal Model 2430-9 TV CHASSIS,

Including your assigned U.H.F. Station  
 90° deflection, operates all 24" or 27" rectangular and 30" round picture tubes. The last word in TV achievement • Ideal for wall or custom-cabinet mounting • Detailed technical data mailed on request, however with the knowledge that this CHASSIS is a 30-tube #630 with both TECH-MASTER'S and OUR guarantee, you need not hesitate sending your order in now.

Complete Ready to Plug in and Play . . . . . **\$262.50** (less CRT)  
 Special at

## DUMONT or SHELDON FINEST GUARANTEED PICTURE TUBES

MOST desirable 5 sizes—ALL RECTANGULAR . . . BRAND NEW in Factory Sealed Cartons—With a Full Year Guarantee

17" #17BP4A \$29.63    20" #20CP4B Aluminized \$39.74    21" #21EP4B Aluminized \$44.68    24" #24CP4A Aluminized \$66.24    27" #27EP4A Aluminized \$82.57

### #630 TV BASIC PARTS KIT

PUNCHED & DRILLED CHASSIS PAN BRACKET & SHIELD KIT (18 items) All for Only  
 VIDEO & I.F. KIT (19 items)  
 POWER TRANSFORMER #201T6  
 VERTICAL OUTPUT TRANSFORMER \$39.49  
 VERTICAL BLOCKING TRANSFORMER  
 FLYBACK TRANSFORMER #211T5  
 FOCUS COIL, 470 ohms #202D2  
 COSINE DEFLECTION YOKE 70°  
 Including LIFE-SIZE TV BUILDER INSTRUCTIONS

### PULSE KEYED AGC KIT

Finest, most accurate and the easiest Kit to install in a #630 or in any other make TV receiver. Improves performance, and insures a steady picture on all channels.

COMPLETE SET OF PARTS \$4.59  
 Including 6AU6 tube & Instructions

### UNIVERSAL Picture Tube MOUNTING BRACKETS

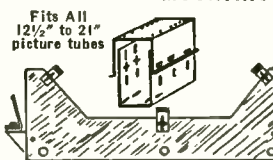
Fits All 12½" to 21" picture tubes Complete—Including band that holds picture tube.  
 \$6.97

### Modernize a #630 or any TV Set with a STANDARD CASCADE TUNER

For better all around performance

Complete with tubes, and Brooks CASCADE MANUAL with step-by-step instructions **\$22.49**

### THE NEW CASCADE TUNER

can now be installed in ANY TV set  
**"Brooks CASCADE MANUAL"** with easy to follow step-by-step instructions only **50¢** Postpaid

Brooks LIFE-SIZE TV INSTRUCTIONS for building any #630 TV Receiver. Postpaid **\$2.49**

HINTS FOR BETTER PERFORMANCE on your #630 TV receiver. Postpaid **\$1.00**

### CUSTOM-BUILT TV CABINETS

2 LEADING STYLES in genuine Mahogany or Walnut (Inlaid 10% extra). Drilled for #630 or blank knob panel for any make TV SET. Complete as pictured for 16", 17", 20" or 21" C.R.T.



H-41", W-25", D-23" **MANHATTAN \$59.37**



H-25", W-26", D-22" **VOGUE \$39.89**

### FINEST PM SPEAKERS

Brand new—factory packed—Alnico 5 magnets  
 5" . . \$1.14    6" . . \$1.49    8" . . \$2.97    12" . . \$4.62

### AUDIO OUTPUT TRANSFORMERS

50L6 type . . 29¢    6K6 . . 44¢    Universal . . 78¢

### SELENIUM RECTIFIERS

75 ma. . 57¢    100 ma. . 68¢    175 ma. . 76¢

### TV POWER TRANSFORMER

110 volts—60 cycles  
 350v-350v each side @ 250 ma worth \$14.  
 5v-3 amp. 6.3v-1.2 amp. **\$4.97**  
 6.3v-5 amp. 6.3v-1.2 amp . . . only

### AM SUPER RADIO FOR #630 or other TV

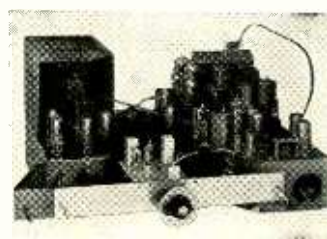

Complete ready to install including tubes & instructions (lists for \$21.95) only **\$7.89**

### PARTS FOR #630 TV SETS

TV WIRE & SOLDER KIT, for any Set. . . \$ 1.49  
 630-KIT, screws, nuts, rivets, washers, etc. . 1.69  
 PUNCHED CHASSIS PAN, cadmium plated. . 4.87  
 UNIVERSAL CRT MOUNTING BRACKETS. . . 6.97  
 STANDARD CASCADE TUNER, incl. tubes. . 22.49  
 POWER TRANSFORMER, 295ma. 201T6. . . 9.97  
 VERTICAL OUTPUT TRANS. 204T2. . . 2.69  
 VERTICAL BLOCKING TRANS. 208T2. . . 1.32  
 HORIZONTAL OUTPUT TRANS. 211T5. . . 3.98  
 FOCUS COIL, 470 ohms, 202D2. . . 3.42  
 DEFLECTION YOKE, Cosine 70°. . . . . 3.98  
 COMPLETE SET OF KNOBS, incl. decals. . . 1.34  
 SOUND DISCRIMINATOR TRANS. 203K1. . . 1.12  
 1st PIX I.F. TRANSFORMER, 202K2. . . 1.08  
 2nd PIX I.F. TRANSFORMER, 202K3. . . 1.08  
 1st or 2nd SOUND I.F. TRANS. 201K1. . . 1.02  
 HORIZONTAL DISCRIM. TRANS. 208T8. . . 1.49  
 FILTER CHOKE, 62 ohms . . . . . 1.47  
 CATHODE TRAP COIL, 202K4. . . . . 1.08  
 WIDTH CONTROL COIL, keyed AGC IFAAG . . . . . .79  
 VIDEO AND I.F. KIT, 19 items. . . . . 7.84  
 VARIABLE CONTROL KIT, 9 controls. . . . . 5.83  
 CARBON RESISTOR KIT, 107 resistors. . . . . 6.98  
 WIREWOUND RESISTOR KIT, 4 resistors. . . . . 2.31  
 BRACKET AND SHIELD KIT, 18 items. . . . . 8.63  
 ELECTROLYTIC CONDENSER KIT, 6 cond. . . . . 7.37  
 TUBULAR CONDENSER KIT, 38 condensers. . . . . 4.28

100 ASSORTED TUBULAR CONDENSERS All Are Standard Brands & Desirable Sizes \$15.00 Value Only **\$3.69**

100— ASSORTED ½ WATT RESISTORS **\$2.97**

15 — Asst. Radio Electrolytic CONDENSERS **\$3.74**

15 — Assorted TV Electrolytic CONDENSERS **\$5.88**

100 — ASSORTED MICA CONDENSERS **\$3.99**

100 — ASSORTED CERAMIC CONDENSERS **\$3.99**

100 — ASSORTED 1 WATT RESISTORS **\$4.86**

100 — ASSORTED SOCKETS Octal, Locfal & Miniature **\$2.92**

100 — ASSORTED KNOBS SCREW & PUSH-ON **\$2.97**

10 — VOLUME CONTROLS ASSORTED, WITH SWITCH ¼, ½, 1, 2 meg. and others **\$2.94**

Resistor & condenser code charts FREE with each order

**BROOKS RADIO & TV CORP., 84 Vesey St., Dept. A, New York 7, N. Y.**

JUNE, 1954

# NOW- STEP AHEAD FASTER! AS AN INDUSTRIAL ELECTRONICS TECHNICIAN

Turn your experience into a big, new better-paying career!

Day by day industrial plants are adding more electronic devices — for sorting, counting, checking, almost any control job you can name. Cash in on industry's great need for men who can keep these devices in top working order. Make more money, feel more secure, doing work that is second nature to you. With what you already know about electronics you have a long head start in a field just beginning to boom. GET INTO IT RIGHT NOW with the help of

## PRACTICAL INDUSTRIAL ELECTRONICS LIBRARY

4 Volumes  
1390 pages  
1050 illus.

\$22.50  
EASY  
TERMS

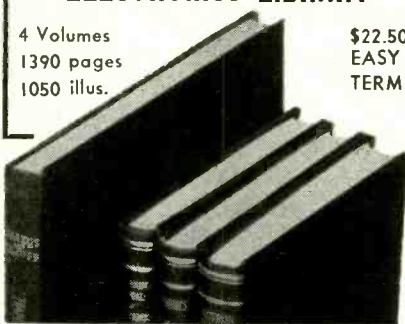

Here's the practical kind of information these 4 volumes give you:

- How to keep the plant's electronic equipment performing as it should
- How to locate and correct tube and circuit troubles quickly and easily
- How to install, service, and maintain even brand new equipment without being stumped by new circuits

No long sessions on math or theory! Instead you get: Clear explanations of how tubes and tube-operated circuits work in motor controls, welding controls, heat controls, etc. A complete manual that covers all maintenance procedures. A handbook of 433 industrial electronic circuits with each fully described. Troubleshooting charts, tested working methods, step-by-step directions—everything you need to start right now is here.

- Contains**
- Chute's *Electronics in Industry*
  - Miller's *Maintenance Manual of Electronic Control*
  - Markus & Zeluff's *Handbook of Industrial Electronics Circuits*
  - Henney & Fohnestock's *Electron Tubes in Industry*
- Shows facts such as:
  - How to operate the vacuum-tube voltmeter
  - How to correct ignitor misfire
  - How to maintain light sources for photoelectric control
  - How to protect circuits of welding machines
  - How tubes serve in conveyor synchronization, color measurement, etc. and hundreds more

## FREE TRIAL—EASY TERMS

McGraw-Hill Book Co.,  
Dent. RE-6, 327 W. 41 St., NYC 36

Send me the Practical Industrial Electronics Library for 10 days' examination on approval. In 10 days I will send \$2.50, then \$4.00 a month until \$22.50 is paid. (A saving of \$3.50 under the regular price of \$26.00.) Otherwise I will return books postpaid. (Print)

Name .....

Address .....

City ..... Zone ..... State .....

Employed by .....

This offer applies in U.S. only. RE-6

through R2 biases the emitter negative and blocks the transistor. When charge is complete, the current dies down through R2. The transistor begins to conduct, permitting C to discharge through it. This process is accelerated by the base resistor feedback and soon the transistor is conducting fully. With discharge completed, the transistor returns to its normal blocked condition while C

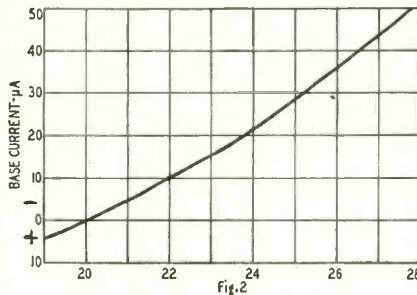

charges. The charge through R1, R2 is gradual. Discharge is rapid through the low-resistance semiconductor. In addition to sawtooth output (see diagram) a pulse output is also available. It is obtained from the collector terminal, and is due to abrupt change from full conduction to complete blocking.

The sawtooth frequency is determined by the values of R1, R2 and C. To control this rate, a junction transistor (PNP) shunts R2. A control voltage from the sync circuits (not shown) feeds this transistor. It controls the resistance between emitter and collector and thus varies the sawtooth rate. In a TV receiver, the control voltage comes from a discriminator.

Fig. 2 is a typical curve for the sawtooth generator. It shows how frequency varies with base current (through the PNP).

## A.F. PREAMPLIFIER FROM A RADIO SET

Patent No. 2,664,469

William D. Moehring, Charlotte, and  
Lawrence V. Wells, Kalamazoo, Mich.

(Assigned to Wilcox-Gay Corp., Charlotte,  
Mich.)

A phono jack is standard equipment in many radio and TV receivers. It permits using the a.f. channel for phonograph and other external sound sources. Generally, however, the audio amplifier has sufficient gain only for high-level signals such as radio or phono. If a mike is plugged in, the speaker might not be driven to full output. This inventor has found a simple solution for the problem. He uses one of the i.f. stages of the radio to double as an a.f. preamplifier. The i.f. efficiency of this stage is not reduced.

The microphone is connected as shown, in the input circuit of the i.f. stage. It may be left in at all times since it does not affect the i.f. gain. T1, T2, are i.f. transformers. Their windings have negligible impedance at a.f., so the microphone is effectively between the grid and ground. The small grid capacitor (.0001 μf) cannot bypass a.f., and the RFC prevents loss of i.f. through the microphone.

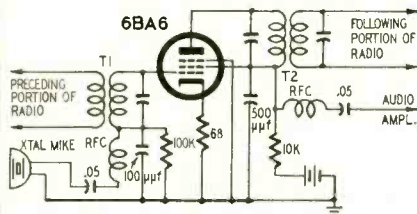

In the output circuit we find another radio-frequency choke to prevent i.f. loss. Because of the low impedance of T2, the plate and screen are effectively tied together for a.f. Thus the tube operates like a triode at these low frequencies. The screen capacitor is too small to bypass these frequencies. A resistor (10,000 ohms) acts as plate load.

The amplified audio may be fed directly or through the phono jack (not shown) to the audio channel of the radio.

## SUPER RECEPTION IN FRINGE AREAS AT BARGAIN PRICES!

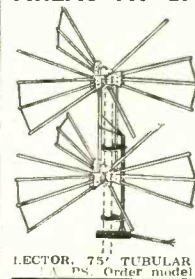

360° Super Directional Electronic Rotates in All Directions VHF-UHF CHANNELS 2-83

Exclusive Engineering and Design Costs to \$23.50

Powerful, 24 element 2 bay Directional Antenna is electronically beamed to any transmitter in fringe area by 6-position selector switch. No motors or electricity. Extremely high gain. COMPLETE WITH 6-POSITION ELECTRONIC BEAM SELECTOR. 75' TUBULAR TRIPLEX CABLE. UNIVERSAL P.S. Order model AX-324.

## TREMENDOUS BARGAIN

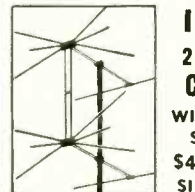

## IN CONICALS 2-BAY 16-ELEMENT CONICAL ARRAY

WITH HI-BAND ADAPTERS  
STURDY 3/8" ELEMENTS  
\$4.99 EACH IN LOTS OF 3  
SINGLE LOTS \$5.30 EACH

These are the same National Electronics had a BARGAIN like this. We made a special purchase in order to get these sensational prices. And this array has everything. This conical 2-bay 16-element array provides ultra-fine fringe reception. Includes sixteen 3/8 inch airplane type aluminum elements, including hi-band adapters for greater gain on the high channels and is complete with one pair of stacking bars to each array. These are packed in cartons of three 16-element arrays per carton, with tie rods, at \$14.95 per carton. When purchased in single 16-element arrays, separately boxed—your cost is \$5.30 each. 3 Two-Bay Arrays per carton without Tie Rods \$13.50 carton. 4 Bay Ultra-Fringe Stacking Assembly for Above—Model 4B \$1.95 set

NEW SPRING-SUMMER CATALOG AVAILABLE

**National Electronics**  
OF CLEVELAND  
**THE HOUSE OF TV VALUES**  
206 Delco Building Cleveland 3, Ohio

## TV GLO-TEST Replaces \$279 in TESTING EQUIPMENT



This is the instrument that appeared in feature articles in RADIO-ELECTRONICS and other publications. GLO-TEST is the sensational new tester that almost talks for TV and Radio servicemen, Sound Technicians, Amateurs, Experimenters, Electricians.

OVER 50 USES, INCLUDING—  
PIXTUBE TESTER—AC-DC VOLTAGE MEASUREMENTS TO 50 KV—SIGNAL GENERATOR—SIGNAL TRACER—TUBE TESTER—RESISTOR AND CAPACITOR MEASUREMENTS—DISTORTION AND LINEARITY CHECKER. ACCURACY COMPARABLE TO VTVM. FULLY GUARANTEED

Replaces instruments costing many times its cost, does a comparable job yet is only a small fraction of their total weight and size. GLO-TEST, complete with test leads and instruction booklet, postpaid, is priced at only **\$14.50**

Send check or money order, 10-day money back guarantee. Free literature on request.

V. A. ENTERPRISES, Dept. AA  
608 East Rosecrans Blvd., Compton, Calif.

RADIO-ELECTRONICS is paying good rates on acceptance for original and unusual articles on audio, television, FM and AM servicing, as well as articles on industrial electronic equipment and applications. Send for a copy of our Authors' Guide. Address:

## THE EDITOR RADIO-ELECTRONICS

25 West Broadway, New York 7, N. Y.

# A Brief Survey of COLOR TV

... how its complex character means job opportunity for you



—by E. H. RIETZKE,  
President, Capitol Radio Engineering Institute

A GOOD MANY YEARS AGO, when he was a young fellow, my Dad was one of the country's fastest typesetters. He could go anywhere and get a highly paid job with any newspaper in the country. Then came the linotype machine! Before he knew it, my Dad's job was obsolete. He had to start all over in another line of work.

How will you get along in the age of Color TV that has already arrived? Will you have to start all over? Or will you be prepared? The choice is a matter of black-and-white—or color. As you may know, color TV involves handling an understandably much more complicated signal than for black-and-white; the components must be in perfect balance; the margin for error is practically zero. Technical personnel need new skills in working to closer tolerances. Microwave relays and coaxial cables require added equipment and special adjustments. Before a station can originate color it needs a great deal of additional equipment, much more expensive and vastly more complicated than that for black-and-white. Slide and film equipment also require additional components and maintenance. Color camera chains are much more complex, requiring more highly skilled adjustments and care. Reports of network experiments indicate that live telecasting in color increases technical man-hours required by 30 to 50%. Lighting personnel need more skill in handling new—and deli-

cate—problems. That's a very quick run-down from the transmitter end. Every step is a technical opportunity.

What about color receivers? They'll be bigger—with roughly twice as many receiver tubes as black-and-white. There is at least one more tuning knob—the chroma control for color saturation. Maintenance is complicated, to say the least, with three highly critical video channels to trouble-shoot instead of one. Service contracts for color receivers will cost considerably more than for black-and-white, according to highly qualified sources—which should give you an idea of servicing complexity—and earnings possibilities. So much for transmission and reception. Manufacture of color equipment is another field for trained technicians.

Most well-informed sources agree that color television will be spread all over the U.S. by 1956 at the latest. The years between now and then are crucial. If you are interested in an honest-to-goodness career in this booming part of the booming electronics industry, here's how you can step ahead of competition, move up to a better job, earn more money, and be sure of a well-paid job: Study radio-television-electronics via CREI. You don't have to be a college graduate. You do have to be willing to invest some of your spare time—at home. You can do it while holding down a full-time job. Thousands have.

Since 1927 CREI has provided men with the technical knowledge that leads to more job security—and more money. CREI starts with fundamentals and takes you along at your own speed, not held back by a class, not pushed to keep up with others who have more experience. You master the fundamentals, then get into more advanced phases of electronics engineering principles and practice. Finally you may elect training at career level in highly specialized applications of radio or television engineering, or aeronautical radio. The coupon below, properly filled out, will bring you—without cost—a fact-packed booklet, "Your Future in the New World of Electronics," which includes outlines of courses offered, a resume of career opportunities, full details about the school, our Placement Bureau (with more requests for trained men currently on file than we can fill), and the names of some of the organizations using CREI training (like All American Cables & Radio, Inc., Canadian Broadcasting Corp., Columbia Broadcasting System, RCA Victor Division, United Air Lines, to name a few). I urge you—for your own good—to send for this free booklet immediately.

**NOTE:** CREI also offers Resident School instruction, day or evening, in Washington, D. C. New classes start once a month. If you are a veteran discharged after June 27, 1950, let the new GI Bill help you obtain resident (or home study) instruction. Check the coupon for more data.

## CAPITOL RADIO ENGINEERING INSTITUTE

An Accredited Technical Institute • Founded in 1927  
3224 16th Street, N.W. Dept. 146-A Washington 10, D. C.

Send booklet "Your Future in the New World of Electronics" and course outline.

CHECK FIELD OF GREATEST INTEREST

- Practical Radio Engineering
- Broadcast Radio Engineering (AM, FM, TV)
- Practical Television Engineering
- TV, FM & Advanced AM Servicing
- Aeronautical Radio Engineering

Name.....  
Street.....  
City..... Zone..... State.....

- Check:  
 Residence  
 School  
 Veteran

**EDLIE**  
says

**"SAVE ON AUTO RADIOS  
and 3-WAY PORTABLE RADIO KITS"**

Also other kits and Wired Units at Cut Prices

**SPECIAL! CUSTOM AUTO RADIOS**

FOR ALL CARS  
1949 thru 1954  
Models

- Custom Built
- Complete with 6 tubes
- 3-Gang Condensers
- 4-Minute installation—no holes to drill
- Great Value

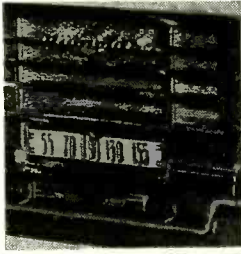

Ford: '49, '50, '51, '52  
Dodge-Plymouth: '49, '50  
Dodge: '51, '52  
Chevrolet: '51, '52  
Hudson: '48, '49, '50, '51, '52, '53  
Studebaker: '50, '51, '52  
Henry J: '51, '52  
Willys: '52, '53

**\$39<sup>17</sup>**

Chevrolet: '49, '50, '53, '54  
Ford: '53, '54  
Studebaker: '53, '54  
Plymouth: '51, '52, '53, '54  
Dodge: '53, '54  
Mercury: '52, '53, '54

**\$41<sup>13</sup>**

Indicate make and year of automobile when ordering

**5-TUBE UNIVERSAL AUTO RADIO \$23<sup>95</sup>**  
FITS ANY CAR UNDER DASH MOUNT

**NEW KIT SUPERSENSITIVE  
2 STATION INTERCOMMUNICATIONS SYSTEM—Kit \$12<sup>95</sup>**



Factory Wired ..... **\$16.95**

The fine unit is suitable for use in home, office, factory, nursery, or sick room. So sensitive it will pick up baby's whimper. Operates from 115 V. AC/DC. Both stations housed in compact, handsome, plastic cabinets: 6" x 6" x 3 1/2". Requires only 2 wires to connect for quick installation. Complete with 50 ft. of twin conductor wire.

**SAVE More Than HALF  
COMPONENT KITS  
INSULATED RESISTOR KIT**

**\$10. Value—Now \$1.65**  
Includes 100 resistors 1/4, 1/2, 1 & 2 watts from 5% to 20% tolerance. Comes in transparent plastic box. New low price. No. D 1273 Complete ..... **\$1.65**

**Paper Tubular By-Pass  
CONDENSER KIT**  
Worth \$15—Yours for \$2.95

Includes 50 by-pass condensers ranging in capacity from .005 mfd. to 5 mfd. and at voltages from 200 to 1600. Complete with transparent plastic cabinet 7" x 3 3/4" x 1 1/2". EDLIE Special No. D 1278. Complete ..... **\$2.95**

**PRECISION RESISTOR KIT**

Consists of 50—1% Wilkor carbonfilm resistors of 50 different ohmages, housed in a transparent plastic box. May be combined in series or parallel to produce almost any desired ohmage. Each resistor retails for about 85¢. Terrific Cash Save! Kit of 50 only ..... **\$2.45**

**3 TUBE PHONO AMPLIFIER  
NOT A KIT**

An assembled unit ready for installation using tone and volume control and 6 ft. rubber cord (less tubes) ... **\$2.95**  
Lowest Price!  
With complete set of tubes ..... **\$4.45**

**PHONO OSCILLATOR  
NEW SAVINGS!  
NOT A KIT!**

Wireless phono oscillator transmits recording for crystal pickups or voice from carbon mike through radio without wires. Can also be used as an intercom by using PM speaker as mike (less tubes) ... **\$2.95**  
With complete set of tubes ..... **\$3.95**



**3-Way Portable RADIO KIT  
AC/DC-Batteries**

NEW compact, lightweight portable radio kit with the very latest super-sensitive superhet. circuit. Wonderful reception from either batteries, or 115 V., 50-60 cycle AC or DC. Includes all complete parts (except wire & solder) necessary to build a great sounding radio. Also includes circuit diagrams and simplified, complete step-by-step instruction folder which makes assembling easy. Housed in a beautifully high-glossed Catalin cabinet in two delightful and distinctive colors: maroon or alabaster (ivory). Size: 9 1/2" x 5 7/8" x 4 3/4". Includes latest (maroon or ivory) **\$14.95 ea.**

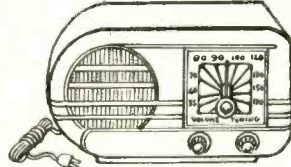

**5 Tube AC/DC Superhet Kit**

Kit #1.5 tube superhet kit. AC/DC cludes all quality components required to construct this latest design, highly sensitive superhet broadcast receiver, complete with black, glistening bakelite cabinet (excludes wire & solder). Kit of 5 tubes. 12AT6, 2/12BA6, 12BE6, 35W4, 50H5. Price, Less Tubes ..... **\$9.95**  
Extra for Tubes ..... **\$3.95**

**Terrific Value!**

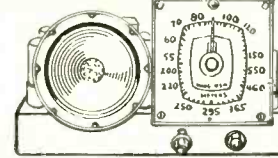

**Great Savings! 6-TUBE RADIO KIT**

Kit #2: Low priced 6-tube kit designed for extra high sensitivity, excellent selectivity and good, rich tone quality. Uses 25L6, 25Z6, 89Q7, 6SA7, 2/6SK7 in an easily constructed circuit. Includes all parts: punched chassis, resistors, condensers, coils, sockets, 1" M speaker, hardware, etc. Special closeout price. (Less tubes & cabinet) ... **\$6.95**  
Matched set of 6 tubes ..... **\$3.25**  
for kit ..... **\$3.25**



**SIGNAL GENERATOR  
BROADCAST BAND**

Completely Wired—New, simplified circuit provides the following switch tuned, tone modulated frequencies:  
1. 453 KC—Intermediate IF frequency  
2. 1500 KC—Hi freq. of b'cast band  
3. 600 KC—Lo Freq. of b'cast band  
4. Audio tone for audio amplifier trouble shooting  
5. Attenuator control is included for adjustment of the output signal strength.  
Housed in small, black bakelite cabinet. 6" x 6" x 3 1/2". Excellent for alignment of all Broadcast Band Radio receivers. Completely Wired—only ..... **\$7.95**

TERMS: All mdse shipped FOB New York City, prices subject to change without notice. Include 20% deposit for COD'S. WRITE TODAY FOR NEW FREE CATALOG!

**BALANCED PULSE CIRCUIT**

Patent No. 2,665,413

Abraham Hyman, New York, N. Y.  
(May be manufactured and used by the U.S. Government without payment of royalties)

This circuit converts an unbalanced (grounded) pulse to a balanced one. It uses two diodes D1, D2, which may be germanium or silicon crystals. T1, T2, are transmission lines.

The input pulse is positive. It passes through T2 and is reflected at the shorted end. Thus it returns as a negative pulse and flows through D2. A negative voltage appears across R2. The

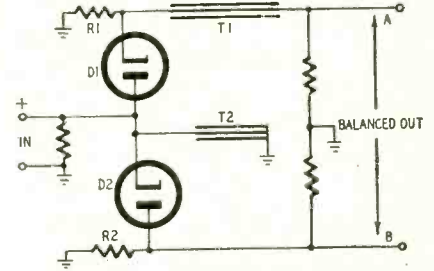

original positive pulse biases D2 to cutoff but it can flow through D1. A positive voltage appears across R1.

The voltage across R1 must flow through the delay line T1 before reaching the output terminal A. T1 is twice as long as T2. Thus it takes as long for a pulse to move through T1 as it does for a pulse to be reflected by T2. This means that the positive pulse arrives at A at the very same instant that the negative pulse arrives at B, and we have a truly balanced circuit.

**CONTROLLED OUTPUT  
AUDIOMETER**

Patent No. 2,662,940

Fred E. Barron, Minneapolis, Minn.  
(Assigned to Maico Co., Inc., Minneapolis)

An audiometer is a calibrated device used to test hearing. It is used in various forms by hearing-aid manufacturers, salesmen, and technicians. When conducting a hearing test, the maximum sound output of the audiometer must be controlled in some way. Too loud a sound could further injure an already defective hearing mechanism. At the very least, it could cause great discomfort. This new audiometer is designed with an automatic limiter.

The diagram shows a conventional audiometer above the dotted line XX. This portion includes a calibrated signal generator capable of delivering preset audio tones, an amplifier, and a calibrated attenuator. The latter is marked off in decibels relative to the threshold of hearing. No detailed description of these conventional

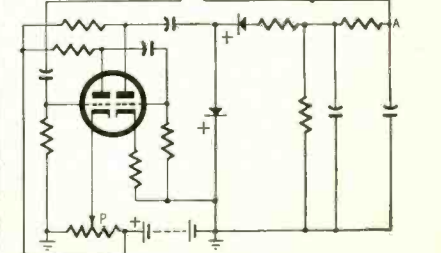
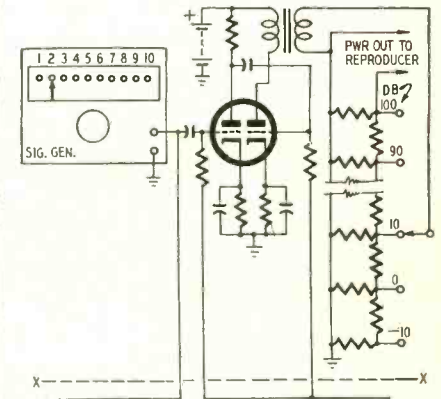

**EDLIE Electronics**

154 Greenwich St.  
DI 9-3143  
New York 6, N. Y.

**Y**ou cannot pick television  
replacement controls from a tree!

use...



It's easy to pick the right television  
replacement control from the Clarostat RTV program.  
Clarostat offers you the most complete line  
of television replacement controls and complete technical data  
to aid you in selecting the right one.

**Get the complete story on the RTV PROGRAM  
from your Clarostat Distributor today!**

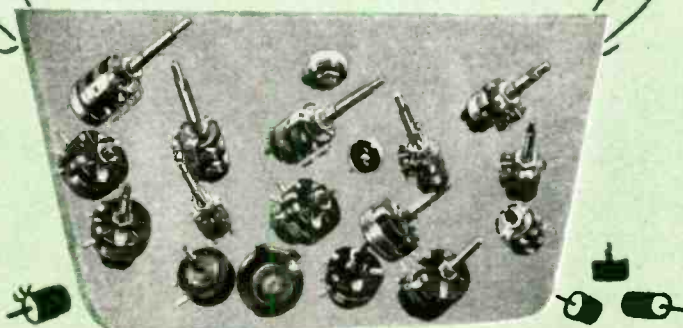

**CLAROSTAT MFG. CO., INC., DOVER, NEW HAMPSHIRE**  
In Canada: Canadian Marconi, Co., Ltd., Toronto 17, Ont.

# PYRAMID'S "Powered" SPECIALS

**VIBRATORS** Standard 4-Prong Special  
Replaces Mallory 294, 859, 901M.  
Rodiant 5300, 5301, Etc. \$1.29 ea. In  
lots of 10 or more \$1.19.

**SPEAKERS**

- 6" x 9" P. M. Speaker \$3.28
- 5" x 7" P. M. Speaker 2.98
- 4" x 6" P. M. Speaker 1.79
- 4" P. M. Speaker 1.49
- 5" P. M. Speaker 1.59

Automobile rear seat speakers, complete  
with all instructions, 3-way switch, grille,  
wiring harness, etc.  
5 x 7 Kit \$5.37      6 x 9 Kit 7.17

**CRT BRITENERS**

(SERIES CIRCUITS)      (Parallel Circuits)  
\$1.28 ea.    \$1.15      1.59 ea.    1.40  
10 or more      10 or more

"TOM THUMB"  
Power Packed  
Indoor Ant.  
2.49 list  
1.29 ea.  
1.19 lots of 10

78 RPM STANDARD  
Crystal Cartridge  
Replaces Astetic  
192 A, M22, Shuve  
W59A, W42M  
1.92 ea.  
1.79 lots of 5

NEW!  
Hi Po 6S78  
Especially  
designed  
Replacement for  
6SN7GT  
2.52 ea.  
2.27 lots of 10

Hi-Po 567 or 5 AW 4  
Heavy Duty Tube  
Replacement for  
5 u. 4 G  
1.59 ea.  
1.40 lots of 10

AUTHORIZED FACTORY TUBE DISTRIBUTORS:  
CBS-HYTRON, NATIONAL UNION, SHELDON,  
SYLVANIA, WESTINGHOUSE. DISCOUNT: 50/10%  
OFF LIST.

**FREE!** Write for our latest  
catalogs and price lists.

TERMS: 25% with order, balance C. O. D. All  
merchandise new and fully guaranteed.  
Minimum order \$5.00 F. O. B. NEWARK,  
NEW JERSEY.

**PYRAMID SUPPLY COMPANY**  
345 W. MARKET STREET  
NEWARK 7, NEW JERSEY  
AUTHORIZED DISTRIBUTORS

**RECORDING TAPE (PLASTIC BASE)**  
40% OFF (NEW)

- 1200 ft. plastic tape with plastic reel included.
- Each reel individually boxed.
- Choice of nationally famous top quality brands such as:  
Wobcor (2806) 3.20; Reeves (SPN-12) 3.20; Audio (1251) 3.25; Scotch (111-A) 3.25; Panacoustic (711-A) 3.25; Irish, Professional grade (211 RPA) 3.30.
- FREE! A 7.95 tape carrying case included with purchase of 12 new tapes!

**USED RECORDING TAPE (PLASTIC BASE)**  
1200 Feet Wound on Plastic Reels

\$1.99 (1-23 reels)	\$1.75 (80-95 reels)
\$1.79 (24-47 reels)	\$1.71 (96-143 reels)
	\$1.68 (gross or more)

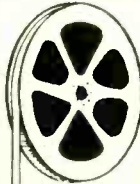

\*\*Standard hub plastic reel supplied with above. For tape wound on professional 2 1/2" hub, add 5c extra per reel.  
\*\*Empty 7" box (2 cover) for above reels 5c each (not sold at this price separately).

New empty plastic reels in boxes for easy labeling. 3" 10c; 4" 22c; 5" 24c; 7" 29c; 7" Professional reel (2 1/2" hub) 39c ea. EMPTY BOXES: 3" 3c; 4" 5c; 5" 5c; 7" 10c ea.

We carry all brands of new tape, recording blanks, tape recorders, etc. at low prices. PLEASE INCLUDE SUFFICIENT POSTAGE.

**COMMISSIONED ELECTRONICS CO.**  
2503 Champlain St. N.W., Washington 9, D. C.

circuits is needed. The grid bias of both triodes is fed in at point A. Thus the audiometer gain depends upon the voltage at this point.

The limiter circuit is drawn below line XX. In the 2-stage amplifier, the left-hand triode is biased (at P) for cutoff. Only if and when the generator output exceeds a predetermined maximum, is this bias overcome. Under this condi-

tion the a.f. is amplified and then rectified in a voltage-doubling circuit. The d.c. signal appears at point A to control the audiometer gain. When properly set, this limiter completely blocks the audiometer whenever maximum output is exceeded. This prevents injury to the patient being tested and keeps the reproducer from being overloaded.

**COMPRESSION AUDIO-FREQUENCY AMPLIFIER**

Patent No. 2,659,777  
Wesley R. Schum, Chicago, Ill.

This amplifier provides quick and effective limiting on strong signals. The stronger the signal, the greater the downward compression. There can be no blasting or overloading. After a predetermined level has been reached, the output is held nearly constant. For example, a rise of 40 db in the signal input may result in only a 3-db increase in the output.

The amplifying channel includes 3 stages: A 6BE6, 12AX7 (one half), and 6AQ5. The output transformer T1 has a third winding shunted by a voltage divider. Thus part of the output is

So far we have only ordinary gain or volume control. However, the rectified voltage on C also controls V1. On strong signals, the cathode of V1 passes less current, so this element goes less positive. Of course, the cathode of V2 does likewise. Then this "triode" (connected as a diode) passes more current and deposits a greater charge on C. The gain of the 6BE6 is drastically cut down.

An initial bias of 0.25 volt is applied across C through R. This prevents the capacitor from going positive at any time. It also reduces charging

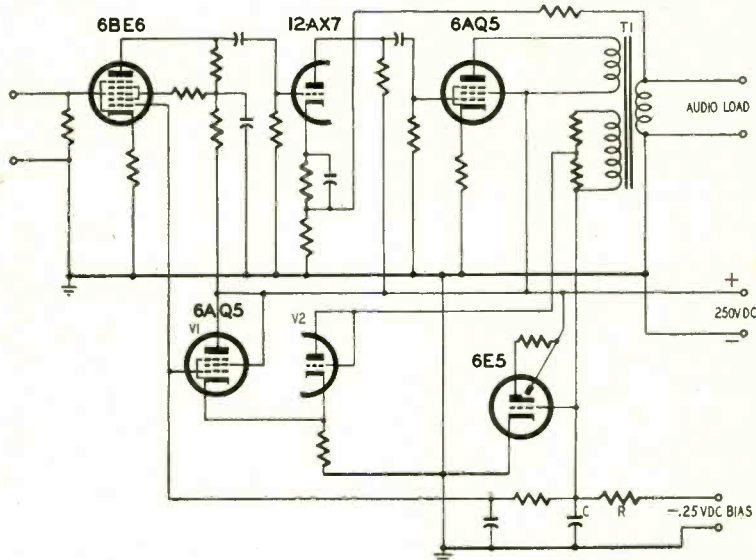

fed to V2, the second half of the 12AX7. V2 rectifies this voltage and charges C. The greater the amplifier input, the more negative C goes. This capacitor delivers its voltage to an R-C filter which in turn biases the 6BE6. Thus a loud signal lowers the gain of this tube because of the increased bias placed upon it.

thumps which might occur. Furthermore, it speeds up the charging process so that compression is accomplished instantaneously. During weak-signal input, C can discharge through R down to its initial voltage.

The tuning eye is for measuring the degree of compression. It may be calibrated in decibels.

**CONTROLLING HIGH-FREQUENCY SUPPLY FOR TAPE HEAD**

Patent No. 2,658,953  
Franz L. Putzrath, Pennsauken, N. J.  
(assigned to Radio Corp. of America)

Tape heads may become magnetized when their high-frequency supply is suddenly removed. This introduces noise and distortion on subsequent tape playbacks. In the circuit described here, the r.f. is reduced in steps. The invention is especially suitable for film projectors. One switch attenuates the radio frequency energy to the tape head while turning on the exciter lamp for optical playback.

first step, S3 shorts its contacts b and c. The shunt resistor R2 takes current away from the head. In a typical circuit the drop was approximately 6.6 db.

The second switching step shorts out b and c on S2. Shunt resistor R1 is now in the circuit, along with R2. This change may drop the head current by about 4 db more. Still further rotation of the switch causes S1 to short out its contacts

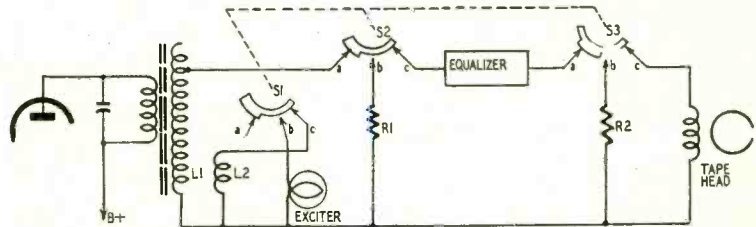

The diagram shows 3 switches which are ganged and controlled by a single knob. In the position shown, the r.f. flows from an oscillator coil L1 to the tape head, through the equalizer. To switch from magnetic to optical playback, the switches are rotated counter-clockwise. After the

b and c. This turns on the exciter lamp for optical reproduction. This lamp is fed from winding L2. Supplying power to the exciter drops the r.f. head current to nearly zero. This current can now safely be shut off, for example, by rotating the switch to its next step. END



**1,000 MEET IN PHILLY**

Possibly the largest gathering ever arranged and attended by service technicians was the Color TV Symposium and Eastern Television Service Conference, held in Philadelphia April 2, 3 and 4. More than 1,000 technicians registered and paid the \$2 fee for the sessions of the Color Symposium. Of these, 141 were regularly accredited delegates from their local associations to the Eastern Conference.

The Color Symposium was organized jointly by the Council of Radio and Television Service Associations of Philadelphia and the Philadelphia parts distributors. It consisted of an introductory session April 2, in which a moving-picture progress report on radio, TV and electronics was presented, and color TV receivers were demonstrated in the exhibition hall.

In the next two days of the Symposium there were 16 lectures on various phases of color TV and related subjects. These ranged from highly theoretical discussions of the composition of the luminance signal to conversational-type talks on the use of present-day test equipment in color servicing.

Other subjects discussed at the Symposium included color tubes, and test equipment specially made for color, installation, and trouble shooting.

Sets of all the leading manufacturers were on display and a TV signal generator loaned for the occasion by RCA permitted continuous display of color slides or test patterns.

The Second Eastern Television Service Conference, which met at the same time, took steps to incorporate permanently as a "regional organization, in which all local, state and national groups retain their autonomy . . . to provide a closer liaison between segments of the television service industry in the eastern part of the United States, and with national service groups, so that we may eventually obtain a semblance of national unity for the television service industry."

Officers for the permanent organization elected at the Conference were: Harold B. Rhodes, Paterson, N. J., chairman; Bert Bregenzler, Pittsburgh, Pa., vice-chairman; Ferdinand J. Lynn, Buffalo, N. Y., secretary; and John Rader, Reading, Pa., treasurer.

**ACTIVITY IN MICHIGAN**

The Television Service Association of Michigan reports that Jackson is forming an association, and that the proposed state law to license TV and radio service technicians (RADIO-ELECTRONICS, April, 1954, page 120) died in committee.

Kalamazoo reports new officers: Bill West, president; Frank Rector, vice-president; Harry Reynolds, secretary; Cliff Bennett, treasurer.

New officers were elected also by TSAM: Al Weiss, president; Russell Voght, first vice-president; Edward Brown, second vice-president; Malcolm R. Wright, secretary; Clayton Hibbert, treasurer.

# NEW INVENTION OUTMODES ALL PRESENT ANTENNAS!

**53 CLAIMS GRANTED IN 5 U.S. PATENTS ON NEW REVOLUTIONARY ANTENNA INVENTION!**

**NEW!**

**SUPER 60**

#2,585,670 #2,609,503 #2,625,655 #2,644,091 #2,661,423 others pending



**COMPLETELY REVOLUTIONARY**

LIST PRICE  
**\$36.75**  
SEE YOUR  
JOBBER

The 9-position selector switch electronically rotates the antenna in a stationary position.

★ GUARANTEED TO POSITIVELY OUTPERFORM ALL OTHER ANTENNAS (with or without rotor motors) on ALL UHF, and ALL VHF stations 2 thru 83 from ALL directions.

★ GUARANTEED to positively give you the CLEAREST, SHARPEST, most PERFECT GHOST-FREE pictures possible in both COLOR and black-white.

**MONEY BACK GUARANTEED TO RECEIVE All CHANNELS 2-83 FROM All DIRECTIONS AND POSITIVELY OUTPERFORM All OTHER ANTENNAS WITH OR WITHOUT A ROTORMOTOR**

**UP TO 10 TIMES MORE POWERFUL THAN ALL PRESENT CONVENTIONAL ANTENNAS!**

New, revolutionary antenna, while being up to 10 times more powerful than conventional antennas, is still able to receive all television and FM stations from all directions without a rotor motor of any kind. The electronic orientation switch used with a new type transmission line developed specifically for this extra powerful antenna now makes it possible to clearly receive stations heretofore considered out of range. It is now possible to put up just one antenna, use just one transmission line, pay for just one installation and receive the finest possible reception from the stations in and coming to your area regardless of their direction.

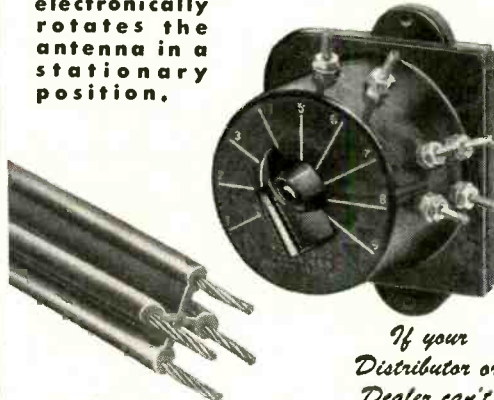

*If your Distributor or Dealer can't supply you... Contact us for the name of one who can*

**NEW POLYMICALENE 4 CONDUCTOR TRANSMISSION LINE**

**THIS IS ALL YOU NEED!**  
The price includes the complete antenna and the 9-position electronic orientation switch. The Air Dielectric Polymicalene Transmission Line is purchased as required for the individual installation.

**ONCE AND FOR ALL SOLVE YOUR ANTENNA PROBLEM**

**ALL CHANNEL ANTENNA CORP.**  
47-39 49th STREET, WOODSIDE 77, N. Y. EXETER 2-1336

## TUBES 1 YEAR GUARANTEE

1B3 .65	6AV6 .37	6BQ6GT .65	6SA7GT .43	6U8 .61	12AV7 .59	12SK7GT .48	25AV5 .83
1X2 .60	6AX4 .53	6BQ7 .90	6SH7 .73	6V3 .93	12AX4 .48	12SL7GT .48	25BQ6GT .62
5U4G .46	6BA6 .39	6C4 .37	6SK7GT .44	6V4GT .39	12AX7 .48	6W4GT .44	25L6 .39
5Y3GT .32	6BA7 .57	6CB6 .44	6SL7GT .41	6W6GT .44	12A27 .69	6X4 .37	12SN7GT .56
6AB4 .44	6BC5 .44	6CD6G .44	6SN7GT .48	6X5GT .37	12BD6 .45	6X4 .37	12SQ7 .42
6AG5 .43	6BC7 .71	6E5GT .129	6SN7GT .48	6Y6G .48	12BE6 .39	6X4 .37	14AF7 .50
6AK5 .72	6BE6 .39	6J5GT .37	6SQ7GT .49	12AT6 .37	12BH7 .63	6Y6G .48	14N7 .60
6AL5 .38	6BF5 .41	6J6 .52	6SQ7GT .49	12AT7 .56	12S8 .70	6Y6G .48	19B6G .39
6AQ5 .39	6BG6G .19	6K6GT .37	6T8 .56	12AU7 .51	12SA7GT .51	6Y6G .48	50C5 .39
6AT6 .37	6BH6 .46	6K6GT .37		12AV6 .39		6Y6G .48	50C5 .39
6AU6 .38	6BL7 .59	6S4 .38				6Y6G .48	50L6GT .40
6AV5 .83						19T8 .79	

**Many Other Types Available**  
25% deposit must accompany all orders—balance C.O.D., F.O.B. Irvington. If full amount is sent with order, we will pay freight charges. On orders under \$10, add \$1. handling charge. All tubes subject to prior sale.

**CECO ELECTRONICS**  
13th Avenue at Columbia • Irvington 11, N. J.

# Transistors

for the practical worker in electronics! TRANSISTORS — THEORY AND PRACTICE boils down the findings of advanced

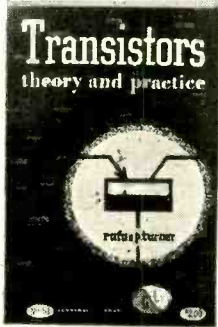

physicists on transistors into the language and experience of the service technician and other practical workers in electronics. Most complete low-cost book on transistors yet published.

## Transistors — Theory and Practice

Gernsback Library Book No. 51. By Rufus P. Turner. 144 pages. Fully illustrated. \$2.00

For you who depend on electronics for a living or who work with it as a hobby, here is a book which gives you the lowdown on transistors, the dramatic new development which promises to revolutionize the entire industry.

Most of what has been written on transistors so far has been limited to the rarified strata of the advanced physicist—so obscure that even some engineers have trouble understanding it.

### NEW PRACTICAL APPROACH

But now, Rufus P. Turner, who knows more about transistors than any popular technical writer in the business, lifts the fog on this fascinating subject. In a simple, straightforward manner, he traces the transistor from the basic semiconductor theory to the application of transistors in practical circuits.

With the actual commercial use of transistors already a reality in hearing aids, and their use in radio and TV just around the corner, the service technician and experimenter owe it to themselves to learn all they can about these new electronic devices. TRANSISTORS—THEORY AND PRACTICE is a giant step along the way to understanding how to work with transistors in practical circuits.

### SOME OF THE CONTENTS OF TRANSISTORS—THEORY AND PRACTICE

- Semiconductor Theory
- Transistor Characteristics
- Equivalent Circuits
- Transistor Amplifiers
- Transistor Oscillators
- Duality in Transistor Circuit Design
- Triggers and Switches
- Practical Transistor Circuits
- Tests and Measurements
- Characteristics of Commercial Transistors

First time in any book—a complete discussion on the surface-barrier transistor!

### EXCLUSIVE FEATURE

Chapter 10 — Characteristics of Commercial Transistors is a complete guide to the physical and electronic characteristics of commercial transistors. Actually the first published manual on transistors, it can save many hours of experimenting and trial and error methods. This unique feature alone makes TRANSISTORS—THEORY AND PRACTICE a book you should own. Get your copy today at your parts distributor's.

### COLOR-BLIND TECHNICIANS

A test carried out in Motorola's television school for distributor service personnel indicates that a color-blind man is not handicapped in adjusting a TV receiver to obtain a good color picture.

According to Carl Finney, instructor who carried out the test: "If a man can adjust a color set to receive a clear black-and-white picture, he can be sure of getting a good color picture since the intensities of color are already focused." None of the test group of 75 service managers had any difficulty in adjusting a color set to get a good black-and-white picture.

### GUILD PUBLISHES PAPER

The Radio Television Guild of Long Island, N.Y. published in February first issue of its organ, *The Guild News*, a 6-page printed paper, excellent both in the quality of its contents and its format. The second issue, just received, maintains and even improves on the standards set by the initial edition.

The February editorial discussed the phenomenal growth of the Guild during the past year and posed a number of problems yet to be solved. The second issue's lead article reports a positive approach to one of these problems: retail selling by distributors. The Guild is setting up a Distributor Shopping Committee, the sole purpose of which is to shop all distributors once a month for the purpose of discovering which sell to the trade only.

The committee will report to the executive board, which will prepare reports to be submitted to the membership at regular monthly meetings.

News of the industry—local and national—appears on the inside and back pages, and there are also photographs and cartoons. There are even advertisements, from members with equipment to swap, and from well-known distributors.

### WHY THE PUBLIC DOUBTS

The Utah Association of Radio and Television Servicemen has discovered ten main reasons for the doubtful attitude large portions of the set-owning public have toward TV and radio service. These, the Utah service techs find, are:

1. Phony ads that offer service at ridiculously low rates.
2. Failure to fulfill the promises of these phony ads.
3. Poor-quality work.
4. Excessive charges.
5. Long delays.
6. Failure to give simple guarantees.
7. Failure to make good on legitimate complaints.
8. Sloppy personnel.
9. Sloppy, ill-equipped shops.
10. Use of second-hand, inferior parts.

The association, in a 7-page excellently mimeographed publication, points out that the local associations have been doing a thorough policing job to protect the public from frauds and incompetents. END

## Have you read these Gernsback Library Books?

TV Repair Techniques. No. 50. \$1.50  
Radio & TV Test Instruments.  
No. 49 ..... \$1.50

See your distributor—or mail this coupon

Gernsback Publications, Inc., Dept. 64  
25 West Broadway, New York 7, N. Y.

Enclosed is my remittance of \$.....  
Please send me the following books postpaid.

- 61 Transistors—Theory and Practice. \$2.00  
 50  49  48  47  46  
 45  44  43  42  41  39

Name \_\_\_\_\_  
(Please print clearly)

Street \_\_\_\_\_

City \_\_\_\_\_ Zone \_\_\_\_\_ State \_\_\_\_\_

High-Fidelity—Design, Construction, Measurements. No. 48. \$1.50

Radio & TV Hints. No. 47. .... \$1.00

Television Technotes. No. 46. . \$1.50

Radio Tube Fundamentals.  
No. 45 ..... \$1.00

Basic Radio Course. No. 44. . \$2.25

Model Control By Radio.  
No. 43 ..... \$1.00

High-Fidelity Techniques.  
No. 42 ..... \$1.00

Public-Address Guide. No. 41. .75¢

Practical Disc Recording. No. 39.75¢

**AS-3 SPEAKER**

Quam-Nichols Co., 236 East Marquette Road, Chicago 37, Ill., announces that the Quam AS-3 rear-seat auto speaker kit is ready for immediate delivery. It is a new 5 x 7-inch model with a 1.47-ounce Alnico V magnet. The AS-3 has

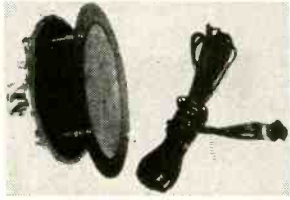

a 3/4-inch voice coil and will handle the complete undivided output of any conventional auto set.

Ford, Chrysler, Studebaker, Hudson, and other models have baffle openings for the AS-3 size unit.

**HI-VO-KAPS**

Centralab, Division of Globe-Union Inc., Milwaukee 1, Wisc., has announced new precision high-voltage capacitors which are designed so terminals will not twist out or break off. The capacitors are available in 20,000 d.c. working volts, 500  $\mu$ mf. Heavy 8-32 threads on both terminal and capaci-

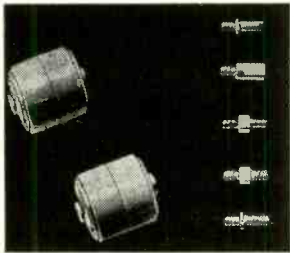

tor lock the terminal tightly and precisely into the Hi-Vo-Kap. Internal corona is prevented by seating the terminal at the bottom of the capacitor tap, avoiding any air gap. Therefore, these terminals should be given a half-twist with a pair of pliers when inserting them into the capacitor.

All Centralab Hi-Vo-Kaps are tested at twice rated working voltage on the basis of 1,000-hour life-load tests, and to assure maximum safety factor each is flash-tested before being shipped.

**TWO NEW FLYBACKS**

Haldorson Transformer Co., 4500 North Ravenswood Avenue, Chicago 40, Ill., has announced two new flybacks, FB414 and FB415, for servicing Emerson TV. They are described as being specific replacements designed to cover well over 100 Emerson models and chassis.

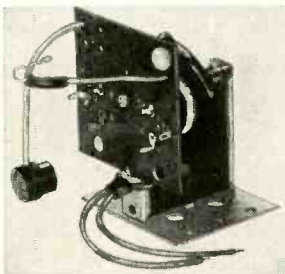

**FUSE HOLDER**

Littelfuse, Inc., Des Plaines, Ill., has introduced a new fuse holder. The innovation consists of substantial cutouts



on each side of the holder which facilitates quick and easy replacement of fuses. With the new model, the blown pigtail fuse can be readily snapped on one side; the regular replacement fuse inserted on the other. Use of the TV snap-on mounting eliminates cutting out the pigtail fuse, messy soldering, and the threat of damage from a hot iron.

**WINDOW ANTENNAS**

Television Hardware Manufacturing Co. (Division of General Cement Manufacturing Co.) Rockford, Ill., has announced two new TV window-mounted antennas.

One is a bowtie intended for u.h.f. reception only, and features an exclusive wishbone free-air insulator that prevents shorting out under any condition.

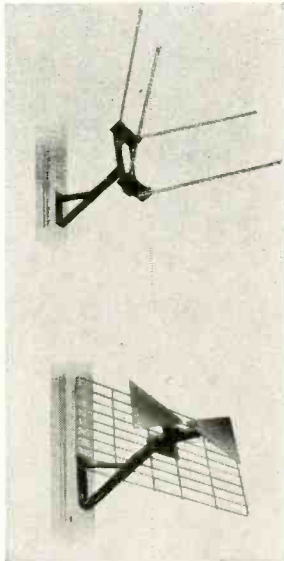

The other window antenna is a stacked-V antenna which can be used for u.h.f. and v.h.f. in primary and secondary signal areas. It is adjustable approximately 120 degrees (v.h.f.) to 160 degrees (u.h.f.) when mounted against a wall or flat surface. This antenna is highly directional and receives both signal bands.

**CHOKE LINE EXPANDED**

International Resistance Co., Philadelphia 8, Pa., introduced two new sizes to its insulated choke line. In addition to a wide extension of ranges, these units are now available in four sizes. They are all in molded plastic housings, protectively insulated against high humidity. Identified as types CL1/2, CLA, CL1, and CL2, these chokes offer a wide range of size and characteristic combinations, and permit accurate specification to individual space and electrical requirements.

The chokes offer numerous circuit applications, such as filament chokes, plate loads, wave traps, parasitic suppressors, line-terminating impedances, cathode chokes, antenna chokes, and grid chokes.

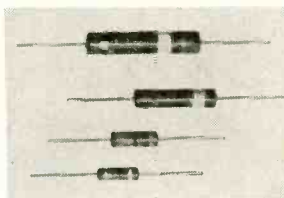

**TENNA-TIE**

Channel Master Corporation, Ellenville, N. Y., has announced an improvement in the design of its Tenna-Tie, the interaction filter which joins high- and low-band v.h.f. antennas for use with a single transmission line.

The new Tenna-Tie now incorporates separate high- and low-pass filters which replace the parallel-resonant circuit previously used. With this new circuit the installation man may connect leads of any length between the

At Last!

a complete

**TUBE TESTER**

\$ **24.90**  
for only



**New EMC Model 208\***

Pat. Pending tests all popular tube types quickly... easily... accurately... in the field or shop.

The sensational new EMC Model 208\* gives you for the first time a complete precision tube tester for less than \$25.00.

With it you can quickly and accurately test all popular tube types for quality as well as shorts, leakages, filament continuity and opens.

MODEL 208 TUBE TESTER (COMPLETELY WIRED AND TESTED) Only \$24.90

MODEL CRA (PICTURE TUBE ADAPTOR OF MODEL 208) \$4.50

**CHECK THIS EXCLUSIVE COMBINATION OF FEATURES:**

1. Lowest market price
2. Completely portable
3. Checks all popular octal, loctal, miniature and novol base tubes
4. Flexible switching system assures complete testing of our present and future tubes types
5. Elements numbered according to RTMA base system
6. Individual sockets for each tube type
7. Checks completely for quality as well as shorts, leakages, filament continuity or opens between any two tube elements
8. Visual line voltage check with adjustable control assures accurate quality testing
9. Matches and checks HI-FI tubes such as 1614, KT 66, and 5881
10. Space saving, high impact case, 5 1/4 x 6 3/4 x 2 7/8"
11. Comes complete with detailed instruction book and tube listings

An invaluable tool for: Servicemen, radio hams, HI-FI fans, students, hobbyists.

Write to Dept. RE-6 today for complete catalog of precision test equipment.

EXPORT DEPT.- 136 LIBERTY ST. N. Y. 6, N. Y.

**EMC** ELECTRONIC MEASUREMENT CORPORATION 260 LAFAYETTE STREET NEW YORK 12, N. Y.

# BUILD 15 RADIOS ONLY AT HOME \$19.95

With the New Improved 1954 Progressive Radio "EDU-KIT"

NOW INCLUDES SIGNAL TRACER and CODE OSCILLATOR

- ATTRACTIVELY GIFT PACKED
- FREE SOLDERING IRON
- NO ADDITIONAL PARTS NEEDED
- EXCELLENT BACKGROUND FOR TV
- 10 DAY MONEY-BACK GUARANTEE
- SCHOOL INQUIRIES INVITED
- ABSOLUTELY NO KNOWLEDGE OF RADIO NECESSARY



## WHAT THE PROGRESSIVE RADIO "EDU-KIT" OFFERS YOU

The Progressive Radio "Edu-Kit" offers you a home study course at a rock bottom price. Our Kit is designed to train Radio Technicians, with the basic facts of Radio Theory and Construction Practice expressed simply and clearly. You will gain a knowledge of basic Radio Principles involved in Radio Reception, Radio Transmission and Audio Amplification. You will learn how to identify Radio Symbols and Diagrams; how to build radios, using regular radio circuit schematics; how to mount various radio parts; how to wire and solder in a professional manner. You will learn how to operate Receivers, Transmitters, and Audio Amplifiers. You will learn how to service and trouble-shoot radios. You will learn code. You will receive training for F.C.C. license.

In brief, you will receive a practical basic education in Radio, worth many times the small price you pay.

## THE KIT FOR EVERYONE

The Progressive Radio "Edu-Kit" was specifically prepared for any person who has a desire to learn Radio. The Kit has been used successfully by young and old in all parts of the world. It is not necessary that you have even the slightest background in science or radio.

The Progressive Radio "Edu-Kit" is used by many Radio Schools and Clubs in this country and abroad. It is used for training and rehabilitation of Armed Forces Personnel and Veterans throughout the world.

The Progressive Radio "Edu-Kit" requires no instructor. All instructions are included. All parts are individually boxed, and identified by name, photograph and diagram. Every step involved in building these sets is carefully explained. You cannot make a mistake.

## PROGRESSIVE TEACHING METHOD

The Progressive Radio "Edu-Kit" comes complete with instructions. These instructions are arranged in a clear, simple and progressive manner. The theory of Radio Transmission, Radio Reception, Audio Amplification and servicing by Signal Tracer is clearly explained. Every part is identified by photograph and diagram. You will learn the function and theory of every part used.

The Progressive Radio "Edu-Kit" uses the principle of "Learn by Doing". Therefore you will build radios, perform jobs, and conduct experiments to illustrate the principles which you learn. These radios are designed in a modern manner, according to the best principles of present-day educational practice. You begin by building a simple radio. The next set that you build is slightly more advanced. Gradually, in a progressive manner, you will find yourself constructing still more advanced multi-tube radio sets, and doing work like a professional Radio Technician. After you will build fifteen radios, including Receivers, Transmitters, Amplifiers, Code Oscillator and Signal Tracer. These sets operate on 105-125 V. AC/DC. An Adaptor for 210-250 V. AC/DC operation is available.

## THE PROGRESSIVE RADIO "EDU-KIT" IS COMPLETE

You will receive every part necessary to build 15 different radio sets. Our kits contain tubes, chassis, variable condensers, electrolytic condensers, mica condensers, paper condensers, resistors, line cords, selenium rectifiers, tie strips, coils, hardware, tubing, etc.

Every part that you need is included. These parts are individually packaged, so that you can easily identify every item. A soldering iron is included, as well as an Electrical and Radio Tester. Complete, easy-to-follow instructions are provided. In addition, the "Edu-Kit" now contains lessons for servicing with the Progressive Signal Tracer, F.C.C. instructions, quizzes. The "Edu-Kit" is a complete radio course, down to the smallest detail.

## TROUBLE-SHOOTING LESSONS

Trouble-shooting and servicing are included. You will be taught to recognize and repair troubles. You will build and learn to operate a professional Signal Tracer. You receive an Electrical and Radio Tester, and learn to use it for radio repairs. While you are learning in this practical way, you will be able to do many a repair job for your neighbors and friends, and charge fees which will far exceed the cost of the "Edu-Kit". Here is your opportunity to learn radio quickly and easily, and have others pay for it. Our Consultation Service will help you with any technical problems which you may have.

## FREE EXTRAS

- ELECTRICAL & RADIO TESTER • ELECTRIC SOLDERING IRON • TV BOOK • RADIO TROUBLE-SHOOTING GUIDE • CONSULTATION SERVICE • QUIZZES • F.C.C. TRAINING
- Progressive "Edu-Kits" Inc. 497 Union Ave., Dept. RE-84, Brooklyn 11, N. Y.

MAIL TODAY—Order shipped same day received.

10-Day Money-Back Guarantee. Include ALL FREE EXTRAS

- Send "Edu-Kit" Postpaid. I enclose full payment of \$19.95 (U.S.A. only).
- Send "Edu-Kit" Postpaid. I enclose full payment of \$20.95 (Outside U.S.A.). 210-250 V. Adaptor for "Edu-Kit"—\$2.50.
- Send "Edu-Kit" C.O.D. I will pay \$19.95 plus postage (U.S.A. only).
- I wish additional information describing "Edu-Kit". No Obligation.
- Send me FREE Radio-TV Servicing Literature. No Obligation.

Name \_\_\_\_\_  
Address \_\_\_\_\_

## PROGRESSIVE "EDU-KITS" INC.

497 UNION AVE., Dept. RE-84, Brooklyn 11, N. Y.

antennas and the Tenna-Tie without affecting the efficiency of the filter. Lead lengths are no longer critical.

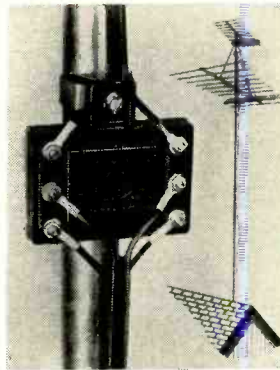

The new Tenna-Tie is designated model 9033-A, superseding model 9033. Its cut-off frequency is approximately 125 megacycles.

## AUTO RADIO AERIALS

Delco Radio, Division of General Motors Corporation, Detroit 2, Mich., has announced two new universal auto radio aerials designed for quick and easy one-man installation on any passenger car or truck.



An important new feature of these auto aerials is the positive elimination of "rod rattle" through the use of long-lasting nylon plastic inserts. The aerial masts are made of admiralty brass, triple chrome plated, with top sections of stainless steel, and high impact plastic base which allows adjustment to any desired angle and contour. The base construction is also corrosion-resistant and waterproof, and eliminates rough road flutter because of the sturdy construction.

## ROOF MOUNTS AND BASES

Rohn Manufacturing Co., 116 Limestone, Bellevue, Peoria, Ill., has designed two new roof mounts, model TMB and model ETMB, and also a drive-in ground-mount base, model GTMB.

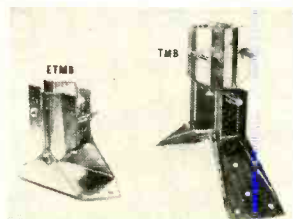

The roof mounts accommodate all masts from 1 to 2 1/4 inches diameter. They can be installed successfully on peak roofs, flat roofs or surfaces, side walls, or any horizontal surface. The GTMB drive-in ground-mount base is suitable for use on 30-40-50-foot masts. It is driven into the ground and the mast is affixed to the protruding portion.

## NEW V.H.F. ANTENNA

The John Winegard Company, 3000 Scotten Boulevard, Burlington, Iowa, have introduced their newest v.h.f. antenna The Interceptor. It combines the Winegard multi-resonant dipole with electro-lens focusing.

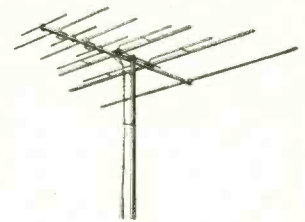

This antenna is so designed that the lens (consisting of the first five elements) absorbs the full signal out of the air and focuses it on the driven or collector elements in much the same way the familiar optical lens focuses light rays.

The interceptor focusing system's ability to produce exceptionally high gain and directivity will in many cases eliminate virtually all co-channel interference.

## U.H.F. CONVERTER

P. R. Mallory & Co., Inc., Indianapolis, Ind., has announced a new concealed u.h.f. converter. The new Mallory "188" is the first all-channel converter designed to fit completely inside a TV set. Installation requires no chassis or cabinet alterations. All that can be seen of the finished installation is the clear plastic selector dial and switch.

The entire job of installation can be done in a few minutes time in the set owner's home. No special tools are required and the cabinet is not marred or damaged in any way.

The Mallory concealed converter also offers a choice of mounting positions—at the left, right, or top of the cabinet.



## NEW U.H.F. BOOSTER

Service Instruments Co., 422 S. Dearborn Street, Chicago 5, Ill., has announced its new u.h.f. booster. It provides extremely high gain by using two 6AN4 tubes in a push-pull grounded-grid neutralized circuit. The booster covers approximately one-third of the u.h.f. band. Boosters are furnished for any particular one-third of the u.h.f. band.



RADIO-ELECTRONICS

**V.H.F.-U.H.F. TUNER**

General Instrument Corporation, 829 Newark Avenue, Elizabeth 3, N. J., has designed a new combination all-channel v.h.f.-u.h.f. tuner, model 80, which is composed of a new 13-position, turret type v.h.f. tuner and a compact and continuously tuned u.h.f. unit.

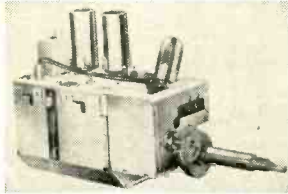

The tuner is less than 7 inches long and 3 1/2 inches wide. It is so designed that the v.h.f. section can be purchased and installed separately in sets.

**CLEANER AND LUBRICANT**

General Cement Manufacturing Co., 919 Taylor Avenue, Rockford, Ill., has



introduced Sprakleen—a new noise-preventing chemical for the service technician. Developed as a two-in-one electrical contact cleaner and lubricant, it is said to be fast and easy to use in all contacts, relays, switches,

controls, and other moving parts. Since the chemical is released under pressure and has a directional nozzle, remote parts like controls are easy to reach without being removed. Sprakleen is packed in a 6-ounce spray type container.

**CAPACITOR-RESISTOR BRIDGE**

Cornell-Dubilier Electric Corp., South Plainfield, N. J., has announced the capacitor-resistor bridge BF-60 which quickly measures the important characteristics of substantially all types of capacitors and resistors and determines their quality. It detects opens, shorts and intermittents; the capacitance between wires and shielding, transformer windings, and wires in cables, and makes it possible to measure the insulation resistance of paper, mica, and ceramic dielectric capacitors.

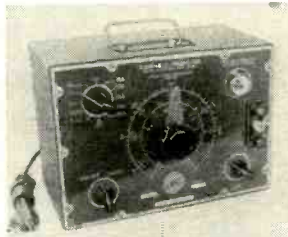

**TEST SOCKET ADAPTERS**

Pomona Electronics Company, 524 West Fifth Ave., Pomona, Calif., has introduced three new service aids to the electronics field. They are the 7- and 9-pin miniature test socket adapters and the 8-pin octal test socket adapter.

These adapters are inserted between the tube base and its socket. This completes the circuit and makes all connections readily accessible without removing the chassis from the cabinet or without turning the set upside down on



the service bench. Measurements can be made without tracing circuit wiring to test points below the chassis, thereby saving valuable time and increasing efficiency in troubleshooting.

**FRINGE-AREA ANTENNAS**

Finney Co., 4612 St. Clair Ave., Cleveland 3, Ohio, has put on the market the Finco 400-SA antenna which features a screen type reflector designed to deliver a high front-to-back ratio for fringe-area use. Except for this screen, it is identical to the 400-A.

Model 400-SA does not replace model 400-A, but is intended for use in areas where there are front-to-back ratio problems.

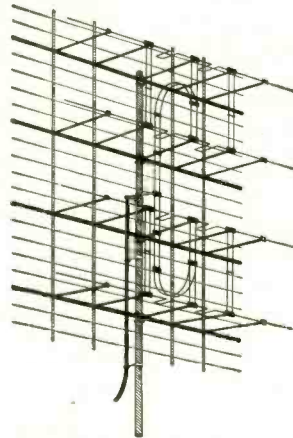

**U.H.F. ADAPTER-CONVERTER**

Trans-Tel Corporation, 828 N. Highland Ave., Hollywood 38, Calif., has announced the new model 38 u.h.f. signal generator adapter designed for use with a v.h.f. TV generator to produce u.h.f. signals between 470 and 890 mc. The output of a v.h.f. signal, marker, or sweep generator is fed into



the model 38 and heterodyned to produce a u.h.f. signal with the same sweep width as the v.h.f. generator. It reproduces any markers that may be superimposed on the response curve.

The model 38 will also convert any u.h.f. signal between 470 and 890 mc to a v.h.f. signal on channels 5 or 6 and convert any low-band TV signal to a frequency in the u.h.f. band. With accurate v.h.f. signal input, the dial calibration accuracy is better than ± 0.5%.

The unit draws 15 watts from a 110-120-volt 60-cycle line, weighs 12 pounds, and measures 14 x 9 1/2 x 7 inches. It comes complete with 75- and 300-ohm cables and connectors.

**NEW INSULATION MATERIAL**

Cannon Electric Co., 3209 Humboldt St., Los Angeles 31, Calif., has introduced its new Cannon-Gray Dial 51-01 insulating material to the industry. Tested to MIL-P-14D, type MDG specifications, the material is particularly suited for use in electrical connectors and will soon be used in all Cannon plugs having plastic type insulators. Full technical data can be obtained from the firm.

Get This Valuable Book

Just for Examining COYNE'S New 6-Volume Set

**FREE**



*Applied Practical Radio-Television*

**ON 7 DAY FREE TRIAL!**

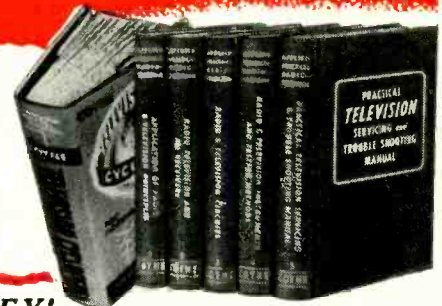

Yes, you get this big, new 1954 book, "150 Radio-Television Picture Patterns and Diagrams Explained", absolutely FREE! Just off the press! Gives complete 11x22" Schematic Diagrams on leading models Radio and Television Sets. Easy-to-read, large 8 1/2 x 11" pages, with full instructions on how to read and use the diagrams. A "must" in every Radio and Television service-man's repair kit. You get this valuable book as a FREE Gift for asking to see Coyne's great new 6-book set, "Applied Practical Radio-Television"!

**SEND NO MONEY!** Just mail coupon for 6-volume set on 7 days free trial. We'll include book of 150 TV-Radio Patterns & Diagrams. If you keep the set, pay \$2 in 7 days and \$2 per month until \$22.50 plus postage is paid. (Cash price \$20.95). Or you can return the library at our expense in 7 days and owe nothing. **YOU BE THE JUDGE.** Either way, the book of TV-Radio Patterns is yours FREE to keep! Offer is limited. Act NOW!

**At Last! Money-Making "Know-How" on Transistors, Color TV and Servicing**  
Coyne's great new 6-volume set gives you all the answers to servicing problems—quickly! For basic "know-how" that is easy to understand, you'll find everything you want in volumes 1 to 5 which contain over 5000 practical facts and data. They cover every step from principles to installing, servicing, trouble-shooting and aligning all types of radio and TV sets. So up-to-date it includes COLOR TV and UHF, adapters, converters. Also covers latest data on TRANSISTORS.

**Extra! 802-Page Television Cyclopeda Included**  
And then, for speedy on-the-job use, you get volume 6—the famous Coyne TELEVISION CYCLOPEDIA. It answers today's television problems on servicing, alignment, installation and others. In easy-to-find ABC order, cross indexed. Use this 6 volume TV-RADIO LIBRARY free for 7 days; get the valuable Servicing Book ABSOLUTELY FREE!

**FREE BOOK—FREE TRIAL COUPON!**

COYNE ELECTRICAL & TELEVISION-RADIO SCHOOL, Dept. 64-T1  
500 S. Paulina St., Chicago 12, Ill.

YES! Send 6-volume "Applied Practical Radio-Television" for 7 days FREE TRIAL per your offer. Include TV-Radio Patterns & Diagram Book FREE.

Name..... Age.....  
Address.....  
City..... Zone... State.....  
Where Employed.....  
( ) Check here if you want library sent COD. You pay postman \$20.95 plus COD postage on delivery. 7-day money-back guarantee.

**COYNE** ELECTRICAL & TELEVISION-RADIO SCHOOL  
500 S. Paulina St., Dept. 64-T1 Chicago 12, Ill.

**COMBO-FAN**

Insuline Corporation of America, 186 Granite Street, Manchester, N. H., has announced the *Combo-Fan* antenna. This antenna gives high gain on chan-

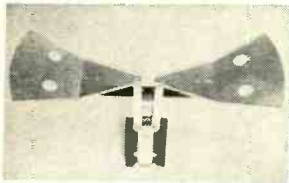

nels 14 through 83 without affecting normal operation on channels 2 through 13. The unit includes a printed-circuit filter that permits use of the present v.h.f. down-lead to the receiver.

The *Combo-Fan* is easily installed above or below the v.h.f. antenna with a mounting bracket provided for the purpose. Vent holes in the two fans minimize picture flutter due to wind.

**VOLT-OHMMETER**

Hickok Electrical Instrument Co., 10531 Dupont Avenue, Cleveland 8, Ohio, has developed a low-priced electronic volt-ohmmeter, model 225. Built around a 9-inch internal pivot meter, the unit has long scales which minimize reading errors and permits use of the instrument at longer working distances.

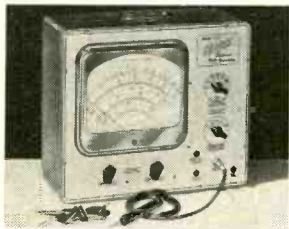

Peak-to-peak scales are provided for measuring complex waveforms, and a d.c. zero-center scale is provided for galvanometer applications.

Ranges are: Positive or negative d.c. volts: 1.5, 3, 12, 30, 120, 300, and 1,200. Input resistance: 10 megohms with Hickok *Dual-Probe*.

Ohms: R X 1, R X 10, R X 100, R X 1,000, R X 10,000, R X 100,000, and R X 1 megohm. The meter is readable from 0.2 ohm to 1,000 megohms.

Voltages, a.c., r.m.s.: 1.5, 3, 12, 30, 120, 300, 1,200. Peak-to-peak: 4, 8, 32, 80, 320, 800, and 3,200. Flat from 40 cycles to 3.5 megacycles.

**PICKUP ARM**

Pickering & Co., Oceanside, N. Y., has announced that its high-quality model 190 pickup arm has been re-engineered to require less mounting space, while fully retaining the low vertical mass, static and dynamic balance, lack of arm resonance, and low friction of the original design.



This new and smaller arm, known as model 190D, when combined with a typical high-quality manually operated turntable, requires a 17 x 17-inch motor board. The arm is designed to overcome the disadvantages of all conventional arms, the shortcomings of which are accentuated by long-playing microgroove records.

**NEW TEST INSTRUMENTS**

Radio Corporation of America, Tube Division, Harrison, New Jersey, has announced the development of three new pieces of electronic test equipment essential to installation and maintenance of home color television receivers.

The WR-61A service-type color-bar generator (top photo) produces on a receiver screen a multiple-color test pattern of 10 color bars for adjusting color phasing and matrixing circuits.

The WR-36A is a portable dot-bar generator (see lower photo) designed

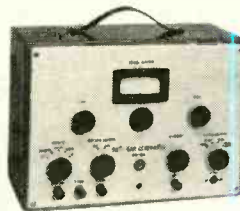

specifically for making all convergence adjustments in the color receiver. The dot-bar and color-bar generators together with a new designed-for-color oscilloscope supplement existing sweep generators, crystal calibrators, and volt-ohm meters to provide complete over-all color television service.

A five-inch dual-bandwidth oscilloscope (RCA WO-78A) is designed for observing the color-burst signal and for checking the operation of the color-burst circuit. It may also be used as a general purpose oscilloscope.

**GERMANIUM DIODES**

International Rectifier Corp., 1521 E. Grand Ave., El Segundo, Calif., is now producing a *Red Dot* series of germanium diodes for high-temperature applications, identified by special red dot marking on the glass housing. Each unit is exceptionally well sealed. Exposure to 95% relative humidity for 500 hours at temperatures from 0° to 85° C does not change back resistance appreciably or cause appearance of hysteresis.

**A CORRECTION**

The photograph of the Hickok 697 sweep alignment generator, described in the May issue, was not printed with the description of the generator, though it did appear on another part of the page. The photograph is shown here. As stated in the previous issue,

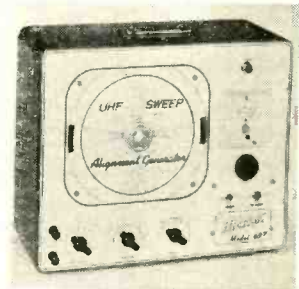

it is an all-electronic sweep with no moving parts, providing fundamental output on channels 14-83, with constant amplitude over the entire sweep range. END

All specifications given on these pages are from manufacturers' data.

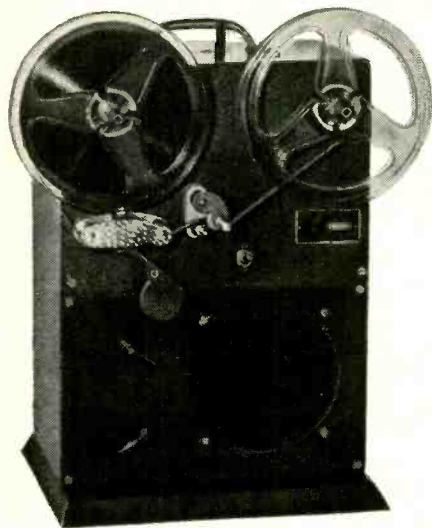

**COMMUNICATIONS TYPE  
TAPE RECORDER**  
**59<sup>00</sup>** **READY TO OPERATE COMPLETE**

with plastic base tape, patch cord, and all features to record, playback, erase, rewind, dual track at two speeds, 7 1/2 and 3 3/4 inches per second.  
**SPECIFICATIONS:** Solid aluminum drive mechanism. Heavy flywheel. 110 volt, 60 cycle AC phono motor. Shure Bros. Model 815 head responds to more than necessary to cover frequency range of standard broadcasting. Takes seven inch reels. Wow and flutter sufficiently low to be imperceptible to the ear in the service for which this machine is intended. Case 11"x15"x5". Natural wood finish. Total weight less than 15 pounds.

**NO MICROPHONE REQUIRED**

Properly damped built-in feature permits use of speaker for microphone with greater sensitivity than usual home recorder type crystal microphone. No breath blasts or hisses. May be used for close talking or will pick up normal room conversation. This feature eliminates mike and cord troubles. Positively does not sound like a cheap intercom. Gives full sensitivity over entire voice range and music pick up equal to the average radio. Any standard Xtal mike may be connected, however, if the user prefers. Patch cord permits recording directly from the output of any phono, radio, TV, or amplifier speaker.

**MANUFACTURER DIRECT TO YOU—GREATEST TAPE RECORDER BUY EVER OFFERED**

**AMPLIFIER:** Uses simple, novel three tube hi-gain circuit employing 12SL7, 50L6, 50Y6 to drive a good quality 6" speaker. This self-compensating circuit automatically provides erase current and DC bias for recording, and on playback will drive the speaker to full room volume without excessive distortion. Single control for record-playback. This very simple circuit using high quality components is as easy to service as an AC-DC radio. No trick oscillators or special knowhow required to maintain.

**THIS ADVERTISEMENT WILL NOT BE REPEATED**  
Dealer-distributor arrangements will not permit us to make this wholesale, direct-to-user offer again. See this machine at your dealer's after July 1.

The requirements for low cost manufacture of this unit does not allow us to carry stock. **ALL ORDERS SUBJECT TO SOME DELAY.** We will forward prompt acknowledgement and shipping date upon receipt of your order. \$59.00 postpaid. COD's one-third cash. **ABSOLUTE MONEY BACK GUARANTEE** with one year parts warranty. Send orders to—

**ULTRA-AUDIO BROADCASTING SYSTEM**

**1815 ADAMS AVENUE  
SAN DIEGO 16, CALIFORNIA  
RADIO-ELECTRONICS**

EASILY BUILT GRID-DIP METER

An accurate grid-dip meter is a handy gadget for checking the frequency of resonant circuits in transmitters, receivers, antennas, and signal generators. It is also useful for adjusting stub type traps. G6FW describes a wide-range instrument of this type in *Short Wave Magazine*. Constructed from components which can be found in the average spare-parts box, this instrument tunes from about 960 kc to 80 mc.

Saturate the thread with coil dope. The coils, wound to details given in the table, are placed close to the top of the forms. The ends and center-taps are brought down inside the forms and then out to the pins through holes drilled for this purpose. The 30-80-mc coil is self-supporting. Leads 1½ inches long are left on the ends and a third lead of similar length is soldered to the center of the coil.

The low-frequency coils can be cali-

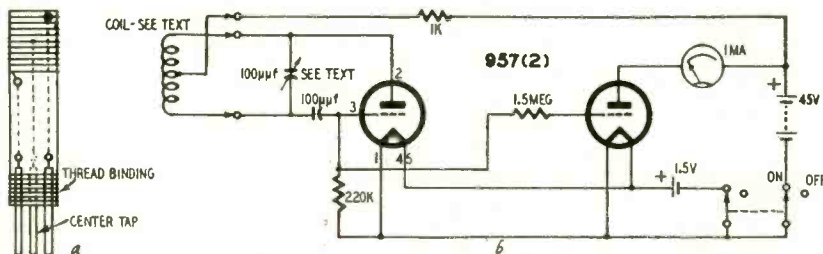

As the diagram shows, the unit uses two 957 acorn type tubes, three resistors, two capacitors, a 1-ma meter, and batteries. If 957's are not available, triode-connected 1T4's can be substituted. In this case, it may be necessary to vary the values of the 1,000- and 220,000-ohm resistors to get strong, reliable oscillations throughout the entire tuning range.

The original g.d.o. was constructed in a metal box about 7 x 3 x 1½ inches. A 1¼-inch meter and hearing-aid batteries were used. The size of the box may be adjusted to suit the components which you have on hand. The tuning capacitor should be a miniature unit with low-loss insulation. Select a type having the lowest minimum capacitance. Mount it so its rotor and stator are insulated from the case. An insulated coupling and plastic shaft extension insulate the tuning dial from the capacitor and reduce hand capacitance.

A miniature button type socket is used for the plug-in coils. The four lower-frequency coils are wound on ½-inch diameter polystyrene tubes 2 inches long. The drawing at a shows the construction of the coils. The coil pins are three 1-inch lengths of No. 18 tinned copper wire set into grooves cut into one end of the form with a piece of broken hacksaw blade. With ½ inch protruding beyond the end of the form, bind the wire pins in place with a few turns of strong thread.

brated with a communications receiver. The 30-80-mc coil is calibrated with Lecher wires which may consist of two 30-40-foot lengths of No. 20 copper wire pulled taut and spaced about 2 inches apart. A single-turn loop across the ends of the wires is loosely coupled to the coil in the g.d.o. Beginning at the end nearest the loop, short the two wires with a sharp knife blade. If the coupling between the wires and the coil is sufficiently loose, you will find a spot where the meter will kick up-scale. Mark this point on the wires. Move the blade along until you find the second spot where the meter kicks. Mark this point and measure the distance between the two. The frequency of the g.d.o. in megacycles equals 5906 divided by the distance between the two points in inches.

When using the instrument, remember that the indications get sharper as the coupling is decreased. When checking resonant circuits in a transmitter or receiver, do so with the tubes heated. At high frequencies, changes in inter-electrode capacitance may cause a pronounced shift in the resonant frequency.

Coil table for g.d.o.

Range	Wire size	Turns	Spacing
0.96-2.5 mc	36	125	Close-wound
2.4-6.0 mc	28	57	Close-wound
5.8-15 mc	28	27	Close-wound
14-35 mc	28	15	Spaced to ½"
30-80 mc	18	5	Spaced to ½"

All wire, enamel covered.

A SUPPRESSOR-GRID MODULATOR

Suppressor-grid modulation is often used in portable and mobile transmitters where cost, volume, weight, or power requirements of a plate modulator are prohibitive. The audio equipment for suppressor modulation is simple. An amplifier delivering 5 to 10 watts will supply enough power to modulate 100% a rig running several hundred watts input.

A suppressor-modulated stage is operated with a fixed negative suppres-

or bias voltage that reduces plate and r.f. output currents to half the values obtained with zero suppressor voltage. The output is modulated by supplying the modulating voltage in series with the fixed bias. Maximum r.f. output, 100% modulation, is obtained when the peak value of the modulating signal equals the d.c. bias voltage. When the peak a.c. voltage exceeds the bias, the suppressor is driven positive and severe distortion is produced.

**Mr. Serviceman check these items for... Value!**

**See your local Parts Jobber**

*Align-o-Pak*

Model BE2  
Eliminates TV Alignment Bias Batteries. Provides voltages recommended by all TV manufacturers. Quickly diagnoses AGC trouble.

**\$7.85**

**UHF HI-PASS FILTER**

Model HP2  
Passes UHF rejects VHF up to 50 DB without tuning. Eliminates FM. Airport Taxi cab interference, etc.

**\$2.37**

**Up-Down VOLTAGE BOOSTER**

Model LB2  
Adds or subtracts 10 volts line voltage with heavy, safe toggle switches for any TV set. Line restored to normal when turned off.

**\$5.97**

**PEAK-TO-PEAK Comparison Meter**

Add peak-to-peak measurements to your scope for only **\$8.75**  
Handy for servicing gated AGC, gated sync separator, and essential for color.  
Write for Additional Information

**SERVICE INSTRUMENTS CO.**  
422 So. Dearborn—Chicago 5

# Windsor TUBES

RADIO & TV RECEIVING

TESTED and  
GUARANTEED  
for PEAK  
PERFORMANCE

We've EARNED your Confidence . . . and we mean to KEEP IT! Thousands of Service Organizations and Dealers throughout America send us REPEAT orders month after month—they now KNOW you can DEPEND upon the WINDSOR promise of PEAK PERFORMANCE! And here's why: Every tube we ship is first carefully tested in our laboratories, for maximum functioning characteristics, right in a radio or TV set—under actual operating conditions! That's why we unconditionally guarantee every Windsor Tube in accordance with the Standard Warranty: Full replacement of any defective tube within 90 days of purchase, excepting only burnouts and breakages. Each tube attractively packaged in individual carton.

BUY—AND SELL, WINDSOR TUBES—WITH CONFIDENCE!

Type	Each	Type	Each	Type	Each	Type	Each
1A7GT	\$.67	3V4	.82	6BD5GT	.98	6QZGT	.55
1B3GT	.69	5R4GY	1.00	6BD6	.54	6S4	.51
1H5GT	.51	5U4G	.44	6BE6	.51	6S8GT	.75
1J6	.93	5V4G	.43	6BF5	.66	6SA7GT	.57
1L4	.63	5Y3G	.37	6BF6	.43	6SC7	.63
1L6	.66	5Y3GT	.32	6BG6G	1.47	6SD7	.55
1LA4	.82	5Y4G	.43	6BH6	.63	6SF5GT	.66
1LA6	.80	6A0GT	.68	6BJ6	.53	6SH7GT	.52
1LB4	.82	6AB4	.51	6BK5	.76	6SJ7GT	.52
1LC5	.80	6AC5GT	.82	6BK7	.97	6SK7GT	.55
1LC6	.80	6AG5	.59	6BL7GT	.94	6SL7GT	.68
1LD5	.80	6AH4	.68	6BN6	.98	6SN7GT	.48
1LE3	.80	6AH6	.89	6BQ6GT	.98	6SQ7GT	.48
1LG5	.80	6AK5	1.05	6BQ7	.92	6T8	.85
1LH4	.80	6AL5	.44	6BZ7	1.09	6U4GT	.60
1LN5	.80	6AQ5	.51	6C4	.41	6U8	.86
1N5GT	.63	6AQ6	.47	6C5GT	.60	6V3	1.09
1R4	.85	6AQ7	.75	6CB6	.58	6V6GT	.51
1R5	.82	6AR5	.42	6CDB6	2.04	6W4GT	.50
1S4	.87	6AS5	.55	6D6	.63	6W6GT	.63
1S8	.52	6AT6	.42	6E5	.72	6X4	.37
1U4	.61	6AU6GT	.85	6F5GT	.54	6X5GT	.36
1U5	.51	6AV5	.85	6G6GT	.55	6V6G	.64
1X2A	.74	6AV6	.41	6J5GT	.44	7A4/XXL	.57
2X2	1.43	6AX4	.72	6J7	.70	7A6	.57
3LF4	.76	6B8G	.93	6K6GT	.45	7A7	.58
3Q4	.66	6BA6	.50	6K7	.70	7A8	.56
3Q5GT	.72	6BA7	.68	6L6G	.88	7AD7	1.05
3S4	.61	6BC5	.58	6L6GA	.88	7AF7	.63

Type	Each	Type	Each
7AG7	.65	12BY7	.77
7AH7	.65	12L5GT	.48
7A17	.70	12SA7GT	.57
7B4	.54	12SH7GT	.67
7B5	.61	12SK7GT	.55
7B6	.52	12SL7GT	.67
7B7	.68	12SN7GT	.59
7C4	1.05	12SQ7GT	.46
7C5	.86	14A7	.68
7C6	.50	14AF7	.68
7C7	.58	14B6	.50
7E5	.85	14C5	.85
7E6	.65	14C7	.70
7E7	.85	14E6	.70
7F7	.69	14E7	.85
7F8	.97	14F7	.69
7G7	.85	14I7	.99
7H7	.61	14J7	.99
7K7	.85	14K7	.62
7L7	.85	14R7	.85
7N7	.62	14S7	.80
7P7	.62	19BG6G	1.53
7R7	.70	19T8	.87
7S7	.80	25BQ6GT	.98
7V7	.92	25L6GT	.53
7W7	.99	25W4GT	.53
7X6	.82	25W4	.46
7Y4	.48	35A5	.55
7Z4	.80	35B5	.53
12AT6	.53	35C5	.53
12A7	.75	35D5	.52
12A6	.47	35E5	.52
12A7	.58	35F5	.52
12A6	.41	35G5	.43
12A7	.87	50A5	.55
12AX4	.72	50B5	.52
12AX7	.67	50C5	.52
12AV7	2.15	50L6GT	.52
12B4	.66	117Z3	.43
12B6	.52	117Z6GT	.75
12BH7	.69		

**FREE!**  
**WINDSOR**  
**TUBE CADDY**



The most practical Service-Aid ever designed for the radio and TV repairman. This ideal television carry-all now offered free with every purchase of \$160.00 or accumulated purchases totaling \$160.00 within 90 days. (You get caddy credit memo with each purchase). Windsor Tube Caddy may also be purchased outright for \$14.95.

- Carries approximately 125 tubes including meters and tools.
- 16 1/2 inches long x 8 1/4 inches wide x 13 3/4 inches high.
- Weighs only nine pounds.
- Ruggedly constructed with heavy leatherette covering, strong plastic handle, nickel plated hardware, and reinforced with metal clamps.

**DON'T MISS THIS SENSATIONAL OFFER!**

**Windsor ELECTRONIC TUBE CO.**  
2612-C NOSTRAND AVENUE, BROOKLYN 10, N. Y.

**OPPORTUNITY ADLETS**

Rates—45¢ per word (including name, address and initials). Minimum ad 10 words. Cash must accompany all ads except those placed by accredited agencies. Discount, 10% for 12 consecutive issues. Misleading or objectionable ads not accepted. Copy for August issue must reach us before June 18, 1954. Radio Electronics, 25 W. Broadway, New York 7, N. Y.

**SPEAKER REPAIRS ON ALL MAKES.** Jobbers wanted. Amprite Speaker Service, 70 Vesey St., New York 7, N. Y.

**SUBSTITUTION GUIDE—All Tubes—Changes Shown.** \$1.00. Blackwell, 28 Orchard St., Ridgewood Park, New Jersey.

**DESIGN SERVICE:** electronic, transistor, and magnetic amplifiers or control devices. Reasonable rates, working models, free estimate. Box 345, Grand Rapids, Michigan.

**DIAGRAMS FOR REPAIRING RADIO \$1.00 TELEVISION \$2.00.** Give make and model. Diagram Service, Box 672-RE, Hartford, Conn.

**TEST EQUIPMENT** Repaired and Calibrated by Factory staff. All makes. Superior, Simpson, Triplett, Heath, etc. Immediate service. Douglas Instrument Laboratory, 176a Norfolk Avenue, Boston 19, Mass.

**TUBES-TV, RADIO, TRANSMITTING, AND SPECIAL PURPOSE TYPES BOUGHT, SOLD AND EXCHANGED.** Send details to B. N. Gensler W2LNI, 138 Liberty, N. Y. 6, N. Y.

**ALL MAKES OF ELECTRICAL INSTRUMENTS AND TESTING** equipment repaired. Write for free catalogue on new and used instruments at a savings. Hazleton Instrument Co., 128 Liberty Street, New York, N. Y.

TELEVISION SETS \$24.50 up. Jones TV, 1115 Rambler, Pottstown, Pa.

**SALESMEN WANTED—SELL AT MANUFACTURERS LOW PRICES—**Television Wire to Retail Outlets. 10% commission on Original and Repeat orders. All Territories Open. King Mfg. Co., 45 Huron Road, Mohagan Heights, Yonkers, New York.

**BUILD YOUR OWN ELECTRONIC ORGAN, OR MINIATURE** electronic brain. Jim Kirk, W6JKX, 1552 Church Street, San Francisco 14, California.

**WANTED: AN/APR-4, other "APR", "TS", "IE", "ARC-1, ARC-3, ART-13, IC-348, etc.** Microwave Equipment, Everything Surplus, Special tubes, Tec Manuals, Lab Quality Equipment, Meters, Fast Action, Fair Treatment, Top Dollar! Littell, Fairhills Box 26, Dayton 9, Ohio.

**TOPOS SYMLOGISMS** for amateur Logicians. Unshaded Venn and Euler diagrams marked by "Sy" the mirror-wise "is". A 2-page pamphlet 20¢. 10 copies \$1.00. 100 copies \$8.00. W. J. Mallory, 616 No. 34th St., Omaha, Nebr.

**ALUMINUM TUBING.** Angle and Channel, Plain and Perforated Sheet. Willard Radcliff, Potosia, Ohio.

**SMALL HIGH VOLTAGE POWER SUPPLY.** Ideal for Geiger or Scintillation Counters. 3 to 6 VDC Input. Adjustable, Regulated Output 700 to 1000 VDC @ .2ma. Money back Guarantee, \$24.95. Free Literature. Radioelectronics Laboratory, Harre De Grace, Md.

**TELEVISION RECEIVERS \$30 UP.** W4API, 1420 South Randolph, Arlington 4, Virginia.

**TV FM ANTENNAS. ALL TYPES INCLUDING UHF.** Mounts, accessories. Lowest prices. Wholesale Supply Co., Lunenburg 2, Mass.

To prevent overmodulation, Harry B. Foster and Joseph R. Parker have invented a system that prevents overmodulation by preventing the suppressor from being driven positive. This invention is described in U. S. patent No. 2,651,758. The diagram shows a conventional suppressor-modulated r.f. amplifier with R1 and C1 added to prevent overmodulation.

When the peak modulation voltage exceeds the d.c. bias, the suppressor behaves momentarily like the plate of a clamping diode. Grid current flows through R1 and develops a voltage drop across R1. This grid-leak bias adds to the fixed bias and increases the suppressor bias so the modulation peaks no

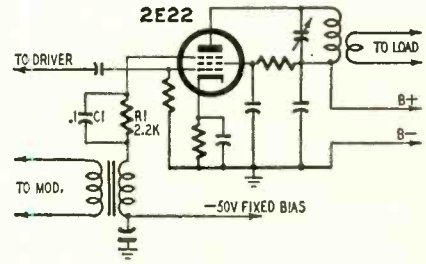

longer drive the suppressor positive. Capacitor C1 is an r.f. bypass capacitor. It should have a low reactance at the r.f. signal frequency and a high reactance at audio frequencies.

Some distortion is produced when the suppressor operating bias is shifted but it is not objectionable when the values of R1 and C1 are carefully chosen. Distortion is less than 15% at 90% modulation.

**BIAS FOR A.C.-D.C. SETS**

Several circuits have been developed that supply fixed bias voltages for tubes in a.c.-d.c. amplifiers and receivers. One fairly well-known scheme used in receivers is to tap off a portion of the negative voltage developed across the oscillator grid resistor and use it as grid bias for amplifier stages. The novel bias supply system shown in the diagram is described by G. A. French in *The Radio Constructor*, a British publication.

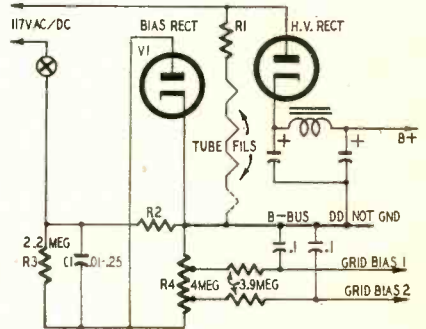

Resistors R1 and R2 are series resistors to drop the line voltage to the value required for the series-connected heater string. R2 is a comparatively low value selected so that when the supply is used



# PHILCO

announces  
**3 new**  
 super-performance

# TV

# antennas

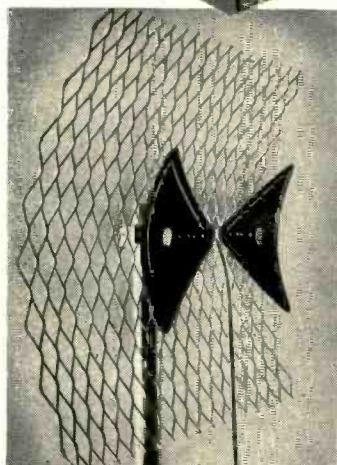
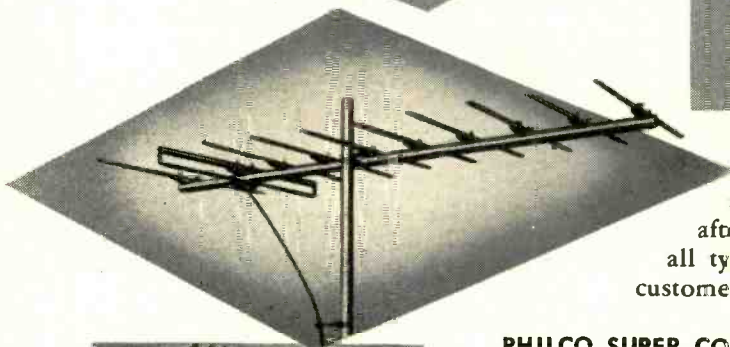
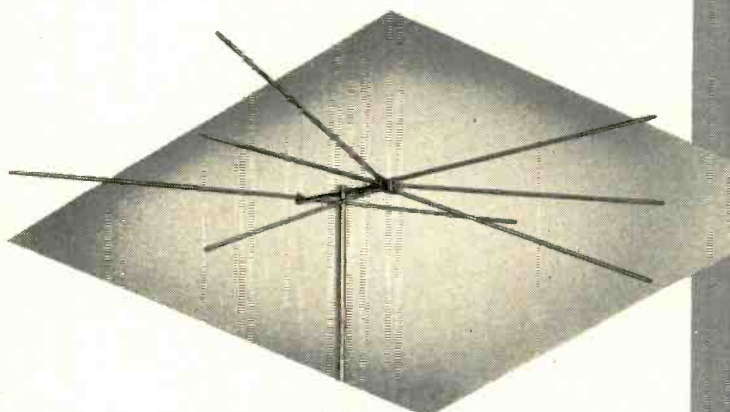

The finest TV antennas in their class... designed by the world famous Philco Laboratories after thorough research into receiver requirements in all types of locations... designed to give complete customer satisfaction... to meet competition on any level!

#### PHILCO SUPER CONICAL UHF-VHF ALL-CHANNEL ANTENNA

Full 45" dowelled aluminum antenna elements and full 53" dowelled aluminum reflector assure strong signal pickup on VHF channels 2 through 13... top quality performance on UHF channels 14 to 83.

Single or stacked array Super Conicals produce new balanced performance... super picture quality plus high gain. All-aluminum construction in the Super Conical... it's easy to erect: Part No. 45-3096.

#### PHILCO SUPER YAGI VHF ANTENNAS

Quick-rig model with ten elements gives top fringe-performance on VHF channels 2 through 13. Excellent front to back ratio (6 to 1). This Super Yagi eliminates ghosts in strong signal areas... selects signals

from adjacent weak area channels or co-channel stations. 10 db to 12 db gain depending on channel. Strong, all-aluminum: Part No. 45-3112. (Single channel 2 thru 13 and broadband 2 thru 6; 7 thru 13; 4, 5, 6).

#### PHILCO PARAFLECTOR ALL-CHANNEL UHF ANTENNA

Light weight pre-assembled all-channel UHF antenna. Outstanding performance in far-fringe areas. High gain... 8 to 10 db. Exceeds gain of corner reflector of like dimensions. Impedance matched to 300

ohm line. Completely assembled, all-aluminum construction... can be mounted on existing masts for immediate use... all-channel paraflector weighs only 1½ lbs: Part No. 45-3071.

See them today at your Philco Distributor



## PHILCO CORPORATION

### ACCESSORY DIVISION

"A" and Allegheny Ave., Philadelphia 34, Pa.

# Lafayette Greatest Tape Buy Ever!

1200 FT. REEL  
Genuine Plastic Base RECORDING TAPE

LAFAYETTE made a terrific deal with one of the leading manufacturers of recording tape to supply us with their regular tape which sells for almost twice our price. **WE GUARANTEE ABSOLUTE SATISFACTION OR YOUR MONEY BACK.** The finest, professional-quality recording tape obtainable. Highest performance for thousands of playings. Red Oxide Base in a smooth, uniform coating; greater signal strength; with maximum fidelity; uniform frequency response from 40-15,000 cps at 7½" per second; and freedom from background noise and distortion. Each reel is individually boxed. Shipping weight 10 oz.

**SALE!**  
**MASCODE BOOSTER**  
\$5.95 ea. in lots of 3, singly, ea. 6.25

**WESTERN ELECTRIC HEARING AID**  
Reg. price \$185.00 Our price \$14.95  
Brand new, in original Western Electric's jeweler's case. Supplied with receiver, receiver cord, battery cord and plug (less batteries). Money back guarantee. Act now while they last! Uses Burgess XX30E and 8R batteries at \$1.55 per set.

**Lafayette Radio**  
Write for free catalog. DEPT. JF  
NEW YORK, N.Y. 100 Sixth Ave.  
BRONX, N.Y. 542 E. Fordham Rd.  
NEWARK, N.J. 24 Central Ave.  
PLAINFIELD, N.J. 139 West 2nd St.  
BOSTON, MASS. 110 Federal St.

on d.c. lines the drop across it is somewhat greater than the highest bias voltage. R2 may be one or more pilot lamps or tube heaters instead of the resistor shown.

When the apparatus is used on d.c. lines, R2 is between the negative side of the power line and the B minus bus. Its left-hand end is the most negative. The bias voltage developed across R2 is applied across a voltage divider consisting of R3 and R4. The sum of the resistances of R3 and R4 should be between 2 and 10 megohms. Typical values are shown. The desired bias voltages are tapped off R4 which may consist of a number of selected resistors connected in series.

The operation of the bias supply is somewhat different when used on a.c. lines. In this case, an a.c. voltage is developed across R2. This voltage is applied to the plate of bias rectifier V1 through C1 and R3 in parallel. The rectified voltage developed across R4 makes the left end of R2 negative with respect to the B minus bus. The value of the rectified voltage is determined by the values of R3 and C1. Adjust the value of C1 so the drop across R4 is the same on a.c. as on d.c. lines.

### SIMPLE FILAMENT CHECKER

The little tester in the diagram speeds up the task of locating a burned-out filament or heater in a series-connected string. It consists of a small neon lamp, a 100,000-ohm resistor, and four sockets connected as shown and mounted in a small box.

There is no need for adjusting the voltage or waiting to see if the tube lights. Just plug in the tube and watch the neon lamp. If it lights, the filament or heater is good. The resistor limits

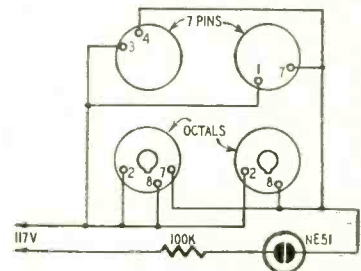

the current to a safe value so the tester will handle tubes with filaments from 1 to 117 volts.

The octal socket with connections to pins 2 and 8 is used chiefly for 5-volt rectifier tubes. The other is used for tubes with heater or filament connections to pins 2 and 7 or pins 7 and 8. Do not try to save the cost of a 7-pin socket by paralleling the 3-4 and 1-7 connections on a single socket. This makes it impossible to check tubes like the 50B5 that have an internal jumper between pins 1 and 7.

The scope of this tester can be broadened by adding a loctal socket for 7- and 14-volt tubes. Connect pins 1 and 2 on one side, and pins 7 and 8 on the other. For 9-pin miniatures, connect heater lines to pins 3 and 4.—M. Gottlieb  
END

## XCELITE Hand Tools

PREFERRED BY THE EXPERTS

### MAKE TV REPAIRS PAY OFF!

Save Time On the Job with this New BERYLLIUM-COPPER FOCALIZER ADJUSTER!

Non-Sparking  
Won't Effect Image  
Enters Chassis Easily

Makes Every Minute Count—For Profits

Like all Xcelite tools, this new Focalizer Adjuster grips without slips; it doesn't need frequent regrinding as do plastic and fibre tools. Long 10" shank, traditional man-sized Xcelite handle. Get at least one for the shop, and one for your carry-kit.

See your XCELITE DEALER now.  
If your dealer can't supply you  
WRITE TO: XCELITE, INCORPORATED  
(Formerly Park Metalware Co., Inc.)  
Dept. J, Orchard Park, N. Y.

For Originality  
LOOK TO XCELITE

### ENJOY 3 COLOR TELEVISION FILTER SCREEN NOW

Changes dull eye-straining black and white pictures into beautiful color tones. Seconds to attach. No tools used. Helps eliminate glare and snow in fringe areas. Order direct. Send \$1 for screen size up to 16". \$1.25 size 17". \$1.50 size 20". \$2 size 24". \$3 size 27". (Also available are single solid color screens in blue, green, or amber.) Prices on solid color screens are 10% less. We pay postage except on C.O.D. orders. Satisfaction guaranteed. Inquiries from dealers are welcomed.  
Zingo Products, Johnstown 13, New York

Free!

Get More Service Calls with  
**EICO DECALS**  
For Store Windows & Cars.  
Write EICO  
Brooklyn 11, N.Y. Dept. DC-6

**EXPERT RADIO-TELEVISION SERVICE**  
EICO  
1951 INSTRUMENTS

**MULTIMETER AS SIG TRACER**

I have found that some multimeters with a.c. ranges can be used as emergency signal tracers. On my Eico 511, I plug test prods into the OUTPUT and 0-100 VOLT A.C. jacks, and headphones into the COMMON and 0-10 VOLT A.C. jacks. With this connection, the signal voltage applied to the test prods will be heard in the phones and its value indicated on the meter. The meter seems to be accurate over its usual range of frequencies.

The 511 uses a crystal-diode rectifier so I am able to hear the modulation on r.f. signals. You may not be able to do this with a meter using copper-oxide rectifiers.—*J. Sareda*

**ADJACENT-CHANNEL INTERFERENCE**

Here in Fort Worth, Texas, WBAP-TV, channel 5, is so strong that it causes severe interference on channels 4 and 8 in Dallas. Since alignment was perfect and the set operated properly, I decided to try a trap in the antenna circuit.

I connected a piece of 300-ohm line about 6 feet long across the set's antenna input terminals in parallel with the lead-in. I started at the far end and began shorting both conductors with a razor blade at intervals of about 1/2 inch until I found a spot where the interference disappeared from channel 4. I cut the stub at this point and tied the ends together.

Switching to channel 5, I found that its signal was almost entirely wiped out, so I connected the stub-trap to the antenna terminals with a double-pole switch.

Moving the stub varied its effect, so I tacked it around the bottom of the TV cabinet and used a tin-foil slider to tune it for minimum interference.—*Robert C. Dunham*

**6X5 REPLACEMENT FOR 80?**

When the current and voltage requirements are within its ratings, a 6X5 can be substituted for an 80 rectifier by changing the socket to an octal type. The 6X5 draws only 600 ma as compared to 2 amps. required by the 80. Thus the lightly loaded 5-volt filament winding delivers approximately 6 volts to the 6X5. Take the d.c. output from the cathode of the 6X5 instead of the filament in the 80 circuit. The 6X5 and similar newer types supply a slightly higher voltage. The 6X4 and 6X5-GT may be operated in any position. The 6X5 may be operated on its side if pins 3 and 5 are in a horizontal plane.—*O. C. Vidden*

**CAPACITOR MOUNTING STRAPS**

Aluminum-can electrolytic capacitors which are no longer usable can be cut open, cleaned, and then cut into strips to make mounting rings and clamps for smaller tubular electrolytics and paper capacitors. A large-size metal-can electrolytic is pliable enough and just the right size for a typical ring or clamp.—*B. W. Welz*

**Ready NOW!**

**completely NEW STANCOR TV TRANSFORMER REPLACEMENT GUIDE**

The new 1954 Stancor TV Replacement Guide and Catalog is a fully revised, up-to-the-minute listing of accurate transformer replacement data. Every recommendation has been rechecked against the latest information obtainable.

This Stancor reference lists over 6800 TV models and chassis of 115 manufacturers, including hard-to-locate information on "private label" sets.

To make your servicing easier, *virtually all flybacks, yokes and power transformers listed are exact replacements.* Where an exact replacement unit is not available, reference is made to the circuit or terminal changes required.

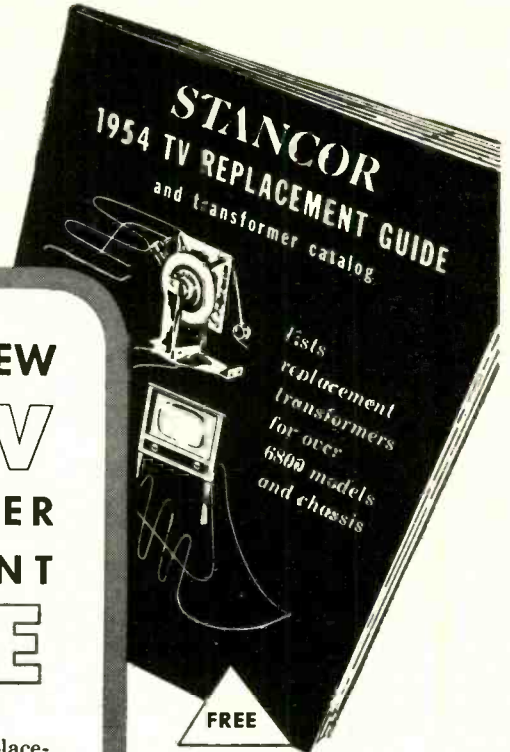

FREE

If you haven't received your copy, see your Stancor distributor, or write us directly.

**STANCOR-WILLIAMSON ULTRA-LINEAR HI-FI amplifier bulletin 479**

Build your own ultra-linear hi-fi amplifier using Stancor high fidelity output transformer A-8072 (\$15.00 net). You can also use A-8072 to convert your present Williamson amplifier to ultra-linear operation. Bulletin 479, available FREE, contains performance curves, schematics, parts lists, chassis layouts and other helpful construction and conversion information.



Stancor transformers are listed in Photofact Folders and Counterfacts.

**CHICAGO STANDARD TRANSFORMER CORPORATION**

3592 Elston Avenue Chicago 18, Illinois

EXPORT SALES: Roburn Agencies, Inc., 39 Warren Street, New York 7, N. Y.

**WISSOR**

Electronic Contact  
**CLEANER & LUBRICANT**

- Cleans Contact Points and Tuners Instantly
- Lubricates Tuners and Controls
- Eliminates Noises and Scratches
- Restores Carbon Controls
- Longer lasting protection for Radio-TV equipment

**THE SCIENTIFIC FORMULA . . . THAT CLEANS AND LUBRICATES!**  
USE EITHER METHOD TO APPLY . . .  
Squeeze Bottle or Brush Bottle — supplied with each qt. can.  
Spout provided.

with **2** REFILL DISPENSERS **FREE!**

① Squeeze Bottle and Glass Bottle with Brush

LIST PRICE: (with free bottles) **\$4.80**  
Quart Can

Sold through local distributors everywhere!

**MAIL ORDERS PROMPTLY FILLED.**

**WORKMAN TV INC.**  
309 QUEEN ANNE ROAD, TEANECK, N. J.

**Saves service time!  
Reduces your  
investment in parts!**



**One Single  
Centralab  
Printed Electronic  
Circuit\***

**replaces several old-style  
individual components**

**And its stability assures long  
life . . . happier set-owners**

When you run up against one of the millions of old radio and TV sets that were built before PEC's were used, do you waste costly time trying to locate a shorted or intermittent component?

You don't have to—you can replace an entire section of an old-style circuit with a single PEC. And you can do it at a part-cost of as little as 36¢ to 81¢ net!

For example, if the trouble is in the vertical integrator of a TV set, you can replace the whole section with a vertical-integrator PEC plate. If the trouble is in the audio detector of a radio set, you can replace the entire section with an audio-detector PEC plate.

Why risk service "call-backs", by replacing only one old-style component? All the other parts are the same age—replace 'em all with one PEC.

New, revised Centralab Printed Electronic Circuit Guide No. 3 tells the whole story—and shows circuit schematics that help you install PEC's. Send coupon for free copy.

**Centralab**

Y-2854

CENTRALAB, A Division of Globe-Union Inc.  
924r E. Keefe Avenue, Milwaukee 1, Wisconsin  
Send me a free copy of the 1954 edition of the Centralab Printed Electronic Circuit Guide No. 3.

Name.....  
Company.....  
Address.....  
City.....Zone.....State.....

**DUMMY TUBES ARE GOOD FOR TESTS**

In experimental and service work, it is often desirable to disable certain portions of the equipment. In parallel-heater circuits, we simply remove the nonessential tube. When we remove a tube from series-heater equipment we face the problem of completing the heater string through a suitable resistor. The solution is to use dummy tubes with the required resistance built into them.

Since most octal-base tubes used in a.c.-d.c. circuits have 6.3-volt, 300-ma or 12.6-volt, 150-ma heaters with connections on pins 2 and 7 or 7 and 8, we can make up four dummies which can be substituted for approximately 90 percent of the tubes used in these circuits.

To make the dummy tube, remove the base from a discarded tube and

solder a suitable resistor between the heater pins. Flexible resistors like Clarostat "Glasohms" and those made from Mallory Yard-Ohm resistance kits are particularly adaptable. The table lists the most common 6- and 12-volt octal-based tubes along with the heater connections and the required dummy resistance.

Similar dummies can be made for loktal and other bases, but they are not required when removing miniature types. A suitable flexible resistor is simply inserted into the heater-pin jacks of the empty socket.

The table is by no means complete. It is just an example of what can be done. Refer to the tube manual for heater ratings and pin connections for both the loktal and miniature types of tubes.—K. E. Forsberg

Tube type	Heater ratings	Heater pin connections	Bridging resistance
6A8	6.3 v., 300 ma	2 and 7	Use a single flexible 21-ohm, 2-watt resistor or four 82-ohm, 1/2-watt resistors connected in parallel.
6H6	6.3 v., 300 ma	2 and 7	
6SK7	6.3 v., 300 ma	2 and 7	
6SJ7	6.3 v., 300 ma	2 and 7	
6SC7	6.3 v., 300 ma	7 and 8	
6SL7	6.3 v., 300 ma	7 and 8	
6SQ7	6.3 v., 300 ma	7 and 8	
12A8	12.6 v., 150 ma	2 and 7	Use single 82-ohm, 2-watt resistor or four 330-ohm 1/2-watt resistors in parallel.
12K8	12.6 v., 150 ma	2 and 7	
12SJ7	12.6 v., 150 ma	2 and 7	
12SK7	12.6 v., 150 ma	2 and 7	
12SC7	12.6 v., 150 ma	7 and 8	
12SL7	12.6 v., 150 ma	7 and 8	
12SQ7	12.6 v., 150 ma	7 and 8	

**NOVEL CAPACITANCE RELAY USES BALANCED LINES**

A simple capacitance relay is often needed for phantom control of various apparatus such as garage doors, lights, and alarm systems. Those that have come to my attention have been limited in their application because the "feeler" or antenna must be a certain length—usually about 10 or 15 feet. In the usual single-wire system, the antenna forms one side of a capacitor and the earth forms the other. If used out-of-doors under changing weather conditions, the grid balance becomes unstable, causing false operation and instability, or sluggishness and abso-

lute failure to function.

The diagram shows a Harvey-Wells capacitance relay with my parallel-wire antenna system (enclosed within dashed lines) added to overcome the disadvantages of single-wire types. With this setup, the antenna may be several hundred feet long, depending on the capacitance of C1. With a 20-125-µmf trimmer for C1, antennas up to 300 feet long have been used with good sensitivity and oscillator stability. This antenna has been used on other makes and types of relays and is relatively insensitive to changes in

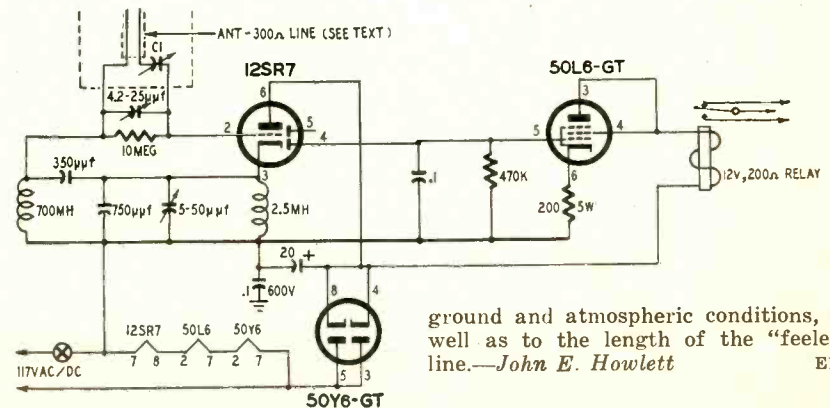

ground and atmospheric conditions, as well as to the length of the "feeler" line.—John E. Howlett

END

**DIRECTIONAL ALARM**

? Can you devise a photoelectric circuit that will indicate the direction of travel of a car using the exit road of a drive-in theater? I want to use it to detect persons sneaking in by using the single-lane exit road. Can I use a circuit that will light a green light and then a red one when a car is going in one direction and reverse the order of lighting when the car is going in the opposite direction? The indicator lamps will be in a box office about 700 feet from the exit road.—L. H., Madison, Kansas

A. The lighting sequence of two lamps can be used to indicate the direction of travel if the operator maintains a close watch on them to note the exact order in which they light. This setup may consist of two photoelectric relays like that shown at a in Fig. 1.

A slight modification of this circuit will make the units into a selective

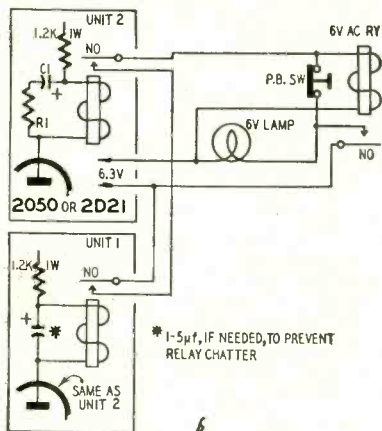
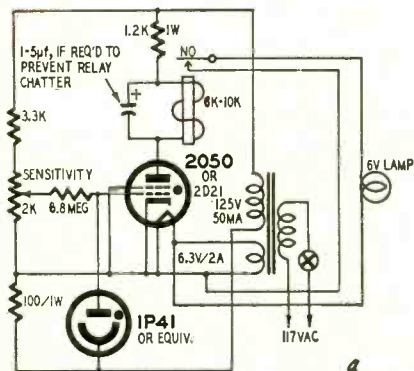

Fig. 1—Photoelectric relay circuits.

direction indicator. For this, you will need two slightly different photoelectric relays, units 1 and 2 in Fig. 1-b. Unit 1 is exactly the same as unit 2 except that R1 and C1 are added and the heater supply of unit 2 is tapped to supply the 6-volt a.c. relay and signal lamp. Photoelectric units 1 and 2 are mounted at the side of the roadway as shown in Fig. 2. The units should be 24 to 36 inches above the ground so the beams will be broken by the body of the car and not by the wheels. They should be spaced apart at a distance slightly greater than the length of the average automobile.

R1-C1 forms a time-delay network that holds the relay contacts of unit 2

**THIS MONTH'S HERSCHEL SPECIALS**

- RELAY BK-22K used with SCR 269F Direction Finder **\$3.95**
- RELAY 200 ohm S.P.S.T. Telephone type **.95**
- RELAY 5000 ohm D.P.S.T. Plate sensitive **1.95**
- RELAY 250 ohm Midget 4P.D.T. 24VDC **1.50**
- SWITCH High voltage IP-6 position from BC-375 Trans. **.75**
- CHOKO 2.5 MH 125 MA. **.35**
- VARIABLE CONDENSER APC. type 200mmfd. with can shield 1/4" shaft **.95**
- VARIABLE CONDENSER 150 mmfd. doubled spaced **.95**
- HEADSET HS-18 less head band **.95**
- CHEST UNIT BE-74 Ideal for antenna installation crews, uses two 1 1/2 volt flash lite cells **1.95**
- RHEOSTAT 30 ohm 50 watts Ohmite Mfg. **.95**
- RHEOSTAT 30 ohm to 145 ohm 25 watts **.49**
- RESISTOR 1Meg 1 watt 1 percent Precision Shallcross **.75**
- GLOW LAMP Argon 2 1/2 watt 105-125 volt med. base **.35**
- CORONA BALLS For tubes like VT-127A tubes **1.00**
- PADDER Dual ceramic 3 to 12mmfd. Ideal for TV wave trap **.25**
- TRANSFORMER Scope Pri 110VAC Sec. 4000V at 10Ma **3.95**
- TRANSFORMER Modulation and Driver—815 Class AB2 output 56 watts Driver 6SN7 to modulator **4.95**
- BOTH UNITS ONLY
- TRANSFORMER RCA Output Push-Pull 6L6's 25 watts Pri. 5000 ohm output Sec. #1—500 ohms, Sec. **4.95**

- #2—600 ohms sidetone 15 to 15,000 cy. flat HI-FI Special **1.95**
- DONUT ANTENNA Navy Type Ground Plane 144MC to 156MC **9.95**
- CHOKO Swinging 2 to 7 H 550MA. **5.95**
- MIKE Lip WE Navy Type #CW51071 **.95**
- TRANSFORMER Silver Slugged IF 30MC **.95**
- TRANSFORMER IF T104 35-110MC. **.95**
- TRANSFORMER IF T109 5MC Disc. **.95**
- TRANSFORMER 1st Lim T107 5MC **.95**

**BUTTERFLY CONDENSERS:**

- TYPE A 106-330 MC Antenna Type **\$4.95**
- TYPE B 300-1000 MC—can use 368As tube **4.95**
- TYPE C 300-1000 MC—has clip for xtal Det. **4.95**
- TYPE D 135 485 MC **4.95**

**CONDENSER SPECIAL:**

MFD	VOLT	PRICE
250	12	\$ .39
500	10	.69
500	200	2.95
1000	3	.79
1000	15	.95
2000	15	1.29
2000	50	2.95
32	450	1.29
16	600	1.75
	1000 oil	.69
	2000 oil	1.10
	3000 oil	1.89
	3600 oil	2.45
	5000 oil	4.95
2	1000 oil	.75
3	660AC oil	2.65
525	450	9.00

**ATTENTION DRAKE! NO MORE TVI** Conversion data for DRAKE FI5U low pass filter for 45MC cutoff frequency. **ALL BANDS** with conversion data **\$4.95**

**HERSCHEL RADIO CO.**  
5245 Grand River Ave.  
DETROIT 8, MICHIGAN

Phone  
**TYler 8-9400**

**TERMS:** Cash with order or 25% DOWN—BALANCE C.O.D. NET 10 DAYS RATED ACCOUNTS **ALL PRICES NET F.O.B. DETROIT** Merchandise Subject to Prior Sale **MIN. ORDER \$2.00**

**NEW TV DYNATRACER**

ONLY \$4.95 Ppd. or C.O.D. + Chgs.

- TRACES TV SIGNALS AND VOLTAGES
- LOCATES DEFECTIVE COMPONENTS
- REQUIRES NO ADDITIONAL EQUIPMENT

This sensationally new piece of test equipment is ideal for trouble-shooting television sets in the home or in the shop. The "DYNATRACER" will outperform more expensive testers and should pay for itself on the very first repair.

**A Must For Every TV Technician**

**SPECIFICATIONS:** The "DYNATRACER" is a self-powered quality test instrument designed to trace TV signals through any Video, Sound, Sync, AFC, Horizontal or Vertical Sweep Circuit—will isolate trouble to a stage or component.

**ADDED FEATURE:** The "DYNATRACER" will also trace voltages (50-500 V. AC/DC) and instantly locate open, shorted, intermittent or leaky (up to 20 MEGOHMS) condensers, resistors, coils, XFormers, etc. Instruction and Trouble-Shooting Book Enclosed

**10 DAY MONEY-BACK GUARANTEE**

Cut out advertisement . . . attach name and address with \$5.00 bill, check or money order and mail to

**Century ELECTRONICS CO.**  
211-04 99th Ave., Dept. 114  
Queens Village, N. Y.

**OSCIL-O-PEN**

Extremely convenient test oscillator for all radio servicing; alignment • Small as a pen • Self powered • Range from 700 cycles audio to over 600 megacycles u.h.f. • Output from zero to 125 v. • Low in cost • Used by Signal Corps • Write for information.

**GENERAL TEST EQUIPMENT**  
38 Argyle Ave. Buffalo 9, N. Y.

**REVOLUTIONARY**

**NEW TYPE TV ANTENNA**

Can be mounted with the dipoles aligned at any angle. More efficient than stacking. Highest gain under every existing condition.

**EXCLUSIVE TERRITORY RIGHTS AVAILABLE**

**C. R. DERR CO.** 1018 Taylor Ave. Vallejo, California

**ARKAY KITS** WORLD'S FINEST

**RADIOS PHONOGRAPHS TV TEST EQUIPMENT HI-FI**

Write for FREE Brochure

**RADIO KITS, INC. • 120 Cedar St., N. Y. 6**

**NOW COYNE TRAINS YOU IN SPARE TIME AT HOME**

**TELEVISION RADIO-ELECTRONICS**

Only from famous COYNE do you get this modern up-to-the minute TV Home Training. Easy to follow, Step-by-Step instructions—fully illustrated with 2150 photos and diagrams. Not an old Radio Course with Television tacked on. Personal guidance by Coyne Staff. So practical you can quickly EARN MONEY in a TV-RADIO SALES AND SERVICE BUSINESS—part time or full time. Not only FINEST TRAINING but COSTS MUCH LESS—pay only for training—no costly extras.

**SEND COUPON FOR DETAILS FREE**

SEND COUPON BELOW for Picture Folder and full details including EASY PAYMENT PLAN. NO COST OR OBLIGATION—NO SALESMAN WILL CALL.

B. W. COOKE, Pres. **COYNE ELECTRICAL SCHOOL** FOUNDED 1899

**A TECHNICAL TRADE INSTITUTE CHARTERED NOT FOR PROFIT**  
500 S. Paulina Dept. A4-HT4 Chicago 12, Illinois

B. W. COOKE, President  
**COYNE ELECTRICAL SCHOOL**  
500 S. Paulina St., Chicago 12, Ill., Dept. A4-HT4

Send FREE Picture Folder and details of your Television-Radio-Electronics Home Training offer.

Name \_\_\_\_\_  
Address \_\_\_\_\_  
City \_\_\_\_\_ State \_\_\_\_\_

## New 2-Speed Magnemite\*



**for Greater Recording Versatility in the Field!**

*For Nature Sounds, Music, Street Sounds, Interviews, Conference Recording, Courtroom Reporting, Missionary Work, Testimony Recording.*

The only two-speed battery-operated spring-motor recorder that meets primary and secondary NARTB standards for flutter, frequency response and dynamic range. Records and plays back frequencies up to 15,000 cycles. Features real portability, constant tape speed and independence of AC source. Models available for tape speeds of 15/7½ ips and 7½/3¾ ips. Quick change without sacrificing equalization.

These tiny recorders weigh only 16 lbs. with self-contained batteries that last 100 hours and include built-in monitoring and headphone playback facilities. Smaller than a portable typewriter (8 x 10 x 11 inches), the two-speed Magnemites\* do away with cumbersome generators, storage batteries, rechargers and may be operated anywhere.

Write for complete technical literature and direct factory prices to Dept. RE

**AMPLIFIER CORP. of AMERICA**  
398 Broadway, N. Y. 13, N. Y.  
\*T.M. Reg. U.S. Pat. Off.

### WHILE THEY LAST!



**10" TV REMOTE "SLAVE" SETS**

**HERE'S YOUR CHANCE TO GET THAT EXTRA SET FOR PLAYROOM, BEDROOM, KITCHEN, ETC.!!**

These are COMPLETE, OPERATING slave units. Hook up to any standard TV receiver (only 4 soldered connections) to reproduce any tuned TV channel. COMPLETE SCHEMATIC & HOOK-UP DATA SUPPLIED. Operates on 110V. DC: AC conversion data included.

**FEATURES:**

- 90 DAY GUARANTEED.
- H.V. OSC. POWER SUPPLY... detachable unit.
- 4" H.V. DUTY FM SPEAKER.
- MAJOR STANDARD PARTS INCLUDE: Def. Yoke, Focus Coil, Horiz. & Vert. Outputs, two 100-100ma Chokes, 150ma Sel. Rect. Electrolytic Controls, etc.
- HANDSOME WALNUT VENEER & LEATHERETTE CABINET (20½" x 17" x 14½").

**!! PARTS ALONE WORTH SEVERAL TIMES THE PRICE !!** Perfect condition —used. Shipped Railway Exp. (Sorry No C.O.D.'s).

**2" PANEL METERS**... round, 0-5 MA DC. Calibrated for recording level output. ¼" diameter, 1" deep... \$2.95

**CRYSTAL HAND MIKE**... rugged all-purpose, modified bakelite with shielded cable. Hi-imped. 3.95

**1" FIBREGLAS ACOUSTICAL CABINET LINING**... 36" wide. Per running foot... 1.15

**2000 OHM LAB. POTENTIOMETER (DeJury)**... ±5%, W.W., 3" O.D., bakelite shaft. ea. 98¢ 6/5.00

**TIMER MOTORS**... 30 RPM A.C. MOTOR (115V). Dble. ¼" shaft. 5"x2½"x1¼" (shpg. wt. 2 lbs.) 2.95

**5 RPM A.C. MOTOR (Bristol)**... 115V. 2W. O.D. 2"x1¼". Mod. 200C. Brand New... 2.49

---

**AND HERE'S A REAL "GOLD-MINE"!!**  
WHOPPING VALUE in new and surplus odds & ends of inventory. Leotone's "JUMBO RADIO ELECTRONICS PARTS KIT" 17 FULL LBS. OF SWITCHES, SOCKETS, CONTROLS, WIRE COILS, TV PARTS & DIAGRAMS, PHOTOFACTS, RESISTORS, CONDENSERS, ETC., ETC. (Shpg. wt. 20 lbs.) ALL FOR **\$3.95**

**!!TUBES!! ... UP TO 90% OFF!!**

90 DAY GUARANTEED. Standard brands, unsealed cartons.

24, 26, 27, 34, 41, 42, 55, 56, 89 or 6K7	29c
1A6, 1C8, 1H4, 1H6, 1J6, 5Y3, 5Y4, 6X7, 6C5, 6F5, 6G5, 6I5, 6BD7, 6SQ7, 6R7, 35Z5, 76, 77, 78 or 80	39c
6Z4, 1A7, 1L4, 2A3H, 6AB, 6AU6, 6BE8, 6CR6, 6P6, 6R6, 6Y6, 6SA7, 6SK7, 6SN7, 6W4, 7A4, 7A7, 7AG7, 7B6, 7C5, 7C6, 7D7, 7Y4, 12SN7, 20L6, 35, 37 or 45	49c
2-11C6, 11E3, 2A5, 2A6, 5V4, 6A5, 6A6, 6A7, 6A8, 6A9, 6AC7, 6L7, 6P5, 6U7, 6V6, 7W7, 12A6, 12AU7, 50, 58, 81	69c

**"DIRECT FACTORY SPEAKER REPAIRS SINCE 1927"**  
Min. order \$3.00 20% deposit req. on all C.O.D.'s. Full remittance with foreign orders.

**LEOTONE RADIO CORP.**  
67 Dey Street, New York 7, N. Y.

closed for a few seconds after the light beam is restored. The delay circuit is omitted from unit 1 so its contacts open as soon as the beam is restored. The alarm circuit operates only when the relay circuits of units 1 and 2 are closed simultaneously.

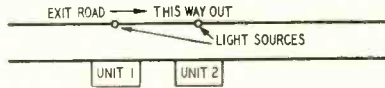

Fig. 2—Locating photoelectric units.

A car attempting to enter the grounds via the exit roadway will first break the beam to relay 2. The time-delay circuit holds the relay closed long enough for the car to advance and break the beam to relay 1. When both relay contacts are closed simultaneously, the 6-volt a.c. relay is closed to light the indicator. This relay is in a self-locking circuit that holds it closed until released manually.

### V.H.F. CONVERTER COVERS CALLS FROM 110 to 235 MC

❓ Please print a diagram of a v.h.f. converter that I can use to receive taxi, police, and amateur transmissions from about 110 mc to as far up as it is practical to go. I want to feed the output into an SW-54 receiver at about 11 mc. —Wm. K. C., Churubville, Pa.

A. The converter shown covers from 110 to about 235 mc. The coils are made by J. W. Miller Co. They will tune the 150-mc range with the tuning capacitors in the schematic. The upper frequency limit is determined by the stray

A car leaving the grounds by the exit road will not activate the alarm. It breaks and restores the beam to relay unit 1 before breaking the beam to unit 2. Thus the relay contacts are not closed at the same time so the alarm is not activated.

Experiment with the values of R1 and C1 to obtain the desired time delay. For C1, try a capacitor (preferably paper) of 4 to 10 µf and use a 1- or 2-megohm variable resistor to determine the correct value of R1. The delay depends on the values of R1 and C1, and on the resistance and drop-out voltage characteristic of the relay in unit 2. Adjust the values so the relay in unit 2 operates when a car passes by at normal speed and stays closed until after the car has broken the beam to unit 1.

You may have false alarms if two or more cars leave the grounds almost bumper-to-bumper. This can be eliminated by using a more complex circuit.

wiring capacitance and the minimum capacitance of the tuning capacitor.

The heater isolation chokes consist of 25 turns of No. 24 enameled wire close-wound on a 47,000-ohm, ½-watt resistor. L1 is a Cambridge thermionic type CTC LS-3 5-megacycle coil with about 15 turns removed. L2 consists of about 12 turns of No. 32 enameled wire scramble-wound close to the bottom of L1.

Adjust the slider on the 3,000-ohm resistor so the current through the V-R tubes is 15 to 20 ma.

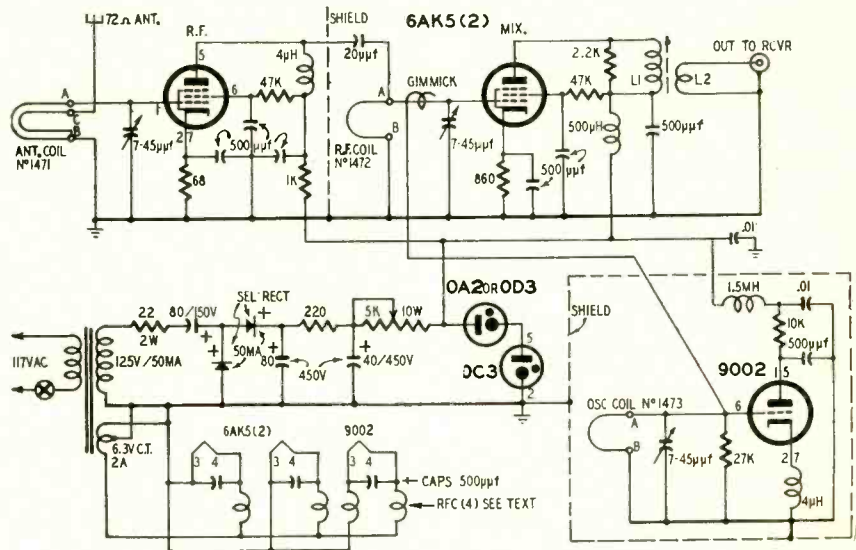

### PHONOGRAPH CONNECTION

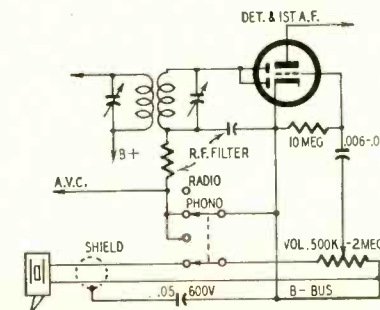

❓ Please print a diagram showing how crystal phonographs can be connected to the average a.c.-d.c. type receiver.—F. B., Philadelphia, Pa.

A. The diagram shows the phonograph connections for a typical a.c.-d.c. set. It is advisable to use a pickup with a nonmetallic arm. The cartridge should have two leads in a common shield. Isolate the shield from the B minus bus with a 600-volt capacitor of about .05 µf or connect it directly to the chassis if the bus is isolated from it. END

**CROSLY 24- AND 27-INCH SETS**

In the 24- and 27-inch receivers (1954 models, F series) the filament of the 1B3-GT high-voltage rectifier is operated at or near maximum allowable voltage. In some cases, such as high line voltage, the filament voltage exceeds the rated value and the tube filament burns out.

To provide lower and better regulated voltage and to increase the life of the 1B3-GT under these conditions, insert a 2.2-ohm, 10%, ½-watt wire-wound resistor (Crosley part 39303-12) in series with the filament as shown in the diagram.

An easy way to make the change is

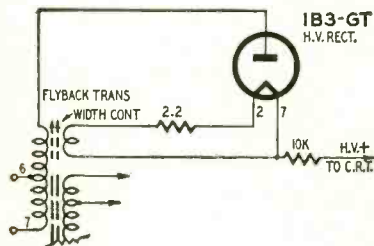

to remove the wire from pin 2 of the tube socket and connect it to pin 4. Then connect one of the resistor leads to pin 2 and the other to pin 4. Resolder both connections.

This resistor increases the life of the 1B3-GT, so it is recommended that it be installed in all receivers of this series that are brought in for service.—*Crosley Service Dept.*

**ZENITH ALL-WAVE RADIO**

When this set was switched to the short-wave band a strong local broadcast station completely blanketed the desired signals. This trouble was traced to cross modulation caused by oxidized contacts on the band-switch.

The trouble was eliminated by cleaning the switch contacts with solvent and then coating them with a service chemical designed to prevent a return of this trouble.—*Ernie Gig*

**WESTINGHOUSE H-233 TV SETS**

In early production runs of this set, complaints of sound bars in the picture may be caused by audio output currents flowing through the chassis.

In these sets, one side of the output transformer secondary and one of the speaker terminals are connected to the chassis. This connection allows the heavy audio currents to flow through the chassis.

To remedy this condition, disconnect the transformer terminal from the chassis and connect it to the grounded terminal on the speaker socket with a length of wire.—*Ross Harris*

**SPROMBERG-CARLSON MODEL 600**

When necessary to replace any components on the printed i.f. strip, a very light iron must be used to avoid excessive heat. It is recommended that a 22.5-watt pencil iron be used. Using a small iron, all components can be changed, including i.f. transformers, without difficulty.—*Current Flashes.*

JUNE, 1954

# INTERNATIONAL RECTIFIER CORPORATION

EL SEGUNDO CALIFORNIA

## Selenium Rectifiers

widest range in the industry

**TV BOOSTER and CONVERTER TYPES available in all standard current and voltage ratings**



# Germanium Diodes

**RADIO RECTIFIERS universal replacement—wider range**

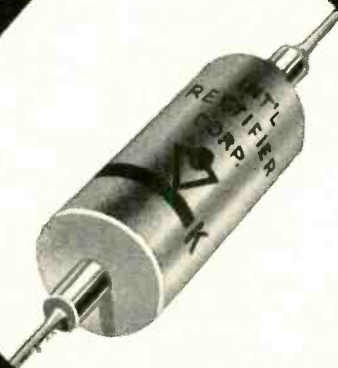

Write for Bulletin JRP-2

Now Available Through Your Favorite Jobber

## INTERNATIONAL RECTIFIER CORPORATION

1521 E. Grand Ave., El Segundo, Calif. • Phone: ORegon 8-6281  
 CHICAGO: 205 W. Wacker Drive • Phone: Franklin 2-3889  
 NEW YORK: 501 Madison Avenue • Phone: Plaza 5-8665

# CRYSTAL GRINDING KIT!

- ★ Grind your own crystals to desired frequency for ham bands.
- ★ No elaborate frequency measuring equipment needed. Your receiver is sufficient.
- ★ It's easy—simple as A, B, C!

## CONTENTS OF BASIC KIT

- A) 9 good, commercially-made crystals below band frequency, within reason, for re-grinding. Mounted in original holders with fundamental frequencies indicated on holders.
- B) 1 master crystal for calibration purposes.
- C) Crystal grinding components.
- D) Easy-to-follow instructions.
- E) Material to re-mark holders to your new frequency.

KIT No. 1 for 80 METERS	postpaid	<b>\$7.95</b>
KIT No. 2 for 40 METERS	postpaid	<b>\$6.95</b>
KIT No. 3 for 2 METERS 18th Harmonic	postpaid	<b>\$6.95</b>
KIT No. 4 for 2 METERS 24th Harmonic	postpaid	<b>\$6.95</b>

NOTE: Check, cash or M.O. IN FULL MUST ACCOMPANY ORDERS. NO C.O.D. Items subject to prior sale and change of price without notice.

## U. S. CRYSTALS, INC.

805 S. UNION AVE. DEPT. RE  
LOS ANGELES 17, CALIFORNIA  
Phones: DUnkirk 1-3020 DUnkirk 1-3029

When answering advertisements please mention **RADIO-ELECTRONICS**

SAVE MONEY. MAKE MONEY.

# LEARN TV

the practical way..



ASSEMBLE A  
**TRANSVISION TV KIT**

Pay as You Wire **\$39**  
Down Payment

I WILL HELP YOU to start learning TV the practical way — by assembling a TRANSVISION TV KIT in EASY STAGES. For only \$39 you get PACKAGE #1 (standard first pkg. for all of our kits). This package gives you the BASIC CHASSIS and over 450 TV COMPONENTS with complete Instructions, Drawings, Photos, Service Booklet, and a year's subscription to my "TV and Electronics Notes". When ready, you order the next stage (pkg. #2), etc. Low prices make your complete kit a terrific buy!



**FREE CATALOG**

Shows 6 Great TV Kits:

EXCLUSIVE: Only Transvision TV Kits are adaptable to UHF. Ideal for FRINGE AREAS. No Previous Technical Knowledge required. Write now!

TRANSVISION, INC., Dept. E6  
NEW ROCHELLE, N. Y.

MAIL THIS COUPON TODAY

Educational Director  
TRANSVISION, INC., NEW ROCHELLE, N. Y. Dept. E6

- I'm enclosing \$\_\_\_\_\_ deposit. Send standard kit PACKAGE #1, with all Instruction Material. Balance C.O.D.
- Send FREE copy of your new TV Kit Catalog.

Name \_\_\_\_\_  
Address \_\_\_\_\_  
City \_\_\_\_\_ State \_\_\_\_\_

## IMPROPER VOLTAGES AND WEAK PICTURE IN G-E TV RECEIVERS

Improper operating voltages on the first video amplifier in the 14T2, 14C102, 16T5, 16C103, 17T1, 17T2, and 17T4 may be caused by defective components in the second video amplifier stage. The two video amplifier stages are direct-coupled and connected in cascade so the voltages in the first are dependent on those in the second stage. A diagram of the video amplifier

circuit is shown, using a twin-triode 12AT7.

Complaint of a very weak picture with sound and raster O.K. has been traced to a leaky .05- $\mu$ f, 600-volt capacitor connected from pin 8 of the 12AT7 video amplifier to the B minus bus. Replacement of the capacitor eliminates the defect and restores normal performance.—Dee Bramlett, Jr.

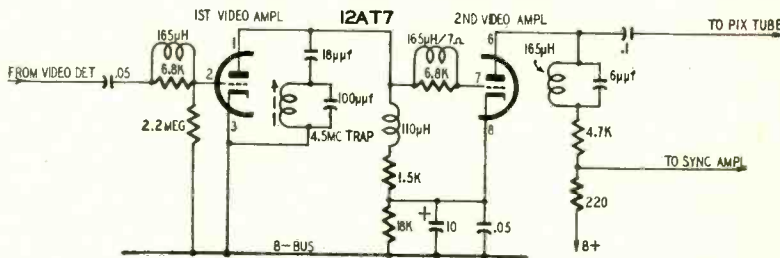

## RETRACE BLANKING REVISION IN ARVIN TV RECEIVERS

The complaint is white horizontal lines on the screen of Arvin TE-358, 358-1, 358-2, 358-3, 363, 363-1, 363-2, 363-3, 364, and 364-1 receivers when the contrast and brightness controls are near maximum settings. This can be corrected by making minor modifications in the vertical retrace blanking circuit as shown in the diagram. Components to be added are shown in dashed lines. Use the following procedure in modifying the blanking circuit:

1. Disconnect the green lead from the picture tube grid at its junction with R330, R339, and C311. [R339 is not used in early production TE-358 and TE-363 chassis. On these, remove and discard the .0047- $\mu$ f capacitor (C316) and the 100,000-ohm resistor

(R338) connected to the grid (green) lead to the picture tube.]

2. Connect a 0.1- $\mu$ f, 200-volt capacitor across the yellow and green leads on the secondary of the vertical output transformer. (This capacitor may already be in the circuit in some receivers.)

3. Connect a 0.1- $\mu$ f, 400-volt capacitor to the junction of the 0.1- $\mu$ f, 200-volt capacitor and the green lead on the vertical output transformer.

4. Connect a 12,000-ohm resistor from the grid end of the 0.1- $\mu$ f, 400-volt capacitor to ground. Connect the grid (green) lead of the picture tube to the junction of the 0.1- $\mu$ f capacitor and 12,000-ohm resistor.—Arvin Service Bulletin

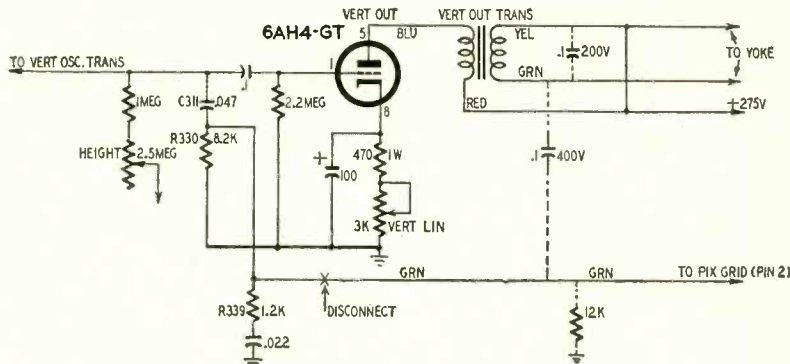

## TROUBLES IN THE G-E MODEL 16T5 TV RECEIVER

Complaints of no raster may be caused by an increase in the value of the horizontal output screen resistor when the sound is O.K. The 25BQ6-GT

screen resistor is a 4,000-ohm, 7-watt unit mounted inside the high-voltage cage. Replace it with a 4,000-ohm, 10-watt resistor. The diagram shows the pertinent circuit of the 25BQ6-GT.

Another complaint on this and similar G-E sets is weak sync with the contrast control ineffective or even working backward. Sound is O.K. This trouble is most often caused by a leaky .01- $\mu$ f capacitor connected to pin 1 of the 6SL7-GT sync amplifier and clipper. Replace it with a .01- $\mu$ f, 600-volt, high-quality unit.—Dee Bramlett, Jr. END

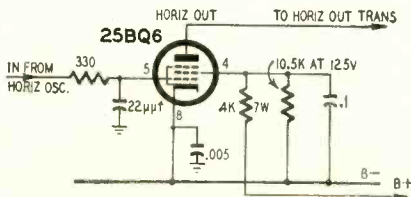





**THE FUND REACHES  
\$11,412.09**

**HELP -  
FREDDIE-WALK  
FUND**

Herschel Thomason, radio technician of Magnolia, Arkansas, and father of little Freddie Thomason, the boy who was born without arms or legs, writes to us as follows:

"We are in the process of building a room on our house especially for Freddie, which we hope to equip later on with things to give him the different exercises he needs. Freddie will probably go back to the Institute [Editor's Note: Kessler Institute for Rehabilitation, West Orange, New Jersey] in a couple of months, and we believe they will start to work on his arm. He is doing fine on his legs, and with the help of an arm, he will do better than ever."

Freddie has made tremendous progress in his six years. With the help of his artificial legs, he is able to simulate walking, moving in the manner of a mechanical doll. He is otherwise a normal healthy, happy six-year-old, and delights in playing with other children, especially a younger brother who is normal in every way. His spirit is indomitable, and with the faith and encouragement of his parents and the many friends he has made through the Help-Freddie-Walk Fund, he can't help but succeed in becoming a well-adjusted, contributing member of society in his adult years.

However, spirit, faith, and courage will not be enough. As Freddie grows, so must the mechanical appliances upon which he depends. Such devices, as well as the expert workmanship it takes to adjust them, all cost money—thousands of dollars, in fact. The Fund is now



"My hi-fi system arrived today, but they sent a corner enclosure for the speaker."

JUNE, 1954

nearing the \$11,500 mark, but it is still small when you consider the number of years before Freddie will stop growing and needing ever-changing appliances.

This is why we ask each and every one of our readers to send in a donation whenever he can. No amount is too small to receive our sincere thanks and acknowledgment by letter. *Make all checks, money orders, etc., payable to Herschel Thomason.* Address all letters to:

**HELP-FREDDIE-WALK FUND**  
c/o RADIO-ELECTRONICS Magazine  
25 West Broadway, New York 7, N. Y.

**CONTRIBUTIONS**

FAMILY CIRCLE FUND contributions	\$ 602.50
RADIO-ELECTRONICS FUND contributions as of January 18, 1954	10,738.59
Contributors since January 18:	
Anonymous, Portland, Oregon	2.00
Warren C. Asplin, Jackson, Mich.	1.00
Curt's, Guymon, Okla.	5.00
A. H. Danter, S. Louis, Mo.	10.00
Mary Haynach, Braddock, Pa.	2.00
Independent Progressive Party, Los Angeles, Calif.	10.00
Little Princess Club, sent in by Ethel Lydia Ehrenstein, New York City	1.00
M. Gordon Mozes, New York City	5.00
John E. Napier, Jr., Waco, Texas	10.00
New Shop, Portland, Ore.	10.00
Juan F. Rogliatti, Buenos Aires, Argentina	1.00
Norman A. Segal, D.D.S., Syracuse, N. Y.	1.00
Miss Frances "Sparky" Spafford, Fitchburg, Mass.	1.00
Jorge Rodriguez Troncoso, Manati, Oriente, Cuba	5.00
Evans Taylor, Jr., Malvern, Ark.	1.00
G. Carroll Utermahlen, Baltimore, Md.	1.00
Frank W. Yarbrough, Haleyville, Ala.	5.00

TOTAL CONTRIBUTIONS as of April 8, 1954 ..... \$11,412.09

**Radio Thirty-Five Years Ago**  
In Gernsback Publications

**HUGO GERNSBACK**  
Founder

Modern Electrics	1908
Wireless Association of America	1908
Electrical Experimenter	1913
Radio News	1919
Science & Invention	1920
Television	1927
Radio-Craft	1929
Short-Wave Craft	1930
Television News	1931

Some of the larger libraries still have copies of **ELECTRICAL EXPERIMENTER** on file for interested readers.

**In June, 1920, Electrical Experimenter (Science and Invention)**

- The Earth as a Magnet, by Isabel M. Lewis, M.A.
- Radium—The Bad Boy of Science, by Harold F. Richards, M.A.
- Secretary Daniels Speaks by Radio
- Radio 100 Words a Minute
- A War-Time Radio Detective, Part II, by Pierre H. Boucheron
- 600-Foot Radio Tower
- New Wireless Portable 'Phone
- Radio Controls Torpedo
- High-Power Radio Arcs
- A Long-Wave Vertical Coupler
- Building a Mica Diafram Microphone

**TRANSVISION**

makes this greatest of TV offers—backed by

**MONEY-BACK GUARANTEE:**

**\$88 TV SERVICE INSTRUMENT \$39.95 VALUE FOR—**

NEW TV Component Tester performs functions you've always wanted. Look what you get:-  
 FLYBACK and YOKE TESTER, value ..... \$39.  
 SELENIUM RECTIFIER TESTER, value ..... 29.  
 CRT TESTER and REACTIVATOR, value ..... 20.  
 Total Instrumentation, value ..... 88.  
 ALL 4 in 1 great instrument, net ..... 39.95



**SELENIUM RECTIFIER TESTER**

**FLYBACK TRANSFORMER and YOKE TESTER**

**PIC. TUBE TESTER**

**PIC. TUBE REACTIVATOR**

NEVER BEFORE SUCH GREAT VALUE. For only \$39.95 you get 4 testing-and-repair instruments all in one! Compact, weighs only 3 lbs. Does things never been done before. Pays for itself quickly. Prove it yourself—

**TRY IT for 10 DAYS on Money-Back Guarantee:**

10 DAY TRIAL: Try this Transvision TV COMPONENT TESTER for 10 days. Then, if you are not 100% satisfied, you may return it. Your purchase price, less 10% (our cost of handling and repacking) will be promptly refunded.

TRANSVISION, INC. • NEW ROCHELLE, N. Y.

--- RUSH THIS COUPON NOW ---

TRANSVISION, INC.  
DEPT. RE-64 NEW ROCHELLE, N. Y.

( ) Send \_\_\_\_\_ TV COMPONENT TESTERS @ \$39.95  
 ( ) Enclosed find \$ \_\_\_\_\_ deposit. Balance C.O.D.  
 ( ) Enclosed find \$ \_\_\_\_\_ in full.  
 I accept your 10 Day Trial terms.

Name \_\_\_\_\_  
 Address \_\_\_\_\_  
 City \_\_\_\_\_ State \_\_\_\_\_  
 My Jobber is \_\_\_\_\_

**JOBBER INQUIRIES INVITED**

# STAN-BURN E-D-A-R-K-E

## CATHODE RAY TUBE SPECIALS

ONE YEAR GUARANTEE		STAN-BURN	
G.E.			
10BP4A	\$14.95	10BP4	\$10.20
10FP4A	21.10	12LP4	11.90
12KP4A	24.45	12LP4A	13.95
12LP4A	18.75	12LP4	11.90
12QP4A/B1014	21.00	12JP4	11.90
Dumont	28.75	12UP4A	14.50
12UP4B	24.50	16CP4	11.95
14CP4	24.50	15DP4	17.50
15DP4/B1014	23.75	16KP4	17.50
Dumont	30.95	16DP4 or A	17.50
16AP4A	25.25	16JP4 or A	17.50
16DP4A (N.U.)	25.25	16CP4 or A	17.50
16CP4 or A	24.20	16FP4A	17.50
16KP4/16RP4	24.20	16WP4	17.50
16KP4A	28.35	16AP4	17.50
(Aluminum)	25.25	16AP4A	23.00
16JP4A (N.U.)	26.50	16EP4A	19.00
16LP4A	26.50	16EP4A	23.50
16WP4A	28.50	16GP4 or A	21.00
16RP4A	28.75	17BP4	18.50
17BP4A	24.25	17CP4A	21.50
17BP4B	30.30	17GP4B	22.60
17CP4	23.90	19FP4	23.00
17CP4B	29.00	19FP4A	24.00
(Aluminum)	41.50	19AP4	23.90
19AP4A	30.00	19AP4A	24.90
20CP4	37.50	20CP4	23.95
21AP4	42.00	21EP4	25.50
21EP4	31.80	21AP4	26.50
21EP4A	36.35	24AP4	49.00
24AP4	48.50		

**QUANTITY CRT USERS**  
We will give you DUD allowances if you ship them to us Prepaid 10 CRT's minimum shipment. WRITE FOR DETAILS.

## ANTENNAE SPECIALS

RED DOUBLE "W" Antenna	1-5	or more
10 ELEMENT CONICAL	1.19	1.98
Dowelled Inserts	2.98	2.79
Folded Hi Straight Low Quick Rig		
5" elements	4.25	3.25
WINDOW CONICALS	4.95	3.75
5 FOOT SWAGED	.79	.69
MASTS	10 FOOT PLAIN	1.39
NEPCO MASTS	1.69	1.49
TV WIRE	42 MH	\$9.95 M Ft.
	55 MH	300 OHM
	72 OHM COAXIAL	35.00 M Ft.
CHASSIS G30 TECHMASTER		\$149.50
Model 1930 with Cascade Tuner		
OPEN FACE CABINET		\$42.00

## TAPE RECORDERS IN STOCK

PENTRON—Model 9T3C—2-speed Tape Recorder	Write for Price.
RADIO CRAFTSMAN	
Model C400—Hi Fi Amplifier	Net \$42.90
Model C10—AM-PM Tuner	Net 131.50
Model C500—Williamson Amplifier	Net 99.50
We also carry MASCO—BOGEN—PILOT, etc. Amplifiers—Pre-Amps, FM Tuners and WEBSTER Tape Recorders.	
6"x9" PM SPEAKER	\$3.98
7" PM SPEAKER	3.98
70" Yoke	1.98
630 Vert. Output Upright	1.98
630 Vert. Output Potted	1.29
630 Vert. Block Osc. Xform.	.89
CASCADE TUNERS	14.95
DUMONT 21.25 mc	10.00
Famous INPUTNER	1.98
TV Permanent Magnet Focus Assembly	1.98

Three Speed Automatic VM Record Player in portable carrying case. Special \$39.95  
20CP4 Progressive Special \$23.95

**AUTHORIZED DISTRIBUTORS for:** General Electric, Kenrad, Tung-Sol, National Union, De Wald, Regal, Automatic and General Motors.

**AUTOMATIC CUSTOM-BUILT RADIOS for Plymouth, Ford, Chevrolet and many others, always in stock.** We carry a complete stock of HI-FIDELITY and SOUND EQUIPMENT. Send us your requests. We also carry a complete line of popular makes of Radio tubes at 50/10% discount. Also many other special purpose and transmitting types, and all electronic parts and equipment at lowest prices. Send us a list of your requirements for prompt quotations. Terms: 20% with order. Balance C.O.D. All prices FOB. NEW YORK Warehouse. Minimum order \$5.00. Write for our latest price list and Hi-Fi Catalog to Dept. RE-6.

**STAN-BURN RADIO and ELECTRONICS CO.**  
1697 BROADWAY • NEW YORK 19, N.Y.

## TELEVISION

Big demand for graduates

**B.S. DEGREE IN 27 MONTHS** in radio including TV engineering—VHF, UHF, AM and FM. Students use over \$100,000 worth of equipment including 2 large commercial type transmitters in new TV lab. Intense specialized course includes strong basis in mathematics, science and advanced design in radio and TV.

Hundreds of young men each year are earning engineering degrees in this recognized institution. Start any quarter. Many earn a major part of expense in this industrial center. Low tuition. Competent instruction. Thorough, intense, practical program.

Also **B.S. DEGREE IN 27 MO.** in Aeronautical, Chemical, Civil Electrical and Mechanical Engineering. G.I. Gov't approved. Enter June, Sept., Dec., March. Free catalog. **ENROLL NOW.**

**INDIANA TECHNICAL COLLEGE**  
1764 E. Washington Blvd., Fort Wayne 2, Indiana



V. M. Graham

George J. Desposito joined Pyramid Electric, North Bergen, N. J., capacitor manufacturer, as administrative assistant to the executive vice-president. He was formerly with Emerson Radio and Phonograph.

Virgil M. Graham was named to head the RETMA Engineering Department, succeeding Ralph R. Batcher, who resigned. As its new chief engineer, he comes to RETMA from Sylvania, where he had been director of technical relations.

John Bentia, vice-president of the Alliance Mfg. Co., Alliance, O., and associated with the company the past 15 years, was promoted to executive vice-president at a recent meeting of the Board of Directors. Mr. Bentia's new duties will entail wider responsibilities, including re-organization changes in the sales department.

## Obituaries

Edward M. Kolman, industrial and technical representative of Kester Solder Co., Newark, N. J., died of a heart attack in his Brooklyn, N. Y., home.

Joseph H. Lecour, retired New York lawyer and chairman of the board of Mitchell-Rand Manufacturing Co., died at his home in Chester, N. J. He was a former president of the National Electrical Credit Association.



G. J. Desposito

Nat Welch was promoted to the position of vice-president in charge of sales of ORRadio Industries, Opelika, Ala., sound recording tape manufacturer. He joined the staff last year as sales manager, and has been since working with distributors.

## Personnel Notes

... Edward S. Miller and John Narrace were promoted to vice-president and chief engineer respectively of Radio Craftsmen Inc., Chicago. Miller was formerly chief engineer and Narrace, in charge of TV design.

... John F. Gilligan retired as vice-president in charge of advertising for Philco Corp., Philadelphia, after 32 years of service with the company. Morgan Greenwood, who was named general advertising manager for Philco last January, will supervise all the company's advertising.

... Frank Sleeter was elected vice-president, facilities administration of RCA. He was formerly director of the plant facilities administration.

... Robert C. Sprague, founder and chairman of the Board of Sprague Electric Co., North Adams, Mass., was elected to the additional post of treasurer, succeeding George B. Flood, who remains as a director and consultant. All directors of the company were re-elected.

... George S. Bond was named advertising manager of P. R. Mallory & Co., Indianapolis. He was formerly sales manager of the Metals and Ceramics Division.

... H. E. Moon, executive vice-president of General Industries Co., Elyria, Ohio, was elected a director of the company at the annual stockholders meeting.

... Dr. Dean E. Wooldridge and Dr. Simon Ramo, both of Los Angeles, were elected to the Board of Directors of Thompson Products, Cleveland, Ohio. Formerly top executives with Hughes Aircraft, they organized Ramo-Wooldridge, a research and development firm, with the financial backing of Thompson Products, last year.

... Harold C. Anderson is the new purchasing agent for Merit Coil & Transformer Corp., Chicago. He was formerly personnel director.



N. Welch

Walter R. Wolfgram joined Jensen Manufacturing Co., Chicago, as factory superintendent. He takes over the duties of T. L. Pierce, who is setting up production facilities for Jensen outside the state. Wolfgram comes to Jensen from Standard Transformer Corp.



W. R. Wolfgram

C. F. Sullivan was elected controller of General Instrument Corp., Elizabeth, N. J. He had been acting controller since July of 1953. Sullivan will be in charge of budget control and cost reduction.



C. F. Sullivan

Abraham Hyman was appointed head of the recently expanded TV Antenna Development Section of Brach Manufacturing Corp., Division of General Bronze Corp., Newark, N. J. He will report to Ira Kamen, vice-president in charge of Sales and TV development. Hyman was a consulting engineer and an employee of the CAA.



Abraham Hyman

# GREATEST TUBE BUYS

Every Tube **GUARANTEED 6 Months**

BRANDED—BULK PACKED IN ORIGINAL MFR'S NESTED CARTONS OR INDIVIDUALLY BOXED

EVERY TUBE METER & CHASSIS TESTED FOR TOP QUALITY

OA4G . . . \$ .50	1U4 . . . \$ .46	6BF5 . . . \$ .69	6SQ7GT \$ .37	7X6 . . . \$ .57	19BG6G \$1.15
OZ4 . . . .49	1U5 . . . .38	6BG6G . . . 1.10	6SR7 . . . .49	7Y4 . . . .40	19T8 . . . .61
1A4P . . . .35	1X2A . . . .65	6BH6 . . . .45	6T8 . . . .57	7Z4 . . . .45	22 . . . .35
1A5 . . . .30	2A5 . . . .39	6BJ6 . . . .46	6U7 . . . .49	12A6 . . . .39	25AV5 . . . 1.05
1A7GT . . .45	2A7 . . . .35	6BL7GT . . .65	6U8 . . . .59	12A7 . . . .98	25BQ6GT .75
1B3GT . . .65	2X2 . . . .39	6BN6 . . . .88	6V3 . . . . 1.04	12AT6 . . . .31	25L6GT . .40
1C5GT . . .39	3LF4 . . . .71	6BQ6GT . . .69	6V6GT . . .38	12AT7 . . . .57	25Z6GT . .37
1C7G . . . .35	3Q4 . . . .48	6BQ7 . . . .88	6W4GT . . .41	12AU6 . . . .34	32L7GT . .39
1D7G . . . .35	3Q5GT . . .48	6C4 . . . .31	6W6GT . . .41	12AU7 . . . .59	33 . . . .29
1E7GT . . .35	3S4 . . . .46	6C5GT . . .41	6X4 . . . .35	12AV7 . . . .60	34 . . . .29
1F4 . . . .35	3V4 . . . .46	6C6 . . . .49	6X5GT . . .33	12AX7 . . . .62	35-51 . . .35
1F5G . . .39	5U4G . . .49	6CB6 . . . .42	7A4 . . . .45	12AY7 . . . .72	35B5 . . .38
1H4G . . .35	5V4G . . .76	6CD6G . . . 1.05	7A7 . . . .45	12BA6 . . . .52	35C5 . . .38
1H5GT . . .38	5Y3G . . .36	6E5 . . . .76	7B5 . . . .46	12BA7 . . . .61	35L6GT . .42
1J6 . . . .88	6A6 . . . .35	6F6 . . . .45	7B6 . . . .45	12BD6 . . . .46	35W4 . . .32
1L4 . . . .47	6A8GT . . .63	6H6GT . . .49	7B7 . . . .45	12BE6 . . . .40	35Z5GT . .49
1L6 . . . .61	6AB7 . . .69	6J5GT . . .34	7C7 . . . .53	12BH7 . . . .41	36 . . . .32
1LA4 . . .77	6AC7 . . .68	6J6 . . . .50	7E5 . . . .80	12H6 . . . .49	37 . . . .32
1LA6 . . .75	6AG5 . . .46	6J7 . . . .49	7E6 . . . .60	12SA7GT .58	39-44 . . .35
1LB4 . . .77	6AH6 . . .88	6K6GT . . .36	7E7 . . . .80	12SG7 . . .61	46 . . . .35
1LC5 . . .75	6AK5 . . .69	6K7G . . .49	7F7 . . . .64	12SH7 . . .49	47 . . . .75
1LC6 . . .75	6AL5 . . .34	6L6GA . . .99	7F8 . . . .92	12SK7 . . .49	49 . . . .32
1LD5 . . .75	6AQ5 . . .37	6Q7GT . . .51	7G7 . . . .80	12SN7GT .46	50B5 . . .41
1LE3 . . .75	6AQ6 . . .36	6S4 . . . .47	7H7 . . . .56	12SQ7 . . .49	50C5 . . .41
1LG5 . . .75	6AQ7GT .69	6SA7 . . .59	7J7 . . . .80	12SR7 . . .49	50L6GT . .59
1LH4 . . .75	6AS5 . . .62	6SA7GT .61	7K7 . . . .80	12Z3 . . . .39	117Z3 . . .39
1LN5 . . .75	6AT6 . . .36	6SC7 . . .81	7L7 . . . .80	14A7 . . . .53	117Z6GT .70
1N5GT . . .61	6AU6 . . .36	6SF5GT . .58	7N7 . . . .57	14AF7 . . .63	9003 . . . 1.10
1Q5GT . . .39	6AV5GT .79	6SG7 . . .59	7Q7 . . . .57	14B6 . . . .45	801A . . . .35
1R4 . . . .81	6AV6 . . .36	6SH7 . . .65	7R7 . . . .59	14C5 . . . .80	803 . . . .2.95
1R5 . . . .46	6BA6 . . .33	6SJ7 . . .54	7S7 . . . .85	14C7 . . . .65	814 . . . .3.50
1S4 . . . .40	6BA7 . . .57	6SK7GT .39	7V7 . . . .87	14E6 . . . .65	836 . . . .7.95
1S5 . . . .38	6BC5 . . .46	6SL7GT .49	7W7 . . . .94	19 . . . .35	866A . . . 1.45
1T4 . . . .46	6BE6 . . .37	6SN7GT .46			

Minimum Order: \$10.00. Terms: 25% with order balance C.O.D. Please include postage.

All prices subject to change without notice. F. O. B. New York City. Mail Order Division:

**TRANSAMERICA ELECTRONICS CORP.**

**115 Liberty Street New York 6, N. Y.**

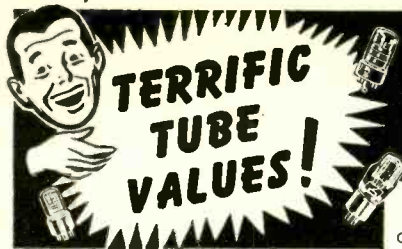

**TERRIFIC  
TUBE  
VALUES!**

**TOP QUALITY  
FULLY GUARANTEED TUBES  
BELOW MFRS' PRICES**

**THIS MONTH'S SPECIALS**

Our new policy brings you greater tube savings than you thought possible! As a GOODWILL offering, we are giving, each month, a number of popular tube types (listed below in extra bold) AT PRICES BELOW OUR OWN COST! Look for these terrific offers of different types each month, in industry-wide publications!

Type	Price	Type	Price	Type	Price
0A2	.89	5W4	.50	6J6	.49
0A3/VR75	.99	5X4	.50	6J7	.49
0A4G	.65	5Y3GT	.36	6J8G	.95
0B2	.74	<b>5Z3</b>	<b>.33</b>	6K8G	.65
0B3/VR90	.95	6A6	.47	6L5G	.79
0C3/VR105	.98	6A7	.82	6L7	.05
0D3/VR150	.89	6A8	.69	<b>6L7G</b>	<b>.39</b>
0Z4	.54	6A84	.49	6N7	.98
1A5GT	.39	6AB7	.75	6O7	.49
1A7	.49	6AC5GT	.99	6R7	.49
1AB5	.39	<b>6AC7</b>	<b>.69</b>	6S4	.42
1AX2	.61	6AF4	.89	6S7G	.59
<b>1B3</b>	<b>.59</b>	6AF6	.75	6SA7	.40
1D8GT	.77	6AG5	.46	6S7	.49
1G6GT	.77	6AG7	.95	6SD7GT	.38
1H5GT	.48	6AJ5	.89	6SF5	.45
1J6G	.59	<b>6AK5</b>	<b>.49</b>	6SF7	.59
1L4	.45	<b>6AL5</b>	<b>.29</b>	6SG7GT	.40
1L4A	.79	6AQ5	.37	6SH7	.60
1L6A	.79	6AR5	.39	6SH7GT	.50
1L84	.69	6AS5	.50	<b>6SJ7</b>	<b>.39</b>
1LC5	.79	6AT6	.37	6SK7	.40
1LC6	.79	6AU6	.40	6SL7GT	.49
1LD5	.77	6AV5	.79	6ST7	.79
1LE3	.78	6AV6	.37	6S07	.41
1LG5	.77	6AX4GT	.55	6SR7	.45
1LH4	.78	6B7	.95	6S77	.49
1LH5	.61	6B8	.88	6T8	.59
1N5	.59	<b>6B8G</b>	<b>.29</b>	6UG7	.45
1P5GT	.56	6BA6	.40	6U8	.59
1Q5GT	.57	6BA7	.56	6V6GT	.39
1R4	.89	6BC5	.49	<b>6W4GT</b>	<b>.39</b>
<b>1R5</b>	<b>.42</b>	6BD6	.44	6W6	.46
1S4	.58	6BE6	.37	6X4	.36
1S5	.42	6BG6	1.18	6X5GT	.36
1SA6	.48	6BH6	.45	6Y7	.79
1T4	.48	6BJ6	.42	6Z7G	.75
1U4	.48	6BK7	.95	7A5	.59
1U5	.48	6BN6	.79	7A6	.69
<b>1X2A</b>	<b>.55</b>	6BQ6	.79	7A7	.69
2A5	.95	6BQ7A	.88	7AD7	.95
2A6	.59	<b>6BZ7</b>	<b>.79</b>	7AG7	.55
2A5	.59	6C4	.37	7AH7	.56
2A6	.49	6C5	.39	7B4	.44
2A7	.64	6C6G	.57	7B5	.59
2B7	.62	6C8G	.85	7B6	.59
2X2	.39	6CB6	.45	7C4	.58
2X2A	1.15	6CD6	1.10	<b>7C5</b>	<b>.49</b>
3A4	.44	6D6	.69	7C7	.65
3A5	.93	6D8G	.98	7E5	.59
3A8	.60	6E5	.48		
3B7	.39	6F5	.39		
3D6	.39	6F6	.45		
3L74	.79	6F7	.93		
3Q4	.48	<b>6F8G</b>	<b>.69</b>		
3Q5GT	.55	6G6G	.65		
3S4	.48	6H6	.49		
3V4	.51	6J5	.40		
5T4	1.28				
5U4G	.53				

Type	Price
7F7	.65
7H7	.59
7J7	.75
7K7	.79
7L7	.59
7N7	.62
7O7	.61
7R7	.65
7S7	.85
7T7	.91
7W7	.85
7X7	.70
7Y4	.44
7Z4	.49
7Z7	.85
10Y	.69
12A6	.59
12AH7	.89
12AT6	.39
<b>12AT7</b>	<b>.55</b>
12AU6	.39
<b>12AU7</b>	<b>.49</b>
12AV6	.49
12AV7	.69
12AX4GT	.59
12AX7	.59
12AY7	.79
12BA6	.49
12BA7	.59
12BD6	.49
12BE6	.49
12B7	.59
12BY7	.65
12BZ7	.63
12C8	.34
12C8	.19
12F5GT	.35
12H6	.45
12J5GT	.39
12J7GT	.58
12K7	.58
12K7	.55
12K8	.58
12L8GT	.30
12Q7GT	.59

We specialize in TUBES—of every kind and description—serving the industry for years. More than 3000 different types in stock for IMMEDIATE DELIVERY—including hard-to-get and discontinued numbers. All tubes exhaustively tested in our fully equipped laboratories, and re-tested at time of shipment. FULL ONE-YEAR GUARANTEE. All tubes individually boxed and code-dated.

Type	Price	Type	Price	INDUSTRIAL	
12S8GT	.61	35C5	.37	Type <th>Price</th>	Price
12SA7GT	.64	35W4	.37	1B22	1.80
12SC7	.69	35Y4	.45	1B24	8.89
12SF5	.49	35Z3	.43	1B27	1.90
12SG7	.49	35Z5GT	.48	1B32	1.90
12SH7	.75	42	.42	1N23	1.95
12SJ7	.59	43	.55	2C40	6.95
12SK7GT	.62	46	.46	2C44	.89
12SL7GT	.48	49	.44	2D21	1.09
12SN7GT	.58	50S5	.44	2E26	26.95
12SQ7GT	.56	50C5	.44	3C24	1.75
12SR7	.49	50X6	.64	3C24	2.21
12T23	.39	50Y6GT	.59	3C24	1.75
14A4	.69	57	.55	307A	4.80
14A5	.59	58	.58	316A	2.50
14A7	.59	59	.49	325A	3.46
14B8	.65	71A	.54	325A	3.46
14C7	.69	77	.43	325A	3.46
14D7	.69	77	.43	325A	3.46
14E7	.69	78	.45	325A	3.46
14F7	.69	81	1.11	803	2.90
14G7	.69	82	.69	815	3.90
14H7	.69	83	.79	826	3.89
14I7	.69	84	.54	836	3.89
14J7	.69	85	.59	841	1.40
14K7	.69	86	.44	842	1.30
14L7	.69	87	.44	842	1.30
14M7	.69	88	.44	842	1.30
14N7	.69	89	.44	842	1.30
14O7	.69	90	.44	842	1.30
14P7	.69	91	.44	842	1.30
14Q7	.69	92	.44	842	1.30
14R7	.69	93	.44	842	1.30
14S7	.69	94	.44	842	1.30
14T7	.69	95	.44	842	1.30
14U7	.69	96	.44	842	1.30
14V7	.69	97	.44	842	1.30
14W7	.69	98	.44	842	1.30
14X7	.69	99	.44	842	1.30
14Y7	.69	100	.44	842	1.30
14Z7	.69	101	.44	842	1.30
15A7	.69	102	.44	842	1.30
15B7	.69	103	.44	842	1.30
15C7	.69	104	.44	842	1.30
15D7	.69	105	.44	842	1.30
15E7	.69	106	.44	842	1.30
15F7	.69	107	.44	842	1.30
15G7	.69	108	.44	842	1.30
15H7	.69	109	.44	842	1.30
15I7	.69	110	.44	842	1.30
15J7	.69	111	.44	842	1.30
15K7	.69	112	.44	842	1.30
15L7	.69	113	.44	842	1.30
15M7	.69	114	.44	842	1.30
15N7	.69	115	.44	842	1.30
15O7	.69	116	.44	842	1.30
15P7	.69	117	.44	842	1.30
15Q7	.69	118	.44	842	1.30
15R7	.69	119	.44	842	1.30
15S7	.69	120	.44	842	1.30
15T7	.69	121	.44	842	1.30
15U7	.69	122	.44	842	1.30
15V7	.69	123	.44	842	1.30
15W7	.69	124	.44	842	1.30
15X7	.69	125	.44	842	1.30
15Y7	.69	126	.44	842	1.30
15Z7	.69	127	.44	842	1.30
16A7	.69	128	.44	842	1.30
16B7	.69	129	.44	842	1.30
16C7	.69	130	.44	842	1.30
16D7	.69	131	.44	842	1.30
16E7	.69	132	.44	842	1.30
16F7	.69	133	.44	842	1.30
16G7	.69	134	.44	842	1.30
16H7	.69	135	.44	842	1.30
16I7	.69	136	.44	842	1.30
16J7	.69	137	.44	842	1.30
16K7	.69	138	.44	842	1.30
16L7	.69	139	.44	842	1.30
16M7	.69	140	.44	842	1.30
16N7	.69	141	.44	842	1.30
16O7	.69	142	.44	842	1.30
16P7	.69	143	.44	842	1.30
16Q7	.69	144	.44	842	1.30
16R7	.69	145	.44	842	1.30
16S7	.69	146	.44	842	1.30
16T7	.69	147	.44	842	1.30
16U7	.69	148	.44	842	1.30
16V7	.69	149	.44	842	1.30
16W7	.69	150	.44	842	1.30
16X7	.69	151	.44	842	1.30
16Y7	.69	152	.44	842	1.30
16Z7	.69	153	.44	842	1.30
17A7	.69	154	.44	842	1.30
17B7	.69	155	.44	842	1.30
17C7	.69	156	.44	842	1.30
17D7	.69	157	.44	842	1.30
17E7	.69	158	.44	842	1.30
17F7	.69	159	.44	842	1.30
17G7	.69	160	.44	842	1.30
17H7	.69	161	.44	842	1.30
17I7	.69	162	.44	842	1.30
17J7	.69	163	.44	842	1.30
17K7	.69	164	.44	842	1.30
17L7	.69	165	.44	842	1.30
17M7	.69	166	.44	842	1.30
17N7	.69	167	.44	842	1.30
17O7	.69	168	.44	842	1.30
17P7	.69	169	.44	842	1.30
17Q7	.69	170	.44	842	1.30
17R7	.69	171	.44	842	1.30
17S7	.69	172	.44	842	1.30
17T7	.69	173	.44	842	1.30
17U7	.69	174	.44	842	1.30
17V7	.69	175	.44	842	1.30
17W7	.69	176	.44	842	1.30
17X7	.69	177	.44	842	1.30
17Y7	.69	178	.44	842	1.30
17Z7	.69	179	.44	842	1.30
18A7	.69	180	.44	842	1.30
18B7	.69	181	.44	842	1.30
18C7	.69	182	.44	842	1.30
18D7	.69	183	.44	842	1.30
18E7	.69	184	.44	842	1.30
18F7	.69	185	.44	842	1.30
18G7	.69	186	.44	842	1.30
18H7	.69	187	.44	842	1.30
18I7	.69	188	.44	842	1.30
18J7	.69	189	.44	842	1.30
18K7	.69	190	.44	842	1.30
18L7	.69	191	.44	842	1.30
18M7	.69	192	.44	842	1.30
18N7	.69	193	.44	842	1.30
18O7	.69	194	.44	842	1.30
18P7	.69	195	.44	842	1.30
18Q7	.69	196	.44	842	1.30
18R7	.69	197	.44	842	1.30
18S7	.69	198	.44	842	1.30
18T7	.69	199	.44	842	1.30
18U7	.69	200	.44	842	1.30
18V7	.69	201	.44	842	1.30
18W7	.69	202	.44	842	1.30
18X7	.69	203	.44	842	1.30</

Any or all of these catalogs, bulletins, or periodicals are available to you on request direct to the manufacturers, whose addresses are listed at the end of each item. Use your letterhead—do not use postcards. To facilitate identification, mention the issue and page of RADIO-ELECTRONICS on which the item appears. All literature offers void after six months.

**SERVICE DATA AND SCHEMATICS**

Blonder-Tongue has issued a 16-page booklet giving complete service data and schematics and including a replacement parts price list.

The booklet is divided into sections giving hints for the installer, schematics, and information on the booster HA-3, "ultraverter" BTU-2, u.h.f. converter UC-1H, u.h.f. converter UC-1L, "amplivert" BTU-1, commercial "antensifier" CA-1, distribution amplifiers DA2-1 and DA8-1, mixer amplifier MA4-1, and channel strips CS-1H and CS-1L.

Available from Blonder-Tongue distributors or direct from Blonder-Tongue, Westfield, N. J., for 25 cents.

**RIDER'S 1954 CATALOG**

John F. Rider Publisher, Inc., announces the availability of its spring 1954 32-page book catalog. It gives a complete up-to-date listing of the latest Rider books, Rider Tek-File, and Rider manuals. Two just-issued books on color TV are described along with several other new books which will be available within the next few months.

Four pages have been reproduced from different Rider books giving information on some methods of i.f. marker injection, constructional details and design data for bass-reflex and labyrinth cabinets for various sizes of loudspeakers, intermediate amplifier reflections in tuner curves, and hum modulation on signals, which break up modulation. As new books are released additional pages will be made available for the catalog.

Free and available from distributors and bookstores, or direct from John F. Rider Publisher, Inc., 480 Canal Street, New York 13, N. Y.

**NEW HI-FI AND GENERAL CATALOGS**

Magnecord, Inc., has issued two new comprehensive catalogs. One is a general full-line catalog for professional use and the other is a complete catalog designed for the high-fidelity market.

The general catalog describes all professional equipment in detail, including the new M-80 push-button controlled full-range tape recorder and amplifier as well as the PT-6 and PT-63 series. It also gives the listing and specifications of the Magnecorder binaural recorder. All specifications for each type of recording mechanism and each available amplifier are given in a comparative chart.

Copies of these catalogs may be obtained by writing directly to Magnecord, Inc., 225 West Ohio Street, Chicago 10, Ill.

JUNE, 1954

**TV AND RADIO TROUBLESHOOTING**

Radio Corporation of America has issued a new 20-page booklet, Form No. 2F785, written by John R. Meagher. It describes the latest troubleshooting techniques and many new applications for an r.f. signal generator. The booklet is generously illustrated with easy-to-read diagrams.

Available free from RCA test equipment distributors.

**TORODIAL COILS**

Burnell & Co. has announced a new 16-page catalog, No. 102A, introducing their new line of subminiature torodial coils and torodial coil meters. It also includes valuable and complete information on toroids, high-quality coils, and various audio filter networks.

Obtainable from Burnell & Co., Yonkers 2, N. Y.

**TEST AND MEASURING EQUIPMENT**

The Clough-Brengle test equipment line is presented in a 12-page catalog, No. 54-A, with complete specifications and data. Among the models listed in the catalog are: Model 603 i.f. sweep generator; models 179A and 405 beat-frequency oscillators; models 182-A and 282-A audiomatic generators; model 217 H transmission measuring set; models 299A and 552 r.f. signal generators; model 712 capacitance-resistance-inductance bridge; and model 411 extended-range audio oscillator.

Available upon request from The Clough-Brengle Co., Dept. RZ, 6014 Broadway, Chicago 40, Ill.

**RADIO, TV, ELECTRONICS CATALOG**

Burstein-Applebee has issued its annual catalog, No. 541, on radio, television, and electronic equipment for dealers, service technicians, amateurs, engineers, and experimenters.

Illustrations, full descriptions, and prices of all the equipment are given.

Available free from Burstein-Applebee Co., 1012-14 McGee Street, Kansas City, Mo.

**CROSS-REFERENCE GUIDE**

P. R. Mallory & Co., Inc., has issued a 28-page cross-reference guide for capacitors, controls, selenium rectifiers, and vibrators, which covers radio and television components through the use of manufacturers' part numbers.

The guide is separated into four sections and provides a cross-reference for dry-electrolytic capacitors, television and radio controls (including carbon and wire-wound single-section controls, universal-section and preassembled dual controls, and L and T pads), radio and television selenium-rectifier stacks, and communications and auto radio vibrators.

The part numbers of each section of the guide are in alphabetical-numerical sequence.

Copies of the guide may be obtained through Mallory distributors or direct from P. R. Mallory & Co., Inc., Distributor Division, P. O. Box 1559, Indianapolis, Ind.

END

**LOOK at these STEVE-EL "Steals"**

Very limited quantity!  
First come, first served!

**SONORA 3-SPEED RADIO-PHONO**

Famous "Clear As A Bell" radio and 33 1/3, 45, 78 RPM phono. Maroon plastic cabinet.

Each \$24.91



Only \$23.99 lots of 3

**SONORA 3-WAY PORTABLE RADIO**

Sturdy plastic case in maroon or green. Uses 90 V and 4 1/2 V batteries. Excellent reception.

Each \$21.49

Batteries for above \$2.84



Only \$19.99 lots of 3

Write Dept. RE-6 for latest STEVE-EL SUPER-VALUE catalog. Hundreds of values.

FREE! →

**STEVE-EL Electronics Corp.**

61 Reade St.

New York 7, N. Y.

**SAVE MONEY ON INSTRUMENTS!**

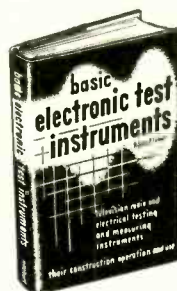

How to test better with fewer instruments . . .

How to use old instruments in new ways . . .

How to select the instruments you need . . .

How to evaluate instrument readings and put them to practical use.

**BASIC ELECTRONIC TEST INSTRUMENTS**

by Rufus P. Turner

254 pages, 171 illus., Price \$4.00

Written especially for servicemen, amateurs and experimenters, this new book is a complete training course in instruments. Over 60 instruments—from the most modern TV pattern generators to grid-dip oscillators and special-purpose bridges—are fully explained. Work-saving short cuts are outlined. You learn how to put your old instruments to new uses and thus avoid buying costly new ones. Tells all about current and voltage meters; ohm-meters and V-O-M's; V-T voltmeters; power meters; oscilloscopes; r-f test oscillators; signal tracers; tube testers; TV linearity pattern generators; sweep and marker generators; square-wave generators; distortion meters and dozens more.

**READ IT 10 DAYS . . . at our risk**

Dept. RE-64, Rinehart & Co., Inc.  
232 Madison Ave., New York 16, N.Y.

Send Turner's BASIC ELECTRONIC TEST INSTRUMENTS for 10-day examination. If I decide to keep book, I will then remit \$4.00 plus postage in full payment. Otherwise, I will return book postpaid and owe you nothing.

Name .....

Address .....

City, Zone, State .....

## RADELCO HI-CHANNEL BROAD BAND YAGI

*Gives Clearer,  
Brighter*

**TV PICTURES  
ON ALL 7  
HIGH BAND  
VHF CHANNELS**



Ideal for areas having two or more high channel stations. Completely preassembled.

LIST

**\$10<sup>20</sup>**

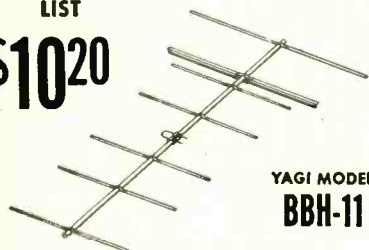

YAGI MODEL  
BBH-11

ORDER FROM YOUR  
NEAREST PARTS JOBBER

## TEST EQUIPMENT REPAIRS

Our ALL NEW MODERN LABORATORY is equipped to handle courteously, quickly, and accurately the Repair and Recalibration of all Meters, V.O.M.s., V.T.V.M.s., Signal Generators, Signal Tracers, Oscilloscopes, etc.

All Work is Unconditionally Guaranteed

Your Testers that have been "BENCHED" can now be put to use with our service. Send units via Parcel Post or Prepaid Express for prompt service.

Write for Catalogue of New Test Equipment

**GENERAL ELECTRONIC  
DISTRIBUTING CO.**

Dept. RE-6, 98 Park Place, New York 7, N. Y.

## EASY TO LEARN CODE

It is easy to learn or increase speed with an Instructograph Code Teacher. Affords the quickest and most practical method yet developed. For beginners or advanced students. Available tapes for beginner's alphabet to typical messages on all subjects. Speed ranges 5 to 40 WPM. Always ready—no QRM.

ENDORSED BY THOUSANDS!

The Instructograph Code Teacher literally takes the place of an operator-instructor and enables anyone to learn and master code without further assistance. Thousands of successful operators have "acquired the code" with the Instructograph System. Write today for convenient rental and purchase plans.



**INSTRUCTOGRAPH COMPANY**

4701 Sheridan Rd., Dept. RC, Chicago 40, Ill.

**RADIO CONTROL for MODEL SHIPS, BOATS and AIRCRAFT**, by F. C. Judd, G2BCX. Published by Data Publications, Ltd., 57 Maida Vale, London W.9. Obtainable in U.S.A. through Gilfer Enterprises, Box 239, Grand Central Station, New York 17, N. Y. 5½ x 8½ inches, 144 pages. Price \$1.25 (cloth bound \$1.75).

The union of mechanical ability and electronic knowledge sometimes has all the earmarks of a shotgun wedding. The boys who do wonders with pinions, gears, and cams usually look askance at electronic circuits. Those who know radio often regard mechanisms with an awe approaching mystification. Yet these two widely different techniques, one electrical, the other mechanical, have been carefully joined by Mr. Judd in a well-illustrated, meticulously prepared book.

Mr. Judd makes no assumptions. He takes the mechanically-minded and the electronically minded in hand, and carefully guides them through basic concepts, radio components, transmitters and receivers for radio control, servo-mechanisms, and antennas.

Here is one way in which you can fly, yet keep both feet on the ground, operate a boat with no chance for seasickness. This is an enjoyable introduction to a fabulous, mature hobby. —MC

**TELEVISION SERVICING, Second Edition**, by Walter H. Buchsbaum. Published by Prentice-Hall, Inc., 70 Fifth Ave., New York 11, N. Y. 6 x 9 inches, 367 pages. Price \$5.95.

This revised version to *Television Servicing* is an attempt to integrate recent advances in television receivers, antennas, and transmission lines with the material covered in the first edition. As might be expected, most of the new material deals with u.h.f. and a chapter on color TV. With most of the book covering alignment, installation, and trouble-shooting, the book is obviously aimed at the service technician. It is written at an elementary level, resorting to no mathematics.

The general television theory presented in the first part of the book covers each section of the television receiver with a minimum of information necessary for servicing. The author's straightforward style makes for very easy reading. However, in an attempt at simplification, certain technical errors appear. For instance (page 304), "Observe the shape of the vertical synchronizing pulses by setting the 'scope sweep frequency to *about 120 c.p.s. and synchronize it so that two complete frames appear on the 'scope.*" (Italics are ours.) Also, on page 115 the author states that in a stagger-tuned i.f. system, varying the bias on one of the i.f. stages would vary the response curve of the i.f. system. Actually, the frequency response of such an i.f. stage is not affected by its gain.

(Mr. Buchsbaum is by no means alone in falling into that particular error, as witness the correspondence which appears on page 14 of this issue.—Editor)

The author's treatment of u.h.f. is the finest part of the book. He has

accomplished the not-so-easy task of weaving practical u.h.f. theory at just the right place and to just the right extent to be most beneficial to the service technician.—JK

**INTRODUCTORY CIRCUIT THEORY** by Ernest A. Guillemin. Published by John Wiley & Sons, Inc., New York, N. Y. 6 x 9¼ inches, 545 pages. Price \$8.50.

Many authors strive for a book that doubles as a study text and a reference work, and sometimes fail on both counts. This well-known authority has planned and successfully prepared a text that *teaches*, as well as expounds, network fundamentals. It is not an easy text. Written at college sophomore level, it does provide all the basic theory for student engineers and physicists. It is a complete volume for a serious student.

Material is arranged in logical sequence and is fed at an optimum rate. First chapters deal with network geometry and Kirchoff's laws, with various ways of choosing correct circuit equations. Methods of solving then follow. In working out examples here (and all through the book) the author wants to make sure that the student is learning how to handle practical equations and is not wasting energy on arithmetic practice. Thus we find circuits with components like 2 farads, 1 volt, 3 ohms, 4 amperes.

More advanced chapters discuss effects of pulse and step functions, duals, sinusoids, vectors. Energy and power, mutual inductance, steady-state and transient behavior appear later in the volume. The tenth and last chapter gives general forms for various circuit equations.—IQ

**HIGHLIGHTS OF COLOR TELEVISION**, by John R. Locke, Jr., 5 x 8 inches, 48 pages. Price 99¢. **INTRODUCTION TO COLOR TV**, by M. Kaufman and H. Thomas, 5 x 8 inches, 144 pages. Price \$2.10. Published by John F. Rider Publisher, Inc., 480 Canal St., New York 13, N. Y.

Authors Kaufman and Thomas do a highly creditable job in their Introduction to Color TV. Except for minor lapses into engineerese, they write for the purpose of teaching in such a way that the reader understands and learns. This is indeed a radical approach.

Answering numerous questions and problems posed by color TV, Introduction to Color TV lives up to its title. It furnishes a good foundation on which to build your color TV house of knowledge.

Apparently written for an extremely limited audience, Highlights of Color Television seems to have been produced for those who already have a thorough knowledge of this subject. Within a space of only 43 actual text pages the author tries (in extremely involved language) to describe colorimetry, the NTSC color signal, color transmitter, receiver and picture tubes. This book is to television what a vitamin pill is to the human system. Sustaining, but not filling.—MC

END

RADIO-ELECTRONICS

**MORE JOBS than graduates**

**Electronic Engineers**  
Excellent opportunity for professional growth and advancement in a growing industry.

Demand for our engineering graduates exceeds supply. *Effective placement.* Study in this world-famed college established 1884. Quarters start June, Sept., Jan., March. *Approved for Korean Vets.*

**Bach. Sc. degree in 27 months**

Complete Radio Eng. courses . . . TV, UHF and FM. Also Mech., Civil, Elec., Chem., Aero. and Adm. Eng.; Bus. Adm., Acct. Small classes. Well-equipped labs. Modest costs. Prep. courses. Write *Jean McCarthy, Director of Admissions, for Catalog and Campus View Book.*



**TRI-STATE COLLEGE**

2464 College Avenue, Angola, Indiana

**GET INTO ELECTRONICS**

You can enter this uncrowded, interesting field. Defense expansion, new developments demand trained specialists. Study all phases radio & electronics theory and practice: TV, FM, broadcasting, servicing, aviation, marine, police radio. 14-month course. Graduates in demand by major companies. U.S. or equivalent required. Begin Jan., March, June, Sept. Campus life. *Write for catalog.*  
**VALPARAISO TECHNICAL INSTITUTE**  
Dept. C Valparaiso, Ind.



**RCA INSTITUTES, INC.**

A service of Radio Corporation of America  
350 West 4th St., New York 14, N. Y.

**OFFERS COURSES IN ALL TECHNICAL PHASES OF RADIO, TELEVISION, ELECTRONICS**

Approved for Veterans  
Write Dept. RC-54 for Catalog

**GET INTO TV SERVICE**

Send for free 24-page illustrated booklet which tells you how to become a successful TV technician. America's leading TV servicing school offers you a specialized training program that omits non-essential math & design theory. You concentrate on radio & TV servicing only. You get professional training & experience right in our fully-equipped shops & laboratories. Send for this booklet today. Write Dept. E-64. No obligation—no salesman will call.  
Approved for Veterans

**WESTERN TELEVISION INSTITUTE**  
341 W. 18th St. Los Angeles 15, Calif.

**RADIO SCHOOL DIRECTORY**



**TV REPAIRMEN MAKE TOP MONEY**

In just 39 weeks, you can get complete TV service training! Streamlined course gives you all essentials for a good job as service technician. Graduates in great demand; jobs are plentiful in this growing field. Other courses, in electronics, radio operation and maintenance. Day or evening classes; modern equipment. Opportunity for employment in local industry.

*Write for Catalog 111 Today*

**INDIANAPOLIS ELECTRONIC SCHOOL**  
312 E. Washington, Indianapolis 4, Ind.

**Get Your F.C.C. LICENSE Quickly!**

Correspondence or residence preparation for F.C.C. examinations. Results guaranteed.

An FCC commercial operator license means greater opportunities and higher pay. We are specialists in preparing you, in a MINIMUM OF TIME, to pass FCC examinations for all classes of licenses. Beginners get 2nd class license in 5 weeks and 1st class in 3 additional weeks. Write for free booklet.

**GRANTHAM SCHOOL OF ELECTRONICS**  
Dept. 101, 6064 Hollywood Blvd., Hollywood 28, Calif.

**RADIO ENGINEERING DEGREE IN 27 MONTHS**

Intensive, specialized course including strong basis in mathematics and electrical engineering, advanced radio theory and design, television. Modern lab. Low tuition. Self-help opportunities. Also B.S. degree in 27 months in Aeronautical, Chemical, Civil, Electrical, and Mechanical Engineering. G.I. Gov't approved. Enter June, September, December, March. Catalog

**INDIANA TECHNICAL COLLEGE**

1564 E. Washington Blvd., Fort Wayne 2, Indiana

**CODE SENDING SPEED**  
**CODE RECEIVING SPEED**

Be a "key" man. Learn how to send and receive messages in code by telegraph and radio. Commerce needs thousands of men for jobs. Good pay, adventure, interesting work. Learn at home quickly through famous Candler System. Quality for Amateur or Commercial License. Write for FREE BOOK.  
**CANDLER SYSTEM CO.**  
Dept. 3-G, Box 928, Denver 1, Colo, U.S.A.

You Can Become an  
**ELECTRICAL ENGINEER**  
with a Bachelor of Science Degree  
**IN 36 MONTHS**

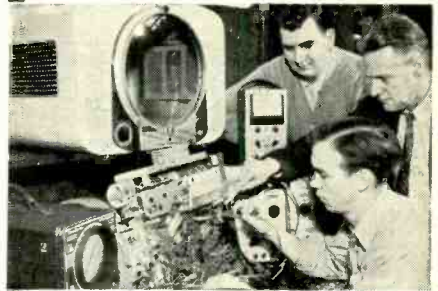

Major in Electronics or Power at  
**Milwaukee School of Engineering**

Everyone knows the tremendous opportunities ahead in electrical engineering. The expanding field of color television alone is one example. In addition to the demand for engineers, thousands of engineering technicians are needed. The Milwaukee School of Engineering can prepare you to become an engineer in 36 months or an engineering technician in 12 to 18 months. It'll pay you to look into it today. No obligation.

**Technician and Service Courses — 12 to 18 months**

In 12 months you can be a radio technician. An additional 6-month course qualifies you as a radio-television technician with an Associate in Applied Science degree. Or you can earn an industrial electronic technician certificate in 12 months.

These technician courses form the first third of the program leading to a B.S. Degree in Electrical Engineering. Twenty-one subjects studied include electronics, electronic engineering, and electronic design.

Also offered are: radio-television service course (12 mos.); electrical service course (6 mos.); general preparatory and refresher course (3 mos.).



Terms open  
**July, September, January and April**

Faculty of specialists — 50,000 former students — Annual enrollment from 48 states and 23 foreign countries — Non-profit institution — 51st year of service — Course approved for veterans — Residence courses only.

**MILWAUKEE SCHOOL OF ENGINEERING**

TEAR OUT AND MAIL TODAY

MILWAUKEE SCHOOL OF ENGINEERING  
Dept. RE-654, 1025 N. Milwaukee Street  
Milwaukee 1, Wisconsin

Send me  Free illustrated booklet on opportunities in Electrical Engineering or  Free illustrated booklet on careers in Radio-TV.

I am interested in \_\_\_\_\_ (name of course)

Name \_\_\_\_\_ Age \_\_\_\_\_

Address \_\_\_\_\_

City \_\_\_\_\_ Zone \_\_\_\_\_ State \_\_\_\_\_

If veteran, indicate date of discharge \_\_\_\_\_

**exact duplication**



It Pays To Replace With...

**ROGERS TV DEFLECTION COMPONENTS**

"the eye tells why"

**Original Equipment**

on Better TV Sets

For complete customer satisfaction . . . replace with Rogers Deflection Yokes and Flybacks. They're original equipment on most TV sets . . . so replacement with Rogers mean exact duplication.



DEFLECTION YOKES

Assure double brilliance with knife-edge sharpness. Designed for peak performance and extra long life.

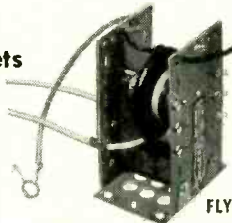

FLYBACKS

Higher voltage insulation, greater efficiency and higher voltage.

In Attractive . . . Individual Packages

**ROGERS**

**ELECTRONIC CORP.**

43-49 Bleecker St. • New York 12, N. Y.

**FREE**  
Send for new catalog "A" listing TV set models and ROGERS Yoke and Flyback replacements or see your jobber.



**THE NEW  
PRECISION  
MODEL 120**

**GIVES YOU WHAT YOU WANTED  
IN A  
HIGH SENSITIVITY  
MULTI-RANGE TEST SET**

**20,000 OHMS PER VOLT D.C.  
5,000 OHMS PER VOLT A.C.**

*The '120' gives you . . .*

- ✓ MORE RANGES
- ✓ AN EXTRA-LOW RESISTANCE RANGE
- ✓ AN EXTRA-LOW VOLTAGE RANGE
- ✓ AN EXTENDED LOW CURRENT RANGE
- ✓ A LARGER METER SCALE FACE
- ✓ SIMPLE, POSITIVE RANGE SELECTION
- ✓ POSITIVE CONTACT JACKS and PLUGS

**Compare These Wide Spread Ranges  
and Special Features:**

- ★ **8 DC VOLTAGE RANGES:** 20,000 ohms per volt.
- ★ **8 AC VOLTAGE RANGES:** 5,000 ohms per volt. 0-1.2-3-12-60-300-600-1200-6000 volts.
- ★ **8 AC OUTPUT RANGES:** same as AC volt ranges. Built-in 600 volt blocking capacitor.
- ★ **7 DC CURRENT RANGES:** 0-60-300 Microamperes. 0-1.2-12-120-600 Ma. 0-12 Amperes.
- ★ **5 RESISTANCE RANGES:** self-contained. 0-200-2000-200,000 ohms. 0-2-20 megohms.
- ★ **8 DECIBEL RANGES:** -20 DB to +77DB. 0 DB = 1 Milliwatt, 600 ohms.
- ★ **EXTRA LARGE 5 1/4" RUGGED 'PACE' METER:** 40 microamperes sensitivity, 2% accuracy.
- ★ **1% MULTIPLIERS and SHUNTS:** Wire-wound and deposited film types.
- ★ **TWO JACKS SERVE ALL STANDARD RANGES:** Separately identified and isolated jacks provide for extra high ranges.
- ★ **"TRANSIT" SAFETY POSITION** on range selector protects meter during transport and storage.
- ★ **CUSTOM-MOLDED PHENOLIC CASE and PANEL:** Compact, laboratory styled instrument.

MODEL 120...complete with internal ohmmeter batteries, banana-plug test leads and detailed operating manual. Overall case dimensions, 5 3/4 x 7 x 3 1/8" **Net Price \$39.95**

**PRECISION APPARATUS CO., INC.**  
92-27 Horace Harding Blvd., Elmhurst, L. I., N. Y.

Export: 458 Broadway, New York 13, U. S. A.  
Canada: Atlas Radio Corp., Ltd., 560 King St. W., Toronto, 2B

**ADVERTISING INDEX**

Radio-Electronics does not assume responsibility for any errors appearing in the index below.

All Channel Antenna Corp.	105
Allied Radio Corp.	17
American Microphone Co.	98
American Phenolic Corp.	94
American Television and Radio Co.	95
Amplifier Corporation of America	118
Arkay Radio Kits, Inc.	117
Astatic Corp.	14
Atlas Sound Corp.	87
Audel Publishers	92
Barry Electronics Corp.	128
Belden Manufacturing Co.	29
Bell Telephone Labs.	12
Brooks Radio & TV Corp.	99
Bruno-New Jersey, Inc.	86
CBS Hytron (Division of Columbia Broadcasting System)	25
Capitol Radio Engineering Institute	101
Ceco Electronics Co.	105
Centralab—Division of Globe Union	24, 80, 116
Century Electronics Co.	117
Channel Master Corp.	27
Chicago Standard Transformer Corp.	115
Ciarostat Manufacturing Co.	103
Cleveland Institute of Radio Electronics	9
Collins Audio Products Co., Inc.	16
Commissioned Electronics	104
Concord Radio	7
Coyne Electrical & TV Radio School	96, 109, 117
Decray, Frank W.	98
Delco Radio (Division of General Motors Corp.)	28
Derr Co., Clondy, Inc.	117
DeVry Technical Institute	102
Edie Electronics	102
Electric Sweeper Service Co.	82
Electro Products Labs., Inc.	81
Electro-Voice, Inc.	8
Electron Tube Wholesalers, Inc.	124
Electronic Instrument Co. (EICO)	30, 92, 114
Electronic Measurements Corp.	107
Erie Resistor Corp.	87
Fenton Co.	93
G & H Wood Products Co.	86
General Electronic Distributing Co.	126
General Industries Co.	90
General Test Equipment	117
Haldorson Transformer Co.	10
Harjo Sales Co.	98
Heath Co.	71-74
Hershel Radio Co.	117
Hudson Specialties Co.	95
Hughes Research & Development Labs.	304
Indiana Technical College	122
Instructograph Co.	126
International Correspondence Schools	11
International Rectifier Corp.	119
Jensen Industries	96
Krylon, Inc.	82
Lafayette Radio	114
Leotone Radio Corp.	118
McGraw-Hill Book Co.	100
Mallory & Co. Inc., P. R.	85
Maxims Radio Sales & Service Co., Inc.	96
Moss Electronic Distributing Co.	88, 89
National Electronics of Cleveland	100
National Radio Institute	3
National Schools	5
Opportunity Radio	112
Oradio Industries, Inc.	97
Oxford Electric Co.	24
Permotlux Corp.	18
Philk Corp.	113
Precise Development Corp.	86, 87
Precision Apparatus Co., Inc.	90, 128
Precision Electronics	96
Progressive "Edu-Kits", Inc.	108
Pyramid Electric Co.	19
Pyramid Supply Co.	104
RCA Institutes, Inc.	21
RCA Victor Division (Radio Corporation of America)	Back Cover
Rad-Tel Tube Co.	129
Radelco Manufacturing Co.	126
Radiart Corp.	77
Candler System Co.	
Grantham School of Electronics	
Indiana Technical College	
Indianapolis Electronic School	
Milwaukee School of Engineering	
RCA Institute, Inc.	
Tri-State College	
Valparaiso Technical Institute	
Western Television Institute	
Radio Television Training Ass'n	17
Raytheon Manufacturing Co.	15
Rider, Inc., John F.	76
Rinehart & Co., Inc.	84, 125
Rogers Electronic Corp.	127
Sams & Co., Inc., Howard W.	26, 82
Service Instruments Co.	111
Sprague Products Co.	98
Sprayberry Academy of Radio	99
Stan-Burn Radio & Electronics	122
Steve-El Electronics Corp.	125
Stuart Electronic Distributing Co.	81
Superior Instrument Co.	84
Sylvania Electric Products	23
Tab	130
Technical Appliance Co.	Inside Front Cover
Television Communications Institute	97
Teltron Electric Co.	92
Terraco	26
Transmeris Electronics	123
Transvision, Inc.	120, 121
Trio Manufacturing Co.	91
Triplet Electrical Instrument Co.	Inside Back Cover
Tung-Sol Electric Co.	6
Ultra Audio Broadcasting	110
U. S. Crystals, Inc.	120
V.A. Enterprises	100
Windsor Electronic Tube Co.	112
Winegard Co.	22
Workman TV	115
Xcelite Inc.	114
Zingo Products	114

**RADIO SCHOOL DIRECTORY  
PAGE 127**

**FIVE TOP NAME BRANDS**



**STANDARD BRAND  
TUBES**

*at Sensational  
Savings!*

**TOP  
QUALITY  
FIRST  
LINE**

**FULLY GUARANTEED  
INDIVIDUALLY BOXED**

NO SECONDS . . . NO REMASHED "BARGAINS" . . .  
NO REACTIVATED TUBES. YOU CAN PLACE YOUR  
CONFIDENCE IN OUR DEPENDABLE NEW TUBES.

Tube Orders Over \$25.00, with full  
remittance, PREPAID to you in U.S.A.

**RECEIVING TUBES**

Type	Net	Type	Net	Type	Net
0A2	.98	6AK5GT	1.25	7C4	.78
0B2	.85	6B8	.75	7C5	.29
0B3 VR90	.82	6B8A	.70	7C5	.69
0C4 VR105	.91	6C6	.84	7E5	.39
0D3 VR150.89	.89	6B8E	.72	7F7	.85
0Z4 0Z4A	.55	6B8GG	1.8	7F8G	1.55
1A7GT	.77	6B8K	.85	7H7	1.20
1B3GT	.90	6B8J	.85	7N7	1.20
1B27	11.50	6B8K5	.95	7Q7	.98
1A5GT	.77	6B8K7A	1.50	7H7GT	.90
1L4	.60	6B8L7GT	1.20	12AT6	.90
1L6	.95	6B8N	1.20	12AT7	1.05
1L6G	1.10	6B8GGT	1.27	12AU7	.84
1L84	1.10	6B87A	1.23	12B7G	.55
1L85	1.10	6B87GT	1.25	12AV7	1.00
1N5GT	.95	6B75G	1.75	12AW6	.88
1R4	.75	6B7A	1.28	12AX4	.90
1R5	.75	6C4	.56	12AX7	.80
1S5	.75	6C6	.50	12AY7	1.75
1T4	.70	6C6B	.60	12B7	.92
1U4	.75	6CD6G	1.80	12BA	.98
1V	1.03	6CL6	1.10	12BA6	.70
1V2	.90	6CL6B	1.10	12BD6	.75
1X2B	.90	6D6	.75	12BE6	.72
1Z2	3.25	6F4	3.50	12BH7	1.00
2X2	.55	6F5	.80	12C7	1.05
3A4	.59	6F5GT	.68	12BZ7	1.10
3B7	.39	6F6	.70	12SA7	.69
3Q4	.89	6F6G	.60	12S7	.70
3Q5GT	.90	6F8G	.85	12SG7	.80
3L4	.75	6G6G	.85	12SH7	.83
3V4	.90	6B7	.75	12SK7	.69
5W4	1.75	6J5	.55	12SL7GT	.65
5R4G	1.50	6J5A	.80	12ST7GT	.80
5U4G	.59	6J7	.75	12SQ7GT	.83
5B7	.97	6K6GT	.65	12SR7	.69
5W4G	.80	6K7A	1.10	12A7GT	1.10
5X4G	.75	6L6G	1.10	14F7	.70
5Y4G	.48	6L6GA	1.10	19B6GG	2.05
6A8GT	1.10	6L6M	1.20	19R7B	1.10
6AB4	.70	6L6M	.80	25B8GGT	1.70
6AR5	.95	6N7M	.70	25L6GT	.70
6AC7	1.14	6Q7GT	.80	25W4GT	.70
6AD7G	1.85	6S7M	.98	25Z6GT	.64
6AR5	1.39	6S7	.69	8A6	1.75
6AG3	.78	6S7GT	.68	28A7GT	.72
6AG7	1.10	6SD7GT	.80	26C6	1.25
6AH5GT	.83	6S7G	.66	26D6	1.75
6AJ5	1.30	6SH7	.65	28B7	1.25
6AK5-W	1.50	6S7J	.65	35A5	.72
6AK6	.98	6SK7	.69	35B5	.70
6AL5	.60	6SL7GT	.65	35C5	.72
6AN4	1.60	6SN7GT	.79	35L6GT	.70
6AN5	3.65	6SQ7	.63	35W4	.45
6AQ5	.72	6S8	.99	35Z3	.70
6A06	.73	6UB	1.35	35Z5GT	.50
6A55	.75	6V3	1.30	50A5	1.75
6A55G	2.65	6V6GT	.67	50B5	.72
6AT6	.58	6W4GT	.65	50C5	.72
6AU4GT	1.00	6W6GT	.82	50L6GT	.70
6AUSGT	1.15	6X8	1.00	81	.75
6AU6	.65	7A7	.75	83V	1.15
6AV5GT	1.10	7B8	.69	84/6Z4	.65
6AV6	.57	7B8	.75	11Z7G	.75
6AX4GT	.84	7B7	.76	11Z7E	1.00

**SPECIAL PURPOSE TUBES**

1N21B	1.88	211-VT4C	.88	1616	.85
1N23B	2.20	304TH	1.80	1619	.90
1N36A	.75	(Surplus) 7.75	1622	1.30	
1N54	.75	304TL	1.625	1625	.30
2C51	4.85	(Surplus) 8.75	1626	.20	
2E26	2.20	310A(WE)	3.75	1629	.25
2E30	2.20	407A(WE)	4.95	2050	1.40
2J39	12.50	408A(WE)	3.00	5516	7.65
2J41	29.50	416A(WE)	6.50	6254	1.75
2J62	25.00	803	write	656	10.00
2K28	25.00	805	3.25	4670	3.35
3B2B	4.95	807	2.95	5687	2.95
3C23 (GE)	6.75	807	1.55	5691	7.00
3C24/24G1.00	809	809	3.50	5693	6.20
4B2	4.50	812A	1.35	5814	1.75
5C22	44.95	816	1.40	6096	1.85
5D21	11.90	830B	2.75	9003	1.45
7C25	110.00	872A (GE)	5.2	9004	.30
7C30	85.00	955	.45	9006	.25

Above is only a partial listing of our huge stock. Types not listed may be ordered at approx. the same savings. Many new special purpose types in stock.

**DELUXE TUBE CADDY**

This newly designed Tube Caddy is lightweight and compact. 16 3/4 x 8 3/4 x 1 3/4". Ruggedly constructed, retainer and trough. Holds approx. 150 tubes plus meters and tools. **SPECIAL AT \$12.95**

**TWO-COLORED TUBE CARTONS**, with new Safety Partitions, Prevents Tube Breakage. This Super-Glass Red and Black Carton is the Most Distinctive Box Available Today! Minimum: 100 any one size. Quantity prices on request.

**SIZE** Miniature . . . (6AU6, 6AL5, etc.) . . . \$ .01  
GT . . . (6SN7, 6W4, etc.) . . . . .0125  
LARGE GT. (1B3, 6B8GGT, etc.) . . . . .015  
LARGE G. (5U4G, 6B8GG, etc.) . . . . .02

Terms: 25% with Order, balance C.O.D.  
Minimum Order \$5.00  
All Merchandise guaranteed. F.O.B. NYC.  
Phone: Rector 2-2562

**BARRY ELECTRONICS  
CORP.**  
136-B LIBERTY ST. N. Y. 6, N. Y.



# Compare! Save!.. on RAD-TEL TUBES and PARTS!

**SAME DAY SERVICE . . . OVER 300 TYPES IN STOCK AT ALL TIMES!**

## 70% to 90% OFF on TUBES INDIVIDUALLY FULL YEAR GUARANTEE! BOXED

### Philco TV BOOSTER

Made by PHILCO, famed for quality and precision communications equipment. Completely self-contained. Includes 2 tubes . . . 1 for High Channels and 1 for Low Channels and selenium rectifier plastic cabinet. In factory-sealed cartons, complete with instructions.

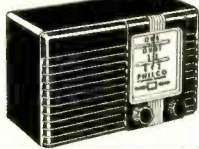

**10<sup>95</sup>**  
Ea.  
In Lots of 3  
\$9.95

### Granco "Star" UHF-CONVERTER

Brand new! Latest model! Unit is highly engineered, receives all UHF channels. Coaxial tuned cavity elements complete with 6AF4 oscillator, 6CB6 I-F and crystal mixer. Shipped ready to install and operate. List Price \$29.95.



**22.45**  
The luxe model Five Star UHF Converter. Pres-selector N82-6B07 exciter and 6AF4 oscillator. List price \$39.95.  
**\$29.97**

### STANDARD BOOSTER

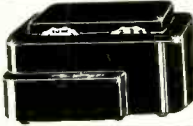

L channel RF Amplifier with self-contained AC power supply. Handsome plastic cabinet. List price \$23.00.

Each **6.95** Lots of 3 **6.45**

### SELENIUM RECTIFIERS

Mfd. by FEDERAL

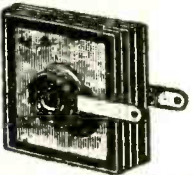

MA	PRICE
65	59c
75	69c
100	79c
150	84c
200	1.25
250-1010A	1.75
250-1028A	1.75
300	1.39
350-1238A	1.59
350-1023A	1.59
400	1.50
500	1.90

### UNIVERSAL FLYBACK

High efficiency FERITE core horizontal transformer supplies 14,000 Volts. For all 65" to 70" kinescopes. Famous Type. In constant demand. List price \$11.50

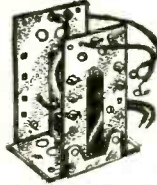

**1.95** each  
Lots of 3 **1.85** each

### CATHODE RAY TUBE REJUVENATOR

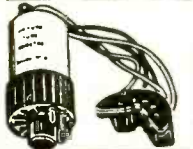

Fits all makes of picture tubes. Completely automatic. Easy to install, no tools needed. For A.C. parallel circuits. Your Old Picture Tubes Are Still Useful. List price—\$5.95.

Lots of 10 **1.09** each  
Lots of 3 **1.39** each

### All New Parts At Old Fashioned SAVINGS!

#### VOLUME CONTROL KIT



Kits of 10 includes wire-wound, dual and carbon. The price of one (1) for the quantity of ten (10), short and long shaft. Lots of 3 Kits **1.59** Ea. **1.79** PER KIT

#### WEN SOLDERING GUN



3 seconds on 120 Volt AC readies it for any soldering requirement. 250 Watt size. Also cuts plastic tile with special tip. Multi-useful! U.I. Approved. Built in spot light. **9.71** Each. List price—\$12.95. Lots of 3 **8.64** Each. TIPS: Peralloy Long Life . . . 35c ea. Standard Tip . . . 11c ea.

#### Famous Make—Giant 21" Picture



Giant 21" self-focusing picture tube. Famous STANDARD Cascade tuner. Fine tuning adjustment for fringe areas. Cabinet hand rubbed to a smooth glossy finish. Beautiful furniture piece, compact size fits standard size desk or table. Rich gold finish trim. Mahogany or blond. Wt. 100 lbs.

#### TABLE MODEL TV

Lots of 3 **144.50** each Available with all channel tuner. Tunes any 12 VHF and 70 UHF station channels. Order No. 46U. Slight additional charge. Lots of 3 **139.50** each

#### Personal Portable BATTERY RADIO



4 TUBES (2 DUAL-PURPOSE) Has extra long life hundred hour batteries. Long distance reception. Large dynamic speaker. Thumb wheel tuning. All stations, plastic case, with collapsible handle. Rich gold finish trim. Red, brown or grey. Complete with batteries and leather case, each \$19.95 complete. Lots of 3 **\$19** ea.

#### Sensational! New! Famous 3-Way INDOOR ANTENNA

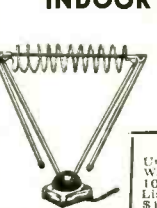

For UHF, VHF and FM radio. Delta-beam. 50% increase in pulling power by extending dipoles. For average, fringe and UHF areas. For movie-clear pictures. Sixtic antenna . . . 3.95. Lots of 6 . . . 3.69. RESISTORS (Asst. of 200) Unshunted, 1/2 Watt, 1 Watt, 2 Watt, and some 10 Watt. List price—**1.39** \$10.00

#### Knob Kit



Bag of 50 **1.29** (Choice Groups) Assortment of home, auto and TV knobs. All colors—plastic, wood and bakelite knobs. Sells 12c to 18c each. Super Bag of 100 extra val. **1.95**

#### 2-STATION INTERCOM



For instant communications. Easily installed and operated. Uses 110 V A.C. or D.C. Ready 24 hrs. a day. Uses no current when in "off" position. Completely wired, ready to use. With master unit and remote unit and 50 ft. plug in cable. Portable. Install it yourself, no tools needed. Plastic cabinet in ebony or gold. 6 3/4 x 5 1/4 x 2 1/4. \$24.75 complete

Type	Price	Type	Price	Type	Price	Type	Price
OA2	.74	6AV6	.37	7AF7	.53	14AF7	.59
OA4	.68	6AX4GT	.65	7B4	.44	14B6	.63
OB2	.81	6B4	.64	7B5	.45	14B8	.63
OC3	.72	6BA6	.39	7B6	.69	14C7	.79
OD3	.70	6BA7	.57	7B7	.49	14E6	.75
OZ4M	.55	6BC5	.49	7C4	.59	14E7	.88
IA5	.49	6BD5	.59	7C5	.69	14F7	.65
IA7GT	.47	6BD6	.45	7C6	.59	14H7	.59
IAX2	.62	6BE6	.39	7E5	.59	14J7	.30
IB3GT	.73	6BF5	.41	7E6	.30	14N7	.84
IC5	.43	6BF6	.37	7E7	.59	14R7	.79
IE7	.29	6BG6G	1.25	7F7	.79	14S7	.89
IG6	.24	6BH6	.46	7G7	.89	14W7	.30
IH4	.30	6BJ6	.43	7H7	.59	14X7	.69
IH5GT	.49	6BK7	.80	7J7	.79	14Y7	.62
IL4	.46	6BL7GT	.83	7K7	.69	19BG6	.95
IL6	.59	6BN6	.59	7L7	.59	19C8	.70
ILA4	.59	6BQ6GT	.79	7N7	.69	19T8	.69
ILA6	.69	6BQ7	.90	7Q7	.66	24A	.39
ILC5	.59	6BZ7	.90	7R7	.89	25AV5GT	.83
ILC6	.79	6C4	.37	7S7	.79	25BQ6GT	.79
ILD5	.59	6C5	.39	7V7	.89	25L6GT	.51
ILE3	.59	6C6	.58	7X6	.54	25W4GT	.59
ILG5	.69	6CB6	.44	7X7	.70	25Z5	.66
ILH4	.69	6CD6	1.11	7Y4	.69	25Z6	.49
ILN5	.59	6D6	.59	7Z4	.59	26	.45
IN5GT	.67	6E5	.48	12A6	.54	27	.39
IP5GT	.57	6F5GT	.39	12A8GT	.61	32L7	.89
IQ5GT	.58	6F6	.59	12AL5	.37	35	.58
IR5	.49	6G6	.52	12AQ5	.52	35B5	.40
IS4	.59	6H6GT	.41	12AT6	.37	35C5	.39
IS5	.43	6J5GT	.43	12AT7	.66	35L6GT	.41
IT4	.49	6J6	.52	12AU6	.38	35W4	.47
IU4	.49	6J7	.43	12AU7	.54	35Y4	.54
IU5	.43	6K5	.47	12AV6	.39	35Z3	.59
IV	.53	6K6GT	.37	12AV7	.63	35Z4	.47
IX2A	.63	6K7	.44	12AX4	.56	35Z5GT	.47
2A3	.30	6L6	.64	12AX4	.56	36	.39
2A4G	.24	6L7M	.68	12AX7	.56	41	.42
2W3	.38	6N7M	.63	12AY7	.99	42	.42
2X2	.59	6Q7	.45	12AZ7	.59	43	.55
3A4	.45	6R7	.69	12BA6	.38	45	.55
3E5	.46	6S4	.38	12BA7	.60	45Z3	.44
3LF4	.69	6S7M	.79	12BD6	.45	45Z5	.49
3Q4	.48	6S8GT	.53	12BE6	.51	50A5	.55
3Q5GT	.49	6SA7GT	.43	12BF6	.39	50B5	.52
3S4	.49	6SD7GT	.41	12BH7	.63	50C5	.51
3V4	.51	6SF5GT	.46	12BY7	.65	50L6GT	.61
5U4G	.55	6SG7GT	.41	12BZ7	.65	50Y6	.49
5W4CT	.50	6SH7GT	.49	12C8M	.34	50Y7	.50
5Y3GT	.37	6SJ7GT	.41	12H6	.56	55	.49
5Z3	.45	6SK7GT	.41	12SC7M	.63	56	.49
6A6	.51	6SL7GT	.48	12J5	.42	57	.58
6AB4	.44	6SN7GT	.52	12J7	.49	58	.60
6A7	.69	6SQ7GT	.37	12K8	.59	70L7	.97
6AC7M	.86	6SR7GT	.45	12Q7	.59	75	.49
6AF4	.90	6SS7GT	.42	12S8GT	.62	76	.44
6AG5	.48	6T4	.99	12SA7GT	.65	77	.57
6AG7M	.99	6T8	.80	12SF5	.50	78	.47
6AH4	.57	6U6	.59	12SG7	.51	80	.35
6AH6	.73	6U8	.61	12SJ7M	.67	83V	.68
6AJ5	.65	6V6GT	.50	12SK7GT	.63	84/6Z3	.46
6AK5	.55	6W4CT	.44	12SK7M	.63	85	.59
6AK6	.59	6W6GT	.44	12SL7GT	.47	117L7	.99
6AL5	.38	6X4	.37	12SN7GT	.52	117P7	.99
6AQ5	.39	6X5GT	.37	12SQ7GT	.56	117Z3	.37
6AQ6	.37	6X8	.75	12SR7M	.49	117Z6	.69
6AR5	.37	6Y6C	.48	12V6GT	.46	807	.99
6AS5	.50	7A4	.47	12X4	.38	866A	1.39
6AT6	.37	7A5	.59	14A4	.69	1274	.30
6AU4GT	.68	7A6	.69	14A5	.59	Hi-Po	
6AU5GT	.82	7A7	.69	14A7	.63	#567	1.39
6AU6	.46	7A8	.68				
6AV5GT	.83	7AD7	.79				

# RAD-TEL TUBE CO.

Dept. RE6 115 Coit St., Irvington 11, N. J. "Integrity Is Our Chief Asset"

TERMS: A 25% deposit must accompany all orders—balance C.O.D. All shipments F.O.B. Irvington warehouse. ORDERS UNDER \$10—\$1.00 HANDLING CHARGE. Subject to prior sale. PLEASE send full remittance . . . allow for postage and save C.O.D. charges! We refund all unused money! Send FOR FREE Illustrated PARTS CATALOGUE Phone Essex 5-2947 Bold Face Tubes cover 90% of Demand



## FROM FIRST TO FOREMOST

### 50 Years of Setting Standards

Ray L. Triplett with the first commercial tube tester—a Triplett production—and Triplett Model 3423, the leading tube tester of today and tomorrow. See it at your parts jobber. Model 3423 Mutual Conductance Tube Tester. Dealer's net \$199.50

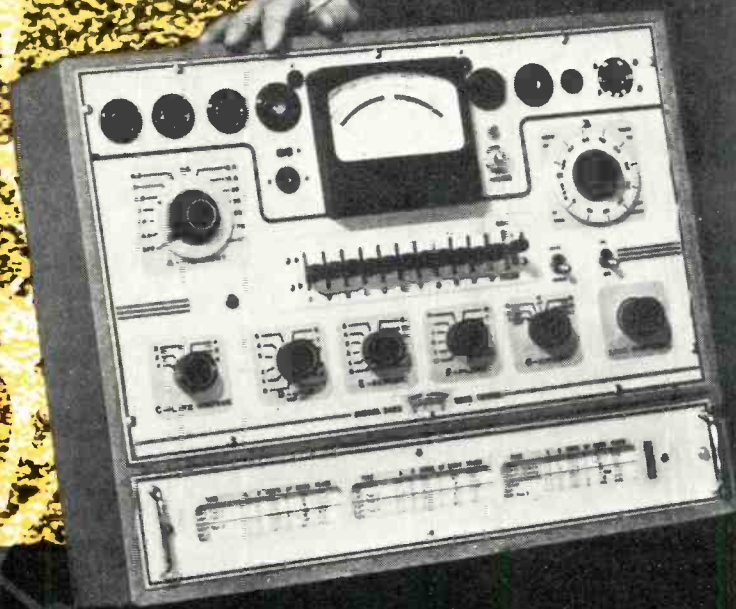

The only tube tester designed with 50 years experience. Two important lessons are learned, from experience, by the manufacturer of test equipment. First, the value of test equipment to a service man is in direct proportion as it reduces his necessary labor and increases his profit for the same span of work time. Model 3423 will give you no false readings to waste time—the patented circuit for tube testing employs actual signal (4KC) for grid signal. It also has a complete coverage of all tube types—six plate voltages (including 0-10 variable). Micromhos scales read C-1800, 0-6,000, 0-18,000 and 0-36,000.

Secondly, test equipment costs money and the purchaser must be protected against quick obsolescence. In Model 3423 the multiple switches allow making any combination of tube connections and its protection against such obsolescence.

Ask your jobber to demonstrate the many other extra features of this tester.

Only Triplett offers you a ten day free trial on all test equipment.



# TRIPLETT

Electrical Instrument Co.  
Bluffton, Ohio

# They look alike...

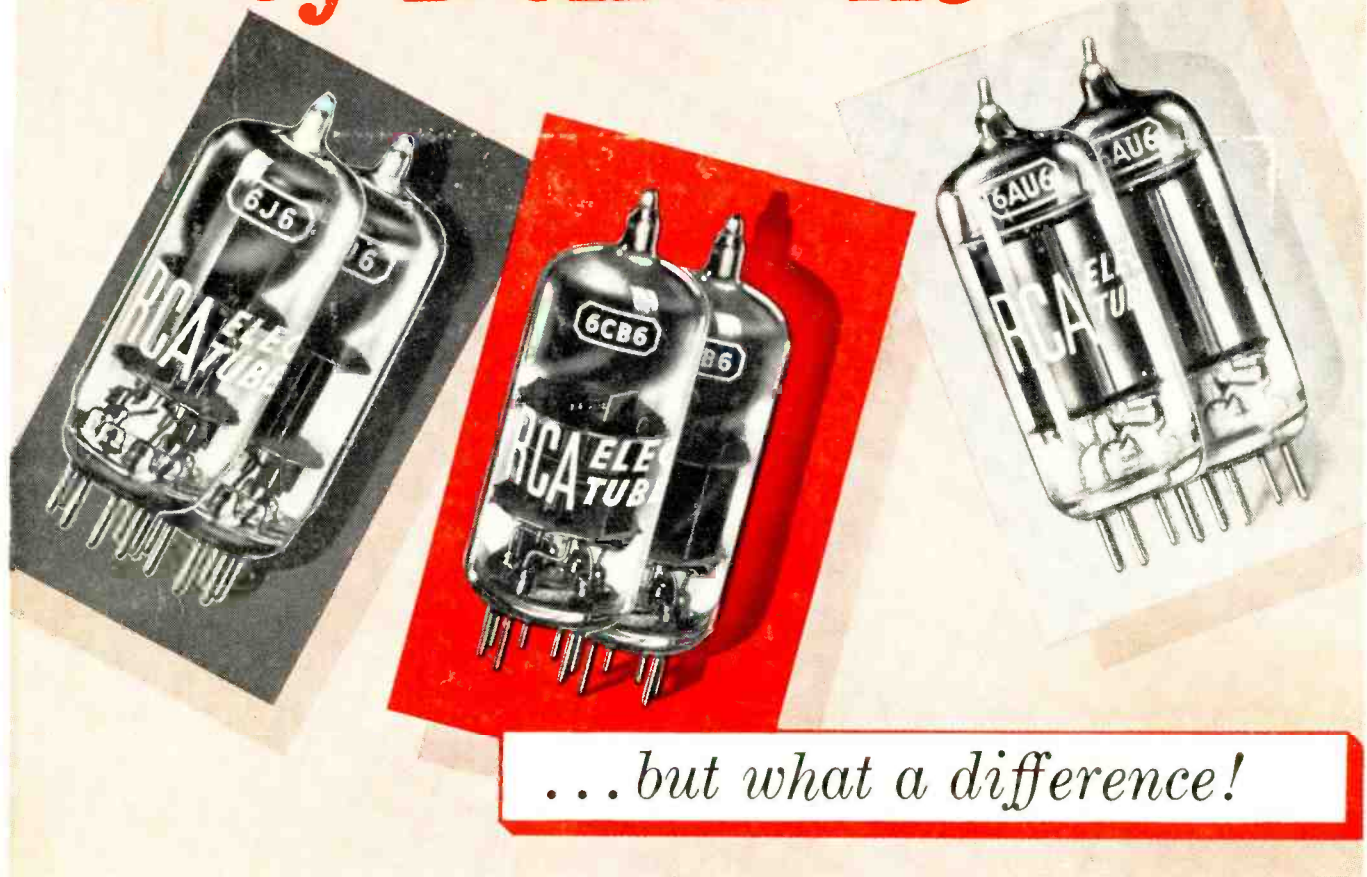

## These RCA types today give you . . .

**LONGER LIFE**



**SUPERIOR PERFORMANCE**



**AT NO EXTRA COST**



Here are 3 more examples of how regular RCA receiving tubes are constantly being improved to meet the changing requirements of radio and television applications. These RCA types provide you with the superior performance usually claimed for higher priced specialty designed types.

**RCA-6J6** features pure tungsten heaters for improved life . . . uses a special cathode material to help maintain characteristics throughout the life of the tube. Each tube mount is adjusted to provide increased uni-

formity of characteristics of each triode unit.

**RCA-6CB6** uses a No. 2 grid of improved design, resulting in lower grid operating temperature and longer tube life. Special controls on materials and processing improve uniformity of plate cutoff and reduce variations in characteristics when heater voltage fluctuates.

**RCA-6AU6** uses a double helical heater, resulting in an extremely low hum level. Inverted pinched cathode reduces possible motion of tube ele-

ments thus minimizing microphonics.

The superior performance of *regular* RCA receiving tubes—at *regular* prices—eliminates unnecessary callbacks, assures you of greater customer satisfaction, results in increased profits for you.

↑ ↑ ↑

When you sell a receiving tube, your reputation and profit depend on its *performance* and *reliability*. So, you can't afford to buy anything less than the best in receiving tubes . . . and the best are RCA.



**RADIO CORPORATION of AMERICA**  
ELECTRON TUBES

HARRISON, N. J.