

7th ANNUAL TELEVISION NUMBER

JANUARY 1954

Meyers
**RADIO —
ELECTRONICS**

TELEVISION • SERVICING • HIGH FIDELITY

HUGO GERNSBACK, Editor



The screen of a color TV receiver
showing a Faye Emerson broadcast

50¢

U. S. and
CANADA

Decide on DuMont

on the basis of...

*Product
Superiority*



Microscopic look at the cathode surface reveals soft, even texture, necessary for efficient tube performance

*not too wet, not too dry—
not too light or heavy...*

THE CATHODE plays an important role as source of electron energy in the picture tube. Moisture content and texture of the cathode coating must meet rigid standards to insure maximum picture tube life.

At Du Mont, exclusive processes are used for applying the cathode substance. The soft even texture achieved (see illustration) packs the effective emitting area (in circle) with extra electron power.

The resulting brighter performance over maximum tube life tells you why Du Mont is the right replacement for any set.



*Trade-mark

REPLACEMENT SALES, CATHODE-RAY TUBE DIVISION • ALLEN B. DUMONT LABORATORIES, INC., CLIFTON, N.J.

ADVANCE! Raise your earning power—learn RADIO-TELEVISION-ELECTRONICS by SHOP-METHOD HOME TRAINING

GOOD JOBS AWAIT THE TRAINED RADIO-TV TECHNICIAN

There is a place for you in the great Radio-Television-Electronics industry when you are trained as National Schools will train you at home!

Trained technicians are in growing demand at good pay—in manufacturing, broadcasting, television, communications, radar, research laboratories, home Radio-TV service, and other branches of the field. National Schools Master Shop-Method Home Training, with newly added lessons and equipment, trains you in your spare time, right in your own home, for these fascinating opportunities. OUR METHOD IS PROVED BY THE SUCCESS OF NATIONAL SCHOOLS TRAINED MEN, ALL OVER THE WORLD, SINCE 1905.

EARN WHILE YOU LEARN

Many National students pay for all or part of their training with spare time earnings. We'll show you how you can do the same! Early in your training, you receive "Spare-time Work" Lessons which will enable you to earn extra money servicing neighbors' and friends' Radio and Television receivers, appliances, etc.



Signal Generator

Audio Oscillator

T. R. F. Receiver

National Schools Training is All-Embracing

National Schools prepares you for your choice of many job opportunities. Thousands of home, portable, and auto radios are being sold daily—more than ever before. Television is sweeping the country, too. Co-axial cables are now bringing Television to more cities, towns, and farms every day! National Schools' complete training program qualifies you in all fields. Read this partial list of opportunities for trained technicians:

- Business of Your Own • Broadcasting
- Radio Manufacturing, Sales, Service • Telecasting
- Television Manufacturing, Sales, Service
- Laboratories: Installation, Maintenance of Electronic Equipment
- Electrolysis, Call Systems
- Garages: Auto Radio Sales, Service
- Sound Systems and Telephone Companies, Engineering Firms
- Theatre Sound Systems, Police Radio
- And scores of other good jobs in many related fields.

TELEVISION TRAINING

You get a complete series of up-to-the-minute lessons covering all phases of repairing, servicing and construction. The same lesson texts used by resident students in our modern and complete Television broadcast studios, laboratories and classrooms!



MASTER ALL PHASES!



Get Master Shop-Method Home Training from an Established Practical Resident School with its own Training with its own Training of almost 50 Years of Successful Experience in Training Ambitious Men.

Shops, Laboratories, Studios — We Bring National Schools To You!



You also receive this Multitester

Superheterodyne Receiver

LEARN BY DOING

You receive and keep all the modern equipment shown above, including tubes and valuable, professional quality Multitester. No extra charges.

FREE! RADIO-TV BOOK AND SAMPLE LESSON!

Send today for National Schools' new, illustrated Book of Opportunity in Radio-Television-

This course also offered in Spanish and Portuguese

Electronics, and an actual Sample Lesson. No cost—no obligation. Use the coupon now—we'll answer by return airmail.

APPROVED FOR VETERANS AND NON-VETERANS Check coupon below

Both Resident and Home Study Courses Offered!



NATIONAL SCHOOLS

LOS ANGELES 37, CALIFORNIA • ESTABLISHED 1905 IN CANADA: 811 W. HASTINGS STREET, VANCOUVER, B.C.

GET FACTS FASTEST! MAIL TO OFFICE NEAREST YOU!

(mail in envelope or paste on postal card)

NATIONAL SCHOOLS, Dept. RG-14

4000 S. Figueroa Street or 323 West Polk Street
Los Angeles 37, Calif. or Chicago 7, Ill.

Send FREE Radio-TV Electronics book and FREE sample lesson. No obligation, no salesman will call.

NAME _____ BIRTHDAY _____ 19 _____

ADDRESS _____

CITY _____ ZONE _____ STATE _____

Check here if interested in Resident School Training at Los Angeles. VETERANS: Give Date of Discharge.

RADIO - ELECTRONICS

Formerly RADIO-CRAFT • Incorporating SHORT WAVE CRAFT • TELEVISION NEWS • RADIO & TELEVISION*

Hugo Gernsback
Editor and Publisher

M. Harvey Gernsback
Editorial Director

Fred Shunaman
Managing Editor

Robert F. Scott
W2PWG, Technical Editor

Jerome Kass
Associate Editor

I. Queen
Editorial Associate

Matthew Mandl
Television Consultant

Charles A. Phelps
Copy Editor

Angie Pascale
Production Manager

Wm. Lyon McLaughlin
Tech. Illustration Director

Sol Ehrlich
Art Director

Lee Robinson
General Manager

John J. Lamson
Sales Manager

G. Aliquo
Circulation Manager

Adam J. Smith
Director, Newsstand Sales

Robert Fallath
Promotion Manager



Member
Magazine Publishers
Association

ON THE COVER:

Unique study of Faye Emerson, as photographed directly in color from the screen of an RCA color-mask TV tube. It was taken during one of the first of the recent experimental transmissions with NTSC compatible standards.

Color original courtesy NBC.

CONTENTS

JANUARY, 1954

7th ANNUAL TV ISSUE

Editorial (Page 33)	
Color TV Problems	by Hugo Gernsback 33
Television (Pages 34-92)	
Color Television—Past, Present, Future	by Dr. Lee de Forest 34
Transmission Line Lead-In for U.H.F.	by Bruce Richards 37
TV Channels Table (with Antenna data)	39
New U.H.F. Booster	by L. P. Hagey 40
FCC's Sterling Warns Manufacturers on TVI	42
82-Channel Cascode Tuner	by E. D. Lucas, Jr. 43
Understanding Video I.F.s	by H. L. Matsinger 46
Vertical Sweep Troubles	by Cyrus Glickstein 48
Servicing Horizontal Sweeps	by Robert B. Smith 51
Video Amplifier Problems	by Wallace Wamer 53
Television—it's a cinch (Eighth Conversation, first half—The Sawtooth in Action)	by E. Aisberg 56
Basic Color TV (Part I—Color and Vision)	by D. Newman and J. J. Roche 58
Booster Transmitter Increases TV Station Range	61
Modern 630 Circuitry	by Robert F. Scott 63
Color Receiver Circuits	66
TV DX in 1953	by E. P. Tilton, W1DQ 68
U.H.F. Design Promotes TVI?	71
TV Service Clinic	conducted by Matthew Mandl 72
Improving U.H.F. Performance	by Edward M. Noll and Matthew Mandl 74
Picture Tube Replacement Guide	by E. W. Scott 76
U.H.F. Converters and Boosters	78
TV Station List	80
Most Useful Schematics of 1953	81
Audio—High Fidelity (Pages 106-112)	
High Quality Audio, Part V—More on Pickups	by Richard H. Dorf 106
Radio (Pages 116-126)	
More About Attenuators	by N. H. Crowhurst 116
Transistor Keying Monitor	by I. Queen 124
Test Instruments (Pages 136-138)	
Phase Shift Oscillator	by Darwin H. Harris 136
New Design (Pages 150-154)	
New Tubes	150
Departments	
The Radio Month	6
Radio Business	16
The Service	127
Runaround	127
With the Technician	142
Miscellany	148
New Patents	156
New Devices	164
Radio-Electronic Circuits	169
Try This One	174
Question Box	176
Technotes	180
People	183
Communications	186
Electronic Literature	190
Book Reviews	192



MEMBER Audit Bureau of Circulations

Average Paid Circulation over 173,000

Vol. XXV, No. 1

RADIO-ELECTRONICS, January, 1954, Vol. XXV, No. 1. Published monthly at Erie Ave., F to G Sts., Philadelphia 32, Pa., Gernsback Publications, Inc., Entered as Second Class matter September 27, 1948, at the Post Office at Philadelphia, Pa., under the Act of March 3, 1879.
SUBSCRIPTION RATES: In U. S. and Canada, and in U. S. possessions, \$2.50 for one year; \$6.00 for two years; \$8.00 for three years; single copies 30¢. All other foreign countries \$4.50 a year, \$8.00 for two years; \$11.00 for three years.
EXECUTIVE, EDITORIAL and ADVERTISING OFFICES: 25 West Broadway, New York 7, N. Y. Telephone REctor 2-8630. Gernsback Publications, Inc. Hugo Gernsback, President; M. Harvey Gernsback, Vice-President; G. Aliquo, Secretary.
SUBSCRIPTIONS: Address correspondence to Radio-Electronics, Subscription Dept., Erie Avenue, F to G Sts., Philadelphia 32, Pa., or 25 West Broadway, New York 7, N. Y. When ordering a change please furnish an address stencil impression from a recent wrapper. Allow one month for change of address.
BRANCH ADVERTISING OFFICES: Chicago: 7522 North Sheridan Road, Tel. Rogers Park 4-8000. Los Angeles: Ralph W. Harker and Associates, 1127 Wilshire Blvd., Tel. MAdison 6-1271. San Francisco: Ralph W. Harker and Associates, 582 Market St., Tel. GArfield 1-2481. **FOREIGN AGENTS:** Great Britain: Atlas Publishing and Distributing Co., Ltd., London E.C.4. Australia: McGill's Agency, Melbourne. France: Brentano's, Paris 2e. Belgium: Agence et Messageries de la Presse, Brussels. Holland: Trilectron, Heemstede. Greece: International Book & News Agency, Athens. So. Africa: Central News Agency Ltd., Johannesburg. Capetown, Durban, Natal. Universal Book Agency, Johannesburg. Middle East: Steimatzky Middle East Agency, Jerusalem. India: Broadway News Centre, Dadar, Bombay #14. Pakistan: Paradise Book Stall, Karachi 3. Copyright 1953 by Gernsback Publications, Inc. Text and illustrations must not be reproduced without permission of copyright owners. **POSTMASTER:** If undeliverable send form 3578 to: RADIO-ELECTRONICS, 25 West Broadway, New York 7, N. Y. *Trademark registered U.S. Patent Office.

RADIO-ELECTRONICS

Now IN YOUR OWN HOME Learn

TELEVISION RADIO ELECTRONICS

the Amazingly Effective

D. T. I. WAY

—with the aid of BOTH
HOME EQUIPMENT
and HOME MOVIES

NO PREVIOUS EXPERIENCE NEEDED
NOW... get
**EVERYTHING
YOU NEED**

for real Laboratory-
type training
AT HOME

Above:
Work over
300
fascinating
experiments
with this
equipment

What will mailing the coupon below do for YOU? Just this! You'll find out about one of today's most remarkable... practical ways to prepare to get into America's amazing billion dollar opportunity field of TELEVISION-RADIO-ELECTRONICS. You'll see how to get into fascinating work that pays well... that offers one of America's most promising futures... that enables you to start your own business almost "on a shoe string," if you prefer this to a job opportunity.

And above all, you'll get some GOOD NEWS especially welcomed by men anxious to earn REAL MONEY in this thrilling field. For you'll see that NOW you can get the kind of practical, laboratory-type training so desirable for making real progress in Television-Radio-Electronics AND WITHOUT LEAVING HOME.

You'll see that DeForest's Training, Inc. sends everything needed to set up your own HOME LABORATORY.

You get and keep the same type of basic electronic equipment used in our modern Chicago Training Laboratories. You get home training that includes the knowledge and experience gained from training thousands of students first hand in Chicago.

And to top it all, you use DTI's amazingly effective and exclusive home training aid—**INSTRUCTIVE MOVIES**. But why not get the complete story? Mail coupon today for information-packed literature.

MODERN LABORATORIES

If you prefer, get all your preparation in our new Chicago Training Laboratories—one of the finest of its kind. Ample instructors, modern equipment. Write for details!

MILITARY SERVICE!

If you're subject to military service, the information we have for you should prove very helpful. Mail coupon today.

1. Build over 300 fascinating experiments from 16 BIG SHIPMENTS of Electronic-Radio parts which you KEEP.
2. Build valuable commercial-type test equipment—as shown to the left—which you KEEP. This includes a quality 5 INCH oscilloscope and jewel bearing Multi-Meter—both highly useful for Television work.
3. Build and keep a big 21 INCH TV Set. (D.T.I. offers another home training in Television-Radio-Electronics, but without the TV set.)
4. Use a 16 mm. movie projector and new series of highly instructive movies—a wonderful aid to help you grasp important fundamentals faster... easier... better.
5. Enjoy well-illustrated, easy-to-read lessons with handy FOLD-OUT diagrams.
6. Get an honest-to-goodness EMPLOYMENT SERVICE to help you get a good job after graduating—or assistance in starting your OWN SALES AND SERVICE BUSINESS. Mail coupon today for the complete details.



Get this
information-packed publication



FREE!

Mail Coupon Today

"ONE OF AMERICA'S FOREMOST TELEVISION TRAINING CENTERS"
— Established 1931 —



DEFOREST'S TRAINING, INC.
AFFILIATED WITH
DEVRY Technical INSTITUTE
CHICAGO 14, ILLINOIS

DEFOREST'S TRAINING, INC.
2533 N. Ashland Avenue, Chicago 14, Ill.

Dept. RE-1-K

I would like your valuable information-packed publication showing how I can get started toward a good job or my own business in Television-Radio-Electronics.

Name..... Age.....
Street..... Apt.....
City..... Zone..... State.....

**NEWEST
FASTEST SELLER
in the field!**



CDP
**COMPOUND
DIFFRACTION
PROJECTOR***

Public Address Loudspeaker System

setting new standards for
**VOICE PENETRATION
AND MUSICASTING**

- Greatly outperforms comparably sized reentrant horns
- Tremendous penetrating power and coverage at very low unit energy cost
- Exclusive E-V coaxial design and diffraction principle
- Peak-free response ± 5 db to 10,000 cps
- Delivers $2\frac{1}{2}$ octaves more musical range
- Weather-proof, blast-proof, splash-proof
Virtually indestructible

Model 848 CDP. 25 watts. 16 ohms.

List Price, \$65.00 Net, \$39.00

**COMPARE
POLAR PATTERN**
Sound distribution of CDP exceeds 120° at all frequencies up to 10,000 cps.

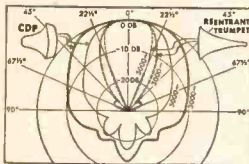

**COMPARE
RESPONSE AND
EFFICIENCY**
Note extended high frequency range of CDP. Response is smooth, peak-free ± 5 db to 10,000 cps.

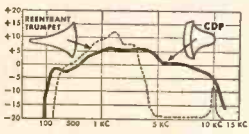

Write for Free
Bulletin No. 197

*Pat. Pend.

Electro-Voice

421 CARROL ST. • BUCHANAN, MICHIGAN
Export: 13 E. 40th St., New York 16, U.S.A. Cables: Arlab

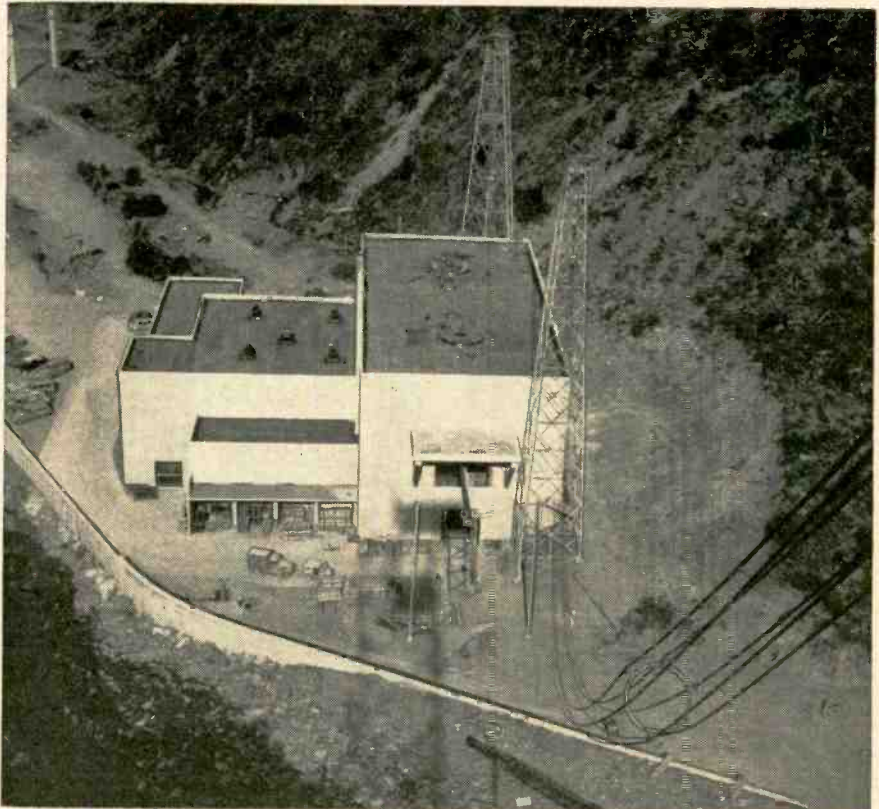

Courtesy U.S. Navy

The Jim Creek Valley installation as seen from one of the 200-foot towers above.

BIGGEST TRANSMITTER in the world went into operation at Jim Creek Valley, Washington on November 17. Constructed for the U.S. Navy by RCA, it has a power of 1,200,000 watts (1200 kw). With it, the Navy can communicate instantly with any of its units at any point on the globe using c.w. on any frequency from 14.5 to 35 kc.

The transmitter itself is composed of two identical units operated in parallel. Either can be used independently if the other should be put out of service.

The antenna—stated to be the largest ever erected—is strung between twelve 200-foot towers erected along the crests of two 3,000-foot mountains which enclose the valley on the north and south. The ten antenna spans zig-zag back and forth between the towers, covering an area of 435 acres with active radiating elements. Because the mountain crests are not exactly parallel, the spans vary in length from 5,640 to 8,700 feet. Like the transmitter, the antenna is divided in two, either half of which could be used independently.

DR. HERBERT EUGENE IVES, TV pioneer, whose research resulted in the first American public demonstration of television in 1927, and who also developed three-dimensional pictures, died on November 13. He was 71 years old.

At the end of World War I, Dr. Ives joined the technical staff of Bell Telephone Laboratories. His first work was in the field of photoelectric cells and their applications to the communication industry. He was in charge of the general development of picture transmission over telephone lines which was first used in 1924.



Dr. Herbert Eugene Ives

Following this, Dr. Ives had charge of the investigation of television which resulted in the first demonstration in April, 1927. Two months later television images in color were demonstrated, using three transmission lines, one for each primary color. He remained a member of the technical and research staff at Bell Telephone Laboratories until his retirement in 1947.

COLOR TV PICTURE TUBES will soon represent the entire picture tube production of Crosley's Batavia, Ill., tube plant. Crosley has announced they will discontinue the production of black-and-white picture tubes at that plant by February.

Production of the Lawrence tube, called the Chromatron, has been started at the plant in very small quantities, and is expected to reach 100 color tubes a day by February. From then on, Crosley will buy all its black-and-white picture tubes from other tube makers.

RADIO-ELECTRONICS

TRIO

proudly announces

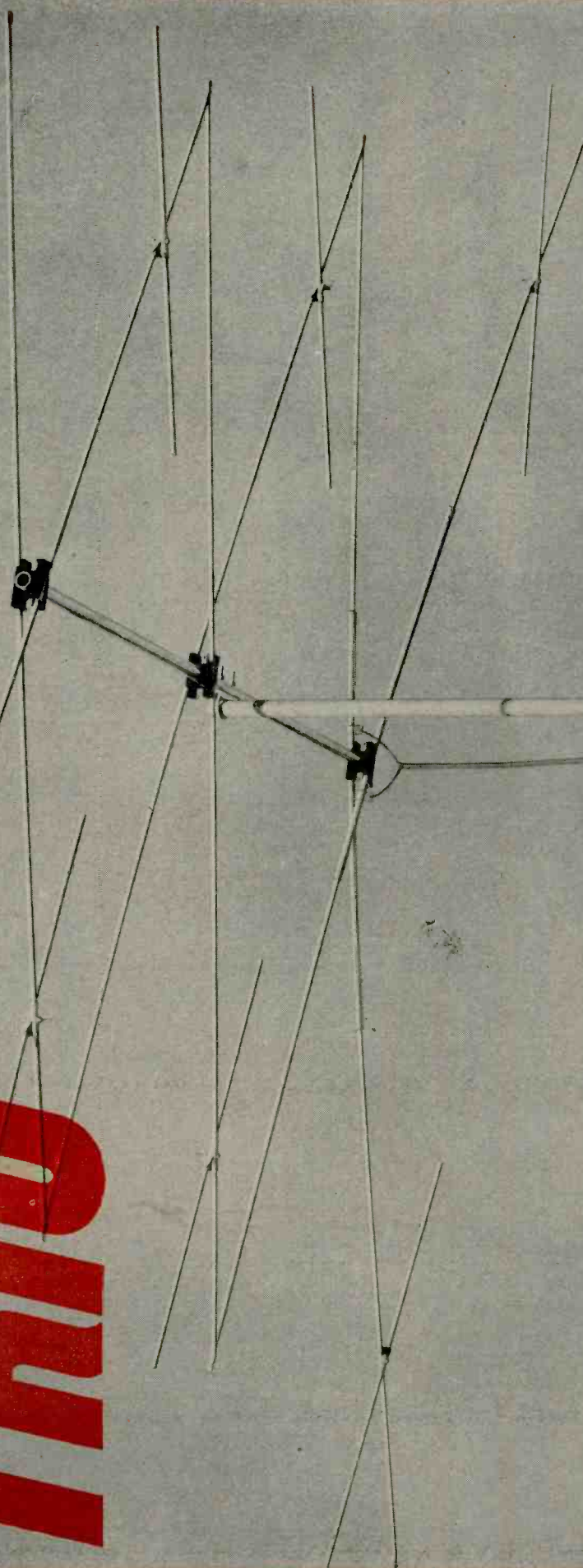

The New ZIG-ZAG

"TWIN-SIX"

(A significant addition to the Zig-Zag line)

... the greatest advance ever made in ALL-CHANNEL antenna design!

Not content to bring out just another all-channel antenna, TRIO studied and tested every other model available. Months of research produced the "Twin-Six", a Zig-Zag that provides all of the desirable features indicated above. Quantitative ratings for antennas are practically meaningless because of some exaggerated claims. For this reason, the "Twin-Six" is announced without the usual gain charts. The new "Twin-Six", however, equals and, in most cases, greatly exceeds the gains of these antennas on every channel. For instance, the "Twin-Six" showed a 2 to 6 db higher gain than a competitive antenna which is advertised as having a 12 db gain.

MINUTE-UP ASSEMBLY

There's no antenna easier to assemble. Shipped with all hardware mounted on the boom. Complete assembly consists of matching elements to color coded insulators and snapping on spring clips. Improper assembly impossible.



Insulators color coded and mounted on boom and are so designed that "shorting-out" is impossible. Antenna elements mounted merely by snapping on the spring clips.

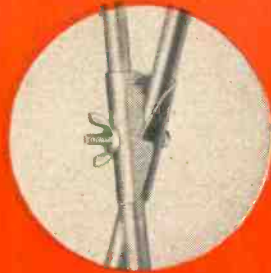

Pre-assembled high channel elements are swung into position and quickly locked by mating brackets.



Team the new Zig-Zag "Twin-Six" with the dependable TRIO rotator for the maximum in TV enjoyment!

NEW ZIG-ZAG "TWIN-SIX" OFFERS:

Measurable Higher Gain On All VHF Channels Than Any Other Single Bay All-Channel Antenna

PLUS

1. One Horizontal Bay Does It All!
2. Single Lead-In Operation!
3. Easy-Up, One Minute Assembly!
4. Rugged Construction Throughout — No Droop, No Sag! Light Weight — Attractive Appearance!
5. UHF Reception For All Primary Areas!
6. Low Standing Wave Ratio!
7. Built and Backed by TRIO — A Name You Can Trust!
8. Competitively Priced!



TRIO

MANUFACTURING CO. GRIGGSVILLE, ILL.



HERE'S A WELL-KNOWN TV HANDYMAN

Just press the button and spray on a tough, quick-drying dielectric Acrylic coating.

KRYLON Acrylic coating helps prevent corona when sprayed on high voltage coil and insulation, the socket of the high voltage rectifier, and component parts of the rectifier circuit.

KRYLON Acrylic coating*, when sprayed on antenna and lead-in connections, effectively seals out air, moisture, dirt . . . prevents pitting and keeps picture at peak quality.

KRYLON CUTS DOWN SERVICE CONTRACT CALLS . . . INCREASES YOUR PROFITS . . . AND IS THE NATION'S LARGEST SELLING ACRYLIC COATING FOR TV AND RADIO.

TECHNICAL CHARACTERISTICS:

Dielectric constant—2.8 to 2.4 (1,000 cycles)
 Dielectric strength—400 to 800
 Electrical resistance— 10^{10} ohms/cm³
 Available from TV Jobbers everywhere.

KRYLON, Inc., Phila. 46, Pa.

*Also available in non-conductive Bright Aluminum, Glossy Black, and appliance White.

THIMBLE SIZE TRANSISTOR 100 times as powerful as present commercially available types has been developed by the Minneapolis Honeywell Regulator Co.

Dr. Finn J. Larsen, research director, said the new power unit, which has an output of 20 watts, would do work not possible with the low-output types, and should greatly expand the range of transistor uses.

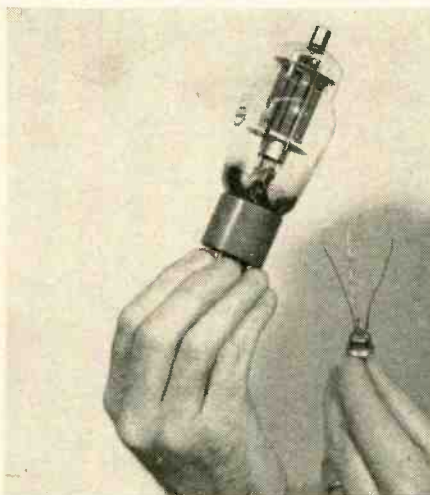

Thimble-size power-type transistor.

A prototype aircraft electronic fuel gauge making use of the new transistor has already been built by the company, though the transistor is not yet in commercial production, being built on a pilot-line basis.

The new transistor's power output of 20 watts contrasts with that of 20 hundredths of a watt for present commercial types. This greater power enables it to do things heretofore impossible with transistors, such as the operation of motors, valves, relays and other equipment.

Dr. Larsen said the inability of transistors to handle sizable amounts of current has been a major drawback, and one that many researchers in the electronic industry have been trying to overcome. The big stumbling block has been the problem of heat.

The key to Honeywell's development of a power-type unit was the discovery of an effective means of removing heat from the germanium-alloy junction.

MICROWAVE WIRING method that may revolutionize the production of television links and aircraft radar devices will be made available to electronic manufacturers on an industry-

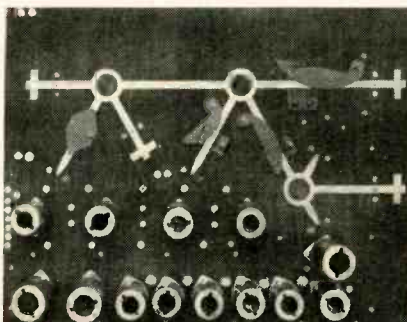

Microstrip receiver weighs 5 pounds.

wide basis.

The technique, called *Microstrip*, was developed by Federal Telecommunication Laboratories, Nutley, N. J., a division of IT&T, and is being offered to prospective users under a special licensing agreement.

As described in *RADIO-ELECTRONICS*, May, 1952, the equipment differs radically in design from conventional microwave circuitry. In conventional circuits, radio waves travel inside a highly polished tube, while in their *Microstrip* equivalent they are carried by metal strips etched on a thin sheet of metal. With the new device, costly wave guides may virtually be eliminated.

The *Microstrip* components can be produced directly from diagrams by etching the circuits on a dielectrically coated base plate, as in photo engraving, or by the use of stamping and embossing techniques. The units resemble oversized calling cards, and can be turned out almost as rapidly as sheets from a printing press. They can be produced at a fraction of the cost of their conventional counterparts.

TV INTERFERENCE was the subject of a stern warning delivered by FCC Commissioner Sterling to TV, radio, and broadcast equipment makers. The occasion for this warning was the Fall meeting of the combined RETMA, RTMA of Canada and IRE in Toronto.

Commissioner Sterling stressed that the industry must do much more about reducing radiation from TV receivers and transmitters which interfere with reception on government, aircraft, amateur and TV-radio bands.

Sterling said that the FCC received 22,264 interference complaints in fiscal 1953. More than 12,600 resulted from spurious responses of broadcast receivers—6,000 from TV sets. Some 9,600 were the result of spurious radiations from transmitters.

At one point, the commissioner departed from his prepared text, reminding manufacturer's of FCC's new power to issue "cease and desist" orders, which in some cases could have the effect of putting an offending company out of business.

The Commission has been making extensive field measurements in Portland, Oregon, site of the first commercial u.h.f. station, on radiation from u.h.f. TV receivers and converters. The results gave great cause for concern. In the instance of strips and separate converters, excessive radiation was observed in the region between 200 and 500 mc. The radiation from u.h.f. oscillators was in the order of thousands of microvolts per meter, and in one instance a field of 10,000 microvolts-per-meter was obtained at 100 feet from a set of one of our major manufacturers.

In reply, Crosley's Lewis M. Clement, chairman of RETMA engineering department's executive council reported that the vast majority of manufacturers have now reduced spurious v.h.f. oscillator radiation below RETMA's "interim" maximums (50 microvolts-per-meter at 100 feet for channels 2-6 and 150 microvolts-per-meter for 7-13). **END**



Edward H. Guilford
Executive Vice President

Want To DOUBLE YOUR PAY?

How To Pass FCC COMMERCIAL RADIO OPERATOR EXAMINATIONS

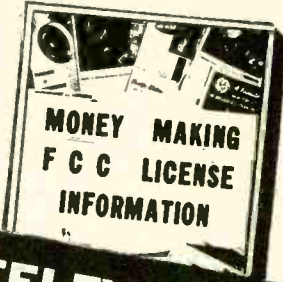

TELEVISION ENGINEERING
Included in our
Training and coaching

GET THIS AMAZING NEW BOOKLET FREE!

TELLS HOW...

HERE IS YOUR GUARANTEE

TELLS HOW...

WE GUARANTEE
TO TRAIN AND COACH YOU AT
HOME IN SPARE TIME UNTIL YOU GET
YOUR FCC LICENSE

If you have had any practical experience—Amateur, Army, Navy, radio repair, or experimenting.

If you fail to pass your Commercial License exam after completing our course, we guarantee to continue your training without additional cost of any kind, until you successfully obtain your Commercial license, provided you first sit for this examination within 90 days after completing your course.

**Our Amazingly Effective
JOB-FINDING SERVICE**

Helps CIRE Students Get Better Jobs
Here are a few recent examples of Job-Finding results:

GETS CIVIL SERVICE JOB

"Thanks to your course I obtained my 2nd phone license, and am now employed by Civil Service at Great Lakes Naval Training Station as an Equipment Specialist."
Kenneth B. Leiser, Fair Oaks, Md. Del., McHenry, Ill.

GETS STATE POLICE JOB

"I have obtained my 1st class ticket (thanks to your school) and since receiving same I have held good jobs at all times. I am now Chief Radio Operator with the Kentucky State Police."

Edwin P. Healy, 264 E. 3rd St., London, Ky.

GETS BROADCAST JOB

"I wish to thank your Job-Finding Service for the help in securing for me the position of transmitter operator here at WCAE in Pittsburgh."

Walter Koschik, 1442 Ridge Ave., N. Braddock, Pa.

GETS AIRLINES JOB

"Due to your Job-Finding Service, I have been getting many offers from all over the country, and I have taken a job with Capital Airlines in Chicago, as a Radio Mechanic."
Harry Clare, 4537 S. Drexel Blvd., Chicago, Ill.

TELLS HOW...

**Employers Make JOB OFFERS Like These
to Our Graduates Every Month!**

Letter from nationally-known Airlines, "We would also appreciate if you would place the following additional advertisement in your bulletin—Wanted—Superintendent of Communications . . . Salary \$666.66 per month."

Letter from nationally known airplane manufacturer, "We need men with electronic training or experience in radar maintenance to perform operational check-out of radar and other electronics systems . . . starting salary . . . amounting to \$329.33 per month."

Letter from nationally-known Airlines, "We are contemplating placing . . . an Airline Ground Radio Engineer." Starting salary \$385 per month.

These are just a few examples of the job offers that come to our office periodically. Some licensed radioman filed each of these jobs . . . it might have been you!

**HERE'S PROOF FCC LICENSES ARE OFTEN
SECURED IN A FEW HOURS OF STUDY WITH
OUR COACHING AT HOME IN SPARE TIME**

Name and Address	License	Lessons
Lee Worthy 2210 1/2 Wilshire St., Bakersfield, Calif.	2nd Phone	16
Clifford E. Vogt Box 1016, Dania, Fla.	1st Phone	20
Francis X. Foerch 38 Beucier Pl., Bergenfield, N. J.	1st Phone	38
S/Sgt. Ben H. Davis 317 North Roosevelt, Lebanon, Ill.	1st Phone	28
Albert Schoell 110 West 11th St., Escondido, Calif.	2nd Phone	23

CLEVELAND INSTITUTE OF RADIO ELECTRONICS
Carl E. Smith, E. E., Consulting Engineer, President
Desk RE-60, 4900 Euclid Bldg., Cleveland 3, Ohio

OURS IS THE ONLY HOME STUDY COURSE WHICH SUPPLIES FCC-TYPE EXAMINATIONS WITH ALL LESSONS AND FINAL TESTS.



Your FCC Ticket is recognized in all radio fields as proof of your technical ability.

MAIL COUPON NOW

CLEVELAND INSTITUTE OF RADIO ELECTRONICS
Desk RE-60—4900 Euclid Bldg.
Cleveland 3, Ohio
(Address to Desk No. to avoid delay.)

B I want to know how I can get my FCC ticket in a minimum of time. Send me your FREE booklet: "How to Pass FCC License Examinations" (does not cover exams, for Amateur License), as well as a sample FCC-type exam and the amazing new booklet, "Money-Making FCC License Information. Be sure to tell me about your Television Engineering Course."

Name
Address
City Zone State
Paste on two cent postcard or send air mail.

NEW Certified Quality Service Business Builders SIGNS...POSTALS ...AD MATS

GET THIS CATALOG →

TIE IN even stronger with your *Certified Quality Service* campaign in LIFE and POST. Tell your customer again and again. *You* offer him the quality service and fair charges that spell C...Q...S. Win his confidence and you win his business. Along with your CQS tags and displays, use your new CQS illuminated indoor sign... flange sign... postals... and ad mats. You'll be proud of them. They are modern, dignified, economical... and their CQS message sells *hard*. See them at your CBS-Hytron distributor's. Or write for CQS-10 catalog. But act now!



NEED MORE CQS TAGS?

With your 3-line imprint, they are priced low: 250 for \$2.25, 500 for \$3.50, 1000 for \$6.00. Order from your distributor... or direct.

4 MORE CQS Sales Aids

IDENTIFY YOU AS A...
Certified
QUALITY SERVICE DEALER

NEW CQS ILLUMINATED INDOOR SIGN
Wraps your potent *Certified Quality Service* message into a dignified display. Brilliant... colorful... Plexiglas sign (25 1/2 by 10 by 3 1/2 inches) pulls customers to you. Hang it (comes equipped with chains and hooks) or stand it in window... on counter... on shelf. Comes ready to plug into a-c fluorescent tube. Makes ideal night light and 24-hour salesman. Identify yourself. Get your CQS illuminated indoor sign up right away. Only \$9.45, F.O.B. continental U. S. A.; or see your CBS-Hytron distributor.

NEW CQS METAL PLAM
Proudly, boldly *Certified Quality Service* seen by millions in campaign. Big, sturdy 12 inches, with colors in weather-resistant outdoor or indoor. Mount this sign. Only \$1.75 each, U. S. A.; or see your distributor.

NEW CQS AD MATS
All the *Certified Quality Service* message in one place. 9 ad mats. 3 direct-mail postals.

60-DAY OFFER!

10 SOCKET LOCATORS with 20 miniature tubes

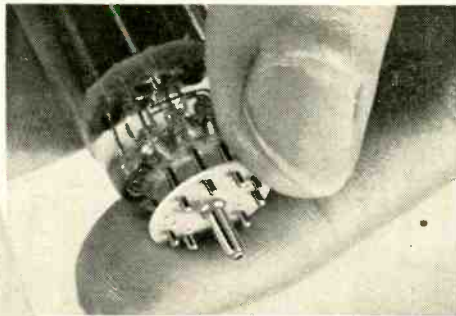

During January and February. Order 20 CBS-Hytron miniature tubes. Your distributor will give you this package of 10 new CBS-Hytron Socket Locators. With them, plugging miniatures into hard-to-locate sockets is easy. Socket Locator slips over pins of tube (7-pin or 9-pin). Key of Locator finds socket... guides tube into it, quickly. Save time and temper... take advantage of this limited offer. See your CBS-Hytron distributor.

NEW... FREE CBS-HYTRON CRYSTAL DIODE MANUAL

Complete, down-to-earth, 8-page manual on crystal diodes. Three parts: 1. Advantages and construction. 2. Complete data, 38 types. 3. Selection and application. Profusely illustrated. Ten basic circuits. Gives you *all* the crystal-diode information you have been seeking. FREE... from your CBS-Hytron distributor... or write direct.

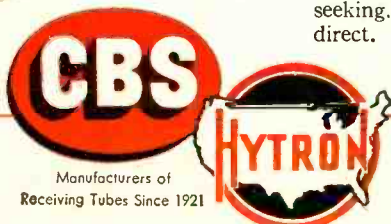
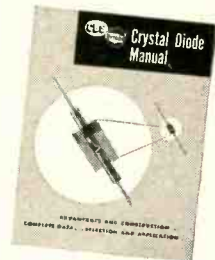

CBS-HYTRON Main Office: Danvers, Massachusetts

A Division of Columbia Broadcasting System, Inc.

A member of the CBS family... CBS-Radio • CBS-Television
Columbia Records, Inc. • CBS-Laboratories • CBS-Columbia • and CBS-Hytron

RECEIVING... TRANSMITTING... SPECIAL-PURPOSE AND TV PICTURE TUBES • GERMANIUM DIODES AND TRANSISTORS

RADIO-ELECTRONICS

How I foxed the Navy

by Arthur Godfrey

The Navy almost scuttled me. I shudder to think of it. My crazy career could have ended right there. Who knows, I might still be bumming Chesterfields instead of selling them.

To be scuttled by the Navy you've either got to do something wrong or neglect to do something right. They've got you both ways. For my part, I neglected to finish high school.

Ordinarily, a man can get along without a high school diploma. Plenty of men have. But not in the Navy. At least not in the U. S. Navy Materiel School at Bellevue, D. C., back in 1929. In those days a bluejacket had to have a mind like Einstein's. And I didn't.

"Godfrey," said the lieutenant a few days after I'd checked in, "either you learn mathematics and learn it *fast* or out you go. I'll give you six weeks." This, I figured, was it. For a guy who had to take off his shoes to count



above ten, it was an impossible assignment.

I was ready to turn in my bell-bottoms. But an ad in a magazine stopped me. Here, it said, is your chance to get special training in almost any subject—mathematics included. I hopped on it. Within a week I was enrolled with the International Correspondence Schools studying algebra, geometry and trig for all I was worth.

Came week-end liberty, I studied. Came a holiday, I studied. Came the end of the six weeks, I was top man in the class. Within six weeks I had mastered two years of high school math, thanks to the training I'd gotten.

I.C.S. made the impossible—easy!

GET EXPERT GUIDANCE 2 FREE BOOKS

Free, illustrated catalog on career that interests you. Also 36-page, pocket-size guide to advancement, "How to Succeed." Just mail the coupon!

I. C. S., Scranton 9, Penna.

INTERNATIONAL CORRESPONDENCE SCHOOLS

ICS

BOX 2877-K, SCRANTON 9, PENNA.

Without cost or obligation, send me "HOW to SUCCEED" and the booklet about the course BEFORE which I have marked X:

<input type="checkbox"/> ART <input type="checkbox"/> Commercial Art <input type="checkbox"/> Magazine Illustrating <input type="checkbox"/> Fashion Illustrating <input type="checkbox"/> Cartooning <input type="checkbox"/> Sketching and Painting <input type="checkbox"/> Show Card and Sign Lettering <input type="checkbox"/> AUTOMOTIVE <input type="checkbox"/> Automobile, Mechanic <input type="checkbox"/> Auto Elec. Technician <input type="checkbox"/> Auto Body Rebuilding and Refinishing <input type="checkbox"/> Diesel—Gas Engines <input type="checkbox"/> AVIATION <input type="checkbox"/> Aeronautical Engineering Jr. <input type="checkbox"/> Aircraft Engine Mechanic <input type="checkbox"/> Airplane Drafting <input type="checkbox"/> BUILDING <input type="checkbox"/> Architecture <input type="checkbox"/> Arch. Drafting <input type="checkbox"/> Building Contractor <input type="checkbox"/> Estimating <input type="checkbox"/> Carpenter and Mill Work <input type="checkbox"/> Carpenter Foreman <input type="checkbox"/> Reading Blueprints <input type="checkbox"/> House Planning <input type="checkbox"/> Plumbing	<input type="checkbox"/> Heating <input type="checkbox"/> Painting Contractor <input type="checkbox"/> Air Conditioning <input type="checkbox"/> Electrician <input type="checkbox"/> BUSINESS <input type="checkbox"/> Business Administration <input type="checkbox"/> Certified Public Accountant <input type="checkbox"/> Bookkeeping and Accounting <input type="checkbox"/> Office Management <input type="checkbox"/> Stenography and Typing <input type="checkbox"/> Secretarial <input type="checkbox"/> Federal Tax <input type="checkbox"/> Business Correspondence <input type="checkbox"/> Letter-writing Improvement <input type="checkbox"/> Personnel and Labor Relations <input type="checkbox"/> Advertising <input type="checkbox"/> Retail Business Management <input type="checkbox"/> Managing Small Business <input type="checkbox"/> Ocean Navigation <input type="checkbox"/> Sales Management <input type="checkbox"/> Short Story Writing <input type="checkbox"/> Creative Salesmanship <input type="checkbox"/> Traffic Management <input type="checkbox"/> CHEMISTRY <input type="checkbox"/> Chemical Engineering <input type="checkbox"/> Chemistry <input type="checkbox"/> Analytical Chemistry	<input type="checkbox"/> Petroleum—Nat'l Gas <input type="checkbox"/> Pulp and Paper Making <input type="checkbox"/> Plastics <input type="checkbox"/> CIVIL, STRUCTURAL ENGINEERING <input type="checkbox"/> Civil Engineering <input type="checkbox"/> Structural Engineering <input type="checkbox"/> Surveying and Mapping <input type="checkbox"/> Structural Drafting <input type="checkbox"/> Highway Engineering <input type="checkbox"/> Reading Blueprints <input type="checkbox"/> Construction Engineering <input type="checkbox"/> Sanitary Engineering <input type="checkbox"/> DRAFTING <input type="checkbox"/> Aircraft Drafting <input type="checkbox"/> Architectural Drafting <input type="checkbox"/> Electrical Drafting <input type="checkbox"/> Mechanical Drafting <input type="checkbox"/> Structural Drafting <input type="checkbox"/> Sheet Metal Drafting <input type="checkbox"/> Ship Drafting <input type="checkbox"/> Mine Surveying and Drafting <input type="checkbox"/> ELECTRICAL <input type="checkbox"/> Electrical Engineering <input type="checkbox"/> Electrician <input type="checkbox"/> Electrical Maintenance	<input type="checkbox"/> Electrical Drafting <input type="checkbox"/> Electric Power and Light <input type="checkbox"/> Lineman <input type="checkbox"/> HIGH SCHOOL <input type="checkbox"/> High School Subjects <input type="checkbox"/> Mathematics <input type="checkbox"/> Commercial <input type="checkbox"/> Good English <input type="checkbox"/> MECHANICAL AND SHOP <input type="checkbox"/> Mechanical Engineering <input type="checkbox"/> Industrial Engineering <input type="checkbox"/> Industrial Supervision <input type="checkbox"/> Foremanship <input type="checkbox"/> Mechanical Drafting <input type="checkbox"/> Machine Design-Drafting <input type="checkbox"/> Machine Shop Practice <input type="checkbox"/> Tool Design <input type="checkbox"/> Industrial Instrumentation <input type="checkbox"/> Machine Shop Inspection <input type="checkbox"/> Reading Blueprints <input type="checkbox"/> Toolmaking <input type="checkbox"/> Gas—Electric Welding <input type="checkbox"/> Heat Treatment—Metallurgy <input type="checkbox"/> Sheet Metal Work <input type="checkbox"/> Sheet Metal Pattern Drafting <input type="checkbox"/> Refrigeration	<input type="checkbox"/> POWER <input type="checkbox"/> Combustion Engineering <input type="checkbox"/> Diesel—Electric <input type="checkbox"/> Electric Light and Power <input type="checkbox"/> Stationary Steam Engineering <input type="checkbox"/> Stationary Fireman <input type="checkbox"/> RADIO, TELEVISION COMMUNICATIONS <input type="checkbox"/> Practical Radio—TV Eng'ring <input type="checkbox"/> Radio Operating <input type="checkbox"/> Radio and TV Servicing <input type="checkbox"/> Television—Technician <input type="checkbox"/> Electronics <input type="checkbox"/> Telephone Work <input type="checkbox"/> RAILROAD <input type="checkbox"/> Locomotive Engineer <input type="checkbox"/> Diesel Locomotive <input type="checkbox"/> Air Brakes <input type="checkbox"/> Car Inspector <input type="checkbox"/> Railroad Administration <input type="checkbox"/> TEXTILE <input type="checkbox"/> Textile Engineering <input type="checkbox"/> Cotton, Rayon, Woolen Mfg. <input type="checkbox"/> Carding and Spinning <input type="checkbox"/> Warping and Weaving <input type="checkbox"/> Loom Fixing <input type="checkbox"/> Throwing <input type="checkbox"/> Finishing and Dyeing <input type="checkbox"/> Textile Designing
---	---	--	---	---

Name _____ Age _____ Home Address _____

City _____ Zone _____ State _____ Working Hours _____ A.M. to P.M. _____

Occupation _____

Canadian residents send coupon to International Correspondence Schools Canadian, Ltd., Montreal, Canada. . . . Special tuition rates to members of the U. S. Armed Forces.



gives
**BETTER
UHF**
RECEPTION . . .
"ANACONDA"
finest UHF Foam
Polyethylene transmission
line

- ◆ NO MOISTURE PROBLEMS!
- ◆ NO TERMINATION PROBLEMS!
- ◆ EXTREMELY LIGHTWEIGHT!
- ◆ LOW ATTENUATION!



THIS ↑



NOT THIS

Has all channel reception for both UHF and VHF

We have a UL approved universal type "Lightning Arrestor" for use with all Anaconda UHF lines & other types of flat or round TV wires. A stripper for easy installation is also available.

Write for Samples and New Descriptive Literature

Sold through recognized jobbers only!

"National distributors and warehouse for ANACONDA denseath television and radio wires and cables"

Columbia
WIRE & SUPPLY CO.
2850 Irving Park Road • Chicago 18, Ill.

Merchandising and Promotion

Aerovox Corporation, New Bedford, Mass. designed a new *Ceramic Center*

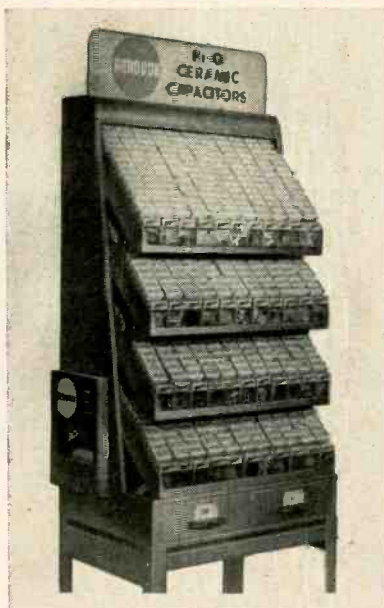

display and dispenser cabinet which holds 700 window cartons of the company's ceramic capacitors.

Raytheon Manufacturing Co., Waltham, Mass., in co-operation with its



Boston area distributors, held a lecture for service technicians in Boston. Bill Ashby, staff lecturer of Raytheon, outlined the company's new *Service Saver* plan which tells the service technician how to save time on service calls and how to build good will and extra business with his customers.

Finnery Co., Cleveland antenna manufacturer, set up an exhibition of its



antennas in a Fort Wayne, Ind. department store in conjunction with the

opening of WKJG-TV, new Fort Wayne TV station. The company followed up with an advertising campaign over the new station.

Alliance Manufacturing Co., Alliance, O., reported considerable success with the fall advertising campaign on its Tenna-Rotor and other TV accessories, according to John Bentia, Alliance vice-president. An independent survey reported that the company ranked 16th among national TV spot advertisers. Mr. Bentia also announced that the company's tie-in promotion with the Milwaukee Braves on the Alliance u.h.f. converter last fall in the Milwaukee area was highly successful.

Simpson Electric Co., Chicago, recently sponsored a series of lectures for service technicians in Northwestern cities. Lloyd Austin, assistant chief engineer for Simpson, demonstrated the use of Simpson equipment in TV alignment.

Javex, Redlands, Calif., designed a new plastic promotional package for

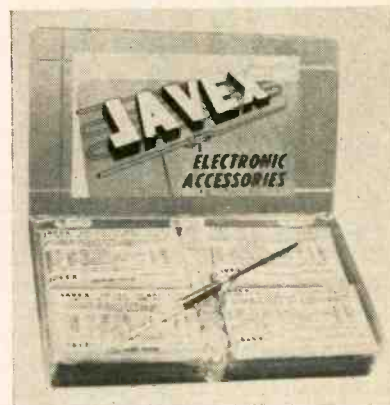

distributors who carry its line of wall plates and other products.

Cornell-Dubilier, South Plainfield, N. J., developed a new compartment type, plastic, hinged-cover case for an assortment of 76 of its most popular *Cub* capacitors.

Ram Electronics, Irvington-on-Hudson, N. Y., held another in its series of forums for service technicians in the St. Louis area under the joint sponsorship of its distributors in that territory.

Jensen Industries, Chicago, issued a new pocket-size booklet for service technicians telling how they can add \$240 a year to their income by selling just one Jensen needle per day.

Production and Sales

RETMA reported the sale of 7,522,862 cathode-ray tubes and 347,152,450 receiving tubes for the first 9 months of 1953. This compares with 3,908,745 cathode-ray tubes and 245,689,629 receiving tubes for the 1952 period. RETMA announced that 5,524,370 TV sets and 10,149,163 radios had been produced in the first 9 months of 1953. This compares with 3,670,590 TV sets and 7,528,412 radios produced in the 1952 period. The association also noted that 4,300,360 TV receivers and 4,526,186 radios (excluding car radios) were sold at retail during the first 9 months of 1953.

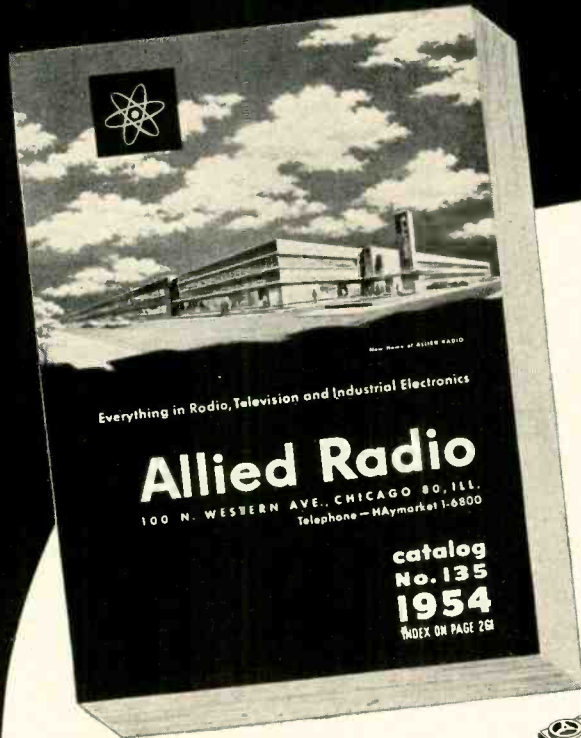

the only COMPLETE catalog for Everything in TV, Radio and Industrial Electronics

FREE value-packed
1954 ALLIED
268-PAGE CATALOG

The World's Largest Stocks

- TV and Radio Parts
- Test Instruments
- High-Fidelity Equipment
- Custom TV Chassis
- AM, FM Tuners and Radios
- Recorders and Supplies
- P.A. Systems, Accessories
- Amateur Station Gear
- Builders' Kits, Supplies
- Equipment for Industry

**Fastest Service
in Electronic Supply**

SEND FOR THE LEADING
ELECTRONIC
BUYING GUIDE
FREE!

NEW HOME OF
ALLIED RADIO
ultra-modern facilities
TO SERVE YOU BEST



EASY PAY TERMS

Use ALLIED'S liberal Easy Payment Plan—only 10% down, 12 months to pay—no carrying charge if you pay in 60 days. Available on Hi-Fi and P.A. units, recorders, TV chassis, test instruments, Amateur gear.

TV and HI-FI SPECIALISTS

To keep up with developments in High-Fidelity and TV, look to ALLIED. Count on us for *all* the latest releases and largest stocks of equipment in these important fields. If it's anything in High-Fidelity or Television—we have it *in stock!*



SEND FOR IT TODAY

Get ALLIED'S latest catalog—268 pages packed with the world's largest selection of quality equipment at lowest, money-saving prices. See all the latest releases in custom TV chassis, TV antennas and accessories; AM and FM tuners and radios; *everything* in High-Fidelity custom components; latest P. A. Systems and accessories; recorders and supplies; Amateur receivers, transmitters and station gear; specialized industrial electronic equipment; test instruments; builders' kits; huge listings of parts, tubes, tools, books—your choice of the world's most complete stocks of quality equipment. ALLIED gives you every buying advantage: speedy shipment, expert personal help, lowest prices, assured satisfaction. Get the big 1954 ALLIED Catalog. Keep it handy—and save time and money. Send for your FREE copy today.

**SAVE ON EVERYTHING
IN ELECTRONICS**

ALLIED RADIO
World's Largest Electronic Supply House

ALLIED RADIO CORP., Dept. 2-A-4
100 N. Western Ave., Chicago 80, Illinois

Send FREE 268-Page 1954 ALLIED Catalog

Name _____

Address _____

City _____ Zone _____ State _____

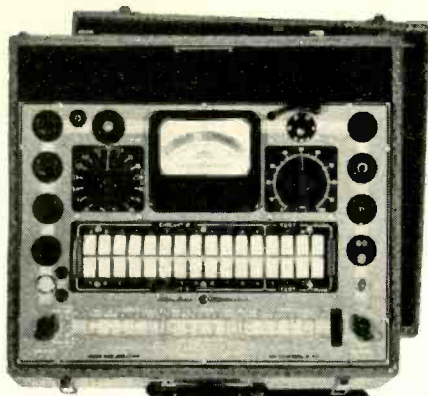

tied together



You get latest tube test data

With the Jackson Model 648 Dynamic® Tube Tester is furnished a roll chart which gives tube data on recently released types, all generally used types, and many older types.

Besides, to keep you right up-to-date between roll chart revisions, we promptly issue a Bullet-in to distributors giving the test setting data on newly announced tubes. The Bullet-in also tells when revised roll charts are ready.

This extra service keeps users of Jackson Tube Testers strictly on the ball—and that's what alert electronic experts want to be!

Get complete information from your electronics distributor—or write us.

JACKSON

ELECTRICAL INSTRUMENT CO

"Service Engineered"
Test Equipment

DAYTON 2, OHIO

In Canada:
The Canadian Marconi Co.

Shows and Conferences

The Second International Sight and Sound Exposition will be held in the Palmer House, Chicago, September 30 through October 2, 1954, a month later than the 1953 show. The show management announced there would be a 75% increase in display space.

The 1954 Audio Fair—Los Angeles, sponsored by the Los Angeles section of the Audio Engineering Society, has been scheduled for February 4-6 in the Alexandria Hotel.

New Plants and Expansions

Sylvania Electric Products broke ground on a new 20-acre site in Fullerton, Calif., for a new TV picture-tube factory. The company is also nearing completion on a 200,000-square-foot extension to its TV picture-tube plant in Seneca Falls, N. Y. It will be used for the manufacture of large picture tubes and for pilot production of color tubes.

Allen B. Du Mont Laboratories moved the Teletron Service Department of its Cathode-Ray Tube Division to new and larger quarters at 760 Bloomfield Ave., Clifton, N. J.

Waldom Electronics broke ground for the construction of a modern new plant in Chicago. The new plant is expected to double the company's production capacity for its electronic components and *Croname* products.

Business Briefs

... RCA announced that it will begin deliveries of its compatible color TV broadcast equipment before the beginning of 1954.

... Channel Master Corp., Ellenville, N. Y. is sponsoring an educational program for its employees under which they may study any course related to their jobs at any school in the country. Channel Master will foot the bill for tuition, books, and any necessary laboratory fees.

... JFD Manufacturing Co., Brooklyn, N. Y., protected the design and construction of its lightning arresters which have sawtooth contact washers with U. S. patents.

... The Gaslight Club, a private club in Chicago, was opened by the *Secret 16*, a group of prominent men in the electronics industry headed by Burton Browne, owner of the Chicago advertising agency bearing his name.

... United Catalog Publishers, Inc., New York City, introduced its File-O-Matic perpetual counter catalog service for distributors.

... NEDA announced more definite plans for its series of regional educational conferences for distributors, at a committee meeting in Pittsburgh. The first meeting will be held in New York City, in the Hotel New Yorker, on either February 8th or March 1st.

... Sarkes Tarzian Rectifier Div., Bloomington, Ind., recently conducted a survey among consumers (predominantly women) in an effort to determine their reaction to color TV. According to George Eannarino, director of the Rectifier Division, \$500 was the

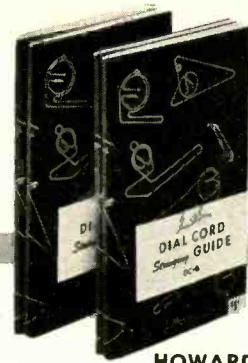

**NEW
VOLS.
3 & 4**

HOWARD W. SAM'S

"DIAL CORD STRINGING GUIDES"

Shows you the ONE right way to string any dial cord in just seconds...

There is only ONE RIGHT WAY to string a radio receiver dial cord, and these are the *only* books that show you how. They cover thousands of receivers, clearly illustrating each dial cord system in a legible diagram that shows you how to solve the knottiest stringing problem in seconds. You'll say goodbye to trouble when you own these invaluable guides—they pay for themselves in the time you save!

VOL. 4. Latest volume includes dial cord stringing diagrams for hundreds of radio and TV-radio receivers produced from mid-1951 through 1953. Includes cumulative index to all 4 volumes. 96 pages. 5½" x 8½".
ORDER DC-4. Only.....\$1.00

VOL. 3. Includes dial cord stringing diagrams for radio receivers produced from 1950 through mid-1951, as well as TV-radio receivers produced from 1946 through mid-1951. 96 pages. 5½" x 8½".
ORDER DC-3. Only.....\$1.00

VOL. 2. Covers dial cords used in receivers produced from 1947 through 1949. Indexed for quick reference. 96 pages. 5½" x 8½".
ORDER DC-2. Only.....\$1.00

VOL. 1. Complete dial cord stringing data for hundreds of receivers produced from 1938 through 1946. 112 pages. 5½" x 8½".
ORDER DC-1. Only.....\$1.00

OWN ALL 4—LICK ANY DIAL CORD STRINGING PROBLEM IN SECONDS

HOWARD W. SAM'S & CO., INC.

Order from your Parts Jobber today, or write to Howard W. Sams & Co., Inc., 2205 East 46th St., Indianapolis 5, Ind.

My (check) (money order) for \$..... enclosed. Send the following books:

- DC-4 (\$1.00) DC-2 (\$1.00)
 DC-3 (\$1.00) DC-1 (\$1.00)

Name.....

Address.....

City..... Zone..... State.....

(Outside U.S.A. priced slightly higher)

RADIO-ELECTRONICS



J. E. SMITH
 President
 National Radio
 Institute
 Washington, D. C.
 40 years of success
 training men at
 home in spare time.

I Will Train You at Home

for Good Pay Jobs, Success in

RADIO-TELEVISION



Practice Broadcasting with Equipment I Send

As part of my Communications Course I send you kits of parts to build the low-power Broadcasting Transmitter shown at the left. You use it to get practical experience putting a station "on the air," performing procedures demanded of Broadcasting Station Operators. An FCC Commercial Operator's License can be your ticket to a better job and a bright future; my Communications Course gives you the training you need to get your license. Mail card below and see in my book other valuable equipment you build.



Practice Servicing with Equipment I Send

Nothing takes the place of **PRAC-TICAL EXPERIENCE**. That's why NRI training is based on **LEARN-ING BY DOING**. You use parts I furnish to build many circuits common to Radio and Television. With my Servicing Course you build a modern Radio (shown at right). You build a Multitester which you use to help fix sets while training. Many students make \$10, \$15 a week extra fixing sets in spare time starting a few months after enrolling. All equipment is yours to keep. Card below will bring book showing other equipment you build.

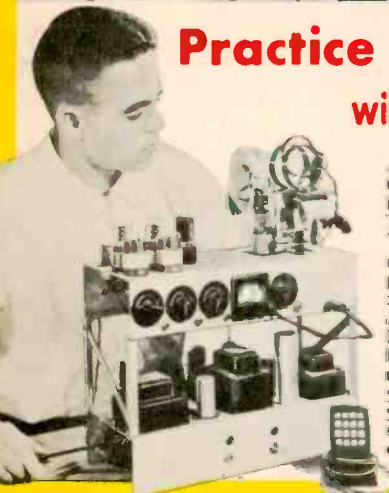
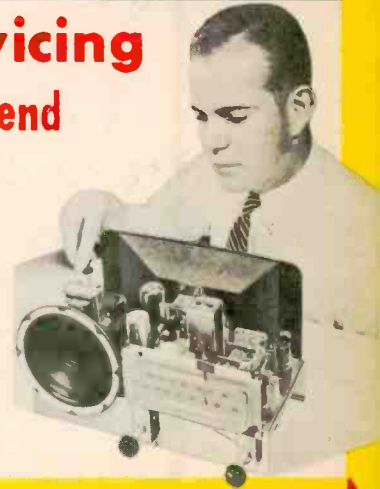

Television is Growing Fast Making New Jobs, Prosperity

More than 25 million homes now have Television sets and thousands more are being sold every week. Well trained men are needed to make, install, service TV sets. About 200 television stations on the air with hundreds more being built. Think of the good job opportunities here for qualified technicians, operators, etc. If you're looking for opportunity get started now learning Radio-Television at home in spare time. Cut out and mail postage free card. J. E. Smith, President, National Radio Institute, Washington, D. C. OUR 40TH YEAR.

**AVAILABLE TO
 VETERANS
 UNDER G.I. BILL**

**Good Jobs, Good Pay, Success
 in Radio-TV! SEE OTHER SIDE**

CUT OUT AND MAIL THIS CARD NOW

Sample Lesson & 64-Page Book
Both FREE

This card entitles you to Actual Lesson on Servicing, shows how you learn Radio-Television at home. You'll also receive my 64-Page Book, "How to Be a Success in Radio-Television." Mail card now!

NO STAMP NEEDED! WE PAY POSTAGE

Mr. J. E. SMITH, President,
 National Radio Institute, Washington 9, D. C.

Mail me Lesson and Book, "How to Be a Success in Radio-Television." (No Salesman will call. Please write plainly.)

NAME.....AGE.....

ADDRESS.....

CITY.....ZONE.....STATE.....

VETS write in date
 of discharge.....
 B C D E

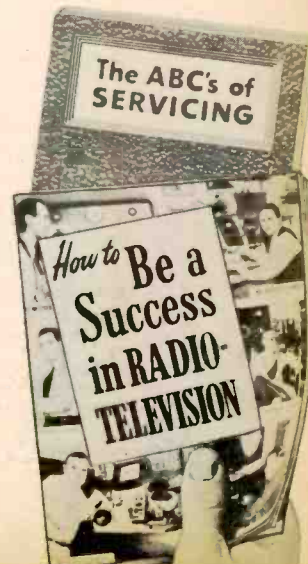

Train at Home to Jump Your Pay as a RADIO-TV Technician



J. E. Smith, President
National Radio Institute

The men whose messages are published below were not born successful. Not so long ago they were doing exactly as you are now... reading my ad! They decided they should KNOW MORE... so they could EARN MORE... so they acted! Mail card below now.

Get a Better Job—Be Ready for a Brighter Future in America's Fast Growing Industry

Training PLUS opportunity is the PERFECT COMBINATION for job security, good pay, advancement. When times are good, the trained man makes the BETTER PAY, GETS PROMOTED. When jobs are scarce, the trained man enjoys GREATER SECURITY. NRI training can help assure you and your family more of the better things of life.

Radio-Television is today's opportunity field. Even without Television, Radio is bigger than ever before. Over 3,000 Radio Broadcasting Stations on the air; more than 115 million home and Automobile Radios are in use. Then add Television. Television Broadcast Stations extend from coast to coast now with over 25 million Television sets already in use. There are channels for 1,800 more Television Stations. Use of

Aviation and Police Radio, Micro-Wave Relay, Two-way Radio communication for buses, taxis, trucks, etc. is expanding. New uses for Radio-Television principles coming in Industry, Government, Communications and Homes.

My Training is Up-to-Date You Learn by Practicing

Get the benefit of my 40 years experience training men. My well-illustrated lessons give you the basic principles you must have to assure continued success. Skillfully developed kits of parts I furnish "bring to life" the principles you learn from my lessons. Read more about equipment you get on other side of this page.

Naturally, my training includes Television. I have, over the years, added more and more Television information to my courses. The equipment I furnish students gives experience on circuits common to BOTH Radio and Television.

Find Out About the Tested Way to Better Pay

Read at the right how just a few of my students made out who acted to get the better things of life. Read how NRI students earn \$10, \$15 a week extra fixing Radios in spare time starting soon after enrolling. Read how my graduates start their own businesses. Then take the next step—mail card below.

You take absolutely no risk. I even pay postage. I want to put an Actual Lesson in your hands to prove NRI home training is practical, thorough. I want you to see my 64-page book, "How to Be a Success in Radio-Television" because it tells you about my 40 years of training men and important facts about present and future Radio-Television job opportunities. You can take NRI training for as little as \$5 a month. Many graduates make more than the total cost of my training in two weeks. Mailing postage free card can be an important step in making your future successful. J. E. Smith, President, National Radio Institute, Washington 9, D. C. OUR 40TH YEAR.

I TRAINED THESE MEN



Handicapped but Successful

"I am now Chief Engineer at WHAW. My left hand is off at the wrist. A man can do... if he wants to." R. J. Bailey, Westob, W. Va.



\$10 a Week In Spare Time

"Before finishing, I earned as much as \$10 a week in Radio servicing, in my spare time. I recommend NRI." S. J. Petrucci, Miami, Fla.



Control Operator, Station WEAN

"I received my license and worked on ships. Now with WEAN as control operator, NRI course is complete." R. Arnold, Rumford, R. I.



Has Own Radio-Television Shop

"Doing Radio and Television servicing full time. Have my own shop. I owe my success to NRI." Curtis Stath, Fort Madison, Iowa.



Has Growing Business

"Am becoming expert Teletician as well as Radiotriplan. Without your course this would be impossible." P. Brogan, Louisville, Ky.



Got First Job Thru NRI

"My first job was with KDLR. Now Chief Engr. of Radio Equipment for Police and Fire Dept." T. Norton, Hamilton, Ohio.

NRI Training Leads to Jobs Like These

- | | |
|--|---|
| BROADCASTING
Chief Technician
Chief Operator
Power Monitor
Recording Operator
Remote Control Operator | GOVERNMENT RADIO
Operator in Army, Navy, Marine Corps, Coast Guard
Forestry Service
Dispatcher
Always Radio Operator |
| SERVICING
Home and Auto Radios
P. A. Systems
Television Receivers
Electronic Controls
FM Radios | AVIATION RADIO
Plane Radio Operator
Transmitter Technician
Receiver Technician
Airport Transmitter Operator |
| IN RADIO PLANTS
Design Assistant
Transmitter Design Technician
Service Manager
Tester
Serviceman
Research Assistant | TELEVISION
Pick-up Operator
Voice Transmitter Operator
Television Technician
Remote Control Operator
Service and Maintenance Technician |
| SHIP AND HARBOR RADIO
Chief Operator
Assistant Operator
Radiotelephone Operator | POLICE RADIO
Transmitter Operator
Receiver Serviceman |

Find Out What RADIO-TV Offers You

SAMPLE LESSON and 64-PAGE BOOK Both FREE

Cut out and mail postage-free card today!

Start Soon to Make \$10, \$15 a Week Extra Fixing Sets

Keep your job while training. Many NRI students make \$10, \$15 and more a week extra fixing neighbors' Radios in spare time starting a few months after enrolling. I start sending you special booklets that show you how to fix sets the day you enroll. The multimeter you build with parts I furnish helps discover and correct troubles.



Do You Want Your Own Business?

Many NRI trained men start their own successful Radio-Television sales and service business with capital earned fixing Radios in spare time. My book tells how you can be your own boss. Joe Travers, a graduate of mine, in Asbury Park, N. J., writes: "I've come a long way in Radio and Television since graduating. Have my own business on Main Street."



FIRST CLASS
Permit No. 20-R
(Sec. 34.9, P.L. & R.)
Washington, D.C.

BUSINESS REPLY CARD

No Postage Stamp Necessary If Mailed In The United States

POSTAGE WILL BE PAID BY
NATIONAL RADIO INSTITUTE
16th and U Sts., N.W.
Washington 9, D. C.

price set as the limit most of those questioned would pay. However, an overwhelming majority would be satisfied to wait two years if the price could be brought down to \$300.

... The General Electric Tube Dept., Schenectady, N. Y., has launched a new program of controlled field testing of its TV receiving tubes, according to John T. Thompson, manager of replacement tube sales for the Tube Department. The program is being conducted by Howard W. Sams & Co., Indianapolis, Ind.

... Superex Electronics Corp., Yonkers, N. Y., is now operating Rayburne Corp. and will market the combined lines of electronic components and equipment under the Superex name. Superex is headed by engineers Daniel Schulman and Marvin Buchalter.

... The Finney Company, 4612 St. Clair Avenue, Cleveland 3, Ohio, manufacturers of the FINCO 400-A fringe area antenna, have obtained a court judgment for damages and a permanent injunction against a Canton, Ohio service company that had been selling an antenna much inferior to the FINCO as a genuine FINCO antenna.

The following quotation is reproduced from a decision of the Court of Common Pleas, Stark County, Ohio, November 6, 1953: "Being fully advised in the premises and by agreement of the parties hereto, the Court finds that the defendant has engaged in unfair competition, as in said petition complained of, by passing off unto its customers, as "FINCO" antenna, other antennas of similar appearance which were not genuine "FINCO" antennas and which were not products of the plaintiff, and that plaintiff is entitled to an award of damages and a final and permanent order restraining defendant from further unfair competition with the plaintiff."

Within a week after the decision was rendered, The Finney Company ran a large ad in the Canton newspaper reproducing a paragraph from the court decision and warning the Canton public against the possibility of being victimized in the future by the few and isolated service companies who engage in unscrupulous substitution practices.

... 1954 Electronic Parts Show manager, Kenneth C. Prince, announced that contracts for more than one half the Exhibition Hall space at the Conrad Hilton Hotel for the May show had been received within ten days of the original mailing. Drawings for space were held in New York City, December 9th.

... National Union Radio Corp., Hatboro, Pa., has begun pilot production on RCA color tubes and it announced plans to begin similar production on the CBS color tube as well, at a later date.

... The 1954 Western Electronic Show and Convention to be held in Los Angeles will have Mal Mobley, Jr. as business manager. Heckert Parker, business manager of the 1953 show, will act as management consultant. END

Quality Features OF TUNG-SOL PICTURE TUBES

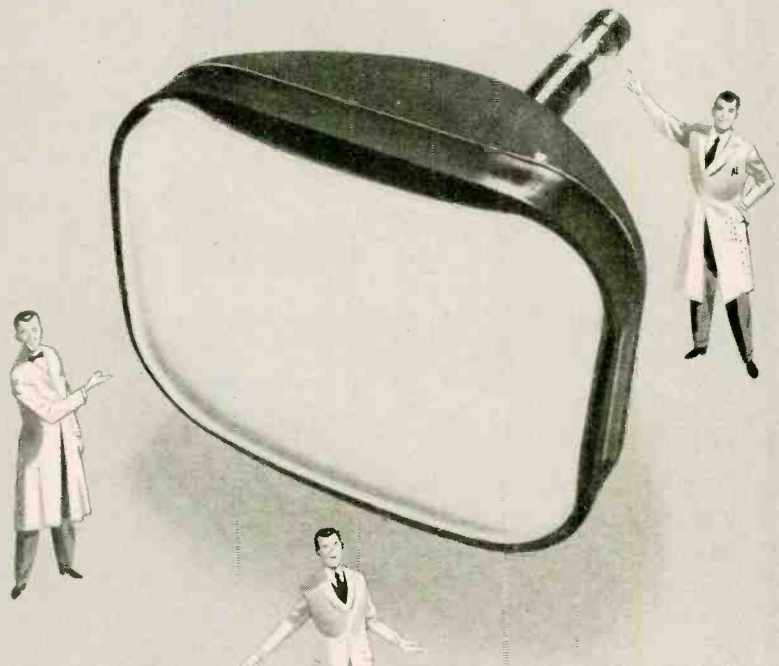

Gun made of best grade non-magnetic steel.

Glass bead type assembly is stronger both mechanically and electrically—gives greater protection against electrical leakage.

Rolled edges in gun minimize corona.

Custom built stem with greater spacing between leads assures minimum leakage.

Low resistance of outside conductive coating minimizes radiation of horizontal oscillator sweep frequency.

Double cathode tab provides double protection against cathode circuit failure.

Selected screen composition resists burning (X pattern).

Rigid control of internal conductive coating provides utmost service reliability.

Designed for use with single or double field ion trap designs.

One-piece construction of parts assures better alignment.

Maximum dispersion of screen coating assures uniform screen distribution.

Tung-Sol makes All-Glass Sealed Beam Lamps, Miniature Lamps, Signal Flashers, Picture Tubes, Radio, TV and Special Purpose Electron Tubes and Semiconductor Products.

TUNG-SOL®

RADIO AND TV TUBES

TUNG-SOL ELECTRIC INC., Newark 4, N. J.
Sales Offices: Atlanta, Chicago, Columbus, Culver City (Los Angeles), Dallas, Denver, Detroit, Newark, Seattle.

YOU CAN BUILD A REPUTATION ON TUNG-SOL QUALITY

**THIS ANTENNA
OUT-PERFORMS:**

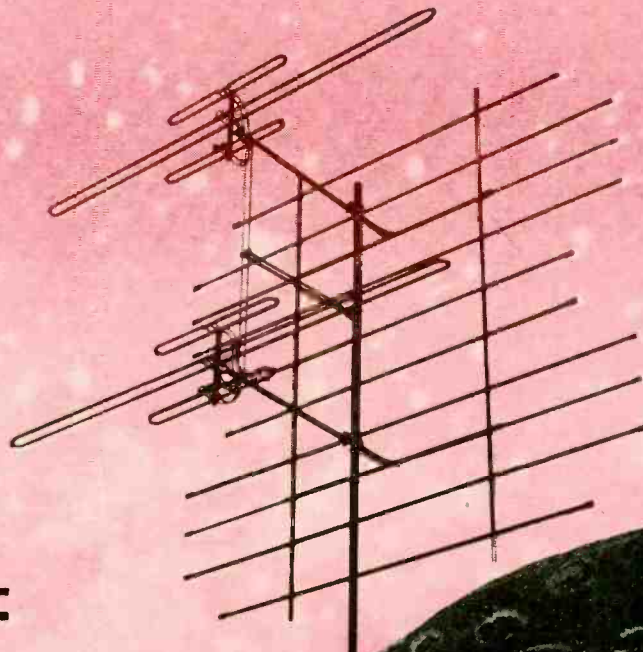
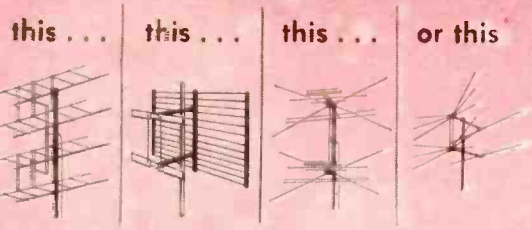

the AMAZING VHF
CHAMPION*

a NEW KIND of Antenna
that out-performs every all-channel
VHF antenna ever made — —
and many Yagis, too!

America's servicemen have spoken! In only 2 months, they've made the CHAMPION the nation's top-selling VHF antenna! It's the highest gain all-channel VHF antenna ever developed, and its performance has now been proven by over 30,000 outstanding installations.

Only the CHAMPION has the unique new "Tri-Pole", a triple-powered dipole system in which the Low Band dipole also functions as three dipoles tied together, in phase, on the High Band.

Folded dipoles throughout give close to 300 ohms impedance across entire band. Lightweight, all-aluminum construction. Available in one, two, or four-bays.



**CHANNEL
MASTER
CONQUERS
SPACE!**

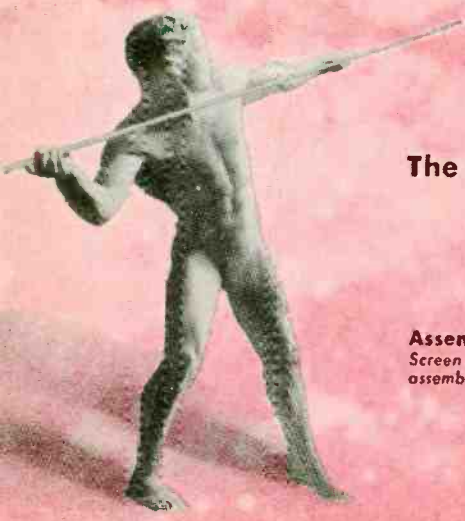

The stacked CHAMPION provides:

- 11-13 DB High Band gain
- 6½-7½ DB Low Band gain

Assembles faster than a five-element Yagi.
Screen "Pops-Up" instantly. "Tri-Pole"
assembly just snaps into place.

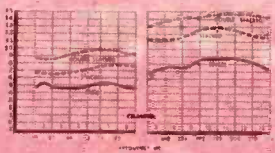

horizontal polar pattern (relative voltage)

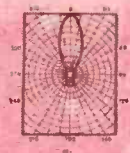

CHANNEL MASTER CORP.
OLEENVILLE, N. Y.



model no.	description	list price
325-1	single bay	\$20.95
325-2	two bay	42.50
325-4	four bay	88.95
Separator Stacking Harnesses		
325-3	2 bay harnesses	\$2.00
325-5	4 bay harnesses	4.10

*Pat. Pend.

3 great, new UHF antennas

by **CHANNEL MASTER**

STACKED TWIN CORNER REFLECTOR model no. 406-2

The most powerful UHF fringe area installation you can make today!

- Broad Band coverage — yet out-performs most stacked Yagis.
- Covers every UHF channel, not just segments of the band.
- New impedance-matching, two-stage stacking system.

Another original Channel Master development!

Model No.	Description	List Price
406	Twin Corner Reflector	\$18.06
406-2	2-Stage Twin Corner Reflector. Stacking harness furnished free.	36.10
406-3	Stacking harness only, furnished separately.	2.08

up to **17 1/2 DB**

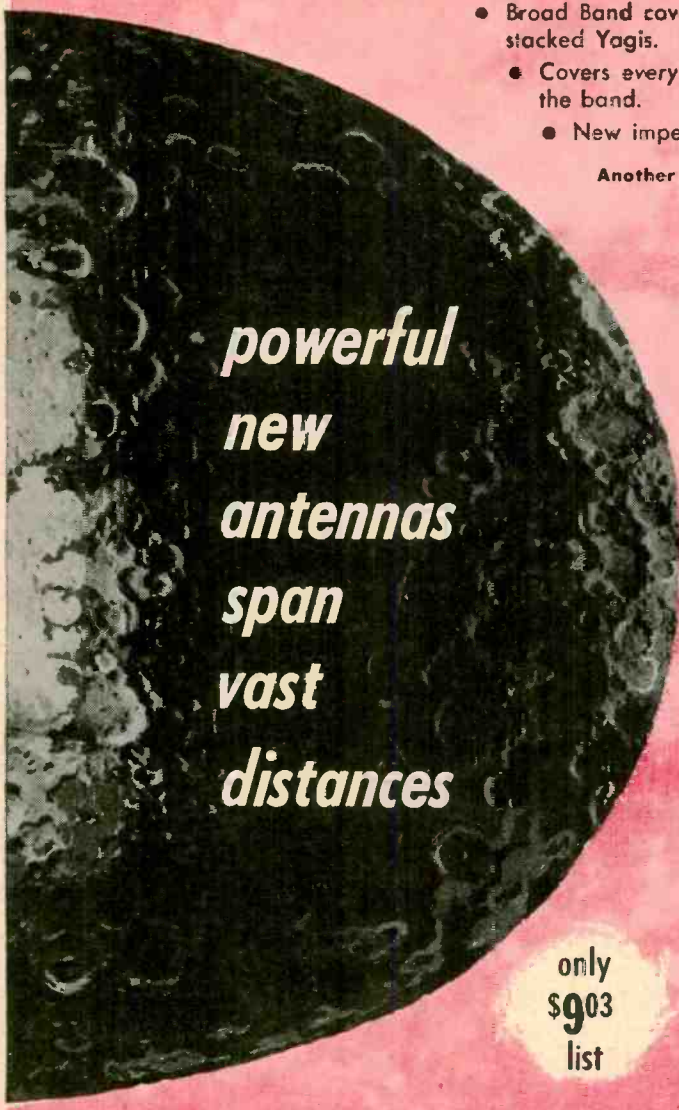
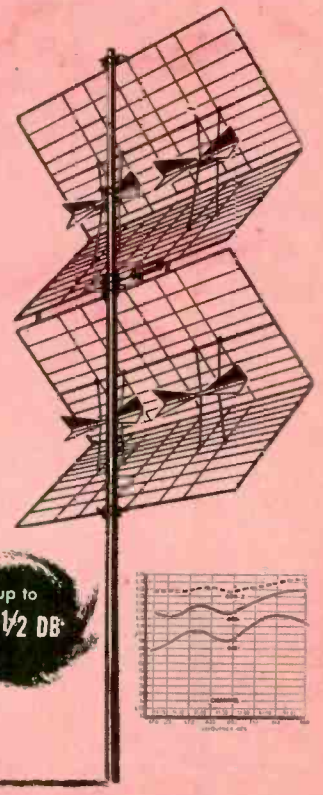
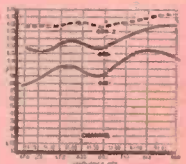

*powerful
new
antennas
span
vast
distances*

only \$903 list

the first UHF CORNER REFLECTOR with optional "2-way" mounting!

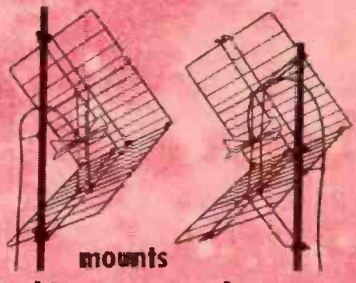

mounts this way ... or this way

model no. 409

Only CHANNEL MASTER'S CORNER REFLECTOR can be adapted to any kind of UHF installation — with or without VHF — at no extra cost. Every antenna contains all necessary hardware and braces for BOTH popular types of mounting. Sharp directivity and unusually high gain across entire UHF band.

Installs instantly! Original Channel Master assembly feature: Screen swings open like a book — dipole assembly snaps into place.

"SWEET 16" The World's First 15-Element UHF Yagi!

- Custom-designed for your particular area.
- Super-power! Sensational fringe area reception.
- Delta-Weld design. Elements WELDED to crossarm. Delta-matched dipole gives uniform impedance.
- Wide band coverage, up to 21 channels.
- Average gain: 13 DB single
16 DB stacked

model no. 420

\$8.20 list

CHANNEL MASTER CORP.
LITTLEVILLE, N. C.



Send for complete technical literature.



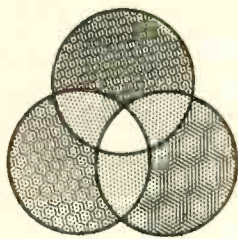

"Color Television"



A special issue containing

▲ 15 N.T.S.C. Monographs

The National Television Systems Committee has authorized IRE to publish its long awaited Monographs in the January 1954 special Color Television issue of "Proceedings of the I·R·E" — thus giving them industry-wide distribution for the first time in print.

▲ 25 additional Color TV articles —

will also appear in this issue, which brings the reader up-to-the-minute on the developments of Color Television. Copies of the first Color Television issue are still available and combined with this second Color Television issue will form a complete bibliography of major historical importance. Also included in the January issue will be a complete listing of the N.T.S.C. system specifications as submitted to the F.C.C.; and field test reports on the system's performance.

▲ in "Proceedings of the I·R·E" January '54

Available to non-members for \$3.00. Extra copies to I R E members are \$1.25. All members get one copy free!

*Another
History
Making
Issue!*



I R E is an organization of 33,312 member-engineers. There are no company memberships. Operating continuously since 1913, its sections meet in 78 cities. 21 specialized Professional Groups widen the scope of its member-services and 40 technical committees help the industry.

"Proceedings of the I·R·E"

Published by

THE INSTITUTE OF RADIO ENGINEERS

1 East 79th Street, New York 21, N. Y.

**You can't
do without...**

SYLVANIA'S SEE-WELL TOOL KIT

A NEW, TIME-SAVING TOOL-SENSATION!

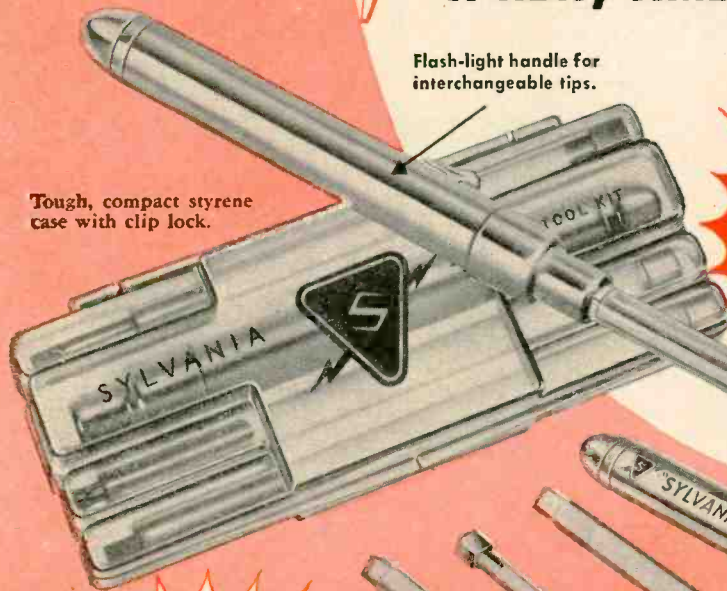

Tough, compact styrene case with clip lock.

Flash-light handle for interchangeable tips.

**YOUR 3 MOST NEEDED TOOLS
IN 1 KIT-MAGNETIC PHILLIPS AND
FLATHEAD SCREWDRIVERS, NYLON
ALIGNMENT TOOL - PLUS
POWERFUL FLASHLIGHT!**

This
\$ 7.95
VALUE
for only 15
Sylvania Premium Tokens.

Flat screwdriver, magnetized tempered steel, clear lucite shaft for tight fitting handle.

Break-resistant lucite spotlights work.

Stainless steel handle with built-in flash-light. Uses 2 pencil light batteries of any size (not included in kit).

Magnetized tempered steel Phillips screwdriver head embedded in clear lucite shaft.

Nylon, non-conductive alignment tool on lucite rod, to reach and see what you're doing.

NO MORE FUMBLING inside dark radio and TV cabinets. At the flick of a switch, a bright light automatically focuses right at the spot you're seeking. Saves your time . . . improves your work.

3 Handy Tools in 1. Magnetized Phillips and Flathead screwdrivers, nylon alignment tool - all 3 built into break-resistant lucite shafts perfectly fitted to flashlight handle.

Without doubt, this SEE-WELL Tool Kit is one of the slickest, quickest service tools ever built!

See your Sylvania Distributor Today! He has this remarkable tool kit for you now - you need only 15 Sylvania Premium Tokens. The time to get this valuable Sylvania See-Well Tool Kit is NOW - so don't delay, order high quality Sylvania tubes TODAY.

Remember, you get 1 token with every 25 Sylvania Receiving Tubes or every Sylvania TV Picture Tube you buy.

SYLVANIA

Sylvania Electric Products Inc. Dept. 4R-3801, 1740 Broadway, New York 19, N. Y.

In Canada: Sylvania Electric (Canada) Ltd.
University Tower Bldg., St. Catherine Street, Montreal, P. Q.

LIGHTING • RADIO • ELECTRONICS • TELEVISION

JANUARY, 1954



For accurate
flexible and
quick tube
testing at
low cost...
model 3413-A

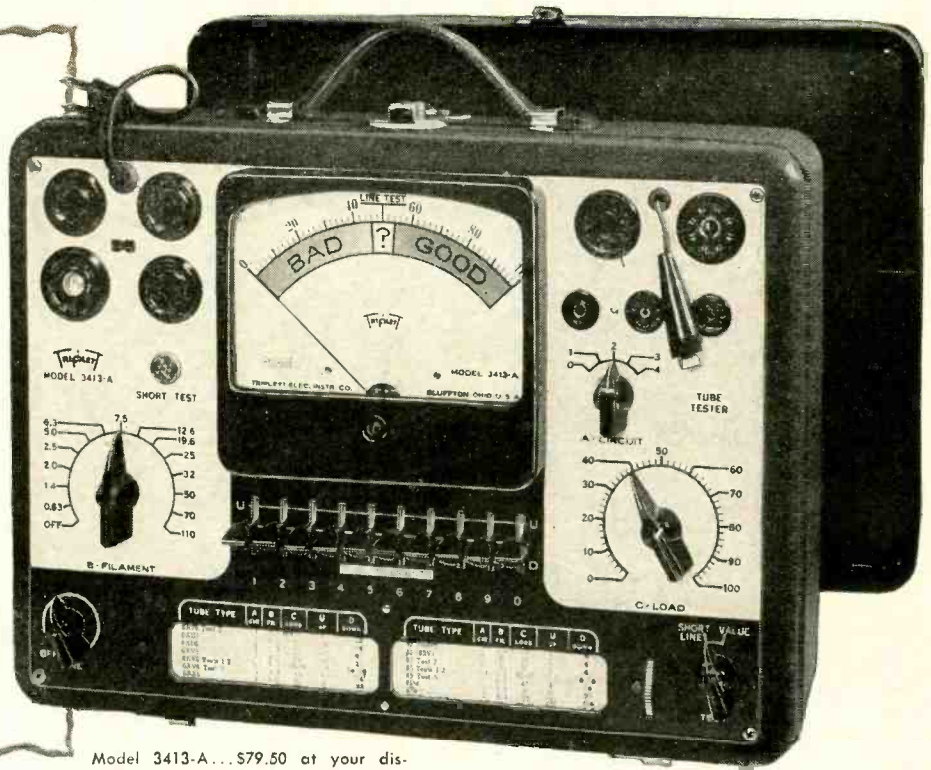

Model 3413-A...\$79.50 at your distributor. (Price subject to change.) BV Adapter, \$7.90 Add'l.

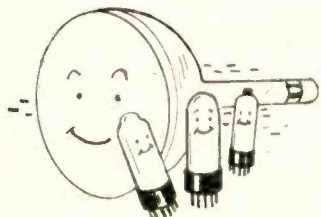

1. YOU CAN TEST MORE TYPES of tubes, also appliances for shorts and open circuits.

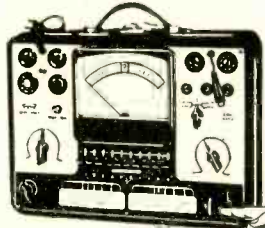

2. JUST SPIN THE KNOB—for correct, last-minute data, on the speed roll chart. Lists 700 tubes.

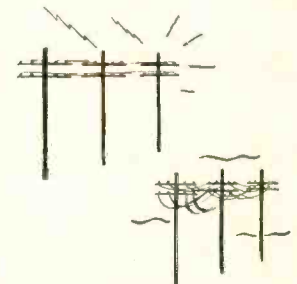

3. YOU CAN COMPENSATE for line voltage—just throw snap-action switch.

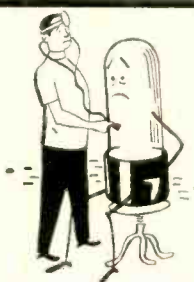

4. YOU CAN TEST EACH ELEMENT in each tube—by a simple flip of the switch.

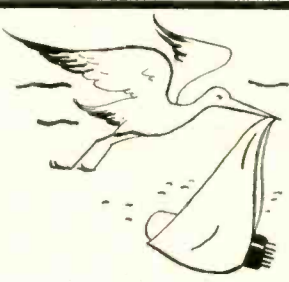

5. YOU CAN TEST THE NEW TUBES—including those with low cathode current.



6. YOU GET NEW TUBE DATA—immediately, while it is still news. No waiting.

Nearly Half a Century of Service to the Service Man

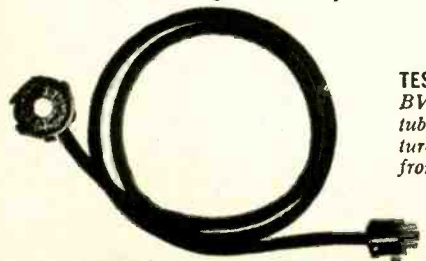

TESTS PICTURE TUBES, TOO! With this BV Adapter, Model 3413-A tests every tube in a TV receiver, including the Picture Tube—without even removing tube from receiver or carton! Saves time!

FOR THE MAN WHO TAKES PRIDE IN HIS WORK

Triplet

TRIPLET ELECTRICAL INSTRUMENT CO., BLUFFTON, OHIO, U. S. A.

RADIO-ELECTRONICS

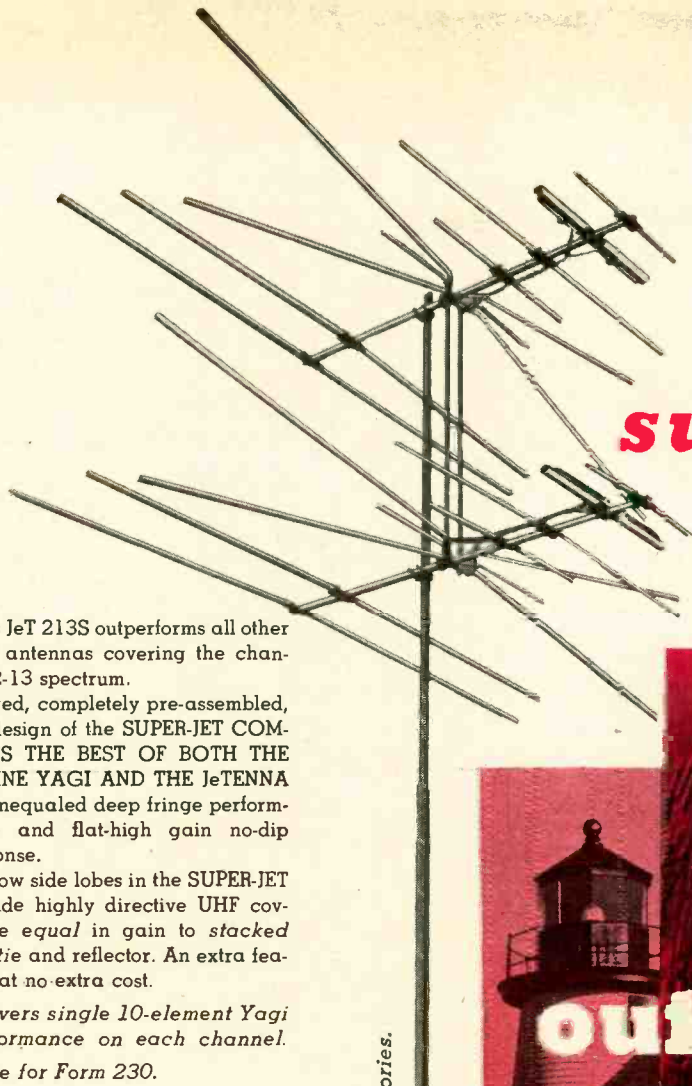

THE JFD
super-jet

JFD's JeT 213S outperforms all other VHF antennas covering the channel 2-13 spectrum. Rugged, completely pre-assembled, the design of the SUPER-JET COMBINES THE BEST OF BOTH THE BALINE YAGI AND THE JeTENNA for unequalled deep fringe performance and flat-high gain no-dip response. Narrow side lobes in the SUPER-JET provide highly directive UHF coverage equal in gain to stacked bowtie and reflector. An extra feature at no extra cost.

Delivers single 10-element Yagi performance on each channel. Write for Form 230.

HERE ARE THE FACTS—
COMPARE FOR YOURSELF.

JFD JeT 213 S	Competitor D CHS 213 YAGI	Competitor C RADAR SCREEN TYPE B	Competitor B RADAR SCREEN TYPE A	Competitor A MATTRESS (4 STACK)	CHAN
					NELS
6.5	4.50	0.75	0.0	4.0	2
7.5	5.00	3.25	3.0	5.0	3
9.5	5.75	4.5	4.0	7.0	4
8.5	3.00	3.5	3.25	6.25	5
8.5	2.50	3.5	3.0	5.0	6
11.0	3.50	6.0	4.5	5.25	7
11.0	1.00	7.0	7.0	6.0	8
12.0	0.0	6.5	7.0	5.25	9
12.0	.875	7.75	8.0	7.25	10
11.25	.875	8.0	10.0	9.25	11
12.75	.50	7.5	10.0	6.5	12
12.0	7.5	6.0	9.0	7.0	13
DB GAIN					
YES	NO	NO	NO	NO	1" Square Cross Arm Completely Pre-Assembled
YES	NO	NO	NO	YES	
\$42.50	\$65.90	\$47.50	\$34.95	\$55.00	LIST PRICE

World's largest manufacturer of TV antennas and accessories.

outperforms
across
the nation

JFD MFG. CO.



BRONX 4, N. Y.

Burton Browne adv.

A **Leader** First

No Drift, No Coast



Only
Superotor[®]
HAS
Double Lock Stop

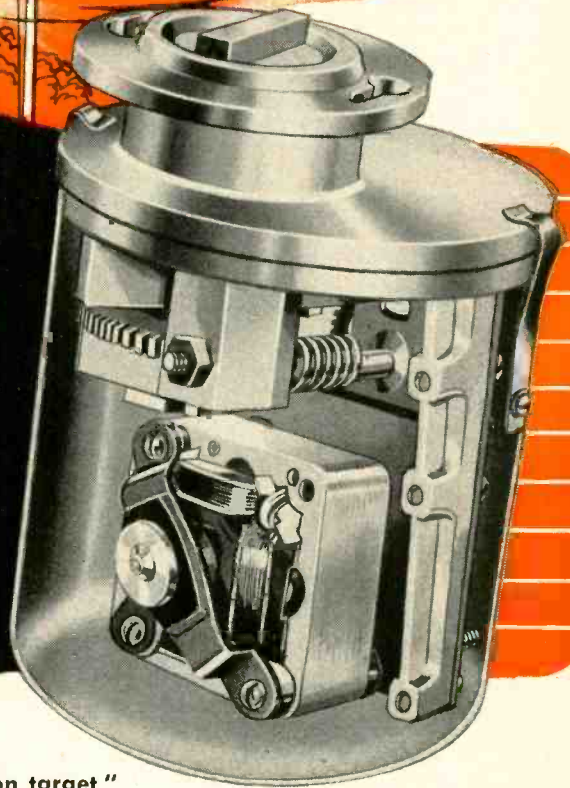

At last! — an antenna rotator that really stays "on target." With Superotor there's no jumping up to make adjustments, because it locks in place two ways, instead of one. First, a motor brake eliminates "coasting"; second, a worm gear lock prevents "drifting." This exclusive double lock also permits rotation in increments of less than 1/2-degree, enabling razor-sharp tuning for top UHF reception!



Compare All The Features, And You'll Join The Big Switch To Superotor



• Quick Detachable Drive Unit

A **Leader** First



• Built-in Chimney Mount

A **Leader** First



• Steel-Reinforced Construction

A **Leader** First



• VP* Tuning Accurate—Precise Simple

A **Leader** First



2925 EAST 55TH STREET
CLEVELAND 27, OHIO

Patent Applied for Copyright

LEADING THE WAY TO BETTER PRODUCTS

RADIO-ELECTRONICS

CREI prepares you quickly for success in

The future is in your hands!

The signs are plain as to the future of the trained men in the electronics industry. It is a tremendous industry, and—at the *present time* there are more jobs than there are trained men to fill them. But—when there's a choice between a trained and untrained applicant, the trained man will get the job. Your biggest problem is to decide on—and begin the best possible training program.

**CREI Home Study . . .
The Quick Way to Get There.**



Since 1927, CREI has given thousands of ambitious young men the technical knowledge that leads to more money and security. The time-tested CREI procedure can help *you*, too—if you really want to be helped. CREI lessons are prepared by experts in easy-to-understand form. There is a course of instruction geared to the field in which you want to specialize. You study at *your* convenience, at *your* rate of speed. Your CREI instructors guide you carefully through the material, and grade your written work personally (not by machine).

Industry Recognizes CREI Training.

CREI courses are prepared, and taught with an eye to the needs and demands of industry, so your CREI diploma can open many doors for you. Countless CREI graduates now enjoy important,

good-paying positions with America's most important companies. Many famous organizations have arranged CREI group training for their radio-electronics-television personnel. To name a few: All America Cables and Radio, Inc.; Canadian Aviation Electronics, Ltd.; Canadian Broadcasting Corporation; Columbia Broadcasting System; Canadian Marconi Company; Hoffman Radio Corporation; Machlett Laboratories; Glenn L. Martin Company; Magnavox Company; Pan American Airways, Atlantic Division; Radio Corporation of America, RCA Victor Division; Technical Appliance Corporation; Trans-Canada Air Lines; United Air Lines. Their choice for training of their own personnel is a good cue for *your* choice of a school.



Benefits Felt Right Away.

Almost immediately, you feel the benefits of CREI training. Your employer, when informed of your step toward advancement (only at your request), is certain to take new interest in you and in your future. What you learn in CREI Home Study can start helping you do a better job immediately.

- BROADCASTING
- TELEVISION
- MANUFACTURING
- COMMUNICATIONS
- SERVICING
- AERONAUTICAL ELECTRONICS



CREI also offers Resident Instruction

at the same high technical level—day or night, in Washington, D. C. New classes start once a month. If this instruction meets your requirements, check the coupon for Residence School catalog.

INFORMATION FOR VETERANS

If you were discharged after June 27, 1950—let the new G. I. Bill of Rights help you obtain resident instruction. Check the coupon for full information.

Get this fact-packed booklet today. It's free.

Called "Your Future in the New World of Electronics," this free illustrated booklet gives you the latest picture of the growth and future of the gigantic electronics world. It includes a complete outline of the courses CREI offers (except Television and FM Servicing) together with all the facts you need to judge and compare. Take 2 minutes to send for this booklet right now. We'll promptly send your copy. The rest—your future—is up to you.



CAPITOL RADIO ENGINEERING INSTITUTE

An Accredited Technical Institute • Founded in 1927

3224 16th Street, N.W.

Washington 10, D. C.

JANUARY, 1954

MAIL COUPON TODAY

CAPITOL RADIO ENGINEERING INSTITUTE

Dept. 141-A 3224 16th St., N.W., Washington 10, D. C.

Send booklet "Your Future in the New World of Electronics" and course outline.

- CHECK FIELD OF GREATEST INTEREST
- TV, FM & Advanced AM Servicing
 - Practical Radio Engineering
 - Broadcast Radio Engineering (AM, FM, TV)
 - Practical Television Engineering
 - Aeronautical Radio Engineering

Name.....

Street.....

City.....Zone.....State.....

Check— Residence School Veteran

Now It's

Plug - In

Selenium Rectifiers

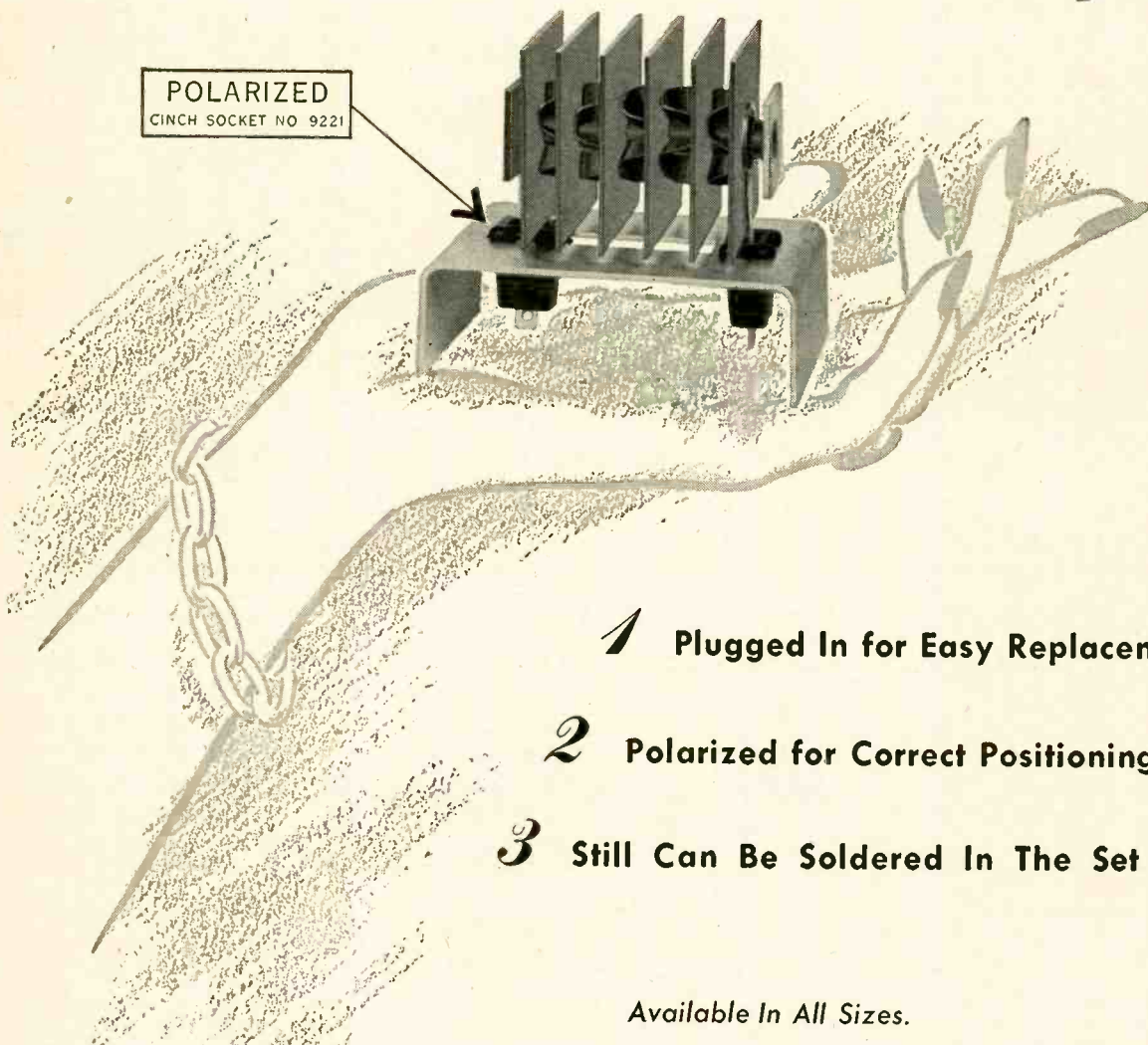

- 1** Plugged In for Easy Replacement
- 2** Polarized for Correct Positioning
- 3** Still Can Be Soldered In The Set

Available In All Sizes.

Write for Further Information.



RECTIFIER DIVISION

415 N. College Ave., Dept. N-1, Bloomington, Indiana

In Canada - 50 St. Clair Ave., N. W., Toronto

Here's your Opportunity

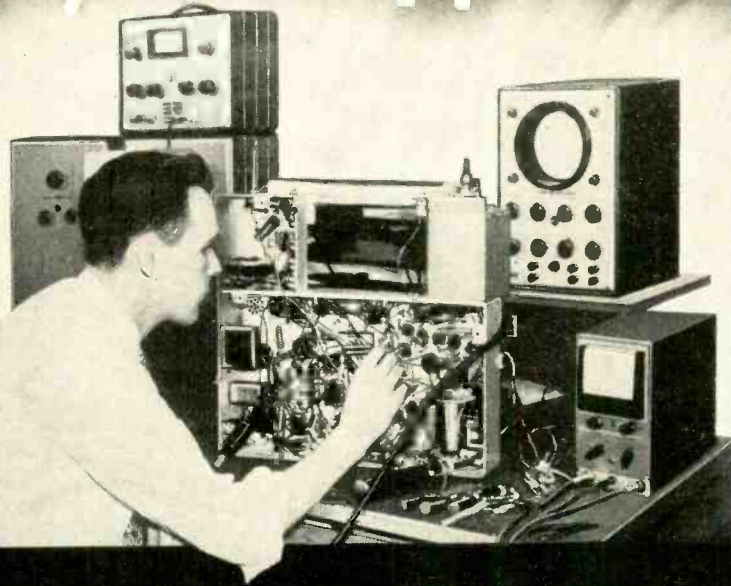

**to prepare for a good job or a business
of your own in TV SERVICING**

ARE YOU SATISFIED with the position you now hold? Do you feel you're worth more money? Are you pleased with yourself, your work, your associates . . . and your future? What does the next year hold for you . . . and the year after that?

Are you content merely to plod along through the best years of your life . . . or do you want to get into more pleasant work . . . hold a well-paid job . . . perhaps establish your own business?

If you are looking for a REAL opportunity . . . If you want to GROW with a GROWING INDUSTRY . . . If you want to grasp the success that should be yours, *then we say to you, study TV Servicing.*

Everyone knows that Television is the fastest growing industry today. Opportunities are going begging for men who have

the training and ability to grasp them. *Now is the time to start on the road to success in TV Servicing.*

Study at Home in your spare time

The RCA Institutes Home Study Course in TV Servicing is easy to learn. You progress rapidly, step by step, as you learn the procedure of servicing and trouble-shooting TV receivers and installing TV antennas. Hundreds of pictures and diagrams help you understand the how-it-works information and the how-to-do-it techniques.

A Service of Radio Corporation of America

The RCA Institutes TV Servicing course was written and planned by instructors with years of specialized experience in training men. You get up-to-the-minute information, too, because you study right at the source

of the latest developments in Television. Your lessons are carefully examined and accurately graded by competent teachers who are interested in helping You to succeed.

RCA Institutes is licensed by the University of the State of New York . . . an affiliate member of the American Society for Engineering Education . . . approved by leading Radio-Television Service Organizations.

It costs so little to gain so much

RCA Institutes makes it easy for you to take advantage of the big opportunities in TV Servicing. The cost of the TV Servicing Home Study Course has been cut to a minimum. You pay for the course on a pay-as-you-learn unit lesson basis. *No other home study course in TV Servicing offers so much for so little cost to you.*

RCA Institutes conducts a resident school in New York City offering day and evening courses in Radio and TV Servicing, Radio Code and Radio Operating, Radio Broadcasting, Advanced Technology. *Write for free catalog on resident courses.*



RCA INSTITUTES, INC.
A SERVICE OF RADIO CORPORATION OF AMERICA
350 WEST FOURTH STREET, NEW YORK 14, N.Y.

SEND FOR FREE BOOKLET—Mail the coupon—today. Get complete information on the RCA INSTITUTES Home Study Course in Television Servicing. Booklet gives you a general outline of the course by units. See how this practical home study course trains you quickly, easily. Mail coupon in envelope or paste on postal card.



MAIL COUPON NOW!

RCA INSTITUTES, INC., Home Study Dept. RE154
350 West Fourth Street, New York 14, N. Y.

Without obligation on my part, please send me copy of booklet "RCA INSTITUTES Home Study Course in TELEVISION SERVICING." (No salesman will call.)

Name _____ (please print)

Address _____

City _____ Zone _____ State _____

NOW... 2 SENSATIONAL EICO SCOPE VALUES!

NEW AMAZING FEATURE PACKED
7" PUSH-PULL OSCILLOSCOPE

Only **EICO** Has All These Features

- VERTICAL FREQ. RESPONSE: flat ± 2 db 10 cps - 1 mc
- VERTICAL SENS.: .01 volts rms/inch
- HOR. FREQ. RESP.: flat ± 0 db 10 cps - 200 kc, -4 db at 500 kc
- HOR. SENS.: .3 volts rms/inch
- SWEEP RANGE: 15 cps-100 kc
- 3-STEP FREQ.-COMPENSATED ATTENUATOR eliminates freq. distortion, overloading.
- CATHODE FOLLOWER inputs to both amplifiers
- PUSH-PULL outputs in both amplifiers
- RETURN TRACE BLANKING
- INT. VOLTAGE CALIBRATOR
- V & H TRACE EXPANSION & CENTERING: 1.5X full screen without distortion.
- DIRECT CONNECTION to vert. CRT plates.
- PHASING CONTROL of internal 60 cps sine wave sweep.
- AT FRONT PANEL: intensity mod. Input; 60 cps, sawtooth outputs.

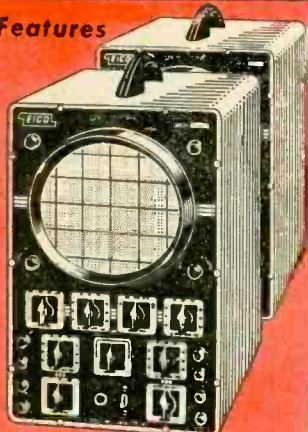

MODEL 470K
KIT \$79.95. WIRED \$129.50.

EICO EXCLUSIVE! 5" PUSH-PULL SCOPE, 425K, Amazing feature-packed economy-priced Wired, \$79.95.

- PUSH-PULL V & H amplifiers. Sens: 0.5-1 rms v/in. Useful to 2.5 mc.
- SWEEP: 15 cps-76 kc. Z-axis intensity modulation. Dual trace positioning controls.



SCOPE VOLTAGE CALIBRATOR KIT
495K KIT \$12.95. WIRED \$17.95.

- Sq. wave output at power-line freq. with full-scale readings of 1, 10, 100 V. peak-to-peak.
- Accuracy $\pm 5\%$ of full-scale on each range.

6V & 12V BATTERY ELIMINATOR KIT
3050K KIT \$29.95. WIRED \$38.95.

- DC output: 0-8 V or 0-16 V.
- Continuous current rating: 10 A at 6 V, 6 A at 12 V.
- Intermittent current rating: 20 A at 6 V, 12 A at 12 V.
- Separate Voltmeter & Ammeter.



New! EICO SCOOPS!



CATHODE RAY TUBE CHECKER
630K, WIRED \$24.95 KIT, \$17.95.

- Checks all types of TV picture and C.R. tubes in the set or carton. Bridge measurement of peak beam current (proportional to screen brightness).
- Detects shorted & open elements.

BAR GENERATOR
352K, WIRED \$19.95 KIT, \$14.95

- Enables rapid adjustment of TV picture V & H linearity without hard-to-find station-transmitted test pattern.
- Produces 16 V or 12 H bars. Operates on TV channels 3, 4, or 5.

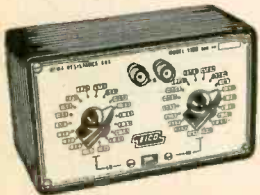
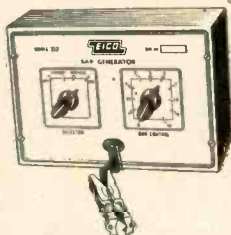

RTMA RESISTANCE
SUBSTITUTION BOX
1100K WIRED \$9.95 KIT, \$5.50.

- Enables rapid substitution of resistances from 15 ohms to 10 megs in decade multiples of 15. 22, 33, 47, 68, 100 ohms.
- Uses 36 standard 1 watt, $\pm 10\%$ RTMA resistors.

221K VTVM KIT \$25.95. WIRED \$49.95.

- AC & DC volts: 0-5, 10, 100, 500, 1000 V (30 KV with HVP-1 probe).
- 5 ohm ranges from .2 ohm to 1000 megs.
- DC input ≥ 26 megs.
- $4\frac{1}{2}$ " meter movement in can't-burn-out circuit.
- 1% mult. resistors.



HIGH VOLTAGE PROBE \$6.95

- Extends range of VTVMs & voltmeters to 30 KV.



PIX TUBE ADAPTER
for Tube Testers \$4.50.
Checks TV picture tubes while in set.

625K TUBE TESTER KIT \$34.95. WIRED \$49.95.



- Illum. gear-driven "Speed Rollchart."
- New lever-action switches for individual testing of every element.
- Tests all conventional & TV tubes.

COUNTER CABINET for above: add \$10.00 to Kit or Wired Prices.

360K SWEEP GEN. KIT \$34.95. WIRED \$49.95.

- Continuous coverage of all TV & FM freqs. from 500 kc to 226 mc.
- Sweep width variable 0-30 mc.
- Crystal marker oscillator, variable amplitude.

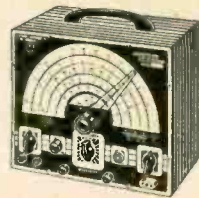

214K VTVM KIT \$34.95. WIRED \$54.95.

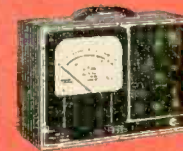

- Large $7\frac{1}{2}$ " meter, can't-burn-out circuit.
- AC/DC volts: 0-5, 10, 100, 500, 1000 (30 KV with HV Probe).
- 5 ohm ranges from .2 ohm to 1000 megs.
- DC input ≥ 26 megs.
- 1% mult. resistors.

950A-K R-C BRIDGE & R-C-L COMP. KIT \$19.95. WIRED \$29.95.



- Measures & tests all resistors; .5 ohm to 500 megohms.
- Every type condenser, 10 mmf to 5000 mmf.
- 0-500 DC voltage source for capacitor leakage testing.

NOW! ONLY EICO KITS & WIRED INSTRUMENTS Gives You LIFETIME SERVICE & CALIBRATION GUARANTEE*

*at less than our cost of handling (See EICO Guarantee Card enclosed with each Kit & Instrument).

111K RES. DECADE BOX KIT \$19.95. WIRED \$24.95.

- Resistance values from 0 to 99,999 ohms with 0.5% precision.
- All resistors have 0.5% accuracy

DECADE CONDENSER BOX KIT
1180X KIT \$14.95. WIRED \$19.95.

- All capacitors precision silver mica, accuracy $\pm 1\%$.
- Range from 100 mmf - 0.111 μ d in steps of 100 mmf.
- Smooth-action positive detent ceramic switches.



Prices 5% higher on West Coast. Specifications and prices subject to change without notice.

315K DELUXE SIG. GEN. KIT \$39.95. WIRED \$59.95.

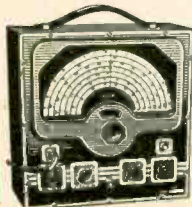

- Covers range of 75 kc to 150 mc.
- 7 calibrated scales: accuracy better than 1%.
- Bandsread vernier tuning.
- 4-step RF shielded output multiplier: constant output Z.

377K SINE & SQUARE WAVE AUDIO
GEN. KIT \$31.95. WIRED \$49.95.



- Complete sine wave coverage, 20-200,000 cps in 4 direct-reading ranges.
- Complete square wave coverage, 60-50,000 cps.
- Cathode follower output circuit.

565K MULTIMETER KIT \$24.95 WIRED \$29.95.

555K MULTIMETER KIT \$29.95
WIRED \$34.95.
(1% precision resistors)



- 20,000 Ω/V ; 31 ranges.
- DC/AC/Output volts: 0-2.5, 10, 50, 250, 1000, 5000.
- DC Current: 0-100 ua; 10, 100, 500 ma; 10 A.
- Ohms: 0-2K, 200K, 20 meg.

145K SIG. TRACER KIT \$19.95.
WIRED \$28.95.



- Audibly signal traces all IF, RF, Video & Audio circuits from ANT to SPKR or CRT in all TV, FM, AM, etc. without switching.
- Germanium crystal diode probe responsive to over 200 mc.
- Integral test speaker.

536K MULTIMETER KIT \$12.90. WIRED \$14.90.

526K MULTIMETER KIT \$13.90. WIRED \$16.90.



- 1000 Ω/V . 31 ranges
- DC/AC volts: Zero to 1, 5, 10, 50, 100, 500, 5000.
- DC/AC Current: 0-1, 10 ma; 0.1, 1 A.
- Ohms: 0-500, 100 K, 1 meg.

320K SIG. GEN. KIT \$19.95. WIRED \$29.95.

322K SIG. GEN. KIT \$23.95. WIRED \$34.95.



- Fundamentals 150 kc to 34 mc, harmonics to 102 mc.
- 5-step band switching.
- Colpitts audio oscillator generates 400 cps pure sine wave voltage.
- Permits pure RF, modulated RF, or pure AF.

Write NOW for FREE latest Catalog C-1

Ask your jobber for FREE EICO business building decals.

Separate Assembly & Operating Manuals supplied with each EICO KIT!

You build EICO Kits in one evening, but... they last a lifetime!

SAVE OVER 50%! See the famous EICO line TODAY, at your local jobber.

ELECTRONIC INSTRUMENT CO., Inc., 84 Withers Street, Brooklyn 11, N. Y.

www.americanradiohistory.com



COLOR TV PROBLEMS

. . . . *The new multichrome sets will make TV history*

By HUGO GERNSBACK

THE year 1954 is certain to go down in history as the official beginning of Color Television in the U. S. *In a technical sense, color TV is here.* In the economic, business, production, and servicing sense, color TV is just beginning.

A comparatively small number of color TV sets will be manufactured and sold in 1954. All will be expensive—four or five times as costly as monochrome receivers today. It will be difficult to get any type of color TV set—nor can one be choosy—customers will have little choice in style or finish. The screens will be mostly small—15 inch average. It will also be difficult to get satisfactory TV color servicing in 1954.

Nevertheless, color TV is here with a bang and the uproar it is causing is only second in comparison to the excitement created when television started a few short years ago. And it is quite true that once you have seen color television in all its often incredible splendor, you can no longer doubt that this is the REAL beginning of the Television Era.

Unfortunately, as so often in the past, under parallel circumstances, the set industry, as a whole, failed to alert the public that color TV is definitely *not* around the corner, and that the few thousand color TV sets manufactured in 1954 will only be a token production. For every thousand anxious customers, there will be only one or two color TV sets in 1954.

Multichrome TV sets are far more complex than monochrome receivers. They have several times as many parts and components, thus are more difficult and consequently slower to assemble. This is true for the complex tricolor TV tube—only more so. Small wonder then that we cannot reasonably expect mass production of color TV sets running in the millions in 1954.

Let us also not forget that it took us seven years to produce the 27 million present black-and-white sets. If all these receivers were to be replaced or duplicated with color TV sets, it is probable that it would take us into 1960 to achieve this output. But, in our opinion, this reasoning is not sound. Past history in our industry teaches us that, contrary to early opinions, television never replaced radio. It did not even make a dent in radio. To the contrary—and much to the surprise of the industry—there are many more radio receivers in active use today than in 1947. Incidentally, we predicted that too, in no uncertain language on this page in our June 1949 issue. This history is certain to repeat itself in TV. Just as not everybody owns a Cadillac or a Rolls Royce, yet even people not considered wealthy in the United States own more than one medium-priced car.

For several years to come and until color TV sets are really mass produced, *prices will be high*—not everyone will rush to buy one. Many people who can afford it will certainly not buy the present small screen, 15 inch sets—they will prefer to wait for larger screen types. And most of those who do buy color TV sets will probably keep their monochrome sets for the children, or as a spare to be used in other quarters in the house—particularly where members of the same household routinely want to watch different programs. Yes, even the kitchen—if there is sufficient room—is now a popular spot, often a must, for TV.

But that only scratches the surface. Not everyone likes color TV. Many older people prefer black-and-white. *There will always be a big demand for monochrome receivers which will increase as the prices come down.* Mass production, new techniques, transistors, cheaper cabinets, all will make it possible to sell good 21 inch black and white sets for around \$100—perhaps for less—in the future.

Add to all this the tens of millions of utility sets, in offices, banks, factories, jails (for supervision), two-way communication, etc., and it becomes plain that the monochrome set will be in the ascendancy for many years to come.

Indeed, we think that it is a safe prediction that in 1960 there will be more monochrome than multichrome TV sets in use.

As the present trend consistently has been towards larger and larger pictures, we have even now reached the practical limit in our direct view television tubes. It is almost certain that future TV sets—monochrome as well as multichrome—will be equipped with projection type TV tubes. This will give us life-size (and larger) faces and people, projected against a wall or screen. With projection TV it is no longer necessary to have a heroic size console, as projection tubes are far smaller than our present day direct view tubes.

The great trouble with projection TV in the past was poor definition, dim pictures, focus difficulties and high voltage servicing trouble. Many of these have now been overcome. Then, most important, there was the public's indifference to the projection idea itself. The reason for this is simple. Most walls in homes are not white or sufficiently light in color. Roll-up screens make a poor appearance and are psychologically wrong—they always look like makeshifts. Never—if left hanging—do they blend with the surroundings. And people just refuse to put up a wall screen every time they want to turn on the TV.

We therefore advance the thought that the industry must develop new means to sell projection TV to the public. The answer is: *do away entirely with the present-day make-shift screen.* Develop something both esthetic and utilitarian.

We can imagine a 3 by 4 foot (or larger) "mirror" permanently installed on a wall. When not used as a television projection screen, it looks like an art mirror, but during TV projection the rear of the "mirror" becomes white and serves as a screen. The trick mirror can be like a "one way" mirror or a special dichroic type of mirror, or a combination of both. We can also imagine a beautiful painting in a frame. But the painting has no canvas—the scene is painted on a number of closely fitting narrow wooden, metal, plastic—or other material—slats. By moving a small lever at the side of the picture frame, the slats rotate through 180°. *The reverse side of the slats are painted white*—making an excellent screen. Move the lever once more and in a second you restore the original picture.

There are many other optical, chemical and mechanical ways to accomplish the same result for TV projection screens.

Let us now consider color TV servicing. Perhaps it is a blessing in disguise that there will not be millions of multichrome TV sets in 1954. Who would service them? True, in a few of our larger cities TV set manufacturers probably are even now training a small body of service technicians to take care of a few thousand sets. But as there are over 110,000 TV technicians in the U. S., the great majority at the present time naturally has had no chance to even see a color TV set, much less become sufficiently acquainted with one to learn its intricacies. All this will take time, just as it took time and study for the former radio technicians to evolve into TV service technicians.

The servicing of color TV sets is complex and the service technicians are in for many new and interesting experiences. But by the end of 1954 most of these difficulties will have been resolved. By then color TV will be on its triumphal rainbow carpeted march.

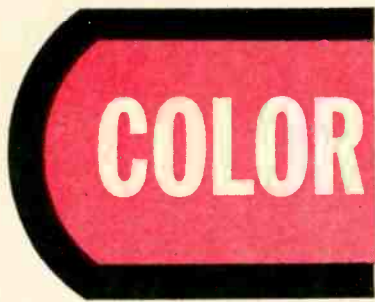

COLOR

TELEVISION



PAST



PRESENT



FUTURE

Luc de Forest

RADIO and television technicians, scientists, the general public, are today focusing attention on the absorbing topic of color television. When can we see it; place it in our homes; how good and reliable will "color" be; at what price, or range of prices?

Today's color television is the outcome of many years of careful thought, persistent ingenuity, and thousands of experimental hours. That sterling British TV pioneer inventor, John Logie Baird, made interesting experiments and gave the art some highly valuable suggestions as to how his crude television images could be combined with natural colors. There has been scarcely a television inventor since Baird who has not conceived some method or apparatus for mingling natural colors with the present monochrome image.

To actually accomplish this, one must begin with the television pickup device or camera. The simplest way to do so is—quite obviously—to employ three cameras, exactly like the present black-and-white type, typified by the RCA orthicon camera. Most researchers have been content to use the amazingly faithful and instantaneous qualities of the orthicon—three of these focused upon the color image to be transmitted: live object, wide scene, or Technicolor film. Each camera is synchronized with the TV transmitter; each views the scene through one of three primary color filters—red, green, and blue—of the exact shade found by practice to produce the most nearly correct color or tint on the final projected image tube, or screen. The three colored images are separated by a dichroic mirror into three images, each in its own color, and directed upon the lens of its own orthicon. Thus each color image is translated into an electron image. The three-electron images are scanned simulta-

neously by the cathode beam in each pickup camera. The combined electron output, now in the form of electric, high-frequency images, is caused to modulate—at a subcarrier frequency—the common television carrier as it is delivered to the transmitter antenna.

If the color filters were removed from the front end of each orthicon, these would see and translate the same all-color image, and the resultant would be that from three identical camera images—black and white or monochrome, all in perfect synchronism.

The old CBS field sequential color television system employed only one camera, located behind a rapidly rotating tricolor disc. The color segments transmitted only those picture elements from the scene which were of the same color as that of the segment then in the line of sight. A similar arrangement of a tricolor segmented disc rotating before the kinescope of the receiver and synchronized with the disc at the transmitter camera caused the picture to be seen in a semblance of its true colors. The practical limitations of the sizes of the disc in front of the kinescope so limited the size of the latter as to be disappointing to the viewer who had become accustomed to kinescopes of 15 or more inches in diameter. Moreover, the large, rapidly whirling disc in the room constituted a serious disadvantage to this method, quite aside from the fact that the CBS color system was incompatible and required special frequency standards.

With the casting into limbo of the rotating disc type of television, and the rapid development of large cathode-beam viewing tubes, (10 or 12 inches at first, then rapidly expanding after the war to our present 21-inch and 27- to 30-inch tubes), the combined active zeal of a hundred inventors and technicians in a half-dozen laboratories gradually

resulted in an intelligent aggregation of ideas from which developed our present official National Television Systems Committee (NTSC) color TV standards, covering first the optimum use of the 6-megacycle band which the Federal Communications Commission had allotted for monochrome picture transmission, the prescribed synchronizing signal wave form, the number of horizontal lines permitted in the picture, the aspect ratio, the intensity and duration of the blanking signal, the burst frequency, etc. Such co-operative spirit had never before been witnessed, though it had been foreshadowed by the work of that earlier committee which—before the monochrome dawn of television—made to the FCC the recommendations which integrated finally to today's highly practical, well-proven national black-and-white standards, now universally adopted in the United States. The results of their foresight are evidenced today by more than 27 million television receivers in use; the highly profitable employment of thousands of so-styled, "artists," mostly unknown otherwise; a systematic process of implanting terror, fright, and rough manners into the impressive generation of younger ones; the frantic resurrection of millions of feet for opportune gain, of long-forgotten "Western" murder and mayhem films—plus the most gigantic travesty—advertisement conspiracy—in the history of modern civilization.

Scientific and engineering brains and their standards apparently are no match against the impropriety and lack of moral obligation of the group comprising program producers and advertising business managers, whose wholesale profanations of God's and mankind's ether in the name of beer, cigarettes, laxatives and cosmetics may mean millions of dollars to a few hundred private interests, but only impatient dis-

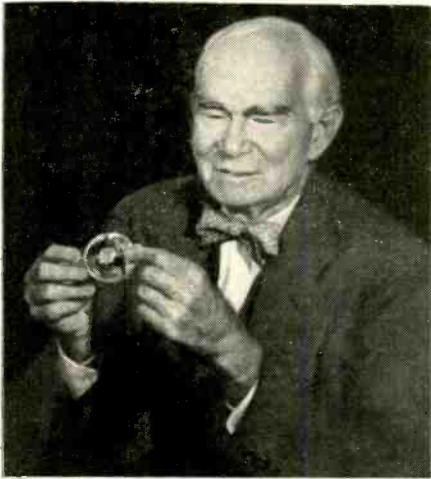

The Father of Radio and the Audion. From a painting by George Camarero.

gust to millions of other persons.

Television is a great and marvelous institution toward which science has been steadily working through decades. The dignity of its future will not be limited by commercial exploiters.

There are today, over three hundred television transmitters in operation. The number is increasing at an average of nearly three dozen per month. Within two years, scarcely a household in the United States will be out of range of at least one TV station, v.h.f. or u.h.f. This great increase in station erection, following the prolonged "freeze" by the FCC, exceeds the forecasts of its most enthusiastic proponents.

Unquestionably, the present state of compatible color television is chiefly due to the determined, long pursued, and ingenious labors of the research engineers of the Radio Corporation of America in its laboratories in Camden and Princeton, N. J. Spurred on by the zeal of RCA chairman, General David Sarnoff, the advent of compatible color TV has been advanced by years, so that today daily demonstrations of live and color-film pictures may be seen in New York, and will be available soon in Hollywood, Washington, and elsewhere.

To make this rapid progress possible it was necessary that the technical leaders of the TV industry should

jointly and harmoniously agree upon a national set of standards, to avoid prolonged and manifold working at cross purposes throughout the industry. Last March the previously agreed upon standards were somewhat altered and improved. Patent licences were generously exchanged so that the various technical leaders can now work harmoniously in the common aim to bring to the public, as quickly as possible, (following FCC formal approval of the NTSC standards), color television receivers at the lowest possible prices.

Today there are at least three types of color kinescopes in "laboratory" production, the tridot perforated masking screen kinescope of RCA, using at present three guns; the horizontal tricolor narrow horizontal strip (or wire), so-called Lawrence tube; and the new CBS-Hytron tube to be described later.

The three guns of the RCA tube are located within a nickel cylinder converging at a narrow angle which brings the three narrow cathode beams together in the plane of the perforated plate. Magnetic deflection means similar to those used with the conventional black-and-white single gun cause the three beams to be swept across the perforated masking plate, horizontally and vertically, exactly as in the monochrome kinescope. The three beams are controlled in time and intensity by the arriving "red," "green," and "blue" signals from the distant transmitter, so that any one, two, or all three beams pass through a single hole in the masking plate simultaneously. Upon passing through any aperture in the masking plate, the three beams diverge, each beam falling upon a tiny red, green, or blue fluorescent spot on the parallel flat glass plate which is mounted approximately one inch in front of the perforated masking plate. By this arrangement the viewer in front of the tube sees true color reproduction, because the intensity of the three primary color dots varies in accordance with the three colors picked up by the three closely grouped cameras at the distant transmitter, and are commingled so as to reproduce all color tints and shades with their proper intensities.

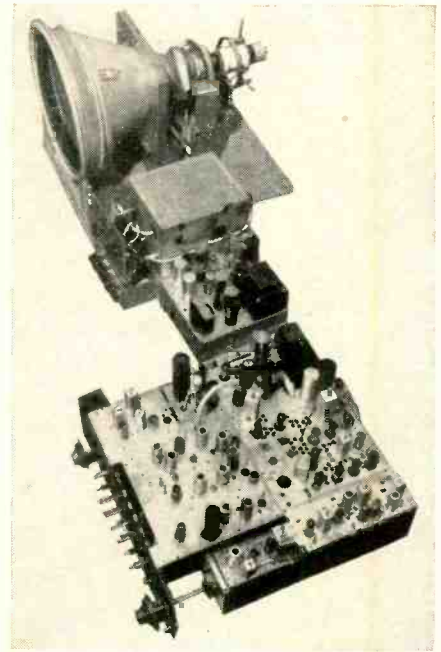

Courtesy General Electric Review
Experimental G-E color TV receiver.

The basic idea of a perforated masking plate, located before a transparent plate carrying on its face a vast number of tricolor phosphor dots, symmetrically located, is attributed jointly to TV engineer Levering, and Dr. Alfred Goldsmith. To date this arrangement, using three guns, or only one, is generally accepted as the most practical and promising of a multiplicity of more or less practical suggestions.*

The so-called Lawrence color tube employs a flat viewing plate carrying a series of fine tricolor stripes, preferably horizontal. Behind this plate is a parallel array of fine wires. Every third wire is connected to a common terminal. These three terminals are connected—each to a high-voltage source controlled by the incoming color signal, so that one set of wires divert the horizontally swept beam so that it falls upon the desired color stripe—red, green or blue—as it travels along. Thus the other-

* Included is a patent application recently filed by the writer.

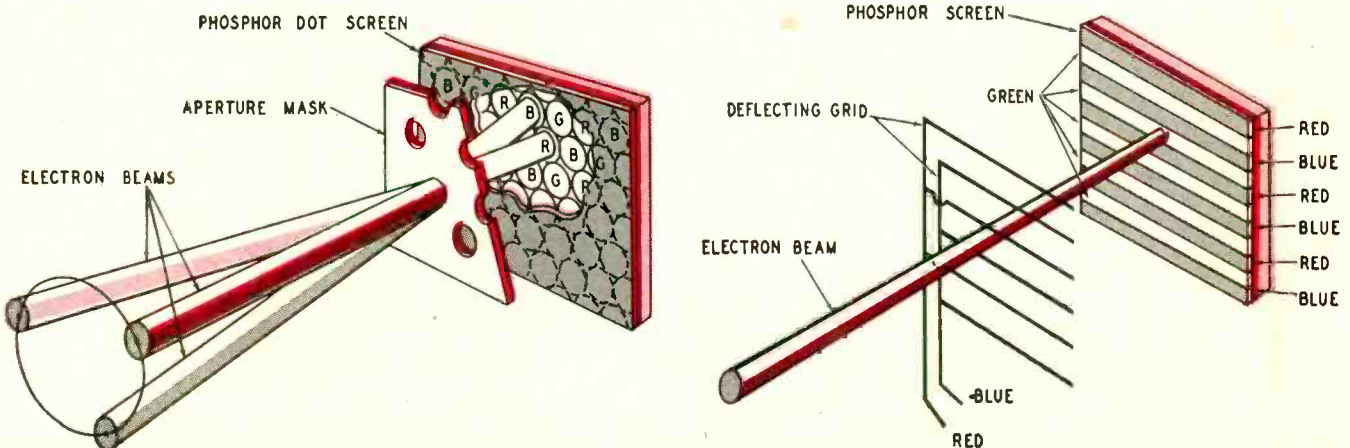

Section of two types of color screens. Left is the RCA shadow-mask; right the Lawrence tube with its deflecting grid.

wise "black and white" beam is made to appear in the proper sequential color picture elements. Inasmuch as the cathode beam at the plane of the control grid wires is at high voltage, high velocity, the rapid control of the beam requires correspondingly high voltages. This may be a distinct disadvantage. Furthermore, there is a considerable loss of beam energy in transversing the wire grid, resulting in a loss in brilliance of the picture. To obtain a sufficiency of picture detail, the color modulation of the beam must occur at high frequency, a disadvantage considering the high voltages which must be applied to the beam-shifting wires.

The most recently developed type of color tube is that of the CBS-owned Hytron engineering staff. It differs from the above-described RCA in that, instead of using a flat glass plate to carry the three-color dot pattern, the tricolor dots are implanted directly upon the inner face of the kinescope. A perforated screen plate, or shadow mask, is employed as with RCA, but this is curved as is the tube face, the shadow mask plate being rigidly fastened at the correct distance behind the tube face. The tube carries three guns, as does RCA's.

This arrangement weighs much less than do the two flat plates, and the necessary heavy metal frame and screen—stretching means in the RCA tube. The exhaustion problem is thereby simplified and the tube cost is claimed to be substantially less. Further, the curved surfaces of the *Colortron* tube should avoid the size limitations presently inherent in the use of the two flat parallel plates of RCA. The anode voltage in both tubes is the same, 20 kv. Both screens are aluminized. The CBS receiver employs 40 tubes, including 2 rectifier tubes.

CBS uses the NTSC signal standards. Its newly demonstrated color system employs at the transmitter a single orthicon camera (instead of three with dichroic mirror color separators of RCA), with the familiar color-segment wheel, quite like what was used in the original CBS color system. Recent public demonstrations of this system show future promise, but as yet it is comparatively unimpressive in its performance. Doubtless Dr. Peter Goldmark is well capable of solving the problems yet remaining.

The present NTSC color signal consists of a wide-band "luminance" signal transmitted according to FCC standards for black-and-white TV, to which has been added a narrow-band color subcarrier having a video frequency of 3.58 mc. This combination of the two carriers, a color carrier of high frequency relative to that of the horizontal line frequency, makes the pattern of the subcarrier virtually invisible in monochrome receivers, so that the color signal may be received by present black-and-white receivers, an outstandingly clever solution. Hence the new color standards result in complete compatibility, an absolute essential for

successful color television today. The color subcarrier sidebands extend to 1 mc below and 0.4 mc above the color subcarrier frequency, as measured to the 6 db down point.

The well-known standard horizontal synchronizing pulse is followed by a burst of 3.58 mc frequency which is delivered during the "backporch" of the horizontal blanking period. This burst, of exceedingly brief duration, is used in the standard color system to lock the oscillating system of the receiver. For black-and-white reception the burst signal is omitted. For a burst of eight cycles, the pulse duration would be 2.2 microseconds. The color subcarrier frequency is chosen to be an odd multiple of one-half the horizontal deflection frequency. Therefore the unit generating the 3.58-mc signal and the synchronizing generator must be locked together.

The various types of compatible color TV systems must all conform to the present NTSC standards, but as regards the receiver, a wide variety of design of the picture tube, including the color screen (dot or linear type), is permissible and a number of inventors are still very active in efforts to obtain better results and to permit use of much larger viewing tubes than the present RCA type (approximately 15-inch) screen.

A vast amount of research to determine the most efficient types of red, green, and blue phosphors has resulted in the following: Red (zinc phosphate; manganese), green (zinc silicate; manganese), blue (zinc sulfide; silver and calcium-magnesium silicate; titanium). The relative luminosity of these three phosphors is 25.3, 100 and 26.6 respectively, that of the green being taken as 100 or standard. Doubtless, further research may result in yet greater color efficiencies. The chemists continue their researches.

Disturbance of the color picture due to outside interference is found to be no greater than with the monochrome receiver; although the present color receiver employs from 30 to 50 electron tubes, of a large variety of types. Servicing of commercial color TV receiver is certain to be a far more complicated and tricky job than for black-and-white receivers. *The good service technician will require long and meticulous training. No ordinary slap-dash "tube shifter" can be expected to qualify or give customer satisfaction. Alignment techniques and general know-how must be developed to a high degree. (The italics are ours.—Editor)*

As far as sound in color TV is concerned, nothing novel is introduced. The old standard sound circuitry and the spectrum space reserved for sound are the same as for present standard monochrome transmission and reception. It is to be hoped that the larger color receiver cabinets will involve needed improvements in sound emitters, such as two or three good loudspeakers distributed in the cabinet, with selective circuits and controls. *Improved video*

should demand correspondingly better acoustic reproduction facilities.

The estimated initial cost of color receivers varies from \$800 to \$1,400. These costs are certain to come down as quantity production proceeds, but it is clear that color will always be relatively costly, even for screen sizes small compared with our present 21- to 27-, or 30-inch kinescopes. Furthermore, much will depend on the quality of color programs. Color commercials will, of course, be much more attractive than are today's dull displays of beer-bottles and cigarette packages; but to justify the high cost of receivers, and their proper maintenance, the viewer must be given a superior quality of program along with a minimum of commercial commands.

Color television will not be all beer and skittles—we hope. The new program director will have many new problems, but also he will have a magnificent new medium for the public's delectation—not dejection.

What does the future of color TV present? A most enticing and challenging question that will stimulate ingenuity and imagination unlimited. Why, for example, must color TV be necessarily confined to a vacuum chamber? Why not use a dazzling needle of light instead of the cathode ray? Assume a brilliant gas tube which can be modulated millions of times per second, focused with tiny concave mirrors mounted in spiraled formation upon a small, light, rapidly revolving cylinder, or disc, which throws the beam across the face of a large screen, from left to right, and from top to bottom of the screen. The mechanism may be small, cabinet enclosed, and noiseless. This is a flareback to the old neon-light television ideas of C. Francis Jenkins, John Baird, and Mihaly. But it can be resurrected and refined, provided only that we can find the gas tube combining sufficient brilliancy with no inertia lag or hangover, one whose light output can be quantitatively modulated at 6,000,000 times per second!

Or, let our synthetic chemists provide a new type of light-modulating liquid cell, (resembling the Kerr cell); or, better yet, a new type of refracting crystal which deflects a transmitted light beam quantitatively in response to the received modulated television signal. This beam could then be spread sequentially over the viewing screen by a mirror drum, or two drums, as above described, traversing first a focusing lens or system of lenses.

Let's imagine further: Insert in the light path a *color cell* whose chameleon-like fluid changes its hue from red to green to blue instantly, in response to the incoming color signals, by voltage or high-frequency changes—a tricky problem for future chemists!

Given such inertialess voltage response cells, it will not take our TV engineers long to chuck the huge, bulky, implosion-labile, highly evacuated kinescopes into the trash can—an outcome devoutly to be wished. END



TRANSMISSION LINE LEAD-IN

for

U.H.F.

By BRUCE RICHARDS

*Dielectrics take on
great importance
in u.h.f. trans-
mission lines*

TRANSMISSION line lead-in is a necessary evil. The service technician should not regard it lightly. The best antenna and the best receiver in the country may not give satisfactory reception unless serious attention is paid to the connection between them.

There are no certain tests by which the service technician can determine which is the best type transmission line lead-in. Any transmission line attenuates the signal. Theoretically, the best transmission line is the one that couples the antenna to the receiver with the smallest attenuation loss. The problems involved are different for u.h.f. than for v.h.f. At ultra-high frequencies the losses are greater. A typical attenuation curve is shown in Fig. 1.

We are going to present some of the fundamental principles of transmission line cable for u.h.f. lead-in and will make comparisons between cables now on the market. The attenuation losses for several types of line will be indicated. The effect of weather on the lines will be indicated where data are available. See Fig. 2.

Nothing will be said about the effects of mismatch. Obviously, the more closely matched the antenna, line, and receiver, the less will be the attenuation and other mismatch losses.

Let's confine ourselves to three basic types of u.h.f. lead-in line: open wire, ribbon, and tubular twin-lead cable.

Open-wire line

The open-wire line has a lower attenuation figure than other types. This attenuation is approximately 1 db per 100 feet at the center of the u.h.f. spectrum. See Table I.

Where it is necessary to run an exceptionally long lead from antenna to

receiver this wire will hold to the low attenuation limit necessary for such an application. Or, if it is possible to run a lead-in completely indoors so that it will be shielded from weather, this is an ideal lead-in.

There are some disadvantages which make this wire a headache to the service technician. It is difficult to mount, and it requires special care to avoid changing the spacing of the wires between the insulators. Matching to a 300-ohm impedance is a serious problem, because the characteristic impedance of open-wire line is 225-250, 375, or 450 ohms.

A desirable characteristic of this type of line is that there is practically no difference in its attenuation under wet or dry conditions. This is the only type of line for which it can be said that if the picture is good under dry conditions, the picture will be good under wet conditions.

Punched-ribbon line

Tests made under all types of weather conditions along seacoast sections have shown that the average flat or round 300-ohm lead-in will give only a short period of satisfactory service. The quality of the picture then deteriorates rapidly and remains at a low level, as a result of the salt-spray deposits which encrust the lead-in. Similar problems exist in areas where there is a hot, humid climate, where much alternate rainfall and strong sunlight prevail, or where the lead-in is subject to frost, snow, and ice.

One solution to this problem, which permits use of ribbon line for some locations, is to punch out rectangles about an inch long and use short ribs to support the wire at these inch intervals. This line has certain outstanding features. Eighty percent of the loss-

producing dielectric web is eliminated; the nominal 300-ohm impedance is correct for a large number of receivers and antennas; it is lower in cost than other lead-lines; and by insuring correct spacing of the flexible stranded conductors, less than 1% of the operating wavelength is radiation loss.

Ordinarily, attenuation losses of unpunched twin-ribbon type lead are greater than that of the punched-ribbon lead, except when water droplets accumulate in the punched-out areas. The losses of punched lead are then very high; but this condition disappears when the line dries out.

This punched type of line is good for an inside installation where it can be kept clean and dry and would not be subject to the lossy effects of weathering. Attenuation losses are moderate; it is flexible, easy to install; it fits into standard insulators; and it does not present any impedance-matching problem.

Tubular cable

Each new advance in television brings along a number of accompanying advances in associated products. The u.h.f. boom has encouraged the development of a large variety of tubular-type twin lead-in cables. This is the type that is likely to win general acceptance because it seems to provide the best overall characteristics for good u.h.f. reception under all conditions of installation, as well as with aging and weathering. See Fig. 3. In tubular 300-ohm lead-in, the extremely important field of energy is concentrated on the inside and is virtually unaffected by weather conditions. In flat 300-ohm lead-in, the field of energy is largely outside, exposed to all weather conditions and subject to signal loss.

The basic patents on putting two or

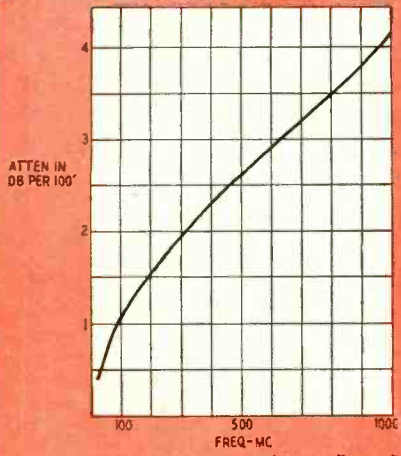

Fig. 1—Attenuation curve for an "air-spaced" two-conductor oval cable.

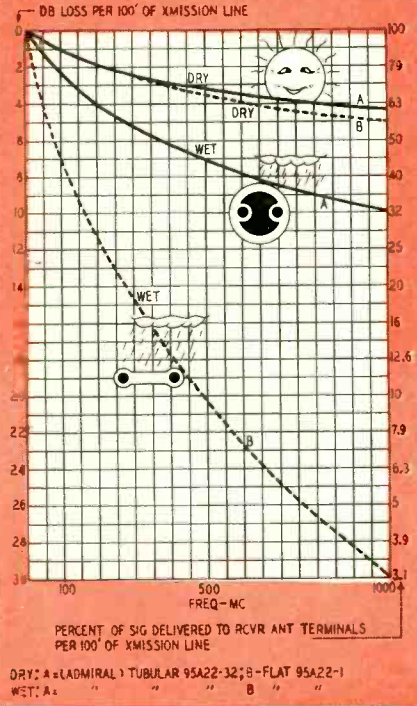

Fig. 2—Comparison of transmission lines under wet and dry conditions.

more conductors inside a cable are over 50 years old. This means there is little room for invention in this field beyond minor improvements. Hence manufacturers have been concerned with producing as good a wire as possible with the lowest possible attenuation losses.

The published attenuation figures for a variety of these tubular twin cables are in Table I. Some data were not available. For the most part these are laboratory experimental data; what the data would be with respect to actual reception of a u.h.f. station is not known for the most part. This would be desirable information, but it is not available.

All the u.h.f. receiver manufacturers usually purchase a number of competing types of cable and set up some experimental procedures to determine the performance of the lead-in under ideal conditions, under wet conditions, and to determine results of aging. These data become a company report and un-

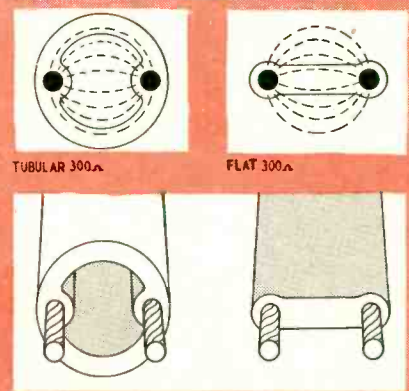

Fig. 3—Tubular and flat type lead-in.

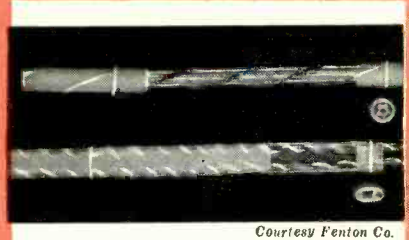

Fig. 4—Fentube Airspace cable below; the Fenton Twistube is shown above.

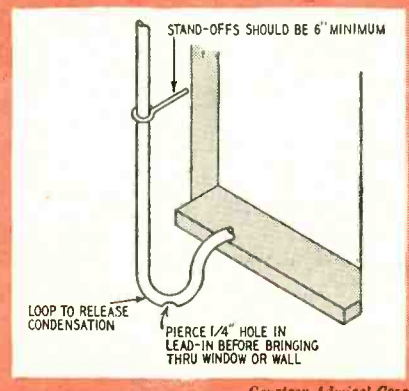

Fig. 5—Diagram shows tubular transmission line lead-in at point of entry.

less the information is released the service technician, who would profit much from such information, is not likely to see it.

The data on the Rego *Spiraline* given in this table were obtained under actual test conditions of a u.h.f. station operating in the 700-mc region. Incidentally this was the best performing tubular cable out of a group tested under dynamic conditions in the metropolitan New York City area. This is a novel design twin-lead wire, using a solid conductor. Let's look at it more closely.

Air is the most desirable dielectric for the twin-conductor cable now commonly used for v.h.f. and for the tubular type cable being used for u.h.f. An ideal cable would be a pair of air-supported twin conductors properly spaced inside a tubular cable. However, this can exist in theory only.

It is common to support the cables and to maintain them in their proper spacing by means of a thin film of di-

electric, sufficiently thick to serve the purpose of maintaining uniform spacing. See Fig. 3, "tubular 300 ohm." The dielectric, by surrounding the cable throughout its entire length, contributes markedly to attenuation losses, since the highest energy field is in the straight-line path between the two conductors.

Rego *Spiraline* has adopted a design featuring a thin wall of dielectric material supporting the twin conductors at points such that the ratio of bare conductor to dielectric-covered conductors is sufficient to permit maintaining uniform wire spacing throughout the cable length and at the same time permitting most of the twin conductors to be free of dielectric covering. The points at which the dielectric holds the twin conductor to the wall of the tubular cable do not have to be opposite each other; they may be staggered along the cable at alternate spots. The bottom cable in Fig. 4 illustrates the design used by *Spiraline*.

This cable has low dielectric losses and superior characteristics under wet conditions. This wire must be handled carefully during installation. Rough handling or sharp bends will change the spacing of the bare conductors and affect the impedance characteristics and attenuation losses of the wire. For the service technician who is very careful in his workmanship, this is an ideal tubular type lead. The manufacturers have not been pushing this wire because they don't know whether the service technician will give it the installation care it requires.

Characteristic impedance

The characteristic impedance of a transmission line is important—more important at u.h.f. than at v.h.f. because there is a relationship between the impedance of a line and its attenuation losses. Both the size of the conductor and the spacing of conductors affect the impedance of a transmission line. Standard tables of attenuation losses show that losses are greater for lines with impedances less than 300 ohms. For lines comparable in all other respects there would be greater losses for a 280-ohm line as compared to a 300-ohm line. Again, there is little the service technician can do about this as the difference in spacing of conductors for 280 or 320 ohms is negligible. Comparatively little wire is sold with a guaranteed impedance.

The spacing of the conductors varies from manufacturer to manufacturer for a variety of reasons. Here are typical comments:

A. The spacing of the conductors was determined more by economic reasons than any other. It was felt that it was best to keep the conductor spacing at the minimum and so decrease the over-all size of the line, rather than get somewhat higher impedance with a wider separation and therefore larger over-all dimensions.

B. The characteristic impedance of the flat and tubular line is 300 ohms

TV CHANNELS TABLE

Channel No.	Freq. Range (mc)	1/4 λ Electric (inches)	1/4 λ Physical (inches)
V. H. F.			
2	54-60	51 13/16	42 13/32
3	60-66	46 29/32	38 15/16
4	66-72	42 3/16	35 3/32
5	76-82	37 3/32	30 21/32
6	82-88	34 3/4	28 1/2
7	174-180	16 21/32	13 21/32
8	180-186	16 3/32	13 3/16
9	186-192	15 9/32	12 13/16
10	192-198	15 3/32	12 13/32
11	198-204	14 23/32	12 1/16
12	204-210	14 1/16	11 23/32
13	210-216	13 27/32	11 11/32
U. H. F.			
14	470-476	6 1/4	5 1/8
15	476-482	6 3/16	5 1/16
16	482-488	6 1/8	5 1/32
17	488-494	6 1/32	4 31/32
18	494-500	5 31/32	4 29/32
19	500-506	5 7/8	4 13/16
20	506-512	5 3/4	4 25/32
21	512-518	5 3/8	4 23/32
22	518-524	5 1/8	4 21/32
23	524-530	5 5/16	4 19/32
24	530-536	5 1/16	4 9/16
25	536-542	5 1/2	4 1/2
26	542-548	5 7/16	4 7/16
27	548-554	5 3/8	4 13/32
28	554-560	5 5/16	4 3/8
29	560-566	5 1/4	4 5/16
30	566-572	5 3/16	4 1/4
31	572-578	5 5/32	4 7/32
32	578-584	5 3/32	4 3/16
33	584-590	5 1/8	4 1/8
34	590-596	5	4 3/32
35	596-602	4 15/16	4 1/16
36	602-608	4 29/32	4
37	608-614	4 27/32	3 31/32
38	614-620	4 13/16	3 15/16
39	620-626	4 3/4	3 29/32
40	626-632	4 11/16	3 7/8
41	632-638	4 21/32	3 13/16
42	638-644	4 5/32	3 25/32
43	644-650	4 9/16	3 3/8
44	650-656	4 17/32	3 23/32
45	656-662	4 1/2	3 11/16
46	662-668	4 15/32	3 21/32
47	668-674	4 13/32	3 5/8
48	674-680	4 3/8	3 19/32
49	680-686	4 5/16	3 17/32
50	686-692	4 9/32	3 17/32
51	692-698	4 1/32	3 1/8
52	698-704	4 7/32	3 13/32
53	704-710	4 3/16	3 7/8
54	710-716	4 5/32	3 13/32
55	716-722	4 3/32	3 3/8
56	722-728	4 3/32	3 11/32
57	728-734	4 1/16	3 5/16
58	734-740	4 1/8	3 9/32
59	740-746	3 31/32	3 1/8
60	746-752	3 15/16	3 1/4
61	752-758	3 29/32	3 7/32
62	758-764	3 29/32	3 3/8
63	764-770	3 7/8	3 5/32
64	770-776	3 29/32	3 1/8
65	776-782	3 13/16	3 1/8
66	782-788	3 25/32	3 3/8
67	788-794	3 3/32	3 1/16
68	794-800	3 23/32	3 1/32
69	800-806	3 11/16	3 1/32
70	806-812	3 21/32	3
71	812-818	3 5/8	2 31/32
72	818-824	3 9/32	2 31/32
73	824-830	3 9/16	2 15/16
74	830-836	3 1/8	2 29/32
75	836-842	3 1/16	2 7/8
76	842-848	3 1/32	2 7/8
77	848-854	2 5/8	2 31/32
78	854-860	2 7/16	2 27/32
79	860-866	2 1/16	2 13/16
80	866-872	2 3/32	2 25/32
81	872-878	2 3/32	2 25/32
82	878-884	2 3/8	2 3/4
83	884-890	2 1/32	2 3/32

From the October, 1953, issue of Sylvania News

A listing of all TV channels and frequencies with useful dimensional data for constructing antennas and making impedance-matching sections and rejection traps from 300-ohm ribbon line. Use the electrical-length data in the third column for antenna elements and spacings. The fourth column gives the physical length of a quarter-wavelength section of 300-ohm ribbon line with a propagation factor of 82%. Use these when constructing matching sections and traps. When using other types of transmission lines, multiply the electrical length by propagation factor.

nominally with a production tolerance of ± 20 ohms. For this reason it is possible that the impedance could be 280 ohms and still be within tolerance.

Dielectric material

Most manufacturers advertise that their tubular cable is made with virgin polyethylene. This may not always be true. Polyethylene is not available in the quantities necessary to supply all demands by the wire and cable plants. Some of them are maintaining production with a percentage of reused polyethylene. The Bakelite Company, manufacturer of polyethylene, suggests, "The dielectric constant of reprocessed

2. 14-076 has seven strands of No. 26 wire as conductors rather than seven strands of No. 28 wire as used in the 14-271 cable which has higher attenuation losses.

3. The design of the cable is such that there is a thin wall of dielectric covering the wires and most of the field between the conductors is air. This is illustrated in Figure 3.

The Fentube Aircased tubular u.h.f. cable is illustrated in Fig. 4. This figure also shows the Twistube. Both are made by the Fenton Company, New York City. For most of the Fentube conductor length there is very little between the bare conductors to interfere with

TABLE I—TRANSMISSION LINE ATTENUATION

Type	Attenuation in decibels per 100 feet		
	100	500	1,000
225-250 ohm open	0.4	0.8	1.8
450-ohm open	0.4	0.8	1.1
300-ohm tubular	1.2	3.2	5.0
ATV 270 (Anaconda)	1.5	3.6	5.1
ATV 270 Foam (Anaconda)	1.5	3.6	5.0
Rego Spiruline	1.1	2.4	4.0
Fentube Aircased	1.1	2.6	4.2
Fentube Twistube	1.2	2.6	4.7
Amphenol 14-076	1.0		
Amphenol 14-271	1.3		
Admiral 95A22-32	1.0	3.2	4.3
Goodline 733 GA	0.7	2.5	
Goodline 823 GS	0.7	2.1	
Belden Ultra Weldohm	1.1	3.2	5.0
Federal Pipeline	1.2	3.0	4.5

polyethylene, we believe, is greater than that of new polyethylene due to the impurities which are introduced either prior to or during the reprocessing operation. While we have no data to substantiate our belief we do believe that reprocessed polyethylene attenuation losses would increase more quickly with age due to impurities, as mentioned above, which might be introduced either prior to or during the reprocessing operation."

Unfortunately there is little the service technician can do about such manufacturing substitutions, as it is practically impossible to determine the difference between virgin and reprocessed polyethylene. There is one clue which will help the service technician get a good polyethylene wire. The smoothness of the finish on the tubular twin-lead u.h.f. cable does influence the losses of the cable. If there is any roughness on the outer surface of the polyethylene this rough portion would tend to catch and be a collecting spot for dust, dirt, soot, and other foreign particles. Under wet conditions this would tend to increase the losses for the cable involved.

Notes on tubular cable

Amphenol makes two types of tubular *Twin-Lead* cable: 14-076 and 14-271. The 14-076 is superior because of the following design and construction features:

1. The tubular design of the insulation reduces dirt and moisture concentration in the field between the conductors. This means the impedance is constant for wet or dry conditions.

the concentrated energy field. The No. 20 AWG conductors are solid wires supported by means of the helical polyethylene wire-like cords.

The lines least affected by moisture and contamination are the new ATV-270 lines. There are two types: the ATV-270 and the ATV-270 Foam. The Foam line is superior at the high end of the u.h.f. band, because the attenuation losses are small. This line uses two single solid conductors accurately spaced and firmly fixed in place in foamed polyethylene. This line is so new there are no reports on it from field tests as yet. These data are based upon the manufacturer's literature. The manufacturer, Anaconda Wire and Cable Co., claims that attenuation characteristics for both types of line are practically unaffected by moisture.

Installation

For new installations, 300-ohm flat line should be avoided for u.h.f., particularly when long lengths must be used. There should be a minimum separation of 6 inches from surrounding objects to prevent signal absorption losses. The standoffs should keep the wire at least 6 inches from the building. Make a drainage loop in the line just before it enters the house. Punch a hole at the bottom of the loop to remove moisture condensation in the line (see Fig. 5). Avoid coils or kinks anywhere between the antenna and the receiver. Cut the line to the proper size to reach the receiver and do not leave any extra line which might be coiled up or kinked, causing impedance changes. **END**

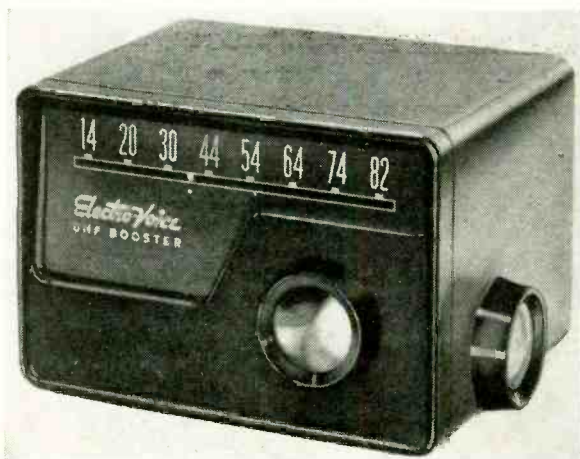

NEW

U.H.F.

By L. P. HAGEY*

BOOSTER

As more and more u.h.f. television stations open, new problems peculiar to u.h.f. reception are beginning to be recognized. One of the most serious difficulties, of low signal strength, is not peculiar to u.h.f. It has been found that in many regions, particularly those in rough terrain, that *dead spots* may be large, and may occur fairly close to the transmitter.

The presence of these dead spots indicates that the term "fringe area," as applied to v.h.f. reception, must be changed to include all low-signal areas when applied to u.h.f. reception.

Because of the large u.h.f. fringe area, there is a great need for a sensitive preamplifier or booster. The signal strength required for an acceptable picture on u.h.f. is considered to be about 1,500 microvolts per meter, while a signal strength of only 200 microvolts per meter is required for a similar picture on v.h.f. This difference in sensitivity is due to the relatively high noise figure of the input circuits of present u.h.f. receivers. A crystal mixer is almost always used in the input circuit. In addition to high noise, the crystal also introduces a conversion loss of from 6 to 10 db. The problem of increasing the receiver sensitivity then becomes one of providing an input circuit with the lowest possible internal noise and the highest possible gain.

Types of input circuits

Vacuum tube mixers have conversion gains at u.h.f., but they too suffer from high noise, and require high oscillator drive, which magnifies radiation problems. New tubes and circuits are helping to overcome these difficulties, but the indications are that the crystal mixer will be here for some time.

Another approach to the problem of

increasing sensitivity is to provide a stage of amplification ahead of the mixer. In this position, a low-noise stage is most effective in reducing the over-all noise of the system.

Circuit considerations

A triode stage is indicated because of its low noise. The triode, however, must be neutralized to eliminate electrostatic coupling between output and input circuits. The problems of neutralization are almost impossible to overcome at these frequencies. In addition, transit time and lead reactance effects operate to so lower the input impedance that the gain is seriously lowered at the higher frequencies.

The above remarks refer to the stand-

ard grounded-cathode triode amplifier. If a triode is employed in a grounded-grid circuit, no neutralization is required. The grounded grid acts as an electrostatic shield between the output and input circuits. See Fig. 1. Since

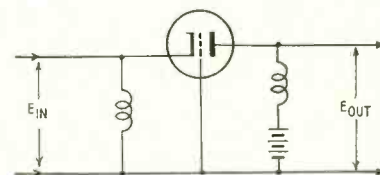
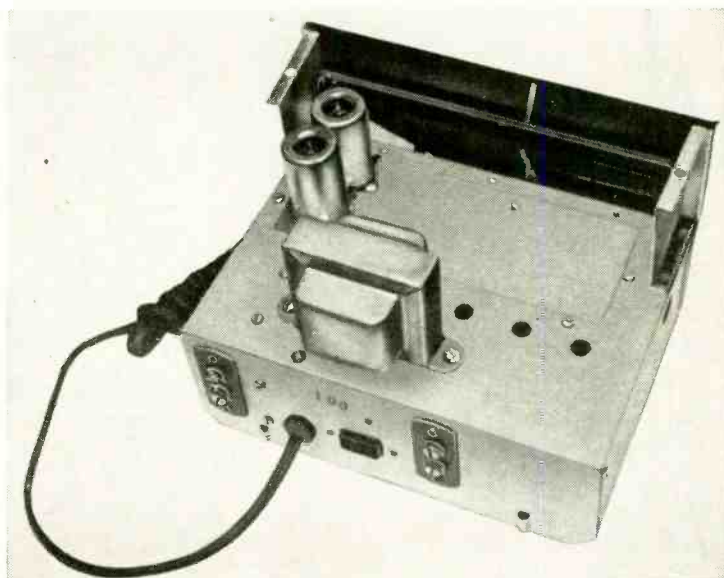

Fig. 1—Basic grounded-grid circuit.

the input signal is in series with the external plate-to-cathode circuit of the

Photo shows rear and top view of u.h.f. booster. A push-pull grounded grid circuit is used.



*Electronic Engineer, Electro-Voice, Inc.

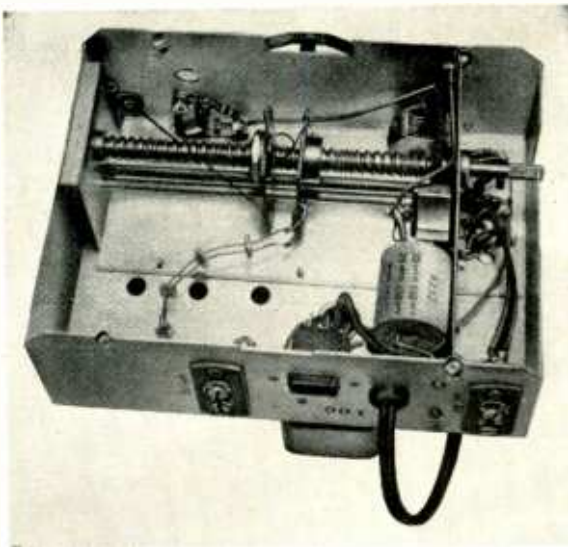

Photo shows under-chassis view of the u.h.f. TV booster. "Differential micrometer" tuning mechanism can be seen.

tube, a portion of the signal is transferred directly to the output circuit. This represents a load on the input and would seem to be more harmful than the transit time and lead reactance effects in the standard circuit. This is true at medium frequencies. But the loss of gain suffered by the grounded-grid stage increases much more slowly with frequency than that of the grounded-cathode stage. For a given tube, the grounded-grid circuit will still deliver useful amplification of frequencies where the grounded-cathode circuit is useless. In addition, the grounded-grid triode has less noise than the grounded cathode triode. The high degree of isolation between output and input provided by this circuit is also important, because it provides a higher attenuation of radiated energy from the local oscillator. This energy is kept from feeding back to the antenna where it could cause interference in neighboring receivers.

Lead reactance is a serious problem. Even a length of conductor such as the tube pin itself can have an inductance whose reactance is substantial at 900 megacycles. Obviously, if the grid pin of the tube offered inductive reactance, a signal voltage would appear on the grid. When this occurs, the conditions of grounded-grid operation no longer apply and the advantages of this type of operation are lost.

Tube capacitances are equal in value to the resonant circuit capacitances at these frequencies, and represent a serious obstacle to obtaining an external circuit which may be varied over a wide range of frequencies. A push-pull circuit effectively places the tube capacitances in series and reduces this effect to one-half that experienced with a single tube. Thus, a push-pull circuit places more of the resonant circuit outside of the tube.

Special tube types such as the light-house tubes and pencil triodes, which will operate satisfactorily at u.h.f., have been available for several years. However, due to high cost and difficult application, it is not worth while to use these tubes. New tubes with conven-

tional bases, suitable for use in special circuits at the ultra-high frequencies, have now been developed.

The u.h.f. booster circuit

Due to the above considerations, a push-pull grounded-grid triode circuit was chosen for the design of the model 3400 u.h.f. booster (Fig. 2). The 6AJ4 tube is a new high-transconductance triode especially developed for grounded-grid operation at ultra-high frequencies. This tube features extremely short leads and excellent internal shielding between plate and cathode. The miniature noval base lends itself to standard circuits and to ease of tube replacement. It has five grid pins so that grid-lead inductance may be kept to a minimum. In the booster design these five grid pins are grounded directly at the tube socket. The tube sockets are of special low-loss design and have very short leads.

Electrostatic shielding is provided by the grounded grid and a vertical shield which divides the underside of the chassis into two compartments. The shield passes over the tube sockets, with all input contacts (cathode, heater, and three grid pins) on one side and all output contacts (plate and two grid pins) on the other.

The low input impedance of the

grounded-grid stage makes it possible to connect it directly to 300-ohm transmission line. In addition, excellent balance to ground is maintained by the push-pull feature. The input impedance, due to the untuned input and the excellent isolation of input and output, is quite stable at about 120 ohms per tube. The total input impedance of 240 ohms presents very little mismatch to a 300-ohm line. The shunting effect of the cathode-to-heater capacitance is minimized by means of the series r.f. chokes (L1, L2, L3 and L4), which place the heaters above ground potential.

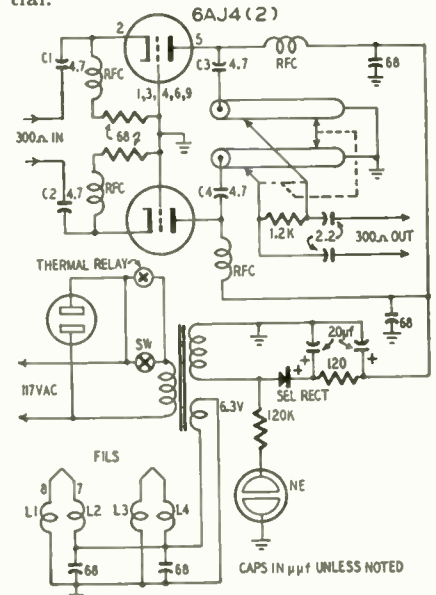

Fig. 2—Schematic diagram of the Electro-Voice model 3400 u.h.f. booster.

The output tuned circuit is a shorted quarter-wave resonant line. The 4.7- μ f series capacitors, C3 and C4, serve as d.c. isolation and also provide a small amount of decoupling to allow the external tuned circuit to reach the upper frequency limit of 900 megacycles. The resonant line is designed with a relatively low (115-ohm) characteristic impedance and is heavily silver-plated to keep losses at a minimum. A loaded Q of about 70 is reached with a bandwidth of 6 megacycles at a frequency of 470 megacycles and a gain of 12 db. The relatively high Q and narrow bandwidth keep the noise characteristic



Rear view of the booster, showing the v.h.f. bypass filter in place.

low, and also help reject many types of interference.

A resonant circuit of this type can be adjusted over a very wide range of frequencies by providing a short-circuit which can be moved along the line. Thus the effective length is varied, changing the resonant frequency. Fig. 3 shows how this is done. When the lead screw (9) is turned, the drive nut (7) and carriage (4) which carries the shorting contact move along the length

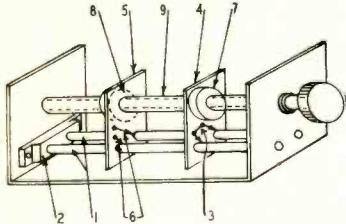

Fig. 3—Tuner mechanism. 1—Resonant line elements; 2—Low loss, low-capacitance line support insulator; 3—Silver shorting contact; 4—Insulating carriage; 5—Insulating carriage; 6—Silver 300-ohm output contacts; 7—Six-pitch drive nut; 8—Seven-pitch drive nut; 9—Lead screw with six- and seven-pitch threads superimposed.

of the line (1). The silver contact (3) forms a short-circuit between the two line elements, varying the length of line between it and the open end.

The problem of coupling energy from a resonant line section is easily solved by coupling a pickup loop inductively to the line, if only a narrow range of frequencies is involved. When a wide range must be covered the optimum position for the pickup loop moves along the line as the line length is varied. It was found practically impossible to maintain correct inductive coupling with a pickup loop over the entire frequency range of the booster. Therefore, another scheme is used.

Amateurs and many television technicians know that a resonant line section may be made to function as an efficient transformer simply by connecting to the proper points on the line. Thus, a shorted quarter-wave line presents a very high impedance at the open end (connected to the plates in

our case) and zero impedance at the short-circuit. Any intermediate value of impedance may be obtained by connecting to the proper intermediate point on the line.

The high efficiency and excellent impedance match which may be obtained by this method of tapping the line makes it especially attractive. Of course, the mechanical problem arises of moving the tapping, or output, contacts in correct space relation to the shorting contact. This is not too difficult, since the distance between the tapped point and the short circuit for a constant output impedance varies with the wavelength.

The mechanical problem was one of causing the shorting contact and the output contacts to move down the line at different but constant speeds, when the tuning knob was turned at a constant speed. Flexible belt or cord drive methods were tried and discarded because they were unreliable. Instead, a positive drive was provided by a single lead screw. The lead screw has two threads of different pitch superimposed on each other. The drive nuts, (7) and (8), Fig. 3, follow only the thread of their own particular pitch. This "differential micrometer" tuning mechanism** can never slip or get out of adjustment. The high efficiency and constant impedance characteristic insure maximum transfer of energy to the 300-ohm output terminals. The entire range of u.h.f. television frequencies is covered in about 25 turns of the tuning knob.

U.h.f.—v.h.f. reception

When a single transmission line must be used for both v.h.f. and u.h.f. signals, there must be a way to shunt the v.h.f. signals around the booster. To avoid using a manual switch, filters are introduced. They provide high attenuation over the entire u.h.f. band and negligible attenuation at v.h.f. Discontinuities in the transmission line—introduced in part by the connecting leads—are responsible for much of the difficulty experienced with these matching units (filters).

To eliminate line discontinuities, small inductances are wound directly

* Patent applied for.

on special composition capacitor bodies to form parallel resonant or *band-stop* circuits of very small physical size. In the final filter design, (Fig. 4) these band-stop coils are connected by very short leads directly to the booster terminals. These short lead lengths are maintained by mounting the entire filter on a small low-loss phenolic base which mounts on the back of the booster and is supported directly on the booster terminals. See photo. The band-stop coils thus serve to isolate the longer leads in the filter from the u.h.f.

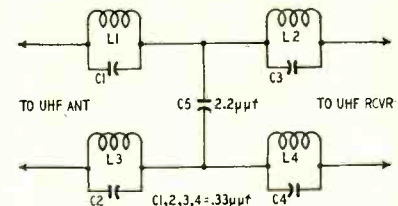

Fig. 4—Schematic of 3450 v.h.f. bypass.

lines and eliminate discontinuities. The series capacitors, C1, C2, C3 and C4 (Fig. 2), in the input and output circuits of the booster are electrically a part of this v.h.f. bypass network and prevent the v.h.f. signals from being shorted out by the u.h.f. circuits. The filter is called model 3450 v.h.f. bypass. Maximum attenuation of the filter to v.h.f. signals is 3 db, which is hardly noticeable.

Summary

In actual field tests the 3400 u.h.f. booster substantiates the theory that there is an appreciably lower noise figure through its use. Even where signal strength is adequate for acceptable picture contrast without the booster, a reduction of snow is noted when it is used. Extremely flexible in application, it may be used with any installation, providing increased sensitivity and a reduction in snow and back radiation. In the many areas where only one u.h.f. station can be received, completely automatic operation is possible. A thermal relay turns the assembly on and off automatically with the TV receiver. This allows the booster to be concealed if desired. END

FCC'S STERLING WARNS MANUFACTURERS ON TVI

TV interference was the subject of a stern warning delivered by FCC Commissioner Sterling to TV, radio, and broadcast equipment makers. The occasion for this warning was the Fall meeting of the combined RETMA, RTMA of Canada and IRE in Toronto.

Commissioner Sterling stressed that the industry must do much more about reducing radiation from TV receivers and transmitters which interfere with reception on government, aircraft, amateur and TV-radio bands.

Sterling said that the FCC received 22,264 interference complaints in fiscal 1953. More than 12,600 resulted from spurious responses of broadcast receivers—6,000 from TV sets. Some 9,600 were the result of spurious radiations from transmitters.

At one point, the commissioner departed from his prepared text, reminding manufacturers of FCC's new power to issue "cease and desist" orders, which in some cases could have the effect of putting an offending company out of business.

The Commission has been making extensive field measurements in Portland, Oregon, site of the first commercial u.h.f. station, on radiation from u.h.f. TV receivers and converters. The results gave great cause for concern. In the instance of strips and separate con-

verters, excessive radiation was observed in the region between 200 and 500 mc. The radiation from u.h.f. oscillators was in the order of thousands of microvolts per meter, and in one instance a field of 10,000 microvolts-per-meter was obtained at 100 feet from a set of one of our major manufacturers.

In reply, Crosley's Lewis M. Clement, chairman of RETMA engineering department's executive council reported that the vast majority of manufacturers have now reduced spurious v.h.f. oscillator radiation below RETMA's "interim" maximums (50 microvolts-per-meter at 100 feet for channels 2-6 and 150 microvolts-per-meter for 7-13).

Fig. 1—A three-quarter view of the new v.h.f.-u.h.f. TV tuner.

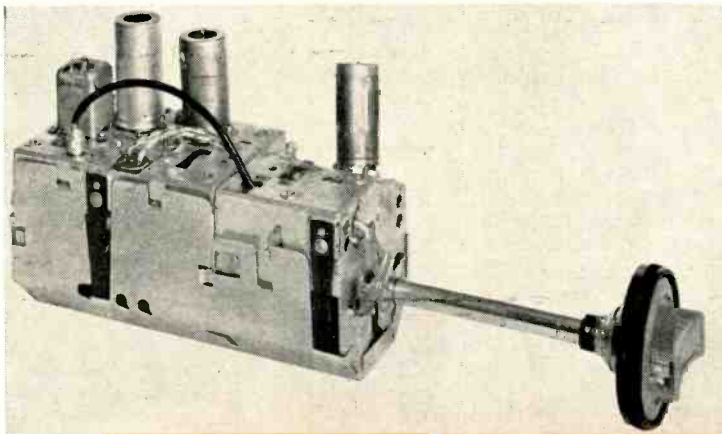
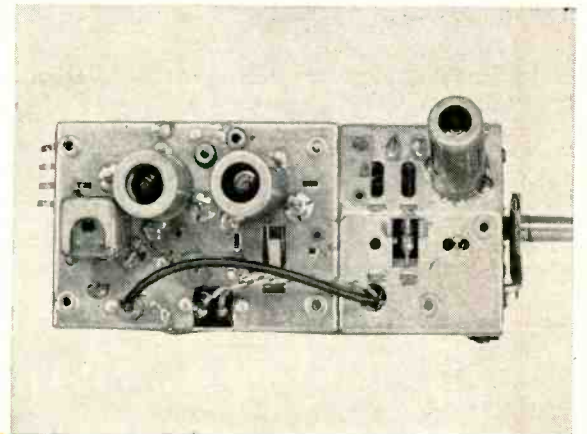

Fig. 2—Top view. The i.f. traps are in can at left.



Courtesy Tech-Master Products Co., Inc.

U.H.F. | V.H.F. 82-CHANNEL CASCODE TUNER

By E. D. LUCAS, JR.

THE new Standard Coil v.h.f.-u.h.f. television tuner is a detent—or step-type instrument designed for exceptionally high gain and low noise reception of channels 2 through 83. It was developed primarily for use with 41-mc i.f.'s, but is available in a modified form for 21-mc i.f. strips.

Using only three tubes, this tuner provides a gain of more than 34 db on all v.h.f. and u.h.f. channels. A high-pass filter and fixed and tunable i.f. traps in the antenna input circuits provide good i.f. and image rejection. On v.h.f., image rejection is better than 50 db and i.f. rejection is at least 60 db at the interfering frequency. The maximum noise figure is 7 db on channels 2 to 6 and 9 db on 7 to 13.

In the u.h.f. range, v.h.f. signal rejection is greater than 50 db and i.f. rejection exceeds 60 db. The noise figure is less than 19 db on any channel between 14 and 83. The tuner's r.f. response is flat within 0.25 db per mc for any desired pass-band in the u.h.f. TV spectrum and within 3 db over the v.h.f. bands.

The tuner is small considering its performance and all the parts it contains. Its length (exclusive of shaft) is 7.34 inches, width is 3.5 inches, and maximum height (including tube shields) is 5.6 inches. The shaft length is specified by individual receiver manufacturers to meet their requirements for various chassis and cabinet styles. The tuner requires 6.3 volts a.c. at 1.07 amp, 1.5 volts of negative bias, 250 volts d.c. at 20 ma, and 150 volts d.c. at 12 ma for v.h.f. and 17.5 ma for u.h.f. reception.

Figs. 1 and 2 show that the new tuner is literally a combination of separate v.h.f. and u.h.f. tuners. The larger section contains the v.h.f. section and the smaller chassis contains most of the

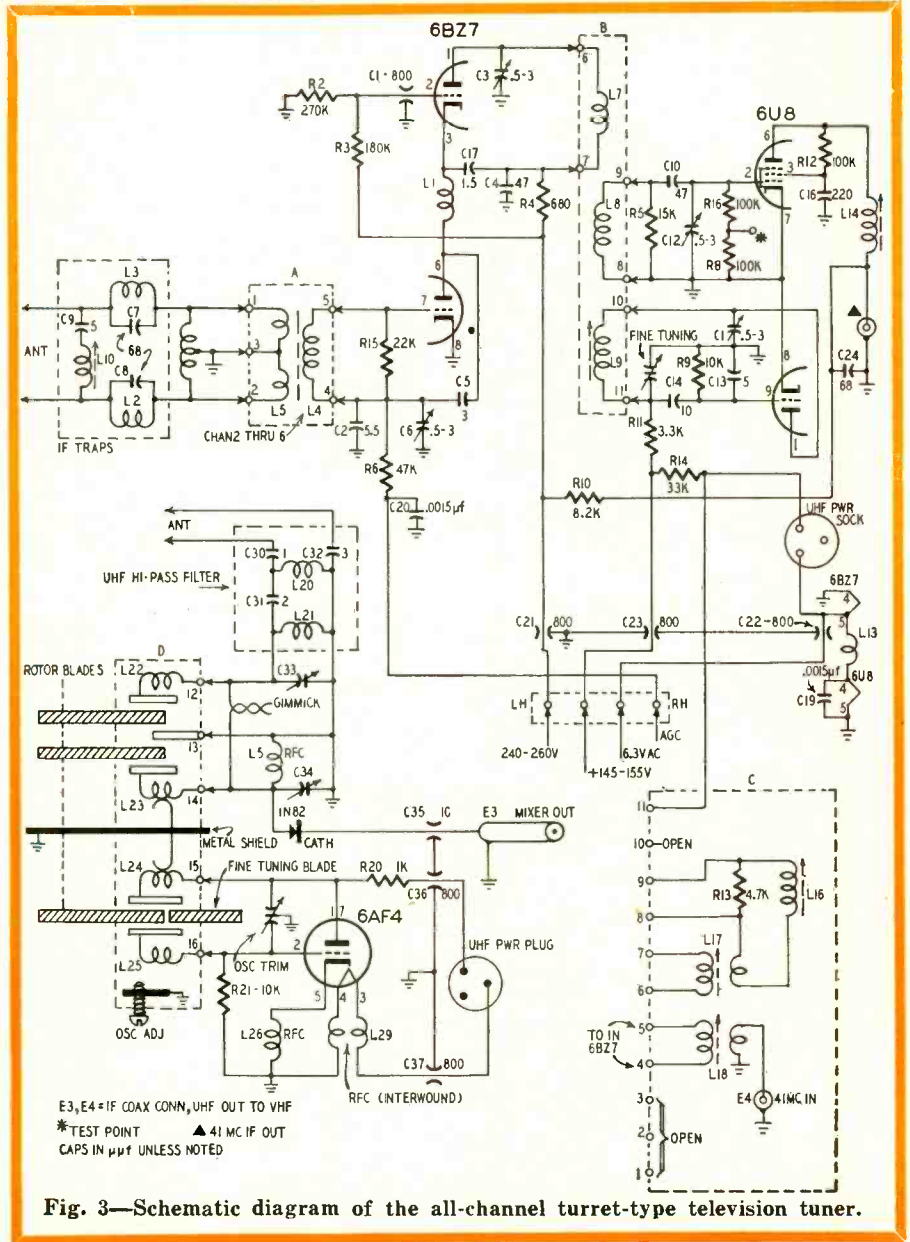

Fig. 3—Schematic diagram of the all-channel turret-type television tuner.

u.h.f. circuitry. By constructing the tuner in two distinct sections, production is simplified and the sections can be tested separately, reducing the number of rejected finished units. The technician's service problems are simplified when the v.h.f. section is used alone in areas where the number of u.h.f. channels is small.

The tuning control consists of three concentric control knobs or rings mounted on concentric shafts. The outer ring and shaft control the fine tuning for the v.h.f. and u.h.f. oscillators. The central shaft is a decade selector—a sort of band-switch with nine decade positions. One is for v.h.f. channels 2 through 13, one for channels 10 through 19, and the other seven for channels 20 through 83. The innermost of the three shafts controls the selection of the individual channels, both v.h.f. and u.h.f. To tune to channel 4, for example, the central ring is turned to the v.h.f. position (channels 2 through 13) and the innermost ring is then turned until the number 4 appears in the clear plastic window. Now, the outer ring controls the fine tuning. U.h.f. channels are selected the same way.

The v.h.f. section

A major addition to the v.h.f. circuit appears at the extreme left of the v.h.f. chassis in Fig. 1 and schematically in Fig. 3. This feature consists of i.f. traps to reject interfering signals within the 41-mc i.f. pass-band. Tuned circuit C9-L10 is tunable over a range from 35 to 48 mc. Traps C7-L3 and C8-L2 are fixed-tuned for maximum rejection of i.f. interference. The entire trap section is shielded.

The signal passes from the i.f. traps to L5 and L4 mounted on coil board A, shown in Fig. 3. These coils are separate windings, which represents a departure from the antenna coils of the previous Standard Coil 21-mc tuner, since the latter are bifilar-wound. In the new design, the primary L5 is a reversed helix. L4, the secondary, includes an iron core for tuning channels 2 through 6 on the coil boards for those channels. These newly designed windings help isolate the v.h.f. antenna input from the input of the 6BZ7 cascode amplifier. The single-tuned input to this first grid also incorporates a physical shield for further isolation of the v.h.f. antenna and grid circuit.

To compensate for tube input-capacitance variations, the variable steatite capacitor C6 is paralleled with C2. This adjustment is useful when replacing 6BZ7's.

C5 is a neutralizing capacitor. It reduces noise by compensating for the plate-to-grid capacitance of the first triode and minimizes the change in response with changes in the a.g.c. voltage applied to the grid. Thus a flat characteristic is maintained in the first r.f. amplifier stage, and input noise is kept at a minimum. R15 is a damping resistor which improves the VSWR (voltage-standing-wave ratio) on the low-band v.h.f. channels. On the high-

band v.h.f. channels, the tube loading takes care of the required damping.

Design of the cascode amplifier is similar to that of the corresponding circuit in the 1952 v.h.f. tuner. At the grid (pin 2) of the second stage, resistors R2 and R3 act as a bias network. The values of these two resistors are selected to provide delayed a.g.c. action on the cascode amplifier. This maintains a high signal-to-noise ratio when a.g.c. is applied to the first triode, until the signal overrides tube noise. Value of the delayed a.g.c. is about 1.5 volts. Feedthrough capacitor C1, in the grid circuit of the 6BZ7 (pin 2), minimizes oscillator radiation.

C17 provides feedback for neutralizing the second triode to improve the tilt of the frequency response vs. a.g.c. bias curve. This action of C17 and the similar action of C5 in the first triode's plate circuit help to maintain a reasonably flat frequency response despite considerable change in a.g.c. voltage. Output of the cascode amplifier is fed from the second plate (pin 1) of the 6BZ7 through an overcoupled double-tuned circuit, variable trimmer C3, L7, and L8 on oscillator coil board B, to the grid of the 6U8 mixer.

The 6U8 pentode-triode was chosen as the mixer-amplifier (pentode) for v.h.f. and second i.f. amplifier stage for u.h.f., as well as the local oscillator (triode) for v.h.f., for two principal reasons. One is to isolate the plate and grid circuits at intermediate frequencies and thus eliminate the need for neutralization, which was required with the 6J6 mixer-oscillator in the previous Standard tuner. Another reason for choosing the 6U8 is the considerably greater gain (an average of 3 db on v.h.f. channels) possible with the pentode amplifier stage as compared with a triode. It also helps to account for the high gain of the tuner when used for u.h.f. reception.

R5 is a damping resistor used to flatten the response of the overcoupled circuit (L7 and L8) to a maximum variation of 3 db. Trimmer C12 tunes out the variations in internal capacitance between individual 6U8 tubes.

R12 is a screen-dropping resistor to maintain the voltage at a sufficiently low level to prevent excessive dissipation or overloading of the pentode. An interesting feature of C16 is that its leads are relatively long, to increase the screen grid's input impedance—by adding inductance—for the high-band v.h.f. channels. At intermediate frequencies C16 provides adequate isolation.

The combination of L14 and C24 provides a low-side capacitance-output circuit which, with the first i.f. stage of the television receiver, can be tuned to provide any desired bandpass and to minimize oscillator radiation.

All voltages are fed to the oscillator-mixer section through feed-through capacitors C21, C22, and C23, mounted in the center shield, to isolate the r.f. section from oscillator voltage which might appear on the supply leads.

The v.h.f. oscillator, or triode section of the 6U8, is a fairly conventional Colpitts circuit. The negative-temperature-coefficient capacitors C13 and C14 reduce short-term oscillator warmup drift to a minimum. After a minute or so of warmup, drift is negligible.

Fine tuning is achieved by moving a nylon dielectric blade between two electrically-hot plates connected to the oscillator grid and plate circuits. The same fine-tuning control operates similar blades for the v.h.f. and u.h.f. oscillators, with both blades on the same shaft but about three inches apart physically in carefully shielded sections. R9 is a conventional grid-leak resistor, and C1 is a trimmer inserted to compensate for variations in capacity between 6U8 tubes. Oscillator injection voltage is applied to the mixer by the coupling between L8 and L9 on coil board B. L9, like the oscillator coils in previous Standard tuners, is slug-tuned and is accessible from the front of the tuner through a slot in the movable fine-tuning sector. In the new combination tuner, the plastic-tipped tuning tool must be inserted through the u.h.f. section at the front of the tuner to reach the v.h.f. slug core in L9.

The u.h.f. section

The u.h.f. antenna terminals connect to capacitors C30, C31, and C32 and coils L20 and L21 which form a u.h.f.-band high-pass filter with cutoff below 470 mc. Physically, C30 and C31 are small metal-and-dielectric blades held with nylon screws. This high-pass filter at the antenna input prevents i.f., v.h.f., and other interfering frequencies from entering the u.h.f. section of the tuner.

The remainder of the antenna circuit consists of the portion of coil board D shown above the metal shield (Fig. 3), together with the trimmers C33 and C34, choke L5, and an r.f. coupling gimmick to the 1N82 crystal mixer. There are eight different D type coil boards mounted on the u.h.f. drum. Each of these eight boards covers one of the eight decade bands in the u.h.f. spectrum. A typical coil board D covers the 60-mc range of 10 u.h.f. channels. Channels within this range are tuned by moving dielectric vanes or rotor blades between capacitive plates mounted on the board. This construction is shown in Fig. 4.

The three capacitive blades, attached respectively to L22 and terminal 12, to terminal 13, and to L23 and terminal 14, vary in size and spacing depending upon the decade range to be covered. The tuned circuit of these three blades and associated coils L22 and L23 is pre-aligned at the factory. Trimmers C33 and C34 are adjusted to tune in any specific u.h.f. channel, an alignment procedure to obtain the correct r.f. bandpass.

The dielectric vanes for tuning individual u.h.f. channels within the decade range covered by each coil board D are so connected to the u.h.f. drum that they are turned by the same inner

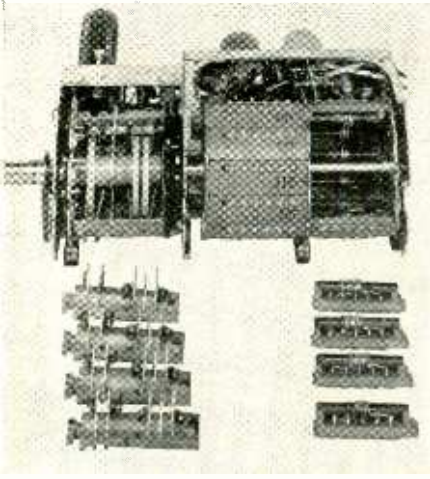

tuner-dial ring and shaft that turns the drum for v.h.f. stations. The same control makes the transition between v.h.f. and u.h.f., with the one exception of the decade, channels 14 to 19. Here, because of the action of the small cam shown in Fig. 5, which fits into the larger cam for other u.h.f. decade positions, the unit goes along as a v.h.f. tuner for channels 10, 11, 12, and 13. Then at 14, the small cam operates to switch the tuner to u.h.f. reception for channels 14, 15, 16, 17, 18, and 19. In the normal v.h.f. operation, it is also possible to tune in channels 2 through 13 at the v.h.f. decade position. Thus channels 10 through 13 can be tuned in at two positions of the decade dial's ring.

The u.h.f. oscillator is a 6AF4 operated 41.25 mc above the sound carrier of each TV channel. The oscillator section of each coil board D consists of L24 and L25 connected with fixed metal blades as indicated in Fig. 3, the schematic, and shown in Fig. 4. Individual u.h.f. channels within the decade range covered by any coil board D are tuned in by moving a dielectric vane between these two blades.

An adjustment for each board D's oscillator section—corresponding to the slug-tuning of the v.h.f. oscillator coils—is provided by means of the screw indicated on Fig. 3 and shown in the hole in the middle of the fine-tuning sector in Fig. 6. This screw can be turned closer to, or away from, the blade attached to L25 to change the capacitance of the circuit sufficiently to provide an oscillator tuning adjustment. The screw can be reached through the same hole at the front of the tuner that is used for v.h.f. oscillator-slug tuning.

In the circuit of the u.h.f. oscillator, the oscillator trimmer is a split-stator ceramic padder used to compensate for variations in internal capacitance of 6AF4's. The oscillator and incoming signals are heterodyned in the mixer to produce a 41-mc i.f. The 41-mc signal is amplified by the cascaded 6BZ7 and the pentode section of the 6U8 to compensate for the 9-db conversion loss in the mixer.

From the 1N82 mixer, the 41-mc signal is applied through connectors E3

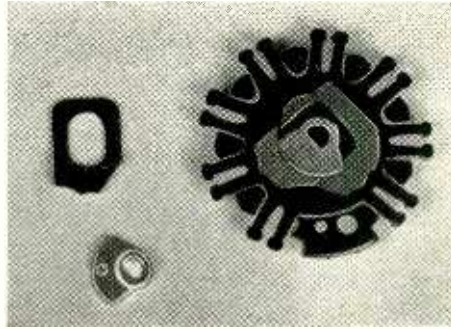

Fig. 4 (Left)—The v.h.f.-u.h.f. tuner with cover and several u.h.f. and v.h.f. strips removed to show the construction. Note the dielectric tuning vanes and the metal blades in the u.h.f. tuner section. Fig. 5 (Right)—The spider disc contains two small cams like those shown to control movement of coil strip C.

Fig. 6—Front view. The u.h.f. and v.h.f. oscillators are adjusted with plastic tool through the fine-tuning sector.

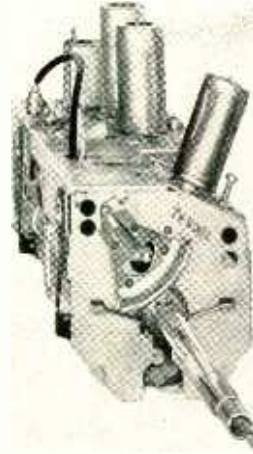
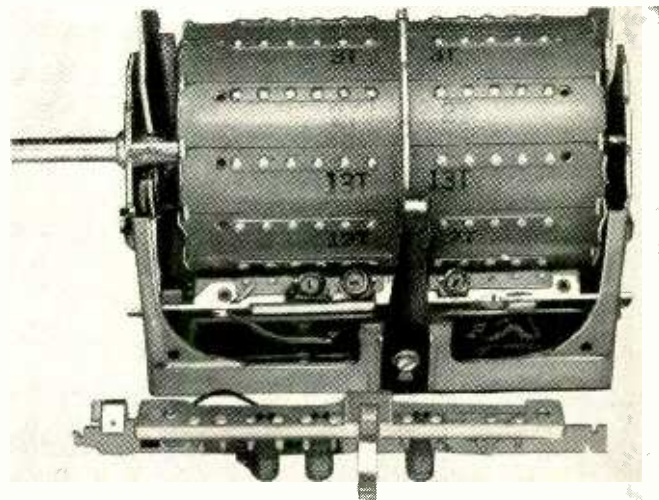

Fig. 7—The "rocking horse" (coil board C) is shown below the v.h.f. drum and in the foreground outside of the tuner.



Figs. 4 and 6 courtesy Tech-Master Products Co., Inc.; Figs. 5 and 7 courtesy Standard Coil Products Co., Inc.

and E4 to coil board C which contains coils for the 41-mc i.f. preamplifier. Coil board C is mounted in the v.h.f. section of the tuner and is used only during u.h.f. reception. It is shown in Fig. 7. Standard Coil engineers call it the "rocking horse" because it rocks from one position depending on whether the tuner is set for v.h.f. or u.h.f. On v.h.f., the spider cams shown in Fig. 5 disengage board C from the springs which make contact with terminals on the exterior of coil boards mounted on the v.h.f. tuner drum.

In all u.h.f. positions, strip C contacts the springs and the v.h.f. drum is disengaged. Board C rocks to and fro so contacts are automatically wiped clean each time the tuner is switched

from one of the u.h.f. channels to another.

L16, L17, and L18 form a band-pass circuit which is loaded by R13 to provide flat response over a range of 6 mc. Signals from the mixer are fed over shielded cable to the primary of L18. L16, L17, and the secondary of L18 connect to numbered terminals in the 6BZ7 and 6U8 circuits. The 41-mc signal at the plate of the 6U8 pentode section appears across L14 and is fed from there to the receiver's 41-mc i.f. circuits.

This writer is indebted to Edward F. Theis, vice-president in charge of engineering and research, and Robert Eland, chief engineer of Standard Coil Products Co., for major assistance in the preparation of this article. END

UNDERSTANDING VIDEO I. F.'s

A study of i.f. bandwidth and coupling clarifies the subject

By H. L. MATSINGER

OUR problem with the intermediate frequency stages of AM radio receivers was to get 10-kc selectivity with as much suppression of signals outside that band as we possibly could. In TV we are faced with a harder problem. Our i.f.'s now have to have a passband of 4 megacycles, with a sharp cutoff at the upper limit to keep sound modulation out of the picture.

cutoff at 4 mc, so the sound signal does not interfere with the picture. This type of curve—up to 4 mc—is desirable whether we use split sound or the intercarrier system. With intercarrier sound we must provide for a passband of 4.5 mc, the strength of which should be at least 80% below that of the picture signal.

Fig. 1 shows the relationship between the TV signal and the response of an ideal i.f. transformer. For the low modulation frequencies which extend 0.75 mc on either side of the carrier frequency, we have a sloping response. This is so the combined strength of the two sidebands over this region will not add up to more than the single sideband at the higher frequencies.

There are many types of coupling used in i.f. stages: single-tuned, double-tuned, and overcoupled, to mention the most common. In every case there is a good reason for using some particular type. Some sets are designed with low cost as the most important factor; others with best performance; and still others represent a compromise of the two. As a rule of thumb, it is safe to say that the more aligned circuits a set has, the better will be the picture. It does not make a great deal of difference whether the i.f. is 24 or 44 mc; it is the i.f. bandwidth and shape which determines picture quality.

When we use an i.f. amplifier consisting of only three stages of single coil, single tuned transformers (Fig. 2), it is hard to get good results. The single-tuned coil gives a sharply peaked response, and it is necessary to place a resistor (4,000 to 10,000 ohms) across the coil to broaden its response. In such an amplifier, the adjustments are so few and the circuits so sharply peaked, that

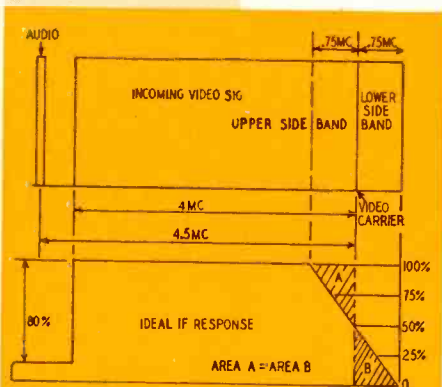

Fig. 1—Relationship between the signal and ideal response of i.f. transformer.

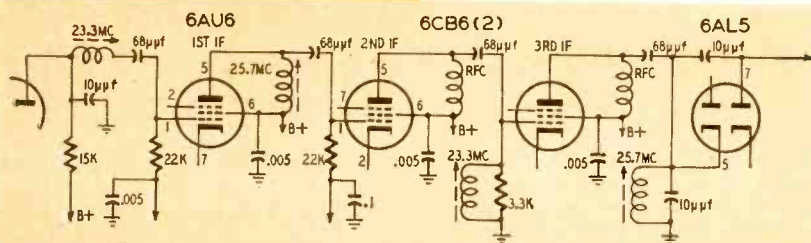

Fig. 2—Typical single tuned i.f. coils. Circuit is similar to Mirrortone 17MC.

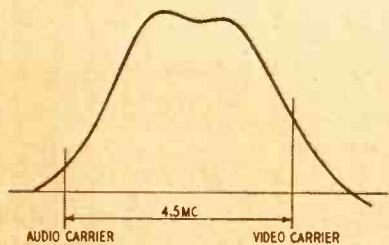

Fig. 3—Overall response of Fig. 2.

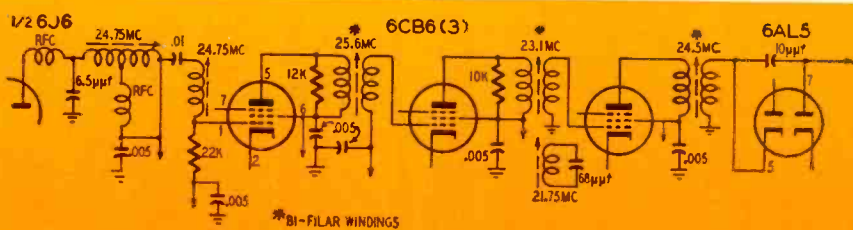
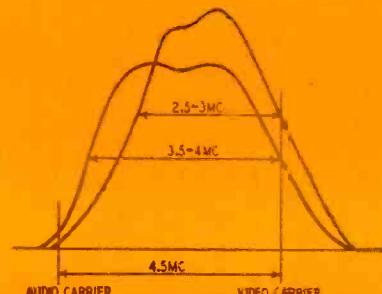
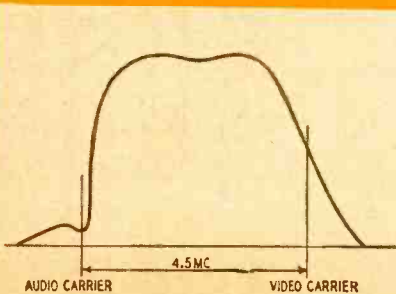

Fig. 4—I.f. circuit with overcoupling, similar to the Hallicrafters A1100D.

Fig. 5—Right, diagram shows overall response of Fig. 4.

Fig. 6—Far right, i.f. gain greatly increased by peaking.



no amount of tuning will give us a really good response curve. To get good low-frequency response, and still retain about 85% of the picture components, we have to sacrifice some of the higher picture frequencies.

When a tuned circuit is loaded, as when plate current flows through it, there is a tendency for the resonance peak to be reduced. On the other hand, a grid circuit will tune sharply. Many design engineers, to take advantage of this, alternate the tuned circuits in the i.f. stages.

Mirrortone model 17MC is a good example of this. The mixer plate is shunt fed through a resistor, and the first i.f. coil is in series with the first i.f. grid. The unloaded coil tunes sharply. A broadening effect is introduced because the next tuned circuit is in the plate of the first i.f. tube. The second i.f. is untuned, in both the plate and grid, giving some amplification, but having little effect upon the response curve. The third i.f. stage is grid tuned, but the response is broadened by the use of the parallel 3,300-ohm resistor. There is also another tuned circuit before the video detector. This design is not flexible, and Fig. 3 represents about the best that can be done. The 4-mc upper limit of video modulation comes down about 50% on the response slope. This is not too bad, since it is possible to regain much of this by peaking in the video amplifier.

Fada uses a similar circuit in their model 7T32; except for the addition of a 21.6-mc trap in the grid circuit of the third video i.f. This trap, in addition to removing adjacent-channel video signals, also permits the proper positioning of the sound channel on the flat portion of the response curve.

Although stagger-tuned 3-stage i.f. amplifiers are often used in less expensive sets, full 4-mc bandwidth is easily attained through use of an additional stagger-tuned stage. A wise choice of peaking frequencies and adequate traps can result in response and gain that meet all standards of performance. The 630, Radio Craftsmen, Hoffman, and other makes and models provide high-gain 4-mc-wide i.f. response with 4-stage stagger-tuned systems.

We obtain better control over the response and gain of 3-stage stagger-tuned amplifiers when the tuned chokes and R-C coupling networks are replaced by dual-winding transformers with a single tuning adjustment. Bandwidth and gain are controlled by varying the turns ratio and spacing between the windings and by shunting a resistance across one or both windings. The response and alignment procedures of a single-tuned transformer are about the same as when a tuned choke is used.

The basic i.f. circuit of the Hallcrafters chassis A1100D is shown in Fig. 4. The total effect of tuning the circuit is shown in Fig. 5. The output of the mixer is a tapped coil tuned to 24.75 mc. Plate current flows through this coil, and it is capacitively coupled to a second coil, also tuned to 24.75 mc. A bifilar i.f. coil, with single slug tun-

ing, is used between the first and second i.f. tubes. The same type coil is used between the second and third i.f. tubes, which has, in addition, an absorption trap tuned to 21.75 mc. This trap is used to remove any adjacent-channel picture signal, and can be used as an aid in the proper positioning of the sound channel. Another single-slug-tuned bifilar coil is used in the input to the detector. To help broaden the response of the i.f. in the first and second stages, two resistors of 12,000 and 10,000 ohms respectively are used across the primaries.

The foregoing arrangement is very flexible. You have ample control of the bandpass. Ample bandpass means good detail. With the larger tubes, and good bandpass, you can see flies buzzing around the studio.

Some sets use double-tuned i.f. transformers to obtain the desired bandpass. The windings are placed close together (overcoupled) so a double-humped response curve is obtained when both are tuned to the same frequency. Schematically, the circuit of an overcoupled i.f. stage is essentially the same as the single-tuned transformer-coupled circuit in Fig. 4. You can usually identify overcoupled transformers by the dual tuning slugs or trimmer capacitors. However, the mere fact that a transformer can have two tuning adjustments does not necessarily mean that it is an overcoupled unit. It may be a tuned choke or a single-tuned transformer with a built-in adjustable trap. Check the schematic to be sure. Some overcoupled transformers may have a small capacitor connected between the grid and plate terminals to prevent a droop at the high end of the passband.

Alignment

In fringe areas, where the basic picture is more important than the fine detail, it is possible to get more energy by narrowing the passband. Truetone suggests that this trick be used with their model 2D2149A. In normal reception areas, a passband of 3.5 to 4.0 mc is used; while in fringe areas, a passband of 2.5 to 3.0 mc is recommended. As indicated in Fig. 6, you do get a worthwhile increase in gain. Of course, picture detail and sound output will be less. To compensate for the loss in sound signal, Truetone has available a plug-in adapter which incorporates two stages of sound i.f. This adapter plugs into the socket provided for the regular sound i.f. tube, and gets its power from the chassis. Almost any service technician can make up this type of an adapter if he wishes to take advantage of the gain from a narrowed i.f. bandpass.

The most common method of aligning overcoupled i.f. amplifiers is to use a scope and sweep generator. The scope is connected across the video detector load or across the output of the video amplifier. A single frequency—usually set at about the center of the i.f. passband—is used for alignment of all stages. The generator is set for a sweep of about 10 mc and its output is fed

to the grid of the last i.f. stage. The i.f. output transformer and traps, if any, are adjusted for the desired response at this point. The sweep generator is then moved in steps from the grid of one i.f. stage to the next until the mixer grid is reached. At each point, the circuits are adjusted for the specified over-all response curve at that point. Be sure to check the set manufacturer's data for alignment procedure and response curves.

Alignment of the sound i.f. in an intercarrier sound receiver is quite simple; almost like the older AM sets. We have two signals in the output of the video detector, one containing the picture elements which extends up to 4 mc beyond the zero frequency, and the other is the 4.5-mc beat (plus or minus 25 kc for 100% modulation) which can be likened to the squeal which we sometimes get on an AM receiver. In AM jobs, the squeal comes from adjacent station interference, in TV it is an intentional co-channel beat, the beat of the FM audio.

The sound take-off is from the output of the detector or video amplifier, through a coupling capacitor or transformer which acts as a wave-trap, but the amplifier is always tuned for 4.5 mc. There are no tricks in the audio i.f., just straight peaking.

With most signal generators, exclusive of those which are crystal controlled, there is a degree of error. If you are not certain of your signal generator, you can always fall back on the crystal used by the transmitter. Tune in the test pattern signal with constant tone modulation, connect your output indicator, and align for maximum signal. You can also align the ratio detector with the same signal, since with constant tone modulation the deviation on either side of the center frequency is the same, and the exact center will be zero. If you use a voltmeter, the correct setting is halfway between minimum and maximum. Alignment of split carrier sets is identical except for center frequency used (it must be accurate, too). Whenever possible, consult manufacturer's data before aligning.

If there are any 4.5-mc traps in the circuit, align these with care, for they can destroy picture quality when tuned too low. The best way to be certain is to shoot a strong 4.5-mc signal through the detector output, hook the terminals of your oscilloscope across the trap, and align for maximum indication. You can also align for least herringbones on the picture, but sometimes the signal is so strong that you have to go way below 4.5 mc to remove them, and you end up taking away picture detail. The resonance method is the best.

Before you call any i.f. alignment job complete, always make an over-all check through the input of the set. No matter how well you align the i.f.'s, an improperly aligned oscillator will gum up the works. If there is any doubt, check and recheck. It might even be a good thing to zero heat the signal generator against the transmitter's carrier on each channel to be received. END

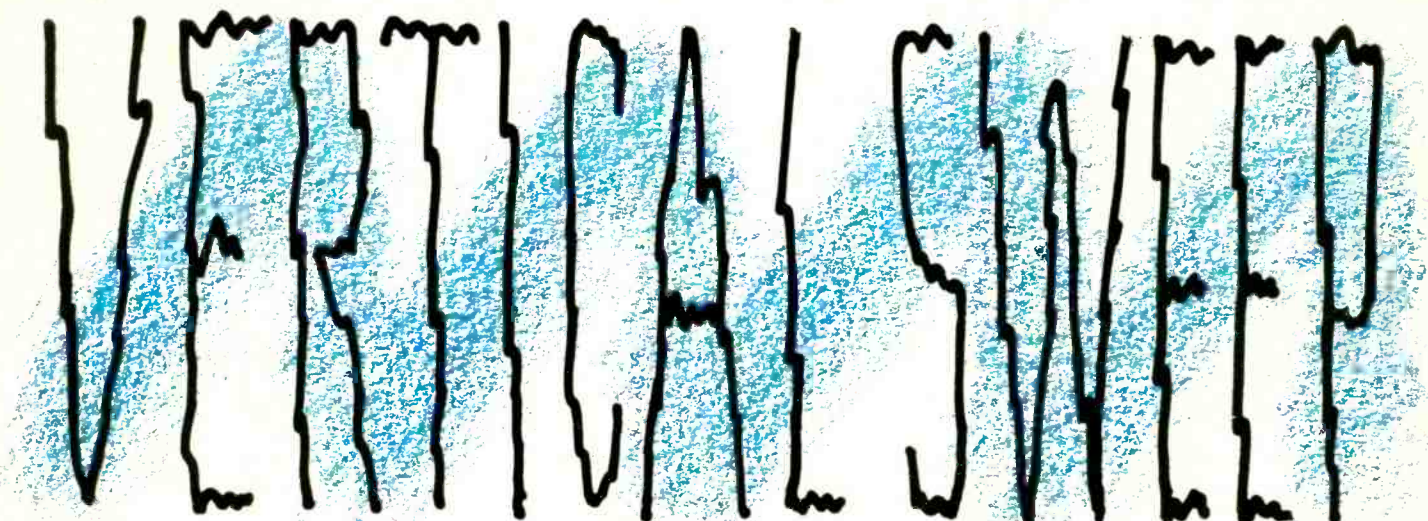

TROUBLES

The vertical sweep circuit is not too complex: by turning a few controls you can usually localize the trouble

By CYRUS GLICKSTEIN

VERTICAL sweep circuit troubles are among the most common in TV. In fringe areas especially, vertical roll is a frequent complaint. As a background for trouble-shooting, let us look at the basic circuit operation.

A typical vertical sweep circuit is shown in Fig. 1, with a blocking oscillator as the sawtooth generator. A multivibrator oscillator for generating the sawtooth is shown in Fig. 2. Both types of oscillators are in common use. The same symbols in the two diagrams refer to components having the same function.

For proper operation, the vertical circuit output waveform must have the correct frequency, amplitude, and linearity. The free-running frequency of the sawtooth sweep depends mainly on the time-constant of the R-C network in the grid circuit, C4, R4, and R5

(Fig. 1). C4 acts as the grid leak capacitor in the oscillator circuit. R4 and R5 in series act as the grid-leak resistor across which C4 discharges. A negative voltage, which keeps the oscillator tube cut off most of the time, is developed from grid to ground. Varying R5 changes the time-constant of the discharge circuit—that is, the speed with which C4 can discharge—thereby varying the frequency of oscillation. R5 is the vertical hold control.

For proper operation, the vertical hold control must be set so the free-running frequency is somewhat below 60 cycles. Then the vertical synchronizing pulses will trigger the oscillator and keep it in sync with the transmitted signal.

Troubles in the oscillator circuit, the sync circuit, or the video strip may account for a loss of vertical sync. Vertical roll occurs more often in

fringe areas because of the low signal-to-noise ratio. Horizontal synchronization is less affected by the low signal level because of a.f.c. (automatic frequency control) commonly used in horizontal sweep circuits.

R1, R2, R3, C1, C2, and C3 make up the integrating network. This network builds up the vertical sync pulses, which come in at the end of each field, to the point where they can trigger the vertical oscillator and start the retrace, sending the beam back to the top of the picture tube to start the next field.

The amplitude of the vertical output waveform determines the height of the picture or raster, and is controlled by the following factors:

1. The time constant of the R-C charge circuit which generates the modified sawtooth waveform (C5, R6, R7, and R8).
2. The amount of B plus applied to this charge circuit.
3. The amount of amplification in the output stage (including the yoke).

In the charge circuit of the sawtooth generator, C5 is the sawtooth charging capacitor and R6 is the peaking resistor. The charge and discharge of C5 through R6 produces the modified (trapezoidal) waveform (from the top of C5 to ground) which is required to deflect the beam vertically (Fig. 3-a).

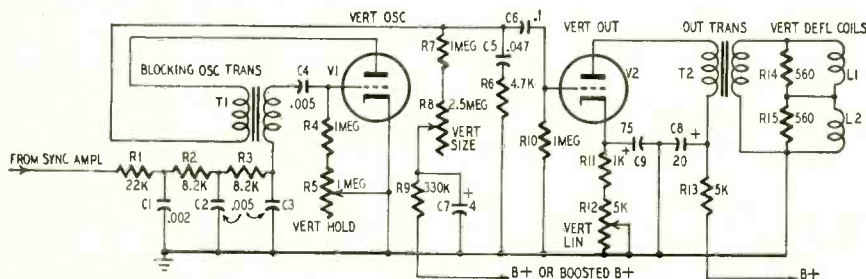

Fig. 1—Vertical sweep circuit. Blocking oscillator generates sawtooth wave.

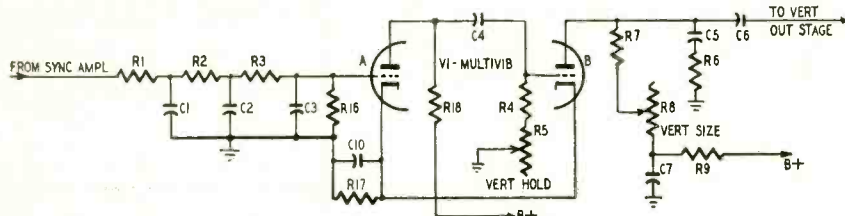

Fig. 2—Schematic of a multivibrator generator for vertical sawtooth waves.

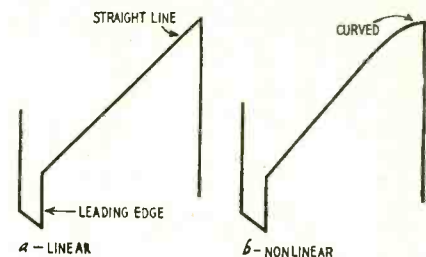

Fig. 3—Modified sawtooth waveforms.

The charge path of C5 is through R6, R7, and R8 to B plus. The discharge path is through R6, V1, and the primary of T1 (Fig. 1). The value of B plus and the time-constant of C5, R7, and R8 are the main factors determining the voltage amplitude to which C5 will charge before the sync pulse causes V1 to fire. The peaking resistor R6 is for wave shaping. R6 determines the amplitude of the leading edge of the wave only (Fig. 3-a), and this affects the linearity of the output. Varying R8, the vertical size control, varies the time-constant of the charge path and so varies the height.

R9 and C7 act as a decoupling circuit to prevent any B plus ripple from getting into the vertical sawtooth generator. At the same time, they prevent any sawtooth voltage from being applied to the B plus line and fed into other circuits. (C7 charges up to the value of B plus, therefore R9 is not part of the charge circuit for C5.) In many receivers, the voltage applied to the vertical oscillator plate is the boosted B plus from the horizontal damper circuit.

The *linearity* of the sawtooth is responsible for the even distribution of the picture, with no vertical stretching, crowding, or foldover at the top or bottom. A linear modified sawtooth waveform is shown in Fig. 3-a; Fig. 3-b shows a nonlinear one, which will produce a nonlinear picture, possibly with foldover at the bottom (Fig. 4). R12 (Fig. 1), the vertical linearity control, is part of the cathode resistance in the vertical output stage. Varying this control changes the amount of cathode bias, shifting the operating point of V2 to compensate for any nonlinearity in the sawtooth. Since changing the bias also changes the amplification, it is usually necessary to vary the vertical size control when the vertical linearity control is varied. Nonlinearity in the vertical output which cannot be corrected by the linearity control may be caused by a fault either in the sawtooth generator (oscillator stage) or in the output stage.

T2 (Fig. 1) is the vertical output transformer feeding the stepped-down sawtooth voltage (and stepped-up sawtooth current) to the yoke. In many receivers, T2 is an autotransformer (one winding), with the output taken

off the lower part of the winding. R13 and C8 are a decoupling circuit. L1 and L2 are the vertical deflection coils which deflect the C-R tube beam vertically. R14 and R15 are damping resistors which load down the deflection coils and damp out any oscillations that might be caused by the sharp polarity changes in the sawtooth wave.

Troubleshooting

Methods for finding troubles in the vertical sweep system are:

1. Analyzing indications on the screen and checking the effect of varying the controls; especially the vertical controls—hold, size, and linearity.
2. Tube changes.
3. Waveworm analysis on the oscilloscope.
4. Resistance and voltage measurements.

The first step in localizing vertical faults is careful observation of the information on the screen and of how the picture or raster is affected as the controls are rotated.

For example, the picture which was previously normal, rolls vertically, and cannot be stopped by the vertical hold control. If this happens on each active channel at a normal contrast control setting, there is obviously a loss of vertical sync. The fault may originate in the vertical oscillator or in the preceding sync or video circuits.

A simple check can indicate the probable location of the trouble. Rotate the vertical hold control through its range. (When the picture rolls upward, the vertical oscillator frequency is too low; when rolling downward, the frequency is too high.) If the picture rolls upward at one extreme of the control rotation and downward at the other extreme, this indicates the oscillator is capable of reaching the frequency needed for correct operation but is not being synchronized properly. Therefore the fault must be in the video or synchronizing circuits. If the vertical hold control cannot make the picture roll in both directions (when there is a loss of sync), the fault is usually in the vertical oscillator stage. In either case, the next step is to change the tube or tubes.

When, as a result of the above test, trouble is indicated in the video or synchronizing circuits, the fault may be a weak r.f. amplifier tube, video amplifier tube, or sync separator or clipper tube. These tubes should be changed before looking for further trouble. As a check, before changing these tubes, rotate the horizontal hold control. Trouble in the video or sync circuits affects

both vertical and horizontal pulses, but the fault may show up as a loss of vertical sync only because of the greater stability of the horizontal sweep circuit. If the horizontal hold has a smaller than normal range, this indicates weaker than normal sync pulses—both horizontal and vertical—and the trouble is in the video or sync circuits. To narrow down the source of trouble further, a defect in the video circuit usually shows up in the picture quality—as an overcontrasted, weak, or noisy picture. Where the picture quality is normal, and the horizontal hold has the normal range of control and the vertical hold makes the picture roll in both directions, the fault is most likely to be in the integrating circuit.

If tube changes do not eliminate the trouble, signal tracing with an oscilloscope can be used to localize the fault. By noting the peak-to-peak amplitude of the wave and the shape, and comparing these to the information provided in the manufacturer's service notes, it is possible to find the approximate location of the fault quickly. D.c. voltage and resistance checks, compared to the correct readings in the service notes, usually tell the rest of the story immediately.

The main troubles in the vertical sweep system are:

1. Vertical roll.
 2. Poor linearity, or foldover at top or bottom or both.
 3. Inadequate height.
 4. Loss of vertical sweep—horizontal line.
- Other less common troubles are:
5. Poor interlace.
 6. Intermittents.
 7. Vertical buzz.
 8. Keystoning.

Circuit defects

The basic trouble-shooting procedures described above should be used in each case of vertical trouble. To serve as a handy reference guide, the most common causes for each of these troubles will be noted.

Frequently, the manufacturer's field service bulletins will list certain troubles that might be anticipated, and troubleshooting procedure. These of course should always be referred to. The following are general in nature.

1. **Poor vertical sync** (including vertical roll, jitter, and instability). Vertical jitter may be caused by incorrect control settings: excessive contrast setting or a vertical hold setting too near the lock-in point. The common causes

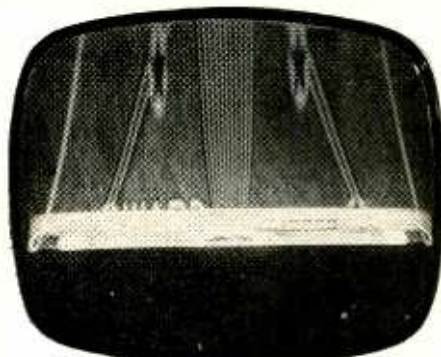

Courtesy Allen DuMont Labs.
Fig. 4—Vertical foldover; caused by excessive nonlinearity of sawtooth.

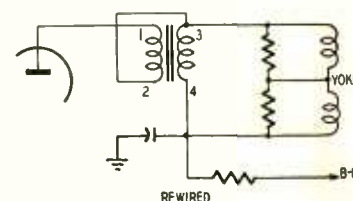
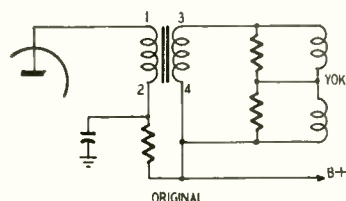

Fig. 5—Schematic showing how the connections of a two-winding vertical output transformer can be changed to make it function as an autotransformer.

for poor vertical sync include: poor signal-to-noise ratio or fault in the video, sync, integrating, or vertical oscillator circuits. The methods for isolating the cause to a given circuit were outlined above in the discussion of trouble-shooting methods.

When the instability originates in the vertical circuit, the most common causes include:

Defective tubes. Change the oscillator tube (and output tube if there is any feedback from the output to the oscillator stage). In receivers using a 6BL7-GT tube, try a 6BX7-GT. The pin numbers are the same. If insufficient vertical size and compression at the bottom results, make certain the vertical oscillator plate circuit is returned to the boosted B plus point. If foldover at the top of the picture occurs after the tube is changed, increase the value of peaking resistance (R6, Figs. 1, 2) by about 2,000 ohms.

Change of value of grid capacitor (C4, Figs. 1, 2) or grid leak resistor (R4, R5).

Insufficient decoupling in the vertical circuits. If there is no decoupling circuit in the output stage, insert one between the bottom of the output transformer primary and the B plus supply—a 5,000-ohm, 5-watt resistor and a 20- μ f, 450-volt capacitor (R13, C8, Fig. 1). This prevents feeding a ripple into the B plus supply from the vertical output stage, which may in turn be fed to the sync circuits to trigger the vertical oscillator out of phase. In sets where the vertical oscillator plate circuit is connected to low-voltage B plus, decoupling is sometimes insufficient and an additional decoupling circuit may be needed.

A slight ringing in the blocking oscillator transformer may be responsible for unstable sync. A 10,000-ohm, 0.5-watt resistor across the primary (plate) winding of the blocking oscillator transformer dampens ringing which might interfere with sync.

Pickup from leads which are not correctly dressed may be responsible for poor sync. Some possibilities are: damper filament leads too close to the vertical oscillator; hot horizontal deflection coil lead too close to the vertical oscillator.

Vertical sync pulses which are too small in amplitude can be the cause of unstable vertical sync, especially in fringe areas. In such cases, it may be necessary to modify the sync circuit to obtain a larger output.

2. Poor linearity or foldover. The most important reasons for nonlinearity are:

Incorrect adjustment of the vertical linearity control. In some receivers, misadjustment can cause foldover.

Bad vertical oscillator or output tube.

Leaky coupling capacitor to the vertical output stage or a leaky charge capacitor (C5, Figs. 1, 2).

Low line voltage or low B plus. If the line voltage falls below 105, vertical foldover may result. In homes where this is likely to occur, as one of the first steps check the line voltage. If the line

voltage is O.K., change the low-voltage rectifier tube.

Other possible troubles include: defective blocking oscillator or output transformer; defective cathode resistor or bypass capacitor in the vertical output stage; leaky decoupling capacitor in the plate circuit of the vertical oscillator or output stage.

When there has been poor linearity from the beginning, that could not be corrected by the vertical linearity control, a small change in value of peaking resistor (R6, Figs. 1, 2) may correct it. Increasing the value of this resistor (25 to 50%), causes stretching at the top of the picture; decreasing the value causes compression.

3. Inadequate height. If the inadequate height is due to foldover, then the basic fault is foldover rather than inadequate height. The most important reasons for insufficient height are:

Low emission of the vertical oscillator or output tube. Change tube or tubes. In many receivers, a dual tube is used for both stages.

Low line voltage or low B plus. If the line voltage is normal, change the rectifier tube. Low line voltage or low B plus usually results in insufficient width also. When width and height are both affected, look for trouble in the common supply—either B plus or boosted B plus. In many sets, the vertical oscillator is fed from the boosted B plus point.

Other possible defects include: change of resistor values in the charge circuit, or change in the value of charging capacitor; defective vertical output transformer; open capacitor in the decoupling circuit of the output stage (C8, Fig. 1); change of resistor value in either decoupling circuit (R9 or R13, Fig. 1); defective yoke (ferrite core cracked.)

If the fault has been present from the beginning, check the manufacturer's field modifications for the particular model. Some common methods for increasing height include: Boosting B plus with new (or a more efficient type of) low-voltage rectifier tube; using a 6Y6-G instead of a 6K6-GT as the vertical output tube in converted 630 type sets where the filament supply permits this (the 6Y6-G filament takes 1.25 ampere, about three times the current of the 6K6-GT); lowering the value of the fixed resistor in the charge path (R7, Figs. 1, 2) to two-thirds or one-half the original value; changing the two-winding vertical output transformer connections to make it function as an autotransformer (Fig. 5).

4. Loss of vertical sweep. The most common cause is a defective vertical oscillator or output tube. Other common causes are: shorted charge capacitor; shorted decoupling capacitor to B plus in the oscillator or output stage; open blocking oscillator transformer; open vertical output transformer; open yoke. In some receivers, a circuit is used where the vertical output stage

feeds back a signal to keep the vertical oscillator operating. In these models, a defect in the output stage may be responsible for no output at the plate of the vertical oscillator.

5. Poor interlace. Poor interlace shows up as the pairing of lines with black space between. This fault is particularly annoying on large screens since it shows up to a much greater degree. The most common defect causing this is a defective capacitor in the integrating circuit. However, in some receivers, interlace is not optimum and circuit changes are recommended by the manufacturer to improve the condition. These changes may include one or both of the following: reducing the value of peaking resistance to about half or shorting it out altogether; reducing the value of cathode resistance in the vertical output stage about 25%. Other causes for poor interlace include: misadjustment of the vertical hold control; horizontal leads in the high-voltage compartment dressed too close to the vertical oscillator stage.

6. Intermittents. The most common causes for intermittent operation in the vertical circuit as in other circuits are defective tubes or capacitors. But this fault can be caused also by almost any other defective component—including resistors and transformers.

Intermittent operation of the vertical circuit usually shows up as intermittent collapse of the picture to a horizontal line, or as intermittent foldover. An additional reason for intermittent collapse to a horizontal line is momentary oscillation of the vertical output tube. Remedies for this condition include: a new tube; a 330-ohm resistor from the grid to the grid return; a 100-ohm resistor between the plate and screen when the output tube is a pentode connected as a triode.

7. Vertical buzz. A 60-cycle buzz may be caused by pickup from the vertical circuit, hum in the audio, loose laminations in the power transformer, and sync buzz in the audio in intercarrier sets. To check whether the buzz is originating in the vertical circuit, vary the vertical hold control. If this varies the pitch of the buzz, the buzz is being picked up from the vertical sweep circuit. Possible causes for this are: audio cable is (even if shielded) too close to the vertical output tube; loose laminations in one of the vertical transformers; an insulation breakdown in the vertical output transformer. If a vertical transformer has defective windings, this shows up as a defect in the vertical sweep also.

8. Keystoning. (Picture becomes narrow at the right or the left side.) Keystoning is caused by a short or partial short in one section of the vertical deflection coil (yoke) or a defective damping resistor (R14, R15, Fig. 1).

While not covering every possible defect, this should facilitate vertical sweep servicing in general. END

SERVICING

HORIZONTAL SWEEPS

By ROBERT B. SMITH*

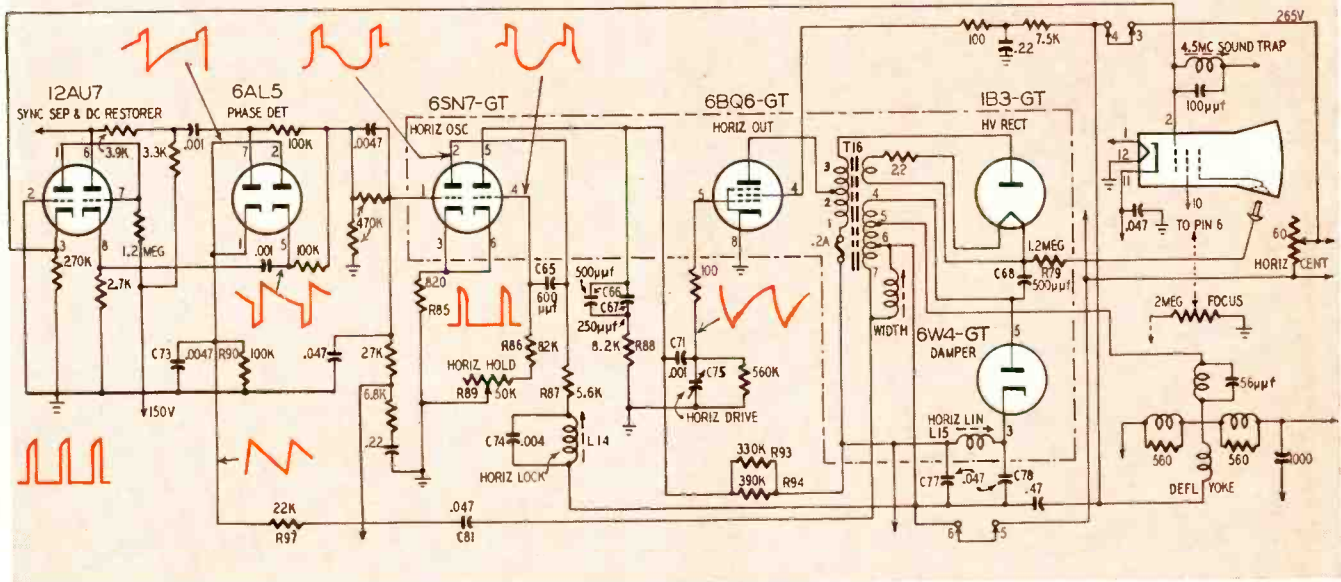

Fig. 1—Schematic diagram of the horizontal section of Sentinel model 438 XD chassis. Waveforms are shown throughout.

THE functions of the horizontal circuit in TV receivers are: 1. To provide horizontal sweep. 2. To supply high voltage. 3. To closely control horizontal frequency. 4. To provide a power boost.

Starting with the horizontal phase detector circuit, let us examine the high points of the horizontal section (Fig. 1). Two voltages are fed into the 6AL5 balanced phase detector. They are the incoming signals' horizontal sync pulses and the horizontal reference feedback voltage. These two voltages are compared in phase, and the d.c. voltage developed is applied to the control grid, pin 1 of the 6SN7-GT horizontal oscillator. The d.c. voltage varies the plate resistance of the tube, keeping the oscillator from going out of synchronization.

The horizontal sync pulses are applied to the 6AL5 phase detector through two .001- μ f capacitors to pins 7 and 5 respectively. The horizontal reference voltage is applied simultaneously to pins 1 and 2 of the phase detector through the .047- μ f capacitor (C81) and the wave-shaping network consisting of R97, R90, and C73.

The phase detector functions as a close-tolerance automatic frequency control. It is called a phase detector because it must prevent any shift in horizontal oscillator frequency, and any change in phase of the oscillator with respect to the synchronizing signal. Any tendency of the horizontal oscillator frequency or phase to change is automatically offset by the counteracting

d.c. voltage from the phase detector.

The circuit action can be observed by connecting a v.t.v.m. to pin 1 of the 6SN7-GT horizontal oscillator and noting the positive-to-negative voltage change as the horizontal hold control is varied. *Never use anything but a v.t.v.m. on this pin.* (A 1,000-ohm-per-volt meter would start a pulse 10 times normal amplitude throughout the horizontal circuit. This will break down parts unable to stand the abnormal voltage.)

The 6AL5 phase detector creates a d.c. voltage proportional to the phase relationship of the signals' horizontal sync and the receiver's horizontal reference voltage. This d.c. voltage is used for automatic control of the horizontal oscillator.

The horizontal oscillator is a cathode-coupled multivibrator, with parallel sawtooth-forming capacitors (C67 and C66) and a platform-forming resistor (R88) connected in series from the plate (pin 5) to ground. The fundamental frequency determining components are the 600- μ f capacitor (C65) from plate (pin 2) to grid (pin 4) and the resistors R86 and R89 in the horizontal hold circuit from grid to ground. The other factor controlling frequency is the d.c. voltage on the grid (pin 1).

Horizontal lock coil

The ability of the circuit to maintain synchronization is stabilized by the horizontal lock coil connected between the 5,600-ohm 5%-tolerance plate-load resistor (R87) and B plus. The value

of this plate-load resistor is critical, and is a frequent source of horizontal instability when either the 6SN7-GT or the .047- μ f feedback capacitor (C81) shorts and causes excessive current flow through it. It is not uncommon for this 5,600-ohm resistor to change in value, several thousand ohms. When it does it is impossible to adjust the horizontal lock and properly stabilize the picture.

The horizontal lock coil (L14) has a .004- μ f silver mica capacitor (C74) in parallel, making a parallel-resonant circuit. As the inductance is varied its resonant frequency is changed. This resonant circuit introduces a 15,750-cycle ripple into the plate voltage applied to the left triode section of the horizontal oscillator. In operation, just as the grid voltage is decaying from its negative peak, this positive-going ripple in the plate triggers the tube into conduction. For the balance of the cycle, the ripple voltage lowers the plate voltage in a negative direction.

This reduced plate voltage makes the oscillator less sensitive to transient noise pulses which might start a cycle at the wrong time. At the time for the next cycle, the ripple is positive-going and helps trigger the oscillator into action at the proper time. The energy to maintain the lock circuit in oscillation is derived from the pulses of current through it.

The sawtooth voltage waveshape produced in this circuit is coupled to the grid of the 6BQ6-GT horizontal output tube through a .001- μ f capacitor (C71). This .001- μ f capacitor and the drive

*Service Manager Sentinel Radio Corp.

capacitor (C75) form a capacitance voltage divider which determines the amount of signal or drive that is applied to the 6BQ6. Grid-to-cathode rectification provides the bias voltage for the horizontal output stage. The larger the signal applied, the higher the negative bias or drive voltage.

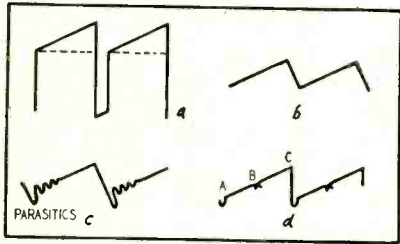

Fig. 2—Waveforms used in analysis of horizontal sweep circuit operation.

A versatile signal

The amplified signal in the plate circuit does quite a number of things. It supplies a pulse for the high voltage applied to the 1B3 rectifier. It supplies the filament voltage for this high-voltage rectifier. A voltage is applied in the yoke circuit which enables the spot to be moved in the horizontal sweep. And last but not least, part of the signal is used as a horizontal feedback reference voltage.

The very rapid cutting off of current in the 6BQ6 plate circuit causes a high-voltage pulse to be created in the primary of the horizontal output transformer (T16). This pulse is stepped up by the autotransformer action and applied to the 1B3-GT plate. Its rectification provides the high voltage for the picture-tube second anode, through the R-C π filter formed by the 1.2-megohm resistor (R79) and the 500- μ mf 20,000-volt capacitor (C68), and the capacitance of the picture tube anode to the aquadag coating and ground.

One of the lesser known difficulties that arise in the high-voltage section is an arc that is audible only when the brightness is advanced far enough to bring the picture tube above cutoff. The arc frequency increases as the brightness control is advanced. This is usually due to an arc inside the 1.2-megohm high-voltage filter resistor (R79). Many service technicians inadvertently contribute to the failure of this resistor by excessive arcing of the picture tube anode connector to ground as a check for high voltage. A shorted picture tube also will cause this trouble. Resistors have a voltage rating that is just as important as those used for capacitors. A $\frac{1}{2}$ -watt resistor should never have more than 400 volts placed across it, or arcing from granule to granule will occur. This "eats" out the center and increases the resistance beyond tolerance, and at times may open the resistor.

Evolution of the circuit

Before examining the process of producing the sweep current in the yoke, it would be a good idea to consider

some history of the design of horizontal circuits. The first electromagnetic-deflection sweep circuits had to have a perfect trapezoidal voltage wave (Fig. 2-a) to apply to an inductive circuit like the yoke to obtain a sawtooth current wave (Fig. 2-b) through it.

When this trapezoidal wave was applied to the horizontal section of the yoke it was found to produce parasitic oscillation which resulted in a very non-linear sweep at the left side of the raster (Fig. 2-c). The damper tube was installed to suppress this parasitic oscillation by absorbing energy from it and quickly damping it. It was then found that the damper continued to conduct, interfering with the sweep. It was quite a problem to design a circuit in which the damper would stop conducting soon enough to allow linear sweep.

The final decision was to design the circuit of the horizontal output transformer and yoke to resonate at about 70 kc. A half cycle of this parasitic oscillation could then be used to provide a very rapid retrace. This was the first negative half-cycle of the parasitic oscillation. The positive half-cycle made the 6W4 damper tube conduct, and due to the time-constant of the damper circuit it continues to conduct for approximately one-half line of the horizontal trace A-B (Fig. 2-d). Just as the 6W4 current starts to drop off, the grid of the 6BQ6 is brought up above cutoff and the horizontal output tube current provides the energy through the output transformer which gives the last half of the horizontal sweep B-C for that line (Fig. 2-d). Thus, the 6W4 is active in the first half, and the 6BQ6 is active for the last half of the horizontal line. This can be seen by setting the drive too high. There will appear in the center or the left of the raster a tendency to squeeze, and several bright vertical lines show that the 6W4 and the 6BQ6 are not able to transfer the horizontal sweep action as smoothly as they should. Also, the sawtooth fed into the horizontal output tube is a far cry from a trapezoidal waveshape.

We see that the diode called the "damper" is not just loafing along on one job at all. As a matter of fact, the engineers had another bright idea. As long as the damper was rectifying the parasitic oscillation, why not throw in a filter circuit and use the rectified voltage to give us a higher positive voltage than we could normally get from the power supply? Thus power boost was born. This higher positive voltage is used for the plate of the horizontal output tube, the horizontal oscillator, and the vertical oscillator. It is sometimes used for the first-anode supply on the picture tube.

Summary

The damper tube dampens parasitic oscillation, provides the first half of our horizontal sweep, and gives us power-boost voltage to be applied wherever needed. This may make you think of

the large meat-packing firms that have succeeded in finding use for everything in a pig except the squeal and are still looking for some way to sell the squeal. We have a case not too far from that in Sentinel television sets. The filter circuit in the power boost contains a variable inductance L15, the horizontal linearity control. Adjusting this inductance varies the phase of the ripple applied to the plate of the 6BQ6 horizontal output tube. Varying the phase of this ripple in the 6BQ6 plate circuit affects the tube's conduction and the last half of the horizontal sweep. Many service technicians concentrate on the left half of the raster when adjusting the horizontal linearity, and they say that the control has no effect on the picture.

Service tips

A few trouble-shooting hints for Sentinel television horizontal section follow.

1. No high voltage until 6AL5 horizontal phase-detector tube is removed from its socket: The .047- μ f feedback capacitor (C81) is shorted. This applies a high positive voltage through cathode to plate of the 6AL5 (pins 2 and 5) and on to the control grid (pin 1) of the 6SN7 horizontal oscillator, which kills the oscillator and the high voltage. When this capacitor shorts it frequently affects R97, R90, R86, R85, and C73. Even if no obvious horizontal instability develops after the capacitor has shorted, it is a good idea to check the above parts. If the set was on long enough with the capacitor shorted you can be sure that some or all were affected.

2. Insufficient high voltage: The cathode and plate of the 6W4 have the same d.c. potential. Shorted power boost capacitor C77 or C78. In many sets, no voltage appears at cathode terminal of the 6W4 damper tube when the tube is removed from its socket unless the boost capacitors are leaky.

3. Inability to lock horizontally: Usually due to changed value of the 5,600-ohm, 5% resistor, R87.

4. Horizontal squeal and double image on the horizontal: It is sometimes possible to synchronize the set to one picture, but changing stations or interrupting the sync momentarily produces the double image again. Open .0047- μ f capacitor (C73).

5. Drive voltage down to about 5 volts, insufficient high voltage: An open resistor in 6SN7-GT parallel plate load, R93 or R94.

6. Drive voltage very high (40 volts and up) and decided foldover: An open platform-forming resistor, 8,200-ohm (R88).

7. High voltage arc audible only when the brightness control is advanced far enough to produce a raster: Due to internal arc in the 1.2-megohm high-voltage filter resistor R79.

8. Horizontal instability: Due to leaky .047- μ f feedback capacitor C81, changed value of R97, R90, R85, or R87. END

VIDEO AMPLIFIER PROBLEMS

Reflected troubles and great number of components complicate the life of the service technician

By WALLACE WANER

THE video amplifier in present-day receivers has many tasks to perform. Besides boosting the video signal level for application to large-screen picture tubes, it must provide for intercarrier sound take-off and furnish signals for the sync separator and noise-reducing circuits. Thus, the current video amplifiers are more complex than earlier types; there are more components which can give trouble.

Besides this, any trouble in the various circuits which are fed by the video amplifier can reflect the defect back into the video amplifier and seriously disturb its normal operation. Thus, leaky or shorted capacitors, defective tubes, or other troubles in a.g.c. systems, noise circuits, or sound i.f. stages can place a heavy load on the video

amplifier and lower picture quality.

A defect in the noise circuit may influence the sound take-off signals or reduce the sync levels to the separator stages. Because of this, knowledge of modern circuit arrangements will help considerably when it is necessary to trouble-shoot the video amplifier.

Typical circuits

The video amplifier in 1954 Zenith television receivers is shown in Fig. 1 (19L25 and 19L27 chassis). It uses the efficient 12BY7, the video amplifier which produces high output signals for low values of load resistance and voltage. It provides sufficient signal strength for the picture tube without an additional amplifier between it and the video detector.

The 6BE6 sync clipper prevents noise pulses from triggering the sweep oscillators, besides performing the usual function of sync separation. Two signals must be fed to the 6BE6 from the video amplifier. The first is from the grid circuit (the output of the video detector), which applies the composite video signal to the first grid of the sync clipper. The second signal, the amplified video signal, is taken from the junction of the two 3,300-ohm resistors in the plate circuit of the video amplifier and is applied to the third grid of the 6BE6. The third grid acts as the control grid of a standard sync separator, and only the sync pulses appear at the output (plate) of the clipper tube. Whether or not any output is produced in the plate circuit depends on the voltage of grid 1. Thus, the fringe lock control is adjusted so the bias on the first grid permits normal sync separation. If a noise pulse rides in with the video signal and appears at the first grid, it will drive the grid negative enough to cause complete plate current cutoff. Thus, noise pulses cannot get through to upset the normal synchronization of the vertical and horizontal sweep generators. The manual fringe-lock control can be adjusted to give good sync stability in fringe or local areas for a wide variety of signal and noise levels.

The fringe lock must be adjusted together with the vertical and horizon-

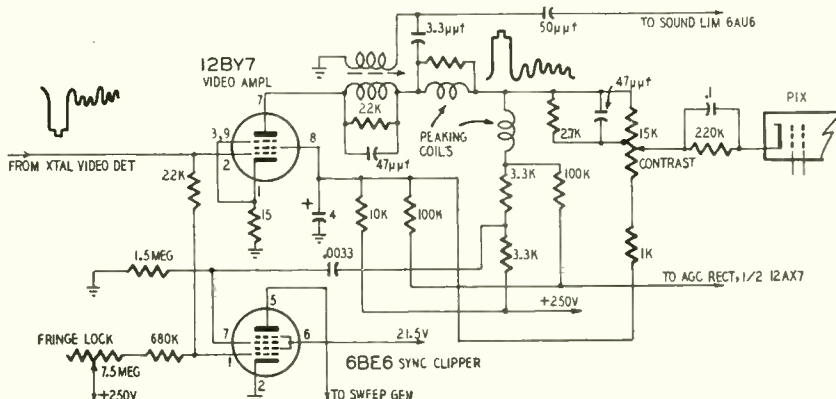

Fig. 1—Schematic of the video amplifier in Zenith chassis 19L25 and 19L27.

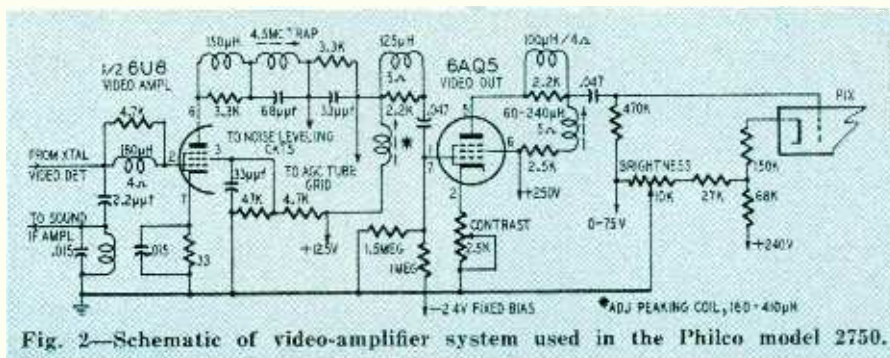

Fig. 2—Schematic of video-amplifier system used in the Philco model 2750.

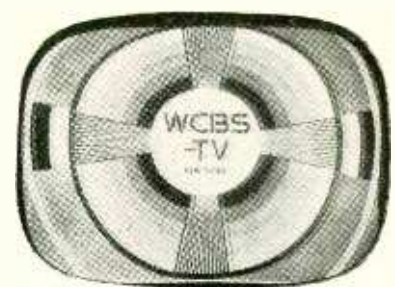

Fig. 3—Picture shows repeat lines.

tal hold controls. Turn it fully clockwise and back it off $\frac{1}{4}$ turn at a time while checking performance. At each setting the hold controls are adjusted and performance checked for each channel received in the area.

If the picture is unstable, back down the control more, readjust the hold controls, and check for performance on each channel, until good sync stability is obtained.

A defective component or tube in the sync clipper circuit can change the load on the video amplifier grid and plate circuit. Thus, when there is insufficient contrast or poor picture quality, video amplifier trouble-shooting would have to take in also the sync clipper circuit.

The sound take-off is in the plate circuit of the video amplifier, thereby assuring a high level of sound i.f. signal. Since the sound i.f. in intercarrier receivers is always 4.5 megacycles, the take-off transformer must be tuned to that frequency. When both primary and secondary slugs are adjusted for maximum sound output, the primary section will automatically act as a 4.5-mc trap, since it acts as a high-impedance parallel resonant circuit. The tweet interference which would result on the picture-tube face is thus minimized. Also adjust the sound take-off coils till intercarrier buzz is at a minimum.

The signal for the a.g.c. rectifier is taken from the other 3,300-ohm resistor in the plate circuit of the video amplifier. A voltage-divider network, with a tapped potentiometer, serves as the contrast control. The variable arm picks off the required amplitude of video signal.

Since the video signal is positive-going in the plate circuit of the amplifier, it is applied to the cathode of the picture tube rather than the grid. The d.c. has a direct path from the plate of the video amplifier to the picture-tube cathode, via the peaking coils and series resistors. Hence, the d.c. level is not disturbed and no d.c. restorer is necessary. With direct coupling, however, the voltage relationships between the cathode and grid of the picture tube are critical. A change in value of any of the resistors in the contrast control circuit (or the control grid of the picture tube) will upset bias relationships and can cause excessive or insufficient brilliancy. Thus, when either of these symptoms occur, check the voltages between cathode and grid

while the brilliancy control is varied. The grid should always be minus with respect to the cathode and should vary with the control. Check the resistor values in both the contrast and brilliancy control circuits against those given in the service notes for the receiver. Make sure the capacitors in these circuits are not leaky or shorted when brilliancy troubles occur.

Another typical video amplifier system is shown in Fig. 2. It is used in the Philco model 2750 receiver which uses a 27LP4 picture tube. Two amplifier tubes are used. The first is one-half of a 6U8 triode-pentode tube. The video output amplifier uses the 6AQ5 beam-power tube which furnishes sufficient signal amplitude for good contrast in the 27-inch tube.

The sound take-off is in the grid circuit of the first video amplifier. The necessary signal is developed across an impedance composed of the inductance and capacitor shown. Since the arrangement does not trap the signal from the video amplifier, a 4.5 mc trap is inserted after the first peaking coil in the plate of the first video amplifier. This is followed by the noise leveling circuit take-off, and the a.g.c. signal take-off. This is followed by an adjustable peaking coil in series with the B plus, and a series peaking coil to the grid of the video output amplifier.

In the plate circuit of the video output stage, the series peaking coil (100 μ h) is followed by a shunt peaking coil which is also adjustable. These two adjustable peaking coils are preset at the factory and normally do not require readjustment. If the coils are not adjusted properly, they may produce either smears or transients which will result in repeat lines on the screen (Fig. 3). Repeat lines indicate a slightly excessive high-frequency response, and as pointed out in the Philco service notes, a small amount of high-frequency overshoot may be desirable to produce a sharper picture.

At the same time, in weak-signal areas where a snowy picture is received, it might be better to have a slight amount of smear, to reduce the sharp outlines of the snow effect.

To make adjustments to the peaking coils: Tune in a station and adjust for best picture quality and contrast. Turn fine-tuning clockwise until a faint beat pattern shows on the screen. Repeat lines are produced by turning both

peaking-coil slugs clockwise. Trailing smears are caused by turning both peaking-coil slugs counterclockwise. These adjustments should not be made to compensate for poor i.f. alignment or defective components. In Fig. 4, for instance, faint repeat lines are visible on the right side of the vertical wedge, indicating exceptional high-frequency response in the video amplifiers. Despite this, however, more than one-third of the vertical wedge is hazy and obscure, showing poor video i.f. alignment. While the over-peaking has helped the picture somewhat, a much sharper picture would be obtained if the tuner were tracked properly and the video i.f. alignment corrected.

The contrast control for the Philco video amplifier system is located in the cathode of the output tube as shown in Fig. 2. No cathode bypass is used, so the low-frequency response will not be affected. The lack of a bypass capacitor will cause degeneration and some decrease in amplification, but these shortcomings are tolerated in the interests of a wider frequency amplifier. Since a variation of the contrast control will affect bias, a fixed bias is applied to the control grid from the power supply (24 volts).

The brightness control varies the voltage between the grid and cathode in the cathode-ray tube as shown in Fig. 2.

Service hints

When poor contrast, lack of definition, or other troubles point to defects in the video amplifier system, the tubes should be checked first as a matter of routine. Since only one or two video amplifier tubes are involved, tube substitution can be tried. Frequently, a change in tube characteristics results in a sync level decrease and causes sweep instability. Such tubes will often check all right in a tube tester—particularly the emission type.

The tubes of the circuits fed by the video amplifiers, such as the noise clippers, a.g.c. rectifiers, first sound i.f. amplifier and d.c. restorer, also should be tested. After tubes have been eliminated as the source of trouble, voltage checks should be made at the grids, screens, and plates, of the video-amplifier tubes. The grid should always be negative with respect to the cathode. If it shows zero or a positive voltage, check the coupling capacitor for leakage. (A gassy tube could also cause a



Fig. 4—Left—Faint repeat lines are visible on the right-hand side of the vertical wedge.

Fig. 5—Right—Leaky coupling capacitors or open peaking coils are the cause of poor definition.

positive grid, but it is assumed the tubes have been checked prior to voltage readings.)

Voltages for the screens and plates, as well as those associated with the brilliancy-control section, should be compared with those given in the manufacturer's service notes for the receiver under test.

If tubes and voltages check out all right, the next logical step is a check of resistor values against those given in the schematic. The capacitors should be checked for leakage. To make sure tests are accurate, one side of the resistor or capacitor to be checked should be disconnected from the circuit. While the leakage of paper capacitors can be checked with the R \times 1 megohm scale of a v.t.v.m., many capacitors become intermittent or show defects only when operating under the normal voltages applied by the circuit. For this reason, a capacitor checker is advisable, for the actual working voltage can be applied and the power factor (leakage) determined.

Leaky coupling capacitors or open peaking coils will greatly affect picture quality. If a picture has been good and *suddenly* shows poor definition, trailing smears, or improper contrast levels (Fig. 5), the likely cause is some trouble in the video amplifier. An inspection at close range of the horizontal line trace on the screen helps the diagnosis.

If the horizontal line trace is fuzzy or no longer visible, the trouble would be in the focus control, or focus unit assembly on the picture-tube neck. However, if the line trace is clearly defined but the picture appears out of focus, the trouble is probably in the video-amplifier system. (Poor tuner tracking or video i.f. alignment could also cause such a condition, but the tuner and video i.f. alignment will not change *suddenly* and by a sufficient amount to cause the poor picture definition shown in Fig. 5.)

With peaking coils, the most common defect is an open circuit. On occasion, however, some turns will short together or the parallel resistor will change value or become otherwise defective. An open circuit in the shunt-peaking coils is easy to determine, because the plate voltage of the tube will be lost. With the series peaking coils, an ohmmeter will still give a reading when the coil is open because of the parallel resistor. Since the ohmic value of the peaking coils is only a few ohms as compared with several thousand for the shunting resistor, an open coil is indicated if the meter shows the value of the resistor. (With the coil in good condition, the meter of course would show a reading of only a few ohms.)

If the series peaking coil is shorted, the ohmmeter check would immediately indicate this because of the zero resistance reading. Shorted turns in the peaking coil can contribute to poor picture quality as well as can open peaking coils, but unless the actual ohmic

value of the coils is shown, the shorted turns couldn't be detected if only a few were involved. In such an instance the only recourse is to try a new peaking coil. Of considerable help to the technician is the listing of the ohmic value of the peaking coils. In Fig. 2, for instance, the peaking coil in the grid of the 6U8 is listed at 4 ohms, while the one in the grid circuit of the 6AQ5 is 5 ohms. With an accurate low-range ohmmeter, shorted turns can be located quickly.

Meter accuracy and sensitivity is very important, as a few shorted turns may make very little change in resistance.

The series peaking coils help isolate the interelectrode and stray capacitances between the output circuit of one stage and the input of the next. The shunt peaking coils form high-impedance parallel resonant circuits with the circuit capacitances and prevent shunting of high-frequency signal components. Thus, their inductive values are critical and must be maintained if trailing smears, transients, and high-frequency losses are to be avoided. For this reason, an exact replacement must be made—that is, one having the same inductance and resistance.

Remember, when replacing peaking coils, to space them well away from the chassis. Normally in high-frequency work we are told to use short leads to reduce lead inductance or capacitance to other wires. With peaking coils, however, the leads *are not* cut short, but are left sufficiently long so the peaking coil can be mounted at

right angles and away from the chassis. This prevents the capacitance effect between the peaking coil and the chassis from affecting the characteristics of the coil and affecting picture quality. Also dress the peaking coils away from other peaking coils and from all nearby circuit wiring.

Frequency response

The reader may feel that no discussion of video-amplifier servicing is complete without a description of frequency-response measurements. Testing the response by injecting a square wave into the video amplifier input and measuring the amount of distortion by checking the shape of the square wave at the output with a scope is often mentioned.

The writer has serviced hundreds of receivers and many video-amplifier circuits without once using this procedure. If the video amplifier is giving trouble, the picture-tube screen will give the clues. If the picture exhibits dark trailing smears, it indicates poor low-frequency response. If repeat lines show as in Fig. 3, the high-frequency response is excessive. Without enough high-frequency response, the fine detail will suffer. These symptoms are all the technician needs to know to get busy on the video amplifier circuit checking. His time is too limited to undertake redesign. He is concerned mainly with restoring the receiver to the level of performance which was built into it by the manufacturer. END

THE RCA COLOR TELEVISION DYNAMIC DEMONSTRATOR

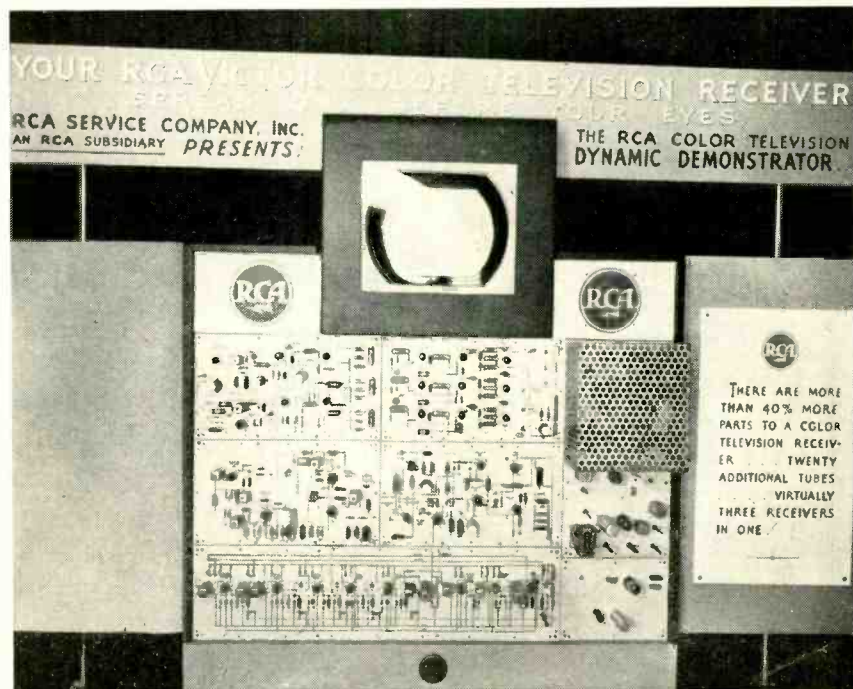

Photo shows latest in long line of RCA dynamic demonstrators. Similar in layout and operation to past dynamic demonstrators, this color TV receiver contains many more components. Using high-quality parts throughout, the demonstrator enables student and technician alike to closely examine the interrelation of the fixed and variable components at work in the various circuits. With all terminals accessible, voltage measurements and oscilloscope patterns can be obtained.

TELEVISION... it's a cinch!

From the original "La Télévision? . . . Mais c'est très simple!" Translated from the French by Fred Shunaman. All North American rights reserved. No extract may be printed without the permission of RADIO-ELECTRONICS and the author.

By E. AISBERG

Eighth conversation, first half—Sawtooth action; an amplifier full of good points

Will—Last time, Ken, you promised that today we would have something better to talk about than sweep oscillators. I'm beginning to see them in my dreams! Right now, my trouble is that I don't just see *how* you get those sawtooth voltages onto the deflecting equipment—the deflection yokes, or—if you have an electrostatic set—plates.

Ken—Good! It's fine to have those voltages, but even better to know how to use them. First, we have to put them through an amplifier; they usually don't have enough amplitude to swing the bright spot all the way across the fluorescent screen.

Will—That should be easy—the frequencies are fairly low.

Ken—Not so fast! The *fundamental* frequency of the time-bases is reasonably low. But they're not sinusoidal oscillations—far from it! So they're very rich in harmonics. You still remember what a harmonic is?

Will—Of course! Harmonics are oscillations at multiples of the fundamental frequency!

Ken—Roger! Now, our harmonic-rich sawteeth need an amplifier that can pass a very wide band of frequencies. Otherwise we'd eliminate some of the higher frequencies, and deform our waves.

Will—If I get you right, an amplifier that would cut off *all* the harmonics and leave only the fundamental would make sine waves out of our sawteeth?

Ken—Exactly—if you could get an amplifier that would cut off *all* the harmonics and still leave the fundamental! An amplifier usually attenuates only the higher frequencies, and just rounds the teeth off a little.

Will—Oh! A worn-out saw!

Ken—Remember, quite often we use an amplifier that changes the form of the sawteeth *intentionally*! We can use one to make sections of an exponential curve into straight lines, for instance.

Will—So I was in too much of a hurry when I decided that a time-base amplifier was simple!

Ken—At last you're right! It does a lot of jobs—it's an amplifier, it produces high-frequency harmonics, and it linearizes curved waveforms. But that's not all! In magnetic-deflection receivers, it has to deliver power . . .

Will— . . . like an ordinary radio output stage that supplies power to the speaker. But in electrostatic-deflection receivers the amplifier supplies only voltages. There isn't any current to speak of, and so, practically no power.

Port and starboard

Ken—Yes, the electrostatic-deflection jobs are simpler—pity they don't use 'em in TV any more! But let's find out how they work first, then go on to the magnetic systems, which are a little harder. Even electrostatic deflection has its problems. We have to apply a pair of voltages phased oppositely to the two deflection plates. That is, while one plate becomes more positive, the other is becoming more negative. Then both plates have to drop back to zero simultaneously and practically instantly, so the whole thing can start over again.

Will—But how do we get these two oppositely phased voltages? Do we need a pair of sawtooth generators? What a mess!

Ken—Take it easy, Will! Remember when we were studying

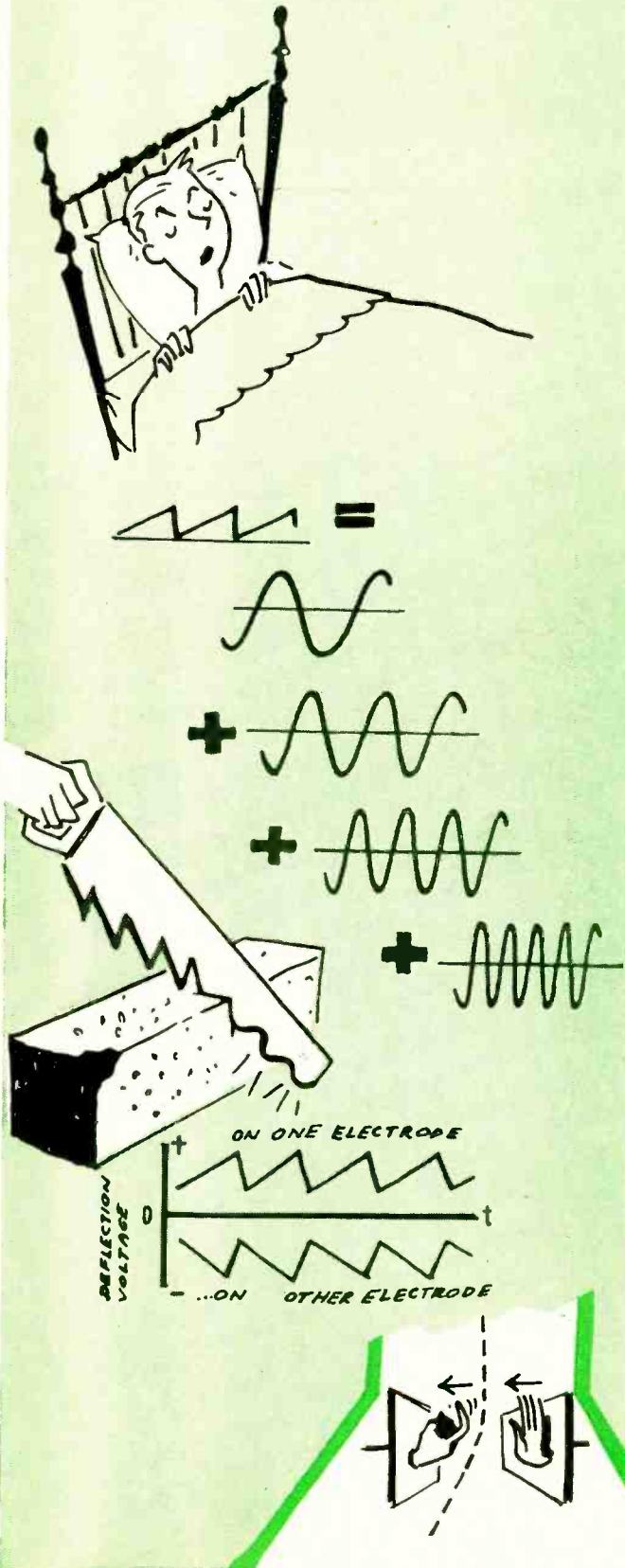

push-pull audio amplifiers? What did we find to be the easiest way to apply equal and opposite voltages to the output grids?

Will—A center-tapped transformer was the simplest way out.

Ken—And so it is here! Take a look at this sketch. You put the primary in the plate circuit of the horizontal sweep amplifier, connect the ends of the secondary to the deflection plates, and bring the center-tap back to the last anode, so that the deflection plates and it will be at the same voltage.

Will—And could you use a tube-type phase inverter with cathode-ray tubes?

Ken—Sure! Look at this. V1 is an amplifier; V2 a phase inverter. Potentiometer P controls V2 so its output is exactly the same as V1.

All seems simple

Will—None of this looks very tough. When you really know radio, you don't run up against many surprises in television!

Ken—You'll find that out when you look at magnetic-deflection circuits, where you have to get power out of your amplifier, just like an audio-output circuit. The power is used to set up magnetic fields around the deflection coil. The field strength depends on the number of turns in the coil and the amount of current going through it.

Will—I know, Ken! And you make me feel good by talking about ampere-turns that I can understand, instead of gausses, maxwells, or oersteds, that don't mean a thing to me!

Ken—You know then that a coil of 1,000 turns with 0.12 ampere passing through it. . . .

Will— . . . sets up a field of $0.12 \times 1,000$, or 120 ampere-turns.

Ken—And that you could get the same field from a coil of 200 turns . . .

Will— . . . and a current of 0.6 ampere.

Ken—Yes, and that happens to be just about the power needed to sweep a 10-inch tube screen. The field must rise from zero to 120 ampere turns to sweep the spot once across the screen from left to right. That is, the current through our 1,000-turn coil must increase evenly to 0.12 ampere, then drop very rapidly to zero, and repeat.

Will—That sounds easy. All you need is a good big tube. Insert the deflection coils in its plate circuit . . .

Ken— . . . and the d.c. through the coil would set up a permanent field that would keep the spot somewhere right off the screen!

Will—So that won't work, eh? But how would this work? Connect the two deflection coils B through the capacitor C, with this inductance A to carry the current?

Ken—Fine, chum, fine! But what are you going to do about the well-known phenomenon of self-induction?

Will—What's self-induction got to do with it?

Deduction about induction

Ken—Well, now, we've quite a bit of wire in these coils—about 1,000 turns each. The inductance is about 0.15 henry. Won't the rapid current variations produce some effects we'll have to take notice of?

Will—Now I remember our old formula: "Induction equals contradiction." The induced current always opposes the current that produced it. If the current in a winding increases, it induces a current in the opposite direction. But if the current decreases, the induced current goes in the same direction, doing all it can to keep the inducing current up to its old value.

Ken—What a memory! All you need to add is that the induced current shows itself as a voltage at the ends of the winding. Can you guess what the value of that voltage depends on?

Will—I suppose it's proportional to the variation in the inducing current and the amount of inductance in the winding?

Ken—Right! But there's just one other thing—the variation speed of our current—the time it takes to change. If the sawtooth currents passing through our windings are quite linear, we can say that the voltage of self-induction increases as the duration t of the variation in current becomes shorter.

(TO BE CONTINUED)

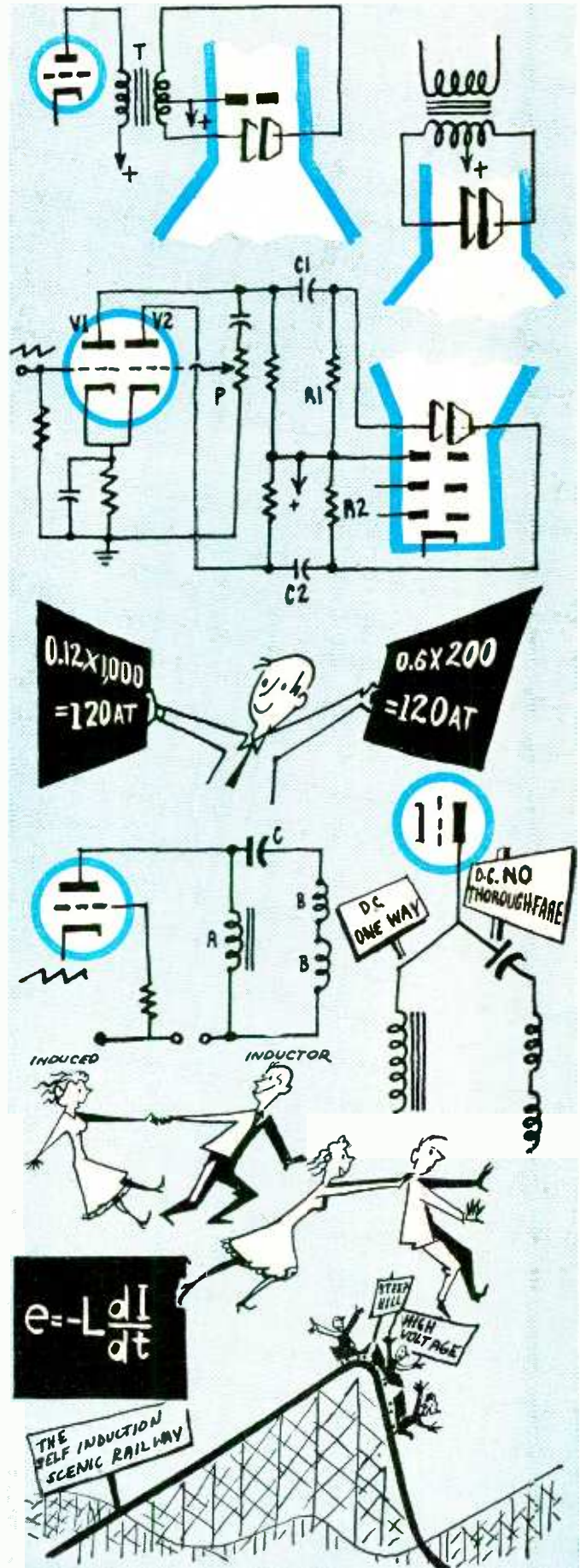

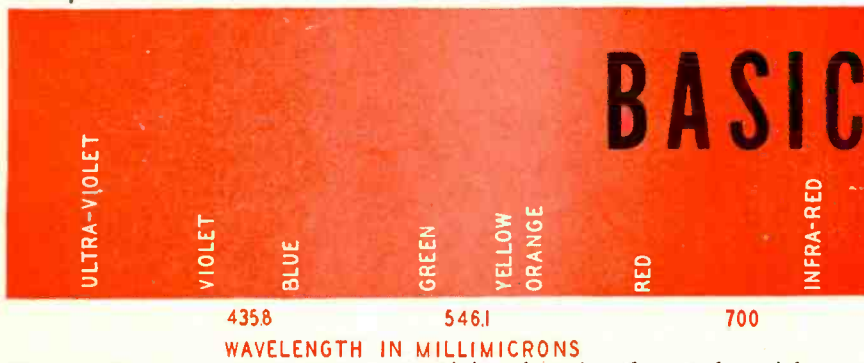

BASIC COLOR TV

Part I—Some of the fundamental principles of color and vision

By **D. NEWMAN*** AND **J. J. ROCHE***

MOST readers will recall that back in 1950 the FCC adopted a set of color television broadcasting standards based on the CBS color TV system. Soon after, it became apparent that this system would obsolete millions of black-and-white receivers already in use. This dampened the industry's enthusiasm for the CBS color system, and as a result, little effort was made to develop it into a practical reality.

The general feeling in the industry was that if a color television system

was to be universally accepted, it could not afford to obsolete the millions of black-and-white sets already in use.

Fortunately, the FCC, in adopting the CBS color system, left the door open for consideration of a better color system should one ever be developed and demonstrated.

Prior to the war, the RETMA, then the RMA, established a committee composed of representatives of most of the major manufacturers, known as the National Television System Committee. The NTSC was given the job of formulating a set of black-and-white television broadcast standards for presenta-

tion to the FCC for its approval. These standards were subsequently adopted and are the ones in use today.

Taking a page from past experience, the RETMA again called on the NTSC in November, 1950, and assigned it the job of formulating a set of color television broadcast standards for presentation to the FCC.

As in 1941, the NTSC is composed of the best engineering brains in the country contributed by the members.

On July 23, 1953, the NTSC formally petitioned the FCC for adoption of a set of color television standards.

In studying the NTSC system, you will find it easier to understand if you realize that it is not necessarily the simplest, nor even the best, color system which could have been designed.

The NTSC system was developed to meet, on the one hand, a set of FCC requirements, and, on the other hand, the economic requirements which its originators felt were a necessity.

The FCC requirements were:

1. The system must operate within the present 6-mc channel allocations.
2. The quality of color reproduction had to be excellent. The pictures had to be well-defined and free from annoying defects such as line crawl, jitter, or prominent dot structure.
3. Pictures had to be sufficiently bright for adequate contrast under normal lighting conditions, and free from objectionable flicker.
4. Receivers had to be simple enough for the average person to operate, and cheap enough for the average person to buy.
5. The transmitting apparatus had to be reasonable in cost and simple enough to be operated by average station personnel.
6. The system could not be unduly susceptible to interference as compared to black-and-white.
7. The color signals had to be transmittable over existing and future relay facilities.

In addition to the above, the NTSC imposed upon itself other requirements, the most important of which was that the system had to be *compatible*.

A compatible color television signal is one that can be received by existing black-and-white receivers, in monochrome, without any changes or adjustments.

To accomplish these objectives, a

* Allen B. DuMont Laboratories, Inc.

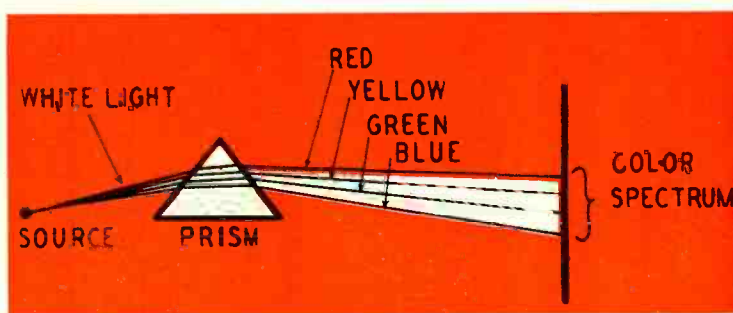

Fig. 2—A prism breaks white light up into the spectral colors.

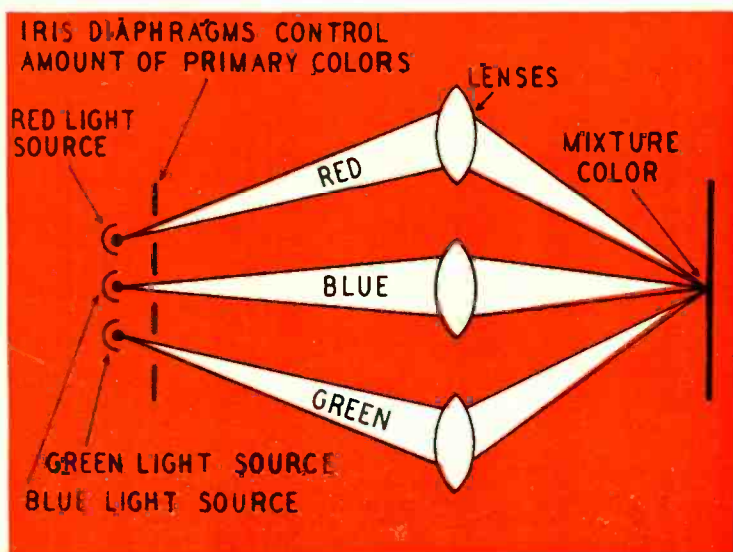

Fig. 3—Adding primaries to produce color (or white light).

number of new circuit techniques and electrical concepts were necessary. None of these new ideas are basically difficult, but at first they may appear strange and unfamiliar to the service technician.

To understand any color television system, some knowledge of color fundamentals is required:

What is color

Light is a form of radiant electromagnetic energy, just as is the familiar radio wave. Light waves are of much higher frequency than radio waves, and while radio-frequency energy is not perceptible to our senses, light produces sensation in the brain, via the eye.

Because the wavelengths of the visible frequencies are extremely short, it is not convenient to specify light wavelengths in meters. A much smaller unit, called the "millimicron," is commonly used. A millimicron is equal to one billionth of a meter and is written " $m\mu$ ".

The frequency range, or spectrum, over which radiant energy is visible extends from 380 to 780 $m\mu$. (See Fig. 1.)

What does this have to do with color?

Well, when viewing light of a single frequency, located anywhere within the visible spectrum, we experience a sensation referred to as "color." The particular "color" we see is dependent upon the frequency of the light.

For example, light of a wavelength of approximately 700 $m\mu$ is called red; if the frequency is around 550 $m\mu$, it is green; if about 450 $m\mu$, it is blue.

When the light is made up of approximately equal portions of red, green, and blue energy, we see *white light*. This can be demonstrated by passing white light through a prism, as shown in Fig. 2. As the white light passes through the prism, its individual components separate and produce a series of colors known as the spectrum.

It is apparent from the above that it is quite incorrect to refer to white light as "colorless," since it is made up of all "colors."

Color properties

A pure color can be described by stating the frequency of its light and by stating its brightness or amplitude.

In nature, light of a pure color seldom occurs. In most cases, it is mixed with, or diluted by, white light. So, to describe the light which we commonly see, we must also state the extent to which the color is free from dilution by white light.

Therefore, a colored object should be described by stating three properties.

1. Brightness, or luminance

The total amount of light given off by the object determines its brightness. The term used in color television work for brightness is "luminance."

2. Frequency, or hue

A colored object is either reddish, bluish, greenish, yellowish, etc., depending upon which color predominates. This dominant color or frequency is called "hue."

3. Freedom from dilution by white light, or saturation

As stated, most colored objects have a

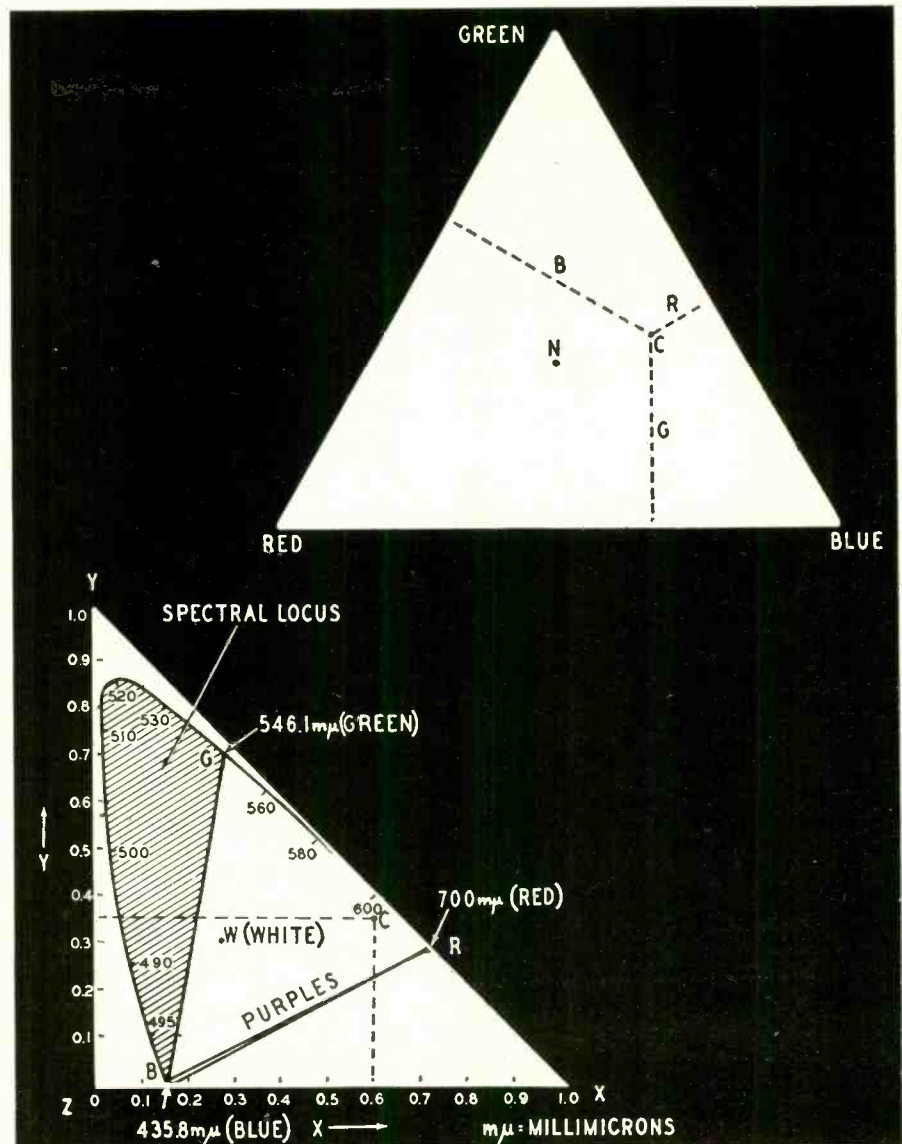

Fig. 4, above—The basic Maxwell triangle. N is the neutral or "white" point.
Fig. 5, below—Diagram with artificial primaries, as used by color engineers.

principal or dominant "hue" which is diluted to some extent by white light. For example, if an object were pure red (that is, undiluted by white light), it would be 100% saturated, or have a *purity* of 1. A "pink" object would be specified as being red in "hue," but incompletely saturated, and its purity would be considerably less than 1.

Note: Purity is expressed as a number between 0 and 1, and is the ratio of the intensity of the "dominant color" light to the total light intensity.

Reproduction of color

You will recall that when using water colors it is possible to mix two colors together and produce a third color. Carrying this idea further, it is possible to mix three selected colors, known as *primary* colors, and produce a very wide variety of other colors.

In modern printing, the three primary colors are deposited alongside one another in dots of varying size. These dots are so small that the eye blends them together, creating the same effect

as the mixed water colors.

In the familiar Kodachrome transparency, three layers of differently colored filters are placed on top of one another. As the transparency is viewed, white light passes through each filter in succession. The eye sees the net result in a wide variety of colors.

Both color printing and color photography achieve their results by using the *subtractive* method.

In the subtractive method a desired color is obtained by removing a predetermined amount of red, green, and blue from a source of white light. (You will recall that white light consists of equal amounts of the red, green, and blue primaries.)

By removing portions of the three primaries in varying degrees, we can obtain a wide variety of colors. (If you mix red and blue, for instance, the result is the mathematical *difference* between the red and blue primaries.)

In a color television receiver, the red, green, and blue light is produced on the face of the C-R tube. On the screen of

the receiver the three primary colors are self-luminous—they create their own light and must be *added* together to produce the desired range of colors. The additive method of producing color is shown in Fig. 3. In this system, we start with the three primary colors (red, green, and blue) and by adding together the required amounts of each of the primaries, we can produce almost any desired color. In both the subtractive and additive systems, we vary the amounts of three primaries to produce the desired color.

You may wonder why red, green, and blue are always used. Actually, red, orange, and green or many other combinations of colors could be used. (Remember that red, yellow, and blue are the common subtractive primaries.) However, red and blue, located at opposite ends of the color spectrum, in combination with green, which is located at the center of the color spectrum (refer to Fig. 1) enable us to obtain the widest possible range of colors.

Color specification

Years ago, a need for exact color specification became apparent. What one person referred to as "red" might possibly mean any one of dozens of shades called "red", for example.

Because of these individual variations, tests were conducted with a large number of observers and the results were averaged out. Based on these tests, a set of color standards were adopted in 1931 by the International Commission on Illumination, to apply all over the world in all color activity.

These standards are known as the ICI system, after the commission which adopted them.

The standards specify that the red primary shall correspond to light of the wavelength 700 m μ , green as 546.1 m μ , and blue as 435.8 m μ .

We have seen that almost any desired color can be produced by mixing together appropriate portions of the three primary colors. Therefore, we can say that a particular color consists of so much red, so much green, and so much blue.

A convenient way of illustrating the exact amounts of the three primary colors which are present in a given color is by the triangle of Fig. 4.

Note that the center of gravity of the triangle is the neutral or white point (N) since this represents a "color" to which the three primaries are contributing equal amounts. As the described color departs from the neutral point, it takes on a definite, recognizable hue depending on whether the green, red, or blue frequencies predominate. Also the closer the described color point moves toward the sides of the triangle, the more saturated the color becomes. (Freer from dilution by white.)

When using this type of diagram (known as the Maxwell triangle), an exact color is specified by stating the proportion of each color to the total.

This is illustrated graphically in Fig. 4. Note that the proportion of red

is indicated by the length of the line drawn perpendicularly from the side of the triangle opposite the red apex point. Similarly, the proportion of blue and green is specified by the perpendicular lines drawn from the sides of the triangle opposite the blue and green apex points.

Thus by knowing the numerical proportions of the three primaries to the total, we have sufficient information to reproduce any color. These proportions are always stated as a fraction of 1 to provide a standard method for color specification.

Since the total is always arbitrarily taken as 1, no information is furnished as to the real brightness of the colored object being described. If we were to reproduce a color using only the information given in the triangle, its color would be correct, but its brightness might be quite different from the original. Therefore, if we are to match the original colored object exactly, we must also be given information concerning the brightness. We see that we can specify the *color* of any object on the one hand, and its brightness as a *separate quantity* on the other. This principle is used in the NTSC color television system and will be described in the next article.

The triangle shown in Fig. 4 is seldom actually used. The basic reason for this is that it requires that three fractional proportions be specified while only two are necessary.

You will recall that the proportions are always stated as fractions of 1. If we know two of the proportions, the third can be found by simply adding the two and subtracting their sum from 1.

Since only two numerical quantities or proportions are required, it is more convenient to plot a color or "chromaticity" diagram in the form of a right triangle as shown in Fig. 5.

The three apex points of the triangle in Fig. 5, labeled X, Y, and Z, represent what can be considered imaginary primaries as compared to the real primary colors shown in Fig. 4. This is done for the sake of convenience in specifying all of the colors in the spectrum, including those which cannot be achieved by mixing the three standard ICI primaries.

Using the standard color diagram, a color is specified by stating its vertical (Y) and horizontal (X) co-ordinates. For example, the color C, corresponding to $X = 0.6$ and $Y = 0.35$, is seen to be a not quite fully saturated orange. In other words, color C consists of 60% imaginary red primary color X, 35% imaginary green primary color Y and 5% (1.0 minus 60% plus 35%) imaginary blue primary color Z.

Using these figures, plus information on brightness, the skilled colorimetrist is able to specify any given color. The method is not simple, and uses rather involved mathematics, therefore it would be unprofitable to attempt to go further into the details at this point.

The three ICI primaries which are used in color television are marked on the XYZ diagram. The area enclosed

by the triangle connecting these points represents all of the colors which can be achieved with these primaries. Note that some of the highly saturated blues and greens, indicated by the shaded portion of the diagram, fall outside of this area and thus cannot be reproduced with the ICI primaries. These colors seldom occur in nature and very little is lost by not reproducing them in color television. The ICI primaries permit us to reproduce the saturated reds, yellows, and oranges, which are very common. With this compromise we can still obtain very pleasing color reproduction.

From the above, we see that it is possible to specify, or describe accurately the color of any object in terms of its *hue* (principal color) and *saturation* (freedom from dilution by white), by simply stating its X and Y coefficients on the color diagram. This information, plus brightness or "luminance" information, tells us all we need.

Peculiarities of vision

We are all familiar with that peculiar behavior of the human eye known as *persistency of vision*. The brain's ability to retain an image for a fraction of a second after it has actually disappeared forms the basis of motion pictures and television.

Less commonly known is the fact that people become progressively more color-blind as the size of the object they are looking at gets smaller. Another way of stating this is to say that the color of a large area looks different than the same color confined to a small area.

Most of us have had the experience of selecting paint of a certain color from a small sample and perhaps being disappointed in the results when the entire room was painted. We are sometimes inclined to question the skill of the painter and tend to blame him for improper mixing of the color. In many cases, the actual colors are identical—it is simply the fact that the difference in size has the effect of producing a mismatch.

This color-blindness phenomenon follows a definite pattern which has been established as a result of extensive tests conducted with a great many people having normal color vision. The NTSC color television system takes advantage of this fact by transmitting only that amount of color information that can be appreciated by the eye. Full color information is transmitted for large-area portions of the picture; restricted color information is supplied for smaller areas of the picture, and only brightness information (no color at all) is furnished for the tiny areas (fine detail) of the picture.

This results in a substantial reduction in the bandwidth necessary to transmit a color television picture, and is one of the reasons it was possible to sandwich the color signal into the existing 6-mc channels. (TO BE CONTINUED)

In the next article we will discuss the basic requirements of a color television system, and how the peculiarities of color vision have been used to advantage in the design of a compatible system utilizing a 6-mc transmission channel.

BOOSTER

TRANSMITTER INCREASES TV STATION RANGE

*Co-channel booster brings
TV to fringe areas, lowers
antenna installation costs*

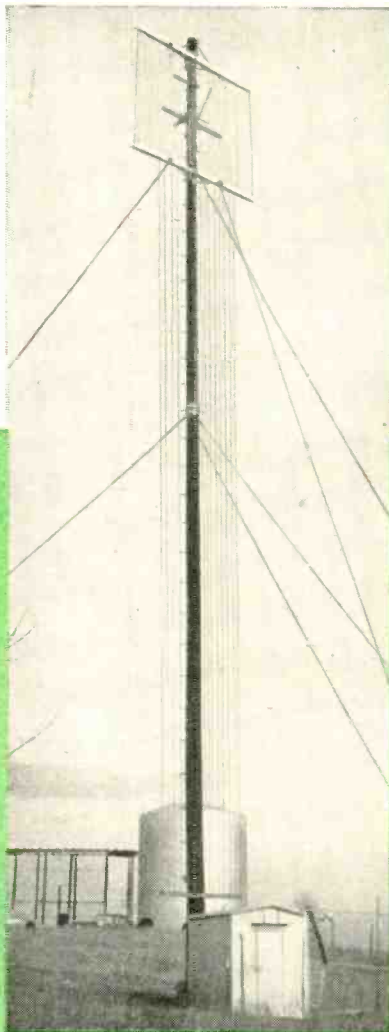

The booster transmitting antenna with the receiving array in the background.

HOW are we to bring television service to residents of fringe-area towns? Numerous methods have been proposed, including Stratovision, community antenna systems, satellites, and boosters. The co-channel booster described here was developed to meet this demand at the lowest possible cost. The experiment is being made at Lawrenceburg, Tennessee, a town of 70,000 people located 68 airline miles southwest of Nashville.

Lawrenceburg has 275 television sets

with outside antennas which cost at least \$100 each. This means that if every family in town had a TV set, there would be a total antenna investment of at least \$175,000. Besides the initial cost, the life of these high antennas is short and the hazards involved in their use are great.

Wired systems—many of them very satisfactory—have been installed in many communities. To use them, the TV set owner must usually pay a fee of \$100 or more, plus a monthly charge.

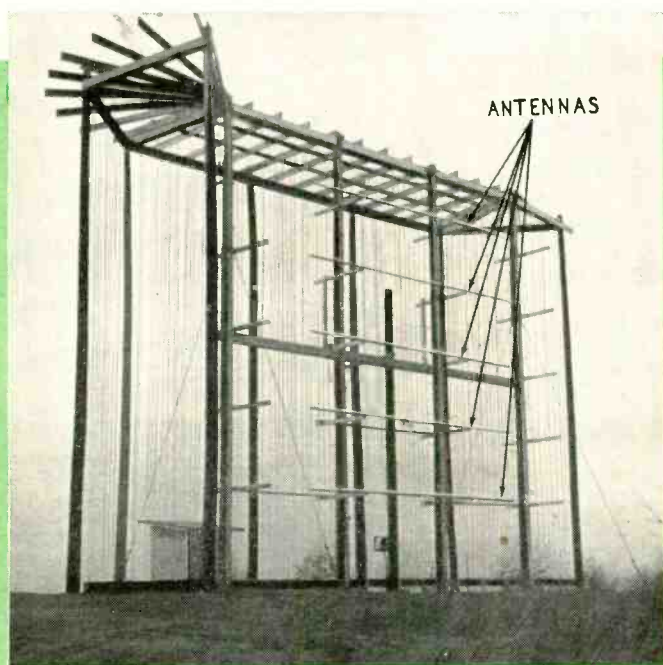

A view of the 20-element receiving array at the booster installation.

Radio transmission to bring TV programs to people in fringe areas would seem to be more economical to the consumer. Such radio systems—of the type now being tested by Sylvania—are more attractive than wired systems, and (if the signal is strong enough) approach the service of a primary television station. But they require additional channels in the crowded u.h.f. band, and in some communities, might prevent or hinder the establishment of local TV stations.

The booster system has the great advantage of working on the same channel as the main transmitter, thus needing no extra channels. WSM-TV (Channel 4), of Nashville, proposed to the FCC in 1951 to experiment with an on-channel crossed polarization booster system, and after authorization on July 16, 1952, developed an experimental booster system.

Such a system should have a number of advantages, besides that of requiring no additional channel space. Vertical polarization is used, and a strong signal is delivered over the town. This overrides the interference which troubles the users of tall antennas, and makes cheap—or even indoor—antennas possible. The cost of installation and operation is low, interference to other stations (and its own) is negligible, and the hazards of tall antenna towers are eliminated. The station licensee retains control of the booster, simplifying relationships with the FCC; and the system fits readily into existing allocations plans.

The basic booster system

Briefly, the system consists of a high-gain receiving antenna and a low-gain transmitting antenna placed back-to-

back and connected through a low-power radio-frequency amplifier system with an over-all gain of about 100 db. The system is polarized *vertically* to maximize booster coverage for a given booster power and to minimize interference to the main TV station and other co-channel stations.

The transmitting antenna at Lawrenceburg is a vertical folded dipole mounted a quarter wave from a screen of one wavelength square consisting of No. 10 vertical wires. A transformer at the center of the radiator assures balance. It is mounted on a 100-foot pole, guyed with tarred rope. To prevent distortion of the vertical polarization, no horizontal metal was used in the construction. The crossarm bolts and the steps on the pole are made of nylon.

The receiving antenna is a broadside array of 20 half-wave elements in front of a screen of horizontal No. 10 wires spaced at 4-inch intervals. To this is added a maze of vertical wires which outline the walls of a theoretical waveguide operated beyond cutoff. To further attenuate pickup from the rear, a screen with rectangular openings 1 x 2 inches was applied to the backs of the poles which support the horizontal reflector wires (so that the reflector wires

are between the screen and the antenna elements). This practically eliminates interference in a wide arc behind the antenna. Gain in forward direction is 17 db.

The station, with an effective radiated power of 10 watts, covers the city of Lawrenceburg and the adjacent urban area with a field intensity of 500 μ v per meter, and a much wider area with a signal in excess of 100 μ v.

Within the 100- μ v area set owners with simple vertical antennas find reception from the booster more satisfactory than was reception from the station with the large high Yagi's that were necessary. But between the 100- μ v and the 10- μ v contours, there have been several cases of interference between booster and main station. This interference takes the form of a ghost which may be displaced halfway across the receiver screen. Elimination of the interference depends on the relative strength of the two signals. Where the booster signal is considerably stronger, the best approach is to erect a low vertical antenna and abandon reception from the main station. Where reception from the booster is only slightly stronger or weaker than that from the main station, a 5-element Yagi mounted vertically produces good signals from the booster in most cases. Where the relative strengths of the two signals are such that the owner prefers to retain his tall tower installation and receive direct, slight modifications of the antenna setup virtually eliminate the booster signals.

In a number of such cases, it was found that the long wire guys on the tall masts were reradiating the booster signal. Replacing the wire guys with nylon rope removed the trouble. In other cases it was necessary to replace the flat 300-ohm line lead-ins with shielded line.

As a result of experience to date, WSM's engineers believe that "... the present development offers a cheap and effective means of raising the signal level over a town to the point where satisfactory pictures can be obtained at very low cost to the consumer. The power consumed by the booster equipment is little more than that needed to run the average TV set." Cost is reduced by fully automatic operation, so that labor required is reduced to a weekly checkup by a maintenance man. "The initial cost appears to be low enough to warrant installation in fairly small communities which certainly will not be able to support TV stations of their own for many years to come." END

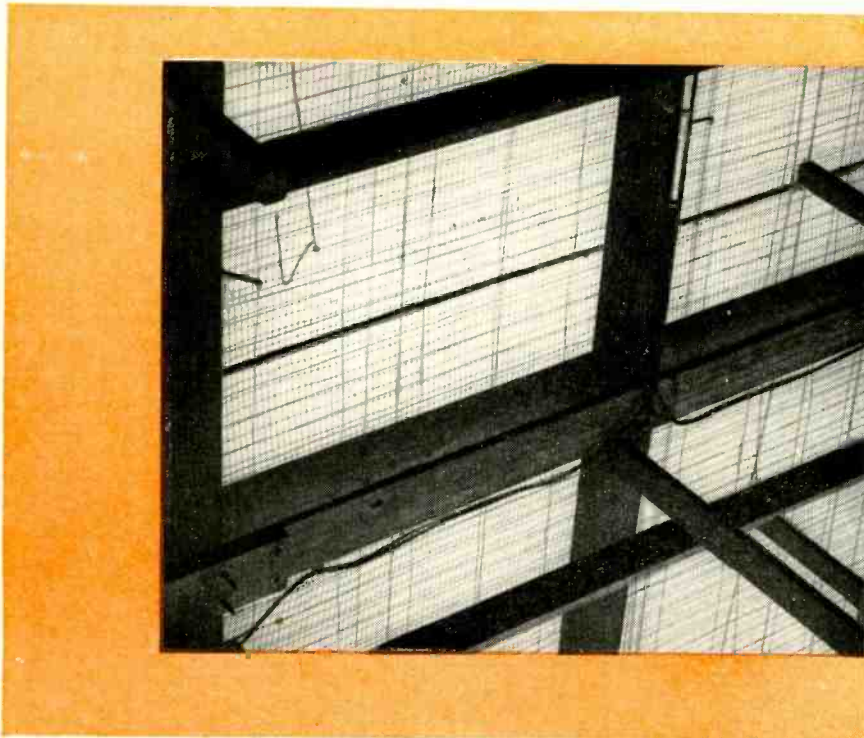

A close-up view of part of the receiving antenna at the booster station. The vertical wires minimize feedback between receiving and transmitting antenna systems.

Here is a type of TV operation which may solve the problem of bringing television to many small communities. For the information in this article, we are indebted to a report by John H. DeWitt, Jr., president of WSM, Inc., and known to our readers (RADIO-CRAFT, April, 1946) as the man who first bounced radar signals off the moon. This latest achievement of his may be an even more important feat in the eyes of fringe-area television set owners!

MODERN

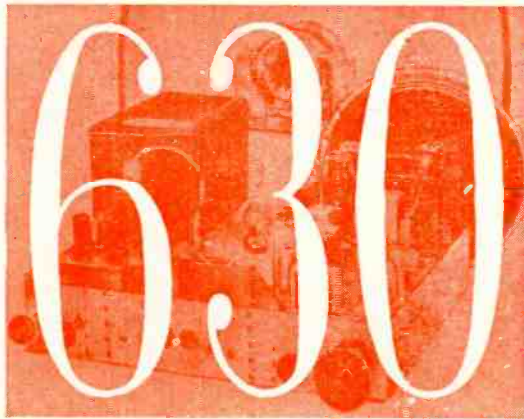

CIRCUITRY

The remarkable RCA 630TS, discussed on the following pages, has undergone very few changes. It remains a TV receiver yardstick

By **ROBERT F. SCOTT**
TECHNICAL EDITOR

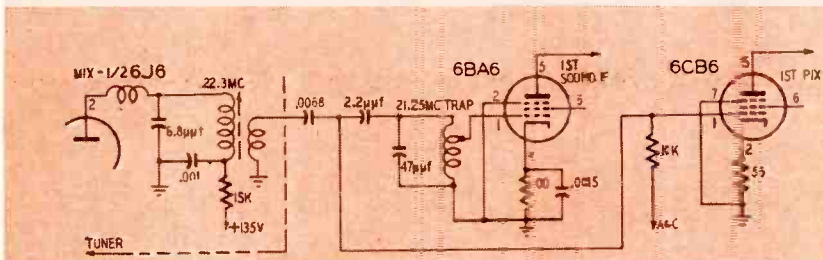
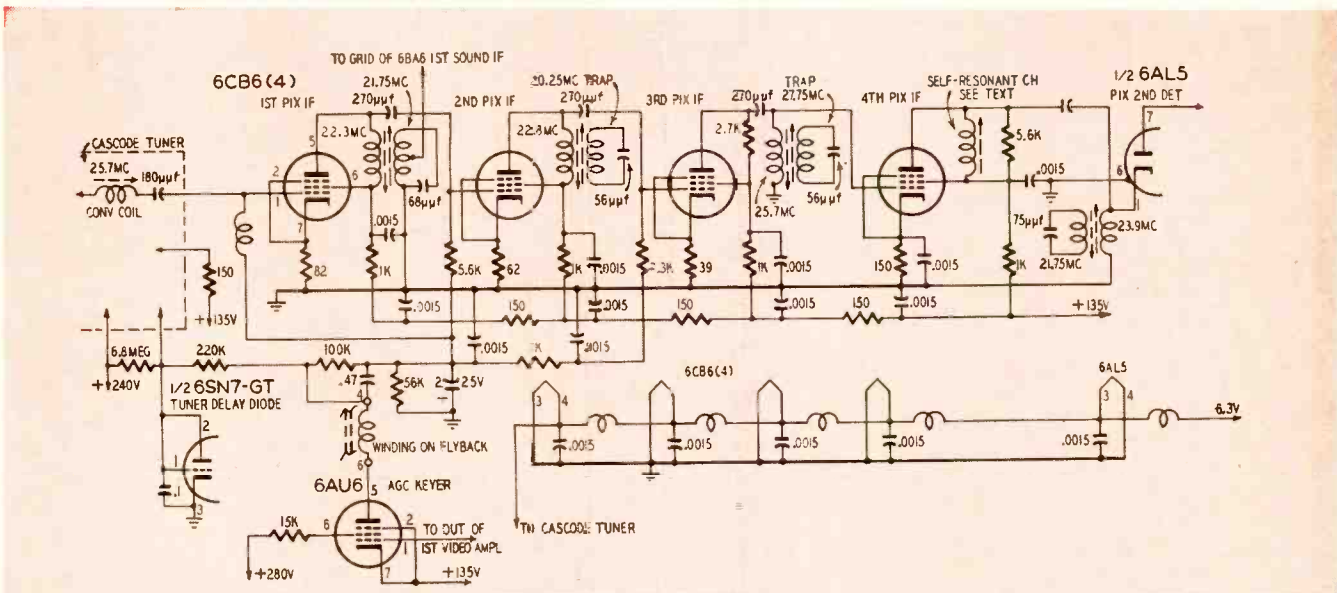
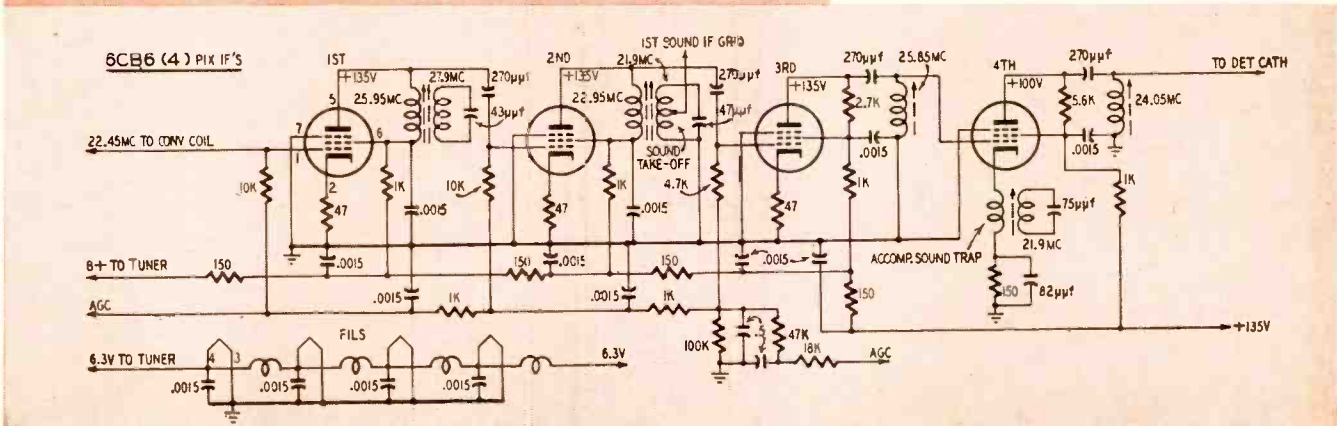

Fig. 1—Above-Video i.f. strip used in Video Products and Mattison models.

Fig. 2—Left-Tuner coupling of video and sound i.f. amplifiers in Regal.

Fig. 3—Below-Schematic diagram shows sound take-off coupled to the plate of second picture i.f. amplifier in Airex.



IN THE fall of 1946, which was about one year after its introduction, the top-notch performance of the RCA 630TS had made the TV world 630-conscious. Its high sensitivity, sync stability, and reliability had become yardsticks by which other sets were rated. Several large competitive manufacturers and many small ones obtained rights to manufacture 630-type chassis through RCA's licensing service. Nearly all these manufacturers included "630" in their model or chassis numbers.

The larger manufacturers have replaced the 30-tube 630 chassis with simpler types using fewer tubes. However, a number of small manufacturers are still producing 630 type kits, custom chassis, and complete receivers which incorporate all of the latest components and circuit developments. The owners of older 630 type chassis can improve their sets and bring them up to date by making many of the improvements described here. Table I lists new circuit features and tube changes covered in the text. Table II compares traps and sound and sync take-off points in the 630TS with those in the 1953-1954 models.

The i.f. amplifier

Circuitwise, the i.f. amplifiers in the 1953-1954 630 type chassis are pretty close to the original. The most outstanding changes have been made in the video i.f. strip to provide higher gain and to permit use of the Standard Coil cascode tuner. The Philmore is the only set covered in this survey that retains the four 6AG5 video i.f. amplifiers. All other makes except Regal have four 6CB6's. The Regal models use a 6AG5 or 6BC5 in the fourth video i.f. stage. The circuit of a typical video i.f. strip is shown in Fig. 1.

In primary service areas where a booster is used, the signal level may drive the fourth video i.f. amplifier to the point where video and sync signals are compressed, resulting in poor picture quality and sync instability. This problem is overcome by shunting a small coil across the 5,600-ohm plate-load resistor. See Fig. 1. This raises the plate voltage and the point at which sync compression and clipping begins. (This is probably the reason why Regal uses 6AG5's or 6BC5's in this stage.)

As shown in Table II, the sound take-off point varies with the make and model. Fig. 2 shows the method of coupling the tuner output to the sound and video i.f. amplifiers in the Philmore and Regal sets. In all others except the Transvision model, the sound take-off is at the plate of the first or second video i.f. amplifier. Fig. 1 illustrates a sound take-off point coupled to the plate of the first video i.f. stage.

Fig. 3 shows the sound i.f. strip of a receiver with the sound take-off coupled to the plate of the second picture i.f. amplifier. I was startled to note that with this arrangement there is no adjacent-channel picture-carrier trap. In some areas where it is possible to

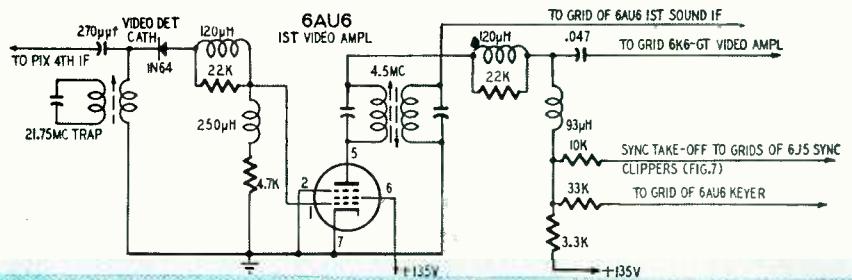

Fig. 4—Transvision sound take-off from plate of first video amplifier.

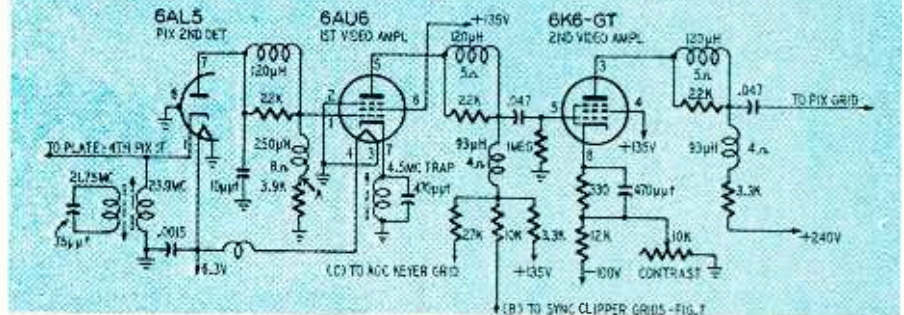

Fig. 5—The video detector and amplifier circuits used by Video Products.

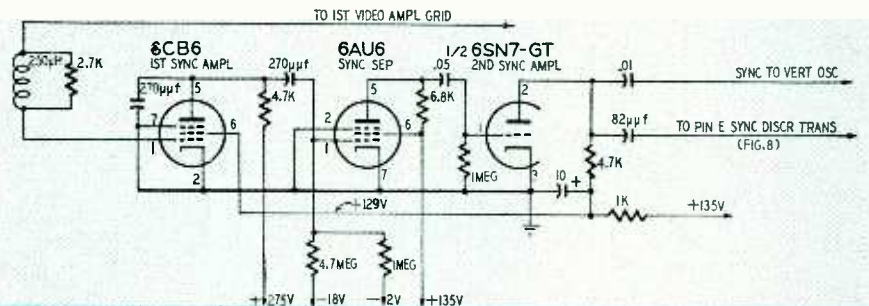

Fig. 6—Original RCA 630TS sync circuit, with modern tubes substituted.

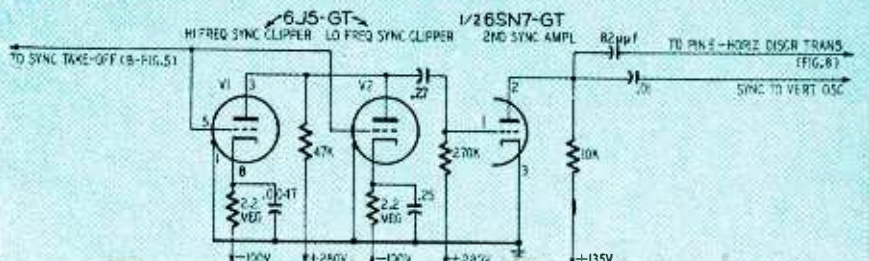

Fig. 7—New type of sync separator. Circuit designed to stabilize sync pulses.

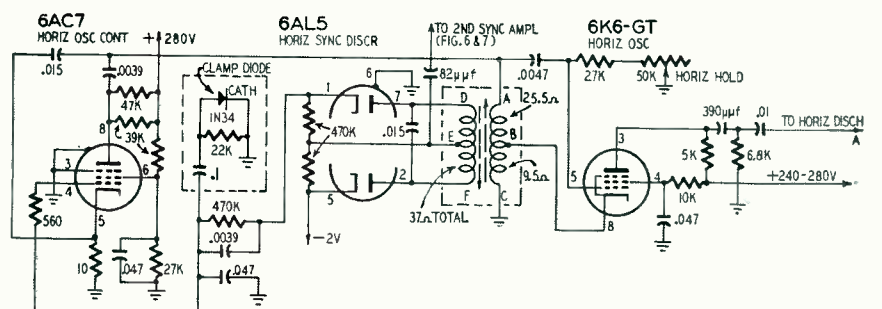

Fig. 8—The Synchrolock horizontal a.f.c. circuit used in the 630TS.

receive stations on adjacent channels, this can be a source of trouble.

The Transvision set is an *intercarrier* type with the sound take-off coupled to the plate of the first video amplifier as shown in Fig. 4. This radical change from the original 630 circuit was probably made to minimize picture and

sound separation when receiving u.h.f. stations. This set is the only one to use a germanium diode as the video detector. The others use 6AL5's.

The video amplifier

In all the sets, the first video amplifier is a 6AU6 and the video output is

a 6V6 or 6K6. See Table I. The contrast control is in the cathode circuit of the video output stage.

The 630 is a wide-band receiver. When 16-inch and larger picture tubes were substituted for the old 10BP4, there were complaints of a strong 4.5-mc beat causing interference in the picture. A 4.5-mc trap was installed to prevent this. In some sets, this trap is inserted in the plate circuit of the first video amplifier. In the Transvision set (Fig. 4), the sound-take-off transformer also serves as a 4.5-mc trap. The cathode is grounded when the trap is in the plate circuit. The Philmore model does not employ a 4.5-mc trap.

The video detector and amplifier circuits of the Video Products 630K4C are shown in Fig. 5. Here, the 4.5-mc beat is eliminated by a low-Q degenerative trap in the cathode return on the 6AU6. This trap is made by shunting a 470- μ f capacitor across a 630 type third or fourth picture i.f. coil. This arrangement is also used in the Mattison, Airex 630 FA, and Regal sets.

Sync circuits

Two distinct types of sync circuits are used on the receivers discussed here. Philmore, Tech-Master (*Videola*), and the Airex 630FA-2 and 630FA-2-A use the original RCA type sync separator and sync amplifier circuits in Fig. 6. Tech-Master sets use a 6AC7 first sync amplifier and Airex sets have a 6CB6 in this stage in place of the 6SK7 in the 630TS. The 6SH7 in the 630TS has been replaced by the 6AU6 in all sets except the Philmore.

A new type of sync separator that some manufacturers are adopting is shown in Fig. 7. This circuit is designed to stabilize the sync pulses and minimize picture roll and tearing under severe noise conditions.

In a set which has a single time-constant sync clipper or separator, the time-constant is selected as a compromise value that provides good separation of horizontal and vertical sync pulses under normal conditions. With this arrangement, sustained noise bursts may gradually increase the operating bias on the clipper until it blocks. This causes momentary interruption of sync pulses, and the sweep oscillators may fall out of sync.

In the dual sync clipper in the Airex 630FA, Mattison, Regal, Transvision, and Video Products sets (see Fig 7), V1 and V2 are high- and low-frequency sync clippers, respectively. They operate with their grids in parallel and the plates connected to a common load resistor. The cathode circuit of V1 has a short time-constant, and V2 has a comparatively long time-constant.

The time-constant of V2 is designed to provide good separation of vertical and horizontal sync pulses. In strong-signal noise-free areas, the set will provide satisfactory sync operation with V1 removed from the circuit. When dual sync clippers are used in the presence of strong noise pulses, V2 may

Mfr.	Model	No. of tubes	Horiz. output	Vert. output	Audio output	Video output	Horiz. Blank.	Vert. Blank.	De-layed a.g.c.	High Voltage (kv)
RCA	630TS	30	6BG6-G	6K6-GT	6K6-GT	6K6-GT	No	No	No	9
Airex	630FA	31	6BG6-G	6K6-GT	6AQ5 ¹	6V6-GT	No	Yes	No	14.5-15
	630FA-2	31	6CD6-G	6S4	6AQ5 ¹	6V6-GT	No	Yes	No	16
	630FA-2-A	31	6CD6-G	6S4	6AQ5 ¹	6V6-GT	No	Yes	No	16
Mattison	630-6A	30	6BG6-G or 6BQ6	6K6-GT	6K6-GT	6K6-GT	No	Yes	Yes	14.5
Philmore	CP7-31D	31	6CD6-G	6K6-GT	6K6-GT	6K6-GT	No	No	No	14
Regal	See footnote	30	6BG6-G	6S4	6V6-GT	6V6-GT	No	Yes	No	14.5-15
	1930R-C	30	6CD6-G	6S4	6K6-GT	6V6-GT	No	Yes	No	16
Tech-Master	2430	30	6CD6-G	6S4	6K6-GT	6V6-GT	Yes	Yes	No	16
	2431P	31	6CD6-G	6S4	6AQ5 ¹	6V6-GT	Yes	Yes	No	16
Transvision	630-A	30	6BG6-G	6K6-GT	6AQ5 ¹	6K6-GT	No	Yes	Yes	14.5
Video Products	630K4C	30	6BG6-G or 6BQ6	6K6-GT	6K6-GT	6K6-GT	No	Yes	Yes	14.5

Note: Regal models are: 1731, 1736, 2031, 2036, 2131, 2136, 2431, and 2436. Chassis code 101.
¹—Push-pull output stage.

Table I—630 comparisons. New circuit and tube changes covered in article.

Mfr.	Model	Sound take-off point	Sync take-off point	Type of sync	Accompanying sound trap	Adj. chan. sound trap	Adj. chan. video trap	4.5-mc trap
RCA	630TS	Converter plate	D.c. restorer	RCA	4th i.f. cathode	1st i.f. plate	2nd i.f. plate	None
Airex	630FA	1st picture i.f. ampl.	1st video amplifier	Dual	Detector cathode	2nd i.f. plate	4th i.f. grid	1st video cathode
	630FA-2	2nd picture i.f. ampl.	Video detector	RCA	4th i.f. cathode	1st i.f. plate	None	1st video plate
	630FA-2-A	2nd picture i.f. ampl.	Video detector	RCA	4th i.f. cathode	1st i.f. plate	None	1st video plate
Mattison	630-6A	1st picture i.f. ampl.	1st video amplifier	Dual	Detector cathode	4th i.f. grid	2nd i.f. plate	1st video cathode
Philmore	CP7-31D	Converter plate	Picture tube grid	RCA	4th i.f. cathode	1st i.f. plate	2nd i.f. plate	None
Regal	See footnote	Converter trans.	1st video amplifier	Dual	4th i.f. cathode	1st i.f. plate	2nd i.f. plate	1st video cathode
	1930R-C	2nd picture i.f. ampl.	Video detector	RCA	4th i.f. cathode	1st i.f. plate	None	1st video plate
Tech-Master	2430	2nd picture i.f. ampl.	Video detector	RCA	4th i.f. cathode	1st i.f. plate	None	1st video plate
	2431P	2nd picture i.f. ampl.	Video detector	RCA	4th i.f. cathode	1st i.f. plate	None	1st video plate
Transvision	630-A	1st video plate	1st video plate	Dual	Detector cathode	4th i.f. grid	2nd i.f. plate	1st video plate
Video Products	630K4C	1st picture i.f. ampl.	1st video amplifier	Dual	Detector cathode	4th i.f. grid	2nd i.f. plate	1st video plate

Note: Regal models are: 1731, 1736, 2031, 2036, 2131, 2136, 2431, and 2436. Chassis code 101.

Table II—630 comparisons. Sound and video traps; sound and sync take-off points.

block, but the shorter time-constant of V1 enables it to continue to conduct.

Although the short time-constant of V1 favors the passage of horizontal sync pulses over the vertical, the overall performance of the dual clipper in the presence of heavy noise is superior to that of any single time-constant type.

The sync take-off point is at the output of the video detector for the RCA type circuit in Fig. 6 and at the plate of the 6AU6 video amplifier for the dual sync clipper in Fig. 7. In the original RCA 630, sync take-off was at the plate of a 6AL5 d.c. restorer in the output of the second video amplifier.

Fig. 8 shows the Synchrolock hori-

zontal a.f.c. circuit made famous in the 630TS. The 0.1- μ f capacitor, 22,000-ohm resistor, and 1N34 germanium diode shown within the dashed lines are added components used in the Transvision 630-A and Airex 63FA receivers. In the Video Products and Mattison sets, diode plates and the grounded cathode of the 6AT6 first a.f. amplifier are used instead of the 1N34.

The 1N34 or 6AT6 diodes are used as clamps to stabilize the voltage on the horizontal sync discriminator in the presence of transients. The clamp diode regulates the voltage on the cathodes and eliminates the effects of transients.

TO BE CONTINUED

Have you ever asked yourself: "What new and different circuits are we going to find in a color TV receiver?" Here are the new and different parts, with a brief description of their function

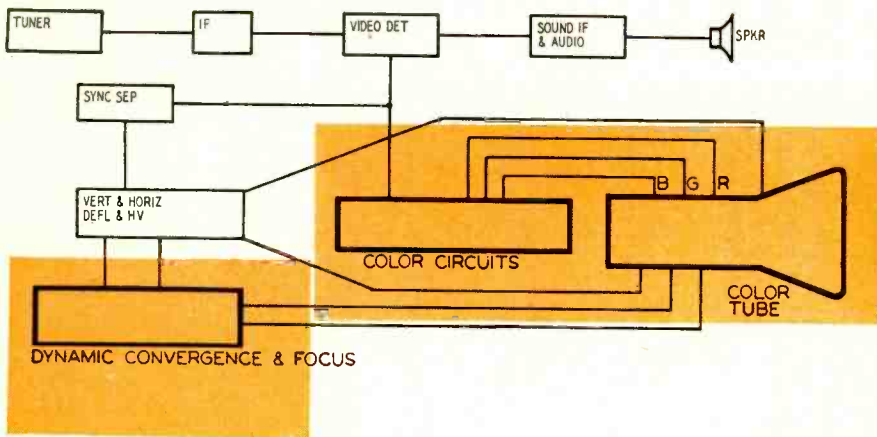

COLOR CIRCUITS

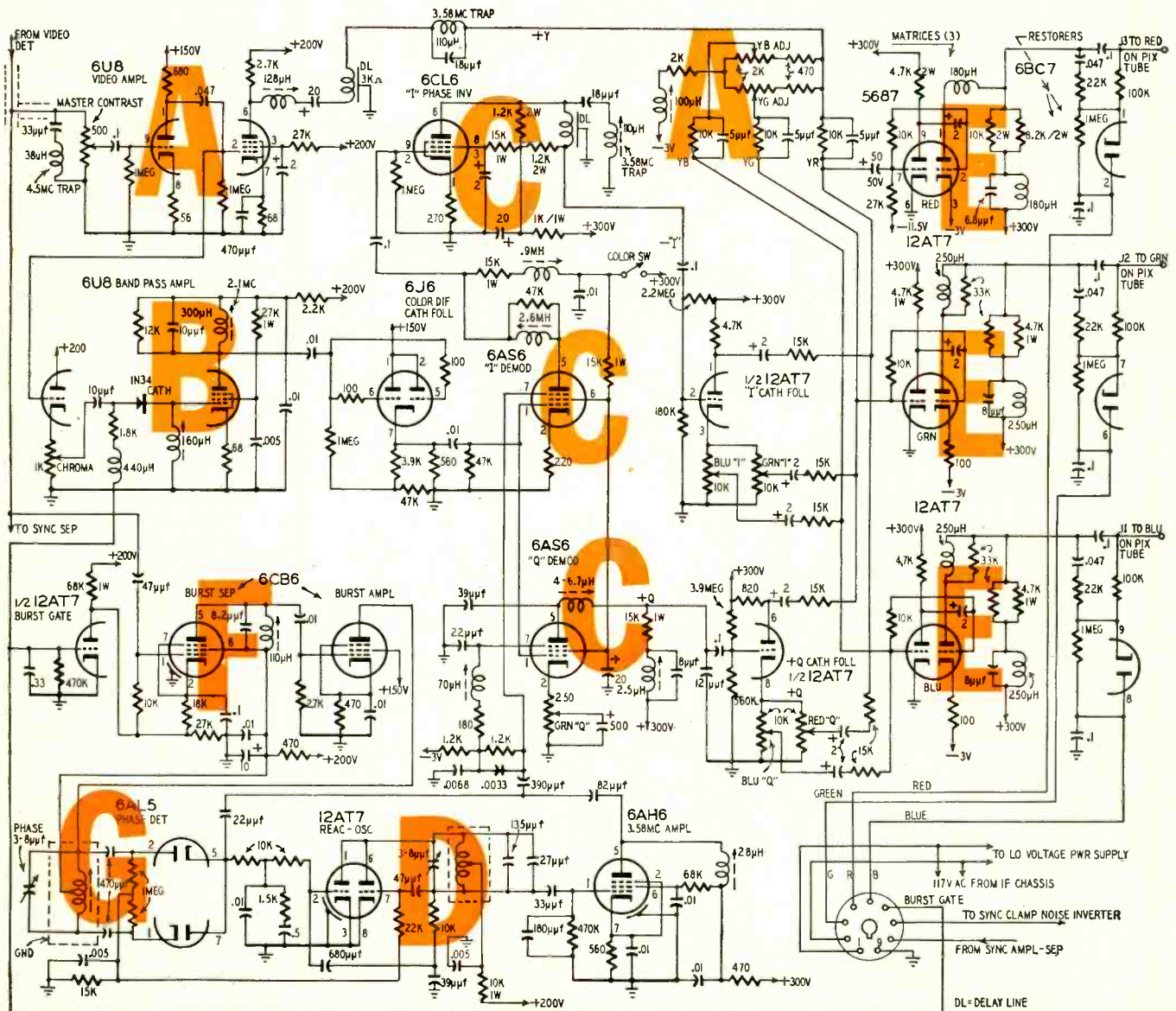

COLOR RECEIVER CIRCUITS

A COMPLETE description of the circuits on this and the opposite page would constitute a complete course in color television. So the reader must expect the discussion to be incomplete and oversimplified. Some important circuits—time-delay networks for instance—have been passed over. Others—like the cathode followers—have been mentioned without explanation. All these points will be handled in detail in full articles within the next few months.

Up to the video detector, the only difference between a straight black-and-white and a color receiver is that the i.f. channel must be especially wide and flat. Therefore a color receiver may have more i.f. stages than has been common.

After the video detector, the signal is split into two parts. One goes to the luminance or "Y" (black-and-white) circuit (A); the other to the color circuits. The Y circuit consists of a two-stage video amplifier and a network through which the signal is applied to the grids of all three guns, essentially in parallel.

The first tube in the chroma circuit (B) is a bandpass amplifier which passes the 3.58-mc color carrier and its sidebands. It feeds a 6J6 color-differ-

ence cathode follower, which supplies the signal to the "I" and "Q" demodulating circuits (C). Since the color signal is phase-modulated for color, these detectors are there to find out the phase of the transmission. Their suppressors are supplied with a local 3.58-mc carrier generated by the 12AT7 triode section and amplified by a 6AH6 (D). The "I" ("in-phase") demodulator is fed direct; the "Q" (quadrature) through a 90-degree phase-shifting network. (Two values at right angles to each other—the "x" and "y" axes of trigonometry—can express any phase angle from 0 to 360°.) The "I" and "Q" signals then go (one of them through a phase inverter) to cathode followers which feed the three matrices or adder circuits (E) in which the color and luminance signals are combined. The cathode followers contain the controls for varying the individual colors. The matrix tubes are double triodes. The first half of each is a wideband mixer, the second half is an amplifier. Gain of each is set so that the picture tube receives color signals in correct proportion for good color balance. The diodes which are seen at the extreme right of the diagram are used as d.c. restorers.

The burst circuits (F) pick up an

8-cycle synchronizing burst sent at the end of each line, amplify it and feed it to a phase detector, which with the reactance tube, forms an a.f.c. circuit (G) for the local 3.58-mc oscillator.

Convergence circuits (H) appear below. A convergence electrode, supplied with 10,000 volts, is used to keep the spots in registry. But, since the path a spot travels is longer to the corners than to the center of the tube, that voltage must be varied. So signals are taken from the vertical and horizontal amplifier outputs, amplified and superimposed on the steady convergence voltage, as well as to the focus control, which keeps the spots registered and in focus at all points along the line. The background controls (J) are individual brightness controls for each color, and the screens (K) are adjusted for color balance. The purity coil (L) adjusts the axis of the three beams so that the spots strike the color dots on the screen accurately.

Our thanks to Emerson for supplying the original schematic of this prototype experimental receiver, and especially to Chief Engineer Dorman Israel and to William Feingold for assistance in expediting, for technical information, and for aid in checking the diagram. END

CONVERGENCE AND FOCUS CIRCUITS

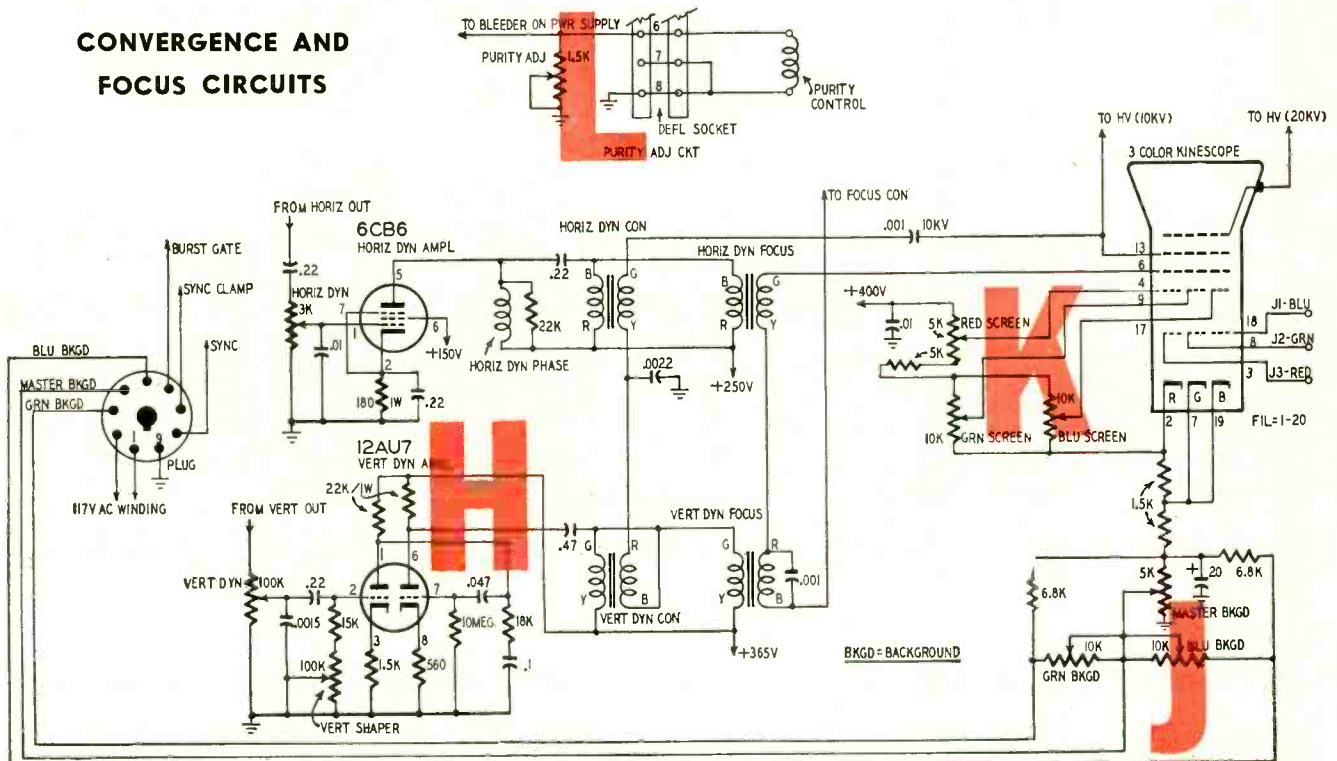



in 1953

By E. P. TILTON, W1DQ,
v.h.f. Editor, QST

Another great year for dx hounds and students of propagation. Hardly a day went by without remarkable dx reports

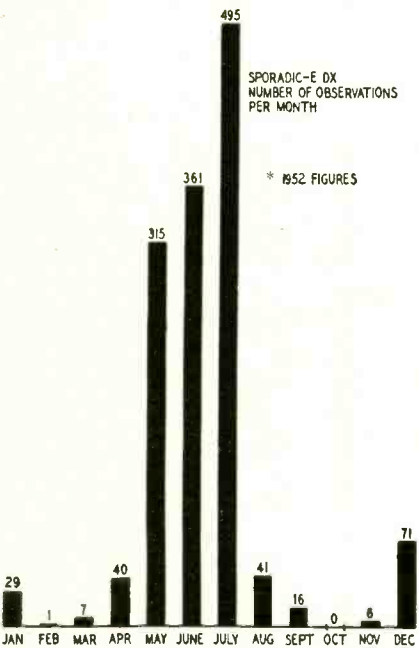
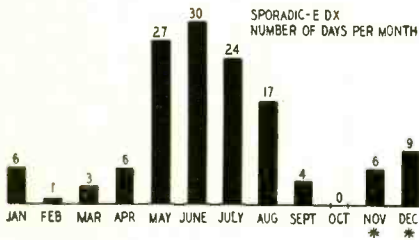

Fig. 1—Sporadic-E dx, report for 1953.

DESPITE all that's been written on the subject and the fact that hams have been working similar kinds of v.h.f. dx for nearly 20 years, it is still a source of amazement to most TV owners to discover that reception is possible over distances of more than 150 miles or so. Probably not one percent of all home viewers have seen any TV dx. Yet in 1953 *sporadic-E* TV dx was received in the United States on considerably more than one-third of the days; 133, to be exact. If we add all forms of dx, we find that hardly a day passed in 1953 without someone pulling in TV reception over distances that may seem incredible to the average viewer.

The nearly 150 people listed at the end of this article took the trouble to record their observations and send them in to RADIO-ELECTRONICS. They are all ages, of both sexes, and from varied walks of life; schoolboys of 14 or 15, invalids bedridden or confined to wheelchairs, TV service technicians, doctors, housewives. Quite a few are hams, and all seem to share that special blend of curiosity and enthusiasm that has made radio the fine hobby that it has been through the years.

Causes of TV dx

Probably the most intriguing cause of TV dx is sporadic ionization of the E region of the ionosphere, roughly 50 miles above the earth's surface. Normally v.h.f. waves go off into space, but at largely unpredictable times this region

bends them back to earth at distances from 600 to 1,200 miles or so from where they started. They may come in as close as 300 miles on rare occasions, and multiple-hop propagation has been known to bring in stations as much as 2,500 miles distant. *Sporadic-E dx* is most common in May, June, and July, with a shorter period around Christmas time, but it can happen anytime.

More common is extended-range propagation associated with easily observable weather effects. *Tropospheric dx* can often be anticipated several hours to a day or two in advance. It is usually at its best just before a general rain, and is almost always associated with the middle or trailing edges of well-defined high-pressure areas. Tropospheric dx is most common in the warm months, reaching its peak in September and October.

Many other natural phenomena affect TV reception to some degree. The aurora borealis, meteors hurtling through space, high-flying planes, and various forms of scattering may cause weak signals to appear occasionally. All these are minor sources of TV dx. Except for aurora they can be neglected, and even the northern lights are seldom responsible for anything approaching entertainment quality reception.

Nature of sporadic-E dx

The seasonal character of E_s (sporadic-E) dx is shown clearly in Fig. 1. (November and December fig-

ures were taken from 1952 records.) The upper columns show the number of days in each month when dx was logged; the lower ones give the number of individual observations each month. The cycles for 1951¹ and 1952² were similar, but by no means identical. In 1951, May produced the largest number of reports, with June a close second. In 1952, June topped the list by a wide margin, with July second. This year we find July in the top spot, with August well ahead of previous years.

That frequency is a dominant factor in Es dx is shown in Fig. 2. This shows the percentage of the total number of stations in each channel plotted against the percentage of the reports for that channel. It agrees well with previous years. Nearly half the dx was recorded by channel 2 stations, though only 20% of the low-band stations are in that channel. Channel 3 report and station columns are about equal. In channel 4, most populated of all, 34% of the stations yielded but 29% of the reports. Channels 5 and 6 together have one-third of the stations, but they account for a bare 13% of the dx.

Geographical situation of the station is important. Those receivable in all directions naturally outclass stations on either coast, but stations in lower latitudes enjoy another advantage: dx occurs much more often below the Mason-Dixon Line. Note the predominance of Cuban, Mexican, and Southern stations in the reports on Page 71.

A new champion!

For the first time since these reports have been collected, KPRC-TV, Houston, Texas, has been pushed out of first place. In 1953, KFEL-TV, Denver, Colo., nosed out the Houston station, 129 reports to 114. These two stations accounted for more than a third of all the channel 2 reports, and KFEL-TV reported nearly 10% of *all* dx reported. Looks like Denver should be a good place for 50-mc ham work!

KMTV, Omaha, WKY-TV, Oklahoma City, KRLD-TV, Dallas, WBAP-TV, Fort Worth, and all the Cuban stations piled up impressive totals. A newcomer to the upper brackets was WCBS, New York, with nearly three times their 1952 score. Could it be that new Empire State Building antenna?

Tropospheric dx reports were received in great quantities in 1953. They show that the higher ERP's now being employed by many stations are having a considerable effect on coverage. They also reflect the recent improvements in receiver and antenna design. Particularly in the south, viewers are reporting reliable reception over distances in excess of 200 miles in a large number of instances.

Outstanding observers

The work being done by the more serious observers is most impressive,

and the number of both reports and observers is well up over previous years. To record details of all would take most of this issue, but the work cited below is typical. Not a little of it is being done in areas where there is no local service at all. Some make a hobby of photographing dx for evidence, but such evidence is not always accepted as valid. Observer Penc, Utica, N. Y., says one fellow he showed his pictures to accused him of traveling around the country to get them!

Fantastic numbers of stations have been logged by several of the fraternity. Louis Matullo, Washington, Pa., holds unquestioned lead in this department, having identified 95 different stations! His list includes virtually every v.h.f. station within a 500-mile radius, and is very close to the maximum possible under present-day conditions. Lou is after more u.h.f. stations to add to the 7 he already has. There are 29 high-band v.h.f. stations on his list, along with 59 on channels 2 through 6.

Lou keeps involved records of weather and signal strength, and has photographed more than 50 different station identification slides and test patterns. He regularly logs up to 20 stations a day, and on July 15 he caught 36. Most home viewers refuse to believe that this many stations could be received in any day, but it's no record for Matullo. The top was 37, on September 9 of last year.

Richard Baker, Moberly, Mo., a schoolboy of 15, has 56 stations to his credit, and some fine tropospheric dx, including WHAS-11 and WAVE-3, 390 miles, WLWD-2 and WHIO-7, 450 miles, and Chicago, 300 miles, on all channels now in use, WAFM-13 and WBRC-6, 525 miles, and WXEL-9, 600 miles. Seeing the name of Gordon Amery, Braymer, Mo., listed among the 1952 observers, Baker made a trip up to compare notes. Both were pleased to find that they were the same age, and in the same grade in school!

Observer Van Gunten, Berry, Ind., has 63 stations logged, and has identified as many as 40 in a single 24-hour period. Akers, Charleston, W. Va., has 57, including all on channel 2 except the *nearest*, WFMV-TV. He is deep in a valley, with very mountainous terrain in the direction of Greensboro. Mellenbruch, Hiawatha, Kan. also has 57.

The favorable nature of the Gulf Coast for tropospheric dx shows in the reports of observers Atkisson and Blalock of Tallahassee, Fla. They report reception of Cuban stations on all channels in the warmer months, over distances up to 600 miles. Birmingham and New Orleans are also received frequently in Tallahassee. Walker of Daytona Beach has received WGUL-11, Galveston, Texas, more than 800 miles across the Gulf. Young of Orlando also received WGUL, about 775 miles, on September 13. At 10:15 pm Young was able to get a fine clear photograph of their beautiful seagull identification slide, and the signal remained in for about an hour thereafter. No low-band dx was in evidence. Rogers, of Mobile,

also has seen WGUL.

Schuman, McAllen, Texas, logs KTBC-7, Austin, 309 miles, and KGUL-11, 340 miles, frequently. Even KPRC-2, Houston, 309 miles, can be received on a channel 11 antenna. Landry, Friars Point, Miss., has KPRC, WSB-2, WAVE-3, WSM-4, WBRC-6, WAFM-13, WTTV-10, KGUL-11, and WHAS-11 at distances from 285 to 450 miles. Hale of Natchez, Miss., has a similar list, covering about everything "from Natchez to Mobile; from Memphis to Saint Jo . . ." and Galveston to San Antonio, to boot.

A session of tropospheric dx that would look like Es, if it weren't on high channels, is reported by Hedges of Kingman, Kansas. The night of May 21 WKY-4 and KOTV-6, his "locals" at 170 and 190 miles, were snow-free after about 8:45 pm, so he started looking around. Result: KF'DX-3, 325 miles, WBAP-5 and WFAA-8, 360 miles, KSWO-7, 225 miles, KPRC-2, 600 miles, and WGUL-11, 625 miles. The steady reception or slow-fading change of tropospheric dx, as contrasted to the more rapid fluctuation of Es, was present on these signals. They lasted until around 11 pm.

Not all the high-band dx is logged along the Gulf or in Texas and Oklahoma. Sproule, up in Toronto, lists WMAL-7 and WTOP-9, Washington, D.C., along with many nearer in Ohio, New York, and Pennsylvania. Teal of Burlington, N. C., says that the high-band stations give better service in that mountainous terrain than does WBTV-3. He gets WSLS-10, Roanoke, and WLVA-13, Lynchburg, better as a rule than the Charlotte station, though all are at about the same distance. The high-band stations run much lower power, but they have superior mountain sites. Teal has also received WROV-27, Roanoke, 120 miles, when the high-band signals were good.

High-band stations in Ohio, Kentucky, Illinois, and Indiana are reported by Guin, Russellville, Ala., who looks at Atlanta, 200 miles, on 8, 5, and 2 with considerable regularity. May 27 was an occasion of particularly good reception from the north. Adding a screen reflector made of chicken wire to his Skyline antenna has improved his reception markedly.

TV dx received under unusual and probably favorable conditions is reported by Radio Officer Proctor, of the S.S. Sabine. He and his captain see stations along the Gulf and Atlantic seaboard at distances up to about 250 miles more or less regularly.

A quite different sort of dx is described by Haley, Estes Park, Colo., and Beard, of Hayfork, Calif. Both are surrounded by mountains that provide a mass of reflections, making it almost impossible to tell the true direction of the station coming through. Haley caught a few minutes of sound and picture on channel 13 on December 18 of last year. He assumes that it came from KLAC, Los Angeles, but that's more than 700 miles away, directly over the 13,000-foot Continental Divide.

¹ "TV Dx in 1951," RADIO-ELECTRONICS, January 1952, p. 40.

² "TV Dx in 1952," RADIO-ELECTRONICS, January 1953, p. 45.

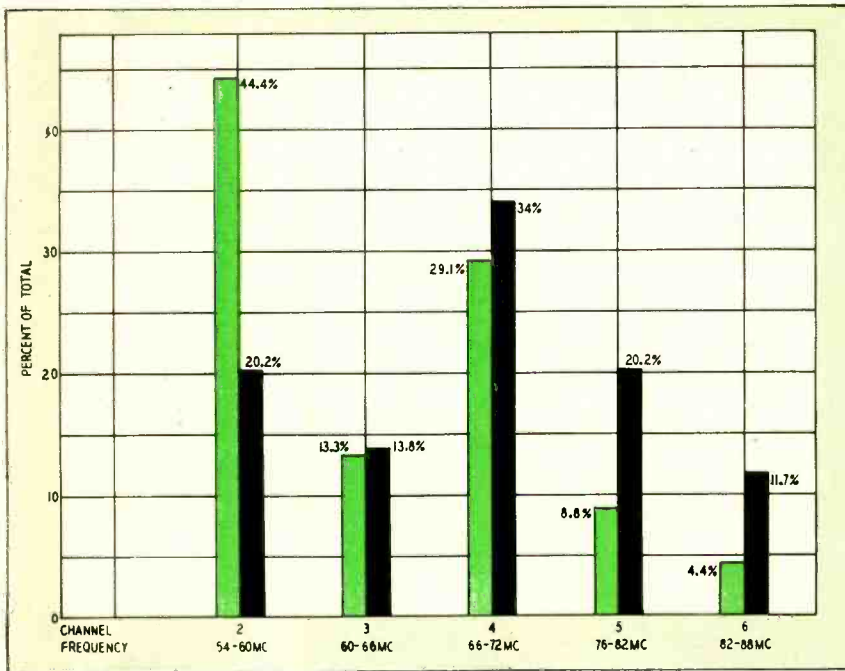

Fig. 2—Showing how the TV dx is divided among the low-band v.h.f. channels.

Beard's valley location, 200 miles north of San Francisco, is so full of reflections that when he caught KFEL-2, Denver, on July 4, he was able to distinguish six separate ghosts, all fading out of phase!

Dx on u.h.f., too

True to predictions in the monthly dx forecast appearing regularly in RADIO-ELECTRONICS, dx is beginning to show up in the u.h.f. channels. Honors for the first u.h.f. report that can be called dx go to Mrs. W. C. Breithaupt, Little Rock, Ark. She picked up WJTV-25, Jackson, Miss., at 10:15 am, April 9, a 200-mile haul. Other u.h.f. reports were contributed by observers Ross, Walker, Peters, Wieskamp, Teal, Hill, Grave, Kuehn, De Haven, Melson, Collins, Kidd, Ashworth, Perry, Paul, Richards, Cooper, Cafritz, and Carnes.

An Atlantic seaboard path that has produced many fine contacts for hams on 144 mc has shown itself capable of producing u.h.f. dx, too. Ashworth of New Bedford, Mass., pulled in WVEC-15, Hampton, Va., around 8 pm October 3. It's about 450 miles, the best u.h.f. dx yet reported by an observer. De Haven, Atlantic City, N. J., brought in WICC-43, Bridgeport, Conn., 150 miles, on August 25. Since then, Bob has logged WVEC-15, WEEU-33, WGLU-59, and WHUM-61, all in eastern Pennsylvania.

Midwestern reports include WTVO-39, Rockford, and WTVI, Belleville, Ill., by Kidd, of Decatur, 170 and 100 miles, respectively. WSBT-34, South Bend, Ind., is reported by Richards, Keensburg, Ill., more than 250 miles. WSBT is also mentioned by Kuehn of Milwaukee, 130 miles. Melson, Niagara Falls, N. Y., has logged WKBN-27, Youngstown, and WICA-15, Ashtabula, Ohio, 180 and 125 miles, respectively.

Over-water, coastal, and river-valley paths seem to produce u.h.f. dx in a manner now well established in v.h.f. work. At Quogue, Long Island, Perry has received WFPG-46, Atlantic City, nearly 150 miles, WHYN-55, Holyoke, Mass., and WKNB-30, New Britain, Conn. A shot of well over 300 miles, mostly over salt water, WCOS-25, Columbia, S. C., received by Walker, Daytona Beach, Fla., has already been reported in the monthly dx column as an early u.h.f. record.

Co-channel and adjacent-channel interference, not supposed to occur in the "interference-proof" u.h.f. region, has already reared its ugly head. Paul, Honeybrook, Pa., noting some interference on his local WEEU-33 the night of October 3 (remember this was a big night), turned his antenna and found the cause to be WKNB-30, three channels and 170 miles away in New Britain, Conn. (We repeat here the prediction made at the time the u.h.f. allocations plan was first announced: There's going to be a lot more interference between stations in the u.h.f. region than most people now anticipate. When tropospheric propagation is good on u.h.f., it's terrific!) Observer Paul holds the record, incidentally—8 u.h.f. stations identified, and in one evening.

The only West Coast u.h.f. report is from Cooper of Lafayette, Calif., formerly of Ithaca, N. Y. Bob sees KCCC-40, Sacramento, 100 miles, and KMJ-24 and KJEO-47, Fresno, 125 miles fairly regularly. This is made possible by a "relay rhombic" on a hill about a mile away from and 500 feet above his valley location.

Some really rare ones

Nearly all the dx reports, v.h.f. and u.h.f., can be classified according to well-established patterns. But every so

often an observer comes up with a report that cannot be explained by any of the known theories. Such is the reception of KLAC-13, Los Angeles, by Phil Rader, Indianapolis, July 2. This far exceeds the amateur 144-mc record of 1,400 miles, and it's three times the best that has been done on 220 mc. Assuming that it's not a case of mistaken identification, how did it happen? Phil also reports reception of PRF-3, São Paulo, Brazil, July 8.

Cooper calls our attention to a report that appeared in *Broadcasting* regarding the reception of WKY-4, Oklahoma City, in England. The same publication also reported KTNT-11, by a viewer in McAllen, Texas. No details—but what dx, if true!

And here's the real killer. John Shipley, chief engineer of WKNB, New Britain, Conn., called the writer one afternoon last summer to pass along information on reported reception of their new channel-30 rig by a viewer in Ames, Iowa. The correspondent reproduced the WKNB test pattern accurately, and correctly identified the pitch of the tone that accompanied it. This neat 1,100-mile trick was turned shortly after noon on July 11. Can anyone explain it? We have a few things to learn, yet!

END

1953 Observers

Akers, Dorsey W., Charleston, W. Va.
Anderson, A. Leland, Squirrell, Idaho.
Anderson, Leland, San Antonio, Texas.
Angelo, T. C., Little Rock, Ark.
Anglado, George R., Biloxi, Miss.
Artkin, W. H., Toronto, Ont.
Ashworth, Russell, New Bedford, Mass.
Atkisson, Jerry, Tallahassee, Fla.

Baker, Richard, Moberly, Mo.
Bare, Claude, Starr, S. C.
Bass, Chase, Colonial Heights, Va.
Batten, W. R., Rockford, Ill.
Baughman, R. D., Newport, Ohio.
Beard, R. N., Hayfork, Calif.
Bennett, J. B., New Cumberland, Pa.
Blakely, Justin, McAllen, Texas.
Blalock, Tommy, Tallahassee, Fla.
Bocker, Nick, Brandon, Man.
Breithaupt, Mrs. W. C., Little Rock, Ark.
Brierton, David, Watertown, N. Y.
Brown, N. L., St. Johnsville, N. Y.
Brasseur, Bob, Saginaw, Mich.
Buchanan, Francis D., Keokuk, Iowa.
Burnett, J. B., Scranton, Pa.

Cafritz, Carter and Conrad, Washington, D. C.
Caldwell, Alton L., Jr., Brockton, Mass.
Campbell, T. E., Douglas, Ariz.
Canning, L. A., Halifax, N. S.
Carnes, P. G., Orangeburg, S. C.
Carrier, G. M., Bedford, Ind.
Charlier, B. J., Kankakee, Ill.
Churchill, Harry R., Gravenhurst, Ont.
Cleveland, Bruce, Jamaica Plain, Mass.
Collier, J. W., Arlington, Va.
Collins, Art, Buffalo, N. Y.
Cooper, Robert B., Ithaca, N. Y.

Davies, W. L., Hamilton, Ont.
Davis, Dr. G. W., Sydenham, Ont.
DeGeer, M. W., Tulsa, Okla.
DeGroat, F. E., Salamanca, N. Y.
DeHaven, Bob, Atlantic City, N. J.
Dell, Vernon W., Mapleton Depot, Pa.
Dochak, Sudbury, Ontario.
Downs, Snyder H., Los Alamos, N. Mex.

Etherington, G. E., Hamilton, Ont.

Fellows, Harold L., Stockton, Calif.
Ferguson, George A., San Antonio, Tex.
Frahm, Lorene, Sidney, Neb.
Freiberger, Texas City, Texas.
Flora, Perry, Mt. Dora, Fla.
Fox, R. F., Raleigh, N. C.

Gibbs, P. W., Cobden, Ont.
Grave, Peter W., Germantown, Pa.
Guin, R. F., Jr., Russellville, Ala.
Guinn, Paul R., Oak Ridge, Tenn.
Guynes, George A., San Antonio, Texas.

U.H.F. DESIGN PROMOTES TVI!

IN A letter to the FCC, A. Budlong of the American Radio Relay League pointed out that although u.h.f. TV is relatively free from interference problems that are common to v.h.f., there are indications that there may be serious interference from amateurs and other communications services. The v.h.f. sets which receive u.h.f. stations by installing special tuning strips are particularly susceptible to u.h.f. TVI.

These sets use double conversion for the u.h.f. channels. A harmonic of a local v.h.f. oscillator beats with the incoming signal to produce the first intermediate frequency. The fundamental of the oscillator heterodynes the first i.f. to the set's i.f. in the 21- or 45-mc range. In his letter, Budlong illustrates how unavoidable interference may be caused by operation of a normal 144-mc amateur transmitter.

Suppose that a channel 14 (475.75 mc) strip is installed in a set having a 21.25-mc i.f. The local oscillator is set to approximately 165.67 mc with its second harmonic (331.33 mc) beating with the channel 14 signal to produce the first i.f. at 144.42 mc (475.75-331.33). The fundamental of the oscillator beats with the 144.42-mc first i.f. to create the second i.f. at 21.25 mc.

Note that the first i.f. falls in the 144-148-mc (2-meter) amateur band. Since the 144-mc tuned circuit is near the antenna input of a comparatively wide-open front end, signals from 2-meter transmitters may, through no fault of the operator or his equipment, ride through and wipe out the picture.

Assuming a normal 6-mc TV bandwidth and a 21.25-mc i.f. system, 2-meter transmissions may cause interference on u.h.f. channels 14 to 18, 40 to 48, and 69 to 77. Sets using 41.25-mc i.f. circuits are liable to 2-meter TVI on channels 20 to 25, 51 to 58, and channels 82 and 83. Thus, more than half of the total number of u.h.f. TV channels are subject to unavoidable 2-meter TVI.

Amateur stations are not the sole source of interference on the u.h.f. channels when the receiver is a double conversion type having the first i.f. around 144 mc. Tuning these sets to channels other than those mentioned above places the first i.f. on one side or the other of the 144-148-mc amateur band. The band each side of the 2-meter band is similarly occupied by other communications services which also may cause unavoidable TVI.

Of course, TVI works both ways. Not only are u.h.f. receivers and converters generally more susceptible to interference from amateur and other services, but they also emit spurious radiations.

Recently, the chairman of RETMA's TV receiver committee recommended that companies which have sold receivers or converters or turret strips, assume it as a moral obligation to satisfy the customer in each case of complaint. The situation as it stands is an unhappy one. **END**

- Hale, James A., Natchez, Miss.
- Haley, H. D., Estes Park, Colo.
- Hall, C. D., Chillicothe, Ohio.
- Hall, E. R., Miami, Fla.
- Hansen, Floyd, Waukegan, Ill.
- Harman, Oliver, Decatur, Ind.
- Hartin, Robert, Mattawamkeag, Maine.
- Hendershott, Myrl, Laramie, Wyo.
- Hedges, John R., Kingman, Kan.
- Hill, Joe C., Laurel, Miss.
- Hill, Sherman A., Galata, Mont.
- Hinton, Orval J., Spencer, Ind.
- Hollis, James L., Clyde, Texas.
- Horacek, Edwin C., Yankton, S. D.
- Houde, W. D., Eureka, Mont.
- Hughner, Robert, Canandaigua, N. Y.
- Holt, H. D., East Hampton, Conn.
- James, Edgar R., Chesham, N. H.
- Johnson, Charles W., Little Falls, N. Y.
- Johnson, Elmer W., Cornwall-on-Hudson, N. Y.
- Kasticky, John S., Benwood, W. Va.
- Kemery, Richard D., Columbia City, Ind.
- Kidd, S. E., Decatur, Ill.
- Kish, G. J., Temperance, Mich.
- Koch, Stanley G., Caro, Mich.
- Kuehn, Harvey, Milwaukee, Wis.
- Landry, Duke, Friars Point, Miss.
- Lapham, Henry, Towanda, Pa.
- Larkins, Tommy, Clarksville, Tenn.
- Leeson, Raymond H., Auburn, N. Y.
- Lester, Cloyd M., Bristol, Va.
- Lipskey, Edwin E., London, Ont.
- Liszcak, John, Griffin, Ind.
- Long, Terry, Wabash, Ind.
- Mahler, Charles F., Portland, Ore.
- Manly, W. A., Auburn, Ala.
- Mayo, S. D., Portland, Maine.
- Mayernik, Joseph, Monessen, Pa.
- McGehee, B., Arcadia, Fla.
- McPhail, G. A., Renfrew, Ont.
- McQuentin, George, Fullerton, N. Y.
- Mellenbruch, Reuben, Hiawatha, Kan.
- Melson, Frank, Niagara Falls, N. Y.
- Millot, Dan, Louisville, Ky.
- Minnis, Roy T., Murphys, Calif.
- Morris, Dale, Austin, Texas.
- Mueller, Ronald C., W. Milwaukee, Wis.
- Meyer, J. H., Georgetown, Colo.
- Martin, Jack R., Augusta, Ga.
- Matullo, Louis M., Washington, Pa.
- Nafzger, Paul K., Round Lake, Ill.
- Nichols, Den, Mason, Mich.
- Nienow, Virgil, Mapleton, Minn.
- Oberto, G. P., Richmond, Va.

- Parks, Lyle M., Bay City, Mich.
- Patterson, Clay, Ainsworth, Neb.
- Paul, Dr. John D., Jr., Honeybrook, Pa.
- Penc, Stanley J., Utica, N. Y.
- Perry, Arthur M., Quogue, N. Y.
- Peters, Robert B., S. Orange, N. J.
- Popper, Dennis, Cedar Rapids, Iowa.
- Proctor, Gerald R., S. S. Sabine.
- Rader, Phil, Indianapolis, Ind.
- Radke, Merle, Seattle, Wash.
- Rainey, Sidney, Shelbyville, Mo.
- Richards, Wade, Keensburg, Ill.
- Richardson, Stanley, County Line, Okla.
- Riebman, R., Coatesville, Pa.
- Roberts, Earl R., Indianapolis, Ind.
- Rogers, James R., Prichard, Ala.
- Ross, Leonard, E. Orange, N. J.
- Salter, F. X., Norfolk, Va.
- Savoy, David, Madison, Maine.
- Seanton, V. C., Toronto, Ont.
- Schauperl, William, Winnipeg, Man.
- Scriven, R. L., Cedar Rapids, Iowa.
- Schuman, G. T., McAllen, Texas.
- Schultz, Erwin F., Milwaukee, Wis.
- Sechler, F. E., Denver, Colo.
- Sloss, Raymond, Baton Rouge, La.
- Smith, Millard, Malone, N. Y.
- Smith, Wilfred E., Muskegon, Mich.
- Smick, Robert, Oshkosh, Wis.
- Stanek, John A., New Kensington, Pa.
- Sproule, T., Toronto, Ontario.
- Swann, Jesse F., Celina, Tenn.
- Teal, Nelson B., Burlington, N. C.
- Thompson, Sam, Klamath Falls, Ore.
- Titsworth, V. O., Heavener, Okla.
- Unsigned, Granite City, Ill.
- Von Gnanten, Fred, Berne, Ind.
- Vuyksteke, George, Story, Wyo.
- Walker, R. J., Daytona Beach, Fla.
- Warren, Bud, Cocoa, Fla.
- Weems, R. C., Jr., State College, Miss.
- Wenth, Allen W., Orlando, Fla.
- Whiting, Larry D., Iderton, Ont.
- Wieskamp, H., Holland, Mich.
- Wilcox, W. W., Richmond, Va.
- Wilson, Don, Wichita, Kan.
- Witschen, Robert B., St. Cloud, Minn.
- Wolfe, Stanley H., Philadelphia, Pa.
- Young, Ernest, Jr., Orlando, Fla.
- Also reports excerpted from *The TV DXer* Hank Ward, Ponca City, Okla.

SPORADIC-E DX REPORTS BY STATION AND CHANNEL

Channel 2, 54-60 mc; 19 stations, 643 reports	WNBW, Washington, D. C.	8
KFEL-TV, Denver, Colo.	WWJ-TV, Detroit, Mich.	7
KPRC-TV, Houston, Texas	KOB-TV, Albuquerque, N. Mex.	7
CMQ-TV, Havana, Cuba	WOI-TV, Ames, Iowa	5
WCBS-TV, New York City	WBEN-TV, Buffalo, N. Y.	5
WSB-TV, Atlanta, Ga.	WBBM-TV, Chicago, Ill.	3
WBAY-TV, Green Bay, Wis.	KRON-TV, San Francisco, Cal.	2
WFMY-TV, Greensboro, N. C.	WNBK, Cleveland, Ohio	2
XEW-TV, Mexico City	WRGB, Schenectady, N. Y.	2
WMAR-TV, Baltimore, Md.	KROD-TV, El Paso, Tex.	1
WDTV, Pittsburgh, Pa.	WOC-TV, Davenport, Iowa (5?)	1
KNT, Los Angeles, Cal.	KHQ-TV, (?) Spokane, Wash.	1
CBFT, Montreal, Quebec	WLWC, Columbus, Ohio	1
WJBK-TV, Detroit, Mich.	WBKB, Chicago, Ill.	1
WLWD, Dayton, Ohio	Channel 5, 76-82 mc; 19 stations, 128 reports	
WBBM-TV, Chicago, Ill.	CMQ-TV, Santa Clara, Cuba	20
XETV, Matamoros, Mexico	KSD-TV, St. Louis, Mo.	14
WKAQ-TV, San Juan, Puerto Rico	WMCT, Memphis, Tenn.	14
CBOT, (?) Ottawa, Canada	WBAP-TV, Ft. Worth, Texas	21
KFEQ-TV, St. Joseph, Mo.	KTSP-TV, Minneapolis-St. Paul, Minn.	10
Channel 3, 60-66 mc; 13 stations, 193 reports	KEYL, San Antonio, Texas	8
KMTV, Omaha, Neb.	KPHO-TV, Phoenix, Ariz.	6
WBTW, Charlotte, N. C.	WCSC-TV, Charleston, S. C.	6
WPTZ, Philadelphia, Pa.	KCSJ-TV, Pueblo, Colo.	5
KFDX-TV, Wichita Falls, Texas	WAGA-TV, Atlanta, Ga.	4
WAVE-TV, Louisville, Ky.	WLWT, Cincinnati, Ohio	4
WKZO-TV, Kalamazoo, Mich.	WSYR-TV, Syracuse, N. Y.	4
WSAZ-TV, Huntington, W. Va.	WNBQ, Chicago, Ill.	3
KDZA-TV, Pueblo, Colo.	KSL-TV, Salt Lake City, Utah	3
WTMJ-TV, Milwaukee, Wis.	WABD, New York City	2
CMQ-TV, Cuba	KING-TV, Seattle, Wash.	1
WLWC, Columbus, Ohio	WTTG, Washington, D. C.	1
WDTV, Pittsburgh, Pa.	WEWS, Cleveland, Ohio	1
PRF3, São Paulo, Brazil	Channel 6, 82-88 mc; 11 stations, 63 reports	
Channel 4, 66-72 mc; 32 stations, 422 reports	CMQ-TV, Havana, Cuba	19
CMUR-TV, Cuba	WOW-TV, Omaha, Neb.	9
WKY-TV, Oklahoma City, Okla.	WDAY-TV, Fargo, N. Dak.	8
KRLD-TV, Dallas, Texas	WDSU-TV, New Orleans, La.	6
WOAI-TV, San Antonio, Texas	WBRC-TV, Birmingham, Ala.	6
WSM-TV, Nashville, Tenn.	KOTV, Tulsa, Okla.	4
WTVJ, Miami, Fla.	WFIL-TV, Philadelphia, Pa.	3
WDAF-TV, Kansas City, Mo.	WNHC-TV, New Haven, Conn.	3
WCCO-TV, Minneapolis, Minn.	WFBN-TV, Indianapolis, Ind.	3
WMBR-TV, Jacksonville, Fla.	XETV, Matamoros, Mex.	2
WBZ-TV, Boston, Mass.	WTVR, Richmond, Va.	1
XHTV, Mexico City, Mexico	Note: Where the same call appears on two different channels it is a case of a shift in channel during the year. There is also the possibility of a mistake in identification by the observer, or reception on the wrong channel by a detuned turret oscillator.	
KDYL-TV, Salt Lake City, Utah		
WTAR-TV, Norfolk, Va.		
KGNC-TV, Amarillo, Texas		
WNBT, New York City		
WBFB-TV, Rock Island, Ill.		

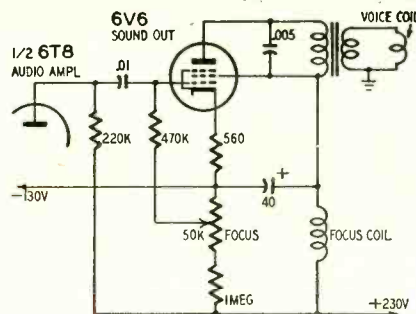
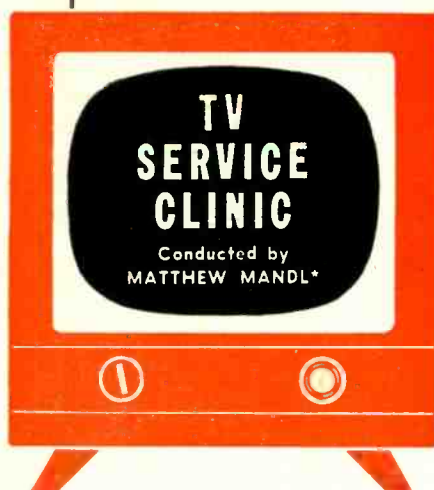

Fig. 1—Focus circuit in Emerson 663B.

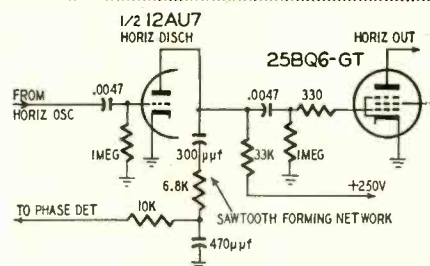

Fig. 2—Drive circuit in G-E 21C208.

MANY set owners buy and install their own u.h.f. converters. They don't seem to present any installation problems, since they are designed to operate with any v.h.f. receiver. You simply attach the u.h.f. and v.h.f. antenna lead-ins to their respective terminal posts, and fasten the necessary length of line from the output of the converter to the antenna terminals of the v.h.f. receiver.

What a pity it doesn't work out that way! More than occasionally, the set owner finds that no amount of switching or tuning brings in that local u.h.f. station which the neighbors are enjoying, or if it does appear it is snowy and lacks contrast.

Eventually the converter is returned to the dealer who checks it and finds it all right. Then the puzzled owner at last calls the technician. Since the troubles he has to cure are common to all installations, let's review them briefly for the guidance of those who are still unfamiliar with u.h.f.

Converters like the Mallory, Sylvania, and others take the incoming u.h.f. and mix it with the frequency generated by the oscillator in the converter. The difference frequency output is acceptable to the v.h.f. receiver only if the latter is tuned to either channel 5 or 6. If one of these channels is on the air locally, the receiver must be set for the other channel. Here's where one trouble often occurs.

When receivers are installed, they are usually checked for performance on the local channels. Thus, when the converter is used on a channel that had not been adjusted, it may be impossible to bring the circuit into resonance with the fine-tuning control. The converter can't bring the u.h.f. station in on the v.h.f. receiver.

If the receiver tuning isn't too far off and the u.h.f. station can be seen faintly, the local oscillator slug of the receiver can be adjusted for best picture at the center setting of the fine-tuning control. If the oscillator slug is so far off that the u.h.f. station can't be brought in, the problem is much more severe.

Converter dials are apt to be slightly

* Author: Mandl's Television Servicing

inaccurate and this complicates things.

If the dial of the converter is set for the u.h.f. station and the local oscillator slug of the receiver is tuned, you're never sure whether or not the converter is really tuning in the station. So the converter dial should be rocked several degrees above and below the dial frequency while tuning the slug in the receiver. In one receiver with a drum tuner, even this failed to produce results. Later it was found the contact points for channel 6 (the unused v.h.f. station) had worn to the point where reception was impossible. Since this channel could not be received in the area, the owner knew nothing about the trouble until he tried to use the u.h.f. converter.

Where the set owner also installed his own u.h.f. antenna, better take a little time out to inspect it. Misorientation is a common fault and it isn't uncommon to find the lead-in wrapped around the mast "so the wind won't blow it." One owner even had 10 turns wrapped around his water-pipe in the basement to save the cost of a lightning arrester.

In strong-signal areas, aging of the r.f. and mixer tubes in the tuner may not affect the picture enough to be noticed. For u.h.f., however, the weaker signal needs all the amplification it can get. For this reason the r.f. and mixer-oscillator tubes should be checked and replaced if below par. The r.f. tube will help the signal amplification, while the new oscillator tube will minimize the drift often experienced with u.h.f. converters when an unstable local oscillator tube is in the receiver.

Emerson focus circuit

I have an Emerson model 663B with intermittent bad focus. When the picture blurs, the focus control brings it back into focus for perhaps fifteen minutes; then it goes out of focus again. After two hours, the control no longer is effective. I have checked the focus control and the 6V6, but could not find the trouble. P. J. L., Randolph, Mass.

As shown in Fig. 1, the focus control regulates the bias on the 6V6 sound output stage, thus regulating the cur-

rent through the focus coil, which is in series with the plate of the tube and the power supply. Since you have checked the 6V6, you should also check the 6T8 tube preceding the sound output, because a gassy or defective 6T8 would draw excessive currents and disturb the voltage applied to the 6V6 and the focus coil.

A leaky 0.01-µF coupling capacitor, as well as other parts which change value during warmup also can cause the trouble you described.

Make sure the voltages shown in Fig. 1 are as indicated. If not, check for defective resistors from the voltage feed of the power supply to the output circuit. Also check the 40-µF capacitor at the focus coil. If none of these checks disclose anything wrong, the focus coil may have shorted turns or leakage, and should be tested or replaced with a new one. During warmup, the expanding wire of the coil may develop shorts.

Repeated 1X2 failure

The 1X2 high-voltage rectifier keeps breaking down after about 30 hours of operation. The heaters open with a popping sound only when the set is turned on, and not while in operation. What could cause this? F. F. E., Oaklyn, N. J.

During warmup, the peak voltage is higher than normal and the danger of arcing is greater. It is possible that an intermittent arc occurs in the high-voltage lead which loads down the rectifier and causes an excessive amount of current flow. In time, this could cause filament failure. Inspect the lead dress, and make sure there is good spacing between high-voltage wires and that no sharp bends are present. Space wires well away from the chassis, and use anticorona dope where you feel corona or arcing are likely to occur. Also inspect the 1X2 socket for arcover. Check the high-voltage filter, and make sure drive to the horizontal output tube is not excessive.

With receivers using 16,000 volts (approximately) for the high voltage, 1X2 failure is often due to the pull exerted on the filament by the high electrostatic fields set up in the tube during



Fig. 3—Picture is improperly centered.

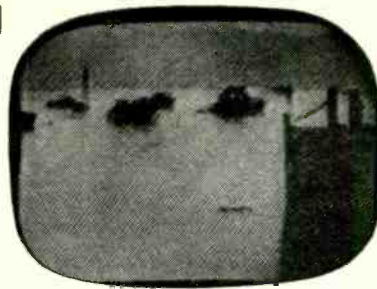

Fig. 4—Adjacent channel interference.

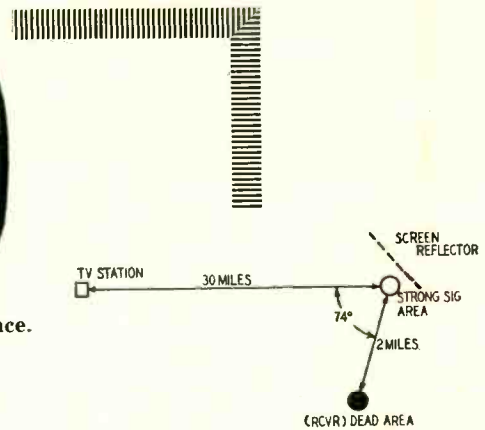

Fig. 5—Application of screen reflector.

the negative peak of the waveform. Eventually the filament bends sufficiently to short to the anode of the tube.

Indoor antenna length

Several months ago our channel 4 changed to channel 2. A customer was using an indoor antenna and could get other channels, but not channel 2 until I installed several turns of wire at the center of the antenna, in series with the two dipole elements. I stumbled on this solution accidentally, and would appreciate an explanation. E. F. W., Riverside, Ill.

Most indoor antennas do not have good gain for channel 2 because manufacturers try to keep down the physical size. For best reception of channel 2, the element lengths should span 97 inches from end to end. Coils help to increase the electrical length when the physical length is too short to provide maximum antenna gain. Some manufacturers utilize some sort of coil or other loading device on their indoor antennas so that channel 2 gain will not suffer, while at the same time minimizing the awkward antenna lengths which would result with a full span.

No drive control

In a G-E 21C208 there is pronounced left-hand stretch which I can't eliminate by adjusting the width or horizontal linearity control. I noted in a previous issue that you suggest adjusting the drive control, but I can't locate one in this receiver. What must I do to restore drive to normal? E. W. S., Newcomerstown, Ohio.

That receiver does not have a drive control, and when left-hand stretch and center compression occur, the component parts between the discharge tube and the grid of the horizontal output tube must be checked for defects or off-values. Also check the B voltages. As shown in Fig. 2, the sawtooth forming network is in the output of the 12AU7 horizontal discharge tube.

Pix off-center

When there is no station on a Tele-King model 201, the picture tube has a complete raster. As soon as the set is on a station, the picture is over to

the right hand-side, with a black strip two inches wide on the left. A portion of the picture on the right is lost. I have checked voltages, including the voltages on the yoke, and they agree with the schematic. I can't seem to correct the condition and would appreciate some advice. I. B., Jackson, Mich.

Try centering the picture with the focus assembly. This applies to a receiver using either the focus magnet ring with centering lever, or a focus coil. Misadjustment will result in improper centering and corner shadows as shown in Fig. 3. Centering should be done with a picture on the screen, and not just the raster. The picture is always narrower than the raster because of the space taken by the blanking which is transmitted. After centering, the width and height controls must be adjusted so the picture fills the mask. If the focus assembly is unable to bring the picture over to the left, the idling voltage through the horizontal deflection coils will have to be changed. After centering, readjust the ion trap for maximum brilliancy. Never use the ion trap to eliminate corner shadows.

Adjacent-channel interference

In our area, channel 2 blocks out channel 3 which is a fringe station about 100 miles farther from us than channel 2. When the channel 2 station is on, we get nothing on channel 3 except the sound. I have tried several types of wave traps and also half-wave-length stubs, but none help. I would like to know what else can be tried? M. S., Malone, N. Y.

When a strong local station is in the area, it may be very difficult to receive a distant adjacent channel. Solutions consist of careful adjustment of the adjacent-channel traps of the receiver, plus realignment of the tuner and video i.f. stages so the bandpass characteristics are not too broad. An additional lower-adjacent-channel trap can also be installed in the video i.f. stages. These measures will block the local sufficiently to permit reception, though the diagonal line interference shown in Fig. 4 will probably still appear in the picture.

Intermittent picture tube

The brightness in a Muntz model 17A3 takes about 45 minutes to come up to normal. If the picture tube neck is struck lightly, the brightness comes on full and will stay on, until the receiver is shut off.

Would any of the picture-tube brighteners help? S. V., Lodi, N. J.

These symptoms indicate a defective picture tube which should be replaced. Sometimes, flakings from the cathode structure short out gun elements and cause this condition, or there are loose connections within the tube neck. The brighteners will not help, as they are useful only when emission is low.

Reception at angle

Perhaps you can help me with an installation as follows: This area is hilly with spots of very high signal and others with none. We are trying to receive on channel 12, but the receiver is located in an area where there is no reception. About two miles across the lake there is a very high signal area, a possible site for a reflector. I have tried a rhombic to reflect across the lake, but get severe ghosts. When a train goes by near the reflector site, we get an excellent picture. The station is about 30 miles from the site of high signal, and the receiver is located at an angle of 74° from it. Do you think it is possible to use a large plane reflector and bisect the angle as per the sketch submitted? (Fig. 5.) A. L., Ithaca, N. Y.

The angle involved lends itself nicely to the erection of a screen reflector. At that distance, however, the reflector would have to be oriented carefully and also moved toward and away from the receiving antenna to strike a signal loop area. (With airplane reflections you will note the increase and decrease of signal as the plane reflects in-phase and out-of-phase signals in conjunction with those received directly.) Space loops occur about every wavelength. The approximate height or maximum results will have to be determined experimentally. Use a channel 12 Yagi to pick up the reflected signal, and orient carefully. END

Improving

U.H.F.

Performance

To obtain maximum gain at u.h.f., special attention must be paid to antenna selection and installation

By EDWARD M. NOLL and MATTHEW MANDL

TO get consistently good reception at u.h.f. much more attention must be given to antenna selection, methods of installation, and procedures for reducing losses. Many an installation is giving poor or erratic results because of a hurried job which overlooked any one of the numerous factors which must be observed at u.h.f.

The technician must learn the precautions and limitations imposed by u.h.f. Knowledge of such principles will erase the mystery of poor performance and enable the technician to take proper steps for getting the most signal with the least effort. Installations will be more dependable, and callbacks because of ghosts, fading, or intermittent reception will be minimized.

Reception factors

The frequencies involved in u.h.f. as compared with v.h.f. make a considerable difference in reception. Shadow effect is more pronounced. This means that the signal does not bend around buildings or hills as it does for v.h.f. For this reason many dead spots will exist for some distance behind obstructions.

The higher the frequency the more such waves assume some of the characteristics of light waves. For this reason, u.h.f. signals reflect to a greater extent from surrounding objects than would v.h.f. signals. Ghost reception is therefore worse at u.h.f.

The u.h.f. signal suffers greater attenuation, so the transmitter needs more power to provide a satisfactory signal at the receiver. The greater absorption also means that the reception can be affected by trees with heavy foliage.

It can be seen that greater care must be exercised in the placement of the antenna so that it is clear of sur-

rounding buildings and trees. The antenna should also have a sharp pattern when situated where reflections occur. The mast should also be reinforced with guys so that the antenna will not sway. At u.h.f., a swaying antenna will cause the picture contrast to vary. Technicians often refer to this as *picture breathing*.

In a series of articles which ran from January to June, 1949, in RADIO-ELECTRONICS the authors described how the direct television waves and the reflected waves cause a series of high and low signal spots in both a vertical and horizontal plane. These were referred to as *space loops* to indicate areas where signal intensity was high, and as *space nodes* for sections having low signal strength. Tests showed that a space loop occurred approximately each wavelength of distance along either a horizontal or vertical plane. This meant that if an antenna were shifted for a distance of one-half wavelength, the difference in reception could be increased from a point where the picture was snowy and weak to a point of high signal-to-noise ratio.

At u.h.f., such space loop conditions are even more pronounced than at v.h.f. The effect is even more noticeable in locations where there are surrounding buildings, hills, or other reflecting surfaces. This means that a lateral or vertical shift of the antenna can mean the difference between excellent reception and very poor reception. Thus, for weak signal areas it is extremely important that a preliminary test be made by shifting the antenna location along a horizontal plane or raising it up or down.

If proper precautions are taken for installation, consistent u.h.f. reception is possible up to 50 miles from the

station in areas of flat terrain. If the signal-to-noise ratio is reasonably good, the primary advantages of u.h.f. reception can be realized. These include freedom from static, ignition noise, or other types of impulse-noise interference.

These advantages, however, are difficult to achieve unless an outdoor antenna of considerable height is used. Many set owners have found that an indoor antenna will provide satisfactory

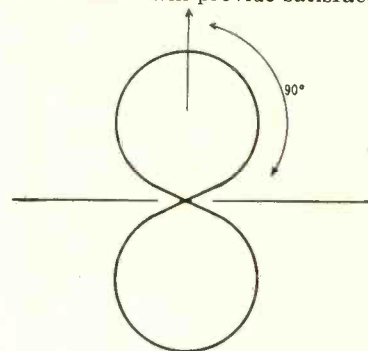

Fig. 1—Figure-eight antenna pattern.

reception in metropolitan areas where the u.h.f. station is nearby. The indoor antenna, however, is closer to noise sources than the outdoor type, and the signal-to-noise ratio is usually poor.

In extensive tests with low antennas, the authors have found that cars traveling across the line of sight between the receiver and transmitter affected the picture and caused considerable variation in signal intensity. This was the case, even though signal strength was exceptionally high, because the receiver was less than 10 miles from the station. In most instances, the a.g.c. system was inadequate to hold the signal level constant.

Antennas at u.h.f.

Most broad-band v.h.f. antennas, such as biconicals, double-V types, and folded dipoles, can be used for u.h.f. reception. Such antennas, however, have numerous lobes when operated at frequencies substantially higher than those for which they are designed.

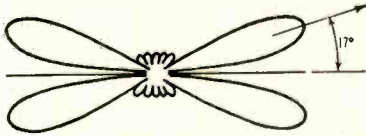

Fig. 2—Antenna operating at frequency nine times higher than fundamental.

A channel 2 antenna, for instance, has a figure-eight pattern such as shown in Fig. 1 when it is operating on the lower v.h.f. channels. When used at the ultra-high frequencies it acts as a long-wire antenna. Fig. 2 shows the multiple lobes present for a frequency nine times higher than the fundamental frequency. Thus, for u.h.f. channel 21 (512-518 mc), four primary lobes are present, which would make orientation more critical. At the same time the additional lobes are more likely to create ghost reception by picking up reflected signals.

Even for v.h.f. reception, broad-band antennas have additional lobes in the higher channels. For this reason, biconical antennas are usually tilted forward so that the lobes combine into a unidirectional pattern. At the upper v.h.f. channels an antenna designed for channel 2 would also exhibit a clover-leaf pattern, but the lobes would not incline as much toward the antenna elements as shown in Fig. 2. As the frequency which is received becomes higher the lobes incline more and more toward the antenna elements.

It is difficult to design a single antenna which has a unidirectional pattern for both v.h.f. and u.h.f. One approach to this problem is the double-V type (Fig. 3). This antenna, has adjustable elements so that the pattern

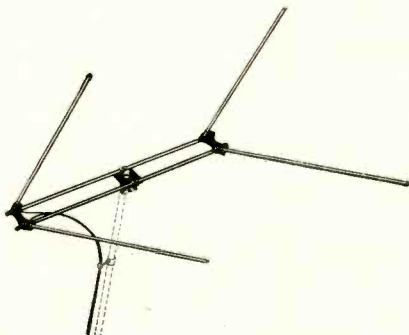

Fig. 3—The double-V type antenna.

can be adjusted to pick up stations primarily from one direction. The double-V types have two dipoles spaced a quarter wavelength apart which produce a unidirectional pattern for the v.h.f. stations. As shown in Fig. 4, a sharp pick-up pattern is produced for the low u.h.f. stations when the antenna elements are tilted 60° apart, and a somewhat broader pattern is obtained for the high

u.h.f. channels. A 45° angle between elements is suitable for the upper u.h.f. channels, as indicated in Table I. This shows the relative db gain for this type of antenna over a matched dipole.

	V.H.F. Channel Numbers													U.H.F.		
	2	3	4	5	6	7	8	9	10	11	12	13	14-35	36-55	55-83	
Ward U-VEE																
90° V's	-2	1/2	2	1	0	6	6 1/2	7 1/2	7 1/2	8	7 1/2	7 1/2	6*	7*	—	
60° V's	-2	-1	0	1	2	5	5 1/2	5 1/2	6	6	6 1/2	6	10	12	—	
45° V's	← Not recommended →													9*	12	12

*Split-lobe Pattern.

Table I—Relative db gain of double-V type antenna over matched dipole.

The disadvantage of this type of antenna is that the gain for the low v.h.f. stations is poor. For areas where there are no low v.h.f. stations, or where such stations are close enough to produce a high signal, the antenna would be satisfactory. Because of its critical directional characteristics a motor is required for orienting stations in scattered directions. Some split-lobe characteristics show up at the upper ultra-high frequencies, as shown by the dotted line pattern of Fig. 4.

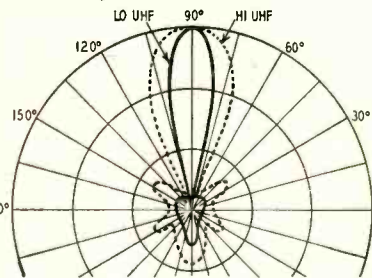

Fig. 4—Horizontal pattern for double-V antenna. Elements are tilted 60°.

For weak-signal u.h.f. areas the Yagi and corner-reflector types provide high gain with a sharp unidirectional pattern. As shown in Fig. 5, the screen acts as shield for signals arriving from the rear. The reflector screen also increases forward gain. Fig. 6 indicates the type of pattern such antennas produce. It can be seen that the front-to-back ratio is excellent and the beam is narrower for the higher u.h.f. channels. This type, as well as a Yagi antenna, is excellent for minimizing ghost reception.

Installation hints

Except in areas where the signal strength is exceptionally good, the u.h.f.

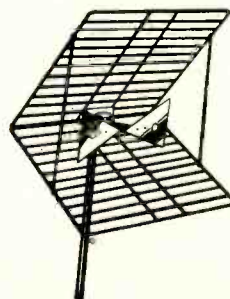

Fig. 5—The JFD u.h.f. corner reflector.

antenna should be installed above an existing v.h.f. type. The antenna should be raised and lowered a few feet experimentally to take advantage of space lobes.

Many technicians do not disturb the existing v.h.f. installation, but run a separate transmission line from the u.h.f. antenna to the receiver: the u.h.f. and v.h.f. types are attached to the u.h.f. converter, and most models automatically switch the proper antenna to the system as the selector knob is changed from v.h.f. to u.h.f. If the converter has no provisions for automatic antenna switching, a double-pole, double-throw switch can be installed. A u.h.f. antenna should not be coupled

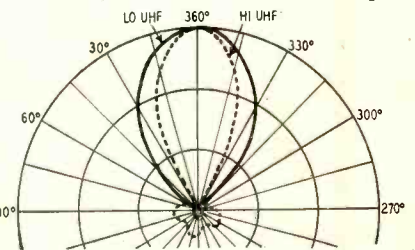

Fig. 6—Horizontal pattern for bow-tie antenna with corner reflector.

directly to a v.h.f. type because it will result in severe loading. This will affect both antennas and will result in a decrease in pickup from each.

If a single transmission line is desired for both the u.h.f. and v.h.f. antennas, a coupler such as shown in Fig. 7 can be used. The one shown uses a

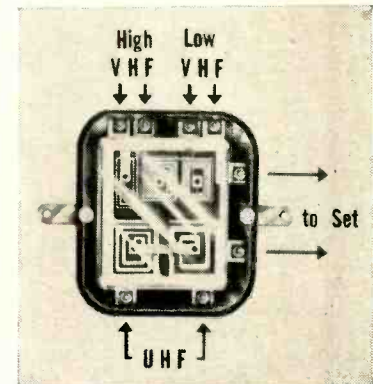

Fig. 7—U.h.f.-v.h.f. antenna coupler.

printed circuit. Others use more conventional wiring. Filter networks are used to isolate the various antenna systems to minimize interaction.

Some couplers of this type also introduce losses to both the v.h.f. and u.h.f. antennas, and the technician should check one before buying them in quantity. **END**

PICTURE TUBE REPLACEMENT GUIDE

By E. W. SCOTT

IN THE course of their daily labors, TV service technicians sometimes find it necessary to replace an expensive, obsolete, or hard-to-get picture tube with a different type. Parts distributors may find that a desired tube type is not included in the brand or brands that they have in stock, so they must be prepared to recommend a type that can be substituted with the least amount of work. This chart is designed to aid in making a wise selection. Tubes are classified according to size, shape, diagonal deflection angle, and type of focusing. In each basic class, tubes are listed according to dimensions, the largest one first.

Whenever possible, the replacement type should be an improved type which will be more pleasing to the set owner. There are several different types of face plates: clear, grey (tinted), frosted, etched, aluminized, or combinations of types, with cylindrical or spherical surfaces. Grey and neutral-tint glass increases the apparent contrast. Frosted and etched types reduce reflection of room light, and aluminized (metal-backed) types provide greater

Tube type	Bulb diameter or diagonal (inches)	Over-all length	Ion trap type	Base diagram Fig. No.	Anode connector	Notes
10-inch glass round, 50°						
10BP4	10 ¹ / ₂	17 ⁵ / ₈	Double	1	Cavity	
10EP4	10 ¹ / ₂	17 ⁵ / ₈	Double	1	Ball	
10FP4	10 ¹ / ₂	17 ⁵ / ₈	None	1	Cavity	
10MP4	10 ¹ / ₂	17	Single	2	Cavity	
10CP4	10 ¹ / ₂	16 ⁵ / ₈	None	1	Ball	
10-inch glass round, 50°, electrostatic focus						
10DP4	10 ¹ / ₂	17 ⁵ / ₈	None	5	Cavity	a
12¹/₂-inch round, 50°						
B1034	12 ⁹ / ₁₆	17 ⁷ / ₈	Single	1	Cavity	p
12LP4	12 ⁷ / ₁₆	18 ³ / ₄	Double	1	Cavity	
12TP4	12 ⁷ / ₁₆	18 ³ / ₄	Double	1	Cavity	a
12VP4	12 ⁷ / ₁₆	19	Single	2	Cavity	
12WP4	12 ⁷ / ₁₆	17 ³ / ₄	Single	7	Special	
12KP4	12 ⁷ / ₁₆	17 ³ / ₄	None	1	Cavity	
12QP4	12 ⁷ / ₁₆	17 ¹ / ₂	Single	1	Ball	
12JP4	12 ⁷ / ₁₆	17 ¹ / ₂	None	1	Ball	d
12RP4	12 ⁷ / ₁₆	17 ¹ / ₂	Single	1	Ball	d
12CP4	12 ⁷ / ₁₆	18 ³ / ₈	None	3	Cavity	a, b, c
12¹/₂-inch glass round, 40°, electrostatic focus						
12AP4	12 ³ / ₁₆	25 ³ / ₈	None	4	Cap	a, c
14-inch glass rectangular, 70°						
14FP4	13 ¹³ / ₁₆	16 ¹ / ₂	Single	1	Cavity	a
14BP4	13 ¹¹ / ₁₆	16 ¹³ / ₁₆	Double	1	Cavity	
14EP4	13 ¹¹ / ₁₆	16 ¹³ / ₁₆	Double	1	Cavity	
14CP4	13 ¹¹ / ₁₆	16 ³ / ₄	Single	1	Cavity	
14DP4	13 ¹¹ / ₁₆	16 ³ / ₄	Double	1	Cavity	a
14-inch glass rectangular, 70°, h.v. electrostatic focus						
14GP4	12 ²¹ / ₃₂	17 ³ / ₁₆	Single	5	Cavity	
15-inch glass round, 50°						
15CP4	15 ³ / ₄	21 ⁷ / ₈	Double	1	Cavity	a
15-inch glass round, 52°						
15EP4	15 ¹ / ₁₀	22 ¹ / ₁₀	Single	1	Cap	
15-inch glass round, 57°						
15AP4	15 ³ / ₄	20 ⁷ / ₈	None	1	Ball	a
15DP4	15 ³ / ₄	20 ⁷ / ₈	Single	1	Ball	a
B1015	15 ³ / ₄	20 ⁷ / ₈	Single	1	Cavity	k
16-inch glass round, 50-60°						
16MP4	16 ¹ / ₈	21 ³ / ₄	Double	1	Cavity	
16FP4	16 ¹ / ₈	21 ¹ / ₄	Single	1	Ball	a
16JP4	16 ¹ / ₈	20 ³ / ₄	Double	1	Cavity	
16LP4	15 ⁷ / ₈	22 ¹ / ₄	Double	1	Cavity	f, g
16CP4	15 ⁷ / ₈	21 ¹ / ₂	Double	1	Cavity	a, f, g
16HP4	15 ⁷ / ₈	21 ¹ / ₄	Double	1	Cavity	f
16DP4	15 ⁷ / ₈	20 ³ / ₄	Double	1	Cavity	a

Tube type	Bulb diameter or diagonal (inches)	Over-all length	Ion trap type	Base diagram Fig. No.	Anode connector	Notes
16-inch glass rectangular, 70°, i.v. electrostatic focus						
16AEP4	17 ¹ / ₈	19 ¹ / ₈	Single	5	Cavity	
16-inch glass rectangular, 70°						
16UP4	17 ¹ / ₈	18 ¹ / ₈	Single	1	Cavity	a
16TP4	16 ⁵ / ₁₆	18 ¹ / ₈	Single	1	Cavity	
16QP4	16 ¹ / ₈	19 ¹ / ₈	Double	1	Cavity	a, e
16KP4	16 ¹ / ₈	18 ³ / ₄	Single	1	Cavity	
16RP4	16 ¹ / ₈	18 ³ / ₄	Single	1	Cavity	
16XP4	16 ¹ / ₈	18 ³ / ₄	Double	1	Cavity	a
16ABP4	16 ¹ / ₈	18 ³ / ₄	Single	1	Cavity	t
16-inch glass round, 70°						
16ZP4	15 ⁷ / ₈	22 ¹ / ₄	Double	1	Cavity	h
16WP4	15 ⁷ / ₈	17 ³ / ₄	Double	1	Cavity	a, h
16SP4	15 ⁷ / ₈	17 ⁵ / ₁₆	Single	1	Cavity	h
16YP4	15 ⁷ / ₈	17 ⁵ / ₁₆	Single	1	Cavity	h
16VP4	15 ⁷ / ₈	17 ³ / ₁₆	Single	1	Cavity	a
16-inch metal round, 53°						
16AP4	15 ⁷ / ₈	22 ⁵ / ₁₆	Double	1	Cone	o
16-inch metal round, 60°						
16EP4	15 ⁷ / ₈	19 ⁵ / ₈	Double	1	Cone	o
16-inch metal round, 70°						
16CP4	15 ⁷ / ₈	17 ¹ / ₁₆	Single	1	Cone	a, i
16-inch glass round, 60°, self-focus						
16ACP4	15 ⁷ / ₈	20 ⁷ / ₈	Single	6	Cavity	
17-inch glass rectangular, 70°						
17BP4	16 ³ / ₄	19 ⁵ / ₈	Single	1	Cavity	i
17AP4	16 ³ / ₄	18 ⁵ / ₈	Single	1	Cavity	
17JP4	16 ³ / ₄	19 ¹ / ₁₆	Single	1	Cavity	
17QP4	16 ³ / ₄	19 ¹ / ₁₆	Single	1	Cavity	m
17UP4	16 ³ / ₄	19 ¹ / ₁₆	Single	1	Cavity	m
17YP4	16 ³ / ₄	19 ¹ / ₁₆	Single	1	Cavity	m
17-inch glass rectangular, 70°, electrostatic focus						
17FP4	16 ³ / ₄	19 ⁵ / ₈	Single	5	Cavity	s
17HP4	16 ³ / ₄	19 ¹ / ₁₆	Single	5	Cavity	r
17LP4	16 ³ / ₄	19 ¹ / ₁₆	Single	5	Cavity	m, r
17RP4	16 ³ / ₄	19 ³ / ₄	Single	5	Cavity	r
17VP4	16 ³ / ₄	19 ¹ / ₁₆	Single	5	Cavity	m, r
17KP4	16 ³ / ₄	19 ⁵ / ₈	Single	6	Cavity	t
17SP4	16 ³ / ₄	19 ³ / ₁₆	Single	6	Cavity	m, t
17-inch metal rectangular, 70°						
17CP4	17	19	Single	1	Cone	a

brightness. Tubes that are electrically and mechanically interchangeable can be substituted without regard to type of face-plate. A different mask must be used when cylindrical and spherical types are interchanged.

Tubes of the same basic type are often available with several different types of face plates, which may be indicated by a suffix letter. As an example, the 17BP4 and 17BP4A have gray face-plates. The 17BP4B has a grey aluminized face-plate and the 17BP4C is grey frosted. Unfortunately the suffix letters have not been standardized, so they do not mean the same on all tube types. On the 17BP4A, the A indicates that this type has an external conductive coating while the basic type does not. In another type of tube, A may indicate that the face-plate is tinted and frosted.

Last year there were only three 90° tubes: two 27-inch rectangular and one 30-inch round. Now, there are a great many more. Replacement type 90° yokes and output transformers are available, so the technician can use 90° tubes in conversion jobs. However, he

should approach this type of conversion with caution. Aside from the special yokes and transformers, 90° tubes require considerably more deflection power than 70° and smaller types.

Above all, he must be sure that the set has enough reserve power and extra space for the paralleled horizontal output and damper tubes which may be necessary for conversion. END

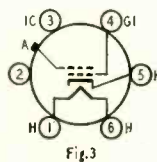
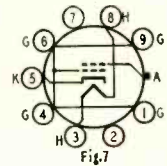
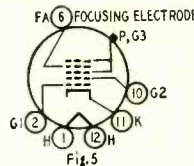
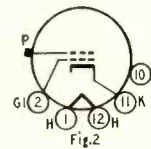
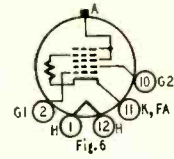
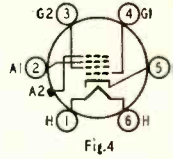
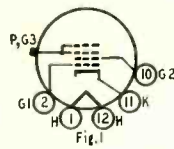

Tube type	Bulb diameter or diagonal (inches)	Over-all length	Ion trap type	Base diagram Fig. No.	Anode connector	Notes
17-inch metal rectangular, 70°, electrostatic focus						
17GP4	17	18 1/8	Single	5	Cone	a, s
17TP4	16 3/16	19 5/16	Single	5	Cone	a, r
19-inch glass round, 66°						
19FP4	18 7/8	22	Double	1	Cavity	a
19DP4	18 7/8	21 1/2	Double	1	Cavity	e
19GP4	18 7/8	21 1/4	Single	1	Cavity	a
19-inch metal round, 66°						
19AP4	18 3/4	22	Single	1	Cone	a
19-inch glass rectangular, 70°						
19JP4	18 5/8	21 3/16	Single	1	Cavity	a
19QP4	18 5/8	21 1/8	Single	5	Cavity	r
19EP4	17 1/8	21 1/2	Double	1	Cavity	a
20-inch glass round, 54°						
20BP4	20 3/8	28 3/4	None	1	Cap	a
20-inch glass rectangular, 70°						
20CP4	20 7/32	21 13/16	Single	1	Cavity	a, n
20DP4	20 3/32	21 7/8	Single	1	Cavity	a
20-inch glass rectangular, 70°, electrostatic focus						
20MP4	20 9/32	22 1/8	Single	5	Cavity	r
20HP4	20 7/32	22 1/8	Single	5	Cavity	a, n, r
20LP4	20 7/32	22 1/8	Single	5	Cavity	r
20FP4	20 3/32	22 1/8	Single	5	Cavity	a, n, s
20GP4	20 3/32	22 1/8	Single	5	Cavity	s
20-inch glass rectangular, 70°, self focus						
20JP4	20 7/32	22 1/8	Single	6	Cavity	a
21-inch metal rectangular, 70°						
21DP4	22 5/8	21	Single	5	Cone	a, s
21GP4	22 5/8	21	Single	6	Cone	a, t
21MP4	21	22 5/8	Single	5	Cone	a, r
21AP4	20 3/4	22 5/8	Single	1	Cone	a
21-inch glass rectangular, 70°						
21JP4	21 1/32	23 1/2	Internal	1	Cavity	a
21FP4	21 1/32	23 3/8	Single	5	Cavity	m, r
21KP4	21 1/32	23 3/8	Single	6	Cavity	m, t
21EP4	21 1/32	23 3/8	Single	1	Cavity	o
21ZP4	21 7/32	23 3/8	Single	1	Cavity	a
21WP4	20 5/8	22 5/8	Single	1	Cavity	a
21WP4X	20 5/8	22 5/8	Single	1	Cavity	q
21-inch glass rectangular, 70°, electrostatic focus						
21AFP4	21 1/32	23	Single	5	Cavity	a, r
21XP4	20 5/8	22 1/4	Single	6	Cavity	a
21-inch glass rectangular, 90°						
21AMP4	20 1/4	20	Single	1	Cavity	a

Tube type	Bulb diameter or diagonal (inches)	Over-all length	Ion trap type	Base diagram Fig. No.	Anode connector	Notes
21-inch glass rectangular, 70°, i.v. electrostatic focus						
21YP4	21 3/8	23 3/8	Single	5	Cavity	a
22-inch metal round, 70°						
22AP4	24 1/8	22 7/8	Single	1	Cone	a
24-inch metal round, 70°						
24AP4	24 1/8	24 7/16	Single	1	Cone	a
24-inch metal round, 70°, i.v. electrostatic focus						
24BP4	24 1/8	24 7/16	Single	5	Cone	a
24-inch glass rectangular, 90°						
24CP4	24	21 1/8	Single	1	Cavity	a
24VP4	24	21 1/8	Single	1	Cavity	a
24XP4	24	21 1/8	Single	1	Cavity	a
24-inch glass rectangular, 90°, i.v. electrostatic focus						
24DP4	24	21 1/8	Single	5	Cavity	a
24QP4	24	21 1/8	Single	1	Cavity	a
24TP4	24	21 1/8	Single	1	Cavity	a
27-inch metal rectangular, 90°						
27AP4	26 7/8	21 7/8	Single	1	Cone	a
27MP4	26 7/8	22 3/16	Single	1	Cone	a
27-inch glass rectangular, 90°						
27EP4	27	23 3/32	Single	1	Cavity	a
27GP4	27	23 7/16	Single	1	Cavity	a
27LP4	27	24 23/64	Single	1	Cavity	a
27NP4	27	23 3/8	Single	1	Cavity	a
27RP4	27	23 3/8	Single	1	Cavity	a
30-inch metal round, 90°						
30BP4	30 1/8	23 3/16	Single	1	Cavity	a

- a—Tube has no exterior conductive coating. Add 500-μuf, high-voltage filter capacitor when using tube as replacement for type having exterior coating. When this type is replaced by tube having outside coating, ground the coating to the chassis.
- b—Triode type tube; has no No. 2 grid. For circuitry, refer to diagrams of sets using triode and tetrode types. Alter receiver circuits where necessary to suit tube being used for replacement.
- c—This tube has 2.5-volt, 2.1-amp heater; all others have 6.3-volt, 600-ma heaters.
- d—Face-plate curvature has 20-inch radius; all others in this group have 40-inch radius.
- e—Requires JETEC-RETMA type 106 focus coil; others in this group use type 109 focus coil.
- f—Face-plate curvature has 56-inch radius; others in this group have 27-inch radius.
- g—Deflection angle is 50°. The deflection angle for other tubes in this group is 60°.
- h—Radius of face-plate curvature is 56 inches.
- i—Radius of face-plate curvature is 40 inches; all others in this group have 27-inch radius.
- j—17BP4-A and B have outside conductive coatings; 17BP4 has not.
- k—Identical to 15DP4 except it has gray face-plate and cavity type anode contact.
- m—Cylindrical face.
- n—Tube with suffix "A" has external conductive coating.
- o—Tube with suffix "A" has cylindrical face.
- p—Identical to 12QP4 except that anode contact is recessed-cavity type.
- q—Experimental type—first run.
- r—Tube has low-voltage electrostatic-focus electrode.
- s—Tube has high-voltage electrostatic-focus electrode.
- t—Self-focus tube.

U.H.F. CONVERTERS

Manufacturer	Model	Channels	Tubes. Crystals	Tuning system	Impedance	Instal- lation
Alliance Manufacturing Co. Alliance, Ohio	C2	All	1-6AF4 or 6T4 1-6CB6 1-1N72	Tuned lines	300	Cab.
	AC80	All		Spiral inductor	300	Cab.
The Astatic Co. Conneaut, Ohio	CB-1	All ¹	1-6T4Q 1-6J6 1-6BQ7A 1-1N82	Circular lines	300 ²	Cab.
Blonder-Tongue Labs., Inc. 526-536 North Avenue Westfield, N. J.	BTU	All	1-6T4 1-6AB4 1-1N72	Circular line	300	Cab.
David Bogen Co., Inc. 29 Ninth Ave. New York, N. Y.	UCT-1	All	1-6BZ7 or 6BK7A 1-6AF4 or 6T4 1-3	Circular lines	300	Cab.
Allen D. Cardwell Mfg. Co. Plainville, Conn.	ES-1	All	1-6AF4 1-6CB6 1-1N72	Prntd-ckt lumped constant	300	Cab.
	ES-2	(As above, Serviceman's Tuner for internal mounting)				
Electro-Voice, Inc. Buchanan, Mich.	3300	All	1-6AF4 or 6T4 1-6BC5 1-1N72	Tuned lines	300	Cab.
General Electric Co. Electronics Park Syracuse, N. Y.	UHF-103	Any 3	1-6AF4 1-6BK7A 1-1N72	Turret	300	Int.
General Instrument Corp. 829 Newark Ave. Elizabeth, N. J.	63 and 64	All	1-6J6 1-6CB6 1-1N82 1-G7C	Coaxial line	300	Cab.
Granco Products, Inc. 36-17 20th Ave. Long Island City, N. Y.	LCU	All	1-6AF4 1-6CB6 1-1N82	Cavity tuner	300	Cab.
	MTU	All	1-6AF4 1-6BQ7 1-1N82	Cavity tuner	300	Cab.
I.D.E.A., Inc. (Regency) 7900 Pendleton Pike Indianapolis, Ind.	RC-600	All	1-6AF4 1-6BK7 1-1N72	Tuned lines	300	Cab.
	RC-53	All	1-6AF4 1-TS-2	Tuned lines	300	Cab.
P. R. Mallory & Co., Inc. 3029 E. Washington St. Indianapolis, Ind.	TV-101	All	1-6AF4 or 6T4 1-6CB6 1-1N72	Induc- tuner	300	Cab.
Radio Corporation of America RCA Victor Division Camden, N. J.	U70	All	1-6AF4 2-6CB6 1-1N82	Lumped constants	72 or 300	Cab.

Manufacturer	Model	Channels	Tubes, Crystals	Tuning system	Impedance	Installation
RCA (continued)	U2	Any 2	1-6BQ7 1-6CB6 1-CK710	Lumped constants	72 or 300	Cab.
Note: U2 and U2A have certain differences in input arrangement.	U2A	Any 2	1-6BQ7A 1-6CB6 1-CK710	Lumped constants	72 or 300	Cab.
Note: U1A has plug for 6AQ5; U1B for 6K6-GT or 6V6; both get power from TV receiver.	U1A, U1B	Any 1	1-6AF4 1-CK710	Lumped constants	72 in; 300 out	Rear
Radio Receptor Co., Inc. 84 North Ninth St. Brooklyn, N. Y.	C-1709-P	All	1-6AF4 1-6BQ7A 1-1N82	Cavity tuner	300	Cab.
Rex Electronics Corp. 1351 East DeLoss St. Indianapolis 3, Ind.	UC-1	All	1-6AF4 1-6CB5 1-1N72	Prntd-ckt Tuned lines	300	Cab.
Sutton Electric Co., Inc. 426 West Short St. Lexington, Ky.	22B	All ¹	1-6AF4 1-6J6 1-1N82	Circular lines	300	Cab.
Transvision, Inc. New Rochelle, N. Y.	UHF-1	Any 1	1-6AF4 1-CK710	Lumped constants	75 in; 300 out	Rear
The Turner Company Cedar Rapids, Iowa	TV-3	All	1-6AF4 1-6BZ7 or 6BQ7A 1-1N82	Cavity tuner	300	Cab.
Videon Electric Corp. 222 East Ohio St. Indianapolis 4, Ind.	C-232 Savoy	All	1-6AF4 1-1N72	Parallel lines	300	Cab.
	C-222 Navarre	All	1-6AF4 1-6BC5 1-1N72	Parallel lines	300	Cab.
Walsco Electronics Corp. 3602 Crenshaw Blvd. Los Angeles, Calif.	2000 Imperial	All	1-6AF4 1-6BK7A 1-1N82	Turret	300	Cab.

Notes: ¹Booster on channels 2-13; converter for u.h.f. channels.

²U.h.f. input 300 ohms; v.h.f. output (and v.h.f. antenna input) 300 or 75 ohms.

³Gahagan, Inc. u.h.f. crystal.

Converter output channels are 5 and 6 on most converters. The G-E UHF-103 is designed for channel

5 but adjustable for 6; Astatic will operate on 3, 4, 5, and 6, and the Videon can be adjusted to work on 4 and 5 instead of 5 and 6. The 1-channel Transvision UHF-1 can be specified to receive a signal on any u.h.f. channel and convert it to any of the channels from 2 to 6.

Practically all the converters are self-powered, with isolating power transformers and selenium or tube rectifiers (not included among tubes and crystals in the listing). The RCA U1A and U1B, as well as the Transvision UHF-1, take their power from the TV receiver.

U.H.F. BOOSTERS

Manufacturer	Model	Channels	Tube(s)	Tuning system	Impedance	Installation
David Bogen Co., Inc. 29 Ninth Ave. New York, N. Y.	UHB	All	6AN4	Tuned cavity	300	Cab.
Electro-Voice, Inc. Buchanan, Mich.	3400	All	2-6AJ4	Parallel lines	300	Cab.
Industrial Television Inc. 369 Lexington Ave. Clifton, N. J.	IT-133A	All	1-6AJ4	⁴	300	Cab.
Tele-Matic Industries, Inc. One Joralemon St. Brooklyn, N. Y.	UH-14-83	All	1-6AJ4	⁵	300 ⁶	Cab.

Notes: ⁴Series-resonant circuit consisting of inductor and capacitor metallized on glass tubing, with silverplated slug tuning.

⁵Input broad-band fixed tuning. Output high-Q transmission line selective network.

⁶50- or 75-ohm impedance available on request.

Explanation of terms: "Tubes and crystals" do not include those in power supplies. "Tuning system" generally follows manufacturer's nomenclature. "Circular lines" and "spiral tuner" may describe the same equipment; "tuned lines" may, but is more likely to

refer to straight parallel lines. "Impedance" is both input and output impedance unless otherwise noted. Abbreviations under "Installation" refer to converters or boosters in separate cabinet, mounted on rear of or inside the receiver.

TV STATION LIST as of November 23, 1953

* = Station shares time.

Alabama

WBAB-TV	Birmingham	13
WBRC-TV	Birmingham	6
WALA-TV	Mobile	10
WKAB-TV	Mobile	48
WCOV-TV	Montgomery	20

Alaska

KFIA	Anchorage	2
------	-----------	---

Arizona

KTYL-TV	Mesa (Phoenix)	12
KOOL-TV	Phoenix	10
KOY-TV*	Phoenix	10
KPHO-TV	Phoenix	5
KOPO-TV	Tucson	13
KVQA-TV	Tucson	4
KIVA	Yuma	11

Arkansas

KFSA-TV	Fort Smith	22
KRTV	Little Rock	17

California

KAFY-TV	Bakersfield	29
KERO-TV	Bakersfield	10
KHSL-TV	Chico	12
KHMT-TV	Eureka	3
KJEO	Fresno	47
KMJ-TV	Fresno	24
KECA-TV	Los Angeles	24
KHU-TV	Los Angeles	9
KLAC-TV	Los Angeles	13
KNBH	Los Angeles	4
KNXT	Los Angeles	2
KTHE	Los Angeles	28
KTLA	Los Angeles	5
KTTV	Los Angeles	11
KMBY-TV*	Monterey	8
KCCC-TV	Sacramento	40
KSBW-TV*	Salinas	8
KFMB-TV	San Diego	8
KFSD-TV	San Diego	10
KGO-TV	San Francisco	7
KPIX	San Francisco	5
KRON-TV	San Francisco	4
KVEE-TV	San Luis Obispo	6
KEYT	Santa Barbara	3
KCOK-TV	Tulare	27

Colorado

KKTV	Colorado Springs	11
KRDO-TV	Colorado Springs	13
KBTV	Denver	9
KFEL-TV	Denver	2
KLZ-TV	Denver	7
KCSJ-TV	Pueblo	5
KDZA-TV	Pueblo	3

Connecticut

WICC-TV	Bridgeport	43
WKNB-TV	New Britain	30
WNHC-TV	New Haven	8
WATR-TV	Waterbury	53

Delaware

WDEL-TV	Wilmington	12
---------	------------	----

District of Columbia

WMAL-TV	Washington	7
WNBW	Washington	4
WTOP-TV	Washington	9
WTTG	Washington	5

Florida

WFTL-TV	Fort Lauderdale	23
WMBR-TV	Jacksonville	4
WTV	Miami	4
WEAR-TV	Pensacola	3
WPFA-TV	Pensacola	15
WSUN-TV	St. Petersburg	38
WIRK-TV	W. Palm Beach	21

Georgia

WAGA-TV	Atlanta	5
WLVA	Atlanta	8
WSB-TV	Atlanta	2
WJBF-TV	Augusta	6
WDAK-TV	Columbus	28
WRBL-TV	Columbus	4
WETV	Macon	47
WMAZ-TV	Macon	13
WROM-TV	Rome	9

Hawaii

KGMB-TV	Honolulu	9
KONA	Honolulu	11

Idaho

KIDO-TV	Boise	7
KBOI	Meridian	2

Illinois

WCIA	Champaign	3
WBMM-TV	Chicago	2

WBKB	Chicago	7
WGN-TV	Chicago	9
WNBQ	Chicago	5
WTVP	Decatur	17
WEEK-TV	Peoria	43
WTVM-TV	Peoria	19
WGEM-TV	Quincy	10
WREX-TV	Rockford	13
WTVO	Rockford	39
WHBF-TV	Rock Island	4
WICS	Springfield	20

Indiana

WTTV	Bloomington	10
WFIE	Evansville	62
WKJG-TV	Fort Wayne	33
WFBM-TV	Indianapolis	6
WFAM-TV	Lafayette	59
WLBC-TV	Muncie	49
WRAY-TV	Princeton	52
WSBT-TV	South Bend	34

Iowa

WOI-TV	Ames	5
KCRI-TV	Cedar Rapids	9
WMT-TV	Cedar Rapids	2
WOC-TV	Davenport	6
KGTV	Des Moines	17
KQTV	Fort Dodge	21
KYTV	Sioux City	9
KWWL-TV	Waterloo	7

Kansas

Hutchinson	12
Pittsburg	7
Topeka	13
Wichita	16

Kentucky

WEHT	Henderson	50
WAVE-TV	Louisville	3
WHAS-TV	Louisville	11
WKLO-TV	Louisville	21

Louisiana

Baton Rouge	28
Lake Charles	25
Monroe	43
Monroe	8
New Orleans	6
New Orleans	61

Maine

WABI-TV	Bangor	5
WPMT	Portland	53

Maryland

WAAM	Baltimore	13
WBAL-TV	Baltimore	11
WMAR-TV	Baltimore	2

Massachusetts

WBZ-TV	Boston	4
WNAO-TV	Boston	7
WTAO-TV	Cambridge	56
WHYN-TV	Holyoke	55
WWLP	Springfield	61
WWOR-TV	Worcester	14

Michigan

WPAG-TV	Ann Arbor	20
WBKZ-TV	Battle Creek	64
WWJ-TV	Detroit	4
WJBK-TV	Detroit	2
WXYZ-TV	Detroit	7
WTAC-TV	Flint	16
WOOD-TV	Grand Rapids	7
WKZO-TV	Kalamazoo	3
WILS-TV	Lansing	54
WJIM-TV	Lansing	6
WKNX-TV	Saginaw	57

Minnesota

KMMT	Austin	6
WFTV	Duluth	38
KSTP-TV	Minneapolis - St. Paul	5
WCCO-TV	Minneapolis	4
WTCN-TV*	Minneapolis	11
KROC	Rochester	10
WMIN-TV*	St. Paul	11

Mississippi

WJTV	Jackson	25
WTOK-TV	Meridian	11

Missouri

KACY	Festus-St. Louis	14
KHQA-TV	Hannibal	7
KCMO-TV	Kansas City	5
KCTY	Kansas City	25
KMBC-TV*	Kansas City	9
WDAF-TV	Kansas City	4
WHB-TV*	Kansas City	9
KFEQ-TV	St. Joseph	2
KSD-TV	St. Louis	5
KSTM-TV	St. Louis	36
WTVI	St. Louis - Belleville	54

KTTS-TV	Springfield	10
KYTV	Springfield	3

Montana

Billings	2
Butte	4
Butte	6

Nebraska

Lincoln	10
Lincoln	12
Omaha	3
Omaha	6

Nevada

Las Vegas	8
Reno	8

New Jersey

Atlantic City	46
Newark	13

New Mexico

Albuquerque	13
Albuquerque	7
Albuquerque	4
Roswell	8

New York

Albany	41
Binghamton	12
Buffalo	4
Buffalo	59
Buffalo	17
Elmira	18
Elmira	24
New York	7
New York	5
New York	2
New York	4
New York	9
New York	11
Rochester	6
Rochester	10
Rochester	10
Schenectady	4
Syracuse	8
Syracuse	3
Utica	13

North Carolina

Asheville	62
Charlotte	3
Greensboro	2
Raleigh	28
Winston-Salem	12
Winston-Salem	26

North Dakota

Fargo	6
Minot	13

Ohio

Akron	49
Ashtabula	15
Cincinnati	9
Cincinnati	12
Cincinnati	5
Cleveland	5
Cleveland	4
Cleveland	9
Columbus	10
Columbus	4
Columbus	6
Dayton	7
Dayton	22
Dayton	2
Lima	7
Talado	13
Youngstown	73
Youngstown	27
Zanesville	50

Oklahoma

Lawton	7
Oklahoma City	19
Oklahoma City	25
Oklahoma City	4
Tulsa	23
Tulsa	6

Oregon

Medford	5
Portland	6
Portland	27

Pennsylvania

Altoona	10
Bethlehem	51
Chambersburg	46
Easton	57
Erie	12
Harrisburg	55
Harrisburg	71
Johnstown	56
Johnstown	6

Lancaster	8
Lebanon	15
New Castle	45
Philadelphia	10
Philadelphia	6
Philadelphia	3
Pittsburgh	2
Pittsburgh	16
Pittsburgh	53
Reading	33
Reading	61
Scranton	22
Scranton	73
Wilkes-Barre	28
Wilkes-Barre	34
York	49
York	43

Rhode Island

Providence	10
------------	----

South Carolina

Charleston	5
Columbia	25
Columbia	10
Columbia	67
Greenville	23

South Dakota

Sioux Falls	11
-------------	----

Tennessee

Johnson City	11
Knoxville	6
Knoxville	26
Memphis	13
Memphis	5
Nashville	8
Nashville	4

Texas

Abilene	9
Amarillo	10
Amarillo	4
Austin	7
Dallas	4
Dallas	8
El Paso	4
El Paso	5
Fort Worth	9
Galveston	11
Harlingen	4
Houston	39
Houston	2
Houston	8
Longview	32
Lubbock	11
Lubbock	13
San Angelo	8
San Antonio	5
San Antonio	4
Temple	6
Texarkana	6
Tyler	19
Waco	34
Wichita Falls	3
Wichita Falls	6

Utah

Salt Lake City	4
Salt Lake City	5

Virginia

Hampton-Norfolk	15
Harrisonburg	3
Lynchburg	13
Newport News	33
Norfolk	4
Norfolk	27
Parkersburg	15
Richmond	6
Roanoke	10

Washington

Bellingham	12
Seattle	5
Seattle	4
Spokane	6
Spokane	4
Tacoma	13
Tacoma	11
Yakima	29

West Virginia

Charleston	49
Huntington	3
Parkersburg	15
Wheeling	7

Wisconsin

Green Bay	2
Madison	27
Madison	33
Madison	33
Milwaukee	25
Milwaukee	19
Milwaukee	4
Oshkosh	48

RADIO-ELECTRONICS

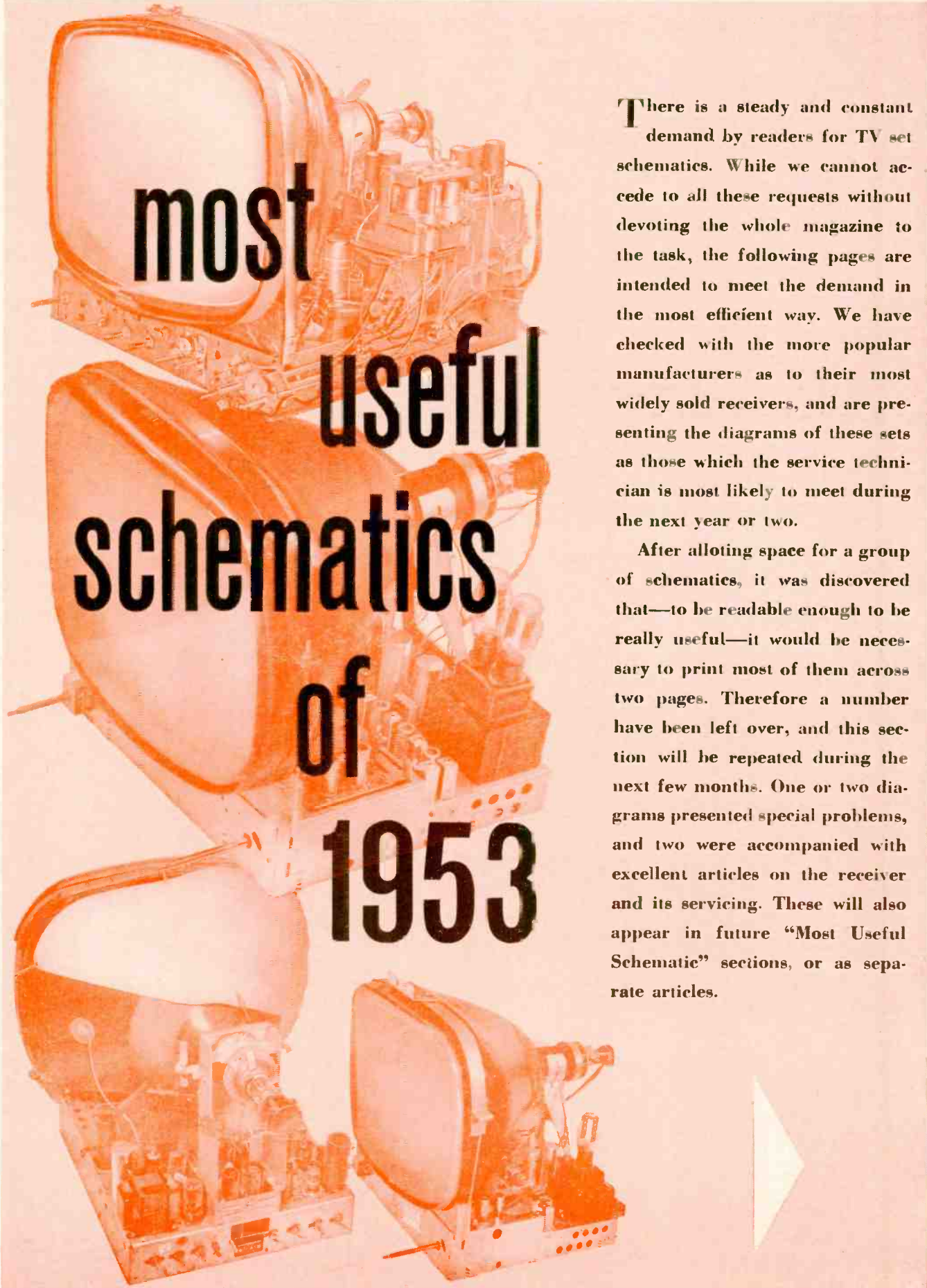

**most
useful
schematics
of
1953**

There is a steady and constant demand by readers for TV set schematics. While we cannot accede to all these requests without devoting the whole magazine to the task, the following pages are intended to meet the demand in the most efficient way. We have checked with the more popular manufacturers as to their most widely sold receivers, and are presenting the diagrams of these sets as those which the service technician is most likely to meet during the next year or two.

After allotting space for a group of schematics, it was discovered that—to be readable enough to be really useful—it would be necessary to print most of them across two pages. Therefore a number have been left over, and this section will be repeated during the next few months. One or two diagrams presented special problems, and two were accompanied with excellent articles on the receiver and its servicing. These will also appear in future “Most Useful Schematic” sections, or as separate articles.

RCA Models 21-S-354U

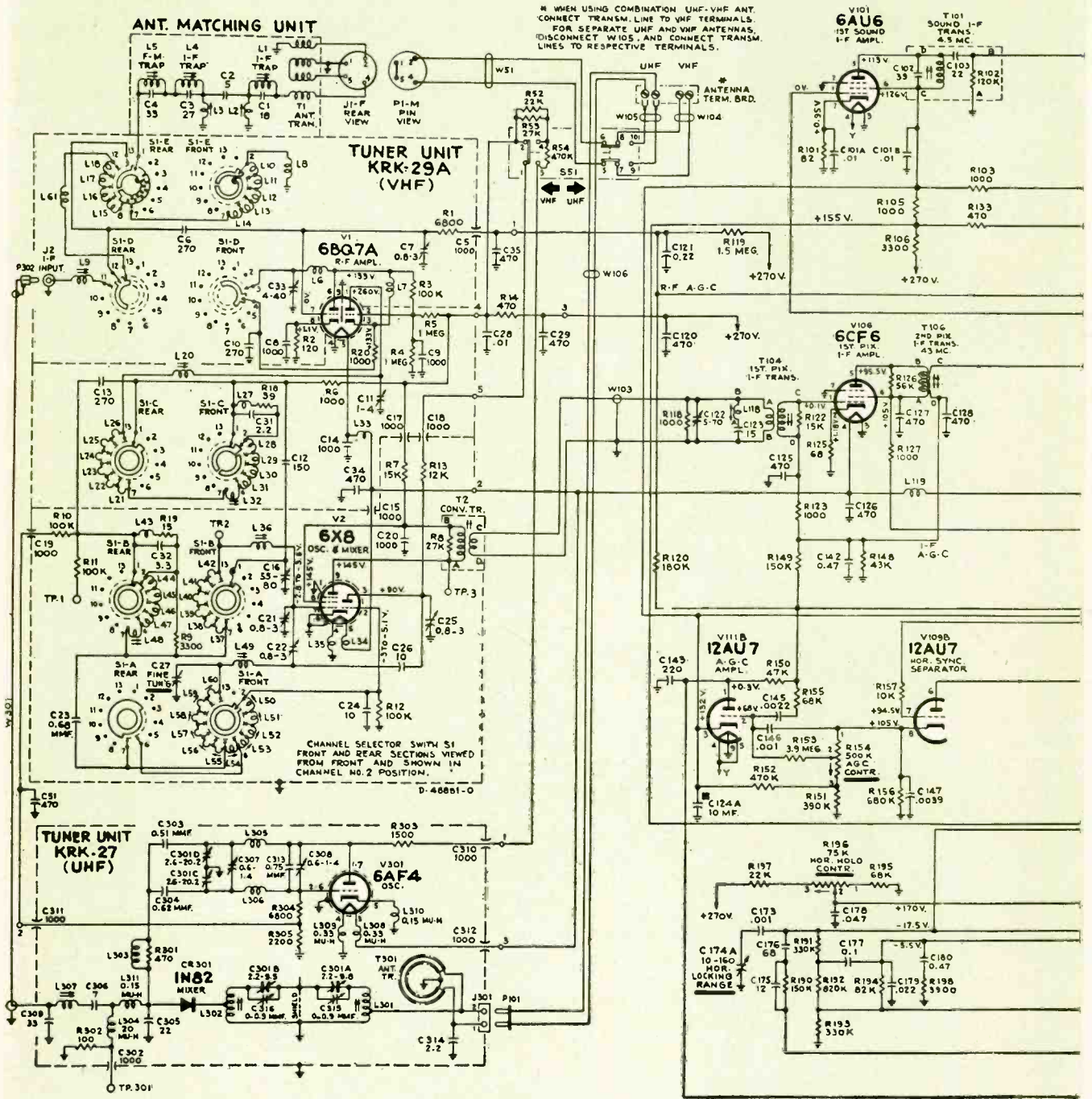

All resistance values in ohms. K = 1000
 Direction of arrows at controls indicates clockwise rotation.

All voltages measured with *Volt-Ohmyst* and with no signal input. Voltages should hold within $\pm 20\%$ with a 117-volt a.c. supply.

Antenna input impedance:
 U.h.f.—300 ohms balanced.
 V.h.f.—300 ohms balanced.

Picture i.f. carrier—45.75 mc.
 Sound i.f. carrier—41.25 mc.

and 21-S-362U

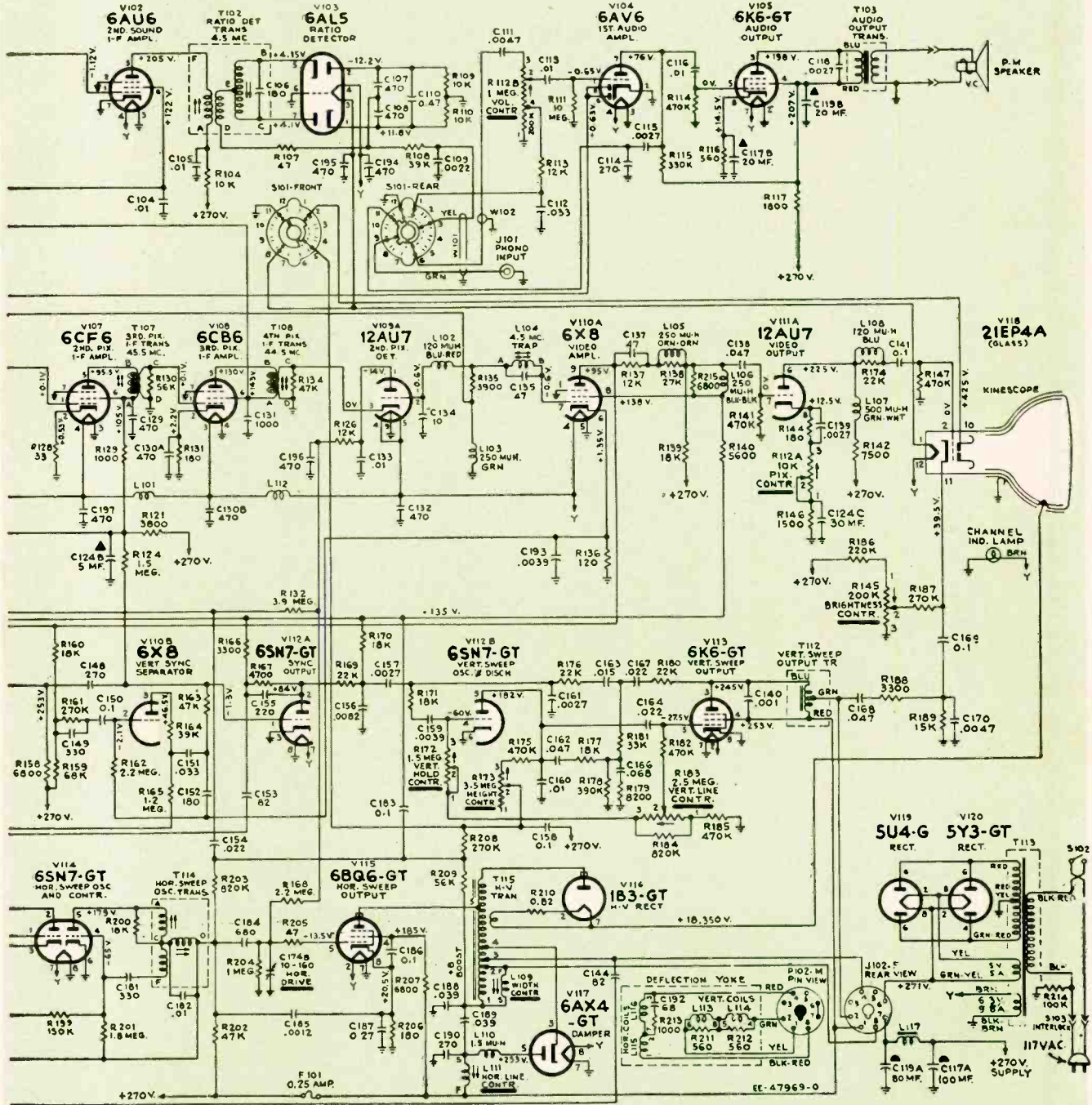

Function switch S101 front and rear, viewed from front with control shaft in maximum counterclockwise position (No. 1).
 Position 1—TV min. highs

- 2—TV normal
- 3—TV min. lows
- 4—Phono min. highs
- 5—Phono normal
- 6—Phono min. lows

Video response to 3.5 mc.
 TV r.f. range:
 70 u.h.f. channels—470-890 mc.
 12 v.h.f. channels—54-88 mc,
 174-216 mc.

TV and Radio Chassis

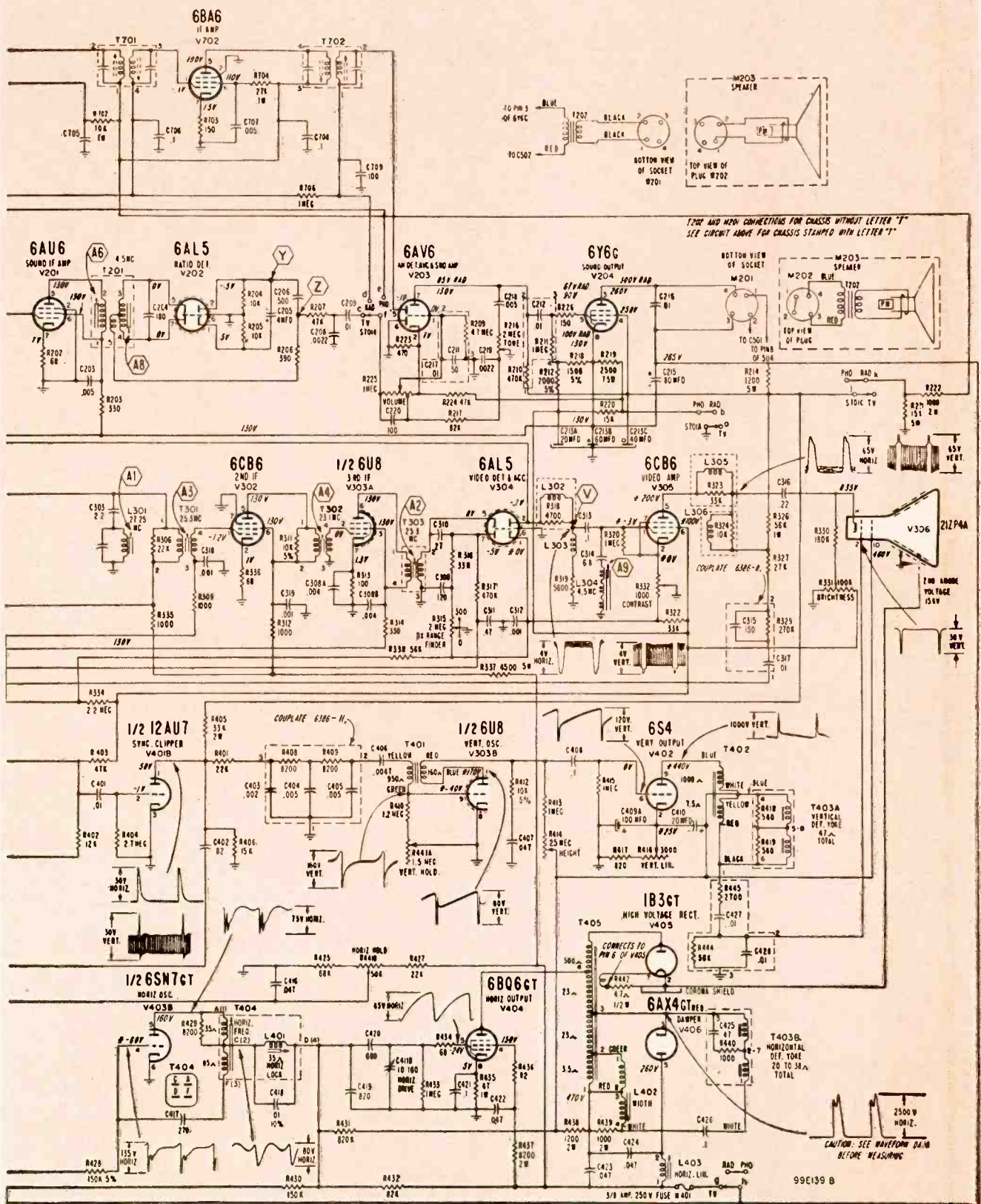

ZENITH Chassis 19L26-19L28

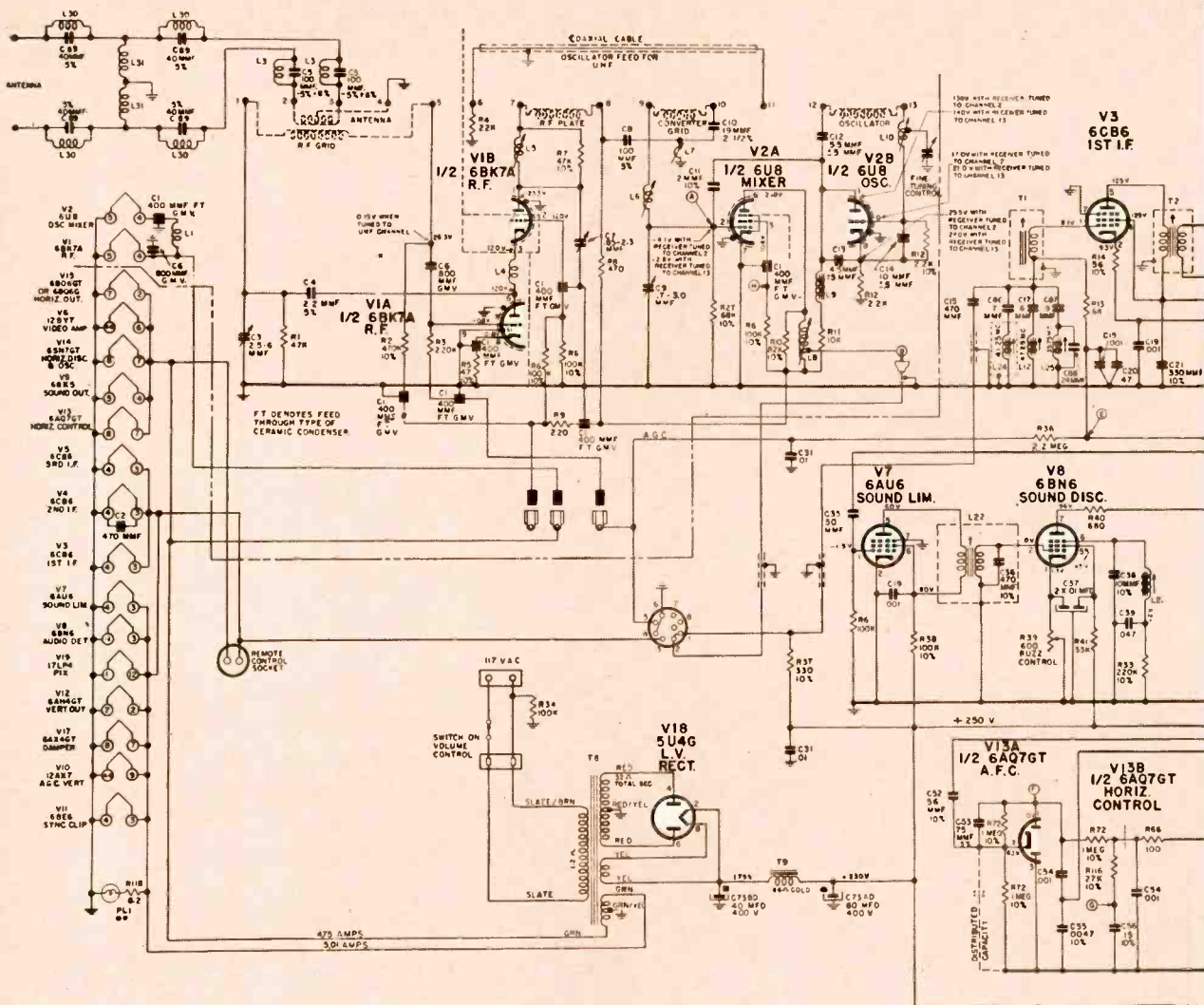

All voltages measured from chassis to points indicated; all are d.c. unless otherwise specified.

All capacitor values in microfarads unless otherwise specified.

Cathode-ray tube second anode voltage to be measured with electrostatic or with 20,000 ohm-per-volt high voltage meter.

All d.c. voltages to be measured with v.t.v.m. with 11-megohm input resistance.

Resistance measurements shown with coils disconnected from circuit.

Arrows on potentiometers indicate clockwise rotation.

All voltages measured with no signal present; normal setting of controls; channel selector set to 2 unless otherwise specified.

Coil resistances not given are under one ohm.

Circled letters indicate alignment and test points.

19L30-19L33-19L34

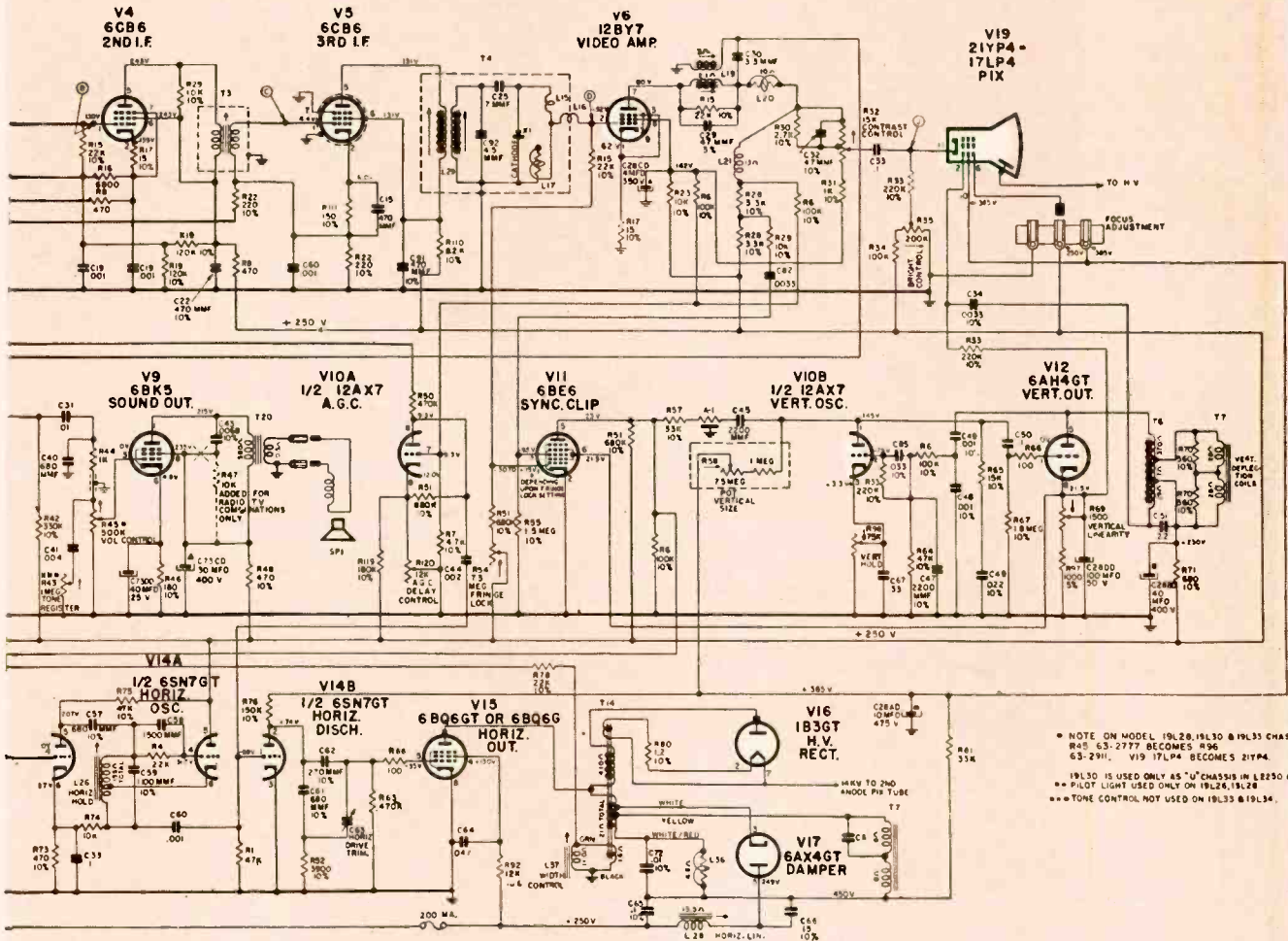

NOTE ON MODEL 19L28, 19L30 & 19L33 CHASSIS
 R48 63-2777 BECOMES R96
 63-2911, V19 17LP4 BECOMES 21YP4
 19L30 IS USED ONLY AS "U" CHASSIS IN L2250 CABINET
 **PILOT LIGHT USED ONLY ON 19L24, 19L28
 **TONE CONTROL NOT USED ON 19L33 & 19L34

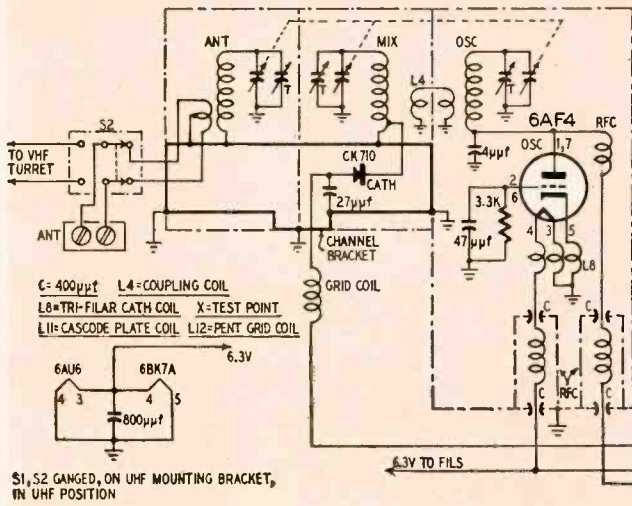

The S-19670 Continuous Tuner

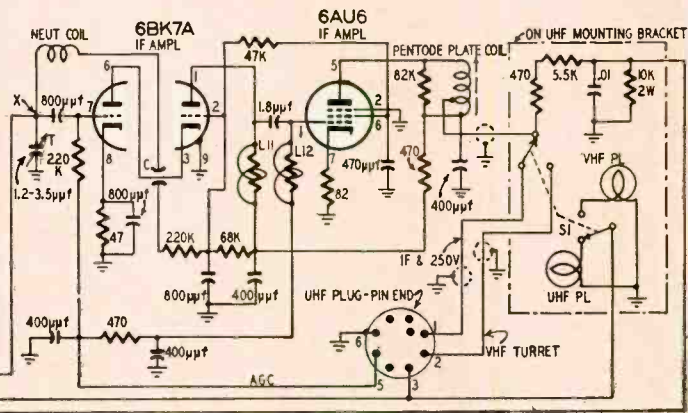

Emerson Chassis 120185B, 120190-D,

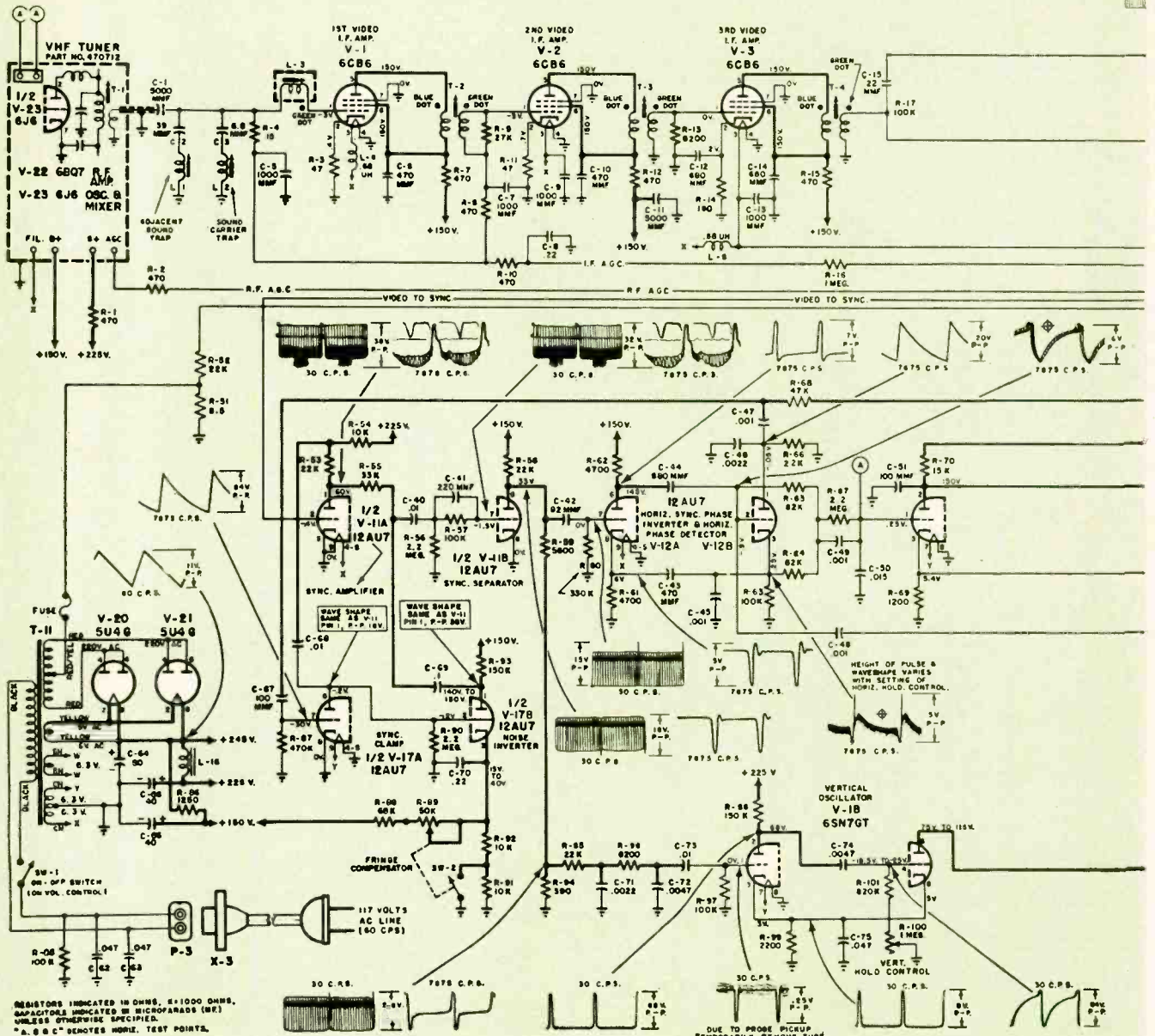
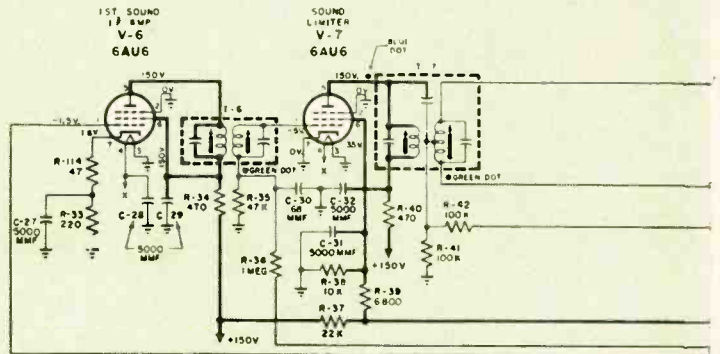
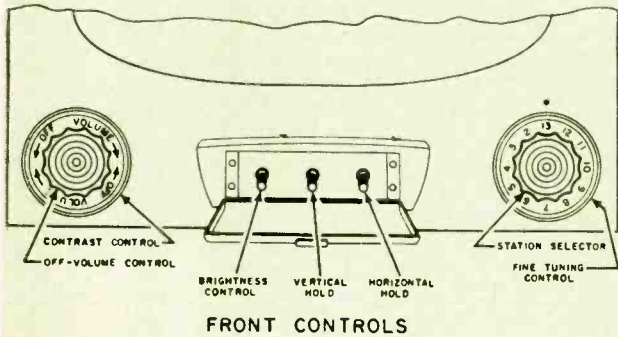

RESISTORS INDICATED IN OHMS, 1000 OHMS.
CAPACITORS INDICATED IN MICROFARADS (MF),
UNLESS OTHERWISE SPECIFIED.
"A, B & C" DENOTES HORIZ. TEST POINTS.

DUE TO PROBE PICKUP
TEMPORARILY REMOVE TUBE
#12 FOR THIS WAVE SHAPE.



**TRAIN FASTER—TRAIN BETTER—TRAIN EASIER
 IN 10 MONTHS—OR LESS—FOR
RADIO-TELEVISION
 Our 21st Year Training Men for Greater Incomes and Security in Radio-Television**

**I SEND YOU
 18 BIG KITS**

of Radio-Television parts and equipment. Much of your training will be actual construction and experimentation . . . the kind of truly **FRACTIC** instruction that prepares you for your Radio-Television career.



Frank L. Sprayberry
 President
 Sprayberry Academy
 of Radio

NEW! NO OBLIGATION PLAN

**You Have No Monthly Payment Contract to Sign
 Pay For Your Training as You Earn and Learn**

You can get into Radio-Television, today's fastest growing big money opportunity field, in *months* instead of years! My completely new "package unit" training plan prepares you in as little as 10 months or even less! *No monthly payment contract to sign—thus NO RISK to you!* This is America's finest, most complete, practical training—gets you ready to handle any practical job in the booming Radio-Television industry. Start your own profitable Radio-Television shop . . . or accept a good paying job. I have trained hundreds of successful Radio-Television technicians during the past 21 years—and stand ready to train you, even if you have no previous experience! Mail coupon and get all the facts—**FREE!**



**Valuable Equipment Included
 With Training**

The new Sprayberry "package" plan includes many big kits of genuine, professional Radio-Television equipment. You perform over 300 demonstrations, experiments and construction projects. You build a powerful 6-tube 2-band radio set, multi-range test meter, signal generator, signal tracer, many other projects. All equipment and lessons are *yours to keep* . . . you have practically everything you need to set up your own profitable Radio-Television service shop.

Earn Extra Money While You Learn!

All your 10 months of training is **IN YOUR HOME** in spare hours. Keep on with your present job and income while learning. With each training "package" unit, you receive extra plans and "Business Builder" ideas for spare time Radio-Television jobs. New television stations everywhere, open vast new opportunities for trained Radio-Television Technicians—and those in training. If you expect to be in the armed forces later, there is no better preparation than practical Sprayberry Radio-Television training.

YOU BUILD the Television set and the powerful superhet radio receiver shown above. **IN ADDITION** to the other test units shown here (many are not shown because of lack of space). All equipment I send you is **YOURS TO KEEP.**

Approved for Veterans under the G. I. Bill

**SPRAYBERRY ACADEMY OF RADIO 111 NORTH CANAL ST.
 Dept. 20-E, Chicago 6, Ill.**

**MAIL COUPON
 TODAY!
 NO OBLIGATION**

I invite you to get all the facts—
**FREE TO 3 BIG
 RADIO-TELEVISION BOOKS**

I want you to have ALL the facts about —without cost! Rush coupon for my three big Radio-Television books: "How to Make Money in Radio-Television" PLUS my new Illustrated Television Bulletin PLUS an actual sample Sprayberry Lesson—**ALL FREE.** No obligation and no salesman will call. Mail coupon NOW!

**SPRAYBERRY ACADEMY OF RADIO, Dept. 20-E
 111 North Canal St., Chicago 6, Ill.**

Please rush to me all information on your 10-MONTH Radio-Television Training Plan. I understand this does not obligate me and that no salesman will call upon me. Be sure to include 3 books **FREE.**

Name..... Age.....

Address.....

City..... Zone..... State.....

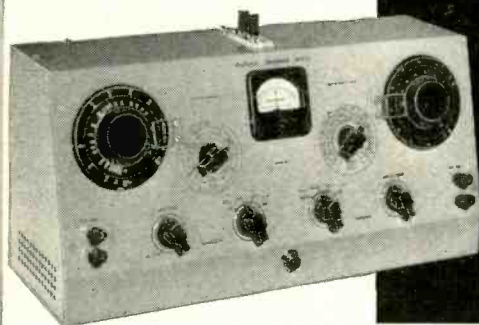

Heathkit IMPEDANCE BRIDGE KIT

MODEL IB-2

\$59⁵⁰

SHIPPING WT.
15 LBS.

Another new, outstanding instrument design so typically characteristic of Heathkit operation in producing high quality instrument kits at the lowest possible price. A new, improved model Impedance Bridge kit featuring modern cabinet styling, with slanted panel for convenience of operation and interpretation of scales at a \$10.00 price reduction over the preceding model. Built-in adjustable phase shift oscillator and amplifier with all tubes of the battery operated type completely eliminates warm-up time. The instrument is entirely AC line operated. No bothersome battery replacements.

The Heathkit IB-2 Impedance Bridge Kit actually represents four instruments in one compact unit. The Wheatstone Bridge for resistance measurements, the Capacity Comparison Bridge for capacity measurements, Maxwell Bridge for low Q, and Hay Bridge for high Q inductance measurements. Read Q, D, DQ all on one dial thereby eliminating possible confusion due to the incorrect dial reference or adjustment. Only one set of instrument terminals nec-

essary for any measurement function. Panel provisions provided for external generator use.

A newly designed two section CRL dial provides ten separate "units" switch settings with an accuracy of .5%. Fractions of units are read on a continuously variable calibrated wire-wound control. A special minimum capacity, shielded, balanced impedance matching transformer between the generator and the bridge. The correct impedance match is automatically switch selected to provide constant load operation of the generator circuit. The instrument uses 1/2% precision resistors and condensers in all measurement circuits.

The new Heathkit IB-2 provides outstanding design features not found in any other kit instrument. The single low price includes the power supply, generator, and amplifier stages. No need to purchase separate instrument accessories in order to obtain the type of operation desired.

Features

- Simpson 100-0-100 microampere meter.
- Completely AC operated.
- Built-in phase shift generator and amplifier.
- Battery type tubes, no warm-up required.
- Newly designed two section CRL dial.
- Single knob D, Q, and DQ functions.
- Special impedance matching transformer.
- New modern cabinet styling.
- 1/2% precision resistors and silver mica condensers.

Heathkit AUDIO WATTMETER KIT

MODEL AW-1

\$29⁵⁰

SHIPPING WT.
6 LBS.

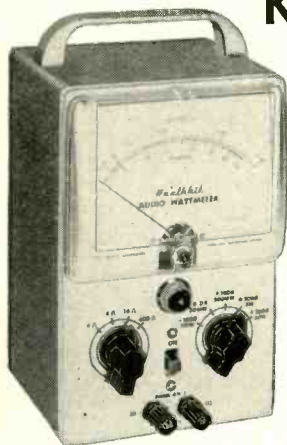

A new Heathkit design for the audio engineer, serious hi fi enthusiast, recording studio, or broadcast station; the Heathkit Audio Wattmeter Kit. This specialized instrument instantly indicates the output level of the equipment under test without requiring the use of external load resistors. All readings are taken directly from the calibrated scales of a 4 1/2" 200 microampere Simpson meter.

The Heathkit Audio Wattmeter features five full scale power measurement ranges from 5 milliwatts up to 50 watts with db ranges of -15 db to +48 db. The instrument has a power measurement rating of 25 watts continuous and 50 watts maximum for intermittent operation. Non-inductive resistance load impedances of 4, 8, 16, and 600 ohms are provided through a panel impedance selector switch. Frequency effect is negligible from 10 cycles to 250 kc. A conventional VTVM circuit utilizes a 12AU7 twin triode tube. The meter bridge circuit uses four germanium diodes for good linearity.

With the Heathkit AW-1 desired information can be obtained instantly and conveniently without bothering with the irksome setups and calculations usually required. Useful for power curve measurements, frequency response checks, monitoring indicator, etc. Convenient calibration directly from 110 volt AC line source. This new instrument will help to supply the answers to your audio operating or power output problems.

Heathkit LABORATORY GENERATOR KIT

MODEL LG-1

\$39⁵⁰

SHIP. WT.
16 LBS.



Another welcome new addition to the popular line of Heathkit instruments, the Heathkit Laboratory Generator. Specifically designed for flexibility of operation, accuracy and versatility beyond the performance level provided by the conventional service type generator. Frequency coverage of the Colpitts oscillator is 150kc to 30mc in five convenient ranges with provisions for internal or external modulation up to 50%, and .1 volt RF output throughout the frequency range. Panel mounted 200 microampere Simpson meter for RF "set reference level" to provide relative indication of RF output. Individually shielded oscillator and shielded variable and step attenuator provide flexible control of RF output.

The circuit features a 6AF4 high frequency oscillator, a 6AV5 amplifier with grid modulation, 12AU7 400 cycle oscillator and modulator, OB2 voltage regulator tube, and a selenium rectifier for the transformer operated power supply. The smart professional instrument appearance and over-all flexibility of operation will prove a decided asset to any industrial or educational laboratory. The Heathkit Laboratory Generator sets a new level of operation, far superior to any instrument in this price classification.

HEATH COMPANY • Benton Harbor 20, Mich.

RADIO-ELECTRONICS

CHECK THESE *Features*

- ✓ New 5U1 CR tube
- ✓ Re-trace blanking
- ✓ Voltage regulation
- ✓ Extended band width
- ✓ Peak-to-peak calibrating provisions
- ✓ Good square wave response
- ✓ Astigmatism control
- ✓ New heavy duty shielded power transformer

NEW 5" *Heathkit*
**OSCILLOSCOPE
KIT**
MODEL O-9
\$59⁵⁰
SHIPPING
WT. 28 LBS.



Announcing the latest addition to a brilliant series of Heathkit Oscilloscopes, the new Model O-9. This outstanding instrument incorporates all of the features developed and proven in the production of well over 50,000 kits, in addition to a host of many new design features for truly outstanding performance. This new scope features a brand new (no surplus) commercially available 5U1 cathode ray tube for fine focusing, high intensity, and freedom from halation. The 5" CR tube is the standard size for design and industrial laboratories, development engineers, and service men. The only size CR tube offering a wide range of types, colors, phosphors, and persistence. The answer to good oscilloscope performance lies in improved basic design and operating characteristics, and not in the use of larger CR tubes.

VERTICAL AMPLIFIER — New extended band width vertical amplifier with sensitivity of .025 volts per inch, down 3 db at 2 mc. down only 5½ db at 3 mc. Three step vertical input attenuator, quality ceramic variable capacitors for proper input compensation, provisions for calibrated 1 volt peak-to-peak reference, with calibrated screen for direct reading of TV pulses.

HORIZONTAL AMPLIFIER — New input selector switch provides choice of horizontal input, 60 cycle sweep input, line sync, internal sync, and external sync. Expanded horizontal sweep produces sweep width several times the cathode ray tube diameter. New blanking amplifier for complete retrace blanking and new phasing control.

POWER SUPPLY — New high voltage power supply and filtering circuit for really fine hairline focusing. New heavy duty power transformer with adequate operating reserve. Voltage regulated supply for both vertical and horizontal amplifiers for absolutely rock steady traces and complete freedom from bounce and jitter due to line variations.

The acid test of any oscilloscope operation is the ability to reproduce high frequency square waves and the new Heathkit O-9 will faithfully reproduce square waves up to 500 kc. This is the ideal all around, general purpose oscilloscope for educational and industrial use, radio and TV servicing, and any other type of work requiring the instantaneous reproduction and observation of actual wave forms and other electrical phenomena.

Heathkit **LOW CAPACITY
PROBE KIT**



NO. 342
\$3⁵⁰ SHIP. WT. 1 LB.

Oscilloscope investigation of high frequency, high impedance, or broad bandwidth circuits encountered in television work requires the use of a low capacity probe to prevent loss of gain, distortion, or false service information. The Heathkit Low Capacity Probe features a variable capacitor to provide the necessary degree of instrument impedance matching. New probe styling with bright polished aluminum housing and polystyrene probe ends.

Heathkit **SCOPE DEMODULATOR
PROBE KIT**



NO. 337-B
\$3⁵⁰
SHIP. WT. 1 LB.

In applications such as trouble shooting or aligning TV, RF, IF, and video stages, the frequency ranges encountered require demodulation of signals before oscilloscope presentation. The newly-styled Heathkit Demodulator Probe in polished aluminum housing will fulfill this function and readily prove its value as an oscilloscope service accessory. Detailed assembly sheet provided, including instructions for probe operation.

Heathkit **VOLTAGE CALIBRATOR KIT**



MODEL VC-2
\$11⁵⁰
SHIPPING WT. 4 LBS.

The Heathkit Voltage Calibrator provides a convenient method of making peak-to-peak voltage measurements with an oscilloscope by establishing a relationship on a comparison basis between the amplitude of an unknown wave shape and the known output of the voltage calibrator. Peak-to-peak voltage values are read directly on the calibrated panel scales. To offset line voltage supply irregularities, the instrument features a voltage regulator tube.

With the Heathkit Voltage Calibrator, it is possible to measure all types of complex wave forms within a voltage range of .01 to 100 volts peak-to-peak. A convenient "signal" position on the panel switch by-passes the calibrator completely and the signal is applied to the oscilloscope input thereby eliminating the necessity for transferring test leads.

Heathkit **ELECTRONIC SWITCH
KIT**



MODEL S-2
\$23⁵⁰
SHIP. WT. 11 LBS.

The basic function of the Heathkit S-2 Electronic Switch Kit is to permit simultaneous oscilloscope observation of two separate traces which can be either separated or superimposed for individual study. A typical example would be observation of a signal as it appears at both the input and output stages of an amplifier. It will also serve as a square wave generator over the range of switching frequencies, often providing the necessary wave form response information without incurring the expense of an additional instrument.

Continuously variable switching rates in three ranges from less than 10 cps to over 2,000 cps. Individual controls for each input channel and a positioning control. The five tube transformer operated circuit utilizes two 6SJ7, two 6SN7, and one 6X5 tubes. Buy this kit and enjoy increased versatility of operation from your oscilloscope.

HEATH COMPANY • Benton Harbor 20, Mich.

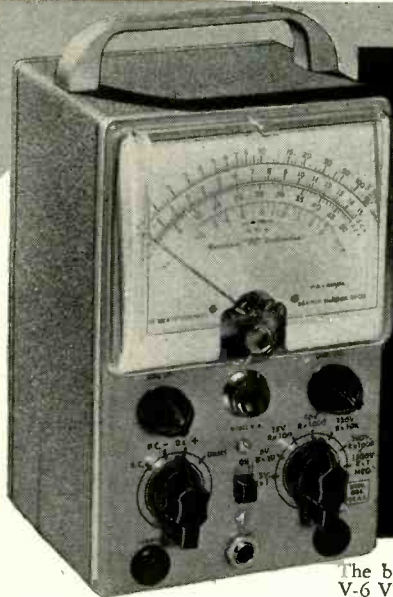

Heathkit VACUUM TUBE VOLTMETER KIT

MODEL V-6

\$24⁵⁰

SHIPPING WT. 6 LBS.

The beautiful Heathkit Model V-6 VTVM, the world's largest selling kit instrument, now offers many outstanding new features in addition to retaining all of the refinements developed and proven in the production of over 100,000 VTVM's. This is the basic measuring instrument for every branch of electronics. Easily meets all requirements for accuracy, stability, sensitivity, convenience of ranges, meter readability, and modern styling. It will accurately measure DC voltages, AC voltages, offers tremendous ohmmeter range coverage, and a complete db scale for a total of 35 meter ranges.

New 1½ volt full scale low range provides well over 2¼" of scale length per volt. Upper DC scale limit 1,500 volts. DC ranges 0-1.5, 5, 15, 50, 150, 500, 1,500 volts full scale. AC ranges 0-1.5, 5, 15, 50, 150, 500, 1,500 (1,000 volts maximum). Seven ohm-

meter ranges from .1 ohm to 1,000 megohms. For added convenience a DC polarity reversing switch and a center scale zero adjustment for FM alignment.

The smartly styled, compact, sturdy, formed aluminum cabinet is finished in an attractive gray crackle exterior. The beautiful two-color, durable, infra-red, baked enamel panel further adds to the over-all professional appearance.

Top quality components used throughout. 1% precision resistors — silver contact range and selector switches — selenium rectifier — transformer operated power supply. Individual calibration on both AC and DC for maximum accuracy. DB scale printed in red for easy identification, all other scales a sharp, crisp black for easy reading. A variety of accessory probes shown on this page still add further to over-all instrument usefulness.

Features

- ✓ New 1½ volt full scale low range
- ✓ 1,500 volt upper limit DC range
- ✓ Increased accuracy through 50% greater scale coverage
- ✓ High impedance 11 megohm input
- ✓ Center scale zero adjust
- ✓ Polarity reversal switch
- ✓ 1% precision resistors
- ✓ Clearly marked db scales

Heathkit 30,000 VOLT DC PROBE KIT

For TV service work or any similar application where the measurement of high DC voltage is required, the Heathkit Model 336 High Voltage Probe Kit will prove invaluable. A precision multiplier resistor mounted inside the two-color, sleek, plastic probe body provides a multiplication factor of 100 on the DC ranges of the Heathkit 11 megohm VTVM. The entire kit includes precision resistor, two-color plastic probe, tip connector spring, test lead, phone plug panel connector, and complete assembly instructions.



No. 336

\$4⁵⁰

SHIP. WT.
2 LBS.

No. 338-B

Heathkit PEAK-TO-PEAK PROBE KIT



\$5⁵⁰

SHIP. WT. 2 LBS.

Now read peak-to-peak voltages on the DC scales of the Heathkit 11 megohm VTVM. Readings can be directly made from the VTVM scale without involved calculations. Measurements over the frequency range of 5 kc to 5 mc. Use this probe to extend the usefulness of your VTVM in radio and TV service work. The Peak-to-Peak Probe Kit features the new polished aluminum housing with two-color polystyrene probe ends. Detailed assembly sheet including instructions for probe operation.

Heathkit AC VACUUM TUBE VOLTMETER KIT

MODEL AV-2

\$29⁵⁰

SHIPPING WT.

5 LBS.

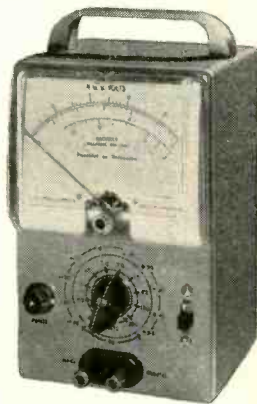

The new Heathkit AC VTVM that makes possible those sensitive AC measurements required by laboratories, audio enthusiasts, and experimenters. Especially useful for hum investigation, sensitive null detection, phono pick-up output measurements, making frequency response runs, gain measurements, ripple voltage checks, etc. Low level measurements are easy to make because of the complete voltage coverage of the instrument and the one knob operation.

The large 200 microampere Simpson meter has clearly marked and easy to read meter scales. Ten voltage ranges covering from .01 rms full scale to 300 volts rms full scale, with frequency response ± 1 db from 20 cycles to 50,000 cycles. Instrument input impedance 1 megohm, ten db ranges from -52 db to +52 db. For stability and good linearity characteristics the meter bridge circuit features 4 germanium diodes. Attractive instrument styling, a companion piece for the popular Heathkit VTVM and the new AW-1 Audio Wattmeter.

Heathkit RF PROBE KIT

The Heathkit RF Probe used in conjunction with any 11 megohm VTVM will permit RF measurements up to 250 mc, ± 10%. A useful, convenient accessory for those occasions when RF measurements are desired. The RF probe body is housed in the new, smartly-styled polished aluminum probe body featuring two-color polystyrene probe ends and a low capacity flexible shielded test lead. The kit is complete with all necessary material and a detailed assembly sheet as well as instructions for probe operation.

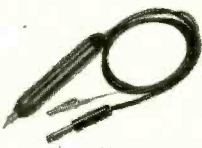

No. 309-B

\$3⁵⁰

SHIP. WT. 2 LBS.

HEATH COMPANY • Benton Harbor 20, Mich.

RADIO-ELECTRONICS

CHECK THESE *Features*

- ✓ 20,000 ohms per volt DC sensitivity, 5,000 ohms per volt on AC
- ✓ Polarity reversal switch
- ✓ 1% precision multiplier resistors
- ✓ 50 microampere 4½" Simpson meter
- ✓ Meter ranges for service convenience
- ✓ New resistor ring-switch assembly
- ✓ Total of 35 meter ranges
- ✓ New Modern cabinet styling

NEW *Heathkit* MULTIMETER KIT

MODEL MM-1

\$26⁵⁰

SHIPPING WT. 6 LBS.



The most important Heathkit announcement of the year, the new 20,000 ohms per volt Heathkit Multimeter, Model MM-1. The universal service measuring instrument, accurate, sensitive, portable, and completely independent of AC line supply. Particularly designed for service use incorporating many desirable features for the convenience of the service man. Full 20,000 ohms per volt sensitivity on DC ranges—5,000 ohms per volt sensitivity on AC—polarity reversal switch, no bothersome transferring of test leads—1% precision multiplier resistors—large 4½" recessed non-glare 50 microampere Simpson meter—conveniently slanted control panel—recessed safety type banana jacks—standard universally available batteries—rugged practical sized cabinet with plastic carrying handle, and a total of 35 calibrated meter ranges.

RANGES

Voltage ranges selected entirely for service convenience. For example 1½ volt full scale low range for measuring portable radio filament voltages, bias voltages, etc., 150 volt full scale range for AC-DC service work, 500 volt full scale range for conventional transformer operated power supply systems. Complete voltage ranges AC and DC, 0-1.5—5—50—150—500—1,500—5,000 volts. DC current ranges, 0-150 microamperes—15 milliamperes—150 milliamperes—500 milliamperes—15 amperes. Resistance measurements from .2 ohms to 20 meg-

ohms x 1 x 1,000 x 10,000.
DB coverage from -10 db
to +65 db.

CONSTRUCTION

Entirely new design permits assembly, mounting and wiring of precision resistors on a ring-switch assembly unit. The major portion of instrument wiring is completed before mounting the ring-switch assembly to the panel. No calibration procedure is required, all precision resistors readily accessible in event of replacement.

CABINET

Strikingly modern cabinet styling featuring two piece construction, durable black Bakelite cabinet, with easy to read panel designations. Cabinet size 5½" wide x 4" deep x 7½" high. Good cabinet physical stability when operated in vertical position.

The Heathkit MM-1 represents a terrific instrument value for a high quality 20,000 ohms per volt unit using all 1% deposited carbon type precision resistors. Here is quality, performance, functional design, and attractive appearance, all combined in one low priced package.

Heathkit BATTERY TESTER KIT



MODEL BT-1

\$8⁵⁰SHIP. WT.
2 LBS.

The Heathkit Battery Tester measures all types of dry batteries between 1½ volts and 150 volts under actual load conditions. Readings are made directly on a three color Good-Weak-Replace scale. Operation is extremely simple and merely requires that the test leads be connected to the battery under test. Only one control to adjust in addition to a panel switch for "A" or "B" battery types. The Heathkit Battery Tester features compact assembly, accurate meter movement, and a three deck wire-wound control, all mounted in a portable rugged plastic cabinet. Checks portable radio batteries, hearing aid batteries, lantern batteries, etc.

Heathkit HANDITESTER KIT



MODEL M-1

\$14⁵⁰SHIPPING WT.
3 LBS.

The Heathkit Model M-1 Handitester readily fulfills major requirements for a compact, portable volt ohm milliammeter. Despite its compact size, the Handitester is packed with every desirable feature required in an instrument of this type. AC or DC voltage ranges full scale, 0-10—30—300—1,000—5,000 volts. Two ohmmeter ranges, 0-3,000 and 0-300,000. Two DC current measurement ranges, 0-10 milliamperes and 0-100 milliamperes. The instrument uses a Simpson 400 microampere meter movement, which is shunted with resistors to provide a uniform 1 milliamper load on both AC and DC ranges. Special type, easily accessible, battery mounting bracket—1% deposited carbon type precision resistors—hearing aid type ohms adjust control. The Handitester is easily assembled from complete instructions and pictorial diagrams. Necessary test leads are included in the price of this popular kit.

HEATH COMPANY • Benton Harbor 20, Mich.



New *Heathkit* 12 Volt BATTERY ELIMINATOR KIT

MODEL BE-4

\$31⁵⁰

SHIPPING WT.
18 LBS.

CHECK THESE *Features*

- ✓ Either 6 or 12 volt operation
- ✓ Continuously variable voltage output
- ✓ Constant ammeter and voltmeter monitoring
- ✓ Automatic overload relay — self-resetting
- ✓ Two 10,000 mf condensers
- ✓ New 18 disc split type heavy duty rectifier unit
- ✓ Fuse protection

Here is the new Heathkit Battery Eliminator necessary for modern, up-to-date operation of your service shop. The Heathkit Model BE-4 furnishes either 6 volts or 12 volts output which can be selected at the flick of a panel switch. Use the BE-4 to service the new 12 volt car radios in addition to the conventional 6 volt radios.

This new Battery Eliminator provides two continuously variable output ranges, 0-8 volts DC at 10 amperes continuously, or 15 amperes maximum intermittent; 0-16 volts DC at 5 amperes continuously or 7.5 amperes maximum intermittent. The output voltage is clean and well filtered as the circuit uses two 10,000 mf condensers. The continuously variable voltage output feature is a definite aid in determining the starting point of vibrators, the voltage operating range of oscillator circuits, etc. Panel mounted meters constantly monitor voltage and cur-

rent output and will quickly indicate the presence of a major circuit fault in the equipment under test. The power transformer primary winding is fuse protected and for additional safety an automatic relay of the self-resetting type is incorporated in the DC output circuit. The heavy duty rectifier is a split type 18 plate magnesium copper sulfide unit used either as a full wave rectifier or voltage doubler according to the position of the panel range switch.

Here is the ideal battery eliminator for all of your service problems and as an additional feature, it can also be used as a battery charger. Another new application for the Heathkit Battery Eliminator is a variable source of DC filament supply in audio development and research. More than adequate variable voltage and current range for normal applications.

Heathkit VIBRATOR TESTER KIT

Your repair time is valuable, and service use of the Heathkit Vibrator Tester will save you many hours of work. This tester will instantly tell you the condition of the vibrator being checked. Checks vibrators for proper starting and the easy to read meter indicates quality of output on a large Bad-?-Good scale. The Heathkit VT-1 checks both interrupter and self rectifier types of vibrators. Five different sockets for checking hundreds of vibrator types.

The Heathkit Vibrator Tester operates from any battery eliminator capable of delivering continuously variable voltage from 4 to 6 volts DC at 4 amperes. The new Heathkit Model BE-4 Battery Eliminator would be an ideal source of supply.

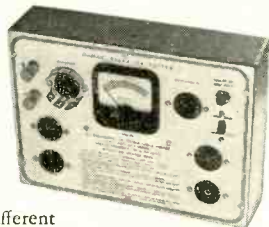

MODEL VT-1

\$14⁵⁰

SHIPPING WT.
6 LBS.

NEW *Heathkit* VARIABLE VOLTAGE ISOLATION TRANSFORMER KIT

The new Heathkit Isolation Transformer Kit provides line isolation for AC-DC radios (not an auto transformer), thereby eliminating shock hazard, hum problems, alignment difficulties, etc. The output voltage is variable from 90 to 130 volts AC and is constantly monitored by a panel mounted AC volt meter. Use it to increase AC supply voltage in order to induce breakdown of faulty components in circuits thereby saving service time. Use it also to simulate varying line voltage conditions and to determine the line voltage level at which oscillator circuits cease functioning, particularly in three-way portable radios. Rated at 100 watts continuous operation and up to 200 watts maximum intermittent operation. A useful radio and TV service tool.



MODEL IT-1

\$16⁵⁰

SHIP. WT. 9 LBS.

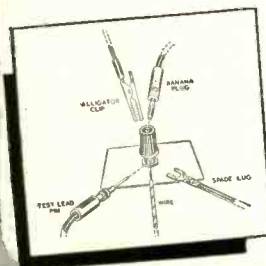

Heathkit BINDING POST

Binding post kit now available so that standardization of all instrument connectors is possible. This new, five-way binding post will accommodate an alligator clip, banana plug, test lead pin, spade lug, or hook-up wire. Sold in units of 20 binding post assemblies. Each assembly includes binding post, flat and shoulder fiber washers, solder lug, and nut. 120 pieces in all. Kit 362, \$4.00.



Heathkit TECHNICAL APPLICATION BULLETINS

An exclusive Heathkit service. Technical application bulletins prepared by recognized instrument authorities outlining various combinations of instrument applications. Available now with 40 four-page illustrated bulletins and an attractive flexible loose-leaf binder. Only \$2.00. (No c.o.d. on this item, please.)

HEATH COMPANY • Benton Harbor 20, Mich.

RADIO-ELECTRONICS

CHECK THESE *Features*

- ✓ INCREDUCTOR controllable inductor sweep
- ✓ TV and IF sweep deviation 12-30 mc
- ✓ 4 mc- 220 mc continuous frequency coverage
- ✓ Oscillator operation entirely on fundamentals
- ✓ Output in excess of 100,000 microvolts
- ✓ Automatic amplitude circuit
- ✓ Voltage regulation
- ✓ Simplified operation

NEW *Heathkit*
**TV ALIGNMENT
GENERATOR
KIT**

MODEL TS-3

\$44.50

SHIPPING WEIGHT
18 POUNDS



Proudly announcing an entirely new, advanced model TV and FM Sweep Generator, the Heathkit Model TS-3. This new design provides features and combinations of functions not found in any other service type instrument. Every design consideration has been given to the requirements of the TV service man to provide a flexible, variable sweep source with more than adequate RF output and complete frequency coverage throughout the TV and FM spectrum.

The frequency range of the TS-3 is from 4 mc to 220 mc in four switch selected ranges. All frequency ranges are overlapping for complete coverage. A particularly important feature of the instrument is that the oscillator operates entirely on fundamentals, thereby providing complete freedom from spurious oscillation and parasitics normally encountered in beat frequency type oscillators. This circuitry assures a much higher total RF output level and simplifies attenuation problems.

The new TS-3 features an entirely new principle of sweep operation. Sweep action is entirely electronic with no moving parts or electro-mechanical devices so commonly used. The heart of the sweep system is a newly-developed INCREDUCTOR controllable inductor. With this system, the value of inductance of each oscil-

lator coil is electrically varied with an AC control current, and the inductance variation is achieved by a change in the magnetic state of the core on which the oscillator coils are wound. This system provides a sweep deviation of not less than 12 mc on all TV frequencies, and up to a maximum of 30 mc on TV IF frequencies. The high RF output level throughout the instrument frequency range overcomes the most common complaint of the older type sweep generators. A new, automatic amplitude control circuit maintains the output level flat to ± 2 db throughout the instrument range. For convenience of operation a low impedance 50 ohm output is used.

Operation of the instrument has been simplified through the reduction of panel controls and separate panel terminals provide for external synchronization if desired. The circuit uses a voltage regulator tube to maintain stable instrument operation. A built-in variable oscillator marker further adds to flexibility of instrument operation. Provisions are also made for the use of an external marker, such as your service type signal generator, if desired. Use the Heathkit TS-3 for rapid, accurate TV alignment work, and let it help you solve those time consuming, irksome problems so frequently encountered.

NEW *Heathkit*
SIGNAL GENERATOR KIT

MODEL SG-8

\$19.50

SHIPPING WEIGHT
8 POUNDS



Announcing the new Heathkit Model SG-8 service type Signal Generator, incorporating many design features not usually found in an instrument in this price range. The RF

output is from 160 kc to 100 mc in five ranges, all on fundamentals, with useful harmonics up to 200 mc. The RF output level is in excess of 100,000 microvolts throughout the frequency range.

The oscillator circuit consists of a 12AT7 twin triode tube. One half is used as a Colpitts oscillator, and the other half as a cathode follower output which acts as a buffer between the oscillator and external load. This circuitry eliminates oscillator frequency shift usually caused by external circuit loading.

All coils are factory wound and adjusted, thereby completely eliminating the need for calibration and the use of additional calibrating equipment. The stable low impedance output features a step and variable attenuator for complete control of RF level. A 6C4 triode acts as a 400 cycle sine wave oscillator and a panel switching system permits a choice of either external or internal modulation.

The transformer operated circuit is easy to assemble, requires no calibration, and meets every service requirement for an adjustable level variable frequency signal source, either modulated or un-modulated.

NEW *Heathkit*
BAR GENERATOR KIT

MODEL BG-1

\$14.50

SHIPPING WEIGHT
6 POUNDS



The Heathkit BG-1 Bar Generator represents another welcome addition to the fast growing line of popular Heathkits. The

station transmitted test pattern is rapidly disappearing, and the bar generator is the logical answer to the TV service man's problem in obtaining quick, accurate adjustment information without waiting for test patterns.

The Heathkit BG-1 produces a series of horizontal or vertical bars on a TV screen. Since these bars are equally spaced, they will quickly indicate picture linearity of the receiver under test. Panel switch provides "stand-by position" — "horizontal position" — "vertical position." The oscillator unit utilizes a 12AT7 twin triode for the RF oscillator and video carrier frequencies. A neon relaxation oscillator provides low frequency for vertical linearity tests. The instrument will not only produce bar patterns but will also provide an indication of horizontal and vertical sync circuit stability, as well as overall picture size.

Instrument operation is extremely simple, and merely requires connection to the TV receiver antenna terminal. The unit is transformer operated for safety when used in conjunction with universal or transformerless type TV circuits.

HEATH COMPANY • Benton Harbor 20, Mich.



**NEW Heathkit
TUBE CHECKER
KIT**
MODEL TC-2
\$29.50
SHIP. WT. 12 LBS.

The new Model TC-2 Heathkit Tube Checker features many circuit improvements, simplified wiring, new roll chart drive and illumination of roll chart. The instrument is primarily designed for the convenience of the radio and TV service man and will check the operating quality of tubes commonly encountered in this type of work. Test set-up procedure is simplified, rapid, and flexible. Panel sockets accommodate 4, 5, 6, and 7 pin tubes, octal and loctal, 7 and 9 pin miniatures, 5 pin Hytron and a blank socket for new tubes. Built-in neon short indicator, individual three-position lever switch for each tube element, spring return test switch, 14 filament voltage ranges, and line set control to compensate for supply voltage variations, all represent important design features of the TC-2. Results of tube tests are read directly from a large 4½" Simpson three-color meter, calibrated in terms of Bad-?-Good. Information that your customer can readily understand. Checks emission, shorted elements, open elements, and continuity.

The use of closer tolerance resistors in critical circuits assures correct test information and eliminates the possibility of inaccurate test interpretation. Improvement has been made in the mechanical roll chart drive system, completely eliminating diagonal running, erratic operation, and backlash. The thumb wheel gear driven action is smooth, positive, and free running. As an additional feature, the roll chart is illuminated for easier reading, particularly when the tube checker is used on radio or TV home service calls.

Wiring procedure has been simplified through the extended use of multi-cable, color coded wires, providing a harness type installation between tube sockets and lever switches. This procedure insures standard assembly and imparts that "factory built" appearance to instrument construction. Completely detailed information is furnished in the new step-by-step construction manual, regarding the set-up procedure for testing of new or unlisted tube types. No delay necessary for release of factory data.

The new Heathkit Tube Checker will prove its value in building service prestige through usefulness—simplified operation—attractive professional appearance. Don't overlook the fact that the kit price represents a savings of \$40.00 to \$50.00 over the price of a comparable commercially built instrument. At this low price, no service man need be without the advantages offered by the Heathkit Tube Checker.

**CHECK THESE
NEW Features**

- ✓ Simplified harness wiring
- ✓ Improved, smooth, anti-backlash roll chart action
- ✓ Optional roll chart illumination
- ✓ Individual element switches
- ✓ Portable or counter style cabinet
- ✓ Spare blank socket
- ✓ Contact type pilot light test socket
- ✓ Simplified test set-up procedure
- ✓ Line adjust control
- ✓ 4½" three-color meter

New
**HEATHKIT
PORTABLE
TUBE CHECKER
KIT**



MODEL TC-2P
\$34.50
SHIP. WT. 14 LBS.

The portable model is supplied with a strikingly attractive two-tone cabinet finished in rich maroon, proxylin impregnated, fabric covering with a contrasting gray on the inside cover. Detachable cover, brass-plated hardware, sturdy plastic handle help to impart a truly professional appearance to the instrument.

PORTABLE TUBE CHECKER CABINET as described above will fit all earlier Heathkit TC-1 Tube Checkers. Shipping weight 7 lbs. Cabinet only, 91-8, \$7.50.



Heathkit **TV PICTURE TUBE
TEST ADAPTER**

No. 355 **\$4.50**
Ship. Wt. 1 lb.

The Heathkit TV Picture Tube Test Adapter used with the Heathkit Tube Checker will quickly check for emission, shorts, etc., and determine picture tube quality. Consists of standard 12 pin TV tube socket, four feet of cable, octal socket connector, and data sheet.

Heathkit **POWER SUPPLY KIT**



MODEL PS-2
\$33.50
SHIPPING WT. 17 LBS.

The Heathkit Laboratory Power Supply features continuously variable, regulated, voltage output with good stability under wide load variations. A 4½" Simpson plastic enclosed panel mounted meter provides accurate meter output information of voltage or current. All panel terminals completely isolated from the cabinet. Separate 6.3 volt AC supply at 4 amperes for filament requirements. Ripple component exceptionally low, stand-by switch provided to eliminate warm-up time of the five tube circuit.

**LABORATORY AND
SERVICE SHOP
BOOKLETS**



"Planning Your Service Business" by John T. Frye, and "Establishing the Industrial Electronics Laboratory" by Louis B. Garner, Jr., are booklets available to Heathkit customers at no charge. These booklets, written by nationally recognized authorities, outline the various requirements and considerations for establishing your own service business or for setting up an industrial electronics laboratory. Full attention is given to various details that are frequently overlooked when projects of this nature are undertaken. Just write in to the Heath Company requesting your free copy, or attach a memo to your next order.

HEATH COMPANY • Benton Harbor 20, Mich.

CHECK THESE *Features*

- ✓ Visual and aural signal tracing
- ✓ Two channel input
- ✓ High RF sensitivity
- ✓ Unique noise locator circuit
- ✓ Calibrated wattmeter
- ✓ Substitution test speaker
- ✓ Utility amplifier
- ✓ RF, audio probes and test leads included

Heathkit VISUAL-AURAL SIGNAL TRACER

KIT

MODEL T-3

\$23⁵⁰

SHIPPING WEIGHT
10 POUNDS

An entirely new type of signal tracer incorporating a combination of features not found in any other instrument. Designed expressly for the radio and TV service man, particularly for the servicing of AM, FM, and TV circuits. Here in a five tube, transformer operated instrument are all of the useful functions so necessary for speedy, accurate isolation of service difficulty.

This new signal tracer features a special high gain RF input channel, used in conjunction with a newly-designed wide frequency range demodulator probe. High RF sensitivity permits signal tracing at the receiver antenna input. A separate low gain channel and probe available for audio circuit exploration. Both input channels are constantly monitored by an electron ray beam indicator, so that visual as well as aural signal indications may be observed. The instrument can also be used for comparative estimation of gain per stage.

A decidedly unusual feature is a noise localizer circuit in conjunction with the audio probe. With this system, a DC potential is applied to a suspected circuit component and the action of the

voltage in the component can be seen

as well as heard. Invaluable for ferreting out noisy or intermittent condensers, noisy resistors, controls, coils, IF and power transformers, etc. A built-in calibrated wattmeter circuit is very useful for a quick preliminary check of the total wattage consumption of the equipment under test. Separate panel terminals provide external use of the speaker or output transformer for substitution purposes. Saves valuable service time by eliminating the necessity for speaker removal on every service job. The terminals also permit the utilization of other shop equipment, such as your oscilloscope or VTVM. The T-3 Signal Tracer can be used as a high gain amplifier for checking tuners, record changers, microphones, phono crystals, etc.

Don't overlook the interesting service possibilities provided through the use of this new instrument and let it work for you by saving time and money. The kit is supplied complete with all tubes, circuit components, demodulator probe, audio probe, and additional test leads.

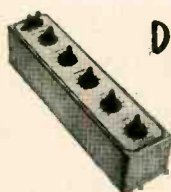

Heathkit DECADE RESISTANCE KIT

MODEL DR-1 The Decade Resistance Kit provides individual switch selection of resistance values using twenty 1% resistors providing a choice of 1 to 99,999 ohms in 1 ohm steps. Ceramic wafer switches, silver-plated contacts, smooth, positive detent action, baked enamel panel, and handsome, polished birch cabinet.

\$19⁵⁰

SHIP. WT.
4 LBS.

Heathkit DECADE CONDENSER KIT

The Heathkit Decade Condenser Kit features silver mica, precision condensers with a rated accuracy of $\pm 1\%$. Capacity values are arranged in three decades from 100 mmf to .111 mf in steps of 100 mmf. Ceramic wafer switches with silver-plated contacts and smooth detent action. Useful in laboratory work, for circuit development.

MODEL DC-1

\$16⁵⁰

SHIP WT.
4 LBS.



Heathkit RESISTANCE SUBSTITUTION BOX KIT

MODEL RS-1

\$5⁵⁰

SHIP. WT.
2 LBS.



The Heathkit Resistance Substitution Box provides individual switch selection of any one of 36 RTMA 1 watt 10% standard value resistors, ranging from 15 ohms to 10 megohms. Many applications in circuit development work, and also in radio and TV service work. Ideal for experimentally determining resistance values and for quickly altering circuit operating characteristics. Entire unit housed in attractive Bakelite cabinet, featuring the new universal type Heathkit binding posts to simplify circuit connections.

Heathkit CONDENSER CHECKER KIT

MODEL C-3

\$19⁵⁰

SHIPPING WT.
8 POUNDS

Use the Heathkit C-3 Condenser Checker to quickly and accurately measure those unknown condenser

and resistor values. All readings are taken directly from the calibrated panel scales without requiring any involved calculation. Capacity meas-

urements in four ranges from .00001 mf to 1,000 mf. Checks paper, mica, ceramic, and electrolytic condensers. A power factor control is available for accurate indication of electrolytic condenser measurements. A leakage test switch with switch selection of five polarizing voltages, 25 volts to 450 volts DC, will indicate condenser operating quality under actual load condition. The spring return leakage test switch automatically discharges the condenser under test and eliminates shock hazard to the operator.

Resistance measurements can be made in the range from 100 ohms to 5 megohms. Here again all values are read directly on the calibrated scale. Increased circuit sensitivity coupled with an electron beam null indicator increases overall instrument usefulness.

For safety of operation the circuit is entirely transformer operated and the instrument is housed in the attractive, newly-styled Heathkit cabinet, featuring rounded corners, and drawn aluminum panel. The outstanding low kit price for this surprisingly accurate instrument includes necessary test leads. Good service shop operation requires the use of this specialized instrument, designed for the express purpose of determining unknown condenser values and operating characteristics.

HEATH COMPANY • Benton Harbor 20, Mich.



Heathkit AMATEUR TRANSMITTER KIT

MODEL AT-1

\$29.50

SHIPPING WEIGHT
16 POUNDS

CHECK THESE NEW Features

- ✓ Single knob band switching
- ✓ Pre-wound coils
- ✓ Metered operation
- ✓ 52 ohm coaxial output
- ✓ Crystal or VFO excitation
- ✓ Built-in power supply
- ✓ Rugged, clean construction

Here is the latest Heathkit addition to the ham radio field, the AT-1 Transmitter Kit, incorporating many desirable design features at the lowest possible dollar-per-watts price. Panel mounted crystal socket, stand-by switch, key click filter, AC line filtering, good shielding, etc. VFO or crystal excitation—up to 35 watts input. Built-in power supply provides 425 volts at 100 ma.

This kit features pre-wound coils, single knob band switching, 52 ohm coaxial output, plug in chassis provisions for VFO or modulator and rugged clean construction. Frequency range 80, 40, 20,

15, 11, and 10 meters. Tube line-up 6AG7 oscillator-multiplier, 6L6 amplifier-doubler, 5U4G rectifier. Physical dimensions 8 1/8" high x 13 1/8" wide x 7" deep.

This amazingly low kit price includes all circuit components, tubes, cabinet, punched chassis, and detailed construction manual. The ideal kit for the novice just breaking into ham radio. It can be used later on as a stand-by rig or an all band exciter for higher powered transmitter.

NEW Heathkit ANTENNA COUPLER KIT

New Heathkit Antenna Coupler, specially designed for the Heathkit AT-1 Transmitter. The Antenna Coupler can be used with any 52 ohm coaxial input—up to 75 watts power. Low pass filter with cut-off frequency of approximately 36 mc — L section tuning network—neon tuning indicator — rugged, compact construction — transmitter type variable condenser, and high Q coil are all outstanding features. The AC-1 has both inductance and capacity tuning for maximum operating versatility. Dimensions 8 1/8" wide x 4 3/8" high x 4 7/8" deep.



MODEL AC-1

\$14.50 SHIP. WT.
3 LBS.

Heathkit ANTENNA IMPEDANCE METER

Use the Heathkit Antenna Impedance Meter for measuring antenna impedance for line matching purposes—adjustment of beam antennas—phone monitor, etc. It will determine antenna resistance at resonance, match transmission line for minimum SWR, determine receiver input impedance, and provide a rough indication of SWR. Precision resistors, germanium diode, 100 micro-ampere Simpson meter. Dial calibrated from 0-500 ohms. Shielded aluminum cabinet, 7" long x 2 1/2" wide x 3 1/4" deep.



MODEL AM-1

\$14.50

SHIP. WT. 3 LBS.

Heathkit COMMUNICATIONS RECEIVER KIT



MODEL AR-2

\$25.50 SHIP. WT.
12 LBS.

Here is the new receiver kit you have repeatedly asked for, the Heathkit Communications Receiver. The perfect companion piece for the AT-1

Transmitter kit. Many outstandingly desirable features have been incorporated in the design of the AR-2; such as, electrical bandspread

for logging and tuning convenience—high gain miniature tubes — IF transformers for high sensitivity and good signal to noise ratio—separate RF gain control with optional automatic volume control or manual volume control, in addition to the conventional audio gain control. Noise limiter—stand-by switch—stable BFO oscillator circuit—headphone jack—transformer operation, etc., all contribute to a high performance standard.

Frequency coverage is continuous from 535 kc to 35 mc in four ranges. For added convenience, various ham bands have been separately identified in respect to their relative placement on the slide rule tuning scale. A chassis mounted, 5 1/2" PM speaker is included with this kit. Tube line up 12BE6 mixer oscillator, 12BA6 IF amplifier, 12AV6 detector AVC audio, 12BA6 BFO oscillator, 12A6 beam power output, 5Y3GT rectifier.

RECEIVER CABINET

Proxylin impregnated, fabric covered, plywood cabinet with aluminum panel designed expressly for the AR-2 Receiver. Part 91-10, shipping weight 5 lbs., \$4.50.

IMPROVED Heathkit GRID DIP METER KIT



\$19.50 SHIP. WT.
4 LBS.

MODEL GD-1B

The invaluable instrument for service men, hams, and experimenters. Useful in TV service work for alignment of traps, filters, IF stages,

Locates spurious oscillation, provides a relative indication of power in transmitter stages, use it for neutralization, locating parasitics, correcting TVI, measuring C, L, and Q of components, and determining RF circuit resonant frequencies. With oscillator energized, useful for finding resonant frequency of tuned circuits. With the oscillator not energized, the instrument acts as an absorption wave meter. Variable meter sensitivity control, head phone jack, 500 microampere Simpson meter. Continuous frequency coverage from 2 mc. to 250 mc. Pre-wound coil kit and rack, new three prong coil mounting, 6AF4 high frequency triode.

Two additional plug-in coils are available and provide continuous extension of low frequency coverage down to 355 kc. Dial correlation curves included. Shipping weight 1 lb., kit 341, \$3.00.



HEATH COMPANY • Benton Harbor 20, Mich.

RADIO-ELECTRONICS

CHECK THESE *Features*

- ✓ First popular priced Q Meter
- ✓ Reads Q directly on calibrated scale
- ✓ Oscillator supplies RF frequencies of 150 kc to 18 mc
- ✓ Calibrate capacitor with range of 40 mmf to 450 mmf with vernier of ± 3 mmf
- ✓ Measures Q of condensers, RF resistance, and distributed capacity of coils
- ✓ Many applications in design and development work
- ✓ Useful in TV service work for checking deflection yokes, coils, chokes, etc.

Heathkit "Q" METER KIT

MODEL QM-1

\$44.50

SHIPPING WT. 14 POUNDS

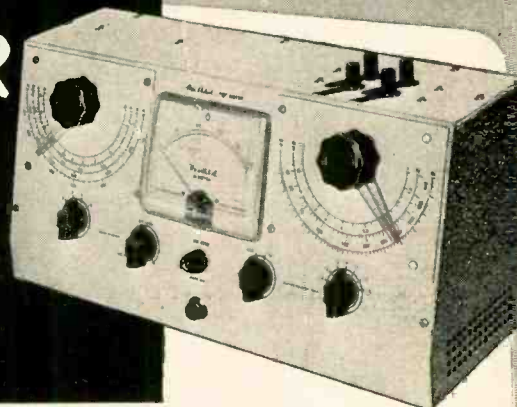

Another outstanding example of successful Heathkit engineering effort in producing a Q Meter Kit within the price range of TV service men, schools, laboratories, and experimenters. This Q Meter meets RF design requirements for rapid, accurate measurement of capacity, inductance, and Q at the operating frequency and all indications of value can be read directly on the meter calibrated scales. Oscillator section supplies RF fre-

quencies of 150 kc to 18 mc. Calibrate capacitor with range of 40 mmf to 450 mmf, with vernier of ± 3 mmf.

Particularly useful in TV service work for checking peaking coils, wave traps, chokes, deflection coils, width and linearity coils, etc. At this low kit price research laboratory facilities are within the range of service shops, schools, and experimenters.

Heathkit INTERMODULATION ANALYZER KIT



MODEL IM-1

\$39.50SHIPPING WT.
17 POUNDS

The Heathkit IM-1 is an extremely versatile instrument specifically designed for measuring the degree of inter-action between two signals in any portion of an audio chain. It is primarily intended for making tests of audio amplifiers, but may be used in other applications, such as checking microphones, records, recording equipment, phonograph pick-ups, and loud-speakers. High and low test frequency source, intermodulation unit, power supply, and AC vacuum tube volt meter all in one complete instrument. Per cent intermodulation is directly read on the calibrated scales, 30%, 10%, and 3% full scale. Both 4:1 and 1:1 ratios of low to high frequency easily set up. With this instrument the performance level of present equipment, or newly developed equipment can be easily and accurately checked. At this low price, you can now enjoy the benefits of intermodulation analysis for accurate audio interpretation.

Heathkit AUDIO GENERATOR KIT

A Heathkit Audio Generator with frequency coverage from 20 cycles to 1 mc. Response flat ± 1 db from 20 cycles to 400 kc, down 3 db at 600 kc, and down only 8 db at 1 mc. Calibrated, continuously variable, and step attenuator output controls provide convenient reference output level. Distortion is less than .4% from 100 cps through the audible range. The ideal controllable extended frequency sine wave source for audio circuit investigation and development.



MODEL AG-8

\$29.50

SHIP. WT. 11 LBS.

Heathkit AUDIO OSCILLATOR KIT

Sine or square wave coverage from 20 to 20,000 cycles in three ranges at a controllable output level up to 10 volts. Low distortion, 1% precision resistors in multiplier circuits, high level output across entire frequency range, etc., readily qualify this instrument for audio experimentation and development work. Special circuit design consideration features thermistor operation for good control of linearity.



MODEL AO-1

\$24.50

SHIP. WT. 11 LBS.

Heathkit AUDIO FREQUENCY METER KIT



MODEL AF-1

\$34.50

SHIP. WT. 12 LBS.

The Heathkit Audio Frequency Meter provides a simple and convenient means of checking unknown audio frequencies from 10 cycles to 100 kc at any voltage level between 3 and 300 volts rms with any non-critical wave shape.

Instrument operation is entirely electronic. Just set the range switch, feed an unknown frequency into the instrument, and read the frequency directly on the calibrated scale of the Simpson $4\frac{1}{2}$ " meter.

Heathkit SQUARE WAVE GENERATOR KIT

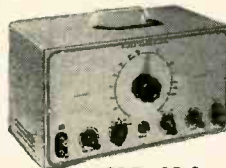

MODEL SQ-1

\$29.50

SHIP. WT. 12 LBS.

The Heathkit Square Wave Generator provides an excellent square wave frequency source with completely variable coverage from 10 cycles to 100 kc. This generator features low output impedance of 600 ohms and the output voltage is continuously variable between 0 and 20 volts, thereby providing the necessary degree of operating flexibility. An invaluable instrument for those specialized circuit investigations requiring a good, stable, variable square wave source.

HEATH COMPANY • Benton Harbor 20, Mich.

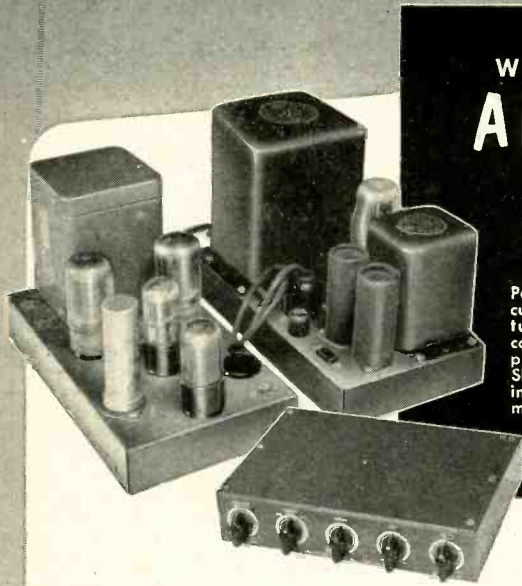

Heathkit
WILLIAMSON TYPE
AMPLIFIER KIT
MODEL W-2

\$69.50

Particularly designed for custom installations, featuring separate cable connected units for simplicity of installation. Sheet metal work finished in attractive gray hamertone for smart appearance. All control shafts of the adjustable length break-off type.

PRICES OF COMBINATIONS

W-2 Amplifier Kit including main amplifier, power supply, and WA-P1 Preamplifier Kit. Shipping Weight 37 lbs. Shipped Express only. **\$69.50**

W-2M Amplifier Kit includes main amplifier and power supply. Shipping Weight 29 lbs. Shipped Express only. **\$49.75**

WA-P1 Preamplifier Kit only. Shipping Weight 6 lbs. Shipped Express or Parcel Post. **\$19.75**

When selecting an amplifier for the heart of your high fidelity audio system, investigate the outstanding advantages offered by the Heathkit Williamson Type Amplifier. Meets every high fidelity audio requirement and makes listening to recorded music a thrilling new experience. This outstanding amplifier is offered with optional output transformer

operation, providing either the conventional triode output circuit or the new extended power circuitry in which the screen supply voltage is obtained from separate transformer primary taps. Frequency response within ± 1 db from 10 cycles to 100 kc. Tube complement — 6SN7 cascade amplifier and phase splitter, 6SN7 push pull driver, two 5881 push pull power amplifiers, one 5V4G cathode type rectifier. Matching preamplifier available providing three switch selected inputs, correct compensation, and individual bass and treble tone controls. Uses 12AY7 (or 12AX7) preamplifier — 12AU7 tone control amplifier. Particularly designed for the novice kit builder and requires no specialized knowledge or equipment for successful assembly and operation.

NEW *Heathkit* 20 WATT
High Fidelity AMPLIFIER KIT

MODEL A-9A



\$35.50

SHIP. WT. 18 LBS.

A new 20 watt high fidelity amplifier, designed especially for custom audio installations demanding clean reproduction, adequate power, and flexibility to meet individual requirements. Separate treble and bass tone controls provide up to 15 db boost or cut. Four switch selected inputs, each with the necessary compensation for the service desired. Output transformer impedances of 4, 8, and 16 ohms. Preamplifier, tone control, and phase splitter circuits utilize 9 pin twin triode miniature tubes for low hum and noise level. Two 6L6 push pull power output tubes provide full 20 watts power. Frequency response ± 1 db, 20-20,000 cycles. Total harmonic distortion 1% (at 3 db below rated output). Tube line-up: 12AX7 preamplifier, 12AU7 voltage amplifier and tone control, 12AU7 voltage amplifier and phase splitter, two 6L6 push pull pentode power output, 5U4G rectifier. Truly outstanding amplifier performance coupled with low cost.

Heathkit ECONOMY 6 WATT
AMPLIFIER KIT



MODEL A-7B

\$15.50

SHIP. WT. 10 LBS.

The new Heathkit Model A-7B Amplifier offers many unusually fine features not normally expected in this low price range. Either of the two input circuits may be individually switch selected for phono or tuner operation. Separate bass and treble tone controls. Output impedances of 4, 8, and 15 ohms. Push pull beam power output stage for balanced reproduction. Excellent voltage gain characteristics, good frequency response, and full 6 watts power output. 12J5 amplifier, 12SL7 second amplifier and phase splitter, two 12A6 beam power output, one 5Y5 GT rectifier. A-7C incorporates preamplifier stage with special compensated network to provide necessary gain for operation with variable reluctance or low output level phono cartridge. Circuit is properly compensated for microphone operation. \$17.50.

NEW *Heathkit*
BROADCAST BAND
RECEIVER KIT



MODEL BR-2

\$17.50 SHIP. WT. 11 LBS.

Another new Heathkit for the student, beginner, or hobbyist. If you have ever had the urge to build your own radio receiver, this kit warrants your attention. New high gain miniature tubes and IF transformers provide excellent sensitivity and good signal to noise ratio. A built-in ferrite core rod type antenna has been provided. A chassis mounted $5\frac{1}{2}$ " PM speaker provides excellent tone and volume. Convenient phono input. Can be operated either as a receiver or tuner. Simplified construction manual outlines circuit theory. Ideal for students. Tube line-up: 12BE6 mixer oscillator, 12BA6 IF amplifier, 12AV6 detector-AVC-first audio, 12A6 beam power output, 5Y3GT rectifier.

CABINET — Proxilyn impregnated fabric covered plywood cabinet. Shipping weight 5 lbs. Part number 91-9, \$4.50.

Heathkit
FM TUNER KIT

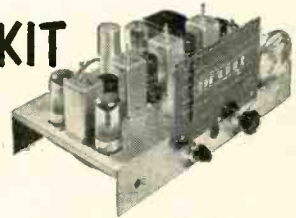

MODEL FM-2

\$22.50

SHIP. WT. 9 LBS.

The Heathkit FM-2 Tuner was specifically designed for simplified kit construction. Can be operated through the "phono" portion of your radio or with a separate amplifier. The kit features a pre-assembled and adjusted tuning unit, three double tuned IF transformers, and a discriminator transformer in an 8 tube AC operated circuit. Frequency coverage 88 to 108 mc. Experience the thrill of building your own FM tuner and at the same time enjoy all of the advantages of true FM reception.

Free CATALOG

Write for free catalog containing latest price information, schematics, specifications, and descriptions of all Heathkits.

HEATH COMPANY • Benton Harbor 20, Mich.

RADIO-ELECTRONICS

HIGH-QUALITY AUDIO

By RICHARD H. DORF*

Part V—More on pickups: The construction and application of crystal and magnetic types

THERE are two principal types of phonograph pickups; crystal and magnetic. Before electrical recording and playback, pickups were acoustical—that is, the needle vibrated a membrane which set air in motion. Acoustical pickups are seldom used today, and then only on small portable phonographs. Present-day high-quality pickup types also include the capacitive and the strain-gauge. Though the magnetic pickups are the ones principally used for high-quality home music systems, we shall discuss all types, because all are used to some extent.

Pickup requirements

The requirements of a good pickup are in part the same as for any other good audio equipment. It should have a wide frequency range, extending from at least 40 to 10,000 cycles. The best pickups cover from 20 or 30 to above 15,000 cycles.

The pickup should have smooth frequency response, without obvious peaks or valleys in the response curve. In fact, a pickup with less range and greater smoothness is preferable to one with wide range but a sharp peak in the early thousands of cycles. A peak in the neighborhood of 3,000 cycles, which is common with less expensive crystals, not only emphasizes record surface noise, but also makes the music seem high-pitched or screechy. The effect is very unpleasant.

Of course, distortion should be low. Unfortunately, it is very difficult to design an electromechanical transducer with low-level intermodulation. Even the best pickups have some intermodulation distortion; at least 1 or 2%. The subject of intermodulation in pickups has never been thoroughly explored because it is very difficult. When it is measured by playing back test records, it is almost impossible to separate the distortion created by the pickup from that created by the record cutter during recording. Harmonic distortion is not bad on the better pickups. However, with good records, both types of distortion are so low that the user of a fine pickup is not troubled.

A characteristic of pickups is stylus compliance. The stylus must be very free to move with respect to the pickup

element, as explained in last month's article. This compliance must be high at all frequencies—the stylus must easily comply with the movement instructions given it by the record groove. The stylus assembly must also be free of resonance as explained last month in connection with arm resonance. While arm resonance takes place at low frequencies and causes *juke-box boom*, stylus-assembly resonance takes place at high frequencies because of its much smaller mass. This results in undesirable peaks in pickup output at the resonant frequencies.

The old-fashioned needle chuck was undesirable from a sound quality standpoint. It was the assembly into which a steel needle was inserted and held by tightening a knurled set-screw. The massiveness of the assembly made it less compliant than it should have been, though there was little loss, because the pickup elements themselves were not capable of good quality.

Ideally, a good pickup should give sufficiently high output so as to require little amplification. Here we run into a law of nature that says roughly you can't eat your cake and have it too. Either you build for high output—which requires the stylus assembly and the grooves to do some work—and corresponding poor quality, or you settle for low output and good quality. These of course, are the extremes. Crystal pickups give higher output than magnetic types, when the quality is the same. But a crystal, when built primarily for quality, does not have the same output as a medium-quality crystal built for use in department-store sets.

Crystal pickups

The crystal pickup is the least expensive type in general use today, though a few of the very best crystal pickups are equal in price to some magnetics. Its heart is an element known as a piezoelectric crystal, made of either rochelle salts (sodium potassium tartrate), or an artificial ceramic substance such as barium titanate. These crystalline materials, when sliced into blocks, have the property of generating a voltage across opposite faces when they are physically stressed—squeezed or twisted. The voltage output is directly proportional to the physical

stress over a certain frequency range, depending on the dimensions of the block and the type of stress. A stylus is coupled in some manner to the crystal so that lateral stylus movements cause stress on the crystal, which produces a voltage output.

Fig. 1 shows the construction of a typical crystal pickup. The crystal element has at the right, a clamp (nose piece), to which is attached a torque wire. At the end of this fairly stiff wire

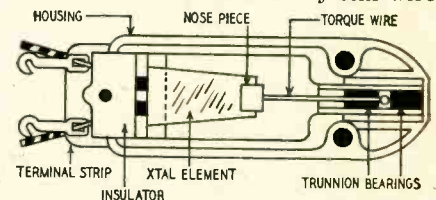

Fig. 1—Construction of crystal pickup.

is cemented a stylus, consisting of a shank with a piece of sapphire at its end. When the stylus is driven by the record groove the wire twists, and through the nose-piece, imparts a twisting stress to the crystal. Silver-foil leads attached to the opposite faces of the crystal pass the generated voltage to the pickup terminals.

Actual construction of various pickups differs in many respects but the principle is always the same. Rubber or artificial rubber mounting and damping blocks are used, as well as additional mechanical necessities such as trunnion bearings which hold the stylus assembly and allow it to move in only one manner. Almost all crystal cartridges are equipped with mounting holes to allow mounting in any standard arm. Almost all crystal cartridges

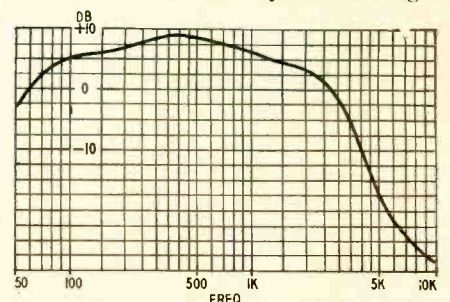

Fig. 2—Frequency response curve of a typical crystal pickup cartridge.

*Audio Consultant, New York City



Fig. 3—The type U Astatic cartridge.

found in manufactured radio-phono sets have medium to poor frequency response. The curve of Fig. 2 is an example. These cannot be considered for high-quality systems.

On the other hand, cartridges such as the Astatic type U illustrated in Fig. 3 are flat within 2 decibels from 50 to 10,000 cycles when used on LP records similar to those made by Columbia. Its maximum output is 0.5 volt. It needs no preamplifier and cannot pick up hum from a turntable motor. The stylus is held by a friction type assembly and can be replaced. It is only one of many models with comparable performance available from several manufacturers.

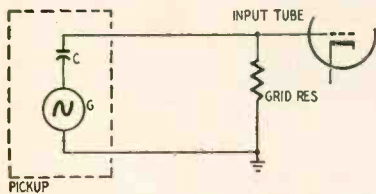

Fig. 4—Equivalent of crystal pickup.

An outstanding cartridge is the new Electro-Voice ceramic unit (type 84). It provides high-fidelity, having a flat response of plus or minus 2.5 db from 20 to 15,000 cycles. Because of its high output (1.5 volts—working into a 3-megohm load), it requires no pre-amplifier.

Using crystal pickups

The question of whether to use a crystal pickup depends on consideration of advantages and disadvantages. On the black side of the ledger are the high output and zero hum pickup. Some facts appear on the red side.

The crystal pickup must always be operated very close to the amplifier; the cable certainly cannot be carried across a room. The pickup, seen electrically from the amplifier end of the line, consists of two electrodes separated by a dielectric—the crystal itself. This is effectively a capacitor, and the pickup is said to be capacitive. The cable itself is capacitive, consisting of two wires (or a wire and a shield) separated by the insulation of the cable. The longer the line, the more capacitance is placed in parallel with the pickup, and the smaller is the part of



Fig. 5—G-E's RPX-050 dual cartridge.

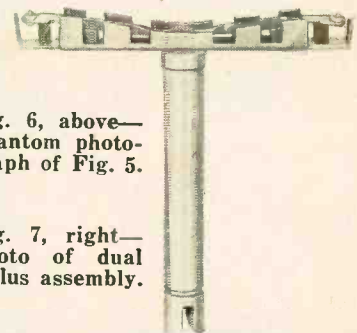
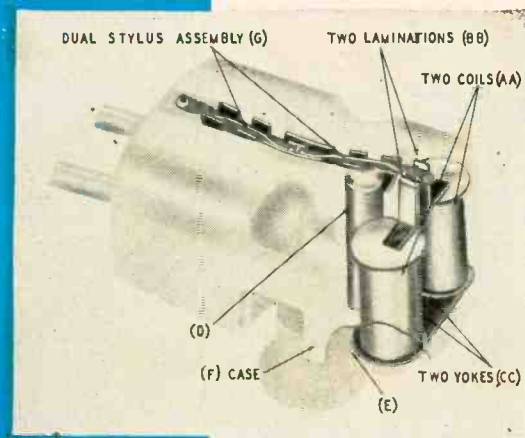

Fig. 6, above—Phantom photograph of Fig. 5.

Fig. 7, right—Photo of dual stylus assembly.

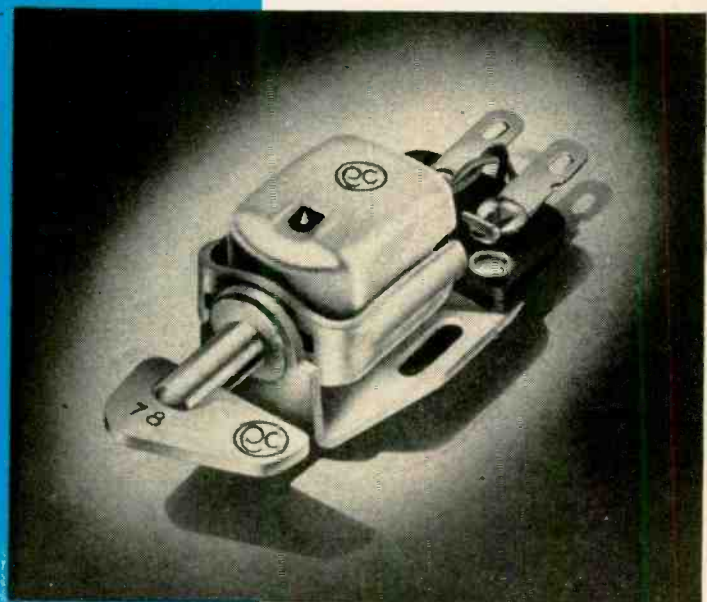

Fig. 8—Pickering model 260 cartridge.

ADJUSTABLE

for added gain on the cha

NEW 82 CHANNEL FALCON "VARI-CON"

- Provides all channel reception, VHF and UHF!
- Variable patterns eliminate ghosts and co-channel interference!
- Single lead-in operation!
- Provides a very sharp lobe on UHF!
- Provides excellent reception on VHF while peaked for UHF!
- With two-bay model, you can point and peak one antenna in one direction and point and peak the other bay in another direction — obtaining excellent results from both with but a single lead-in!
- No isolation transformer or network to give trouble, attenuate the signal, or add to installation cost!
- Low, low price!

VARIABLE PATTERNS OVERCOME "GHOST" AND CO-CHANNEL PROBLEMS

With other antennas you're "stuck" with a fixed pattern that nothing short of a hack-saw can change. NOT SO WITH THE "VARI-CON"! By changing the angle of the dipole elements — and it takes only seconds — it is possible to shift the positions of minor lobes and nulls to fit any particular reception problem. There are very few cases of ghost or co-channel interference that can't be quickly solved by use of the "VARI-CON".



TOTAL ASSEMBLY AND PEAKING TIME — 10 SECONDS!

You only need swing reflector elements (A) into position and tighten wing nuts. Slide adjusting sleeve (B) to calibrated channel range on which added gain is desired and tighten wing nuts. It's just like opening an umbrella. Remove retaining clamps (C) from dipole elements; the elements automatically fan out and are locked securely in position by snap-action spring assemblies.

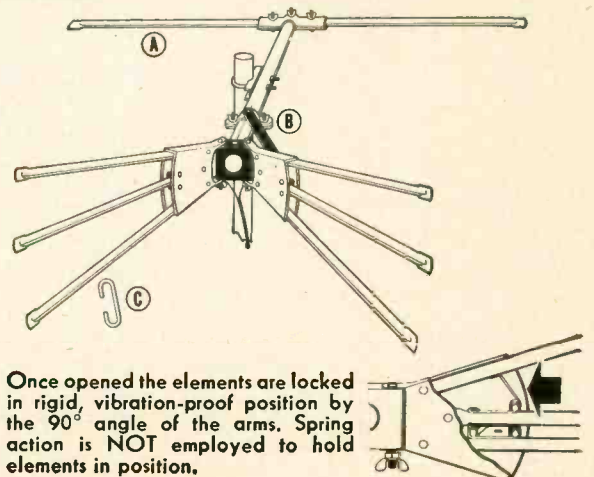

Channels of your choice...

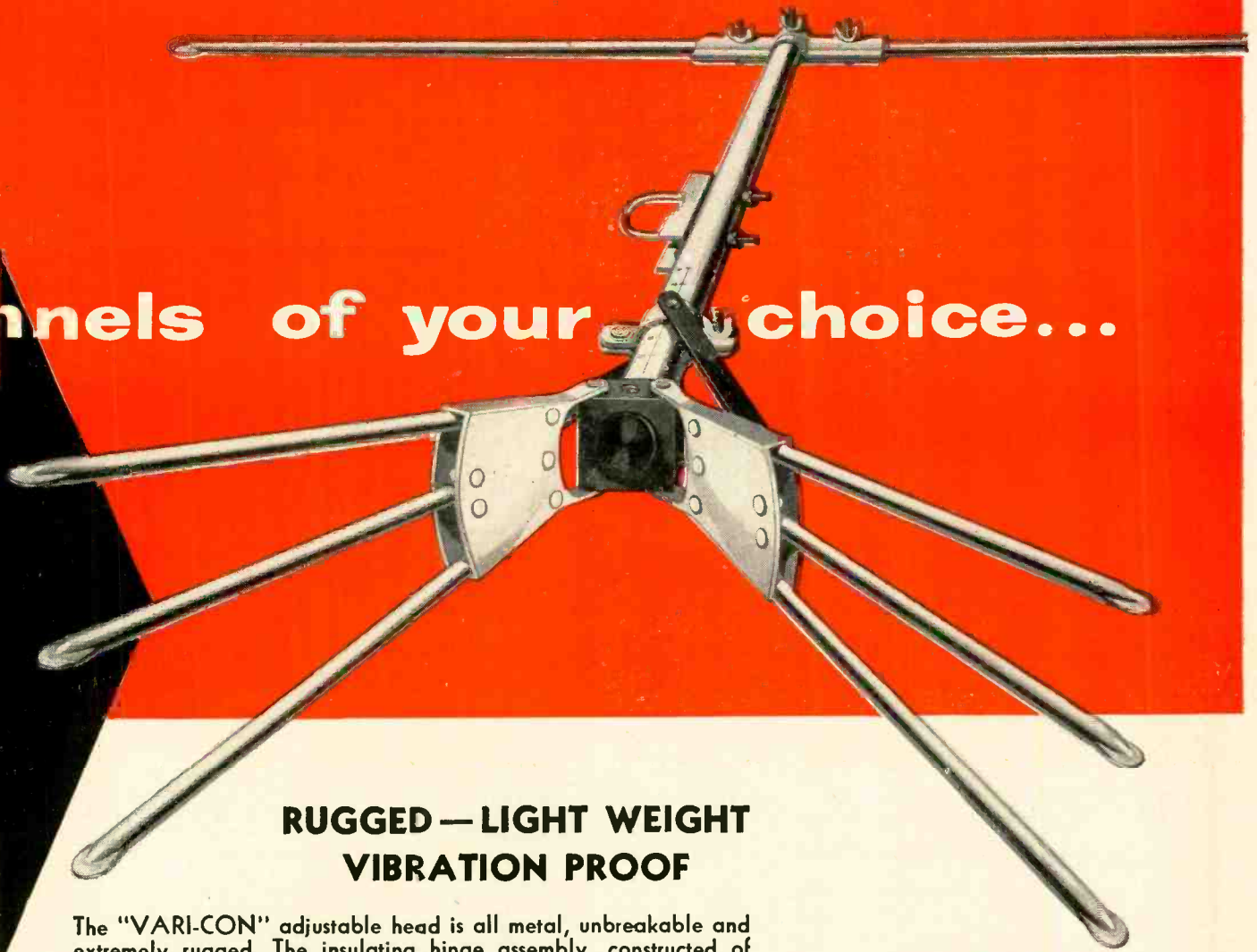

**RUGGED — LIGHT WEIGHT
VIBRATION PROOF**

The "VARI-CON" adjustable head is all metal, unbreakable and extremely rugged. The insulating hinge assembly, constructed of tough, warp-proof high-dielectric materials, is weather-proof and can't short out. Full 48 inch elements are used, yet weight has been kept to a minimum without sacrificing rigidity.

The FALCON "VARI-CON" gives you all the desirable features of a conical PLUS adjustable, calibrated channel range peaking — for added gain where you need it . . . variable patterns, to cope with those difficult ghost and co-channel problems, plus all-channel VHF & UHF coverage! Give your customers the best — the FALCON "VARI-CON"!

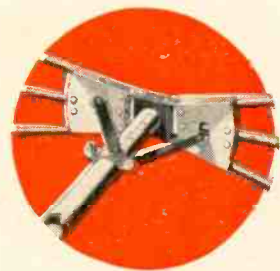

Heart of the "VARI-CON"

FALCON ELECTRONICS COMPANY, 2003 Cedar St., Quincy, Ill.

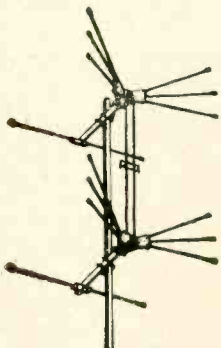

Stack VARI-CONS for even higher gain! One bay can be pointed and peaked in one direction, and the other bay pointed and peaked in a different direction. Three bay models also available.

**Write for Illustrated
Spec Sheet.**





Ultraverter

THE ALL CHANNEL UHF CONVERTER
THAT OFFERS YOU *Everything*



PRICE
PERFORMANCE
SALES APPEAL
EXCLUSIVE FEATURES
and GREATER
PROFIT MARGIN

**Make Your Own
Point By Point
Comparison:**

- ✓ LIST PRICE IS ONLY \$39⁹⁵
- ✓ High Gain with Lowest Noise Factor
- ✓ Makes ANY TV Set a Modern 82 Channel Receiver
- ✓ Rapid Dual-Speed Tuning Controls
- ✓ Has No Power-Switch—'On-Off' Automatically Controlled by TV Set
- ✓ Rugged Construction, Attractive Styling, and Rubber Protective Feet
- ✓ Exclusively Designed 3-Section B-T Ultratuner
- ✓ Better Discounts for Greater Profits.



Supported By Hard Hitting Sales Promotion

- ✓ National Advertising in Consumer, Dealer, and Service Publications.
- ✓ Cooperative Newspaper Advertising
- ✓ FREE Attention-Getting Sales Displays for Dealers
- ✓ Catalog Sheets, Service Data, other Sales Aids

It's *Ultra* POWERFUL . . . It's *Ultra* DEPENDABLE

For complete details, write to Dept. OA-3



BLONDER-TONGUE LABORATORIES
WESTFIELD, N. J.

Manufacturers of TELEVISION AMPLIFIERS, UHF CONVERTERS,
MIXERS, DISTRIBUTION UNITS and TV ACCESSORIES

the total capacitance contributed by the pickup. As the line gets longer, the output at the amplifier end goes down, being shunted by the capacitance of the cable.

Contrary to popular belief, the capacitance of the long cable does not reduce the high-frequency response of the crystal pickup. It reduces the overall level of the signal at the amplifier end of the cable, and allows any noise picked up by the cable to be more effective.

The low-frequency response of the crystal is dependent on the value of the grid resistor. Fig. 4 is a schematic diagram of an ordinary crystal pickup input circuit, with the pickup shown by its electrical equivalent. Electrically, the pickup consists of an a.c. generator G of zero internal impedance in series with a capacitance C. C and the grid resistor form an ordinary r-c high-pass filter—series capacitance and shunt resistance. As in all filters of this kind, the cutoff frequency—the frequency below which the response begins to drop—depends on the impedances of the two filter components, R and C. The higher the shunt impedance or the lower the series impedance, the lower the frequency at which attenuation begins. In order to keep this frequency down as far as possible—preferably below the range of hearing—the resistance and

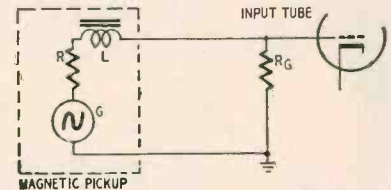

Fig. 9—Equivalent of magnetic pickup.

capacitance must be made as large as possible. The capacitance is fixed by the crystal itself, so a large grid resistor is necessary; at least 0.5 megohm.

This makes for a very high-impedance grid circuit. Noise, induced line hum, and the like are hard to keep out. The most thorough shielding right up to the tube's grid pin is essential. This is skimmed sometimes in inexpensive sets, on the theory that speakers are not good enough to show up hum, and the high pickup output level tends to cover it. But in a home music system this is usually not true.

Magnetic pickups

The modern electromagnetic pickup has an advantage over the crystal in that the stylus assembly does no significant physical work other than that required to overcome the tiny inertia caused by its own mass and any stiffness in its mounting. Therefore, the stylus can have much greater compliance. Magnetic pickups can be made self-resonant well above the audible spectrum, producing relatively flat frequency response.

While magnetic pickups vary in construction and operation, the General Electric cartridge is useful for illustration of the general principle. Fig. 5 shows the RPX-050, a dual cartridge

FACTS YOU SHOULD KNOW ABOUT UHF CONVERTERS

Many converters on the market today are unsatisfactory in fringe and shadow areas where signal strength is low. Before you install a UHF converter in these areas you should know these facts:

- 1 Signal power loss in the preselector seriously affects picture quality. Most UHF converters use sliding-contact shorted line tuners in the preselector with a fixed power loss of 6 db. The Turner uses High Q coaxial cavity tuners with no sliding contacts. Signal power loss is cut to 3 db. The resulting low noise figure keeps picture quality high.
- 2 Oscillator radiation often causes interference with neighboring sets. In the Turner converter the oscillator tube socket and all associated circuits are inside the coaxial cavity, self-shielded. Removable covers provide a second shield against radiation.
- 3 High amplifier noise figure can further damage picture quality. The Turner converter uses a special broadband amplifier with Cascode circuit. It retains the preselector signal savings without appreciably increasing the noise figure. The Turner amplifier noise figure is only 4 db.

Whether installing converters in shadow and fringe areas, or putting one in your own home, remember . . . the Turner often means the difference between good reception and bad reception.

EXCLUSIVE TURNER FEATURES

- Higher sensitivity
- Extremely low noise figure
- Exceptional frequency stability
- Double shielding
- Hi-Q silver plated coaxial cavities
- No sliding contacts

OTHER MAJOR TURNER FEATURES

Continuous single-knob tuning. Illuminated slide-rule dial. Smaller size: 8"x6"x6". Use with UHF or combination antennas. Self powered, uses channels 5 or 6. Complete installation instructions. For 110-120 volts 50-60 cycles AC. Schematic included.

List price \$49.50



In VHF fringe and shadow areas, the Turner Booster is a superior performer, too.

The TURNER Company

933 17th St., N.E., Cedar Rapids, Iowa

Gentlemen: Please send complete information on the Turner UHF Converter

Turner Booster

Name _____

Address _____

City _____

State _____

Export: Ad Auriema, Inc.,
89 Broad St., New York 4, N. Y.
Canada: Canadian Marconi Co.,
Toronto, Ont. & Branches

used for playing both standard and LP discs. Its frequency response is flat from 30 to 15,000 cycles with 3 db or less variation. Its output is 10 millivolts minimum into an open circuit (no shunt resistor), and damping is sufficient for good transient response and lightweight tracking.

Fig. 6 is a phantom photograph showing the inner works of the cartridge. Two coils AA are mounted on a pair of yokes CC. A small cylindrical magnet D is mounted in a hole in the phenolic base behind the coils. Mounted in a hole behind the magnet is a dual stylus assembly G which can be seen in detail in Fig. 7. One of the cantilevers with its sapphire or diamond stylus at the end, extends over the magnet and between two laminations BB which extend from the cores of the coils. The laminations, cores, yokes, and cantilevers are made of a high-permeability (easily magnetized and demagnetized) alloy, while the magnet is made of Alnico V, powerful permanent-magnet material.

A path of magnetic flux exists from the upper end of the magnet to and through the cantilever which is in play-

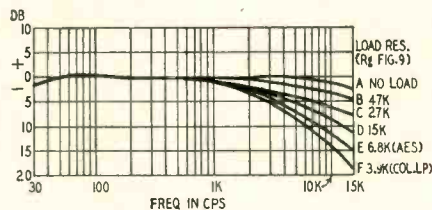

Fig. 10—Treble response of G-E pickup.

ing position. From the outer end of the cantilever the flux divides evenly between the two core laminations, through each core. At the bottoms of the cores the flux combines in the yokes and returns to the bottom of the magnet, completing the magnetic circuit.

The outer end of the cantilever is normally placed equidistant from the two core laminations. When the stylus and cantilever move in response to record modulation, the cantilever is swung alternately closer to and further from each lamination. Thus, with each cycle of modulation, there is greater magnetic flux passing through first one core, and then the other. The reluctance (magnetic resistance) of the air path between the cantilever and the lamination has changed because of the change in distance. This is why the pickup is referred to as the *variable-reluctance* type.

The constant change of flux in the cores causes constantly rising and falling magnetic lines of force around the cores. These lines cut the turns of the coils and induce a.c. voltages in them, which are replicas of the audio waveforms in the record groove. The cores are connected series opposing and thus produce a combined push-pull voltage which is fed to the amplifier. This can happen only when magnetic lines of force cut each coil separately and alternately. If a magnetic field cuts the two coils as a whole—for instance, a 60-cycle field from a motor—the result-

HBG

is here!

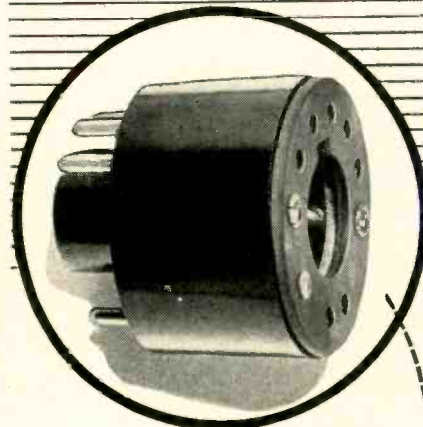

for Quick TV Set Adjustment and Alignment!

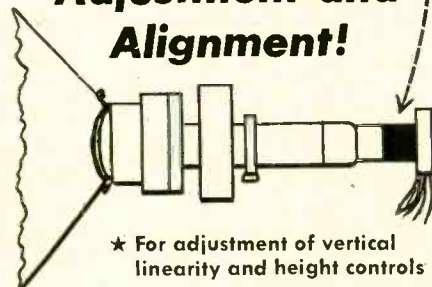

- ★ For adjustment of vertical linearity and height controls
- ★ Accurate positioning of focus coil or magnet
- ★ Precise setting of yoke
- ★ Complete with instructions

PermaPower

HBG
*HORIZONTAL BAR GENERATOR

Dealer Net \$1.95

See Your Jobber Today!

manufactured by

PermaPower COMPANY
Chicago 25, Ill.
Manufacturers of Electronic Equipment Since 1928

Sangamo
top Quality
Capacitors
 since
1924

First
 molded wire lead
 mica

Complete line
 for all requirements

First molded paper tubular

Developer of
HUMIDITITE

Look to Sangamo—the fastest growing capacitor manufacturer in America—for top quality capacitors at a fair price. The line includes wire lead micas, transmitting micas, silvered button micas, molded paper tubulars, oil filled paper capacitors, dry electrolytics, tantalum electrolytics. Write for Engineering Data Sheets on the types you need.



SANGAMO ELECTRIC COMPANY

MARION, ILLINOIS

AUDIO—HIGH FIDELITY

ing induced coil voltages tend to cancel, and produce no hum output.

The stylus cantilevers are fitted with small rubber-like blocks to damp out resonance and help keep the cantilever equidistant from the two pole pieces. The cantilever assemblies may be reversed by pushing in and turning the small knob, to bring either stylus into position. A case covers the entire assembly. Made of high-permeability metal, it provides shielding.

Fig. 8 shows another very popular magnetic cartridge, the Pickering model 260. The cartridge turns over completely, to place the other stylus in position. Its characteristics are as good as the G-E. Its output is approximately 30 millivolts.

Using magnetic cartridges

Because their output is much lower than that of crystals, magnetic cartridges invariably require extra amplification. This can be obtained simply by using the microphone channel of the amplifier rather than that intended for crystal pickups. Usually, a separate preamplifier is inserted between the pickup and the amplifier.

The high-frequency response of a magnetic cartridge is affected by the load into which it operates. The reason is similar to the low-frequency limit of crystal pickups, and is illustrated by Fig. 9. The magnetic pickup is shown by its equivalent electrical circuit, a generator G of zero internal impedance, in series with an inductance L and resistance R. R is the resistance of the coil winding and can be ignored for explanation purposes. The grid-leak resistor R_g and the inductance L form a low-pass filter. For a high cutoff frequency with a fixed inductance, the resistance must be as high as possible.

The curves of Fig. 10 show how the treble response of the G-E pickup drops off as R_g becomes lower. With no resistor at all (the pickup itself acts as the grid leak) curve A shows only a 3-db drop at 15 kc. Curves B, C, D, E, and F show what happens with various resistance values. They also show that the choice of shunt resistor can provide the high-frequency equalization necessary for various record types.

Next month we shall discuss two other pickup types and shall go into the subject of pickup equalization. END

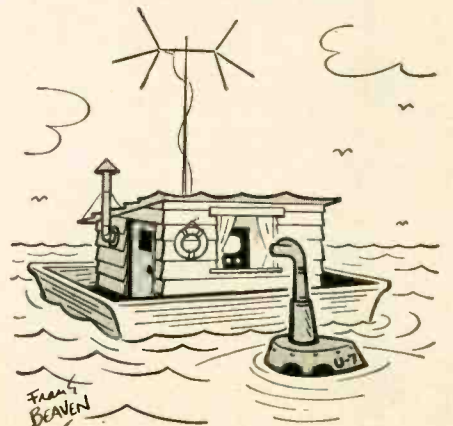

Suggested by Gerald Drew, Sacramento, Calif.

BACK THE LINE THAT BACKS YOU!

ALLIANCE

New, Restyled Models + \$500,000 Ad Campaign

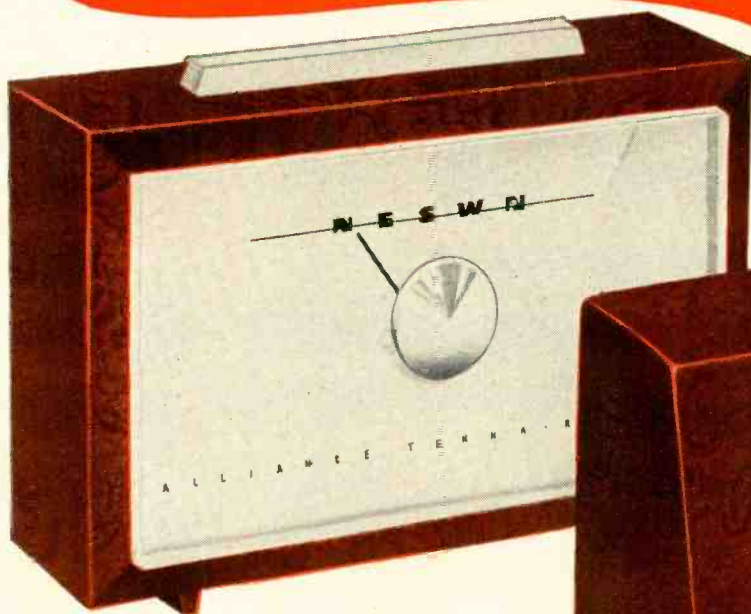

MODEL T-10, finger-tip electrically controlled Alliance Tenna-Rotor with direction indicator dial. Extremely accurate. Modern styling by Reinecke & Associates **\$44.95**

IMPROVED ROTATOR UNIT
—Speed increased to 2 r.p.m.
Magnetic anti-drift brake.
Smoother synchronization with control units.

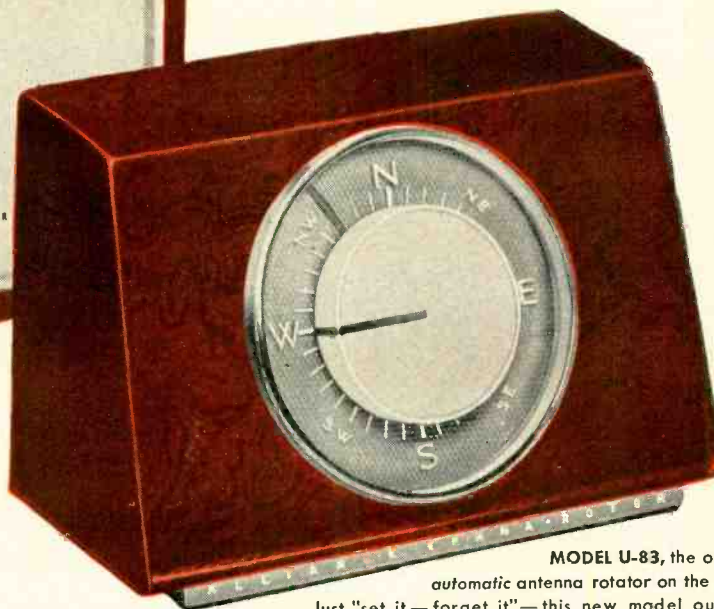

MODEL U-83, the only fully automatic antenna rotator on the market. Just "set it—forget it"—this new model automatic Alliance Tenna-Rotor. Reinecke-designed . . **\$44.95**

Here's how Alliance pre-sells for you!—

1 New styling sells on sight! Style's the thing, and Alliance has it! More eye-appeal, more buy-appeal in these smart, new Alliance Tenna-Rotors and the Alliance TV Converter! Boost your sales, boost your profits with Alliance—the line that backs you!

2 \$500,000 ad campaign sends sales your way! Alliance keeps spring promises!

TV Spots—eye-compelling "home" demonstrations—more than 16 million viewers on more than 100 stations—*this is our fifth straight year of TV advertising!*



ALLIANCE TV CONVERTER
adds all new UHF channels. Advertised on TV! The quality converter built to last! **\$42.50**



— full-page ad in this top consumer magazine! Newspapers—dominant, sales-making ads in key markets! Point-Of-Sale Displays—full-color, on-the-spot reminders!

OVER ONE AND ONE-QUARTER MILLION ALLIANCE TENNA-ROTORS NOW IN USE!

ALLIANCE MANUFACTURING CO., ALLIANCE, OHIO

KAY-TOWNES

Announces

the new
Super

"KATYS"

(PATENTS PENDING)

Highest Gain

**ALL-CHANNEL VHF ANTENNAS
EVER DESIGNED!**

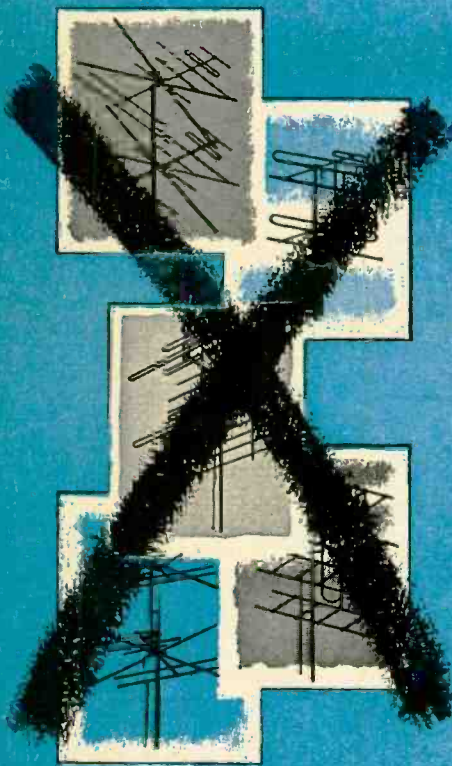

GUARANTEED

**TO OUT-PERFORM ANY OTHER
ALL-CHANNEL VHF ANTENNA
ON THE MARKET**

Practically every TV Antenna maker in America has made just such statements as these . . . *but, there is a big difference in making these broad claims and then being able to back them up!*

WE CAN! We are prepared to run a PERFORMANCE TEST with *anyone . . . anywhere . . . anytime . . .* to prove the vast superiority of the new SUPER "KATYS" over all other all-channel VHF antennas . . . regardless of manufacture, design, type or number of bays!

IN FACT, WE WILL POSITIVELY AND ABSOLUTELY GUARANTEE THAT OUR SINGLE-BAY SUPER KATY WILL OUTPERFORM ANY VHF 4-BAY ANTENNA MADE TODAY!

Our 2-Bay SUPER KATY is designed for *extremely difficult* reception areas. It has been tested in many practically impossible locations . . . **AND HAS NEVER FAILED TO BRING IN A PICTURE RATED EITHER "VERY GOOD" OR "EXCELLENT"!**



4½ Years **IN DEVELOPMENT...**

**THE AMAZING SUPER KATY DESIGN MAKES OTHER VHF ALL-CHANNEL ANTENNA DESIGNS AS OBSOLETE AS THE HORSE AND BUGGY!
WE CHALLENGE YOU TO TEST IT . . . ANYWHERE!**

Super
KATY-2
2-BAY

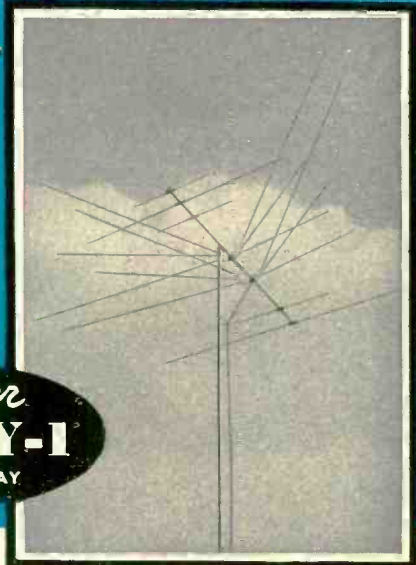

Super
KATY-1
SINGLE-BAY



Now **THE WORLD'S FINEST ALL-CHANNEL VHF RECEPTION!**

The SUPER KATY all-channel VHF antennas feature a twin-driven array with a combination of special cut elements for a close 300 OHM impedance across the entire VHF Band. This feature in conjunction with the long, accumulative fan dipoles, with directors and reflectors properly cut and spaced, results in performance never before obtained by any antenna design . . . including our own "BIG JACK", whose design has been so widely "hijacked".

Actual tests show that the Single-Bay KATY-1 will outperform any 10-element Yagi on every channel, 7 through 13 . . . and will perform as well as any 10-element Yagi on every channel, 2 through 6.

	List Price
SUPER KATY-1	\$25.00
Single-Bay	
SUPER KATY-2	\$50.00
2-Bay	

K-T Antennas are sold through selected distributors only . . . write for name of your nearest jobber.

KAY-TOWNES
ANTENNA COMPANY
ROME, GEORGIA

Recognized leaders in the field of fringe area antenna design

MORE ABOUT ATTENUATORS

Maintaining proper attenuation and impedance reflection when connecting two different impedances

By N. H. CROWHURST

IN THE preceding article (page 36, December) on the design of constant impedance attenuators, the author stated that attenuators perform correctly only when properly terminated. If terminated with impedances other than those on which the design is based, both attenuation and impedance reflection through the attenuator become incorrect. Two of the three charts here deal with the result of using an attenuator of the constant-impedance type with incorrect impedances, while the third shows how to design matching pads for connecting together two dif-

ferent impedances so that both terminating impedances are matched.

Chart I is a simple alignment abac (alignment chart or monogram) with two impedance scales on the outside and a reference line in the middle, giving on the left, the ratio between the impedances on the outside scales, and on the right, the mismatch loss resulting from connecting these impedances together.

If a constant-impedance attenuator is connected to one of the working impedances, and is correctly designed for (TEXT CONTINUED ON PAGE 120)

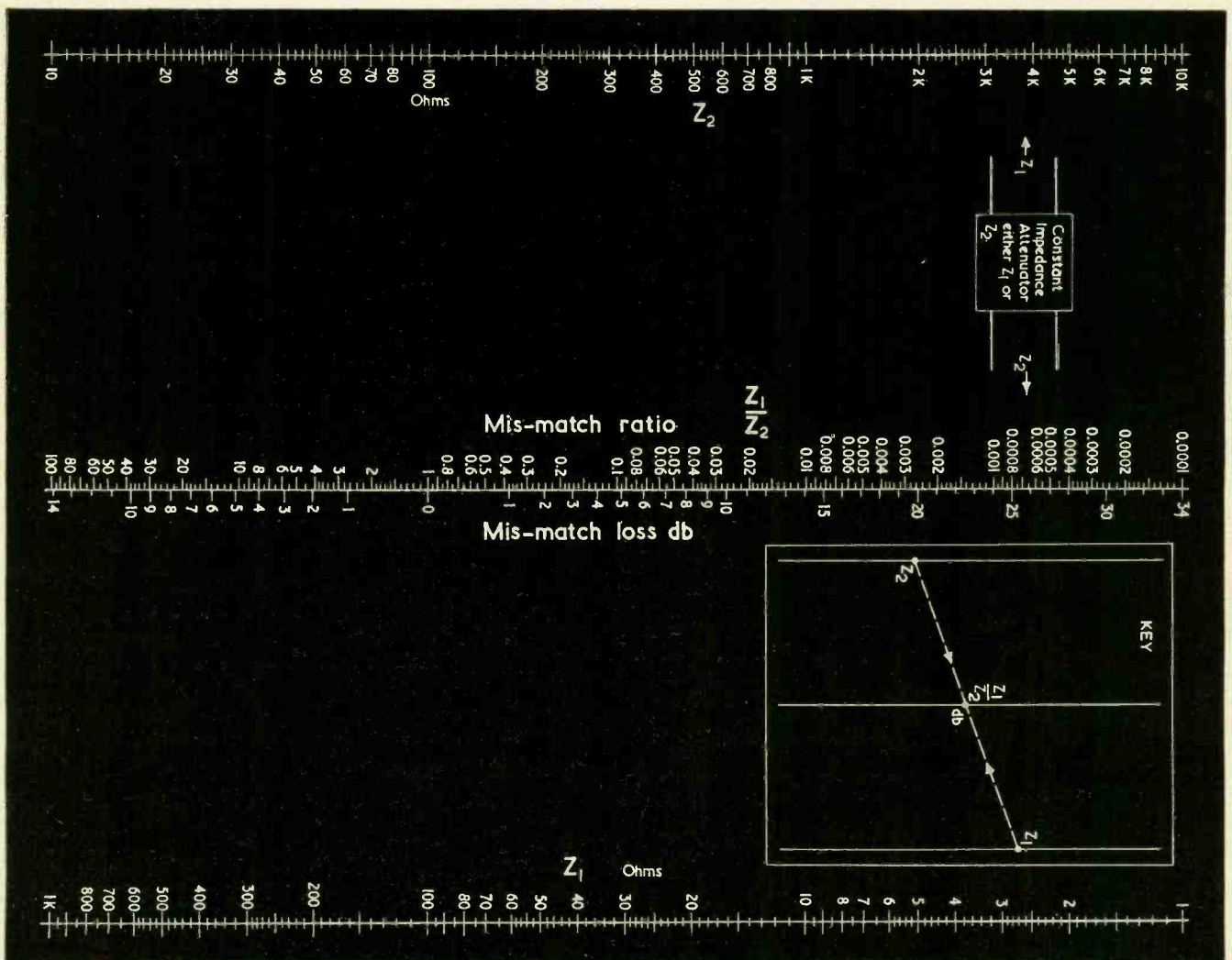

Chart I—Reference line in the middle gives the ratio between the impedances and attenuation resulting from mismatch.

DISCOVER WHAT **GOLD**

AND 2 INCHES OF AIR

DO FOR

2

NEW

WALSCO ANTENNAS

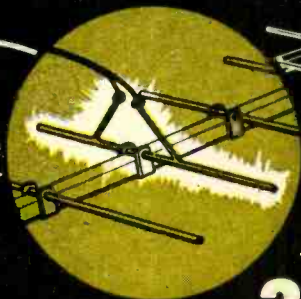

AMAZING
3 YEAR
GUARANTEE

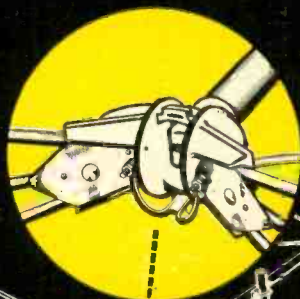

● **NEW WALSCO GOLD DIPOLE YAGI (UHF)**

No less than 24 kt. gold plating on the receiving dipole of this great, new, 10 element Yagi. Why gold? Because gold resists corrosion better than any other metal... and gold is an excellent conductor. Like the most powerful radar antennas, the Walsco Gold Dipole Yagi guarantees permanent high gain in any location, under all weather conditions. It's custom-made for each location. The *only* Yagi that carries a 3 year unconditional guarantee! And it costs no more than conventional Yagis.

● **NEW WALSCO IMPERIAL CONICAL (VHF)**

Here's the first radical improvement in Conicals. A new insulator which utilizes "barrier discs" and 2 inches of air space between the terminals prevents "shorts." Soot deposits, dirt, moisture, salt, etc., cannot affect the insulator. This great, new Conical will therefore maintain high gain performance under any and all weather conditions. Front-end hardware is stainless steel to prevent corrosion losses permanently. Takes only 2 minutes to assemble because there's no loose hardware. Nothing compares to the Walsco Conical at any price... and it's backed by the *only* 3 year unconditional guarantee!

Write for complete information

WALSCO ELECTRONICS CORPORATION

3302 Crenshaw Boulevard, Los Angeles 16, California

The complete line of AMPHENOL VHF and UHF antennas are a dealer's best investment in his business—selling up to quality with AMPHENOL results in customer satisfaction and better profits.

AMPHENOL dealers have a wonderful prestige in their community. Set owners equipped with an AMPHENOL antenna can see the difference in the picture quality of their set and sets receiving with other makes of antennas. They are pleased that their dealer recommended the best antenna—and they let their friends know about it. The reputation of AMPHENOL dealers for quality is very satisfying to them and to AMPHENOL.

IT PAYS
TO SELL
UP TO
QUALITY

Better business also results from selling up to quality. Sales increase, profits increase, dealers prosper. An important savings in service calls is made with quality AMPHENOL antenna installations—the antenna stays up, provides top reception for years.

Prosperity and prestige have proved an unbeatable combination for every AMPHENOL dealer.



AMERICAN PHENOLIC CORPORATION
chicago 50, illinois



114-005

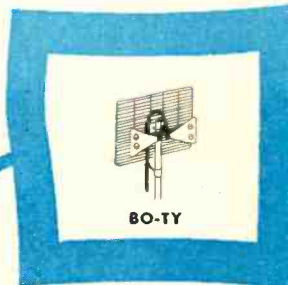

114-065

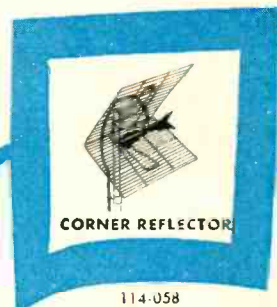

114-058



114-060

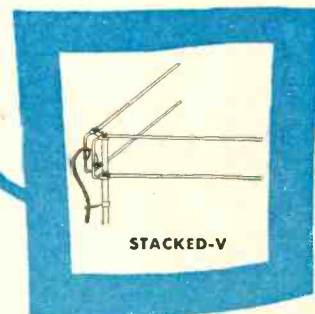

114-059



114-054

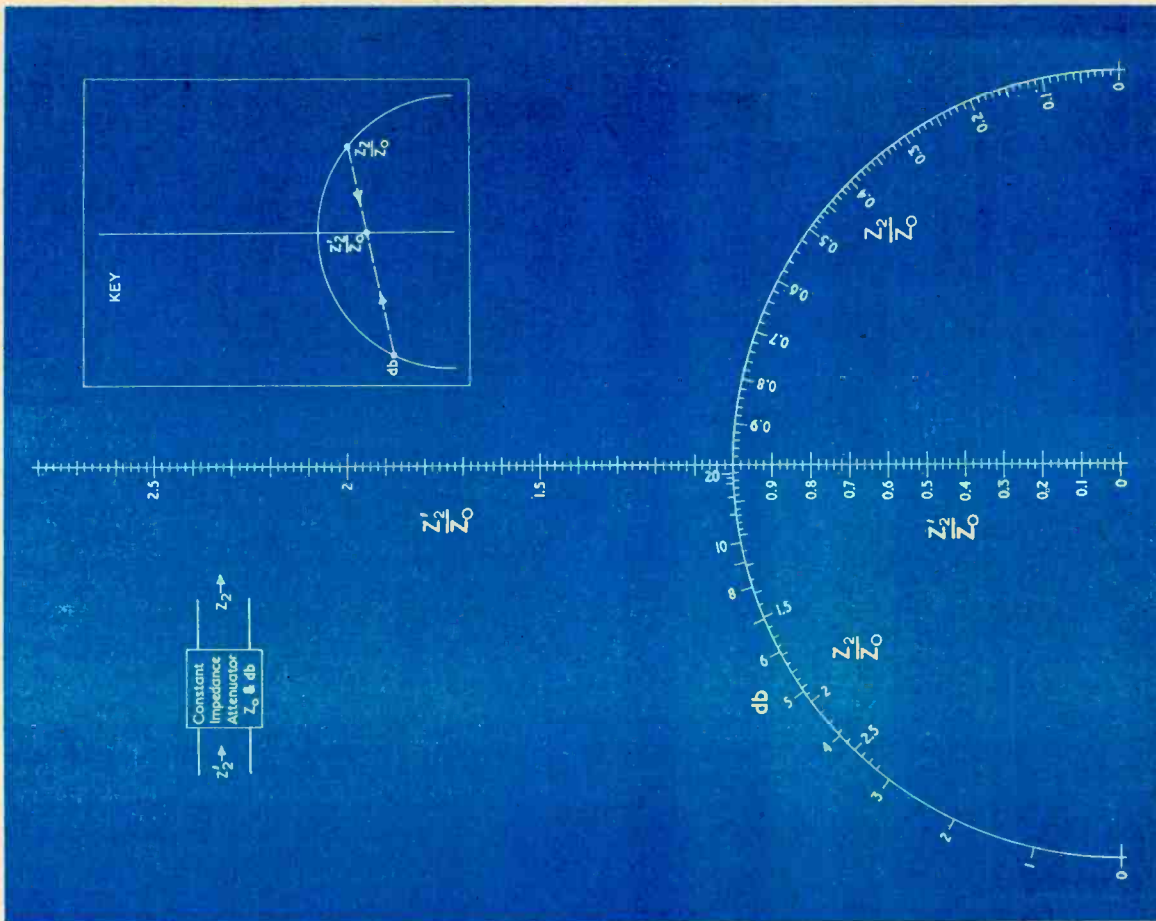

Chart II—For determining mismatch reflection through the attenuator when attenuator is improperly terminated.

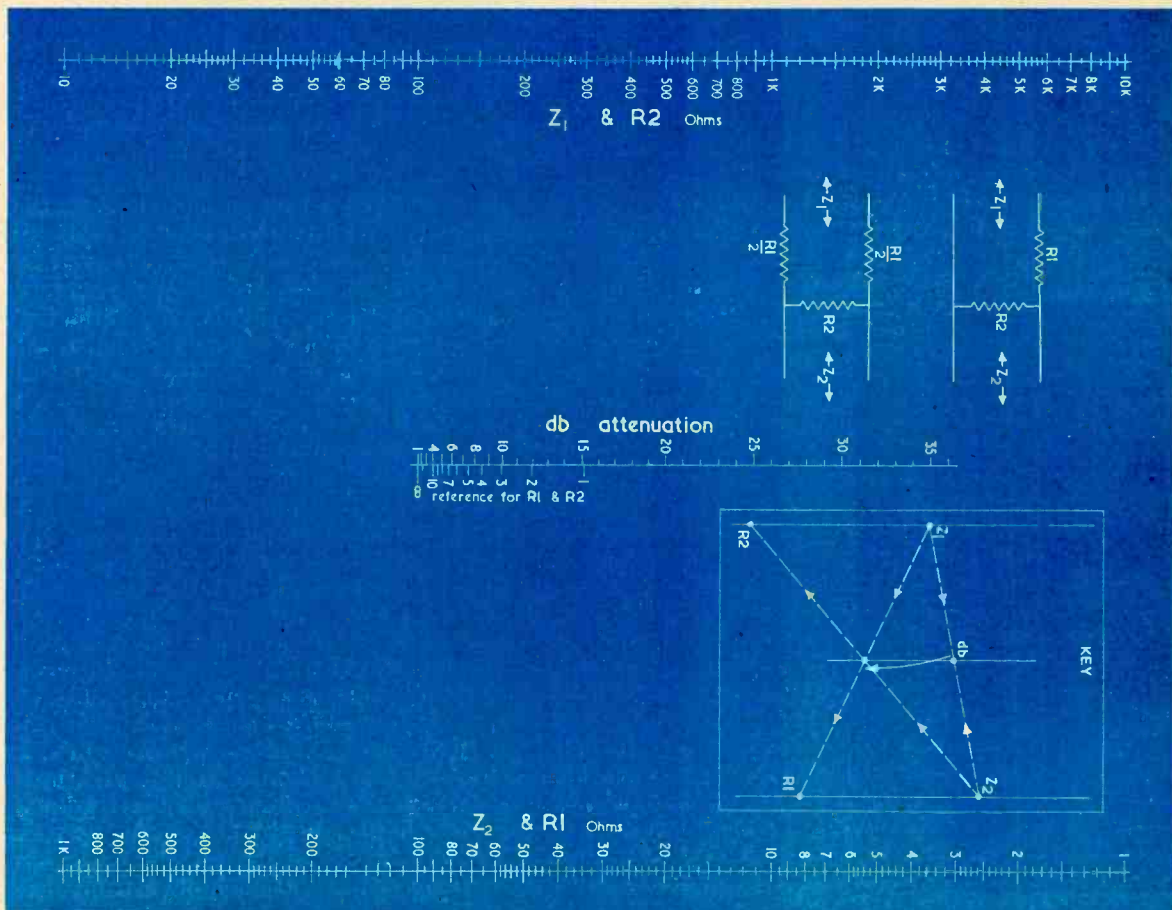
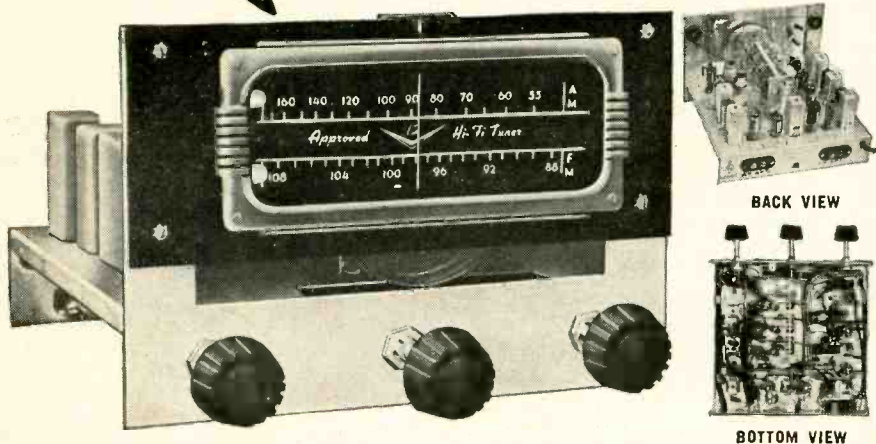

Chart III—To determine minimum attenuation necessary for correct matching, and resistor values required for L-pads.
 JANUARY, 1954

WAS \$85.00
NOW \$41.95
SAVE \$43.05



12 TUBE HI-FI FM-AM TUNER AT FABULOUS 50.6% SAVINGS!

TREMENDOUS NATIONAL ACCEPTANCE!

Just a few weeks ago, Radio Shack contracted to buy the ENTIRE output of Approved Electronic's new V-12 tuner. As soon as the word got around that a REAL hi-fi bargain was available, orders have literally poured in; we shipped them out just as fast as they rolled off Approved's assembly line. Yet our stock position now enables us to guarantee AT ONCE delivery — at least for the next few weeks!

EXCLUSIVE AT RADIO SHACK CORP.!

The brilliant new Approved V-12 is available ONLY at Boston's famous Radio Shack — nowhere else in all the world. And at no other place can you buy a 12-tube, double-limiter/FM detector, FM-AM tuner for \$41.95 (or even \$71.95)!

GUARANTEED FM SENSITIVITY!

We flatly (and proudly) guarantee 15 microvolt sensitivity for 20 db quieting on FM, and better in many instances! Compare! Also, the AM sensitivity is far better than V-12's antecedent, the highly regarded Approved A-710.



SEPARATE V-12 POWER SUPPLY

110-115V 50/60 cy. Delivers 6.3V @ 4A, 190V DC @ 55 ma. Only 3/2 x 4 1/2 x 8", weighs 7 lbs. Built for V-12.
 Order No. 36-207..... Net \$12.05

Yes! All This For \$41.95 —

- 12 miniature tubes
- Germanium Diode
- Double limiters
- Tuned RF FM
- Tuned RF AM
- Separate RF, IF stages on FM, AM
- 6-gang condenser
- Cathode follower output 30-15,000 cps
- Band-indic. lamps
- 15 uv sensitivity FM
- Ultra compact chassis
- 8 1/4 W x 5 3/8 H x 8 D.
- Full RETMA guarantee
- Requires 6.3V AC @ 4A, 190V DC @ 55 ma supply.
- Order No. 36-207, 7 lbs.

NOTE: For use with any amplifier, TV, radio; designed especially for high quality hi-fi home systems.

ORDER BY MAIL, PHONE, WIRE! FREE 224-PAGE CATALOG!

RADIO SHACK CORPORATION
 167 Washington St., Boston 8, Mass. (Dept. RE)

that impedance, the presence of the attenuator will not affect the mismatch loss, because the impedance reflected to the opposite terminals will be the same as the correct impedance terminating it. This applies to only those attenuators, either where the constant impedance characteristic applies for both directions, or, in the case of L pads, where the attenuator is correctly terminated in the direction for which it is designed to have constant impedance. It would be pointless to extend the chart for other cases using L pads, because there seems to be no reason why the correct matching type L pad could not be used.

The mismatch loss, over and above the attenuation of the attenuator, will be quite independent of either the type of attenuator or the amount of attenuation for which it is designed.

Chart II deals with the mismatch reflection through the attenuator. The diagram on page 119 shows that the attenuator is designed for a working impedance Z_0 and a specific attenuation in db. It is, however, improperly terminated by the impedance Z_2 . As a result, the chart shows what impedance will appear at the opposite end of the attenuator, represented by the symbol Z_2' . The type of attenuator is unimportant. What affects the mismatch reflection is the design figure of attenuation for the particular unit.

It is also unimportant whether the designed attenuation is achieved in one stage or in a number of separate stages. For example, the mismatch reflection would be the same through 40 db of constant-impedance attenuation, whether this was made up in a single pad, or of a number of separate pads of, say, 20 plus 10 plus 5 plus 2 plus 1.

Example 1

A constant-impedance attenuator designed for 5,000 ohms is terminated by a resistance load of 5 ohms resulting in a mismatch loss.

To find the mismatch loss: Chart I, using Z_2 5,000 ohms and Z_1 5 ohms, gives 24 db. Using Chart II to find the mismatch reflected impedance, Z_2'/Z_0 , as given from Chart I, is .001, which will be indistinguishable from zero at the right-hand side of Chart II. This means, that, to all intents and purposes, a 5-ohm resistance connected to a 5,000-ohm attenuator is a short circuit. Suppose the attenuation is designed for 20 db, then by using the straight-edge, or ruler, as shown in the key on Chart II, Z_2'/Z_0 is given as .98, which means the input impedance is .98 x 5,000 ohms, or 4,900 ohms.

If the attenuation was 10 db, Z_2'/Z_0 becomes .82, making the impedance at the input end of the attenuator 4,100 ohms.

Example 2

An attenuator is designed for 250 ohms and is actually terminated by 600 ohms. Using Chart I, the ratio Z_1/Z_2 is 2.4, and the mismatch loss attenuation is slightly less than 1 db.

NO ROTORMOTOR-YET ALL DIRECTION UHF-VHF RECEPTION

53 CLAIMS GRANTED IN 5 U. S. PATENTS

- #2,585,670
- #2,609,503
- #2,625,655
- #2,644,091
- #2,661,423
- OTHERS PENDING



Guaranteed
60 mi UHF
60 mi VHF

SUPER 60

LIST PRICE
\$36.75
SEE YOUR
JOBBER

UP TO

10 TIMES MORE POWERFUL
THAN ALL OTHER ANTENNAS
Solves Your Problem in Your Area

Guaranteed
40 mi UHF
40 mi VHF

SUBURBAN 40

LIST PRICE
\$24.50
SEE YOUR
JOBBER

The Super 60 is the general purpose model for conditions prevailing in most communities today. Within a short time 15 to 20 UHF-VHF stations will be on the air within a 60 mile radius of every fair sized community. With the installation of the Super 60, you are improving your present reception in all directions and you are ready for the future.

The Suburban 40 has been developed for suburban areas where the stations are closer and trouble with distance is less of a problem — but the advantage of all direction all channel reception is necessary. A low priced high quality antenna for the present and the future.

Here is the real go-getter of the All Channel family. The Ultra 150 reaches out at long distances on VHF and gives you a bright, clear picture 150 miles and more. This antenna has solved the problem for thousands throughout the country where long range reception was otherwise impossible.

9 POSITION ELECTRONIC ORIENTATION SWITCH



PRICE INCLUDES

Antenna arrays - necessary stacking bars - 9 position switch - switch-to-set coupler - necessary hook-up harness - 7 1/2" stand-offs Individually boxed in mailable carton.

Yes, we said YOUR area. With the FCC allocating over 2,000 new TV Stations covering 12 VHF and 70 UHF channels, your area is due to change and you will require an antenna able to receive both UHF and VHF channels from all directions. All Channel Antenna Corp. has just the antenna to fill your needs and money back guaranteed to positively bring you at your location, clearer, sharper, pictures than any combination of present day antennas using expensive rotor motors, boosters, etc. With a flick of the 9 position electronic beam selector switch, any station in any area is instantly brought in on any TV set clearer and sharper.

NEW POLYMICALENE 4 CONDUCTOR TRANSMISSION LINE

- Low Loss External Air Dielectric
- Matched Impedance
- Eliminates End Sealing
- Eliminates Condensation
- Up to 50% Less Loss Than Tubular When Wet
- Easily Spiraled
- No Breaking or Shorting
- Patents Pending - T. M. Reg.

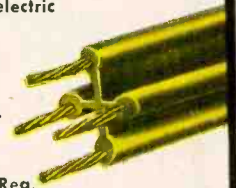

While antenna reception is guaranteed as specified, perfect pictures have been consistently received from 2 to 3 times these distances.

Guaranteed
100 mi VHF
30 mi UHF

ULTRA 150

LIST PRICE
\$43.50
SEE YOUR
JOBBER

ALL CHANNEL ANTENNA CORP.

70-07 Queens Blvd., Woodside 77, N. Y.

Hickory 6-2304

NOW - GREAT precise TWO GREAT OSCILLOSCOPES

(IN KIT OR WIRED FORM)

THE NEWEST, THE ONLY ONE OF ITS KIND!

8½" OSCILLOSCOPE: PRECISE MODEL #308

Now another great Precise Oscilloscope! The only 8½" Oscilloscope on the Commercial Market... in Kit or Wired Form... at an unbelievably low price. Designed to bring you true TV picture clarity and laboratory tested accuracy.

ALL THE OUTSTANDING FEATURES OF THE MODEL 300 as shown below, PLUS:

- ★ INTENSIFIER ANODE
- ★ HI-LOW-NORMAL SYNCH. (A Precise First)
- ★ 8½ INCH TUBE (A Precise First)
- ★ VOLTAGE REGULATION (A Precise First)

"Seeing is Believing"—Go and See! your nearest jobber

308K—kit form..... **\$129.50**

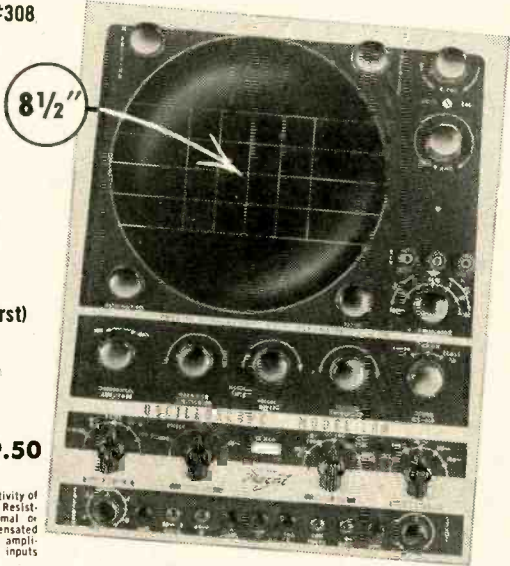

SPECIFICATIONS: PRECISE MODEL 300 OSCILLOSCOPE
VERTICAL — Vertical-lit (300) DC through 5 megacycles with sensitivity of greater than 10 millivolts push-pull (3.94 Millivolts/cm). Constant Resistance. Push-pull input immediately converted to single-ended normal or reverse phase by shunting bar at inputs 1 and 2; Frequency compensated vertical stepping attenuator selects AC or DC inputs. Push-pull DC amplifiers from input through output; Internal electronic mixing through inputs 1 and 2; five-way binding posts.
POSITIONING — Bridge type positioning on vertical and horizontal does not vary tube characteristics.
HORIZONTAL — Frequency compensated stepping attenuator in horizontal amplifier; Push-pull Horizontal out.
BLANKING — Internal (return trace blanked), external (return trace not blanked), 60 cycle or 120 cycle Blanking through Blanking amplifier circuit.
SYNCHRONIZATION — External, Internal Positive, Internal Negative, Internal 60 cycle or internal 120 cycle synchronization.
SWEEP RATE — Driven or non-driven linear sweeps from 1 cycle to 40KC in five ranges (1-10 cycles uses external C circuit). Trigger potentiometer.
MAGNIFIER — Electronic magnifier and magnifier positioner allows any part of a signal to be magnified up to ten times (equivalent to 70 inches of horizontal deflection).
CALIBRATION — Internal square wave calibrator and potentiometer for using oscilloscope at a VTVM on Peak to Peak measurements.
CALIBRATION SCREEN — Edge-illuminated scale and graticule may be turned on or off; filtered screen.
OUTPUTS ON FRONT PANEL — Plus Gate output; Sawtooth output; 60 cycle phasing output; 60 cycle unphased output; Calibration output
FOCUSING — Astigmatism, focus and Intensity Control.
CRT — NEW 7" Tube, normally supplied is medium persistence type 71P1 (oscilloscope green trace) — high persistence types available at additional cost.
DIRECT — Deflection plates available from rear of cabinet.
INTENSITY MODULATION — 2 modulation through modulation amplifier
GENERAL — Low loss components; Over-designed fused power supply for additional circuitry. Deeply etched aluminum panel. New parts from original manufacturers — (NO SURPLUS). Steel cabinet, 11" x 14" x 17"; complete with instruction book and all components. Accessories: Model 912(MM) Demodulator Probe and Model 960 Capacity Attenuator Probe available at extra cost — Please see specifications on following pages. There are many additional features and circuits in kit form, which may be added to the Model 300. Please write us for descriptive literature.

300K—kit form — **\$94.95**
 300W—factory wired — **\$199.50**

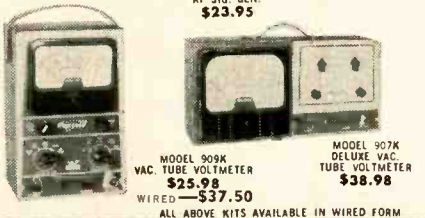
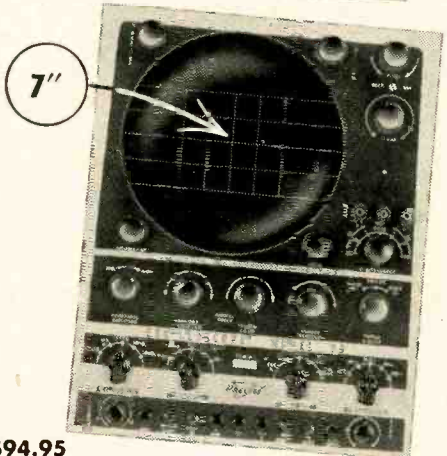

Prices slightly higher in the West. Prices and specifications subject to change without notice.

PRECISE DEVELOPMENT CORP. Dept. RE 25
 999 LONG BEACH ROAD • OCEANSIDE, L. I., NEW YORK

GENTLEMEN: Without any obligation on my part, kindly send me the following:

PRECISE CATALOG
 NAME OF DISTRIBUTOR NEAREST ME

NAME _____
 ADDRESS _____
 CITY _____ ZONE _____ STATE _____

precise
DEVELOPMENT CORP.
 OCEANSIDE, NEW YORK

Turning to the mismatch impedance transfer, using 2.4, Z_2/Z_0 , which is in the left hand part of the arc on Chart II, and supposing the attenuator is designed for an attenuation of 6 db, alignment gives a reading of 1.24 for Z_2/Z_0 . So, the reflected impedance is 1.24×250 , or 310 ohms.

If the attenuation is 20 db, the mismatch drops to a ratio of 1.01, representing 252.5 ohms.

To avoid any trouble due to mismatch, which in r.f. can result in reflections and their consequent troubles as well as just losses (as in television attenuators), it is advisable to design a matching pad so that both impedances are correctly matched. This can be done quite easily with Chart III.

The chart gives the minimum attenuation necessary to produce correct matching, and the resistor values for an L-pad to produce such matching. This pad can of course be combined with further attenuators of the constant-resistance type, designed at either of the working impedances, using one of the charts in the earlier article.

To use Chart III, the two impedances to be matched, denoted by Z_1 and Z_2 , are aligned; and the db attenuation can be found on the left-hand side of the center reference line. The figure from this scale is then transferred to the scale on the right-hand side of the same reference line, and aligned with Z_1 and Z_2 . This locates the values of R_1 and R_2 as shown in the key on the chart.

Example 3

Take the case of 5,000 ohms being matched down to 5 ohms. To do this correctly, using Z_1 5,000 ohms and Z_2 5 ohms, the attenuation is 36 db. On the right-hand center scale, 36 db is so close to the infinity point as to be indistinguishable from it. In aligning 5,000 ohms with this point to find the value of R_1 , the straight-edge falls beyond the bottom of the right-hand line; similarly for the value of R_2 . This can be overcome by dividing by 10 on the Z scales; then converting the R value back again by multiplying by 10. Aligning Z_1 at 500 with the infinity mark gives R_1 as 500, which means its actual value will be 5,000 ohms; similarly R_2 is 5 ohms.

Now consider the case where the impedances are closer—the second example given above—working between 250 and 600 ohms. Using Z_1 as 600 and Z_2 as 250, the attenuation is about 8.8 db. Transferring this to the right-hand reference scale on the center reference line, R_1 is 440 ohms and R_2 is 325 ohms.

Values as calculated from the chart are the exact values required for perfect matching. In practice, the closest preferred value resistor in the 5% or 10% range will probably give a good enough match for all practical purposes. It will almost certainly result in obtaining much closer matching than using an attenuator without giving proper attention to matching. In most cases 10% resistors will do. **END**

-the MOST popular!

C • D • R
R O T O R S

built to last

dependable

powerful

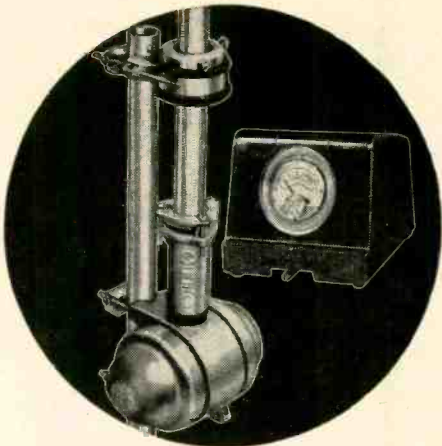

TR-12 ... a special combination value consisting of complete rotor including thrust bearing ... handsome modern design cabinet with meter control dial \$47.95

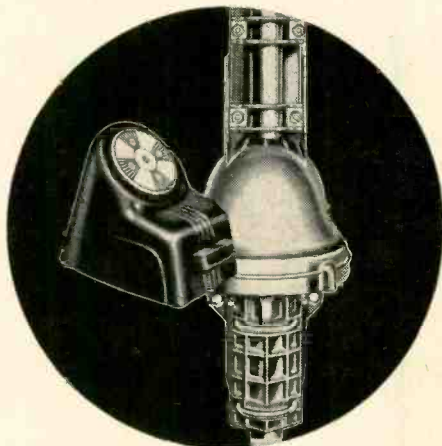

TR-2 ... the HEAVY DUTY rotor especially suited for special TV antenna installations. Complete rotor with "compass control" cabinet having illuminated "perfect pattern" dial \$49.95

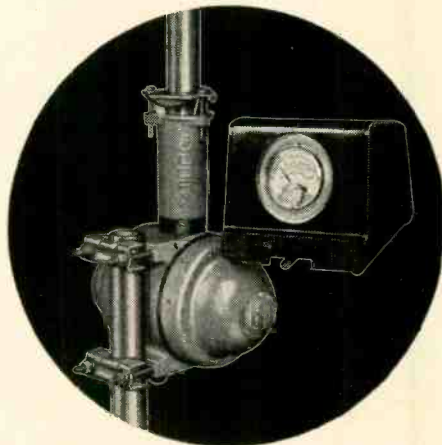

TR-11 ... the same as the TR-12 without the thrust bearing, complete with meter control dial cabinet \$44.95

ONE OF THE WORLD'S LARGEST ELECTRONICS MANUFACTURERS SINCE 1912



CORNELL-DUBILIER
 SOUTH PLAINFIELD, N. J.



THE RADIART CORP.
 CLEVELAND 13, OHIO

NEW! 4 P.E.C.* KITS

Right now there are 100,000,000 radio and TV sets — 4 or more years old — in everyday use. These sets do not have P.E.C.'s. You'll save service time and parts investment — have greater confidence in your service jobs if you replace old-style components with P.E.C.'s. Centralab P.E.C. kits are your best supply source!



PCK-18

18 P.E.C. units. Replace 42 old-style resistors and 52 old-style capacitors.

Net - - - - \$9.00



PCK-110

110 P.E.C. units. Replace 255 old-style resistors and 52 old-style capacitors.

Net - - - - \$55.80



PCK-220

220 P.E.C. units. Replace 525 old-style resistors and 620 old-style capacitors.

Net - - - - \$115.80

All prices subject to change without notice



PCK-45

45 P.E.C. units. Replace 106 old-style resistors and 133 old-style capacitors.

Net - - - - \$24.00

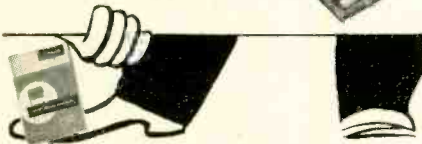

This P.E.C. Guide No. 2 (included with each kit) tells you how and when to use P.E.C.'s. Shows cross indexing — schematics — tells you how to test P.E.C.'s. Get complete details from your CRL distributor or use coupon below.

Centralab

*Trademark — Printed Electronic Circuits

CENTRALAB

A Division of Globe-Union Inc.
922-A E. Keefe Ave., Milwaukee 1, Wis.

Please send name of distributor stocking P.E.C. Kits, also additional technical data.

Name _____

Firm _____

Address _____

City _____ Zone _____ State _____

TRANSISTOR KEYING MONITOR

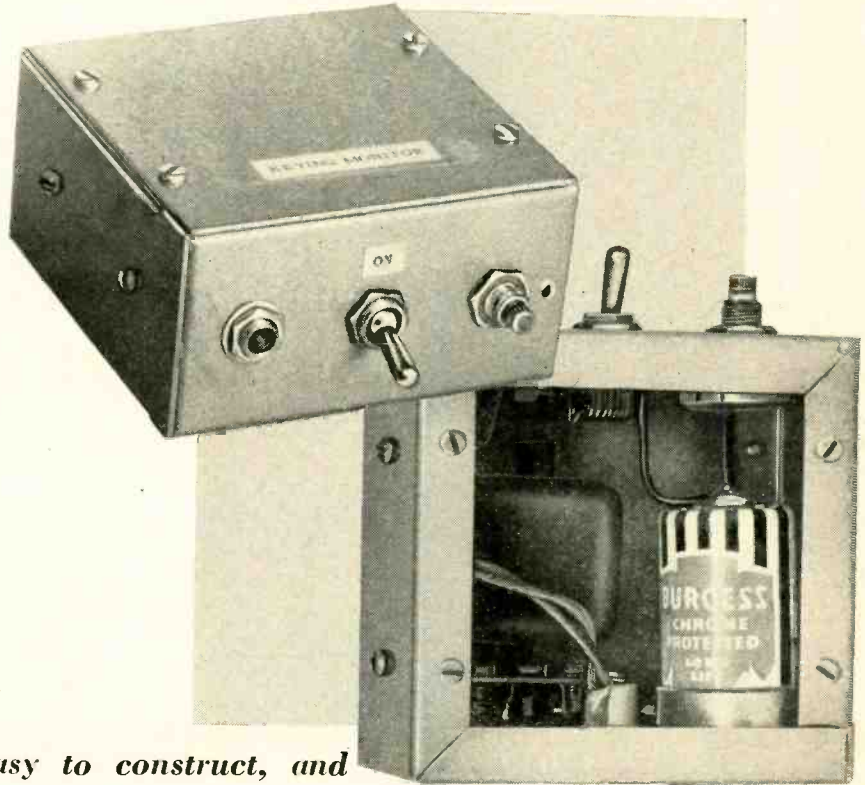

Easy to construct, and easy to use, the monitor makes for clean keying

Upper left, photo of the transistor keying monitor. Above, internal view shows simplicity of construction.

By I. QUEEN

MANY c.w. operators monitor their keying by listening to the blocking of the receiver or to the clicks of the key. These methods are O.K. when sending at slow speeds but are definitely no go when sending at 15 words per minute and higher speeds. Receivers often block for periods long enough to convert a dot into a dash and make the operator stumble over his own fist. Using a bug without a keying monitor is one sure way to make the other fellow break off the contact with some weak excuse like QRM, QRN, or gotta QRT for chow.

This keying monitor makes it possible for you to follow your own keying with ease so you are more relaxed and can really enjoy the contact. Your keying will be cleaner and the fellow on the other end will find it easier to copy and won't be so eager to run off and work someone else. It is so easy to construct and use that no c.w. man should be without one.

The circuit is essentially an a.f. oscillator with trigger characteristics. No positive emitter bias is used, so the

transistor tends to remain blocked. If a positive signal energizes the emitter, the transistor begins to conduct. Current flows in the high-resistance base circuit. Due to the voltage drop in this circuit, a positive bias is placed on the emitter. The transistor, once conducting, tends to remain that way.

The base resistor is adjustable. It may be set to a *medium* value, so that triggering is only temporary. Then the circuit oscillates only for an instant after its emitter is energized. Removing the external signal permits oscillations to die out at once and the transistor blocks again. This is the correct adjustment for a keying monitor. The monitor is coupled very loosely to a transmitter antenna or final tank. When the key is pushed down, the strong r.f. field triggers the transistor and a tone is heard. Releasing the key stops the tone. I didn't need a crystal to rectify the r.f. field. Evidently the periodic disturbance of the r.f. keeps the circuit triggered and operates the oscillator. This circuit will follow dots up to any speed Mackay can transmit.

"BEST FREQUENCY • STABILITY • ACCURACY"

SUMS UP ALL FIELD COMMENT ON THIS LATEST HICKOK TELEVISION ALIGNMENT EQUIPMENT



Model 690

Marker Generator

Crystal controlled. High 25 volt R.F. output. Provides dual markers with any TV sweep generator. This unit features another HICKOK First by incorporating a Non-Parallax shadow type dial. In conventional type dials, error generally is introduced in setting frequencies since the hairline or indicator is at a slight distance from the scale. This distance, however slight, can introduce error if the scale is not viewed directly at right angles.

In alignment of any type of receiver the marker generator is the unit that is to be relied upon and must therefore be consistently accurate in frequency settings. The Hickok Non-Parallax dial can be viewed from any angle without introducing error. The 45 inches of dial can be self calibrated to within crystal accuracy (.05%) since the unit includes a self contained crystal calibrator.

Leading features of this unit are:

- (1) The simple and time saving method employed in calibration of the dial—there is no counting of beats—no interpolation—no remembering of frequencies.
- (2) Provision for calibrating any other signal generator to crystal accuracy.
- (3) Complete R.F. coverage up to and including channel 83. All channels have picture and sound settings marked directly on the scale—this eliminates checking on these values when they become applicable.
- (4) The marker can be modulated by a self contained 400 cycle signal. This is especially valuable in stage-by-stage alignment and eliminates the introduction of another instrument.
- (5) Position for adding two other crystals is provided in addition to the 2.5 Mc crystal which is included.
- (6) It is possible to view two markers at once on the response curve. This will include the main marker and a marker corresponding to the crystal value selected. For instance, a 4.5 Mc crystal may be used to obtain two markers with a 4.5 Mc separation. This will greatly speed up alignment procedures since it is not necessary to re-set dials to check response curve width.
- (7) Both an electronic eye tube and a headphone jack are available for either visual or audible indications of zero beat.
- (8) Attenuation is controlled by both a step attenuator and vernier to attain complete regulation of output.
- (9) The unit is completely double shielded to assure a minimum of leakage.
- (10) All frequencies are covered on fundamentals with the exception of U.H.F. channels. There are no spurious

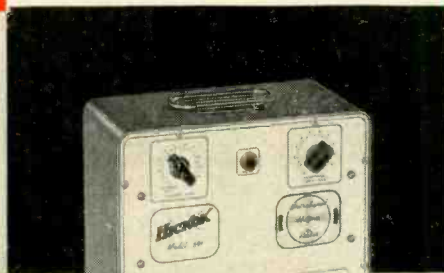

This entirely new and advanced alignment equipment represents the latest HICKOK achievement in offering a complete, fast and accurate solution to TV alignment.

Many leading TV engineers have tested this new equipment and highly compliment its practical design for individual unit use or compatible set use.

The stability frequency and accuracy of this new equipment plus its ease of use make the 690-691-695 today's best tools for a more profitable TV service business.

or confusing beats or frequencies generated by the unit. It is an all around instrument in view of its very complete R.F. coverage.

Model 691

Heterodyned Marker Adder

This unit, in conjunction with the Model 695 Sweep Generator and Model 690 Marker Generator provides the utmost in television alignment techniques. It takes the guesswork out of receiver alignment and eliminates any errors previously introduced by overloading due to markers.

The 691 provides a marker visible at all times (including trap points) and will not change in amplitude or distort the response curve what-so-ever. This feature, in addition to the accuracy and minimum leakage of the other units (690-695), will greatly simplify any alignment.

The outputs of the sweep generator and marker generator are heterodyned and applied to an oscilloscope in such a manner that the marker signal will never pass through the receiver itself—therefore cannot cause overloading.

In short, we can say that we are calibrating the oscilloscope with a marker which is visible at all times—even on the base line.

The 691 is specifically designed as a companion to the HICKOK 690 Marker and 695 Sweep Generator; however, it will work well with any of your present equipment that has an output of 50,000 microvolts or more.

Many leading TV engineers have tested this new Hickok equipment and highly compliment its frequency, stability and ease of use in offering today's fastest, most complete and accurate solution to TV alignment tasks. See your jobber today or write factory direct for complete technical information.

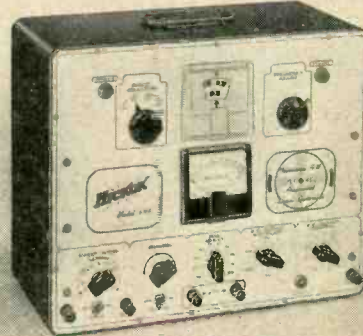

Model 695

Sweep Generator

This is a completely new electronic sweep generator that will exactly fill top requirements of the professional TV serviceman or lab. There are no moving parts to produce vibration or to wear out. This unit, although moderately priced, features a sweep signal that is absolutely linear and without amplitude modulations.

This unit has technical advantages over other sweep generators because:

- (1) The unit is completely triple shielded to insure that there is as little leakage from the unit as is engineeringly possible. It is possible to attenuate the signal down to 3 microvolts, and the unit has a maximum output of 300,000 microvolts.
- (2) A bias voltage, variable from 0 to 12 volts, and metered directly by the voltmeter on the front panel, eliminates the usual time-consuming method of obtaining bias voltage from dry cells. Since this bias voltage is variable with continuous tuning, one can determine more accurately the effects of bias on the overall response curve and can align sets to more sensitive for "fringe area" reception or align them to prevent "overloading" when the station signal is very powerful.
- (3) Three RF oscillators provide complete VHF coverage (Channels 2-13) on fundamentals and heterodyned output IF frequencies 0-50 Mc. This assures a strong signal necessary for aligning "front ends."
- (4) Continuous tuning and an easy-to-read scale marked off in channels literally provides the serviceman with a fool-proof method of alignment.
- (5) An internal method of "retrace blanking" provides a reference base line and eliminates confusion sometimes brought about by retrace curves.
- (6) Even though the sweep width is varied, it will not be necessary to readjust the phasing control.
- (7) As is common to all Hickok Signal generators, a Standby position is incorporated in which the plate voltage is removed from all the tubes leaving filament voltage alone to keep the unit at a constant temperature and ready to operate the moment the Range Selector Switch is rotated.
- (8) The instruction manual accompanying the unit gives complete, detailed and easy-to-follow instructions on correct alignment procedures, uses of the instrument, and a thorough understanding of alignment.

All of these features have been developed with the TV serviceman in mind.

THE HICKOK ELECTRICAL INSTRUMENT COMPANY

10531 Dupont Avenue • Cleveland 8, Ohio

See your parts jobber or write direct for technical details.



BUY DIRECT AND SAVE
'PRE-FAB' COLLINS TUNERS and RECEIVERS
AUDIO PRODUCTS CO.

Two ALL NEW Complete Kits for Every High-Fidelity Need

Collins Audio Products Co. is the way of interest with Collins Radio Co.

Each Collins Tuner Kit is complete with punched chassis, tubes, power transformer, power supply components, hardware, dial assembly, tuning eye, knobs, wire, etc., as well as the completed sub-assemblies: FM tuning units, AM tuning units, IF amplifiers, etc., where applicable. All sub-assemblies wired, tested and aligned at the factory make Collins Pre-Fab Kits easy to assemble even without technical knowledge. The end result is a fine, high quality, high fidelity instrument at often less than half the cost—because you helped make it and bought it direct from the factory.

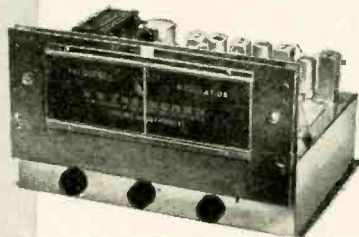

FM Tuner Kit

\$55

The FM-11 tuner is available in kit form with the IF Amplifier mounted in the chassis, wired and tested by us. You mount the completed RF Tuning Unit and power supply, then after some simple wiring, it's all set to operate. 11 tubes: 6J6 RF amp, 6AG5 converter, 6C4 oscillator, 6BA6 1st IF, (2) 6AU6 2nd and 3rd IF, (2) 6AU6 limiters, 6AL5 discriminator, 6AL7-GT double tuning eye, 5Y3-GT rectifier. Sensitivity 6 to 10 microvolts, less than 1/2 of 1% distortion, 20 to 20,000 cycle response with 2DB variation. Chassis dimensions: 12 1/2" wide, 8" deep, 7" high. Illustrated manual supplied. Shipping weight 14 lbs.

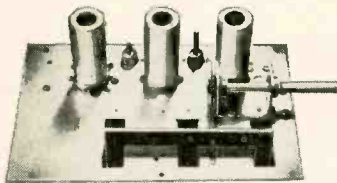

FMF-3 Tuning Unit

\$15²⁵

The best for FM. The most sensitive and most selective type of "front end" on the market. 6 to 10 microvolts sensitivity. Image ratio 500 to 1. 6J6 tuned RF stage, 6AG5 converter, 6C4 oscillator. Permeability tuned, stable and drift-free. Chassis plate measures 6 1/2" x 4 1/2". In combination with the IF-6 amplifier, the highest order of sensitivity on FM can be attained. Tubes included as well as schematic and instructions. Draws 30 ma. Shipping weight FMF-3: 2 1/2 lbs. Dial available @ \$3.85.



IF-6 Amplifier

\$19⁷⁵

A remarkable value! 6 tubes are used in the IF amplifier: 6BA6 1st IF, (2) 6AU6 2nd and 3rd IF's, (2) 6AU6 limiters and 6AL5 discriminator. High gain, wide-band response (200 KC) for highest fidelity. 20 to 20,000 cycles. Distortion less than 1/2 of 1%. Draws 40 ma @ 220 volts. Chassis plate dimensions: 11 1/4" x 2 1/2". Shipping weight: 3 lbs.



AM-4 Tuning Unit

\$24⁵⁰

Tops in AM superhet performance! A 3-gang tuning condenser gives 3 tuned stages with high sensitivity and selectivity. Assembly is completely wired, tested and aligned ready for immediate use. Frequency coverage 540 KC to 1650 KC at a sensitivity of 5 microvolts. Tubes 6BA6 RF amplifier; 6BE6 converter; 6BA6 IF amplifier and 6AT6 detector. Draws 30 ma @ 220 volts. Mounts on a chassis plate measuring 4" x 7 3/8". Shipping weight 2 1/2 lbs. Dial available at \$3.85.

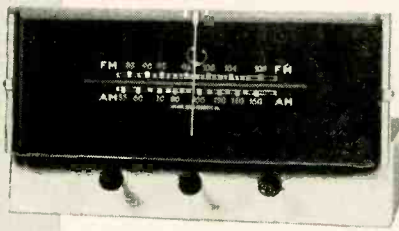

FM/AM Tuner Kit

\$77⁵⁰

The original 15 tube deluxe FM/AM pre-fab kit redesigned on a smaller chassis. The tuner now measures 14" wide by 12" deep by 7 1/2" high. This attractive new front and dial assembly opens up new applications where space is at a premium. Kit includes everything necessary to put it into operation—punched chassis, tubes, wired and aligned components, power supply, hardware, etc. Kit comprises FMF-3 tuning unit, IF-6 amplifier, AM-4 AM tuning unit, magic eye assembly and complete instructions. All tubes included. Shipping weight 19 lbs.

Few adjustments or controls are needed. Finding the proper resistance between switch and ground may require a little experimenting. I found 330,000 ohms O.K. If it is too high, oscillations will continue with the key up. If too low, the circuit may not oscillate.

The base resistor varies tone. It also determines trigger conditions. Near zero, the transistor will be too critical. It will oscillate at the slightest touch of the headphones. Results are best with about 4,000 ohms in the base circuit.

The transformer is the type used in a TV vertical blocking oscillator. It measures 250 ohms across the primary (between GR and BR) and 1,600 ohms across the secondary. There is no reason why high-ratio audio transformers should not work in this circuit.

I have used this monitor on all bands with a low-power (30-watt input) transmitter. The only coupling procedure required is to wrap the short insulated lead from the emitter once or twice around the antenna. Placing it near the final tank also works fine.

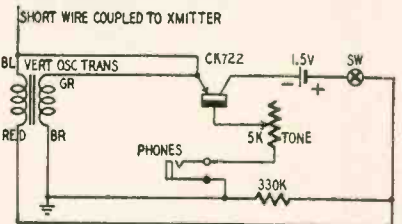

Schematic of transistor keying monitor.

Materials for Keying Monitor

Resistors: 1—330,000 ohms, 1/2 watt; 1—5,000 ohms, potentiometer.

Miscellaneous: 1—vertical blocking oscillator type transformer; 1—transistor, type CK-722; 1—s.p.s.f. toggle switch; 1—1.5-volt dry cell; 1—phone jack; 1—4 x 4 x 2-inch utility box.

This instrument can also serve as an excellent a.f. oscillator. The base resistor varies tone over a fairly wide range, almost 3 octaves. With a larger resistor, the variation is even greater. If much use is to be made of this unit as a generator, it might be better to add a switch to disconnect the high resistance. This will do away with the trigger characteristic and permit the transistor to oscillate at all times.

This circuit has another curious characteristic, mentioned earlier. When used as a trigger circuit, you will find that the instrument is sensitive to mechanical shock as well as acoustic and r.f. signals. For this reason, turn the tone control as near to zero as you can without oscillations. Now, if you tap the headphones ever so lightly, the circuit will be tripped and oscillations will be heard. Speaking or whistling into the phones will do the same thing. Once oscillations begin, they may be stopped by turning off the switch or returning the tone control to maximum. This resets the trigger.

Most c.w. men take pride in their signal quality, and this transistor keying monitor will enable them to hear themselves as others hear them. Its compactness and ease of installation make it a valuable instrument.

END

WHEN YOU THINK OF TUNERS, THINK OF COLLINS AUDIO PRODUCTS

To: Collins Audio Products Co. Inc. RE-1
 P.O. Box 268, Westfield, N. J.
 Tel. Westfield 2-4390

FM Tuner Kit FM/AM Tuner Kit Slide Rule Dial Assembly
 FMF-3 Tuning Unit IF-6 Amplifier AM-4 Tuning Unit

NAME

ADDRESS

CITY STATE

Amount for Kit \$ See weights, add shipping cost \$

Total amount enclosed \$ Check Money Order

MAIL COUPON TODAY

THE SERVICE RUNAROUND

BLOOD AND TEARS

Reprinted by permission
 Copyright, 1953 The New Yorker Magazine, Inc.

Nobody knows what TV repairmen go through—nobody, that is, except other TV repairmen and, because we've been looking into the subject, us. We've learned, for example, that one of the greatest hazards they face in the slow completion of their appointed rounds is children. Hell hath no fury like a tot about to be deprived of even an extremely fuzzy image of Roy Rogers, and TV repairmen invariably try to sneak sets out of the house while children are at school or (but this is chancy) napping. Children are known to have kicked, pommelled, clawed, and bitten men engaged in removing TV sets. Children also go in for making their own TV repairs, often by kicking, pommelling, and clawing the sets. A repairman in Scarsdale tells us he was recently called in to examine a 1948 model that appeared absolutely done for—no image, no sound, nothing. Now, 1948 is the paleolithic, or flint-chipping, era of TV, and the repairman was about to report to the mistress of the house that the set had better be scrapped when a two-year-old, the son of next-door neighbors, darted into the room. The little fellow hadn't yet learned to speak but had evidently been fooling around with TV all his life. Sizing up the situation, he brushed the repairman aside, took off a sandal, and slammed it as hard as he could against the back of the set. There followed a sound of tinkling glass from inside the set, a gummy substance started running out of the bottom of it, and then clear on the screen and loud from the speaker came "Shop, Look, and Cook, with Ruth Bean."

Children not only repair sets; they like to experiment with them. Forcing foreign objects into the cabinet to see what will happen next is the favorite sport of many an infant Edison, and in the past few years repairmen have reaped a rich harvest of pennies, buttons, paper clips, marbles, and dead grass.

Occasionally, a TV set will outdo itself by accident. Take the case of a set we've heard about that, thanks to the combination of a defective tube and a film of furniture polish on the screen, managed to produce a sort of color. The owner of the set was furious when a well-meaning repairman, summoned to adjust the antenna, replaced the tube, and the screen reverted to plain old black-and-white.

Some accidental improvements are both pleasant and alarming. Not long ago, a lady in Forest Hills discovered that whenever she turned on her set, her living room began to smell exactly like the cider mill on her grandfather's farm in New England, which she hadn't visited in twenty years. Luckily, she got in touch with her repairman before getting in touch with her doctor, and he traced the singular fragrance to its source. One of the children in the house had emptied a jar of apple jelly into the set, and as the tubes warmed up,

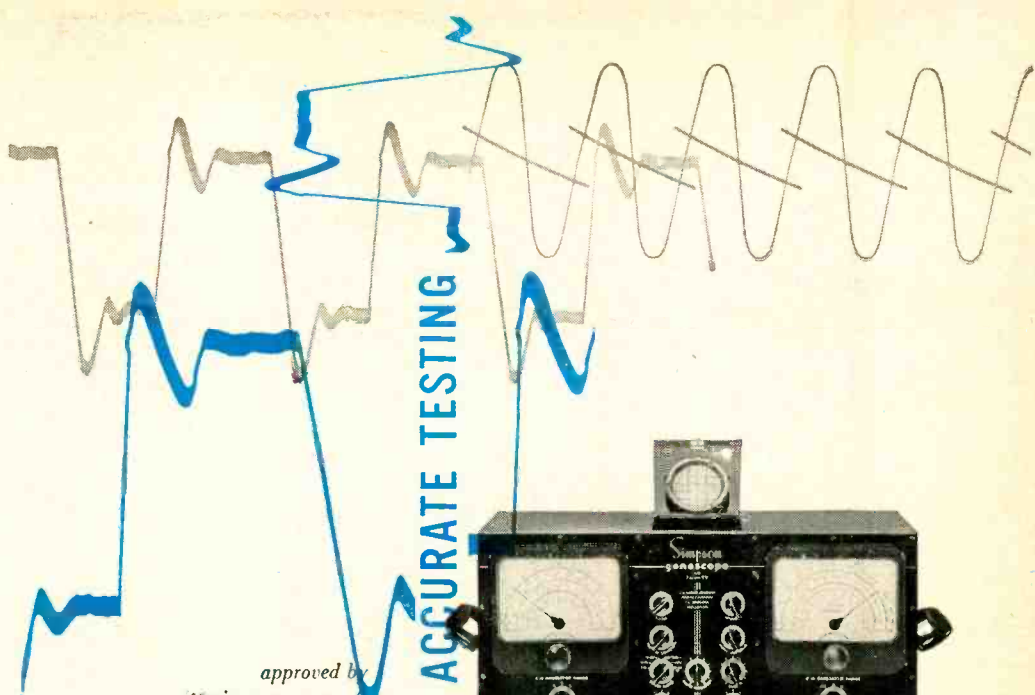

approved by
 service managers of

admiral
 zenith
 motorola
 emerson
 hoffman
 hallicrafters

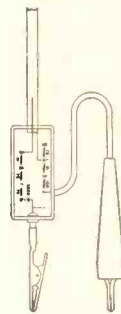

SIMPSON MODEL 480 GENESCOPE FOR ACCURATE TESTING

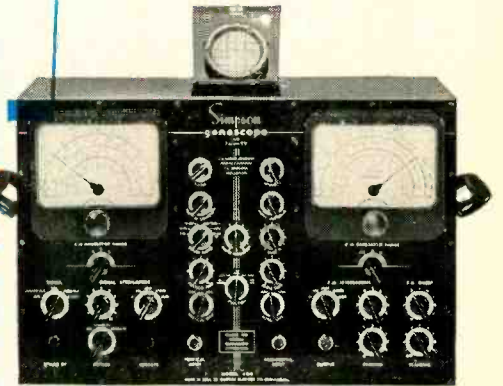

- All the necessary signal sources for alignment of FM and TV receivers • Includes the Simpson High Sensitivity Oscilloscope and high frequency crystal probe for signal tracing • Independent, continuously variable attenuators and step attenuators for both AM and FM units offer complete control of output at all times • 0-15 megacycle sweep is provided by a noiseless specially designed sweep motor based on D'Arsonval meter movement principles • The exclusive Simpson output cable (illustrated) includes a variable termination network, quickly adapted to provide open, 75 or 300 ohm terminations—the addition of a pad provides attenuation and isolation. Use of appropriate resistors across certain terminals will provide any other termination required. A .002 MFD blocking condenser can be added on any termination for use on circuits containing a DC component • The FM generator output voltage is constant within .2 DB per MC of sweep.

dealer's net \$475.00

SIMPSON ELECTRIC COMPANY

5200 W. Kinzie St., Chicago 44, Illinois • Phone: ESTebrook 9-1121 • In Canada: Bach-Simpson, Ltd., London, Ont.

25-5229

BURTON BROWNE ADVERTISING



... **FIRST CHOICE** with
 servicemen because
Fenwire is BEST by TEST

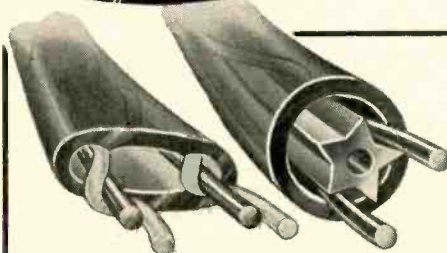

*FENTUBE-AIRSPACED and *TWISTTUBE are outstanding for high performance—low loss—stable characteristics under all atmospheric conditions—reduced interference pick up—reasonable price.

Write Dept. RE-1 for literature on complete FENWIRE line including "TUF-GUY" ... finest guywire made.

(Sold through jobbers only.)

*U.S. & British Pat. Pending

FENTON COMPANY • 15 Moore Street, N. Y. 4, N. Y. Tel. BOWling Green 9-3445

THIS BOOK HELPS YOU

Make Increased Profits

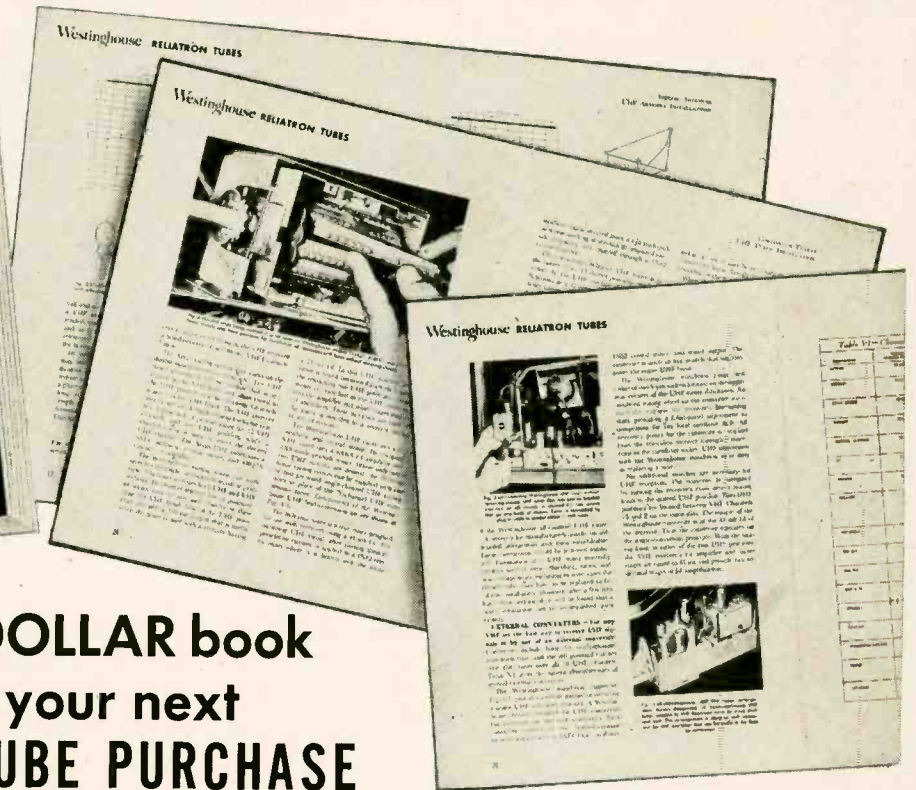

Get this **ONE DOLLAR** book
FREE with your next
25-TUBE PURCHASE

This newest, most helpful book on UHF conversions is yours free when you buy 25 RELIATRON receiving tubes or one picture tube from your Westinghouse Distributor.

This vital handbook covers conversion data, tuners and converters, antenna installations, channel frequency charts, station coverage, and many other necessary, conveniently arranged facts you will need.

There's a gold mine in UHF conversions. And this book will help you make the most out of

the biggest profit opportunity since television came alive.

Get this dollar value for no extra charge with your next order of 25 tubes! For your nearest Westinghouse Distributor, see the list of all Distributors of Westinghouse RELIATRON Tubes on the opposite page.

Act Now for
UHF PROFITS

See Westinghouse Tube Listings in 1954 Photofact Folders.

ET-95046

YOU CAN BE SURE... IF IT'S
Westinghouse

RELIATRON TUBES
TM

WESTINGHOUSE ELECTRIC CORPORATION, ELECTRONIC TUBE DIVISION, ELMIRA, N. Y.

RADIO-ELECTRONICS

Get the Newest, Finest
UHF Conversion Handbook
 from one of these Westinghouse Tube Distributors
FREE with your next 25-tube order

ALABAMA

Birmingham — James W. Clary Co.
 Birmingham — Moore-Handley Hardware Co.
 Mobile — Moore-Handley Hardware Co.

ARKANSAS

Little Rock — Southern Radio Supply

CONNECTICUT

Bridgeport — Hatry of Bridgeport
 Danbury — Pilgrim Electronics Co.
 Hartford — Hatry of Hartford
 New Haven — Hatry of New Haven
 Stamford — Hatry of Stamford
 Waterbury — Hatry of Waterbury

DELAWARE

Wilmington — D & M Radio Sales & Service Co.

DISTRICT OF COLUMBIA

Washington — Electronic Wholesalers, Inc.
 — Silberne Radio & Electronics Co.

FLORIDA

Jacksonville — Bay Co.
 — Thurow Distributors Inc.
 Miami — Herman Radio Supply Co.
 — Thurow Distributors Inc.
 Orlando — Thurow Distributors Inc.
 Pensacola — Grice Radio & Electronics Supplies
 St. Petersburg — Thurow Distributors Inc.
 Tallahassee — Thurow Distributors Inc.
 Tampa — Thurow Distributors Inc.
 West Palm Beach — Thurow Distributors, Inc.

GEORGIA

Atlanta — Herndon-Thomas Electronics
 — Specialty Distributing Co.
 — Yancey Co., Inc.
 Albany — Specialty Distributing Co.
 Augusta — Specialty Distributing Co.
 Macon — Specialty Distributing Co.
 Savannah — Specialty Distributing Co.
 — Yancey Co., Inc.

ILLINOIS

Alton — Radonics Alton, Inc.
 Chicago — Broadwin Radio & TV, Inc.
 — Chauncey's, Inc.
 — Clayton Radio Parts
 — Irving Joseph, Inc.
 — J. G. Bowman & Co.
 — Radio Parts Co.
 — Walker-Jimison, Inc.
 Danville — Bud Electronic Supply Co.
 Elgin — Elgin Electronic Supply
 Joliet — Joliet Radio Supply
 Kankakee — Radio Doctors Supply House
 Oak Park — Melvin Electronics, Inc.
 Peoria — Warren Radio Co.
 Rockford — Superior Radio Co.
 Rock Island — Tri-City Radio Supply, Inc.

INDIANA

Angola — Shaw Engineering Co.
 Columbus — H. A. Williams & Co.—Radio Parts
 Evansville — Hutch and Son
 Ft. Wayne — Wall Distributing Co.
 — Warren Radio Co.
 Hammond — Broadwin Television & Radio,
 Inc. of Indiana
 Indianapolis — Graham Electronics Co. Inc.
 — Meunier Radio Supply Co.
 — Warren Radio Co.
 Marion — Mobile Radio Supply Co.
 Terre Haute — Archer & Evinger
 Valparaiso — Jess Bowman & Assoc.

IOWA

Cedar Rapids — Gifford-Brown, Inc.
 Council Bluffs — World Radio Laboratories
 Davenport — Tri-City Radio Supply
 Des Moines — Gifford-Brown, Inc.
 — Radio Trade Supply Co.

KANSAS

Pittsburg — Pittsburg Radio Supply
 Topeka — Overton Electric
 Wichita — Radio Supply Co.

KENTUCKY

Lexington — Lex-Tronics
 Louisville — Peerless Electronic Equipment Co.
 — Universal Radio Supply Co.
 Paducah — Warren Radio Co.

LOUISIANA

Baton Rouge — 'Ole Miss Supply
 New Orleans — Atlas Radio Supply
 — Crescent Radio & Supply Inc.
 — 'Ole Miss Supply
 — Pelican Radio Supply
 Sulphur — General Electronic & Engineering
 Service Corp.

MAINE

Hallowell — Powell Radio Supply

MARYLAND

Baltimore — Wholesale Radio Parts Co. Inc.

MASSACHUSETTS

Boston — Commercial Radio Corp.
 — Gerber Radio Supply Co.
 — Lincoln Electronic Supply Corp.
 — Radio Wire Television, Inc.
 Lynn — Essex Electrical Supply Co. Inc.
 Natick — Willett Radio Supply
 New Bedford — E. A. Ross & Co.
 Springfield — Regent Sales, Inc.

MICHIGAN

Battle Creek — Electronic Supply Corp.
 Benton Harbor — Benton Electronic Supply
 Co., Inc.
 Detroit — Glendale Electronic Supply
 Flint — Lifsey Distributing Company
 Grand Rapids — Radio Parts, Inc.
 — Wholesale Radio Co.
 Highland Park — Hi-Park Distributor
 Jackson — Matteson Electronics, Inc.
 Muskegon — Bell Laurim Electronics, Inc.
 Pontiac — Electronic Supply Co.

MINNESOTA

Duluth — Lew Bonn Co.
 Minneapolis — Electronic Center, Inc.
 — Lew Bonn Co.
 St. Paul — Lew Bonn Co.

MISSOURI

Kansas City — Manhattan Radio Supply
 — Radiolab
 St. Louis — Van Sickle Radio Co.
 — Radonics Co.

NEW JERSEY

Hackensack — American Distributing Co.
 Hillside — Sherwood Distributors, Inc.
 Jersey City — Hallmark Electronics Corp.
 Manville — Masters TV Supply Co.
 Newark — Emerson-New Jersey, Inc.
 — Radio Wire Television, Inc. of N.J.
 — Variety Electric Co., Inc.
 North Bergen — American Distributing Co.
 Paterson — Jersey Electronic Distributing Co.
 Perth Amboy — Bennett's Radio Supply
 Teterboro — Van Dusen Aircraft Supplies
 Trenton — Allied Electrical Appliance Parts, Inc.

NEW YORK

Albany — Air Waves Electronic-Radio Dist. Co.
 Binghamton — Stack Electronic Supply Co.
 Brooklyn — Ace Electronics
 — Bay Electronic Distributors
 — Benray Electronics Corp.
 — Hygrade Electronics, Inc.
 Buffalo — Buffalo Electric Co. Inc.
 — Radio Electric Products, Inc.
 Elmira — Le Valley McLeod, Inc.
 Fredonia — Barker-Higbee, Inc.
 Ithaca — Stallman of Ithaca, Inc.
 Mineola — Emerson-Long Island, Inc.
 Monticello — Fleisher Distributors, Inc.
 Newburgh — Chief Electronics, Inc.
 New Rochelle — Transvision, Inc.
 New York City — Barry Electronic Corp.
 — Bay Electronic Distributors
 — Emerson-New York, Inc.
 — House of Electronics
 — Magic-Vue Television Corp.
 — Midway Radio &
 — Television Corp.
 — Milo Radio & Electronics Corp.
 — Radio Wire Television, Inc.
 — Sanford Electronics Corp.

Patchogue — South Bay Radio Distributors
 Poughkeepsie — Chief Electronics, Inc.
 Rochester — Maseline Radio & Electronic
 Equipment, Inc.
 Rome — Rome Electronic Supply
 Staten Island — B & D Distributing Co.
 Syracuse — Karl-Williams Co., Inc.
 Troy — Troy Electronics Distributing
 Utica — Electronic Laboratories & Supply Co.
 White Plains — Emerson Radio Westchester, Inc.

NORTH CAROLINA

Charlotte — Dixie Radio Supply Co.
 — Westinghouse Electric Supply Co.
 Greensboro — Westinghouse Electric Supply Co.
 Hickory — Victor Radio TV Supply Co.
 Raleigh — Raleigh-Allied Electronics, Inc.
 — Westinghouse Electric Supply Co.

Salisbury — Leonard Electronics of
 Salisbury, Inc.

OHIO

Akron — Sun Radio Co.
 Canton — Burroughs Radio, Inc.
 Cincinnati — Holub & Hogg
 — Mytronic Co.
 — Radio TV & Refrigeration
 Supply, Inc.
 Cleveland — Radio Electronic Parts Corp.
 Columbus — Buckeye Electronics
 — Electronic Supply Corp.
 — Whitehead Radio Co.
 Dayton — Allied Supply Co., Inc.
 — Stotts-Friedman Co.
 Lima — Allied Supply Co., Inc.
 Mansfield — Burroughs Radio Inc.
 Marion — Servex Distributing Co.
 Toledo — Lifetime Electronics
 — Warren Radio Co.
 Warren — Radio Specialties
 Youngstown — Radio Parts Co.

OKLAHOMA

Oklahoma City — Dulaney's
 — Electronic Supply Co.
 Tulsa — S & S Radio Supply

PENNSYLVANIA

Allentown — Radio-Television Supplies
 Braddock — Marks Parts Co.
 Erie — B & D Wholesale Distributing Co.
 Harrisburg — Harrisburg Radio Laboratory
 Supply
 Hazleton — Moyer Electronic Supply Co., Inc.
 New Brighton — Television Parts Co.
 Philadelphia — Allied Elec. Appliance Parts, Inc.
 — Almo Radio Co.
 — Barnett Bros. Radio Co.
 — Herbach & Rademan Co.
 Pittsburgh — Cameradio Co.
 — Radio Parts Co. Inc.
 — Tydings Co.
 Scranton — General Radio & Refrigeration Co.
 — Penn Electrical Engineering Co.
 Wilkes-Barre — General Radio & Electronic Co.
 York — York Radio & Refrigeration Parts

RHODE ISLAND

Providence — Television Accessory House

SOUTH CAROLINA

Columbia — Dixie Radio Supply Co.
 — Westinghouse Electric Supply Co.
 Florence — Dixie Radio Supply Co.
 Greenville — Dixie Radio Supply Co.
 — Westinghouse Electric Supply Co.
 Spartanburg — McElhanney Co., Inc.

TENNESSEE

Chattanooga — Mills & Lupton Supply Co.
 — Specialty Distributing Co.
 Kingsport — Chemcity Radio & Electric Co.
 Knoxville — Chemcity Radio & Electric Co.
 Memphis — Electronic Supply, Inc.
 — McGregor's, Inc.
 — W & W Distributing Co.
 Nashville — Currey's Wholesale Distributors
 — Electra Distributing Co.
 — Moore-Handley Hardware Co., Inc.

TEXAS

Amarillo — Dulaney's Co., Inc.
 Beaumont — Covington Distributing Corp.
 Corpus Christi — Hayes Radio Supply Co.
 Dallas — Adleta Co.
 — Crabtree's Wholesale Radio Co.
 Denison — Denison Radio Supply
 Ft. Worth — Sutton's Wholesale Electronics
 Houston — Angie Radio & Supply Co.
 — Electro-Mechanical Products Co.
 — Hall, Inc.
 Midland — Henderson-Hoff
 San Antonio — Mission Radio, Inc.
 — Modern Radio Supply
 Tyler — Radio Service Supply Co.

VIRGINIA

Bristol — Bristol Radio Supply Corp.
 Fredericksburg — J & J Appliance Co.
 Lynchburg — Eastern Electric Co.
 Newport News — Noland Co., Inc.
 Norfolk — Radio Parts Distributing Co.
 Richmond — Meridan Electronic Equipment Co.
 Roanoke — Leonard Electronics of
 Roanoke, Inc.
 Winchester — Leonard Electronics of
 Winchester, Inc.

WEST VIRGINIA

Bluefield — Superior-Sterling Co.
 Huntington — TV Supply Co.

WISCONSIN

Madison — Superior Radio Co. of Madison
 Milwaukee — Electronic Expeditors Co.
 — Marsh Radio Supply Co.
 Racine — Superior Radio Co.
 Wausau — Electronics, Inc.

The above listing was closed as of November
 10, 1953. Watch for new Westinghouse Dis-
 tributor Appointments in your area.

ET-95046

BOOKS!

NEWCOMERS OR OLDTIMERS

HOW TO TROUBLESHOOT A TV RECEIVER

by J. R. Johnson

A step-by-step guide for newcomers to rapid systematic troubleshooting. Read this book and start out on the right foot!

Over 120 (5 1/4 x 8 1/4") pages..... \$1.80

HOW TO USE SIGNAL AND SWEEP GENERATORS

by J. R. Johnson

First book on all types of signal and sweep generators. Gives test uses and discusses problems and their solutions in using this equipment. Applications of all signal and sweep generators in AM, FM radio and TV servicing.

Over 140 (5 1/4 x 8 1/4") pages..... \$2.10

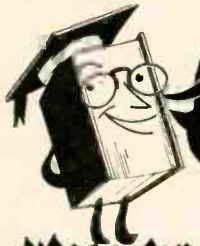

LATEST PRACTICAL INFORMATION

COMPLETE COLOR TV STORY

INTRODUCTION TO COLOR TV

by Thomas & Kaufman

Complete story on NTSC color TV system. Explains how color receiver differs from black and white; how single and triple gun color tubes differ from black and white picture tubes. Answers all questions on present day color TV.

Over 100 (5 1/4 x 8 1/4") pages, illus..... \$2.10

TV TROUBLESHOOTING AND REPAIR GUIDE BOOK VOL. 2

by R. G. Middleton

Companion book to best selling Vol. 1. Finest practical book to make TV servicing easy. Spot TV receiver troubles fast. All items in TV receivers not in Vol. 1. Does not duplicate!

Vol. 2, 160 (8 1/2 x 11") pages..... \$3.30

Vol. 1, 204 (8 1/2 x 11") pages..... \$3.90

GUIDE TO AUDIO REPRODUCTION

by David Fidelman

A to Z explanation of the reproduction of sound, design, construction, assembly and testing of sound systems and their components. Valuable for service technicians, engineers, amateurs.

Over 250 (5 1/2 x 8 1/2") pages..... \$3.50

OBTAINING AND INTERPRETING TEST SCOPE TRACES

by J. F. Rider

Over 500 actual photographs of test scope traces. Shows how to use scopes and what traces mean. Valuable for servicing TV receivers, FM and AM radio receivers, audio systems and test equipment. Specific test equipment set-ups shown with each application. No other book like it!

Over 140 pages..... Only \$2.40

CAREFULLY SELECTED for EVERY NEED of RADIO, TV Service Technicians

POSITIVE CURES FOR TV TROUBLES



TV MANUFACTURERS' RECEIVER TROUBLE CURES

VOL. 1, VOL. 2, VOL. 3 and VOL. 4

Positive cures for TV troubles! Gives you exact directions for correcting TV receiver performance "bugs". Each cure is official, factory-authorized, direct from the receiver's manufacturer. Listings by manufacturer and model or chassis number. Helps correct the most difficult faults—picture jitter, hum, instability, buzz, tearing, etc.

Vol. 1, 115 (5 1/4 x 8 1/4") pages..... \$1.80

Covers 12 brands, Admiral through Dumont.

Vol. 2, 117 (5 1/4 x 8 1/4") pages..... \$1.80

Covers 11 brands, Emerson through Jackson.

Vol. 3, 119 (5 1/4 x 8 1/4") pages..... \$1.80

Covers 16 brands, Kaye-Halbert through Philco.

Vol. 4, Over 115 (5 1/4 x 8 1/4") pages..... \$1.80

Covers 10 brands, Philharmonic through Shaw TV.

VOLUME 5 COMING SOON!

Prominent manufacturers not in first 4 volumes.
ONE SERVICE JOB WILL MORE THAN PAY
THE COST OF THIS SERIES OF BOOKS!

TV SWEEP ALIGNMENT TECHNIQUES

by Art Liebscher, Test Equipment Specialist
Never before has there been a book such as this on TV sweep alignment! An expert gives you accurate time-saving methods—and tells you how they work. Introduces the new Supermark method. Chock-full of sweep curve pictures. Valuable for servicing in UHF signal areas.

123 (5 1/2 x 8 1/2") pages, illus..... \$2.10

ENCYCLOPEDIA ON CATHODE-RAY OSCILLOSCOPES AND THEIR USES

by Rider and Usland

Most complete 'scope book! Cloth cover.

992 (8 1/2 x 11") pages, 3000 illus..... \$9.00

RECEIVING TUBE SUBSTITUTION GUIDE BOOK

by H. A. Middleton

Answers all tube problems by listing 2,500 radio-television tube substitutions in numerical sequence, with accompanying wiring instructions, original and substitute socket illustrations.

224 (8 1/2 x 11") pages..... \$3.00

FIRST SUPPLEMENT, RECEIVING TUBE SUBSTITUTION GUIDE BOOK

48 (8 1/2 x 11") pages..... \$.99

UHF TELEVISION ANTENNAS AND CONVERTERS

by A. Lytel

Latest information on all types of converters, antennas, transmission lines. Valuable for UHF installation techniques

Over 128 (5 1/4 x 8 1/4") pages..... \$1.80

WRITE FOR COMPLETE RIDER CATALOG
Buy these books now from your jobber, bookstore —
if not available from these sources, write to:



JOHN F. RIDER

Export Agent:
Roburn Agencies, Inc.
39 Warren Street
New York 7, New York

PUBLISHER, INC.

480 Canal Street, New York 13, N. Y.

West Coast Office:

4216-20 W. Jefferson Blvd.
Los Angeles, California

Cable Address:

Roburnage N. Y.

THE SERVICE RUNAROUND

the jelly melted.

TV sets are sometimes thrown out of kilter by mice, most of which are not planted by children. Neither are they planted by repairmen, though the accusation has been made. It appears that mice consider the warm, dark coziness of the sets ideal for nesting.

Clambering about on the upper reaches of peoples' houses is one of the risks of a repairman's life. The weekly meeting of a women's bridge club in East Orange was broken up early this month when a TV man who was rigging an antenna in an unfinished attic slipped between two rafters, plunged through the living-room ceiling, and landed right in the middle of a card table. The man wasn't hurt, but the table was wrecked and two cards in dummy's club suit simply disappeared.

Last week in Brooklyn, a TV addict complained to his repairman that his TV screen tended to fog over late in the evening. He'd made the same complaint a dozen times before, and the TV man had checked the set a dozen times without finding anything wrong with it. Acting on a hunch, he stopped in at his customer's house along about 11 P.M. and, sure enough, it wasn't the screen but the owner of the set, a man highly susceptible to the beer ads on TV, who tended to fog over late in the evening.

Also last week, trouble in the Bronx: A TV repairman got a call from a Mr. Schneider, at such-and-such an address, asking him to pick up a set that had gone haywire. The repairman had previously done work for a Schneider at that address, and next morning he sent his driver around for the set. Schneider wasn't at home, so the driver explained his mission to a maid, who let him take the set away. The following day, the TV man called Schneider to say that the set had been repaired and would be delivered in an hour or so. "What set?" Schneider asked. "I'm looking at my set this minute. It works fine." The TV man had no sooner apologized and hung up than the telephone rang; it was Schneider, calling to ask when his blankety-blank set would be picked up, if ever. The TV man said he'd be right over, and over he went, to find that there were three Schneiders living in one apartment building. The third Schneider had already notified the police that his set was missing, and they were scouring the neighborhood for a thief posing as a TV repairman.

RADIO-ELECTRONICS will be happy to print future contributions similar to the ones in the above article, giving personal experiences of radio and television technicians. We shall pay \$10 for each contribution used by this department. The contribution may be either serious or humorous, but should be an actual experience encountered by a service technician.

Address all contributions to:

Editor, THE SERVICE RUNAROUND
% RADIO-ELECTRONICS
25 West Broadway
New York 7, New York

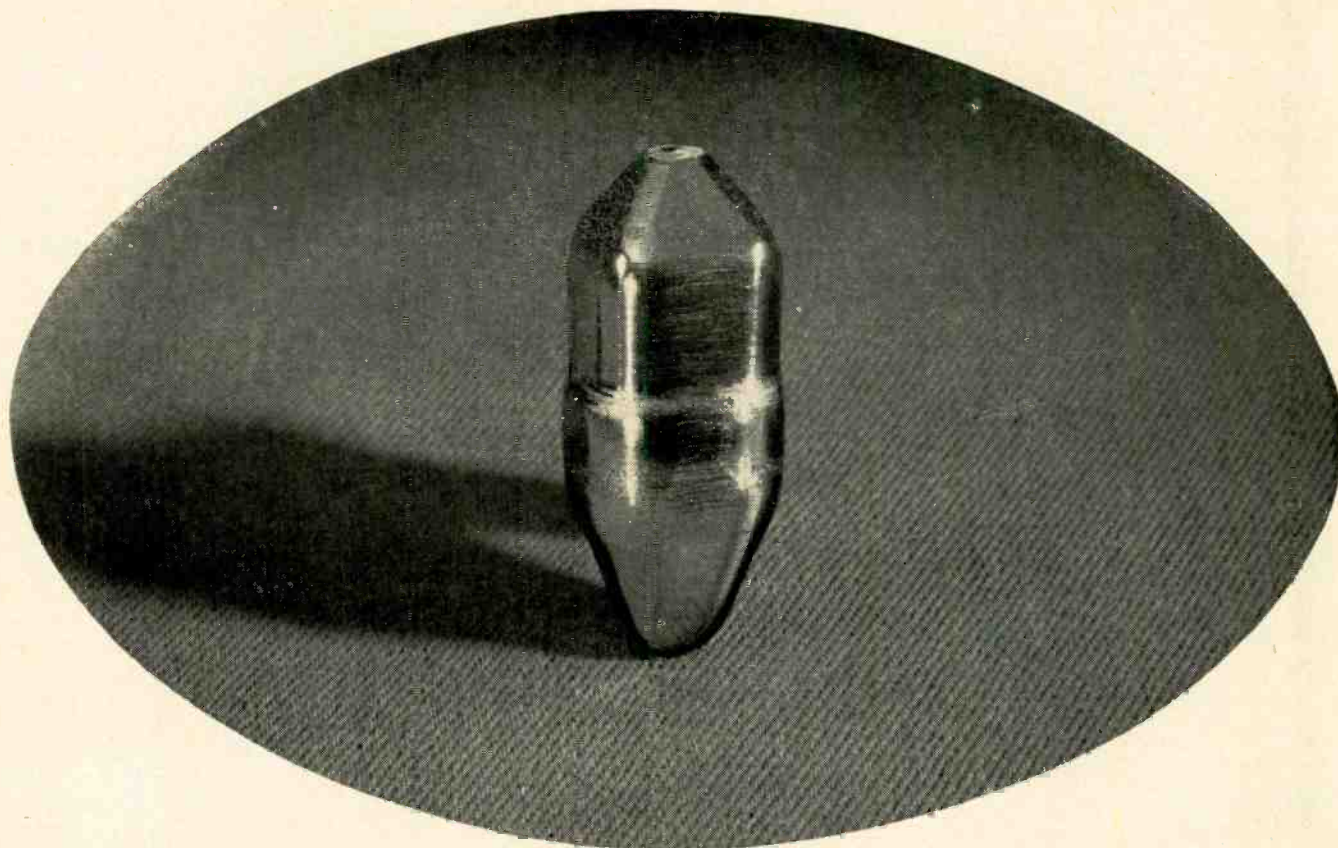

Germanium crystal grown at Bell Telephone Laboratories (life size). It is sliced into hundreds of minute pieces to make *Transistors*. *Transistor* action depends on the flow of positive current-carriers as well as electrons, which are negative. Arsenic—a few parts per 100,000,000—added to germanium produces prescribed excess of electrons. With gallium added, positive carriers predominate. Latest junction type *Transistor* uses both kinds of germanium in the form of a sandwich.

THEY GREW IT FOR TRANSISTORS

Heart of a *Transistor*—Bell Telephone Laboratories' new pea-size amplifier—is a tiny piece of germanium. If *Transistors* are to do their many jobs well, this germanium must be of virtually perfect crystalline structure and uniform chemical composition. But it doesn't come that way in nature.

So—Bell scientists devised a new way to *grow* the kind of crystals they need, from a melt made of the natural product. By adding tiny amounts of special alloying substances to the melt, they produce germanium that is precisely tailored for specific uses in the telephone system.

This original technique is another example of the way Bell Laboratories makes basic discoveries—in this case the *Transistor* itself—and then follows up with practical ways to make them work for better telephone service.

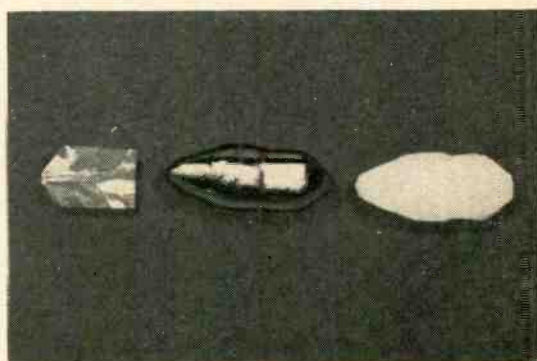

Section of natural germanium, left, shows varying crystal structure. At right is sectioned single crystal grown at Bell Laboratories.

IMPROVING TELEPHONE SERVICE FOR AMERICA PROVIDES CAREERS FOR
CREATIVE MEN IN SCIENTIFIC AND TECHNICAL FIELDS

BELL TELEPHONE LABORATORIES



NO INTEREST!!

Buy on our radically new
Time Payment Plan

NO CARRYING CHARGES!!



Superior's new
Model 670-A

SUPER METER

A COMBINATION VOLT-OHM MILLIAMMETER PLUS
CAPACITY REACTANCE INDUCTANCE AND DECIBEL MEASUREMENTS

SPECIFICATIONS:

D.C. VOLTS: 0 to 7.5/15/75/150/750/1,500/7,500 Volts
A.C. VOLTS: 0 to 15/30/150/300/1,500/3,000 Volts
OUTPUT VOLTS: 0 to 15/30/150/300/1,500/3,000 Volts
D.C. CURRENT: 0 to 1.5/15/150 Ma. 0 to 1.5/15 Amperes
RESISTANCE: 0 to 1,000/100,000 Ohms 0 to 10 Megohms
CAPACITY: .001 to 1 Mfd. 1 to 50 Mfd. (Quality test for electrolytics)
REACTANCE: 50 to 2,500 Ohms 2,500 Ohms to 2.5 Megohms
INDUCTANCE: .15 to 7 Henries 7 to 7,000 Henries
DECIBELS: -6 to +18 +14 to +38 +34 to +58

ADDED FEATURE:

The Model 670-A includes a special **GOOD-BAD** scale for checking the quality of electrolytic condensers at a test potential of 150 Volts.

The Model 670-A comes housed in a rugged, crackle-finished steel cabinet complete with test leads and operating instructions.

\$28⁴⁰ NET



Superior's new
Model TV-11

TUBE TESTER

SPECIFICATIONS:

- ★ Tests all tubes including 4, 5, 6, 7, Octal, Lock-in, Peanut, Bantam, Hearing Aid, Thyatron, Miniatures, Sub-miniatures, Novals, Sub-minars, Proximity fuse types, etc.
- ★ Uses the new self-cleaning Lever Action Switches for individual element testing. Because all elements are numbered according to pin-number in the RMA base numbering system, the user can instantly identify which element is under test. Tubes having tapped filaments and tubes with filaments terminating in more than one pin are truly tested with the Model TV-11 as any of the pins may be placed in the neutral position when necessary.
- ★ The Model TV-11 does not use any combination type sockets. Instead individual sockets are used for each type of tube. Thus it is impossible

to damage a tube by inserting it in the wrong socket.

- ★ Free-moving built-in roll chart provides complete data for all tubes.
- ★ Newly designed Line Voltage Control compensates for variation of any Line Voltage between 105 Volts and 130 Volts.
- ★ **NOISE TEST:** Phono-jack on front panel for plugging in either phones or external amplifier will detect microphonic tubes or noise due to faulty elements and loose internal connections.

The model TV-11 operates on 105-130 Volt 60 Cycles A.C. Comes housed in a beautiful hand-rubbed oak cabinet complete with portable cover

\$47⁵⁰ NET

EXTRA SERVICE—The Model TV-11 may be used as an extremely sensitive Condenser Leakage Checker. A relaxation

type oscillator incorporated in this model will detect leakages even when the frequency is one per minute.

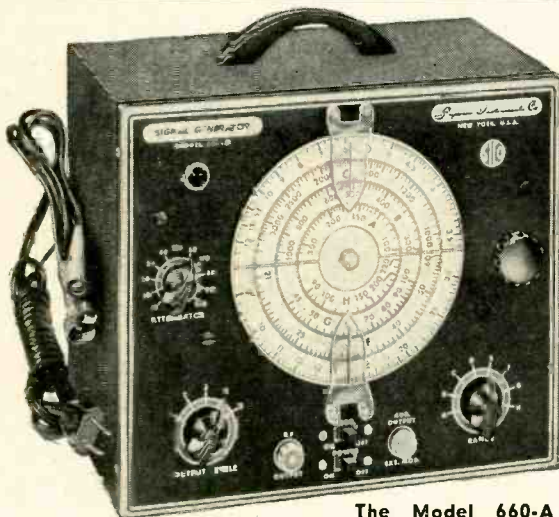

Superior's New Model 660-A AN AC OPERATED

SIGNAL GENERATOR

PROVIDES COMPLETE COVERAGE for AM-FM & TV Alignment

SPECIFICATIONS:

● Generates Radio Frequencies from 100 Kilocycles to 60 Megacycles on fundamentals and from 60 Megacycles to 220 Megacycles on powerful harmonics. ● Accuracy and Stability are assured by the use of permeability trimmed HI-Q coils. ● R.F. available separately or modulated by the internal audio oscillator. — Built in 400 cycle sine wave audio oscillator used to modulate the R.F. signal also available separately for audio testing of receivers, amplifiers, hard of hearing aids, etc. ● R.F. Oscillator Circuit: A high transcendence hep-

tone is used as an R.F. oscillator, mixer and amplifier. Modulation is effected by electron coupling in the mixer section thus isolating the oscillator from load changes and affording high stability. ● A.F. Oscillator Circuit: A high transcendence heptode connected as a high- μ triode is used as an audio oscillator in a High-C Colpitts Circuit. The output (over 1 Volt) is nearly pure sine wave. ● Attenuator: A 5 step ladder type of attenuator is used.

The Model 660-A comes complete with coaxial cable test lead and instructions.

Tubes used: 1—6BE6 as R.F. Oscillator, mixer and amplifier. 1—6BE6 as Audio Oscillator. 1—6H6 as Power Rectifier.

\$42⁹⁵ NET

MOSS ELECTRONIC DISTRIBUTING CO., INC.
Dept. B-90, 3849 Tenth Ave., New York 34, N. Y.

Please send me the units checked. I am enclosing the down payment with order and agree to pay the monthly balance as shown. It is understood there will be no carrying interest or any other charges, provided I send my monthly payments when due. It is further understood that should I fail to make payment when due, the full unpaid balance shall become immediately due and payable.

Name.....
Address.....
City..... Zone..... State.....

- MODEL 670-A Total Price \$28.40 \$7.40 down payment. Balance \$3.00 monthly for 6 months.
- MODEL TV-11 Total Price \$47.50 \$11.50 down payment. Balance \$6.00 monthly for 6 months.
- MODEL 660-A Total Price \$42.95 \$12.95 down payment. Balance \$5.00 monthly for 6 months.
- I enclose \$..... as down payment.
- Ship C.O.D. for the down payment.

RADIO-ELECTRONICS

Buy on our radically new

NO INTEREST!! **Time Payment Plan** **NO CARRYING CHARGES!!**



Superior's New Model 770-A *The FIRST Pocket-Sized*

VOLT-OHM MILLIAMMETER

USING THE NEW "FULL-VIEW" METER

71% MORE SCALE AREA!!

Yes, although our new FULL-VIEW D'Arsonval type meter occupies exactly the same space used by the older standard 2 1/2" Meters, it provides 71% more scale area. As a result, all calibrations are printed in large easy-to-read type and for the first time it is now possible to obtain *measurements instead of approximations* on a popular priced pocket-sized V.O.M.

- Features**
- ★ Compact—measures 3/8" x 5/8" x 2 1/4"
 - ★ Uses "Full View" 2% accurate, 850 Microampere D'Arsonval type meter
 - ★ Housed in round-cornered, molded case
 - ★ Beautiful black etched panel. Depressed letters filled with permanent white, insures long-life even with constant use.

- Specifications**
- 6 A.C. VOLTAGE RANGES: 0-15/30/-150/300/1500/3000 Volts. 6 D.C. VOLTAGE RANGES: 0-7.5/15/75/150/-750/1500 Volts. 2 RESISTANCE RANGES: 0-10,000 Ohms, 0-1 Megohm. 3 D.C. CURRENT RANGES: 0-15/150 Ma., 0-1.5 Amps. 3 DECIBEL RANGES: -6 db to +18 db, +14 db to +38 db, +34 db to +58 db.

The Model 770-A comes complete with self-contained batteries, test leads and all operating instructions.

\$1585

NET

Superior's
New

TELEVISION BAR GENERATOR

THROWS AN ACTUAL BAR PATTERN ON ANY TV RECEIVER SCREEN



- Two Simple Steps**
1. Connect Bar Generator to Antenna Post of any TV Receiver.
 2. Plug Line Cord into A.C. Outlet and Throw Switch.
- Result:** A stable never-shifting vertical or horizontal pattern projected on the screen of the TV receiver under test.

SPECIFICATIONS:

Power Supply: 105-125 Volt 60 Cycles
 Power Consumption: 20 Watts
 Channels: 2-5 on panel, 7-13 by harmonics
 Horizontal lines: 4 to 12 (Variable)
 Vertical lines: 12 (Fixed)
 Vertical sweep output: 60 Cycles
 Horizontal sweep output: 15,750 Cycles

FEATURES:

Provides linear pattern to adjust VERTICAL linearity, height, centering • Provides linear pattern to adjust HORIZONTAL drive, width, peaking, linearity, centering • Provides vertical sweep signal for adjusting and synchronizing vertical oscillator discharge and output tubes • Provides vertical signal to replace vertical oscillator to check vertical amplifier operation • Provides horizontal sweep signal for adjusting and synchronizing horizontal oscillator A.F.C. and output tubes • Provides horizontal sweep signal to check H.V. section of fly-back and pulse operating power supplies • Provides signal for testing video amplifiers • Can be used when no stations are on the air.

TV BAR GENERATOR COMES COMPLETE WITH SHIELDED LEADS AND DETAILED OPERATING INSTRUCTIONS. ONLY

\$39.95

NET

SUPERIOR'S NEW MODEL TV-40

C.R.T. TUBE TESTER



A complete picture tube tester for little more than the price of a "make-shift" adapter!!

The Model TV-40 is absolutely complete! Self-contained, including built-in power supply, it tests picture tubes in the only practical way to efficiently test such tubes: that is by the use of a separate instrument which is designed exclusively to test the ever increasing number of picture tubes!

EASY TO USE:

Simply insert line cord into any 110 volt A.C. outlet, then attach tester socket to tube base (Ion trap need not be on tube). Throw switch up for quality test . . . read direct on Good-Bad scale. Throw switch down for all leakage tests.

Tests all magnetically deflected tubes . . . in the set . . . out of the set . . . in the carton!!

SPECIFICATIONS:

- Tests all magnetically deflected picture tubes from 7 inch to 30 inch types.
- Tests for quality by the well established emission method. All readings on "Good-Bad" scale.
- Tests for inter-element shorts and leakages up to 5 megohms.
- Test for open elements.

Model TV-40 C.R.T. Tube Tester comes absolutely complete—nothing else to buy. Housed in round-cornered, molded bakelite case. Only

\$1585

NET

MOSS ELECTRONIC DISTRIBUTING CO., INC.
 Dept. B-90, 3849 Tenth Ave., New York 34, N. Y.

Please send me the units checked. I am enclosing the down payment with order and agree to pay the monthly balance as shown. It is understood there will be no carrying interest or any other charges, provided I send my monthly payments when due. It is further understood that should I fail to make payment when due, the full unpaid balance shall become immediately due and payable.

Name.....

Address.....

City.....Zone.....State.....

Model 770-A Total Price \$15.85
 \$3.85 down payment. Balance \$4.00 monthly for 3 months.

Bar Generator Total Price \$39.95
 \$9.95 down payment. Balance \$5.00 monthly for 6 months.

Model TV-40 Total Price \$15.85
 \$3.85 down payment. Balance \$4.00 monthly for 3 months.

I enclose \$..... as down payment.

Ship C.O.D. for the down payment.

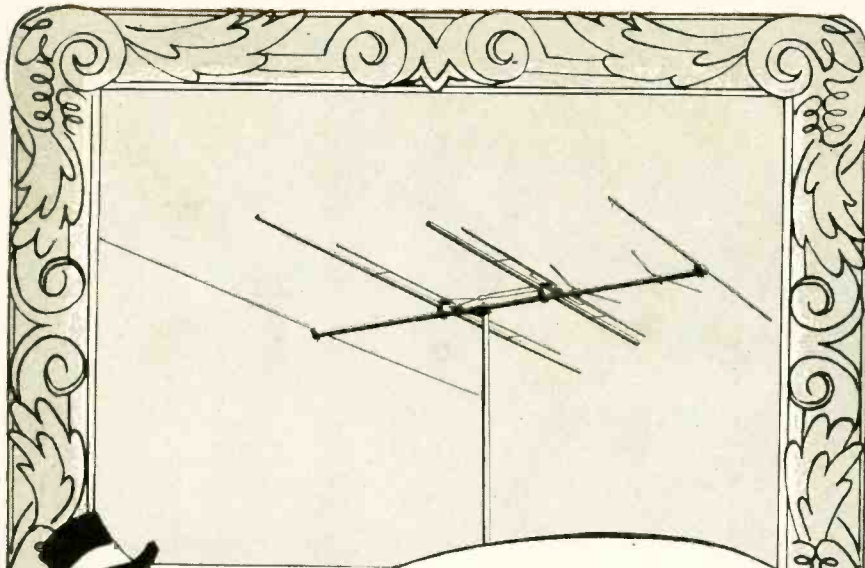

obviously outstanding

the **W W** CLIPPER VHF all channel antenna

Not Just Claims But Unquestioned Proof Of

- **PERFORMANCE** — an engineering accomplishment providing an outstanding antenna designed for increased sensitivity and higher gain in both primary and fringe areas.
- **ACCEPTANCE** — a phenomenal customer acceptance resulting from WW's superb performance characteristics — thousands in use throughout the U.S.
- **SALES** — performance, design, workmanship . . . outstanding selling points to create unprecedented sales demand. Get your share now!

Specifically engineered and designed for true and complete all-channel VHF reception.

Performance charts for the W-W Clipper

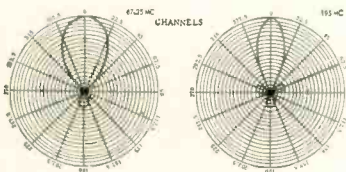
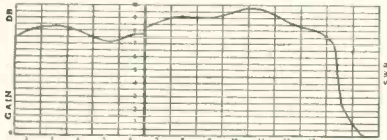

CHECK THESE FEATURES

High Uniform Gain — One Major Forward Lobe — Narrow Beam Reduces Ghosts and Noise Pickup — High Signal to Noise Ratio — Good Front-to-Back Ratio Eliminates Co-Channel Interference — Perfect 300 Ohm Match — Light, Rigid, Quickly and Easily Installed to All Heights — Low Wind Resistance.

ALSO MANUFACTURERS OF

Models 10 and 20 UHF Fans — Models 30 & 40 Colinear Fans — Model UH 6 element UHF Yagi — Model HI High Band VHF Antenna — K series Original Hairpin, Combination Yagi Antenna.

Wells and Winegard
television accessory mfgs.
DEPT. RE, BURLINGTON, IOWA

TV CONVERSION KITS
Easily installed consisting of rectangular tube, 70 degree yoke, beautiful mesh, flyback transformer and width coil.

17" Conversion Kit, as above, complete	\$24.95
19" Conversion Kit, as above, complete	29.95
21" Conversion Kit, as above, complete	34.95
24" Conversion Kit, as above, complete	49.95
27" Conversion Kit, as above, complete	59.95

RESISTOR KITS
Insulated, 1/2 and 2-watt assortment of most used values, I.R.C. Ohmite, Stackpole, Spec. \$24.95 for 100 for

Write for our **BARGAIN FLYER No. 22**

TELEVISION PICTURE TUBES

SIZE	PRICE
10BP4	11.45
10BP4A	11.45
10BP4B	11.45
10BP4C	11.45
10BP4D	11.45
10BP4E	11.45
10BP4F	11.45
10BP4G	11.45
10BP4H	11.45
10BP4I	11.45
10BP4J	11.45
10BP4K	11.45
10BP4L	11.45
10BP4M	11.45
10BP4N	11.45
10BP4O	11.45
10BP4P	11.45
10BP4Q	11.45
10BP4R	11.45
10BP4S	11.45
10BP4T	11.45
10BP4U	11.45
10BP4V	11.45
10BP4W	11.45
10BP4X	11.45
10BP4Y	11.45
10BP4Z	11.45

ONE FULL YEAR WARRANTY ON ALL TYPES SEND US YOUR ORDER AND WE WILL SHIP FROM STOCK IMMEDIATELY

PREMIER TV RADIO SUPPLY
Division of CONTINENTAL CORPORATION
3239 West North Avenue, Chicago 47, Ill.
DEPARTMENT 202 ARmitage 6-5550

COAST ELECTRONICS has the **NEW precise** MODEL 308 K **8 1/2" OSCILLOSCOPE** THE GREATEST OSCILLOSCOPE FROM COAST TO COAST

ALL THE FEATURES OF THE FAMOUS MODEL #300 PLUS:

- ★ INTENSIFIER ANODE
- ★ HI-LOW-NORMAL SYNCH. (A Precise First)
- ★ 8 1/2 INCH TUBE (A Precise First)
- ★ VOLTAGE REGULATION (A Precise First)

See Precise Ad Page 122

The only 8 1/2" Oscilloscope on the commercial market today. We have this Precise "scope" for you . . .

NEW 7" Oscilloscope Kit..... \$ 94.95
LATEST 8 1/2" Oscilloscope Kit..... \$129.50

OTHER PRECISE KITS AVAILABLE:

MODEL 909K—VACUUM TUBE VOLTMETER	\$25.98
MODEL 630KA—RF-AF TV & MARKER GENERATOR (pre-assembled head)	\$38.95
MODEL 610KA—RF SIGNAL GENERATOR (pre-assembled head)	\$28.95
MODEL 635K—UNIV. AF SINE, SQ. & PULSE GEN.	\$33.50

Terms: All merchandise shipped FOB Alhambra, California. Prices slightly higher in the West. Prices and specifications subject to change without notice. Include 20% deposit for C.O.D.'s. WRITE FOR NEW CATALOG — FREE!

COAST ELECTRONICS SUPPLY CO. Dept. P4
527 W. Main Street • Alhambra, Calif.

Send me _____
 Enclosed find \$ _____ deposit. Balance COD
 Enclosed find \$ _____ in full.

NAME _____
ADDRESS _____
CITY _____ ZONE _____ STATE _____

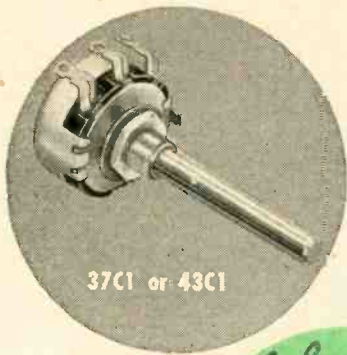

37C1 or 43C1

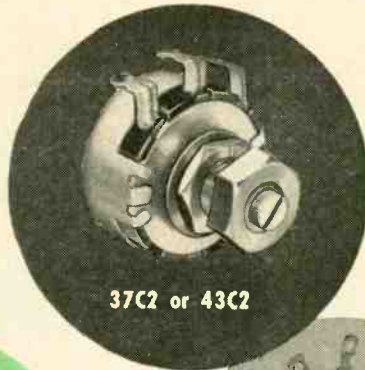

37C2 or 43C2



Rear view of 43C1



58C1

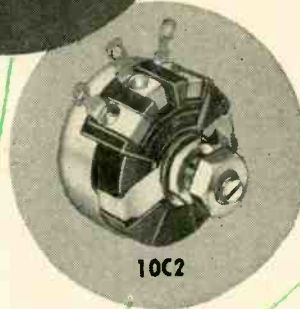

10C2



Where better-than-standard components are desirable...

CLAROSTAT C-Line Controls

A new line of composition-element and wire-wound controls designed specifically for custom-built, industrial, laboratory or other semi-critical applications. These controls are *de luxe versions* — mechanically and electrically — of the popular Clarostat standard types widely used in radio-TV sets and for the servicing thereof.

With factory-assembled fixed 1 5/8" round shaft (C1) or 1/8" screwdriver-slot shaft (C2) with split locking bushing.

All exposed metal parts have corrosion-resistant finish. Terminals have suitable finish for ease of soldering.

Close-fitting covers — no holes or cut-outs. Maximum protection against dust and dirt.

Ratings: 37C1 and 37C2 composition-element, 1 watt; 43C1 and 43C2 wire-wound, 2 watts; 58C1 and 58C2, 3 watts; 10C1 and 10C2, 4 watts.

Electrical tolerances plus/minus 10% for composition-element controls up to 100,000 ohms; plus/minus 20% from 100,000 ohms to 10 megohms.

Wire-wound controls within plus/minus 5% in all ohm-ages. Independent linearity to plus/minus 1% for 58C1 and 58C2, and 10C1 and 10C2 controls; for 43C1 and 43C2, plus/minus 2%.

Available with switches on special order.

Units sealed in dustproof plastic bags within standard Clarostat cartons. Factory-fresh appearance and condition, regardless of shelf life.

If you want still better-than-standard quality, performance and life, insist on Clarostat C-LINE controls.

STAND PAT WITH

CLAROSTAT Controls & Resistors

CLAROSTAT MFG. CO., INC., DOVER, NEW HAMPSHIRE

In Canada: Canadian Marconi Co., Ltd., Toronto, Ontario

PHASE SHIFT OSCILLATOR

By DARWIN H. HARRIS

An R-C audio-frequency oscillator that produces an excellent waveform

THE phase-shift oscillator is a simple audio-frequency generator. It produces an excellent waveform, and is not disturbed by supply-voltage fluctuations. Positive plate-to-grid feedback is applied through a resistance-capacitance network (Fig. 1), which shifts the phase of the plate signal. Oscillation takes place at the frequency where the feedback is maximum. The approximate frequency may be predicted by the formula:

$$F = \frac{6 \times 10^4}{RC}$$

in which RC is in microseconds (ohms times microfarads or megohms times micromicrofarads) and F is in cycles per second. The phase reversal results in a large signal loss, so a high-gain tube is necessary. A pentode is commonly used, but a high-mu triode is

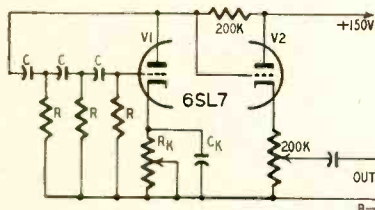

Fig. 1—The phase-shift oscillator.

satisfactory at low and medium frequencies. (In the writer's opinion, triodes—particularly the 6SL7-GT—produce better waveforms than pentodes, and are preferable.)

Several other types of phase-shifting circuits may be used instead of the network shown in Fig. 1. Of these, the most important one has the configuration shown, but uses a four-R-C network. In that type the network loss is much lower, and the gain requirement is less important. Hence it is more useful for triode operation, especially at higher frequencies. The factor 6 in the frequency equation is changed to 12 in this case. The discussion here, however, is about the three-R-C oscillator.

In spite of its good reputation, the oscillator has certain disadvantages. The waveform is not always perfect. Often, too much feedback is fed to the grid; the grid is overdriven, and the signal is distorted. Thus, a scope must always be used in setting up the oscillator. A variable cathode resistor is the best way to control the gain, and, in turn, the waveform. A rheostat of 10,000 ohms or so is required. In adjusting this, the output will rise from

a minimum (zero) at the extremes of the resistor to a maximum at some intermediate value. If distortion appears at maximum output, good waveform will usually be found with the resistor adjusted on the cathode side of maximum. If distortion remains at maximum resistance, it indicates that the B voltage is too high and should be reduced. A 150-volt supply is ample in most cases. An interesting effect that accompanies the resistance change is a small (about 10%) frequency variation; this is one reason the frequency equation is approximate. When varying the resistance from zero to maximum, the frequency first decreases sharply. As the resistance is increased, the frequency keeps decreasing, reaching a minimum at the point of maximum output. The frequency then rises as the resistance is made larger. The rise in frequency from its lowest point is only a fraction of the decrease that occurs initially.

Another disadvantage is the sensitivity of the oscillator to the output load, affecting both frequency and voltage. A buffer amplifier is used between the oscillator and load to serve as an impedance transformer. Since the generated voltage is often higher than required (a pentode with a 150-volt B supply may have 25 volts undistorted output, or 40 volts maximum), amplification is not necessary. The writer suggests a cathode follower as a buffer in place of an amplifier. The simple arrangement of Fig. 1 is recommended. Two points should be observed: the load resistor of V2 should be about the same as the plate resistor of V1; and the direct voltage at the cathode of V2 (more positive than the plate of V1) should be less than the rated cathode-to-filament voltage for the tube. This limits the maximum B voltage in this circuit. This type of cathode follower cannot be shunted with a small load since negative peak clipping takes place when the peak a.c. is equal to the d.c.

A definite maximum frequency exists for a given tube and B voltage, which is related to the tube gain. Experiments by the writer gave these approximate maxima: 12AT7, 150-volt B supply, 300 c.p.s.; 12AX7 and 6SL7, 150 volts, 900 c.p.s.; 6SJ7, 150 volts, 5 kc; 6SH7, 150 volts, 8 kc; and 6AG7, 300 volts, over 100 kc. This is partly due to the fact that when R is reduced, as required for higher frequencies, the necessary gain increases. Ginzton and Hollingsworth show¹ that the gain needed for oscilla-

tion, A, depends on the ratio of the net load at the plate, R_L , to R, as follows:

$$A = 29 + 23 \left(\frac{R_L}{R} \right) + 4 \left(\frac{R_L}{R} \right)^2$$

R is the resistance of each of the network resistors; they are of equal value. Similarly, C, the network capacitors, are also equal. R_L is the parallel resultant of the plate resistance, plate resistor, and load resistor. The gain, when R_L/R is unity, is nearly double that needed when R is much larger than R_L .

Frequency is determined not by R alone but by C as well. Neither R nor C can be reduced beyond a certain point. Minimum C values found by the writer were, 12AT7, .001 μ f; 6SL7, 500 μ f; 12AX7, 200 μ f; 6SJ7, 6SH7, and 6AG7, 25 μ f. Operation at minimum C is not advisable because of oscillator instability. Minimum R values were: 12AT7, 6SL7, and 12AX7, 150 volts, 150,000 ohms; 6SJ7 and 6SH7, 150 volts, 100,000 ohms; and 6AG7, 300 volts, 10,000 ohms. Oscillation will not occur with both R and C at minimum. The smallest R-C product is reached with C at twice minimum and R at minimum. Thus, minimum values for the 6SH7 at 150 volts are 25 μ f and 100,000 ohms, but the highest frequency is reached with 50 μ f and 100,000 ohms.

The writer believes that 10 kc is the practical upper limit since above this

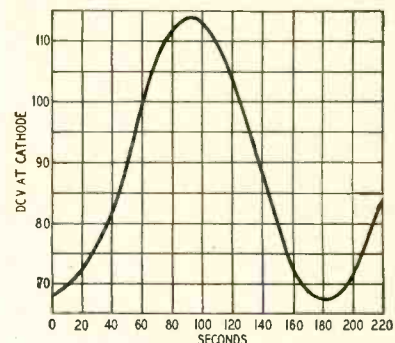

Fig. 2—Graph shows waveform generated at a frequency of 0.0055 c.p.s.

point the oscillator becomes extremely sensitive to stray capacitance.

The equation for the oscillation fre-

IMPACT IN UHF

FINCO

series 500

Great UHF ANTENNAS

IMPACT Through Advertising

LOCAL NEWSPAPERS

LIFE

FARM MAGAZINES

RADIO

TELEVISION

**FINCO IS A NAME
YOUR CUSTOMERS
KNOW BECAUSE OF
THIS POWERFUL
NATIONAL ADVERTISING
PROGRAM!**

**THE
FINNEY COMPANY**

Dept. RE-31, 4612 St. Clair Ave., Cleveland 3, O.

This great series once again reaffirms Finco leadership! Model 502 is a 2-bay unit of the colateral* type with a "snap-out" screen for instantaneous installation. Model 504 is the 4-bay version, highly effective in super fringe areas where ultra high gain is consistently required. Both models feature high front to back ratio and excellent impedance match to 300 OHM line for low signal fringe areas. Completely preassembled — corrosion proof aluminum throughout (including screen) — one antenna, one transmission line!

Both Units available in 3 models which peak on channel ranges shown below and maintain high gain on balance of frequencies:

- #502A — channels 14-32
- #502B — channels 29-55
- #502C — channels 53-83

- #504A — channels 14-32
- #504B — channels 29-55
- #504C — channels 53-83

Patent No. 2,566,287

*Reg. U.S. Pat. Off.

One body with 6 interchangeable terminals for the widest mounting combinations.

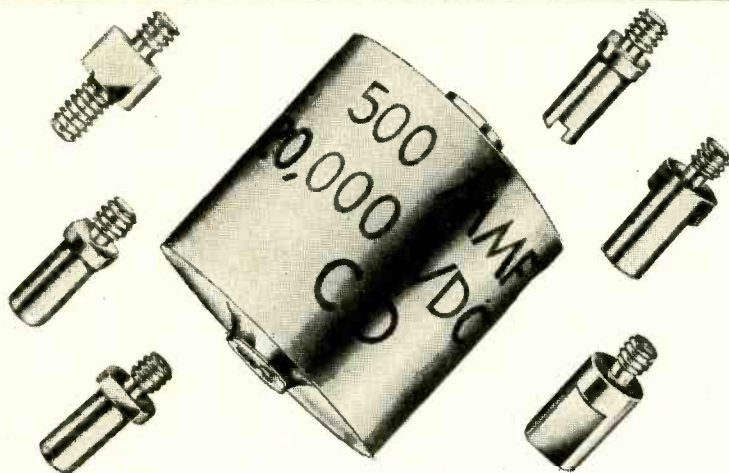

C-D's NEW

Mity Mike[®]

(Type MMU)

CERAMIC CAPACITORS

- Interchangeable terminals take less room in your parts kit -- let you do the job right
- Just attach the needed terminals to fit the job ...
- Always the right ceramic unit handy -- and without tying up money in a big stock
- With the improved construction and processing at point where corona-effects attack
- Rugged -- stable -- durable
- Use it at Full Rated Voltage
- Precision manufactured with extra-large safety margin -- greater dependability
- Now at your C-D Jobber. For his name and address see your Classified Telephone Directory. Catalog on request, Dept. RC-24, Cornell-Dubilier Electric Corp., So. Plainfield, N. J.

CONSISTENTLY DEPENDABLE

CORNELL-DUBILIER

There are more C-D capacitors in use today than any other make.



PLANTS IN SOUTH PLAINFIELD, NEW JERSEY; NEW BEDFORD, WORCESTER AND CAMBRIDGE, MASSACHUSETTS; PROVIDENCE AND HOPE VALLEY, RHODE ISLAND; INDIANAPOLIS, INDIANA; SANFORD AND FUQUAY SPRINGS, NORTH CAROLINA. SUBSIDIARY RADIART CORPORATION, CLEVELAND, OHIO

ONLY \$4.95
Pd. or C.O.D. + Chgs.

THE NEW TV DYNATRACER

- TRACES TV SIGNALS AND VOLTAGES
- LOCATES DEFECTIVE COMPONENTS
- REQUIRES NO ADDITIONAL EQUIPMENT

This sensationally new piece of test equipment is ideal for trouble-shooting television sets in the home or in the shop. The "DYNATRACER" will outperform more expensive testers and should pay for itself on the very first repair.

A Must For Every TV Technician

SPECIFICATIONS: The "DYNATRACER" is a self-powered quality test instrument designed to trace TV signals through any Video, Sound, Sync, AFC, Horizontal or Vertical Sweep Circuit--will isolate trouble to a stage or component.

ADDED FEATURE: The "DYNATRACER" will also trace voltages (50/500 V. AC/DC) and instantly locate open, shorted, intermittent or leaky (up to 20 MEGOHMS) condensers, resistors, coils, XFormers, etc.

10 DAY MONEY-BACK GUARANTEE
Instruction and Trouble-Shooting Book Enclosed
Cut out advertisement... attach name and address with \$5.00 bill, check or money order and mail to

Century ELECTRONICS CO.
8509-21st Ave., Dept. 109, Brooklyn 14, N. Y.

CORONA RADIO KITS

- Easy Assembly • Excellent Reception

SINGLE BAND SUPER
Rocket 115K--Latest superhet circuit for ultimate in sensitive reception and tonal quality. Kit includes all necessary parts, punched chassis, attractive bakelite mahogany cabinet, built-in loop antenna, iron core IFs, big 5" Alnico V spkr., tubes: 12SK7, 12SA7, 12SQ7, 50L6, 35Z5. Automatic vol. control, beam power out. Tunes 340 to 1700 Kc. Simple step-by-step instructions included. Net \$14.75

2 BAND AC-DC SUPER
Plaza 812K--Excellent sensitivity. Tunes standard Broadcast 535 to 1800 Kc. foreign shortwave 6 to 18 Mc (16.6 to 50 meters). Features iron core IFs, bass-treble tone control, 3" Alnico FM Spkr., phono jack. Handsome bakelite mahogany cabinet. 1 1/2" x 8 1/2" x 3 1/2". Tubes: 12SK7, 12SA7, 12SQ7, 50L6, 35Z5. All parts, punched chassis, easy step-by-step instructions included. Net \$20.75

3-BAND SUPER Globemaster 814K Complete
Kit supplied for wire and solder. Net \$24.75
All kits supplied in wire and solder. Please include 25% deposit with C.O.D. Orders. Dept. E-1

CORONA RADIO & TV CO.
136 LIBERTY ST., NEW YORK 6, N. Y.

TEST INSTRUMENTS

quency derived by Ginzton and Hollingsworth is:

$$F = \frac{1}{2\pi RC \sqrt{6 + 4 \left(\frac{R_L}{R}\right)}}$$

where R_L is the same quantity involved in the gain equation. The equation shows how the frequency is affected by varying the load and by changing the cathode resistor (both affect R_L). The factor 6 in the approximate equation given earlier corresponds to the R_L/R ratio of 1/4. If the ratio is 1/100, the factor becomes 6.5; at 1/2, the factor is 5.6; while at unity, the figure is 5.0. It is not necessary to use this equation in designing an oscillator. The approximate form is sufficient.

Maximum feedback occurs when the R-C sections are equal, but this is important only near the high-frequency limit of operation, where the feedback falls off. Since feedback is reduced by inequality among the R-C elements, this is a way of correcting overdrive. The effect of variations in R and C is complicated. However, in the simplest case, where only one component is changed at a time, the following relations seem to be general: the effect of varying C is the same, regardless of its position in the network; any C may be decreased by 0.5 or increased by 5 to 10; the effect of varying R differs with its network position; the resistor nearest the plate may be decreased by 0.3 or increased by 1.5; the center resistor may be decreased by 0.5 or increased by 2 or 2.5; the resistor nearest the grid may be decreased by a factor of 0.7 or increased by 4 or 5.

An advantage of the oscillator is its excellent waveform at very low frequencies. The writer was interested in finding how well the wave appeared at the lowest frequency that could be conveniently produced. That turned out to be 0.0055 c.p.s., or 180 seconds per cycle. The waveform, Fig. 2, was smooth; apparently a sine wave. The circuit of Fig. 1 was used, with R, 1 megohm, C, 10 μf (oil-filled), R_K , 2,700 ohms, and C_K , 10,000 μf (electrolytic, 25 volts). Data for Fig. 2 were taken by reading the d.c. voltage at the V2 cathode at 10-second intervals. The fluctuation was from 68 to 114 volts or 46 volts peak-to-peak, equal to 16 volts r.m.s.

It appears that the size of the capacitors, especially the cathode bypass, becomes the limiting factor at low frequencies. In this example, 10,000 μf seems none too large since the reactance is about 3,000 ohms. Oscillation at a reduced amplitude took place with half that value, but ceased with 3,000 μf. At extremely low frequencies no ordinary v.t.v.m. will read a.c. volts. However, frequency measurement is very easy: just count the cycles! An oscillator operating around 0.1 to 1 c.p.s. would be excellent for demonstrating the fundamental action of a vacuum tube—the generation of an a.c. voltage from a fluctuating direct current. END

Reference

E. L. Ginzton and L. M. Hollingsworth, "Phase-Shift Oscillators," Proc. IRE., Vol. 29, p. 43 (1941).

BLAK-RAY SELF-FILTERING ULTRA-VIOLET LAMP

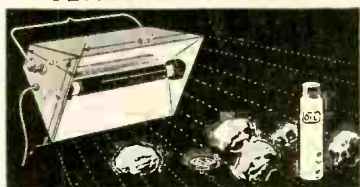

BLAK-RAY 4-watt lamp, model X-4, complete with U-V tube. This lamp gives long-wave ultra-violet radiation having a wave-length of 3654 to 4000 angstrom units. Some of the substances made to fluoresce visibly when illuminated by U-V light are certain woods, oils, minerals, milkstone, cloth, paints, plastics, yarn, drugs, crayons, etc. This lamp is self-filtering and the invisible U-V rays are harmless to the eyes and skin. Equipped with spectral-finish aluminum reflector. Consumes only 4 watts and can be plugged into any 110 volt 50-60 cycle A.C. outlet. Will give 2000 to 3000 hours of service. It weighs but 1 3/4 lbs. Approved by the Underwriters Laboratories and has a built-in transformer so that it may be safely used for long periods when necessary. Extra U-V tubes are available.

Ship wt. 4 lbs. **\$16.75**
ITEM NO. 125
UNUSUAL BUY (Shp. Chgs. 70c)

POWERFUL ALL PURPOSE MOTOR

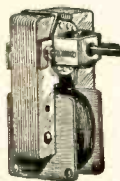

Sturdy shaded pole A.C. induction motor. 15 watts, 3000 rpm. 3"x2"x1 3/4"; 4 mounting studs; 3/8" shaft, 3/16" diameter; 110-120 volts, 50-60 cycles, A.C. only. When geared down, this unit can operate an 18" turntable with a 200 lb. dead weight. Use it for fans, displays, timers and other purposes. Ship wt. 2 lbs. **\$2.45**
ITEM NO. 147
UNUSUAL BUY (Shp. Chgs. 35c)

WATTHOUR METER

Leading makes-reconditioned. Ideal for trailer parks. 100-110 volts, 60 cycles, 2-wire A.C. 5 amp. Heavy metal case 8 1/2" x 6 1/4" x 5". Easy to install. Ship. wt. 14 lbs. **\$4.50**
ITEM NO. 33
NOW ONLY (Shp. Chgs. \$1.25)

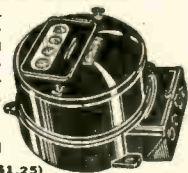

WESTERN ELECTRIC BREAST MIKE

Lightweight 1 lb. carbon microphone. Aircraft type. Breastplate mounting, adjustable 2-way swivel. Easily fastened straps. For home broadcasts, communications etc. Complete with 6 foot cord, hard rubber plug. Sherardized plate, non-rusting finish. Ship. wt. 2 lbs. **\$2.25**
ITEM NO. 152
NEW LOW PRICE (Shp. Chgs. 35c)

AMAZING BLACK LIGHT

250-watt ultra-violet light source. Makes fluorescent articles glow in the dark. Fits any lamp socket. For experimenting, entertaining, unusual lighting effects. Ship. wt. 2 lbs. **\$2.45**
ITEM NO. 87
A SAVING AT (Shp. Chgs. 35c)

250 POWER TELESCOPE LENS KIT

Make your own high powered 6 ft. telescope! Kit contains 2" diam., 75" focal length, ground and polished objective lens and necessary eye pieces. Magnifies 50x to 250x. Full instructions. Ship. wt. 1 lb. **\$2.95**
ITEM NO. 123
YOU SAVE AT (Shp. Chgs. 10c)

HUDSON SPECIALTIES CO.
25 West Broadway, Dept. RE-1-54
New York 7, N. Y.

I am enclosing full remittance for items circled below. (Be sure to include shipping charges.)
OR, my deposit of \$... Ship balance C.O.D.
MINIMUM C.O.D. ORDER \$5.00.
C.O.D. ORDERS ACCEPTED ONLY WITH 20% DEPOSIT INCLUDE SHIPPING CHARGES.

Circle Items Wanted
87 147 33 152 128 123

Name Please Print Clearly
Address
City Zone State

YOU'LL FIND PAGE AFTER PAGE OF BIG VALUES LIKE THESE IN THE 1954 156 PAGE B-A CATALOG

FREE! 1954 CATALOG

BURSTEIN-APPLEBEE CO. Dept. 5, 1012-14 McGee St., Kansas City 6, Mo.

Send Free B-A Catalog No. 541
 My order attached for items in this ad.

\$..... enclosed.

Name.....
Address.....
City..... State.....

FORMER SELL-OUT AGAIN AVAILABLE! NOW \$13.69 ONLY

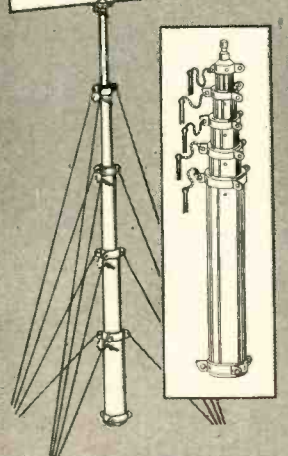

41-FT. TELESCOPING STEEL MAST FOR TELEVISION, ETC.

Thousands were previously grabbed up as an outstanding buy at \$24.88 . . . Now, another huge special purchase from Gov't. surplus makes possible this Terrific Bargain. (Original Gov't cost said to be \$60.00 each.)

Built to rigid Army Specs. (AN-S-2) for portable field lighting . . . ideally suited for a truly superior TV mast as well as for amateur beams, lighting, flagpoles, etc.

Compare these specifications with ordinary TV Masts . . . 5 sections extend to 41 ft., telescope to 9 1/2 ft. Super-strong chrome alloy seamless steel tubing, baked brown weather-proof enamel inside and out. Two machined close-fitting bushings and 3-hole guy ring at each joint. Sections extend easily, are held in position by heavy cross pins . . . **May even be raised horizontally fully extended, with no buckling!** Can be dis-jointed for shortening or dividing. Top section diameter 3/4" yet stronger than usual TV masts and of ample size to accommodate antenna mast clamp hardware. Mid-sections 1 3/8", 1 3/4" and 2 1/8". Base section 2 1/2" diameter.

Makes possible at low cost ground mounted antenna systems commonly preferred to roof-top installations because of less hazard for the installer and the home—plus better choice of antenna location.

Order Now While Available at this Low Price! Every Mast Brand New.
No. 6A85. Shpg. wt. 40 lbs. **SPECIAL EACH \$13.69**
4 Masts in Original Wood Crate
Shpg. wt. 200 lbs. Lots of 4 for..... **\$49.97**

BATTERY-OPERATED TELEPHONE HANDSETS



\$4.59 PAIR

Provides, at an unbelievably low cost, a dependable two-way phone system, powered by self-contained flashlight batteries (935 Eveready or equivalent) and operated over two-conductor wire for distances up to 1 mile with exceptionally fine speech reception, equal to that of any ordinary telephone.

Ideal for TV installers in making proper alignment of roof or attic antennas. "Just it" for construction gangs, temporary communication systems in factories, on the farm, in homes or for emergency uses.

So simple in operation even a child can use it for house-to-house, house-to-garage, and other play uses. Push button switch automatically connects battery.

Molded of break-resistant telephone-black polystyrene. Complete, ready-to-use with clips for easy connection to any two-conductor wire.

No. 20A946. (less batteries) **\$4.59** 6 Pair **\$3.94**
Per Pair.....
Batteries for above (requires one per phone) No. 21A2. Ea...10c
Two Conductor Telephone Wire: No. 2A171. Per 100 Feet.....95c

NEW! CONTINUOUS-DUTY 1/4-IN. ELECTRIC DRILL

Streamline design, well balanced continuous duty drill with popular Jacobs geared key chuck. Features built-in spotlight for focusing on work in dark recesses of cabinets, in attics when installing antennas, anywhere better visibility is required while drilling.

Extra powerful with plenty of torque for drilling in hard woods or metal without danger of stalling. Precision made with aluminum die-cast housing and ball thrust bearings. Trigger-lock type switch; 2100 RPM no load speed 110-120 Volts, 2 Amp AC-DC motor. 3 cond. cord with grounding terminal. Shpg. wt. 5 lbs.

No. 37A302. Net Each..... **\$20.96**



\$20.96

Built-In Spotlight

BURSTEIN-APPLEBEE CO.
1012-14 McGEE ST. KANSAS CITY, MO.

TERMS: F.O.B. Kansas City. Remit with order. Include postage for parcel post shipments.

FIX ANY TV or



Handle any job on any set easier and better! This complete Ghirardi training shows you exactly what to do . . . every step of the way.

Let these two up-to-the minute Ghirardi books make it easy for you to handle ALL types of AM, FM and Television receiver service by the very best and latest methods! Learn to handle jobs faster, better . . . and with less testing! Whether you're a service beginner or an experienced technician you'll find the speedy, professional methods that are so clearly explained can give BOTH your service efficiency and your earnings a big boost!

SAVE \$1.25!

Make your service library complete! Have the needed data at your fingertips **WHEN YOU NEED IT!**

If broken into "lessons" and sent to you as a "course," you'd regard this new Ghirardi training as a bargain at \$100 OR MORE! Instead you buy BOTH big books at the bargain price of only \$12.00 (you save \$1.25!)



A. A. Ghirardi More servicemen have trained from Ghirardi books than any other books or courses of their kind!

A "GOLD MINE" OF HOW-TO-DO-IT SERVICE DATA!

Almost 1500 pages and over 800 big, clear pictures and diagrams explain EVERY troubleshooting and repair operation so simply it's next to impossible to go wrong. Each book contains up-to-date data on the latest methods and equipment. Books are sold separately at prices indicated. Better yet, you can save \$1.25 by buying both together! Send no money. Practice from these great books for 10 full days FREE. Mail coupon today to Rinehart Books, Technical Div., Dept. RE-14, 232 Madison Ave., New York 16, N. Y.

Radio & Television Receiver

1 Circuitry & Operation

by Ghirardi & Johnson
669 pages, 417 clear illustrations, \$6.50

It's lots easier to repair ANY radio or television set when you know all about its circuits and just why and how each one works! You locate troubles in much less time and with less testing. You repair them faster, better—more profitably! That's why *Radio & Television Receiver CIRCUITRY AND OPERATION* is invaluable to servicemen who want to be well equipped to handle today's complicated receivers! First it gives a complete understanding of basic circuits and their variations. It teaches

you to recognize each one quickly. Then it shows how to eliminate useless testing and guesswork in making repairs. Throughout, this book gives you the kind of above-average training that takes the "headaches" out of servicing—the kind that fits you for the better-paid jobs. Covers all basic circuits used in modern TV and radio receivers as well as phono pick-ups and record players. Sold separately for \$6.50—or see big MONEY-SAVING COMBINATION OFFER IN COUPON.

Radio & Television Receiver

2 Troubleshooting & Repair

by Ghirardi & Johnson
822 pages, 417 clear illustrations, \$6.75

Backed by the how-to-do-it methods and procedures so clearly explained in this big book, you can breeze through all types of television and radio service jobs easier and faster than you may have thought possible! Throughout its 822 pages, *Radio & Television TROUBLE-SHOOTING AND REPAIR* is an amazingly complete, how-to-do-it guide to professional service methods—the kind that help you handle jobs lots faster and make more money doing it! For beginners, this big book is an easily understood course in locating troubles fast and repairing them r-i-g-h-t. For experienced servicemen, it is a quick way

to "brush up" on specific jobs; to develop better methods and shortcuts; or to find fast answers to tough service problems. Modern troubleshooting is clearly explained—from quick "static" tests to dynamic signal tracing and all the rest. Special hard-to-fix troubles are fully covered. Step-by-step charts demonstrate exactly what to do on different operations. A big, television section includes everything you need to know for fast, accurate work on any TV receiver model or make. Sold separately for \$6.75. Save money by ordering the SPECIAL COMBINATION offer. Send coupon today. Practice 10 full days FREE!

DON'T THROW OLD RADIOS AWAY!



This big Handbook contains just the data you need to fix them in a jiffy!

It's a cinch to repair old radios when you have Ghirardi's famous RADIO TROUBLESHOOTER'S HANDBOOK at your side! Many users say this big book has made it easy for them to fix sets that dealers said could no longer be repaired and should be junked.

Just look up the make and model you want to repair. The Handbook shows just what the trouble is likely to be . . . then explains step by step exactly how to fix it.

No guesswork! No useless testing! No wasted time! Handbook covers common trouble symptoms of over 4,800 old models of home and auto radios and automatic record changers by 202 manufacturers . . . from Atwater Kent to Zenith. Even beginners can follow its clear, easy instructions.

CUTS SERVICE TIME IN HALF ON 4 OLD SETS OUT OF 5!

Gives how-to-do-it data on specific jobs—not just a lot of general theory. In addition, a big section is chock full of tube and other component data, graphs, diagrams, service short cuts and money-making ideas. Cuts time in half on hundreds of jobs. Enables you to fix old sets cheaply for customers . . . and at a real profit to yourself! Order *Radio Troubleshooter's Handbook* in coupon today for 10-day FREE examination.

BE AN EXPERT ON MAGNETIC RECORDING!

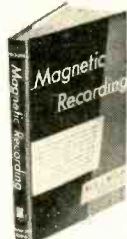

MAGNETIC RECORDING
by S. J. Begun
242 pages, 116 illustrations
Price \$5.00

Magnetic Recording, by one of the nation's acknowledged experts, clearly explains all details of the art.

A COMPLETE GUIDE TO RECORDING METHODS AND EQUIPMENT

First you get a clear understanding of every phase of wire and tape recording . . . from basic acoustic and magnetic theories to components, equipment and circuits in present day use. Subjects include Acoustic Factors; Magnetism; Magnetic Recording Theory and Practice; System Components; Magnetic Recording Equipment; Magnetic Recording Applications; Instrumentation and Recording Measurements; The Magnetic Phonograph, and many more.

Read it 10 full days at our risk. Order *Magnetic Recording* in coupon.

This how-to-do-it book makes it easy to specialize in one of the fastest-growing electronic fields

There's a real future for men who specialize in the fast-growing field of magnetic recording in all of its many branches!

From high fidelity sound to broadcasting, to sound movies, industrial communications, secret communications (speech scrambling), amateur radio, industrial sound and noise measurements and many others, magnetic recording is now an important factor. This book

CASH IN ON TELEVISION SERVICE PROFITS!



PRACTICAL TELEVISION
by Johnson & Newitt
375 pages,
230 illustrations
Price \$4.00

CHECK FULL OF HELPFUL CASE HISTORIES AND SERVICE HINTS

Dozens of actual television servicing case histories, service shortcuts and tips make the book ideal for beginners and experienced servicemen alike.

Subjects include: TV System Fundamentals; R-F, I-F and Detector Sections; Video Amplifiers; Cathode Ray Tubes; Synchronizing and Sweep Circuits; Power Supplies; Antennas and Wave Propagation; TV Receiver Installation; Test Equipment and Alignment; Wiring and Repair Techniques; Color TV; Receiver Layout Diagrams and dozens more.

Practice from it 10 days FREE. Order *Practical Television Servicing* in coupon.

Learn Right from this easily understood book

Good training in television service doesn't need to cost you a lot of money! This great book at only \$4.00 tells you step by step what to do, what mistakes to avoid, what tools, parts and equipment to use . . . in short, how to handle all kinds of TV receiver servicing fast, easy and r-i-g-h-t!

Besides explaining just how television work differs from radio, this book tells you exactly how to perform all operations in troubleshooting, diagnosing and in making repairs.

USE COUPON FOR 10-day Free Trial!

RADIO EVER MADE

**FAST!
EASY!
R-I-G-H-T!**

Here's How to Make
HIGH FIDELITY
Mean What it Says!



JUST OUT!

HIGH FIDELITY TECHNIQUES

by John H. Newitt
Staff, Mass. Inst. of
Technology
494 pages, 203 illustrations,
Price \$7.50

A COMPLETE GUIDE TO AMERICA'S FASTEST GROWING HOBBY

Get better results from "Hi-Fi" by having all the facts and latest ideas at your fingertips!
This big, brand new book by one of the nation's experts, brings you the complete "low down" on modern sound reproduction methods and equipment. It shows how to get better results at lower cost; how to build your own; how to service hi-fi equipment; discusses all details of components; compares different methods—**AND IS CRAMMED FULL OF HOW-TO-DO-IT TIPS AND IDEAS.**

ANSWERS YOUR HI-FI QUESTIONS
... Helps you get top notch results!

Here are just a few of the many subjects: How to get the right hi-fi equipment for your needs; Hi-fi versus P.A. type speakers; Loud-speaker construction and performance; Adjusting bass-reflex cabinets; Controlling distortion; Getting rid of "hangover"; The best reproducer enclosure; Selecting a woofer-tweeter; Sound-proofing materials; All about output transformers; Special hi-fi circuits; Ways to suppress noise; Negative feedback and how to use it; Amplifier construction hints; Minimizing tuner distortion; Avoiding chatter; Limiter-discriminator vs. ratio detector FM circuits; All about records and record players; Avoiding record wear; Tips for custom builders; Bass-reflex calculations and design charts; Acoustical horn design data . . . and literally dozens of other subjects.

Order High Fidelity Techniques in coupon today for 10-day FREE trial!

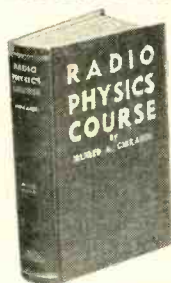

RADIO PHYSICS COURSE

by Ghirardi
972 pages, 508 illus.
856 self-test
questions
Price only \$6.50

More people now in Radio-Television-Electronics got their basic training from this book than any other of its type!

"The most complete training course in radio fundamentals ever offered!" . . . that's what the experts say about Ghirardi's world-famous **RADIO PHYSICS COURSE** book. More widely used in World War II military training and for home study than any other basic text.

RADIO PHYSICS COURSE is the oldest text of its kind on the market—and still a "best seller" because it is so complete, clear and easy to understand, even without any previous radio training. You can buy newer and far more costly training—but you can't buy better training at anywhere near the price. Ask the men who know!
Starts right at the beginning with Basic Electricity. Then it takes you step by step through the entire field from circuits showing basic functions to the final applications of these circuits in radio-electronic equipment.

Study from it for 10-full days. Specify **RADIO PHYSICS COURSE** in coupon.

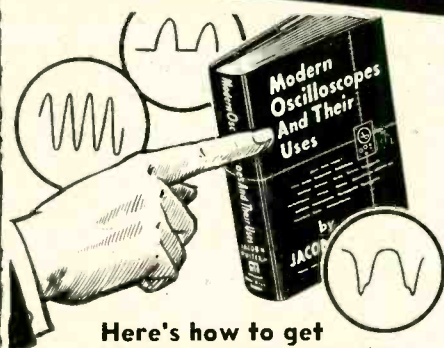

Here's how to get
MORE WORK OUT OF YOUR OSCILLOSCOPE!

MODERN OSCILLOSCOPES AND THEIR USES

By J. H. Ruiter, Jr.,
of Allen B. DuMont
Laboratories, Inc.
326 pages, 370 illus.
Price \$6.00

Oscilloscopes are "gold mines" for servicemen who learn to use them fully—and here is a book that **REALLY SHOWS YOU HOW.**
In clear, easily understood terms, *Modern Oscilloscopes and Their Uses* explains when, where and how to use the oscilloscope . . . how to interpret patterns . . . how to use your 'scope to handle all sorts of jobs easier, faster and better.

A complete guide to the HANDIEST INSTRUMENT OF THEM ALL!

Each operation is made as simple as A-B-C. You learn where and how to use the 'scope on specific jobs; how to make connections; how to adjust circuit components, how to set the controls, and **HOW TO ANALYZE PATTERNS.** 370 illustrations including dozens of pattern photos make things doubly clear.



Practice from it 10 days FREE. Order Modern Oscilloscopes in coupon.

'SCOPE EXPERTS get better jobs . . . bigger pay!

Here's How to
SAVE MONEY ON INSTRUMENTS!

... for servicemen
... amateurs
... experimenters

BASIC ELECTRONIC TEST INSTRUMENTS

by Rufus P. Turner
254 pages, 171 illus. Price \$4.00



Here, at last, is an instrument book especially for servicemen, amateurs and experimenters!

Basic Electronic Test Instruments helps you work better and faster with fewer instruments; shows how to increase the usefulness of old instruments; how to choose the right instrument for each job; how to understand instrument readings and put them to practical use; how to avoid buying unnecessary instruments . . . and lots more.

Over 60 instruments from the old standbys to the very latest ones are fully described. Their uses are clearly explained. Work-saving shortcuts are outlined.

TEST BETTER - FASTER - RIGHT!

Included are complete details on simple meters for current and voltage; ohmmeters and V-O-M's, V-T voltmeters; power meters; impedance meters; capacitor checkers; inductance checkers; special-purpose bridges; oscilloscopes; R-F test oscillators; signal generators; audio test oscillators; R-F and A-F measuring devices; signal tracers; tube testers and many others.

Among other things this handy book is a complete training course in the latest instruments including grid-dip oscillators, TV sweep and marker generators; TV linearity pattern generators, square wave generators, distortion meters, etc.

Dozens of time-saving "tricks" help you put old instruments to new uses.

Check Basic Electronic Test Instruments in coupon for 10-day FREE trial.

Send No Money!
TRY ANY BOOK
TO FULL DAYS FREE!

Dept. RE-14, Rinehart Books, Inc., Technical Division,
232 Madison Ave., New York 16, N. Y.

Check here for **MONEY-SAVING COMBINATION OFFER . . .**

on Ghirardi's Radio & TV Receiver **CIRCUITRY AND OPERATION**, and Radio & TV Receiver **TROUBLESHOOTING AND REPAIR**. Price only \$12.00 for the two books. (Regular price \$13.25 . . . you save \$1.25). Payable at rate of \$3 after 10 days if you decide to keep books and \$3 a month for three months until \$12 has been paid. If not satisfactory, return books in 10 days and owe nothing.

Check here to order **INDIVIDUAL BOOKS**

- Radio & TV Receiver **CIRCUITRY & OPERATION** . . . \$6.50
- Radio & TV Receiver **TROUBLESHOOTING & REPAIR** . . . \$6.75
- RADIO TROUBLESHOOTER'S HANDBOOK** . . . \$6.50
- MAGNETIC RECORDING** . . . \$5.00
- PRACTICAL TELEVISION SERVICING** \$4.00
- HIGH FIDELITY TECHNIQUES** . . . \$7.50
- MODERN OSCILLOSCOPES AND THEIR USES** . . . \$6.00
- BASIC ELECTRONIC TEST INSTRUMENTS** . . . \$4.00
- RADIO PHYSICS COURSE** . . . \$6.50

To order **OUTSIDE U.S.A.**—Special combination offer, \$13.00 for both books. For all other books, add 50¢ each to above prices for handling through customs, etc. Sold for cash only. Any book may be returned in 10 days and money will be refunded.

Name
Address
City, Zone, State
Employer

the **630**

IS STILL THE FINEST TV CHASSIS EVER DESIGNED

...and there is no finer 630 chassis than the **GOLD MEDAL**

by **TECH-MASTER**

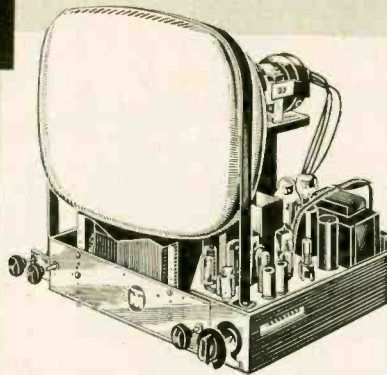

There is a Tech-Master Custom-Designed, custom-built TV Chassis for every requirement where quality and reliability are the predominant factors.

- MODEL 2430: For picture tubes up to 24". Audio connection for optional use of external amplifier. Net Price..... (Less Kine).....\$189.50
- MODEL 2431P: Same as 2430, but with true fidelity Push-Pull audio amplifier. Net Price..... (Less Kine).....\$199.50
- MODEL 2439: For new 90° kinescopes. (24" rectangular, 27" and 30") Net Price..... (Less Kine).....\$262.50



Write for Detailed Data

TECH-MASTER PRODUCTS CO.
445 BROADWAY, NEW YORK 13, N. Y.

TECH-MASTER TV Chassis

TECH-MASTER TV Kits

TECH-MASTER Audio Equipment

Check! these NJRT TUBE prices **70% to 90% off list ...**

Type	Price	Type	Price	Type	Price	Type	Price
1A7GT	.45	6A6	.49	6BQ6GT	.57	6X4	.35
1B3GT	.47	6AB4	.42	6BQ7	.80	6X5GT	.35
1H5GT	.38	6AF4	1.06	6BZ7	.89	7F8	.63
1L4	.44	6AF6	.75	6C4	.39	12AL5	.40
1L6	.41	6AG5	.41	6CB6	.42	12AT6	.35
1LC5	.49	6AJ5	.88	6CD6G	1.09	12AT7	.54
1LN5	.49	6AK5	.73	6F6G	.37	12AU6	.38
1NSGT	.44	6AL5	.36	6F6GT	.35	12AU7	.41
1R5	.43	6AQ5	.37	6J5GT	.40	12AV6	.50
1S5	.37	6AQ6	.35	6J6	.50	12AV7	.57
1T4	.43	6AT6	.35	6K6GT	.35	12AX4GT	.46
1U4	.43	6AU4GT	.69	6L6	.62	12AX7	.49
1U5	.37	6AU6	.36	6S4	.37	12BA6	.36
1X2	.52	6AV6	.35	6S8GT	.31	12BA7	.44
3A4	.43	6AX4GT	.57	6SA7GT	.41	12BE6	.37
3Q4	.46	6BA6	.41	6SD7GT	.39	12BH7	.65
3Q5GT	.47	6BA7	.57	6SK7GT	.39	12SA7GT	.42
3S4	.44	6BC5	.42	6SL7GT	.46	12SK7GT	.46
3V4	.25	6BD6	.45	6SN7GT	.50	35A5	.50
5A24	.50	6BE6	.37	6SQ7GT	.35	12SQ7GT	.42
5U4G	.45	6BGG	.92	6T8	.54	12SR7MET	.47
5V3GT	.30	6BH6	.44	6U8	.59	12V6GT	.60
5Y4G	.33	6BH6	.41	6V6GT	.37	19B6GG	.96
5Z3	.37	6BK7	.65	6W4GT	.42	19T8	.77
6A3	.57	6BL7GT	.60	6W6GT	.45	25BQ6GT	.60

Guarantee

ALL NJRT TUBES ARE BRAND NEW AND FULLY GUARANTEED FOR 1 YEAR.

Type	Price	Type	Price
25L6GT	.37	42	.40
25W4GT	.45	43	.53
25Z6GT	.35	45	.53
35A5	.50	50B5	.37
35B5	.38	50C5	.37
35C5	.37	50L6GT	.39
35L6GT	.40	70L7GT	1.07
35W4	.35	76	.42
35Z3	.43	117Z3	.35
35Z5GT	.35	807	.97

T.V. PIX TUBE BRIGHTENER \$1.59
LOTS OF 10 \$1.49

Free 50

Assorted Condensers with every tube order of \$25.00 or more.

For T.V. sets where voltage supply is low AC LINE BOOSTER with safety fuse and switch \$5.95

Many 7 volt types not listed. All tubes individually boxed. Minimum order \$10.00. Tubes offered subject to prior sale. Prices subject to change. Orders shipped prepaid if check is enclosed. 25% deposit required on c.o.d. shipments.

SEND FOR FREE TUBE LISTING.

NEW JERSEY TELEVISION SUPPLY CO.

906A WESTFIELD AVE., ELIZABETH, N. J. EL 3-6166

EASTERN CONFERENCE

Samuel Brenner, PRSMA, and Max Liebowitz, ARTSNY, were appointed chairman and co-chairman in charge of arrangements for an Eastern Conference of electronic technicians and service dealers. Appointments were made at the October meeting of the National Electronic Technicians and Service Dealers Association, held in Trenton, N. J. The meeting also considered plans for the proposed conference.

It was decided by the delegates that under the organization's charter, three meetings will be held a year, on the first Sundays of February, May, and October. The next meeting will be in Philadelphia, February 7.

NATESA AWARD TO ARTSD

Fred Colton of ARTSD, Columbus, Ohio, was proclaimed by Frank Moch, president of the National Alliance of Television and Electronic Service Associations as the "regional vice-president who during the year did the most to make the convention a success." Mr. Moch also gave credit to the Columbus Association, which turned out the biggest delegation outside of Chicago. A suitable award, known as "The President's Cup," will be presented to Mr. Colton.

ARTSD TEN YEARS OLD

The November issue of the *Associated Radio-Television Service Dealers' News* (Columbus, Ohio) reminds us that ARTSD was 10 years old November 11. The association was formed with five members, Francis Gibb, Leo Loudner, Frank Knoderer, Harvey Brower, and John Graham. Three of the original members are still active.

Despite the November 11 anniversary, the organization decided to postpone celebration of its 10th birthday to the January meeting, at which time the officers for 1954 would be installed.

RCA WILL ISSUE BOOK

A complete color text for the service technician is promised soon by the Radio Corporation of America. The book, tentatively titled "Practical Color Television for the Servicing Industry," may be available early in the year.

ARTSNY ON THE AIR

Associated Radio and Television Service Technicians of New York City are co-operating with NBC's TV station WNBT and radio station WNBC in a campaign for better—and better paid—radio and television service in the New York City area. The case of the service technician is being presented in a number of radio and television spots that would be worth more than \$20,000 if purchased as straight paid advertising.

Station manager Ernest de la Ossa, in pointing out that the service technicians rate such attention, stated: "We have long realized that we at WNBC and WNBT rely on the hundreds of reputable service technicians who keep millions of radios and television receivers in operation. We commend ARTSNY's continuing project of better, more fairly priced service, and its technical help to its membership."

PHILCO TEST EQUIPMENT SPECIFICALLY DESIGNED FOR THE SERVICEMAN

AGAIN PHILCO LEADS THE INDUSTRY

Serviceman's needs seen as Philco's Engineering Goal

This new Philco VHF to UHF adapter pioneers a whole new approach to service problems and at the same time is the most economical and practical unit ever offered. Servicemen are taking full advantage of the introductory demonstrations of this amazing piece of equipment now offered by Philco distributors coast to coast.

The First and Only VHF to UHF Signal Generator Adapter

Continuing its engineering program designed to provide the serviceman with the best possible test equipment Philco Corporation now offers at a fraction of the usual cost an exclusive highly specialized adapter unit for converting the output of VHF TV servicing test equipment to UHF.

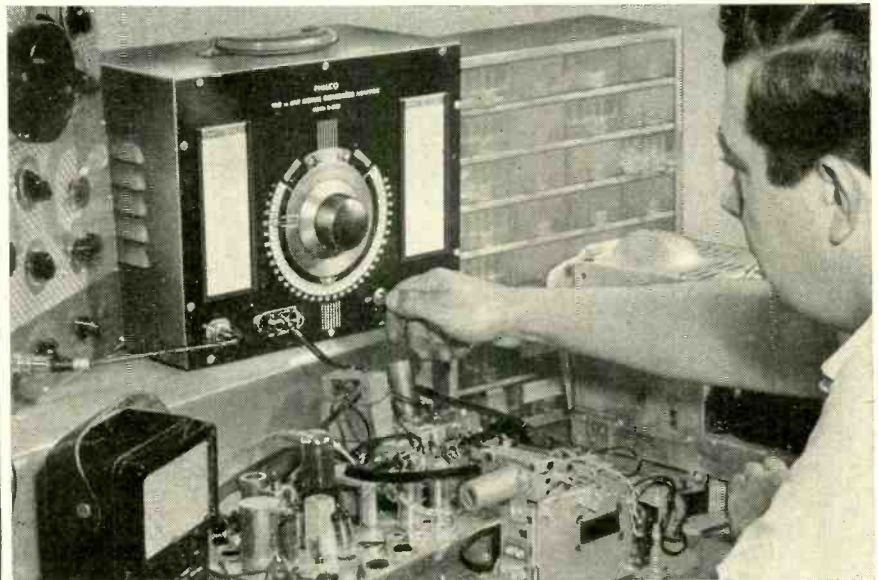

Under the trained eye of a Philco Serviceman the amazing model G-8000 VHF to UHF signal generator adapter is shown in action.



One of the Finest Vacuum Tube Voltmeters ever Designed

Facing up to the task of measuring high impedance circuits where loading effect must be kept to a minimum Philco has again designed a unit which meets the most rigid engineering specifications. All reports indicate this unit is unexcelled for complete and accurate measurements.

Practical Portable 3-inch Television Oscilloscope

The tremendous growth of television requires the most practical and versatile types of equipment to answer service needs. Philco has such equipment, particularly in its 3" scope which is 2½ times smaller than other 3" units, making it adaptable to either bench use or field servicing. High sensitivity and wide response make it ideal for TV work.



"Philco Test Equipment Specifically designed for the serviceman!" That's the theme of Philco's engineering program. A program which you, the serviceman, can depend upon to supply the very finest in service test equipment. Discover how easy it is to own a complete Philco Test Equipment Laboratory. Your Philco Distributor is eager to serve you by offering his new special payment plan to best accommodate your needs. Fill out the attached coupon as shown and mail to Philco Accessory Div.

PHILCO CORPORATION

Accessory Division
Allegheny Ave. & "A" St., Phila. 34, Pa.

- I am interested in the Philco Test Equipment shown here. Please send me details of your SPECIAL PURCHASE PLAN for obtaining these units.
- Please send FREE copy of your new booklet on Philco Test Equipment.

NAME

ADDRESS

CITY STATE

ARTSNY DINNER

A testimonial dinner to president Max Liebowitz was held by the Associated Radio and Television Servicemen of New York City on November 19th. The dinner was attended by more than 60 members and guests.

Master of ceremonies Sam Marshall, an early officer of the organization, led in hailing Max as founder and sustaining spirit of the association and one of the leading figures in the organization of the state and national federations. Others who paid tribute to ARTSNY's president were John Rider, Fred Shunaman of RADIO-ELECTRONICS, Lewis Winner of *Service*, and Joseph Forman, attorney for the organization. The appreciation of the membership was expressed by Arthur Rhine, Phil Goldfarb, O. Capitelli and Henry Levine.

INVITE COMPLAINTS

Service technicians of Kalamazoo, Michigan, plan a series of "clinics" to clear up any complaints of improper TV service. Forms have been placed in shops of all members of the Kalamazoo Radio and TV Association, and members of the public invited to fill out details on any case in which he feels he may have been cheated, misled, or otherwise improperly treated. The complaints, together with evidence that the customer paid the bill are addressed to the offices of Kalamazoo RTA.

The organization's plan is to send trucks to pick up all sets under dispute and to examine them at a public clinic—or series of public clinics—then give a verdict on whether the work was done properly and if the charges were justified.

Paul Goeche, the organization's president, stated: "We intend to do this sort of thing regularly, and if possible eliminate any technicians who bring discredit to the field." END

Radio Thirty-Five Years Ago

In Gernsback Publications

**HUGO GERNSBACK
Founder**

Modern Electrics	1908
Wireless Association of America	1908
Electrical Experimenter	1913
Radio News	1919
Science & Invention	1920
Television	1927
Radio-Craft	1929
Short-Wave Craft	1930
Television News	1931

Some of the larger libraries still have copies of **ELECTRICAL EXPERIMENTER** on file for interested readers.

JANUARY 1920

ELECTRICAL EXPERIMENTER

A Celestial Short-Circuit, By H. Gernsback

Magnetic Storms, by Lindley Pyle Learning Telegraphy and Radio at School

Is There a Sub-Electron?, by Rogers D. Rusk, M.A.

The Radio Compass, by Pierre H. Boucheron, U.S.N.R.F.

An Oscillation Radio Telephone and Telegraph

New Undamped Radio Receiver

Radio Fog Signalling a Success

New 165-ft. Portable Radio Mast

Less than
2 hands
wide

**JACKSON
MODEL 709
TELE-VOLTER**

Handy
to move
around shop



- 7-inch meter.
- Easy reading 4-color dial.
- Calibrated to "0" center scales.
- Single probe for all ranges.

Controls consist of on-off circuit switch, range switch, zero adjust, ohms adjust, besides switch built into probe for changing from DC to AC or ohms. Meter is electronically protected against overload.

Dealer net price . . . \$95.00

High Voltage Probe (to 30,000v DC) and High Frequency Probe (200mc) available as accessories.

See it at your electronics distributor's or write us for fully descriptive bulletin.



**JACKSON ELECTRICAL INSTRUMENT CO.
DAYTON 2, OHIO**

"SERVICE ENGINEERED" TEST EQUIPMENT

IN CANADA: THE CANADIAN MARCONI CO.

WARD TELE-VANES

styled for **NEW BEAUTY on the housetops**
INCREASED SALES of TV antennas

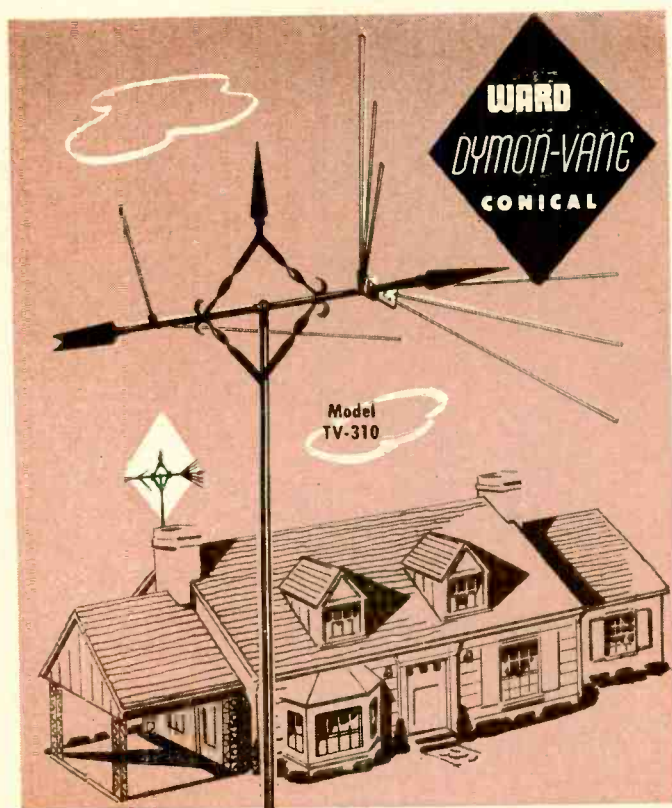

Sell the antennas that are "selling" for you. Ward is promoting their new line of Tele-vane

I The American Home
 Architectural Forum
 Better Homes and Gardens
 Business Week
 House Beautiful

Write today for the giant Tele-vane Sales Kit that gives you the complete schedule plus many, many more selling aids. Tie-in with this gigantic selling

Antennas right to the consumer with national advertisements in:

I Popular Mechanics Magazine
 Popular Science Monthly
 Time
 House and Garden Book of Building
 Newsweek

campaign for the newest, most revolutionary idea in TV antennas yet.

THE WARD PRODUCTS CORP.

DIVISION OF THE GABRIEL COMPANY

1148 Euclid Avenue, Cleveland 15, Ohio

In Canada: Atlas Radio Co., Ltd., Toronto, Ont.



NORTH, EAST, SOUTH, WEST...

Federal has a lead-in

Whatever the area or atmosphere... city or fringe... rain, snow ice, heat, dust, salt spray, polluted air or radiation... you'll find the answer in these quality-controlled cables by Federal —

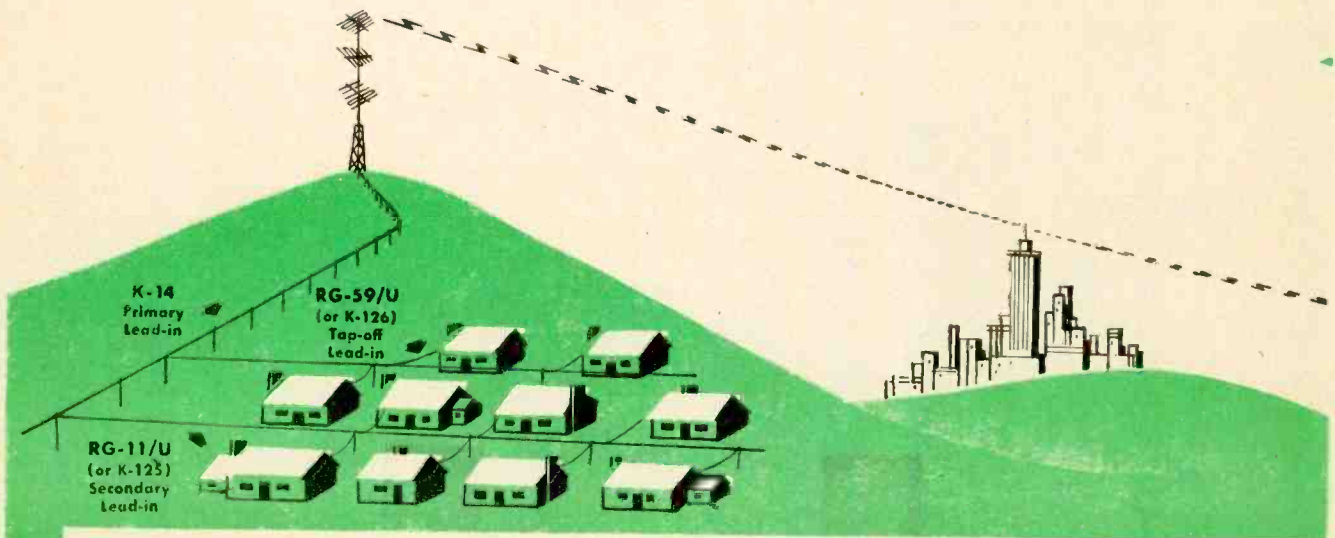

FOR COMMUNITY TV IT'S *Federal's* "BIG 5"



K-14—71-ohm shielded primary transmission line for community distribution systems. Famous for lowest line loss, long cable runs and fewer amplifiers required. Capacitance: 21.5 mmf/ft. Attenuation DB 100/ft: .57–50 Mc; .90–100 Mc; 1.42–200 Mc; 2.3–400 Mc.



RG-11/U—75-ohm shielded low-loss coaxial. One of the best small-diameter cables. Tops as a community TV secondary lead-in. Seven strands #26 tinned copper. Capacitance: 20.5 mmf/ft. Attenuation DB 100/ft: 1.5–50 Mc; 2.15–100 Mc; 3.2–200 Mc; 4.7–400 Mc.



RG-59/U—73-ohm coaxial TV lead-in cable. Highly efficient as a community system pole-to-house tap-off. Meets all needs wherever a high-grade installation is a must. Capacitance: 21 mmf/ft. Attenuation DB 100/ft: 2.7–50 Mc; 4.0–100 Mc; 5.7–200 Mc; 8.5–400 Mc.

Use these 2 for Community TV radiation:

FOR URBAN CENTERS



K-111—300-ohm shielded, balanced TV lead-in developed by FTR. Minimizes noise, snow, ghosts due to transmission line pick-ups. Ideal for many areas where good TV was impossible before. Capacitance: 4.2 mmf/ft. Attenuation DB 100/ft: 3.4–100 Mc; 6.6–400 Mc.



TV-1184—300-ohm dumbbell-shaped TV lead-in. A standard low-cost lead-in for areas without unusual conditions. Cinnamon-brown color is highly resistant to ultraviolet. Two conductors: 7/#28. Capacitance: 4 mmf/ft. Attenuation DB 100/ft: 1.28–100 Mc; 3.0–400 Mc.



TV-1182—300-ohm deluxe type heavy-duty TV lead-in with 90 mil. web. Insulated with "silver" polyethylene, Federal development that provides maximum weather protection and long life. Capacitance: 4 mmf/ft. Attenuation DB 100/ft: 1.22–100 Mc; 2.85–400 Mc.

Non-Radiating Lead-ins for MULTIPLEX TV SYSTEMS



K-125—75-ohm coaxial TV lead-in cable. Double-shielded and jacketed. Formerly listed as SP-75.



K-126—73-ohm coaxial TV lead-in cable. Double-shielded and jacketed. Formerly listed as SP-76.

K-125 alternates for RG-11/U as secondary lead-in
K-126 alternates for RG-59/U as tap-off lead-in

Wherever there are **TV** customers...

for the finest **VHF-UHF**

Federal's **TV-1185** *

...**"PIPELINE"** of the Air!



**300-OHM
ALL-CHANNEL
TWIN-LEAD
THAT LAUGHS
AT WEATHER**

FOR FRINGE AREAS

TV-1182—Provides remarkably low line loss in fringe areas. Outstanding for resistance to weather and sunlight. Silver-colored insulation blends with any color scheme in home decoration.

K-200 (RG-86/U)—200-ohm heavy-duty ultra low-loss lead-in. Particularly adaptable to remote-area installations — especially long runs and multi-stack antennas. Also used with rombics.

**See your local
Federal Distributor
or write to
Federal direct
Dept. D-963**

TV-1185's "Silver" pigmentation lets you **INSTALL IT and FORGET IT!**

FEDERAL's TV-1185 is virtually a "pipeline" for better-than-ever TV reception... VHF or UHF. Insulated with the revolutionary Federal-developed "silver" polyethylene, TV-1185 is amazingly tough, flexible and efficient.

TV-1185 leads in Weatherometer tests... fights heat, resists moisture and other destructive deposits... minimizes deterioration due to sunlight.

TV-1185 keeps the energy field inside the weather-proof sheath... providing exceptionally low loss... more constant impedance... a better TV picture regardless of area or length of lead. It's easy to install and tight-seal against all atmospheric conditions.

There's no finer tubular lead-in of its type on the market today!

Capacitance: 4 mmf/ft. Attenuation DB 100/ft:
0.5-10 Mc; 0.95-50 Mc; 1.25-100 Mc; 1.7-200 Mc;
2.6-400 Mc; 3.0-500 Mc; 4.5-1000 Mc.

Product of America's leading producer of solid dielectric coaxial cables



Federal Telephone and Radio Company

SELENIUM-INTELIN DEPARTMENT

100 KINGSLAND ROAD, CLIFTON, N. J.

In Canada: Federal Electric Manufacturing Company, Ltd., Montreal, P. Q.

Export Distributors: International Standard Electric Corp., 67 Broad St., N. Y.

If you want professional sound quality

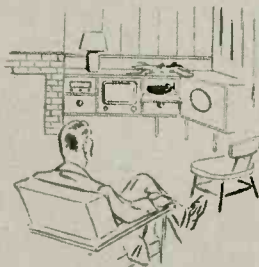

Sound engineers know that the selection of a fine amplifier, pickup and speaker system is only part of the story; that unless the turntable is of equal quality, music reproduction must suffer. That is why they insist on such high standards for turntable performance.

do as the professionals do...



Rek-O-Kut precision turntables are made to conform to the highest standards in the professional field, and they certainly represent the finest you can use in the home. A Rek-O-Kut turntable will make all the difference in the world. The finer your present system, the more apparent the improvement will be. Whether you select the deluxe T-12H or the standard LP-743, the entire performance of your sound system will become a new and thrilling experience.

use a REK-O-KUT precision turntable



Rek-O-Kut Precision Turntables are priced from \$59.50. Write for specifications and descriptive literature to Dept. J-13

The REK-O-KUT COMPANY

Manufacturers of Professional Disc Recorders and Specialized Sound Systems.

38-01 Queens Boulevard, Long Island City 1, New York
Export Division 458 Broadway, New York, U.S.A. Cables: Morhanex
In Canada: Atlas Radio Corp., Ltd., 560 King Street, W., Toronto 2B

SERVICE TECHNICIANS

What was your most unusual service case? Not necessarily the most difficult one, but the one you will remember longest, either because of the problem itself or because of other conditions surrounding the job. If the experience was interesting to you, it probably will be to other readers of RADIO-ELECTRONICS. We will pay \$10 for each "My Most Unusual Service Job" item we consider outstanding enough to publish in this magazine. If the item is striking enough or carries sufficient technical information to be worth more than \$10 in our opinion, it will be paid for at our regular space rates. Address your stories to

Unusual Service Job

RADIO-ELECTRONICS

25 WEST BROADWAY

NEW YORK 7, N. Y.



17" Table \$119.95 Pl. 10% Fed. Excise Tax	Check these luxury features: Ultra sensitivity, dynamic range control, UHF adaptability, Duo power supply, Acousticlear Sound System... All in a beautiful Mahogany Finish Cabinet.	20" Console \$139.95 Pl. 10% Fed. Excise Tax
20" Table \$129.95 Pl. 10% Fed. Excise Tax		21" Console \$149.95 Pl. 10% Fed. Excise Tax

Better Prices on quantity lots.

ALSO AVAILABLE T.V. CHASSIS

All sets have full 1 yr. factory picture tube warranty, and standard 90 day RTMA parts warranty.

MAIL and Phone orders filled. \$25 deposit, Balance C.O.D., Shipping Charges Add'l.

STEPHEN SALES CORP.

45 Crosby St., N. Y. 12, Phone WO 4-8233

Dealer Inquiries Invited

Reduce or Eliminate TELEVISION INTERFERENCE

with a

BUD HF-600 Filter

only **\$3.57**



Now you can stop or considerably reduce annoying picture disturbances caused by short wave broadcasting stations, amateur

radio stations, diathermy and X-ray equipment or airplane and automobile ignition systems.

Keep your picture clear of distortions from interference picked-up by your antenna. A Bud Filter will not affect the strength or quality of your picture. Easily attached to the rear of your set. Simple instructions enclosed. Thousands now in use with excellent results.

Order your Bud HF-600 Filter today. Send Check or Money Order. We pay postage. Add 3% tax in Ohio.

MAIL THIS COUPON TODAY

Radio & Electronics Parts Corp.
3235 Prospect Ave., Cleveland 15, Ohio

I enclose \$_____ please send me at once _____ Bud HF-600 Filters.

Name _____

Address _____

City _____ State _____

RADIO-ELECTRONICS

New Professional Magnemite*



Battery-Operated Long-Play Spring-Motor Portable Recorder

Specifically designed for maximum professional performance with greatest operating ease. Friction free, ball-bearing drive system enables tape transport mechanism to run 15 minutes on a single wind (at 7½ ips). Dynamically balanced hidden flywheel reduces flutter and wow, equivalent to studio equipment. Incorporates high speed motor rewind (100 seconds). Built-in spring-motor meter continually indicates condition of spring motor. Single knob controls tape and play-record functions. Safety "Record" interlock. 4 Models available in speeds of 3¾, 7½ & 15 ips.

Check These Unusual Features:

- ★ High-speed rewind
- ★ 15 Minute play per wind
- ★ Hidden high-speed flywheel
- ★ Ultrasonic bias
- ★ Meets NARTB standards
- ★ 100 Hours battery life
- ★ Size: 7 x 10 x 11 inches
- ★ Weight: 14 lbs.

Write for complete technical literature and direct factory prices to Dept. RE



AMPLIFIER CORP. of AMERICA

398 Broadway, N. Y. 13, N. Y.

T. H. Reg. U.S. Pat. Off.

WIRE WARNING!

WHY

pay more for questionable quality* tubular TV lead-in wire?

*subject to patent infringement.

LOOK



for highest quality license-labeled* Tubular TV Wire...

*JSC Tubular Wire is manufactured under license of Amphenol Pat. 2543696.

DEMAND



the most for your wire dollar... get BOTH Quality**! AND Low Price**!

**JSC—Highest in Quality... Lowest in Price

JSC NEW Twin Tubular TV Lead-In Wire...

The best low loss, low cost 300 ohm lead-in for UHF and VHF television.

Rain, snow, dirt or salt deposits do not materially affect impedance and electrical efficiency.

JSC tubular construction contains and protects the concentrated field of energy and reduces to a minimum high ratio signal losses.



Always Look for Orange and Blue Disc of Quality

WEN "Quick-Hot" ELECTRONIC SOLDERING GUN

567 HOURS CONTINUOUS SERVICE

250 WATT

110-120 VOLT AC



and only \$12⁹⁵

Which Soldering Gun?



You be the judge! Three competitive soldering guns were to be plugged in each morning... kept connected, operative, HOT all day. But Soldering Gun "A" lasted only 1¼ hours, burned out its transformer and started smoking! Gun "B" burned out in 21 minutes! The WEN Soldering Gun with Feraloy tip scored 567 HOURS! Or compare this way — the WEN Gun with 50c Feraloy tip averages 25,000 soldering connections. Gun "A" (replacement tip 25c) 800 connections. Gun "B" (new tip \$5.00) 1,627 connections. That means your soldering connections need cost you but 1/500 of 1c — using the WEN Gun. Practically lasts forever under ordinary conditions.

THEN THERE'S THE NEW Electric



WEN SANDER-POLISHER

Only \$13⁹⁵

Ideal for home use and many shop operations. It's light (2½ lbs.) quiet like an electric razor and handy to work with. Operates 240 strokes per second. Sands wood, metal, polishes furniture, your car — anything. Even gives a good massage

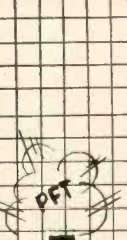

RADIO SUPPLY STORES SELLING THOUSANDS

		
GUN "A" 1¼ HR.	GUN "B" 21 MIN.	WEN GUN

Get the Facts! — See Your Jobber or Write —

WEN PRODUCTS, INC., 5808 Northwest Highway, Chicago 31, Ill.

(Export sales — Scheel International, Inc., Chicago)

I've switched to
ERIE SWITCHES
 They're in the BAG!

The new, full line of ERIE rotary selector and lever switches includes twenty-five item numbers. They are made in four styles, in single or multiple sections, shorting and non-shorting types. ERIE switches meet existing R.E.T.M.A. requirements. For protection against the corrosion of heavy silver plated contacts, each switch is sealed in a durable plastic bag and then boxed for convenient stocking.

Descriptive literature is available at your distributors, or write Dept. G for your copy.

ERIE components are stocked by leading electronic distributors everywhere.

ERIE ELECTRONICS DISTRIBUTOR DIVISION
ERIE RESISTOR CORPORATION
 Main Offices: ERIE, PA.
 Factories: ERIE, PA. • LONDON, ENGLAND • TORONTO, CANADA

NEW DESIGN

new
tubes

and
Transistors

THE smallest TV camera tube ever developed for broadcast use has been announced by RCA. The vidicon, type 6326, weighs only two ounces, and promises greater efficiency and economy in the televising of movie films.

The new electronic "seeing eye" is only a fraction of the size of an iconoscope tube normally used for film pickup, yet it is up to three times more sensitive and has a spectral response



Smallest TV camera tube, Vidicon 6326.

approaching that of the human eye. The tube measures 1 inch in diameter and 6 1/2 inches in length. Cameras using this new pickup tube can be used with any type TV-film projector.

Developed from the well known industrial vidicon which is not suited to fine-detail work, the film-pickup type 6326 has a resolution capability of approximately 600 lines, and needs only one-third to one-half the light required by an iconoscope for television motion pictures.

The vidicon's visual equivalent of signal to noise ratio (the ratio of the intensity of desired video signal to that of undesired noise signal) has been measured as 300 to 1. The tube itself contributes no appreciable noise to the video signal. The new tube is also highly suitable for the reproduction of color films on a monochrome system.

G-E has announced the addition of tube type GL-6386 to its line of "Five Star" high-reliability tubes.

The 6386 is a miniature medium-mu triode with each section being of the

Only STEVE-EL can make an offer like this!

Famous Make
**21" TV
 CONSOLE**

Complete
 ready
 to play

\$169⁹⁵



STEVE-EL brings you the TV buy of the year. This is not a kit but a factory wired and aligned chassis. The price is far below wholesale so the famous manufacturer does not want his name mentioned. The chassis can be bought with tubes or without or complete in beautiful mahogany cabinet all 3/4" wood. Complete sets come in 17" or 21". Here is truly exceptional quality TV which will outperform most receivers on the market today. Employs the finest of modern engineering innovations assuring the clearest sharpest picture ever.

Just a few
 of the many features:

- R.F. Amplifier on all bands. • 3 Stage I.F. system. • Peak A.G.C. • Kinescope cathode fed with DC restoration. • Balanced AFC system. • High Voltage using 2-1X2A. • Frequency Modulation Sound • Range 44-88Mc 174-216 Mc. • 12 Channels of VHF. • Separate power supply with voltage regulator. • Plug in yoke assembly. • Vertical integrator system. • AC interlock. • Filtered heater wiring for I.F. amplifier. • Wide range of adjustment controls. • 70° Cosine yoke. • Precision matched components assuring efficient maximum performance. • Heavy duty Alnico V 10" PM Speaker. • Complete circuit diagram. • Tubes: 1-5U4, 1-6BQ5, 2-1X2A, 1-6V6, 1-6AX4, 1-6SQ7, 3-5CB6, 3-6AL5, 1-6AG7, 1-6AU6, 3-12BH7, 1-6J6, 1-6BC5.

Chassis 14 1/2" wide, 19" deep (controls included). Power supply 14 1/2" wide, 9" deep.
 Complete Chassis Less Tubes\$49.95
 Complete Chassis with Tubes (Less Picture Tube) 64.95
 Complete Chassis with Tubes and 17" Picture Tube 86.95
 Complete Chassis with Tubes and 21" Picture Tube 95.95
 Complete Chassis with Tubes and 17" Picture Tube in cabinet as illustrated, with Safety Mask and Back159.90
 Complete Chassis with Tubes and 21" Picture Tube in cabinet as illustrated, with Safety Mask and Back169.90

We have only a limited quantity of cabinets. First Come, First Served. Cabinet 40" High x 33" Wide x 22" Deep.
 At our 2 stores: 61 Reade St., New York 7, N. Y.
 166 Washington St., New York, N. Y.

Order By Phone: COrlandt 7-0086
 Order By Mail: Dept. RE-1, 61 Reade St., New York 7, N. Y.

STEVE-EL ELECTRONICS CORP.

Dept. RE-1 61 Reade St., New York 7, N. Y.
 COrlandt 7-0086

Send for Your
FREE
Copy of the **NEW 1954**
MIDWEST
TELEVISION and
RADIO Catalog

MIDWEST *Presents*

For 1954 a Completely **NEW LINE** of
21" and 27" TELEVISION

CONSOLES
TABLE MODELS

and
COMPLETE
CHASSIS

at
LOW FACTORY
PRICES



YOUR CHOICE OF EITHER 12 CHANNEL
VHF or All-Channel VHF-UHF Models

Buy your Television or Radio Direct from the Midwest Factory . . . on
30 DAYS TRIAL . . . Easy Terms . . . and at LOW FACTORY PRICES.
For 34 years Midwest, the world's largest and oldest exclusive Factory-
To-You radio and television manufacturer, has served hundreds of thou-
sands of satisfied customers all over the world.



EASY TERMS
— . —
30 DAYS
TRIAL



FACTORY-TO-YOU

Also—Powerful New 1954 World-Ranging
MIDWEST Series 16 RADIOS
In Beautiful Consoles and Complete Chassis

All models available in your choice of mahogany, walnut finish or blond limed oak.

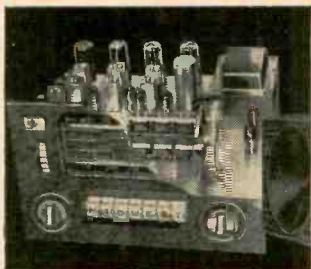

Once again Midwest offers its famous series 16 five band AM-FM radio chassis and the magnificent new Symphony Grand Radio-Phonograph with 3-Speed Automatic Inter-mix Record Player. Also, a complete line of clock radios, table radios, and portables.



WRITE IN NAME AND ADDRESS (PLEASE PRINT) ON COUPON OR 2c POSTCARD

MIDWEST RADIO & TELEVISION CORP.
Dept. D-38 909 BROADWAY • CINCINNATI 2, OHIO

Please send me your new **FREE 1954 Catalog.**

NAME _____
ADDRESS _____
CITY _____ ZONE _____ STATE _____

MIDWEST RADIO & TELEVISION CORP.

DEPT. D-38 909 BROADWAY, CINCINNATI 2, OHIO

CUSTOM-BUILT CABINETS FOR #630 AND ALL OTHER TV SETS — from FACTORY to YOU

5 LEADING STYLES in genuine mahogany or walnut (blond 10% extra). • • • Ready drilled for any #630 TV chassis and cutout for any 14", 17", 19", 20" or 21" picture tube at no extras in price. • • • Also supplied with undrilled knob panel for any other TV set. • • • EVERYTHING NECESSARY for an easy perfect assembly is included. • • • Each cabinet is delivered complete as pictured with mask, safety glass, mounting brackets, backboard, backcup, hardware and assembling instructions. • • • Each cabinet is shipped in an air cushioned carton from FACTORY to YOU!

The **VOGUE**
Most Popular
Table Model

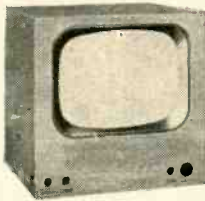

H-25", W-26", D-22"
\$39.89

The **MANHATTAN**
Style, Quality, Price

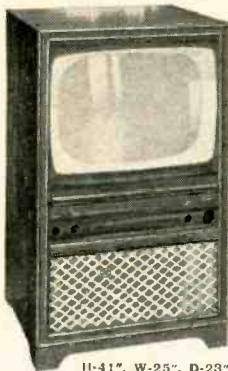

H-41", W-25", D-23"
\$59.37
MANHATTAN (for 24" or 27" CRT
H-46 1/2", W-27 3/4", D-24" **\$86.22**)

The **MAYFAIR**
Exquisitely modern, with an elegance of simplicity in styling.



H-40", W-26", D-25"
\$98.56

The **PLYMOUTH**
Choice of interior Decorators, truly superb in every detail.

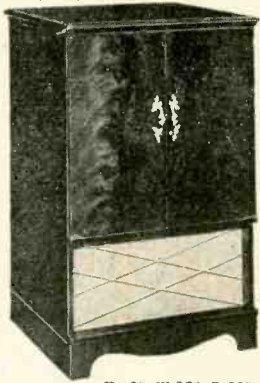

H-40", W-27", D-23"
\$105.48

The **TOWN & COUNTRY**
Patterned after the popular credenza. Available for all size picture tubes 14" to 27"

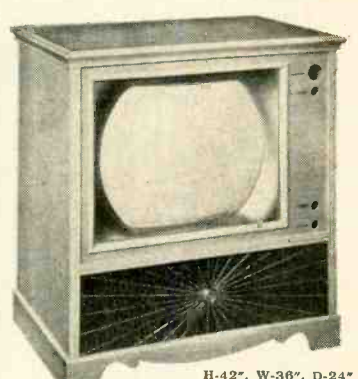

H-42", W-36", D-24"
For 14", 18", 17", 19", 20", 21", 24" or 27" C.R.T.'s **\$109.62**

VOGUE also available for 24" or 27" picture tube
H-31", W-27", D-23"
\$62.54

SHELDON FINEST GUARANTEED PICTURE TUBES

MOST desirable 5 sizes — ALL RECTANGULAR • • • BRAND NEW in Factory Sealed Cartons — With a Full Year Guarantee

17" #17BP4A **\$29.63** | **20"** #20CP4A **\$39.74** | **21"** #21EP4A **\$44.68** | **24"** 90° #24CP4A **\$58.26** | **27"** 90° #27NP4A **\$82.57**

THE #630 TV RECEIVER remains unmatched for quality and performance • RCA designed and developed this set quality-wise *not* price-wise • The original 10" set retailed at \$375.00 • Subsequent TV sets serve to prove the sacrifice of quality for price • What better proof can there be of its superiority than the fact that it is the choice of TV engineers and TV technicians! Herewith we offer you — **YOUR BEST BUYS IN TV!** All you pay is the price shown • • • Excise taxes have already been paid by us.

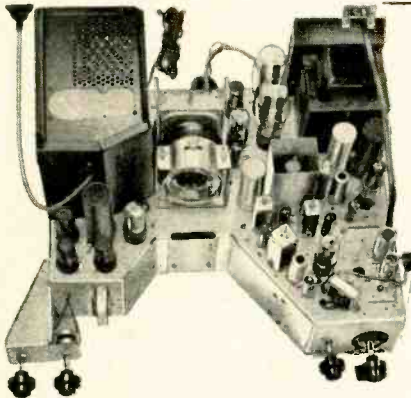

Build your own

#630 Super Deluxe TV CHASSIS
with . . . **U. H. F.**

With a **#630 SUPER DELUXE 31-TUBE TV KIT** including your favorite U.H.F. Station • OPERATES 16" TO 24" PICTURE TUBES • Engineered in strict adherence to the genuine RCA #630 plus added features • FULL 4MC BANDWIDTH • CAS-CODE TUNER • COSINE DEFLECTION YOKE • LARGER POWER TRANSFORMER • KEYED AGC • 12" SPEAKER • UNIVERSAL MOUNTING BRACKETS • CONDENSERS and RESISTORS at rated capacities and tolerances. You receive a COMPLETE SET OF PARTS and TUBES, everything needed is included (less wire & solder). All I.F. Coils and Transformers are factory pre-aligned and tuned. You will enjoy building it with "LIFE-SIZE" easy to follow step-by-step ASSEMBLING INSTRUCTIONS" included with each KIT.

NOTHING BETTER AT ANY PRICE!
only . . . \$119.44 (less CRT)

#630 SUPER DELUXE TV CHASSIS

with U.H.F.—Licensed under RCA patents

COMPLETE READY TO PLUG IN AND PLAY—Similar in characteristics and features to the TV KIT at left • Manufactured especially for us by Regal Electronics Corporation • No efforts or expense have been spared in workmanship or materials, to make this #630 SUPER DELUXE TV CHASSIS the Best obtainable for fringe areas, clarity and all-around performance, regardless of price. Customers report reception better than 200 miles • Each Set is factory aligned and air-tested • All parts carry the RMA three month guarantee • Our mass volume of business on this CHASSIS (numbering thousands of pleased customers) now makes it possible for us to reduce the price to

\$157.97 (less CRT) only

#630 TV SPECIALS BY TECH-MASTER

both with U.H.F.

TECH-MASTER Model C-30 TV CHASSIS. This Model has retained the outstanding characteristics of the RCA-630 circuitry, namely the four-stage, full bandwidth picture IF strip and the three-stage FM sound section • In addition, the latest innovations in synchronization and sweep circuits have been incorporated to produce a custom-quality receiver assuring outstanding performance • 30 tubes, 12" speaker.

Complete Ready to Plug in and Play. **\$149.50** (less CRT) Special at

TECH-MASTER Gold Medal Model 2430-9 TV CHASSIS. 90° deflection, operates all 24" or 27" rectangular and 30" round picture tubes. The last word in TV achievement • Ideal for wall or custom-cabinet mounting • Detailed technical data mailed on request, however with the knowledge that this CHASSIS is a 30-tube #630 with both TECH-MASTER'S and OUR guarantee, you need not hesitate sending your order in now.

Complete Ready to Plug in and Play. **\$262.50** (less CRT) Special at

#630 TV BASIC PARTS KIT

PUNCHED & DRILLED CHASSIS PAN BRACKET & SHIELD KIT (18 items) VIDEO & I.F. KIT (19 items) POWER TRANSFORMER #20IT6 VERTICAL OUTPUT TRANSFORMER VERTICAL BLOCKING TRANSFORMER FLYBACK TRANSFORMER #21IT5 FOCUS COIL, 470 ohms #202D2 COSINE DEFLECTION YOKE 70" **39.49** All for Only Including LIFE-SIZE TV BUILDER INSTRUCTIONS

Modernize a #630 or any TV Set with a **STANDARD CASCODE TUNER** For better all around performance

Complete with tubes, and Brooks CAS-CODE MANUAL with step-by-step instructions and all extra parts needed. **\$22.49**

Brooks CASCODE MANUAL, how to install Cascode Tuner in any make TV Set. Postpaid. **50¢**

PULSE KEYED AGC KIT

Finest, most accurate and the easiest Kit to install in a #630 or in any other make TV receiver. Improves performance, and insures a steady picture on all channels.

COMPLETE SET OF PARTS **\$4.59** Including 6AU6 tube & Instructions

Brooks LIFE-SIZE TV INSTRUCTIONS, for building any #630 TV Receiver. Postpaid. **\$2.49**

HINTS FOR BETTER PERFORMANCE on your #630 TV receiver. Postpaid. **\$1.00**

BROOKS RADIO & TV CORP., 84 Vesey St., Dept. A, New York 7, N. Y.

RADIO-ELECTRONICS

PARTS for #630 & Other

STANDARD CASCADE TUNER, incl. tubes	\$22.49
ESCUTCHEON PLATE, for tuner	.69
COMPLETE SET OF KNOBS, incl. decals	1.34
POWER TRANSFORMER, 295ma.	201T6... 9.97
VERTICAL OUTPUT TRANS.	204T2... 2.69
VERTICAL BLOCKING TRANS.	208T2... 1.32
HORIZONTAL OUTPUT TRANS.	211T1... 2.47
HORIZONTAL OUTPUT TRANS.	211T5... 3.98
FOCUS COIL, 247 ohms,	202D1... 2.29
FOCUS COIL, 470 ohms,	202D2... 3.42
DEFLECTION YOKE, 60°	201D1... 2.97
DEFLECTION YOKE, Cosine 70°	206D1... 3.98
SOUND DISCRIMINATOR TRANS.	203K1... 1.12
1st PIX I.F. TRANSFORMER,	202K2... 1.08
2nd PIX I.F. TRANSFORMER,	202K3... 1.08
1st & 2nd SOUND I.F. TRANS.	201K1... 1.02
HORIZONTAL DISCRIM. TRANS.	208T8... 1.49
FILTER CHOKE, 62 ohms	202K4... 1.08
CATHODE TRAP COIL,	
WIDTH CONTROL COIL, keyed AGC	1R4AG... .79
HORIZONTAL LINEARITY COIL,	201R3... .39
3rd & 4th PIX COILS	202L1... .39
FILAMENT CHOKES	204L1... .09
VIDEO PEAKING COIL,	203L1... .18
VIDEO PEAKING COIL,	203L2... .18
VIDEO PEAKING COILS	203L3... .18
VIDEO PEAKING COILS	203L4... .18
ION TRAP BEAM BENDER, double	203D3... .98
ION TRAP BEAM BENDER, single	203D1... .79

TV SETS & EQUIPMENT

PUNCHED CHASSIS PAN, cadmium plated	\$4.87
630-KIT, screws, nuts, rivets, washers	1.69
HI VOLTAGE CAGE ASSEMBLY, complete	3.73
VOLTAGE DIVIDER SHIELD & COVER	1.79
ELECTROLYTIC COND. SUB-CHASSIS	.94
SOUND DISCRIMINATOR SHIELD	.19
DEFLECTION YOKE BRACKET	.29
DEFLECTION YOKE MOUNTING HOOD	.59
FOCUS COIL BRACKETS	set .49
CATHODE TRAP COIL SHIELD	.39
CHASSIS MOUNTING BRACKETS, set of 4	.54
BRIGHTNESS & HOLD CONTROL BRACKET	.59
WIDTH CONTROL BRACKET	.16
TUNER SHAFT BRACKET	.17
FUSE (.25 amp.) & HOLDER	.24
HV RECTIFIER, SOCKET ASSEMBLY, single	.79
HV RECTIFIER, SOCKET ASSEMBLY, double	1.37
TV 6' LINE CORD, with both plugs	.29
INTERLOCK SAFETY CONNECTOR (input)	.17
COMPLETE TERMINAL STRIP KIT, set of 30	.98
AGC BRACKET & SOCKET	.39
MINIATURE WAFER SOCKETS	.07
MINIATURE MOLDED SOCKETS	.12
OCTAL WAFER SOCKETS	.07
CATHODE RAY TUBE SOCKET, 18" leads	.39
HV KINESCOPE LEAD, with clip	.39
AUDIO OUTPUT TRANSFORMER (6K6)	.69
8" PM SPEAKER, heavy alnico #5 magnet	3.97
12" PM SPEAKER, heavy alnico #5 magnet	6.94

BELIEVE IT OR NOT!

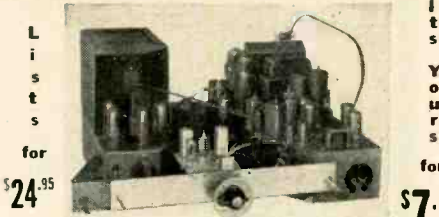

AM SUPER RADIO FOR #630 or other TV. Complete, ready to install w/tubes & instructions.

72 OHM COAXIAL CABLE

100' — hank	\$ 4.64
500' — spool	21.99
1000' — two 500' spools	39.86

300 OHM TWIN LEAD-IN

100' — hank	\$ 1.48
500' — spool	6.91
1000' — two 500' spools	12.82

INDOOR TV ANTENNA

- Newest, panorama high-gain type
- Brass 3-section chrome plated dipoles
- Absolutely tilt and tip-proof

list price \$5.95 special at **\$1.69**

CONICAL TV ROOF ANTENNA

Sturdy, Efficient, covers all TV and FM channels. Uniform spacing between dipoles and reflectors insures greater concentration of signals reaching the dipoles and reduces the number of reflected rays. Made of seamless aluminum, assembles in a jiffy.

only **\$2.84**

SKY SWEEPER TV ANTENNA

Most POWERFUL PERFORMANCE on Your TV Set. A flip of a Selector Switch (no rotor is used) instantly orients the Antenna for MAXIMUM PERFORMANCE on any V.H.F. or U.H.F. Station, (Channels 2 to 82.)

Complete Precision-built STACKED ARRAY ASSEMBLY. Special price **\$21.90** Unconditional money back guarantee.

LOW-LOSS 4-CONDUCTOR LEAD-IN **\$8.90** WIRE, 100 feet.

TV CRYSTAL-CLEAR LUCITE MASKS

Framed in Rich Gold Leaf Finish

Tube Size	Overall Dimensions	
17" — Rect. 13 1/2" x 17"		\$ 5.97
21" — Rect. 15 3/4" x 20 7/8"		8.84
24" — Round 20 3/4" x 26 1/4"		14.65
27" — Rect. 21 1/2" x 27"		15.48

(Including Set of Rosettes)

TV PLASTIC OPEN MASKS

Used in conjunction with safety glass

17" — Rect. 14 1/8" x 17 1/2"	\$1.87
21" — Rect. 18" x 22 5/8"	3.36
24" — Round 20" x 27"	6.74
27" — Rect. 21 1/2" x 27"	7.23

TV SAFETY GLASS in HANDY SIZES

13 3/8" x 16 1/4"	\$2.96	16" x 22"	\$4.29
15 7/8" x 20 1/4"	3.72	22 3/4" x 25 3/8"	6.47
17 3/8" x 23 3/8"	5.24	21 1/2" x 27"	6.98

VARIABLE CONTROLS

PICTURE & SOUND, 10k ohms 1 meg. & switch	1.14
VERTICAL & HORIZ. 50k ohms 1 meg.	1.04
BRIGHTNESS CONTROL, 50k ohms	.44
HORIZ. CENTERING, wirewound 20 ohms	.57
HEIGHT CONTROL, 2.5 megohms	.48
VERTICAL LINEARITY, 5000 ohms	.44
VERTICAL CENTERING, wirewound, 20 ohms	.96
FOCUS CONTROL, wirewound, 1500 ohms	.98
HORIZONTAL DRIVE, 20k ohms	.44

H.V. FILTER CONDENSERS — (Cartwheels)

15kv	500 mmf	.67
20kv	500 mmf	.79
30kv	500 mmf	1.49

#630 PARTS & COMPLETE SETS

TV WIRE & SOLDER KIT, for any Set	\$1.49
VIDEO AND I.F. KIT, 19 items	7.84
VARIABLE CONTROL KIT, 9 controls	5.83
CARBON RESISTOR KIT, 107 resistors	6.98
WIREWOUND RESISTOR KIT, 4 resistors	2.31
BRACKET AND SHIELD KIT, 18 items	8.63
ELECTROLYTIC CONDENSER KIT, 6 cond	7.37
TUBULAR CONDENSER KIT, 38 condensers	4.28
CERAMIC CONDENSER KIT, 28 condensers	3.37
MICA CONDENSER KIT, 11 condensers	1.38
TERMINAL STRIP KIT, set of 30	.98
COMPLETE SET OF TUBES, 29 tubes	30.31

ELECTROLYTIC CONDENSERS — 85°C

40/10/80 mfd — 450/450/150 v	1.37
40/40/10 mfd — 450/450/450 v	1.49
80/50 mfd — 450/50 v	1.49
40/10/10 mfd — 450/450/350 v	1.37
20/80 mid — 450/350 v	1.49
250/1000 mid — 10/6 v	.98

RADIO & TV TUBES

STANDARD TOP KNOWN BRANDS

- At 14¢ each — 37, 38, 39/44.
- At 39¢ each — 35Z5, 35W4, 5Y3, 6AL5, 43, 80, 6H6, 6SQ7, 12SJ7, 6F5, 7C5, 7F5.
- At 59¢ each — 1LD5, 0Z4, 5U4, 6AT6, 6K6, 6SA7, 6SK7, 7F7, 117Z3, 45Z5.
- At 69¢ each — 1H5, 1Q5, 1T4, 1T5, 6C4, 6C5, 6AB4, 6AU6, 6BE6, 12AL5, 12SK7, 12SA7, 50L6, 6BA6, 6AC5, 6C86, 6SN7, 7A8, 6AB7, 35L6, 50B5, 12SG7, 12AT6, 7V7.
- At 72¢ each — 1LE3, 1R5, 1S4, 3Q4, 3Q5, 35A, 12AT7, 12AU7, 12BE6, 35Y4, 14A7.
- At 98¢ each — 1A7, 1B3, 11B4, 5V4, 6AC7, 6AH6, 6AK5, 6J6, 6SH7, 6T8, 6SD7, 7F8, 25A6, 35A5, 50A5, 117Z6.

TUBE CARTONS in Lots of 100

(10% extra discount in lots of 1000)

SMALL PEANUT 1"x1"x2 1/8"	\$.89
LARGE PEANUT 1"x1"x2 3/4"	.98
GT TYPE 1 1/4"x1 1/4"x3 3/8"	1.06
SMALL G 1 1/2"x1 1/2"x4 1/2"	1.39
LARGE G 2"x2"x5"	1.59
EXTRA LARGE 2 1/4" x 2 1/4" x 6 1/2"	2.97

MISCELLANEOUS ITEMS

TV HIGH VOLTAGE PROBE	.49
TV BACK CUP, recesses C.R.T.	.59
ONE POUND ROSIN CORE SOLDER	.59
UNIVERSAL OUTPUT TRANS. (any tube)	.89
6 FOOT LINE CORD, molded plug	.16
VARIABLE CONDENSER, 2 gong, super	.59
I. F. TRANSFORMER, 456 kc	.49
I. F. TRANSFORMER, FM 10.7 mc	.58
PHONO MOTOR, 78, 45, 33 rpm	4.97
PHONO AMPLIFIER, incl. 3 tubes	4.87

UNIVERSAL Picture Tube MOUNTING BRACKETS

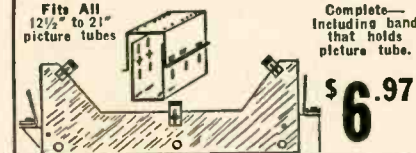

100 ASSORTED TUBULAR CONDENSERS

All Are Standard Brands & Desirable Sizes **\$4.69**

\$15.00 Value Only

100 — ASSORTED 1/2 WATT RESISTORS	\$3.97
15 — Ass. Radio Electrolytic CONDENSERS	\$4.74
15 — Assorted TV Electrolytic CONDENSERS	\$6.88
100 — ASSORTED MICA CONDENSERS	\$4.99
100 — ASSORTED CERAMIC CONDENSERS	\$4.99
100 — ASSORTED 1 WATT RESISTORS	\$5.86
100 — ASS. PILOT LIGHTS #44, 46, 47, & 51	\$4.83
100 — ASSORTED SOCKETS Octal, Localt & Miniature	\$3.92
100 — ASSORTED KNOBS SCREW & PUSH-ON	\$3.97
10 — VOLUME CONTROLS ASSORTED, WITH SWITCH 1/4, 1/2, 1, 2 meg. and others	\$2.94
10 — VOLUME CONTROLS ASSORTED, LESS SWITCH 1/4, 1/2, 1, 2 meg. and others Resistor & cond. code charts FREE with each order	\$1.94

BROOKS RADIO & TV CORP., 84 Vesey St., Dept. A, New York 7, N. Y.



70% to 90% off list! TOP TUBE BUYS

All Tubes Individually Boxed! Same Day Service!
Check this list for Fully 1-Year Guaranteed Tubes.

Type	Price	Type	Price	Type	Price	Type	Price	Type	Price
0A2	.74	6AF4	.90	6J5GT	.43	7E6	.30	19V8	.79
0B2	.81	6AG5	.98	6J6	.52	7N7	.46	24A	.53
0C3	.72	6AG7	.49	6J7G	.43	7X7	.70	25AV5	.83
0D3	.70	6AH4	.57	6K5	.47	7Y4	.69	25B06GT	.79
0Z4	.55	6AJ5	.65	6K6GT	.37	12A8	.61	25L5GT	.39
1A5GT	.30	6AK5	.55	6K7	.44	12AL5	.37	25Z5	.66
1A7GT	.47	6AL5	.38	6L6	.64	12AT6	.37	26	.45
1AX2	.62	6AQ5	.39	6Q7	.45	12AT7	.66	27	.39
1B3	.68	6AQ6	.37	6S4	.38	12AU6	.38	35	.58
1B7GT	.30	6AR5	.37	6S8	.53	12AU7	.54	35B5	.40
1C5GT	.43	6AS5	.50	6SA7GT	.43	12AV6	.39	35C5	.39
1E7	.29	6AT6	.37	6SD7GT	.41	12AV7	.63	35L5GT	.41
1G6	.24	6AU4	.68	6SF5GT	.46	12AX4	.56	35W4	.37
1H4G	.30	6AU6	.38	6SG7GT	.41	12AX7	.56	35Z5GT	.47
1H5GT	.49	6AV5	.83	6SH7	.49	12AY7	.99	36	.39
1L4	.46	6AV6	.37	6SJ7GT	.41	12BA6	.38	41	.42
1LN5	.89	6AX4	.53	6SK7GT	.41	12BA7	.60	42	.42
1N5	.67	6B4G	.64	6SL7GT	.48	12BD6	.45	43	.55
1P5	.57	6BA6	.39	6SN7GT	.52	12BE6	.39	45	.55
1Q5	.58	6BA7	.57	6SQ7GT	.37	12BF6	.39	45Z3	.44
1R5	.49	6BC3	.49	6SR7GT	.45	12BH7	.63	45Z5	.49
1S4	.79	6BD5GT	.59	6SS7	.42	12BY7	.65	50A5	.79
1S5	.43	6BD6	.45	6T4	.99	12BZ7	.65	50B5	.43
1T4	.49	6BE6	.39	6T8	.56	12C8	.34	50C5	.39
1T5	.53	6BF5	.41	6U4	.60	12I5GT	.42	50L6GT	.61
1U4	.49	6BF6	.37	6U5	.44	12I7GT	.59	50Y7	.50
1U5	.43	6BG6G	1.25	6U6	.59	12K7GT	.59	53	.24
1V	.53	6BH6	.46	6U8	.61	12S8	.62	57	.58
1X2A	.30	6B16	.43	6V6GT	.39	12SA7GT	.65	58	.60
2A3	.30	6BQ6GT	.79	6W4GT	.44	12SF5	.50	70L7GT	.09
2A4G	.24	6BQ7A	.90	6W6GT	.44	12S17	.67	76	.44
2W3	.38	6BZ7	.90	6X4	.37	12SK7GT	.63	77	.57
2X2	.59	6C4	.37	6X5GT	.37	12SL7GT	.47	78	.47
3A4	.45	6C5GT	.39	6X8	.75	12SN7GT	.52	80	.35
3E5	.46	6C6	.58	6Y6	.48	12SQ7	.56	83V	.68
3Q4	.48	6CB6	.44	7A4	.47	12SR7	.49	85	.59
3Q5GT	.49	6CD6G	1.11	7A6	.69	12V6GT	.46	117L7	1.09
3S4	.49	6D6	.45	7A7	.69	14J7	.30	11Z3	.37
3V4	.51	6E5	.48	7AF7	.53	14W7	.30	807	1.19
5U4G	.30	6F5GT	.39	7B4	.44	19B6G6	.95	1274	.30
5W4	.53	6F6	.59	7B6	.69	19C8	.70	2050	.89
5Y3	.37	6G6G	.52	7C5	.69	19T8	.69	1000F M	.59
6AB4	.44	6H6GT	.41	7C6	.40				

All tubes FULLY GUARANTEED for ONE YEAR!

NOW! RAD-TEL PARTS AT BIG SAVINGS!

Here's your big opportunity to save as never before on PARTS you need NOW!

Send for free illustrated catalog!

TERMS:

TERMS A 25% deposit must accompany all orders — balance C.O.D. All shipments F.O.B. Irvington warehouse. Orders under \$10—\$1.00 Handling Charge. Subject to prior sale.

RAD-TEL TUBE CO.

"Integrity Is Our Chief Asset"

Phone: Essex 5-2947

Dept. RE-1 115 Coit Street Irvington II, N. J.

RADIO-ELECTRONICS is paying good rates on acceptance for original and unusual articles on audio, television, FM and AM servicing, as well as articles on industrial electronic equipment and applications. Send for a copy of our Authors' Guide. Address:

THE EDITOR, RADIO-ELECTRONICS
25 West Broadway, New York 7, N. Y.

spotlighting the CRIPLER

Support . . .
TREATMENT
REHABILITATION
EDUCATION
RESEARCH



Arthritis & Rheumatism Foundation

NEW DESIGN

remote-cutoff type. It is designed for applications as a cascode r.f. amplifier, i.f. amplifier, or mixer in circuits which use a.g.c. When used in cascode applications, the performance of the tube is

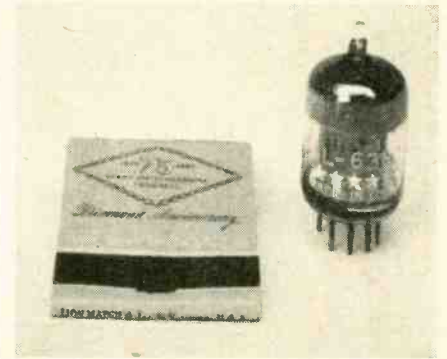

Miniature medium-mu triode, GL-6386,

characterized by high gain, low noise figure, and low third-order harmonic distortion.

The tube minimizes cross modulation which can occur in the first stage of a receiver when a strong signal is close to the desired signal.

Under typical operating conditions as a cascode amplifier, the plate supply voltage is 200; grid supply voltage, -2; cascode transconductance, 4,000 micromhos; cascode plate current, 10.5 ma.

Development of a 21-inch, 90° deflection TV picture tube has been announced by Westinghouse and Sylvania.

Designated as type 21AMP4 and type 21ANP4 for magnetic and electrostatic focus respectively, the tube produces a picture 5% larger than any previous 21-inch type.

The over-all length of the new tube is approximately 3 inches shorter than current 21-inch types.

Radio Receptor has announced production of their type RR38 P-N-P junction transistor. The RR38 is designed for operation at low power output levels. It is particularly applicable as the output stage for hearing aids and personal receivers.

Maximum ratings for the RR38 are: collector voltage, -25; collector current, -5 ma; collector dissipation, 50 mw; ambient temperature, 50° C.

RCA has announced a short multiplier phototube of the 9-stage type for automobile headlight-dimming.

Designated as the RCA-6328, it has instantaneous response to meet the critical timing requirements of headlight-control service, and is capable of providing stable performance over long periods. Its high luminous sensitivity allows use of an amplifier with relatively low-impedance input and fewer stages than required by a less sensitive tube.

The low dark current of the 6328 permits the use of high-resistance voltage-divider networks to minimize power requirements and to improve not only operating stability but also tube life.

Its maximum anode-supply voltage is 1,250, current, 0.1 ma. **END**

RADIO-ELECTRONICS



Custom Engineered Antennas

The Adelco FDY is the complete answer to an all channel fringe area VHF-UHF antenna.

Shipped completely preassembled.

List price — \$27.75 — double stack

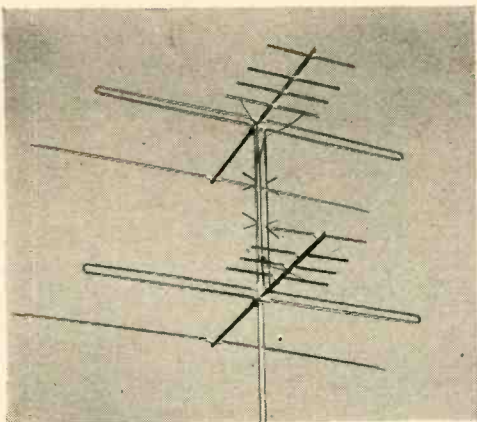

Model FDY VHF-UHF

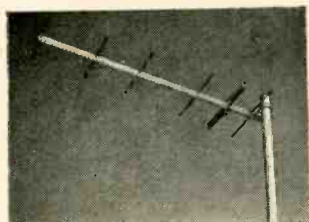

Model UHF Yagi

Adelco UHF Yagis are high gain, cut to channel, 8 element antennas.

A rigid aluminum channel crossarm allows the mast clamp to be set behind the reflector.

Available in single or double stacks.

List price range—\$5.55 to \$8.90 depending on channel.

ADVANCE ELECTRIC CO., 8510 NORTH END AVE., OAK PK. 37, MICHIGAN

WE BOUGHT

SET MANUFACTURERS'

SURPLUS

TUBES

ALL RADIO

AND TV

TYPES

Standard Brand Warranty • BRANDED • Bulk or Individually Boxed

1B3GT54	6AK579	6B06GT76	6SQ744	12SK749
1L447	6AL534	6BQ776	6T861	12SN7GT46
1R546	6AQ538	6BK768	6V6GT41	12SQ744
1S452	6AG546	6C431	6W4GT41	19B6G1.16
1S538	6AT636	6C541	6W6GT41	19T861
1T446	6AU636	6C8642	6X5GT31	25B06GT79
1U446	6AV636	6CD6G1.08	12AT631	25L6GT42
1U538	6BG479	6H538	12AT757	35B546
1X2A52	6B555	6J5GT34	12AU634	35C546
3Q5GT55	6BA633	6J651	12AU752	35L6GT42
35446	6BC546	6J749	12BA642	35W432
3V446	6BE638	6K6GT36	12BE642	35Z533
5U4G44	6BG6G1.16	6SA744	12BH753	50B546
5Y3GT36	6BH646	6SK744	12C849	50C546
6AC768	6BJ646	6SN7GT46	12SA749	50L6GT42
6AH661	6BL7GT76			

More than 400 types in stock. Include all your needs when ordering.

Orders less than \$10.00—add \$1.00 service charge. Terms: 25% with order, balance C.O.D. Please include postage. All prices subject to change without notice. F.O.B. New York City, Mail order division.

Television Materials Corp.
120 LIBERTY ST., NEW YORK 6, N.Y. • COntlandt 7-4307

Fight Polio!

Join the
MARCH OF DIMES
January 2 to 31

Record in '53

POLIO PATIENTS HELPED

Join the
MARCH OF DIMES
January 2 to 31

Follow this path to faster, more profitable repair service

If you're like thousands of other busy Service Engineers, you can't afford to sacrifice profit time — hunting for repair parts. That's why it pays to have your Centralab controls on hand when you need 'em — in one of these 3 handy Blue Shaft Control kits. Assortments contain *exact* replacement values you use every day, in plain or switch types, for popular radio and TV sets!

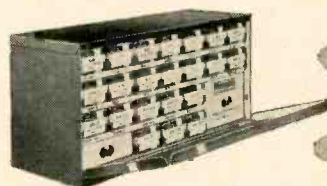

Kit deal B-A contains 22 controls (8 types) in 1/2 and 1 megohm. All units C₂ audio taper. Standard full-length fluted mill and split-knurl shafts.



Kit deal B-B newest, revised. Has 22 controls (15 C₂ types, —1000 ohms to 5 megs) plus 4 Fastatch™ type KB line switches.



Handy Plastic-Paks of 12 controls each in 10 fast moving assortments. You pay for parts only — no charge for metal or plastic containers.

And remember . . . switches are factory-attached and tested for immediate installation. Your Centralab distributor has plenty of Blue Shafts on hand to keep kits well-stocked. Order kits from him NOW. *Trademark

Centralab

CENTRALAB
A Division of Globe-Union Inc.
922A E. Keefe Ave., Milwaukee 1, Wis.
Please send me Catalog 28 with complete details on Centralab Radio-TV control kits.

Name.....
Firm.....
Address.....
City..... Zone..... State.....



irish BRAND OFFERS YOU A SOUND RECORDING TAPE TO FIT THE PERFORMANCE REQUIREMENTS OF YOUR TAPE RECORDER

Not all tape recorders are alike. A professional instrument intended for high quality music reproduction will perform differently than a portable unit intended for home or office use. Whereas one will record and reproduce from 30 to beyond 15,000 cycles per second, the less costly unit may be limited to a range from 100 to 7000 cps. or less.

Obviously, there is no advantage in using a wide response tape with a limited-response recorder! And there is a definite disadvantage . . .

WHY PAY MORE FOR WIDER RESPONSE WITHOUT GETTING ANYTHING IN RETURN?

Until the development of IRISH Brown Band, users of sub-professional tape recorders had no choice! But IRISH Brown Band was designed specifically for such recorders. THERE HAS BEEN NO SACRIFICE IN QUALITY . . . IRISH Brown Band has been specially developed to reproduce with true fidelity the frequency range between 100 and 8000 cycles.

The considerable savings in production costs now enables you to buy high quality, plastic tape at a price, which up to now, could only buy ordinary paper tape!

1200 feet, plastic tape, on plastic reel \$3.75

For professional recording on equipment with wide frequency response, your best tape buy is IRISH GREEN BAND NO. 211, the professional super-sensitive, wide-range recording tape that is used in broadcast stations and recording studios throughout the industry.

1200 feet on plastic reel \$5.50
2400 feet on metal reel 12.85

One day you will surely use IRISH . . . write direct to factory for a free sample test reel today.



At all leading radio parts distributors

ORRADIO INDUSTRIES, INC.
OPELIKA 5, ALABAMA

EXPORT DIVISION: Morhan Exporting Corp., New York, N. Y.

WANTED

WE NEED YOUR SURPLUS ELECTRONIC EQUIPMENT

WE PAY TOP \$\$\$ FOR:

- ★ RADIO RECEIVERS
- ★ TRANSMITTERS
- ★ ARC-1
- ★ ARC-3
- ★ ART-13
- ★ CONTROL BOXES
- ★ INDICATORS
- ★ CLAMPS
- ★ PLUGS
- ★ CORDS
- ★ RELAYS
- ★ TELEPHONE MATERIALS
- ★ AN CONNECTORS
- ★ WE BUY ANYTHING!

Write, Wire today! Tell us what you have.

TALLEN CO., Inc., Dept. RE
159 Carlton Ave., Brooklyn 5, N. Y.

Watch for the

February Issue

of

RADIO-ELECTRONICS

on the newsstands

JANUARY 27, 1954

NEW PATENTS

MILLIOHMETER PROTECTION

Patent No. 2,648,820

John H. Miller, Short Hills, N. J.

(Assigned to Weston Electrical Instr. Corp.)

A milliohmmeter measures thousandths of an ohm. The instrument is actually used as a millivoltmeter and is connected across the resistance to be measured. A controlled current flows through this resistance and the voltage drop is measured by the meter.

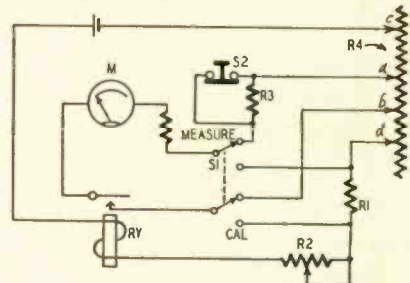

A milliohmmeter must be used with special care, for, if the unknown resistance is high or open-circuited, it will develop a very high voltage and will damage the meter. This patent shows the use of a relay to protect the meter.

In the diagram, R4 is the unknown resistor. Battery current flows through terminals c-d, but only the resistance a-b is to be measured. Since the meter consumes a very low current, the terminal resistance at a-b is negligible. Terminals c, d, are not within the measured circuit, so their resistance has no effect.

To make a measurement, depress S1. The meter M then measures a standard resistor R1. Adjust R2 till M reads full-scale. Then release S1 to its MEASURE position across a-b. Since the battery current is unchanged, the new reading will show the percentage of a-b to R1. M is calibrated in milliohms.

The relay coil RY is energized only when sufficient current flows through R4. If R4 is too high or open-circuited, RY will not attract its armature, and the meter circuit will be open. RY is adjusted to operate only if the unknown resistor is low enough for safe meter current.

R3 is a range multiplier. Normally S2 is closed. With this switch open, the milliohmmeter can measure higher resistance.

D.C. AMPLIFIER

Patent No. 2,646,515

Leslie Lynch, Bell, Calif.

This amplifier has a very high input resistance and a low output resistance. It is sensitive and consumes little power. The tube is connected as an inverted voltmeter. G1 acts as anode, and G2 is the control element. At the start of a measurement, S1 is closed momentarily to place a negative voltage on G2. Radiation causes loss of this negative charge so that the microammeter needle deflects upward.

The v.t.v.m. and associated parts are enclosed within an ionization chamber, one side of which is represented by a broken line. At the center of the chamber is a collector plate. When the switch is closed, the plate goes negative. Radiation acting within the chamber ionizes it and releases positive particles which fall on the plate.

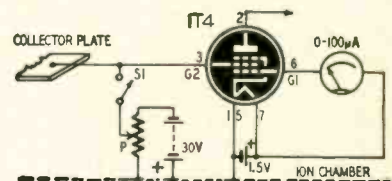

They neutralize the negative charge and thus permit more current flow in the G1 circuit. With more intense radiation, the meter will deflect faster. The inventor has determined that a 1T4 or similar tube will have a linear output between 40 and 100 microamperes. Therefore P should be set for an initial meter reading of .40 µa. Normally, the circuit as shown here will saturate at about 100 µa, so no limiting device is needed.

In practice, errors may occur due to cosmic rays and leakage. These factors, like the radiation itself, cause a gradual loss of the negative charge

RADIO-ELECTRONICS

Again, **TACO** does it!

HIGH-GAIN

Cat. No.
3015 (—)
Price **\$6.75**
ea. list

ALL-ALUMINUM

ALL-WELDED

The **TACO**
UHF GRID YAGI

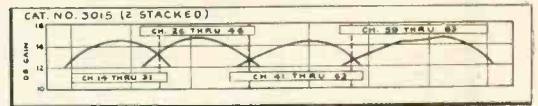
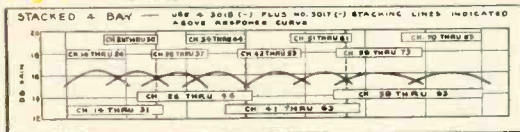
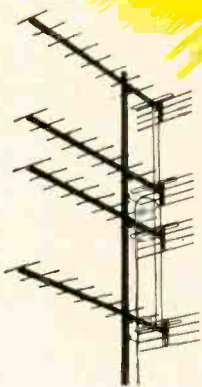

A new high in UHF antenna design — with new and better performance — the antenna you have looked for!

All welded!—perfect mechanical and electrical union between all elements—no chance for corrosion between—grid reflector for maximum back door rejection.

Extra-high gain—yagi performance improved through use of Grid Reflector.

Packed two per carton with stacking lines for dual stacking. Use as single antenna or as stacked array for extra gain.

PLUS — Four stack installation by addition of full-wave stacking lines for the ultimate in UHF gain and "pin-point" directivity.

Cat. No. 3017 (—)
Price
\$1.25 ea. list

GET COMPLETE DETAILS FROM YOUR JOBBER, OR WRITE . . .

TECHNICAL APPLIANCE CORPORATION, SHERBURNE, NEW YORK

In Canada: Hackbusch Electronics, Inc., Toronto 4, Ont.

Lowell BETTER LOOKING rear seat auto extension SPEAKER BAFFLE KIT

Available as a complete kit, with or without speaker. In chrome or standard colors.

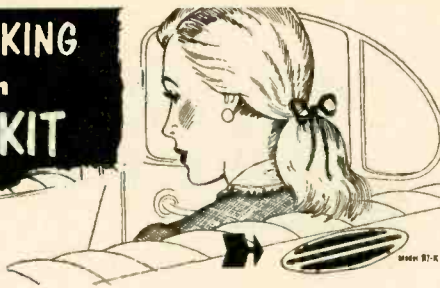

Features

- Custom quality—smartly styled—all metal.
- Finishes to harmonize with any car interior. Standard colors include grey, light blue or light bronze. Chrome at slight additional cost.
- Perforated metal grille protects speaker cone from damage, is fade-proof, tamper-proof.
- Kit includes easy to mount 3-position switch to permit use of car radio speaker alone, rear speaker alone or both speakers simultaneously. All hardware and 15' cable furnished.
- Highest quality 6" x 9" oval speaker with 2.15 oz. magnet for finest reproduction of speech and music.

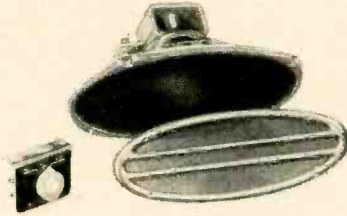

All the way around, LOWELL extension auto speaker baffle kits offer you smarter styling, higher quality, improved fidelity and easier installation.

A LOWELL installation is equally "at home" in the old jalopy or the new "Cad". You can see the difference; hear the difference, yet LOWELL costs you no more.

"HEARD EVERYWHERE"

Lowell MANUFACTURING CO.
3030 LACLEDE STATION RD., ST. LOUIS 17, MO.

Write for illustrated folder which gives complete details.

The skyline of tomorrow
is the **SKYLINE** of today!

Install it today and enjoy the fabulous reception that makes it famous!

- Amazing reception at 150 miles and more!
- UHF reception to 50 miles
- Now 32 elements
- Extra-heavy... All-aluminum
- Pre-assembled... Quick rig

SKYLINE MANUFACTURING CO.
1652 ROCKWELL AVENUE
CLEVELAND 14, OHIO

RADIO-ELECTRONICS is paying good rates on acceptance for original and unusual articles on audio, television, FM and AM servicing, as well as articles on industrial electronic equipment and applications. Send for a copy of our Authors' Guide. Address:

THE EDITOR
RADIO-ELECTRONICS
25 West Broadway, New York 7, N. Y.

NEW PATENTS

and a continual rise in the meter deflection. To offset these errors, the instrument should first be used with no radiation present. From the time S1 is momentarily closed, the meter reading will continue to rise toward the saturation value. This no-radiation measurement is the back count. When the instrument is placed within a radiation field, it measures both the unavoidable back count and the radiation. Allowance must be made for back count if radiation count is to be accurate.

REMOTE GEIGER-MULLER TUBE

Patent No. 2,642,539
Samuel W. Lichtman, Oxon Hill, Md.
(May be manufactured and used by the U. S. Government without royalty payments)

A Geiger-Muller tube must usually be operated near the radiation source it is measuring. Sometimes the source is not easily accessible and must be remotely probed. Often, the radiation is intense and presents a hazard to nearby personnel. In either case it is necessary to use the G-M tube far from its power supply and from the pulse counter into which it feeds.

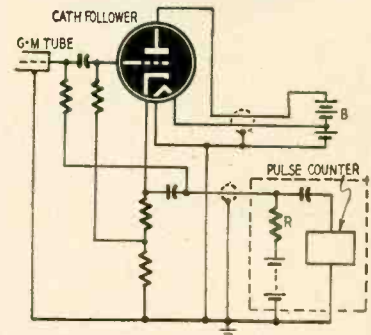

The G-M tube feeds directly into a cathode follower triode. These tubes are fed remotely by 2 cables as shown in the diagram. The lower cable contains the high voltage lead for the G-M tube. It also carries output from the cathode follower to the pulse counter. Due to the cathode follower connection, the output impedance of the triode is quite low. It can be made to match the line impedance. R is the termination load for the line. The upper cable contains the plate and filament supply from battery B to the triode.

RADAR CAMERA

Patent No. 2,627,600
Robert H. Rines, Brookline, Mass.

This patent discloses an idea for making photographs by radar. Radio waves reflected from a target are focused on a special sensitive plate and thereby photographed.

The photographic plate is made by spraying an aluminum compound on a suitable backing of any kind. Germanium or other semiconductive substance is mixed with the metal. Then a chemical compound sensitive to heat is applied. Under the influence of heat, the acid concentration (pH) of the compound is changed.

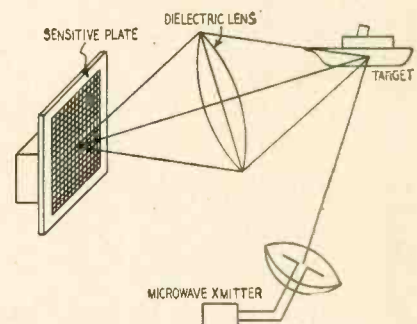

To make a radar photograph of a distant object, it is scanned by pulses of microwave energy from a highly directional transmitter. The reflected waves are focused by a dielectric lens onto the sensitive plate. The particles of the film receive and rectify the waves. Heat is liberated in proportion to signal strength and changes the pH of the chemical coating. Suitable dyes controlled by the acid concentration produce a permanent image.

BLACK BEAUTY® TV TUBULARS

**first and still finest...
accept no substitutes**



Imitation, they say, is the sincerest form of flattery. If so, you who have installed some of the 250,000,000 Black Beauty Telecaps in the past 7 years can be mighty proud. Few Sprague developments have been so closely copied as this capacitor in which you have placed your confidence.

Black Beauty imitations are available in almost every color imaginable . . . including black! But no other molded tubular can equal the unprecedented record set by Sprague TV Tubulars since 1947 when they were first introduced.

Don't be vague — insist on Sprague Black Beauty Telecaps for your TV and radio service needs! There is only one Sprague Black Beauty, and it has no equal. Accept no imitations.

Write today for the complete Sprague television and radio service catalog C-609 to Sprague Products Company,* 81 Marshall Street, North Adams, Mass.

There is a Sprague Distributor in every sales area in the United States. Write for the name of your nearest source of supply today.

SPRAGUE

dry-assembly process
anodic molded paper
capacitors offer:

- extra high insulation resistance
- minimum capacitance change with temperature variations
- absence of drift with repeated heating and cooling

Don't Be Vague... Insist on

SPRAGUE

**WORLD'S LARGEST
CAPACITOR MANUFACTURER**

*Sprague Products Company is the Distributors' Division of the Sprague Electric Company

JANUARY, 1954

CATALOG NO. 154



MILLER QUALITY PRODUCTS
TV Technicians COIL REPLACEMENT GUIDE
 J. W. MILLER COMPANY
 5917 South Main Street, Los Angeles 3, Calif.

Announcing

THE NEW Miller TV COIL REPLACEMENT GUIDE

ASK YOUR JOBBER FOR YOUR COPY TODAY
 (Replacement Catalog No. 154)

THE MILLER EMBLEM - ASSURES THE FINEST IN RADIO AND TV REPLACEMENT COMPONENTS

For a Complete Listing of MILLER PRODUCTS Get Our Latest General Catalog.
J. W. MILLER COMPANY
 5917 South Main Street • Los Angeles 3, California

NEW 1954 IMPROVED 630-DX CHASSIS

Lowest price for quality

LATEST! 1954 630DX CHASSIS

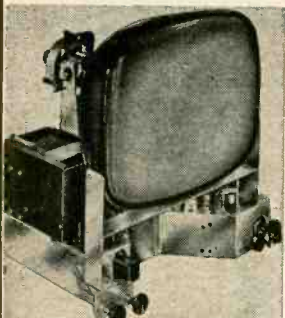

Includes all newest developments: Cascade Tuner, 30 Tubes, for 16" to 24" picture tube. Wonderful Value! Adaptable for color & UHF.

The 1954 630 with all up-to-date improvements! Terrific reception is yours now at this sensationally low-low price. Gives 3-times normal reception. Special super high-train cascade coil tuner gives greater sensitivity, top performance on any channel. Aligned and tested for 5 hours; molded condensers, 4 microvolts sensitivity, FM sound system, horizontal & linear lock & in directly adaptable for color & UHF.

RTMA Guaranteed - Factory Wired, Ready to Play. Complete with 12" speaker, hardware & knobs.

\$145.50 (less CRT)

Mounting Brackets for tube... \$5.95
 FREE: New Trouble Shooting Booklet with each chassis.

PM FOCUS COILS For all Tubes up to 21". \$1.19 ea. 99¢ ea. lots of 3

FOCUS COILS Reduced To: 247 ohm. ea. \$1.25 470 ohm. ea. \$2.95

70° COSINE YOKES The most popular type for general replacement \$3.89 ea. \$3.49 ea. lots of 3

10 ELEMENT CONICAL All Aluminum Antenna \$3.29 ea. lots of 10 \$2.89 ea.

V ANTENNA All Aluminum \$2.95 ea. lots of 10 \$2.69 ea.

Interstage Transformers, 3:1 ratio ea. \$1.10 Input Transformers, for Intecom sets. en. .79

TV PICTURE TUBES
 Brand New, Fully Guaranteed For One Year.
 17". \$26.47 20". \$36.37 21". \$39.48

\$50. OFF! DECORATOR TV CABINETS for 20" & 21" picture Tubes—630 or other chassis!



Every beautiful cabinet is richly finished, hand rubbed mahogany and made by our own master cabinet makers. They are custom styled, guaranteed new & perfect. Includes mask & mounting brackets. Cabinets are also available with blank control panel to fit any chassis. Made in 200; Original list: \$99.95. Blonde finish, add \$10.

For Deluxe Cabinets, write for catalog!

FILTER CHOKES
 1 Hv-300 MA. ea. 97¢ 20 Hv-10 MA. ea. 49¢
 FREE: Write for 1954 Catalog! TERMS: Min. order: \$5. 25% dep. with COD's. All shipments FOB NYC. Prices subject to change without notice.

MERCURY SWITCHES
 39¢ ea. 34¢ ea. lots of 10

QUARTZ CRYSTALS

FT-243-.093" PIN DIA.—.486" PIN SPC FOR HAM OR GENERAL USE

4035 5500 9550 6706 7506 7825	1015 2605 3995 6573 7240 8173
4080 3675 5973 6725 7525 7840	1110 2738 6000 6575 7273 8175
4110 3677 5973 6740 7540 7850	1150 2785 6025 6600 7325 8200
4163 3700 6000 6750 7550 7873	1215 2832 6075 6650 7375 8250
4190 3706 6225 6773 7573 7875	1915 2940 6050 6625 7350 8250
4255 3725 6240 6775 7575 7900	1930 3005 6075 6640 7325 8375
4280 3740 6250 6800 7600 7906	1940 3010 6075 6650 7340 8380
4300 3750 6255 6806 7606 7925	1950 3200 6100 7000 7350 8400
4397 3760 6273 6825 7610 7940	2065 3215 6106 7006 7375 8425
4420 3770 6275 6830 7610 7940	2105 3237 6125 7025 7400 8430
4485 3800 6306 7641 7975	2118 3245 6140 7040 7425 8450
4495 3806 6306 7641 7975	2125 3250 6130 7030 7440 8460
4550 3773 6275 6840 7625 7950	2145 3500 6175 7075 8483
4930 3840 6340 6906 7675 8240	2305 3540 6200 7100 8025 8500
5030 3850 6350 6925 7700 8250	2320 3590 6440 7108 8040 8525
5205 3852 6373 6940 7706 8273	2390 3640 6500 7173 8100 8600
5235 3873 6375 6950 7720 8275	2415 3680 6475 7140 8075 8575
5250 3875 6400 6973 7725 8300	2430 3720 6475 7150 8075 8583
5300 3880 6406 6973 7740 8306	2442 3735 6500 7173 8100 8600
5305 3890 6425 7450 7750 8325	2460 3760 6506 7175 8106 8625
5333 3906 6473 7473 7773	2532 3800 6525 7200 8125 8650
5385 3923 6475 7475 7775	2544 3840 6540 7208 8140 8700
5485 3940 6700 7500 7800	2557 3885 6550 7225 8150 8733

49¢ each—10 for \$4.00 99¢ each—10 for \$8.00

Low Frequency—FT-241A for 580 Lattice Filter etc., .093" Pins, .486" SPC, marked in Channel Nos. 0-9. 7th, 34th Harmonic and 270 to 369, 72nd Harmonic, listed below by Fundamental Frequencies, Fractions omitted.	CR-322 1 1/2" P 1/2" S	FT-1710 RC-810 2 Banana Plugs 3/4" SPC
370 393 414 436 498 520	400 459 5910	2030 2300 3185
372 394 415 437 501 522	440 461 6370	2045 2305 3202
375 396 418 481 502 523	441 462 6450	2082 2320 3215
378 397 419 483 504 526	442 463 6470	2092 2330 3223
379 401 420 484 505 527	445 465 6522	2105 2415 3230
380 402 423 486 507 530	446 466 6540	2125 2435 3232
381 403 424 487 508 531	448 469 7350	2145 2442 3242
383 404 425 488 509 532	450 472 7380	2185 2455 3250
384 405 426 490 511 534	451 473 7390	2220 2462 3270
385 406 427 491 512 536	452 473 7480	2228 2460 3280
386 407 428 492 513 537	453 474 7380	2280 2490 2945
387 408 430 493 514 539	454 475 7410	2305 3035 3885
388 409 431 494 515	455 476 7930	2282 3120 3970
390 411 433 495 518	456 477 8100	2290 3150 3995
391 412 434 496 519	457 479	
392 413 435 497 519	458 480	

BC 746 TUNING UNITS—Foundation coils and condenser for 80 meter VFO or exciter—less extols...98¢
 Special—200 KC or 500 KC In FT-241A Holder...\$1.95 ea. add 20¢ postage for every 10 crystals for less!



SUN PARTS DISTRIBUTORS, LTD.
 520 Tenth St. N.W. — Wash. D.C., Dept. R

Use in Broadcast Quality TAPE RECORDER MECHANISM 38.75

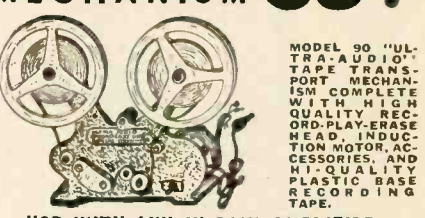

USE WITH ANY HI-GAIN AMPLIFIER
 The "Ultra-Audio" tape transport mechanism comes complete with receiver terminals and full instructions which permit its application to your present amplifier, radio-phonograph, or other audio unit. (For the making, reproduction, and erasing of tapes, just as any standard tape recorder—but at unbelievable quality and fidelity! This unit is ideal for Hi-fi enthusiasts, the experimenter, the radio ham, or commercial user. It is identical to that provided for our radio-broadcast outlets. No experience required to follow simple instructions and comprehensive circuit diagrams to connect to almost any radio or audio unit for full life-like performance!)
Records—Reproduces—Erases, At Two Speeds
 Simple change-over mechanism permits operation at either 7 1/2 or 3 1/2 inches per second speeds. A number of circuit diagrams are provided to enable even the novice to construct special amplifiers, etc., at minimum cost to obtain results far surpassing recorders selling for many hundreds of dollars. Unit will operate with any amplifier capable of being excited by crystal mike or magnetic phono—and with most radios. Unit comes complete, ready to connect and use. Operates in either horizontal or vertical position. Provided with convenient mounting lugs. **MONEY BACK GUARANTEE.**

FIRST COME—FIRST SERVED (Shipped pre-paid on cash-with-orders—otherwise charges collect. 1/2 cash with order on all C.O.D.'s.)
 Order from **EQUIPMENT—SERVICE DIVISION**
ULTRA-AUDIO BROADCASTING SYSTEM BOX 243, SAN DIEGO (12), CALIFORNIA

Please Mention Radio-Electronics When Answering Advertisements

OPPORTUNITY ADLETS

Rates—45¢ per word (including name, address and initials). Minimum ad 10 words. Cash must accompany all ads except those placed by accredited agencies. Discount, 10% for 12 issues. Misleading or objectionable ads not accepted. Copy for March issue must reach us before January 21, 1954.
 Radio-Electronics, 25 W. Broadway, New York 7, N. Y.

SPEAKERS REPAIRED at wholesale prices. Guaranteed workmanship. Jobbers wanted. Amprite Speakers Service, 70 Vesey St., New York 7, N. Y.

DIAGRAMS, RADIO \$1.00 TELEVISION \$2.00. Give make and model. Diagram Service, Box 672-RE, Hartford, Conn.

TUBES-TV RADIO, TRANSMITTING, AND SPECIAL PURPOSE TUBES BOUGHT AND EXCHANGED. Semi details to B. N. Gensler W2LNI, 136 Liberty, N. Y. 6, N. Y.

ALL MAKES OF ELECTRICAL INSTRUMENTS AND TESTING equipment repaired. Write for free catalogue on new and used instruments at a savings. Hazelton Instrument Co., 128 Liberty Street, New York, N. Y.

WANTED: AN/APR-4, other "APIK", "TS", "IE", "ARC-1, ARC-3, ART-13, BC-348, etc. Microwave Equipment, everything Surplus, Special tubes, Test Manuals, Lab Quality Equipment, Meters, Fast Action, Fair Treatment, Top Dollar! Latell, Fairhills Box 28, Dayton 9, Ohio.
FREE money saving bargain list, 10 MFD/600VW Oil Capacitor 98¢ RCA 3AP1A \$4.95 add postage. Mark Electronics, 1888 Randell Ave., Bronx 72, N. Y.

BUY WHOLESALE—25,000 ITEMS—CATALOG 25¢. Matthews, 1472-P4, Broadway, N. Y. C. 38.

SERVICEMEN, NOW, A POWDER SPRAY THAT CLEANS INSTANTLY and restores indefinitely, just a squeeze on your unbreakable bottle eliminates all your metal to metal contact troubles, a serviceman's must, try with money refund guarantee. Mail \$1.00 with return address to POW LABS., P. O. Box 25, Bay Ridge, Brooklyn, N. Y.

ALUMINUM TUBING, ANGLE AND CHANNEL Plain and perforated sheet. Willard Radcliff, Fostoria, Ohio.

AUTO RADIOS—ALL MODELS, BEST BRANDS. Wholesale. Free Catalog. Radio Frank, 14456 Michigan, Dearborn, Michigan.

AMATEUR RADIO IS FUN, FIFTY PAGES, EASY TO understand, code and theory for Novice Class license, \$1.00. Satisfaction guaranteed. Radiographic, 3246 North Orange, Chicago, Illinois.

SURPLUS BARGAINS. New coaxial cables 100 ft. RG 8/U, \$5.95; 100 ft. RG 59/U, \$6.25. Coaxial Connectors 83-18P plug 4 for \$2.25; 83-1R Socket 5 for \$2.00. 200 Asst. 1/2 watt resistors, all insulated, \$2.50. Postage Extra. Request Bargain Bulletin, RELIANCE MERCHANDISING CO., 2221 ARCH ST., PHILADELPHIA 3, PA.

COMPLETE TELEVISION SETS \$30 UP. W4APL 1420 South Randolph, Arlington 4, Virginia.

TV FM ANTENNAS, ALL TYPES INCLUDING UHF. Mounts, accessories. Lowest prices. Wholesale Supply Co., Lunenburg 2, Mass.

TRANSISTOR TRIGGER

Patent No. 2,604,496

Lloyd P. Hunter, Pittsburgh, Pa.
(Assigned to Westinghouse Electric Corp.)

This circuit can be triggered by a positive pulse of about a volt. Triggering is extremely rapid, requiring only about 0.1 microsecond. Reset time is a few microseconds. See Fig. 1.

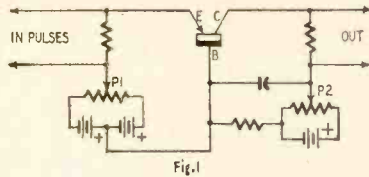

Fig. 1

P1 and P2 adjust the emitter and collector voltages. The output characteristic of the point-contact transistor is shown in Fig. 2. The lowest portion AB shows positive resistance. At higher currents there is a kink in the curve indicated by BC. This portion has negative resistance. Thereafter, the resistance goes positive again (CD). The peak B varies with emitter bias. A more positive emitter reduces the peak, for example from B to H.

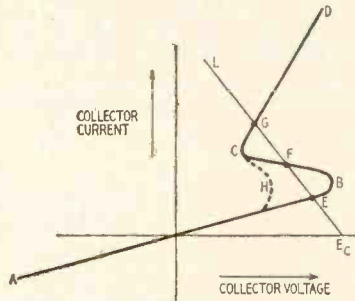

Fig. 2

The collector load line is shown as L. It intersects the curve at 3 points: E, F, G. Since F lies on an unstable portion of the curve, there are only two permissible operating points. For this trigger application, E is chosen.

If a positive pulse arrives at the emitter, B is momentarily reduced to H. This leaves only one intersection (G) between load line and characteristic curve. The circuit is instantly tripped to this point, the collector current rising from about 1 ma to 10 ma. This output pulse lowers the collector voltage for an instant and the operating point returns to E.

CASCADE AMPLIFIER

Patent No. 2,644,860

Christopher P. Gadsden, Belmont,
Alan B. Macnee, Boston, and
Henry Wallman, Cambridge, Mass.

(Assigned to United States of America as represented by the Secretary of the Navy)

The cascode combines the desirable features of the grounded-cathode and grounded-grid amplifiers, and eliminates their disadvantages. It has the high gain of a pentode and the low noise of a single triode. It is stable and covers a wide band. The equivalent source resistance (R1) is made high. The equivalent output resistance (R3) of the cascode is low for wide-band coverage. R2 is the equivalent low resistance of a grounded-grid amplifier. It prevents instability in the first triode. L neutralizes the grid-plate capacitance of V1.

END

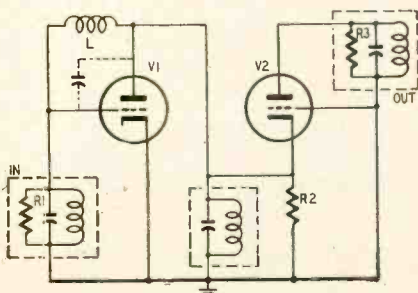

Distinctively Different
FOR THE FINEST UHF RECEPTION

Cardwell
UHF ALL-CHANNEL CONVERTER

This modern converter sells itself after the first demonstration of its superior picture-producing qualities. Tuning is stable because of the exclusive advanced design printed circuit. Small, beautifully styled mahogany or blonde wood cabinet.

Model ES-2 available without cabinet for custom installation inside any TV set. Small pancake design permits simple installation to receive all-channel UHF programs from VHF sets *in the home or in stock.*

Write for complete information including details of the Packaged Promotion Plan to help you sell.

The ALLEN D. CARDWELL Mfg. Corp.
97 WHITING STREET, PLAINVILLE, CONNECTICUT



PHOTOGRAPHS

RADIO-ELECTRONICS can use good photographs of service benches, service shops, high-fidelity audio layouts, and any other interesting and original radio-electronic devices.

We will pay \$6.00 each for good professional photos or equivalent, suitable for reproduction.

Full information on subject photographed will increase their acceptability.

The Editor, RADIO-ELECTRONICS
25 West Broadway, New York 7, N. Y.

the BOOSTER with the CASCODE CIRCUIT



Turner:
Model TV-2

... for sharper reception
on any set — new or old!

We'll give it to you straight. This booster costs a little more. *It's worth it!* Who wants to watch Milton Berle through a blizzard of snow. The high-quality cascode circuit in the Turner booster reduces noise and snow to a minimum. Produces an excellent picture even in extreme fringe areas. Many servicemen say, "The Turner is the *only* booster that will help the new sets with cascode tuners." *Install a Turner booster and you guarantee the best possible reception.*



The TURNER Company
933 17th Street N.E.,
Cedar Rapids, Iowa

Gentlemen: Please send me complete information on the superior performance of your booster.

Name _____
Address _____
City _____ State _____

Brand New
Set Mfr's
SURPLUS

TUBES

STANDARD
BRAND
WARRANTY

Bulk Packed in Original Mfr's Nested Cartons or Individually Boxed
Every tube meter and chassis tested for top quality... **BRANDED**

1B3GT54	6AK579	6BQ779	6S0744	12SK749
1L450	6AL537	6BQ6GT79	6T864	12SN7GT49
1R549	6AQ541	6BK771	6V6GT41	12SQ744
1S455	6AG549	6C434	6W4GT41	19BG6G1.19
1S541	6AT634	6C544	6W6GT31	19T864
1T449	6AU637	6CB645	6X5GT34	25BQ6GT82
1U449	6AV634	6CD6G1.11	12AT634	25L6GT41
1U541	6B4G82	6H641	12AT760	35B549
1X2A55	6B555	6J5GT37	12AU637	35C549
3Q5GT58	6BA636	6J654	12AU749	35L6GT45
3S449	6BC549	6J749	12BA611	35W432
3V449	6BE641	6K6GT37	12BE641	35Z536
5U4C37	6BG6G1.19	6SA744	12BH756	50B549
5Y3GT34	6BH649	6SK744	12CA849	50C549
6AC771	6BJ649	6SN7GT49	12SA749	50L6GT45
6AH664	6BL7GT79			

More than 400 types in stock. Include all your needs when ordering.

Orders less than \$10.00—add \$1.00 service charge. Terms: 25% with order, balance C. O. D. Please include postage. All prices subject to change without notice. F. O. B. New York City. Mail order division.

TRANSAMERICA ELECTRONICS CORP.

120 LIBERTY ST., NEW YORK 6, N. Y. • COrtlandt 7-4307

ARGYLE

again revolutionizes
TV installation
business... one look
shows you
how

The Argyle Mast Type Universal Standoff combined with the new Argyle Mast-Lok clamp permits the best installation possible. Is stronger, more versatile—clamps will not slip or loosen... entire installation is done in a few seconds.



a must
for UHF...

you need it
for VHF too!

Now—Argyle introduces Mast-Lok... the clamp used in conjunction with the Universal Mast Type Standoff! Available at no difference in price. The strongest, quickest, and most positive method of securing standoffs to the mast... heavy duty steel with a re-inforced cantilever clamp.

- Improves Reception... rigid engineering and lab tests prove that the New Argyle Universal Standoff tends to substantially reduce coupled-in effects and related evils in the line.
- Big Time Saver... you can actually save 75% of your installation time.
- No Threading—use any type of wire at all... Flat, Tubular, Open, Rotor—When ordering MAST-LOK with Argyle Universal Standoffs*—add letters MC after model number of standoff... Separately model AMC-12.

ARGYLE ELECTRONICS CO.

8 West 18th Street, New York 11, N. Y. • CH 2-2093



a Vaccine will mean Victory!
Join the **MARCH OF DIMES**
January 2 to 31

ENGINEERED TO THE SPECIFICATIONS OF TELEVISION SET MANUFACTURERS

Line includes every necessary TV tool to service all receivers. Below are just a few:

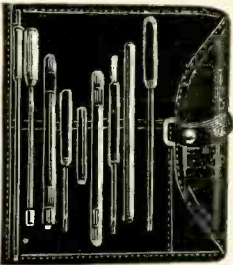
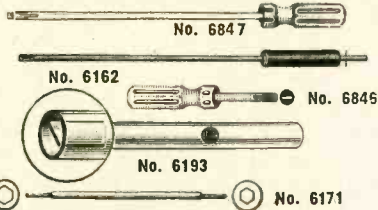

Be sure it's Insuline when you need the right tool for a TV service problem. Write Dept. RE-1 for complete tool list and new TV tool brochure.



insuline

CORPORATION OF AMERICA
INSULINE BUILDING • 36-02 35th AVENUE
LONG ISLAND CITY, N. Y.

Exclusive Canadian Sales Agents:
CANADIAN MARCONI COMPANY, Toronto

National Electronics GREATEST Special Purchase BARGAIN Tremendous Savings While They Last

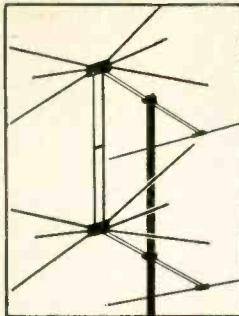

**2 BAY
16 ELEMENT
CONICAL
ARRAY**
WITH STURDY
3/8" ELEMENTS
AND HIGH BAND
ADAPTERS
\$4.99
EACH
IN LOTS OF THREE
Single Lots \$5.30

Never before has National Electronics had a BARGAIN like this. We made a special purchase in order to get these sensational prices. And this array has everything. This conical 2-bay 16-element array provides ultra-fine fringe reception. Includes sixteen 3/8 inch airplane type aluminum elements, including hi-band adapters for greater gain on the high channels and is complete with one pair of stacking bars to each array. These are packed in cartons of three 16-element arrays per carton, with tie rods, at \$14.95 per carton. When purchased in single 16-element arrays, separately boxed—your cost is \$5.30 each

- 3 Two-Bay Arrays per carton without Tie Rods \$13.50 carton
- 4 Bay Ultra-Fringe Stacking Assembly for Above—Model 4B \$1.95 set

FAMOUS ROCKET ZOOM-UP TOWERS

• Sturdy • Reliable • Easiest Installation
Economy with Rocket Zoom-up Towers. Offers quickest, easiest way to make an installation up to 50'. Each section telescopes inside the other—to erect, simply slide out each section in its turn—insert bolt thru section below—tighten to keep mast from turning. Each tower complete with guy rings, bolts, and mounting base suitable for peak or flat roof. Handsome and sturdy, Rocket Zoom-ups offer you economy and long life. Order by size.

- 20' \$ 9.95 30' \$16.95
 - 40' 21.95 50' 32.95
- (Deduct 10% discount in lots of 3)

Sensational Low Prices on UHF Accessories

- M-5-C 5' steel mast extender (crimped to mate with 1 1/2" steel mast) \$1.05
- UHF low-loss tubular twin-lead-100' coil 4.95
- 7 1/2" UHF mast stand-off13
- 7 1/2" UHF screw stand-off06
- UHF-VHF antenna coupler-low-loss 2.75 ea.

SUPER SENSATIONAL!

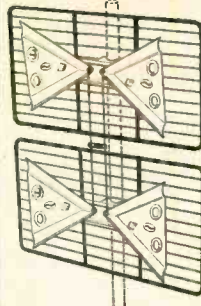

BOW TIE UHF REFLECTOR
Ultra High Gain
Bargain Priced
at
\$1.95
ONLY

For Single Array
ONLY \$4.40 For
Two-Bay Array

We are offering the BIGGEST UHF TV Antenna Bargain ever offered. The single array is designed for metropolitan usage—the two-bay array where greater gain is required—and the 4-bay array for fringe. At this sensational low price this antenna is the BEST BUY on the market. Get your needs filled while they last!

In lots of 6, individually cartoned \$10.95 for 6
4-bay arrays, with tie rods 8.75 ea.
Matching tie rods—per pair50 pair



\$29.37

TR-2 RADIART TELORATOR

WITH DIRECTION INDICATOR
Streamlined, waterproof, sturdy. 12 heavy duty ball bearings. Heavily reinforced die-cut housing. Precision gears. Positive stop at end of rotation. Heavy duty motor reverses instantly. Mast, tower or platform mounting. Factory lubricated for life. Perfect pattern dial gives immediate indication of antenna position.
Requires 8 Conductor Cable
8 Conductor Wire \$.08 ft.

UHF STRIPS—Now available for Standard Coil tuners. To order, specify channel No. and series designated by letter, such as F, G, Q, etc., stamped on each strip of your present tuner. (Set consists of one. & ant.)
\$7.50
Ea.

ALL PRICES F.O.B. CLEVELAND, OHIO
Do not remit more than complete purchase price. Pay shipping charges on receipt of goods. 25% deposit on all C.O.D. orders, please. Money-back guarantee.
Prices Subject to Change Without Notice

National Electronics
OF CLEVELAND
THE HOUSE OF TV VALUES

201 Delco Building Cleveland 3, Ohio

Get This Valuable Book

Just for Examining COYNE'S New 6-Volume Set

FREE



"Applied Practical Radio-Television"

Yes, you get this big, brand new book, "150 Radio-Television Picture Patterns and Diagrams Explained", absolutely FREE! Just off the press! Gives complete wiring circuits and diagrams on the latest Radio and Television Sets. Easy-to-read, large 8 1/2 x 11" pages, with full instructions on how to read and use the diagrams. A "must" in every Radio and Television service-man's repair kit. You get this valuable book as a FREE Gift for asking to see Coyne's great new 6-book set, "Applied Practical Radio-Television"!

Here's "Know-How" That Makes You Worth More!

Coyne's great new 6-volume set gives you all the answers to servicing problems—quickly! For basic "know-how" that is easy to understand, you'll find everything you want in volumes 1 to 5 which contain over 5000 practical facts and data. They cover every step from principles to installing, servicing, trouble-shooting and aligning all types of radio and TV sets. So up-to-date it includes COLOR TV and UHF, adaptors and converters. Also covers very latest information on TRANSISTORS.

802-Page Television Cyclopeda Included

And then, for speedy on-the-job use, you get volume 6—the famous Coyne TELEVISION CYCLOPEDIA. It answers today's television problems on servicing, alignment, installation and others. In easy-to-find ABC order, cross indexed. Use this 6 volume TV-RADIO LIBRARY free for 7 days; get the valuable Servicing Book ABSOLUTELY FREE!

ON 7 DAY
FREE
TRIAL!

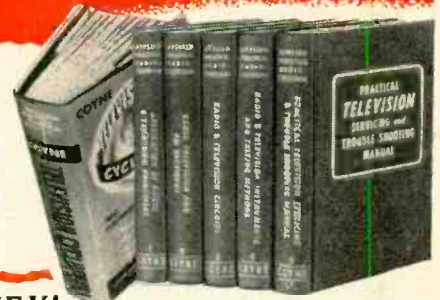

SEND NO MONEY! Just mail coupon for 6-volume set on 7 days free trial. We'll include book of 150 TV-Radio Patterns & Diagrams. If you keep the set, pay \$2 in 7 days and \$2 per month until \$22.50 plus postage is paid. (Cash price \$20.95). Or you can return the library at our expense in 7 days and owe nothing. **YOU BE THE JUDGE.** Either way, the book of TV-Radio Patterns is yours FREE to keep! Offer is limited. Act NOW!

FREE BOOK—FREE TRIAL COUPON!

COYNE ELECTRICAL & TELEVISION-RADIO SCHOOL, Dept. 14-T1
500 S. Paulina St., Chicago 12, Ill.

YES! Send 6-volume "Applied Practical Radio-Television" for 7 days FREE TRIAL per your offer. Include TV-Radio Patterns & Diagram Book FREE.

Name..... Age.....

Address.....

City..... Zone..... State.....

Where Employed.....

() Check here if you want library sent COD. You pay postman \$20.95 plus COD postage on delivery. 7-day money-back guarantee.

COYNE ELECTRICAL & TELEVISION-RADIO SCHOOL
500 S. Paulina St., Dept. 14-T1 Chicago 12, Ill.

Attention!! • EXECUTIVES • SALEMEN • PUBLIC OFFICIALS • POLICEMEN • FIREMEN • OUTDOOR MEN • REPORTERS • FIELD INSPECTORS • DOCTORS • LAWYERS, ETC.

DICTATE IN YOUR CAR



with **ATR**

INVERTERS

for changing your battery current to **A.C. Household CURRENT** *Anywhere . . .* **in your own car!!**

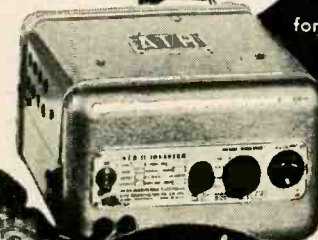

Announcing!
NEW MODELS
NEW PRICES

ATR INVERTERS . . . especially designed for operating standard 110 volt A.C. Tape Recorders, Wire Recorders, Dictating Machines and Electric Razors **IN YOUR CAR.**

EASY TO INSTALL
EASY TO OPERATE

A VALUABLE TIME SAVER FOR:

- **TRAVELLING SALESMEN**—Dictate reports in your own car. Send your dictated reports in daily to your home office or sales manager.
- **FIELD INSPECTORS & INVESTIGATORS**—Dictate your field inspection reports in the field—on the spot. Give the complete story factually and completely. Include your clients recordings also.
- **DOCTORS**—Dictate and record your house calls on the completion of your call while everything is fresh in your mind. Have these records for transcription by your office girl.
- **LAWYERS**—Record evidence in the field at your client's premises. Obtain factual and complete witness reports, etc.
- **EXECUTIVES**—Dictate in your car all business matters while on trips for pleasure or business.
- **PUBLIC OFFICIALS**—Dictate complete field reports in your car. Obtain recorded opinions and expressions of Mr. Public in the field. Dictate your business reports while traveling.
- **POLICE SQUAD CARS**—Dictate accident reports right on the scene complete and factual. Include witness recordings at the same time. Have the complete story available by dictation.
- **FIRE TRUCKS**—Dictate your fire reports factually and complete on the scene and include witness reports. Have the complete story.
- **AMBULANCES**—Dictate complete reports of your ambulance run. (Include witness recordings, etc.)
- **ADVERTISING AGENCIES**—Use AC operated animated or illuminated displays in or on the car.
- **FISHERMEN & HUNTERS**—Use your electric razor on camping trips, operating in your car. Also small home radios and other electrical or electronic items.
- **CAMPERS**—Make your camping and outing trips more exciting using mini-masters, tape recorders, or wire recorders operating from your car battery.
- **WAREHOUSE & MATERIAL HANDLERS**—Dictate your inventory and material handling reports on the scale, in the warehouse, yard, or wherever you may be.

FREE !! ATR INVERTER!
... given away every 30 days to lucky registrant of preceding month. Mail a postcard as your registration request today!

Announcing!
NEW ATR INVERTERS
New models New features New prices
WRITE FOR NEW FREE LITERATURE

See your dealer or write factory ✓ NEW MODELS ✓ NEW DESIGNS ✓ NEW LITERATURE
"A" Battery Eliminators, DC-AC Inverters, Auto Radio Vibrators
ATR AMERICAN TELEVISION & RADIO CO.
Quality Products Since 1931
SAINT PAUL 1, MINNESOTA—U. S. A.

UHF CONVERTER

P. R. Mallory & Co., Inc., 3029 E. Washington St., Indianapolis 6, Ind., has announced a redesigned all-channel u.h.f. converter, model 88. This converter is 50 percent smaller than their previous model. A single knob tunes all the u.h.f. channels in a total of 7 1/2 turns. A second knob switches from u.h.f. to v.h.f. and also turns both the converter and television set on and off. When using the converter, the television set may be left on either channel 5 or 6, whichever receives less external interference.



The model 88 is continuously tuned for channels 14-83. It uses a 6AF4 or 6T4 oscillator tube, a 6C86 i.f. amplifier, and a 1N72 v.h.f. diode detector. Input and output impedances are 300 ohms. The converter uses a power transformer, selenium rectifier, and resistance-capacitance filter, and requires about 25 watts from a 115-volt, 60-cycle power line. The cabinet measures 7 1/2 x 4 9/16 x 5 3/4 inches.

FLYBACK TRANSFORMERS

Chicago Standard Transformer Corp., Standard Division, Addison and Elston, Chicago 18, Ill., has announced three new Stancor replacement flyback transformers for Motorola sets.



Each unit has a horizontal-centering control, variable-gap width control, and a socket for a 1B3 rectifier. These three transformers cover 91 Motorola models of 52 chassis. Stancor part number A-8224 replaces Motorola flybacks 24C711265, 24C711265-A, and 24C721290 in 56 models. A-8225 replaces 24K712193 in 15 models. A-8226 replaces 24K721301C and 24K721517C in 20 models.

TWO NEW TV ANTENNAS

Ward Products Corp., a Division of the Gabriel Co., Cleveland, Ohio, has developed two new antennas, the Circle-vane and the Dymon-vane. The Circle-vane is designed for use in rural or suburban fringe areas where a great deal of sensitivity is required. It is a 10-element Yagi type antenna with aluminum elements on a Permatube crossarm.

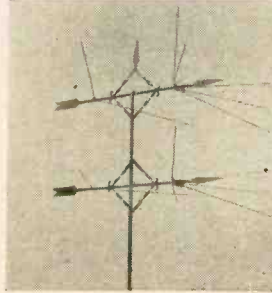

The Dymon-vane conical pictured above is recommended for areas where both low- and high-band tele-

vision stations are in operation and transmitting in the same general direction. By supplementing the single unit with additional units or bays, this may be used to receive signals up to 100 miles from the transmitting station.

WAVE-TRAP SELECTOR

Vidaire Electronics Mfg. Co., Lynbrook, N. Y., has developed a wave-trap selector, the *FT-Test*, which determines the type of filter or wave-trap needed by switching two dials. If a TV service technician makes a repair call and finds no interference present at the time, he can hook up this meter and explain to the set owner that when the trouble reoccurs, twist



the two dials until it clears. The technician then stops by later to take his reading and pick up the instrument, for he then knows what filter or trap to install. Known as the model FT-100, the unit has wavetraps and filters which may be switched into the antenna and a.c. line circuits.

ALIGNMENT TOOL

Service Instruments Co., 422 S. Dearborn St., Chicago 5, Ill., has announced the *Align-O-Pak* unit to replace bias batteries when aligning TV receivers. Its output is variable from 0 to 10 volts d.c. Output leads are isolated from the metal case and power line to provide a fixed a.c. bias for any television receiver. If a stable picture appears when the bias leads are connected to the a.g.c. bus and the output is varied, then the a.g.c. is faulty.



Regency Division—I.D.E.A., 7900 Pendleton Pike, Indianapolis 26, Ind., is manufacturing a remote control for TV, model RT-700. This device is operated on a single-conductor cable, and selects stations, adjusts fine-tuning and controls contrast and volume from as far away as 100 feet.

REMOTE CONTROL

Regency Division—I.D.E.A., 7900 Pendleton Pike, Indianapolis 26, Ind., is manufacturing a remote control for TV, model RT-700. This device is operated on a single-conductor cable, and selects stations, adjusts fine-tuning and controls contrast and volume from as far away as 100 feet.



ALL-CHANNEL ANTENNA

Trio Manufacturing Co., Griggsville, Ill., has announced an addition to their Zig-Zag line, the *Twin-Six*. This single-bay, all-channel antenna offers satisfactory u.h.f. reception in primary areas.

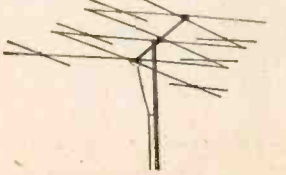

THE "TELCO TEN"

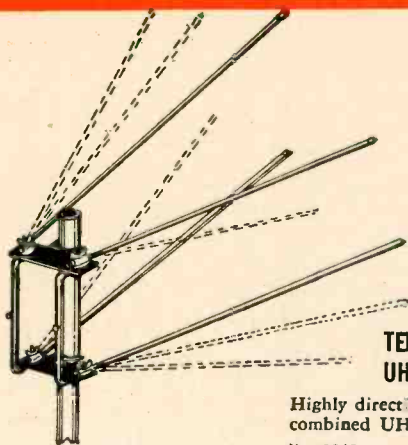

NEW!

TELCO "DOUBLE V" UHF-VHF ANTENNA

Highly directional...adjustable for combined UHF-VHF 50°-70°-90°.
No. 9010 List \$6.95

... the "T" formation line—T for Top Quality and T for Ten Antenna Styles. Insist on TELCO ... the best TV antennas for the greatest "show" on earth.



WISHBONE

... exclusive with TELCO, is a free air insulator that prevents shorting out under any condition ... found only on TELCO UHF Antennas.

FREE CATALOG—illustrates all TELCO products. Available at your jobber or write direct today!



TELEVISION HARDWARE MFG. CO.
DIVISION OF GENERAL CEMENT MFG. CO.
910 Taylor Street Rockford, Illinois

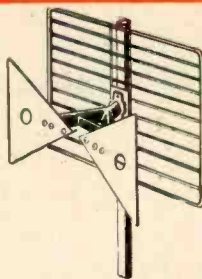

TELCO UHF "GOLDEN GRID" SUPER DELUXE BUTTERFLY ANTENNA
No. 8965 List \$5.95



TELCO UHF "GOLDEN GRID" STANDARD BUTTERFLY ANTENNA
No. 9001 List \$3.95

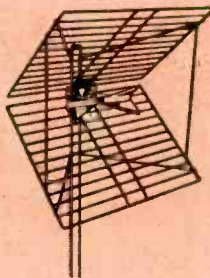

TELCO UHF "GOLDEN GRID" DELUXE CORNER REFLECTOR ANTENNA
No. 8984 List \$11.25

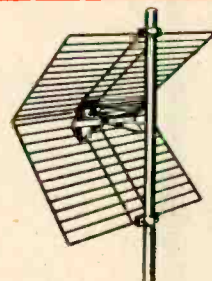

TELCO UHF "GOLDEN GRID" STANDARD CORNER REFLECTOR ANTENNA
No. 9002 List \$11.25



TELCO UHF "GOLDEN GRID" 2-STACK DOUBLE TIE ANTENNA
No. 9004 List \$7.50 less mast

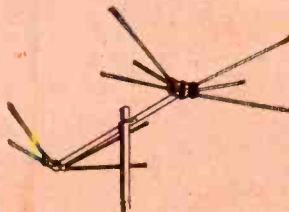

TELCO VHF CONICAL ANTENNA
No. 8700 List \$9.25

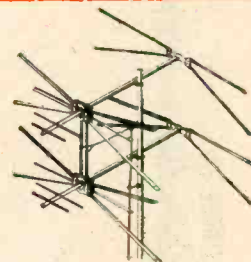

TELCO VHF SUPER CONICAL ANTENNA
No. 8902 List \$19.85

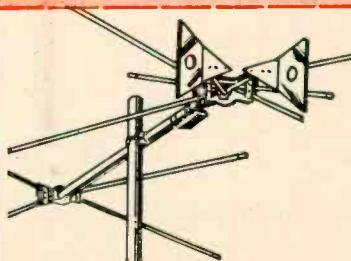

TELCO UHF-VHF UNIVERSAL CONICAL ANTENNA
No. 8981 List \$16.25



TELCO UHF-VHF "GOLDEN HALO" IN-DOOR ANTENNA
No. 9000 List \$4.95

BUILD 15 RADIOS ONLY AT HOME \$19.95

With the New Improved 1954

Progressive Radio "EDU-KIT"

NOW INCLUDES
SIGNAL TRACER
and
CODE OSCILLATOR



- FREE TOOLS WITH KIT
- ABSOLUTELY NO KNOWLEDGE OF RADIO NECESSARY
- NO ADDITIONAL PARTS NEEDED
- EXCELLENT BACKGROUND FOR TV
- 10 DAY MONEY-BACK GUARANTEE

WHAT THE PROGRESSIVE RADIO "EDU-KIT" OFFERS YOU

The Progressive Radio "Edu-Kit" offers you a home study course at a rock bottom price. Our Kit is designed to train Radio Technicians, with the basic facts of Radio Theory and Construction Practice expressed simply and clearly. You will gain a knowledge of basic Radio Principles involved in Radio Reception, Radio Transmission and Audio Amplification. You will learn how to identify Radio Symbols and Diagrams; how to build radios, using regular radio circuit schematics; how to mount various radio parts; how to wire and solder in a professional manner. You will learn how to operate Receivers, Transmitters, and Audio Amplifiers. You will learn how to service and trouble-shoot radios. You will learn code. You will receive training for F.C.C. license.

In brief, you will receive a basic education in Radio exactly like the kind you would expect to receive in a Radio Course costing several hundreds of dollars.

THE KIT FOR EVERYONE

The Progressive Radio "Edu-Kit" was specifically prepared for any person who has a desire to learn Radio. The Kit has been used successfully by young and old in all parts of the world. It is not necessary that you have even the slightest background in science or radio. The Progressive Radio "Edu-Kit" is used by many Radio Schools and Armed Forces Personnel and Veterans throughout the world. The Progressive Radio "Edu-Kit" requires no instructor. All instructions are included. All parts are individually boxed, and identified by name, photograph and diagram. Every step involved in building these sets is carefully explained. You cannot make a mistake.

PROGRESSIVE TEACHING METHOD

The Progressive Radio "Edu-Kit" comes complete with instructions. These instructions are arranged in a clear, simple and progressive manner. The theory of Radio Transmission, Radio Reception, Audio Amplification and servicing by Signal Tracing is clearly explained. Every part is identified by photograph and diagram. You will learn the function and theory of every part used. The Progressive Radio "Edu-Kit" uses the principle of "Learn by Doing". Therefore you will build radios to illustrate the principles which you learn. These radios are designed in a modern manner according to the best principles of present-day educational practice. You begin by building a simple radio. The next set that you build is slightly more advanced. Gradually, in a progressive manner, you will find yourself constructing still more advanced radio sets, and doing work like a professional Radio Technician. Altogether you will build fifteen radios, including Receivers, Transmitters, Amplifiers, Code Oscillator and Signal Tracer. These sets operate on 105-125 V. AC/DC.

THE PROGRESSIVE RADIO "EDU-KIT" IS COMPLETE

You will receive every part necessary to build 15 different radio sets. Our kits contain tubes, tube sockets, chassis, variable condensers, electrolytic condensers, mica condensers, paper condensers, resistors, line cords, selenium rectifiers, tie strips, coils, hardware, tubing, etc. Every part that you need is included. These parts are individually packaged, so that you can easily identify every item. Tools are included, as well as an Electrical and Radio Tester. Complete, easy-to-follow instructions are provided. In addition, the "Edu-Kit" now contains lessons for servicing with the Progressive Signal Tracer, F.C.C. instructions, quizzes. The "Edu-Kit" is a complete radio course, down to the smallest detail.

TROUBLE-SHOOTING LESSONS

Trouble-shooting and servicing are included. You will be taught to recognize and repair troubles. You will build and learn to operate a professional Signal Tracer. You receive an Electrical and Radio Tester, and learn to use it for radio repairs. While you are learning in this practical way, you will be able to do many a repair job for your neighbors and friends, and charge fees which will far exceed the cost of the "Edu-Kit". Here is your opportunity to learn radio quickly and easily, and have others pay for it. Our Consultation Service will help you with any technical problems which you may have.

FREE EXTRAS

- ELECTRICAL AND RADIO TESTER
- ELECTRIC SOLDERING IRON
- BOOK ON TELEVISION
- RADIO TROUBLE-SHOOTING GUIDE
- MEMBERSHIP IN RADIO-TELEVISION CLUB
- CONSULTATION SERVICE
- QUIZZES
- TRAINING FOR F.C.C. LICENSE

MAIL TODAY—YOUR ORDER SHIPPED SAME DAY RECEIVED

Send me the "Edu-Kit" with 10 Day Money-Back Guarantee—include All FREE extras.

Check or M.O. enclosed—postage prepaid Send further information.

C.O.D. (U. S. Only)—I will pay postage Outside U.S.A. — no C.O.D.'s; send check on U.S. bank or international M.O. for \$19.95. Postage prepaid. "Edu-Kit" for 210-250 V. AC/DC \$22.45.

NAME _____
ADDRESS _____

PROGRESSIVE "EDU-KITS" INC.

497 UNION AVE., Dept. RE-79, Brooklyn 11, N. Y.

RETRACE ERASER

Tele-Matic Industries, Inc., 1 Jerome St., Brooklyn 2, N. Y., has made available a device to eliminate retrace lines which interfere with TV reception. This unit, the model CR-59, is plugged into the back of the cathode-ray tube and connected to the yoke by one lead.



Its size is the same as a 1-watt composition resistor—body length $\frac{9}{16} \pm \frac{1}{32}$ inches, body diameter $\frac{3}{32} \pm \frac{1}{32}$

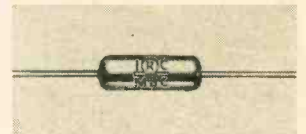

inches, lead length $1\frac{1}{2} \pm \frac{1}{8}$ inches, and lead diameter .032 inches minimum. The resistor meets Signal Corps specification MIL-R-10509A, and is recommended for application where stability and high-voltage insulation are needed.

UHF ANTENNAS

Telrex, Inc., Asbury Park, N. J. has announced the new "80" Series u.h.f. Conical-V Beam all-channel antennas. The series includes 1-, 2- and 4-bay models, a parabolic array, and a corner reflector. They are light-weight, all-aluminum antennas, and are single-clamp mounted to any standard mast.

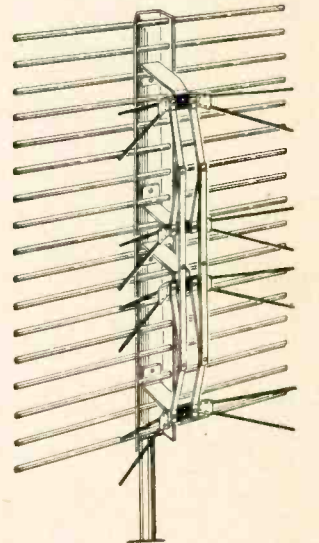

DEFLECTION YOKE

RCA, Harrison, N. J., has announced a magnetic deflection yoke for 27-inch rectangular picture tubes with horizontal deflection angles of 85° and diagonal deflection angles of 90°. The horizontal and vertical coils of the deflection yoke type 219D1 are especially wound to compensate for deflection defocusing, and provide good side and corner resolution.



ROTOR SECTION

The Buchan Co., Bricelyn, Minn., is manufacturing the LL300 Rotor-Section, a 6-foot length of 300-ohm open-wire line with each conductor insulated with fiberglass tubing. Equipped with Nicopress-sleeve solderless connectors, it can be quickly and easily attached to 300-ohm open-wire line so that it can be used with an antenna rotor without danger of shorting, and still maintains the low-loss, long-life features of open-wire line.

LIGHTNING ARRESTER

IE Manufacturing, 325 N. Hoyne St., Chicago, Ill., is producing a lightning arrester for all common types of transmission lines, including tubular, small-oval, large-oval, open-wire, 300-ohm, and Anaconda line.

Positive contact is made by long,

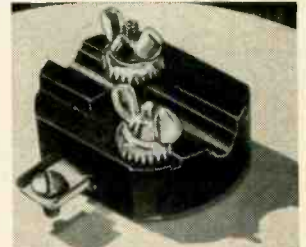

piercing teeth which bite into the insulation. Insulation, regardless of thickness, need not be stripped. Impedance of the line is not disturbed. The unit is completely enclosed in plastic molded housing and is adaptable for indoor or outdoor installation on walls, windows, masts, or pipes.

PRINTED-CIRCUIT KITS

Centralab—Division of Globe Union, Dept. H-22, 900 E. Keefe Ave., Milwaukee 1, Wis., is now furnishing its Printed Electronic Circuits in four handy kit assortments. The four kits range from a group of 18 units to a complete stocking cabinet of 220 plates. With these units, sets can be made smaller and more compact, and circuits themselves are simplified when one component is used to replace 9 or 10 different parts. Solder connections are substantially reduced, and now even the original cost of the units

PRECISION RESISTORS

International Resistance Co., 401 N. Broad St., Philadelphia 8, Pa., has developed a molded-boron carbon-film type precision resistor rated at $\frac{1}{2}$ watt. This unit, type MBC, is molded in a special plastic housing to provide complete mechanical protection.

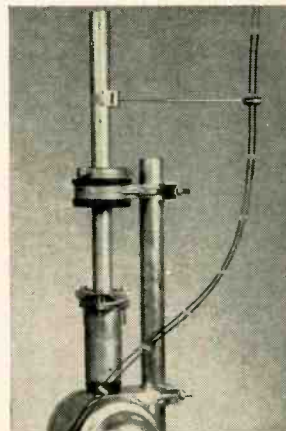

is lower than the total of old-style components.

When trouble is located in a certain section of a radio or TV chassis, instead of spending time locating the exact faulty component, the service technician removes the entire circuit



part, replacing three to nine old-style components with a single printed circuit.

The smallest kit of 18 printed circuits will replace 42 resistors and 52 capacitors. Kits PCK-18 and PCK-45 contain 18 and 45 units respectively and come in plastic boxes. Kits PCK-110 and PCK-220 contain 110 and 220 units respectively and come packed in large, sturdy metal cabinets.

TANTALUM CAPACITOR

General Electric Co., Schenectady 5, N. Y., has announced a tantalum capacitor, believed to be the smallest high-capacitance unit ever designed for low-voltage direct-current applications. It is intended as a companion for the transistor. The unit is 3/16 inch long and 1/8 inch in diameter.

The major feature of the unit is the advantage in size per volt-microfarad over most other electrolytics. Other features include: long shelf and operating life, wide temperature range, and low leakage current. The unit is sealed against leakage or contamination and utilizes a nonacid electrolyte.

It is designed to operate over a temperature range of -20 degrees C to +50 degrees C and is suitable for storage at -65 degrees C.

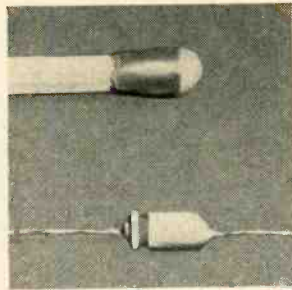

The new unit is available in ratings from 2 to 16 volts, 4 to 0.7 uf respectively. Another, larger capacitor—1/2 inch long—with similar characteristics and the same voltage range, but with 8 to 1.5 uf, has also been announced as available.

AUTO SPEAKER KIT

Lowell Manufacturing Co., 3030 Laclede Station Road, St. Louis, Mo., announces a new rear seat auto extension speaker baffle kit that replaces their older model.

The model R7-K includes a 6 x 9-inch oval speaker with 2.15-oz. magnet, a 3-way switch, knob, dial plate, stamped metal baffle plate with temper-proof metal screening, 15 feet

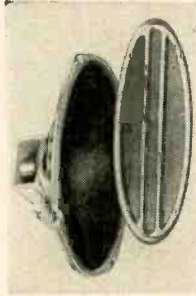

of cable, and complete mounting instructions.

The new kit is available with or without speaker, in chrome as well as in grey, light blue, or light bronze.

MICROPHONE STANDS

Atlas Sound Corp., 1451 39th St., Brooklyn 18, N. Y., has added the BS-36 professional boom-type microphone stand to its line. This model features an "air-lock cushion" built into the vertical section to prevent slipping, and a new swivel joint at the microphone end of the boom.

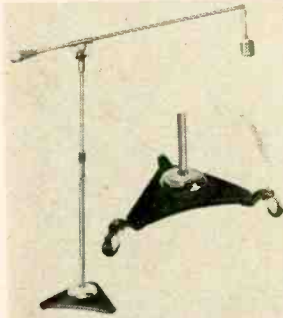

The mobile model BS-36W is identical to the BS-36, except for a base equipped with ball-bearing swivel casters. Boom length is 72 inches. An extension may be added if the microphone used is light-weight.

TUBE CHECKER

Weston Electrical Instrument Corp., 614 Frelinghuysen Ave., Newark 5, N. J., has announced a new tube checker, model 981, type 2. This unit measures proportional mutual conductances, emission characteristics of rectifiers and diodes, and the firing potential limits of voltage regulators and low-power thyratrons.

The model 981, type 2 provides 19 filament voltage settings from 0.65 to 115 volts and five plate voltages from



20 to 177, with a 45-volt source to facilitate testing of subminiature type tubes. Over-all voltage variations are corrected by a line-control adjustment. Signal voltages of 3.2, 1.6, .8, and .4 volts are provided at a frequency of 5 kc. For testing voltage-regulator tubes a selenium-rectifier supply furnishes 200 volts d.c. for a maximum current of 65 milliamperes. The instrument comes in a sturdy steel case of grey hammertone finish, measuring 17 1/2 x 13 1/4 x 6 inches.

BINAURAL TAPE RECORDER

Electronic Teaching Laboratories, 1818 M St., N.W., Washington 6, D. C. has announced the new Electro-Dual binocular magnetic tape recorder designed especially for educational applications. It features simultaneous parallel tracking with either or both tracks in play or record. Instructions can be issued to the student on one channel and student responses can be recorded on the other.

The unit consists of separate miniaturized amplifiers using two 5879's, two 12AU7's, and one 6X4 for each channel. Response is ±2 db from 40 to 8,000 cycles at 3.75 inches per second and ±3 db from 50 to 12,000 cycles at 7.5 inches per second. Each amplifier has a meter for measuring signal input and output. One 3-circuit phone jack permits binocular phones to be used in monitoring either channel. Another jack is provided for binocular output.

New RADIO COURSE only \$2.50



MADE MONEY FIRST WEEK

"You should get more money for your Course. The first week I studied it, I made \$10.00 repairing sets. I built my own test outfit from details given in this course. I have repaired 100 radios to date. . . ."

Signed: Robert C. Hammel, 120 W. 13th, Davenport, Iowa.



COMPLETED IN 8 WEEKS

"I am very satisfied with the course. When I was at the twelfth lesson I started repairing radios. It took me two months to master your course." From a letter written by Roger Langlois, 1679 Poupard St., Montreal, Canada.



MODERN, UP-TO-DATE

"Your course is modern and up-to-date. There is not one page in the whole course which anyone can afford to miss. Your course started me on the road to a well paid job and has repaid me many times." Charles Alspach, 433 Elm St., Reading, Pa.

AMAZING BARGAIN OFFER

Here is a practical home-study course that will teach you how to repair all radio sets faster and better. These newly reprinted 22 lessons cover all topics just like other correspondence courses selling for over \$150.00. Our amazing offer permits you to obtain the course complete for only \$2.50, nothing else to pay. Easy-to-follow, well illustrated sections on test equipment, circuit tracing, alignment, F.M., use of oscilloscope, amplifiers, and every other topic needed to be an expert in radio repairing. Trouble-shooting hints, circuits, short cuts, service suggestions, new developments. Send coupon today, and use the complete course at our risk. Satisfaction guaranteed. All 22 lessons, in large manual form, + self-testing questions, **\$2.50** complete, your cost only

INTRODUCTION TO TELEVISION

These practical lessons making up this course-book are easy to follow and apply to actual radio jobs. Use this training to get ahead in radio and as an introduction to television. Hundreds of radio facts that puzzled you will be quickly cleared up. You will find yourself doing radio repairs in minutes instead of hours — quickly finding faults or making needed adjustments. Every new radio development of importance and thousands of time-saving radio facts are packed into this complete course-manual. For example, there is a large lesson on servicing F.M. sets and another full lesson on audio amplifiers. Use coupon below to order Course for 10-day examination in your own home. Look over the material, read a few lessons, apply some of the hints. Then decide to keep the lessons at the bargain price of \$2.50 (full price), or return the material and get a cash refund. (Offer may be withdrawn at any time.)



Supreme Radio & TV Manuals

Your complete source of all needed RADIO and TV diagrams and service data. Most amazing values. Still sold at pre-Korean prices. Only \$2 for most volumes. Every Radio manual contains large schematics, all needed alignment facts, parts lists, voltage values, trimmers, dial stringing, and service hints. Each TV manual is a practical treatise on servicing the year's sets, with giant blueprints, patterns, waveforms, hints, charts, suggested changes. See coupon at right for a complete list of these low-priced manuals.

NO-RISK TRIAL ORDER COUPON

SUPREME PUBLICATIONS, 1760 Balsam Rd., Highland Park, Ill.

Radio Diagram Manuals

- New 1953 Manual, \$2.50
- 1952 Radio
- 1951 Diagrams
- 1950 Manual
- 1949 Radio
- 1948
- 1947
- 1946
- 1942
- 1941
- 1940
- 1939
- 1926-1938 Manual, \$2.50

EACH \$2.50
PRICED AT ONLY \$2 EACH

Send Radio and TV manuals checked at left and below. Satisfaction guaranteed or money back.

- Complete RADIO COURSE, all 22 lessons \$2.50
- 1953 TV Manual, \$3. 1953 UHF Units, \$1.50
- 1952 Television Manual, \$3. 1951 TV, \$3.
- 1950 Television Manual, \$3. 1949 TV, \$3.
- 1948 TV, \$3. 1947 TV & FM, only \$2.
- I am enclosing \$ Send postpaid.
- Send C.O.D. I am enclosing \$ deposit.

Name:

Address:

Supreme Publications

Sold by All Leading Radio Jobbers

JANUARY, 1954

NEVER BEFORE

-so many features packed into one Signal Generator

MODEL 700

RF-AF Crystal Marker
TV Bar Generator
\$55.90

1. Complete coverage from 18 cycles to 108 megacycles on fundamentals.
2. Bar generator for TV adjustment with a variable number of bars available for horizontal or vertical alignment.
3. Square Wave Generator to 20 kilocycles.
4. Wien Bridge AF oscillator with sine wave output from 18 cycles to 300 kilocycles.
5. Crystal marker and amplitude control.
6. Individually tuned coils.
7. Constant RF output impedance.
8. Stepped RF attenuator.
9. Electrostatically shielded transformer.
10. Thorough shielding.
11. Colpitts RF oscillator from 300 KC to 108 megacycles on fundamentals—up to 216 megacycles on 2nd harmonic.
12. Variable percentage of modulation.

Write Dept. RE-1 for latest free Catalog

ELECTRONIC MEASUREMENTS CORP.

280 LAFAYETTE STREET, NEW YORK 12, N. Y.
EXPORT DEPARTMENT 136 LIBERTY STREET, N.Y.C. 6, N.Y.

NEW DEVICES

GUY-WIRE WINCH

Royal Television Supply Co., Modesto, Calif., has announced its new *Giline Winch*, designed to simplify the securing of guy lines.

The *Giline Winch* is mounted with one bolt. The channel and ratchets are made of 12-gauge steel, with drums of heavy steel rods. It is virtually fool-proof, in that the cotter pins lock firmly in place against the ratchet pawls. A turn of the wrench gives proper tension to the guy lines.



VHF YAGI

Channel Master Corp., Ellenville, N. Y., has developed a 5-element broadband



Yagi, model 626. The antenna covers channels 2-6.

A specially designed phasing harness keeps the gain flat over the entire band. The antenna has up to 7-db gain as a single bay and 9 1/2-db gain stacked. The front-to-back ratio is over 20 db.

ROTARY SWITCHES

Erie Resistor Corp., Erie, Pa., has announced a new line of rotary selector and lever switches.

Among the new design features are a flat rivet which fastens contact to the stator to prevent loosening or rotating due to soldering heat. The rotor

assembly is combined with the solid stator for rugged construction in which rotor blades do not support the assembly.

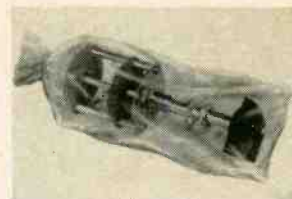

CAPACITY DECADE BOX

Precise Development Corp., Ocean-side, L. I., N. Y., has announced the model 478 capacitance decade box, which offers four decades from 100 μf to 1.111 μf , equivalent to 10,000 capacitors. The entire unit is pocket-size, (measuring 3 3/4 x 6 1/4 x 2 inches), and comes in a bakelite case. The model 478 is available in kit or wired. **END**



All specifications given on these pages are from manufacturers' data.



GERMANIUM

Do you know Radio Receptor Company gives

Instant attention to Diode

Orders, and prompt

Deliveries on many types—

Especially JAN types 1N34A, 1N69, 1N70, 1N81.

So why not consult with us now!

Other Types too

AND

TRANSISTORS

Diffused PNP Junction Transistors
RR14, RR20, RR21 and RR34
in production quantities for
applications in low level audio
circuits. Also available
hermetically sealed.



Selenon & Germanium Division
RADIO RECEPTOR COMPANY, INC.
In Radio & Electronics since 1922
SALES DEPARTMENT
251 WEST 19th ST., NEW YORK 11
FACTORIES IN BROOKLYN, N. Y.

Windsor TUBES

RADIO & TV RECEIVING

TESTED and
GUARANTEED
for **PEAK**
PERFORMANCE

TO MERIT YOUR CONFIDENCE—to insure your satisfaction—Every tube we ship has been tested in a radio or TV set for **PEAK PERFORMANCE**. Each tube is attractively packaged in individual carton—and, **EACH WINDSOR Tube you buy carries the full RTMA GUARANTEE!**

Type	Each	Type	Each	Type	Each	Type	Each
JA7GT	.67	1U5	.51	6AUG	.47	6J5GT	.44
IB3GT	.69	1X2A	.74	6AV5	.85	6J6	.68
IC6	1.06	2A7	.74	6AV6	.41	6J7	.70
IE7GT	1.09	2X2	1.43	6AX4	.72	6K6GT	.45
IH5GT	.51	3LF4	.76	6B8G	.93	6K7	.70
IH6	.93	3Q4	.56	6BA6	.50	6L6G	.88
IL4	.93	3Q5GT	.72	6BA7	.68	6L6A	.88
IL6	.66	3S4	.61	6BC5	.58	6Q7GT	.55
IL6A	.66	3V4	.62	6BD5GT	.98	6S4	.51
IL4A	.82	5R4GY	1.00	6BD6	.54	6S8GT	.75
IL6A	.80	5U4G	.44	6BE6	.51	6SA7GT	.57
IL8A	.82	5V4G	.83	6BF5	.66	6SC7	.63
ILC5	.80	5Y3G	.37	6BF6	.43	6SD7	.55
ILC6	.80	5Y3GT	.32	6B6GG	1.47	6SF5GT	.66
ILD5	.80	5Y4G	.43	6BH6	.63	6SH7GT	.52
ILE3	.80	6ABGT	.68	6B16	.53	6SJ7GT	.52
ILG5	.80	6AB4	.51	6BK5	.76	6SK7GT	.55
ILH4	.80	6AC5GT	.82	6BK7	.97	6SL7GT	.68
ILN5	.80	6AG5	.59	6BL7GT	.94	6SN7GT	.59
IN5GT	.63	6AH4	.68	6BN6	.98	6SQ7GT	.46
IP6	.76	6AK5	1.05	6BQ6GT	.98	6T8	.85
IQ6	.72	6AL5	.44	6BQ7	.92	6U8	.70
IR4	.85	6AQ5	.51	6BZ7	1.09	6V3	1.09
IR5	.62	6AQ6	.47	6C4	.41	6V6GT	.51
IS4	.67	6AQ7	.75	6CB6	.58	6W4GT	.50
IS5	.52	6AR5	.42	6CD6G	2.04	6W6GT	.63
IT4	.62	6AS5	.55	6D6	.63	6X4	.37
ITSGT	.78	6AT6	.42	6E5	.72	6X5GT	.36
IU4	.61	6AUSGT	.85	6F5GT	.54	6Y6G	.64



FREE!
WINDSOR
TUBE CADDY



The most practical Service-Aid ever designed for the radio and TV repairman. This ideal television carry-all now offered free with every purchase of \$160.00 or accumulated purchases totaling \$160.00 within 90 days. (You get caddy credit memo with each purchase.)

Windsor Tube Caddy may also be purchased outright for \$14.95.

DON'T MISS THIS SENSATIONAL OFFER!

- Carries approximately 125 tubes including meters and tools.
- 16 3/4 inches long x 8 1/4 inches wide x 1 3/4 inches high.
- Weighs only nine pounds.
- Ruggedly constructed with heavy leatherette covering, strong plastic handle, nickel plated hardware and reinforced with metal clamps.

WRITE FOR ADDITIONAL TUBE TYPES AND PRICES. We also stock Special Purpose and Transmitting Tubes at similar savings! Dept. C-1.

25% Deposit with Order. All merchandise F.O.B. NYC. For orders less than \$10 add \$1 handling cost. Deduct 2% if full remittance accompanies order. All merchandise subject to prior sale and price changes without notice.

Windsor ELECTRONIC TUBE CO.

1515-C SHEEPSHEAD BAY ROAD, BROOKLYN 35, N. Y.

for *like - new* performance

replace with original **ROGERS** full-focus deflection yokes



Since most of the better TV sets are made with **ROGERS** Deflection Yokes, this same top quality yoke should be used for replacement. With over 25 years of electronic know-how, **ROGERS** Precision Engineered Products make TV sets perform *like new*.

ROGERS Full-Focus Deflection Yoke assures double brilliance with knife-edge sharpness over the entire screen. Each **ROGERS** yoke—precision tested for perfect focus—is designed for peak performance and extra long life.

"the eye tells why"

packaged individually—attractively

ROGERS ELECTRONIC CORP.

43-49 Bleecker St. New York 12, N. Y.

FREE: Send for new catalog "A," listing TV set models and **ROGERS** Yoke and Flyback replacements, or see your jobber.

S2 which is ganged to the on-off control S1. C1 is a storage capacitor connected between the first anode and ground. When S1 and S2 are closed, C1 is charged to the operating voltage on the first anode. As soon as the switches are opened, the B plus filter capacitors begin to discharge through the horizontal sweep and voltage-boost circuits and are soon drained of their charge. C1 has a decay time-constant longer than that of the high-voltage filter. It can discharge only through the first anode circuit, leakage in the picture-tube socket and S2. The decay time of this capacitor holds the first anode at normal operating potential. This permits beam current to flow heavily until the high-voltage filter capacitor has discharged beyond the point where it attracts sufficient electrons to the screen to damage it. The screen can take the concentrated electron bombardment for the short period that the high-voltage filter capacitor is discharging through the electron beam. It would be burned if the first anode voltage were allowed to decay rapidly and thus increase the time required for the high-voltage filter capacitor to discharge.

VIDEO PEAKING COILS

Many constructors of TV receivers, scopes, and other equipment often waste a lot of time calculating winding data for r.f. chokes and coils used in resonant and peaking circuits when suitable coils or winding data for them already may be on hand. Usually, the problem is one of recognizing a suitable coil and adapting it to fit the circuit. When the required inductance is known, it is easy to find winding data.

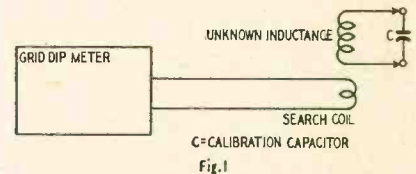

For inductances of about 100 microhenries, iron-cored broadcast antenna and oscillator coils may be used. When the inductance range of broadcast coils is exceeded, various i.f. transformers and stripped-down r.f. chokes are suitable. Short-wave coils and broadcast coils with some turns removed are suitable for many circuits requiring low inductance values. Slug-tuned forms permit varying the inductance over a wide range.

Since most available coil data is prepared to cover a definite frequency range with a capacitor of a given size, we usually have to calculate the inductance to determine whether the coil satisfies our needs. This calculation time can be minimized by referring to the table. It lists frequencies to which inductances from 1 to 1,000 μ h resonate when tuned by a 100- μ mf capacitor. For example, assume that we need a 45- μ h coil for high-frequency peaking in a TV set or scope. The table shows that

RCP Meets TV Service Needs!



"DO-ALL" Peak-To-Peak VT VM—Model 655

Provides for the accurate measurement of complex waveshapes, with peak-to-peak voltages able to be read directly from the scales of the instrument. Serves a variety of industrial applications in the maintenance of vibrator power supplies, AC generators and industrial equipment utilizing complex waves. Supplied with the New "RCP SOLDERLESS" Test Leads.

Features:

- Peak-to-peak AC measurements of from .2 V to 2000 V on 7 ranges.
- AC RMS measurements of .1 V to 1500 V on 7 ranges.
- DC measurements of from .02 V to 1500 V on 7 ranges.
- RESISTANCE measurements of from .2 ohms to 1000 Megohms on 7 ranges.
- Sizes: 10" x 6" x 5".
- Wt: 7 lbs. 12 oz.

Price: \$59.50 Net



Model 533 M Midgetscope

A 3" scope with high sensitivity and wide band response—Weights only 9 pounds.

- Masterfully Engineered for Top Performance.
- All Controls on Front Panel.
- Quality—Dependability—Accuracy—Economy.
- Operates in Either Horizontal or Vertical Position.

Check This Performance

Sensitivity . . . Vertical—20 millivolts. (.020 volts for 1" rms deflection on CRT face.)
Horizontal—6 volts. **Frequency Response** . . . 2 db from 20 cycles to 180 kilocycles.
Excellent Transient Response. Push-Pull Deflection . . . for undistorted Response—Eliminates Parallax. Full Vertical and Horizontal Expansion of Trace.

Input Impedance . . . Vertical—5 megohms shunted by 50 MMF. **Horizontal**—5 megohms shunted by 70 MMF. **Size:** 11 3/4" x 7 3/4" x 5 1/8".
 Model 533M complete, ready to operate. \$99.50 Net.



UHF and VHF "DO-ALL" TV Signal Generator Model 150

Complete in one instrument—a SIGNAL GENERATOR, MARKER GENERATOR, and PATTERN GENERATOR covering all the UHF and VHF channels for every TV and FM receiver.

- Inductance insures accuracy of within 1/2 of 1% over the entire range of 9 Mc to 900 Mc.
- All VHF frequencies are on fundamentals.
- RF's and IF's are clearly calibrated on a large etched aluminum dial.
- Steady horizontal bars, vertical bars and cross hatch pattern individually produced on all channels. Price \$79.50

Remember—you can do more with a "DO-ALL". Write for RCP Catalog RE-1.

RADIO CITY PRODUCTS CO., INC.
 152 WEST 25th STREET NEW YORK 1, N. Y.

a 45-μh coil tunes to 2,370 kc with a 100-μmf capacitor. We immediately recognize this as a simple short-wave coil for which you probably have winding data on hand.

L (μh)	f (kc)	L (μh)	f (kc)	L (μh)	f (kc)
1	15,900	60	2,053	280	950
2	11,243	65	1,972	290	934
3	9,180	70	1,900	300	920
4	7,950	75	1,836	310	904
5	7,111	80	1,778	320	888
6	6,491	85	1,725	330	875
7	6,010	90	1,676	340	862
8	5,622	95	1,631	350	850
9	5,300	100	1,590	360	838
10	5,025	110	1,516	380	816
12.5	4,497	120	1,451	400	795
15	4,105	130	1,394	420	776
17.5	3,801	140	1,344	440	758
20	3,563	150	1,328	460	741
22.5	3,352	160	1,257	480	726
25	3,180	170	1,248	500	713
27.5	3,032	180	1,185	550	678
30	2,903	190	1,154	600	649
32.5	2,789	200	1,143	650	624
35	2,688	210	1,097	700	601
37.5	2,597	220	1,070	750	581
40	2,514	230	1,048	800	562
42.5	2,439	240	1,026	850	545
45	2,370	250	1,005	900	530
47.5	2,307	260	986	950	516
50	2,249	270	968	1,000	502
55	2,144				

$$\frac{159,000}{\sqrt{L \times C}} = f \text{ in kc}$$

L in microhenries (μh)

C in micromicrofarads (μmf)

There are several ways to measure the inductance of a coil without a bridge. One is to tune the coil with a known capacitor and measure the resonant frequency of the combination with a grid-dip meter as shown in Fig. 1. The second method is to tune the coil with a known capacitance and make it oscillate and then measure the frequency on a receiver or an absorption wavemeter. Fig. 2 shows how a Meissner oscillator may be used for the purpose. The grid and plate coils should

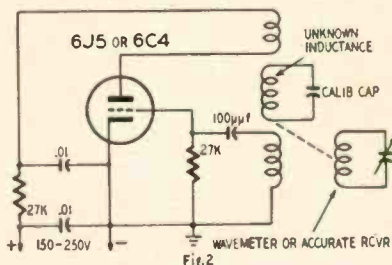

each have approximately one-fourth the number of turns in the coil being checked. This method is subject to error caused by reflected capacitance, stray inductance, resistance in the oscillator circuit, and inaccuracy of the measuring device. When a grid-dip meter is used as in Fig. 1, the accuracy is limited only by the sensitivity and calibration accuracy of the grid-dip meter.—L. H. Trent

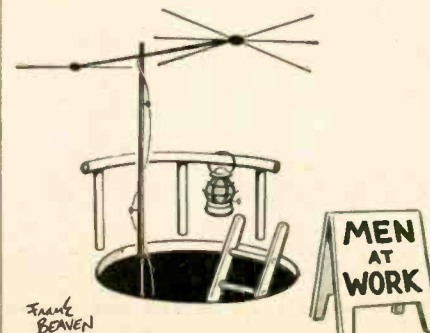

Suggested by Gerald Drew, Sacramento 14, Calif.

Save TV Alignment Time

with the EAZY to use *Align-O-Pak*

TV alignment Bias Battery Eliminator

★ Quickly determines AGC troubles

Think of the time wasted connecting batteries in series . . . The *Align-O-Pak* provides all the voltages recommended by these leading TV manufacturers:

- ADMIRAL 1 1/2-4 1/2v
- MOTOROLA 3v • PHILCO 7 1/2v
- RCA 1v • ZENITH 2v Variable.

- ★ Forget messy Bias Batteries
- ★ Fix only TWO AGC troubles and your *Align-O-Pak* is paid for
- ★ Just Plug it in . . .
- ★ Provides from 0 to 10 Volts BIAS Instantly
- ★ Completely isolated from Power Line and Case

Only \$7.85

DEALER NET

INSTRUCTIONS

FOR ALIGNMENT: Plug *Align-O-Pak* in and turn unit on. Connect black lead to the Receiver AGC buss and red lead to B minus (usually chassis). Set *Align-O-Pak* knob to voltage recommended by TV manufacturer.

FOR AGC TROUBLE SHOOTING: With *Align-O-Pak* connected as described above, turn control knob slowly from 0 to 10. If normal picture appears, AGC is defective.

Carried by leading jobbers!

SI SERVICE INSTRUMENTS COMPANY
 422 South Dearborn Street, Chicago 5, Illinois

ASSEMBLE YOUR OWN HI FI CABINETS

NEW LOW COST KITS COME COMPLETE-EASY TO ASSEMBLE

It's easy to build your own High Fidelity Cabinets with these new kits by Cabinart. These magnificently styled cabinets can be readily assembled to save you real money. Complete easy to follow instructions show you every step of the way.

KLIPSCH HORN CORNER CABINET

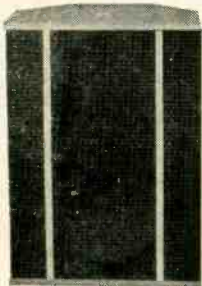

This magnificent Rebel IV Corner Enclosure was designed by Paul Klipsch to house your own Klipsch Horn. It is identical in acoustic design to corner cabinets costing much more. Beautifully appointed in unfinished birch wood.

For 12 inch speaker **ONLY \$36.00** | For 15 inch speaker **ONLY \$42.00**

BASS REFLEX CABINETS

Here's the ideal housing for your Hi Fi components. Removable panels make future changes easier. The loudspeaker cabinet is



acoustically designed for either 12 or 15 inch speakers, and has a baffle volume of 6 cubic feet. Overall dimensions: 33 1/2 L, 23 W, 16 H. The tuning component is 20 H, 2 1/4 L, 1 1/4 W.

No. 80 Cabinet for Equipment **\$27.00** | No. 8112 Cabinet for 12" Speaker **\$18.00** | No. 8115 Cabinet for 15" Speaker **\$18.00**

All kits include 5/8" white pine plywood cut to size, baffle pre-cut for 12" or 15" speaker. Saran Plastic Acousticcloth, Kimsul Acoustic Insulation, Assembly and finishing instructions, hardware, plastic wood, sandpaper and glue.

YOUR NAME YOUR ADDRESS

Send me the following kit(s):
Enclosed is my check or M.O. for 10% of order.
REBEL IV 12" model \$36.00
15" model 42.00

BASS REFLEX and EQUIPMENT CABINETS

#80 Equipment Kit \$27.00
#8112 12" speaker 18.00
#8115 15" speaker 18.00

Name _____
Address _____
City _____ State _____

ALMO RADIO CO.
509 ARCH ST. & 6205 MARKET ST.
Philadelphia, Pa.
6th & ORANGE STS. • Wilmington, Del.
4401 VENTNOR AVE. • Atlantic City, N. J.
1133 HADDON AVE. • Camden, N. J.
219 Highland Ave. • Salisbury, Md.

NOVEL TUNING METER

Simple tuning and signal-strength meters in superheterodyne receivers often consist of a milliammeter connected in series with the B plus lead to one or more of the i.f. stages connected to the a.v.c. line. In a circuit of this type the meter reading decreases as the signal strength increases. Three rather clumsy tricks are often used to make the meter swing upward with increasing signal strength. One is to connect the plate-current meter in a delicate bridge circuit; another is to mount the meter upside down; and the third is to use a v.t.v.m. to measure the x.v.c. voltage.

Experimenters desiring to include a tuning indicator or S-meter in a sensitive superheterodyne receiver may consider using this combination S-meter and second detector described in *The Radio Constructor* (London, England). The meter reads forward and the audio

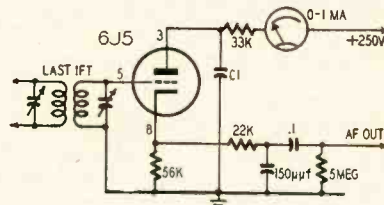

quality is good. This circuit does not depend on a.v.c. voltage for its indications, so it can be used for tuning in c.w. signals with the a.v.c. turned off. The circuit (see diagram) consists of a 6J5 or equivalent triode connected as an infinite impedance detector with a 0-1-ma meter in the plate circuit.

The infinite impedance detector requires a comparatively husky input signal for good audio quality and wide meter deflection, so the receiver in which it is used should have two high-gain i.f. amplifier stages. The plate filter capacitor C1 should be just large enough to bypass the r.f. and audio signals but should not be so large that its charging current may damage the meter. Use the smallest value that will not cause the meter to deflect on audio peaks. A value of about 0.1 µf is about the largest that can be used. END

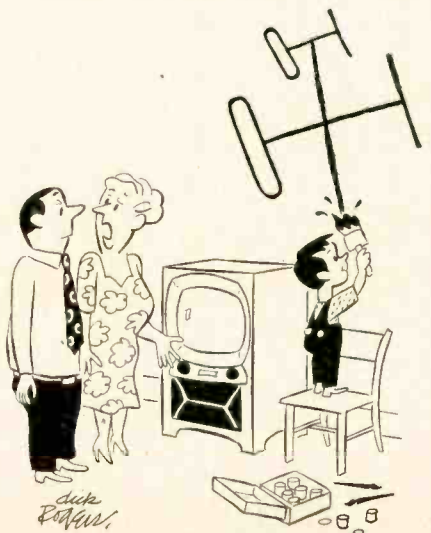

"Now he's experimenting with painted circuits"

TV SERVICE ESSENTIALS



No. MA-4 Pocket Size Bar Generator
Provides actual bar pattern on TV receiver screen, portable and lightweight for on the spot linearity adjustments. Can be used when no stations are on the air to produce adjustable number of horizontal or vertical lines. Plugs on picture tube. **\$18.25 List Price**

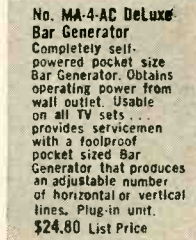

No. MA-4-AC Deluxe Bar Generator
Completely self-powered pocket size Bar Generator. Obtains operating power from wall outlet. Usable on all TV sets... provides servicemen with a foolproof pocket sized Bar Generator that produces an adjustable number of horizontal or vertical lines. Plug-in unit. **\$24.80 List Price**

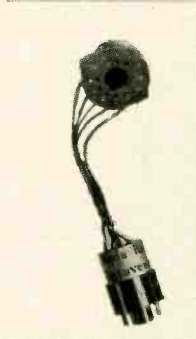

Picture Tube Rejuvenators
Renews brightness of low emission CRT, 48B for magnetic or electrostatic CRT; parallel filaments. **\$2.75 List Price**
49C For standard focus CRT, parallel filaments. **\$2.50 List Price**
50D For magnetic or electrostatic focus, series filaments. **\$3.40 List Price**
51E Isolation rejuvenator for weak CRT having inter-element leakage. For any CRT using parallel filaments. **\$3.60 List Price**

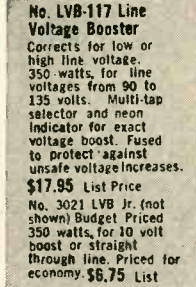

No. LVB-117 Line Voltage Booster
Corrects for low or high line voltage. 350-watts, for line voltages from 90 to 135 volts. Multi-tap selector and neon indicator for exact voltage boost. Fused to protect against unsafe voltage increases. **\$17.95 List Price**
No. 3021 LVB Jr. (not shown) Budget Priced 350 watts, for 10 volt boost or straight through line. Priced for economy. **\$6.75 List**



No. 200K Variable Inductance, Universal Substitution Kit
For video, IF circuits; 8 variable coils cover range from 1 to 590 µh; Q Max Impregnation. Data enclosed on L, m, n, R, C dis., Res. Req. Individual calibration charts permit adjustment without test equipment. **\$7.95 List Price**

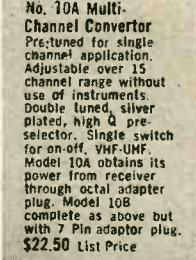

No. 10A Multi-Channel Converter
Pre-tuned for single channel application. Adjustable over 15 channel range without use of instruments. Double tuned, silver plated, high Q pre-selector. Single switch for on-off, VHF-UHF. Model 10A obtains its power from receiver through octal adapter plug. Model 10B complete as above but with 7 Pin adaptor plug. **\$22.50 List Price**

CREST LABORATORIES INC.
84-11 Blvd.
Rockaway Beach, N. Y.
write for complete literature

ATLAS RADIALS

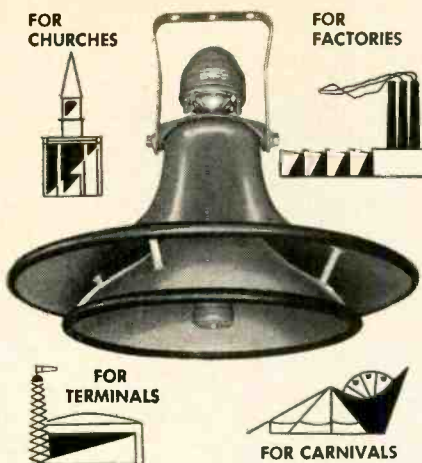

With uniform 360° coverage, non-resonant construction, and 100% storm-proofing, ATLAS Radial Driver Unit Projectors often solve the most difficult sound problems—are excellent for reproduction of speech, chimes and music. For complete details on Radials and the famous ATLAS line of Public Address and Microphone Stand Equipment . . .

WRITE NOW for FREE Catalog 553

ATLAS SOUND CORP.
 1443 39th St., Brooklyn 18, N. Y.
 In Canada: Atlas Radio Corp., Ltd., Toronto, Ont.

Editors and Engineers
RADIO & ELECTRONICS BOOKS

- RADIO HANDBOOK. GIANT 13TH EDITION.** A one-volume library of radio information with extensive, simplified theory. Detailed how-to-build-it data on dozens of items of practical radio equipment. Book No. E&E-RH13...\$6.00*
- BETTER TV RECEPTION** (in fringe and low-signal areas). **NEW SECOND EDITION.** The standard guide for installation technicians. A popular text for TV enthusiasts. Book No. E&E-TR2...\$2.50*
- RADIOTELEPHONE LICENSE MANUAL.** Typical study questions with concise answers for any commercial U.S.A. radiotelephone operators license. Book No. E&E-RL1...\$3.75*
- WORLD'S EQUIVALENT TUBES** (Equivalents Vade Mecum) **NEW 10TH EDITION.** A guide for substitutions of radio tubes, indicating direct or near equivalents. Book No. E&E-VM10...\$5.00*
- WORLD'S RADIO TUBES** (Brans' Vade Mecum) **9TH EDITION.** Lists over 15,000 tubes from every tube making country. Printed in 16 languages. Book No. E&E-VM9...\$5.00*
- ANTENNA MANUAL.** A practical, comprehensive book on antennas, for everyone interested in transmission and reception. Over 300 pages. Book No. E&E-AM1...\$3.50*
- SURPLUS RADIO CONVERSION MANUAL. VOL. 1.** Practical conversions. Write for list of contents. Book No. E&E-SM1...\$2.50*
- SURPLUS RADIO CONVERSION MANUAL. VOL. 2.** Companion to Volume 1. Book No. E&E-SM2...\$2.50*

*Plus any tax.

Send three cent stamp for circular with detailed contents of books listed.

BUY FROM YOUR DISTRIBUTOR
 Add 10% ON DIRECT MAIL ORDERS TO EDITORS and ENGINEERS, LTD., BOX 689B, SANTA BARBARA, CALIF.
Bookstores order from BAKER & TAYLOR, Millers, N. J.



CBS-COLUMBIA
GENERAL ELECTRIC
PHILHARMONIC
WESTINGHOUSE
MOTOROLA
SYLVANIA
HOFFMAN
EMERSON
PHILCO
ADMIRAL
MUNTZ
RCA

Designed for quick, simple installation, these Stancor flybacks save your time. There are no holes to drill, no leads to splice. Terminal board layouts duplicate the original units—even include choke coils, resistors, tube sockets and any other components that are on the original,

STANCOR HAS EXACT REPLACEMENT FLYBACKS FOR ALL THESE TV MANUFACTURERS' SETS...and others will be available soon

Stancor TV replacements are listed in Sams' Photofact Index, Counterfacts, Rider Manuals and Tek-Files



CHICAGO STANDARD TRANSFORMER CORPORATION
 3592 ELSTON AVE., CHICAGO 18, ILL.

EXPORT SALES: Roburn Agencies, Inc.
 39 Warren Street • New York 7, New York

RADIO-ELECTRONICS is paying good rates on acceptance for original and unusual articles on audio, television, FM and AM servicing, as well as articles on industrial electronic equipment and applications. Send for a copy of our Authors' Guide. Address:

THE EDITOR,
RADIO-ELECTRONICS
 25 West Broadway,
 New York 7, N. Y.

GET YOUR COMMERCIAL TICKET EASIER WITH ...

RADIO OPERATOR'S LICENSE Q AND A MANUAL (4th Edition)
 by Milton Kaufman
 Covers Elements 1 through 8. Complete discussion of answers to every technical question in the F.C.C. Study Guide! Used by over 50 leading schools. Only \$6.60 at jobbers, bookstores or direct from—

JOHN F. RIDGER Publisher, Inc.
 480 Canal Street, New York 13, N. Y.

Please Mention
RADIO-ELECTRONICS
 When Answering Advertisements

LEARN MORE! EARN MORE!

WITH H. G. CISIN'S



SERVICE BOOKS

**NEW! 1954 TV Consultant
TV Serviceman's Silent Partner**



New, easy-to-use way to solve toughest TV troubles. UHF sect. Includes conversions, installations and servicing. Modern alignment methods shown by pictures, diagrams and simple directions, tell exactly what to do and how to do it. Practical pointers on use of all TV Test Instruments. Over 300 pix. Raster and sound symptoms. Detailed directions tell where and how to find faulty parts. Over 135 **RAPID CHECKS**, many using pix tube as trouble locator. 125 illustr. of scope wave forms, diagrams, station patterns, show various defects—take mystery out of TV servicing. **NO THEORY—NO MATH—NO FORMULAS**—Just practical service info. covering all types of TV sets.

Only \$2

**NEW! 1954 TV Tube Locator
All Pix Tubes Listed!**

Money-making Time Saver tells which tubes to replace to cure every type of tube trouble. Over 135 such TV troubles listed with clear charts for quickly locating the faulty tubes. Copyrighted **TROUBLE INDICATING TUBE LOCATION GUIDES** for over 3000 most popular models from Admiral to Zenith plus **PIX TUBES** used in each model! 1947 to 1953 models. A storehouse of valuable TV servicing info. priced very low for large volume sales.

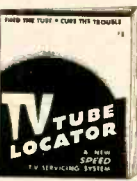

Only \$1

**NEW! Trouble Shooting PIX
GUIDE incl. TV TERMS Explained**



Sec. 1 is a fully illustrated **GUIDE** to oft-recurring pix faults. Causes and cures explained. Copyrighted **Trouble Indicating Illustrated chart** tells where troubles start in typical TV set—illustrations show resulting faulty TV pictures. Sec. 2 explains hundreds of TV terms in non-technical language. **SPEEDS UP TV SERVICING—HELPS YOU DO A BETTER JOB FASTER!**

Only \$1

**NEW! TV Trouble Tracer
Vol's 1 & 2 Now Ready!**

70 Common TV troubles traced to source and cured. Copyrighted **trouble indicating tube location guides** covering over 1200 most popular TV models. Many models different from those shown in **TV TUBE LOCATOR**. Each contains over 70 illustrations and tube location guides. Forty most common picture troubles illustrated, with symptoms described, causes given and remedies prescribed.



Vol. 1 Only 50¢
Vol. 2 Only 50¢

H. G. CISIN, PUBLISHER

Order from your Jobber today, or if not stocked, write to
Harry G. Cisin, Dept. E-24
Amagansett, New York

Enclosed find \$ Send

- TV Consultant TV Locator
- TV Pix Guide TV Tracer Vol. 1
- TV Tracer Vol. 2

Name

Address

City Zone State

FLATS ON CONTROL SHAFT

When a flat is necessary on a radio control shaft to facilitate using a spring-type or a set-screw-type knob on a stiff moving control, a file and a vise is usually used, but the finished job is often uneven and inaccurate despite the hard work that went into it.

If you have access to a motor-driven bench grinder or even a hand-cranked

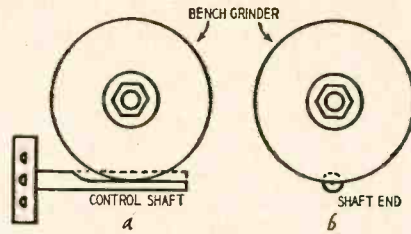

type, you can turn out neat, factory-looking flats on any type of shaft. See drawings. Grinding lengthwise as at *a* provides a common flat surface; grinding across the end view of the shaft as shown at *b* leaves a slight concave which further aids in holding the knob firm.—*W. F. Woychoski*

VARYING A 230-VOLT LINE

The diagrams show a way of using a 115-volt adjustable autotransformer to vary the voltage of a 230-volt a.c. line for shop-testing motors and other equipment. Variable autotransformers are commonly used for adjusting 115-volt lines, and may be obtained from radio and electrical supply houses.

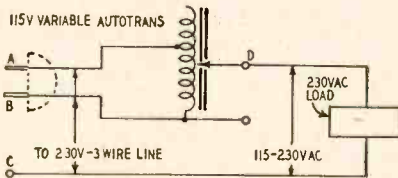

Lines A and B in the sketch must be properly identified with a series test lamp or meter. Connect B to the neutral or ground side of the 230-volt 3-wire supply line. Connect A to one side and C (an extra conductor) to the other. The circuit through the load is completed by D which connects to the side of the output receptacle connected directly to the movable arm. Lead D may be connected to one lug of a standard male plug to facilitate plugging it into the autotransformer output terminal.—*Hugh Lineback*

(Several variations of this circuit designed to permit varying the output of a 115-volt autotransformer continuously from 0 to 245 volts appeared in the November, 1952, issue of *General Radio Experimenter*.—*Editor*)

**SIMPLIFIED U.H.F. CHANNEL
FREQUENCY CALCULATIONS**

In an article on page 31 of the August, 1953, issue, A. G. Hatfield presents the formula

$$F = 800 - 6(69 - N)$$

for finding the low end of u.h.f. TV channels below channel 69 and

$$F = 800 + 6(N - 69)$$

for channels above 69 where F is the

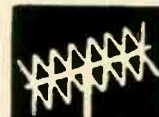

**ARE YOU
GETTING
A GOOD
PICTURE
HERE?**

**AND
LOSING
IT
BEFORE
IT GETS
HERE?**



**WRITE
FOR FREE
CIRCULAR**

**R. J. BUCHAN
CO.**

BRICELYN MINN.

**GET CLEAR
SHARP
RECEPTION
WITH THE
NEW
LL300
OPEN
WIRE
LINE**



300 OHMS IMPEDANCE

This results in maximum signal transfer from antenna to set.

EXTREMELY LOW LOSS

Air dielectric plus clear polystyrene spacers results in the lowest possible loss of signal.

LESS NOISE PICKUP

Close spacing plus perfect impedance match results in lowest possible noise pickup.

EASILY INSTALLED

Conventional hardware for 300 ohm ribbon lines are perfect for LL300 open wire line.

LONG LIFE

Copperweld conductors, polystyrene spacers, plus light weight and low wind resistance result in virtually indefinite life.

EASY TO USE SPOOLS

Packaged on 100, 150, 200, 250' convenient, easy to use spools.

If not available through your regular Jobber, order direct, immediate shipment via parcel post. Dealer cost \$4.95 per 100 feet.

**PERFECT FOR
VHF - UHF
INSTALLATIONS**

TELEVISION

Big demand for graduates

B.S. DEGREE IN 27 MONTHS in radio including TV engineering—VHF, UHF, AM and FM. Students use over \$100,000 worth of equipment including 2 large commercial type transmitters in new TV lab. Intense specialized course includes strong basis in mathematics, science and advanced design in radio and TV.

Hundreds of young men each year are earning engineering degrees in this recognized institution. Start any quarter. Many earn a major part of expense in this industrial center. Low tuition. Competent instruction. Thorough, intense, practical program.

Also **B.S. DEGREE IN 27 MO.** in Aeronautical, Chemical, Civil, Electrical and Mechanical Engineering. G.I. Gov't approved. Enter March, June, Sept., Dec. Free catalog. **ENROLL NOW.**

INDIANA TECHNICAL COLLEGE
1714 E. Washington Blvd., Fort Wayne 2, Indiana

RADIO-ELECTRONICS

frequency in megacycles and N is the channel number.

I have found that both of the above formulas can be reduced to the simpler form

$$F = 386 + 6N.$$

Using Hatfield's examples, we find the low-frequency end of channel 22 as

$$F = 386 + 6(22)$$

$$F = 386 + 132$$

$$F = 518 \text{ mc}$$

and the low end of channel 82 is

$$F = 386 + 6(82)$$

$$F = 386 + 492$$

$$F = 878 \text{ mc.}$$

The frequencies of the video and sound carriers and the high-frequency end can be found as described before or by adding 1.25, 5.75, and 6 mc to the low-end frequency to find the video carrier, sound carrier, and high-end frequencies, respectively.

This new formula is easier to remember and to use than the two given previously.—J. C. Galbraith

HANDY FUSE CHEST

You'll hardly ever lose or mislay one of the several boxes of fuses that you carry in your TV or auto-radio service kit if you modify a few old fuse boxes to make a chest-of-drawers assembly like that shown in the photo.

You need one box for each size fuse



that you use. Remove the covers from all except one box and flatten the bottom flanges so they parallel the sides. Stack the boxes and solder the sides together where they overlay to complete the assembly.—John M. Macgowan

END

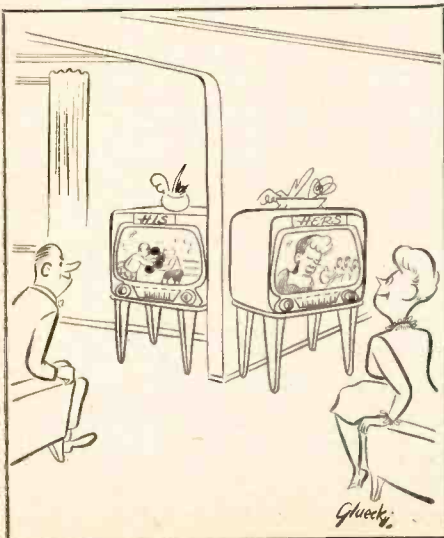

THERE ARE

QUAM

Adjust-a-Cone[®]

SPEAKERS

FOR ALL YOUR REPLACEMENT NEEDS

Manufacturers of

- High Fidelity Speakers
- Outdoor Theatre Speakers
- Quam Focalizer Units
- Tru-Match Output Transformers
- Quam Ion Traps

Be sure to get the latest Quam catalog, listing 94 replacement speakers—at the best distributors in every city—or write us for your FREE copy.

Quam replacement speakers are listed in Photofact Folders and in Counterfacts.

QUAM-NICHOLS CO.
 236 East Marquette Road
 Chicago 37, Illinois

*Quam cataloged speakers are available in any voice coil impedance and field resistance.

SCALA SUPER-MARKER INJECTOR mixer-amplifier unit mixes small sample of sweep voltage with small sample of marker voltage (from external sweep-marker generator). Injects a large, stable pip into scope being used for alignment of TV receiver. Marker pip is always same size—from base line to top of curve. Pip does not affect pattern on scope, even at resonance peaks. Greatly speeds up and simplifies alignment jobs. Separate video and marker gain controls. May be used with any standard marker generator, sweep generator, and scope. Five tubes and Germanium diode. Size, 10x8x7". Cables and instructions supplied. For operation from 110-120 volts, 60 cycle AC. Net, at leading jobbers, \$67.50

SCALA TEST PROBES—

BZ-1 Signal Tracing Probe for individual check of IF stages, calibrating marker generator, checking output of sweep generator, etc. Low C, Hi-Z demodulator range, non-resonant to 225 mc; useful to 1000 mc. Cables supplied. Net, at leading jobbers, \$9.75.

BZ-2 Low Capacity Probe permits tracing waveforms through Hi-Z circuits without distortion from circuit loading. Cuts effective input capacity of scope, attenuation 10 to 1. Net, at leading jobbers, \$9.75.

BZ-3 Voltage Divider Probe for checking horizontal sweep waveforms and voltages at plates of horizontal output or damper tubes. Does not distort waveform. Net, at leading jobbers, \$9.75.

BZ-4 Voltage Doubler Probe provides virtually double deflection on scope screen compared to half-voltage probes. Dual low C Hi-Z demodulators useful to 150 mc. Net, at leading jobbers, \$10.75.

SCALA RADIO COMPANY, 2814—19th Street, San Francisco 10, Calif.

NEW Multi-Purpose Flyback Transformer

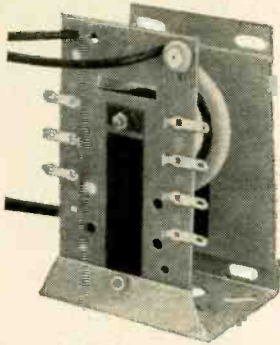

Halldorson FB410

NOW—Replace All these Mounting Types

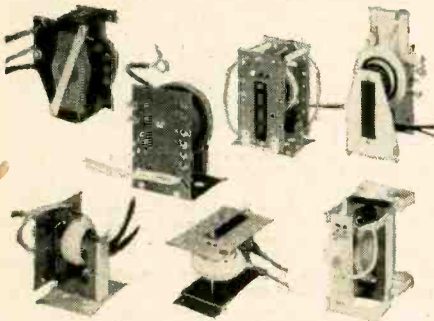

...without Drilling a Single Hole!

Here is a flyback so versatile that it is a "complete stock assortment in itself"! Works with *original* circuit components. Accommodates both low and high MH width controls. Matches 8 to 25 MH yokes. Generates from 10 to 15 KV for 10" to 21" picture tubes. Has separate winding for AGC/horizontal phase detection. Equipped with exclusive universal mounting brackets. *Standardize* with Halldorson FB410, only \$5.97 Dealer Net.

WRITE OR ASK YOUR DISTRIBUTOR FOR—

BULLETIN NO. 113—Illustrates versatile features of FB410 Flyback Transformer.

BULLETIN NO. 114—Contains circuit diagrams and technical application data.

HALLDORSON TRANSFORMER CO.
4500 Ravenswood Avenue
Chicago 40, Illinois



QUESTION BOX

FIDELOTUNER ON 156-MC BAND

? I have an Edwards Fidelotuner 88-108-mc FM tuner that I want to convert to cover the 156-mc police band. Can you tell me how to make the conversion?—V. B. J., Indianapolis, Ind.
A. Parallel-wire transmission lines with movable shorting bars are used to tune the antenna and oscillator circuits in this tuner. These circuits are shown in the illustration. The lowest frequency

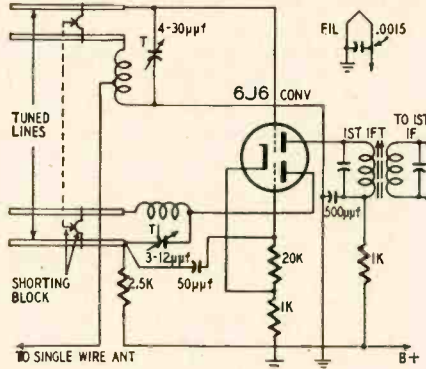

is determined by the length of the effective lines and the highest is determined by the trimmer capacitor and coil shunting the open end of each line. The oscillator inductance padder is a small coil with 3 or 4 turns. The antenna padding inductance is a U-shaped loop with the antenna lead tapped onto it.

The frequency of the circuits must be increased, so you must decrease the inductance of the padding coils. To cover the 152-162-mc band, the oscillator must tune from 141.3 to 151.3 mc or from 162.7 to 172.7 mc. Short out the oscillator padding inductance with short, heavy leads and measure the oscillator tuning range with a grid-dip meter. If the highest frequency is above 151 and below 172 mc, the best bet is to operate the oscillator below the signal frequency. Vary the oscillator trimmer capacitor so the lowest frequency is about 141 mc. Now check the high-frequency end of the range. It should be about 152 mc. If it is not, install a trimmer inductance of about half the number of turns in the original one. Now, juggle the settings of the trimmer capacitor and the turns and spacing of the inductance padder until the oscillator covers the required range.

Set the tuner to the lowest frequency and adjust the antenna trimmer so the meter indicates resonance at 152 mc. If the circuit does not tune this high, reduce the padding inductance. One way is to replace the padder inductor with one made of flat copper strip about 1/2 inch wide or soft copper tubing about 1/4 inch in diameter. Another way is to connect a coil across the present padder inductor. Try about 35 turns of No. 28 enameled wire close-wound on a 1/4-inch polystyrene form and note the effect on the tuning range. Adjust the L and C values in the antenna circuit for best performance across the band or peak the circuits at the frequency of the local police transmitter.

RADELCO

LIGHTNING ARRESTOR

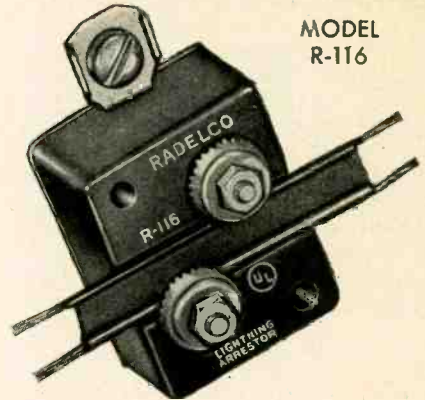

MODEL R-116

MODEL R-116 TAKES BOTH OVAL AND FLAT CABLES UNDERWRITERS' LISTED

ORDER FROM YOUR NEAREST PARTS JOBBER

LIST PRICE **90¢**

THOMAS TELESCOPING MASTS HYDRAULIC-PNEUMATIC

Versatile in application

- TV Antenna Supports
- Signal Evaluation
- Communication Antenna
- Micro-Wave
- Weather Instruments
- Radar
- Amateur

Also easily adaptable for mobile or permanent use ... Chrome plated steel or aluminum ... Any height up to 200' available. Thousands in daily use by Government and commercial agencies.

Write for details

THOMAS MOLD & DIE CO.

Box 126
Wooster, Ohio

Record in '53

POLIO RESEARCH GAINS

Join the
MARCH OF DIMES
January 2 to 31

\$3.00 FOR CARTOON IDEAS

RADIO-ELECTRONICS prints several radio cartoons every month. Readers are invited to contribute humorous radio ideas which can be used in cartoon form. It is not necessary that you draw a sketch, unless you wish.

Address
**RADIO-CARTOONS,
RADIO-ELECTRONICS**
25 West Broadway,
New York 7, N. Y.

AUDELS TV-RADIO SERVICE LIBRARY

HERE IS LATE INFORMATION IN A HANDY FORM FOR RADIO & TELEVISION REPAIRMEN, SERVICEMEN & STUDENTS



2 VOLS. \$6 COMPLETE \$1 MO. PAY ONLY

IT PAYS TO KNOW!

AUDELS T.V.-RADIO SERVICE LIBRARY presents the important subjects of Modern Radio, Television, Industrial Electronics, F.M. Public Address Systems, Auto, Marine & Aircraft Radio, Phonograph Pick-Ups, etc. Covers Basic Principles—Construction—Installation—Operation—Repairs—Trouble Shooting. Shows How to get Sharp, Clear T.V. Pictures. Install Aerials—How to Test. Explains Color Systems & Methods of Conversion. 1001 Facts—Over 1260 Pages—625 Illustrations—Parts & Diagrams—Valuable for Quick Ready Reference & Home Study. Tells How to Solve T.V. & Radio Troubles—Answers T.V. & Radio Questions.

Get this information for Yourself.
7 DAY TEST—ASK TO SEE IT!

MAIL ORDER

AUDEL, Publishers, 49 W. 23 St., N. Y. 10
Mail AUDELS T.V. RADIO SERVICE LIBRARY 2 Vols. \$6 on 7 days free trial. If O. K. I will remit \$1 in 7 days and \$1 monthly until \$6 is paid. Otherwise I will return them.

Name _____
Address _____
Occupation _____
Employed by _____ **RE**

THE TEST OF TIME

Has proven
ROHN TOWERS
Superior!

IN CONSTRUCTION
Rohn Towers are built of heavy duty tubular steel electrically welded throughout by skilled workmen exactly to specifications. Proof of Rohn construction lies in the fact that thousands of towers have been sold in the past several years and have successfully withstood the rigors of time in all climates and under the severest of conditions!

IN PERFORMANCE
Rohn Towers assure you of trouble-free performance and once installed give unquestioned satisfaction year in and year out! You are free of complaints because over the years Rohn Towers have proved themselves from the serviceman, dealer and customer point of view!

IN SALES
Sales acceptance has been phenomenal—thousands have been sold coast-to-coast—and the design has been one which has withstood every test known! Why "experiment" with an unproved tower design when you can sell Rohn?

So we ask you, "Why take chances with an untried tower? Be sure—sell Rohn—the only tower of its kind to withstand every test!"

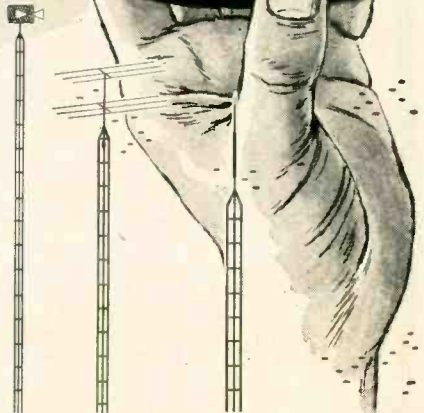

3 Self Supporting Rohn Towers To Fit Your Every Need

- The No. 5—The self-supporting tower for use up to 40', or guyed to 80'. An economical, yet sturdy, permanent tower!
 - The No. 10—The standard 12' design that is self-supporting to 50' and can be installed to 120' when guyed!
 - The No. 20—The heavy duty Rohn Tower, ideal for communication and where great height is required—self-supporting to 60', or guyed to 150'!
- All Rohn Towers are in 10' sections—easily erected, transported and stored!

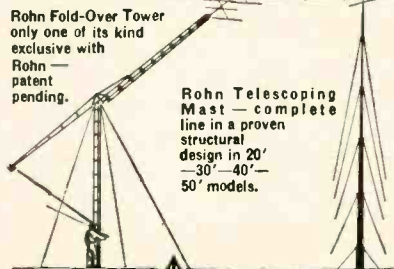

A COMPLETE LINE OF TOWER ACCESSORIES AND HARDWARE

A full line of Superior Design Tower accessories is available including guying brackets, house brackets, wall mounts for towers and masts, special tower bases such as peak and flat roof mounts, etc.

Contact your Rohn authorized representative or your distributor for **FREE CATALOG** or write . . .



MANUFACTURING CO.
DEPT. RE 116 LIMESTONE BELLEVUE
PEORIA, ILL.

SUBSCRIBERS

If you're moving, please don't forget to send us your address as it appears on the copy of the magazine, including the numbers shown beside your name, as well as your new address. If we receive this information before the 20th of the month, you will continue getting the magazine without interruption. Your cooperation will be most helpful and greatly appreciated.

TRANSVISION FIELD STRENGTH METER

*Finest
at
Any Price*

For 110V AC,
and BATTERY
OPERATION

**SAVES 50% OF
INSTALLATION COST**

Works from antenna
(no TV set needed)

FINEST because: Each Meter is individually calibrated in microvolts on every channel. Widest range—10-50,000 microvolts. 12 channel selector. Multiplier switch for weak signal areas. Pays for itself on 3 or 5 jobs.

Measures relative picture signal strengths directly from antenna. Determines best antenna system and orientation. Checks receiver re-radiation (local oscillator.) Identifies signals—TV, FM, TVI. Easy to operate, light, rugged. Many other exclusive features.

*Model FSM-4, for 110V AC only. Complete with tubes.

Wt. 13 lbs. net \$69.

Model FSM-4B, for 110V AC and Battery Operation (case and cables included, batteries extra).

Wt. 22 lbs. net \$89.

TRANSVISION, INC.
NEW ROCHELLE, N.Y.

\$69
NET*

A MUST IN
FRINGE AREAS

**UHF
or
VHF**

10 DAY TRIAL:
Try these fine instruments for 10 DAYS. Then, if you return them, your cost less 10% (our cost of re-packaging) will be refunded.

Test & Repair CRTs

Make **BIG PROFITS** this **EASY** way:

Every Service Shop needs these Transvision Instruments. Can be used while picture tubes are in sets or cartons. Choice of 4 types:

TESTER-REACTIVATOR-SPARKER: 3 instruments in 1. Measures cathode emission; locates shorts between elements; locates high resistance shorts (leakage). Gives rapid check of gas condition of tube. Reactivates dim tubes—renews brightness and detail. Sparks out electrical leakage. net \$34.95

TESTER-REACTIVATOR: 2 instruments in 1. Similar to the above but without the sparking function. net \$19.95

TESTER-SPARKER: 2 instruments in 1. Sparks out electrical leakage between elements—saves many variable 8,000-14,000V D.C. supply; useful for analyzing hard-to-solve deflection problems. net \$25.95

SPARKER: Eliminates leakage between elements in C.R.T.s and small tubes. net \$18.95



Transvision, Inc., New Rochelle, N. Y., Dept. E1

- Send me _____
- Enclosed find \$_____ deposit. Balance C.O.D.
- My JOBBER is _____

I accept your 10 Day Trial terms.

Name _____
Address _____
City _____ State _____

JOBBER INQUIRIES INVITED

You will have to move the tap on the antenna coil. Connect a good antenna to the input terminal and solder the tap to the point of maximum signal and minimum noise. A vertical J (page 96 of the December, 1951, issue) or ground-plane antenna will provide the omnidirectional pickup required for reception of mobile stations. For increased gain, try a vertical collinear array like that shown on page 99 of the August, 1953, issue.

DELTA MATCH SYSTEM

? Where can I get information on using a delta-match system for connecting an antenna to a transmission line. I would like to know how to compute the impedance of the antenna and the dimensions for the matching section.—C. P. J., Athens, Pa.

A. A delta-match is a tapered-line impedance transformer used to match a dipole radiator to a transmission line having a higher impedance. It is often used to match a 72-ohm transmitting dipole to a high-impedance open-wire transmission line or the radiator of a multielement array—such as a Yagi—to a 72-ohm transmission line. In each case, the feed-point impedance of the antenna is much lower than the characteristic impedance of the transmission line. The diagram of a delta matching system is shown.

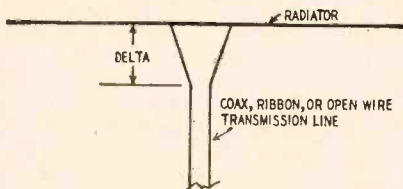

The dimensions of the delta depend on the impedance of the antenna at its center, the diameter and spacing of the transmission line, and the reactance which the matching section presents to the transmission line. Design formulas including all of these variables are not available, so a delta is hardly ever used in homemade receiving antennas.

Antenna manufacturers sometimes use a delta-matching system instead of a folded dipole to step up the impedance to an antenna to match the transmission line. They usually excite a model antenna with a signal generator or grid-dip meter and then measure the standing-wave ratio on a bridge. The dimensions of the delta are then adjusted for a minimum standing-wave ratio. The delta is set up for one type of transmission line. Substituting a line of a different impedance increases the losses in the antenna system.

POWER TRANSFORMER QUERY

? I am constructing an audio amplifier in which the center-tapped filament winding is connected to a tap on a B plus voltage divider. My power transformer does not have a center-tapped filament winding. Can I get the same results by installing a separate filament transformer with a tapped secondary? Why is the tap connected to a low B plus voltage?—J. C. M., Nyack, N. Y.

SOLVE your hi-fidelity problems with
**University
CONE
SPEAKERS**
**-HIGHEST QUALITY!
-LOWEST COST!**



MODEL 6201 — COAXIAL SPEAKER SYSTEM. Now generally acknowledged to be industry's finest value in a high quality 12" speaker. TRUE coaxial dual range system comprising clean sounding woofer with heavy exclusive Alnico 5W magnet, DRIVER TYPE tweeter with "Reciprocating flares" wide angle horn, and BUILT-IN crossover network complete with "Balance" control.

DIFFUSICONE-12 — WIDE RANGE WIDE ANGLE 12" SPEAKER. Exclusive "diffusicone" design utilizes the benefits of dual-horn loading, radial projection and diffraction principles to achieve unsurpassed quality and sound distribution from a single unit speaker. Enjoy full fidelity ANYWHERE in the room . . . at a surprisingly reasonable cost.



DIFFUSICONE-8 — WIDE ANGLE 8" SPEAKER. Same as the Diffusicone-12 except in 8" size. Remarkable fidelity and exceptional sensitivity and power handling capacity make this a truly outstanding eight. Ideal for use where space is limited, and is also a perfect selection for a mid-range speaker in 3-way systems.

MODEL 6200—EXTENDED RANGE 12" SPEAKER. Designed for general applications, capable of highly efficient FULL-BODIED response throughout the operating spectrum. May be used with equal facility to improve commercial radio, TV, phono sets, high quality sound re-inforcement in night clubs, churches, schools, etc., or as a woofer. The 6200 must be heard to be appreciated.



MODEL C-15W—DUAL IMPEDANCE RANGE 15" WOOFER. Brand new low frequency reproducer embodying many exclusive advance features. Its superior response and acoustic output is due, in part, to a newly University-developed cone and voice coil suspension system permitting the greatest axial movement ever achieved. The incredibly low distortion results from a new magnet assembly.

There is a UNIVERSITY Tweeter for every application and pocketbook. Write for descriptive illustrated literature. Address Desk H-12

**University
LOUDSPEAKERS INC**
80 SO. KENSICO AVE., WHITE PLAINS, N. Y.

Crystal Clear Pictures like MAJIC with amazing CLEAR-PIX FILTERS



HIGH REJECTION EFFICIENCY

- Scientifically designed with proven HI-Q circuits
- Low Cost
- Easy to install

Most of the 26 million TV sets now in use suffer from some type of interference. What a tremendous market to exploit! Save your customer discomfort and eyestrain... boost your reputation as a technician... boost your profits! Recommend and install GRAYBURNE CLEAR-PIX filters. There's one for each type of major interference.

Model #	Interference
CPF	FM
CPD	Diathermy
CPI	Ignition
CPH	Amateur (21 mc.)

BE PREPARED: Carry several of each model in your service kit at all times to cash in on handsome profits.

ORDERTODAY from your local dealer.

1.98 list

Successor to Grayburne Corp.

Superelex CORP.

23 Atherton St., Yonkers, N. Y.

Let me show you how EASY it is to

LEARN TV

the practical way--



D. Gnessin, Educational Director



ASSEMBLE A TRANSVISION TV KIT

Pay as You Wire \$ **39**

Down Payment

I WILL HELP YOU to start learning TV the practical way -- by assembling a TRANSVISION TV KIT in EASY STAGES. For only \$39 you get PACKAGE #1 (standard first pkg. for all of our kits). This package gives you the BASIC CHASSIS and over 450 TV COMPONENTS with complete Instructions, Drawings, Photos, Service Booklet, and a year's subscription to my "TV and Electronics Notes". When ready, you order the next stage (pkg. #2), etc. Low prices make your complete kit a terrific buy!



Shows 6 Great TV Kits:

EXCLUSIVE: Only Transvision TV Kits are adaptable to UHF. Ideal for FRINGE AREAS. No Previous Technical Knowledge required. Write now!

TRANSVISION, INC., Dept. RE1
NEW ROCHELLE, N. Y.

FREE CATALOG

MAIL THIS COUPON TODAY

Mr. D. Gnessin, Educational Director
TRANSVISION, INC., NEW ROCHELLE, N. Y. Dept. RE1

I'm enclosing \$ _____ deposit. Send standard kit PACKAGE #1, with all Instruction Material. Balance C.O.D.

Send FREE copy of your new TV Kit Catalog.

Name _____
Address _____
City _____ State _____

A. The filament winding on your transformer need not be center-tapped. All you need do is connect a 50-100-ohm wire-wound potentiometer across the untapped winding and connect the movable arm to the B plus point. Adjust the arm of the potentiometer for minimum hum in the amplifier output.

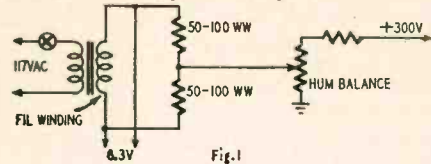

Fig. 1

In some electronic circuits, the cathode of a tube may be a hundred volts or so above ground. If the heater is grounded, the tube is likely to be damaged by a short or flashover between heater and cathode. The maximum voltage between heater and cathode is 90 volts for most receiving-type amplifier tubes. So, if the cathode must be operated more than 90 volts positive, the heater is usually biased positive to reduce the voltage between these two elements.

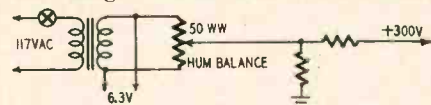

Fig. 2

In high-gain circuits, hum may occur when a heater emits electrons to the cathode or when there is leakage between the heater and cathode. In either case, hum can be greatly reduced or eliminated by using Fig. 1 or Fig. 2. Typical circuits use about 150,000 ohms for the series element and around 50,000 ohms for the control in Fig. 1 and grounded resistor in Fig. 2. The heater bias voltage should be limited to about 90 and the bleeder current to 2 ma or less.

FULL-WAVE DETECTOR CIRCUIT

? I have an i.f. output transformer which has a center-tapped secondary for feeding a full-wave detector. I would like to use this as a replacement for a half-wave output transformer in my receiver. Please publish a diagram of a full-wave detector using this transformer.—P. W., Viola, Kansas

A. A full-wave detector is shown in the diagram. The audio and a.v.c. voltages developed for a given i.f. signal input are only about half those obtained from a half-wave detector so

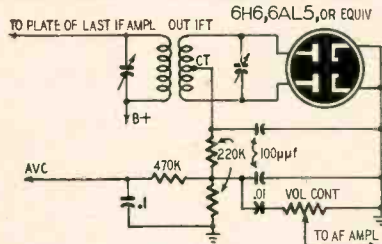

you may find that your set does not have enough gain to operate properly. Sets which use full-wave detectors usually have two or more high-gain i.f. amplifiers and two a.f. amplifier stages ahead of the output stage to make up for the decreased detector output. It will probably be better to use a half-wave i.f. output transformer as the replacement in your set. END

INTERNATIONAL RECTIFIER CORPORATION
EL SEGUNDO CALIFORNIA

RADIO & TV

Selenium Rectifiers

Top Performance Requires RELIABLE REPLACEMENT RECTIFIERS

AVAILABLE AT YOUR FAVORITE JOBBER

DIRECT REPLACEMENT UNIVERSAL MOUNTING WIDER RANGE

Ask for Bulletin JRP-1

INTERNATIONAL RECTIFIER CORPORATION

1521 E. Grand Ave., El Segundo, Calif. • Phone: ORegon 3-6781
CHICAGO: 205 W. Wacker Drive • Phone: Franklin 2-3883
NEW YORK: 501 Madison Avenue • Phone: Plaza 5-8665

ATTENUATOR SWITCH eliminates "cut and try" methods for better TV reception



A twist of the dial on this Centralab TV Attenuator Switch instantly shows proper amount of attenuation for best reception. You know how important this is in multi-station areas!

Four different H-pads are mounted in the attractive metal case. You simply hook up the 300-ohm antenna twin-lead, and dial finds correct setting. Then, unhook leads and install proper H-pad. Simple as that. And it's accomplished in a few minutes.

If customers want permanent selective attenuation installation, a handy mounting bracket does the trick. And it's another sale for you!

Yes, time saved by Centralab TV Attenuator on one job is profit time for another job. That's why you'll want to contact your distributor for full details.

Centralab

CENTRALAB, A Division of Globe-Union Inc. 922A E. Keefe Ave., Milwaukee 1, Wis.

Please send additional technical data on Centralab's TV Attenuator and H-pads.

Name.....
 Firm.....
 Address.....
 City..... Zone..... State.....

ADMIRAL 82-CHANNEL TV SETS

Poor performance of Admiral all-channel sets on u.h.f. may be caused by the u.h.f. antenna lead from the u.h.f. antenna terminals to the tuner being too close to or touching the metal brackets on the rear-picture tube mount. This lead is purposely long and acts as a quarter-wavelength trap at the mean frequency of the low-band channels and as a three-quarter wavelength trap at the mean frequency of the high band.

Remove the back of the cabinet and check this lead to be sure that it is not close to any metal, and straighten it out if it is looped or doubled up.

While the back is off the set, check this lead at the point where it is soldered to the u.h.f. tuner. Remove the metal bracket (if any) that covers the u.h.f. antenna connections. This bracket was used on the production line and is not required after the set is installed in the cabinet.—Admiral Radio & TV Service Bulletin

MECK XB-702 TV SET

When the set was first turned on it would not sync vertically until the hold control was to the extreme low-resistance end of its range. After a warmup, the vertical oscillator would drift until sync was lost and could not be restored with the hold control.

The vertical drifting was remedied by replacing the .01- μ f paper capacitor in the grid circuit of the 12SN7-GT with a .01- μ f ceramic unit. The oscillator still locked in at the low-resistance end of the hold control, so we substituted a 100,000-ohm resistor for the 390,000-ohm unit in series with the control. This increases the vertical hold range and permits the oscillator to lock-in in the center of the control range.—Charles Erwin Cohn

HUM IN MOTOROLA 1778

The complaint was a loud hum at all settings of the volume control. A normal picture ruled out filter troubles. A check with a v.t.v.m. showed a grid-to-cathode short in the 25L6-GT audio output tube. Replacing this tube cleared the trouble. A neon short indicator showed barely a flicker when the old tube was tested.—Raymond H. Leeson

ZENITH 28T925R

The set came in with the complaint that the picture had shrunken to a thick horizontal line. We plugged it in and it operated normally about two hours before the trouble occurred. The picture returned to normal as a test prod was touched to a tube pin to measure the vertical supply voltage. The resistances of the primary and secondary of the vertical output transformer agreed with manufacturer's data, so we did not suspect the transformer until we happened to check the resistance between the windings and found that it was only 1,600 ohms.

A new transformer eliminated the trouble.—W. S. Ross

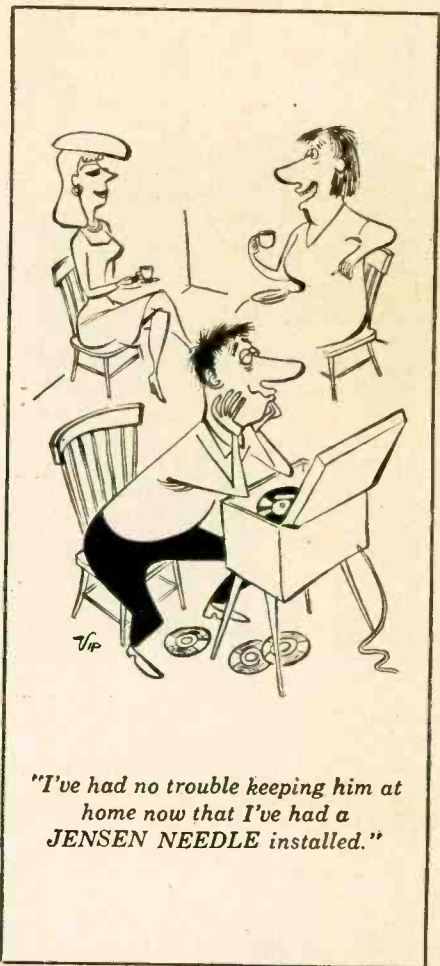

"I've had no trouble keeping him at home now that I've had a JENSEN NEEDLE installed."

FASTER EASIER more PROFITABLE operation

RADIO'S MASTER NEW! 1954 EDITION

- 1370 pages
- Over 85,000 items
- Over 8,000 illus.
- Completely indexed

GET INTO THE MASTER HABIT!

\$1.95 at your parts distributor. Publisher's price \$4.50

Have complete access to the many thousands of products vital to your daily sales and service operations. In the customer's home, across the counter or on the bench, you'll value the Master's thoroughly complete descriptions, specs, illustrations and prices . . . all systematically organized in 18 big sections for instant reference. Increase your sales . . . sell directly from the Master. Facilitate your stock problem . . . use the Master for jiffy comparison of all electronic products. The Master is the only Official Buying Guide for the TV-Radio-Electronics industry. It contains unabridged catalog data direct from the manufacturers. For buying and selling—the Master gives you all the needed facts in a single volume. Over 100,000 in active daily use. Get into the Master habit. Order your copy today!

Just a few of the products included: Tubes — Test Equipment — Tools — Transformers — Capacitors — Resistors — Relays — Coils — Antennas — Recording & PA Systems — Hardware — Transmitters — Receivers — Kits — Wire — Cable . . . and thousands of allied products!



Eliminate Incomplete Small Catalogs and Loose Literature

UNITED CATALOG PUB., INC.
 110 LAFAYETTE ST., NEW YORK 13, N. Y.

WESTINGHOUSE ABC CIRCUIT

A handy incandescent light source is necessary when adjusting the a.b.c. (automatic brightness control) circuit on the Westinghouse V2233-4 TV chassis. Furthermore, you must be able to turn this light on and off at intervals if it should. The a.b.c. adjustment control is on the rear of the chassis. This makes it inconvenient to turn the light on and off as needed.

This little gadget is a great help in adjusting the control and it will serve a lot of steps if you service many of these sets. The unit consists of a 6-inch length of line cord with a small push or rotary switch in the center of one lead, a male interlock plug on one end, and a female line plug on the other.

Set up a small table or bridge lamp about 5 feet in front of the receiver—you can probably borrow one from the set owner. Plug its cord into the female plug of your adapter and then plug the male interlock into your cheater cord. This puts the light switch at your fingertips.

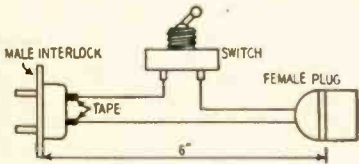

Follow these steps when adjusting the controls:

1. Set the ABC switch on the back of the chassis to OFF.

2. Adjust the brightness and picture controls for normal picture contrast under normal operating conditions. Do not block or obscure the phototube while making these adjustments.

3. Move the ABC switch to ON. Turn on the lamp and make sure that its rays illuminate the front of the set.

4. Start with the ABC control in its counterclockwise position. Rotate it slowly clockwise while switching the lamp on and off until you find the setting where brightness and contrast vary in proportion to changes in lighting.—*H. L. Matsinger* END

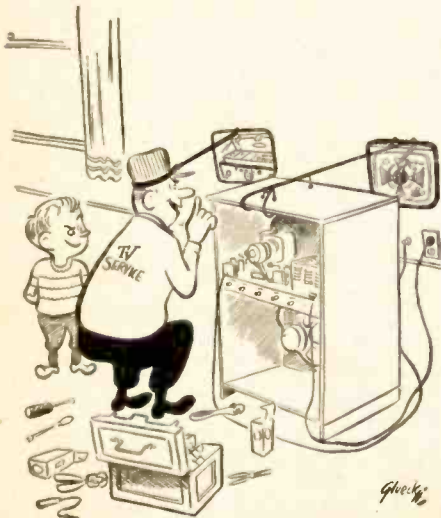

"I use that one to keep an eye on my tools"

JANUARY, 1954

DAVIS ELECTRONICS CHALLENGES THE TV ANTENNA MANUFACTURING INDUSTRY

AN OPEN LETTER:

"In the interest of PROTECTING Electronics TV Dealers from the huckster practices of releasing sales propaganda disguised as 'technical information' WE CHALLENGE THE INDUSTRY TO SET UP STANDARDS.

"We believe that all technical information released to the trade should have the dignity which the phrase 'technical information' implies... This technical information should come from RECOGNIZED INDEPENDENT RESEARCH and/or TESTING LABORATORIES to insure its accuracy."

Jack Moore, *Jack Moore* Sales Manager

DAVIS ELECTRONICS DIDN'T WAIT

We foresaw what was, and is, happening in the TV Antenna Industry. We now provide the Dealer with facts—not fiction.

Securing the actual "technical information" was a long and costly process, but we knew how valuable it would be for you to have.

We invite comparison with any other TV antenna that is tested by a competent testing research institution.

TO BACK UP OUR CONVICTIONS, DAVIS SUPER-VISION ANTENNAS ARE SOLD WITH A DEALER NET PRICE MONEY-BACK GUARANTEE "to perform to the dealers' satisfaction"

WE HAVE PROTECTED DEALERS: We provide Dealers with FACTS about the Unexcelled Performance of the Davis Super-Vision All-Channel VHF Antenna. This is contained in a NEW CATALOG FOLDER & TECHNICAL BULLETIN—and if you want to give your customers the finest television reception, write for your copy.

BUILT BY AMERICA'S FASTEST GROWING ANTENNA MANUFACTURER
Copyright 1953

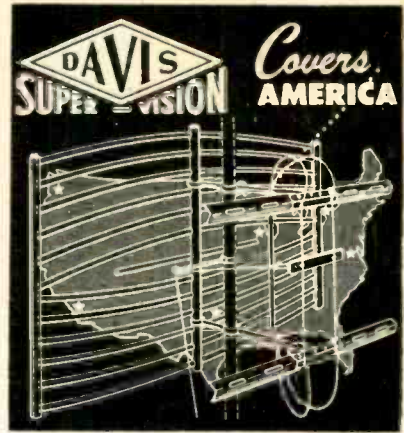

Trade Mark Reg. (First use)

DAVIS ELECTRONICS
BOX 1247, Burbank, California

SIRS: RUSH INFORMATION TO ME AS CHECKED:

Send Complete Information and Technical Data on New SUPER-VISION ANTENNA.

Send Name and Address of NEAREST JOBBER.

Name _____

Street _____

City _____ State _____

SOUND POWERED HEAD AND CHEST SET

Navy Type—No Batteries Required—Ideal for TV Antenna Installations and many other uses. 20 Ft. Cord. Used Tested: **\$5.59 EA.**



TELEPHONE WIRE FOR THE ABOVE

COMBAT TYPE—2 Cond. Twisted, Rubber Covered, Medium Weight. W-130..... @ .01c per Ft.

FIELD WIRE—2 Cond. Twisted, Weather-proof, Heavy Duty. W-110—525 Ft. Roll **\$4.75**

COPPER WELD WIRE—Weatherproofed, 2 Cond. Solid. 1200 Ft. Roll. \$10.00. Per Ft. @ .01c per Ft.

FREE CATALOG

JUST OFF THE PRESS—OUR NEW SURPLUS CATALOG! SEND FOR YOUR COPY!

ATTN.: TELEVISION FRINGE AREAS

AIRCRAFT GUY CABLE— $\frac{3}{32}$ " 7 x 7 Strand, Weatherproofed, Galvanized, Preformed—920 lb. Test. This cable has been tested and proven in many fringe areas over many years—millions of feet in use. PRICES: $\frac{4}{8}$ ¢ per Ft.—1000 Ft. @ $\frac{4}{8}$ ¢ per Ft.—5000 Ft. @ $\frac{3}{8}$ ¢ per Ft.

AERIAL WIRE—Phosphorus Bronze #16 Stranded, 200 lb. test. Weatherproof, 150 Feet **\$1.50** on Reel. RL-3 with Clips.....

JANUARY, 1954 \$1.00 SPECIAL:

100 Ass't. CARBON RESISTORS— $\frac{1}{4}$ — $\frac{1}{2}$ & 1 Watt... \$1.00! If ordering this Special only—add 25c for postage and handling charges!

COAXIAL CABLES:

RG-8/U (SPECIAL) 51.5 ohms. Same size as RG-8/U. Prices: 1 to 100 ft. @ 8¢ per ft.—100 to 500 ft. @ $\frac{7}{8}$ ¢ per ft.—500 to 1000 ft. @ $\frac{7}{8}$ ¢ per ft.—1000 ft. Rolls @ $\frac{6}{8}$ ¢ per ft.

RG-34/U—71 ohms. 145 ft. length..... \$15.00

Address Dept. RE • Minimum Order \$5.00
Prices F.O.B., Lima, O. 25% Deposit on C.O.D. Orders

FAIR RADIO SALES
132 SOUTH MAIN ST. • LIMA, OHIO

PLEASE MENTION RADIO-ELECTRONICS WHEN ANSWERING ADVERTISEMENTS

Just Out! PRACTICAL REFERENCE BOOK ON TRANSISTORS

Every Radio-TV Serviceman and Technician Needs It includes complete "how-to-do-it" wiring data on the use of Transistors in TV, Radio, Photo Cell Relays, Hearing Aids, Amplifiers, Oscillators. You learn how to install, test and service transistorized equipment. Contains the latest, practical information about this revolutionary new electronic development!



SEND NO MONEY! Just mail coupon. On delivery pay postman introductory price of just \$1.50, plus C.O.D. fee and postage. Or save postage by sending \$1.50 with coupon now. Sold on 7-day money-back guarantee. Be first with the latest "know-how" Order your Transistor book TODAY!

RUSH THIS INTRODUCTORY OFFER COUPON

COYNE ELECTRICAL & TV-RADIO SCHOOL
500 S. Paulina St., Dept. 14-T2, Chicago 12, Ill.

YES! Rush your new book: "TRANSISTORS & THEIR APPLICATIONS", at \$1.50 plus C.O.D. and postage, on 7-day trial.

Name _____

Address _____

City _____ State _____

Check here if you are enclosing \$1.50. We pay postage. 7-Day Money Back Guarantee.

Free Placement Service for Grad's. Courses offered—Radio Engineering, Broadcast or TV Engineering, TV, FM, AM Servicing. Write for free catalog. Approved for Vets.

CAPITOL RADIO ENGINEERING INSTITUTE
Dept. RE, 3224—16th St., N.W., Washington 10, D. C.

NAME _____ AGE _____

ADDRESS _____

CITY _____ ZONE _____ STATE _____

City _____ Zone _____ State _____

If veteran, indicate date of discharge _____

JANUARY, 1954

REAL QUALITY TUBE

ADVERTISING INDEX

196

AUDIO AMPLIFIERS READY TO GO
MODEL AMP 5 HI-FI 5
 watt AC Amplifier plus built in Pre Amp GE V.R. pickup 60 to 18000 cps./1DB/own 2 DB 40 cys. hum level-35 db. mike & phono volume controls 6S7, 6SC7, 6X4, 6AB7, TAB Hi-Fi special to your door PREPAID \$21.98
 Same unit less GE Pre Amp PREPAID \$15.98
Model 302PA 3 Tube Pre Amp. Ideal for Custom Building Your Phonograph... \$ 4.98

GROMMERS HI-FI AMPLIFIERS
 L12 Pre & Pwr Amp 8 Watt 20-20Kc. \$35.77
 503PG Pre & Pwr Amp 10 Watt 20-20Kc \$53.90
 215BA Williamson Pre & Pwr Amp 15 Watt 10 to 100 Kc... 97.51
 205PA Pre Amp 0.5DB 20-20 Kc... 53.90
 1PA Pre Amp for G.E. Relect cart... 11.37
 RC1 Record Compensator... 9.50
 Garrard RC80 & GE Dual RFX 050 47.00
 Columbia 360 Hemispheric P.F. USA 136.71
WRITE FOR DETAILS & PRICES

SPEEDWAY ELECTRIC DRILL 1/4" MODEL 200J
 Hi-Torque (powerful) UL apvd. 2400 RPM 115V AC/DC motor. Jacobs geared chuck and key. Self-aligning - oilless - ball thrust bearing. Light weight and easy to handle. Treat yourself to this workhorse drill. Plus 9 drill bits 14.95
Model 210 Drill. 1/2" Jacobs chuck. 2400 RPM to a drill press... \$9.65
Model 400J 1/2" electric drill. 425 RPM Jacobs Chuck & 9 drill bits in case \$29.95

CHROME VANADIUM SPEED DRILLS
 29CS CHROME VANADIUM SPEED STEEL. Top Quality for Mechanists of all purposes. Standard Full Length 1/16" to 1/2" by 6 1/2".
 12 PCS SET 1/16" to 1/2" w/ Index \$7.98
 60 PCS DRILLS 2 1/16" to 1/2" w/ Index \$6.49
 13 PCS 1/16" to 1/2" w/ Index \$1.98

SPEEDWAY UTILITY KIT
 The serviceman's workshop. Kit includes 600 Jacobs drill bits and accessories for grinding, polishing, sanding, buffing, sanding and many other uses. 55 pieces in all. As shown. \$19.95
Model 200JK

TUBES

*From This Special List We Ship \$10.00 and Up Tube Orders At Our Expense (Post-paid) Within Continental Limits of U.S.A. 90 Day Gtd. When ordering mention 1RE

0A2	.88	6A06	.81	6H6	.60	6X5	.54
0A3/VR75	1.04	6AQ7GT	1.29	6J4	6.66	6Y6G	.88
0B2	.54	6AV6	2.98	6K7	.58	7C7	.76
0C3 VR90	.96	6AS5	.79	6J7	.72	7F7	.82
0C3 VR105	.92	6AS6	2.22	6K7	.58	7H7	.72
0B3/VR150	.84	6BE6	3.48	6K7	.58	7N7	.82
1B3/8016	.80	6AT7	.54	6K7	.58	7N7	.82
1L4	.84	6AU6GT	1.10	6K4A	3.64	7N7	.82
1L6	1.35	6AV5GT	.98	6L6	1.48	7Y4	.68
1LD5	.98	6AV6	.49	6L6GT	1.08	12AU6	.98
1LW5	.78	6BA6/6U4	1.18	6L6GT	1.08	12AU6GT	.98
1P5	.52	6BA8	.64	6L6GT	1.08	12AL5	.54
1U4	.54	6BA8	.64	6L6GT	1.08	12AL5	.54
1X2A	1.18	6BC5	.53	6L6GT	1.08	12AL5	.54
2A4Q	1.42	6BC7	1.23	6L6GT	1.08	12AL5	.54
2X2	1.32	6BD6	.83	6L6GT	1.08	12AL5	.54
3A4GY	1.20	6BE6	.54	6L6GT	1.08	12AL5	.54
3A5	1.75	6BF6	.98	6L6GT	1.08	12AL5	.54
3T4	1.42	6BG6	1.58	6L6GT	1.08	12AL5	.54
5U4G	.55	6BH6	.63	6L6GT	1.08	12AL5	.54
5Y3GT	.43	6BJ6	.69	6L6GT	1.08	12AL5	.54
6AC7	.71	6BK7	1.19	6L6GT	1.08	12AL5	.54
6AG5	.43	6BL7GT	1.19	6L6GT	1.08	12AL5	.54
6AG7	.43	6BN7	1.98	6L6GT	1.08	12AL5	.54
6A8	1.22	6BT7	1.98	6L6GT	1.08	12AL5	.54
6A85	.77	6B7GT	1.65	6L6GT	1.08	12AL5	.54
6A85	.77	6C4	.52	6L6GT	1.08	12AL5	.54
6A85	.77	6C5	.68	6L6GT	1.08	12AL5	.54
6A85	.77	6C6	.68	6L6GT	1.08	12AL5	.54
6A85	.77	6D4	2.70	6L6GT	1.08	12AL5	.54
6A85	.77	6F6GT	.79	6L6GT	1.08	12AL5	.54

"TAB" THAT'S A BUY

TUBE SPECIALS

YOU PICK THEM

lots of 10 Cracked base or broken key electrically perfect.

TESTED & 90 DAY GUARANTEED ORDER NOW, WHILE THEY LAST

5Y4G - 6S7 - 25L6GT - 35Z5
 5Y3GT - 6K6GT - 12SA7GT - 6H6
 6V6GT - 6BQ6 - 6W4GT - 12SG7

AUDIO COMPONENTS

GE RPX04 Cart. Gold Tone \$5.25
 GE RPX050 Triple Play Cart 4.98
 Electrovoice Triple Play 1.99
 GE RPJ004 Single .001" Sapphire 1.98
 Pickup Arm & Xtal Hi-Output \$3.99
 GE RPX-052 Triplay Diamond and Sapphire 17.75
 GE RPJ005 Single .001" Sapphire 1.35
 GE RPJ001 Single .003" Sapphire 1.35
 GE RPJ004 Single .001" Diamond 1.98
 GE RPJ013 Dual Diamond & Sapphire 12.98

COAXIAL SPEAKERS

All 8 ohm. V.C. Alnico V Magnets. Inbuilt Network, 2 wires needed for HF & LF Response. Famous Hi-Fi Speaker Mfrs.

15" Coaxial PM & 5" Tweeter, 25 watt/20-17500 cy. shpg wt 13 lbs
 Special P250C \$23.75
 12" Coaxial PM & 3 1/2" Tweeter, 12 watt/45-15000 cy shpg wt 8 lbs \$12.25

ELECTROLYTIC CONDENSER KIT

POPULAR VALUES **25¢ ea.**

Here is a handy assortment of 15 condensers for the serviceman. Only \$3.75

ADJUST-A-VOLT

Standard Elect (Staco) Variable Voltage Transformer
 TYPE 20/0-135V/3 Amp/1N \$14.98
 TYPE 116U/0-135V/7.5A/1N \$16.98
 TYPE 116 Specs 116U & Cased/N \$21.98
 TYPE 1126/0-135V/15 \$43.98
 TYPE 1226/0-270V/9 Amp/ Cased/N \$43.98
 GE 50A VARIAC/0-135V/45AMP/LN \$112.00
 GE 50B VARIAC/0-270V/31AMP/LN \$112.00
 STACO LRL-5/METERED/140V/5A/ 0.5KW/1N \$41.50
 STACO PAL-7/METERED/135V/7.5A/ 1KW/1N \$40.50

RHEOSTAT SALE

2 ohm 50W Model J... 2.25; 5 for 10.00
 2 ohm 50W Model LB... 1.48; 2 for 2.49
 20 ohm 50W Model J... 1.98; 2 for 3.50
 60 ohm 50W w/knob... 2.25; 2 for 3.98
 100 ohm 50W Model K... 1.98; 2 for 3.50
 300 ohm 225W Model P... 2.98; 2 for 5.00
 350, 500, 5000 ohm Slotted shaft. 25 watt... .79; 3 for 2.00

866A KIT and XFORMER

2 Tubes, 600v, 6mfr. 115V/60Cyc Inpt. output 2.5vct/10A/4.98
 HiVna Probe Tube Unexcelled for No-Loss VHF testing. Ultra-sensitive subminiature-envelope. New. w/data VR92... 25¢; 5 for \$1.

ONE YEAR GTD PICTURE TUBES

7J4	\$17.95	CX534AX	.99
10BP4	10.00	CX538DX	.98
12" Glass	12.00	CX539DX	2.19
14" Rectangular	14.00	CX547GT	.99
16" Glass	16.00	CX544DX	.99
17" Rectangular	17.00	CX546DX	1.99
18" Round	18.00	CX547GT	1.35
20" Rectangular	20.00	CX544DX	.99
21" Rectangular	21.00	CX546DX	1.99
22" Hytron	89.95	CX547GT	1.35

DC POWER SUPPLY

0 to 12 VDC/2 Amp. variable DC supply, un-cared and completely built-inpt 115v/60 cyc. Usable LAB supply, filament D. C. plating, battery charging, model rail road, includes voltage or speed control and center off reversing sw. Ideal for two "HO" locomotives Prepaid USA. \$10.95; 2 for \$20.00

FEDERAL "ITT" SELENIUM BATTERY CHARGER RECTIFIER

10-0-10V (CT) 100 Amp., fan cooled. Replace your old inefficient sulfide rectifier w/new selenium type. SPECIAL... \$11.98

SELENIUM RECTIFIERS

Current (Cont.)	List Price	Qty
65MA @ 130V	\$1.50	\$0.59
75MA @ 130V	1.85	.69
100MA @ 130V	2.05	.79
150MA @ 130V	2.25	.99
200MA @ 130V	2.45	1.19
300MA @ 130V	3.30	1.49
400MA @ 130V	4.25	1.89
500MA @ 130V	4.50	39.00
230MA @ 18V	1.40	.59

RECTIFIER XFMRS

Primary 115V 60 Cyc Secondary 0-9-12-18-24-36V

4 Amp	12 Amp	24 Amp
18 Volt	2 Amps	3 Amps

SELENIUM RECTIFIERS FULL WAVE BRIDGE

We specialize in Rectifiers, Power supplies to applications. Immediate delivery

Current	18/14	36/28	54/40	150/100
(cont.)	Volts	Volts	Volts	Volts
1AMP	2.38	3.15	3.70	4.50
2AMP	2.40	3.60	5.40	10.50
4AMP	4.25	7.95	12.95	25.25
10AMP	6.75	9.00	13.90	33.00
12AMP	6.75	12.75	20.00	44.95
24AMP	8.50	16.25	25.50	49.00
25AMP	12.25	35.50	39.00	57.25
24AMP	16.25	32.50	45.00	95.00

TELEVISION ANTENNA

VEE CONICAL Broad response, all channel, power-ful for fringing areas. \$8.95

CRYSTAL DIODES

IN23B Sylvania \$1.89

Lead Jacketed & Boxed. Lots of 10. Smaller Quantity. Unit Price \$2.25

HI-FI POWER SUPPLY

50LA constant voltage power transformer with 200V AC on chassis with (2) octal rectifier sockets

REPAIR KIT #873

All the tools needed for the spot repair job. Includes (4) interchangeable screw driver blades and handles, electrician's pliers, adjustable wrench, long nose pliers and wrap around end cutters. Tempered tool steel. Model 3701 6 screw driver down. \$2.69

WAREHOUSE CLEARANCE

Antenna Mast sections M940 & M550 4x3/8" 2 ft 49¢; 25 at \$3

FILAMENT TRANS.

2.5V/2A @ 79¢; 2 for \$1.49; 10 for \$6.49
 2.5VCT/10A 12.5KVINS KENTON 6.98
 6.3V/2AMP @ \$1.08; 2 for \$1.98
 2.5V/170A 3KVINS NENTON 5.59
 7.5VCT/12A 3KVINS NYON 10.99
 24V 1.25A CSD @ \$1.98. Two for 3.49
 2X12V/2A or 24V/2A @ \$3.89. Two for 6.98

TRANSFORMERS

All 115 V 60 Cye Input TV, CB power Xmt up to 20" tubes, 81 VOLTs to 20 KV (w/outrunler coil) ALL Tubes, Fil & FIL wdgds. 300VDC/275 Ma Full-Wave: 6.4V 10.3A, 3.4V/3A, 2.5V/3A Hyvons II Core. Oil Imprex. \$6.49; Two for \$11.98
 1000VDC/45MA, 75VCT/10MA, 30VCT/35MA 3X5V/3A, 6.3VCT/1A Hyvons II Core. Oil Imprex. \$6.49; Two for \$11.98
 CAY THEON HYPERSIL CORE \$4.98
 50VCT/100MA, 5V/2.5A, 5V/1A, 45V/1A, 10V/1.5A WESTERN ELECT... \$ 4.99
 90V/35MA, 2X2.5V/2A, XCLENT 1800V HI TR 2MA 2X2 FIL WDGDS \$2.25
 85VCT/148MA, 5V/3A, 6.3V/5A, 6.3V/3A \$2.49
 84VCT/110MA, 6.3VCT/21MA, 2X5V/1A, 3A, 6.3VCT/1A, 6.3VCT/3A \$3.45
 84VCT/150MA STANCOR \$5.98; 3 for \$15
 78VCT/200MA, 5V/3A, 12V/3.5A \$5.98
 78VCT/250MA, 5V/6A, 12V/3.5A \$5.98
 77VCT/200MA, 5V/6A, 12V/3.5A \$5.98
 77V/2.5MA/2.5V/3A, HVINS HMSD includes FILTER PARTS \$2.99
 70VCT/120MA, 2X6.3V/3A, 6.3V/1A \$3.99; Two for 7.25
 78VCT/200MA, 5V/3.5A, 6.3V/4A, 6.3V/1A \$4.39; 3 for \$17
 60VCT/50MA, 6V/3A, 6V/1.5A 6V/1A \$2.49; 2 for \$4.50
 42VCT/90MA, 6.3V/1.0A, W/INPUTS 6, 12, 24, 115VDC & 115 & 230 VAC @ \$ 1.49

FILTER CHOKES

12Hy/80ma H'Sid/3Kvins 2.25
 10Hy/125ma UTC/Cad 1.98
 H'Sid/1Kvins 1.98
 50Hy/250ma H'Sid/4Kvins 2.49
 20Hy/300ma 15Hy/400ma 12Kvins 8.95
 13.5Hy 1 amp 11 Kvins Raytheon 39.95
 6Hy/175ma, 250 ohm 1.48; 2 for 2.49
 12Hy/300ma, Hmsid 5Kvins 4.95
 10Hy/85ma 550 ohm .95; 2 for 1.69
 3Hy/40ma THT #101 .95; 2 for \$1.39

YOU PICK THEM 59¢ WHILE THEY LAST

LOTS OF 10

Your selection of 10 at 59¢ each or smaller quantity at indicated prices.

ELECTROLYTIC CONDENSERS

2X 20MFD/450VDC	.69¢; 3 for \$1.95
3X 15MFD/450VDC	.49¢; 3 for 1.29
3X 20MFD/300VDC	.79¢; 2 for 1.29
25MFD/450VDC	.69¢; 3 for 1.95
20MFD/750VDC/20MFD/25V	.3 for 1.00
30 mfr/300VDC P.F.	.3 for 1.00
30-15-10 mfr/250VDC	.3 for 1.00
30-12-20mfr/450-25VDC	.3 for 1.00

STORAGE BATTERIES

36 Volt WILLARD Mini-BRAND NEW. 5 oz Designed Portable Equip Models. 98¢; 4 for \$3
 (4) 36V Batteries w/acid... \$3.35
 2V/20AH Willard PLUS 2V, Vibrator, 2.98
 2V/20AH w/wb & acid... 1.59
 6V/4AH Willard N76/B214U... 2.98
 6V/8AH Battery w/acid... 3.25
 6V/40AH Battery... 9.98
 6V/40AH Battery w/acid... 9.25

TAB PHOTOFLASH LAMPS

No.	Replaces	Max. Each
USW	SPRG/PA104	150 \$5.98
No. 1	AMGLO 5804X	100 10.98
23ST	GE FT 219	200 9.98
VA	STYL. 4330	200 9.98
22ST	FT 110	200 9.98
V4X4	X400	100 9.98
DX	SPRGFA100	150 9.00

100 WATT SEC PHOTOFLASH KIT

Includes DX Flash Lamp Rated 150 Watt Sec. Flash Lamp Holder & Reflector & Cable. Power Trans. "CO" Condensers (2) 525 MFD/450V/100 Watt Sec. Resistors, Capacitors, and Sockets \$34.98

OIL CONDENSER SPECIAL

10 MFD 600 VDC \$1.75 ea

lots of 3

Case dimensions, not including insulators 4 1/4 x 3 3/4 x 1 1/4" Smaller Quantities, special \$1.98

CONDENSER SPECIAL

2 MFD 1000 VDC 25¢

330 VAC "CD" MFR

lots of 10

Smaller Quantities, each. 49¢; 3 for \$1.25
 2MFD 600VDC Porcel. insulators with Adjustable Mounting Clamp... 3 for \$1.50

OIL CONDENSERS WAREHOUSE CLEARANCE SALE

RECTANGULAR CASE

.5MFD 150VDC	.95¢; 2 for \$1.50
.5MFD 600VDC	1.50¢; 3 for 4.00
10MFD 600VDC	1.50¢; 2 for 2.50
3MFD 330VAC 1000VDC	.49¢; 3 for 1.20
2x2MFD 600VDC/VIT "CD"	1.25¢; 2 for 2.00

CLOCK RADIO

WAKE UP TO MUSIC

Just set the dial, & radio automatically turns on. Beautiful plastic cabinet. MAROON OR IVORY

Powerful 5 tube design. *TAB* SPECIAL Prepaid... \$20.98
 Same Less Clock... \$16.98

THAT'S "TAB" THAT'S A BUY

Dept. 1RE 111 LIBERTY STREET, NEW YORK 6, N. Y., U.S.A.

WESTINGHOUSE ABC CIRCUIT

A handy incandescent light source is necessary when adjusting the a.b.c. (automatic brightness control) circuit on the Westinghouse V2233-4 TV chassis. Furthermore, you must be able to turn this light on and off at intervals to see if the control is working as it should. The a.b.c. adjustment control is on the rear of the chassis. This makes it inconvenient to turn the light on and off as needed.

This little gadget is a great help in adjusting the control and it will serve a lot of steps if you service many of these sets. The unit consists of a 6-inch length of line cord with a small push or rotary switch in the center of one lead, a male interlock plug on one end, and a female line plug on the other.

Set up a small table or bridge lamp about 5 feet in front of the receiver—you can probably borrow one from the set owner. Plug its cord into the female plug of your adapter and then plug the male interlock into your cheater cord. This puts the light switch at your fingertips.

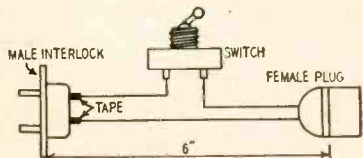

Follow these steps when adjusting the controls:

1. Set the ABC switch on the back of the chassis to OFF.
2. Adjust the brightness and picture controls for normal picture contrast under normal operating conditions. Do not block or obscure the phototube while making these adjustments.
3. Move the ABC switch to ON. Turn on the lamp and make sure that its rays illuminate the front of the set.
4. Start with the ABC control in its counterclockwise position. Rotate it slowly clockwise while switching the lamp on and off until you find the setting where brightness and contrast vary in proportion to changes in lighting.—
H. L. Matsinger END

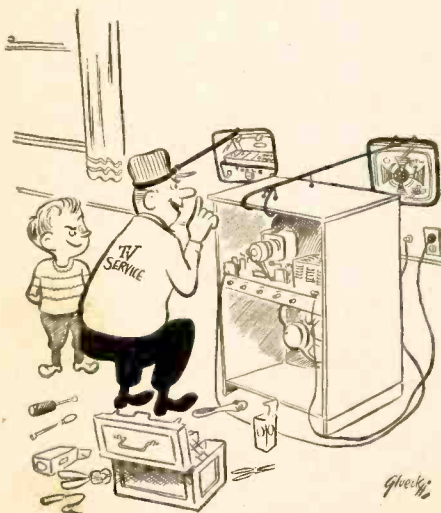

"I use that one to keep an eye on my tools"

JANUARY, 1954

DAVIS ELECTRONICS CHALLENGES THE TV ANTENNA MANUFACTURING INDUSTRY

AN OPEN LETTER:

"In the interest of PROTECTING Electronics TV Dealers from the huckster practices of releasing sales propaganda disguised as 'technical information' WE CHALLENGE THE INDUSTRY TO SET UP STANDARDS.

"We believe that all technical information released to the trade should have the dignity which the phrase 'technical information' implies. . . This technical information should come from RECOGNIZED INDEPENDENT RESEARCH and/or TESTING LABORATORIES to insure its accuracy"

Jack Moore, *Paul Moore* Sales Manager

DAVIS ELECTRONICS DIDN'T WAIT

We foresaw what was, and is, happening in the TV Antenna Industry. We now provide the Dealer with facts—not fiction.

Securing the actual "technical information" was a long and costly process, but we knew how valuable it would be for you to have.

We invite comparison with any other TV antenna that is tested by a competent testing research institution.

TO BACK UP OUR CONVICTIONS, DAVIS SUPER-VISION ANTENNAS ARE SOLD WITH A DEALER NET PRICE MONEY-BACK GUARANTEE "to perform to the dealers' satisfaction"

WE HAVE PROTECTED DEALERS: We provide Dealers with FACTS about the Unexcelled Performance of the Davis Super-Vision All-Channel VHF Antenna. This is contained in a NEW CATALOG FOLDER & TECHNICAL BULLETIN—and if you want to give your customers the finest television reception, write for your copy.

BUILT BY AMERICA'S FASTEST GROWING ANTENNA MANUFACTURER
Copyright 1953

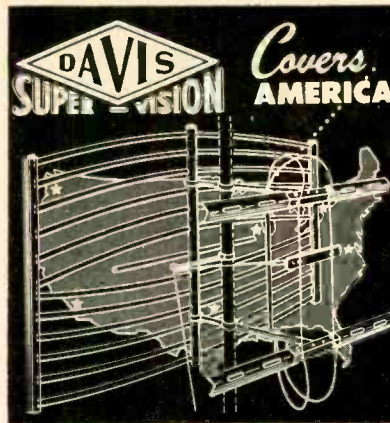

Trade Mark Reg. (First use)

DAVIS ELECTRONICS
30X 1247, Burbank, California

SEND: RUSH INFORMATION TO ME AS CHECKED:

Send Complete Information and Technical Data on New SUPER-VISION ANTENNA.

Send Name and Address of NEAREST JOBBER.

Name _____

Street _____

City _____ State _____

SOUND POWERED HEAD AND CHEST SET

Navy Type—No Batteries Required—Ideal for TV Antenna Installations and many other uses. 20 Ft. Cord. Used Tested: **\$5.59 EA.**



TELEPHONE WIRE FOR THE ABOVE
COMBAT TYPE—2 Cond. Twisted, Rubber Covered, Medium Weight, W-130. @ .01¢ per Ft.

FIELD WIRE—2 Cond. Twisted, Weatherproof, Heavy Duty, W-110—525 Ft. Roll \$4.75

COPPER WELD WIRE—Weatherproofed, 2 Cond. Solid, 1200 Ft. Roll, \$10.00. Per Ft. @ .01¢ per Ft.

FREE CATALOG

JUST OFF THE PRESS—OUR NEW SURPLUS CATALOG! SEND FOR YOUR COPY!

ATTN.: TELEVISION FRINGE AREAS
AIRCRAFT GUY CABLE— $\frac{3}{32}$ " 7 x 7 Strand, Weatherproofed, Galvanized, Preformed—920 lb. Test. This cable has been tested and proven in many fringe areas over many years—millions of feet in use. PRICES: $4\frac{1}{2}$ ¢ per Ft.—1000 Ft. @ 4¢ per Ft.—5000 Ft. @ $3\frac{1}{2}$ ¢ per Ft.

AERIAL WIRE—Phosphorus Bronze #16 Strand—ed, 200 lb. test, Weatherproof, 150 Feet \$1.50 on Reel. RL-3 with Clips.

JANUARY, 1954 \$1.00 SPECIAL:

100 Asst. CARBON RESISTORS— $\frac{1}{4}$ — $\frac{1}{2}$ & 1 Watt . . . \$1.00! If ordering this Special only—add 25¢ for postage and handling charges!

COAXIAL CABLES:

RG-8/U (SPECIAL) 51.5 ohms. Same size as RG-8/U. Prices: 1 to 100 ft. @ 8¢ per ft.—100 to 500 ft. @ $7\frac{1}{2}$ ¢ per ft.—500 to 1000 ft. @ 7¢ per ft.—1000 ft. Rolls @ $6\frac{1}{2}$ ¢ per ft. RG-34/U—71 ohms, 145 ft. length. \$15.00

Address Dept. RE • Minimum Order \$5.00
Prices F.O.B. Lima, O. 25% Deposit on C.O.D. Orders

FAIR RADIO SALES
132 SOUTH MAIN ST. • LIMA, OHIO

PLEASE MENTION RADIO-ELECTRONICS WHEN ANSWERING ADVERTISEMENTS

Just Out! PRACTICAL REFERENCE BOOK ON TRANSISTORS

Every Radio-TV Serviceman and Technician Needs It Includes complete "how-to-do-it" wiring data on the use of Transistors in TV, Radio, Photo Cell Relays, Hearing Aids, Amplifiers, Oscillators. You learn how to install, test and service transistorized equipment. Contains the latest, practical information about this revolutionary new electronic development!



SEND NO MONEY! Just mail coupon. On delivery pay postman introductory price of just \$1.50, plus C.O.D. fee and postage. Or save postage by sending \$1.50 with coupon now. Sold on 7-day money-back guarantee. Be first with the latest "know-how" Order your Transistor book TODAY!

RUSH THIS INTRODUCTORY OFFER COUPON

COYNE ELECTRICAL & TV-RADIO SCHOOL
500 S. Paulina St., Dept. 14-T2, Chicago 12, Ill.

YES! Rush your new book: "TRANSISTORS & THEIR APPLICATIONS", at \$1.50 plus C.O.D. and postage, on 7-day trial.

Name _____

Address _____

City _____ State _____

Check here if you are enclosing \$1.50. We pay postage. 7-Day Money Back Guarantee.

EDLIE
says

"Save with confidence"

The Lowest Priced Kits on the Market

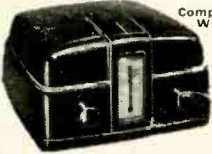

Completely Wired

LOWEST PRICED SIGNAL GENERATOR, BROADCAST BAND

New simplified circuit provides the following switch tuned, tone modulated frequencies:

1. 455 K.C.—Intermediate I.F. frequency
 2. 1500 K.C.—High frequency of Broadcast Band
 3. 600 K.C.—Low frequency of Broadcast Band
 4. Audio tone—for audio amplifier trouble shooting
 5. An attenuator control is included for adjustment of the output signal strength
- Housed in small black bakelite cabinet size 6"x6"x3 1/2". Can be useful for alignment of all Broadcast Band radio receivers. **\$7.95** Completely Wired.

INTRODUCTORY OFFER

Deduct \$1.00 if ordered with Kit #1 or #2

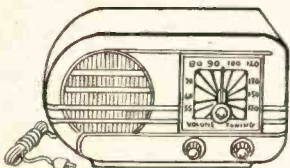

5 TUBE AC-DC SUPERHET KIT

Kit #1—Five Tube superheterodyne kit, A.C.-D.C. contains all components required to construct this latest design, highly sensitive superheterodyne broadcast receiver, complete with black bakelite cabinet (excludes wiring and solder) . . . Only **\$7.95**

Kit of 5 tubes (12AT6, 12BA6, 12BE6, 35W4, 50C5). Only \$3.25.

D 1273

INSULATED RESISTOR KIT

Contains 100 resistors 1/2, 1/2, 1 & 2 watts from 5% to 20% tolerance. Housed in a transparent plastic box. Price complete . . . **\$1.65**

D 1278 PAPER TUBULAR BY-PASS CONDENSER KIT

Contains 50 by-pass condensers ranging in capacity from .005 mfd. to .5 mfd. and at voltages from 200 to 1600, housed in a plastic transparent cabinet, size 7" x 3 1/2" x 1 1/8". Price \$2.95 per kit.

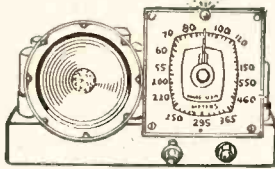

6-TUBE RADIO KIT

Kit #2—A low-priced 6 TUBE KIT designed for high sensitivity, excellent selectivity and good tone quality. Uses 25L6, 25Z6, 6SQ7, 6SA7, 6SK7, 6SK7 in an easily constructed circuit. The 6 Tube Kit is shipped with all parts, including punched chassis, resistors, condensers, coils, sockets, PM Speaker, hardware, etc.

And at a closeout price of only (less tubes and cabinet) **\$6.95**

Matched set of six tubes **\$3.25** for kit

PHONO OSCILLATOR

Not a Kit!

Wireless phono oscillator transmits recording for crystal pickups or voice from carbon mike through radio without wires. Can also be used as an intercom by using P.M. speaker as mike. Price (excluding tubes) **\$2.95**

With Complete Set of Tubes . . . **\$3.95**



D 1910 SUPERSENSITIVE TWO STATION INTERCOMMUNICATION SYSTEM.

The unit is suitable for use in home, office, factory, nursery or sick room. So sensitive it will pick up a baby's cry at a reasonable distance. Operates from 115 volts AC/DC. Both stations housed in compact plastic cabinets (6"x6"x3 1/2"), and requires only 2 wires to connect. Furnished with 50 ft. of twin conductor wire. Price **\$16.95**

D 1279

DISC CONDENSER KIT

Contains an assortment of 50 Erie type disc ceramics, includes the following capacities 001, 2 x .001, .0015, 2 x .0015, 2 x .004, .0047, .005, 2 x .005, .01, 2 x .01 and 10 assorted printed circuited capacitors, housed in a transparent plastic box. Price **\$2.95** per kit.

Electronic Code Practice Oscillator & Blinker Kit

AC/DC or Battery Operated!

Kit #3—One of the most practical Code Practice Oscillators ever designed, yet one of the simplest to build and operate. Can be used with any number of headphones. Adjustable Pitch Control—Any type of headphone can be used. No warmup time—ready to operate instantly. Simple and safe to operate. Operates anywhere—with AC or DC power, or from a 90 volt Miniature Battery.

Learn Blinker Code with flashing light. Blinker can be used as signaling device. International Morse Code included.

Kit **\$1.95** Assem-**\$2.95** each

3-TUBE PHONO AMPLIFIER

Not a Kit!

An assembled unit ready for installation using tone and volume control and six feet of rubber cord (Not including Tubes) **\$2.95**

With Complete Set of Tubes . . . **\$3.95**

D 1274 PRECISION RESISTOR KIT

This kit consists of 50 1/2w Wikor carbon film resistors of 50 different ohmages, housed in a transparent plastic box. These can be combined in series or parallel to produce almost any desired ohmage. Each resistor retails at about .85. Price for kit **\$2.45**.

Terms: All merchandise shipped F.O.B. New York City. Prices are subject to change without notice. Include 20% deposit for C.O.D.'s. WRITE FOR NEW CATALOG—Free!

BAKELITE TUBING . . . 12" Lengths

Type	O.D.	Wall	Per Ft.
Natural	3/8"	1/32"	\$0.25
Natural	1/2"	1/16"	.29
Natural	5/8"	5/32"	.35
Black	3/4"	7/32"	.45
Black	1-1/4"	1/2"	.59
Black	1-3/8"	1/16"	.49
Black	1-1/2"	1/2"	.98
Natural	3"	1/8"	1.15
Natural	3"	1/8"	1.15
Natural	3-1/4"	1/16"	.69

60 MIN. TIMING SWITCH & BELL . . . adjusts 12 sec. to 1 hour. 3" calib. face (12 sec. divisions). S.P. 8A/115V. contacts. Closed during timing. Bell signals end. Spring wound. 1 1/2" ptr. knob. 2" face. **\$2.49**

#32 P.E. MAGNET WIRE . . . 12 oz. spool 98¢, 6/5.00

15V. THERMOSTAT . . . SPST 10A. contacts norm. Closed. Opens at 115°F. O.D. 3/4" x 3/8" . . . **.98**

IMMERSION HEATER . . . 27V. 54W. 3/4" x 2 3/8" . . . **.49**

"OUNCER" TRANSFORMERS . . . S.B. Carbon Mike Input . . . **.98**

OUTPUTS . . . matching 50L8, 50B5 etc. . . . **.98**

HI-FI CRYSTAL HAND MIKE . . . moulded black bakelite case. 6 1/4" ft. cable . . . **3.95**

HAND MIKE CASE only—as above (2" I.D.) ea **49¢**

PERMEABILITY TUNER . . . STD. BROADCAST **.98**



LEOTONE RADIO CORP. JUMBO RADIO-ELECTRONIC PARTS KIT

Check full of: C O I L S, C O N T R O L S, S W I T C H E S, R E S I S T O R S, C O N D E N S E R S, W I R E, S O C K E T S, P H O T O F A C T S, T V P A R T S & D I A G R A M S, P L U S M U C H, M U C H M O R E **\$3.95** (shpg. wt. 50 lbs.)

HEARING AID AMPLIFIER CHASSIS (2 tube) MAKE A REAL VEST POCKET RADIO or AMPLIFIER (1/2" x 2" x 5") adding only simple tuner & phone. WITH SCHEMATICS FOR 2 or 3 TUBE SET. Less tubes & case . . . **\$2.49**

SET OF 2 SUB-MIN. TUBES for above . . . **\$2.49**

HEAR AID BONE CONDUCTOR RCVR . . . (1 1/2" x 5/8" x 1 1/2") Excel. for MUSICAL CONTACT MIKE. 115V. AC ELECTROMAGNET . . . 6 oz. pull. cont. duty. O.D. 7/8" x 7/8" . . . ea **98¢** 6/5.00

19 FT. WHIP ANTENNA . . . complete, orig. carton. **98¢**

RADIO HARDWARE TREASURE . . . FULL LB. CAN OF: Nuts, Screws, Washers, Etc. ea **89¢** 3 lbs. **2.49**

CARBON RESISTORS, 1/2 watt. 100 ass'd. . . **1.98**

ROTARY SELECTOR SWITCHES . . . incl. multi-deck. All with 1/4" shafts. Kit of 6 ass'd. . . **1.75**

LEOTONE RADIO CORP.

67 Dey Street New York 7, N. Y.

TELEVISION SERVICING

All New! 2nd Revised Edition TRANSISTORS COLOR UHF and LATEST TV CIRCUITS

by Walter H. Buchsbaum

Get this brand-new, complete handbook for sure-fire working knowledge of TV installation, maintenance and trouble-shooting. Tells you step-by-step procedures for audio IF alignment, video IF alignment, aligning RF amplifiers, mixers, oscillators, etc. All possible defects classified for ready reference, thoroughly analyzed to show what is wrong and why . . . and what to do to correct the defect. No mathematical knowledge needed!

Part I—Principles of TV receivers, including all new 82 channels. Latest data and illustrations on UHF tuners, converters and antennae. Separate chapter covers the new, all electronic color TV system, explains for the first time all the standards, circuits and color picture tubes. Transistors, theatre TV, industrial TV, etc.

Part II—covers latest installation and alignment techniques for all receivers. Both UHF and VHF alignment data for the newest TV models are given. Antenna installation, fringe area reception and apartment house installations are described.

Part III—the trouble-shooting section. Defects are classified according to symptoms and a detailed step-by-step procedure is given for locating and repairing all possible trouble.

USE IT 10 DAYS FREE—Coupon below brings you "Television Servicing" on FREE trial for 10 days, without obligation. Mail it NOW.

PRENTICE-HALL, INC., Dept. M-RE-154
70 Fifth Ave., New York 11, N. Y.
Send me, for 10 DAYS' FREE TRIAL, "Television Servicing". I will return it in ten days and pay nothing—or keep it and send \$5.95 (plus few pennies postage) in full payment.

NAME
ADDRESS
CITY STATE

SAVE! Send \$5.95 with this coupon, and we'll pay postage and packing!

EDLIE Electronics

154 Greenwich St.
DI 9-3143
New York 6, N. Y.

EASY TO LEARN CODE

It is easy to learn or increase speed with an Instructograph Code Teacher. Affords the quickest and most practical method yet developed. For beginners or advanced students. Available tapes for beginner's alphabet to typical messages on all subjects. Speed ranges 5 to 40 WPM. Always ready—no QRM.

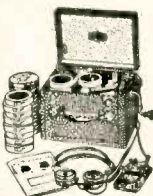

ENDORSED BY THOUSANDS!

The Instructograph Code Teacher literally takes the place of an operator-instructor and enables anyone to learn and master code without further assistance. Thousands of successful operators have "acquired the code" with the Instructograph System. Write today for convenient rental and purchase plans.

INSTRUCTOGRAPH COMPANY

4701 Sheridan Rd., Dept. RC, Chicago 40, Ill.

PRES-PROBE CONDENSER TESTER



Finds Intermittent Condensers Instantly

Pres-probe's sliding tip with variable resistance prevents condenser heating. Tests with power on. Requires no adjustment. Stops guesswork. Saves time. Convenient probe size (7/8" long). Satisfaction guaranteed.

795
Postpaid U.S.A.

See Your Dist. or Order Direct

PRES-PROBE CO.

4034 N. Sixth St., Milwaukee 12, Wisc.

THE SYMBOL OF QUALITY

in **TRANSFORMERS**



QUALITY

you can see!

"Beauty is only skin deep," but the distinctive appearance of Triad Transformers is an outward evidence of inner quality, more than simply good looks.

Brilliant design, fine materials, precision manufacturing techniques and skilled craftsmanship contribute to the end result, which looks like—and is—the finest transformer made.

Triad Transformers are sold by principal jobbers in leading cities.

Write for Catalogs TR-53B & TV-53B.



4055 Redwood Ave., Vanice, California

Lawrence S. Thees, former general sales manager of the RCA Tube Department, Harrison, N. J., was elevated to the top-level post of general commercial manager on the staff of Richard T. Orth, vice-president in charge of the RCA Tube Department, in an organizational change which established four new marketing divisions within the department. In the change, Douglas Y. Smith, former manager of sales operations, was advanced to the new post of



L. S. Thees



D. Y. Smith

general marketing manager with administrative responsibility for the four new marketing divisions, a separate sales division, and two sales-service divisions.

Others promoted in the reorganization include: **Kenneth Bucklin**, to manager of the new Receiving Tube and Transistor Marketing Division; **Michael J. Carroll**, to manager of the Cathode-Ray and Power Tube Marketing Division; **Harry B. Wilson**, to manager of the Electronics Components Marketing Division; **Leonard J. Battaglia**, manager of the Parts and Equipment Marketing Division; **Lee F. Holleran**, to manager of the new separate Sales Division; **Harold F. Bersche**, manager of the Renewal Sales Activity; **Lawrence D. Kimmel**, manager of the Equipment Sales Section; **Gene R. Rivers**, manager of the Government Sales Section; and **Charles B. Swope**, to manager of the Planning and Control Division.

Dr. O. G. Haywood, Jr., was named manager of Engineering Planning of Sylvania Electric Products Inc., New York City. Dr. Haywood was formerly a colonel in the U.S. Air Force, where he organized and headed the Office of Scientific Research and Development Command in Baltimore, Md. In his new position, Dr. Haywood will co-ordinate Sylvania's engineering planning in the fields of lighting, radio, electronics and television.



O. G. Haywood, Jr.



T. C. Rives

Brig. Gen. Thomas C. Rives (ret.) was promoted to the position of manager of the newly organized Laboratories Department of the General Electric Electronics Division, Syracuse, N. Y. General

STOP
VOLUME CONTROL NOISE!

"NO NOISE"

New 6 oz. spray can
Net to Servicemen **\$2.25**

Contains Amazing New **PERMA-FILM**

- ★ **Cleans!** dirt and oxidation immediately on contact.
- ★ **Lubricates!** I drop eliminates scratch, hum and noise.
- ★ **Protects!** assured continued top performance.

Perfect Contact Restorer—cleans & restores volume controls, band switches, push button assemblies, electrical contacts. **NO NOISE** is not a carbon tet solution.

2 oz. bottle Net to Servicemen **\$1.00**

Available in 8 oz. bottles and quart cans.

Nearest distributor . . . or write
ELECTRONIC CHEMICAL CORP.
813 Communipaw Ave., Jersey City 4, N. J.

HI-GAIN TUNER-BOOSTER
LESS TUBES WITH DIAL

\$4.75
COMPLETE WITH TUBES
\$6.00

Solve poor TV reception with a Hi-Gain Booster. Banish weak fringe areas, reduce snow. This unit comes to you as a highly serviceable High-Gain Tuner. Uses 6J6 Tubes in very efficient Hi-Q Circuit. Has 8 tuned circuits using pure silver inductances and individual compensation providing high gain on all channels. Built in 5:1 Vernier Drive.

All necessary parts and instr. included makes highest gain booster on the market reg. of price.

100 ASSORTED RESISTORS

Carbon insulated. New in current RMA Values 5%, 10% and 20% in 1/2, 1 and 2 watt

\$1.00

Shipments sent postpaid when full payment is enclosed. 25% deposit on C.O.D. Send for our new bulletin. No. C.O.D.'s to Canada.

FRANK W. DECRAY & ASSOC.

11842 W. Jefferson Blvd. Culver City, Calif.

\$3.00 FOR CARTOON IDEAS

RADIO-ELECTRONICS prints several radio cartoons every month. Readers are invited to contribute humorous radio ideas which can be used in cartoon form. It is not necessary that you draw a sketch, unless you wish.

Address

RADIO-CARTOONS, RADIO-ELECTRONICS
25 West Broadway, New York 7, N. Y.

TOP VALUE

from **TELEMATIC**

The NEW TV
Add-A-Set



The Only TV
Transformer-Coupler
in the Low-Priced Field

Model AM-74
\$2.00 List

Operate two TV sets with one Antenna

- ✓ All VHF Channels
- ✓ Low-Loss
- ✓ Sturdy

TELEMATIC... Leader in TV Couplers, offers the most complete line, including VHF & UHF.

Model AM-20
The superior two-set coupler incorporates a balanced transformer network. Highly recommended in fringe areas. Works where others fail.



Model AM-44
Four-receiver coupler built with a high efficiency transformer on a magnetic core. Extremely efficient.

Model AM-62
Two-set TV Coupler features 2-stage transformer inductive coupling. Top seller.

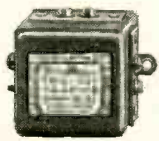

Write for catalog.
Prices slightly higher west of the Rockies

9 Joralemon St., Brooklyn 1, N. Y.

PEOPLE

Rives was formerly manager of Technical Military Liaison for G-E.

John E. Martin was named director of research for the Gabriel Co., Cleveland, Ohio. He was previously a senior staff member of the company. He will make his headquarters at the Gabriel Laboratories Division in Needham Heights, Mass., where he will supervise electronic research and development of various Gabriel products.



J. E. Martin

Harold Blumenthal, sales manager of the Manufacturer Division of Shure Bros., Inc., Chicago microphone manufacturer, was given added responsibilities as export manager.



H. Blumenthal

R. N. Stoddard, former Midwestern regional manager of the Westinghouse Electronic Tube Division, was appointed to the newly created post of headquarters assistant to the general sales manager at Elmira, N. Y. John G. Thompson, former product manager of cathode-ray tubes at Elmira, succeeds Stoddard as Midwestern regional manager.

C. G. Barker, former vice president of Magnecord, Inc., joined the National Co., Malden, Mass., as distribution manager. In his new position he will co-ordinate and direct activities of the company's representatives and establish basic distribution policies.



C. G. Barker

The National Co. designs and manufactures communications receivers and transmitters and electronic components for government, industry and amateurs.

Obituaries

Joseph A. Burstein, president of Burstein-Applebee, Kansas City distributing firm, died in Menorah Hospital recently at the age of 58.

Paul Hetenyi, retired head of Solar Manufacturing Corp., and a consulting engineer for Aerovox Manufacturing Co., New Bedford, Mass., died in his home in New York City recently.

Personnel Notes

... William C. Brown, manager of the Raytheon Magnatron Research and Development Laboratories, Waltham, Mass.; Gordon S. Humphrey, executive assistant to the general manager of the Equipment Division; and William T. Welsh, sales manager of the Power Tube Division, were named assistant vice-presidents of Raytheon.

STAN-BURN SPARKS

CATHODE RAY TUBE SPECIALS

ONE YEAR GUARANTEE		STAN-BURN	
G.E.		STAN-BURN	
★ STP4	544.95	10BP	\$11.00
★ 7JP4	17.10	12LP4A	14.20
★ 10BP4A	19.25	14CP4	17.00
★ 10FP4A	24.00	15DP4	19.50
★ 12KP4A	27.10	16AP4	21.60
★ 12LP4A	21.70	16FP4	19.60
★ 12UP4B	28.25	16GP4	21.60
★ 14CP4	24.50	16HP4A	22.60
★ 16AP4A	30.95	16DP/HP4	19.60
★ 16DP4A (N.U.)	28.20	16DP/HP4A	20.60
★ 16GP4A	31.25	16KP4	18.50
★ 16KP4/16RP4	28.20	16LP4	20.60
★ 17BP4A	23.90	16LP4A	21.60
★ 17CP4	23.90	17BP4	18.50
★ 19AP4A	39.45	17CP4	21.60
★ 20CP4	32.50	19AP4	23.90
★ 20LP4	27.50	19AP4A	25.90
★ 21EP4A	37.35	20CP4	29.50
★ 24AP4 A	78.50	21EP4	32.50

ANTENNA SPECIALS

	1-5	6 or more
★ RED DOUBLE "V" Antenna	2.19	1.78
★ 10 ELEMENT CONICAL	2.98	2.79
★ Doweled Inserts	4.25	3.25
★ Folded Hi Straight Low Quick Rig	4.95	3.75
★ 1/2" elements	.79	.69
★ WINDOW CONICALS	1.39	1.50
★ MASTS	1.69	1.49
★ 5 FOOT SWEGDED	\$9.95	M Ft.
★ 10 FOOT PLAIN	11.95	M Ft.
★ NEPCO MASTS	35.00	M Ft.
★ 42 Mil		
★ 55 Mil. 300 OHM		
★ 72 OHM COAXIAL		

★ 12" Heavy Slug Speaker... Special \$3.98
★ CHASSIS 630 TECH-MASTER Model C-30 with Cascode Tuner... **\$149.50**
★ OPEN FACE CABINET... \$42.00

WIRE RECORDERS IN STOCK

★ PENTRON—Model 9T3C—2-speed Tape Recorder... Write for Price.
★ RADIO CRAFTSMAN
★ Model C400—Hi Fi Amplifier... Net \$42.90
★ Model C10—AM-FM Tuner... Net 131.50
★ Model C500—Williamson Amplifier... Net 99.50
★ We also carry MASCO—BOGEN—PILOT, etc. Amplifiers—Pre-Amps, FM Tuners and WEBSTER Tape Recorders.

★ 6"x9" PM SPEAKER	\$3.98
★ 7" PM SPEAKER	3.98
★ 77J1 G.E. Flyback	1.98
★ 70" Yoke	1.98
★ 630 Vert. Output Upright	1.29
★ 630 Vert. Output Potted	1.89
★ 630 Vert. Blocking Osc. Xform.	1.95
★ CASCODE TUNERS	17.95
★ STANDARD TUNERS	14.95
★ DUMONT 21.25mc	

★ AUTHORIZED DISTRIBUTORS for: General Electric, Kenrad, Tung-Sol, National Union, De Wald, Regal, Automatic and General Motors.

AUTOMATIC CUSTOM-BUILT RADIOS for Plymouth, Ford, Chevrolet and many others, always in stock. We carry a complete stock of HI-FIDELITY and SOUND EQUIPMENT. Send us your requests. We also carry a complete line of popular makes of Radio tubes at 50/10% discount. Also many other special parts and transmitting types, and all electronic parts and equipment at lowest prices. Send us a list of your requirements for prompt quotations. Terms: 20% with order. Balance C.O.D. All prices FOB NEW YORK Warehouse. Minimum order \$5.00.
★ Write for our latest price list and Hi-Fi Catalog to Dept. RE-1

STAN-BURN RADIO and ELECTRONICS CO.
(C.B.S. THEATRE BLDG.)
1697 BROADWAY • NEW YORK 19, N.Y.

RECORDING TAPE (Plastic Base) 40% OFF (NEW)

WASHINGTON, D.C. WHERE ELSE WOULD THERE BE MORE RED A TAPE?
Magnetic
• 1200 ft. plastic tape with plastic reel included...
• Each reel individually boxed.
• Choice of nationally famous top quality brands such as:
Vestax (2806) 3.20; Reeves (SPN-12 3.20; Audio (1251) 3.25; Scotch (111-A) 3.25; Panacoustic (711-A) 3.25; Irish, Professional grade (211 RPA) 3.30.
• FREE—7.95 Pentron tape carrying case included with purchase of 12 new tapes.

USED RECORDING TAPE (PLASTIC BASE)

1.99	for 7"—1200 foot
.99	for 5"—600 foot
.59	for 4"—300 foot
.29	for 3"—150 foot
Plastic reels included with all above sizes	
New empty plastic reels in boxes for easy labeling, 3" 10c; 4" 22c; 5" 24c; 7" 30c; 7" Professional reel (2 1/4" hub) 45c ea. EMPTY BOXES: 3" 3c; 4" 5c; 5" 5c; 7" 10c ea.	

We carry all brands of new tape, recording blanks, tape recorders, etc., at low prices. PLEASE INCLUDE SUFFICIENT POSTAGE.
COMMISIONED ELECTRONICS CO.
2503 Champlain St. N.W., Washington 9, D. C.

... William A. Patterson, president of United Air Lines, was elected to the Westinghouse Board of Directors.

... J. J. Kahn and H. J. Hoffman, Machlett Laboratories, were named co-chairmen of the RETMA Membership Promotion Committee. J. B. Elliott, RCA, was reappointed chairman of the Sports Committee, and Fred D. Wilson, DuKane Corp., was reappointed chairman of the School Equipment Committee.

... J. E. Schlener was appointed merchandising manager for the Electronics Division of Sylvania, with headquarters in Woburn, Mass. He was formerly sales engineering supervisor.

... Robert C. Sprague, chairman of the Board of Sprague Electric Co., North Adams, Mass., was appointed by the Senate Armed Forces Subcommittee on Preparedness, to direct a full-scale study of hydrogen and atomic bomb defense.

... J. A. Frabutt was named general sales manager of Federal Telephone and Radio Co., a division of International Telephone and Telegraph Corp. He was formerly manager of sales to Government agencies.

... James J. Shallow, sales manager of Philco Distributors, Inc., of Philadelphia, was appointed general manager of the Accessory Division of Philco Corp.

... William H. Kelley was appointed to the newly created office of vice-president in charge of marketing for Allen B. DuMont Laboratories, Clifton, N. J. He was formerly a vice-president of Motorola.

... Alexander Nepo joined the electrical engineering staff of Littelfuse, Inc., Des Plaines, Ill. He was formerly with the Argonne National Laboratories.

... H. G. Boehm was appointed director of the International Division of P. R. Mallory & Co., Indianapolis.

... Ronald W. Argenta joined La Pointe Electronics, Rockville, Conn., manufacturer of Vee-D-X antennas and accessories, as art director and assistant advertising manager.

... Stanley W. Cramer was appointed acting manager of the Special Apparatus Division of Radio Condenser Co., Camden, N. J., succeeding Frank A. Cowgill who resigned because of ill health. Other Radio Condenser personnel appointments include Joseph S. Robb, director of engineering; Melvin V. Weiss, chief engineer of special apparatus and TV; and Jack Teaf, chief engineer of the Auto Tuner Division of the company.

... Virgil M. Graham, director of technical relations of Sylvania Electric Products, was elected a vice-president and member of the Executive Committee of the U.S. National Committee of the International Electrotechnical Commission.

END

NEW Gernsback Library Books

TV Repair Techniques—No. 50



Save time in servicing! Fourteen top technician-writers give you the benefit of their experience in recognizing, finding and quickly correcting the tough servicing problems which stump even the experts. 128 Pages. Over 100 illustrations. **\$1.50**

Radio & TV Test Instruments—No. 49



How to build just about every instrument needed for modern servicing. Includes unique chapters on how to make a servicing bench and carrying case. Each instrument was actually built, tested and used by the authors who designed them. 128 Pages. Over 100 illustrations. **\$1.50**

High-Fidelity—Design, Construction, Measurements—No. 48

An audio man's audio book! A new 3-way approach to getting top performance from a high-fidelity system. Written by 21 first rate audio writers. **\$1.50**

Radio & TV Hints—No. 47

Over 300 hints, gimmicks and short cuts designed to save you time in radio, TV, and audio work. Compiled from the experience of experts in the field. Illustrated. **\$1.00**

Other helpful Gernsback Library Books

- Television Technotes—No. 46 **\$1.50**
- Radio Tube Fundamentals—No. 45 **\$1.00**
- Basic Radio Course—No. 44 **\$2.25**
- Model Control By Radio—No. 43 **\$1.00**
- High-Fidelity Techniques—No. 42 **\$1.00**
- Public-Address Guide—No. 41 **75¢**
- Practical Disc Recording—No. 39 **75¢**

Publishers of

RADIO-ELECTRONICS

See your distributor—or mail this coupon

GERNSBACK PUBLICATIONS, INC., Dept. 14
25 West Broadway
New York 7, N.Y.

Enclosed is my remittance of \$ _____
Please send me the following books postpaid.

- 39 41 42 43 44
- 45 46 47 48 49 50

Name _____
(Please print clearly)

Street _____

City _____ Zone _____ State _____

Now...

multi-moded, all channel tele-beam antenna

For UHF or VHF or both... close-in or fringe... under any receiving conditions, the TELE-BEAM MULTI-MODED ANTENNA will guarantee your customers top reception on all channels.

Basic single Sabre Comet unit can be built up to meet any need:
Add snorkel for an increase on VHF highs, stack these for more on all VHF channels;
use diamond stacking bars for increase VHF and UHF gain;
add UHF reflectors to increase the UHF gain and directivity.

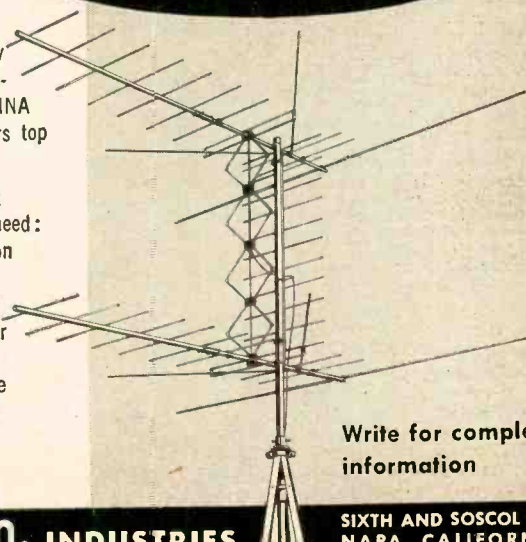

Write for complete information

tele-beam INDUSTRIES

SIXTH AND SOSCOL STS.
NAPA, CALIFORNIA

Train IN
Great COYNE shops
for big pay jobs

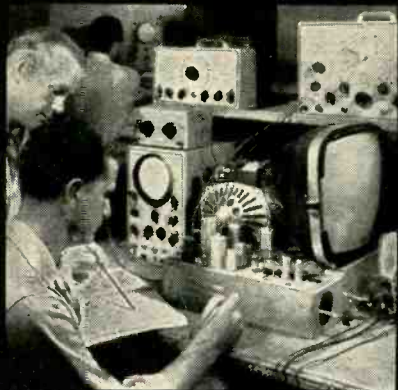

IN Television
-Radio



OR
Electricity
-ELECTRONICS

Learn on REAL EQUIPMENT!
In Best Equipped School of its
kind in U. S.

Prepare for your future NOW! Come to the Great Shops of Coyne. Get practical training in opportunity fields—TELEVISION-RADIO—ELECTRICITY—ELECTRONICS. Prepare for a better job in Industry or better service rating if drafted.

WE TRAIN YOU IN CHICAGO

At Coyne you learn on real, full-size equipment. Trained instructors show you how, then you do shop jobs yourself. No previous experience or advanced education needed.

Approved for Veterans

Finance Plan—Enroll now, pay most of tuition later. If you need part-time work to help out with living expenses while at Coyne, we'll help you get it. Special tuition plan for men of draft age.

FREE BOOK Clip coupon for Big Free Illustrated Book. No salesman will call. Act NOW.

COYNE



510S. Paulina St., Dept. 14-81H
Established 1899
APPROVED FOR VETERANS

B. W. COOKE, Pres.
COYNE School
510S. Paulina St., Chicago 12, Ill., Dept. 14-81H

Send FREE BOOK and full details on:

TELEVISION-RADIO ELECTRICITY

NAME

ADDRESS

CITY.....STATE.....

TUBE FAILURES

Dear Editor:

The information contained in "Tube Failures in TV Receivers" (November R-E) contains numerous inaccuracies. I run my own shop, and take on anything from Admirals to Zeniths. My experience has brought me in contact with about every TV set and brand of tube in common use.

In section 1 of the article, among tubes most likely to burn out, are listed the 5U4-G and 5Y3-GT. For every 20 of these tubes replaced in my shop, 19 are not burned out, but have failed due to dwindling emission. The other one will be an actual burnout.

Similarly, I can't recall seeing even one burned-out 6W4-GT anywhere, although I have replaced many gassy, short circuited or low-emitting 6W4-GT's.

In section 2, tubes most likely to become weak, my experience again conflicts with that of the author. I replace at least 20 low-emission 6SN7-GT's for each 6CD6-G; at least 30 low-emission 6SN7-GT's for each 6BG6-G.

Looking at section 2 from another angle, I find 6BQ6-GT tubes becoming "weak" just about 20 times more often than 6BG6-G's or 6CD6-G's. Likewise, "weak" 1B3-GT's and 1X2-A's are scarce as hen's teeth in these parts. The 1X2-A's I replace are almost invariably either burned out or short-circuited. Most 1B3-GT failures are burnouts, with rare cases of short-circuiting or gas. And how about the 12AU7? There's a tube which is right up with the worst of them in the matter of getting weak.

The author's failure to list the 6AU6 and 6AL5 among tubes most likely to burn out is astounding. I have no exact figures on these tubes, but I venture to say that out of every 100 burned-out (open heaters) tubes replaced in my shop, at least 75 or 80 are either 6AL5's or 6AU6's.

I write more in sorrow than in anger. Your magazine has consistently published useful, authentic information in the past, which I have used much to my advantage. What's the idea of printing this misinformation on what makes up just about 98% of tube failures in TV receivers?

H. A. HIGHSTONE

Santa Rosa, Calif.

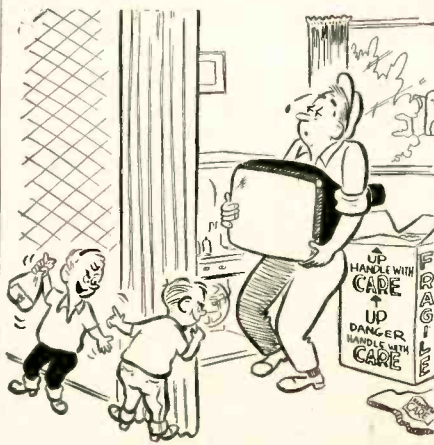

"Now?"

Glueck

SERVICEMEN

if you want the "low-down" on

COLOR TV

if you want to "fit into"

COLOR TV

you've got to get & read

PF INDEX

for January 1954!

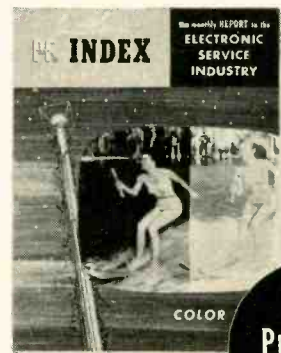

NOW
Published
MONTHLY

GET IT TODAY

AT YOUR PARTS DISTRIBUTOR

get it! only 25¢

RADIO-ELECTRONICS

to the

**E. E. or
PHYSICS GRADUATE**

with an interest
or experience in

**RADAR or
ELECTRONICS**

Hughes Research and Development Laboratories, one of the nation's large electronic organizations, are now creating a number of new openings in an important phase of operations.

Here is what one of these positions offers you

OUR COMPANY

located in Southern California, is presently engaged in the development of advanced radar devices, electronic computers and guided missiles.

THESE NEW POSITIONS

are for men who will serve as technical advisors to the companies and government agencies purchasing Hughes equipment.

YOU WILL BE TRAINED

(at full pay) in our Laboratories for several months until you are thoroughly familiar with the equipment that you will later help the Services to understand and properly employ.

AFTER TRAINING

you may (1) remain with the Laboratories in Southern California in an instruction or administrative capacity, (2) become the Hughes representative at a company where our equipment is being installed, or (3) be the Hughes representative at a military base in this country—or overseas (single men only). Adequate traveling allowances are given, and married men keep their families with them at all times.

YOUR FUTURE

in the expanding electronics field will be enhanced by the all-around experience gained. As the employment of commercial electronic systems increases, you will find this training in the most advanced techniques extremely valuable.

How to apply

If you are under 35 years of age and have an E.E. or Physics degree and an interest or experience in radar or electronics,

write to **HUGHES**

RESEARCH AND DEVELOPMENT LABORATORIES

Scientific and Engineering Staff
Culver City,
Los Angeles County, California

Assurance is required that the relocation of the applicant will not cause the disruption of an urgent military project.

JANUARY, 1954



"Boy... Have I Got the Lines!"

You, too, can have the lines—that meet your exact leadline conditions — whether you are a TV Set Dealer or Service Organization making the finest television reception installations, or a TV fan that demands sharp, "SNOW-FREE" pictures.

We specialize in the manufacture of television transmission lines — built with only one idea in mind: "THE FINEST TELEVISION RECEPTION!"

For UHF and VHF

"SHEATH-LEED" — the all-weather leadline for the toughest conditions: Salt spray in coastal areas; hot, humid weather, or for frosty, icy, wintry wind-whipping conditions which impose a severe tax... Pure Polyethylene Tubing encasing Standard GOODLINE AIRLEAD.



"GOODLINE" AIRLEAD—standard of leadline excellence —with 80% of the loss producing web removed. Correct impedance for sharp, "snow-free" pictures. Of pure polyethylene with flexible stranded copper-clad conductors. MANY IMPORTANT FEATURES.

NEW FULL-WEB "SHEATH-LEED" — the pure polyethylene of "SHEATH-LEED" and full characteristics of GOODLINE AIRLEAD — but NO PERFORATED WEB. No 20 (7 strand 28) copperweld wire in pure electronic golden clear polyethylene — with a pure silver-groy polyethylene sheath overall — for Maximum Weather Protection.

Don Good, INC.

SOLD BY LEADING JOBBERS & DEALERS

Send coupon NOW!
Get samples "in your hands"
—you'll realize why
Don Good Products make
the finest television
reception possible.

DON GOOD, INC. 1-12
1014 Fair Oaks Ave., So. Pasadena, Calif.
Please rush Samples and Complete Information covering Don Good Products.

Name _____
Street _____
City _____ State _____

**OVER 50,000
TECHNICIANS
HAVE LEARNED**

**HOW TO GET
THE MOST OUT
OF BASIC TEST
EQUIPMENT**

for A.M. - F.M. - TV



ONLY 40¢
103 pages. Invaluable information that will help you re-double the value of your basic test equipment.

**'SERVICING BY
SIGNAL SUBSTITUTION'**
A BEST SELLER FOR OVER 12 YEARS!
(NEW, UP-TO-DATE, 12th EDITION)

The Modern, Simplified, Dynamic Approach to Receiver Adjustment & Alignment Problems.

- ★ Nothing complicated to learn
- ★ No extra equipment to purchase
- ★ Universal... non-obsolete
- ★ Employs only Basic Test Instruments

Ask for "S.S.S." at your local Radio Parts Jobber or remit 40¢ in small stamps or coin directly to factory.

PRECISION APPARATUS COMPANY, INC.
92-27 HORACE HARDING BLVD., ELMHURST 4, N. Y.

NOW EICO® brings you
A LABORATORY SCOPE AT A PRICE YOU CAN AFFORD!



Now you can enjoy all the tremendous advantages of trouble-shooting with the greater speed, precision and visual meaning which only an oscilloscope gives you. With the EICO 5" Scope you can:

- Visually align TV, FM and AM sets
- Visually signal trace and trouble-shoot every stage of any electronic device
- Visually analyze complex waveforms

..... All without disturbing circuits

425K 5" Push-Pull Scope KIT \$44.95. Wired \$79.95.

NEW 3 PROBES make 3 INSTRUMENTS of your EICO Scope

DEMODULATOR PROBE KIT \$3.75. Wired \$5.75 — For signal tracing every stage of TV, FM and AM sets.
 LOW CAPACITY PROBE KIT \$3.75. Wired \$5.75 — For broad bandwidth and high impedance circuits.
 DIRECT PROBE KIT \$2.75. Wired \$3.95 — For voltage and current measurements and general analysis.

Special introductory price, set of three PROBE KITS \$9.95. Wired \$14.95

Compare these specifications with scopes selling at many times the EICO economy price!

- Push-pull Vert. & Hor. amplifiers
- Full-screen V & H centering controls
- Intensity (Z-axis) mod.
- 6.3 volt AC, 60 cps test signal output
- Direct connections to deflection plates
- V & H Freq. Resp: 5 cps — 500 kc; usable to 2.5 mc.
- V Sens: .05 to .1 volts rms/inch
- V & H input imp: 1 megohm
- Multivibrator Sweep Generator Range: 15 cps — 75 kc
- Tubes: 2-5Y3, 2-6J5, 3-6SN7, 1-5" CRT.

EICO® See this amazing Scope value at your jobber today. Write NOW for FREE Catalog SC-1 describing the complete EICO line. Turn to our full-page ad on page 32 of this magazine.

ELECTRONIC INSTRUMENT CO., INC.
 84 Withers Street, Brooklyn 11, N. Y.

Concord Catalog

It's Got
EVERYTHING

- STANDARD Lines
- Special Buys

FREE!

SENSATIONAL SELF POWERED 2 WAY PHONE SYSTEM \$4.87 per Set

A MUST FOR EVERY SERVICEMAN or MECHANIC

Extremely sensitive 2 way phone system will operate with telephone like clarity over distances of up to one mile. Phones made of rugged, shockproof Dow Styron with self-contained 1½ Volt flashlight battery. Battery life approx. one year. Has full size All metal parts 24 carat gold plated. Complete with push to talk switch, spring clip-conductor twisted pair. Uses regular two of the most sensational service, office or batteries. Complete with Two conductor twisted pair weatherproof wire for above. . . . 2¢ per ft 100 ft. \$1.50

CONCORD RADIO, 54 Vesey St., N. Y. 7, Dept. C-41

Please send . . . sets of phones at \$4.87 ea.
 Enclosed find \$. . . in complete payment. Minimum 20% deposit with C.O.D.
 Send new 1954 CONCORD CATALOG!

NAME _____
 ADDRESS _____
 CITY _____ ZONE _____ STATE _____

Concord Radio
 55 Vesey Street, New York 7, N. Y.
 Phone DLgby 9-1132

CLEAR TV PICTURE

119 MILES FROM STATION



WITH A **WINPOWER** TV TOWER

Eliminate tower-mounting headaches. Insure better reception and fewer service calls with America's Lowest Cost TV Tower.



Adapter locks mast in position or serves bracket for rotor.

"All-Angle" feet fits any roof.

5' or 10' HEIGHT

DEALERS PROFIT TWO WAYS

1. One man erects a neat, firmly supported antenna without special tools. Towers are light weight easy handling — individually packaged. Reduces objectionable guy wires.
2. Increase television sales with these permanent tower installations. Raise antennas to correct height with mast adapter. Reception goes up — service calls go down.

WRITE FOR PROFITABLE DEALER PLAN

WINPOWER
 NEWTON, IOWA U.S.A.

LIE DETECTOR

Dear Editor:

I recently read your article "Electro Psychometer" in the May 1953 issue of RADIO-ELECTRONICS. I would like to call attention to the following:

If a sensitive galvanometer is connected in series with the hands, it will indicate a current flow. The current flow will increase, if through an effort of will—not quality of thought—the experimenter exerts pressure on the electrodes. It will also increase, if the human body becomes a center of EMF.

This can be verified by a simple experiment. Hold the prods of a sensitive a.c.-d.c. voltmeter—one against a radio chassis ground, and the uninsulated end of the other, with the fingers. The d.c. reading will be small, but I have read about 5½ volts a.c.

The voltage is under the control of the subject. Wearing of rubber, insulated soles decreases the voltage.

It thus becomes apparent that electronic devices used as lie detectors are subject to error.

What Humanity needs, is not a lie detector—lying is a virtue today—but an eradicator for the causes that lead man to crime and the necessity for hiding his offense—first against himself, and then against his fellow man.

JEAN G. LAMOTHE

Charlotte Amalie

Saint Thomas, U. S. Virgin Islands

(While we have not made any experiments with self-generated electricity in the human body, we fell short in not pointing out that devices like the "Electro Psychometer" which measure the body's resistance are not reliable indicators of the subject's veracity. They measure emotion, not guilt, and a nervous but innocent subject may run a higher score than a callous but guilty one. But the devices are fine for entertainment at a party!—*Editor*) END

CORRECTIONS

The Geiger Counter article referred to in our correction notice on page 132 of the November, 1953, issue should have read "page 119 of our September issue." Instead, it was erroneously stated to have appeared in October. The corrected notice follows:

We have been informed by Amperex Electronic Corp. that the 1N tube recommended for the simple Geiger counter described on page 119 of our September issue is no longer obtainable. A tube with closely parallel characteristics is the 75N. It is slightly larger than the 1N, and is rated at 700 volts instead of the 1N's 600.

The 75NB3 is electrically identical with the 75N, but uses a pee-wee 3-pin base. If construction details are slightly modified, this might be a more convenient tube.

The 6V6 cathode biasing resistor in the Junior Golden Ear Amplifier (page 55 of the November, 1953, issue) was erroneously given as 470 ohms in the diagram and parts list. The correct value for the 6V6 cathode resistor should be 250 ohms to develop the 19 or 20 volts of bias required for proper operation. The resistor should be rated at 5 watts or more. We thank the author, Joseph Marshall, for this correction.

JANUARY, 1954



TEST EQUIPMENT
for AM, FM, and TV

KITS and
FACTORY WIRED

**VACUUM TUBE
VOLTMETER**

A rugged, accurate VTVM with 4½" meter. Has 15 different ranges, plus zero-center adjustment for TV and FM alignment.

Model 221-K Complete Kit..... \$25.95
Model 221 Factory Wired..... 49.95

- 1% multiplier resistors for extreme accuracy
- AC and DC ranges: 0-5, 10, 100, 500, and 1000 volts
- Measures up to 30 Kilovolts with HVP-1
- Input DC impedance: 26 megohms
- Measures up to 200 mc with P-75 Probe
- .2 to 1000 megohms in 5 ranges
- Audio and gain measurements directly in db
- Stable, dual-triode bridge circuit
- Dimensions: 9½ x 6 x 5", Ship. Wgt. 10 lbs.

**VACUUM TUBE
VOLTMETER**

Identical in design, circuitry and performance to the Model 221, but equipped with a large 7½-inch meter for greater visibility and accuracy. Dimensions: 13¼ x 9 x 6".

Model 214-K Complete Kit..... \$34.95
Model 214 Factory Wired..... 54.95

**RF PROBE
for VTVM**

Germanium crystal probe for visual RF signal tracing and measurements to over 200 mc. Extends range of any VTVM.

Model P-75-K Complete Kit..... \$3.75
Model P-75 Factory Wired..... 5.95

**HIGH VOLTAGE PROBE
for VTVM**

Designed and insulated for safety and versatility. Extends range of any VTVM or voltmeter to 30,000 volts. Has lucite head, large flash-guards, multi-layer processed handle, and interchangeable ceramic multiplier to match your instrument.

Model HVP-1 Factory Wired only..... \$6.95

HARVEY
ALWAYS HAS IT... IN STOCK
for IMMEDIATE DELIVERY

OSCILLOSCOPES
5" and 7"

Laboratory-precision instruments at lowest cost... extra sensitivity, greater range, and other features for fast, accurate, servicing. Employ steel chassis and cabinets for minimum external interference.

7" Push-Pull 'SCOPE

Model 470-K Complete Kit..... \$79.95
Model 470 Factory Wired..... 129.50

- Push-pull vertical and horizontal amplifiers
- Vertical response: 10 cycles to 1 mc ± 2 db
- Square wave response to 100 kc
- Horizontal response absolutely flat from 10 cycles to 200 kc
- Vert. sensitivity: .01 rms volt/inch
- Hor. sensitivity: .3 rms volt/inch
- Sweep range: 15 cps to 100 kc
- Internal voltage calibrator
- Direct readings of peak-to-peak voltages
- Variable phasing control for internal 60 cycle sweep
- Z-axis modulation
- Available outputs: 60-cycle sine wave, and sawtooth from sweep oscillator
- Other features include: Retrace blanking and control of trace expansion trace position to 1.5 times full screen
- Dimensions: 10 x 15 x 15", Ship. Wgt. 32 lbs.

5" Push-Pull 'SCOPE

Model 425-K Complete Kit..... \$44.95
Model 425 Factory Wired..... 79.95

- Push-pull vertical and horizontal amplifiers
- Vertical sensitivity: .05 to .1 rms volts/inch
- Useful response from 5 cps to 500 kc
- TV-type multivibrator sweep generator
- Stable, accurate sweep range: 15 cps to 75 kc
- Direct connection terminals to CRT plates for measuring % modulation and voltage amplitude
- Dual controls for positioning trace on screen
- Dimensions: 8½ x 17 x 13", Ship. Wgt. 29 lbs.

**RF PROBE
for 'SCOPE**

Germanium crystal probe for visual RF tracing and measurements to over 200 mc. Extends range of Model 425, or any other 'scope.

Model P-76-K Complete Kit..... \$3.75
Model P-76 Factory Wired..... 5.95

NOTE: Prices Net, F.O.B. N. Y. C. Subject to change without notice.

HARVEY RADIO CO., INC.

103 W. 43rd Street, New York 36, N. Y. • JUDSON 2-1500

You need this tool!

MICRO CIRCLE CUTTER

Cuts holes in steel panels. Has famous MICRO fine size adjuster.

Ask your Distributor
PRECISE MEASUREMENTS COMPANY
942 Kings Highway, Brooklyn 23, N. Y.

TV GLO-TEST
The answer to the T.V. serviceman's prayer.

An extremely compact, all purpose T.V. tester, that almost talks. TV GLO-TEST was designed by T.V. instructors; men who know what is needed for fast and accurate servicing. In actual servicing tests it was proven that TV GLO-TEST can find trouble much easier and faster than many other common methods. By the liberal use of miniature components TV GLO-TEST is kept small in size with no loss in overall efficiency or accuracy. The price has been kept so low that all T.V. servicemen can afford TV GLO-TEST. Its cost is much lower than almost any one of the many instruments it replaces. One or two service jobs can pay for TV GLO-TEST. The instrument is more rugged than an ordinary VTVM. TV GLO-TEST comes complete with instruction book, explaining 50 USES of the instrument plus a trouble shooting guide. A few of the 50 USES are: Pixtube tester, low and high range voltmeter up to 50kv, with accuracy comparable to VTVM. Condenser tester, Signal tracer, Signal generator, tests all circuits and components. See your dist. or order direct. New low price \$12.50.

\$3.00 FOR CARTOON IDEAS

RADIO-ELECTRONICS prints several radio cartoons every month. Readers are invited to contribute humorous radio ideas which can be used in cartoon form. It is not necessary that you draw a sketch, unless you wish.

Address
RADIO-CARTOONS, RADIO-ELECTRONICS
25 West Broadway, New York 7, N. Y.

VIDEO SPECIALTIES INC.
4508 Firestone Blvd. South Gate, Calif.

WE HAVE THE
**World's Largest
Selection of
TV Antennas**

JOHN MILLER
"The Man Who Knows"



MILLER
TELEVISION CO.

We Make Antennas
For Any Reception Condition

Why stock antennas from 10 manufacturers—when no matter what the reception problem is there's a Miller antenna that does the job. **WE OFFER THE WORLD'S LARGEST SELECTION OF TV ANTENNAS.** As the West's pioneer TV antenna manufacturer, builder of one million antennas since 1948, we guarantee you **TOP QUALITY** at a **REALISTIC PRICE.** Send for a complete catalog of the world's largest antenna selection.

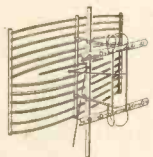

VHF MODEL FRM-200

Fringemaster

~~\$2495~~ \$2795

The king of the fringe area antennas. Adapted from the radar screen antennas employed so successfully by the military services. Broad band on all VHF channels. Amazing long distance reception (up to 150-175 miles).



Miller Television Co.
2840 Naomi
Burbank, Calif.

Write for Free Catalog!

Gives Complete Information on World's Largest Selection of TV Antennas. Just Off Press. Write for Your Free Copy Today!

Name _____

Company _____

Address _____

City & State _____

Any or all of these catalogs, bulletins, or periodicals are available to you on request direct to the manufacturers, whose addresses are listed at the end of each item. Use your letterhead—do not use postcards. To facilitate identification, mention the issue and page of **RADIO-ELECTRONICS** on which the item appears. All literature offers void after six months.

ANTENNA BOOKLET

LaPointe's new 30-page well-illustrated pocket-sized booklet describes their entire Vee-D-X line of u.h.f. and v.h.f. antennas and accessories, including 36 products, headed by the company's new antenna rotator.

Free on request to LaPointe Electronics, Inc., Rockville, Conn.

RELAY DATA

Davis Electric's *Decohm* products are described in a 3-color booklet recently issued by that company. Complete technical data on various molded-coil type open relays, hermetically sealed canister-type relays, and television deflection yokes is given.

Available free from the Davis Electric Co., 230 N. Spring St., Cape Girardeau, Mo.

TV ACCESSORIES

Tele-Matic has issued a 28-page catalog describing their TV accessory and antenna line. Included on the illustrated loose-leaf sheets are wave traps, filters, switches, transformers, antenna couplers, u.h.f. and v.h.f. antennas, a TVI analyzer, and a u.h.f. booster.

Gratis from Tele-Matic Industries, Inc., 1 Joralemon St., Brooklyn 1, N. Y.

HIGH FIDELITY

Admiral's *What You Should Know About High-Fidelity* is an attractively illustrated 12-page booklet discussing the how, why, and what of high quality reproduction in nontechnical language.

10¢ in stamps or coin from the Advertising Dept., Admiral Corp., 3800 Cortland St., Chicago 47, Ill.

VIDICON BOOKLET

Technical information on RCA deflection-circuit components for use with the small television camera tube, the 6198 vidicon, is supplied in a new 14-page booklet. Recommended circuits are shown in a 6-page application section.

Single copies available free on request to RCA Tube Department, Commercial Engineering, Harrison, N. J.

GENERAL CEMENT CATALOG

G-C's 64-page, 2-color catalog gives detailed descriptions, specifications, and prices of their complete line of radio, TV, and electronic products. All products are listed by types in an index for quick reference. More than 3,000 items in over 150 classifications are included.

Request Catalog No. 156 from General Cement Mfg. Co., 904 Taylor St., Rockford, Ill.

CORRECTION

Temples of Tone, the high fidelity brochure described last month, is not available direct from Electro-Voice, Inc. as stated, but may be obtained from local Electro-Voice distributors.

INDUSTRIAL TELEVISION

ITV is a new and growing phase of TV and will provide exciting opportunities for service technicians.

Write to us for information concerning a new inexpensive instruction series that teaches you commercial equipment as well as data on how to construct your own low-cost camera to learn circuit techniques.

Write for information or send \$1.00 for sample lesson. No obligation and money will be refunded if not satisfied.

EDWARD M. NOLL

Box 94, Hatboro, Pa.

OUTSTANDING VALUES!



CONDENSER TESTER

• One of our best sellers! Useful, versatile laboratory item, in kit form. Simple, and easy to build in less than an hour. Checks condenser leakage and continuity up to 8 megs. Will test any paper,

electrolytic, mica or oil capacitor from 50 mfd. to 50 mfd. Self-contained power supply and neon bulb indicator with socket and bezel. Drilled metal cabinet. Complete instructions and diagrams included with each kit. Only **\$5.00.**

325-0-325 at 225 ma. 6.3 at 5A, 5V at 3A. Pri. 115V; 60 cy. AC. Size, 4 1/8" x 4 1/8" x 3 7/16".
Only **\$6.95 ea.**

350-0-350 at 300 ma. 6.3 at 4A, 6.3 at 8A, 5V at 3A. Pri. 115V, 60 cy. AC. Only **\$7.95 ea.**

350-0-350 at 350 ma. 6.3 at 10A, 5V at 6A. Pri. 115V, 60 cy. AC. Only **\$8.95 ea.**

450-0-450 at 200 ma. 5V at 3A, 6.3 at 5A. Pri. 115V, 60 cy. AC. In shielded case. Only **\$8.90 ea.**

920-0-920 or 710-0-740 AC at 200 ma. Pri. 115V, 60 cy. AC. Upright shielded case. Excellent for 807's.
Only **\$10.80 ea.**

Isolation transformer. Useful for AC-DC supplies, etc. Pri. 117V. Sec. 150V AC at 25 ma. Also, 6.3V at 1/2 amp. Only **\$1.80 ea.**

Isolation transformer. Pri. 115V. Sec. 117V at 50 ma. Also, 6.3V at 2 amps. Only **\$2.79 ea.**

2.5V at 10A AC. 10,000V insulation. Pri. 115V, 60 cy. AC. Only **\$3.39 ea.**

OFFENBACH-REIMUS

1564 Market Street, San Francisco, Calif.

OSCIL-O-PEN

Extremely convenient test oscillator for all radio servicing; alignment. • Small as a pen • Self powered • Range from 700 cycles audio to over 600 megacycles u.h.f. • Output from zero to 125 v. • Low in cost • Used by Signal Corps • Write for information.

GENERAL TEST EQUIPMENT
38 Argyle Ave. Buffalo 9, N. Y.

TUBE MANUAL

Tung-Sol has issued the 19th edition of its *Electronic Tube Characteristics Manual*. The first 166 pages contain all the technical information about receiving and cathode-ray tubes required by engineers and service technicians for everyday use. Six different colored pages are used to separate the many charts, diagrams, and technical data for easy reference.

The manual is distributed through Tung-Sol tube wholesalers.

TRANSISTOR MANUAL

CBS-Hytron has issued an 8-page illustrated booklet as an introduction to transistor theory, data, and applications. Both point-contact and junction transistor operation are explained by vacuum-tube analogy.

Among the nine basic transistor applications are hearing-aid and radio receiving circuits, and a circuit for use in switching applications.

Gratis from CBS-Hytron, Danvers, Mass.

SOUND CATALOG

Hudson's new 56 page 1954 high-fidelity catalog has a 3-page introduction on the meaning and methods of achieving high-quality sound. The booklet itself includes tuners, amplifiers, speakers, record changers, tape recorders, and cabinets, and is of interest to both music lovers and professional sound men.

Free on request from Hudson Radio & Television Corp., 48 W. 48th St., New York 36, N. Y.

AUDIO EQUIPMENT

Sun Radio's 1954 high-fidelity catalog is a 93-page, profusely illustrated booklet which features a compatibility chart of radio tuner and amplifier components and a 5,000-word article on the subject of planning a home music system. Phono equipment, tape recorders, tuners, amplifiers, loudspeakers, cabinets, and binaural equipment are described and illustrated.

Gratis from Sun Radio & Electronics Co., 650 Sixth Ave., New York 11, N. Y.

ANTENNA FOLDER

Wells and Winegard has issued a folder describing its complete antenna line. V.h.f. and u.h.f. antennas are included.

Free on request to Wells and Winegard, Burlington, Iowa.

ANTENNA MANUAL

A newly revised, 1954 edition of *TV Tenna Tips*, by Mandl and Noll, has been issued by Snyder. The 44-page pocket reference manual now includes an "Antenna Selector" section, with first, second, and third choices for each area.

Also included in the subject matter are the latest u.h.f. and v.h.f. data, Directronic antennas, Yagis, installation do's and don'ts, dimension guide, channel frequencies, helpful hints, and many other subjects relating to television antennas.

Free copies may be obtained by writing to Snyder Mfg Co., Philadelphia 40, Pa. END



PROFIT-WISE TV DEALERS

DON'T—Send 2 Men To Do A 1 Man Installation Job!

DON'T—Risk Costly Equipment On A Roof-top!

DO—Send 1 Man, A Pocket Meter* and

The NEW MOSLEY "ORIENTOR"

for FAST, ACCURATE ORIENTATION OF ANY UHF/VHF TELEVISION ANTENNA

If TV antenna orientation is a problem in your area, here is a piece of equipment that pays for itself every day it is used. It's the new MOSLEY "ORIENTOR"—a simple-to-use, compact and low cost device that enables the installer on the roof to know, instantly and unerringly, just what is occurring in the TV set.

HERE'S HOW THE "ORIENTOR" SAVES TIME AND MONEY...

- ✓ Permits ONE MAN To Do The Job Formerly Requiring Two!
- ✓ Makes Possible Use Of Low Cost, Portable VOM* To Read Relative Video Signal Strength!
- ✓ Eliminates Need For Extra Wires From Set To Roof!
- ✓ Use To Determine Best Lateral, Vertical and Directional Orientation Of Antenna!
- ✓ Aids In Determining If Transmission Line Is Functioning Properly!



Try it on your next installation job. You'll quickly see why the MOSLEY "ORIENTOR" has been termed "The TV Installers' Handiest Tool Since The Step-ladder...!"

THE NEW MOSLEY "ORIENTOR", includes dual isolation network units, ready-to-use leads for connecting unit to set without removing chassis and complete instructions. Catalog 903, Dealer Net, just \$7.50. Descriptive Folder, Form 903, Sent Upon Request.

The NEW MOSLEY "ORIENTOR"

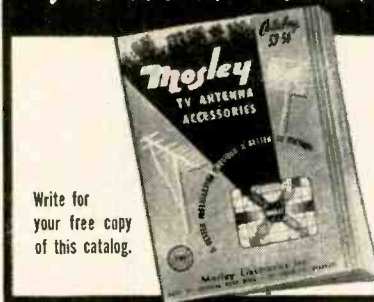

Write for your free copy of this catalog.



8622 St. Charles Rock Road St. Louis 14, Missouri

→ VALUABLE COUPON—SCOOP ←

AUTO RADIO FOOT CONTROL—List \$2.002 for \$0.99
TUBES—STD. BRAND 12SQ7 or 35Z52 for .99
VOL. CONTROLS—STD. BR. .5 Meg. W. SW3 for .99
CONDENSERS—40-40 Mfd. 150V2 for .99
CONDENSERS—20-20 Mfd. 150V3 for .99
LOOP ANTENNA—III GAIN (5"x8")3 for .99
I.F. COILS 455 KC (11 1/4"x2 1/2")3 for .99
OSC. COILS 455 KC (for 12SA7)4 for .99
BY PASS COND. KIT—18 Ass'd99
DIAL CORD KIT—100 ft. Ass'd. & 8 Springs99
GRILLE CLOTH—6 Ass'd. 6"x6" & 10 Knobs99
• COMBINATION KIT—All Above Items—Only	10.00

WITH THIS COUPON—ORDER AT ONCE
Write for Monthly Coupons and Bulletin
RADIO DISTRIBUTING CO., Sun Valley, Cal.

YOUR TESTER DAMAGED?

Let Douglas Repair It
Contractors to U.S. Government
Repairs and calibration by skilled craftsmen on all makes of Meters, SIG. Gens., Testers, etc. Prompt service. For immediate estimate send instrument by P. P. Ins. to
DOUGLAS INSTRUMENT LABORATORY
Electrical Instrument Repairers
176a Norfolk Avenue Boston 19, Mass.

FREE

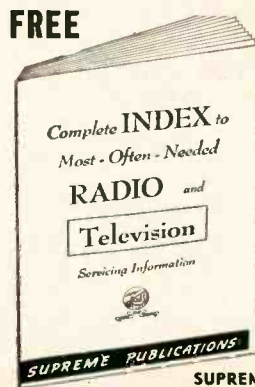

FREE

Write for your copy of Complete INDEX to all popular Supreme Publications radio and TV manuals. Free to readers of Radio-Electronics. This large Index will tell you just what models are included in all SUPREME "Most Often Needed" Radio and Television manuals. Used by 146,000 wise servicemen. Includes diagram hints. It's yours FREE, just send stamp for postage.
SUPREME PUBLICATIONS
1760 Balsam Rd., Highland Park, ILL.

Please mention **RADIO-ELECTRONICS** when answering advertisements

NEW

TELEVISION FUNDAMENTALS

Written by General Electric Co. experts, this book gives a simple presentation of basic TV principles that a radio technician must know to advance to TV service and installation work. The treatment is sound and theoretical, describing each element of the receiver from antenna to picture tube. Includes practical installation procedures, and trouble-shooting charts for quick spotting of receiver faults. By Kenneth Fowler and Harold B. Lippert, both of the General Electric Co. 524 pp., 444 illus., \$7.00.



Principles of TELEVISION SERVICING

Step-by-step information on all types of commercial receivers—how to install, service, and repair them. Shows how to do most testing with just three pieces of equipment: vacuum-tube voltmeter, oscilloscope, and alignment generator. Dozens of trouble-shooting charts... suggestions about going into a servicing business. By Carter V. Rabinoff, Dean; and Magdalena Wolbrecht, Vice-Pres., Amer. TV Lab of Calif. 560 pp., 375 illus., \$7.50

TELEVISION BROADCASTING

A practical manual for radio engineers, operations personnel, and others interested in the technical aspects of television broadcasting. Covers in detail the equipment, facilities, and techniques involved in the running of a television studio—topics such as lighting, staging, television recording, and color television equipment. By Howard Chinn, Columbia Broadcasting System. 700 pp., 180 illus., \$10.00

MUSICAL ENGINEERING

An interrelated engineering treatment of sound, speech, music, musical instruments, acoustics, and sound reproduction. By Harry F. Olson. 369 pp., \$7.00

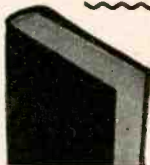

ELECTRONICS FOR COMMUNICATION ENGINEERS

Brings together carefully selected articles from *Electronics* on radio communication and broadcasting, television, and radar. By John Markus and Vin Zelnoff. 624 pp., \$10.00

HANDBOOK OF INDUSTRIAL ELECTRONIC CIRCUITS

Gives you 433 useful, time-saving industrial electronic circuits complete with descriptions of use and performance. By John Markus and Vin Zelnoff. 272 pp., \$7.50

10-DAY FREE EXAMINATION

McGraw-Hill Book Co., 330 W. 42 St., NYC 36

Send me book(s) checked below for 10 days' examination on approval. In 10 days, I will remit for book(s) I keep, plus few cents delivery, and return unwanted book(s) postpaid. (We pay delivery if you remit with this coupon; same return privilege.)

Fowler & Lippert—TV FUNDAMENTALS—\$7.00

Rabinoff & Wolbrecht—TELEVISION SERV.—\$7.50

Chinn—TELEVISION BROADCASTING—\$10.00

Olson—MUSICAL ENGINEERING—\$7.00

Markus & Zelnoff—ELEC. FOR COMM. ENGRS.—\$10.00

Markus & Zelnoff—HDBK. OF IND'L. ELEC. CIRCS.—\$7.50

(Print) Name.....

Address.....

City..... Zone..... State.....

Company.....

Position..... RE-1

This offer applies to U. S. only

HOW TO UNDERSTAND AND USE TV TEST INSTRUMENTS, by Milton S. Kiver. Published by Howard W. Sams & Co., Inc., Indianapolis 5, Ind. 8 1/2 x 11 inches, 147 pages. Price \$3.00.

Realizing that a craftsman's workmanship and efficiency may be considered a direct reflection of his knowledge and ability with the tools of the trade, the author has dedicated this book to a better understanding by the technician of TV servicing instruments.

Five chapters are devoted to detailed discussions of vacuum-tube voltmeters; AM, FM, marker, and cross-bar generators, oscilloscopes, special-purpose probes, voltage calibrators, field-strength meters, and other TV test equipment. The author shows schematics of typical test instruments and goes into considerable detail on each device, explaining each control and showing how and why it is used.

The sixth chapter discusses the use of the various instruments in aligning FM and TV receivers, and the seventh chapter describes the use of test instruments in solving difficult TV receiver servicing problems.—RFS

TELEVISION TUBE LOCATION GUIDE (TGL-4) Compiled and published by Howard W. Sams & Co., Indianapolis 5, Ind. 5 1/2 x 8 1/2 inches. Approximately 190 unnumbered pages. Price \$2.00.

This is the fourth volume of *Television Tube Location Guide*. It brings to the TV service technician drawings showing the location of each tube in relation to the others and the major above-chassis components in 173 different chassis used in a far greater number of models. These charts enable the technician to locate, remove, and replace tubes which cannot be seen without pulling the chassis. Each socket diagram shows the location of the blank pin or key to simplify replacing tubes in sockets that cannot be seen from outside the cabinet.

Each layout shows the location of the fuse or fuses and lists the rating and data on the circuits which they protect. This enables the technician to determine if the defective circuit is protected by a fuse—information that can be exceedingly helpful in isolating the source of trouble.

Also included with each layout chart is a listing of typical circuit-failure symptoms and the tubes that are likely to cause circuit failure. This aids in making a preliminary diagnosis of the trouble without removing the chassis.—RFS

MOST-OFTEN-NEEDED 1953 RADIO DIAGRAMS AND SERVICING INFORMATION. Compiled by M. N. Beitman. Published by Supreme Publications, 1760 Balsam, Highland Park, Ill. 8 1/2 x 10 3/4 inches, 192 pages. Price \$2.50.

Volume 13, the 1953 edition of the *Most-Often-Needed Radio Diagrams* series, is an inexpensive source of original manufacturers' schematics, align-

Brach... exclusives! 3-D line

FREE! write for 3-D counter display with glasses

uhf rhombic antenna No. 406

universal uhf-uhf indoor antenna No. 482

Brach Manufacturing Corp.
Div. of General Bronze Corp.
Since 1906 200 CENTRAL AVE., NEWARK 3, N. J.

D develops highest gain
D doesn't flicker
D designed for service

D diversiform peaks on 82 TV channels
D devised eccentric joint does it all
D designed to reduce uhf skin losses

ENJOY 3 COLOR TELEVISION FILTER SCREEN NOW

Changes dull eye-straining black and white pictures into beautiful color tones. Seconds to attach. No tools used. Helix eliminate glare and snow in fringe areas. Order direct. Send \$1 for screen size up to 16". \$1.25 size 17". \$1.50 size 20". \$2 size 21". \$2.50 size 24". \$3 size 27". (Also available are single solid color screens in blue, green, or amber.) Prices on solid color screens are 10% less. We pay postage except on C.O.D. orders. Satisfaction guaranteed. Inquiries from dealers also welcomed.

Zingo Products, Johnstown 13, New York

ARKAY

world's finest radio kits

Write for free Brochure

RADIO KITS, INC., 120 Cedar St., N. Y. 6

JUST OUT! the book that teaches you fast, expert service techniques

"AM-FM SERVICING SHORT-CUTS"

by Milton S. Kiver

Based on Actual Case Histories

shows you how to solve tough jobs **FAST**

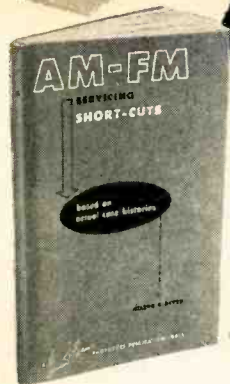

Pays For Itself on Your First Repair

This practical book describes a series of actual AM and FM service case histories, each presenting a specific problem about a specific receiver. The symptoms of the trouble are described and then followed by a step-by-step explanation of how the service technician localized and tracked down the defect. Finally, there is a detailed explanation of how this particular trouble can be tracked down and solved in any receiver.

The book is divided into ten sections, each of which deals with specific troubles, such as hum, oscillations, weak sets, etc. The handy index makes it possible to refer instantly to the specific troubles and solutions discussed in the various case histories. The discussions which follow each case history are invaluable—they explain how to apply the proper time-saving techniques to any AM or FM receiver. Here, in one handy volume, is the successful experience of experts—to make your service work easier, quicker, more profitable. 152 pages, 5½ x 8½".

The Book that Pays for Itself on a Single Service Job

ORDER TODAY

ORDER RK-1 ONLY \$1.50

HOWARD W. SAMS & CO., INC.

Order from your Parts Jobber today, or write to Howard W. Sams & Co., Inc., 2205 East 46th St., Indianapolis 5, Ind.

My (check) (money order) for \$..... enclosed. Send.....copy(ies) of "AM-FM Servicing Short-Cuts" (\$1.50 ea.)

Name.....

Address.....

City.....Zone.....State.....

ment data, dial-stringing diagrams, voltage measurements, and trouble-shooting hints covering about 400 different AM, AM-FM receiver models, and record players and record changers made by leading manufacturers. Although this compilation cannot possibly have the coverage and detailed data of larger service manuals, its low cost and small size give it a place on the work-bench of small shops and part-time service technicians.—RFS

TELEVISION INTERFERENCE (Third edition). Compiled and edited by Philip S. Rand. Published by Remington Rand, Inc., New York, N. Y. 8½ x 11 inches, 107 pages. Single copies obtainable for 25¢ each from Anne Smith, Remington Rand, Inc., 315 Fourth Avenue, New York 10, N. Y.

This third edition is a complete anthology on TVI containing reprints of full-length articles on the subject which appeared in many trade and technical publications. Readers will find this edition consists almost entirely of material published since the printing of the second edition. Of the 30 articles, 8 were published originally during 1953, 13 during 1952, and the remaining 9 between November, 1951, and December, 1948.

In addition to the articles, there is a bibliography listing 100 articles and short items on TVI which appeared in *QST* magazine. Instead of outlining the contents of each article, this reviewer feels that it is sufficient to state that this book should be read by every amateur radio operator, TV service technician, broadcast station engineer, and operator of diathermy and radio-frequency heating apparatus.—RFS

SMALL TRANSFORMERS AND INDUCTORS, by K. A. MacFadyen. Published by Chapman & Hall, Ltd., London, England. 6 x 8½ inches, 237 pages. Price \$8.25.

Of all the components in radio or TV, transformers seem the most mysterious. There are so many different types and they appear to have so little in common. This book shows that all kinds of transformers, whether audio, power, r.f., instrument, pulse, or h.f., are based on the same principles. Charts, tables, and formulas show how to design and use coils and cores.

The book begins with circuit theory; both electric and magnetic. The author discusses the essentials of an ideal transformer: one with no losses, no leakage. From this hypothetical standard, he proceeds to describe "imperfections" that are always present—distributed capacitance, copper and core losses, leakage reactance, and so on. We find that each imperfection has the same result as a hypothetical network added to the ideal standard.

Other chapters describe the measurement of inductance, the design of power and h.f. transformers, and the principles of pulse transformers. The last chapter contains much data on iron cores and coils.—IQ **END**

FOR BEST TV RECEPTION IN ANY AREA...

use these practical aids



Mandl's Television Servicing

This famous service guide shows you, in the clearest, most practical way, how to locate and correct flaws in TV receivers and how to improve reception in fringe areas or difficult locations. You'll see how each unit in the receiver works, how it is set up by the different manufacturers, what flaws may occur in it, how these show up on the TV screen, and how to correct them. A master trouble index makes it easy to spot the cause of trouble and turn directly to the instructions for correcting it. The latest improvements, the hard-to-find troubles, and every other detail that can help you get the most out of a TV set at any location are included.

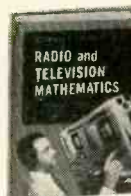

Fischer's Radio & TV Mathematics

This book makes it EASY to use the formulas and work the calculations essential for the best results in radio and TV servicing or construction. Conveniently arranged under topics such as focus and centering, antenna power, and 400 others, are the formulas to use, the numerical values to substitute and step-by-step solutions to all common problems involving math. A quick, accurate calculation is the shortest and best route to the results you want in TV. This book shows you how to make such calculations.



Noll's TV for Radiomen

One of the most widely used of all books on TV theory and construction, this book tells you in simple, non-mathematical terms the function of every TV element, and gives practical instruction on installation, alignment, and adjustment. Here is THE BASIC knowledge you need for any work on TV.

SEE THEM ON APPROVAL

The Macmillan Company, 60 Fifth Ave., N. Y. 11

Please send me the books checked below. I will either remit the full price plus small delivery charge, or return the books in ten days. (SAVE: Send check or money order and we pay delivery charge.)

- Mandl's TV Servicing, \$5.50
- Radio & TV Mathematics \$6.75
- TV for Radiomen \$8.00

Signed.....

Address.....

This offer good only within continental limits of U.S.A.

**REAL SALE TUBE
WHOLESALE PRICES!**

STANDARD BRANDS

- FULLY GUARANTEED
- INDIVIDUALLY BOXED
- FIRST QUALITY

Tube Orders Over \$15.00, with full remittance, PREPAID to you in U.S.A.

Type	Net	Type	Net	Type	Net
0A2	.90	6AV5GT	1.10	12AY7	1.90
0A3/VR75	1.05	6AV6	.48	12B4	.98
0B2	.80	6AX4GT	.72	12B4A	.65
0C3/VR105	.96	6B8	.75	12B6	.75
0D3/VR150	.95	6BA6	.60	12BE6	.64
0Z4	.50	6BC5	.69	12BH7	.85
1A7GT	.77	6BE6	.63	12BY7	1.03
1AX2	1.15	6BG6G	1.80	12B27	1.10
1B3GT	.85	6BH6	.80	12SA7	.64
1B27	1.50	6BJ6	.85	12S7S	.70
1H5GT	.77	6BK5	1.05	12SG7	.80
1L4	.60	6BK7	1.10	12SH7	.63
1L6	.95	6BL7GT	1.00	12SJ7	.55
1L46	1.10	6BN6	1.20	12SK7	.61
1L84	1.10	6BQ6GT	1.17	12SL7GT	.65
1LN5	1.10	6BQ7A	1.23	12SN7GT	.75
1N5GT	.95	6BZ7	1.28	12SQ7GT	.55
1N23A	2.05	6C4	.50	12SR7	.69
1N23B	2.25	6C6	.50	12SX7GT	1.10
1N34A	.75	6C8B	.65	14F7	.75
1N38	.88	6C8E	1.95	19BG6G	2.05
1N48	.50	6CD6G	1.80	12SA7	1.20
1N54	.79	6D6	.75	25B06GT	1.25
1N54A	.90	6F4	3.50	25L6GT	.62
1R4/1299	.59	6F5	.68	25W4GT	.65
1R5	.75	6F5GT	.68	25Z5	.70
1S5	.70	6F6GT	.70	25Z6GT	.59
1T4	.75	6F6G	.80	28D7	1.55
1U4	.50	6F8G	.85	35A5	.62
1U5	.70	6G6G	.85	35B5	.60
1V	1.03	6H6	.52	35C5	.70
1V2	.70	6J4(RCA)	5.10	35L6GT	.65
1X2A	.85	6J5	.50	35W4	.45
1N38	3.25	6J6	.75	35Z3	1.20
2C39A	13.75	6J7	.75	35Z5GT	1.44
2C40	6.75	6K4(Syiv)	2.25	50A5	.75
2C51	3.90	6K4A	2.25	50B5	.60
2E30(Hyt)	2.05	6K6GT	.59	50C5	.65
2I39	7.95	6K7	.60	50L6GT	.65
2I61	37.50	6L6	1.10	80	.99
2I62	33.00	6L6GA	1.10	81	.75
2K28	27.55	6L6M	1.25	83	1.15
2X2	.35	6L7	.80	84/624	.65
3A4	.59	6N7M	.70	11Z23	.78
3B5/11	9.85	6P7	.88	11Z70	.95
3B7/2291	.39	6Q7GT	.80	211A/7C5	.89
3B28	4.25	6S4	.58	250TH	22.95
3C23(GE)	8.50	6S7M	.98	274B	3.00
3C24/24G	1.15	6SA7	.64	304TH	7.75
3D6/1299	.35	6SC7	.88	304TL	8.75
3D4	.89	6SO7GT	.80	310T(WE)	3.50
3Q5GT	.99	6SO7	.66	407A(WE)	3.50
3S4	.75	6SH7	.98	408A(WE)	2.50
3L4	.90	6SJ7	.65	717A	.88
3V4	.75	6SK7	.61	725A	4.70
4B24	4.50	6SL7GT	.65	803	3.25
4D22	18.50	6SN7GT	.72	805	3.35
4X150A	29.95	6S7	.58	807	1.55
5A4	1.55	6T8	.85	811A	3.55
5D21(WE)	12.50	6U8	.90	812A	3.60
5R4GY	1.50	6V3	1.15	816	1.20
5U4G	.56	6V6GT	.61	829B	8.95
5V4G	.92	6V8	.99	830B	2.75
5W4G	.80	6W4GT	.59	832A	9.95
5X4G	.75	6W6GT	.75	866A(JAN)	1.25
5Y3GT	.44	6X5GT	.50	866A(CBS)	1.75
6A8GT	1.10	7A7	.75	872A	3.25
6A8A	.65	7A8	.69	955	.42
6A87	.95	7B7	.76	991/NE16	.50
6AC7 Jan	.80	7B8	.78	CK1005	.75
6AC7	1.12	7C4	.29	161B	.88
6AF4	1.39	7C5	.69	1622/6L6M	1.95
6AG5	.85	7C6	.69	1625	.35
6AG7	1.10	7C30	85.00	1626	.18
6AH4GT	.80	7E5	.39	1629	.25
6AH6	.68	7F7	.65	2050	1.55
6AJ5	1.10	7F8G	1.55	5516(Hyt)	7.25
6AK5	.79	7BP7	4.25	5528/C6L	5.00
6AK6	.98	7H7	.70	5654	1.75
6AL5	.55	7N7	1.20	5656	10.00
6AN4	1.50	7Q7	.98	5670	3.50
6AQ5	.55	12A76	.50	5687	2.95
6AR8	.73	12A77	.89	5993	6.25
6AS5	.70	12A7	.70	5814	2.20
6AS6	1.95	12AV6	.50	9002	.75
6AS7G	3.75	12AV7	.90	9003	1.10
6AT6	.48	12AW6	.88	9004	.35
6AU6	.59	12AX7	.70	9006	.29

Above is only a partial listing of our huge stock. Types not listed may be ordered at approx. the same savings. Many new special-purpose types in stock. AUTHORIZED DISTRIBUTORS: CBS-HYTRON WESTINGHOUSE

TUBE CARTONS

Two Colored Cartons With New Safety Partitions, Prevents Tube Breakage.

Carton Size	For Such Types As	Each
Miniature	6AU6, 6AL5, etc.	\$.01
GT	68N7, 6W3, etc.	.0125
Large GT	1B3, 6HQ6GT, etc.	.015
Large G	5T4G, 6BG6G, etc.	.02

Minimum—100 any one size. Quantity prices on request. FREE SAMPLE, if requested on your letterhead.



136B Liberty Street, N. Y. 6, N. Y. Rector 2-2562

Terms: 25% with order, balance C.O.D. All merchandise guaranteed. F.O.B. N.Y.C.

**ADVERTISING INDEX
JANUARY ISSUE**

Radio-Electronics does not assume responsibility for errors appearing in following index.

Advance Electronics	155
All Channel Antenna Corp.	121
Alliance Manufacturing Co.	113
Allied Radio Corp.	17
Almo Radio Co.	172
American Phenolic Corp.	118
American Television & Radio Co.	164
Amplifier Corporation of America	149
Argyle Electronics	162
Arkay Radio Kits, Inc.	192
Atlas Sound Corp.	173
Audel Publishers	177
Barry Electronics	194
Bell Telephone Labs	191
Blonder-Tongue Labs	110
Brach Manufacturing Co.	110
Brooks Radio & TV Corp.	152, 153
Buchan, Richard J.	174
Burstein-Applebee Co.	139
CBS Hytron (Division of Columbia Broadcasting System)	12
Capitol Radio Engineering Institute	29
Cardwell Manufacturing Co., Allen D.	161
Centralab—Div. of Globe Union	124, 155, 180
Century Electronics Co.	154
Chunnel Master Corp.	22, 23
Chicago Standard Transformer Corp.	173
Cisin, H. G.	171
Claroostat Manufacturing Co.	135
Cleveland Institute of Radio Electronics	11
Coast Electronics	134
Collins Audio Products	126
Columbia Wire & Supply Co.	16
Commissioned Electronics	184
Concord Radio	188
Cornell-Dubilier Electric Corp.	138
Corona Radio	138
Coyne Electrical & TV Radio School	163, 181, 186
Crest Laboratories, Inc.	172
Davis Electronics	181
DeCray & Associates, Frank W.	183
DeForest's Training, Inc.	5
Douglas Instrument Co.	191
DuMont Labs., Inc., Allen B.	Inside Front Cover
Editors & Engineers	173
Edlie Electronics	182
Electronic Chemical Corp.	183
Electronic Instrument Co.	32, 188
Electronic Measurements Corp.	166
Electro-Voice Inc.	6
Erie Resistor Corp.	150
Fair Radio Sales	181
Falcon Electronics Co.	108, 109
Federal Telephone & Radio Corp.	146, 147
Fenton Co.	137
Finney Co.	127
General Cement	165
General Test Equipment	190
Gernsback Publications	185
Good, Inc., Don	187
Halderson Transformer Co.	176
Harveys Radio	189
Heath Co.	94-105
Hickok Electrical Instrument Co.	173
Hudson Specialties Co.	139
Hughes Research & Development Labs	187
Indiana Technical College	174
Institute of Radio Engineers, The	24
Instructograph Co.	182
Insuline Corp.	163
International Correspondence Schools	13
International Rectifier Corp.	179
JFD Manufacturing Co., Inc.	27
Jackson Electrical Instrument Co.	18, 142
Jensen Industries	180
Jersey Specialty Co.	149
Kay-Townes Antenna Co.	114, 115
Krylon Corp.	10
Leader Electronics	28
Leatone Radio Corp.	182
Lowell Manufacturing Co.	158
Macmillan Co., The	193
Mallory & Co., Inc. P. R.	Inside Back Cover
McGraw-Hill Book Co.	192
Midwest Radio & TV Corp.	151
Miller Co., J. W.	160
Miller TV Co.	190
Mosley Electronics	191
Moss Electronic Distributing Co.	132, 133
National Electronics of Cleveland	163
National Radio Institute	19, 20
National Schools	3

New Jersey Television Supply	144
Noll, Edward M.	190
Offenbach-Reimus Co.	190
Opportunity Adlets	160
Orradio Industries	156
Perma-Power Co.	111
Philco Corp.	143
Precise Development Corp.	122
Precise Measurements Co.	189
Precision Apparatus Co., Inc.	187
Premier Radio TV Supply	134
Prentice-Hall Inc.	182
Pres-Probe Co.	182
Progressive Electronics	166
Quam-Nichols Co.	175
RCA Institutes, Inc.	31
RCA Victor Division (Radio Corporation of America)	Back Cover
Rad-Tel Tube Co.	154
Radelca Manufacturing Co.	176
Radiart Corp.	123
Radio City Products	171
Radio & Electronics Parts Corp.	148
Radio Distributing Co.	191
Radio Receptor Inc.	168

**RADIO SCHOOL DIRECTORY
PAGE 195**

Candler System Co.	
Capitol Radio Engineering Institute	
Commercial Trade Inst.	
Grantham School of Electronics	
Indiana Technical College	
Indianapolis Electronic School	
Milwaukee School of Engineering	
RCA Institutes, Inc.	
Tri-State College	
Valparaiso Technical Institute	
Western Television Institute	
Radio Shack	120
Radio-Television Training Assn.	15
Raytheon Manufacturing Co.	7
Rek-O-Kut Co.	148
Rider, Inc., John F.	130, 173
Rinehart Books, Inc.	140, 141
Rogers Electronic Corp.	170
Rohn Manufacturing Co.	177
Rose Co.	160
Sams and Co., H. W.	18, 186, 193
Sangamo Electric Co.	112
Scala Radio Co.	175
Service Instruments Co.	174
Simpson Electric Co.	127
Skyline Manufacturing Co.	158
Sprague Products Co.	159
Sprayberry Academy of Radio	93
Stan-Burn Radio & Electronics	184
Stephen Sales	148
Steve-El Electronics Corp.	150
Sun Parts Distributors	160
Superec Electronics	179
Supreme Publications	167, 191
Sylvania Electric Products	25
Tab	196
Tallen Co., Inc.	156
Tarzian, Inc., Sarkes	30
Tech-Master Products	144
Technical Appliance Co.	157
Tele-Beam Industries	185
Telematic Industries, Inc.	184
Television Communications Institute	177
Television Hardware Mfg. Co.	165
Television Materials, Inc.	155
Telrex, Inc.	14
Thomas Mold & Die Co.	176
Transamerica Electronics	162
Transvision, Inc.	178, 179
Triad Transformer Corp.	183
Trio Manufacturing Co.	8, 9
Triplett Electrical Instrument Co.	21
Tung-Sol Electric Co.	111, 162
Turner Co.	
Ultra-Audio Broadcasting System	160
United Catalog Publishers	180
University Loudspeakers	178
Utah Radio Products Co., Inc.	170
Video Specialties	189
Walsco Electronics Corp.	117
Ward Products Corp.	145
Wells & Winegard	134
Wen Products Co.	149
Westinghouse Electric Corp.	128, 129
Winstor Electric Tube Co.	170
Winpower Mfg. Co.	188
Zingo Products	192

RADIO SCHOOL DIRECTORY

Get Your F.C.C. LICENSE Quickly!

Correspondence or residence preparation for F.C.C. examinations. Results guaranteed.

An FCC commercial operator license means greater opportunities and higher pay. We are specialists in preparing you, in a MINIMUM OF TIME, to pass FCC examinations for all classes of licenses. Beginners get 2nd class license in 5 weeks and 1st class in 3 additional weeks. Write for free booklet.

GRANTHAM SCHOOL OF ELECTRONICS
Dept. 101-A, 6064 Hollywood Blvd., Hollywood 28, Calif.

GET INTO ELECTRONICS

You can enter this uncrowded, interesting field. Defense expansion, new developments demand trained specialists. Study all phases radio & electronics theory and practice: TV, FM, broadcasting, servicing; aviation, marine, police radio, 18-month course. Graduates in demand by major companies. H.S. or equivalent required. Begin Jan., March, June, Sept. Campus life. Write for catalog.
VALPARAISO TECHNICAL INSTITUTE
Dept. C Valparaiso, Ind.

TV REPAIRMEN MAKE TOP MONEY!

In just 39 weeks, you can get complete TV service training! Streamlined course gives you all essentials for a good job as service technician. Graduates in great demand; jobs are plentiful in this growing field. Other courses in electronics, radio operation and maintenance. Day or evening classes; modern equipment. Opportunity for employment in local industry.

Write for Catalog 111 Today

INDIANAPOLIS ELECTRONIC SCHOOL
312 E. Washington, Indianapolis 4, Ind.

CODE SENDING RECEIVING SPEED

Be a "key" man. Learn how to send and receive messages in code by telegraph and radio. Commerce needs thousands of men for jobs. Good pay, adventure, interesting work. Learn at home quickly through famous Candler System. Qualify for Amateur or Commercial License. Write for FREE BOOK.
CANDLER SYSTEM CO.
Dept. 3-A, Box 928, Denver 1, Colo. U.S.A.

RCA INSTITUTES, INC.
A service of Radio Corporation of America
350 West 4th St., New York 14, N. Y.

OFFERS COURSES IN ALL TECHNICAL PHASES OF RADIO, TELEVISION, ELECTRONICS

Approved for Veterans
Write Dept. RC-54 for Catalog

RADIO ENGINEERING DEGREE IN 27 MONTHS

Intensive, specialized course including strong basis in mathematics and electrical engineering, advanced radio theory and design, television. Modern lab, Low tuition Self-help opportunities. Also B.S. degree in 27 months in Aeronautical, Chemical, Civil, Electrical, and Mechanical Engineering. 41 Gov't approved. Enter March, June, September, December. Catalog.

INDIANA TECHNICAL COLLEGE

151 E. Washington Blvd., Fort Wayne 2, Indiana

RADIO-TV ELECTRONICS

CREI graduates in big demand. Accredited by Engineers Council for Professional Development. New classes start every month. Free placement service for grads. Courses offered—Radio Engineering, Broadcast or TV Engineering, TV, FM, AM Servicing. Write for free catalog. Approved for Vets.
CAPITOL RADIO ENGINEERING INSTITUTE
Dept. RE, 3224—16th St., N.W., Washington 10, D. C.

MORE JOBS than graduates

Demand for our engineering graduates exceeds supply. *Effective placement.* Study in this world-famed college established 1884. Quarters start March, June, Sept., Jan. Approved for Korean Vets.

Bach. Sc. degree in 27 months

Complete Radio Eng. courses . . . TV, UHF and FM. Also Mech., Civil, Elec., Chem., Aero. and Adm. Eng.; Bus. Adm., Acct. Small classes. Well-equipped labs. Modest costs. Prep. courses. Write *Jean McCarthy, Director of Admissions, for Catalog and Campus View Book.*

TRI-STATE COLLEGE
2414 College Avenue, Angola, Indiana

BUILD your own TV Set

YES, actually build a valuable TV Set right at home. At the same time learn all about installing, repairing, servicing—and get ready for a Big-Pay Job in America's fastest-growing, most exciting industry. The CII TV Train-out. Home Plan is preparing hundreds for bigger pay TODAY—and a brighter Future TOMORROW. No experience needed. We supply easy-to-understand instructions—made clear with hundreds of charts, diagrams, photos—plus TWENTY KITS of Parts, Professional Equipment and Tools. Get a TV Set to ENJOY. Get set to ENJOY a TV Future. Make money in spare time while taking Course. THOUSANDS SUCCEEDING! So can You. Send today for big FREE Book, "You Can Succeed in Television."

COMMERCIAL TRADES INSTITUTE

Dept. T27-1, 1400 Greenleaf Ave., Chicago 26, Ill.

EARN MORE MONEY— BE A PROFESSIONAL TELEVISION SERVICE TECHNICIAN

STEP INTO THE TOP PAY \$5,000—\$10,000 A YEAR CLASS 7 MONTHS' SHOP TRAINING QUALIFIES YOU.

If you want to reach your goal as a Successful Service Technician you will need plenty of "KNOW HOW" to qualify for the better servicing jobs or profitable shop ownership.

SEND FOR FREE BOOK TODAY!

WESTERN TV offers real experience on live equipment in our BIG SHOPS AND LABORATORIES in the shortest practical time under expert instructors. Graduates are in big demand because they have the "field experience" necessary for immediate "bench" or supervisory positions. You learn every phase of Radio and TV servicing (AM, FM, VHF, UHF). WTI men win fast promotion . . . can demand better pay . . . develop highly profitable businesses of their own with the latest and most PRACTICAL PERSONALIZED TRAINING BEHIND THEM. You concentrate all your time on being a PROFESSIONAL TV SERVICE TECHNICIAN—non-essential math and engineering theory omitted. YOU CAN EARN WHILE YOU LEARN. Special Finance Plan.

APPROVED FOR VETERANS. Find out how you can get into the TOP PAY GROUP—Send for this fact-packed book NOW!

WESTERN TELEVISION INSTITUTE

America's Leading Television Servicing School

Western Television Institute Dept. E-1-4
341 W. 18th St., Los Angeles 15, Calif.
Without obligation, please send FREE fully illustrated booklet. (No salesman will call.)

NAME _____ AGE _____
ADDRESS _____
CITY _____ ZONE _____ STATE _____

BECOME AN ELECTRICAL ENGINEER

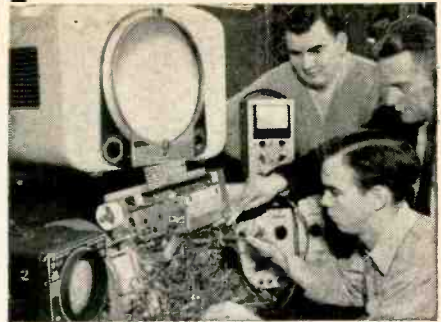

Bachelor of Science Degree in 36 months.

Major in Electronics or Power. Now, prepare for a career in these rapidly expanding fields.

This school will prepare you to become an engineer, technician or service man. Previous military, academic or practical training may be evaluated for advanced credit.

Enter Both Radio and Television

In 12 months you can attain the Radio-Technician's certificate. An added 6 months course qualifies you for the Radio-TV Technician's certificate and the Degree of "Associate in Applied Science." The Technician's course is the first third of the program leading to a Bachelor of Science Degree in Electrical Engineering with a major in Electronics.

Also offered: 12-month Radio-TV service course; 12-month Electronics or Electro Technician Courses; 6-month Electrical Service Course and 3-month refresher and general preparatory classes.

Terms—January, April, July, September

Famous for its Concentric Curriculum. Faculty of specialists. 50,000 former students. Annual enrolment from 48 states and 23 overseas countries. Non-profit. 50th year. Courses approved for Veterans. Residence courses only.



MILWAUKEE SCHOOL OF ENGINEERING

MILWAUKEE SCHOOL OF ENGINEERING
Dept. RE-154, 1025 N. Milwaukee
Milwaukee 1, Wisconsin

Send: Free 45-page "Your Career" booklet describing Electrical Engineering Courses; Booklet on Careers in Radio-TV.

I am interested in _____ name of course _____
Name _____ Age _____
Address _____
City _____ Zone _____ State _____
If veteran, indicate date of discharge _____

AUDIO AMPLIFIERS READY TO GO

MODEL AMP 5 HI-FI 5 watt e-c Amplifier plus built in Pre Amp GE V.R. pickup 60 to 18000 cps / JDB / down 2 DB 4.0 cys. hum level 55 db. mike & phono volume. continuous bass treble controls 6S7, 6BC7, 6V6, 6X5 "TAB" HI-FI special to you, done PREPAID \$21.39. Same unit less GE Pre Amp PREPAID \$15.95. Model 302PA 3 Tube Phono Amp. Ideal for Custom Building Your Phonograph. \$ 4.98

GROMMES HI-FI AMPLIFIERS

L12 Pre & Pwr Amp 8 Watt 20-20Kc. \$35.77
50GP Pre Amp 0.3dB 20-20 Kc. \$3.90
215BA Williamson Pre & Pwr Amplifier 15 watt 10 to 100 Kc. \$7.51
205PA Pre Amp 0.3dB 20-20 Kc. \$3.90
SPA Pre Amp for G.E. Retiuc. cart. \$11.37
R1 Record Compensator "RFX" 0.50 47.00
Columbia 360 Hemisphere P.P. USA 136.71
WRITE FOR DETAILS & PRICES

SPEEDWAY ELECTRIC DRILL 1/2" MODEL 200J

Hi-Torque (powerful) UL approved 2400 RPM 115V 1/2" J.C.B. motor. Jacobs geared chuck and key. Self aligning oilless ball thrust bearing. Light weight and easy to handle. Treat yourself to this workhorse drill. Pilot 9 drill bits \$4.95. Model 210 Drill stand, converts above to a drill press. \$9.65. Model 400J 1/2" cord drill 425 RPM. Jacobs Chuck & 9 drill bits in case \$29.95

CHROME VANADIUM SPEED DRILLS

29PCS CHROME VANADIUM SPEED STEEL. Top Quality for Machinists or all purpose use. Standard Full length bits 1/8" to 3/4" by 64th's. \$7.98
12 PCS SET 1/8" to 3/4" Less Index \$3.49
50 PCS DRILL SET 1/8" to 3/4" with Index \$6.49
13 PCS 1/16" to 1/4" w/Index \$11.98

SPEEDWAY UTILITY KIT

The servicemen's workshop, kit includes 200J Jacobs chuck 1/2" drill, ass't drill bits and accessories. 55 pieces grinding, polishing, paint stirrer, buffing, sanding and many other uses. 55 pieces in all. As shown, special Model 200JK \$19.25

"TAB" THAT'S A BUY

TUBE SPECIALS

YOU PICK THEM lots of 10 Cracked base or broken key electrically perfect TESTED & 90 DAY GUARANTEED ORDER NOW, WHILE THEY LAST

5U4G - 6SN7 - 25L6GT - 3Z5S
5Y3GT - 6K6GT - 12SA7GT - 6H6
6V6GT - 6BQ6 - 6W4GT - 12SG7

AUDIO COMPONENTS

GE RPX041 Cart. Gold Tone \$5.25
GE RPX050 Triple Play Cart 4.98
Electrovoice Triple Play 1.98
Pickup Arm & Xtal \$10.35
GE RPX-052 Triple Play Diamond and Sapphire \$17.75
GE RPJ010 Dual .001" 703" Sapphire 1.98
GE RPJ005 Single .001" Sapphire 1.35
GE RPJ001 Single .003" Sapphire 1.35
GE RPJ004 Single .001" Diamond 11.98
GE RPJ013 Dual Diamond & Sapphire 12.98

COAXIAL SPEAKERS

All B ohm. V.C. Alnico V Magnets. Inbuilt Network. 2 wires needed for HF & LF Response. Famous HI-FI Speaker Mfgs. & 5-15" Coaxial PM & Tweeter. 25 watt / 20-17500 cys. shpg wgt 13 lbs special P2500. \$23.75
6K7 12" Coaxial PM & Tweeter. 12 watt / 45-15000 cys shpg wgt 8 lbs "TAB" SPECIAL P1200
6C Coaxial PM & 2 1/2" Tweeter. 8 watt / 10-15000 cys. Ideal for Home HI-FI TV. Radio & Phono Replacement Special P800 \$8.95

ELECTROLYTIC CONDENSER KIT

POPULAR VALUES 25¢ ea. lots of 18 Here is a handy assortment of 15 condensers for the serviceman. Only \$3.75

ADJUST-A-VOLT

Standard Elect (Staco) Variable Voltage Transformer. TYPE 20/0-135V/3 Amp/N \$19.98
TYPE 116V/0-135V/7.5A/N \$16.98
TYPE 116S Spees 116V/3 \$21.98
Cased/N \$21.98
TYPE 1126/0-135V/15 Amp/Cased/N \$43.98
AMP/CASED/N \$43.98
GR508 VARIAC 0-135V/45Amp/LN \$112.00
GR508 VARIAC 0-270V/31Amp/LN \$112.00
STACO IHL-5/METERED/140V/5A/0.5KW/N \$41.50
STACO PAL-7/METERED/135V/7.5A/1KW/N \$40.50
Industrials Write For Quantity Prices

RHEOSTAT SALE

2 ohm 50W Model J . 2.25; 5 for 10.00
10 ohm 25W Model L . 1.98; 2 for 2.99
20 ohm 50W Model J . 1.98; 2 for 3.50
60 ohm 50W w/knob . 2.25; 2 for 3.98
100 ohm 50W Model K . 1.98; 2 for 3.50
300 ohm 225W Model P . 2.98; 2 for 5.00
360, 500, 5000 ohm Slotted shaft.
25 watt79¢; 3 for 2.00

866A KIT and XFORMER

2 Tubes, Sekts, xmfr. 115V/60cys. Inpt. Outpt 2.5vct/10A/4
Bivina \$4.98
DIODE PROBE TUBE \$1.25
Unexcelled for No-Loss W/PF testing. Ultra sensitive. rubberized. New. tube-envelope. New. w/data VR9225¢; 5 for \$1.

ONE YEAR GTD PICTURE TUBES

7JP \$17.95
10B1 10.00
12" Glass 12.00
14" Rectangular 14.00
16" Glass 16.00
17" Rectangular 17.00
18" Round 19.00
20" Rectangular 21.25
21" Rectangular 21.00
24" Hytron 74.95
27" Hytron 89.95
Send your dud prepaid only, and "TAB" will ship one year guaranteed Picture Tubes at above prices. No dud return required for 7", 24", 27" tubes. Prices based on \$1.00 per inch. Metal or Electrostatic tubes add 10¢ per inch additional.

DC POWER SUPPLY

10 to 12 VDC/2 Amp. Variable DC supply, un-cased and completely built-in. 115V/60cps. Usable LAB supply. battery charging, model railroad, includes voltage or speed control and center of reversing sw. Ideal for two "HO" locomotives Prepaid USA. \$10.95; 2 for \$20.00

FEDERAL "ITT" SELENIUM BATTERY CHARGER RECTIFIER

10-0-10V (CT) 100 Amp., fan cooled. Replace your old inefficient sulfide rectifier w/new selenium type. SPECIAL \$11.58

SELENIUM RECTIFIERS

Current (Cont.)	List Price	"TAB" Price	Qty
65MA @ 130V	\$1.50	\$0.59	12 for \$6.48
75MA @ 130V	1.85	.69	7.58
100MA @ 130V	2.05	.79	8.68
150MA @ 130V	2.25	.95	10.78
200MA @ 130V	3.15	1.39	14.98
300MA @ 130V	3.30	1.49	15.98
400MA @ 130V	4.25	1.85	20.38
500MA @ 130V	4.40	1.98	21.28
230MA @ 18V	1.40	.59	5.98

RECTIFIER XFMRs

Primary 115V 60 Cvc
Secondary 0-9-12-18-24-36V
4 Amp \$ 4.75
12 Amp \$16.75
24 Amp \$35.75
18 Vc. \$ 1.50

RECTIFIER CHOKES

4 Amp. 0.1 Ohm \$7.95
12 Amp. 0.1 Hy 1 Ohm 14.95
24 Amp. 0.04 Hy .025 Ohm 29.95

SELENIUM RECTIFIERS FULL WAVE BRIDGE

We specialize in Rectifiers, Power supplies and applications. Immediate delivery. Currents 18/14 36/28 54/40 130/100 (cont.) Volts Volts Volts Volts
1AMP 1.25 1.70 4.50
2AMP 2.20 3.60 5.40 10.50
4AMP 4.25 7.95 12.95 25.25
6AMP 4.75 9.15 13.50 27.00
10AMP 6.75 12.75 20.00 44.95
12AMP 8.50 16.25 25.50 49.00
20AMP 12.25 24.00 39.00 87.50
24AMP 16.25 32.50 45.00 95.00

Rectifier & Transformer

up to 140Vc at 12 Amps \$ 19.98
up to 28VDC at 4 amps 14.98
up to 28VDC at 12 amps 29.98
up to 28VDC at 24 amps 59.95
up to 28VDC at 50 amps 127.00

TV & COAX CABLE

300 Ohm Twineax. Heavy duty 85 mil all copper TV lead in. per ft. 2e; 100 feet \$1.39
1000 foot reel \$11.39
RG59U 75 Ohm TV Coax Cable MFGRD to rigid UHF spec. per ft. 50 to 100 feet \$4.50
SPECIAL 500 feet \$22.00

TELEVISION ANTENNA

VEE CONICAL Broad response, all channel, power for fringe areas. \$8.95
DIPOL DIPOLE 8' Channel antennas, all channel, sturdy construction \$4.95
VEE CONICAL ANTENNA Channel. Sturdy Includes 8 elements & 100 ft. Twineax. \$5.25
DOUBLE V Ant. All Channel, Sturdy Cons. w/100 Clamps & 100 ft. Twineax. \$4.49
WINDOW CONICAL Ant. All Channel. Hwy Const. Mounts outside window. \$3.95
8' FOOT Interlocking. Hwy Duty. rustproof. 2 for \$1.49; 10 for \$7

CRYSTAL DIODES IN23B Sylvania \$1.89

Lead Jacketed & Boxed. Lots of 10
Smaller Quantity. Unit Price \$2.25
IN21 85¢; 6 for \$ 4.00
IN22A \$1.55; 6 for \$ 9.00
IN21B \$2.89; 4 for \$10.00
IN27 \$1.59; 5 for \$ 7.00
IN40 69¢; 5 for \$ 3.25

HI-FI POWER SUPPLY

SOLA constant voltage power transformer mounted on chassis with (2) octal rectifier sockets.
NEW MFGRD BY DUMONT
Furnishes 400VDC/250MA to filter system, 12.6VCT/6 Amp or 2X 6.3VCT/6 Amp (common tap) and 5V/8 AMP REGULATED
With filter condensers, choke and rectifier tubes \$18.98

EICO TEST EQUIPMENT

Stock #	Type	Price	Unit
221 VTM		\$25.95	\$49.95
311 Gen		31.95	49.95
322 Vtg Gen		23.95	34.95
360 SWP Gen		34.95	49.95
377 Aud Gen		31.95	49.95
425 Scope		44.95	79.95
470 Scope		79.95	129.50
566 VDM		34.90	18.95
625 VSTR		34.95	25.95
1171 Resist Decade		24.95	

Industrials & Schools Write Qty Price

REPAIR KIT #873

All the tools needed for on the spot repair job. Includes (4) interchangeable screw driver blades and handle. (5) Metric pliers, adjustable wrench, jron nose pliers and wrap around tempered tool steel set \$22.69
Model 3701 3 screw driver, 2 tempered tool steel, magnetized, hammer-proof amber handles. Special \$19.98
My Buddy 16 pos. Kit: (5) Metric pliers, screw driver blades and handle, 3 ft. steel tape rule, diagonal cutter and case. \$17.99

WAREHOUSE CLEARANCE

Antenna Mast sections M545 & M550
4' (38') Mast sections 2 ft 4" dia. 25 at 53
Veeder Root Counter 3 digit 85¢; 3 for \$2
RF Choke 2 1/2 MH/300MA 29¢; 6 for \$2
Choke 20MH/200MA 38¢; 6 for \$2
Band Pass Filters 60, 90, 150 cys; 2 for \$3

NEW YORK CITY SERVICEMEN

FREE: 2 Subway Tokens with any \$5.00 Purchase from our Store.

Money Back Guarantee (Cost of Mds. Only) \$5 Min. Order F.O.B. N.Y.C. Add Shpg. Charges or 25% Dep. Tubes Gtd. via R-Exp. only. Prices subject to Change Without Notice. Phone Rector 2-6245. CABLE: "TABPARTS"

TUBES

From This Special List We Ship \$10.00 and Up Tube Orders At Our Expense (Post-paid) Within Continental Limits of U.S.A. 90 Day Gtd. When ordering mention 1R

0A2	.88	6A06	.81	6H6	.60	6X5	.54
0A3	1.04	6AQ6GT	1.59	6J4	6.66	6Y6G	.68
0B3	1.37	6AR6	2.98	6J5	.54	7AB	.68
0C3/VR90	.92	6AS5	2.75	6J6	.54	7F7	.82
0C3/VR105	.92	6AS7G	3.48	6K6	.72	7F8	1.24
1A3/8016	.88	6AT6	1.59	6K7	.54	7G7	.82
1L4	.88	6AQ6GT	1.59	6K4A	3.64	7M7	.92
1L6	1.35	6AU6	.56	6K6GT	.54	7V7	1.06
1L6S	.88	6AV5GT	.98	6L6G	1.08	12A6	.48
1L6S	.78	6AV6	.98	6L6CA	1.08	12AH7GT	1.45
1P5	.78	6AX4/6U4	.74	6L6CA	1.08	12AT6	.54
1U4	.88	6B4G	1.18	6L6CA	1.08	12AV6	.52
1U5	.84	6B6	1.23	6L6CA	1.08	12AX7	.98
1X2A	.98	6BA7	1.09	6L6CA	1.08	12BA6	.59
2A4G	1.18	6BC5	1.23	6L6CA	1.08	12BE6	.59
2X2	1.53	6BD6	.83	6L6CA	1.08	12BH7	1.19
2X2A	1.53	6BE8	.83	6L6CA	1.08	12B8A	.59
3R4G	1.18	6BF5	.58	6L6CA	1.08	12B8B	.59
3R4GYW	1.75	6BF8	.58	6L6CA	1.08	12B8C	.59
5Y4	1.48	6BG6Q	1.58	6L6CA	1.08	12B8E	.59
5Y4G	1.48	6BH7	1.58	6L6CA	1.08	12B8F	.59
6AC7	.80	6BM7	1.58	6L6CA	1.08	12B8G	.59
6AG5	1.18	6BL7GT	1.98	6L6CA	1.08	12B8H	.59
6AG7	1.14	6BQ6GT	1.20	6L6CA	1.08	12B8J	.59
6AH6	1.22	6BQ6GT	1.20	6L6CA	1.08	12B8K	.59
6AJ5	1.14	6BQ7	1.20	6L6CA	1.08	12B8L	.59
6AK5	.77	6C4	.52	6L6CA	1.08	12B8M	.59
6AK6	.92	6C5	.68	6L6CA	1.08	12B8N	.59
6AL5	.88	6C6	.59	6L6CA	1.08	12B8P	.59
6AL7GT	.98	6C8	.59	6L6CA	1.08	12B8Q	.59
6AN5	2.90	6D4	2.70	6L6CA	1.08	12B8R	.59
6AQ5	.52	6F6GT	.70	6L6CA	1.08	12B8S	.59

12SC7	1.08	CK534AX	.99
12SF7GT	.84	CK536AX	.99
12SJ7	.63	CK538AX	.99
12SJ7GT	.63	CK539DX	2.19
12SK7	.52	CK543DX	.99
12SL7GT	.62	CK544DX	.99
12SN7GT	.68	CK546DX	1.99
12SP7GT	.68	CK571AX	2.49
19B6	1.98	2050	1.48
19B8	1.98	2050	1.48
25LEGT	.58	5E87	1.28
25Z6	.78	5K502	3.74
25Z6GT	.78	5K502	3.74
28D7	1.94	CK5703	1.29
35B5	.54	1N21A	1.55
35B5GT	.54	1N21B	1.92
35Z5GT	.54	1N22	1.22
35Y4	.68	1N23	1.35
50A3	.76	1N23A	1.98
50B5	.88	1N23B	2.22
50C5	.88	1N26	6.75
50LEGT	.62	1N27	1.55
8K61/XFG1	2.18	1N44	1.45
8K1	1.38	1N34A	.90
8K2	1.38	1N35	1.65
8K3	1.22	1N45	1.45
8K4	1.22	1N41	8.95
8K4/2A	1.62	1N42	16.95
117L/7M7GT	1.62	1N45	1.45
CK502AX	1.49	1N46	.69
CK503AX	.99	1N47	4.00
CK504AX	1.79	1N51	.75
CK512AX	1.45	1N54	.48
CK513GT	1.89	1N60	1.35
CK532DX	1.89	1N63/K63	2.49
CK533AX	1.29	1N69	.98

OIL CONDENSER SPECIAL

10 MFD 600 VDC \$1.75 ea lots of 3
Case dimensions, not including insulators 4 1/4" x 3 3/4" x 1 1/4"
Smaller Quantities, Special

INFRARED SNOOPSCOPE

SEE-IN-DARK TUBE
Image-Converter Tube. Hi-Sensitivity amplified design 2" dia. Wilconite screen-data & tube. \$19.98
NEW MFGRD BY DUMONT
1800VDC/35MA. Using Doubler Crkt. Transformer, Rectifier, Socket, Resistor, Capacitors and Diagram. \$6.98

CONDENSER SPECIAL

2 MFD 1000 VDC 330 VAC "CD" MFGR Lots of 10
Smaller Quantities, each, 49¢; 3 for \$1.25
2MFD 600VDC Porcelain Insulators with Adjustable Mounting Clamp. 3 for \$1.50

OIL CONDENSERS WAREHOUSE CLEARANCE SALE

5MFD 1500VDC	2 for \$1.50
5MFD 600VDC	1.50; 3 for 4.00
10MFD 600VDC	1.98; 2 for 3.50
3MFD 330VDC	1.00; 4 for 2.00
2X2MFD 600VDC/IT/0	1.25; 2 for 2.00

BATHUB SIDE TERMINALS
1MFD 600VDC39¢; 3 for 1.00
5MFD 600VDC1.00; 5 for 2.00
1MFD 2000VDC1.05; 5 for 4.50

CLOCK RADIO

WAKE UP TO MUSIC
Just set the dial, & radio automatically turns on. Beautifully designed cabinet. MAROON OR IVORY
Powerful 5 tube design.
"TAB" SPECIAL Prepaid \$20.98
Same Less Clock \$16.98

PRECISION RESISTORS

2 MILLION IN STOCK
GUARANTEED 1% TOLERANCE
ORDER ANY VALUE YOU NEED
42 to 970K OHM35¢; 10 for \$3.29
1 MEG & UP70¢; 10 for \$6.49

YOU PICK THEM 59¢ WHILE THEY LAST

LOTS OF 10
Your selection of 10 at 59¢ each or smaller quantity by indicated price.
ELECTROLYTIC CONDENSERS
2X 20MFD/450VDC69¢; 3 for \$1.95
3X 15MFD/450VDC98¢; 3 for 2.50
3X 20MFD/400VDC78¢; 2 for 1.50
25MFD/450VDC89¢; 3 for 1.95
20MFD/450VDC/25V3 for 1.98
50 mfd 250Vdc FP3 for 1.00
30-15-10 mfd/250Vdc3 for 1.00
30-2x20mfd/450-25vdc3 for 1.00

STORAGE BATTERIES

36 Volt WILLARD Mini-BRAND New; 5w; 62
Designed Portable Equip. Models: 98¢; 4 for \$3
(4) 36V Batteries w/acid \$3.35
2V/20AH Willard PLUS 2V. Vibrator. 2.99
12V/20AH Willard PLUS 12V. Vibrator. 2.99
1/6AH Willard NT6/B214U 2.98
6V/6AH Battery w/acid 3.25
6V/4AH Battery w/acid 2.99
6V/40AH Battery w/acid 9.25
We ship acid in bottles. R exp only

TAB PHOTOFLASH LAMPS

"Tab" No.	Replaces	Max. W-sec.	Each
USW No. 1	SPRG/PA104	150	\$5.98
23ST	ANGLO 580AX	100	10.98
23T	GE FT 210	200	9.98
V4X4	SYLV. 4330	200	9.98
	FT 110	200	9.98
	X400	200	10.98
	PA100	150	2.00

100 WATT SEC PHOTOFLASH KIT

Includes DX Flash Lamp Rated 150 Watt Sec. Flash Lamp Holder & 8" Reflector & Cable, Power Transformer, 100 Condensers (2) 25 MFD/450V/100 Watt Sec. Resistors, Capacitors, Rectifiers & Sockets \$34.98
100 Watt Sec. Condenser Bank 72MFD/1800V per unit. \$2.49; 61.2MFD/100 watt seconds \$1.98. SPECIAL \$7.98
325MFD/450V "CD" condenser \$8.00

THAT'S A BUY TAB THAT'S A BUY

Dept. 1RE 111 LIBERTY STREET, NEW YORK 6, N. Y., U.S.A.

Depend on Mallory
for
Approved Precision Quality

The sales leader—
proved in every UHF area

Now...

The MALLORY CONVERTER Packs ALL Features in Half the Size!

The new Model 88 has these important Sales Advantages
originated by Mallory:

Less than half as large . . . measuring only 7 $\frac{5}{8}$ " wide x 5 $\frac{9}{16}$ " high x 4 $\frac{5}{8}$ " deep . . . yet full Mallory quality.

It has linear tracking. Tuning is easier, more exact than ever. No bunching of channels.

The Preselector in the new 88 protects against image interference, oscillator radiation and interference at the IF frequency. It insures better selectivity.

The Mallory 88 Converter adds all UHF channels to any TV set without sacrificing a single VHF channel.

Design refinements and precision quality of the 88 assure high quality picture definition and easy tuning.

The customer has nothing more to buy, no adjustments to make for additional new channels . . . even if he moves to another area.

Installation is easy. It only takes a few minutes to connect the antenna and power leads from the Converter to the set. It can be done right in the customer's home.

ASK YOUR MALLORY DISTRIBUTOR for complete details of the new, handsome, compact Model 88 Converter. It can be your answer to bigger profits . . . just as all Mallory Converters have been for dealers in areas where UHF is already on the air.



P. R. MALLORY & CO. Inc.
MALLORY

CAPACITORS • CONTROLS • VIBRATORS • SWITCHES • RESISTORS
RECTIFIERS • POWER SUPPLIES • FILTERS • MERCURY BATTERIES

APPROVED PRECISION PRODUCTS

P. R. MALLORY & CO., Inc., INDIANAPOLIS 6, INDIANA

Let's face it...

... the best tube you can buy
is your best buy

When it comes to anything so important in radio and television servicing as a receiving tube, *performance* means much more than *price*.

After all, when you purchase a receiving tube, you are not buying just glass and metal. Your reputation and your profit depend on the *performance* that tube will provide!

If you try to cut corners by buying "seconds" . . . or by using "just any tube brand," you may be in for trouble. Unnecessary callbacks alone can eat up all your profit. That's why we think you'll be interested in these two facts about RCA Receiving Tubes . . .

First Fact: There is no such thing as a "second" RCA Receiving Tube that can find its way to market. If an RCA Tube fails to pass its final test, it is not only rejected . . . *it is broken up, dumped into a "meat chopper" and ground up into so much hash.*

Second Fact: The quality of RCA Receiving Tubes is continually being "upgraded." For instance, when television came, you asked for an improved 6SN7-GT. As a result, RCA's 6SN7-GT is a far better tube than the 6SN7-GT of yesterday. You see, we guard our reputation as zealously as you guard yours.

So let's face it . . . you just can't afford to buy anything less than the best in receiving tubes—and that's RCA.



To be sure you're getting unused, factory-fresh RCA Tubes, buy them only in the familiar red, white and black RCA Tube cartons through your authorized RCA Tube Distributor.



RADIO CORPORATION of AMERICA
ELECTRON TUBES
HARRISON, N. J.