

VOL. II

MAY 21-JUNE 2

No. 21

RADIO DOINGS

THE BROADCAST PROGRAM OF THE LEADING
BROADCAST STATIONS — LATEST RADIO NEWS

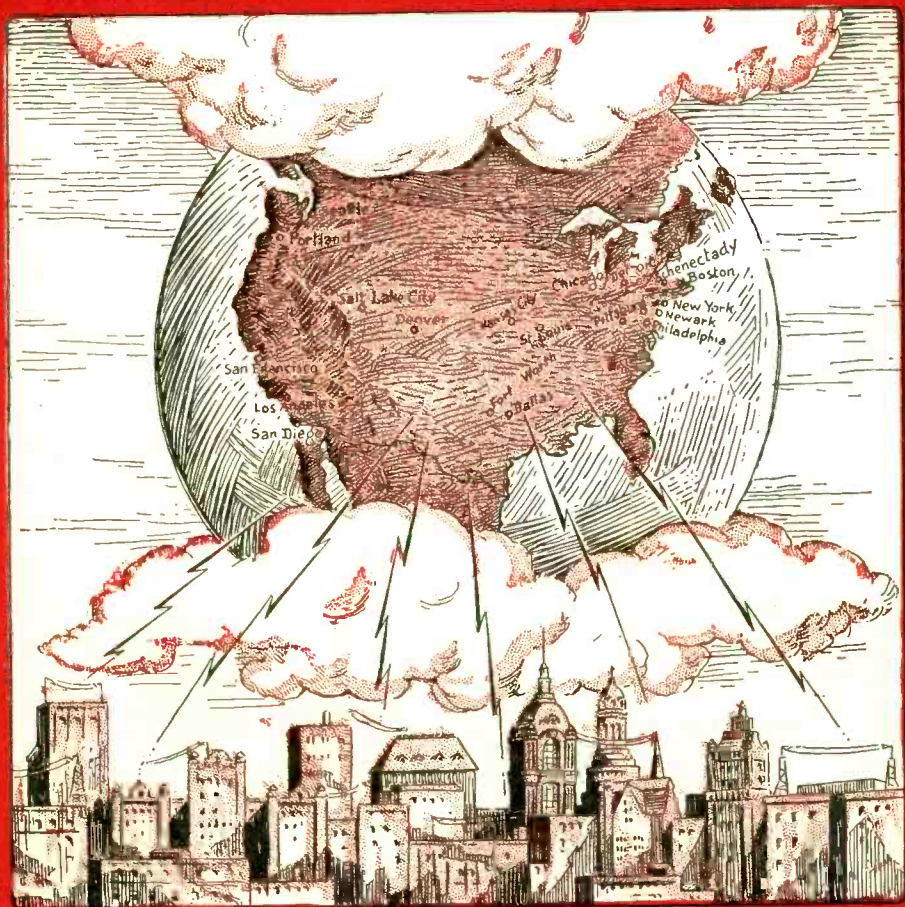

\$2⁰⁰ A YEAR

5 CENTS A COPY

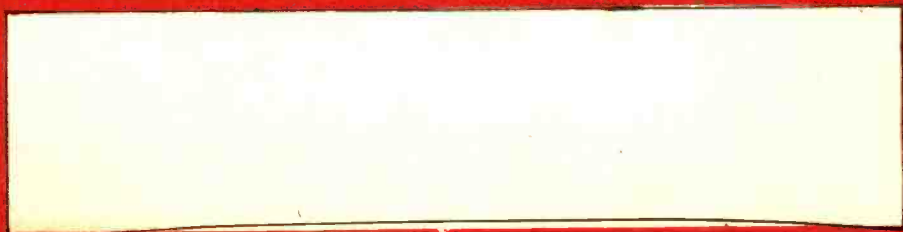

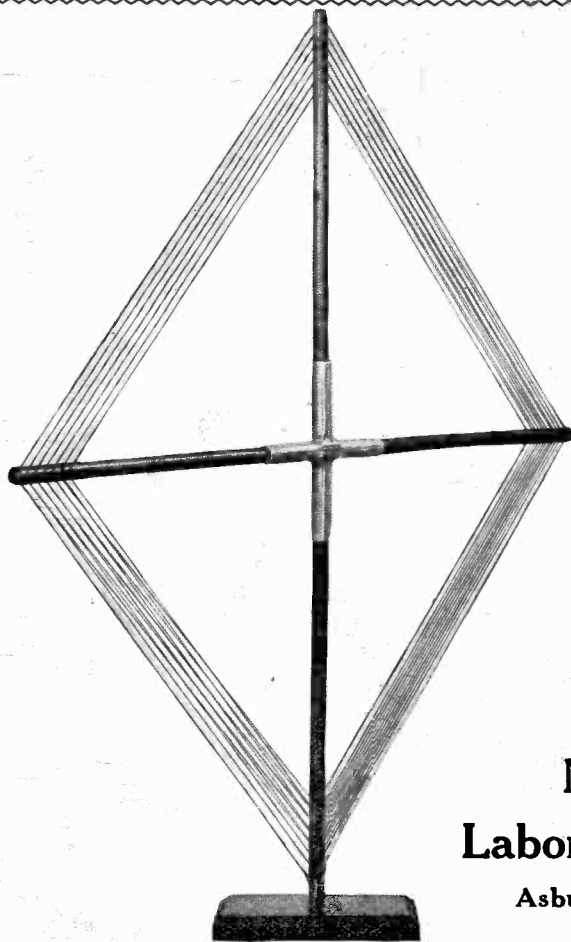

The New Star in the
Radio World

No Outside Wires
1000-Mile Guarantee
on 2-foot Indoor Loop

Mu-Rad Laboratories, Inc.

Asbury Park, N. J.



Type MA-13, 3-Stage R. F. Detector and 2-Stage A. F.

J. D. Miles & Co.
Western Distributors

720 C. C. Chapman Building
Los Angeles, Cal.

Radio Doings

Five Cents a Copy

Two Dollars a Year

H. C. CHARLES, Editor

I. T. PERDUN, Business Manager

HALL BERRINGER, Technical Editor

308 Nan Nuys Building
Los Angeles, California
Phone 673-48

(Entered as second-class matter, November 25, 1922, Los Angeles, California, Post Office, Under Act of March 3, 1879)

Official Program of Allied Musical Interests and Civic and Professional Interests Supporting Radio Central Station of Earle C. Anthony, Los Angeles

Copyright by H. A. Horwood, 1923

Vol. II

Los Angeles, May 26, 1923

No. 21

One of the things that most forcefully impresses us every now and then is the fact that there are many debatable questions connected with radio.

Last week, for instance, we printed an article on Interference that took a definite stand against the single circuit. This has brought a number of letters from the defenders of the single circuit, and in next week's issue we shall publish an article giving their side of the case.

It is fitting in this connection to say something regarding our editorial policy. In the first place, our columns are open to all of our readers to discuss and debate any phase of radio that is of general interest. Our own attitude is one of open-mindedness. If at any time a reader disagrees with an article that we have published, let him write us his side of the case and from the discussion everyone will be the gainer.

We might also add that we are always on the watch for interesting articles. If you have had an unusual experience, if you have worked out a new circuit, if you have made a set that does the unexpected, tell us about it, for if it was interesting to you the chances are that it will be interesting to others.

The Rest of the Year for One Dollar

Do not miss a copy of RADIO DOINGS. Have it mailed every week to your home. Simply sign the blank below. Mail it to us or pay your dealer and let him forward it to us.

RADIO DOINGS, 308 Van Nuys Building, Los Angeles, California:

Inclosed find one dollar for subscription to RADIO DOINGS, from now until the end of the year, to be sent to

Name _____

Address _____

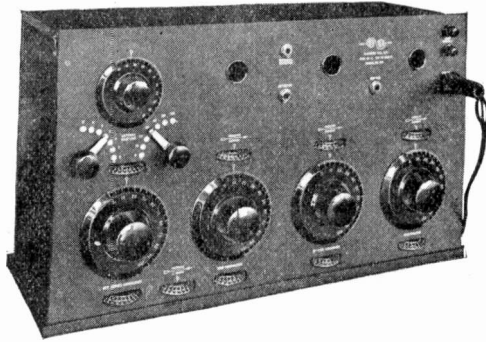

B. H. DENNIS

824-627

O. S. GARRETSON

We Sell and Service Grebe Equipment

Our service department is ever ready to serve you on your Grebe Equipment. A trained force of Radio Experts assure the best service obtainable. Call on us; you will like our Sales and Service.



RADIO

Sales and Service



["We ask no price for trained advice"]

820 West Seventh Street, Los Angeles, Calif.

Grebe CR-6

AUTH RADIO HEADSETS

REGULAR RETAIL PRICE \$8.00

Special Advertising Price \$4.00

2200 OHMS

Get in on This Advertising Bargain—We Have 500 Sets to Sell at Less Than Cost—You Are the Winner

Every AUTH Headset is sold on an absolute guarantee.

The Phones are high grade, highly sensitive, with shells of Polished Aluminum. Note the unusual permanent adjustment of the phones. Navy Type Head Band, covered with cloth webbing.

The best Head Set you ever saw for \$8.00, but you only pay us half price.

LIST PRICE \$8.00—YOUR DISCOUNT 50%
YOUR COST \$4.00

Send Bank Draft, Postal Money Order or Cash with your order, and we will mail headset post-paid immediately, or call at

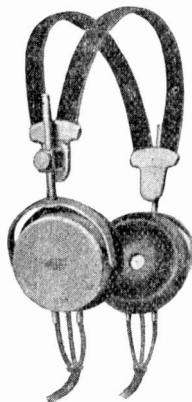

Electric Sales Co.

Phone 627-02

1144 Maple Avenue

Los Angeles

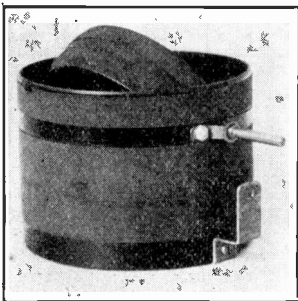

Do You Want Radio Frequency

(Maximum Distance)

On One Tube?

Look These Over

WDAP—Chicago,

CFCN—Calgary,

WWJ—Detroit,

PWS—Havana,

WSB—Atlanta,

And Many More

Only one hook-up will do this. Only one tube is necessary, if this coupler is used. Coupler with diagram mailed within U. S. upon receipt of \$5.00. Money-back guarantee.

Dealers Investigate

Large Stock of Erla Reflex Transformers and W. D. 11 Tubes

Coast Coupler Company

245 East Seventh Street

Telephone 621-230

Long Beach, Cal.

WE BELIEVE

RADIO DOINGS is the most useful accessory to every listener-in. Price \$2.00 a year.

We also believe that **RADIO BROADCAST** is the best general radio magazine published. Price \$3.00 a year.

A combination of these two is ideal. Here is how you can get both for little more than half price.

RADIO DOINGS

308 Van Nuys Bldg., Los Angeles

Inclosed find \$3.50 in full payment for a years' subscription to **RADIO DOINGS** and **RADIO BROADCAST**.

Name _____

Address _____

6-8 A. M.
PACIFIC TIME

RADIO TIME TABLE

7- 9 Mountain Time
8-10 Central Time
9-11 Eastern Time

STATION	METERS	CITY	CALL	MON.		TUES.		WED.		THUR.		FRI.		SAT.		SUN.	
				6.00-6.30	6.30-7.00	7.00-7.30	7.30-8.00	6.00-6.30	6.30-7.00	7.00-7.30	7.30-8.00	6.00-6.30	6.30-7.00	7.00-7.30	7.30-8.00	6.00-6.30	6.30-7.00
City Dye Works		Los Angeles	K U S	A													
Reynolds Radio Co.		Denver	K L Z		A												
Star-Telegram	475	Fort Worth	W B A P			C											
Free Press	517	Detroit	W C X				B										
Detroit News		Detroit	W W J	B													B

8-10 A. M.
PACIFIC TIME

RADIO TIME TABLE

9-11 Mountain Time
10-12 Central Time
11- 1 Eastern Time

STATION	METERS	CITY	CALL	MON.		TUES.		WED.		THUR.		FRI.		SAT.		SUN.	
				8.00-8.30	8.30-9.00	9.00-9.30	9.30-10.00	8.00-8.30	8.30-9.00	9.00-9.30	9.30-10.00	8.00-8.30	8.30-9.00	9.00-9.30	9.30-10.00	8.00-8.30	8.30-9.00
S. F. Examiner		San Francisco	K U O														
Reynolds Radio Co.		Denver	K L Z			C											
Star-Telegram	475	Fort Worth	W B A P			C											
News and Journal	475	Dallas	W F A A	C													
Palmer School	484	Davenport	W O C														
John Wanamaker	509	Philadelphia	W O O	B													

We Buy, Sell, Exchange, Repair, Install Your Radio Equipment

Free Advice—If you are dissatisfied with your equipment come to us.

Send for any parts now—we have them.

Send your questions to our Technical Bureau.

Visit our Educational Department

Salesrooms, Reading
Section, Laboratory

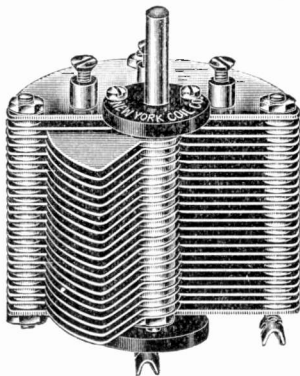
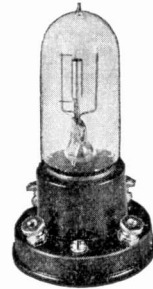

Los Angeles Radio Institute

625 South Hope Street

Third Floor Los Angeles

Come or write today

Mail Orders Filled Promptly

Open Every Evening Till 9 P. M.

10-12 A. M.
PACIFIC TIME

RADIO TIME TABLE

11- 1 Mountain Time
12- 2 Central Time
1- 3 Eastern Time

STATION	METERS	CITY	CALL	MON.		TUES.		WED.		THUR.		FRI.		SAT.		SUN.	
				10.00-10.30	10.30-11.00	11.00-11.30	11.30-12.00	10.00-10.30	10.30-11.00	11.00-11.30	11.30-12.00	10.00-10.30	10.30-11.00	11.00-11.30	11.30-12.00	10.00-10.30	10.30-11.00
L. A. Union Stk. Yds.		Los Angeles	K F C L	C			C		C		C		C		C		
Bible Institute		"	K J S														A
L. A. Times	395	"	K H J														A
Earl C. Anthony	469	"	K F I														A
City Dye Works		"	K U S		A	A											A
Hale Brothers	423	San Francisco	K P O														B
Tribune		Oakland	K L X														B
Warner Brothers		"	K L S			A			A		A						B
Gould		Stockton	K J Q														B
Guy Greason		Tacoma	K F E J	A	A		A	A	A			A	A	A			
Rhodes Co.		Seattle	K D Z E	A	A		A	A	A			A	A	A			
First Presby. Church		"	K T W														
Meier & Frank		Portland	K F E C												A	A	
Reynolds Radio Co.		Denver	K L Z		C		C		C		C		C		C		
News and Journal	475	Dallas	W F A A	B	B		B		B		B		B		B		
Palmer School	484	Davenport	W O C					B		B		B		B			

The numerals next to name of station indicate the wave length. Where no number appears, the wave length is 360. X indicates that the station is "on the air."

Lots of TUBES

UV 199	\$ 6.50
UV 201-A	6.50
WD 11	6.50
WD 12	6.50
UV 200	5.00
C 300	5.00
C 301-A	6.50
216-A	12.00

Adapters and Sockets for UV-199 Tubes

Dealers!
Attractive Discounts
Immediate Deliveries



12-2 P. M.
PACIFIC TIME

RADIO TIME TABLE

1- 3 Mountain Time
2- 4 Central Time
3- 5 Eastern Time

STATION	METERS	CITY	CALL	MON.		TUES.		WED.		THUR.		FRI.		SAT.		SUN.	
				12.00-12.30	12.30-1.00	1.00-1.30	1.30-2.00	12.00-12.30	1.00-1.30	1.30-2.00	12.00-12.30	1.00-1.30	1.30-2.00	12.00-12.30	1.00-1.30	1.30-2.00	12.00-12.30
CITY DYE WORKS		Los Angeles	K U S	A			A		A		A		A		A		
BIBLE INSTITUTE		"	K J S														
L. A. Union Stk. Yds.		"	K F C L	C			C		C		C		C		C		
L. A. TIMES	385	"	K H J			B		B		B		B		B			
L. A. EXAMINER		"	K W H			C		C		C		C		C			
WARNER BROS.		San Francisco	K L S	A	A		A	A	A	A	A	A	A	A	A	A	A
HALE BROS.	423	"	K P O N		B	A		B	A	B	A	B	A	B	A	B	A
L. J. Meyberg		"	K D N		A	A		A	A	A	A	A	A	A	A	A	A
Herrold Lab'y		San Jose	K O W		A	A		A	A	A	A	A	A	A	A	A	A
Modesto Herald		Modesto	K X D														A
Guy Greason		Tacoma	K F E J	A	A		A	A	A	A	A	A	A	A	A	A	A
Rhodes Co.		Seattle	K D Z E														
Reynolds Radio Co.		Denver	K L Z		A		A		A		A		A		A		
STAR-TELEGRAM	475	Fort Worth	W B A P		C	B		C	B		C		C		C		B
NEWS AND JOUR.		Dallas	W F A A					A	C		A		A		A		
PALMER SCHOOL	484	Davenport	W O C	B		B		B	B		B		B		B		
Star	411	Kansas City	W D A F		B	B		B	B		B		B		B		
News Detroit	580	Detroit	W W J	X	X	X	X	X	X	X	X	X	X	X	X	X	X

The numerals next to name of station indicate the wave length. Where no number appears, the wave length is 360. X indicates that the station is "on the air."

A Rare Mineral

A Radio Discovery

CULINA CRYSTAL

A rare crystal for radio detectors that improves with age and will last forever. When obtained from the mines it is worthless as a radio detector, but in the Harris Laboratory, under the personal supervision of Professor E. P. Harris, Ph.D., LL.D., it is subjected to an ageing and oxidizing treatment which brings its sensitiveness to a high standard. Exposed to the air its value increases instead of decreases. Each crystal is individually tested and guaranteed to be perfect.

PRICE 50c

Culina Crystal can be obtained wholesale from:
The Electric Corporation, 836 South Los Angeles Street.
McKillen Bros. & Co., 406 South Main Street.
The Radio Concert Equipment Co., 922 South Flower Street.
Factory Representatives

B. KRUGER & COMPANY

231 Douglas Building

Los Angeles, California

2-4 P. M.
PACIFIC TIME

RADIO TIME TABLE

3- 5 Mountain Time
4- 6 Central Time
5- 7 Eastern Time

STATION	METERS	CITY	CALL	MON.		TUES.		WED.		THUR.		FRI.		SAT.		SUN.	
				2.00-2.30	2.30-3.00	2.00-2.30	2.30-3.00	2.00-2.30	2.30-3.00	2.00-2.30	2.30-3.00	2.00-2.30	2.30-3.00	2.00-2.30	2.30-3.00	2.00-2.30	2.30-3.00
CITY DYE WORKS		Los Angeles	K U S	A	A												
El. Light. Sup. Co.		Los Angeles	K N X														
S. F. Examiner		San Francisco	K U O	A	A	A	A	A	A	A	A	A	A	A	A	A	A
Tribune		Oakland	K L X		A		A		A		A		A		A		A
Portable Wireless		Stockton	K W G														
Kimball-Upson		Sacramento	K F B K		A	A			A		A		A		A		A
Calif. Radio Lab'y		Hanford	K F B D		A	A			A		A		A		A		A
Fallon & Co.		Santa Barbara	K F H J	A		A											A
First Presby. Church		Seattle	K T W														A
Guy Greason		Tacoma	K F E J		A	A			A		A		A		A		A
Rhodes Co.		Seattle	K D Z E		A	A			A		A		A		A		A
Oregonian	492	Portland	K G W		A	B			A		B		A		B		A
Deseret News		Salt Lake City	K Z N		A	A			A		A		A		A		A
Reynolds Radio Co.		Denver	K L Z		A	A			A		A		A		A		A
Sparks High School	226	Sparks	K F F R		A				A		A		A		A		A
Star-Telegram	476	Fort Worth	W B A P														B
Palmer School	484	Davenport	W O C			B											B
Daily News-Fair	448	Chicago	W M A Q		A				A				A				B
Star	475	Kansas City	W D A F			B							B				B
Free Press	517	Detroit	W C X		B	B			B		B		B				B
News	580	Detroit	W W J		X	X			X		X		X		X		X
Drake Hotel	390	Chicago	W D A P		X	X			X		X		X		X		X

Announcement to Radio Retailers!

We courteously desire to inform you that the **GLOBE ACCESSORIES COMPANY** is offering for sale a quality line of Radio Merchandise.

It is our aim to satisfy the retailer with our prices, and the retailer in turn will please customers with our Quality Goods. Respectfully suggest you investigate our essential list of radio parts.

Fixed Condensers
Spiderweb Forms, Wound and Unwound
Phone Connections
Spagetti, Assorted
"Forest City" Inductance Coils

Dealers—Write Us for Prices—Quick Delivery

Globe Accessories Co.

Wholesale Only

309 West Jefferson Street

Telephone 271-273

Los Angeles, Calif.

4-6 P. M.
PACIFIC TIME

RADIO TIME TABLE

5- 7 Mountain Time
6- 8 Central Time
7- 9 Eastern Time

STATION	METERS	CITY	CALL	MON.		TUES.		WED.		THUR.		FRI.		SAT.		SUN.	
				4.00-4.30	4.30-5.00	5.00-5.30	5.30-6.00	4.00-4.30	4.30-5.00	5.00-5.30	5.30-6.00	4.00-4.30	4.30-5.00	5.00-5.30	5.30-6.00	4.00-4.30	4.30-5.00
L. A. Union Stk. Yds.		Los Angeles	K F C L	C			C			C			C				
Earle C. Anthony	469	"	K F I										B				B
City Dye Works		"	K U S			A							A				
L. A. Herald	469	"	Herald Examiner			A			A				A				
L. A. Examiner	469	"	K P O			A			A				A				
Hale Bros	423	San Francisco	K P O	A	B	B	A		B	B	A		B	B	A		
Oakland Tribune		Oakland	K D N	A			A		A				A				
L. J. Meyberg		San Francisco	K D N		/		A		/				/				/
S. F. Examiner			K U O		/		A		/				/				/
Maxwell Elec. Co.		Berkeley	K R E														A
Portable Wireless		Stockton	K W G	A	A	A	A	A	A	A	A	A	A	A	A		
Gould		Stockton	K J O		A	A	A	A	A	A	A	A	A	A	A		A
San Joaquin L. & P.		Fresno	K M J														
Radio Den.		Santa Ana	K F A W	A				A					A				
Nielson Radio Sup. Co.		Phoenix	K F C B			A	A			A			A	A			
First Presby. Church		Seattle	K T W			A							A				A
Northwest Radio		Seattle	K J R			A							A				A
Mullens Electric		Tacoma	K G B			A							A				A
Guy Greason		Tacoma	K F E			A							A				A
Meier & Frank		Portland	K F E C	A	A	A	A	A	A	A	A	A	A	A	A	A	A
Halioc & Watson		"	K G G														
Star-Telegram	475	Fort Worth	W B A P		/	B	/	B	/	B	/	B	/	B	B	B	B
News and Journal	475	Dallas	W F A I		B		B		B		B		B		B		B
		San Antonio	W O A I			B	B	B	B	B	B	B	B	B	B	B	B
Palmer School	484	Davenport	W O C		B	B	B	B	B	B	B	B	B	B	B	B	B
Daily News-Fair	448	Chicago	W M A Q			B	B	B	B	B	B	B	B	B	B	B	B
Westinghouse	337	Springfield, Mass.	W B Z			B	B	B	B	B	B	B	B	B	B	B	B
Kaufman & Baer	326	Pittsburgh	W C A E			B	B	B	B	B	B	B	B	B	B	B	B
Free Press	517	Detroit	W C X		B	B	B	B	B	B	B	B	B	B	B	B	B
Western Elect. Co	492	New York	W E A F		B	B	B	B	B	B	B	B	B	B	B	B	B
News	517	Detroit	W W J		B	B	B	B	B	B	B	B	B	B	B	B	B
Star	415	Kansas City	W D A F		B	B	B	B	B	B	B	B	B	B	B	B	B
Tribune		Great Falls	K D Y S			B		B		B		B		B		B	B
Am. Tel. & Tel.	501	New York	W B A Y		B	B	B	B	B	B	B	B	B	B	B	B	B
Genl. Elect.	382	Schenectady	W G Y			X		X		X		X		X		X	X
Bamberger	405	Newark				X		X		X		X		X		X	X
Drak otel Chl.	390	Chicago	W D A P		X	X		X	X		X	X		X	X		X

The numerals next to name of station indicate the wave length. Where no number appears, the wave length is 360. X indicates that the station is "on the air."

RADIO OPERATORS WANTED

Radio School, Y. M. C. A., Los Angeles, Calif.

Can you get first-class licensed operator to leave Los Angeles tonight for our barkentine City of _____, leaving San Francisco, Friday or Saturday, 4 1/2 months trip, Alaska; pay ninety month. Please wire immediately.

PACKING CO.



This is one of four such calls received in four days. Operators should register here. Y. M. C. A. Radio School, 715 South Hope, Los Angeles, Calif. Phone 108-22. Radio Sta. 6YA.

Cunningham



**Tubes
For Every
Requirement**

For Portable Sets

**The New C-299 Amplifier-Detector
A Dry Cell Tube using only 1/16 ampere**

The Braun Corporation

Wholesale Distributors

**Remler Products
Bradleystats
Baldwin Head Sets
Kellogg Parts**

**Cunningham Tubes
Ray-O-Vac Batteries
France Battery Charger
GILFILLAN PRODUCTS
Amrad Apparatus**

**Lefax Handbook
Coto-Coil Products
Magnavox**

363 New High Street

Los Angeles, California, U. S. A.

Something Decidedly NEW

Saves Labor and Panel Space
of drilling tap switch holes

**CYMO Vario-Unit
Complete \$8.00**

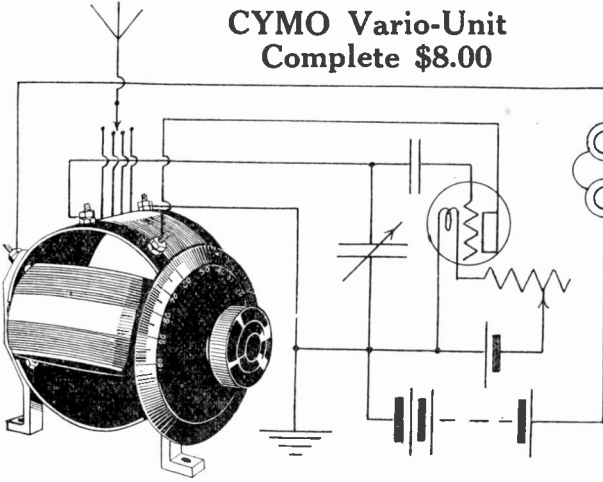
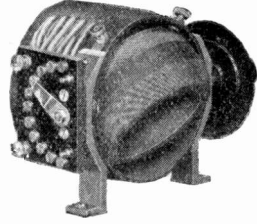

This is simplest form of single tube regenerative hook-up. Gives effective, efficient results of better than 500 to 1,000 miles.

Write for FREE "Hook-Up" Booklet

**RADIO
DEVICES
CO.**

693 Mission Street
San Francisco

Prest and Dean Radio Electric Co.

Complete Line of Radio Supplies and Sets

Colin B. Kennedy

De Forest

742 East Fourth Street

Long Beach Phone 635-213

A Limited Number of the Walpole

Micrometer Condenser

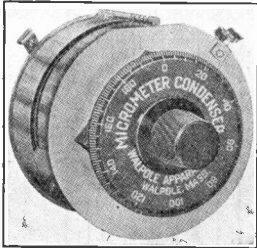

"The Condenser of a Thousand Graduations"
A finer adjustment with one knob that can be obtained with any Vernier Condenser
If your present condenser is causing poor reception you should by all means see and try the WALPOLE MICROMETER CONDENSER.

Condenser Sent C. O. D. with
Money Back Guarantee

Write to W. H. Estes

Phone 1179

Alhambra, Calif.

917 Dos Robles Place

A Peanut Tube Receiver
Noted for Its Selectivity



"RADIO JACK"
An Ideal Broadcast Receiver
Selling on its Reputation
Terms to Suit

NOT IN THE CUT RATE BUSINESS

But we have in stock a line of Condensers. The quality and price can't be beat. Molded ends. Aluminum plates, with knob.

- 43 Plate.....\$3.50
- 23 Plate.....\$2.75
- 13 Plate.....\$2.25
- 7 Plate.....\$1.75

Radio Jack
5528 Moneta Avenue
Los Angeles
Open Till 9 P. M.

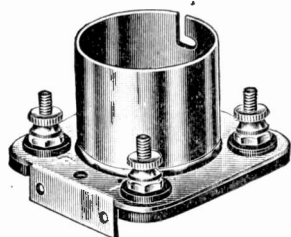

Premier Universal Tube Socket

All brass, nicely nickel-plated, neat and attractive. Mounts flat or on panel. All terminals thoroughly insulated, making the socket practically leak-proof to high frequency alternating current. Fits all standard tubes, making positive and firm contact with no play or "wobble" of tube in socket.

Code No. 1—Price.....75 Cents Each
Packed in individual containers

Premier Grid Condenser

Very well made, accurate and extremely uniform in capacity. Two Bakelite discs 1 1/8 inches in diameter, firmly hold the aluminum storage plates, which are separated by a very thin, high dielectric insulator.

A quality condenser at the right price

Code No. 3—Cap., .00025 M. F., price, each.....35 Cents
Code No. 4—Cap., .0005 M. F. price, each.....50 Cents



Coker Electric Supply Co.

817 West Third Street

Phone 822-237

Los Angeles

Join Our Radio Mechanics Class
TUITION \$4.75 Per Month

We furnish all Tools, Blueprints, Diagrams. Hook-up or change your set here—learn how. Act now—register early and avoid the rush.

Los Angeles Radio Institute

625 South Hope Street (Third Floor)

Los Angeles

FITZGERALD'S
for the
Advancement of Music.

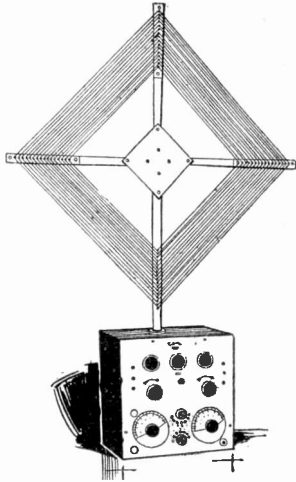

DeForest D-7A

No Loop—No Ground
3000-Mile Range

Compact, Portable, Efficient

\$132.50

Dealers where these may be obtained:

Howland & Dewey Co.
Electric Appliance Company
Charles E. Holland
Yale Electric Company
Advance Bicycle Shop
AA-1 Radio Shop
Stanford Electric Company
United Sales Company
Hensel Electric Store
Normandie Radio Shop
F. McCurtain
Southern California Radio Company
Mohawk Battery Company
Uni. Radio Research Lab., Pasadena
Radio Telephone Shop, Santa Paula
McClay Ignition Works, Santa Ana
Anaheim Ignition Depot, Anaheim
O. B. Radebaugh, Flagstaff, Arizona
Ventura Radiator Works, Ventura
Merrifield Music Co., San Luis Obispo
LeRoy Electric Company, Alhambra
Orange Tire Hospital, Orange

Norman N. Wilson, Balboa
Equipment Sales Company, San Diego
Eklund Music Company, Colton
Prest & Dean, Long Beach
Long Beach Radio Company
W. D. Soper, Ojai
Valley Commercial Company, Calexico
Nielson Radio Supply, Phoenix
Frank Nosworthy, Santa Maria
G. F. Sparling, Inglewood
Claude Chess, Monrovia
Fred F. Newport, Laguna Beach
Wasco Drug Company, Wasco
Creswell Brunswick Shop, Redondo Beach
P. L. Heidner, Azusa
Eagle Rock Hdw. & Furn. Co, Eagle Rock
E. F. Savage, San Francisco
Co-Operative Battery Co., San Francisco
Kahn & Keville, San Francisco
Ben Virden, Oxnard
Brown Music Co., Ontario

*The Fitzgerald Music Co. is the sole distributor
for DeForest equipment in this territory*

THE RADIO DIVISION
Phone 108-49
Main 4632



Telephone 108-49, Main 4632

Los Angeles, California

K H J—Los Angeles Times—395 Meters

Times Building, First and Broadway, Los Angeles. Owned and Operated by Los Angeles Times.
Phone Pico 700

SUNDAY—

10:00 a. m. Program arranged by INES BRICENO. Speaker to be supplied by BISHOP JOHN J. CANTWELL.
8:00 p. m. BEAR LAKE CHAMBER OF COMMERCE will present program "Around a Camp Fire," featuring BURKMAN BROTHERS, Hawaiian Quartet; GLADYS BLACKWELL PICKERING, Soprano; SAMUEL S. HINES, Monologist; NORVAL MacGREGOR, Noted Shakespearean Actor, and REX B. GOODCEL, from Internal Revenue Office, San Bernardino.

MONDAY—

12:30 to 1:15 p. m. G. W. LINDSAY, Baritone, artist pupil of F. X. ARENS. News items.
Music.
6:45 to 7:00 p. m. Silent.
8:00 to 10:00 p. m. Silent.

TUESDAY—

12:30 to 1:15 p. m. News Items. Music.
6:45 to 7:30 p. m. MABEL CUSHMAN HARDISON, Soprano,, EMERSON FROME LIVINGSTON, Reader.
8:00 to 10:00 p. m. Program arranged by M. THERESA BESSLER of Whittier, "The Junior Cabaret" featuring RHENA PETTERIN, Vocalist and Accompanist; JACK KIBLER, Cornetist; BUCK DODSON, Clarinet and Saxophone, HOWARD GILLETTE, Xylophone; WALTER WOOD, Banjo; GORDON BERGER, Baritone, and THERESA BESSLER, Violinist and Director.

WEDNESDAY—

12:30 to 1:15 p. m. News Items. Music.
6:45 to 7:30 p. m. BIANCA BLACKBURN, Reader, 4 years of age; MARCIA CRENSHAW, Pianist and Violinist, 9 years of age; GRACE CRENSHAW, Violinist and Pianist, 11 years of age, pupils of MAE MacDONALD HOPE and CALMON LUBOVISKI.
8:00 to 10:00 p. m. Memorial Program, "Peace," arranged by HARRIET E. CHUBBIC.

THURSDAY—

12:30 to 1:15 p. m. News Items. Music.
6:45 to 7:30 p. m. PAULINE BOLT, Reader, 10 years of age; FANNIE MYERS, Saxophonist, accompanied by P. H. KAUFMAN.
8:00 to 10:00 p. m. Program arranged by "THE BAY NEST OF ORIOLES," of Santa Monica.

FRIDAY—

12:30 to 1:15 p. m. News Items. Music.
6:45 to 7:30 p. m. EDWIN PETERS, Reader; DOROTHY LEE DENT, Pianist, 14 years of age, pupil of ALICE McCOMAS GRAY.
8:00 to 10:00 p. m. Program arranged by OXNARD CHAMBER OF COMMERCE, "Oxnard Sugar Beet."

SATURDAY—

12:30 to 1:15 p. m. News Items. Music.
6:45 to 7:30 p. m. ONOLEE JONES, Reader, pupil of MARSHALL STEADMAN, and MAE SCHWARTZ, Pianist, 11 years of age.
8:00 to 10:00 p. m. Program arranged by ALBERT TESSIER, featuring ALBERT TESSIER, Pianist; AMADEO RENO, Violinist, and PAUL S. FRYER, 'Celist.

C F C N—W. W. Grant Radio, Ltd.—440 Meters

CALGARY, CANADA

WEDNESDAY—

10:00 to 12:00 p. m. PLAZA CABARET ORCHESTRA and musical entertainment.

SATURDAY—

9:30 to 11:00 p. m. PLAZA CABARET ORCHESSTRA and musical entertainment.

SUMMER RADIO

This summer on your camping trip don't be limited by music furnished by a limited number of records—a complete radio set will not only furnish you music, but base-ball scores, news items, sermons, lectures—everything brought right into your camp at your finger's touch. Drop in and look over our stock of portable radio sets and parts for building your own "summer radio set."

COAST RADIO COMPANY, Inc. Phone El Monte 110
(Pasadena Representative Telephone F O 4262 R)

—SAFETY FIRST—

The Daniel A and B Battery Lock-Switch

For many reasons there should be a switch
on every set
SAFETY FIRST—THE LOCK-SWITCH
IT IS THE RADIO SWITCH

Price \$1.00

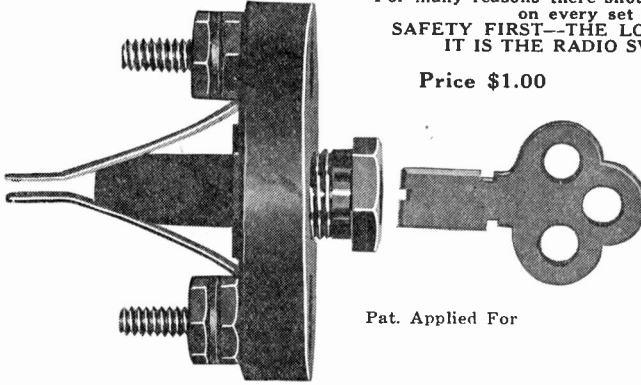

For sale at
radio dealers
or sent post-
paid on
receipt of
price.

Pat. Applied For

The Daniel Variocoper and Variometer Bearing Assemblies are Universal
Build Your Own—There is a Reason
Price 75 Cents

Dealers Call or Write

R. W. DANIEL

5234 Melrose Avenue

Phone Holly 8512

Los Angeles, Calif.

Radio Supplies

Where You Get the Most for Your Money

JUST RECEIVED!

**A Special Shipment of Peanut Tubes
C-301A—C-299 Tubes, Specially Priced**

Come in and let us show you what we have to offer—we carry a full line
of quality products at greatly reduced prices

Sam Sharpe Hardware Stores

101-103 West Seventh Street

733 South Main Street

Los Angeles, Calif.

K F I—Radio Central Station—469 Meters

Telephone Main 6061

6:45 to 7:30 P. M. PERIODS DEVOTED TO FOLK SONGS
AND SONGS OF YESTER YEAR8:00 to 9:00 PERIODS DEDICATED TO CHILDREN'S PLAY GROUNDS—
SONGS FOR CHILDREN, FAIRY STORIES IN MUSIC**SUNDAY—**

- 10:00 to 11:00 a. m. Full Church services by all denominations co-operating through the Church Federation, REV. J. A. STEVENSON, Executive Secretary, 436 Van Nuya Bldg.
4:00 to 5:00 p. m. Full musical Vesper service, under direction of MRS. WM. MABEE, National Chairman of Church Music, National Federation of Music Clubs, 321 Van Ness Avenue.
4:00 to 5:00 p. m. Industrial Choruses under direction of ANTONETTE RUTH SABEL, Director of Bureau Industrial Music, Chamber of Commerce.
8:00 to 9:00 p. m. PACKARD GIRLS CONCERT PLAYERS.
9:00 to 10:00 p. m. Examiner.
10:00 to 11:00 p. m. PACKARD SIX ORCHESTRA, Dance Music.
6:45 to 11:00 p. m. Silent night.

TUESDAY—

- 6:45 to 7:30 p. m. MYRA BELLE VICKERS, Teacher of Voice, presenting members of her two quartettes.
8:00 to 9:00 p. m. Herald.
10:00 to 11:00 p. m. Music Teacher's Association, Special Vocal and Instrumental Music.

WEDNESDAY—

- 6:45 to 7:30 p. m. DR. MARIAN TRACIE WHITING, assisted by her company, THE MUSICAL THREE.
10:00 to 11:00 p. m. American Musical Optimists, Special Instrumental Program.

THURSDAY—

- 6:45 to 7:30 p. m. MRS. J. J. CARTER presenting Hollywood talent.
10:00 to 11:00 p. m. MRSS. J. J. CARTER presenting Hollywood talent, vocal and dance music.

FRIDAY—

- 6:45 to 7:30 p. m. TILDA ROHR and MINA WENZEL, Soprano.
10:00 to 11:00 p. m. BURBANK CHORAL CLUB.

SATURDAY—

- 6:45 to 7:30 p. m. EUTERPEAN MALE QUARTET, MAUDE REEVES BARNARD, Manager.
8:00 to 9:00 p. m. ANNE PRISCILLA RISHER presenting well known children compositions.
10:00 to 11:00 p. m. PACKARD RADIO CLUB, Special Program.
10:00 to 11:00 PERIODS—A SERIES OF SPECIAL PROGRAMS

Erla Duo-Reflex Circuit

The Most Powerful Single Tube Circuit Ever Built
Complete parts for this set with instruction sheet and hook-up

\$24.50

Change Your CR-5 to a Reflex at Small Cost

Erla Reflex transformer.....	\$5.00
Chelsea Audio Transformer.....	3.75
K. D. Crystal detector with mounted galena.....	.35
.002 Mica Condenser.....	.40
25 ohm rheostat.....	.75

Send money order, draft or cashier's check. No C. O. D.

We pay the postage

Yale Radio Electric Co.

Department C, 4816 South Vermont Avenue

Los Angeles, Cal.

Examiner Radio Studio

These programs are rendered in the Examiner Studio and broadcasted by remote control over the leased wire of the Southern California Telephone Company from Radio Central Station K. F. I

SUNDAY,

9:00 to 10:00 p. m. WELCH NIGHT.

MONDAY—

9:00 to 10:00 p. m. Silent.

TUESDAY—

9:00 to 10:00 p. m. Program by SID GRAUMAN.

WEDNESDAY—

9:00 to 10:00 p. m. Special Memorial Day Program. Also the story of the Battle of Cantigny, by ADOLPH M. SUTTRO.

THURSDAY—

9:00 to 10:00 p. m. VENICE NIGHT—VENICE OF AMERICA BAND.

FRIDAY—

9:00 to 10:00 p. m. FINN FROLICH, the Sculptor, program.

SATURDAY

9:00 to 10:00 p. m. Program by SID GRAUMAN.

9:00 to 10:00 p. m. CORTLAND GILMORE of Long Beach, and his saxophone band.

Reliable-Radio-Equipment-Service

We Sell and Recommend Products of

Radio Corpn. of America

Crosley Mfg. Co.

DeForest Radio Tel. & Tel. Co.

Each in a class by itself

Radio Maps of United States and Canada, 15c

Phone or write for our Radio Catalogue

Quality
Mdse.

Howland & Jewey Co.

Expert
Service

EASTMAN KODAK COMPANY

510 SOUTH BROADWAY

LOS ANGELES

K J S—Bible Institute Radiophone—360 Meters

Owned and Operated by Bible Institute of Los Angeles, Inc.
M. E. Carrier, Manager Radio Department
Telephone Main 9293

SUNDAY—

11:30 a. m. Regular Morning Service of the Church of the Open Door. Male Quartet.
6:00 p. m. Verper Service. Organ Recital.
8:00 p. m. Regular Evening Service of the Church of the Open Door. HARMONY MALE QUARTET. Gospel Solo, MR. C. M. BOOKS, Bass; Sermon, DR. R. A. TORREY.

TUESDAY—

7:00 to 7:30 p. m. Organ Recital. Special Vocal Numbers.

THURSDAY—

8:00 to 9:00 p. m. Program by the Men's Glee Club of the Bible Institute. (1) "Lead Kindly Light," Buck; "Arise, Shine," Rhodes, GLEE CLUB. (2) "Crossing the Bar," Adams, Quartet; (3) Flute Solo, Serenade, Gaunod, SAMUEL WHEATLEY; (4) "Oh, Hail Us, Ye Free," Verdi, GLEE CLUB; (5) Violin Solo, "Cavatina," Raff, CURTIS GLENN ELLIOT; (6) "Moonlight on the Lake," White, Quartet; (7) Bugle Song, Hatton, GLEE CLUB; (8) Bass Solo, "Open the Gates of the Temple," Knapp, H. C. RICHERT; (9) "Take Thou My Hand," Sullivan-Parks, Quartet; (10) "My Anchor Holds," owner, GLEE CLUB.

NOTE—Program for May 31 Same as Last Week



"FRANK SAYS"

With every \$2.00 purchase a Novelty
Crystal Set Given Free

6278 Hollywood Boulevard

"If I haven't got it, I'll get it."—"The Originator,
not the Imitator."

Come to the store and get your Radio Doings Free

RC

Reflex—The latest and most popular thing in Radio Frequency Loop and Loud Speaker
reception. Adapted to UV199 tube. Transformers made especially
for Single Tube Reflex. Price, \$3.75—We pay the Postage

Send your orders now—Dealers, get our prices

RAY CAMPBELL

1367 West 100th Street

Los Angeles, Cal.

K U S—City Dye Works Radiophone—360 Meters

Owned and Operated by the City Dye Works, Los Angeles
Telephone South 120

7:00 to 7:30 a. m.	Daily Except Sunday	Walter Camp's Daily Dozen.
12:00 to 12:30 p. m.	Daily Except Sunday	Concert.
2:00 to 2:30 p. m.	Monday and Thursday	Special Programs.
4:00 to 4:30 p. m.	Tuesday and Friday	Code Practice.

WEDNESDAY—

7:00 to 7:30 a. m.	Walter Camp's Daily Dozen.
12:00 to 12:30 p. m.	Concert.
6:00 to 6:45 p. m.	Musical given by the CITY DYE WORKS CHORAL SOCIETY, MISS BEATRICE VANCE, Acompanist.

FRIDAY—

7:00 to 7:30 a. m.	Walter Camp's Daily Dozen.
12:00 to 12:30 p. m.	Concert.
6:00 to 6:45 p. m.	Special Program given by the CHORAL SOCIETY.

DON'T BUY A NEW PANAMA

Why dig down in your jeans and pay hard-earned dollars for a new one when we can make your old one look crisp and white as new in a few days?

Straw hats, Panamas, Bangkoks and Leghorn Straws cleaned by the Jenkins Process look as good as new.

Have us call for your last season's Panama. We will reblock and retrim it into the new 1923 shapes at small cost.

Works
3000 Central
Avenue



Telephones
South 120
270-71

Los Angeles—417 West 7th Street
Los Angeles—224 South Western Avenue
Hollywood—6529 Hollywood Blvd.

Pasadena—390 East Colorado Street
Ocean Park—164 Pier Avenue
Long Beach—4 Pine Avenue

COMPLETE TUBE SETS \$35.00 UP

Installed and guaranteed satisfactory before any money accepted.
Crystal sets accepted as part payments—sets sold on terms to suit.
Any kind of Radio Equipment made to order.

Crystal Sets, \$5.00 Up

Moneta Service Co.

Radio Department

4351 Moneta Avenue, Los Angeles
Phone 291-470 and Representative Will Call

Evening Herald Radiophone

Owned and Operated by the Evening Herald
Broadcasted by remote control from Radio Central Station K F I
Telephone Pico 5100

DAILY EXCEPT SUNDAY—

5:00 to 5:30 p.m. Evening Herald News Bulletins covering the World's News Events up to 5 p. m. Closing market quotations by leased wire.

TUESDAY—

8:00 to 9:00 p. m. Program by MARION WARDE of Warde Dramatic School of Expression.

WEDNESDAY—

8:00 to 9:00 p. m. Program by GLADYS BURCH DALE, Violinist, and other instrumental and vocal talent.

FRIDAY—

8:00 to 9:00 p. m. Dance Orchestra.

K E N N E D Y



Those who wish to tune in one station without interference use Kennedy regenerative receivers. For broadcasting our Type 281 is without peer.

“At Best Dealers Everywhere”

For dealer information apply C. R. Kierulff & Co., 757 South Los Angeles Street, Los Angeles, exclusive wholesale distributors for Southern California.

COLIN B. KENNEDY CORP.

San Francisco

St. Louis

I D E A L

**Kennedy Type 311—Portable Receiver
\$75.00 Complete**

KENNEDY EQUIPMENT

The Royalty of Radio

We are Exclusive Southern California Distributors of
Kennedy Equipment



C. R. KIERULFF & CO.

**WHOLESALE DISTRIBUTORS
757 SOUTH LOS ANGELES STREET**

PHONE 628-87

LOS ANGELES, CALIF.

K P O—Hale Bros. Radiophone—423 Meters

San Francisco, California—Class "B" Station

E. J. MARTINEAU, Director of the Station
ADA MORGAN O'BRIEN, Program Manager

DAILY EXCEPT SUNDAY—
4:00 to 5:30 p. m. Organ music and address by member of PUBLIC SPIRIT CLUB.

SUNDAY—

11:00 to 12:30 a. m. Radio Church Service. This is the only church of its kind in the West. It is undenominational, and is intended to meet the spiritual needs through the fundamentals of religion. Order of Service: Call to Worship. Lord's Prayer. Occasional Prayer. Reading for Shut-ins. Reading of truth. Selections of Classical Music. Address. Popular hymns and other musical selections. GEORGE R. CHAMBERS, Minister in charge. Church Organ: GLADYS SALISBURY.

DAILY—

8:00 to 10:00 p. m. Vocal and instrumental program.

STAR ENGRAVING COMPANY
223 EAST FOURTH ST. LOS ANGELES, CALIF.
15663 TELEPHONE MAIN 5680

Mounted 50c

Unmounted 25c

Cat Whiskers Radio Crystals are Made at the Mine



THIS MEANS:

You get the best selected crystals Nature has to give.

We can afford to choose them carefully, because we have the mine to choose from. The ore we discard for crystals is good for the smelters.

EL PICACHO MINE maintains a radio set to test the crystals before they are sent to RADIO LABORATORIES to be mounted and TESTED CAREFULLY. HERE IN THE DESERT HILLS we hear the concerts, the applause, the laughter, at DENVER, FORT WORTH, PORTLAND, SALT LAKE, SAN FRANCISCO, LOS ANGELES, KANSAS CITY—the world comes to us on the waves of sound. WE USE CAT WHISKER RADIO CRYSTALS for detectors.

THEY SAID IT COULDN'T BE DONE—WE ARE DOING IT!

EL PICACHO MINE is situated in the DESERT OF NEVADA, where the STATIC conditions are worse than anywhere else in the world. WE HEAR THE CANARIES SING AT THE TIMES STUDIO IN LOS ANGELES. IF WE CAN DO THIS, AWAY UP HERE AT THE MINE, YOU CAN DO IT ANYWHERE ON EARTH!

If Your Pet Station Doesn't Come Right in, Write to

RADIO LABORATORIES

El Picacho Mining Co., Inc.

Dealers and Jobbers Write for Our Proposition

1423 West Pico Street

Los Angeles, California

K G W—The Morning Oregonian—492 Meters

Owned and Operated by The Morning Oregonian, Portland, Oregon

SUNDAY—

7:00 to 8:00 p. m. Concert arranged by MITYLENE FRAKER STITES.

MONDAY—

3:30 to 4:00 p. m. Educational Programme by the PORTLAND LIBRARY ASSN.
 7:00 to 7:30 p. m. Oregon Agricultural College Extension Lecture.
 8:00 to 9:00 p. m. Concert by Musician Employees of the Oregonian.
 9:30 to 10:30 p. m. One-act play, "The Maker of Dreams."
 11:00 to 12:00 p. m. Hoot Owls.

TUESDAY—

3:30 to 4:00 p. m. Woman's Programme. Lecture by GEO. B. EHINGER, Secretary Child Welfare Commission, on "The Dependent Child."

WEDNESDAY—

3:30 to 4:00 p. m. Children's Programme for Decoration Day.
 8:00 to 9:00 p. m. Special Memorial Day Program by members of the G. A. R., Spanish War Veterans and American Legion.

THURSDAY—

3:30 to 4:00 p. m. Woman's Program. Lecture by ANDREW MILLER, Field SSecretary Oregon Bankers Association; subject, "Character, the Basis of Bank Credit."

FRIDAY—

3:30 to 4:00 p. m. Woman's Program.
 7:00 to 7:30 p. m. UNIVERSITY OF OREGON Extension Course Lecture.
 8:00 to 8:15 p. m. Vocal Solos by MRS. FRED L. OLSON.
 8:15 to 9:00 p. m. GEORGE OLSEN'S Metropolitan Orchestra directed by HERMAN KENIN.
 11:00 to 12:00 p. m. Hoot Owls.

SATURDAY—

3:30 to 4:00 p. m. Children's Programme. Music by children and stories by AUNT NELL.
 11:30 a. m. Daily Except Sunday.
 7:30 p. m. United States Weather Forecast.



Hurry Along for Radio

Parts and Accessories at Sale Prices
 —Sale Soon Over—

THE RADIO STORES COMPANY

348 South Spring Street, Near Fourth, Los Angeles, Calif.

HOME OF THE RADIOLA

A Real Selective Crystal Set \$15.00

Sent C. O. D. Anywhere

Why hear four or five stations at once? You may tune the Times or Examiner in or out at your discretion—Compare this with any \$30.00 set—

We have spent sixteen years in Radio

Dealers, Get Our Prices

WD-11 Tubes, C301-A Tubes, UV-199 Tubes in Stock

LE ROY ELECTRIC COMPANY

E. W. LE ROY

PHONE 1179
 12 WEST MAIN STREET, ALHAMBRA, CALIF.

S. A. LE ROY, E. E.

WOC—Palmer School of Chiropractic—484 Meters

Davenport, Iowa—Pacific Time

SUNDAY—

- 6:00 p. m. Church Service, REV. W. G. OGLEVE, Pastor South Park Presbyterian Church, Rock Island, Ill. Subject: "A View From the Low, Green Door."
 6:30 p. m. Baseball Scores.
 7:00 p. m. Musical Program (2 hours)—ERWIN SWINDELL, Musical Director. CATHERINE ELLIOT, CATHERINE O'BRIEN, H. L. WALBOURNE, HOWARD SNYDER.

MONDAY—

- 4:30 p. m. Sandman's Visit.
 4:50 p. m. Baseball Scores.
 5:00 p. m. Educational Lecture—"Character Dressing, or Individual Expression in Dress," by E. W. SAMSEL, Director Displays, M. L. Parker Co., Davenport, Iowa.

TUESDAY—

- 3:45 p. m. Chimes Concert.
 4:00 p. m. Weather and Baseball Scores. (No broadcasting on Tuesday evening by agreement of Tri-City tations.)

WEDNESDAY—

- 4:50 p. m. Baseball Scores.
 6:00 p. m. Pipe Organ Recital, E. JOHN RICHARDS, Organist, assisted by JEANETTE BREWBAKER, Soprano.
 8:00 p. m. Artist Musical Program, ERWIN SWINDELL, Musical Director. Program furnished by the WARD TRIO of Sterling, Ill. Immediately following the late musical program, "Tourists' Road Report."

THURSDAY—

- 3:45 p. m. Chimes Concert.
 4:30 p. m. Sandman's Visit.
 4:50 p. m. Baseball Scores.

FRIDAY—

- 4:50 p. m. Baseball Scores.

SATURDAY—

- 4:30 p. m. Sandman's Visit.
 4:30 p. m. Sandman's Visit.
 4:50 p. m. Baseball Scores.
 7:30 p. m. Dance Program (one hour)—P. S. C. ORCHESTRA.

WALTER W. BIDDICK, Inc.

(Wholesale Only to Dealers)

Kilbourne & Clark
Tune-Sharp
Work Rite

Trutone Horns
Nathaniel Baldwin Headsets
Dictograph Headsets
Chelten Midget Vernier

Advance Unit Chargers
De Luxe Homchargers
Work Rite Hydrometers

Dealers—Our Representative Will be Glad to Call

Phone 213-01

1316 South Grand

Los Angeles

Equip Your Set with KELLOGG CONDENSERS

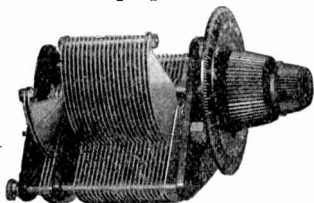

Our Kellogg Stock Is Complete

- No. 601—11-plate with 5-plate Vernier.....\$6.75
 No. 603—23-plate with 5-plate Vernier..... 7.75
 No. 605—43-plate with 5-plate Vernier..... 8.75

We have All Types Tubes in stock
Write for Catalogue

Radio Doings Mailed Anywhere FREE

STONE ELECTRIC SUPPLY CO.

710 West Pico Street

Metropolitan 2291

Los Angeles, Cal.

WBAP—Fort Worth Star-Telegram—476 Meters

Owned and Operated by Fort Worth Star-Telegram, Fort Worth, Texas—Pacific Time

DAILY FEATURES—

- 7:00 to 7:15 a. m. Opening Market Quotations.
- 9:00 to 9:30 a. m. United States weather report; late cotton and grain quotations; first call cotton-seed oil; Department of Agriculture fruits, vegetables and cattle divisions quotations.
- 10:00 to 10:15 a. m. Markets.
- 11:00 to 11:15 a. m. Markets.
- 1:00 to 1:30 p. m. Closing market quotations.
- 1:45 to 2:00 p. m. Financial Review.
- 3:30 to 3:45 p. m. Major League Baseball Scores.
- 4:30 to 4:45 p. m. Texas League baseball scores and sport review.
- 6:00 p. m. Sport Review.

SUNDAY—

- 9:00 to 10:15 a. m. Complete services of First Methodist Church, REV. J. W. BERGIN, D. D., Pastor; WILL FOSTER, Organist.
- 4:30 to 4:45 p. m. Complete Major and Texas League baseball scores.
- 6:00 to 6:10 p. m. Final Sport Review.

MONDAY—

- 7:30 to 8:30 p. m. Concert by the Orchestra of the First Presbyterian Church, MRS. THOMAS HUBBARD, Director. (G. C. A. announcing.)

TUESDAY—

- 7:30 to 8:30 p. m. Concert of band music and novelties, arranged by HUBB DIGGS. (The Hired Hand announcing.)

WEDNESDAY—

- 7:30 to 8:30 p. m. Final concert by the EUTERPEAN CLUB of Fort Worth. (G. C. A. announcing.)

THURSDAY—

- 7:30 to 8:30 p. m. Concert by the North Fort Worth High School Orchestra and Glee Club. (The Hired Hand announcing.)

FRIDAY—

- 7:30 to 8:30 p. m. Texas Christian University, 50-year jubilee program of pageant music and other features. (G. C. A. announcing.)

SATURDAY—

- 5:00 to 5:20 p. m. Review of the Interdenominational Sunday School Lesson by MRS. W. F. BARNUM, Leader of the Barnum Bible Class of First Methodist Church.
- 7:30 to 8:30 p. m. On Saturday and Sunday The Star-Telegram observes a "silent night," courtesy to its tube set listeners wishing to try for long distance records.

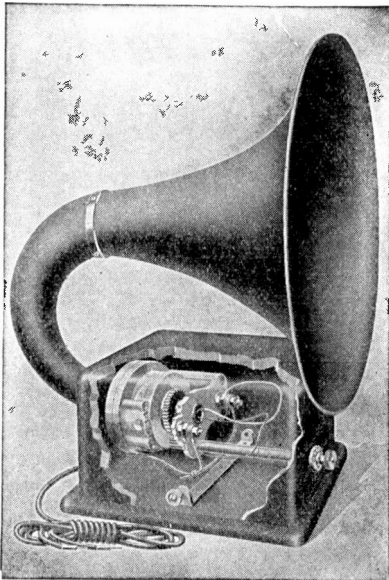

Have you heard the Dicto Grand Radio Loud Speaker

Adjustable Air Gap—Loud—Clear
No Distortion—Absolute Perfection
The Last Word in Radio Loud
Speakers

Price, \$28.50

Best at any price—make us
prove it!

At All Good Radio Dealers

Dictograph Products Corp.

L. C. Bishop, Agent
1240 Pacific Mutual Building
Los Angeles

Dealers—Call Broadway 4573 and
our representative will call and give
you a demonstration.

WWJ—The Detroit News—517 Meters

Pacific Time

MONDAY—

2:00 p. m. The DETROIT NEWS ORCHESTRA.

2:00 p. m. Markets and Baseball Scores.

9:05 a. m. The DETROIT NEWS ORCHESTRA.

The Town Crier; MRS. W. D. SCOTT, Contralto; MRS. FRANK STERNAL, Soprano; ARTHUR LEFFLER, Baritone.

TUESDAY—

9:05 a. m. The DETROIT NEWS ORCHESTRA.

2:00 p. m. Markets and Baseball Scores.

5:30 p. m. The Town Crier; The DETROIT EVENING NEWS; program by the CHAMBER

MUSIC SOCIETY of Detroit, LOUISE LAW TRIO, LOUISE LAW COHN, Pianist;

MISS MARION FRANCES COHN, Violin and MISS DOROTHY LOUISE COHN, Cello.

6:30 a. m. "Tonight's Dinner" and a special talk by the Woman Editor.

WEDNESDAY—

9:05 a. m. The DETROIT NEWS ORCHESTRA.

2:00 p. m. Markets and Baseball Scores.

3:30 p. m. The Town Crier; The DETROIT NEWS ORCHESTRA; program furnished by members of the CHARLES A. LEARNED POST, American Legion.

THURSDAY—

9:05 a. m. The DETROIT NEWS ORCHESTRA.

2:00 p. m. Markets and Baseball Scores.

5:30 p. m. The Town Crier; The DETROIT NEWS ORCHESTRA; the CATHEDRAL MALE

QUARTET; THOMAS C. EVANS, Tenor; EDWARD GALER, Tenor; GEORGE MAC-

DONALD, Bass and JOHN RENTON, Bass.

FRIDAY—

9:05 a. m. The DETROIT NEWS ORCHESTRA.

2:00 p. m. Markets and Baseball Scores.

4:00 p. m. The Town Crier; The DETROIT NEWS ORCHESTRA; MISS JESSIE PHYLLIS

KOPATZ, Mezzo-Soprano; MISS MILDRED SEEMAN, Pianist.

6:30 a. m. "Tonight's Dinner" and a special talk by the Woman Editor.

9:05 a. m. The DETROIT NEWS ORCHESTRA.

2:00 p. m. Markets and Baseball Scores.

SUNDAY—

8:00 a. m. Church Services from St. Paul's Cathedral.

9:05 a. m. The DETROIT NEWS ORCHESTRA.

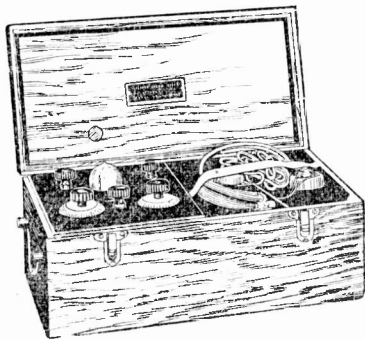

The Portable Radio Set

Just the Thing for Summer
Outings and Home Use

The latest triumph of Kennedy engineers has all the beauty and perfection of the "Royalty of Radio," is simple to operate, yet highly selective, with unusual freedom from interference.

The Kennedy "Portable" is designed for use with any standard tube, including the dry-cell type. When dry-cell tube is used, the set is entirely self-contained, space being provided for dry batteries and phones. Size 15x7½x7, weight 17 lbs.

Complete with tube, dry batteries
and phones\$75.00

716-738

South Broadway

Barker Bros.
Radio Department

Los Angeles

California

W F A A—Dallas News-Journal—475 Meters

Owned and Operated by A. H. Belo & Company, Publishers of Dallas News Pacific Time

MONDAY—

10:30 to 11:00 a. m. Address on "Amusements," by J. D. STEWART, Director of Publicity for the Melba Theatre, Dallas, followed by musical program from the Melba.
6:30 to 7:30 p. m. Orchestra and Glee Club of students in Dallas colleges, D. L. COZZO, Director.

TUESDAY—

10:30 to 11:00 a. m. Address by DeWITT McMURRAY, editor of the Semi-Weekly Farm News, in a medley of humor, pathos and wisdom.
6:30 to 7:00 p. m. Musical Program by TITCHE-Goettinger Company's Orchestra, GEORGE ASHLEY BREWSTER, Director.
9:00 to 10:00 a. m. Musical program by the W. A. GREEN COMPANY ORCHESTRA and Choral Club.

WEDNESDAY—

10:00 to 11:00 a. m. Address, REV. ROBERT A. HUNT, Pastor First Methodist Church, on "Living Epistles." Station will be silent for remainder of the day.

THURSDAY—

10:00 to 11:00 a. m. Address, JUDGE CHARLES F. GREENWOOD, president of the San Jacinto Club, on "Texas, the Republic."
6:30 to 7:30 p. m. Musical program arranged by EMMETT B. PECK, Violinist, for assisting musicians.
9:00 to 10:00 p. m. Music recital arranged under the auspices of the BUSH & GERTS PIANO COMPANY of Texas.

FRIDAY—

10:30 to 11:00 a. m. Address, DR. ROBERT STEWART HYER, Department of Physics, Southern Methodist University on the Sunday School Lesson, "Jeremiah, the Prophet of Courage."
6:30 to 7:30 p. m. Musical program, Grace Methodist Episcopal Church Orchestra, EARLE D. BEHREND, Director.

SATURDAY—

6:30 to 8:30 p. m. Musical program by JAMES G. BENNETT, Basso and MRS. JAMES G. BENNETT, Contralto. Readings by DR. J. J. SIMMONS, Story Teller, specializing in negro and other dialect.
9:00 to 10:00 p. m. Violin and Piano Music Recital, WALTER J. FRIED, MRS. WALTER J. FRIED and PAUL VAN KATWIJK of Southern Methodist University Department of Music.

What About Radio This Summer?

Come in and see our Portable Set for summer use. We have placed on the market a Radio Set which can be used in summer camps or on auto camping tours. This set is very selective. You can tune in the higher wave lengths.

PRICE: ONE TUBE SET\$75.00
PRICE: TWO TUBE SET\$100.00

Stanford Electric Company

Vermont Branch
3574 West First Street
Corner Vermont

Telephone 553-38
Los Angeles, Calif.

Main Store
1249 South Alvarado
Corner Pico

To Our Knowledge

100 PER CENT of our customers are satisfied with the service we are giving AND THE APPARATUS we recommend. For this service see

SOUTHERN CALIFORNIA RADIO CO.

F. G. ALBIN

B. D. ALBIN

Phone Wilshire 9634

Los Angeles, Cal.

1302 South Hoover St.

K S D—St. Louis Post-Dispatch—546 Meters

Pacific Time

MONDAY—

6:00 p. m. Broadcasting the complete opera, "Naughty Marietta" from the Municipal Opera Theatre, St. Louis. Noted principals, chorus of 100, orchestra of 80.

TUESDAY—

6:00 p. m. West Presbyterian Sunday School Orchestra, JOHN H. EGGERT, Director.

WEDNESDAY—

6:00 p. m. Orchestral Concert and Musical Specialties at the Grand Central Theatre.

THURSDAY—

6:00 p. b. Silent.

FRIDAY—

6:00 p. m. Broadcasting the complete opera, "Naughty Marietta," from the Municipal Opera Theatre in St. Louis. Noted principals, chorus of 100; orchestra of 80.

SATURDAY—

1:00 p. m. Children's Concert, DOROTHY CORKINS, Vocalist and Reader; W. J. FORESTEL, JR., Reader; ESTHER PORTMAN, Pianist.
 5:30 p. m. Baseball scores, World Market Survey, U. S. Public Health Broadcast.
 6:00 p. m. Special orchestral concert with solos broadcast from the Missouri Theatre.
 9:30 p. m. Organ recital at Missouri Theatre by STUART BARRIE.

Complete Stock of Wholesale Radio Goods!

In addition to selling you reliable merchandise, our company renders you a discount worthy of your consideration. Buy the best from us and please your customers.

WE FEATURE

C. R. L. Grid Leaks, Erla Reflex Trans., Baldwin Phones, Workrite Parts, "Master" Radio Products, Murdock Phones, All American Transformers

Vesta A Batteries, Howard Parts

FULL LINE OF ELECTRICAL SUPPLIES

COOK-NICHOLS CO.

Wholesale Only—Special Manufacturer's Discount

411 South San Pedro Street Pico 3741 Los Angeles, Cal.

100% Radio Corporation and Western Electric Products

Radiola IV Radiola V Western Electric R. C. Sets

We carry a complete line of radio apparatus, and courteously suggest you allow us to install a set in your home, on trial, with no obligation whatsoever. We desire to please you

THE RADIO DEN

OPERATING KFAW

W. B. Ashford

Tel. 1054W

H. T. White

Grand Central Market, 115 North Broadway, Santa Ana, Calif.

Complete List of New Class B Wave Lengths

Thirty-four Class B stations, each with a territorial zone, have been licensed by the Department of Commerce to start operating on May 15th.

Specific B Waves by Stations

The calls and waves for 34 Class B stations follow:

	Call	Wave
California—		
Los Angeles, Earle C. Anthony.....	KFI	(469)
Los Angeles, Times-Mirror	KHJ	(395)
San Francisco, Hale Bros., Inc.....	KPO	(423)
San Francisco, Mercantile Trust Co.....	KFDB	509
Georgia—		
Atlanta, Constitution.....	WGN	429
Atlanta, Journal.....	WSB	429
Illinois—		
Chicago, Westinghouse Elec. & Mfg. Co.....	KYW	(?)
Chicago, Daily News	WMAQ	448
Iowa—		
Davenport, Palmer School of Chiropractic.....	WOC	484
Kentucky—		
Louisville, Courier Journal and Times.....	WHAS	400
Massachusetts—		
Springfield, Westinghouse Elec. & Mfg. Co.....	WBZ	(337)
Michigan—		
Detroit, Free Press.....	WCX	517
Detroit, News	WWJ	517
Minnesota—		
Minneapolis, Cutting & Washington Radio Corp.....	WIAG	417
Missouri—		
Kansas City, Star.....	WDAF	411
Sweeney School Co.....	WHB	411
St. Louis, Post-Dispatch.....	KSD	546
New Jersey—		
Newark, Bamberger & Co.....	WOR	405
New York—		
New York, American Tel. & Tel. Co.....	WBAY	492
New York, Western Electric Co.....	WEAF	492
New York, Radio Corporation	WJY	405
New York, Radio Corporation	WJZ	455
Schenectady, General Electric Co.....	WGY	(380)
Troy, Rensselaer Polytechnic Inst.....	WHAZ	(380)
Oregon—		
Portland, Oregonian	KGW	(492)
Ohio—		
Cincinnati, U. S. Playing Card Co.....	WSAI	309
Pennsylvania—		
Philadelphia, Gimbel Bros.....	WIP	509
Philadelphia, Lit Bros.....	WDAR	(395)
Philadelphia, Strawbridge & Clothier.....	WFI	395
Philadelphia, Wanamaker	WOO	509
Pittsburgh, Kaufman & Baer Co.....	WCAE	(?)
Tennessee—		
Memphis, Commercial	WMC	500
Texas—		
Dallas, News and Journal.....	WFAA	476
Fort Worth, Star Telegram.....	WBAP	476

Stations with waves in parentheses not definitely assigned.

"Out of the Air"

By Listener-In

Advices from London tell that the radio set mounted on wheels and drawn by a goat or donkey is now seen on the streets and is attracting a big crowd of interested listeners. It will only be a short time until this means of entertainment will crowd off the old-fashioned hurdy-gurdy which has been such a familiar sight in the larger cities in England and this country. The gentlemen who make their living in this way are quick to catch hold of any novelty to catch the pennies, and it will not be long until we see something along the same lines as the London purveyor of melody on our streets.

The Avalon-Long Beach phone, as stated in a recent issue of RADIO DOINGS, is to be replaced with a cable. On June 1 this phone service will be either carried on by cable or will be operated on a wave-length of 1579 meters.

Radio is doing much in Asia toward the education of the masses. The Indian government has now authorized broadcasting by private enterprises. This is another step forward. The problem of educating the teeming thousands in India has always been a problem to the government of that country. Perhaps radio will be used extensively for this purpose and prove, once again, what a blessing radio has been to the world.

RADIO DOINGS seems to travel to many parts of the world. One of our advertisers has brought us in a letter from Hanover, Germany, enclosing his advertisement. The writer of this letter was an old friend and RADIO DOINGS has been the means of bringing these old friends together again, and incidentally of bringing business to this country.

S. L. Rothafel, manager of the Capitol Theater, New York, recently broadcast a 100-minute program of the entire musical portion of the current performance at that house. Mr. Rothafel did the announcing himself, much in the manner of Will Rogers. The unusual feature of the affair is the fact that "Fred," a professional reviewer writing for Variety, wrote a complete review of the entire program. This is said to be the first time that a broadcast program has been reviewed in any theatrical organ, and may be taken as one more indication of the lessening hostility on the part of the theater people for radio.

What we believe to be the first big radio picnic is to be given by the Marysville, Cal., nest of "Hoot Owls" on June 10th at Woodleaf, Cal. We hear that this is going to be a really big affair, and is to be attended by radio fans from the entire "sunshine state."

This is the sort of letter that pleases the whole staff:

"Here's my two bucks.

"You bet I don't want to be dropped from your list. It gets pretty lonesome out here in the desert, or rather it would if Mr. Marconi and his playmates hadn't trained and harnessed the ether.

"I get along pretty well with a six-tube set, and of course I could get along without RADIO DOINGS, but, then, I also could manage to farm without a tractor or horses. Why do it? I'll leave it to you.

"WALTER E. WESTMAN,
"Victorville, Cal."

Users of the new style tubes have experienced considerable trouble from blowouts. The Radio Service Company of Los Angeles and the Workrite Manufacturing Company have put new rheostats on the market which, it is claimed, will eliminate all danger of blowing out the new style of tubes:

RADIO FANS! CAUTION!!

Protect your Family, Home and Instrument by using

Brach Vacuum Arresters

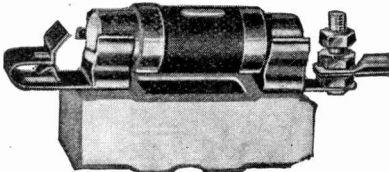

Type 200

The Brach Vacuum Arrester was the first arrester to be tested and formally approved by the Underwriters Laboratories.

Your Insurance Policy may be nullified by the use of electrical apparatus not passed by the National Board of Fire Underwriters. Use the best.

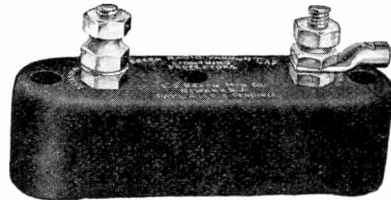

Type 210

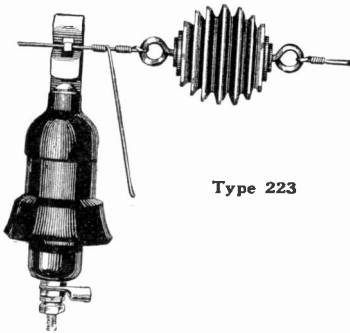

Type 223

Be sure your Battery Charger has passed the Board of Underwriters—that it charges at a rate of at least 5 amps.

Radio Exchange & Service

316 American Bank Building, Second and Spring Streets

Los Angeles

Phone Broadway 733

TRUTONE
TRADE MARK

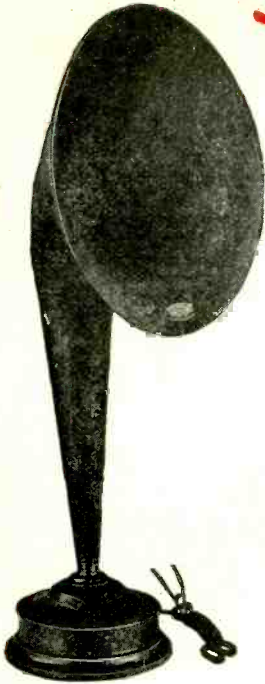

*Have You
Your--*

TRUTONE SENIOR

Quality—Unsurpassed

Tone—Unexcelled

Price—\$25.00

Requires No Batteries—Your Dealer Has It

McKILLEN BROS. & CO.

406 South Main Street

Los Angeles

San Fernando Building

San Francisco

Wholesale Distributors

Los Angeles

Phone Broadway 8365

Seattle