

Beginner's Series; Week's Advance Programs

Radio Digest

EVERY WEEK

Illustrated

TEN CENTS

REG. U. S. PAT. OFF.

Vol. 5

Copyright, 1923
R. D. P. Co. Inc.

SATURDAY, MAY 5, 1923

No. 4

NEW WAVES TO END QRM



To the left is Miss Gertrude Paine, who is spoken of in broadcasting circles as "a peppy monologist and snappy accompanist." From this title you will readily judge she is somewhat of a jack of many trades and her versatility makes her almost indispensable to the broadcasters. Miss Paine recently gave some of her most popular readings and piano selections from Station KQV, of the Doubleday-Hill Electric Company, Pittsburgh, Pa.

MAY 15 DATE PLANTS TAKE ON NEW PLAN

Listener-In's Woes Cease

Official Order by Herbert Hoover to Take Effect—Stations Enthused Over Unique System

By E. E. Plummer

CHICAGO.—Broadcasting station interference and many other woes of the listener will disappear at noon, May 15, with the taking effect of the reallocations of wave lengths in accordance with the Second National Radio Conference. The plan to end QRM, as "interference" is known in Radio code abbreviations, has been signed by Secretary of Commerce Hoover, and provides for 34 distinct and well separated wave lengths for Class B stations in 36 different (Continued on page 2)

Following the recent broadcast of Miss Madeline Borschneck-Bossi from Station WOR, Newark, N. J., we received numerous requests to print the picture of the "lady with the nightingale voice." If you were one of the fortunate ones who were so charmingly entertained by her, you will admit this talented coloratura soprano is equally charming in appearance as is the sound of her voice over the ether. It is unofficially announced that Miss Bossi will again be on one of the early programs of WOR by special request of the many fans who have heard her before



WNAC Gives Jazzmania at Request from Mae Murray

BOSTON, MASS.—Mae Murray, the motion picture star, had a special broadcast arranged for her by WNAC (Shepard Stores) on April 13, when she gave a Radio party in New York. She has been so pleased with WNAC programs that she made a request that the Colonial Orchestra play "Jazzmania" during her party.

TINY RECEIVER TUNES IN WNAC AND OTHERS

BOSTON, MASS.—Carlton Margeson, 171 King street, Dorchester, Mass., has built a tiny crystal Radio set that is only four inches long, seven and one-half inches wide, and one and one-half inches high. The tuner has 500 turns of Number 22 cotton covered wire, with 20 taps 25 turns apart. He gets Station WNAC quite clearly, and even WGI with this set. The total cost was \$1.35.

WGV DISTANCE RECORD CLAIM SUBSTANTIATED

Heard in Alberta, Canada, and Off the Azores

NEW ORLEANS, LA.—The record long distance range for the small current used is believed to have been achieved by WGV, broadcasting station of the Interstate Electric Co., this city.

The station radiates on one and seven-tenths amperes and recently received a report from Grand Prairie, Alberta, Canada, which arrived simultaneously with a verbal report from the Radio operator of the S. S. Broncho, who came ashore and told L. C. Parker, Jr., of the Interstate company that he had heard WGV programs while at sea off the Azores some weeks ago.

"A similar maximum range is claimed by a St. Louis station, but that record fails to approximate the New Orleans record since the St. Louis station uses a nine ampere current," Mr. Parker declares in an interview with a Digest representative.

EXCLUSIVE WAVE LENGTHS FOR BROADCASTERS

(Continued from page 1) cities, with 21 other wave lengths reserved for future B plants not now in existence.

Already a part of the plan has gone into effect; no broadcasters falling below the rigid qualifications set for Class B are being licensed for 360 meters, but are assigned wave lengths between 222 and 300 meters.

Listeners in Can Tune Better

The wave lengths assigned to the B stations in the various localities are in accordance with the plan of the conference and are based entirely on the willingness of the various stations to co-operate in putting them into effect.

It is understood that any station now operating on 360 meters will have the privilege of remaining on that wave length if it so desires.

Besides the elimination of the general 400-meter wave, hereafter all government reports will be sent out by each station on its assigned wave, rather than on 485 meters, thus discontinuing use of this wave.

Exclusive Waves for Class B Plants

The thirty Class B stations, now all on 400 meters, will be heard all over the country, once they obtain their new exclusive wave lengths, inasmuch as interference with other similar plants and small local stations has been their only barrier to this goal.

For the purpose of wave distribution without interference the country is divided into five zones. Assignments within these zones are for cities rather than for specific Class B stations, it will be noted. These follow:

ZONE 1

Table with columns: City, Frequency Kilocycles, Wave Length Meters. Includes Springfield and Wellsley Hills, Mass., Schenectady and Troy, N. Y., New York City and Newark, N. J., Philadelphia, Washington, D. C.

ZONE 2

Table with columns: City, Frequency Kilocycles, Wave Length Meters. Includes Pittsburgh, Pa., Chicago, Ill., Davenport and Des Moines, Ia., Detroit and Dearborn, Mich., Cleveland and Toledo, O., Cincinnati, O., Madison, Wis., and Minneapolis, Minn.

ZONE 3

Table with columns: City, Frequency Kilocycles, Wave Length Meters. Includes Atlanta, Ga., Louisville, Ky., Memphis, Tenn., St. Louis, Mo.

ZONE 4

Table with columns: City, Frequency Kilocycles, Wave Length Meters. Includes Lincoln, Neb., Kansas City, Mo., Jefferson City, Mo., Dallas and Fort Worth, Tex., San Antonio, Tex., Denver, Col. (reserved), Omaha, Neb.

ZONE 5

Table with columns: City, Frequency Kilocycles, Wave Length Meters. Includes Seattle, Wash., Portland, Ore., Salt Lake City, Utah, San Francisco, Cal., Los Angeles, Cal., San Diego, Cal.

Reserved wave lengths in the five zones, that is, wave lengths which will be held awaiting the erection of anticipated plants capable of B ratings, are: Zone 1, 303, 319, 469, 357, and 288 meters, Zone 2, 294, 345 and 366 meters; Zone 3, 300, 316, 375, 462 and 333 meters; Zone 4, 361, 291 and 306 meters; Zone 5, 297, 330, 349 and 370 meters.

What "Kilocycle" Means

In the tabulation above, it is noted that frequency in "kilocycles" is made the basis of the assignment. Dividing the speed of Radio waves, 300,000,000 meters per second, by the wave length, gives the frequency in cycles. A kilocycle is 1,000 cycles.

The difference between each locality assignment, it will be noted, is 50 kilocycles. Another technical reason for this separation is to prevent audible heterodyning, sometimes called "beat notes," as a result of one station's frequency being too close in number to another's.

Stations will be rigidly required to keep within two kilocycles of their assigned waves. Constant check will be required to maintain accurate adjustments of the broadcast transmitters.

Kilocycles will supercede meters in designating the transmitting waves of all stations next year.

Class A Plan Similar

Similar somewhat to the plan for the Class B stations is that which has gone into effect for the Class A stations. District Radio supervisors are reassigning 333-kilocycle (360 meter) stations according to the plan, and all new Class A plants will receive "district-exclusive" wave frequencies between 1050 and 1350 kilocycles, that is, 222 and 286 meters, to take effect at once.

From the schedule of wave lengths for Class A stations, printed below, it will be seen that at least 20 distinct wave lengths are available for distribution in each of the nine Radio districts by the supervisors. Three or four wave lengths in each district will be reserved for the best of the local stations of this class, these waves not being assigned to stations in the immediately adjoining districts.

This gives the better of the Class A broadcasters a partially exclusive transmitting wave. For example, the wave length 222 meters may be assigned to stations only in the 4th, 5th and 8th districts; similarly, the wave of 233 meters will be authorized for use only in the 2d, 5th and 7th districts, while waves 224, 226, 229, etc., will be allocated in every district.

Each of the Class A station allocations, it will be noticed, is separated 10 kilocycles from the next. As in Class B allo-

cations, stations must keep adjusted to within two kilocycles of their assigned wave frequencies.

Class A Wave Frequencies and Lengths

Below is given the Class A broadcasting wave frequencies and lengths, and whether the particular wave is to be assigned in each of the nine Radio supervision districts or is to be restricted in use to only certain districts. In the latter case the numbers of the districts entitled to its use are given:

Table with columns: Kilo-cycles, Wave Length, Assigned Districts. Lists frequencies from 1350 to 1210 and their corresponding wave lengths and district assignments.

Women's Club Gives Hints on Gardening by Broadcast

AKRON, O.—Radio waves were very successfully used by the Ohio Federation of Women's clubs, April 22 to 28, to arouse public interest in gardening and landscaping, it was announced here this week by Mrs. W. W. Milar, chairman of the state federation's conservation committee.

CONTENTS

Radio Digest, Illustrated, Volume 5, Number 4, published Chicago, Illinois, May 5, 1923. Published weekly by Radio Digest Publishing Company, 123 West Madison Street, Chicago, Illinois. Subscription rates, yearly, Five Dollars; Foreign, Six Dollars; single copies, Ten Cents.

Table listing contents: "All the Live News of Radio", Receiving Records, Radio Fools the Pollies, An Evening at Home with the Listener In, WJZ Broadcasts School Lessons, etc.

Looking Ahead

Major General Mason M. Patrick, Chief of the U. S. Air Service, in the next issue will tell Digest readers how Radio is being applied in aviation.

The Hazeltine Neutrodyne Circuit—will be discussed in an article next issue by Harry J. Marx, technical editor of the Digest.

Radio Waves; How They Are Made; How They Travel—the subject of Chapter II of Thomas W. Benson's series of articles for Radio beginners.

The Three Tube Reflex De Luxe Set—description for the making of which starts with this issue, will be continued next week.

E. T. Flewelling's One Condenser Flivver Super Set—Part II next week. Due to illness and need of rest, Mr. Flewelling was forced to postpone the article.

Advance Programs of the Big Broadcasters for the Week—and more stations represented than in any other source of similar information.

Newsstands Don't Always Have One Left

WHEN YOU WANT

Radio Digest

YOU WANT IT!

BE SURE OF YOUR WEEKLY COPY BY SUBSCRIBING NOW

SEND IN THE BLANK TODAY

Subscription form with fields for Name, Address, City, State, and a note to send in the blank today.

RECEIVING RECORDS? SEND 'EM IN—

By the Contest Editor

BACK again this week with twelve new records and seventeen old ones beaten. Of these, S. S. Atwood of Esperance, Washington, wins honorable mention for submitting the most records and also the longest distance, which is 2500 miles.

Station Heard—Miles Away—Who Heard It

- CFAC—1750, Ted Lehman, Ashland, Ky.
CHYC—2300, S. S. Atwood, Esperance, Wash.
KFDJ—2100, Ted Lehman, Ashland, Ky.
KGB—1725, Louis Bruchiss, Chicago, Ill.
KJG—1925, Paul French, Oxford, Mich.
KJS—1150, W. F. Galloway, Vancouver, B. C., Can.
KOG—2350, H. F. Andrews, Albany, N. Y.
KWH—2350, C. B. Richtmeyer, Allentown, Pa.
WAAS—1025, E. B. Miller, Plainview, Tex.
WBAJ—1150, E. B. Miller, Plainview, Tex.
WBT—2250, Kenneth Curtis, Seattle, Wash.
WCAI—1100, A. C. Flint, Chicago, Ill.
WCAZ—1400, S. S. Atwood, Esperance, Wash.
WCAZ—1750, E. B. Miller, Plainview, Tex.
WDAU—1700, E. B. Miller, Plainview, Tex.
WFAH—1300, S. S. Atwood, Esperance, Wash.
WFAV—1350, S. S. Atwood, Esperance, Wash.
WFAV—1750, J. A. Bernier, Quebec, Can.
WIAO—1700, S. S. Atwood, Esperance, Wash.
WLAZ—2075, A. B. Butters, Los Angeles, Cal.
WMAJ—1325, R. T. Andrae, Cobalt, Ont., Can.
WMAH—1350, S. S. Atwood, Esperance, Wash.
WMAU—1400, W. W. Selden, Springfield, Mass.
WNAJ—1550, S. S. Atwood, Esperance, Wash.
WOAN—1100, H. M. Clark, Auburn, Me.
WOAW—1325, H. M. Clark, Auburn, Me.
WWAC—1350, Donald Wood, Waco, Tex.
WWAX—1700, Sydney Warner, Springfield, N. J.

\$1 \$1 \$1 \$1 \$1 \$1 \$1 \$1 \$1 \$1

Book of Hook-Ups

REINARTZ FLEWELLING REFLEX

many others, simple and elaborate, fully diagrammed and explained. Used continuously by thousands of Radio fans, both amateurs and professionals.

BOOK OF HOOK-UPS, \$1.00
E L S RADIO COMPANY
1133 North California Avenue, Chicago, Ill.

\$1 \$1 \$1 \$1 \$1 \$1 \$1 \$1 \$1 \$1

SEND FOR BOOKLET

TRUTH

ABOUT VARIABLE LEAKS

AIREX

REVELATION LEAKS

6-5 MEGOHMS VARIABLE LEAK ONLY

25c

DITTO WITH .0025 or .005 MICA CONDENSER

35c

PAY NO MORE ATTRACTIVE DEALER & JOBBER PROPOSITION

SOLE NATIONAL DISTRIBUTOR

ALBERT J. SLAP

132 NASSAU ST., NEW YORK CITY

A Micrometer Rheostat

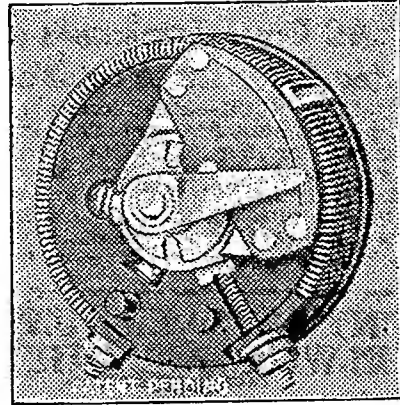

SPECIFICATIONS

The latest development in Micrometer Rheostats. Instantaneous adjustment with one knob control.

Price \$1.50
Jobbers write for discounts
HOWARD RADIO COMPANY
4248 N. Western Ave., Chicago, Ill., U.S.A.

BOOTLEGGERS FIND PROFITABLE FIELD

SMUGGLE "PEANUT TUBES" ACROSS BOUNDARY

Detroit Fans Make Purchases of Scarce Apparatus—Ask No Questions and Say Nothing

DETROIT.—A new kind of bootlegging has developed between Detroit and Windsor, Ont., just over the international boundary—smuggling "peanut tubes" into the States. Just why a situation of this kind should exist is difficult to determine, although there are plenty of critics ready to offer explanations.

However, the stealthy traffic here is a surprise to a great many people. Many are asking the question, "Is it because the North American market is controlled or divided? Is it made easy for the consumer to buy what the interests wish to sell it, but not at all easy for the public to buy what it wishes when it wishes?"

Can Get It Across the River

It is extremely difficult here to buy much of certain kinds of Radio equipment that the people are after. This comes in at infrequent intervals and even then one must have his order filed several days in advance before he can get it. However, it does not seem to be just the same across the Detroit river, a mile from the center of the city. There is little trouble over there it is said getting the very equipment that cannot be obtained here. Many, however, are not stopping to ask questions but make their purchases, put them away securely and say nothing.

JEK of WOR Has New Test Given Aspirants

Hears Violinist Over Phone Before Giving O. K.

NEWARK, N. J.—You know, or perhaps you don't know, that every one who broadcasts from WOR must submit to a test being made of his voice, or playing. When JEK, program director, made this rule, some of the other station managers thought that she would not be able to make artists come all the way to Newark for tests, especially since Radio programs are not paid for. But artists realize the publicity value in Radio, so they are willing to go to a little trouble to get on a program. Every day from 4 to 5 p. m. there is a steady stream of applicants, to make "try-outs." A novel one was made the other day, however. A very busy young violinist from New York had requested the privilege to broadcast and had been given the usual reply—that he would have to make a try-out. So he called up WOR and asked JEK if it would be possible to play without being heard by her beforehand.

"No," said JEK, "I'm sorry, but I must hear you play before I give you permission to play for the vast audience."

"But I can't possibly get over to make the try-out, as I am leaving on a concert tour in two weeks and I want to play over the Radio before that time."

JEK put on her thinking cap—it's a cap she wears nowadays, more than her other hats, too.

"I'll tell you what to do," said she. "Play a piece for me over the telephone. That would be so like the Radio that I can judge how you would come over the air."

"It's a go," said the young man, and played beautifully! And he played for the Radiophans, on Friday, April 13th, at 8:30 p. m.—Lindsay Lindy, who has given concerts in London, Paris and Berlin, and who plays on a real "Strad."

Some big-hearted New Yorker anonymously contributed \$100 for the purchase of a radio outfit for the leper colony in Porto Rico.

WOO CONCERT HEARD THROUGH PARIS LOOP

PHILADELPHIA, PA.—Station WOO has received a letter from Andre A. Marie, Electrical engineer, 4 Rue Richepanse recording the remarkable fact that Station WOO's transatlantic concert, broadcast March 15 with Marcel Dupre, organist of Notre Dame Cathedral at the grand organ, was heard in Paris on a loop aerial. This concert was heard simultaneously across America and across the Atlantic ocean.

YOUNG BROADCASTER HAS NEIGHBOR TALENT

HOUSTON, TEX.—Fred Mahaffey, Jr., 15-year-old high school student, claims to be the youngest broadcasting station operator in the world. He has regular programs daily except Sunday at 7:30 to 8 p. m. with his own violin selections, piano solos by neighbors and vocal numbers. Mahaffey's station is KFCV, 360 meters. He uses 10 watts antenna input and is heard all over the Southwest.

ENGLISH STATIONS RELAY BROADCAST

SIMILAR WAVE LENGTHS HAMPER TEST

Success of Experiment Opens Big Possibilities for British Broadcasting Company's Stations

MANCHESTER, ENGLAND.—A highly interesting experiment in Radio broadcasting procedure was carried out recently at the Manchester station of the British Broadcasting Company. For some time past the station has been relaying the Paris time signals, which are sent out on a wave length of 2,600 meters, then the officials endeavored to pick up and relay the London and Birmingham broadcasting stations.

This they did, part of the children's "talk" from London and the "talk" and orchestral program from Birmingham being received on a special aerial, which is set some short distance away from the normal transmitting aerial on which the items were re-radiated to the Manchester area listeners-in. The great difficulty lies in the fact that the wave lengths of the stations are so similar—Manchester is 385 meters, London 369 meters, and Birmingham 420 meters,—so that a particularly selective circuit is necessary to avoid jamming by the re-radiated signals.

This is the first time a direct Radio relay has been accomplished on the British Broadcasting Company's stations, and it naturally opens up big possibilities. If, as seems quite likely, the development becomes a thoroughly practical proposition, it may probably result in there being one big central broadcasting station only, say in London, where the best of the leading musical and vocal talent could be engaged, while in other parts of the country the auxiliary stations would merely relay the program for the private listeners-in in their areas.

PHONOFILM GIVES VOICE TO MOVIES

New Device Invented by Dr. De Forest Given First Public Showing

NEW YORK.—The first public showing of Dr. Lee de Forest's latest invention, the phonofilm, was given at the Rivoli Theater recently. Many so-called "talking pictures" have been exploited in the past in which a phonograph supplies the sound, but this will be the first showing of a film that literally talks and supplies music.

The phonofilm, as the name implies, is a combination upon the same film of picture and voice or music. The sound waves are photographed on the film at the same time the pictures are taken, thus insuring at all times perfect synchronization. In reproducing these sound waves are transformed into telephonic electric currents. By the use of Audion amplifier these currents are amplified 100,000 times and finally turned back into sound again through "loud speakers" located behind the motion picture screen.

A most astonishing result is accomplished: a dancer appears on the screen keeping perfect time with the music supplied by the film; a singer appears from whose moving lips comes every note in perfect tone and synchronism; the bow of a cello player holds the fascinated attention of the audience, as every stroke brings forth the mellow strains of the instrument.

Frisco Entertains New Orleans

NEW ORLEANS, LA.—At a recent meeting held by the New Orleans Chapter, American Association of Engineers, a Radio program by the San Francisco chapter of their organization was the chief feature of entertainment. Motion pictures of Louisiana bird life followed the other program.

RADIO FOOLS THE POLLIES



Miss Marion Merle, pretty vaudeville girl, fooled her trained troop of macaws, cockatoos and parrots with a Radio instrument. The set she carries is made from an old newspaper camera box, but it works just as good as the best of them and the tropical talking birds got the thrill of their young lives trying to learn the source of the mysterious chatter © International

American Legion Station Closed for Summer, April 1

OMAHA, NEBR.—April 1 marked the close of the American Legion Station, WGAT. The station will not be opened again before early in the fall.

One of the features of WGAT has been simultaneous broadcasting in co-operation with Station WJAB. This was done by using a line and line amplifiers, which connected WJAB with the Legion studio.

Both stations went out on different wave lengths, and the double broadcasting proved quite popular among the Radiophans.

Bequeaths Radio Set

The first case on record of a Radio receiving set being specified in a will was revealed when the will of J. J. O'Heir was probated in New York. He bequeathed a "Radio set and tools, valued at \$500," to William Watson.

THE ANTENNA BROTHERS

Spir L. and Lew P.

E. T. Flewelling, of Course!



WSY, BIRMINGHAM, GETS TRADE MARK

Dick Johnson, Designer of Emblem, to Be Heard on Broadcast

By George H. Watson

BIRMINGHAM, ALA.—WSY, broadcasting station of the Alabama Power Company, has what it believes is something new. It is a trade mark which appears on all literature sent out by the station.



Thousands are already familiar with the three strokes of the anvil which ring before the microphone of WSY and in the phones and loud speakers over the continent. The trade mark, just protected is shown herewith. It depicts Thor, the old Norse God of battle and thunder, striking shafts of lightning from an anvil. The iron is symbolic of the iron and steel working center of the south, the bars of lightning are the artist's conception of WSY's service. The ancient thunder gives a touch of the supernatural still associated with the Radiophone. WSY's slogan "Service From the Heart of Dixie" underlies the figure.

Dick Johnston, announcer for WSY, has just mailed out 5,000 letters announcing that the artist from Tuskegee Institute who made the design will be heard soon on the WSY program. Each letter shows the new trade mark.

Decree Issued to Cover Cuban Radio

Divide Stations into Five Classes and Assign to Each a Set Wave Length

WASHINGTON, D. C.—Pending the passage of a law to cover the use of Radio telegraph in Cuba, a presidential decree has been issued defining the various classes of non-governmental Radio stations and prescribing certain general rules for their operation, says Acting Commercial Attache P. L. Edwards in a report to the Department of Commerce. Up to the present time there has been no law or regulation covering the construction or operation of Radio stations in Cuba.

Under the decree, non-governmental Radio stations are divided into five classes, A, B, C, D and E, to each of which is assigned a wave length and a maximum power. No sets of any of these classes will be used for commercial purposes.

Owners Must Register

All owners of stations coming within any of these five classes were registered with the Director General of Communication before March 16, 1923. After that date no station could be used unless the proper permit had been issued by the office mentioned. The permits are for a term of one year in the case of classes A, B and C, and for five years in the other two classes. Applicants must pass an elementary examination, but it is not believed that this requirement will in any way hamper the issuance of licenses.

Can Not Use S. O. S.

The decree further provides that the Government may, under specified circumstances, require transmitting stations of any of the five classes to cease operation without their claiming indemnity from the Government. Transmitting stations of any class are made subject to the regulations of the International Radio Convention signed in London in 1912. The decree also prohibits the transmitting of the international distress call, S. O. S., either as a special signal or in the course of any general text. Penalties are provided for the disclosure of any public or Government message intercepted by any station. Only apparatus capable of transmitting a pure, continuous wave may be used.

TWO SUPERSENSITIVE CIRCUITS

(Both Copyrighted)

My Highly Improved Reinartz brings in all important stations on both coasts and Mexican border, loud, clear and without distortion. We dance to music from Atlanta received on one loud Baldwin unit. Build one of these wonderful sets from my blueprints and specifications, price 50c, or with a perfect and complete double wound spiderweb coil, \$3.00 by mail. No other windings used. Photo of my set on a glass panel with every order.

This copyrighted circuit is the most successful of any Reinartz modification yet produced, and is imitated the most. Thousands are in use.

My W. D. 11 Circuit is especially designed for use with the "Pickle" tube and brings out the full value of that little tube as no other circuit can. Stations 1000 miles away come in clearly on one tube. This set is small, complete, portable. For the man who wishes the highest efficiency, this is the set to build. Price of blueprint and specifications, 50c, or with complete and perfect windings, \$3.00. Photo of set with every order.

Either set is easy to build, easy to operate. Everything clearly shown.

These high quality silk insulated coils are machine wound on fiber forms. I wind coils to your specifications in lots of 100 or more. Write for prices.

S. A. TWITCHELL

1925 Western Ave. Minneapolis, Minn.

AN EVENING AT HOME WITH THE LISTENER IN

(SEE NOTE BELOW FOR INSTRUCTIONS)

Table with columns for Station and City, Met., Monday, Tuesday, Wednesday, Thursday, Friday, Saturday, Sunday. Lists various radio stations and their broadcast times.

(Instructions for Use.—All the hours above are given in Central Standard Time. If your city uses Eastern Time, add one hour to each of the periods stated; if your city uses Mountain Time, subtract one hour; if your city uses Pacific time, subtract two hours. Thus the use is very simple.)

Wife vs. Husband and Airphone Set

Albert H. Waitt, Millionaire Owner and Operator of Station 1A0V, Sued for Divorce

NEWTON, MASS.—A mania for Radio is given as one of the grounds for the divorce suit instituted by Mrs. Lillian B. Waitt of this city against her millionaire husband, Albert H. Waitt, in an interview recently. "He is obsessed with Radio," declared Mrs. Waitt of her errant husband. "Not only did he have a receiving set, but he had a powerful transmitting apparatus, by special license of the United States government. It was a registered station, with the call 1A0V.

Husband Locks Up and Leaves

"Night after night, with a hired Radio operator, he would go to the Radio room at the top of the house and spend hour after hour there, leaving me alone. I think any jury will consider that gross neglect and cruelty.

"When I returned from a visit to New York, and found him gone, after publishing in the local newspapers and telling the servants and friends that he was going to South America, I went up to the Radio room and found it padlocked, with a printed sign on the door reading: 'Radio Station 1A0V Closed!' That's how far he carried his obsession.

"I had the padlock smashed, after con-

"As valuable to your radio set as RADIO is valuable to the world"

ARTHUR PUDLIN'S Variable High Resistance Leak

Eliminates the hissing and all disagreeable noises. Enables you to hear all stations clearly.

Endorsed by Flewelling, Rosenblum and other leading Radio engineers.

Price with .00025 Mica Condenser\$1.00 Price without Condenser .75

For sale at all good dealers. If your neighborhood dealer hasn't them in stock, send us purchase price and we will mail you immediately the Arthur Pudlin Variable High Resistance Leak. Also send dealer's name.

Arthur Pudlin Engineering Co. 1540 Broadway, New York.

SPEED TRANSMISSION TEST MADE BY ARMY

100 Words a Minute Is Achieved by New Apparatus

WASHINGTON, D. C.—Successful experiments in high speed Radio transmission between the Army Message Center in the Munitions building here have just been completed. With new commercial apparatus, capable of sending mechanically from a perforated tape up to a speed of 100 words a minute and recording the messages in a saw-toothed ink line on a tape, a reception speed of 65 words a minute has been achieved. After a little practice, signal corps experts say, their operators will be able to mechanically copy the received messages visually as well as by ear, and in this way a great saving of time will be made in clearing traffic.



ROBBINS RADIO DESK

An attractive piece of furniture designed and so constructed to accommodate the Radio set and its entire equipment. With it you make a neat installation of Radio in the home. Its many advantages and moderate cost make it almost indispensable.

For sale by first class Radio and Furniture Dealers or write

Robbins Woodworking Co.

Dept. C.

LIBERTYVILLE, ILLINOIS

sulting an attorney, thinking he might have hidden my jewelry there, but I did not find them."

Mrs. Waitt, in a statement, also declared that her husband was displeased with her trip to New York and broadcast the fact from his sending station. When she asked him why he did it, he answered that he wished to let her friends know that she was coming.

When figuring on the wave length of your aerial, remember the lead-in counts.



It is written: "The cure of ignorance is study." The wise man carefully investigates, — then buys a Grebe Receiver.

Doctor Hfy.

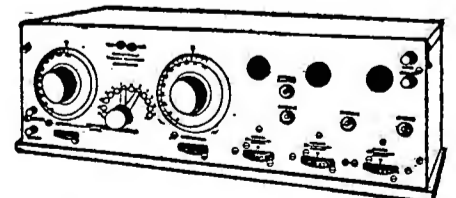

Licensed under Armstrong U. S. Pat. No. 1113149

A. H. GREBE & CO., Inc.

Richmond Hill, N. Y.

Western Branch—451 East 3rd St., Los Angeles, Cal.

WJZ BROADCASTS SCHOOL LESSONS



Left photo shows H. W. Leyenberger, a teacher of the Haaren high school, giving via Radio several problems for his class in mathematics to figure out in their school room several miles away. Two girl students are checking the results of the problems. Miss Elinore Hastings of the teaching staff of the Haaren high school of New York is shown above teaching a class via Radio. The questions are transmitted via Radio from headquarters of the board of education and the students of the class are then required to solve the problems. This is the first attempt at introducing the Radio in the classroom and is being tried by the New York board of education in co-operation with the Westinghouse station WJZ at Newark, N. J. © International

CUBAN PLANT PWX GIVES FANS OPERA

PRIZES OFFERED HEARERS BY DIRECTOR GALLO

San Carlo Grand Opera Company to Remain Three Weeks—Plan Other Broadcasts

HAVANA, CUBA.—Opera across the sea carried the message of friendship from Cuba to the United States on Tuesday night, April 24th, when the San Carlo Grand Opera Company opened its season in the Teatro Nacional here. The entire opera, "The Barber of Seville," with Titta Ruffo, Tito Schipa, Josephine Lucchese, and others in the cast, was broadcast.

Beginning at 9:00 P. M., Eastern time, the broadcasting was done by the Havana station, PWX, arrangement with The Cuban Telephone Company, which transmitted the performance from a microphone in the theater to the sending plant.

This enterprise had the official stamp of the Cuban government through arrangement by General Crowder, U. S. A., with the President of the Cuban Republic. The President was in attendance at the opera and preceded the broadcasting of the music with a speech through the Radio to those listening in this country.

Award Prizes to Listeners In

Fortune Gallo, director of the San Carlo Grand Opera, will give prizes to those Radiophans who send in the best written accounts of what they heard on Tuesday night. These reports should be addressed to Fortune Gallo, Aeolian Building, New York City. The prizes will consist of boxes and seats for performances of The San Carlo Company on its tour of America next season, 1923-1924. The prize winner will determine the time and

R-C CABINETS

Mahoganette—Thoroughly well constructed—hinge top—nickel lift knob. With or without "Arceelite." Special Radio Panel already attached. Costs no more than inferior grades of cabinets.

Ask your dealer or apply to THE R-C MILLS, Manufacturers 303 4th Ave. New York City

PHANTOM-CIRCUIT

Build Your Own. This marvel of mystery, using no loop, no aerial and no ground, brings in music instead of interference. We have heard stations 950 miles distant on one tube. By using WD-11 tube set can be entirely self contained. Very easy to build from our instructions. Use your own spare parts, nothing complicated like radio frequency or super regenerative. Only one tuning control. Complete instructions, with hookup and photo of circuit mailed to you for 60 cents. Stamps accepted. VESCO RADIO SHOP, Box D-704, Vacaville, Calif.

"Sun Dodgers" Give Radio Sets to Crippled Children

CHICAGO, ILL.—Thousands of crippled children in Chicago will soon be "tuning in" their own Radio receiving sets to jokes, musical entertainments and bedtime stories.

The Board of Trade Radio station, WDAP, located on the Drake hotel, has recently organized a "Sun Dodgers" club for this purpose. Membership is \$5 and this sum will purchase a crystal set for one crippled child. Nearly 700 Radiophans have responded to the "via the air" call for volunteers.

Boy Scouts will make the installation and show the children how to manipulate the knobs and dials.

place where he will attend the opera next season as he will be given seats at a performance in a city nearest to his home town on the San Carlo itinerary.

The San Carlo organization will remain in Havana for three weeks and in its casts will appear Giovanni Martinelli, Lucresia Bori, Mari Kouznezova, Anna Fitzliu, Marie Rappold, Sophia Charlebois Stella De Mette, Manuel Salazar, Marie Valle, and others, with Carlo Peroni and Giacomo Spadoni, conductors, and The Pavley Oukrainsky Russian Ballet. Other broadcasts are planned.

President Harding to Speak on WJZ

Broadcast Enables Nation's Leader to Speak to Largest Audience Reached by Any President

NEW YORK, N. Y.—President Harding's voice will undoubtedly vibrate through the ether from Station WJZ, when he speaks before the Volunteers of America in New York on May 10. Definite arrangements have not been made relative to the hall in which the address will be given, but it is expected that the microphone will pick up the President's voice from either the Metropolitan Opera House or the Hippodrome.

Such broadcasting will give President Harding the distinction of addressing the largest audience of any President in the history of the United States. The waves of WJZ have sufficient power to carry their message to every state in the Union, so when this station places its microphone before the President, his voice will be heard in thousands of homes.

The rates of Swedish coast stations were recently reduced to 30 centimes per word, minimum 3 francs per Radiogram.

Club Discusses Radio Frequency

MILWAUKEE, WIS.—Radio frequency amplification has been the topic of interest and discussion at the last several meetings of the Milwaukee Radio Amateur's Club, Inc. I. H. Strassman, 9AHO, A. R. R. L. City Manager, awakened the members' interest with his talk entitled, "Radio Frequency Intervolve Transformers."

RADIO At Cut Prices

Standard parts only in original packing. Sold on a "money-back" basis.

PHONES	
\$ 8.00 Brandes Superior	\$ 5.95
12.00 Nathaniel Baldwin Type C. Double..	8.95
7.50 Dietzen special, 3000 ohms.....	3.95
TUBES	
1 1/2 Volt Peaout Tube.....	2.00
1 1/2 Volt Mercury	4.95
CABINETS	
Made in our factory	
7" x 10".....	1.45
7" x 18".....	2.15
7" x 24".....	2.95
MISCELLANEOUS	
\$25.00 Giblin crystal set.....	7.95
5.50 Triple coil mounting.....	3.95
Solderall, Tube.....	.25
\$12.00 Amplitone, Nickel Horn.....	4.95
25.00 Aerex Crystal Set.....	9.95
DURATEK Permanent Crystal Detector.....	2.00
W.D.-11 Adapter65
\$1.50 Argus Lightning Arrester, Indoor and Outdoor Type95
5.50-180 Degree Variocoupler on Bakelite, Silk Wound Wire	2.45
2-inch Bakelite Dials.....	.25
4-inch Electros Dials.....	.75
3-inch Bakelite Dials.....	.35
\$ 1.00 Freshman Variable Grid Leak and Condenser Combined75
1.00 Bakelite Socket50
5.00 W. D. 12 Audio Frequency transformer	3.75
3.00 Ori Radio Frequency transformer	1.50
5.50 Coto coil Radio frequency transformer	3.45
5.00 Sleeper Radio frequency transformer	1.95
8.00 Dayton Variometer.....	5.45
8.00 Dayton Variocoupler.....	5.45
5.50 Murdock variable condenser, 23-plate	2.95
6.50 Murdock variable condenser, 43-plate	3.25
132.00 Radiola R. C. set.....	79.50
The new Morrison Sireo loud speaker	18.50
5.00 Multi-Radioscope	1.50
Little Gem set.....	6.50
1.25 Western Electric Ammeter for testing B batteries49
.50 New radio map.....	.35

When Ordering by Mail Add Postage by the Following Scale

PURCHASES	
Up to \$1.00.....	add 10c
\$1.01 to \$2.00.....	15c
2.01 to 3.00.....	20c
3.01 to 5.00.....	25c
5.01 to 7.00.....	30c
7.01 to 10.00.....	40c

Money Order or Personal Check Accepted

Modell's
ESTABLISHED 1829
RADIO STORES
Dept. F. 10, 191 Fulton St., N. Y. C.

Cotogrip

"Built First to Last"

This little beauty was approved by our engineers only when convinced that they had produced the one socket that combines all the essential features of a good socket.

1. Positive Cotogrip Contacts.
2. Hard Rubber Insulation.
3. Rugged Construction.
4. Compact Design.
5. Concealed Mounting.

It is impossible to show the unique mechanical action of Cotogrip contacts in a photograph. It is different from any other socket you have ever seen. This socket will interest you in every way.

You ought to have one. Ask Your Dealer

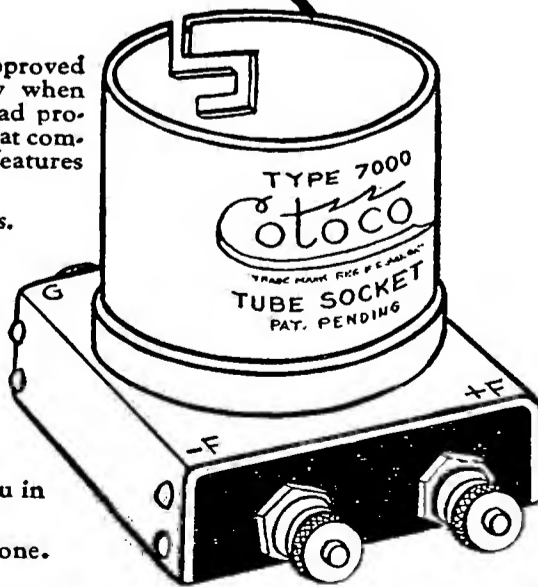

COTO-COIL CO. PROVIDENCE

First Steps for Beginners in Radio

Chapter I—Laws of Electricity Used in Radiophony

By Thomas W. Benson, A. M. I. R. E.

A THOROUGH understanding of Radio phenomena demands a knowledge of the laws of electricity. Radio being but a special application of this useful servant of man depends thereon for its fundamental units and laws. Although having symbols and terms distinctly its own, Radio phenomena will be more clearly understood in the light of the paragraphs to follow.

Electromotive Force

In order that electricity might flow in a wire of circuit it is necessary that a difference of potential or electrical pressure exist between two points connected by a conductor. To measure this potential

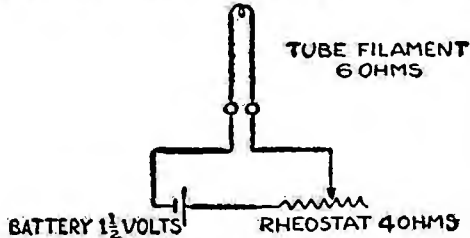

or electromotive force (E.M.F.) we make use of the volt which is then the unit of pressure so to speak. Thus we find that a dry cell has a voltage of 1 1/2, that is, the pressure at the terminals of a battery tending to make a current flow in any circuit connected to it, is 1 1/2 volts. There is no fixed unit of voltage but is arrived at by other means.

Now when we connect an electrical device to the dry cell, let us say the filament of a WD-11 tube with a rheostat in series as shown in Figure 1, a current will flow. The amount of current flowing is measured in amperes which is the quantity of current.

It should be made very clear that the voltage is forcing the current around through the rheostat and filament but the amperes is the amount of current flowing.

Resistance

Whenever a circuit is completed the material or conductor through which the current flows offers a certain resistance or tends to hold back the current. This effect is measured in ohms, the unit of resistance. Going back to our illustration we find we have a very fine wire in the tube and also a rheostat made of wire that has

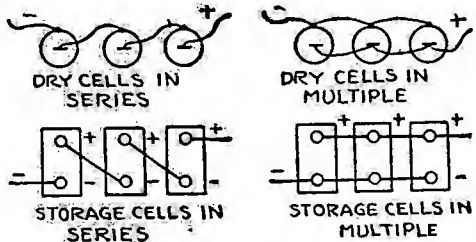

a high resistance. By regulating the holding back effect of the circuit we can control the amount of current or amperes flowing. Thus by turning the rheostat handle so there is less resistance for the voltage to overcome the current through the filament increases and it gets hot.

Ohm's Law

The law of current flow is known as Ohm's Law, the most fundamental law of electricity, and also, the most simple. Put into words, the current in a circuit varies directly as the voltage and inversely as the resistance. Put in the form of a formula we have:

$$I = \frac{E}{R}$$

That is, the current in amperes (I) is equal to the voltage (E) divided by the resistance (R) in Ohms.

Let us see how this works out. When resistances are connected in series their total resistance is equal to the sum. In

Patents Procured and Trade-Marks Registered. Advice and terms upon request. ROBB, ROBB & HILL, 1417 Hanna Bldg., Cleveland, O. 956 McLachlan Bldg., Washington, D. C.

WE REPAIR
WD-11, \$3.50
and OTHER
VACUUM TUBES
Excepting
VT-I and VT-II
MAIL ORDERS Solicited and
Promptly Attended To
H & H RADIO CO.
516 Clinton Avenue NEWARK, N. J.

BEGINNERS will find the accompanying series by Mr. Benson very helpful in learning the rudiments of the popular science of Radiophony. His articles yet to appear are:

- Chapter II—Radio Waves and their Propagation.
- Chapter III—Pointers about Aerials and Grounds.
- Chapter IV—About Condensers and Inductances.
- Chapter V—Tuners and How to Tune Your Set.
- Chapter VI—About Crystal Detectors.
- Chapter VII—Tube Detector Theory and Operation.
- Chapter VIII—The Regenerative Detector.
- Chapter IX—Radio Frequency Amplification.
- Chapter X—Audio Frequency Amplification.
- Chapter XI—How Super Regeneration Is Accomplished.
- Chapter XII—Reflex Circuit Operation.
- Chapter XIII—About Headsets and Loud Speakers.
- Chapter XIV—Batteries Used in Radiophony.

the circuit we have say a 4-ohm rheostat and the filament of the tube with a resistance of 6 ohms. This gives a total of 10 ohms when all the rheostat is in. To determine the current we simply divide the voltage 1.5 by the resistance, 10 ohms giving .15 amperes. Say we cut the rheostat out entirely leaving the battery connected direct to the tube, this gives but 6 ohms and on figuring it out the current will be one-quarter ampere.

Since the current is equal to the voltage divided by the resistance it also holds that when voltage and current are given the resistance is equal to the voltage divided by the current or:

$$R = \frac{E}{I}$$

For instance, the UV 200 takes 1 ampere filament current at 5 volts. To determine its resistance divide voltage, 5, by current 1, and we find its resistance is 5 ohms.

Going one step further it will be clear that the product of the current and resistance should equal voltage. We can express this as $E=IXR$.

Resistance in Series

It has been stated that when resistances are in series that is when the current must flow through one after the other the total resistance is equal to their sum. However, when they are connected in parallel or so

- W. T. 501 Peanut Tubes, 4 V. 1/2 Amp. with Adapter\$2.75 (Use storage battery or 3 dry cells in series)
 - R. V. T. 5-6 V. Detectors..... 2.75
 - R. V. T. 5-6 V. Amplifiers..... 3.35 (Sent on receipt of price. No C. D. D. orders accepted)
 - 1 Tube Regenerative Receiving Set with Detector Tube and 3000 Ohm Headset. VERY SPECIAL VALUE 29.75
- LUX MANUFACTURING CO.**
1045 North Wells Street, CHICAGO, ILLINOIS

HERE IT IS

Just What You Have Been Looking For
A VARIABLE RADIO RESISTANCE
THAT MOUNTS ON PANEL
IN A JIFFY

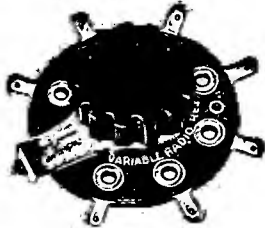

Patents Pending.

Real Radio Fans, in the building of their sets, will more than appreciate this device, which gives them a variable resistance which is adaptable for use in all Radio Hook-ups—in the grid circuit—as amplifier coupling resistance for both radio and audio frequency—"B" battery resistances—antenna shunts—tuned loop circuits—resistance couplers for both radio and audio frequency, and many other places in the radio hook-up that the amateurs' ingenuity will suggest. Has switch lever and seven carefully calibrated values of resistance of 1/2 megohm each between terminals. Protecting bakelite discs assure permanency of moisture-proof India ink resistance. Don't guess—it is important to have resistance properly adjusted to function with your other apparatus to get the best results from all tube sets. A Premier Variable makes this sure and easy. Code No. 250. Price.....\$1.50 each
DISTRIBUTORS—We make a most complete line of radio parts. Some territory open for live, responsible concerns.
PREMIER ELECTRIC COMPANY
Manufacturers Est. 1905
3800 Ravenswood Ave. Chicago, Ill.

sum. When more than two unlikes are in parallel the formula becomes:

$$R \text{ (total resistance)} = \frac{1}{\frac{1}{R_1} + \frac{1}{R_2} + \frac{1}{R_3}}$$

Which can be readily solved. The reader may doubt the value of these formulae to the experimenter but their value will be apparent when one wishes to build up say a given grid leak from a number of smaller or larger leaks.

Standard of Resistance

The standard of resistance being an ohm, it is advisable when high resistances are used to use other units. Thus the megohm is used for one million ohms. A half-megohm leak then has a resistance of half of one million or 500,000 ohms.

The resistance of a conductor varies as its length, diameter and material. Increasing the length of a wire will increase its resistance and vice versa. Increasing the size of wire reduces its resistance and increases the current carrying capacity. The use of special materials, such as German silver, nichrome and constantan, gives wires having high resistances.

Units of Energy and Power

Having obtained an idea of the relationship between the units of pressure, current and resistance, we can go on to a consideration of the units of energy and power. We have seen that a certain voltage is required to force the current through the circuit, and since the current does the work we must consider both voltage and amperage in determining the energy expended in the circuit to do work. (Continued on Page 14)

Hear Atlanta

On Crystal We receivegrams from Atlanta, Minneapolis, Davenport, Fort Worth, Dallas, Kansas City, St. Louis, Denver on Crystal without batteries. Usual crystal set requires only easy, inexpensive changes. Send stamp for further information or \$1 for copyright drawings and instructions. Everything clearly explained. Satisfaction GUARANTEED.
Leon Lambert, 501 South Volusia, Wichita, Kan.

Federal Standard Radio Head Sets



FOR durable efficiency, clearness and wide distance-range, Federal Standard Head Sets have no superiors.

Made of specially treated steel with permanent magnets, scientific wiring and adjustment, and precision machining of metal parts, these Head Sets have achieved a well deserved universal recognition and endorsement by Radio experts.

To secure professional efficiency from your receiver insist on having Federal Standard Head Sets; Federal Standard is the product of over twenty years' experience in the manufacture of communication apparatus.

Ask your dealer for Federal Standard Head Sets. If out of stock he can get them from our nearest office. Accept no substitute.

Federal Telephone & Telegraph Company

BUFFALO, N. Y.

Western District Office: 417 South Dearborn St., CHICAGO, ILL.

Simple Arrangement Adds Step of R.F.

Radio Frequency Permits Loop Aerial to Be Used

It is a very simple matter to add a step of Radio Frequency amplification using the system shown by the accompanying diagram. The simplicity of the arrange-

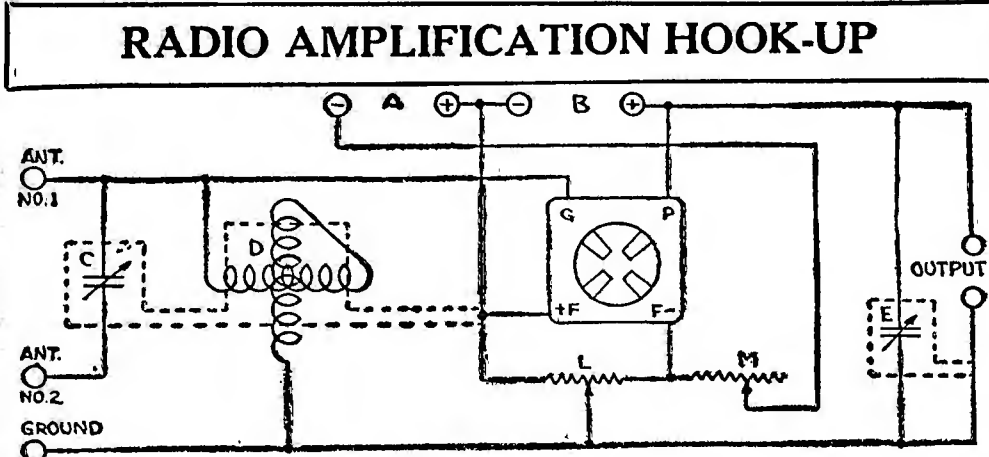

Line Switch on Battery Saves Charge and Tubes

Practically all filament rheostats are constructed with a zero point or "off" position which serves the purpose of a switch between the vacuum tube and the storage or A battery. However, it often happens that in the hurry of cutting off for the night, the rheostats are not turned completely off. Under these circumstances, the filament battery is left connected in the circuit discharging all night long through the resistance.

To prevent this, it is advisable to connect a separate battery line switch, which through practice and force of habit, should be opened first before the filament rheostats are turned back to zero. Then, if the latter operation is not performed, the battery circuit will be opened anyway by means of the line switch.—P. J. M. Clute, Schenectady, N. Y.

WORKSHOP KINKS? EARN A DOLLAR—

THERE are many little kinks worked out at home that would aid your fellow Radio worker if he only knew about them. There are new hook-ups, new ways of making parts and various unique ways of operating sets that are discovered every day. Radio Digest is very much interested in securing such material. Send them in with full details, including stamped envelope so rejected copy may be returned. The work must be entirely original, not copied.

RADIO KINKS DEPARTMENT,
Radio Digest
123 West Madison St., Chicago, Ill.

ment is exceeded only by its efficiency and very few parts are needed to construct the amplifier.

The antenna connection is arranged so that either a loop or outdoor antenna may be used. For a loop, shunt the antenna binding post marked No. 2 to the ground post and connect any standard loop without condenser.

For an outdoor antenna, use the antenna binding post marked No. 1 so that the condenser in the set will not be connected. The other details of the set are standard parts, variometer, tube and socket with proper batteries according to the tube, a 3-plate and a 23-plate variable condenser, a 200 to 400-ohm potentiometer and a filament rheostat.

With this outfit it is unnecessary to have direct connection between the Radio

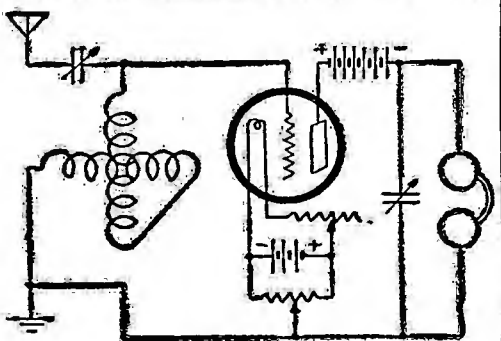

frequency amplifier and the primary circuit of the tuning unit. Instead, if found to be too harsh for local stations, attach the ends of a coil of about 25 turns of an oatmeal box with a No. 25 wire to the output of the Radio frequency amplifier unit and place the coil near the tuning unit, about 3 or 4 inches from the primary coil.—L. W. Martin, Houston, Texas.

Moving Coil Speaker

The best-known loud speaker is composed of a metallic horn connected to what is actually a telephone receiver of large size. The permanent magnet is energized by an external source of current, and the diaphragm is actuated by a coil of wire suspended between the pole pieces of the electromagnet. The actuating current passes through the suspended coil.

KELLOGG RADIO FOR BETTER RESULTS

KELLOGG SWITCHBOARD & SUPPLY COMPANY
Chicago

Shape for Resistance Spring

When laying out the phosphor bronze contact piece for the Flewelling variable leak care should be taken to have this piece of the proper shape. This is to make the change of resistance gradual.

It is quite evident to students of mechanics that a beam supported at one end

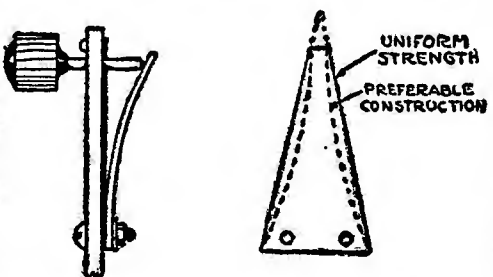

and of uniform thickness should have the shape of a triangle, if the stress is to be uniform. Furthermore, it is best to go one step further and make the contact piece so that the end nearest the adjusting screw will be raised from contact with the resistance unit before the supporting end is raised.—Carl Schindler, West Allis, Wis.

Variable Grid Leak

Many Radiophans have old rheostats lying around whose resistance wire is either loose or broken. It is possible to make a variable grid leak out of one of these.

Pry out the fiber ring on which the wire is wound and remove the wire. Then replace the fiber ring and glue it back into place.

Next take a very fine file and make the surface of the fiber, where the contact lever touches, very smooth. Mark this surface all the way around with a pencil. Connect one end of this marking to a binding post. It will then be seen that resistance can be varied by just turning the knob located on the other side of the panel.

RUSONITE

CRYSTAL RECTIFIER
MULTIPOINT (Patent Pending)
A Synthetic CRYSTAL DETECTOR sensitive over its entire surface. Eliminates all detector troubles. Extraordinary clearness and volume. Endorsed by Radio experts and press. Sold in Sealed Packages only. Join the ever increasing Rusonite fans.
Price mounted, Sensitivity guaranteed..... 50c
RUSONITE CATWHISKER
14 Karat Gold Multiple Contact Super Sensitive..... 25c
Order from your dealer or direct from us, **RUSONITE PRODUCTS CORP.**
19 Park Row, N. Y.

NEW CONSTRUCTION of all FRESHMAN Variable Resistance Leaks

guarantees long life and permanent resistance—no pencil markings—assures an unbroken range of 180 degrees. Eliminates hissing. Clarifies signals.

A New Leak for PANEL MOUNTING
Mounted on any panel in a few seconds—2 mounting screws serving as connections behind the panel.
Complete with either .00025 or .0005 mfd. Micon Condenser
\$1.00
Without Condenser 75c
A necessary essential for every tube receiving set
At your dealer's—otherwise send purchase price and you will be supplied postpaid. Also ask your dealer for a free diagram of the Kaufman and Flewelling circuits.
Chas. Freshman Co. Inc.
Radio Condenser Products
106 Seventh Avenue New York City

Delicate Soldering

Both the manufacturers' and amateurs' problems on all fine work are readily solved by the instrument constructed for this particular purpose.

THE POST SOLDERING IRON
Platinum Heating Unit—Interchangeable Tips—Universal Current
(Large and Small)

\$6 ONE-HALF ACTUAL SIZE
Awarded Certificate of Excellency, N. Y. Evening Mail Radio Institute
From your Dealer, or write
POST ELECTRIC COMPANY (Dept. 509), 30 E. 42nd St., New York

Most for the Money in Radio

"SENIOR" SET
When you buy a Michigan "Senior" Regenerative Receiver for \$125.00 or a "Junior" Receiver for \$57.50, you get the clearest, most satisfactory long distance service that an equal investment ever brought.
These sets are licensed under Armstrong U.S. Pat. 1,113,149 and pending Letters Pat. No. 807,388. This means that they represent the highest achievement in Radio Engineering.

"JUNIOR" SET
Send for Illustrated Circular

Factory Branch: 9 South Clinton Street, Chicago, Illinois
H. O. Rugh, Radio Engineer, in charge

MICHIGAN RADIO CORPORATION
GRAND RAPIDS, MICHIGAN

ADVANCE PROGRAMS

(Continued from page 6)

WGI (Eastern, 360), 5:00 P. M., "Twilight Tales," Uncle David; 5:15 P. M., "General Conditions in the Shoe and Leather Industry," New England Shoe and Leather Ass'n; 9:30 P. M., "Romance of the Shoe," Harry M. Wood; Concert, Crescent Gardens Orchestra.

Friday, May 4

KFI (Pacific, 400), 6:45-7:30 P. M., Peter Rabbit; Concert, Junior Music Clubs of Southern Calif.; 10:00-11:00 P. M., Program, Public School Music Teachers Ass'n; Male chorus, 100 voices, Orpheus Club; Dominant Club; California Federation of Music Clubs.

STOP THAT NOISE! SAVES YOUR TUBES. AMPERITE CURRENT ADJUSTER. AUTOMATIC FILAMENT TUBE TROUBLE SHOOTER. RADIALL COMPANY 99 WARREN STREET NEW YORK.

10c will bring you immediately our 32-page booklet containing complete diagrams and descriptions of Flewelling, Reinartz, Super-Regenerative and other circuits. FREMONT RADIO SALES CO. 227-229 Fulton St. NEW YORK CITY

The Bishop Brothers, B. A. Sullivan; A Vocal Melange; Civil Engineering Quartet; "Sunkist Rose"; "Your Kisses"; Instrumental Club; "The Road to the Isles"; "The Old Road"; Glee Club; "The Kerry Dances"; "The Spring Has Come"; David M. Brockway; "Mah Lindy Lou"; "Exhortation"; "Alma Mater"; Glee Club.

Saturday, May 5

WIP (Eastern, 400), 2:00-3:00 P. M., Song Recital; 6:00-6:30 P. M., Dance music; 7:00-7:30 P. M., Uncle Wip's Bedtime Stories.

Saturday, May 5

CFCN (Mountain, 440), 10:30-12:00 P. M., Dance selections, Imperial Dance Orchestra; Plaza Cabaret; Los Angeles County Dental Sy.; Concert, Junior Music Clubs of Southern Calif.; 8:00-9:00 P. M., Program, University of Southern Calif.; 10:00-11:00 P. M., Vocal selections, Packard Radio Club, Harry Coe, Ben McLaughlin, Leonard Van Berg.

ADJUSTABLE COIL MOUNTINGS FOR FLEWELLING CIRCUIT. Triple Coil Mounting.....\$5.00 List Double Coil Mountings..... 3.50 List. ASTORLOID MFG. CO., 416 Marcy Ave., Brooklyn, N. Y.

How to build the Reinartz Receiver. is told, complete with illustrations and diagrams, in the latest addition to the "Chi-Rad" Handbook-Catalog. Our Handbook also includes: 1. Technical discussions of standard radio apparatus and equipment. 2. Radio definitions, wireless codes, wire tables, definitions, etc. CHICAGO RADIO APPARATUS CO. 415 South Dearborn Street, Chicago, R. D.

Kentucky Sextette Orchestra, Arthur Jackson, director and drums; "Just Among Home Folks," Courier-Journal; 7:30-9:00 P. M., Concert, Apollo Concert Orchestra, Bruno Welner, violin and director; Luigi Resta, trombonist; Miss Balough, accompanist; George A. Resta, clarinetist; Katherine Lucile, pianist; Reading, "An Interesting Historical Episode."

Sunday, May 6

KFI (Pacific, 400), 10:00-11:00 A. M., Church service for all denominations, Church Federation; 4:00-5:00 P. M., Musical vesper service, Natl. Federation of Music Clubs; Industrial chorus, Antonette R. Sabel, director; 8:00-10:00 P. M., Concert, Packard Girls' Concert Club; 10:00-11:00 P. M., Concert, Bennett's Packard Six Orchestra.

Coast to Coast on One Tube ULTRA-AUDION \$12.75. Operates loud speaker on closer stations. All standard parts mounted on 7"x14" Bakelite Panel, string-wired, complete, ready for wiring. SEYFERLICH'S REAL RADIO 68 West Washington St. Chicago, Ill.

BARGAINS IN RADIO PROMPT SERVICE. \$6.50-1 1/2 volt dry cell tube.....\$2.00 \$5.00-6 volt tube detector..... 2.00 \$6.50-6 volt tube amplifier.... 2.25 180 Bakelite coupler, reg. \$5.00.....\$2.25 3 plate vernier condenser..... .40 13 plate precision condenser..... .85 23 plate precision condenser..... 1.10 43 plate precision condenser..... 1.55 Kardon Audio Transformer, reg. \$5.25..... 2.95 .00025 condenser Var. Leak..... .38 Variable Leak only (Airex)..... .25 Freshman Var. Leak & Condenser..... .75 Freshman Variable Leak only..... .60 Long range radio headset, reg. \$10.475..... 4.75 Potentiometer..... .95 7x10 Hard Rubber Panels..... .75 .006 Flewelling condensers..... .38 W. D. 11 Bakelite sockets..... .35 Electric soldering Iron..... 5.00

Cockaday Circuit Complete Parts— Regular Value, \$26.00..... \$14.50 Dx-Flex Circuit Complete Parts— Regular Value, \$28.00..... \$17.00 Reinartz coils.....\$1.75 Coils for Greene circuit..... .35 DX Couplers..... 1.65 43 Plate Vernier..... 3.75 23 Plate Vernier..... 3.25 \$6.00 Diamond Head Set, 2000 ohm..... 3.00 WILLIAMSBURG RADIO SUPPLY CO., INC. 801 Flushing Avenue, Brooklyn, N. Y.

"Danse Arabe," from the "Nutteracker Suite," WGY Orchestra; "A Year Ago," "In the Silent Night," "William A. Fay," "Minuet," from the "Military Symphony," WGY Orchestra; 7:30 P. M., Church services, First Presbyterian Church, Albany, N. Y. Prelude, "Spring Song," Harold W. Thompson; Antiphon, "Bless the Lord, O My Soul," Hymn, "O God, Our Help in Ages Past"; Prayer; Anthem, "Jerusalem, O Turn Thee to the Lord," Quartet; Offertory, "Indian Melody," "Watchman, What is the Night?"; Hymn, "Fling Out the Banner, Let it Float"; Scripture; Sermon, "This Hopeful World," Robert E. Speer, L.L.D., Secretary of Board of Foreign Missions and President of the Federal Council of Churches of Christ in America; Prayer; Hymn, "Christ for the World We Sing"; Benediction; Postlude, "March of the Priest," Harold W. Thompson.

REINARTZ ALL PARTS NECESSARY DEALERS: ATTRACTIVE DISCOUNTS HUDSON-ROSS 123 W. Madison St. Chicago

LOUD SPEAKER FREE BALDWIN. The wonderful SHELSTONE LOUD SPEAKER with every original NATH. 8 1/2" High—Beautiful Rubberized Finish. I PERSONALLY test every pair of phones to GIVE YOU a headset that has no equal. YOU CAN USE HEADSET IN REGULAR WAY ALSO. My price on these special selected \$12.00. Phones is, postpaid..... \$12.00. Cash with Order or C. O. D. WALTER SCOTT, 10 St. Lukes Place, Montclair, N. J.

How to Make a Reinartz Receiver. Complete BLUE PRINTS for the construction of a Reinartz Receiving Unit and two step amplifier. INSTRUCTIONS FOR ASSEMBLY. Description of apparatus and accessories and details of tuning. WINDING A REINARTZ COIL. Cabinet Dimensions Panel Layouts List of Parts. Send only money orders—no checks or stamps. Coins at your own risk. Book Department Radio Digest 123 West Madison Street CHICAGO, ILL. Only 50¢

Making a Three Tube Reflex De Luxe Receiver

Part I—Panel Layout and Hook-Up

By H. J. Marx

AFTER three months of research work and experimentation, there is a considerable degree of satisfaction in presenting a circuit that accomplishes a little more than what has been done before. Experience teaches us that rarely can we get that all-around combination of advantages continually sought, but seldom attained. Some circuits have the advantage of their good distance reception; others have volume; then again others have the disadvantage of requiring too many tubes; or, again, tuning may be complicated and difficult.

In working on this circuit, it has been the aim of the author to eliminate un-

PARTS REQUIRED

- VT—3 Hard vacuum tubes and sockets
- VC—Variocoupler
- CS—2 Contact switches
- RT—2 Radio frequency transformers, reflex type
- AT—2 Audio frequency transformers
- AT—1 Audio frequency transformer, high voltage type
- P—1 Potentiometer, 400 ohms
- J—1—2 Double circuit jacks
- J—2—1 Open circuit jack
- J—3—Jack type battery switch
- R—1—1 Rheostat, 6 ohms
- R—2—1 Power rheostat, 6 ohms
- R—3—1 Grid leak, variable
- C—1—Variable condenser, .0005 mfd.
- C—2—Variable condenser, .0005 mfd., vernier
- C—3—4 Fixed condensers, .002 mfd.
- C—4—1 Fixed condenser, .0015 mfd.
- C—5—2 Fixed condensers, .006 mfd.
- CD—Crystal detector

Eight binding posts
 One panel, 9x12 1/2 x 3/8 inches
 One sub panel, 5 1/2 x 11 1/2 x 3/8 inches
 One cabinet, 7 inches inside depth
 25 Ft. tinned bus bar wire
 20 Ft. spaghetti tubing

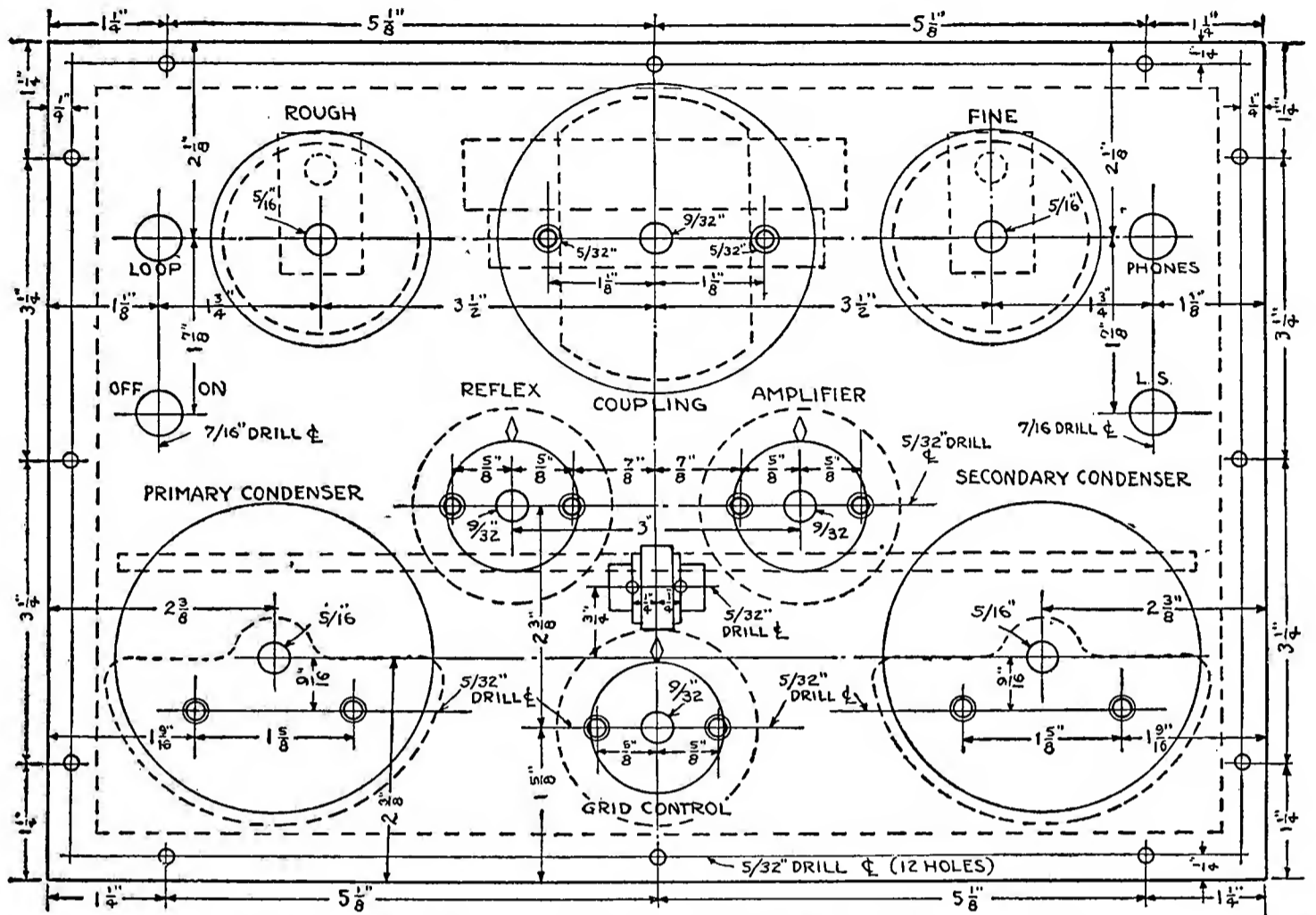

necessary controls, reduce so far as possible not only the quantity of apparatus but also the number of necessary adjustments. After the circuit development was completed, then arose the problem of compact assembly on the panel and in the cabinet. This required time and patience, but was worth the effort.

Not Low-Priced Outfit

The Reflex De Luxe cannot be considered a low-priced outfit, but its cost is low when its possibilities are considered. The

no hesitation in the use of this circuit with either type of receiving antenna. The antenna and ground connections can be made direct to the binding posts, whereas the loop can be plugged in on a jack, automatically cutting out the variocoupler tuning unit. In addition, if the two contact switches are turned so the lever on each one rests on contact 15, the circuit can be operated as a single cir-

switches to 15, a different arrangement is provided.

Circuit Inverse Reflex

The circuit used in this set is not only reflex, but also utilizes the inverse ar-

angement which both Priest and Grimes found to show great possibilities for development. Various changes have been made after trial in an effort to incor- (Continued on Page 14)

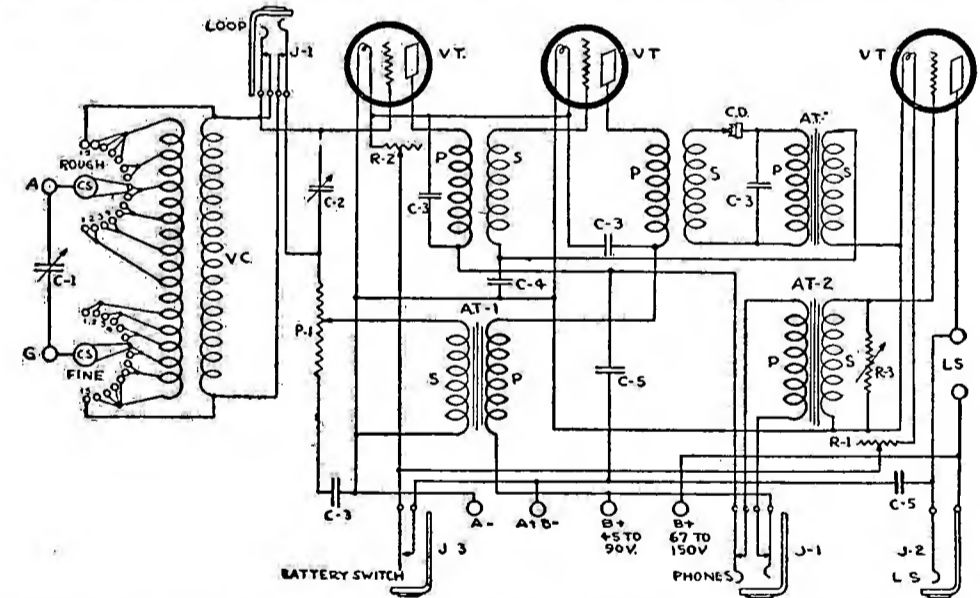

volume with three tubes has been sufficient to make the diaphragms of the best of loud speakers chatter, and one of the chief difficulties was in getting sufficient control over its volume without loss of the good quality of the reception. The circuit has been arranged for use with both outdoor and loop aerials. Experimental work has been conducted entirely with the use of a loop aerial.

Inasmuch as an outdoor antenna is unquestionably more efficient, there need be

cuit tuner, using the primary and secondary condensers for tuning controls, or by switching just one of the contact

FREE VACUUM TUBE RADIO SET

The Set you always Wanted, FREE

A real RADIO SET—Listen in on Concerts, Lectures, Singing, etc. Can receive 75 to 100 miles and more.

RUSH your name and address and we will tell you HOW you can get a VACUUM TUBE RADIO SET

ABSOLUTELY FREE

Don't delay. Write today for FREE RADIO PLAN.

Home Supply Co.
 Dept. 457
 131 Duane St., New York

CARTER RESISTANCE UNIT

By placing this Resistance Unit in the Rheostat circuit, regular 6 ohm Rheostats will properly operate the new No. 201-A and No. 199 Tubes.

Each Code No. 15-A, 15 ohm, for No. 201-A Tube, .50c
 Code No. 25-A, 25 ohm, for No. 199 Tube, .50c

Write for bulletins on this and other Carter products

CARTER RADIO COMPANY
 209 South State Street, Chicago

Spirola BETTER LOUD SPEAKERS \$3.85

TRUE CABINET TYPE, like the finest modern phonographs, with all their beauty and perfect tone. Makes your two-step set a real ENTERTAINER for family and friends. SPIROLA DUPLEX uses any headset. SPIROLA SIMPLEX uses Baldwin or other unit. Either type, black with nickel fittings, \$3.85; mahogany finish with bronzed throat, \$4.85.

At dealers or postpaid (C. O. D. if preferred). Absolutely guaranteed.

L. H. DONNELL MFG. COMPANY, Dept. D, Box 70, ANN ARBOR, MICH.

—WILLARD—

WILLARD RADIO COMPANY
 Dept. R. D., 291 Broadway,
 New York City
 "The Best for Less"

FLEWELLING CIRCUIT

EVERY PART COMPLETE

2 honeycomb coils, 1 2-coil mounting, 2 coil plugs, 3 .006 condensers, 1 variable grid leak, 1 grid leak, 1 23-plate .0005 MFD. variable condenser, 1 vernier rheostat, 1 tube socket, 8 binding posts, 20 feet bus bar wire, 1 high-grade panel ALREADY DRILLED AS PER DIAGRAM, 1 3" dial and the Radio Digest Booklet on Operation and Construction of Circuit

\$11.00

Two-Stage Radio Frequency Amplifier—Parts complete in every detail for this Circuit—\$11.00.

CONDENSERS	
3 Plate Variable; value, \$1.75.....	\$1.05
13 Plate Variable; value, \$2.50.....	1.20
23 Plate Variable; value, \$3.50.....	1.35
43 Plate Variable; value, \$4.50.....	1.85

VARIOCOUPLER—Celeron Condensite and Litz Wire Wound Secondary; Value \$4.50. Special	
	\$2.95

AUDIO FREQUENCY TRANSFORMER	
—Designed for use with W. D. 11 Tubes, list, \$4.50; price.....	
	\$2.75

BALL BEARING INDUCTANCE SWITCH—	
Value 75c, special.....	\$0.30
V. T. SOCKETS—Nickel, brass sleeve, composition base value, \$1.00; special at, .50	
EXTRA SPECIAL—Telephone 3000 Ohms Headsets; \$9.00 value; reduced to.....	\$3.50
ALUMINUM LOUD SPEAKING HORN—Nickel plated, highly polished; \$8.00 list.....	\$3.75

Honeycomb Coils, 50 turns mounted, \$0.95
 Honeycomb Coils, 75 turns mounted, 1.00
 Double Coil Mountings..... 2.45
 Triple Coil Mountings..... 3.35
 Reinartz Coils and Mounting..... 1.75

A BEAUTIFUL "SALRITE" PENCIL FREE

With every order of \$12.50 or more. Made of beautiful Mahogany Rubber, about five inches long. Equipped with vest pocket clip, 10 extra leads and eraser. Will write like a charm and last a lifetime. Only a limited supply available—so rush your order now.

BEST QUALITY JACKS, Single Circuit; value, 65c; special at.....	.30
Double Circuit; value, 90c; special at.....	.45

MULTIPLE POINT INDUCTANCE SWITCH with Knob and Dial (15 switch Points)....	1.75
--	------

LIGHTNING ARRESTERS approved by underwriters.....	\$0.90
--	--------

THREE-INCH DIALS —Unbreakable—heat resisting composition—high finish; special, \$0.30	
--	--

TWO-INCH DIALS —Same design—for rheostats and potentiometer; special at.....	\$0.25
---	--------

FILAMENT RHEOSTAT —Condensite base; value, \$1.10; special at.....	.70
---	-----

FILAMENT RHEOSTAT with 2 1/2" dial; value, \$1.50; special at.....	.85
---	-----

TELEPHONE PLUGS60
------------------------------	-----

FRESHMAN VARIABLE RESISTANCE LEAK and MICON CONDENSER Combined	.75
---	-----

REINARTZ CIRCUIT EVERY PART COMPLETE

1 Reinartz wound coil, 1 tube socket, 1 rheostat, 1 23-plate .0005 MFD. variable condenser, 1-13-plate .00025 MFD. variable condenser, 3 inductance switches, 16 switch points and nuts, 4 switch stops and nuts, 8 binding posts, 2 3" dials, 1 variable grid leak, 1 .002 MFD. phone condenser, 23 feet bus bar wire, 1 high-grade panel ALREADY DRILLED AS PER DIAGRAM and complete instructions.....

\$10.00

Two-Stage Radio Frequency Amplifier—Parts complete in every detail for this Circuit—\$11.00.

Every article advertised above is guaranteed by the manufacturer and by us—Mail orders filled immediately—transportation PREPAID on all orders of \$5.00 or over east of the Mississippi River. All others include postage.

Questions and Answers

Loose Coupler

(2429) CK, Marvel, N. D.
 In a loose coupler, is the secondary and primary coil connected together in any way by wire? What is the use of the rods that the secondary coil slides on? Are they necessary? How do you tune in a station on a crystal set using a loose coupler? I live 15 miles from a sending station. Will a 75-ohm receiver be all right to use? Are the vacuum tubes known as the W-11 the tubes that are used with dry cells.

A.—Answering your inquiry, will advise that primary and secondary of loose coupler are not connected in any way.

Rods are merely used to support the secondary coil, although sometimes the wires from the secondary coil are connected to them for appearance sake. Not necessarily, however.

Tuning is accomplished by experimentation until receiving wave length of broadcasting station desired. It is largely a matter of patience and practice till accomplished.

A seventy-five ohm headset is not very efficient. Better have a three thousand ohm set if possible.

WD11 tubes are used with dry cells, as suggested.

Ultra Audion Hook-Up

(3518) IMA, New Orleans, La.
 Please give me the ultra audion hook-up. I believe it is the same one certain publications are misnaming the "Gibbons"

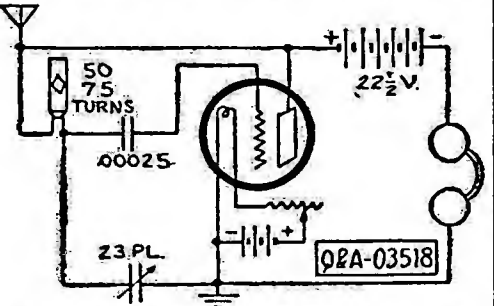

and names of other so-called inventors who do not deserve the credit.

A.—Hook-up is given herewith. Dr Lee DeForest is responsible for the discovery of the ultra audion circuit and to him all credit belongs. You are right in saying the other "inventors" do not deserve falsely claimed credit.

Night and Day Reception

(2362) NG, Philadelphia, Pa.

I am using Radio frequency amplification with various types of transformers and receiving throughout the whole day long distance fine, but as soon as night gets on a terrible static is dropping in my receivers and the noise is so great that I cannot receive any distant station except city stuff. I'm using three steps of R. F. and detector three steps of A. F. amplification. Please help me settle my problem. I'm using about 100 ft. single wire aerial 30 ft. high.

A.—Noting difficulties experienced in night reception will advise that this is contrary to theory and precedent. Reception should far excel that obtained during daytime. It is indicated that there is disturbance occasioned by electrical apparatus in your proximity. Possibly a faulty arc light adjacent to your set. It is not a static disturbance, as suggested. Your antenna construction is good.

FLEWELLING
 ALL PARTS NECESSARY
 DEALERS: ATTRACTIVE DISCOUNTS
HUDSON-ROSS
 123 W. Madison St. Chicago

We Will Mail You One

"VERILOUD" SYNTHETIC RADIO CRYSTAL
 COMPARE IT WITH WHAT YOU ARE NOW USING
IF OURS IS BETTER MAIL US, 30 CENTS NOT Return it at Our Expense!
ZOBEL-STEIN LABORATORIES
 322 9th ST. BROOKLYN, N.Y. SOUTH 2650

Reinartz Hook-Up

(3571) SHL, San Bernadino, Calif.
 Some few issues back you printed a photo-diagram of the Reinartz with a

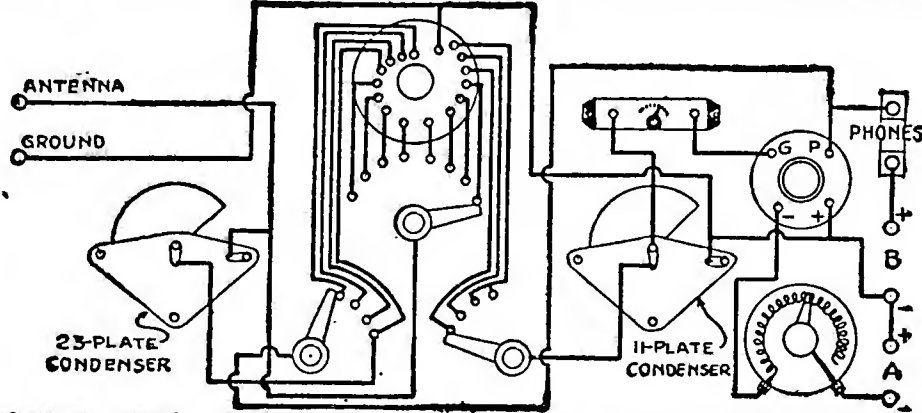

hook-up in panel layout form showing the instruments connected on a panel. Can you repeat this hook-up?

A.—The hook-up was given in the issue of January 13 and is repeated again herewith.

Choke Coils and Transformers

(2318) EAL, Plymouth, Ill.

I would like to ask a few questions regarding the Reflex circuit No. 3 of the January 27th issue. Could I get as good results by using an R. F. transformer in place of the choke coil and high resistance? What tubes would be best for this circuit. Could the W. E. 216A tubes be used? If so what plate voltage should they require? Would it be possible to light the filament and furnish the plate voltage off the 60 cycle A. C.? What is the wavelength range?

A.—In reference to the Reflex circuit would advise that Radio frequency transformer may be used effectively in place of the choke coil and high resistance.

U V 201 tubes will serve satisfactorily in this circuit. W E 216A tubes may be used with about ninety volts plate potential.

It is possible to light filament from A C supply by employment of rectifiers and transformers.

The wave length range is about one hundred and ninety to six hundred meters.

Squeals and Howls

(2867) RLB, New York City.

In your issue of January 27, on page 13 you published a hook up figure 2. I have built this set, and am writing you to see if you can give me some information as to the tuning of it. The local stations come in very fair (although not as good as a 3 bulb set that I have) and I have only been able to get WDAP Chicago for distance. I get any amount of squeals,

howls, etc. I have followed directions very carefully and checked up on them, not once but several times.

A.—The figure two diagram appearing

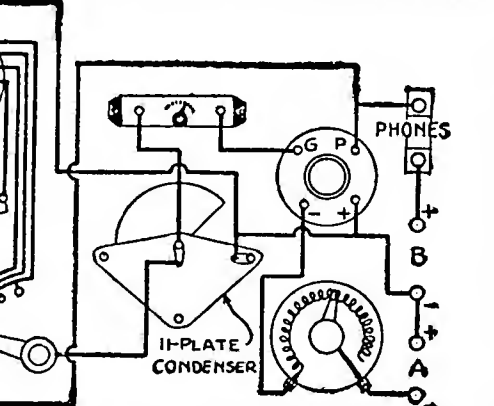

in the January 27th issue of Radio Digest is correct and has given splendid results. It is indicated that a discrepancy exists, possibly inefficient apparatus, since you do not experience the satisfaction afforded to others.

It is difficult to suggest the source of limitation without a personal inspection of set, but having assured you of its possibilities we trust you will not be discouraged before you locate your trouble.

Reflex without Crystal

(2940) FW, New York City, N. Y.

I have made your one tube Reflex. All local stations come in clear and loud on an indoor aerial. I can also receive these stations very faint when I disengage the cat whisker. What is the cause of this?

Can a third R. F. transformer be used in the three tube Reflex? If so where is the best position for it? These two sets were published in the December 30th, 1922 issue.

Do you sell old issues of the Radio Digest, and what is the price? What numbers contain Reflex circuits?

A.—With reference to Reflex circuit will advise that action of same when cat whisker is disengaged is due to induction between various parts and does not interfere with operation.

For addition of a third Radio frequency transformer in this circuit we are directing your attention to page thirteen of the January 27th issue of Radio Digest for

diagram showing method. January 20th issue also contains data on this.

Back numbers of Radio Digest can be secured, unless exhausted, at ten cents a copy.

Resistances

(2852) WGG, Chicago, Ill.

I desire to build the Reflex circuit as described in your January 27th issue, page 13, figure 1. Please tell me how or where to purchase the 50,000 ohm resistances as described and how to make them? I find it almost impossible to secure these resistances. I wish to use three Federal R. F. and two Atwater Kent 9 to 1 ratio A. F. transformers. Will these high resistances be of any advantage in this set? Am I using good judgment in selecting high ratio transformers? Do you consider circuit No. 3 better than No. 1?

I do not quite understand why a jack such as described in this circuit on the second A. F. is used.

A.—Resistances employed may be secured through any responsible dealer.

Would advise the use of lower ratio audio frequency transformers than the 9 to 1 cited. Three and one-half or four to one.

Personally, circuit number one is preferred.

If your reference is to jack used on second stage of audio frequency on number three, this is error. Base of jack should be connected to first prong.

SOMETHING NEW

A real loud Talking Detector made of "B" Metal. 100% superior to any crystal. Puts new life into your set. Guaranteed for one year. It's the cheapest in the long run.

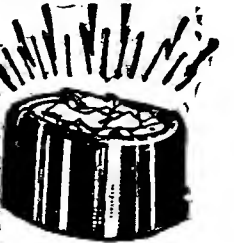

50c

Sold by all live dealers, or can be ordered from the

B-Metal Refining Co.
 3134 Trumbull Ave.
 Detroit, Mich.

Your Choice FREE

Bound Volumes
 Numbers Two, Three, or Four
 Postpaid by Parcel Post with One Year's Subscription to Radio Digest

Supply Limited

Radio Digest Illustrated
 Volume 2
 Flewelling

Radio Digest Illustrated
 Volume 3
 Reinartz
 Flewelling

Radio Digest Illustrated
 Volume 4
 Reflex, Reinartz
 Flewelling

Greatest Collection of Radio Information Ever Published
 Reinartz Long Distance Circuit
 Ultra-Reinartz Circuit
 Flewelling "Flive" Circuit
 Grimes "Inverse Duplex" Circuit
 Single Tube Reflex Circuit
 Armstrong "Super-Heterodyne" Circuit
 Two, Three and Four Tube Reflex Circuits
 A. B. C. Lessons for Radio Beginners

In addition to these features these volumes contain many instructive articles, receiving set diagrams, how to make articles, new apparatus, pictures and illustrations, hook-up diagrams, broadcasting stations, technical articles and book reviews.

65 Numbers

13 Numbers in the Bound Volume
 52 Numbers in Year's Subscription

COUPON
 PUBLISHER, RADIO DIGEST,
 123 West Madison St., Chicago, Illinois.
 Please reserve me Bound Volume Number Two and also Number Three and one year's subscription to the Radio Digest, for which I am enclosing check—M. O. for Seven Dollars.
 Please reserve me Bound Volume Number Two or Three or Four and one year's subscription to the Radio Digest, for which I am enclosing check—M. O. for Five Dollars.

Name
 Address
 City..... State.....

GUARANTEED VACUUM TUBES

1 1/2 Volt Detectors	\$3.95
1 1/2 Volt Detectors and Amplifiers.....	4.95
6 Volt Detectors and Amplifiers.....	3.25

Above Tubes shipped prepaid

WE REPAIR YOUR BURNT OUT VACUUM TUBES Quick Service

WD-11	\$3.50	UV-201-A	\$3.50
UV-200	2.75	UV-201	3.00

When sending Tubes for repair include with your remittance parcel postage for one pound. Tubes guaranteed equal to new.

Abalene Radio
 416 D Broadway New York, N. Y.

DONT PASS THIS-BUY

World Radio Batteries
 SAVE YOU 50%
 WRITTEN 2YR GUAR

Every World User Is a Booster

WRITTEN 2 YEAR GUARANTEE

Because you deal direct with a manufacturer who is responsible for the performance and quality of the Battery.

World-Radio-Batteries

6 Volts—40 Amps.,	6 Volts—80 Amps.,
\$8.50	\$12.50
6 Volts—60 Amps.,	6 Volts—100 Amps.,
\$10.00	\$14.50
6 Volts \$16.00 120 Amps.	

Full Rating Guaranteed

MAIL YOUR ORDER TODAY. WE SHIP EXPRESS C. O. D. SUBJECT TO INSPECTION. OR WILL ALLOW 5% FOR CASH WITH ORDER. ALL ORDERS SHIPPED SAME DAY AS RECEIVED.

WORLD BATTERY COMPANY,
 60 E. Roosevelt Rd., Dept. L, Chicago, Ill.

Radio

Illustrated



Pity the poor working girl. However, after a hard day of labor she has the Radio to bring a small share of cheer to her tortured soul. The waving of the ether waves help her to forget her nerveracking day of spent energy. This is Mae Bush, a "hired" girl at the Goldwin studios, listening in after a day of sham love-making under the glare of a Cooper-Hewitt moon that shimmered through the waving asbestos palm trees



Hudson P. Maxim, noted American scientist and inventor, is shown in the accompanying picture before the microphone in the studio of Station WGM, the Atlanta Constitution, Atlanta, Ga. He delivered a lecture recently to the vast invisible audience of WGM's listeners in



The thing that the feminine mind cannot adapt to decorative purposes never has been created. Even Radio has succumbed to the whims of 'ye ladye ove fashyone' © K. & H.

Below is a novel crystal set that an ingenious fan constructed in the case of an old desk telephone. This set has worked very successfully on local stations where there is no QRM © Swastika



Beginner's Series; Week's Advance Programs

Radio Digest

EVERY WEEK

Illustrated

TEN CENTS

REG. U. S. PAT. OFF.

Vol. 5

Copyright, 1923
R. D. P. Co. Inc.

SATURDAY, MAY 5, 1923

No. 4

NEW WAVES TO END QRM



To the left is Miss Gertrude Paine, who is spoken of in broadcasting circles as "a peppy monologist and snappy accompanist." From this title you will readily judge she is somewhat of a jack of many trades and her versatility makes her almost indispensable to the broadcasters. Miss Paine recently gave some of her most popular readings and piano selections from Station KQV, of the Doubleday-Hill Electric Company, Pittsburgh, Pa.

MAY 15 DATE PLANTS TAKE ON NEW PLAN

Listener-In's Woes Cease

Official Order by Herbert Hoover to Take Effect—Stations Enthused Over Unique System

By E. E. Plummer

CHICAGO.—Broadcasting station interference and many other woes of the listener will disappear at noon, May 15, with the taking effect of the reallocations of wave lengths in accordance with the Second National Radio Conference. The plan to end QRM, as "interference" is known in Radio code abbreviations, has been signed by Secretary of Commerce Hoover, and provides for 34 distinct and well separated wave lengths for Class B stations in 36 different (Continued on page 2)

Following the recent broadcast of Miss Madeline Borschneck-Bossi from Station WOR, Newark, N. J., we received numerous requests to print the picture of the "lady with the nightingale voice." If you were one of the fortunate ones who were so charmingly entertained by her, you will admit this talented coloratura soprano is equally charming in appearance as is the sound of her voice over the ether. It is unofficially announced that Miss Bossi will again be on one of the early programs of WOR by special request of the many fans who have heard her before



WNAC Gives Jazzmania at Request from Mae Murray

BOSTON, MASS.—Mae Murray, the motion picture star, had a special broadcast arranged for her by WNAC (Shepard Stores) on April 13, when she gave a Radio party in New York. She has been so pleased with WNAC programs that she made a request that the Colonial Orchestra play "Jazzmania" during her party.

TINY RECEIVER TUNES IN WNAC AND OTHERS

BOSTON, MASS.—Carlton Margeson, 171 King street, Dorchester, Mass., has built a tiny crystal Radio set that is only four inches long, seven and one-half inches wide, and one and one-half inches high. The tuner has 500 turns of Number 22 cotton covered wire, with 20 taps 25 turns apart. He gets Station WNAC quite clearly, and even WGI with this set. The total cost was \$1.35.

WGV DISTANCE RECORD CLAIM SUBSTANTIATED

Heard in Alberta, Canada, and Off the Azores

NEW ORLEANS, LA.—The record long distance range for the small current used is believed to have been achieved by WGV, broadcasting station of the Interstate Electric Co., this city.

The station radiates on one and seven-tenths amperes and recently received a report from Grand Prairie, Alberta, Canada, which arrived simultaneously with a verbal report from the Radio operator of the S. S. Broncho, who came ashore and told L. C. Parker, Jr., of the Interstate company that he had heard WGV programs while at sea off the Azores some weeks ago.

"A similar maximum range is claimed by a St. Louis station, but that record fails to approximate the New Orleans record since the St. Louis station uses a nine ampere current," Mr. Parker declares in an interview with a Digest representative.

EXCLUSIVE WAVE LENGTHS FOR BROADCASTERS

(Continued from page 1) cities, with 21 other wave lengths reserved for future B plants not now in existence.

Already a part of the plan has gone into effect; no broadcasters falling below the rigid qualifications set for Class B are being licensed for 360 meters, but are assigned wave lengths between 222 and 300 meters.

Listeners In Can Tune Better

The wave lengths assigned to the B stations in the various localities are in accordance with the plan of the conference and are based entirely on the willingness of the various stations to co-operate in putting them into effect.

It is understood that any station now operating on 360 meters will have the privilege of remaining on that wave length if it so desires.

Besides the elimination of the general 400-meter wave, hereafter all government reports will be sent out by each station on its assigned wave, rather than on 485 meters, thus discontinuing use of this wave.

Exclusive Waves for Class B Plants

The thirty Class B stations, now all on 400 meters, will be heard all over the country, once they obtain their new exclusive wave lengths, inasmuch as interference with other similar plants and small local stations has been their only barrier to this goal.

For the purpose of wave distribution without interference the country is divided into five zones. Assignments within these zones are for cities rather than for specific Class B stations, it will be noted. These follow:

ZONE 1

Table with 3 columns: City, Frequency (Kilocycles), Wave Length (Meters). Includes Springfield and Wellsley Hills, Mass., Schenectady and Troy, N. Y., New York City and Newark, N. J., Philadelphia, Washington, D. C., Pittsburgh, Pa., Chicago, Ill., Davenport and Des Moines, Ia., Detroit and Dearborn, Mich., Cleveland and Toledo, O., Cincinnati, O., Madison, Wis., and Minneapolis, Minn., Atlanta, Ga., Louisville, Ky., Memphis, Tenn., St. Louis, Mo., Lincoln, Neb., Kansas City, Mo., Jefferson City, Mo., Dallas and Fort Worth, Tex., San Antonio, Tex., Denver, Col. (reserved), Omaha, Neb., Seattle, Wash., Portland, Ore., Salt Lake City, Utah, San Francisco, Cal., Los Angeles, Cal., San Diego, Cal.

Table with 3 columns: City, Frequency (Kilocycles), Wave Length (Meters). Includes Lincoln, Neb., Kansas City, Mo., Jefferson City, Mo., Dallas and Fort Worth, Tex., San Antonio, Tex., Denver, Col. (reserved), Omaha, Neb., Seattle, Wash., Portland, Ore., Salt Lake City, Utah, San Francisco, Cal., Los Angeles, Cal., San Diego, Cal.

Table with 3 columns: City, Frequency (Kilocycles), Wave Length (Meters). Includes Seattle, Wash., Portland, Ore., Salt Lake City, Utah, San Francisco, Cal., Los Angeles, Cal., San Diego, Cal.

Table with 3 columns: City, Frequency (Kilocycles), Wave Length (Meters). Includes Los Angeles, Cal., San Diego, Cal.

Table with 3 columns: City, Frequency (Kilocycles), Wave Length (Meters). Includes Los Angeles, Cal., San Diego, Cal.

Reserved wave lengths in the five zones, that is, wave lengths which will be held awaiting the erection of anticipated plants capable of B ratings, are: Zone 1, 303, 319, 469, 357, and 288 meters, Zone 2, 294, 345 and 366 meters; Zone 3, 300, 316, 375, 462 and 333 meters; Zone 4, 361, 291 and 306 meters; Zone 5, 297, 330, 349 and 370 meters.

What "Kilocycle" Means

In the tabulation above, it is noted that frequency in "kilocycles" is made the basis of the assignment. Dividing the speed of Radio waves, 300,000,000 meters per second, by the wave length, gives the frequency in cycles. A kilocycle is 1,000 cycles. In Radiophony it has been found best to rate stations according to their kilocycles frequency, as it is the separation or difference in this frequency, one station to another, that will permit the listener in to tune in the one and tune out the other.

The difference between each locality assignment, it will be noted, is 50 kilocycles. Another technical reason for this separation is to prevent audible heterodyning, sometimes called "beat notes," as a result of one station's frequency being too close in number to another's. The beat note is audible to most people when below 18 kilocycles difference exists between stations.

Stations will be rigidly required to keep within two kilocycles of their assigned waves. Constant check will be required to maintain accurate adjustments of the broadcast transmitters.

Kilocycles will supercede meters in designating the transmitting waves of all stations next year.

Class A Plan Similar

Similar somewhat to the plan for the Class B stations is that which has gone into effect for the Class A stations. District Radio supervisors are reassigning 333-kilocycle (360 meter) stations according to the plan, and all new Class A plants will receive "district-exclusive" wave frequencies between 1050 and 1350 kilocycles, that is, 222 and 286 meters, to take effect at once. The reassigned Class A plants will not use their new waves until May 15.

From the schedule of wave lengths for Class A stations, printed below, it will be seen that at least 20 distinct wave lengths are available for distribution in each of the nine Radio districts by the supervisors. Three or four wave lengths in each district will be reserved for the best of the local stations of this class, these waves not being assigned to stations in the immediately adjoining districts.

This gives the better of the Class A broadcasters a partially exclusive transmitting wave. For example, the wave length 222 meters may be assigned to stations only in the 4th, 5th and 8th districts; similarly, the wave of 233 meters will be authorized for use only in the 2d, 5th and 7th districts, while waves 224, 226, 229, etc., will be allocated in every district. This plan, it is believed, will tend to prevent considerable local interference, and create virtually an "A-1" class of stations within the general A class.

Each of the Class A station allocations, it will be noticed, is separated 10 kilocycles from the next. As in Class B allo-

cations, stations must keep adjusted to within two kilocycles of their assigned wave frequencies.

Class A Wave Frequencies and Lengths

Below is given the Class A broadcasting wave frequencies and lengths, and whether the particular wave is to be assigned in each of the nine Radio supervision districts or is to be restricted in use to only certain districts. In the latter case the numbers of the districts entitled to its use are given:

Table with 6 columns: Kilo-cycles, Wave Length, Assigned Districts, Kilo-cycles, Wave Length, Assigned Districts. Lists various frequencies and their corresponding wave lengths and district assignments.

Women's Club Gives Hints on Gardening by Broadcast

AKRON, O.—Radio waves were very successfully used by the Ohio Federation of Women's clubs, April 22 to 28, to arouse public interest in gardening and landscaping, it was announced here this week by Mrs. W. W. Milar, chairman of the state federation's conservation committee. "Garden Hints" were broadcast by Radio, flashed on moving picture screens and printed in the newspapers during the drive.

CONTENTS

Radio Digest, Illustrated, Volume 5, Number 4, published Chicago, Illinois, May 5, 1923. Published weekly by Radio Digest Publishing Company, 123 West Madison Street, Chicago, Illinois. Subscription rates, yearly, Five Dollars; Foreign, Six Dollars; single copies, Ten Cents. Entered as second-class matter at the postoffice at Chicago, Illinois, under the Act of March 3, 1879.

Table listing contents: "All the Live News of Radio" (1 to 7), Receiving Records (2), Radio Fools the Pollies (3), An Evening at Home with the Listener In (4), WJZ Broadcasts School Lessons (5), Advanced Programs for May 1 to 7 Inclusive (6), First Steps for Radio Beginners (7), Radiophone Broadcasting Station Directory, Part III (8), Book Reviews (9), Editorials; Indigest; Condensed by Dielectric (10), Simple Arrangement Add Step of R. F. and Other Kinks (11), Making a Three Tube Reflex De Luxe Receiver; Part I—Panel Layout and Hook-Up (13), Questions and Answers (15), Radio Illustrated, a Page of Pictures (16).

Looking Ahead

Major General Mason M. Patrick, Chief of the U. S. Air Service, in the next issue will tell Digest readers how Radio is being applied in aviation. Of these two modern forces in war, Radio plays an important part in assisting the other, aviation. Read what Major General Patrick has to say.

The Hazeltine Neutrodyne Circuit—will be discussed in an article next issue by Harry J. Marx, technical editor of the Digest. Mr. Marx has some interesting disclosures to make regarding this, the latest addition to the rapidly growing field of Radio "hook-ups."

Radio Waves; How They Are Made; How They Travel—the subject of Chapter II of Thomas W. Benson's series of articles for Radio beginners. Are you a newcomer? Read the second chapter next issue.

The Three Tube Reflex De Luxe Set—description for the making of which starts with this issue, will be continued next week. This wonder set, built and described by H. J. Marx, accomplishes the work of six tubes, but uses only three. Read more about it next week.

E. T. Flewelling's One Condenser Flivver Super Set—Part II next week. Due to illness and need of rest, Mr. Flewelling was forced to postpone the article which was to have appeared this week, but assures us he will have many live hints on the new set to tell Digest readers next issue.

Advance Programs of the Big Broadcasters for the Week—and more stations represented than in any other source of similar information. Watch this exclusive Digest feature expand. Read it every week so you will know the best nights to listen in.

Newsstands Don't Always Have One Left

WHEN YOU WANT

Radio Digest

YOU WANT IT!

BE SURE OF YOUR WEEKLY COPY BY SUBSCRIBING NOW

SEND IN THE BLANK TODAY

Subscription form with fields for Name, Address, City, State, and a note to send in the blank today.

RECEIVING RECORDS? SEND 'EM IN—

By the Contest Editor

BACK again this week with twelve new records and seventeen old ones beaten. Of these, S. S. Atwood of Esperance, Washington, wins honorable mention for submitting the most records and also the longest distance, which is 2500 miles. This is not being done every day. Send in your measured records.

Station Heard—Miles Away—Who Heard It

- List of stations and distances: CFAC-1750, Ted Lehman, Ashland, Ky.; CHYC-2300, S. S. Atwood, Esperance, Wash.; KFDJ-2100, Ted Lehman, Ashland, Ky.; KGB-1725, Louis Bruchiss, Chicago, Ill.; KJG-1925, Paul French, Oxford, Mich.; KJS-1150, W. F. Galloway, Vancouver, B. C., Can.; KOG-2350, H. F. Andrews, Albany, N. Y.; KWH-2350, C. B. Richtmeyer, Allentown, Pa.; WAAS-1025, E. B. Miller, Plainview, Tex.; WBAJ-1150, E. B. Miller, Plainview, Tex.; WBT-2250, Kenneth Curtis, Seattle, Wash.; WCAI-1100, A. C. Flint, Chicago, Ill.; WCAZ-1400, S. S. Atwood, Esperance, Wash.; WCN-1750, E. B. Miller, Plainview, Tex.; WDAU-1700, E. B. Miller, Plainview, Tex.; WFAH-1300, S. S. Atwood, Esperance, Wash.; WFAV-1350, S. S. Atwood, Esperance, Wash.; WFAW-1750, J. A. Bernier, Quebec, Can.; WIAO-1700, S. S. Atwood, Esperance, Wash.; WLAZ-2075, A. B. Butters, Los Angeles, Wash.; WMAG-1325, R. T. Andrae, Cobalt, Ont., Can.; WMAH-1350, S. S. Atwood, Esperance, Wash.; WMAU-1400, W. W. Selden, Springfield, Mass.; WNAJ-2500, S. S. Atwood, Esperance, Wash.; WOAJ-1550, S. S. Atwood, Esperance, Wash.; WOAN-1100, H. M. Clark, Auburn, Me.; WOAW-1325, H. M. Clark, Auburn, Me.; WWAC-1350, Donald Wood, Waco, Tex.; WWAX-1700, Sydney Warner, Springfield, N. J.

\$1 \$1 \$1 \$1 \$1 \$1 \$1 \$1 \$1 \$1

Book of Hook-Ups

REINARTZ FLEWELLING REFLEX

many others, simple and elaborate, fully diagrammed and explained. Used continuously by thousands of Radio fans, both amateurs and professionals. The greatest book ever published for experimenting. Keep this valuable little book before you at all times. Send your check or money-order for one dollar and the book will be mailed to you. Fifty hookups in the book—all different. Send your order today. The edition is limited.

BOOK OF HOOK-UPS, \$1.00 E L S RADIO COMPANY 1133 North California Avenue, Chicago, Ill.

\$1 \$1 \$1 \$1 \$1 \$1 \$1 \$1 \$1 \$1

SEND FOR BOOKLET

TRUTH

ABOUT VARIABLE LEAKS

AIREX

REVELATION LEAKS

6-5 MEGOHMS VARIABLE LEAK ONLY

25c

DITTO WITH .0025 or .005 MICA CONDENSER

35c

PAY NO MORE

ATTRACTIVE DEALER & JOBBER

PROPOSITION

SOLE NATIONAL DISTRIBUTOR

ALBERT J. SLAP

132 NASSAU ST., NEW YORK CITY

A Micrometer Rheostat

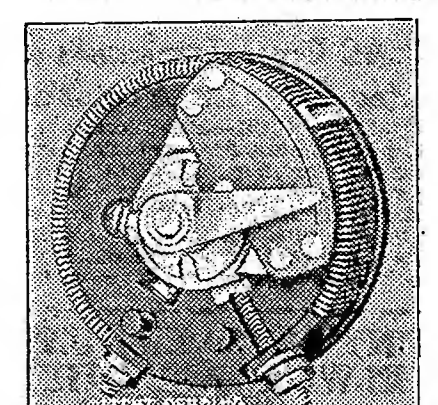

SPECIFICATIONS

The latest development in Micrometer Rheostats. Instantaneous adjustment with one knob control.

Price \$1.50 Jobbers write for discounts HOWARD RADIO COMPANY 4248 N. Western Ave., Chicago, Ill., U.S.A.

BOOTLEGGERS FIND PROFITABLE FIELD

SMUGGLE "PEANUT TUBES" ACROSS BOUNDARY

Detroit Fans Make Purchases of Scarce Apparatus—Ask No Questions and Say Nothing

DETROIT.—A new kind of bootlegging has developed between Detroit and Windsor, Ont., just over the international boundary—smuggling "peanut tubes" into the States. Just why a situation of this kind should exist is difficult to determine, although there are plenty of critics ready to offer explanations.

However, the stealthy traffic here is a surprise to a great many people. Many are asking the question, "Is it because the North American market is controlled or divided? Is it made easy for the consumer to buy what the interests wish to sell it, but not at all easy for the public to buy what it wishes when it wishes?"

Can Get It Across the River

It is extremely difficult here to buy much of certain kinds of Radio equipment that the people are after. This comes in at infrequent intervals and even then one must have his order filed several days in advance before he can get it. However, it does not seem to be just the same across the Detroit river, a mile from the center of the city. There is little trouble over there it is said getting the very equipment that cannot be obtained here. Many, however, are not stopping to ask questions but make their purchases, put them away securely and say nothing.

JEK of WOR Has New Test Given Aspirants

Hears Violinist Over Phone Before Giving O. K.

NEWARK, N. J.—You know, or perhaps you don't know, that every one who broadcasts from WOR must submit to a test being made of his voice, or playing. When JEK, program director, made this rule, some of the other station managers thought that she would not be able to make artists come all the way to Newark for tests, especially since Radio programs are not paid for. But artists realize the publicity value in Radio, so they are willing to go to a little trouble to get on a program. Every day from 4 to 5 p. m. there is a steady stream of applicants, to make "try-outs." A novel one was made the other day, however. A very busy young violinist from New York had requested the privilege to broadcast and had been given the usual reply—that he would have to make a try-out. So he called up WOR and asked JEK if it would be possible to play without being heard by her beforehand.

"No," said JEK, "I'm sorry, but I must hear you play before I give you permission to play for the vast audience."

"But I can't possibly get over to make the try-out, as I am leaving on a concert tour in two weeks and I want to play over the Radio before that time."

JEK put on her thinking cap—it's a cap she wears nowadays, more than her other hats, too.

"I'll tell you what to do," said she. "Play a piece for me over the telephone. That would be so like the Radio that I can judge how you would come over the air."

"It's a go," said the young man, and played beautifully! And he played for the Radiophans, on Friday, April 13th, at 8:30 p. m.—Lindsay Lindy, who has given concerts in London, Paris and Berlin, and who plays on a real "Strad."

Some big-hearted New Yorker anonymously contributed \$100 for the purchase of a radio outfit for the leper colony in Porto Rico.

WOO CONCERT HEARD THROUGH PARIS LOOP

PHILADELPHIA, PA.—Station WOO has received a letter from Andre A. Marie, Electrical engineer, 4 Rue Richepanse recording the remarkable fact that Station WOO's transatlantic concert, broadcast March 15 with Marcel Dupre, organist of Notre Dame Cathedral at the grand organ, was heard in Paris on a loop aerial. This concert was heard simultaneously across America and across the Atlantic ocean.

YOUNG BROADCASTER HAS NEIGHBOR TALENT

HOUSTON, TEX.—Fred Mahaffey, Jr., 15-year-old high school student, claims to be the youngest broadcasting station operator in the world. He has regular programs daily except Sunday at 7:30 to 8 p. m. with his own violin selections, piano solos by neighbors and vocal numbers. Mahaffey's station is KFCV, 360 meters. He uses 10 watts antenna input and is heard all over the Southwest.

ENGLISH STATIONS RELAY BROADCAST

SIMILAR WAVE LENGTHS HAMPER TEST

Success of Experiment Opens Big Possibilities for British Broadcasting Company's Stations

MANCHESTER, ENGLAND.—A highly interesting experiment in Radio broadcasting procedure was carried out recently at the Manchester station of the British Broadcasting Company. For some time past the station has been relaying the Paris time signals, which are sent out on a wave length of 2,600 meters, then the officials endeavored to pick up and relay the London and Birmingham broadcasting stations.

This they did, part of the children's "talk" from London and the "talk" and orchestral program from Birmingham being received on a special aerial, which is set some short distance away from the normal transmitting aerial on which the items were re-radiated to the Manchester area listeners-in. The great difficulty lies in the fact that the wave lengths of the stations are so similar—Manchester is 385 meters, London 369 meters, and Birmingham 420 meters,—so that a particularly selective circuit is necessary to avoid jamming by the re-radiated signals.

This is the first time a direct Radio relay has been accomplished on the British Broadcasting Company's stations, and it naturally opens up big possibilities. If, as seems quite likely, the development becomes a thoroughly practical proposition, it may probably result in there being one big central broadcasting station only, say in London, where the best of the leading musical and vocal talent could be engaged, while in other parts of the country the auxiliary stations would merely relay the program for the private listeners-in in their areas.

PHONOFILM GIVES VOICE TO MOVIES

New Device Invented by Dr. De Forest Given First Public Showing

NEW YORK.—The first public showing of Dr. Lee de Forest's latest invention, the phonofilm, was given at the Rivoli Theater recently. Many so-called "talking pictures" have been exploited in the past in which a phonograph supplies the sound, but this will be the first showing of a film that literally talks and supplies music.

The phonofilm, as the name implies, is a combination upon the same film of picture and voice or music. The sound waves are photographed on the film at the same time the pictures are taken, thus insuring at all times perfect synchronization. In reproducing these sound waves are transformed into telephonic electric currents. By the use of Audion amplifier these currents are amplified 100,000 times and finally turned back into sound again through "loud speakers" located behind the motion picture screen.

A most astonishing result is accomplished: a dancer appears on the screen keeping perfect time with the music supplied by the film; a singer appears from whose moving lips comes every note in perfect tone and synchronism; the bow of a cello player holds the fascinated attention of the audience, as every stroke brings forth the mellow strains of the instrument.

Frisco Entertains New Orleans

NEW ORLEANS, LA.—At a recent meeting held by the New Orleans Chapter, American Association of Engineers, a Radio program by the San Francisco chapter of their organization was the chief feature of entertainment. Motion pictures of Louisiana bird life followed the other program.

RADIO FOOLS THE POLLIES



Miss Marion Merle, pretty vaudeville girl, fooled her trained troop of macaws, cockatoos and parrots with a Radio instrument. The set she carries is made from an old newspaper camera box, but it works just as good as the best of them and the tropical talking birds got the thrill of their young lives trying to learn the source of the mysterious chatter © International

American Legion Station Closed for Summer, April 1

OMAHA, NEBR.—April 1 marked the close of the American Legion Station, WGAT. The station will not be opened again before early in the fall.

One of the features of WGAT has been simultaneous broadcasting in co-operation with Station WJAB. This was done by using a line and line amplifiers, which connected WJAB with the Legion studio.

Both stations went out on different wave lengths, and the double broadcasting proved quite popular among the Radiophans.

Bequeaths Radio Set

The first case on record of a Radio receiving set being specified in a will was revealed when the will of J. J. O'Heir was probated in New York. He bequeathed a "Radio set and tools, valued at \$500," to William Watson.

THE ANTENNA BROTHERS

Spir L. and Lew P.

E. T. Flewelling, of Course!



WSY, BIRMINGHAM, GETS TRADE MARK

Dick Johnson, Designer of Emblem, to Be Heard on Broadcast

By George H. Watson

BIRMINGHAM, ALA.—WSY, broadcasting station of the Alabama Power Company, has what it believes is something new. It is a trade mark which appears on all literature sent out by the station.



Thousands are already familiar with the three strokes of the anvil which ring before the microphone of WSY and in the phones and loud speakers over the continent. The trade mark, just protected is shown herewith. It depicts Thor, the old Norse God of battle and thunder, striking shafts of lightning from an anvil. The iron is symbolic of the iron and steel working center of the south, the bars of lightning are the artist's conception of WSY's service. The ancient thunder gives a touch of the supernatural still associated with the Radiophone. WSY's slogan "Service From the Heart of Dixie" underlies the figure.

Dick Johnston, announcer for WSY, has just mailed out 5,000 letters announcing that the artist from Tuskegee Institute who made the design will be heard soon on the WSY program. Each letter shows the new trade mark.

Decree Issued to Cover Cuban Radio

Divide Stations into Five Classes and Assign to Each a Set Wave Length

WASHINGTON, D. C.—Pending the passage of a law to cover the use of Radio telegraph in Cuba, a presidential decree has been issued defining the various classes of non-governmental Radio stations and prescribing certain general rules for their operation, says Acting Commercial Attache P. L. Edwards in a report to the Department of Commerce. Up to the present time there has been no law or regulation covering the construction or operation of Radio stations in Cuba.

Under the decree, non-governmental Radio stations are divided into five classes, A, B, C, D and E, to each of which is assigned a wave length and a maximum power. No sets of any of these classes will be used for commercial purposes.

Owners Must Register

All owners of stations coming within any of these five classes were registered with the Director General of Communication before March 16, 1923. After that date no station could be used unless the proper permit had been issued by the office mentioned. The permits are for a term of one year in the case of classes A, B and C, and for five years in the other two classes. Applicants must pass an elementary examination, but it is not believed that this requirement will in any way hamper the issuance of licenses.

Can Not Use S. O. S.

The decree further provides that the Government may, under specified circumstances, require transmitting stations of any of the five classes to cease operation without their claiming indemnity from the Government. Transmitting stations of any class are made subject to the regulations of the International Radio Convention signed in London in 1912. The decree also prohibits the transmitting of the international distress call, S. O. S., either as a special signal or in the course of any general text. Penalties are provided for the disclosure of any public or Government message intercepted by any station. Only apparatus capable of transmitting a pure, continuous wave may be used.

TWO SUPERSENSITIVE CIRCUITS

(Both Copyrighted)

My Highly Improved Reinartz brings in all important stations on both coasts and Mexican border, loud, clear and without distortion. We dance to music from Atlanta received on one loud Baldwin unit. Build one of these wonderful sets from my blueprints and specifications, price 50c, or with a perfect and complete double wound spiderweb coil, \$3.00 by mail. No other windings used. Photo of my set on a glass panel with every order.

This copyrighted circuit is the most successful of any Reinartz modification yet produced, and is imitated the most. Thousands are in use.

My W. D. 11 Circuit is especially designed for use with the "Pickle" tube and brings out the full value of that little tube as no other circuit can. Stations 1000 miles away come in clearly on one tube. This set is small, complete, portable. For the man who wishes the highest efficiency, this is the set to build. Price of blueprint and specifications, 50c, or with complete and perfect windings, \$3.00. Photo of set with every order.

Either set is easy to build, easy to operate. Everything clearly shown.

These high quality silk insulated coils are machine wound on fiber forms. I wind coils to your specifications in lots of 100 or more. Write for prices.

S. A. TWITCHELL

1925 Western Ave. Minneapolis, Minn.

AN EVENING AT HOME WITH THE LISTENER IN

(SEE NOTE BELOW FOR INSTRUCTIONS)

Table with columns for Station and City, Met., Monday, Tuesday, Wednesday, Thursday, Friday, Saturday, Sunday. Lists various radio stations and their broadcast times.

(Instructions for Use.—All the hours above are given in Central Standard Time. If your city uses Eastern Time, add one hour to each of the periods stated; if your city uses Mountain Time, subtract one hour; if your city uses Pacific time, subtract two hours. Thus the use is very simple.)

Wife vs. Husband and Airphone Set

Albert H. Waitt, Millionaire Owner and Operator of Station 1AOV, Sued for Divorce

NEWTON, MASS.—A mania for Radio is given as one of the grounds for the divorce suit instituted by Mrs. Lillian B. Waitt of this city against her millionaire husband, Albert H. Waitt, in an interview recently. "He is obsessed with Radio," declared Mrs. Waitt of her errant husband. "Not only did he have a receiving set, but he had a powerful transmitting apparatus, by special license of the United States government. It was a registered station, with the call 1AOV.

Husband Locks Up and Leaves

"Night after night, with a hired Radio operator, he would go to the Radio room at the top of the house and spend hour after hour there, leaving me alone. I think any jury will consider that gross neglect and cruelty.

"When I returned from a visit to New York, and found him gone, after publishing in the local newspapers and telling the servants and friends that he was going to South America, I went up to the Radio room and found it padlocked, with a printed sign on the door reading: 'Radio Station 1AOV Closed!' That's how far he carried his obsession.

"I had the padlock smashed, after con-

"As valuable to your radio set as RADIO is valuable to the world"

is ARTHUR PUDLIN'S Variable High Resistance Leak

Eliminates the hissing and all disagreeable noises. Enables you to hear all stations clearly.

Endorsed by Flewelling, Rosenblum and other leading Radio engineers.

Price with .00025 Mica Condenser\$1.00 Price without Condenser .75

For sale at all good dealers. If your neighborhood dealer hasn't them in stock, send us purchase price and we will mail you immediately the Arthur Pudlin Variable High Resistance Leak. Also send dealer's name.

Arthur Pudlin Engineering Co. 1540 Broadway, New York.

SPEED TRANSMISSION TEST MADE BY ARMY

100 Words a Minute Is Achieved by New Apparatus

WASHINGTON, D. C.—Successful experiments in high speed Radio transmission between the Army Message Center in the Munitions building here have just been completed. With new commercial apparatus, capable of sending mechanically from a perforated tape up to a speed of 100 words a minute and recording the messages in a saw-toothed ink line on a tape, a reception speed of 65 words a minute has been achieved. After a little practice, signal corps experts say, their operators will be able to mechanically copy the received messages visually as well as by ear, and in this way a great saving of time will be made in clearing traffic.



ROBBINS RADIO DESK PATENT APPLIED FOR

An attractive piece of furniture designed and so constructed to accommodate the Radio set and its entire equipment. With it you make a neat installation of Radio in the home. Its many advantages and moderate cost make it almost indispensable.

For sale by first class Radio and Furniture Dealers or write

Robbins Woodworking Co.

Dept. C.

LIBERTYVILLE, ILLINOIS

sulting an attorney, thinking he might have hidden my jewelry there, but I did not find them."

Mrs. Waitt, in a statement, also declared that her husband was displeased with her trip to New York and broadcast the fact from his sending station. When she asked him why he did it, he answered that he wished to let her friends know that she was coming.

When figuring on the wave length of your aerial, remember the lead-in counts.



It is written: "The cure of ignorance is study." The wise man carefully investigates, — then buys a Grebe Receiver.

Doctor My

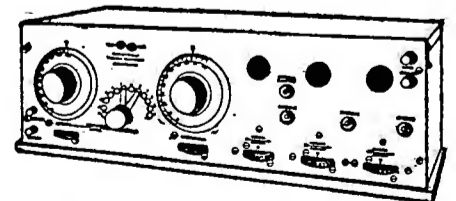

Licensed under Armstrong U. S. Pat. No. 1113149

A. H. GREBE & CO., Inc.

Richmond Hill, N. Y.

Western Branch—451 East 3rd St., Los Angeles, Cal.

WJZ BROADCASTS SCHOOL LESSONS



Left photo shows H. W. Leyenberger, a teacher of the Haaren high school, giving via Radio several problems for his class in mathematics to figure out in their school room several miles away. Two girl students are checking the results of the problems. Miss Elinore Hastings of the teaching staff of the Haaren high school of New York is shown above teaching a class via Radio. The questions are transmitted via Radio from headquarters of the board of education and the students of the class are then required to solve the problems. This is the first attempt at introducing the Radio in the classroom and is being tried by the New York board of education in co-operation with the Westinghouse station WJZ at Newark, N. J. © International

CUBAN PLANT PWX GIVES FANS OPERA

PRIZES OFFERED HEARERS BY DIRECTOR GALLO

San Carlo Grand Opera Company to Remain Three Weeks—Plan Other Broadcasts

HAVANA, CUBA.—Opera across the sea carried the message of friendship from Cuba to the United States on Tuesday night, April 24th, when the San Carlo Grand Opera Company opened its season in the Teatro Nacional here. The entire opera, "The Barber of Seville," with Titta Ruffo, Tito Schipa, Josephine Lucchese, and others in the cast, was broadcast.

Beginning at 9:00 P. M., Eastern time, the broadcasting was done by the Havana station, PWX, arrangement with The Cuban Telephone Company, which transmitted the performance from a microphone in the theater to the sending plant.

This enterprise had the official stamp of the Cuban government through arrangement by General Crowder, U. S. A., with the President of the Cuban Republic. The President was in attendance at the opera and preceded the broadcasting of the music with a speech through the Radio to those listening in this country.

Award Prizes to Listeners In

Fortune Gallo, director of the San Carlo Grand Opera, will give prizes to those Radiophans who send in the best written accounts of what they heard on Tuesday night. These reports should be addressed to Fortune Gallo, Aeolian Building, New York City. The prizes will consist of boxes and seats for performances of The San Carlo Company on its tour of America next season, 1923-1924. The prize winner will determine the time and

R-C CABINETS

Mahoganette—Thoroughly well constructed—hinge top—nickel lift knob. With or without "Arceelite." Special Radio Panel already attached. Costs no more than inferior grades of cabinets.

Ask your dealer or apply to THE R-C MILLS, Manufacturers 303 4th Ave. New York City

PHANTOM-CIRCUIT

Build Your Own. This marvel of mystery, using no loop, no aerial and no ground, brings in music instead of interference. We have heard stations 950 miles distant on one tube. By using WD-11 tube set can be entirely self contained. Very easy to build from our instructions. Use your own spare parts, nothing complicated like radio frequency or super regenerative. Only one tuning control. Complete instructions, with hookup and photo of circuit mailed to you for 60 cents. Stamps accepted. VESCO RADIO SHOP, Box D-704, Vacaville, Calif.

"Sun Dodgers" Give Radio Sets to Crippled Children

CHICAGO, ILL.—Thousands of crippled children in Chicago will soon be "tuning in" their own Radio receiving sets to jokes, musical entertainments and bedtime stories.

The Board of Trade Radio station, WDAP, located on the Drake hotel, has recently organized a "Sun Dodgers" club for this purpose. Membership is \$5 and this sum will purchase a crystal set for one crippled child. Nearly 700 Radiophans have responded to the "via the air" call for volunteers.

Boy Scouts will make the installation and show the children how to manipulate the knobs and dials.

place where he will attend the opera next season as he will be given seats at a performance in a city nearest to his home town on the San Carlo itinerary.

The San Carlo organization will remain in Havana for three weeks and in its casts will appear Giovanni Martinelli, Lucresia Bori, Mari Kouznezova, Anna Fitzliu, Marie Rappold, Sophia Charlebois Stella De Mette, Manuel Salazar, Marie Valle, and others, with Carlo Peroni and Giacomo Spadoni, conductors, and The Pavley Oukrainky Russian Ballet. Other broadcasts are planned.

President Harding to Speak on WJZ

Broadcast Enables Nation's Leader to Speak to Largest Audience Reached by Any President

NEW YORK, N. Y.—President Harding's voice will undoubtedly vibrate through the ether from Station WJZ, when he speaks before the Volunteers of America in New York on May 10. Definite arrangements have not been made relative to the hall in which the address will be given, but it is expected that the microphone will pick up the President's voice from either the Metropolitan Opera House or the Hippodrome.

Such broadcasting will give President Harding the distinction of addressing the largest audience of any President in the history of the United States. The waves of WJZ have sufficient power to carry their message to every state in the Union, so when this station places its microphone before the President, his voice will be heard in thousands of homes.

The rates of Swedish coast stations were recently reduced to 30 centimes per word, minimum 3 francs per Radiogram.

Club Discusses Radio Frequency

MILWAUKEE, WIS.—Radio frequency amplification has been the topic of interest and discussion at the last several meetings of the Milwaukee Radio Amateur's Club, Inc. I. H. Strassman, 9AHO, A. R. R. L. City Manager, awakened the members' interest with his talk entitled, "Radio Frequency Intervolve Transformers."

RADIO At Cut Prices

Standard parts only in original packing. Sold on a "money-back" basis.

PHONES	
\$ 8.00 Brandes Superior	\$ 5.95
12.00 Nathaniel Baldwin Type C. Double..	8.95
7.50 Dietzen special, 3000 ohms.....	3.95
TUBES	
1 1/2 Volt Peaout Tube.....	2.00
1 1/2 Volt Mercury	4.95
CABINETS	
Made in our factory	
7" x 10".....	1.45
7" x 18".....	2.15
7" x 24".....	2.95
MISCELLANEOUS	
\$25.00 Gible crystal set.....	7.95
5.50 Triple coil mounting.....	3.95
Solderall, Tube.....	.25
\$12.00 Amplitone, Nickel Horn.....	4.95
25.00 Aerex Crystal Set.....	9.95
DURATEK Permanent Crystal Detector.....	2.00
W.D.-11 Adapter65
\$1.50 Argus Lightning Arrester, Indoor and Outdoor Type95
5.50-180 Degree Variocoupler on Bakelite, Silk Wound Wire	2.45
2-inch Bakelite Dials.....	.25
4-inch Electros Dials.....	.75
3-inch Bakelite Dials.....	.35
\$ 1.00 Freshman Variable Grid Leak and Condenser Combined75
1.00 Bakelite Socket50
5.00 W. D. 12 Audio Frequency transformer	3.75
3.00 Ori Radio Frequency transformer	1.50
5.50 Coto coil Radio frequency transformer	3.45
5.00 Sleeper Radio frequency transformer	1.95
8.00 Dayton Variometer.....	5.45
8.00 Dayton Variocoupler.....	5.45
5.50 Murdock variable condenser, 23-plate	2.95
6.50 Murdock variable condenser, 43-plate	3.25
132.00 Radiola R. C. set.....	79.50
The new Morrison Sireo loud speaker	18.50
5.00 Multi-Radioscope	1.50
Little Gem set.....	6.50
1.25 Western Electric Ammeter for testing B batteries49
.50 New radio map.....	.35

When Ordering by Mail Add Postage by the Following Scale

PURCHASES	
Up to \$1.00.....	add 10c
\$1.01 to \$2.00.....	15c
2.01 to 3.00.....	20c
3.01 to 5.00.....	25c
5.01 to 7.00.....	30c
7.01 to 10.00.....	40c

Money Order or Personal Check Accepted

Modell's
ESTABLISHED 1829
RADIO STORES
Dept. F. 10, 191 Fulton St., N. Y. C.

Cotogrip

"Built First to Last"

This little beauty was approved by our engineers only when convinced that they had produced the one socket that combines all the essential features of a good socket.

1. Positive Cotogrip Contacts.
2. Hard Rubber Insulation.
3. Rugged Construction.
4. Compact Design.
5. Concealed Mounting.

It is impossible to show the unique mechanical action of Cotogrip contacts in a photograph. It is different from any other socket you have ever seen. This socket will interest you in every way.

You ought to have one. Ask Your Dealer

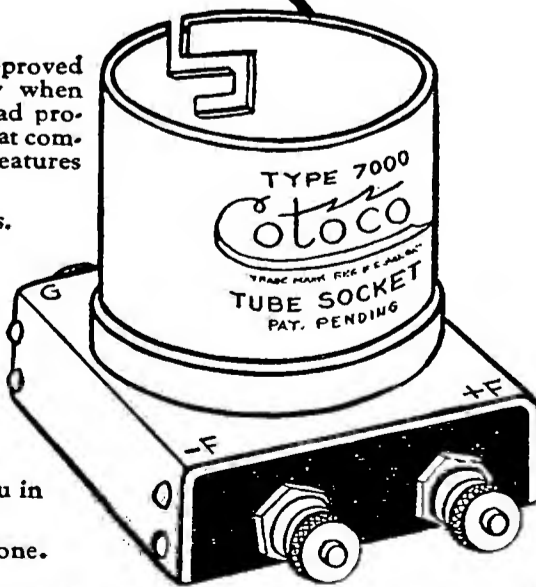

COTO-COIL CO. PROVIDENCE

The Week's Advance Broadcast Programs

Tuesday, May 1

KFI (Pacific, 400), 6:45-7:30 P. M., Peter Rabbit; Los Angeles County Medical Sy.; Concert, Junior Music Clubs of Southern Calif.; 8:00-9:30 P. M., Concert, Egan School; 10:00-11:00 P. M., Reading, Dr. Frank Nagel of Hollywood Opera Reading Club; Programs of Matinee Musical Club, MacDowell Club and Los Angeles Music Teachers' Assn.

Wednesday, May 2

CFCN (Mountain, 440), 10:30-12 P. M., Dance program, Imperial Orchestra, Plaza Cabaret. KFI (Pacific, 400), 6:45-7:30 P. M., Peter Rabbit; Nick Harris Detective Stories from Pathways Theater Bldg.; Concert, Junior Music Clubs of Southern Calif.; 10:00-11:00 P. M., Program, Wa-Wa Club; Vocal selections, Radio Girls Quartet; Program, Musical Optimists.

FORMICA SHEETS TUBES RODS RADIO PANELS POLISHED BLACK FINISH

CUT PERFECTLY SQUARE TO ANY SIZE 1/32" THICK 1/2c PER SQ. INCH 1/16" THICK 3/4c PER SQ. INCH 3/32" THICK 1c PER SQ. INCH 1/8" THICK 1 1/2c PER SQ. INCH 3/16" THICK 2c PER SQ. INCH 1/4" THICK 2 1/2c PER SQ. INCH 3/8" THICK 4c PER SQ. INCH 1/2" THICK 5 1/4c PER SQ. INCH

SEND FOR COMPLETE PRICE LIST PROMPT ATTENTION TO MAIL ORDERS DEALERS PRICES ON APPLICATION STARRETT MFG. CO. 519 SOUTH GREEN ST. CHICAGO

HERE is the fourth appearance of this new service for Digest Readers. There are only fifty eligible stations for the listening, but already twenty-three of these will be found in the "Advance Programs." Only features are listed below. Such parts of station programs as are regular week in and week out, are, as they have been from the start, found in the Digest Radiophone Station Directory. Much other data on the stations for which advance programs are given, will be found there.

Story by "Uncle John," 8:00-10:00 P. M., Soldier's Program, Post War Service League of Hollywood. KYW (Central, 400), 8:00-8:58 P. M., Musical Program courtesy of Lyon & Healy Concert & Artist Department; Wendell W. Hall, KYW's Music Maker. WBAP (Central, 400), 7:15-8:00 P. M., Concert, Mrs. Prigmore, O. Webster, with other artists; 9:30-10:30 P. M., Concert, European Club of Fort Worth.

Recital; 11:30-11:55 A. M., Grand Organ Recital and trumpets; 9:55 P. M. WSY (Central, 360), 8:00 P. M., Musical program, "On The King's Highway," Male Choir; "The Bird of the Wilderness," Mrs. Lucile R. Brooks, soprano; "Crucifix," Brown Bates, bass; J. D. McGill, tenor; "Fraise God in His Holiness," Quartet; "Rose of My Heart," Brown Bates; "Trovatore," Mrs. Kimball Morrison, pianist; "His Way Is Mine," Male Choir; "Farewell," Mrs. H. T. Burnett, contralto; "I Will Magnify Thee," Double Quartet; "Whispering Hope," Mrs. Lucile R. Brooks, Mrs. H. T. Burnett; "Martha," Mrs. Kimball Morrison; "The River of Life," Male Choir.

Thursday, May 3

KFI (Pacific, 400), 6:45-7:30 P. M., Peter Rabbit; Program, Y. M. C. A.; 8:00-9:00 P. M., Concert, Sherwood Music School; 10:00-11:00 P. M., Vocal selections, Hollywood Girls Quartette; Los Angeles Oratorio Sy.; First Congregational Church Choir; Instrumental music, Geo. J. Birkel Co. KGW (Pacific, 400), 7:00-7:30 P. M., Lecture, University of Oregon Extension Course; 8:00-8:15 P. M., Vocal selections, Helen Drain, contralto; 8:15-9:00 P. M., Concert, George Olson and orchestra; 11:00-12:00 P. M., Hoot Owls.

REFLEX Erla Reflex Transformers DEALERS: SEND FOR LITERATURE

HUDSON-ROSS 123 W. Madison St. Chicago

"MAKE PERFECTION YOUR SELECTION"

We Carry Only STANDARD Advertised Radio Equipment. Every Product Sold on a MONEY BACK GUARANTEE. Add 5% for Parcel Post

FREE A \$1.25 VOLTMETER OR AMMETER GIVEN WITH EACH PURCHASE OF \$5. OR OVER FREE

Table listing various radio components and their prices: MAGNAVOX LOUO SPEAKER, Type R. 3..... \$27.45; FLEWELLING CIRCUIT, Complete parts, including ORILLED panel, double coil Mounting and Honeycomb coils; only standard equipment used. FREE DIAGRAM \$17.75; PERFECTION VARIOCOUPLER SILK WOUND, Fibre Base. \$2.25; DICTOGRAPH PHONES, 3000 Ohms. \$8.00 List..... \$5.75; N. & K. PHONES, 6000 Ohms. None Better Made..... \$6.50; PERFECTION VARIOMETER, Guaranteed Quality. List \$5.00. Our Price..... \$2.95; ACME TRANSFORMERS, Type A 2 S. \$5.00 List..... \$4.25; KLOSNER VERNIER RHEO-STATS. List \$1.50..... 59c; REINARTZ CIRCUIT, Complete parts including Drilled Panel. FREE DIAGRAM... \$11.95; REINARTZ COILS, Very Best Quality..... \$1.75; MICA DIAPHRAGMS Improve your phone. List \$2.00. Our Price..... \$1.25; THORDARSON TRANSFORMERS. \$4.50 List..... \$3.25; BALDWIN PHONE, Original Nathaniel. List \$6.00, Special... \$4.75; 180° BAKELITE COUPLER, Silk Wound. List \$5.00. Our Price \$2.95

Table listing various radio components and their prices: VARIABLE CONDENSERS: 3 Plate Vernier Condenser, moulded ends \$1.50 \$1.10; 11 Plate Condenser, moulded ends, .00025 2.50 1.35; 43 Plate Condenser, moulded ends, .001 4.00 2.00; Franco 23 Plate Variable Condenser with Vernier 6.60 4.00; Franco 43 Plate Variable Condenser with Vernier 7.70 4.50; HONEYCOMB COIL MOUNTINGS: Triple Mountings with leads—screw adjustment 5.00 2.75; Double Mountings with leads—screw adjustment 3.50 2.45; Single Mountings .55 .40; BAKELITE PANELS: 7x10 1.25; 7x18 2.25; 7x24 3.25; All Panels 3/16 inch thick; CABINETS: Mahogany Cabinet—hinged top 7x10... 2.35; Mahogany Cabinet—hinged top 7x18... 2.95; Mahogany Cabinet—hinged top 7x24... 3.45; PHONE CONDENSERS: All Capacities Fixed Condensers, Grid Leaks, etc. \$0.30 \$0.09; Freshman Variable Grid Leak .75 .60; Freshman Variable Grid Leak and Condenser combined 1.00 .75; All capacities of Dubilier Micadons and Freshman Microns in stock; HARD RUBBER PANELS: 7x10 Unbreakable .85; 7x18 Unbreakable 1.50; 7x24 Unbreakable 1.95; BATTERIES: EXIDE "A" Storage Battery, 6 V. 40 Amperes Hours, Type 3 LXL5... 17.85 14.00; EXIDE "A" Storage Battery, 6 V. 80 Amperes Hours, Type 3 LXL9... 23.10 19.00; EXIDE "A" Storage Battery, 6 V. 120 Amperes Hours, Type 3 LXL-13... 31.50 25.00; Eveready "A" Variable Storage Battery—6 V., 90 Amperes Hours... 18.00 15.50; Eveready "A" Storage Battery—6 V., 98 Amperes Hours... 18.00 16.00; Eveready "A" Storage Battery—6 V., 110 Amperes Hours... 20.00 18.00; Eveready "B" Battery—45 V. 5.50 3.95; Eveready "B" Battery—22 1/2 V. 3.00 2.20; Voltan "B" Battery—22 1/2 V. 1.75 .95; Bright Star "B" Battery, 22 1/2 Volts 1.75 1.10; Bright Star "B" Battery... 3.00 2.00; 22 1/2 V. Variable, 5 Positive terminals 1.75 1.10; Bus Bar Wire (2 ft. lengths) .03

PERFECTION RADIO CORPORATION, 121 West 23rd St., NEW YORK CITY STORES ALSO AT 59 AND 78 CORTLAND ST. AND 128 CHAMBERS ST. WHOLESALE AND RETAIL

Concert, Rex Maupin's Original Texas Hotel Orchestra. WDAF (Central, 380), 10:00 P. M., Musical program, Mrs. Hannah Butler assisting artists; Millan Lusk, violinist. WOAR (Eastern, 400), 12:02-1:00 P. M., Organ recital, Stanley Theatre; Concert Arcadia Cafe Orchestra; 9:00-9:30 P. M., Soprano and piano solos; 4:15-4:45 P. M., "Affairs of the Heart," Betsy Logan; Talk, Musical program; 5:45-6:00 P. M., Dream Daddy with the little tots; 7:30-7:50 P. M., Dream Daddy with boys and girls; 10:10 P. M.-1:00 A. M., Concert, WDAE artists and Howard Lannan's Arcadia Cafe Orchestra. WFAA (Central, 400), 12:30-1:00 P. M., Address, "Public Service Transportation Problems," W. M. Holland, president Dallas Railway Co.; 8:30-9:30 P. M., Masonic service program under the auspices of Masonic service committee of Grand Lodge of Texas; 11:00-12:00 P. M., Musical program under auspices of Will A. Watkin Co. WFI (Eastern, 400), 1:15-2:00 P. M., Meyer Davis Bellevue-Stratford Concert Orchestra; 3:30-4:15 P. M., Billy Meek, dialect stories; J. S. Magee, violinist. (Continued on page 12)

DEALERS! KELLOGG Distributors Write for our catalogue and dealers helps. It will help your sales. Attractive discounts. SCRANTON DIALS Furnished in the following sizes: 3 inch.....16c net 2 inch.....14c net We sell only to Dealers WERNES & PATCH 159 N. STATE ST., CHICAGO, ILL.

How to Make a Flewelling Receiver BLUE PRINTS for the construction of a Flewelling Receiving Unit and two step amplifier. ALL DETAILS FOR ASSEMBLY Description of apparatus and accessories and details of tuning. CABINET DIMENSIONS PANEL LAYOUTS LIST OF PARTS Send only money orders—no checks or stamps. Coins at your own risk. Book Department Radio Digest 123 W. Madison St., Chicago, Ill. 50c

First Steps for Beginners in Radio

Chapter I—Laws of Electricity Used in Radiophony

By Thomas W. Benson, A. M. I. R. E.

A THOROUGH understanding of Radio phenomena demands a knowledge of the laws of electricity. Radio being but a special application of this useful servant of man depends thereon for its fundamental units and laws. Although having symbols and terms distinctly its own, Radio phenomena will be more clearly understood in the light of the paragraphs to follow.

Electromotive Force

In order that electricity might flow in a wire of circuit it is necessary that a difference of potential or electrical pressure exist between two points connected by a conductor. To measure this potential

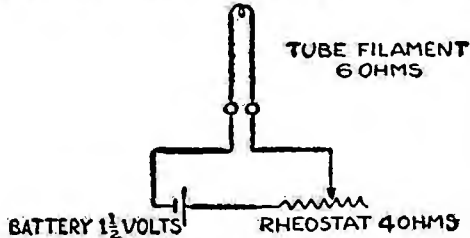

or electromotive force (E.M.F.) we make use of the volt which is then the unit of pressure so to speak. Thus we find that a dry cell has a voltage of 1½, that is, the pressure at the terminals of a battery tending to make a current flow in any circuit connected to it, is 1½ volts. There is no fixed unit of voltage but is arrived at by other means.

Now when we connect an electrical device to the dry cell, let us say the filament of a WD-11 tube with a rheostat in series as shown in Figure 1, a current will flow. The amount of current flowing is measured in amperes which is the quantity of current.

It should be made very clear that the voltage is forcing the current around through the rheostat and filament but the amperes is the amount of current flowing.

Resistance

Whenever a circuit is completed the material or conductor through which the current flows offers a certain resistance or tends to hold back the current. This effect is measured in ohms, the unit of resistance. Going back to our illustration we find we have a very fine wire in the tube and also a rheostat made of wire that has

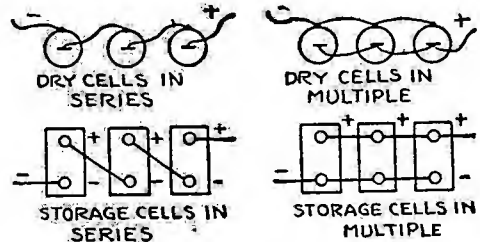

a high resistance. By regulating the holding back effect of the circuit we can control the amount of current or amperes flowing. Thus by turning the rheostat handle so there is less resistance for the voltage to overcome the current through the filament increases and it gets hot.

Ohm's Law

The law of current flow is known as Ohm's Law, the most fundamental law of electricity, and also, the most simple. Put into words, the current in a circuit varies directly as the voltage and inversely as the resistance. Put in the form of a formula we have:

$$I = \frac{E}{R}$$

That is, the current in amperes (I) is equal to the voltage (E) divided by the resistance (R) in Ohms.

Let us see how this works out. When resistances are connected in series their total resistance is equal to the sum. In

Patents Procured and Trade-Marks Registered. Advice and terms upon request. ROBB, ROBB & HILL, 1417 Hanna Bldg., Cleveland, O. 956 McLachlan Bldg., Washington, D. C.

WE REPAIR
WD-11, \$3.50
and OTHER
VACUUM TUBES
Excepting
VT-I and VT-II
MAIL ORDERS Solicited and Promptly Attended To
H & H RADIO CO.
516 Clinton Avenue NEWARK, N. J.

BEGINNERS will find the accompanying series by Mr. Benson very helpful in learning the rudiments of the popular science of Radiophony. His articles yet to appear are:

- Chapter II—Radio Waves and their Propagation.
- Chapter III—Pointers about Aerials and Grounds.
- Chapter IV—About Condensers and Inductances.
- Chapter V—Tuners and How to Tune Your Set.
- Chapter VI—About Crystal Detectors.
- Chapter VII—Tube Detector Theory and Operation.
- Chapter VIII—The Regenerative Detector.
- Chapter IX—Radio Frequency Amplification.
- Chapter X—Audio Frequency Amplification.
- Chapter XI—How Super Regeneration Is Accomplished.
- Chapter XII—Reflex Circuit Operation.
- Chapter XIII—About Headsets and Loud Speakers.
- Chapter XIV—Batteries Used in Radiophony.

the circuit we have say a 4-ohm rheostat and the filament of the tube with a resistance of 6 ohms. This gives a total of 10 ohms when all the rheostat is in. To determine the current we simply divide the voltage 1.5 by the resistance, 10 ohms giving .15 amperes. Say we cut the rheostat out entirely leaving the battery connected direct to the tube, this gives but 6 ohms and on figuring it out the current will be one-quarter ampere.

Since the current is equal to the voltage divided by the resistance it also holds that when voltage and current are given the resistance is equal to the voltage divided by the current or:

$$R = \frac{E}{I}$$

For instance, the UV 200 takes 1 ampere filament current at 5 volts. To determine its resistance divide voltage, 5, by current 1, and we find its resistance is 5 ohms.

Going one step further it will be clear that the product of the current and resistance should equal voltage. We can express this as $E=IXR$.

Resistance in Series

It has been stated that when resistances are in series that is when the current must flow through one after the other the total resistance is equal to their sum. However, when they are connected in parallel or so

- W. T. 501 Peanut Tubes, 4 V. ½ Amp. with Adapter\$2.75 (Use storage battery or 3 dry cells in series)
 - R. V. T. 5-6 V. Detectors..... 2.75
 - R. V. T. 5-6 V. Amplifiers..... 3.35 (Sent on receipt of price. No C. D. D. orders accepted)
 - 1 Tube Regenerative Receiving Set with Detector Tube and 3000 Ohm Headset. VERY SPECIAL VALUE 29.75
- LUX MANUFACTURING CO.**
1045 North Wells Street, CHICAGO, ILLINOIS

HERE IT IS

Just What You Have Been Looking For
A VARIABLE RADIO RESISTANCE
THAT MOUNTS ON PANEL
IN A JIFFY

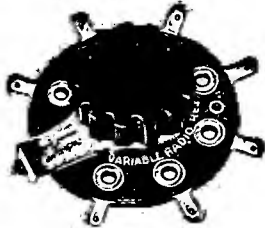

Patents Pending.

Real Radio Fans, in the building of their sets, will more than appreciate this device, which gives them a variable resistance which is adaptable for use in all Radio Hook-ups—in the grid circuit—as amplifier coupling resistance for both radio and audio frequency—"B" battery resistances—antenna shunts—tuned loop circuits—resistance couplers for both radio and audio frequency, and many other places in the radio hook-up that the amateurs' ingenuity will suggest. Has switch lever and seven carefully calibrated values of resistance of ½ megohm each between terminals. Protecting bakelite discs assure permanency of moisture-proof India ink resistance. Don't guess—it is important to have resistance properly adjusted to function with your other apparatus to get the best results from all tube sets. A Premier Variable makes this sure and easy. Code No. 250. Price.....\$1.50 each
DISTRIBUTORS—We make a most complete line of radio parts. Some territory open for live, responsible concerns.
PREMIER ELECTRIC COMPANY
Manufacturers Est. 1905
3800 Ravenswood Ave. Chicago, Ill.

sum. When more than two unlikes are in parallel the formula becomes:

$$R \text{ (total resistance)} = \frac{1}{\frac{1}{R_1} + \frac{1}{R_2} + \frac{1}{R_3}}$$

Which can be readily solved. The reader may doubt the value of these formulae to the experimenter but their value will be apparent when one wishes to build up say a given grid leak from a number of smaller or larger leaks.

Standard of Resistance

The standard of resistance being an ohm, it is advisable when high resistances are used to use other units. Thus the megohm is used for one million ohms. A half-megohm leak then has a resistance of half of one million or 500,000 ohms.

The resistance of a conductor varies as its length, diameter and material. Increasing the length of a wire will increase its resistance and vice versa. Increasing the size of wire reduces its resistance and increases the current carrying capacity. The use of special materials, such as German silver, nichrome and constantan, gives wires having high resistances.

Units of Energy and Power

Having obtained an idea of the relationship between the units of pressure, current and resistance, we can go on to a consideration of the units of energy and power. We have seen that a certain voltage is required to force the current through the circuit, and since the current does the work we must consider both voltage and amperage in determining the energy expended in the circuit to do work. (Continued on Page 14)

Hear Atlanta

On Crystal We receivegrams from Atlanta, Minneapolis, Davenport, Fort Worth, Dallas, Kansas City, St. Louis, Denver on Crystal without batteries. Usual crystal set requires only easy, inexpensive changes. Send stamp for further information or \$1 for copyright drawings and instructions. Everything clearly explained. Satisfaction GUARANTEED.
Leon Lambert, 501 South Volusia, Wichita, Kan.

Federal Standard Radio Head Sets



FOR durable efficiency, clearness and wide distance-range, Federal Standard Head Sets have no superiors.

Made of specially treated steel with permanent magnets, scientific wiring and adjustment, and precision machining of metal parts, these Head Sets have achieved a well deserved universal recognition and endorsement by Radio experts.

To secure professional efficiency from your receiver insist on having Federal Standard Head Sets; Federal Standard is the product of over twenty years' experience in the manufacture of communication apparatus.

Ask your dealer for Federal Standard Head Sets. If out of stock he can get them from our nearest office. Accept no substitute.

Federal Telephone & Telegraph Company

BUFFALO, N. Y.

Western District Office: 417 South Dearborn St., CHICAGO, ILL.

STATION SCHEDULES

(Continued from page 8)
WPAU, Moorhead, Minn. Concordia College.
WPAV, Laurinburg, N. C. Thicket & Sons.
WPAW, Wilmington, Del. 50 mi. The Radio Installation Co. Daily ex Sun. 4-6:30 pm, music, code instruction. Wed. 8-10:30 pm, music. Eastern.

Reviews of Books

Home Radio—How to Make It. By A. Hyatt Verill. This book is particularly adapted for the amateur who desires to know how to make Radiophones. Twelve full page illustrations and diagrams. Price, 75c.
Getting Acquainted With Radio Receivers. By Paul Godley. Describes the necessary parts. How to put an aerial, tuning, regeneration, loud speakers, dry cell tubes, connecting the receiver, operation, faults and their remedies. Price, 25c.

Largest Radio Store in America BUY HERE FOR LESS Largest Radio Store in America

Radio Supplies purchased here are sold under a positive guarantee of satisfaction. We carry the largest new stock of first quality merchandise.

RADIO CORPORATION OF AMERICA
WR-21 DETECTOR AND AMPLIFIER TUBES

4 VOLT FILAMENT, 7 AMPERE. FORMALLY EQUIPPED IN AERIOLA GRANDS. FITS WD-11 SOCKET, OR STANDARD SOCKET WITH ADAPTOR.
WR-21 DETECTOR.....\$3.95
WR-21 AMPLIFIER.....4.25
THESE TUBES WILL OPERATE ON 6 VOLT STORAGE BATTERY

Complete Parts for Ultra Audion Circuit (Known as the Wonder Circuit) \$11.90

FREUND'S WONDER CIRCUIT.....\$13.20

COMPLETE PARTS FOR REINARTZ SETS . . . \$11.45

COMPLETE PARTS FOR 2 STEP AMPLIFIER . . \$12.45

WD-12 TUBES.....\$6.50
The Genuine WD-11 Tube Equipped with Standard Base to Fit Standard Socket

ADAPTORS FOR WD-11 AND WR-21 TUBES.....50c

Table listing various radio components such as Moulded Variometers, Master Baldwin Type C Head Sets, etc. with prices.

Radio Corporation of America New and Improved Radiotron Tube.
UV-199 Detector and Amplifier.....\$6.50
Operates on 3 Volts (2 Dry Cells); Consumes .06 (1/16) Ampere. Same Characteristics for Sensitiveness and Loudness as UV-201.

Socket for UV-199 Tube.....75c

Complete Parts for Knocked Down Receiving Set \$17.95

COMPLETE PARTS FOR FLEWELLING CIRCUIT \$12.45

VARIABLE CONDENSERS

Table listing Variable Condensers with values and prices, e.g., \$4.30 Value, 43 Plate, now \$1.75.

PARTS FOR SINGLE TUBE REFLEX SET \$27.65
as listed in Radio Digest.....

Radiotron UV-201-A Tubes, 6 Volt Filament, .25 (1/4) Ampere..\$6.50
Formerly Sold for \$9.00
Operates on 6 Volt Storage Battery or 4 Dry Cells in Series

U.S.A. SIGNAL CORPS (Aviation Type 194-W) WESTERN ELECTRIC PHONES, \$7.95

Each Phone Cap is covered with soft rubber ear cushions, and an aviation leather helmet goes with each set! These are the only phones to pass the Government specifications for sensitiveness and loudness, the requirements called for in aircraft reception.

ORIGINAL BALDWIN PHONES

These are the Genuine Nathaniel Baldwin "Mica Diaphragm" Phones, complete with silk cord and headband. Special at \$9.95
Genuine Baldwin "Mica Diaphragm" Type "C" Loud Speaking Units. \$4.65
Special.....

3000 Ohm GUARANTEED HEADSETS, \$8.50 Value \$3.65

MAGNAVOX, LOUD SPEAKERS, Type R3 . . . \$27.45

JACKS

Table listing Jacks (150 Turns, 100 Turns, etc.) with prices.

CABINETS

Table listing Cabinets (Mahogany and Walnut) with dimensions and prices, e.g., 6x 5 3/4" by 6" deep \$1.45.

Table listing other radio components like Rhoestats, Spaghetti Tubing, etc. with prices.

Formica Panel, 1/8" thick, black or brown, square inch . . 1 1/2c

We guarantee all merchandise purchased of us
Mail orders receive immediate attention

BUY HERE FOR LESS

CHICAGO SALVAGE STOCK STORE

509 South State Street Chicago, Illinois

AERIOLA SR. STYLE TUNER UNIT
Green silk on Bakelite Tubes with diagram. \$5.65.
REINARTZ ULTRA CIR. SET PARTS, \$29.90
Ultra Reinartz Tuner Unit & Diag. \$5.95, wound to the specifications of March 24 Radio Digest.

GENUINE
WD 12 Tubes.....\$6.50
UV 199 Tubes.....\$6.50
UV 199 Sockets.....\$0.75
UV 199 Adapters.....\$1.25
Also WD 11 and 201 A Tubes in Stock.
Special Prices to Dealers on All Radio Parts.
ENGINEERING SERVICE BUREAU
832 Windsor Avenue Chicago, Ill.

Ritter Loop Aerial \$1
A knock-down aerial. All parts perfect and made to fit properly. Results guaranteed. Can be assembled in 10 minutes.
Ritter Grand \$2.50
Crystal Set
The best set for beginners or others desiring a real good set for little money. Tunes up to 600 meters; can receive up to 50 miles radius under normal conditions. Has received 100% ratings from technical depts. of many publications. Call and see the crystal set and loop aerial working.
Mail orders filled.
RITTER RADIO CORP.
230 Canal Street New York City
DEALERS WRITE FOR DETAILS

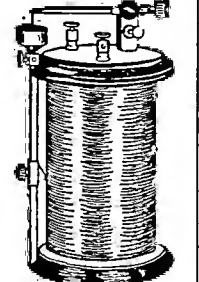
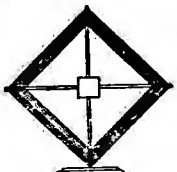

Radio Digest Illustrated

REG. U. S. PAT. OFF.

Published by the Radio Digest Publishing Company, Inc.
123 West Madison Street
Telephone State 4844-4845
Chicago, Illinois

E. C. RAYNER, Publisher
Chas. F. Smisor, Editor
Harry J. Marx, Technical Editor

Eastern Representative, Jacob Miller, 2126 Broadway, New York
Telephone Endicott 2390

Pacific Coast Representatives
E. J. Wood, 251 Kearney St., San Francisco
Telephone Kearney 1472

H. M. Morris, 417 Western Mutual Life Building, Los Angeles
Telephone 12011

58 PUBLISHED WEEKLY

SUBSCRIPTION RATES
Yearly.....\$5.00 Foreign.....\$6.00
Single Copies, 10 Cents

Vol. V Chicago, Saturday, May 5, 1923 No. 4

Two Circuit Sets Best

When Making a Set Make a Good One

IT IS just as easy for the amateur, working from a diagram if necessary, to build a two-circuit set and be assured when he finishes the job that he has something that will give him long distant reception. Let us stick to the hook-ups that get the most of Radio impulses to the receiver rather than urging or even suggesting something that is far inferior in performance under slightly unfavorable conditions.

Hook-ups, diagrammatically, at least, are the cheapest part of the set and the parts required for a two-circuit hook-up are little more than that for a single-circuit set, all things considered.

It is quite necessary to guard against capacity effect in the single circuit, much more than in the two-circuit set, therefore the former is much harder to handle, and there is more internal and external capacity effects that are going to interfere and selectivity is not, it is generally conceded, as easily obtained as with the two-circuit set.

There is rarely a week free from complaint from single circuit users about interference. The logical means to an end is to build a two-circuit set or if you have a single circuit change to a two-circuit.

World's News by Air

Great Demand for Information Is Now Supplied

DEMAND for information is being satisfied by Radio. That this demand is greater than it has ever been in the history of mankind is attested to by librarians, who point to the large number of scientific works being read today. It is part of the great progress made in scientific development in the last quarter century.

Radio has not been in the least progressive in this development. In fact, with the development of Radio, all other sciences are being aided. For Radio is being used as a means by which knowledge of the other sciences is being spread.

Tune in on any broadcasting station and you will just as likely hear a lecture on the fundamental principles of the Einstein theory as you will on the latest developments in the cure of cancer. Universities throughout the United States have enrolled their faculties toward the dissemination of information under their auspices. Regular courses in certain subjects are being broadcast, and more are being planned.

Concerts are giving Radio listeners a wider knowledge and greater appreciation of music. Plays, classic and modern, also help advance the education of the public by Radio. Health lectures are regular events for Radiophans. So are lectures on child care, and on various other topics now and then are broadcasted.

Growth of the Industry

Almost Three Million Fans Now Have Sets

OLD established manufacturers of Radio apparatus of a year ago were wondering how they would dispose of their stock. Many dealers were just making a bare living at selling Radio apparatus. Just about three hundred thousand Radio amateurs scattered throughout the United States constituted the field for sales of Radio goods and apparatus.

Since then a great change has taken place. Old apparatus, instruments manufactured under patents fifteen years old, ordinary double slide coil crystal sets were becoming immediately popular. Now there are more than six hundred incorporated manufacturers of Radio apparatus in the United States. It is impossible to estimate the number of dealers. There are almost three million fans who have bought and installed Radio receiving sets.

These sets receive music and other broadcast matter from some five hundred or more broadcasting stations located in every state in the Union. Every state but one has one or more stations, and some have as many as twenty.

With the establishment of more solid Radio regulations, with the advent of fair competition and intelligent manufacture of Radio apparatus of good design Radio will still grow.

RADIO INDI-GEST

Here we are in our new home! How do you like us over in the center column? That is what we want to know. Do you Radioknuts want a whole column of Indigest or do you like it better as we were? It will all depend on your say so whether or not we stay here or move back to the right hand column under Al Brown. Personally we like it better here but we leave it up to you, so write in and tell us what you think of it.—Indi.

INDIGEST SCOOPS WORLD ON STEBBINS' DEGENERATIVE SET

BULLETIN

Squedunk, Minn.—In an interview with Indigest Stebbins says, "Gee darn, if it ain't the dad blamest shame the way most inventors hold onto they circuits. I intend to give the Sooper Degenerative to everybuddy that's got the nerve to use it."

By Slatherty Simpson

Armstrong, Logwood and Flewelling—and now comes Stebbins. The Radio Indigest has scooped the Radio world on one of the most deficient sets ever invented. It is with pride that we announce the series of articles "written exclusive for INDIGEST" by Lem Stebbins, inventor, postmaster, and constable, of Squedunk, Minn., on his latest circuit "The Stebbins Souper Degenerative Set." Article I begins next issue with Mr. Stebbins' exclusive drawing of the set in INDIGEST. Watch for it!

A Radio Shock

One night, as the storm beat and blustered,
I sat at my Radio set,
And listened to lectures and concerts and talks,
By guys I never had met.

I had just heard a concert that came
From Los Angeles over the wire;
It was followed a few moments after,
By a clergyman preaching "Hell Fire."

I followed as closely as may be,
But my senses would lag and shirk,
And I drowsed as the clergyman ended,
And then came to with a jerk.

He had preached on sinners and sinning,
And I felt like a blooming toff;
But he ended his lecture and then inquired,
"How do you shut the d—n thing off?"
—J. FOSTER MOORE.

QUESTIONS and ANSWERS

Q. & A. Department, Indigest—Dear Sir: Can you tell me whether I can buy, and who makes, the super-ultra panel stretcher? I have a 7x18 panel that I would like to stretch to a 10x20. Thank you horribly.—Lillian G.

A.—It is against the policy of Indigest to advertise any Radioknut apparatus. Sorry. However you might try to borrow one from Al Brown he has one that he stretches his cartoons with.

Q. & A. Department, Indigest, Dear Sir: Will you kindly tell me what are the present circulation figures of your esteemed paper. Thanks for the answer.—Jimsie.

A.—At present we are the leading paper in the field and are now running 000,000,000,07 more copies than our nearest competitor, the radio digest.

READERS' VIEWS

We Shall Ask Arthur—We Shall

Indi: Hah, Hah! Shhh! Not so loud. In looking over Mr. Mohaupt's article last issue of radio digest (April 28), page 11, I noted the title "Storage Batteries and Their Care," and then.....whatcha think? In the first column I note a cut of a glass arrangement with a rubber nipple attached. Ha, Hah! Very clever of that fellow Mohaupt. Yes, yes. Is he married?
—WOR Listener In.

EDITORIALS

The music publishers of a certain society demand pay for their copyrighted material. Is this a mercenary motive or fair?—We think so too.

INDIGEST has taken its stand and we feel that we are founded on the sound principles of *Being Right*. WE WILL NOT publish any copyrighted music of the authors, composers and music pub. assn. in our unfilched column, as we are founded on non-money-making principles and do not believe in grasping extortion (unless the assn. should wish at any time to pay us for doing the same). Until such time we ask that the Radioknuts, and all INDIGEST followers, stand by us in our just and honest views and refrain from whistling any and all songs published by the assn. Their latest number is "My Mammy Was Born in Ireland and Lives in Dixie Land—So That's Why I'm the Sheik of Schenectady." DON'T sing or whistle it!!!!

INDIGEST KINKS? SEND A DOLLAR—

THERE are many little Indigest kinks worked out in the home that would hamper your fellow Radioknut and cause him much worry. Indigest is very much interested in securing such material and is willing to accept a dollar for each kink printed. Send a stamped envelope so rejected copy may be returned. Under no circumstances will the dollar be sent back.

INDIGEST KINKS DEPARTMENT

Deer Endi—i bot a radeeo set and my muther-in law wuz allus trying to listen in, sew i hooked the hed set to her dome during a thunder storm and now the old dame aint botherin me no more. This kink will wurk providing youre luky but you stand to loose a good set by having same burnt out. Enclose pleze find my dollur.
—eZra Hecht.

Looking Ahead

Indigest has scooped the world on the Stebbin's Sooper Degenerative Circuit. It is with pride that we announce the series of articles, to begin in INDIGEST, written exclusively for INDIGEST by the inventor. Reserve your copy of INDIGEST at your favorite news-dealer—10c.



Condensed

By DIELECTRIC

One's mental condition at the time of illness really has much to do with the rapidity of recovery. That may be according to Coué; if it is, don't belittle it on that account. A young lady is doing very well in the Montreal General Hospital in spite of having suffered a broken back and this is largely due to being able to listen in to concerts and other entertaining features over the Radio.

The usual procedure of broadcasting from a college was reversed when the authorities at Haverford College, Pa., used their receiving set a short time ago to bring a lecture to the student body. Lord Robert Cecil's lecture delivered in Philadelphia was broadcast through Station WFI and it was desired to have the students take notes on it. This is likely the first time that a class has been addressed by Radio with the "prof" in another town.

A church without a pastor need not necessarily be a church without preaching. If the members will purchase a receiving set and amplifier they may utilize the services of a minister supported by others. The Belmont Methodist Episcopal Church, of Belmont, Mass., installed just these things and when their regular pastor was away they carried on the services by employing the aid of Radio. Instead of closing a weak church it might be made to thrive by this means.

When Station WEAJ sent out the songs of the college glee club contesting at Caruegie Hall, New York, we were asked to pass upon the merits of each and pick the winner. The singing by each of these clubs displayed careful training and excellent ensemble. Dartmouth received the first prize, Princeton second and Yale third. I'm glad the decision did not rest with me, because I was lost in the beauty of their combined voices.

Radio is fast becoming an economic asset to various fields of endeavor. I shall mention only one instance at this time. Where a large force of foresters were formerly needed to patrol a certain district in the neighborhood of Spokaue that work is accomplished by one airplane. Patrolling these one million acres of timberland requires but two and one-half hours daily, whereas the former system required constant attention. The secret of it lies in the fact of the plane being equipped with Radio. You see Radio is an economizer, whether so used or in place of six seats at a concert hall.

Radio is one of the best publicity agencies available. The use for this purpose is coming to be more extensively recognized both in this country and in Canada. There it is being used by the Calgary Board of Trade to reach probable tourists from every State in the Union and every province in Canada. Calgary and its environs will be extolled as exceedingly attractive points to visit with Radio broadcasting as the medium setting forth this information. CHCG is being used for this purpose and since it has been heard all over the United States the Canadians are expecting notable results.

This is for the pessimist who views Radiophony as a plaything and of but passing interest. When blizzards and cyclones destroyed means of communicating with adjacent territory by putting the telephone and telegraph lines out of commission, what was done? Why they waited until those lines were repaired. During the recent blizzard in the Middle West, which wrought havoc with the telegraph lines, what was done? Well, KYW got busy with their RADIO transmitting station and relayed whatever news was of importance to receiving sets tuned to their station. Without Radio this could not have been done, but with it the storm's damage was mitigated.

Simple Arrangement Adds Step of R.F.

Radio Frequency Permits Loop Aerial to Be Used

It is a very simple matter to add a step of Radio Frequency amplification using the system shown by the accompanying diagram. The simplicity of the arrange-

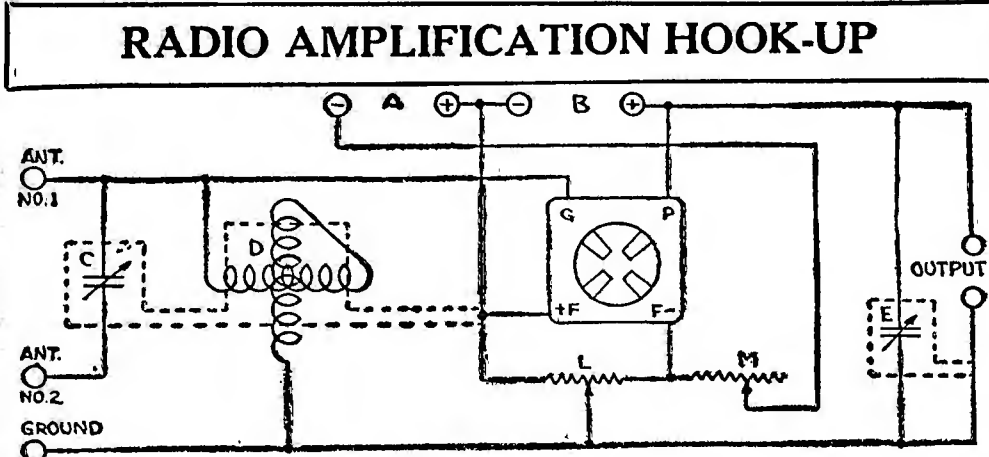

Line Switch on Battery Saves Charge and Tubes

Practically all filament rheostats are constructed with a zero point or "off" position which serves the purpose of a switch between the vacuum tube and the storage or A battery. However, it often happens that in the hurry of cutting off for the night, the rheostats are not turned completely off. Under these circumstances, the filament battery is left connected in the circuit discharging all night long through the resistance.

To prevent this, it is advisable to connect a separate battery line switch, which through practice and force of habit, should be opened first before the filament rheostats are turned back to zero. Then, if the latter operation is not performed, the battery circuit will be opened anyway by means of the line switch.—P. J. M. Clute, Schenectady, N. Y.

WORKSHOP KINKS? EARN A DOLLAR—

THERE are many little kinks worked out at home that would aid your fellow Radio worker if he only knew about them. There are new hook-ups, new ways of making parts and various unique ways of operating sets that are discovered every day. Radio Digest is very much interested in securing such material. Send them in with full details, including stamped envelope so rejected copy may be returned. The work must be entirely original, not copied.

RADIO KINKS DEPARTMENT,
Radio Digest
123 West Madison St., Chicago, Ill.

ment is exceeded only by its efficiency and very few parts are needed to construct the amplifier.

The antenna connection is arranged so that either a loop or outdoor antenna may be used. For a loop, shunt the antenna binding post marked No. 2 to the ground post and connect any standard loop without condenser.

For an outdoor antenna, use the antenna binding post marked No. 1 so that the condenser in the set will not be connected. The other details of the set are standard parts, variometer, tube and socket with proper batteries according to the tube, a 3-plate and a 23-plate variable condenser, a 200 to 400-ohm potentiometer and a filament rheostat.

With this outfit it is unnecessary to have direct connection between the Radio

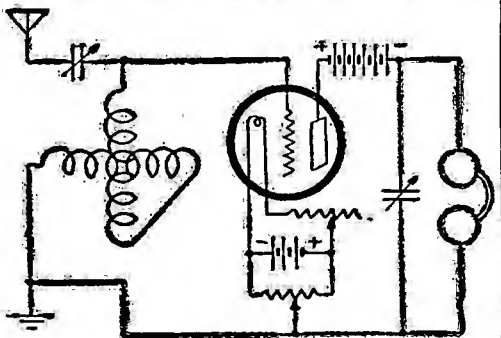

frequency amplifier and the primary circuit of the tuning unit. Instead, if found to be too harsh for local stations, attach the ends of a coil of about 25 turns of an oatmeal box with a No. 25 wire to the output of the Radio frequency amplifier unit and place the coil near the tuning unit, about 3 or 4 inches from the primary coil.—L. W. Martin, Houston, Texas.

Moving Coil Speaker

The best-known loud speaker is composed of a metallic horn connected to what is actually a telephone receiver of large size. The permanent magnet is energized by an external source of current, and the diaphragm is actuated by a coil of wire suspended between the pole pieces of the electromagnet. The actuating current passes through the suspended coil.



**KELLOGG
RADIO FOR
BETTER
RESULTS**

**KELLOGG SWITCHBOARD
& SUPPLY COMPANY**
Chicago

Shape for Resistance Spring

When laying out the phosphor bronze contact piece for the Flewelling variable leak care should be taken to have this piece of the proper shape. This is to make the change of resistance gradual.

It is quite evident to students of mechanics that a beam supported at one end

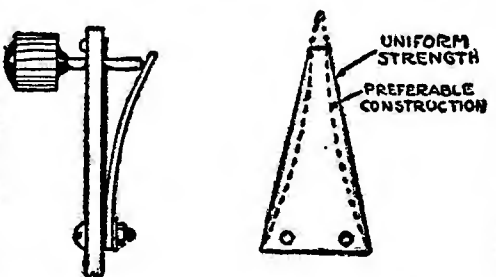

and of uniform thickness should have the shape of a triangle, if the stress is to be uniform. Furthermore, it is best to go one step further and make the contact piece so that the end nearest the adjusting screw will be raised from contact with the resistance unit before the supporting end is raised.—Carl Schindler, West Allis, Wis.

Variable Grid Leak

Many Radiophans have old rheostats lying around whose resistance wire is either loose or broken. It is possible to make a variable grid leak out of one of these.

Pry out the fiber ring on which the wire is wound and remove the wire. Then replace the fiber ring and glue it back into place.

Next take a very fine file and make the surface of the fiber, where the contact lever touches, very smooth. Mark this surface all the way around with a pencil. Connect one end of this marking to a binding post. It will then be seen that resistance can be varied by just turning the knob located on the other side of the panel.

RUSONITE CRYSTAL RECTIFIER

MULTIPOINT (Patent Pending)
A Synthetic CRYSTAL DETECTOR sensitive over its entire surface. Eliminates all detector troubles. Extraordinary clearness and volume. Endorsed by Radio experts and press. Sold in Sealed Packages only. Join the ever increasing Rusonite fans.

Price mounted, Sensitivity guaranteed..... 50c
RUSONITE CATWHISKER
14 Karat Gold Multiple Contact Super Sensitive..... 25c
Order from your dealer or direct from us,
RUSONITE PRODUCTS CORP.
19 Park Row, N. Y.

NEW CONSTRUCTION of all FRESHMAN Variable Resistance Leaks

guarantees long life and permanent resistance—no pencil markings—assures an unbroken range of 180 degrees. Eliminates hissing. Clarifies signals.

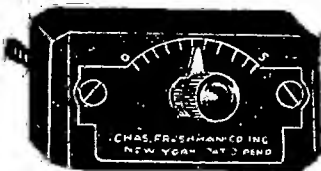

A New Leak for PANEL MOUNTING

Mounted on any panel in a few seconds—2 mounting screws serving as connections behind the panel.

Complete with either .00025 or .0005 mfd. Micon Condenser

\$1.00

Without Condenser 75c

A necessary essential for every tube receiving set

At your dealer's—otherwise send purchase price and you will be supplied postpaid. Also ask your dealer for a free diagram of the Kaufman and Flewelling circuits.

Chas. Freshman Co. Inc.
Radio Condenser Products
106 Seventh Avenue New York City

Delicate Soldering

Both the manufacturers' and amateurs' problems on all fine work are readily solved by the instrument constructed for this particular purpose.

THE POST SOLDERING IRON

Platinum Heating Unit—Interchangeable Tips—Universal Current

(Large and Small)

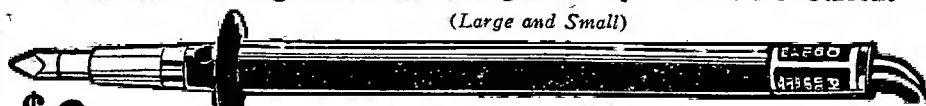

\$6

ONE-HALF ACTUAL SIZE

Awarded Certificate of Excellency, N. Y. Evening Mail Radio Institute
From your Dealer, or write

POST ELECTRIC COMPANY (Dept. 509), 30 E. 42nd St., New York

Most for the Money in Radio

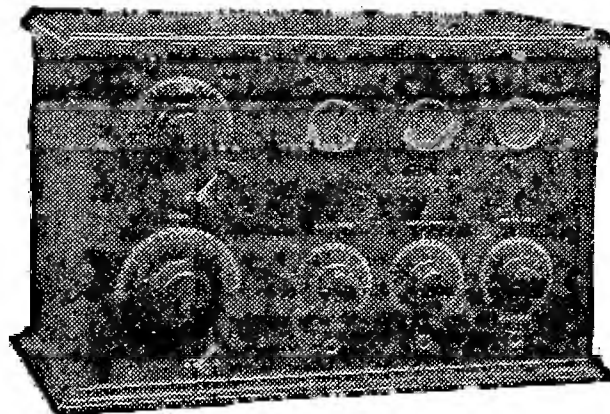

"SENIOR" SET

When you buy a Michigan "Senior" Regenerative Receiver for \$125.00 or a "Junior" Receiver for \$57.50, you get the clearest, most satisfactory long distance service that an equal investment ever brought.

These sets are licensed under Armstrong U.S. Pat. 1,113,149 and pending Letters Pat. No. 807,388. This means that they represent the highest achievement in Radio Engineering.

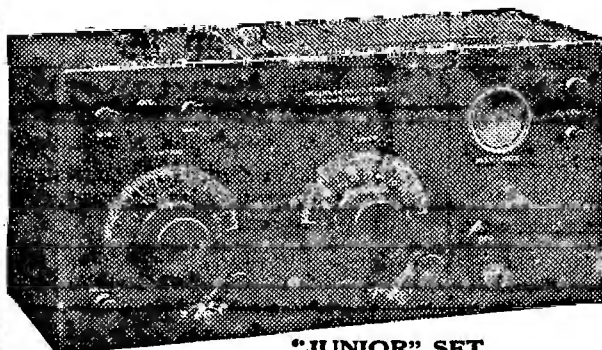

"JUNIOR" SET

Factory Branch: 9 South Clinton Street, Chicago, Illinois
H. O. Rugh, Radio Engineer, in charge

Send for Illustrated Circular

MICHIGAN RADIO CORPORATION
GRAND RAPIDS, MICHIGAN

ADVANCE PROGRAMS

(Continued from page 6)

WGI (Eastern, 360), 5:00 P. M., "Twilight Tales," Uncle David; 5:15 P. M., "General Conditions in the Shoe and Leather Industry," New England Shoe and Leather Ass'n; 9:30 P. M., "Romance of the Shoe," Harry M. Wood; Concert, Crescent Gardens Orchestra.

Friday, May 4

KFI (Pacific, 400), 6:45-7:30 P. M., Peter Rabbit; Concert, Junior Music Clubs of Southern Calif.; 10:00-11:00 P. M., Program, Public School Music Teachers Ass'n; Male chorus, 100 voices, Orpheus Club; Dominant Club; California Federation of Music Clubs.

STOP THAT NOISE! SAVES YOUR TUBES. AMPERITE FILAMENT CURRENT ADJUSTER. AUTOMATIC EXFELS ALL TUBE TROUBLES. RADIALL COMPANY 99 WARREN STREET NEW YORK. \$1.00

will bring you immediately our 32-page booklet containing complete diagrams and descriptions of Flewelling, Reinartz, Super-Regenerative and other circuits. Our complete line of standard equipment is also illustrated and described—an up-to-date catalog of the newest in Radio at right prices. FREMONT RADIO SALES CO. 227-229 Fulton St. NEW YORK CITY

The Bishop Brothers, B. A. Sullivan; A Vocal Melange; Civil Engineering Quartet; "Sunkist Rose," "Your Kisses," Instrumental Club; "The Road to the Isles," "The Old Road," Glee Club; "The Kerry Dances," "The Spring Has Come," David M. Brockway; "Mah Lindy Lou," "Exhortation," "Alma Mater," Glee Club.

Saturday, May 5

WIP (Eastern, 400), 2:00-3:00 P. M., Song Recital; 6:00-6:30 P. M., Dance music; 7:00-7:30 P. M., Uncle Wip's Bedtime Stories.

Saturday, May 5

CFCN (Mountain, 440), 10:30-12:00 P. M., Dance selections, Imperial Dance Orchestra; Plaza Cabaret; Los Angeles County Dental Sy.; Concert, Junior Music Clubs of Southern Calif.; 8:00-9:00 P. M., Program, University of Southern Calif.; 10:00-11:00 P. M., Vocal selections, Packard Radio Club, Harry Coe, Ben McLaughlin, Leonard Van Berg.

ADJUSTABLE COIL MOUNTINGS FOR FLEWELLING CIRCUIT. Triple Coil Mounting.....\$5.00 List Double Coil Mountings..... 3.50 List. A patented feature locks the coil in place and prevents the coil from being thrown out of adjustment once station is tuned in. Dealers write for special discounts. ASTORLOID MFG. CO., 416 Marcy Ave., Brooklyn, N. Y.

How to build the Reinartz Receiver. is told, complete with illustrations and diagrams, in the latest addition to the "Chi-Rad" Handbook-Catalog. Our Handbook also includes: 1. Technical discussions of standard radio apparatus and equipment. 2. Radio definitions, wireless codes, wire tables, definitions, etc. Pin this ad to your letter and mail it together with a dime for your copy of the Handbook. Send for it, today! CHICAGO RADIO APPARATUS CO. 415 South Dearborn Street, Chicago. R. D.

Kentucky Sextette Orchestra, Arthur Jackson, director and drums; "Just Among Home Folks," Courier-Journal; 7:30-9:00 P. M., Concert, Apollo Concert Orchestra, Bruno Welner, violin and director; Luigi Resta, trombonist; Miss Balough, accompanist; George A. Resta, clarinetist; Katherine Lucile, pianist; Reading, "An Interesting Historical Episode."

Sunday, May 6

KFI (Pacific, 400), 10:00-11:00 A. M., Church service for all denominations, Church Federation; 4:00-5:00 P. M., Musical vesper service, Natl. Federation of Music Clubs; Industrial chorus, Antonette R. Sabel, director; 8:00-10:00 P. M., Concert, Packard Girls' Concert Club; 10:00-11:00 P. M., Concert, Bennett's Packard Six Orchestra.

Coast to Coast on One Tube ULTRA-AUDION \$12.75. Operates loud speaker on closer stations. All standard parts mounted on 7"x14" Bakelite Panel, string-wired, complete, ready for wiring. SEYFERLICH'S REAL RADIO 68 West Washington St. Chicago, Ill.

BARGAINS IN RADIO PROMPT SERVICE. \$6.50—1 1/2 volt dry cell tube..... \$2.00 \$5.00—6 volt tube detector..... 2.00 \$6.50—6 volt tube amplifier.... 2.00 180 Bakelite coupler, reg. \$5.00.....\$2.25 3 plate vernier condenser..... .40 13 plate precision condenser..... .85 23 plate precision condenser..... 1.10 43 plate precision condenser..... 1.55 Kardon Audio Transformer, reg. \$5. 2.95 .00025 condenser Var. Leak..... .38 Variable Leak only (Airex)..... .25 Freshman Var. Leak & Condenser..... .75 Freshman Variable Leak only..... .60 Long range radio headset, reg. \$10. 4.75 Potentiometer..... .95 7x10 Hard Rubber Panels..... .75 .006 Flewelling condensers..... .38 W. D. 11 Bakelite sockets..... .35 Electric soldering Iron..... 5.00 Complete list sent on request. ECONOMY RADIO COMPANY 132 Nassau St. New York, N. Y.

Cockaday Circuit Complete Parts— Regular Value, \$26.00..... \$14.50 Dx-Flex Circuit Complete Parts— Regular Value, \$28.00..... \$17.00 Reinartz coils.....\$1.75 Coils for Greene circuit..... .35 DX Couplers..... 1.65 43 Plate Vernier..... 3.75 23 Plate Vernier..... 3.25 \$6.00 Diamond Head Set, 2000 ohm..... 3.00 Mail Orders Promptly Filled WILLIAMSBURG RADIO SUPPLY CO., INC. Manufacturers and Jobbers of RADIO SUPPLIES 801 Flushing Avenue, Brooklyn, N. Y.

"Danse Arabe," from the "Nutteracker Suite," WGY Orchestra; "A Year Ago," "In the Silent Night," "William A. Fay," "Minuet," from the "Military Symphony," WGY Orchestra; 7:30 P. M., Church services, First Presbyterian Church, Albany, N. Y. Prelude, "Spring Song," Harold W. Thompson; Antiphon, "Bless the Lord, O My Soul," Hymn, "O God, Our Help in Ages Past"; Prayer; Anthem, "Jerusalem, O Turn Thee to the Lord," Quartet; Offertory, "Indian Melody," "Watchman, What is the Night?"; Hymn, "Fling Out the Banner, Let it Float"; Scripture; Sermon, "This Hopeful World," Robert E. Speer, L.L.D., Secretary of Board of Foreign Missions and President of the Federal Council of Churches of Christ in America; Prayer; Hymn, "Christ for the World We Sing"; Benediction; Postlude, "March of the Priest," Harold W. Thompson.

REINARTZ ALL PARTS NECESSARY DEALERS: ATTRACTIVE DISCOUNTS HUDSON-ROSS 123 W. Madison St. Chicago

LOUD SPEAKER FREE. The wonderful SHELSTONE LOUD SPEAKER with every original NATH. 8 1/2" High—Beautiful Rubberized Finish BALDWIN Type C Headset Complete I PERSONALLY test every pair of phones to GIVE YOU a headset that has no equal. YOU CAN USE HEADSET IN REGULAR WAY ALSO. My price on these special selected \$12.00. Phones is, postpaid..... \$12.00 Cash with Order or C. O. D. WALTER SCOTT, 10 St. Lukes Place, Montclair, N. J.

How to Make a Reinartz Receiver. Complete BLUE PRINTS for the construction of a Reinartz Receiving Unit and two step amplifier. INSTRUCTIONS FOR ASSEMBLY Description of apparatus and accessories and details of tuning. WINDING A REINARTZ COIL Cabinet Dimensions Panel Layouts List of Parts Send only money orders—no checks or stamps. Coins at your own risk. Book Department Radio Digest 123 West Madison Street CHICAGO, ILL.

Only 50¢. WILLIAMSBURG RADIO SUPPLY CO., INC. 801 Flushing Avenue, Brooklyn, N. Y.

Making a Three Tube Reflex De Luxe Receiver

Part I—Panel Layout and Hook-Up

By H. J. Marx

AFTER three months of research work and experimentation, there is a considerable degree of satisfaction in presenting a circuit that accomplishes a little more than what has been done before. Experience teaches us that rarely can we get that all-around combination of advantages continually sought, but seldom attained. Some circuits have the advantage of their good distance reception; others have volume; then again others have the disadvantage of requiring too many tubes; or, again, tuning may be complicated and difficult.

In working on this circuit, it has been the aim of the author to eliminate un-

PARTS REQUIRED

- VT—3 Hard vacuum tubes and sockets
- VC—Variocoupler
- CS—2 Contact switches
- RT—2 Radio frequency transformers, reflex type
- AT—2 Audio frequency transformers
- AT—2—1 Audio frequency transformer, high voltage type
- P—1 Potentiometer, 400 ohms
- J—1—2 Double circuit jacks
- J—2—1 Open circuit jack
- J—3—Jack type battery switch
- R—1—1 Rheostat, 6 ohms
- R—2—1 Power rheostat, 6 ohms
- R—3—1 Grid leak, variable
- C—1—Variable condenser, .0005 mfd.
- C—2—Variable condenser, .0005 mfd., vernier
- C—3—4 Fixed condensers, .002 mfd.
- C—4—1 Fixed condenser, .0015 mfd.
- C—5—2 Fixed condensers, .006 mfd.
- CD—Crystal detector

Eight binding posts
 One panel, 9x12 1/2 x 3/8 inches
 One sub panel, 5 1/2 x 11 1/2 x 3/8 inches
 One cabinet, 7 inches inside depth
 25 Ft. tinned bus bar wire
 20 Ft. spaghetti tubing

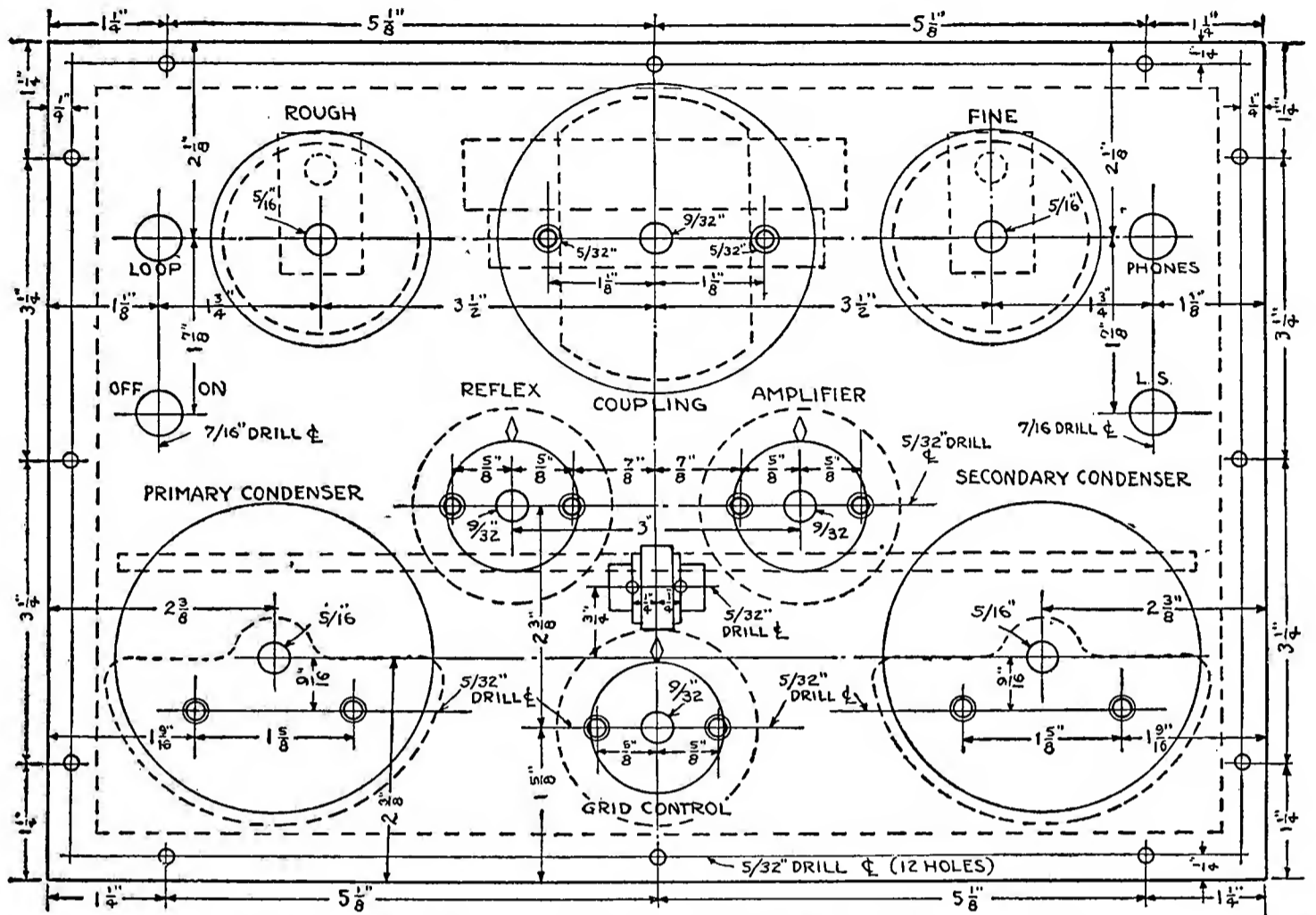

necessary controls, reduce so far as possible not only the quantity of apparatus but also the number of necessary adjustments. After the circuit development was completed, then arose the problem of compact assembly on the panel and in the cabinet. This required time and patience, but was worth the effort.

Not Low-Priced Outfit

The Reflex De Luxe cannot be considered a low-priced outfit, but its cost is low when its possibilities are considered. The

no hesitation in the use of this circuit with either type of receiving antenna. The antenna and ground connections can be made direct to the binding posts, whereas the loop can be plugged in on a jack, automatically cutting out the variocoupler tuning unit. In addition, if the two contact switches are turned so the lever on each one rests on contact 15, the circuit can be operated as a single cir-

switches to 15, a different arrangement is provided.

Circuit Inverse Reflex

The circuit used in this set is not only reflex, but also utilizes the inverse ar-

angement which both Priest and Grimes found to show great possibilities for development. Various changes have been made after trial in an effort to incor-

(Continued on Page 14)

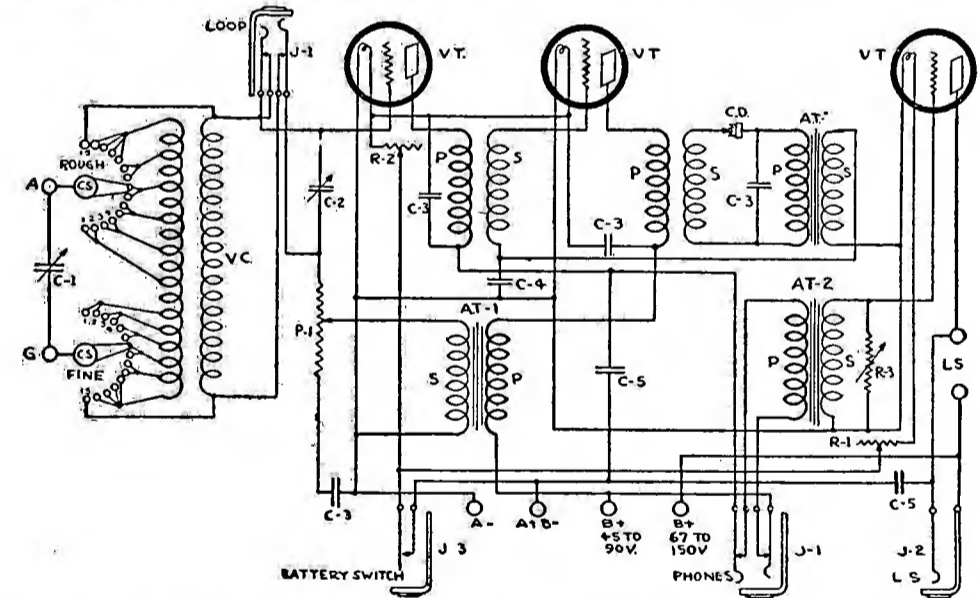

volume with three tubes has been sufficient to make the diaphragms of the best of loud speakers chatter, and one of the chief difficulties was in getting sufficient control over its volume without loss of the good quality of the reception. The circuit has been arranged for use with both outdoor and loop aeriels. Experimental work has been conducted entirely with the use of a loop aerial.

Inasmuch as an outdoor antenna is unquestionably more efficient, there need be

cuit tuner, using the primary and secondary condensers for tuning controls, or by switching just one of the contact

FREE VACUUM TUBE RADIO SET

The Set you always Wanted, FREE

A real RADIO SET—Listen in on Concerts, Lectures, Singing, etc. Can receive 75 to 100 miles and more.

RUSH your name and address and we will tell you HOW you can get a VACUUM TUBE RADIO SET

ABSOLUTELY FREE

Don't delay. Write today for FREE RADIO PLAN.

Home Supply Co.
 Dept. 457
 131 Duane St., New York

CARTER RESISTANCE UNIT

By placing this Resistance Unit in the Rheostat circuit, regular 6 ohm Rheostats will properly operate the new No. 201-A and No. 199 Tubes.

Each Code No. 15-A, 15 ohm, for No. 201-A Tube, .50c
 Code No. 25-A, 25 ohm, for No. 199 Tube, .50c

Write for bulletins on this and other Carter products

CARTER RADIO COMPANY
 209 South State Street, Chicago

Spirola BETTER LOUD SPEAKERS \$3.85

TRUE CABINET TYPE, like the finest modern phonographs, with all their beauty and perfect tone. Makes your two-step set a real ENTERTAINER for family and friends. SPIROLA DUPLEX uses any headset. SPIROLA SIMPLEX uses Baldwin or other unit. Either type, black with nickel fittings, \$3.85; mahogany finish with bronzed throat, \$4.85.

At dealers or postpaid (C. O. D. if preferred). Absolutely guaranteed.

L. H. DONNELL MFG. COMPANY, Dept. D, Box 70, ANN ARBOR, MICH.

—WILLARD—

WILLARD RADIO COMPANY
 Dept. R. D., 291 Broadway,
 New York City

"The Best for Less"

FLEWELLING CIRCUIT

EVERY PART COMPLETE

2 honeycomb coils, 1 2-coil mounting, 2 coil plugs, 3 .006 condensers, 1 variable grid leak, 1 grid leak, 1 23-plate .0005 MFD. variable condenser, 1 vernier rheostat, 1 tube socket, 8 binding posts, 20 feet bus bar wire, 1 high-grade panel ALREADY DRILLED AS PER DIAGRAM, 1 3" dial and the Radio Digest Booklet on Operation and Construction of Circuit

\$11.00

Two-Stage Radio Frequency Amplifier—Parts complete in every detail for this Circuit—\$11.00.

CONDENSERS	
3 Plate Variable; value, \$1.75.....	\$1.05
13 Plate Variable; value, \$2.50.....	1.20
23 Plate Variable; value, \$3.50.....	1.35
43 Plate Variable; value, \$4.50.....	1.85

VARIOCOUPLER—Celeron Condensite and Litz Wire Wound Secondary; Value	
Value, \$4.50; Special.....	\$2.95

AUDIO FREQUENCY TRANSFORMER	
—Designed for use with W. D. 11 Tubes, list, \$4.50; price.....	
Special.....	
\$2.75	

BALL BEARING INDUCTANCE SWITCH—
 Value, \$7.50; special..... \$0.30
 V. T. SOCKETS—Nickel, brass sleeve, composition base value, \$1.00; special at, .50
EXTRA SPECIAL—Telephone 3000 Ohms Headsets; \$9.00 value; reduced to..... \$3.50
ALUMINUM LOUD SPEAKING HORN—Nickel plated, highly polished; \$8.00 list..... \$3.75

A BEAUTIFUL "SALRITE" PENCIL FREE

SALRITE

With every order of \$12.50 or more. Made of beautiful Mahogany Rubber, about five inches long. Equipped with vest pocket clip, 10 extra leads and eraser. Will write like a charm and last a lifetime. Only a limited supply available—so rush your order now.

BEST QUALITY JACKS, Single Circuit; value, 65c; special at.....	.30
Double Circuit; value, 90c; special at.....	.45
MULTIPLE POINT INDUCTANCE SWITCH with Knob and Dial (15 switch Points)....	1.75
LIGHTNING ARRESTERS approved by underwriters.....	\$0.90
THREE-INCH DIALS—Unbreakable—heat resisting composition—high finish; special.....	\$.30
TWO-INCH DIALS—Same design—for rheostats and potentiometer; special at.....	\$.25
FILAMENT RHEOSTAT—Condensite base; value, \$1.10; special at.....	.70
FILAMENT RHEOSTAT with 2 1/2" dial; value, \$1.50; special at.....	.85
TELEPHONE PLUGS.....	.60
FRESHMAN VARIABLE RESISTANCE LEAK and MICON CONDENSER Combined	.75

REINARTZ CIRCUIT EVERY PART COMPLETE

1 Reinartz wound coil, 1 tube socket, 1 rheostat, 1 23-plate .0005 MFD. variable condenser, 1-13-plate .00025 MFD. variable condenser, 3 inductance switches, 16 switch points and nuts, 4 switch stops and nuts, 8 binding posts, 2 3" dials, 1 variable grid leak, 1 .002 MFD. phone condenser, 23 feet bus bar wire, 1 high-grade panel ALREADY DRILLED AS PER DIAGRAM and complete instructions.....

\$10.00

Two-Stage Radio Frequency Amplifier—Parts complete in every detail for this Circuit—\$11.00.

Every article advertised above is guaranteed by the manufacturer and by us—Mail orders filled immediately—transportation PREPAID on all orders of \$5.00 or over east of the Mississippi River. All others include postage.

Questions and Answers

Loose Coupler

(2429) CK, Marvel, N. D.
In a loose coupler, is the secondary and primary coil connected together in any way by wire? What is the use of the rods that the secondary coil slides on? Are they necessary? How do you tune in a station on a crystal set using a loose coupler? I live 15 miles from a sending station. Will a 75-ohm receiver be all right to use? Are the vacuum tubes known as the W-11 the tubes that are used with dry cells.

A.—Answering your inquiry, will advise that primary and secondary of loose coupler are not connected in any way.

Rods are merely used to support the secondary coil, although sometimes the wires from the secondary coil are connected to them for appearance sake. Not necessarily, however.

Tuning is accomplished by experimentation until receiving wave length of broadcasting station desired. It is largely a matter of patience and practice till accomplished.

A seventy-five ohm headset is not very efficient. Better have a three thousand ohm set if possible.

WD11 tubes are used with dry cells, as suggested.

Ultra Audion Hook-Up

(3518) IMA, New Orleans, La.
Please give me the ultra audion hook-up. I believe it is the same one certain publications are misnaming the "Gibbons"

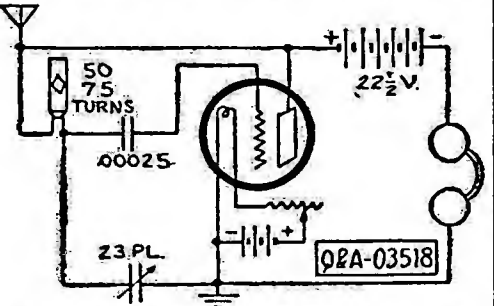

and names of other so-called inventors who do not deserve the credit.

A.—Hook-up is given herewith. Dr Lee DeForest is responsible for the discovery of the ultra audion circuit and to him all credit belongs. You are right in saying the other "inventors" do not deserve falsely claimed credit.

Night and Day Reception

(2362) NG, Philadelphia, Pa.
I am using Radio frequency amplification with various types of transformers and receiving throughout the whole day long distance fine, but as soon as night gets on a terrible static is dropping in my receivers and the noise is so great that I cannot receive any distant station except city stuff. I'm using three steps of R. F. and detector three steps of A. F. amplification. Please help me settle my problem. I'm using about 100 ft. single wire aerial 30 ft. high.

A.—Noting difficulties experienced in night reception will advise that this is contrary to theory and precedent. Reception should far excel that obtained during daytime. It is indicated that there is disturbance occasioned by electrical apparatus in your proximity. Possibly a faulty arc light adjacent to your set. It is not a static disturbance, as suggested. Your antenna construction is good.

FLEWELLING
ALL PARTS NECESSARY
DEALERS: ATTRACTIVE DISCOUNTS
HUDSON-ROSS
123 W. Madison St. Chicago

We Will Mail You One
"VERILOUD" SYNTHETIC RADIO CRYSTAL
COMPARE IT WITH WHAT YOU ARE NOW USING
IF OURS IS BETTER MAIL US, 30 CENTS NOT Return it at Our Expense!
ZOBEL-STEIN LABORATORIES
322 9th ST. BROOKLYN, N.Y. SOUTH 2650

Reinartz Hook-Up

(3571) SHL, San Bernardino, Calif.
Some few issues back you printed a photo-diagram of the Reinartz with a

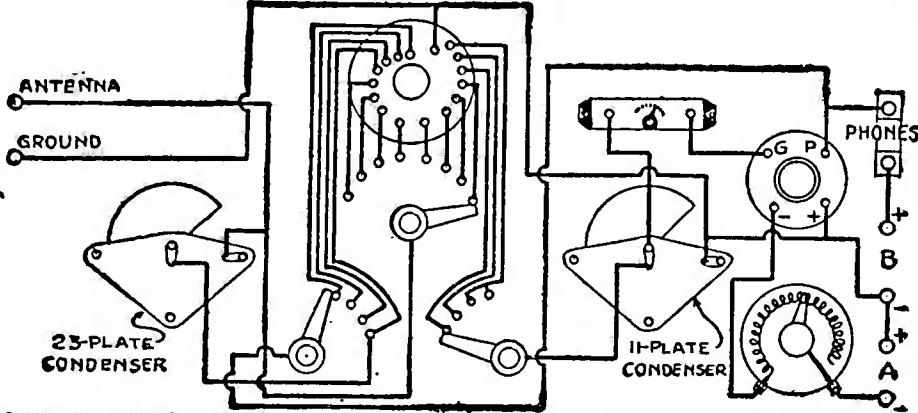

hook-up in panel layout form showing the instruments connected on a panel. Can you repeat this hook-up?

A.—The hook-up was given in the issue of January 13 and is repeated again herewith.

Choke Coils and Transformers

(2318) EAL, Plymouth, Ill.
I would like to ask a few questions regarding the Reflex circuit No. 3 of the January 27th issue. Could I get as good results by using an R. F. transformer in place of the choke coil and high resistance? What tubes would be best for this circuit. Could the W. E. 216A tubes be used? If so what plate voltage should they require? Would it be possible to light the filament and furnish the plate voltage off the 60 cycle A. C.? What is the wavelength range?

A.—In reference to the Reflex circuit would advise that Radio frequency transformer may be used effectively in place of the choke coil and high resistance.

U V 201 tubes will serve satisfactorily in this circuit. W E 216A tubes may be used with about ninety volts plate potential.

It is possible to light filament from A C supply by employment of rectifiers and transformers.

The wave length range is about one hundred and ninety to six hundred meters.

Squeals and Howls

(2867) RLB, New York City.
In your issue of January 27, on page 13 you published a hook up figure 2. I have built this set, and am writing you to see if you can give me some information as to the tuning of it. The local stations come in very fair (although not as good as a 3 bulb set that I have) and I have only been able to get WDAP Chicago for distance. I get any amount of squeals,

howls, etc. I have followed directions very carefully and checked up on them, not once but several times.

A.—The figure two diagram appearing

in the January 27th issue of Radio Digest is correct and has given splendid results. It is indicated that a discrepancy exists, possibly inefficient apparatus, since you do not experience the satisfaction afforded to others.

It is difficult to suggest the source of limitation without a personal inspection of set, but having assured you of its possibilities we trust you will not be discouraged before you locate your trouble.

Reflex without Crystal

(2940) FW, New York City, N. Y.
I have made your one tube Reflex. All local stations come in clear and loud on an indoor aerial. I can also receive these stations very faint when I disengage the cat whisker. What is the cause of this?

Can a third R. F. transformer be used in the three tube Reflex? If so where is the best position for it? These two sets were published in the December 30th, 1922 issue.

Do you sell old issues of the Radio Digest, and what is the price? What numbers contain Reflex circuits?

A.—With reference to Reflex circuit will advise that action of same when cat whisker is disengaged is due to induction between various parts and does not interfere with operation.

For addition of a third Radio frequency transformer in this circuit we are directing your attention to page thirteen of the January 27th issue of Radio Digest for

diagram showing method. January 20th issue also contains data on this.

Back numbers of Radio Digest can be secured, unless exhausted, at ten cents a copy.

Resistances

(2852) WGG, Chicago, Ill.
I desire to build the Reflex circuit as described in your January 27th issue, page 13, figure 1. Please tell me how or where to purchase the 50,000 ohm resistances as described and how to make them? I find it almost impossible to secure these resistances. I wish to use three Federal R. F. and two Atwater Kent 9 to 1 ratio A. F. transformers. Will these high resistances be of any advantage in this set? Am I using good judgment in selecting high ratio transformers? Do you consider circuit No. 3 better than No. 1?

I do not quite understand why a jack such as described in this circuit on the second A. F. is used.

A.—Resistances employed may be secured through any responsible dealer.

Would advise the use of lower ratio audio frequency transformers than the 9 to 1 cited. Three and one-half or four to one.

Personally, circuit number one is preferred.

If your reference is to jack used on second stage of audio frequency on number three, this is error. Base of jack should be connected to first prong.

SOMETHING NEW

A real loud Talking Detector made of "B" Metal, 100% superior to any crystal. Puts new life into your set. Guaranteed for one year. It's the cheapest in the long run.



50c

Sold by all live dealers, or can be ordered from the

B-Metal Refining Co.
3134 Trumbull Ave.
Detroit, Mich.

Your Choice FREE

Bound Volumes
Numbers Two, Three, or Four
Postpaid by Parcel Post with One Year's Subscription to Radio Digest

Supply Limited

Radio Digest Illustrated
Volume 2
Flewelling

Radio Digest Illustrated
Volume 3
Reinartz
Flewelling

Radio Digest Illustrated
Volume 4
Reflex Reinartz
Flewelling

65 Numbers

13 Numbers in the Bound Volume
52 Numbers in Year's Subscription

Greatest Collection of Radio Information Ever Published
Reinartz Long Distance Circuit
Ultra-Reinartz Circuit
Flewelling "Flive" Circuit
Grimes "Inverse Duplex" Circuit
Single Tube Reflex Circuit
Armstrong "Super-Heterodyne" Circuit
Two, Three and Four Tube Reflex Circuits
A. B. C. Lessons for Radio Beginners
In addition to these features these volumes contain many instructive articles, receiving set diagrams, how to make articles, new apparatus, pictures and illustrations, hook-up diagrams, broadcasting stations, technical articles and book reviews.

COUPON
PUBLISHER, RADIO DIGEST,
123 West Madison St., Chicago, Illinois.
Please reserve me Bound Volume Number Two and also Number Three and one year's subscription to the Radio Digest, for which I am enclosing check—M. O. for Seven Dollars.
Please reserve me Bound Volume Number Two or Three or Four and one year's subscription to the Radio Digest, for which I am enclosing check—M. O. for Five Dollars.
Name
Address
City..... State.....

GUARANTEED VACUUM TUBES

1 1/2 Volt Detectors	\$3.95
1 1/2 Volt Detectors and Amplifiers.....	4.95
6 Volt Detectors and Amplifiers.....	3.25

Above Tubes shipped prepaid

WE REPAIR YOUR BURNT OUT VACUUM TUBES
Quick Service

WD-11	\$3.50	UV-201-A	\$3.50
UV-200	2.75	UV-201	3.00

When sending Tubes for repair include with your remittance parcel postage for one pound. Tubes guaranteed equal to new.

Abalene Radio
416 D Broadway New York, N. Y.

DONT PASS THIS-BUY

World Radio Batteries
SAVE YOU 50%
WRITTEN 2YR GUAR

Every World User Is a Booster

WRITTEN 2 YEAR GUARANTEE

Because you deal direct with a manufacturer who is responsible for the performance and quality of the Battery.

World-Radio-Batteries

6 Volts—40 Amps.,	6 Volts—80 Amps.,
\$8.50	\$12.50
6 Volts—60 Amps.,	6 Volts—100 Amps.,
\$10.00	\$14.50
6 Volts—120 Amps.,	
\$16.00	

Full Rating Guaranteed

MAIL YOUR ORDER TODAY. WE SHIP EXPRESS C. O. D. SUBJECT TO INSPECTION. OR WILL ALLOW 5% FOR CASH WITH ORDER. ALL ORDERS SHIPPED SAME DAY AS RECEIVED.

WORLD BATTERY COMPANY,
60 E. Roosevelt Rd., Dept. L, Chicago, Ill.

Radio

Illustrated



Pity the poor working girl. However, after a hard day of labor she has the Radio to bring a small share of cheer to her tortured soul. The waving of the ether waves help her to forget her nerveracking day of spent energy. This is Mae Bush, a "hired" girl at the Goldwin studios, listening in after a day of sham love-making under the glare of a Cooper-Hewitt moon that shimmered through the waving asbestos palm trees



Hudson P. Maxim, noted American scientist and inventor, is shown in the accompanying picture before the microphone in the studio of Station WGM, the Atlanta Constitution, Atlanta, Ga. He delivered a lecture recently to the vast invisible audience of WGM's listeners in



The thing that the feminine mind cannot adapt to decorative purposes never has been created. Even Radio has succumbed to the whims of 'ye ladye ove fashyone' © K. & H.

Below is a novel crystal set that an ingenious fan constructed in the case of an old desk telephone. This set has worked very successfully on local stations where there is no QRM © Swastika

