

Price 15 cents

RADIO DESIGN

**OFFICIAL ORGAN OF THE
RADIO
INTERNATIONAL GUILD**

ROBERT HERTZBERG

**RADIO MANUFACTURERS
SUPPLY CO.**

1000 So. Broadway
New York 10271 THE FAMOUS RADIO BLDG.
In Nassau St.

The "Auto Pilot," A
Broadcast Receiver for
Your Car; How to Get the
Most Out of the Short
Waves; Television in the
Theatre

*Articles by David Grimes, Alfred
A. Ghirardi, Robert Kruse, John
Geloso, Zeh Bouck and Albert Rudick*

Volume 1
Number 2

Summer, 1930
Issue

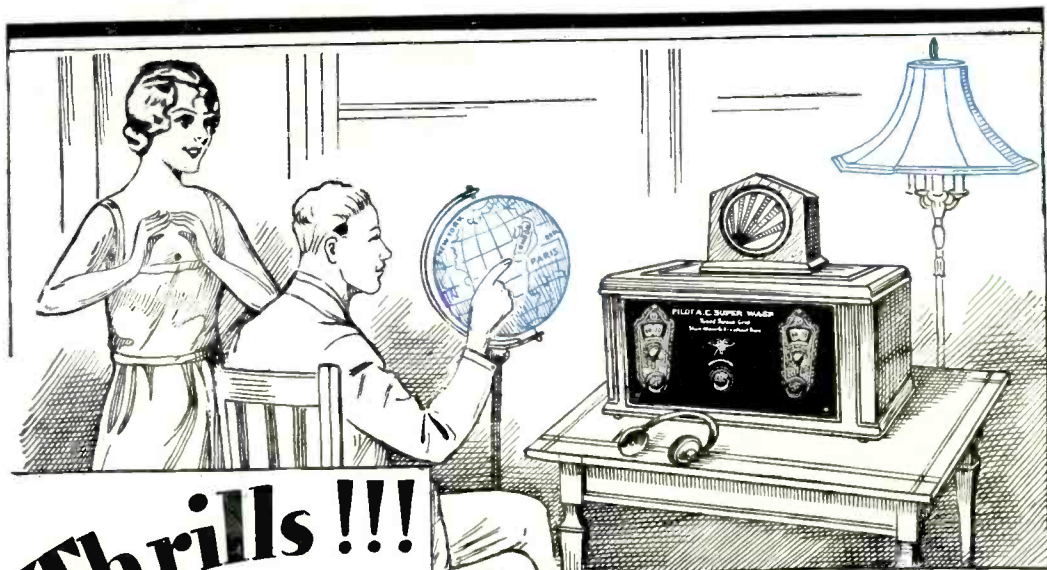

Thrills !!!

**Like You've Never Had
Since You First Heard Radio!**

"Radio?" you say.

"Same old stations—same old programs."

NOT—with a PILOT Super-Wasp!

**PILOT
super-
WASP**

The **PILOT Super-Wasp** Kit for full A.C. operation—everything necessary except power pack (Pilot K-111 is recommended) uses one Pilotron P-224 (A.C. screen-grid tube) and three Pilotron P-227's. Catalogue No. K-115—\$34.50. Power pack and tubes extra.

PILOT Super-Wasp Model for Batteries has all the features of the A.C. set except that it uses one standard type 222 screen-grid and three Pilotron P-201A tubes with a six-volt storage "A" battery and at least three 45-volt "B" batteries. Catalogue No. K-110—\$29.50. Batteries and tubes extra.



Imagine every time you listen, the pleasure of hearing announcements in German, Spanish, Dutch, French, or any other language under the sun, directly from some other foreign country, and without dependence on rebroadcasting.

The call letters you hear will as likely identify a station 6,000 miles away as one 600 miles away. That's bringing back the old DX thrills with a "kick" you never got out of your first radio, even though you did log every big station in the U. S. A.

There's a real dramatic thrill in listening in on the whole wide world with your **PILOT Super-Wasp!**

And—you can also hear programs from local stations, on their regular wavelength, as well as when these stations rebroadcast on short waves. Don't forget that the **PILOT Super-Wasp** is a *broadcast and short wave receiver combined*; wave length range 14 to 500 meters.

Pilot Radio & Tube Corp.

323 Berry Street, Brooklyn, N. Y.—Lawrence, Mass.

234 South Wells Street, Chicago, Ill.—1278 Mission Street, San Francisco, Cal.

BLUEPRINTS

ONLY 10[¢] EACH

These drawings average 24 by 30 inches, and show the sets full size. They are clear and understandable, and you will be proud to tack them to your wall.

Use the coupon below, merely checking off the blueprints you want. Postal money order or U. S. stamps accepted. Do not send coins through the mail.

**The "Auto Pilot"
BP-140**

Complete set of prints shows assembly, wiring and installation of the new receiver for your car. Described in this issue.

**Pilot "Pre-Selector"
BP-126**

The last word in broadcast receivers. Fully described in the Spring issue. Blueprint is full size and shows all details of the construction.

**A. C. Super-Wasp
BP-115**

Full-size assembly and wiring blueprint of the first A. C. short-wave receiver, described in the Fall issue.

**Screen-Grid
BP-122 (P.E.6)**

Full-size assembly and wiring of the K-122, K-123 and K-124 kits. Only a limited number available; order now.

**Battery Operated Super-Wasp
BP-110**

Several thousand of these sets, in daily use, testify to the sound design of the original Super-Wasp. Every short-wave fan should have a copy of this blueprint.

**245 Push-Pull Amplifier
BP-113**

A high-quality power amplifier using two 227's and two 245's. Suitable for radio, phonograph and public address work.

Check Here

BP-140
BP-126
BP-115
BP-122
BP-110
BP-113

RADIO DESIGN PUBLISHING CO., INC.,
103 BROADWAY, BROOKLYN, N. Y.

Enclosed find....., for which
send me blueprints checked at left.

Name.....

Address.....

RADIO DESIGN

OFFICIAL ORGAN OF THE RADIO INTERNATIONAL GUILD

ROBERT HERTZBERG, *Editor*

ALFRED A. GHIRARDI, *Associate Editor* JOHN GELOSO, *Technical Consultant*

ROBERT S. KRUSE.....*Contributing Editors*.....DAVID GRIMES

Vol. 3

No. 2

CONTENTS OF THIS ISSUE

Summer

1930

THE "AUTO PILOT," A BROADCAST RECEIVER FOR YOUR CAR. <i>By John Geloso</i>	4	ADJUSTING THE PRE-SELECTOR. <i>By Alfred A. Ghirardi</i>	36
TELEVISION IN THE THEATRE. <i>By Robert Hertzberg</i>	15	A FEW WRONGS TO BE RIGHTED. <i>By Robert S. Kruse</i>	38
GETTING THE MOST OUT OF THE SHORT WAVES. <i>By Robert Hertzberg</i>	21	HOW THE "PILOT RADIO" MADE THE FIRST BERMUDA FLIGHT. <i>By Zeh Bouck</i>	42
SHORT-WAVE STATION SCHEDULES	29	WHO INVENTED BROADCASTING? <i>By David Grimes</i>	48
SUMMER RADIO, HOW TO PREPARE FOR IT AND ENJOY IT. <i>By A. A. Dolid</i>	33	MORE NEW PILOT PARTS.....	54
		THE RADIO INTERNATIONAL GUILD <i>By Albert L. Rudick</i>	58

NOTICE

The next number of Radio Design will appear during the third week of September. It will contain more than 100 pages, and will be the biggest and best issue published so far. If your subscription runs out with the present number (the Summer one), by all means renew it immediately so you won't miss the Fall number. It will be worth reading and saving.

RADIO DESIGN MAGAZINE

Is Published By

RADIO DESIGN PUBLISHING CO., INC., 103 Broadway, Brooklyn, N. Y.

RADIO DESIGN Magazine is published quarterly, or four times during the year. The subscription price for the four issues is 50 cents for the United States and all other countries of the world. Checks and money orders should be drawn to the order of Radio Design Publishing Company, Inc.; U. S. coin as well as U. S. stamps accepted. Remittances for foreign subscriptions should be made by international postal money order. Subscriptions are always started with the current issue unless otherwise ordered. Single copies of current and back numbers, 15 cents each. The contents of this magazine may be reprinted by other publications if full credit is given. The editors will be glad to cooperate by supplying illustrations.

SUBSCRIBERS: PLEASE NOTIFY US PROMPTLY IF YOU CHANGE YOUR ADDRESS, WRITE OR PRINT YOUR NAME AND NEW ADDRESS CLEARLY.

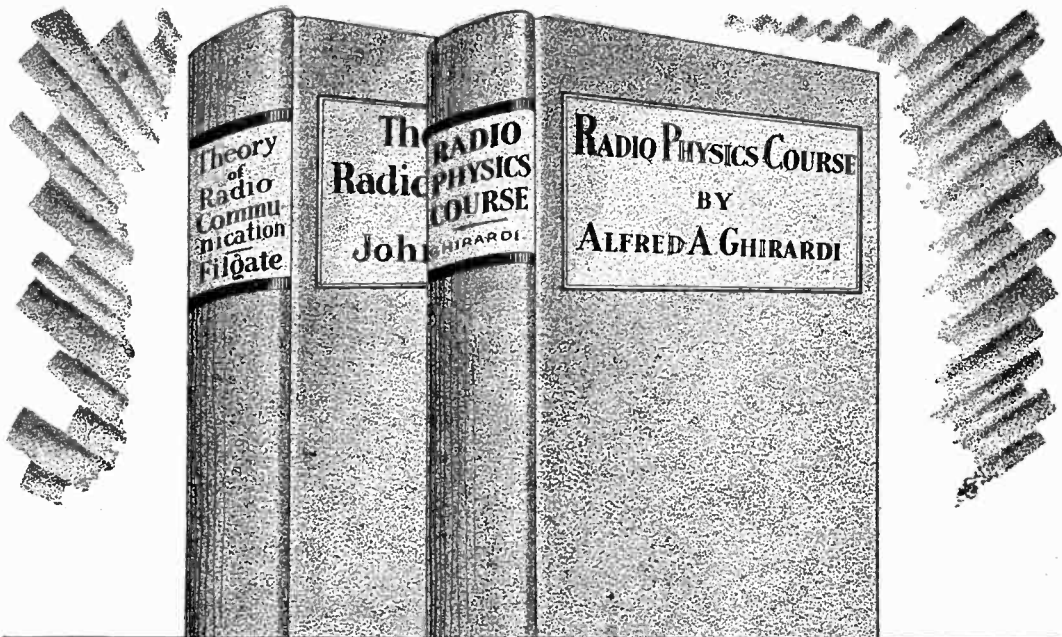

2 BOOKS

*radio fans have
been waiting for*

"Radio Physics Course"

by ALFRED A. GHIRARDI

B. S. in Electrical Engineering; Instructor in Radio and Electrical Engineering, Hebrew Technical Institute; Consulting Engineer, Pilot Radio & Tube Corp.; Associate Editor, "Radio Design"

A complete course, simple enough for the novice, yet technically correct, covering the entire range from radio fundamentals to short-waves, television and the "talkies." A valuable reference work of 362 pages with 300 illustrations. Postpaid **\$2⁵⁰** anywhere.

"Theory of Radio Communication"

by LIEUT. JOHN T. FILGATE

Formerly Instructor at U. S. Army Signal School

Published with approval of U. S. War Department, this is first public printing of the officers' radio manual used by the U. S. Army Signal Corps. A splendid technical textbook for advanced Radio Amateurs. 250 pages, 200 illustrations. Postpaid anywhere. **\$2⁰⁰**

These Books Published Exclusively by

RADIO DESIGN PUBLISHING CO., INC.

103 BROADWAY, BROOKLYN, N. Y.

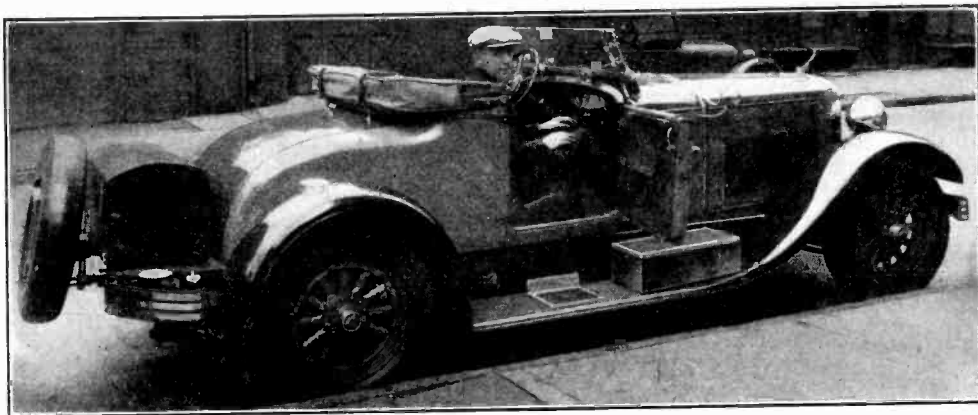

The "Auto Pilot"—a Broadcast Receiver for Your Car

A Sturdy, Full-Grown Screen-Grid Set, Remotely Controlled, That Will Increase Your Motoring Pleasure; Easily Assembled and Installed

by JOHN GELOSO

Chief Engineer, Pilot Radio & Tube Corporation

RADIO in the automobile is just as useful and enjoyable as radio in the home and greatly increases the pleasure you can obtain from your week-end jaunts in the country with your friends or family. When you stop by the roadside or drive into a clearing off the road to rest or to eat lunch, you can turn on the set and enjoy the programs amidst the beauties of nature.

Until now this added pleasure to motoring has been something of a luxury, to be enjoyed only by the more wealthy. The available sets have cost more than a hundred dollars, and in most cases their installation involves considerable carpenter and upholstery work on the car itself. To make radio available to the great mass of people who own small cars and do most of their driving on Saturdays and Sundays, the Pilot company has developed a simple, inexpensive automobile receiver that will fit all makes and models of cars and that will produce results equal to those obtained from outfits costing two and three times as much. Like all Pilot sets, the auto receiver is furnished in kit form, and may be assembled and installed easily and quickly. When

people flock around your car to admire the music that issues from the loud speaker, you will find great satisfaction in being able to say, "I made the outfit myself."

RUNNING BOARD MOUNTING

The receiver unit proper is contained in a black japanned steel case intended for mounting on the running board. It is controlled from the inside of the car by means of a thick flexible cable which terminates at a small, neat control box, on which are placed a tuning dial, a filament switch, a volume control and a pilot light. In this cable, which is six feet long, are five flexible wires for the connections of the latter three devices, and a pair of flexible metal tubes. These tubes carry lengths of flexible brass chain which transmit the motion of the dial on the control box to the shaft of the variable condenser in the receiver. The ends of the chain are merely secured to molded bakelite pulleys, one on the dial and the other on the condenser. Special fixtures to guide the chain and make it run smooth-

The photo at the top of the page shows an "Auto Pilot" installed on the right running-board of a Hudson roadster. Note that the door swings free and that the set is out of its way.

Vol. 3, No. 2, Radio Design

ly are provided. The wires and tubes are enclosed in a strong waterproof fabric sheath.

The steel case is 22 inches long, 8 inches wide and 6 $\frac{7}{8}$ inches high, and will not interfere with the opening of the doors of practically all makes of cars. It may also be mounted in the rumble seats of roadsters and coupés. The control box is molded in one piece of natural color bakelite, and is 6 $\frac{1}{4}$ inches long, 5 $\frac{3}{8}$ inches wide and 1 $\frac{1}{4}$ inches deep. The front panel, on which the controls are mounted, is of walnut-finished bakelite, and is held in place by screws in the corners. The box is fitted with a removable aluminum back plate, by means of which the whole unit may readily be screwed to the dashboard or other place in the car.

The cable leaves the receiver case through a hole in the side bearing the hinged cover. It then is passed through a hole cut in the step-plate of the car, and appears again inside the car through another hole made in the floorboard. In some cars it is not necessary to drill the floorboard, as there are already openings in it through which the cable can be "snaked." Additional wires passing through the same hole in the side of the car lead to the storage battery, the "B" batteries, and the loud speaker.

WHAT THE KIT INCLUDES

The Pilot auto kit, which has been given the number K-140, includes all the parts for the re-

The receiver installed in the carrying case. Note how the cable fits between the tubes, and how the chassis and "C" battery are protected by the sponge rubber pads. Another pad is on the variable condenser.

Important Notice

For your own safety and the safety of other drivers, we strongly recommend that you use your automobile radio receiver only when the car is stationary. With road conditions the way they usually are, you should concentrate on driving, and you should not have your attention distracted by musical programs or talks while the car is in motion. For this reason, no provisions have been made in the Pilot "Auto Radio" for the suppression of interference from the ignition system. To prevent a wave of accidents, it is likely that State legislatures will make radioing-while-you-drive illegal.

ceiver proper, the steel case, the control cable and panel and wires for an under-car aerial. A special small cone speaker, only 8 $\frac{3}{8}$ inches in diameter and 3 $\frac{3}{4}$ inches thick, catalog number 8,000, is available as a separate accessory, and is highly recommended for its sensitivity and tone quality. No "B" battery container is supplied, as each car has been found to present an individual problem in

this regard. The three 45-volt blocks required for the set may be slung under the rear floorboard of closed cars, in a wooden box that the constructor can make himself at little trouble and expense; or they may be put under the rear seat, or in the luggage carrier. In roadsters and coupés the rumble seat or baggage compartment is convenient for the purpose.

For an aerial, a length of wire is merely strung from insulators beneath the front and rear axles, under the car. This is easily and quickly installed and works perfectly.

The radio receiver proper is built on a formed and drilled aluminum chassis. It comprises three stages of tuned radio-frequency amplification, using screen-grid tubes, a screen-grid detector, one resistance-coupled audio stage and one transformer coupled output stage. Tubes of the A. C. type are used, their filaments

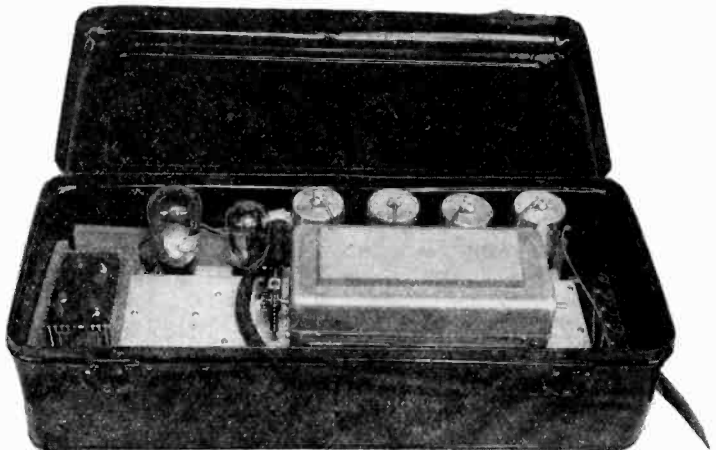



Front view of the control panel and box. The knob in the lower right corner is the volume adjustment.

being wired in series-parallel to work off the regular six-volt storage battery in the car. These tubes are much stronger than battery type tubes and are less susceptible to microphonic disturbances. Four P-224, one P-227 and one P-245 are used. The P-245, used as the audio output tube, normally requires 250 volts on the plate and about 50 on the grid, and some sort of a protective output device; however, it is operated in this set with 135 volts on the plate and $22\frac{1}{2}$ on the grid, without an output filter, and produces highly satisfactory results. It is much more convenient than a 171A in this particular receiver because its filament takes $2\frac{1}{2}$ volts and therefore can be ganged with the 224's and the 227 very nicely. The total filament drain is four amperes; the plate current about 20 milliamperes.

The sensitivity, selectivity and tone quality of this receiver leave nothing to be desired. Mechanically both it and the control apparatus are very sturdy, and will last indefinitely. The outfit has been tested very thoroughly, sample sets having been driven many thousands of miles in a number of cars representing different price classes and body types: a Ford sedan, an Oakland coupé, a Hudson roadster and a LaSalle coach. The weak points that showed up during the preliminary trials have all been eliminated, and the auto set is now presented as a finished, reliable product.

PLACING THE CONTROL PANEL

The position for the control panel should be chosen with a view toward ease of installation of the cable and convenience of operation. The instrument board usually presents itself as the first choice, because it is easily reached and worked on. Keep the panel to the extreme left, if the set is mounted on the left running board, or to the extreme right, if the right running board is employed. In the Ford sedan used as an experimental car, the control box was first mounted on the left end of the instrument board, and then tried on the left side of the car just in front of the rear seat. In this position a passenger sitting in the back could operate the set quite comfortably. This arrangement presented no real inconvenience to the driver, as the set is used only when the car is stationary anyway.

In the Oakland coupé, the panel was put on the instrument board. In the Hudson roadster, it was placed under the right end of the dashboard, as shown in an accompanying photograph, with the set on the right running board. The control cable was cut very short and the smoothness of operation increased somewhat. In the La Salle coach, the control box was screwed to the back of the driver's seat, just above a little sample compartment. The "B" batteries were dropped into the latter, out of sight.

Placing the loud speaker is also a matter to be settled by the individual car

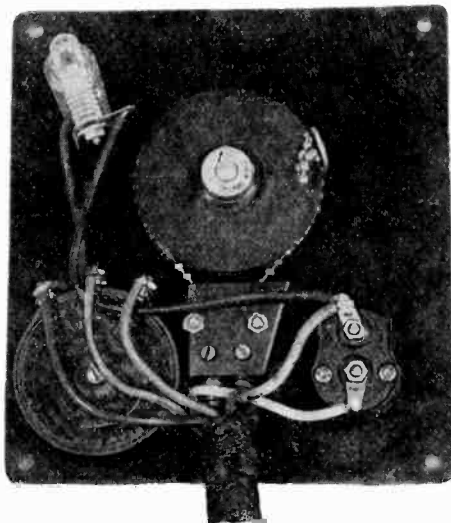

Back view of the control panel, showing the pilot light, Volumgrad, switch, pulley, chain guide and start of cable.

owner. In a closed car, a good place is just above the rear vision mirror on the windshield. The special Pilot speaker, being very flat, lends itself to this position. Another good place is near the dome light, or on the back of the front seat. In coupés and roadsters a good place is under the cowl, behind the dashboard. It is a good idea to arrange the mounting so that the speaker can be removed easily, as many times it is desirable to have it out on the running-board so that a large group of people near the car may be entertained. The Pilot No. 1106 extension cord is useful for this sort of thing.

Following is a list of the parts supplied in the Pilot auto receiver kit, and also detailed instructions for assembling, wiring, installing and operating the outfit:

LIST OF PARTS

Quantity.	Cat. No.	Description
1	598	Special Metal Chassis.
1	3084	Quadruple "Vaultype" Condenser.
5	217	Sockets.
1	216	Socket.
2	806	Condensers.
2	807	Condensers.
1	500	Resistoblock.
2	756	Grid Leaks, 2 megohms.
1	750	Grid Leaks, 100,000 ohms.
1	240	Set of coils, consisting of 3 R. F. and 1 Ant.
1	413	Transformer.
1	963	Fixed Resistance, 1,500 ohms.
4	222-S	Tube Shields.
8		Bakelite Binding Posts.
1	596	Bakelite Binding Post Strip, 1½ in. × 5 in. × ¼ in.
1	594	1½ Volt Dry Cell.
1	2503	Metal Cabinet.
1	502	Rubber Pad. 18 in. × 8 in. × ⅝ in.
3	590	Rubber Strips, 2½ in. × 6 in.
1	46	Switch.
1	941	Volumgrad.
1	1274	Dial.
1	586	Bakelite Panel.
1	584	Bakelite Box.
1	582	Flexible Cable, 6 ft. long.
1	40	Pilot Light.
1	588	Hardware package consisting of:
		2 1 in. N. P. R. II. Screws.
		2 1½ in. N. P. R. II. Screws.
		25 ⅝ in. N. P. R. II. Screws.
		12 ¼ in. N. P. R. II. Screws.
		11 B. P. Bushings.
		4 Screen-Grid Caps.
		2 Grid Leak Fuse Clips.
		40 Lugs.
		45 Hex Nuts.
		55 Lock Washers.
		2 Cond. Brackets for No. 806.
		2 Cond. Brackets for No. 807.
		18 ft. Bus Bar Wire.
		18 ft. Spaghetti Tubing.
		7 ft. Rubber Covered White Wire.
		222 ft. Rubber Covered Black.
		7 ft. Rubber Covered Red.
		7 ft. Rubber Covered Blue.

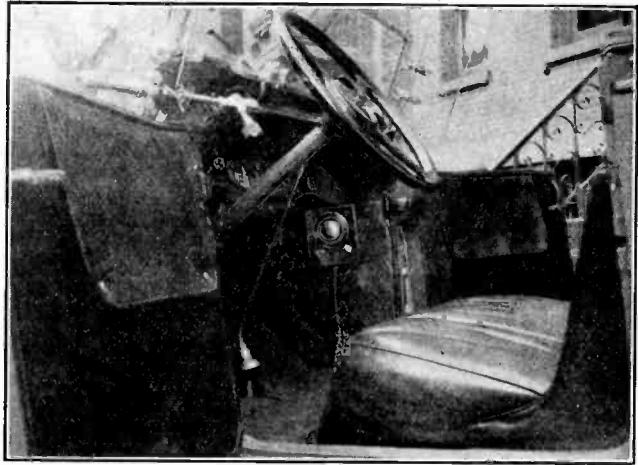

A very good location for the control panel: on the side of the car just under the dashboard. Note how the cable drops straight down. This is the same car shown on page 4.

- 14 ft. Cotton Covered Black.
- 2 Chains (about 14 ft.).
- 2 Pulleys.
- 1 Guide with base.
- Flexible casing.

IMPORTANT

In assembling a portable receiver like the Pilot "Auto" set it is important that a lock washer be placed under every single nut used in the outfit. Being carried on an automobile, the receiver will be bounced around a great deal and the movement will quickly cause the fastening nuts to loosen and perhaps fall off if lock washers are not used. In places where a screw goes into a threaded hole, place the lock washer under the head of the screw.

THE ASSEMBLY

THE assembling and wiring of the set is very simple. Of course, the first thing to do is to unpack the parts from their boxes and to open all the hardware packages.

Start the actual work by mounting the six tube sockets in the large holes on the bottom step of the chassis, using the round-head machine screws packed with the sockets. Before tightening the screws on the first four sockets (for the P-224 tubes) catch the edges of the tube-shield bases under their heads. Notice that soldering lugs are held by some of the socket-mounting screws. To avoid short circuits against the aluminum chassis, carefully bend up all the socket terminals.

(Continued on page 10)

TOP VIEW

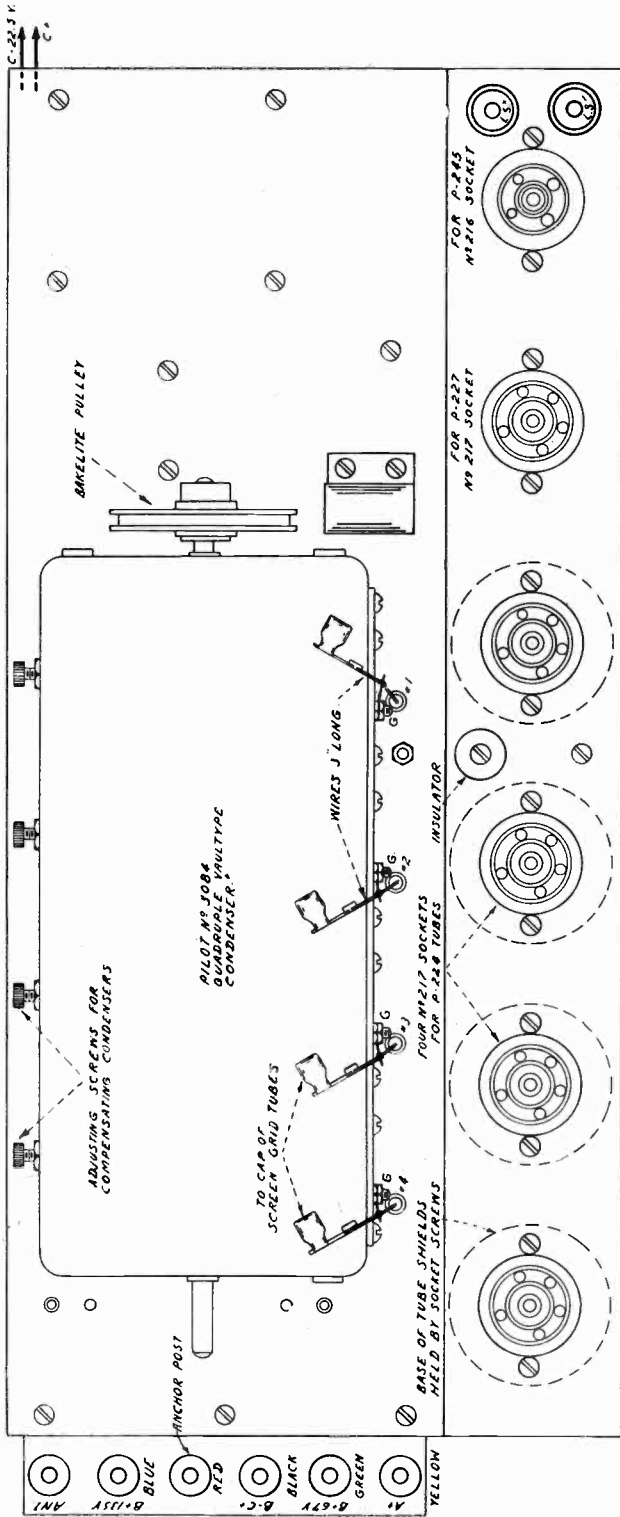

This top view of the "Auto Pilot" chassis shows the positions of the tube sockets, the quadruple Vaultype variable condenser, the binding posts and the bakelite pulley and chain guide (on the right end of the condenser). Before tightening the screws holding the sockets in place, catch the bottom sections of the tube shields under their heads; the shields will then be grounded properly to the chassis.

The wires in the upper right hand corner marked C-22.5 and C+ are each about ten inches long, and run to the single 22½-volt "C" battery block held next to the chassis in the carrying case by means of two pieces of sponge rubber. The wires from the stator posts of the condenser connect to the caps on the four screen-grid tubes.

BOTTOM VIEW

THIS END GROUND

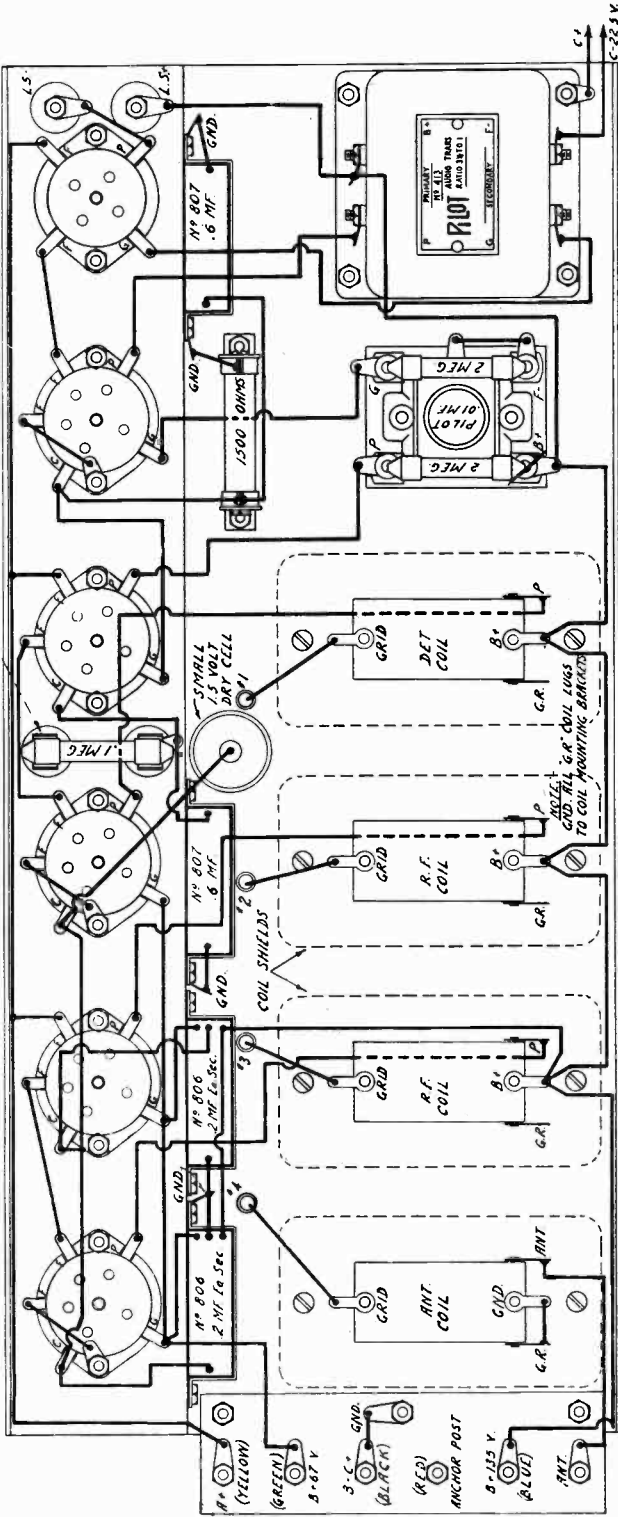

The wiring of the "Auto Pilot" is exceedingly simple, and should not take more than about two hours. Notice that one terminal each of the tube sockets, the 806 and 807 by-pass condensers, the 1500-ohm resistor, the Resistoblock, the .1 megohm leak, the "C" battery and the tuning coils is grounded to the chassis. The dotted rectangles surrounding the tuning coil rep-

resent aluminum shield cans, which are screwed in place after all the wiring has been finished.

Use the tinned copper wire supplied with the kit, and be sure to slip lengths of spaghetti tubing over all connections that are not grounded. In pulling the spaghetti through holes in the chassis be careful not to tear it, as short circuits may easily occur.

(Continued from page 7)

Mount the two grid leak clips between the third and fourth sockets. Note that one of these clips is completely insulated from the aluminum by a pair of molded bakelite washers. The other clip is grounded, but it uses one bakelite washer on the bottom side of the chassis merely to place it on the same level with the other clip. In mounting these clips, put the screws through from the top of the chassis and spread the lips to accommodate the small 6-32 nuts. After doing this, mount the loud speaker binding posts on the extreme end of the set, using bakelite insulating washers for both.

Now take the paper case by-pass condensers and fasten them against the bottom inside of the chassis just under the tube sockets, using the special straps that you will find in one of the hardware packages. Also put the 1,500-ohm resistor in position and then mount the single-cell flashlight battery as shown. The little "C" battery has a screw soldered to its bottom. Merely push the screw through the hole in the chassis directly over the grid-leak clips, and fasten with a nut on the top.

With these parts in place, screw the four coils to the chassis, using short flat-head screws. The antenna coil is marked "ANT" and must be placed to the extreme left. The other three coils are interchangeable. Place the coils with the primaries (the green windings) facing away from the tube sockets.

Complete the assembly on the underside of the chassis by mounting the Resistoblock, the No. 413 transformer and the battery terminal strip. To complete the whole receiver, place the Vaultype

condenser on the top of the chassis and fasten it securely in place by running screws through from the bottom.

In doing the wiring of the set use tinned copper wire throughout, insulating it with lengths of spaghetti. Start with the filament posts and proceed to the by-pass condensers, the R. F. coils and the audio circuit, and finish with the variable condenser. On the top side of the set, connect three-inch lengths of wire to the stator posts of the condenser and to their other ends solder the little snap caps that go on the tops of the screen-grid tubes. With all the wiring finished you can now screw on the coil shields.

THE CONTROL PANEL

Proceed with the control panel. Mount the pilot light in the upper right-hand corner, the filament switch in the lower left corner, and the Volumgrad in the lower right-hand corner. Turn the Volumgrad so that its binding posts face upward. The molded bakelite guide for the control cables is already fastened in place, so that you need not bother with this. Take the ends of the double flexible tubing (bound up in the thick cable) and push them into the bottom holes of the bakelite guide. Tighten them into position by merely screwing in the two set screws. Make the various connections to the pilot light, the filament switch and the Volumgrad as indicated in the accompanying drawings and the blueprint furnished with the kits.

It is a good idea to test the receiver now, before attempting to place it in the car. If you have no separate battery at home, take the set, control panel, tubes, loud speaker and "B" batteries down to

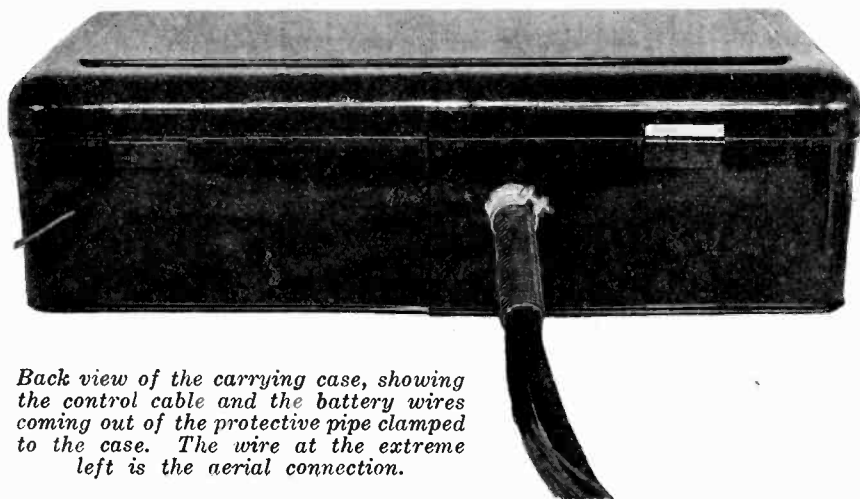

Back view of the carrying case, showing the control cable and the battery wires coming out of the protective pipe clamped to the case. The wire at the extreme left is the aerial connection.

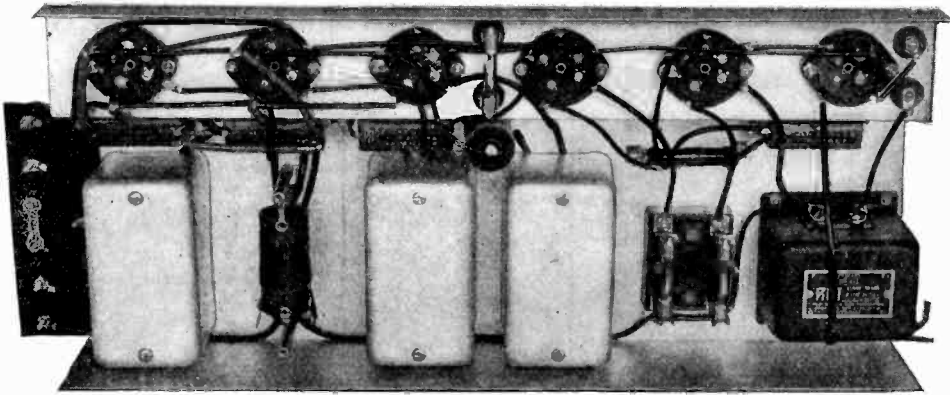

Under view of a completely assembled and wired chassis. The second shield can from the left has been removed to show how the coils are mounted.

the garage and make a temporary connection to the storage battery in the car. String a length of aerial wire 20 or 30 feet long to the nearest pole, connect up the "B" batteries and the loud speaker, and see how the set works. Of course, you will have to make temporary connections to the filament switch and the Volumgrad on the control panel, through the cable. You can turn the variable condenser by fastening the bakelite pulley to the shaft.

The circuit used in the Pilot Auto receiver is of the sure-fire type, and will work without trouble. Of course, if it does not produce results, you will have to start looking for the cause of the silence in the set itself or in the tubes or batteries.

THE CONTROL CHAINS

In one of the hardware packages you will find two lengths of brass chain. These connect the dial on the control panel to the tuning condenser on the chassis, and constitute the remote-control feature of the set. Straighten out the thick cable so that the double flexible tubing hangs straight. Then drop each of the chains through the tubing, feeding it in through the smooth mouth of the bakelite block on the control panel. Knot the ends of the chain so that they will not slip out. Now put the shaft of the molded bakelite pulley through the hole in the center of the control panel, from the back, and fasten the dial on the front side. Loosen the set screw and washer on the edge of the

pulley, and pull the ends of the chain around the groove until they catch in the little notches just under the head of the screw. Then merely tighten the screw so that the chain does not slip off the pulley.

Before mounting the receiver on the car, make a thorough examination of the running board, the step plate, the dash board, and floorboard, and all the incidental machinery underneath the latter. In nine cars out of ten the best place for the set is on the left running board, although in some coupés or roadsters it may be practicable to put it in the rumble seat or on the right running board. The running board is by far the best place for an automobile radio set, as here the outfit is very easy to get at for adjustments or repairs.

You will have to cut two holes in the step plate, just above the running board. One hole must be $1\frac{1}{2}$ inches in diameter, for the main control cable, and the other about $\frac{1}{4}$ inch in diameter, for the aerial wire. You can easily judge the distance between those holes and their height above the running board by placing the metal containing case of the set on the running board and spotting through the holes in the back. The easiest way to make the large hole is to cut a circle of small ones. Of course, it will also be necessary to cut another $1\frac{1}{2}$ inch hole in the floorboard of the car, directly under the spot you intend to mount the control panel. The best posi-

Get Into the Swim!

Don't be envious of the man who has a radio receiver in his automobile. Build a set yourself and put it in your own car! The Pilot "Auto Radio" is as easy to install as it is inexpensive, and it will give you many hours of enjoyment when you are out in the country.

SCHEMATIC DIAGRAM

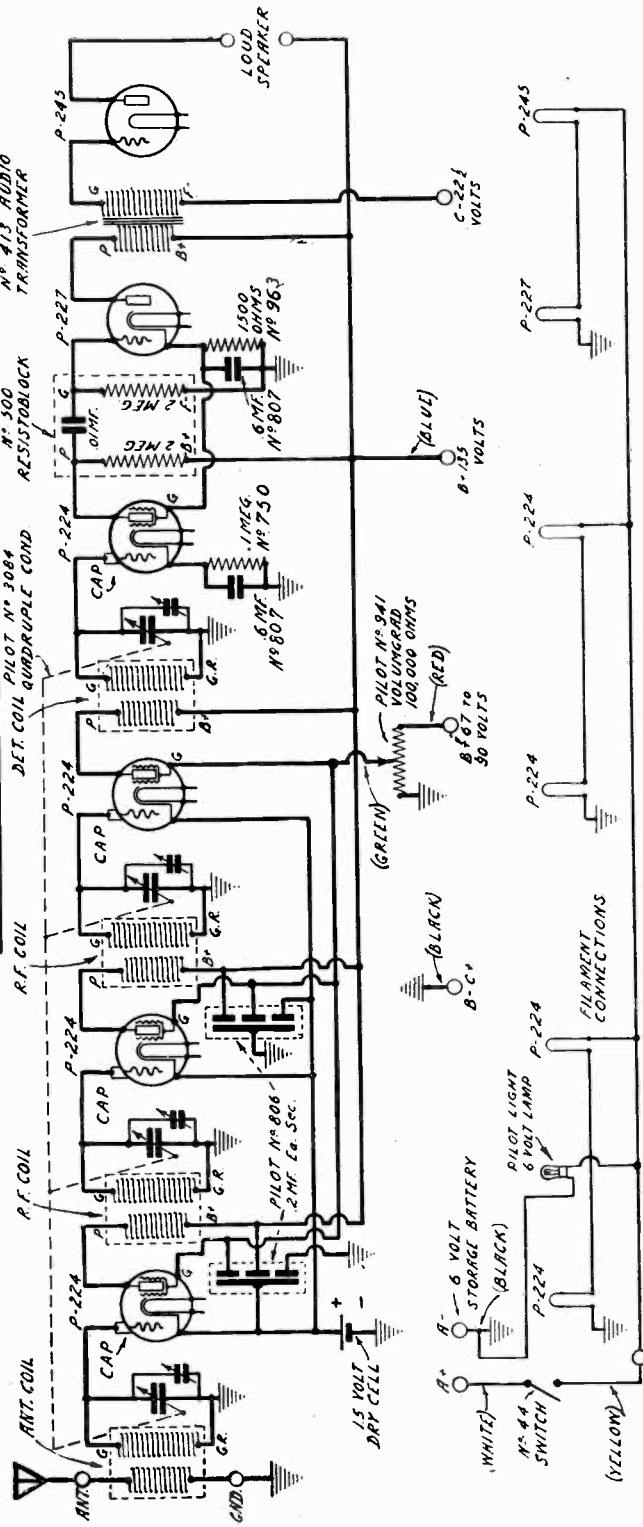

LEFT: Complete schematic diagram of the "Auto Pilot." The filament connections are shown separately for the sake of clarity. The series-parallel arrangement of the filaments is very simple; don't let it confuse you.

tion for this panel is either at the extreme left or the extreme right end of the instrument board, as then the control cable will drop straight down without interfering with the movement of the driver's or passengers' legs. Another good position is on the back of the front seat in sedans or coaches.

Fastening the control box itself is a simple matter. Leave the front panel unscrewed and then simply pass screws through the aluminum back plate into the dashboard. Then screw the panel in place and snake the cable through the hole in the floorboard. With this much work done you are ready to place the receiver itself.

With the kit you will find a short length of flexible pipe, about 1 inch in diameter, and also a clamp by means of which it may be fastened in the large hole in the back of the receiver case. The purpose of this pipe merely is to protect the cable where it passes through the side of the car into the case. Tighten the end of the pipe in the clamp and then tighten the clamp itself in the hole in the back side of the black

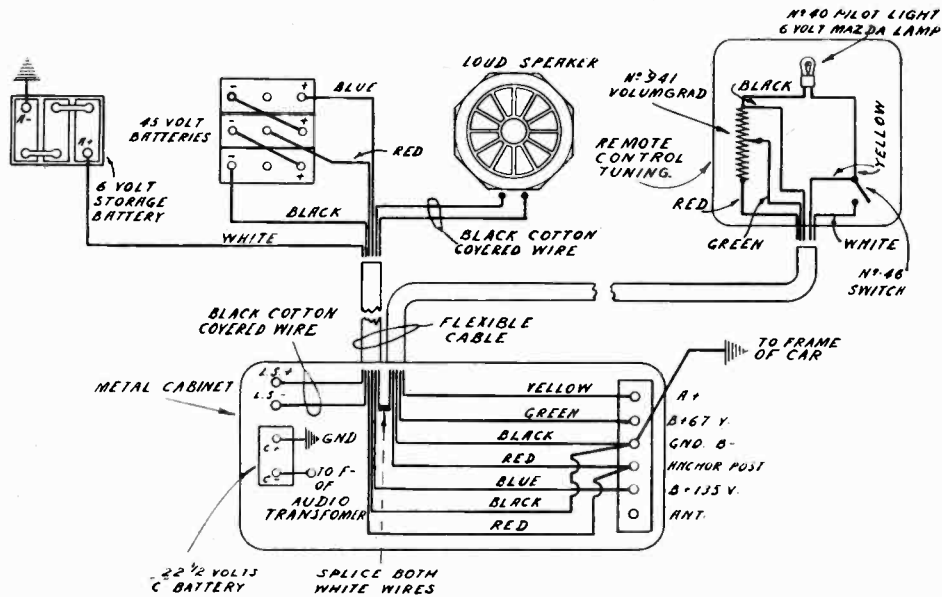

Complete diagram of connections of the "Auto Pilot," showing the receiver proper, the control panel, the loud speaker, and the "A" and "B" batteries.

case. Slide the pipe through the hole you have already cut in the side of the car and adjust the case on the running-board so that there is about 1 inch or 1½ inches of clearance between its back and the step plate. This clearance is necessary to allow the top of the case to swing open. Now simply bolt the case down.

In the kit you will find four pieces of thick sponge rubber, one large and three small. Place the large piece on the inside bottom of the case, leaving the edges turned up a little on the sides so that when the chassis is placed on it they will prevent the set from rocking from side to side. Place the chassis with the tube sockets facing the back of the case and adjust it so that the left end of the condenser shaft appears in front of the opening for the cable.

Before pulling the cable through the protective pipe you will have to tape seven wires to it. Three of these run to the "B" battery, one to the "A" battery, one to the chassis, and two to the loud speaker. These wires are not included in the cable itself because they are arranged differently in different cars and they do not run the full length of the fabric covering. Tape them flat against the free end of the cable for a distance of about one foot, and leave them long enough to reach the places where the batteries and speaker will be located.

If you can remove the floorboard of

your car keep it propped up as high as possible with the cable already running through it. With this board out of the way you can lean over and push the free end of the cable through the pipe in the step plate and into the receiver case. At this time, do not fasten the cable any place under the car, as you must first tighten it in the receiver itself. Go back

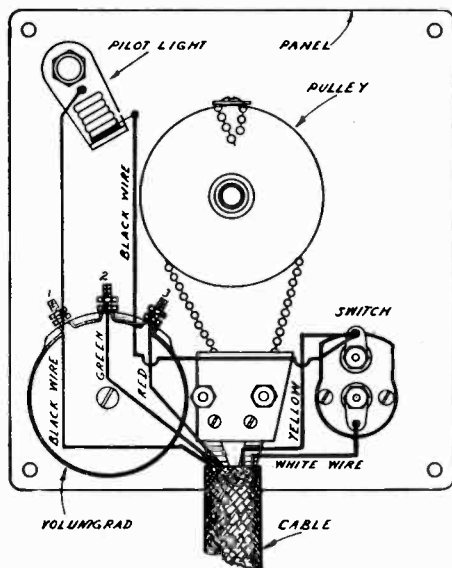

The connections of the control devices in picture form.

to the receiver and untangle the wires of the cable. Unknot the ends of the chain and slip them carefully through the holes in the special little molded bakelite piece that has an aluminum base screwed to it. At the same time, push the ends of the double flexible tubing into the bakelite piece and tighten them in place by means of the two set screws. *Be very careful not to lose the ends of the chain, as they will tend to slip back into the cable.*

Slide the set back and forth a little until the little aluminum plate fits accurately over the two threaded holes in the top of the chassis near the variable condenser. Screw this plate down with two small 6-32 round-head screws. In doing this, still be careful not to lose the ends of the chain. Before tying the chain to the variable condenser, set the dial on the control panel to 100. Also turn the plates of the condenser all the way in by twisting the shaft as far as it will go in the direction of the tube sockets. Then place the bakelite pulley on the left end of the condenser shaft and fasten it with the screw on its edge pointing it directly upward. It is essential that you place the pulley directly in line with the opening in the little block guiding the chains; otherwise the chain will not run smoothly. Still keeping the control dial at 100, pull the chain tightly and fasten it in the groove of the condenser pulley with the aid of the screw and washer. You will have to experiment a little in order to determine the best tension on the chain. With this work done, you can complete the wiring to the binding posts on the terminal strip, at the right end of the set.

The 22½-volt "C" battery for the last audio amplifier tube fits in the box at the left end of the chassis. Simply jam it in place with two of the pieces of sponge rubber, and connect it as shown in the drawings.

Before replacing the floorboard in the car, tie up the cable so that it will not shake excessively while the car is in motion. Try to avoid sharp bends, as these tend to make the action of the control cable rather sticky.

One of the extra wires that you taped to the control cable must be connected to the chassis of the car. Clean away the

steel and make certain that the wire makes good contact with it. Another one of the wires runs directly to the ungrounded terminal of the storage battery. Another pair goes to the loud speaker. If you are going to place the speaker in the back of the car you will have to use your ingenuity in concealing the wires in the upholstery. If you are going to place it up front you can run the wiring alongside the pipe to the windshield wiper. You simply have to examine your own car and determine for yourself the best arrangement.

The construction of your car will also determine the exact disposition of the "B" batteries. If there is room under the front or rear seats, place them there. If you feel ambitious you can cut out an opening in the rear floorboard and hang a wooden or metal box from it. If your car is of the coupé or roadster type the rumble seat is probably the most convenient place. In any event the three batteries should be tied securely together so that they will not shake against each other.

You now need only an aerial to complete the installation. We have found that a simple loop of wire stretched between the front and rear axles provides adequate pick-up and is installed much more easily than wire screening. The under-car aerial has the additional advantage that it is out of sight and does not involve any mutilation of the car's upholstery. Simply regard the front and rear axles as you would the spreaders of a regular aerial, and stretch the wire between them. You must be very careful not to have the wires interfere with the action of the steering gear or any of the brake rods. In some cars it is advisable to fasten the aerial to the spring shackles, to make them clear the steering rod that connects the two front wheels. You can install the whole aerial system in about five minutes the next time you have the crankcase oil changed. Pull one end of the aerial wire through the small hole you had previously cut in the step plate and connect it to the aerial binding post on the terminal strip on the set.

The adjustment of the receiver is very simple and involves nothing more than

(Continued on page 57)

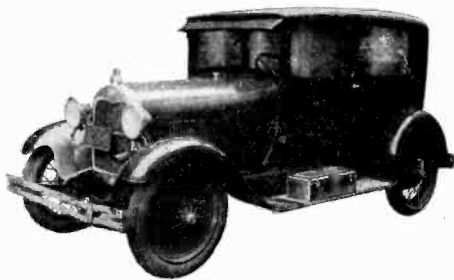

The "Auto Pilot" installed on the running-board of a Ford sedan. It is neat and unobtrusive.

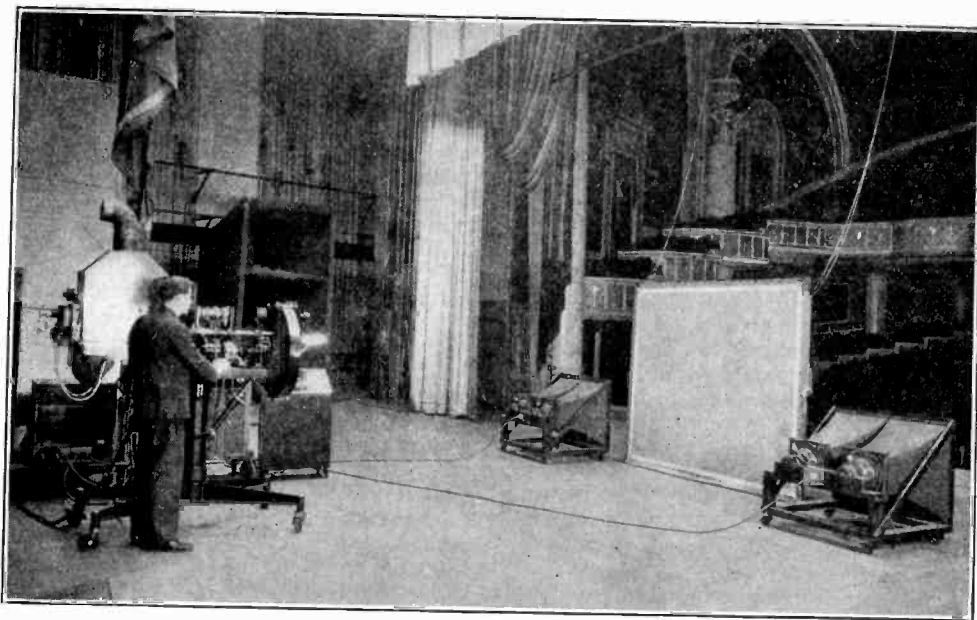

The television projector, screen, and loud speakers set up on the stage of Proctor's Theatre, Schenectady, N. Y.

Television in the Theatre

Remarkably Clear Images of Distant Vaudeville Performers Flashed on Six-Foot Screen Set on Stage, With Voices Reproduced Through Loud Speakers; Radio Transmission Used Throughout, Without Any Wire Line Connections.

By ROBERT HERTZBERG

AS A MAGAZINE for the experimenter and constructor, RADIO DESIGN has deliberately ignored television during the past year and a half. We have refrained from publishing articles on the subject because of the scarcity of television broadcasting stations, the uncertainty of the results obtainable from the few active stations, and the difficulty and cost of purchasing even crude apparatus for reception purposes. Instead, we have swung our readers' interest to the short waves, which have proved to be the most interesting phase of radio ever opened to the amateur.

We believe this policy has been a wise one. Television has definitely been placed in the short-wave channels, so the experience that radio fans have acquired from their short-wave work will give them an

excellent foundation on which to start their experiments with visual broadcasting.

While RADIO DESIGN still has nothing tangible to offer in the way of television receiver "dope," it is publishing this account of the recent achievements of the General Electric Company because of the spectacular nature of the demonstrations and of the impending opening of the television field to the individual experimenter. The Pilot Radio & Tube Corporation, which did some pioneer television broadcasting in 1928 but was prevented from continuing its development program by lack of space in its Brooklyn factory, has recently acquired a gigantic plant at Lawrence, Mass., where it will resume its interrupted work on a large scale. It will help the amateur by operating a television

station of its own and eventually supplying necessary receiver parts.

For the present, our answer to television inquiries is the same as it was a year ago: When we find an outfit that works, and that costs somewhat less than the million-dollar affairs used by the G. E. and the A. T. & T., we'll run a full description of it.

* * *

ON MAY 22, 1930, for the first time in history, television images transmitted by radio were publicly exhibited as part of the regular performance at a theatre. Through a loud speaker system similar to that used for "talking movies," the voices of the televised performers, also transmitted by radio, were heard by the audience. The theatre was the R.K.O. Proctor, in Schenectady, N. Y. The active images of the performers were reproduced on a screen six-feet square and were clearly visible even in the back rows of the balcony of the big playhouse. While they flickered a little, in the fashion of the early movies, and rocked sideways a trifle as the disc-driving motors "hunted," they were astonishingly life-like and real, and evoked prolonged applause.

The system used was developed by Dr. E. F. W. Alexanderson, consulting engineer of the General Electric Company, a pioneer in the development of television and its kindred art—radio.

Audiences at the afternoon and evening shows saw the musical director, John Gamble, lead the orchestra. The musicians were in their customary position in the pit, but the director, miles away, hearing his men over a telephone line, was present only in image. Merrill Trainer, laboratory assistant of Dr.

Alexanderson, was seen and heard as he explained the method by which the images reached the theatre. Other performers were Matilda Biglow Russ, soprano; Frank Camadine, harmonica player; and one of the vaudeville performers, who, after his appearance on the stage, was seen in the same act via television.

The performers appeared before the television camera in an improvised studio in the laboratory of Dr. Alexanderson at the General Electric plant. Light impulses, converted into electrical impulses or radio signals, were sent out by a transmitter in the laboratory on a wavelength of 140 meters. A microphone close to the artist picked up his speech and song, and converted the sound into electrical impulses which were carried by wire to a short-wave transmitter at South Schenectady, from which point they went on the air on a wavelength of 92 meters.

THE THEATRE APPARATUS

At the theatre R. D. Kell, assistant to Dr. Alexanderson in television research,

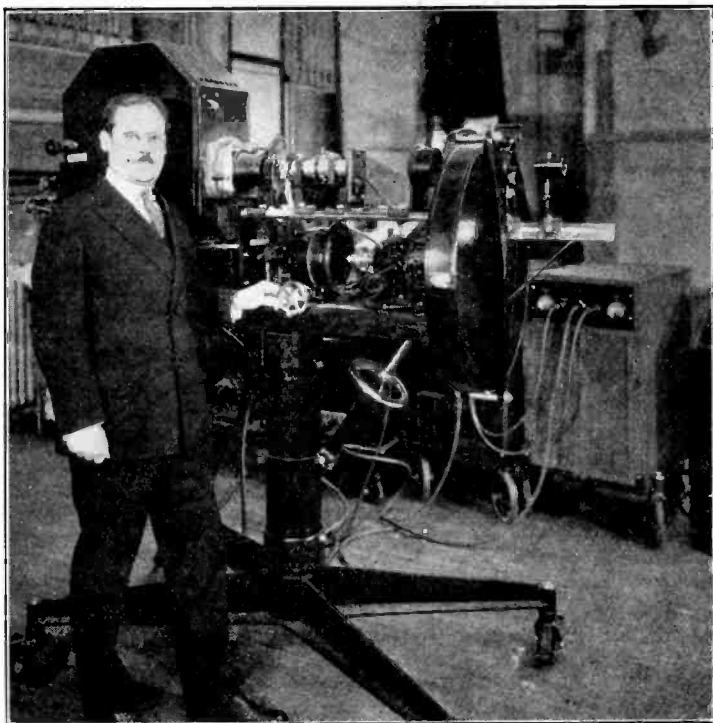

Dr. Alexanderson in front of the television projector used in the theatre demonstration. The scanning disc is enclosed for the protection of the men working around it. In the background are the powerful amplifiers needed for the operation of the system.

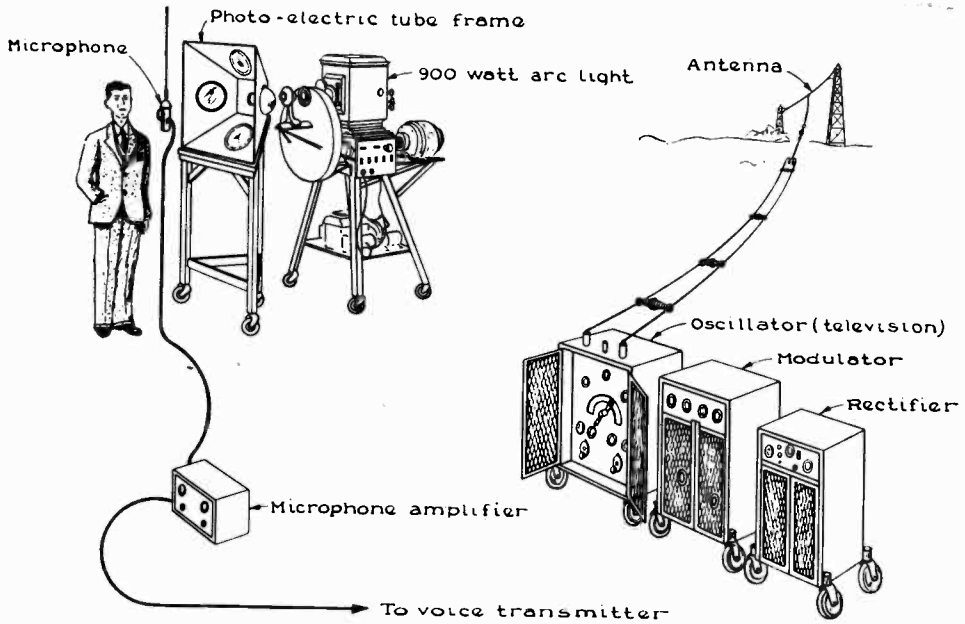

Pictorial representation of the television transmitter. The light thrown on the subject by the arc light is reflected into the photo-electric cells, the output of which operates the modulator section of the television radio transmitter. The modulated signals are then radiated by the antenna. The voice of the performer is transmitted over a separate transmitter on another wavelength.

in the rôle of control operator, received the picture or light impulses, reproduced them on a small monitor telopticon and then transferred these impulses to the light valve, at which point the light was broken up to produce an image corresponding in every detail to the subject at the studio. Head and shoulders only were shown. A second receiver picked up the sound signal and fed it into loud speakers which converted the electro-magnetic waves into sound. The size of the image was a distinct advance over any previously shown. Dr. Alexanderson's first demonstration, three years ago, was a picture in a three inch aperture. Last fall, at the Radio Show at the Madison Square Garden, New York, an image fourteen inches square was exhibited.

The image shown was not simply black and white, on the order of a silhouette. All the gray shades between black and white were reproduced, registering every shadow and shade of the features and giving both depth and detail to the image.

In radio broadcasting the frequencies of speech and music modulate the current sent out from the antenna. In television the antenna radiation is modulated by a succession of light impulses.

THE TRANSMITTING LAYOUT

In the television studio, the method was similar to that used by Dr. Alexanderson in previous demonstrations. The subject to be televised stands before an incandescent lamp. Between the subject and the light is a metal disc about the size of a bicycle wheel and drilled with forty-eight holes. The revolving disc covers the complete subject twenty times per second; that is, there are twenty complete pictures made up of light and shade. A large square frame contains four photo-electric tubes, sensitive to light. The tubes respond 40,000 times per second to impulses reflected back from the subject.

At the theatre the electrical impulses were received and passed on to a light valve, based on an invention by Dr. August Karolus, of Leipzig, Germany. The light valve is in the middle of an intricate lens system, in front of a high intensity arc lamp of a type similar to those used for the projection of motion pictures. The light valve operates delicately and accurately to permit the passage of light in correspondence to the impulses received from the television transmitter. These light emissions are passed on through lenses to a disc corresponding in size, number of holes and rate of rotation to

the disc at the camera or originating point. Additional lenses pass the light forward to the screen, where these light impulses, at the rate of 40,000 per second, become the living, active image of the subject.

The arc lamp, with the lens system and the light valve, the whole making up the television projector, is placed seventeen feet back of the screen. Heavy black cloth from the projector to the screen makes an effective light tunnel which eliminates the possibility of stray light hitting the screen. All the elements in the system, including projector, amplifier and loud speaker, are mounted on wheels to permit assembly and disassembly when used as part of a vaudeville program. The accompanying photographs and drawings show the construction of the transmitting and receiving apparatus in detail.

DEVELOPMENT AND FUTURE OF TELEVISION

Naturally, this demonstration of television in the theater brought up many speculations as to the development and future of the art. Dr. Alexanderson made this the subject of a talk, which we are privileged to publish. We have italicized certain portions of it because of their particular significance to readers of RADIO DESIGN.

"The engineer and inventor who forecasts the future confines himself to the next five to twenty years. His forecast is determined by his knowledge of the problems and difficulties presented and he must have a belief that events are in a broad way predestined by natural social forces.

"Looking back over the development of the electrical industry we can clearly trace those forces; how the science of electricity gave birth to the electrical industry; how later the electrical industry took hold of another branch of science and created the radio industry. We are able to some extent to project into the future the working of the forces that give birth to new epochs, but as to the destiny and significance of these new movements after they have been launched, the engineer is peculiarly blind. Mr. Owen D. Young has repeatedly said that he has the great advantage of not being handicapped by scientific knowledge. His predictions of the future have also been much more far flung and correct than those of the engineers associated with him.

"For fifteen years radio was simply an auxiliary to navigation. In 1915 and 1916 we held daily communication by radio telephone from Schenectady to New York. We found that many amateurs adopted the habit of listening in, and our noon

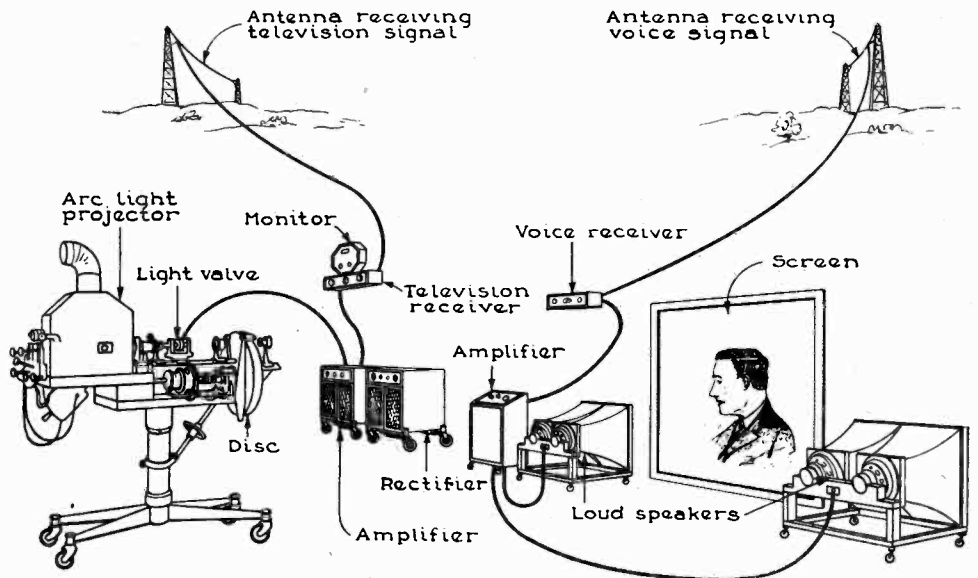

The arrangement of the receiving apparatus in the theatre. The television signals are picked up on a small receiver, detected, strengthened by an audio amplifier using the enormous power of one-half kilowatt, and then lead to the light valve. The latter modulates the light from the arc and the scanning disc reconstructs the picture on the screen. The voice is picked up, amplified and reproduced in the usual fashion.

Projector Lens System

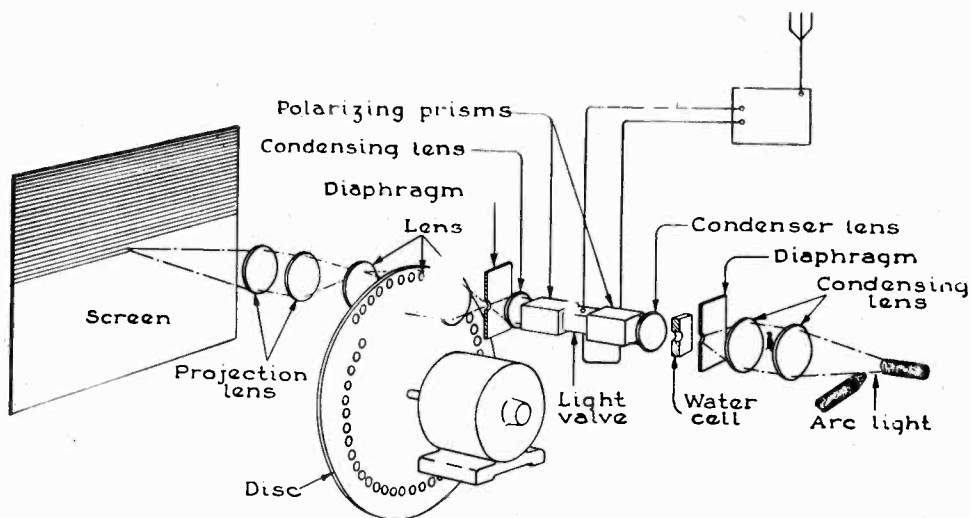

The layout of the television projector in detail. The heart of the system is the light valve, which is the only known means of modulating the great amount of light required for the projection of life-size images on a large screen. Its inner construction is a secret its makers will not yet divulge.

It is evident from this drawing that the design of the apparatus is more of an optical problem than an electrical one.

hour of radio became part of the first regular broadcasting. But we had no idea what it would lead to. Our idea was to telephone across the ocean, and so we did at the close of the war, but we failed to see the great social significance of broadcasting. Television is today in the same state as radio telephony was in 1915. We may derive some comfort from this experience of the past, but on the other hand, we are not sure that the analogy is justifiable and that television will repeat the history of radio telephony. We must then fall back upon our conviction that the development of television is inevitable on account of the forces working in the scientific world today, and that it is a satisfaction to make one's contribution to this evolution even if, in this case, the results should prove to be only a stepping stone to something else.

"If you ask who invented television, the nearest to a simple answer would be that a German, Nipkow, invented television about fifty years ago. However, he did not have the radio amplifier or the neon lamp, and therefore his invention could not be completed at that time. He did, however, clearly explain the idea of scanning the picture, line after line, by a spot of light.

"Before we could produce the results you have seen, we had to make several

tests with different wavelengths which proved to be failures because one ray followed the surface of the earth, whereas the other was reflected from a layer of electrons 100 miles above the earth. We are now working with a wavelength of 140 meters in which the ground wave is predominant. For long distances, on the other hand, we have found it advantageous to use the shortest possible wavelength so that the bulk of the radiation leaves the earth and only the lower fringe of it will arrive at the receiving station. It is expected that the tests that are now in progress are going to throw much more light on the subject of wave propagation.

TELEVISION FOR THE AMATEUR

"Television apparatus is for this purpose an ideal working tool, and I venture to predict that we will soon see a wave of activity in amateur television. There are more than 100,000 experimenters in America, young and old, who go in for radio, not to be entertained, but who like to build their own sets and get a thrill from exploring the unknown. These amateurs have been rather starved of real interest in the last years due to the commercialization of broadcasting. They will be the ones who will popularize long distance television just as they were the ones who

created the interest in broadcasting. In this interest the amateurs and the professional experimenters are on common ground.

"We got a real thrill out of sending a television wave to Australia and have it come back and tell its tale even though it was a simple one. We observed that after traveling 20,000 miles a rectangle still had four corners, which was more than we had expected. As a matter of fact, it was broken up into pieces most of the time. But there were glimpses of encouragement and a fertile field for the imagination. These are the incentives of the explorer, whether he is an amateur or a professional.

"Whether the general public will be enough interested or get enough satisfaction out of television to make it possible to commercialize home sets for television is still to be seen. A new technique of entertainment will be required. As a supplement to broadcasting it can make a reality of the radio drama. Political and educational speakers may use it as a medium, and entertaining personalities like Will Rogers will tell the latest wisecracks and comment on the news of the day. You have seen our test at Proctor's Theatre in this city. It is likely that every moving picture theatre in the large cities will have to be equipped to give a short television act.

"What you have seen today is just one of the many steps that must be taken in our efforts to conquer distance by television.

THE LIGHT VALVE

"The improvement of light control which makes it possible for us to show a picture of theatre size is due to an invention by Dr. Karolus, whom I visited in Leipzig, Germany, some years ago and whose inventions we have been endeavoring to perfect. In our past exhibits the improvements of light control have been due to Dr. D. McFarland Moore and his neon lamps, and I should not be surprised if next time Dr. Moore would go one better than Dr. Karolus. Invention is a delightful and friendly sport, and if we did not have competition we would not have inventions, just as you could not have a race unless you have somebody to race with.

"The possibilities for new inventions in this art of television are inspiring. Just think of it, when you can put an electric eye wherever you wish and you can see through this eye just as if you were there. An airplane with a news reporter will fly

to see whatever is of interest and the whole theatre audience will be with him seeing what he sees, and yet the audience will be perfectly safe and comfortable.

MILITARY ASPECTS

"Or what will this mean in the wars of the future when a staff officer can see the enemy through the television eyes of his scouting planes or when they can send a bombing plane without a man on board which can see the target and be steered by radio up to the moment when it hits? Or what will it mean for peaceful aviation when the ships of the air approach a harbor in fog, take on a local pilot, not from a little craft that comes to meet the ship, but by television, whereby the trained eyes of the pilot, functioning by television, will guide the ship to the airport in safety."

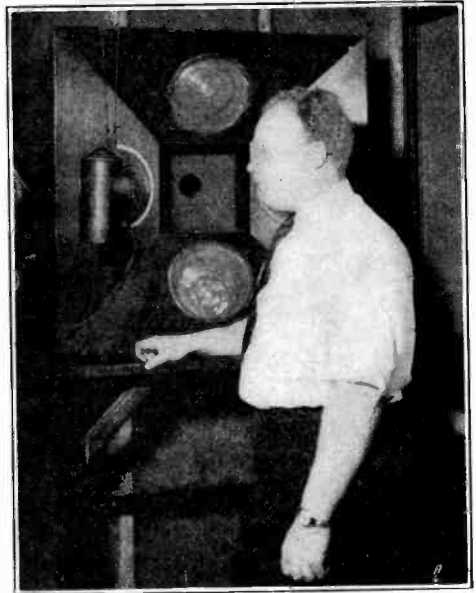

Merrill Trainer, assistant to Dr. Alexander, in front of the television transmitting frame containing the photo-electric cells. The hanging device at the left, which looks like a burglar's lantern, is a condenser type microphone. It is just out of range of the scanning rays.

The scanning rays of light, which sweep across the face of the subject are generated by an arc light and a revolving scanning disc, located behind the photo-electric-cell frame. The light comes through the hole in the center of the latter. The cell frame and the subject are enclosed in a light-proof booth made of black cloth. This prevents stray light from hitting the cells and registering as undesired lines.

Getting the Most

out of the

Short Waves

by Robert Hertzberg

ALTHOUGH the reception of foreign short-wave broadcasting stations is no longer an unusual experience for thousands of radio fans, there are still many owners of short-wave receivers who have never heard anything outside of the United States or Canada. Their disappointing failures can be explained usually by either or both of two reasons. They do not exercise enough patience in adjusting and tuning their sets or they do not know when and where to listen.

The writer has been carefully studying many letters written by readers of *RADIO DESIGN*, and has prepared this article as a general answer to the many questions they have asked. The information given herein applies not only to the well-known Super-Wasp receivers, but also to short-wave receivers of practically all other makes and designs. Short-wave receivers differ greatly in general appearance and construction, but fundamentally they are all very much alike.

Short-wave receivers can be divided into three general classes: the first and oldest is the straight regenerator; the second is a combination of untuned screen-grid R. F. amplification and a straight regenerative detector; and the third is the latest and most advanced design using tuned

screen-grid R. F. and also the usual regenerative detector. The nature of the power supply and of the audio amplifier system is of little consideration. The success of the receiver depends mostly upon the apparatus that precedes the audio amplifier.

REGENERATION CONTROL IMPORTANT

Without question, the most important feature of any of the foregoing types of short-wave receivers is the regeneration control. Unless the regenerative action is smooth and quiet and can be controlled accurately, the receiver will never produce satisfactory results. Obtaining this necessary smoothness of control is really an easy matter. The factors that control the action are the plate voltage, the size of the tickler winding, the detector filament temperature in battery-operated sets, and the resistance of the grid leak. The first two factors are the most important.

If you are using a set of factory-wound coils or have wound your own coils according to reliable information, the tickler windings are probably of the correct size and you will not have to bother with them. If the regenerative action is cranky and the detector tube falls violently into oscillation, regardless of how carefully you turn the regeneration condenser, the thing

for you to do is to provide the detector plate circuit with a potentiometer, by means of which you will be able to adjust the actual detector plate voltage to the best working value. In most sets it is not possible to leave the detector voltage fixed over a wide range of wavelengths, as the circuits tend to oscillate more easily on some wavelengths than on others.

The potentiometer should have a resistance of at least 100,000 ohms, the Pilot No. 941 Volumgrad being especially suitable for the purpose. The instrument is connected as shown in Fig. 1. One end of the potentiometer resistance goes to B-. The other end goes to B+ 90 volts, on either the "B" batteries or the "B" power pack, and the center connection or arm runs to the binding post on the receiver marked B + detector. This hookup applies to any short-wave receiver using a variable condenser as the means of regeneration control. There are a few sets using a variable resistance or potentiometer for the actual regeneration control and in these, of course, the additional potentiometer is of no value. If the regeneration is not smooth the trouble is in some other part of the set.

ADJUSTING THE POTENTIOMETER

To adjust the potentiometer with any one plug-in coil, as in the case of the Wasp and other straight regenerative receivers, or pair of plug-in coils, as in the Super-Wasp, set the tuning condenser or condensers to 100 and start turning the potentiometer knob until the set slides quietly into oscillation just as the regeneration condenser approaches 100 on the scale or maximum capacity. You will now find that the regeneration all the way down the tuning scale is quite smooth and easily controlled.

If a marked reduction in plate voltage still leaves the regeneration very short and abrupt, there are too many turns on the tickler winding for the particular detector tube you are using. Note this last qualification very carefully. Tubes that appear to be alike when tried in a broadcast receiver may work very differently when used as regenerative detectors in short-wave sets. This is particularly true of A. C. tubes. You should always try all the tubes you have in the detector socket, as you will undoubtedly find one that works better than the others.

If you are using a battery receiver by all means try a 112A tube as the detector. This tube is usually used as a power out-

put tube in the last stage of audio amplifiers, but it also happens to be an extremely sensitive detector. Its filament takes $\frac{1}{4}$ ampere at 5 volts, like the 201A, so you can plug it right into the detector socket without making any changes in the wiring.

If you have obtained the best potentiometer adjustment for one wavelength range, plug in the next coil or coils and try again. In a few sets one adjustment may hold for a rather wide range of wavelengths, but in most outfits some re-adjustment is very necessary.

Fig. 2 shows the actual connections of a No. 941 Volumgrad to a battery model Super-Wasp. Do not fail to make the usual connection between the B- post on the receiver and the B- post on the batteries.

In battery-operated sets the detector

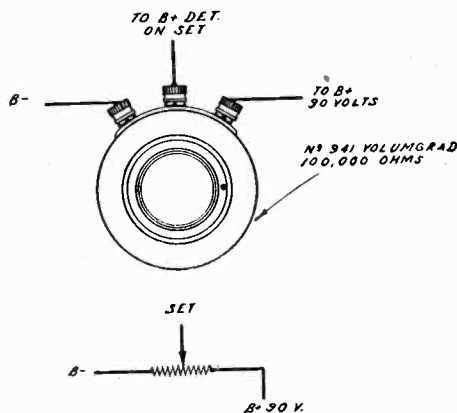

Fig. 1: How a No. 941 Volumgrad (100,000 ohm potentiometer) is connected for control of the detector plate voltage.

filament temperature also has an important effect upon the regeneration. In fact, in some of the older types of receivers vernier rheostats were used for the regeneration control instead of variable condensers in the plate circuit. The 201A tube is not at all critical, but if the set oscillates rather strongly it can be calmed down by a reduction in the filament current. In other words, merely turn the rheostat down a little.

The grid leak used in the detector circuit is not at all as critical as most writers would have you think. Three megohms, with a .0001 mf. condenser, is just about right for most tubes of the 201A, 200A, and 227 types.

- BATTERY MODEL SUPER-WASP -

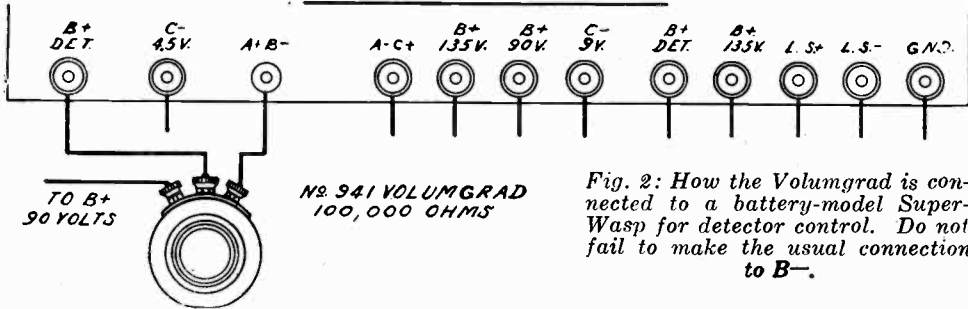

Fig. 2: How the Volumgrad is connected to a battery-model Super-Wasp for detector control. Do not fail to make the usual connection to B-.

THE TUNING PROCESS

The actual tuning process, once you have tamed down the regeneration, is very simple. Keep the detector in a continual state of oscillation by rocking the regeneration dial back and forth as you turn the tuning dial a fraction of a degree at a time. When you encounter a carrier wave you will hear a tell-tale whistle. If the signal is fairly strong, you can back down the regeneration until the whistle disappears; if the signal is rather weak, it is best to "zero-beat" it. This is the process of keeping the circuit in oscillation, but tuning it so that the frequency of the local oscillations is exactly the same as that of the incoming carrier wave. Under this condition no whistle is generated (there being no heterodyne action), and the voice or music can be distinguished. The signals will sound rather "mushy" if they are zero-beated, but at least they will be recognizable. Sometimes, after a station is brought in by the zero-beating method, its strength may increase so much that the detector can be thrown out of oscillation; the signals will then clear up considerably.

CHECK THE POWER SUPPLY

It seems almost superfluous to say that the "A" and "B" batteries, as well as the A. C. power pack, should be in first-class condition if good results are to be expected. However, it is surprising to learn how many people try to get along with run-down storage batteries, dried-out "B" batteries and gassy rectifier tubes. The folks who know the most about such things are usually the ones who neglect the power supply most shamefully.

Unscrew the vent caps from the storage battery and pour in some distilled water if the edges of the plates show above the acid solution. Test the acid with a hydrometer and, if it reads below 1200, have the battery charged. A test with a voltmeter is really of no value, as even a discharged battery will read pretty close to 6 volts on open circuit. Likewise, test the "B" batteries with a voltmeter. If you do not own a meter of your own you can usually borrow one from your local radio dealer. Forty-five volt blocks should be discarded after they drop to 37 or 38 volts. If the set is of the A. C. type the D. C. voltmeter used to measure the plate volt-

A. C. SUPER-WASP

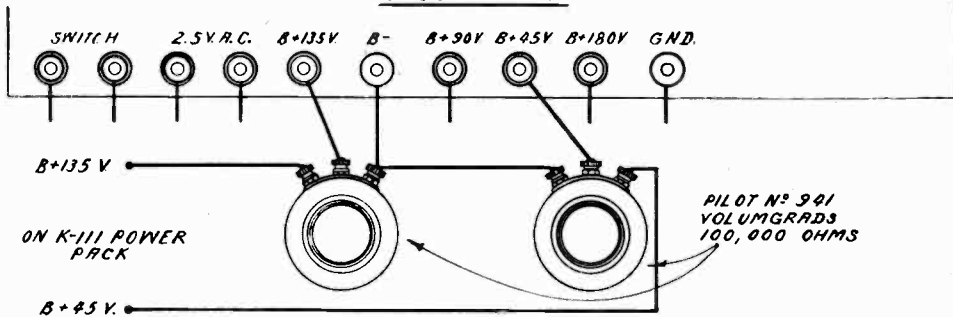

Fig. 3: The best arrangement for voltage control in the A. C. Super-Wasp: two volumgrads connected as potentiometers. Again remember the B- connection.

age must be of the high-resistance type. The small watch-case voltmeters sold for battery-measuring purposes are not at all suitable for measurement of "B" eliminator voltages. They usually draw as much current as the whole receiver itself and give altogether false readings.

As mentioned in previous issues of **RADIO DESIGN**, an incidental little trouble sometimes turns up in the A. C. Super-Wasp due to the use of too much voltage on the screen of the P-224 tube. The usual result of this excess current is uncontrollable oscillation in the radio-frequency portion of the set. The simplest way to cure this is to connect a potentiometer in the B + 45 volt lead. Once the potentiometer is set it may be left alone. Fig. 3 shows the connections of this potentiometer and also an additional potentiometer for the adjustment of the detector plate voltage. The screen potentiometer is the one on the right, the detector potentiometer the one on the left. As these instruments require only occasional manipulation they need not be mounted on the front panel of the receiver. Instead, they can be placed conveniently on a small bakelite shelf fastened between the two shield cans. This strip may be held in place by means of two simple L-shaped brackets, held by the screws in the facing sides of the cans. The illustration marked Fig. 4 shows these two potentiometers mounted in a standard Super-Wasp. Incidentally, this photograph also shows a good way of mounting the whole outfit. Both set and pack are screwed down to a board 25 inches long and 12 inches wide. The two boxes of

coils are placed between the set and the pack, and the whole assembly can be moved around comfortably without disturbing any of the connecting wires. Notice that the various filament and plate leads are tied up in a cable, telephone style.

SUPER-WASP BATTERY CONNECTIONS

There has been much confusion over the proper method of making the battery connections to the K-110 model of the Super-Wasp, when output tubes of either the 112A or 171A type are used. Fig. 5 shows in picture form the connections when a 112A tube is used as the second audio amplifier. Note that only three 45-volt "B" battery blocks are needed for the plate supply and a single 9-volt "C" battery for the grid bias. Of course, two 4½-volt "C" batteries connected in series may be used instead of a single 9-volt unit. Fig. 6 shows the same receiver with enough batteries for a 171A output tube. This time four 45-volt "B" battery blocks are needed, along with two 22½ volt "C" batteries. The binding post on the receiver marked B + 135 volts actually gets 180 volts, for the plate of the 171A.

There is little to choose between the 112A and 171A tubes as last audio amplifiers. The two tubes give just about as much amplification, although the 171A is capable of handling more volume. Please distinguish carefully between amplification and volume. The 171A tube will not make any given signal louder than the 112A will. It is simply capable of handling, without distortion, very loud signals

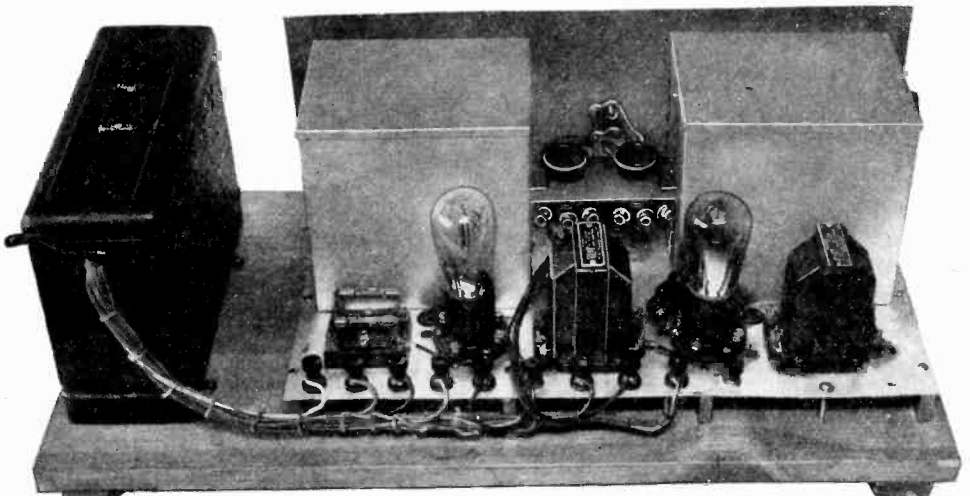

Fig. 4: How the two Volumgrads shown in Fig. 3 are actually mounted in an A. C. Super-Wasp between the two shield cans.

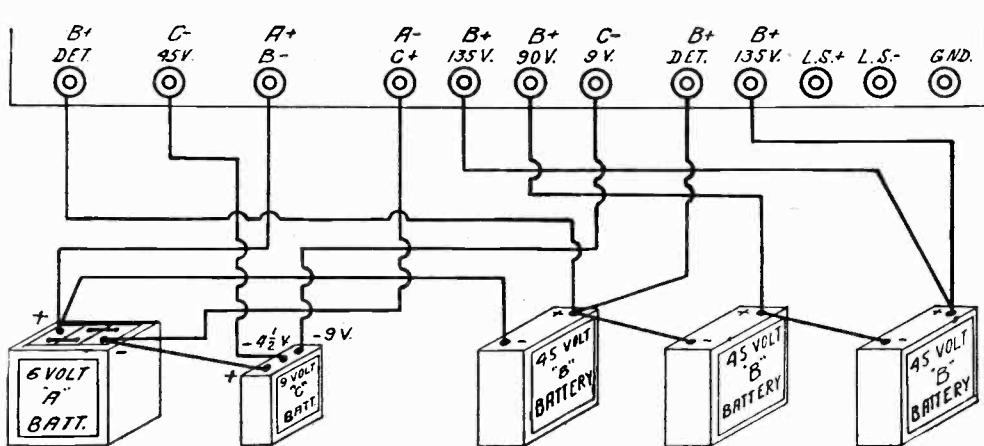

Fig. 5: Battery connections for the K-110 model of the Super-Wasp when a P-112A is used

that would overload the 112A. For all ordinary purposes, the 112A is to be preferred because it has plenty of power-handling capacity and requires a cheaper battery layout.

USING EARPHONES

Many Super-Wasp owners have inquired as to the best method of reducing the audio amplification when earphones are used, as some stations are so strong that they actually hurt the ears. It is possible to reduce the amplification of the audio system by connecting a potentiometer across the secondary of the first audio transformer. However, it is much better to eliminate one stage altogether, by connecting the earphones in the plate circuit of the third tube. With only one audio stage, the incidental little noises are reduced considerably and reception is more

comfortable. Fig. 7 shows how an earphone jack may be connected in the battery model Super-Wasp, and Fig. 8 shows how this jack is used in the A. C. model. It is absolutely essential that the jack in the K-110 be completely insulated from the panel or chassis. If it is not it will shortcircuit the "B" batteries. In the K-115 the frame of the jack should make good contact with the panel, insulating washers being unnecessary.

In Fig. 7, the jack completely cuts out the audio transformer when the earphone plug is inserted in it. In Fig. 8, the phones are merely connected across the transformer primary. The 1-mf. condenser connected between the spring of the jack and the upper or P post of the transformer prevents the high voltage from flowing through the phones and from possibly causing the wearer a severe shock. While

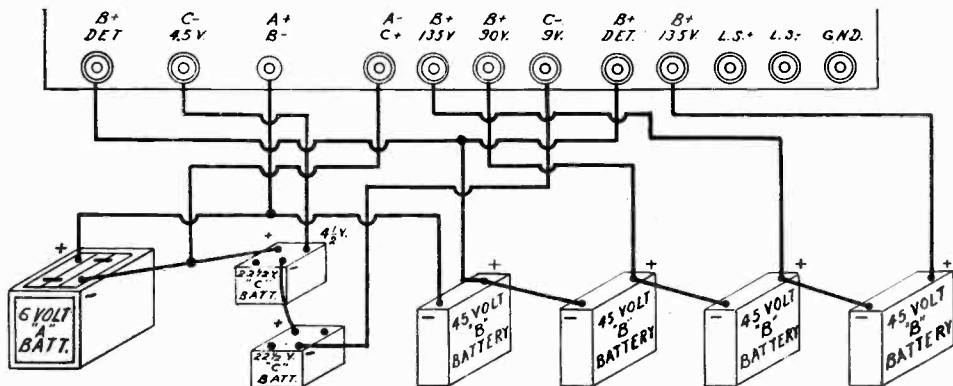

Fig. 6: Battery connections when a P-171A tube is used.

this condenser effectively blocks the direct current supplied by the "B" power pack, it offers very little resistance to the fluctuating signal currents. In neither of these two arrangements is any provision made for shutting off the fourth tubes, as additional switches are undesirable. In the battery set the simplest thing to do is to pull out the last tube. In the A. C. set it is advisable to leave the tube running. If it is removed the "B" voltages to the other tubes will rise and unbalance the receiver.

In connection with the use of earphones, it should be stated that because of the irregularity of short-wave transmission it is extremely difficult to tune in distant stations directly on the loud speaker. It is very much easier to plug in a pair of earphones first, locate the stations, and then connect the loud speaker, if the signals are strong enough for loud speaker reproduction. People who have grown accustomed to tuning in broadcast stations by the loud

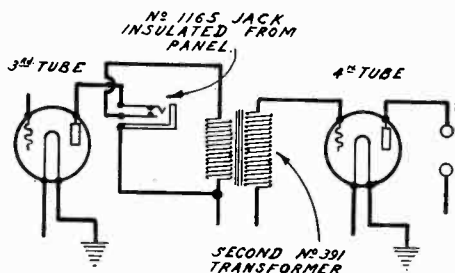

Fig. 7: Connections of an earphone jack in the battery-model Super-Wasp

speaker method may find earphones a bit inconvenient at first, but after a few evenings of use they will find them very much more comfortable and effective than the speaker. Telephone receivers are extremely sensitive and will make audible to the human ear minute signals that will not register at all on a loud speaker.

SHORT-WAVE AERIALS

For short-wave work, the receiving aerial need not be more than 50 feet or so in length. Of course, it should be strung as high and as clear as possible, and should be carefully insulated. The usual ground connection may be made to a steam or water pipe, or to one of the special grounds described in the article entitled "Summer Radio," which appears on Page 17 of this issue.

It is sometimes unnecessary to erect a

separate aerial for the short-wave receiver if you are already using a medium sized aerial for your regular broadcast set. Merely run a wire from the aerial binding post of the short-wave outfit to the aerial lead-in, and see if both sets operate at the same time. Whether they will or not depends on the particular arrangement of the primary circuit in the broadcast receiver. In many cases this stunt works very well.

If the broadcast aerial is a rather large one, merely wrap the wire from the short-wave set around the lead-in for a distance of about a foot or a foot and a half, without actually making connection to it. This gives a capacitive coupling that is usually sufficient to produce excellent results. If you find that neither of these two connections proves satisfactory, you can then erect a separate little aerial for the short-wave receiver.

In connection with aerials, it is appropriate to remark that dead spots on the tuning scales of many straight regenerative receivers is usually due to the absorption defects of the antenna system. The natural wavelength of the aerial and ground may just happen to fall within the tuning range of the set, and the antenna then absorbs the energy from the plate circuit just as quickly as the tickler feeds it back to the grid circuit. The result is that the set refuses to show any of the usual symptoms of regeneration or oscillation on certain points on the dial.

The remedy for this trouble is merely to change the electrical constants of the antenna system by inserting in the aerial lead a very small fixed condenser. The Pilot VM-81 Micrograd is especially recommended for this purpose, as it is very

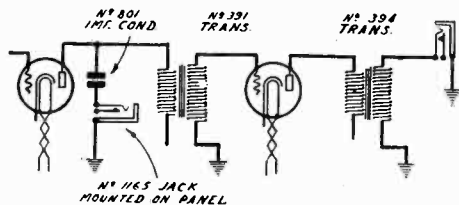
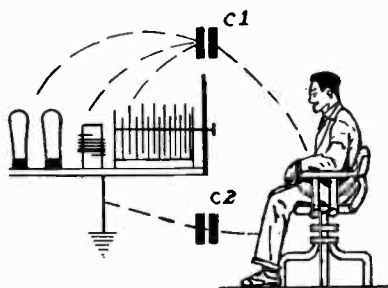

Fig. 8: Connections of an earphone jack in the A. C. Super-Wasp.

small and can be adjusted in a few seconds. Sometimes a slight increase in the detector plate voltage will overcome dead spots, and in this connection the plate circuit potentiometer mentioned in the early part of this article is particularly valuable.

HAND CAPACITY EFFECTS

In many older types of short-wave receivers considerable trouble is experienced from hand capacity effects, the causes of which are not clearly understood by most radio fans. If the parts of a short-wave receiver are left out in the open, without the protection of metal shields, they will act as one plate of a large variable condenser of which the operator's body forms the other plate. The dielectric is the air between the set and the body. This effect is illustrated in Fig. 9. As the operator moves his hands toward and away from the set he changes the overall capacity of the system, and as the capacity of the tuning coils and condensers in the set are affected, the signals will fall in and out of tune.



UNSHIELDED SET

Fig 9: C1 and C2 represent the capacity effect of the operator's body in relation to the receiver.

If a receiver is shielded by means of a metal cabinet, or at least by a metal front panel, one plate of the condenser is formed by the metal frame work and not by the parts of the receiver itself. Therefore, changes in the distance between the operator and the set do not change the constants of the receiver and do not cause detuning effects. Fig. 10 illustrates the capacity action of an installation of this kind.

Many people want to know how they can eliminate hand capacity troubles in their own receivers. The answer must be obvious from the foregoing discussion. Rebuild the outfit to use at least a metal front panel, or better, a completely enclosed metal cabinet. The metal may be copper, brass, or aluminum, the latter usually being used because it is cheap, light and easily worked.

SUPER-WASP WAVELENGTH RANGES

A frequently recurring question deals

with the matter of increasing the wavelength ranges of both the Wasp and Super-Wasp receivers. Many owners of these sets want to make them tune up to 600, 700, 900, and even 1200 meters. This cannot be done efficiently without re-building practically the entire receiver. The Wasp and Super-Wasp are essentially short-wave receivers and use the very small tuning condensers necessary for short-wave work. With the aid of the special bank-wound blue ring coils supplied with the kits, they just about manage to reach 500 meters, but their range cannot be extended beyond this point without the substitution of larger condensers.

Merely winding larger coils and using the present .00016 mf. condensers is no solution of the problem, as the capacity-inductance ratio of the combination becomes very bad and selectivity practically disappears. If you are interested in long-wave reception, the best thing for you to do is to make yourself a separate tuner using honeycomb coils for inductances and tuning condensers of at least .0005 mf. capacity.

ABOUT S. W. ADAPTERS

RADIO DESIGN receives many letters inquiring as to the effectiveness of short-wave adapters as distinguished from complete short-wave receivers. In general, our experience with adapters has not been satisfactory. The reason for this is not so much a technical one as it is a psychological one. The people who are most easily sold on adapters are those who do not understand short-wave radio and who expect to hear foreign stations merely by plugging the magical instrument into their present broadcast receivers and twisting a little knob. Foreign reception is not at all as easy as all that, and only the man who will go to the trouble of making his own short-wave receiver and studying the incidental literature on the subject is able to appreciate the situation.

As a matter of fact, the construction and operation of a separate short-wave receiver like the Super-Wasp is cheaper and involves fewer difficulties than the use of an adapter. With an adapter, you have to pry into the bowels of the receiver, remove tubes and in general disturb the outfit. Of course, you also temporarily put the set out of commission as an instrument of entertainment. With a separate short-wave set you can explore the ether waves without depriving the rest of the family of their usual radio programs.

WHEN AND WHERE TO LISTEN

Having a good receiver in operating condition is only half the battle. You must know when to listen and at what points on the dial. The accompanying chart of dial readings for the Super-Wasp should be of great assistance to owners of this popular receiver. (See page 32.)

One thing many people cannot seem to get into their heads is that time is different in different places. Many short-wave set owners finish their suppers at about 7:00 or 7:30 in the evening and then sit down to their receivers with the innocent expectation that there will be short-wave

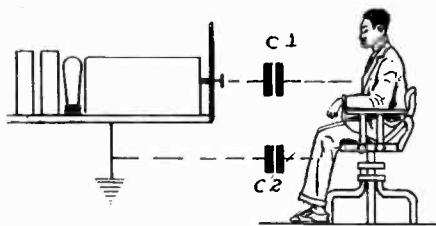

SHIELDED SET

Fig. 10: Here the capacities C1 and C2 exist in relation to the shielding, and therefore have no influence on the receiver itself.

stations to hear all evening. Seven o'clock New York time is midnight in London, and G5SW, the famous B. B. C. short-waver, is just signing off for the night. The writer has seen hundreds of letters from people complaining of their inability to bring in London for their bridge guests—at nine o'clock. This is an age of scientific achievement, but a dozen short-wave sets won't bring in a station that isn't transmitting.

Probably the best time to hear foreign stations is early in the morning and about the middle of the afternoon. Between four and about eight A. M., the stations in Australia, Siam, Siberia, the Dutch East Indies and Holland are quite active, and they deliver astoundingly strong signals. VK2ME, in Sydney, Australia is testing pretty regularly with Schenectady and with the British Post Office stations in England, and comes through with fair reliability. They are not on every morning, but if you don't get him one day you probably will the next.

Those Dutch stations are by far the best ones. PLE and PLF, in Java, working with PHI, PCO, and PCK in Holland,

operate powerful transmitters, and if you tune way down low on your smallest coil, you can get them loudly enough to wake up the family next door. If you have always confined your listening hours to the early evening, you won't know your set in the early morning. The air is nice and quiet, and the very low-wave stations skip in without much coaxing.

During the afternoon the German stations get busy, and come through just a little under WGY, G5SW starts at 2:00 P. M., E. S. T., and is an old stand-by.

As you know, skip distance effects vary with wavelength and the condition of the atmosphere. Therefore, divide your listening schedule something like this: 14 to about 20 meters, best from daybreak to about 2:00 P. M. and then fades out as darkness approaches; 20 to 35 meters, Europeans from 1:00 P. M. to about 10 in the evening (if they happen to be putting on late programs); 35 to 75 meters, best between twilight and daybreak.

SPOTTING THE STATIONS

You can locate many of the foreigners by spotting some of the American stations. For instance, you can get W2XAF (WGY) pretty easily on 31.48 meters; crawl just under him and look for PCJ, NRH, and the German station at Koeningswursterhausen. You can spot these groups of stations because they are about 10 degrees below a very powerful code station on about 33 meters. This is XDA, in Mexico City, which also occasionally uses voice.

There is a whole mess of stations around 48 and 49 meters. Generally the American stations fill up the ether pretty well in this range, but if your set is selective you can cut between them and pick out some interesting stations in Central and South America. First locate W3XAU (Philadelphia), and tune just above him for station HRB, in Honduras. Log KDKA on its new 49 meter wave, and just below him find HKT, in Bogota, Columbia. After tuning in the powerful American telephone transmitter WND, on 44.4 meters, hang on closely and listen carefully for VRY, in Georgetown, British Guiana. It is quite easy to identify the Central and South American stations, as they obligingly announce in English as well as in Spanish.

Short-wave reception conditions have the habit of changing quickly and without apparent provocation. If you don't hear a single foreign station for a week don't feel discouraged; the next week you may hear a dozen at a time.

Short-Wave Station Schedules

The Latest Information on the American and Foreign Transmitters, and Where to Find Them on the Super-Wasp

THE short-wave broadcasting stations of the world have not been changing their wavelengths and hours of operation recently as frequently as they did during the past Winter and Spring. However, we have a number of new items to report that will be of interest to all short-wave fans who are trying to keep up with the short-wave situation.

First of all, we wish to acknowledge some letters received from the Westinghouse Radio Stations and the Crosley Radio Corporation. In the Spring issue of *RADIO DESIGN* we stated that neither of these two organizations would answer our requests for information about their short-wave activities. Now, however, they have made up for their silence by telling all there is to be told.

W8XK, PITTSBURGH, PA.

From Mr. P. A. Boyd, manager of press relations for the Westinghouse stations, we learn that W8XK, the short-wave transmitter associated with KDKA, is on the air only on Sunday, Tuesday, Thursday, and Saturday. It operates on a sliding schedule of three wavelengths, as follows: 8 a. m. to 12 noon, on 19.72 meters or 15,210 kilocycles; noon to 5 p. m., on 25.25 meters or 11,880 kilocycles; 5 p. m. to 12 midnight, on 48.86 meters or 6,140 kilocycles. The silence of the station on Monday, Wednesday, and Friday accounts for the many complaints we have had from short-wave set owners that they are unable to hear Pittsburgh at certain times.

Station W8XK relays the regular programs of KDKA, which include many of the features of the National Broadcasting Company.

THE CROSLY STATION

The mystery regarding the Crosley station is cleared up by Mr. J. A. Chambers, its technical supervisor. It seems there has been some misunderstanding regarding the license for W8XAL, and the transmitter is off the air until the difficulties are straightened out. Mr. Chambers promises to advise us of the return of the station and to keep us informed on its activities.

KZRM, MANILA

The short-wave station of KZRM, at Manila, Philippine Islands, apparently has been shifting its wavelength. We are in receipt of a letter from Miss Marguerite Cromwell, station manager, in which two wavelengths are indicated. One is 26.2 meters, and the other 48.94 meters. The operating hours, in Eastern Standard Time, are as follows: 5 to 6 p. m., 2 a. m. to 4 a. m., 5 a. m. to 10 a. m. This short-wave transmitter is rated at one kilowatt and is heard quite regularly in the United States, particularly along the West Coast. Station KZRM is owned and operated by the Radio Corporation of the Philippines, to whom reports of reception may be addressed.

X6XN, OAKLAND, CAL.

Mr. Joseph A. Copeland, 85 Main Street, South Cortlandt, Maine, who is the owner of a battery model Super-Wasp, has forwarded to us the operating schedule of W6XN, which is operated in conjunction with KGO, the General Electric Company station at Oakland, California. A power of 10 kilowatts is used on a wavelength of 23.35 meters, or a frequency of 12,850 kilocycles. The station is on the air on Monday, from 8 p. m. to 2:45 a. m.; on Tuesday, from 8 p. m. to 3 a. m., and on Saturday, from 8 p. m. to 4 a. m. As KGO is part of the National Broadcasting Company network, many of the NBC chain programs are heard through it.

CHICAGO AND SPOKANE STATIONS

Mr. Stannard Smith, 1823 Grinshaw Boulevard, Los Angeles, California, reports Station WLS of Chicago, Illinois, transmitting on about the same wavelength as station WENR, which is on 49.83 meters or 6,020 kilocycles. He also reports Station KGA of Spokane, Washington, which has also been heard by a number of other listeners. Judging from the Super-Wasp dial readings that he gives, this station is on about 65 meters. Mr. Smith also reports hearing a Cuban station on 49.1 meters and would like to correspond with any other listeners who can help him in identifying it. Mr. Smith also gives his right dial reading for sta-

tion RA97, Moscow, as 51 with the yellow coils.

UOR2, VIENNA

From several of the foreign radio magazines we learn that Station UOR2, the official short-wave transmitter of Vienna, Austria, has definitely acquired the wavelengths of 25.42 and 49.40 meters. The longer wave is unlikely to be heard in the United States because of time differences and interference from local stations.

ITALIAN STATION ACTIVE

An Italian short-wave transmitter, located in Rome, has passed its initial trials very successfully. Reports as to the wavelength are rather conflicting, but we believe that 25.4 meters is correct. A number of American listeners have reported hearing this station, which uses the considerable power of 12 kilowatts.

PARIS CHANGES WAVES

The French short-wave station which announces itself as "Paris Radio Experimental" has recently changed its wavelength from 31.65 meters to 29 meters, in order to avoid the jam that exists on the former channel. The daily broadcasts begin at 5 p. m., the power used being 1,200 watts.

SHIP ACTIVITY

With the advent of the summer tourist season the ship-to-shore radio telephone

The past two issues of Radio Design contained what are probably the most accurate and complete lists of the active short-wave broadcasting stations of the world ever published. These lists not only give the wavelengths, but also the operating hours of the various stations reduced to Eastern Standard Time. Every owner of a short-wave receiver should have them on hand for reference purposes, as they are of great value in locating and identifying both American and foreign stations. Copies may be obtained from Radio Design, 103 Broadway, Brooklyn, New York, at the price of 15c each. Merely ask for Vol. 2, No. 4 and Vol. 3, No. 1. Stamps accepted.

traffic between the Atlantic liners and both America and Europe will probably be very heavy. The steamers *Leviathan*, *Olympic*, *Majestic*, *Bremen*, *Europa* and *Homeric* are known to have stations on board, and their transmissions have been heard with excellent strength and clarity by many listeners. Each one seems to use a number of wavelengths. In general, the shortest waves are used

during daylight hours, and the longer waves during darkness. The American, British and French shore stations that engage with these ships are also heard quite regularly. Most of the American transmitters seem to be located along the coast of New Jersey.

HS2PJ, SIAM

A good target for short-wave fans to shoot at is station HS2PJ, which is located at Bangkok, Siam. According to a letter received from Ghara Aram, radio engineer for the Royal Siamese Post and Telegraph Department, a wavelength of 29.5 meters is used. This station operates on Tuesday, Friday and Sunday, from 1,300 to 1,600 Greenwich Mean Time. Get out your time conversion charts and translate this into your own local time. (See page 43, Vol. 2, No. 4, RADIO DESIGN.)

Speaking of time reminds one that daylight saving must be taken into consideration in all calculations involving international time. The time conversion chart

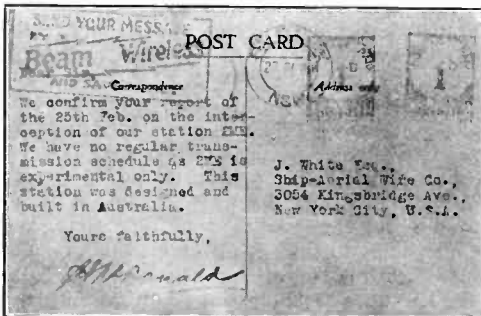

Reproduction of the two sides of VK2ME's verification card—the prize of the short-wave fan. Mr. White picked up the Sydney station on a Super-Wasp.

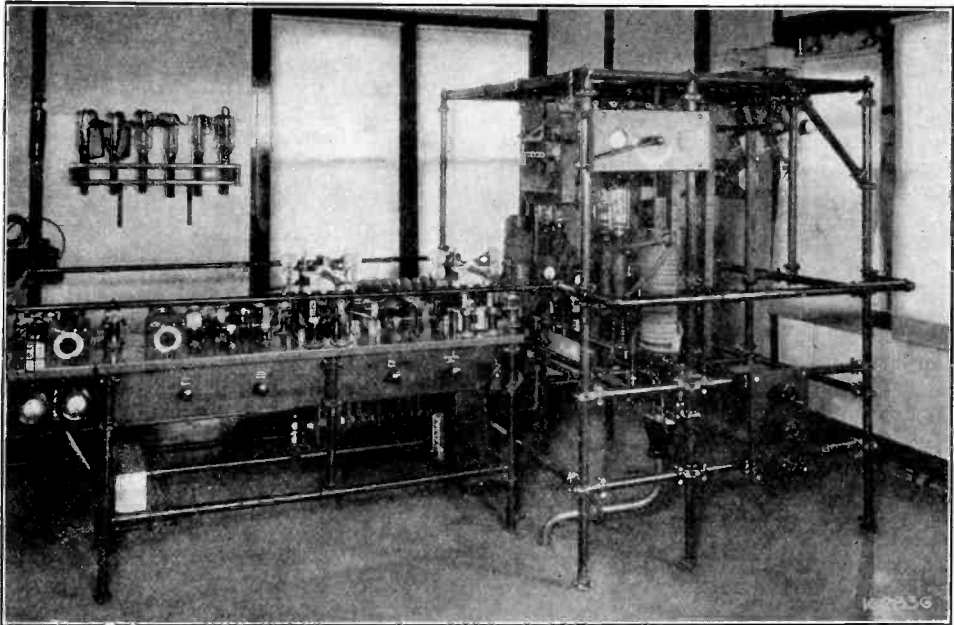

Amateur operators will be interested in this picture of W8XX, the short-wave transmitter of KDKA, at East Pittsburgh, Pa. This is one of the oldest and best known of all short-wave stations.

published by the government deals only with standard time.

THANKS FOR THE LETTERS

RADIO DESIGN wishes to acknowledge interesting and informative letters from T. J. Perry, 620 Moody Street, Waltham, Massachusetts; C. M. Stevenson, 820 Park Avenue, Weehawken, New Jersey; Thomas N. Cranstoun-Day, Capetown, South Africa; and E. L. Cavitt, 272 Park Avenue, Carrollton, Ohio. Many other people who sent in reports on short-wave stations received acknowledgments direct.

We again take the liberty of drawing on the bulletin published by the International Short-Wave Club of Klondyke, Ohio, of which Mr. Arthur J. Green is the enterprising president. We also wish to again recommend this organization very highly to all short-wave fans. Full particulars regarding membership can be obtained from Mr. Green. Address him at Box 713, Klondyke, Ohio.

SPECIAL PROGRAMS

Station HRB, the Tropical Radio Telegraph Company, Honduras, Central America, is putting on a special Saturday-night program for the benefit of members of the short-wave club. This station broadcasts on 49 meters and stages the programs from 11 to 12 p. m., Eastern

Standard Time. During this hour the names of 15 or more members will be called, and each member reporting the time and date of his own name will receive a souvenir from the station.

We take pleasure in reproducing herewith a photograph of some of the staff artists at HRB. These people are quite up-to-date and are known to broadcast excellent programs.

SUPER-WASP DIAL SETTINGS

Following is a list of right-hand dial settings of the Super-Wasp for the most important and frequently heard American and foreign short-wave stations. These figures represent the average taken from the reports of several dozen set owners, and give at least an approximate idea of where to tune. The readings on your own set may be higher or lower, depending on the detector tube you are using. If, for instance, you find that W6XN (Oakland, California), comes in on 81 on the right dial instead of 78, as shown, you will know that your readings in general will be slightly higher than those on the list. If you can pick up a few of the stations indicated, you will know whether to tune above or below them for other stations that you are now missing. Use the list in this way and you will find it very valuable.

As most short-wave stations are of experimental nature, they make frequent changes in their operating wavelengths and schedules. Drop RADIO DESIGN a card and give us all the "dope" when you pick up new stations, or old ones giving their frequency, hours of operation, or other pertinent information.

The readings of the left-hand dial will depend greatly on your antenna, and cannot be predicted in advance. After locating a few of the near-by American stations you will be able to judge the exact relation between the two dials, and then you can make a "log" or station record of your own.

RED COILS

PLE, Island of Java.....	15
GBU, England.....	15
PLF, Island of Java.....	16
PLG, Island of Java.....	16
PHI, Holland.....	21
G2AA, England.....	40
GBX, England.....	42
G2IV, "SS Majestic".....	47
W2XAD, Schenectady, N. Y.....	52
W6XN, Oakland, Cal.....	78
G2GN, "SS Olympic".....	79
W8XK, Pittsburgh, Pa.....	85

G5SW, Chemsford, England.....	86
CJRX, Winnipeg, Can.....	87
KIO, Hawaii.....	88
IBDK, Italy.....	88
KZRM, Manila.....	90
DHC, Germany.....	91

ORANGE COILS

VK2ME, Sydney.....	20
HS2PJ, Siam.....	22
GBU, England.....	24
NRH, Costa Rica.....	26
PCJ, Holland.....	27
Zeesen, Germany.....	27½
W2XAF, Schenectady, N. Y.....	28
7LO Nairobi, British East Africa.....	28
WSBN, "SS Leviathan".....	33
W2XV, Long Island City.....	36
6AG, Perth, Australia.....	78
VRY, Georgetown, British Guiana.....	81
WND, New Jersey, U. S. A.....	82
HKC, Bogota, Columbia.....	88
HKT, Colombia.....	89
W8XK, Pittsburgh, Pa.....	91
HRB, Honduras.....	91½
W2XE, New York.....	92
W3XAL, Bound Brook, N. J.....	93
W3XAU, Philadelphia.....	93
W9XF, Chicago.....	94



This trio entertains short-wave listeners regularly from HRB, the Tropical Radio Broadcasting Company's station in Honduras, Central America. LEFT TO RIGHT: Senorita Davilla. Fernando Ferrari, and Senorita Cordova.

Summer Radio

How to Prepare for
It and Enjoy It

by

A.A. Dolid

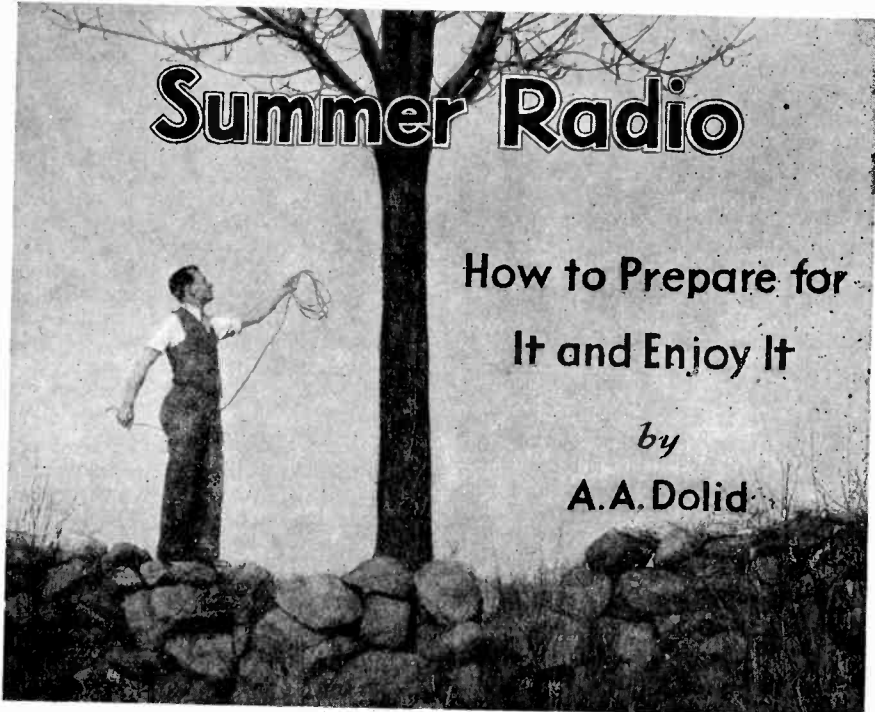

Getting an aerial swung from a tree is an easy job if you know how. Don't attempt to climb the tree; instead, throw the wire up cowboy-fashion.

RADIO receivers that have been in use during the past spring and winter should be examined, cleaned and overhauled in preparation for further service during the hot summer weather. They deserve a little attention, and if you give it to them you will be rewarded with trouble-free results.

If you have a factory-built A. C. broadcast receiver, first disconnect the 110-volt plug, and then turn the cabinet around or open the top, so that you can get at the chassis and the tubes. With a soft brush or a dry rag clean out the accumulation of dust, being careful not to disturb any wires. Remove one tube at a time and wipe it clean with a damp cloth and then a dry one. Tubes of the A. C. type get pretty hot during normal operation, but if the glass is kept clean the heat radiates off into the surrounding air without injurious results.

In removing four-prong tubes, like the 171A, 226, 245, 250, 280 and 281 types, note carefully the direction in which the little brass pins in the bases face, and replace the tubes with the pins in the same direction. Five-prong tubes like the 224 and 227 have no guiding pins, so sim-

ply turn them slowly until they slip into the sockets.

THE AERIAL AND GROUND

Tighten up the aerial and ground wires at the set, and trace these wires to the window lead-in and steam or water pipe, respectively. Unhook the wires at these points, scrape them clean with the edge of a knife, and tighten them back in place.

By all means go up on the roof and examine the aerial. You probably haven't looked at it for months, and the winter storms may have done lots of damage. Make certain that it clears other wires or near-by objects, and if it appears to hang a bit loosely, tighten it as much as you can. A length of aerial wire, hanging exposed all day to the sun, will sag considerably, and should be pulled up occasionally to prevent it from swinging too much during windy weather. Also look over the lead in, and tape over frayed or worn sections.

If your receiver is of the battery type, and you charge the "A" battery yourself, it is a good idea to go over all the connections and to clean away any evidences of corrosion. Wash the case of the battery

with a soaking wet rag and also tidy up the tray or rubber mat on which it stands. In warm weather the water in the battery solution evaporates faster than usual, so keep a small bottle of distilled water on hand and squirt some in before the tops of the plates break through the acid.

The "B" batteries require little attention. Try to keep them in a cool, or at least, a shaded spot, as they wear out more rapidly in hot weather than in cool.

VACATION TIME RADIO

The matter of providing radio reception at the summer vacation place requires careful consideration. If you and your family are moving into a beach bungalow or country cottage for the whole summer season, or at least for a month, and electric power is available, by all means take out the radio receiver from your home. Make sure, however, that the power is of the same kind you have in the city. You can easily determine this by calling up the electric light companies at both places.

Of course you must now erect an aerial. You should have at least thirty or fifty feet of wire exposed, and more if the location allows a good spread. Use seven strand No. 22 flexible wire and small glass insulators, and string the wire as high as possible. Run it from the edge of the building to any convenient pole or tree; or make the acquaintance of the man on the other side of the street or yard and run the wire to his house. If your receiver is a recent model of high sensitivity, you may not need more than twenty feet or so wound around the edge of the porch. Study the local conditions and erect an aerial to suit them.

For a ground, simply run a wire to the nearest water pipe. Use any wire that you happen to have: flexible lamp cord, annunciator wire, etc.

Although the danger from lightning is very slight, it is advisable to install a lightning arrester on the outside of the building, with a wire running directly to the ground. If an outside faucet for a garden hose is near-by, wrap the wire around that. If nothing like this is available, drive a two- or three-foot length of iron pipe into the earth or bury a couple of old pots or pans, and run the ground wire to them.

THE TREE AERIAL

Trees are good natural aerial posts, but they often present problems. It is easy enough to say "String the aerial to any convenient tree"; the trick is to get the

wire up without the aid of a dirigible. Instead of attempting to shinny up the trunk (which you can't do unless you have a pair of heavy leg spurs called pole climbers), tie one end of a length of flexible wire or stout twine to a stone about the size of your fist and curl up the wire loosely in your left hand. Leave a piece about five feet long, and start swinging it in a circle in the direction of the tree you have selected. When you're twirling pretty rapidly let go with a heave so that the rock goes flying up into the branches. The first two or three attempts usually are failures, but after a while you'll be able to get the wire way up in the air.

If your receiver has the loud speaker built right into the cabinet, move the outfit as near a porch window or door as possible, as you and your family will probably do most of your summer listening out-doors. If the loud speaker is separate, or you feel affluent enough to buy another speaker even if the set already has one, run a length of double wire out to the porch and connect either a phone jack or a pair of snap clips to the ends. You can then connect the speaker quickly by means of a phone plug fastened to the tips, or by merely catching the tips in the jaws of the clips.

Take the speaker indoors at night, as most diaphragms tend to absorb moisture. A drenching in the morning dew won't do the instrument any good at all and is likely to give it an attack of sore throat.

THE "PORTABLE" SET

If you are going away for just a few weeks to a country camp or beach colony where no electric light power is available, my earnest advice to you is not to bother with radio at all. Most of the so-called "portable" receivers pictured in enchanting summer surroundings in advertisements are about as portable as a baby grand piano with a handle on it. The real thing is an automobile radio set like the Pilot "Auto Radio," described in this issue. The car itself carries the weight of the instrument, and the storage battery problem is automatically disposed of.

It is hardly worth dragging a separate storage battery to a camp unless you have a car and there is a charging station in some near-by village. And don't attempt to get around this problem by replacing the storage battery by a bank of dry cells. Dry cells are all right if they are used on a light load for short periods and are given time to recuperate. They pass out

very quickly when subjected to current drains that normally require a storage battery.

In addition to the broadcast receiver, by all means take your short-wave set if the power is available. Listening during daylight on the very short waves is very interesting sport, and you will hear stations that are altogether inaudible at night. Receiving conditions in general are usually better at the seashore or mountain place than in the city, because of the absence of large bodies of metal and other disturbing influences, and even small antenna systems produce very good results.

NOVEL AERIALS AND GROUNDS

If you have enough space and wire, you can perform some interesting experimental reception with very long aerials. Piece together all the loose wire you can lay hands on, and string it along the country-side in as straight a line as possible. If you have never had much luck in picking up the European stations, try to locate the antenna so that the *lead-in end*, not the free end, points in the general direction of Europe. If you're after Aus-

tralia or South America, point the lead-in at those countries.

Most people have the idea that an aerial receives best from the direction in which the free end points. This isn't so at all; it is strongly directional the other way.

If you still feel energetic after stringing aerials, it will be worth while for you to pay some attention to the ground. Where no buried water pipe system is available, a good ground can be obtained by burying all the loose bodies of metal you find around. Old wash boilers, frying pans, pails, large gasoline tins, etc., are fine for the purpose. Connect them altogether by means of heavy wire and bury them just below the surface of the earth.

By far the best thing is an old automobile radiator, the leakier the better. Leave the neck sticking out just above the ground, so that you can pour it full of water every now and then. The water leaks out of the honeycomb and seeps through the earth, making the latter highly conductive. If you bury the radiator in the midst of a lot of other miscellaneous junk and keep the system well watered, you will have a really good ground system.



Bring the loud-speaker outdoors and enjoy your radio programs in comfort. Run extension cords to the porch or merely place the speaker on the window, as shown above.

Adjusting the "Pre-Selector"

A Few Simple Suggestions for Obtaining the Best Possible Results From This Popular Broadcast Receiver, Which Is Sold in Kit Form.

by ALFRED A. GHIRARDI

THE Pre-Selector broadcast receiver, described in the Spring issue of *RADIO DESIGN*, has already achieved wide-spread popularity, because of the excellence of its electrical design and the completeness of the kits furnished for the sets. Constructors have experienced very little trouble, but a few little difficulties have turned up, that are not serious and can easily be cured.

SHORT AERIAL ESSENTIAL

In the first place, we wish to emphasize the necessity for using a short aerial. The Pre-Selector is a high-gain screen-grid receiver, and as such need not and should not be used with an indoor or outdoor aerial more than about 30 feet in length. Longer aerials simply ruin the selectivity without adding anything that is particularly advantageous to reception. Only in case of dead spots or under unusually adverse conditions are long aerials needed.

The entire purpose and value of screen-grid tubes and the high-gain amplifiers designed for them is the elimination of the clumsy roof aerial, which has electrical as well as mechanical disadvantages. Short aerials are usually less susceptible to atmospheric interference and, since they produce perfectly satisfactory results with screen-grid sets like the Pre-Selector, they should always be used wherever possible. The shorter the aerial that can be employed in any location, the better will be the tuning.

Another thing that evidently has escaped attention is the little single-pole double-throw knife switch located on the chassis just behind the left tuning condenser. The set should be tried with the switch in both positions. One setting will give decidedly better selectivity than the other.

SETTING THE CONDENSERS

In setting the shafts of the Vaultype condensers in the studs of the No. 1285 dial, make sure that the condenser plates are in the same position. When the dial reads zero both condensers should have the rotor plates all out of the stators; when it reads 100 the plates should be all

in. The Vaultype condensers are completely enclosed, but you can tell where the rotor plates are by noting the positions of the little nicks in the rotor shaft close to the bearing. The nicks point directly toward the outer end of the rotor plate assembly. In the Pre-Selector, the condensers are at zero when the nicks point straight up. The dial set screws should be tightened with the condensers at zero, because, with the dial set to this figure, the screws can be reached very conveniently with a screw driver.

This alignment of the variable condensers is very important. The set will tune very broadly and will appear to be very weak if the two condensers are off only a few degrees.

ADJUSTING THE COMPENSATORS

Once the kit has been completely assembled the only adjustments that can be made in the receiver itself are on the compensating condensers, which are controlled by the screws protruding from the tops of the cases. To set these properly, pick out a weak station somewhere in the middle of the dial and turn the screws in and out, one at a time, while rocking the dial back and forth a degree or so. When the signals sound loudest, lock the screws in place by tightening the nuts with a pair of pliers.

Only the first two compensators to the left are at all critical. These are on the condensers that tune the band-pass stage, on which the selectivity of the receiver depends. The other compensators, on the right-hand condenser, are not at all critical, but should be adjusted anyway for best results.

THE POWER PACK

Do not fail to put the cover on the K-112 power pack. It not only saves you from serious shocks from the high voltage terminals, but also dampens the whole can and reduces mechanical hum.

It is advisable to check all the filament voltages with an A. C. voltmeter, and all the plate voltages with a high-resistance D. C. voltmeter. The output from the 90- and 180-volt posts can be adjusted by means of the Resistograd on the bakelite

terminal strip. Use a screw driver with a wooden handle in turning the slotted shaft of this instrument, and keep your other hand off the chassis. This resistor does not affect the 300-volt tap.

BLUEPRINTS AVAILABLE

Copies of the Spring, 1930, issue of *RADIO DESIGN*, containing the detailed description of the "Pre-Selector," may be obtained at the cost of fifteen cents apiece, coin or stamps. Full-size working blueprints of the set are also available, at ten cents apiece. Merely order blueprint BP-126.

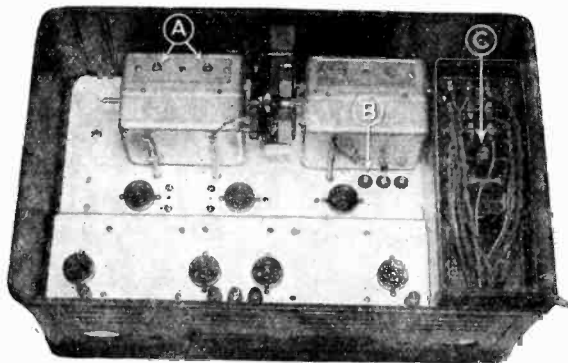

What you should adjust carefully in the Pre-Selector: A, the condenser compensators; B, the antenna switch; C, the voltage control on the power pack. This photo shows a completed set with the top of the cabinet removed.

8000-Mile Signals on Super-Wasp Wake Up Listener's Family

RADIO DESIGN has received many interesting letters from Super-Wasp owners, and has printed some of them in past issues. Recently we received what we consider a particularly unusual one, and we are printing it in full. The experience of our South African friend indicates quite clearly the possibilities of the short waves and the peculiar manner in which they reach out.

RAND CARBIDE, LIMITED
WITBANK, TRANSVAAL
SOUTH AFRICA
April 9, 1930.

RADIO DESIGN MAGAZINE,
Brooklyn, New York.

Dear Sirs:

Enclosed please find five shillings. Enroll me in the Radio International Guild as per slip enclosed.

I purchased an A. C. Super-Wasp about a month ago. These are some of the results I got. I heard a service at the Union College Chapel, Schenectady (where I studied, class of 1922) loud speaker strength, heard by the folks next door, through the open window. G5SW (England), on loud speaker, was heard out of the room. KDKA, WGY, etc., are heard at 3 to 6 a. m. here, but I have to cut down because it wakes up the better half and the youngsters. The organ recitals from Albany are particularly appreciated. The Australian stations come through

well sometimes, but they haven't the pep somehow.

PCJ (Holland) is pie. Longwave stuff from Nairobi (in Central Africa) and Rome, Italy, occasionally. The set has surely got fans talking.

While at Cornell, having served from 1915 to 1918 in the last war, I had the opportunity of studying tubes, etc., the knowledge of which stood me in good stead when I finally had to leave there and go on to the General Electric works at Schenectady, about the time that the old 2XQ began to reach out to the California coast. We used a couple of ordinary electric fans to hold down a transmitting tube with a white hot plate; Great days!

Can you account for our frequently hearing the transatlantic telephone conversations here? We are supposed to be right out of the line, but I have heard London saying "Hello New York," have gotten the call through, and have heard the conversation between two engineers, on transformers, etc. Some man rang his wife or sweetheart, and the conversation was sure edifying—all this 7,000 miles out of the beam line. Guess the Marconi Company would be interested to know of all this. Have heard sugar deals between Havana and New York, and several two-way tests between G5SW and one of the Westinghouse stations.

Yours faithfully,

LOWNE H. SIM.

A Few Wrongs to Be Righted



Robert S. Kruse

A Discussion of Short-Wave Receiver Design and Why Certain Circuit Features, Considered Old-Fashioned in Broadcast Practice, Are Still Desirable for High-Frequency Work

By ROBERT S. KRUSE

I AM not a reformer; I do not belong to a single association for the suppression of anything, nor do I attend meetings for the purpose of furthering some flaming cause.

Of course, I can enjoy the arrival of a badly belated reform. I have chuckled over the removal of the utterly useless traffic lights at West Hartford Center, where I live, and I expect to enjoy gloating over some other things, such as the eventual silencing of the National Broadcasting Company's wearysome gongs, and the appearance of a decently marked road in New Jersey.

Furthermore, I grinned with the rest of you when David Grimes publicly chal-

I worked for one once. We were so busy being impressed with a lot of ardent needs that we were not able to go ahead with any work on the cures that were in sight.

WHY WE KEEP RIGHT ON BEING WRONG

Maybe a reformer is necessary; once in a couple of years he does present a good idea, but I am afraid that most of the time he is talking without much information.

The radio manufacturer gets his full share of this sort of thing. Every one is able to tell him what is the matter with his product and methods—and none of them is as familiar with these things as he is. If he is any sort of a manufacturer he will, of course, listen to critics, just because they *do occasionally* offer a good idea, but he doesn't depend on them. He is digging out ideas and testing them whether anyone demands it or not.

His product, if he remains in the game, shows the effects of these searchings. If this is sometimes not too evident it is perhaps because we do not appreciate the why of some things that are built into the product.

THE SHORT-WAVE TUNER FOR EXAMPLE

Take the short-wave tuner as an example. Pretty consistently our short-wave tuners are made to cover a variety of ranges and quite as consistently they use two tuning controls or one control and a vernier. In addition they quite regularly use a regeneration control.

Is someone asleep at the switch? Isn't it time to get the things cooked down to one control and to throw out the regeneration control just as has been done in the broadcast-range tuner? Is this not a case where the manufacturer has clearly been dozing?



"I am not a reformer."

lenged KDKA's right to the resounding title of "Pioneer Broadcasting Station of the World" and suggested that East Pittsburgh, Pennsylvania, is not the whole world.

But these things do not make me a reformer; I have no wish to rush out and correct a lot of things this afternoon. A reformer may be a necessity, but he is uncomfortable to have around the shop.

I think not. On the contrary, I think that the better short-wave tuners like the Super-Wasp show an amazing amount of performance with very limited equipment, which is sound engineering. Their performance can be improved—it will be improved—but not until the market pays for those improvements. Furthermore, the improvements will be surprisingly costly to make.

This is not idle talk. The facts are before us to choose from. Advanced designs exist at this moment; we would build the 1932 short-wave tuner today if the market would pay us about \$600 each for such tuners.

Does the price sound insane? Let us analyze a bit and see if it really is.

What are we to demand of the 1932 tuner? The answer is ready enough: single control, no regeneration control and enough tuned R. F. to make up for the absence of the regeneration control,—and more.

Simple, isn't it? Suppose we try to do it and see.

GANGING TROUBLES

The modern broadcast receiver of the Pre-Selector type uses about four tuned circuits at the least, sometimes as many as six. Let us take the simplest case because good design will admit of high-grade performance with four tuned circuits. This means that for the ONE tuning range of 550-1,500 kilocycles we have four tuning condensers and four coils, all carefully matched.

The process of matching is, with minor variations, as follows:

- A—Condenser sections are made as nearly alike as is economical.
- B—The sections are measured and sorted into groups that are still more nearly alike.
- C—Gangs are built from sections of the same group.
- D—Coils are built as nearly alike as possible.
- E—The coils are measured and sorted.
- F—Coils from the same group are put into the same set.

Vol. 3, No. 2, Radio Design

G—The remaining irregularities are taken out by means of "trimmer" condenser adjustments.

All that for just four coils and four condensers in ONE tuning range!

Now, suppose that we started to make such a tuner cover the range that is handled by a dual-purpose tuner of the Super-Wasp type. Since it is not especially practical to tune four circuits separately we will need to gang all the controls; the demand was for a single-control tuner, anyway.

Now we know at the start that one coil cannot possibly tune from 16 meters to 550 meters, which is the range we have to cover. We know that our tuning scales will be very crowded at the short waves if we

we attempt to tune more than about a 2-to-1 range with one coil. Thus we can cover

16- 32 meters
 32- 64 meters
 64-128 meters
 128-256 meters
 256-512 meters

Actually we cannot do exactly this. In the first place we MUST allow a little overlap between coils to make certain that there will be no gaps. In the second place the coils just listed break at very clumsy places. The ordinary broadcast band is cut in two and several other groups of stations are split.

A practical arrangement is to use five coils to cover the range from 15 meters to



"Is someone asleep at the switch?"

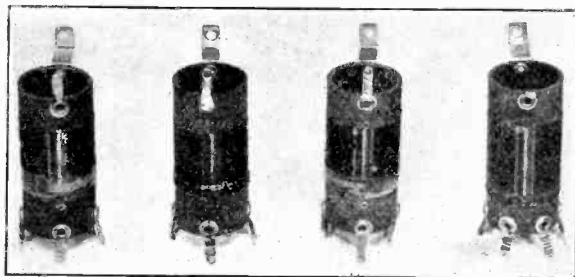

The four coils used in the Pre-Selector. Getting these matched is a comparatively simple job.

550 meters. This can be done and is being done.

"TRY AND DO IT"

Now then, we will go back and try to fit such a set of five coils into EACH of the FOUR tuned circuits in our nice modern Pre-Selector. First of all we realize that this means

5 coils \times 4 tuned circuits = 20 coils!

Think of trying to keep them straight. If we let them lie around loose the whole table is full of them, and if we build them all into the set it will be enormous.

Besides, a set with four tuned circuits has a great deal of R. F. amplification, and the shielding must be good. We will need to take off a lot of shielding before we can even start to pull out four tuning coils and put in four other tuning coils, after which the shielding is all to be replaced before we can proceed with our nice simple one-control set.

Even then, this is simple compared to the job the manufacturer has in trying to make the four tuned circuits run together with five different sets of coils. He cannot even use the same method that was used before: touching up the final irregularities with trimmers. This will not

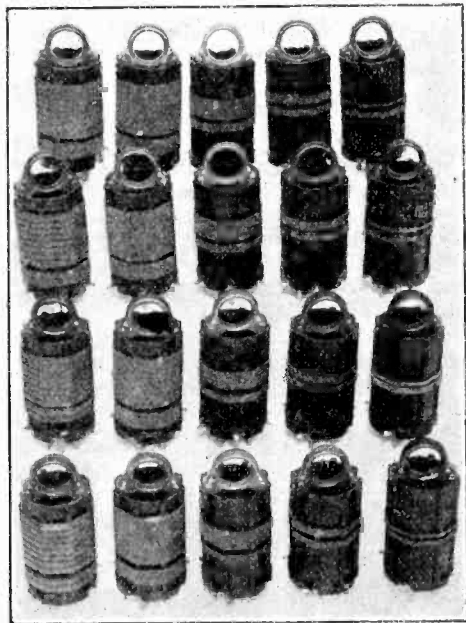

If the regenerative detector is eliminated, you will need all these coils in a T. R. F. set to get equivalent results!

serve when the coils are exchanged because each set has *different* irregularities. Thus one would need to re-align the set each time the coils were changed. This means that we do not have ONE tuning control but FIVE tuning controls—worse than the old three-handed neutrodynes ever were.

THE POSSIBLE WAYS OUT

There are several ways out. One can, of course, make the coils and condensers so carefully that they will actually exchange without re-trimming. This means a good deal more care than is taken in the usual broadcast-tuner construction; therefore it means more cost, especially as the process is applied to twenty coils instead of one set of four. It can be done—it has been done—but the tuner was found to necessitate a retail price of \$400 without counting a final audio stage, loud speaker, or cabinet.

We are still in the habit of regarding dual-purpose receivers as auxiliaries and insist on proportionate prices. We are not paying \$400-\$600 for them. Of course, later on we will quite probably have dual purpose receivers that will be made at costs much below \$600, just as Ford last year made 1,340,000 cars at a cost vastly below what the first few of the series A cost him. Even then it is a perfectly safe prophecy that these improved short wave-plus-broadcast receivers will not be sold at \$35 or any price near that. We will be lucky if we get it for the price we now pay for a broadcast receiver, which does only part of the job.

Meanwhile, therefore, we must concede something to cost and convenience, and in the end it will develop that we are not conceding as much as one might think. We will drop out one of the tuned circuits and see if three instead of four will offer any relief. A very little thought will show that it offers almost no improvement at all. Very much on the contrary, we must now match MORE carefully to make up for the loss of one tuned stage.

Clearly, we do not obtain any financial relief until we go to two tuned circuits, either with separate controls or with a unified control and a vernier. Instantly our trimmer condensers go overboard. We no longer need them because every tuned circuit is now controlled completely from the panel.

WHAT HAS HAPPENED TO THE GAIN?

But, say you, what about R. F. gain? We started out with four tuned circuits and now we have but two—our R. F. am-

plifier must have gone to pieces in the process. Fortunately it is not as bad as one would think. We started with four tuned circuit:

- A- {
- 2 tuned circuits ahead of the first R. F. tube.
 - 1 ahead of the 2nd R. F. tube.
 - 1 ahead of the detector (Cost about \$400.)
 - No regeneration.
 - Total of one main control and at least 3 verniers.

Thus we had two stages of R. F. and a non-regenerative detector.

The new setup just suggested is:

- B- {
- 1 tuned circuit ahead of the first R. F. tube.
 - 1 tuned circuit ahead of the detector.
 - Two main tuning controls (Cost about \$35).
 - Regeneration—to be decided on in a moment.

Obviously our selectivity is a bit less than before, and in the broadcast band we will miss that quite severely, though not enough to make us sorry for the saving of \$365. Obviously, also, our gain is less than before and we must make sure that it has not gone down too badly. In the broadcast band it is not uncommon to get voltage gains of 40 per stage, or even 60, which drifts down gradually as we go to shorter and shorter waves until we can expect about 10 per stage at 20 meters and as little as 6 per stage at 15 meters. Dropping out our one stage of R. F. has not been so terrible at that; we have lost only about 50 at one end of the scale and about 6 at the other end. Regeneration will easily make this up for us. We can, in fact, secure gains as high as 500 by the use of regeneration if we have patience enough and there is no static to trigger off the delicately adjusted detector. It is quite easy, without any critical adjustment, to gain 100 by means of the "regenerative contribution," and there is your 50 back again with 100% interest, while at the low end, 15 meters, we are as well off as if we were using five or six stages of R. F. because regeneration has the very pleasant habit of working very neatly at wavelengths all the way down to 5 meters while tuned R. F. gets flatter and flatter and finally quits us altogether at about 10 meters. (Special tubes can be made to work further down as R. F. amplifiers, but the present ones are not suitable.)

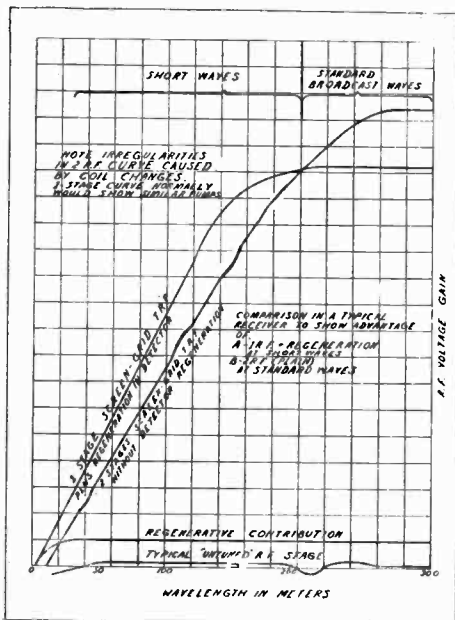

The advantages of regeneration on the short waves are made quite plain by a comparison of the two curves above.

So then, we have the curious result that at the SHORT short-waves we are actually better off with our \$35 tuner than with the \$400 one. Let us twist the dials of it, and the regeneration control as well, and be content with the saving of 365 dollars!

Have I seemed to sell you any particular make or type of tuner? I suppose that I have; but that has been altogether unintentional and only the natural result of taking you over the route that many designers have traveled before, always with the same conclusion except as to details of design and of the audio amplifier, and of the ease of construction and operation, which are things that are a separate story, told elsewhere for each tuner. At least we have wound up with a tuner using TUNED R. F., not one of the "fixed input" type. We have therefore a gain ahead of the detector that amounts to something, for recollect that our detector is a "square-law" detector and that an R. F. gain of even six means much to such a detector—as much as a gain of thirty-six would mean ahead of a "power" detector such as used in most broadcast receivers. This is easy to prove: just remove the R. F. tube and couple the antenna to the detector, and then attempt to hear G5SW, PCV or NRH. The resulting silence is

(Continued on page 47)

How The "Pilot Radio" Made The First Bermuda Flight

The Full Story of the History-Making "Hop" in Which Radio Played an Important Part, Told by the Radio Operator Himself.

By ZEH BOUCK

ONE of the primary objects in the promotion of the recent flight to Bermuda was to determine the extent to which reliable communication with land might be maintained on an over-ocean flight. And when I write "reliable communication," I refer to a continuous interchange of messages between the plane and land, comparable to the traffic handled by an ocean liner. That this object was achieved is demonstrated in the fact that while over fifty messages were handled, back and forth, between WHD, the radio station of the New York Times, and W2XBQ, the airplane "Pilot Radio," not a repeat of a single word was requested. The signals received on plane and land suffered from practically no diminution throughout the eight-hundred mile flight.

One of the last messages transmitted from New York, just before the plane alighted in Murray's anchorage, Bermuda, was to the effect that the signals were every bit as consistent and powerful as when we took our departure from Scot-

land Lightship the day before. As for WHD's signals, it was impossible to tune in this station to full strength, as the signals were painfully loud.

TRANSMITTER AND RECEIVER DESIGN

The transmitter and receiver were built in the laboratories of the Pilot Radio and Tube Corporation, sponsors of the flight, and the plane used in the flight was their flying laboratory. The problems confronting us were those of electrical efficiency, weight and space. Electrical efficiency involves several angles, including the ability to transmit and receive over long distances, and the necessity, from the point of view of safety, of being able to operate for a reasonable period of time from the surface of the sea.

The problem of weight is omnipresent in designing aircraft radio equipment. Space was a matter of convenience and comfort, and was both psychological and physical. A comfortable radio shack is almost essential to efficient operating.

Two transmitters, combined in one unit,



The "Pilot Radio" as it appeared after landing in Hamilton Harbor, Bermuda. Yancey and Alexander are standing on the port pontoon, and Bouck is sitting on the wing strut.

A Splendid Feat of Aerial Navigation!

ON THE morning of April 1st, 1930, the airplane "Pilot Radio," fitted with pontoons instead of its usual landing gear, and carrying William H. Alexander, Zeh Bouck and Captain Lewis A. Yancey as its crew, took off from Flushing Bay, Long Island, with the tiny island of Bermuda as its goal. This feat, never before attempted, has been considered by many fliers as a more difficult and dangerous undertaking than flying to Europe, as the island is only nineteen miles long and is a mere speck in the ocean.

Faced by darkness when only sixty miles from Bermuda, the three intrepid aviators made history by alighting on the ocean, spending the night on the tossing waves, and then taking off in the morning without assistance. On the morning of April 2nd, the plane made a triumphant entry into Hamilton Harbor, to the wild acclaim of the excited populace.

This flight was a splendid tribute to the navigating of Captain Yancey and the piloting of "Bill" Alexander, but in the minds of the public its most interesting feature was the remarkably steady radio contact maintained between the plane and New York. Zeh Bouck, well-known to the readers of RADIO DESIGN, sent a constant stream of messages back to the New York "Times," allaying the fears usually felt for adventurous fliers who skip off into the sky and remain unheard from until the time they land safely—if they do land safely. The flight demonstrated more forcibly than ever the value of a properly designed aircraft radio installation properly handled by a capable operator.

Because of the lack of facilities in Bermuda for repairing the damaged pontoons, the "Pilot Radio" and its crew returned to New York by steamer. By the time this number of RADIO DESIGN reaches you the plane will already have started on the South American Good Will Flight described in the Spring issue.

were carried, covering both long and short waves, the long-wave transmitter being effective between 600 and 1,100 meters, and the short-wave transmitter covering a band from 35 meters to 50 meters. Changing from long to short waves was accomplished by switching over inductors, the same tube and meter combinations being employed on all wavelengths. In addition, an exterior loading coil was used for transmitting on wavelengths above 700 meters. A Hartley oscillator was employed in both transmitters.

The receiver was mounted on a sliding shelf below the transmitter, both receiver and transmitter being combined in a single suspended unit. The receiver was mount-



Welcome home!

Left to right: Yancey, Alexander and Bouck, sitting on one of the pontoons of the "Pilot Radio" on the upper deck of the Royal Mail steamer "Araguaya," photographed on their return to New York on April 10th, 1930.

The wings and tail surfaces of the plane were removed in order to make the body fit on the steamer.

ed below the transmitter in order to provide the greatest possible isolation of the short-wave transmitter, and slides in and out on its shelf to facilitate changing coils. The receiver is a modification of the Pilot A. C. Super-Wasp, which is well known to all readers of RADIO DESIGN. A. C. tubes, operated in series through a suitable resistor, were employed in preference to the D. C. type in view of the lowered microphonic response.

THE POWER SUPPLY

Power for all filaments is supplied from a non-spillable twelve-volt storage battery, which also turned over the dynamotor feeding the transmitting tube with 100 milliamperes at 1,000 volts. The storage

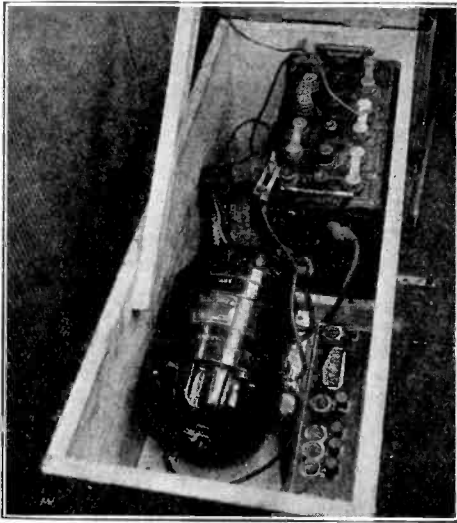

The power box inside the cabin of the "Pilot Radio." The 12-volt storage battery, charged continuously by the wind-driven generator on the body of the plane, operates the dynamotor, which supplies filament and plate current for the transmitting tube. The object in the lower right corner is a single 135-volt "B" battery block. When closed, the box forms a comfortable seat.

battery was charged continuously during flight (except during reception) by a wind driven generator driven by a one blade constant speed propeller. With this power combination and an emergency antenna, about ten hours of average communication is possible when the plane is down on water or land.

A convenient switch made it possible to disconnect the generator, eliminating commutator interference during reception. A send-receive switch on the radio panel controlled the filament and dynamotor, transferred the antenna from the transmitter to receiver and disconnected the plate voltage from the receiver during transmission. A separate filament switch made it possible to burn the receiving filaments while transmitting, eliminating the heating lag. The plate voltage to the receiver was supplied by a special aircraft unit "B" and "C" battery.

A trailing wire antenna was employed, measured lengths being indicated on the wire for different frequencies. The transmitter was operated, during the Bermuda flight, on 41 meters, the antenna being about ninety feet long and working on the third harmonic. This resulted in stable

functioning of the oscillator (somewhat unreliable on the fundamental with close coupling) and provided a highly satisfactory pick up when receiving.

The arrangement of the radio cabin is shown in the accompanying photographs and considers the convenience and comfort of the operator. There is plenty of leg-room under the folding desk, the key is located for comfortable operating, and all controls are at the fingertips of the operator. The cabin is well lighted by a window at the operator's left. There is no loose equipment. All spare parts are carried in closed shelves, and the entire layout is one that lends itself to electrical and mental efficiency.

THE FLIGHT

On the morning of April the first, 1930, with W. H. (Bill) Alexander at the controls, and Captain Lewis A. Yancey, our navigator, alongside of him, we taxied across Flushing Bay, New York, to Clason Point for our first attempt at a take-off. Our first four efforts were failures. There was practically no wind, and Long Island Sound was almost without a ripple. Under these circumstances it is next to impossible to break the suction under the pontoons and take-off a heavily loaded plane. Between attempts we lightened the ship by draining gas and discarding our anchor and kit of spare pontoon plates. Just before our fifth attempt a slight wind arose. We waited until two ferry boats crossed in front of us, to take advantage of the waves created in the wake, and Bill Alexander gave her the gun. As she gained speed, George Post, in his Travel-air, taxied across our path, wide open, throwing up a choppy sea that helped considerably. In another second the "Pilot Radio" was on the step, the bumps becoming sharper and sharper as the air speed indicator rose from fifty to fifty-five, sixty, sixty-five, seventy, seventy-five miles an hour. One more sharp rap on the pontoons and we were off. We gained altitude rapidly and cleared the bridges in good style, Post tagging along with us as an escort.

Half way down the East River, I crawled aft into the radio room, let down ninety feet of antenna and called WHD, the New York Times radio station, and sent my first message at 9:54 A. M. to Police Commissioner Grover Whalen, thanking him for the cooperation of the New York City police in getting us underway from North Beach. At 9:55 A. M. we announced that we had swung into our course just off Staten Island, heading along a line of buoys that run 138° true.

At 9:58 we took our departure from Scotland Lightship.

About this time, WHD wanted a list of the provisions on board. We carried rations for five days, and radioed the following:

"Rations on board consist of two broiled chickens, four boxes wholewheat crackers, five pounds chocolate, twelve oranges, five gallons water, one quart of Scotch."

This message was published and transmitted, and the last item for some unknown reason created a bit of excitement. This was, I must assure you, a perfectly legitimate part of our medical stores.

About this time Yancey wanted to take a sight, which was a most efficacious way of shutting down the radio. In taking sights, Yancey opened the top of the plane, admitting a hundred-mile-per-hour blast of cold wind that worked havoc with the papers in the radio cabin, to say nothing of the good right hand.

Sights are taken from an airplane in pretty much the same way they are from a ship, only in bumpy weather, such as we were experiencing, it is considerably more difficult. A bubble sextant is generally employed, which provides an artificial horizon. Captain Yancey used Longines chronographs, which are pocket chronometer to check time. Three chronographs are carried so that, if any one of them changes its daily rate of variation, it is immediately identified by reference to the other two. Our first position report was radioed in at 11:35 A.M., New York time, as follows:

"At 16:07, Lat. 39:31. Long. 72:50, Course 138, true speed 76 knots."

LANDING ON THE OCEAN

And so went the day. We were in constant contact with WHD, signals at both ends showing absolutely no diminution as the "Pilot Radio" pushed the miles away with the back wash of her prop. As evening approached, it appeared doubtful if we could make the Island before dark due to the fact that our speed had been cut considerably by unfavorable winds. A landing in Bermuda at night was a hazardous possibility, and we went into a quick huddle. I told Iverson, radio operator of the *Times*, that if we did set her down, I'd sign off for the night, rather than rig an emergency antenna to the wing tips, and "see" him again shortly after five the next morning. At 5:20 we sent the following:

"If we don't see the Islands pretty soon will set her down for the night. If we have to set her down for the night, don't

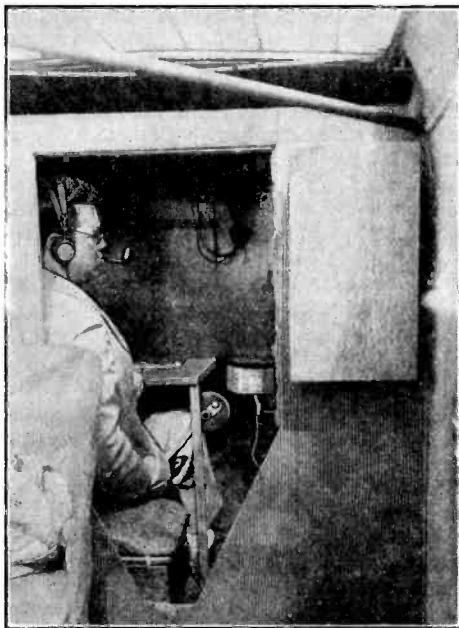

Looking backward from the pilot's seat into the radio cabin, where Zeh Bouck is shown with the earphones on. The inside of the plane is well lighted because of the transparent pyralin top.

let anyone worry about us. The sea is like a lake."

At 5:50 we signed off with: "Setting her down right now. Position sixty miles north of Bermuda. Tell everyone not to worry. Please notify my wife and Goldberg. Sea calm, very. Will continue to Bermuda in the morning. Did you get all? See you five A. M. tomorrow."

And Bill set her down. From above, the sea may have looked "calm, very." But close to the surface it was another proposition. It look the finest sort of piloting, and Alexander had it, to put her down on that heavy ground swell without a crack-up. The pontoons stood the gaff perfectly. As we came to a stop, broached to on a rolling sea, Bill acknowledged our congratulations with:

"Gentleman, I'm going to be sick." He was.

A half hour later it was pitch dark, with only the stars and the stingy sector of a pale moon. This set around nine o'clock. We maintained three watches when we weren't sleeping. Yancey slept well. I dreamed of railroad trains and Bill of stomach pumps. We sighted the lights of a steamer at three different

times, and finally, considering the possibility of its being a ship out from Bermuda to look for us, signaled her with a Very pistol. Two hours later she hove to. At first we talked with blinker and then hailed her. She was the *Lady Sommers*, requested by Bermuda to keep a weather eye cocked for us, and too much credit cannot be given her master for his fine seamanship and sportsmanship. We requested that she report that everything was okay with us and that we would proceed to Bermuda at dawn.

A HISTORY-MAKING TAKE-OFF

At daybreak we cleaned up the cabin a bit, tightened up a stay wire on the pontoon struts that had been loosened in the stress of landing, and took-off. Here again Bill showed his mastership of a ticklish job, and for the first time in the history of flying a plane forced down in the middle of the ocean took-off again.

Five minutes later I came in for the greatest thrill in my life. I reeled out the

antenna, gave WHD a short call, threw the switch over the receiving side, and he was back at me in an instant, as loud and clear as when we were over the East River! This was at 5:50 A. M., New York time, on April 2nd. A half dozen messages flashed back and forth between the "Pilot Radio" and the New York station. Iverson told us that the more flagrant of the New York papers had given us up as lost, which news amused the lads up forward. At 6:17 we sent through the following message:

"Bermuda sighted dead ahead at 6:15

Right: The course followed by the "Pilot Radio" on its epochal flight to Bermuda. Below: The editor of RADIO DESIGN examines the little wind-driven generator that charges the storage battery inside the cabin.

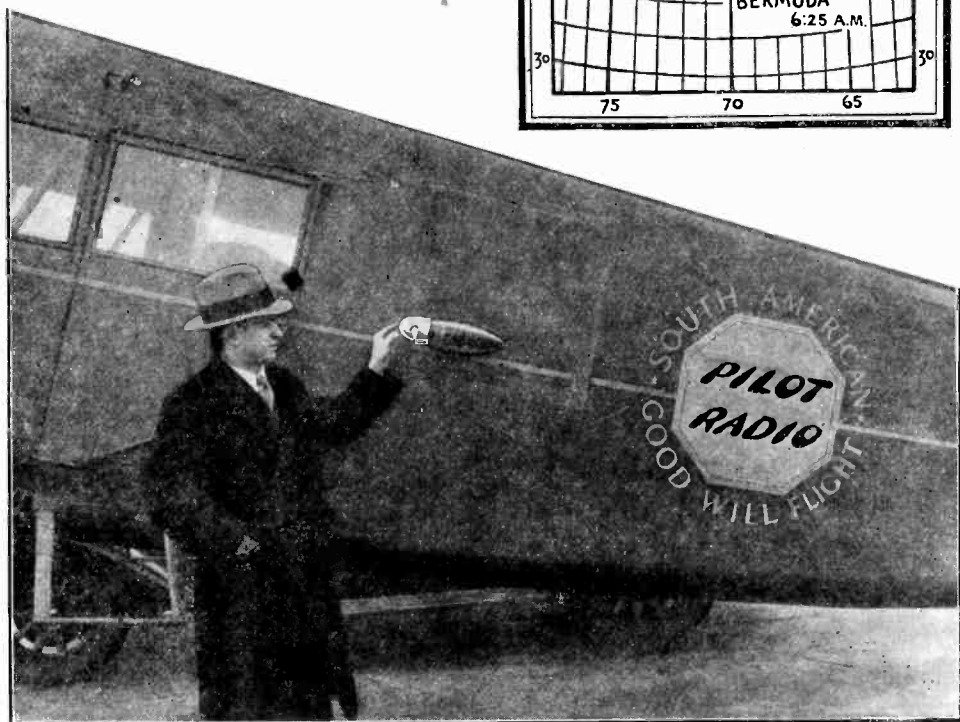
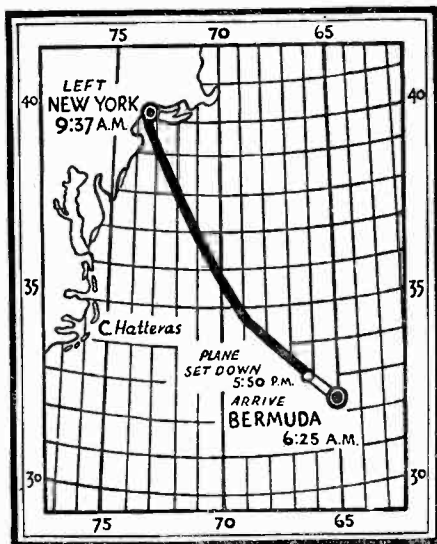

New York time, about thirty miles off," a simple, but eloquent tribute to the finest aerial navigator in the world, Captain Lewis A. Yancey.

CONCLUSION

From the radio point of view one of the most interesting observations was the absence of skip-distance effect. In a pre-flight conference with Fred Meinholtz, engineer in charge of the New York *Times* station, we roughly guessed that the signals from the plane would be lost at about five hundred miles out. It seems apparent, and reasonable, that the distance with which the skip-distance effect becomes noticeable is a function of the altitude of the radio station.

There seems little necessity for carrying long-wave transmitting equipment on trips of this nature. An airplane flying over water should be *in constant contact with a land station*—a contact which it seems is best maintained via short waves. In case of emergency the SOS can be most expeditiously handled by the shore station, without the loss of time and general confusion that often accompanies a distress call transmitted directly from sea. The elimination of the added weight makes it possible to increase the power and efficiency of the short-wave transmitter. A master oscillator design is recommended by the author, and with a modified trans-

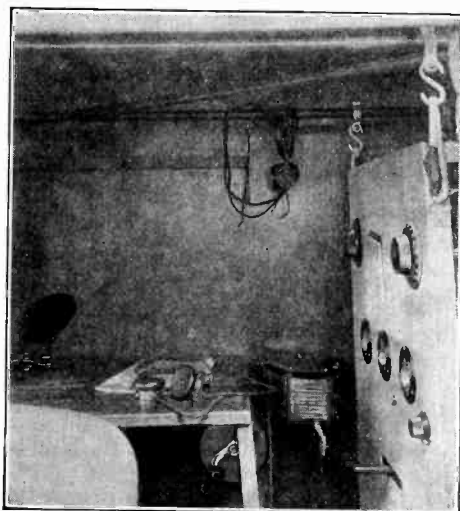

A close-up of the radio panel and operating table inside the "Pilot Radio." Notice the shock-cord suspension of the panel, the antenna reel under the table, and the transmitting key in the far left corner.

mitter along these lines, the now famous "Pilot Radio" will take off on the first commercial good will tour of South America about the time this magazine reaches your hands.

Last Minute News of the South American Flight

The "Pilot Radio," carrying Capt. Lewis A. Yancey as navigator, Zeh Bouck as radio operator and Emil Burgin as pilot, left New York on May 14, 1930, on the first leg of its South American trip. An extra passenger who went only as far as Washington, D. C., was Mr. I. Goldberg, president of the Pilot Radio & Tube Corporation. The four men met President Hoover, who wished the fliers good luck.

Yancey, Bouck and Burgin then hopped off for Miami, Florida, and continued from there to Havana, Cuba, Yucatan, Mexico City, Managua (in Nicaragua), and thence to the Canal Zone. Here Bouck established something of a record when he got in direct touch with the New York *Times* radio station in New York, a distance of 2,500 miles.

At the time this issue of RADIO DESIGN went to press (second week of June) the fliers were preparing for the next jump to Peru.

A Few Wrongs to Be Righted

(Continued from page 41)

very instructive, to say the least. Even the two-stage audio amplifier in our short-wave receivers has a good reason for existence; namely it permits us to work the detector at a low level where we get the benefit of the square-law just mentioned and in addition are able to make regeneration work smoothly and controllably.

These things are perhaps all transient, but I judge that it may have been interesting to you to run over them with me and to see how the regenerative detector—abandoned at broadcast wavelengths—is a highly useful tool at short waves. If in the process we have also discovered that the manufacturer is in this case not a stick-in-the-mud but an astute judge of value—well and good. I told you that I was not a reformer and got no delight from throwing bricks.

Who Invented Broadcasting?

Further Light on the Activities of Some of the Early Experimenters Whose Work Forms the Foundation of Present-Day Radio: deForest, Dubilier, Stearns, Logwood, Gowan, Cockaday, Conrad, and the U. S. A. Signal Corps

(Second and Concluding Part)

By DAVID GRIMES

UNEARTHING information concerning the scientific achievements of early broadcasters is both interesting and exhausting. There hasn't been an important discovery in the past fifty years without its fringe of co-inventors and even wider circle of claimants. Periodicals and books in general circulation have more to do with this than any other cause. A single article in a "fan" publication will start dozens of readers off to perform all sorts of circuit gymnastics. So important has this phase of development become that the large corporations hesitate to disclose recent engineering work until there is some feeling that the work has been fairly well covered. Otherwise, the casual experimenter will pick up the loose ends and perhaps carry the work through to completion before the more slowly moving laboratories who have started the program are able to finish it.

And so it has been with early broadcasting efforts. In proportion to the amount of information that leaked out on Dr. de Forest's broadcasting efforts, the number of local geniuses all over the country increased. Many of these acquired nation-wide fame, while others only received credit in their local newspapers. Apparently the famous date of January, 1910, established by the Doctor, the details of which were related in the late issue of *RADIO DESIGN*, stands alone and unchallenged.

WHAT IS A BROADCASTING STATION?

It is desirable to clarify at this point just what is meant by the first broadcasting station. The mere transmission of the human voice, or even phonograph music, by radio does not constitute in our mind a justifiable claim to pioneer broadcasting. After all, de Forest transmitted speech and "canned" music over the air long before his famous January, 1910, date. The very idea of broadcasting, in view of its present development, conveys the thought of well-known artists performing over the station for the benefit of the listener and on more or less regular schedules. One of

our readers presented some interesting data on early radio broadcasting by Reginald Fessenden around 1907, but close study of this seems to confine the efforts entirely to radio telephony as distinct from radio broadcasting. For, after all, early radio telephonic tests were carried on even before 1907.

Among all the letters received from various sections of the world, none has revealed an earlier date than January, 1910, for a real broadcasting station. But this does not detract from the interest of the tales told by many of those who knowingly or otherwise were emulating the great de Forest. Many important improvements in the art were fostered by these pioneers. After all, if the younger enthusiasts hadn't kept trying to make a success of radio broadcasting, it would never have arrived.

In that way, life is peculiar. The very first venturers soon weary of the public's phlegmatic reactions, and try their abilities in other fields. The other fellows less familiar with the details of past failures to arouse the necessary interest proceed and often succeed. Some of you will recall the first talking movies which went out over the vaudeville circuits before the war. Edison invented and developed them to a point where they were at least presentable. The public reaction was somewhat adverse, so Edison did not attempt them again. Shortly after the war, Dr. de Forest, who had become somewhat discouraged with broadcasting, took up the talking movie cause, adding vacuum tube amplifiers on both recording and reproducing. Pictures under this process were shown on Broadway about 1923 under the name of de Forest Phonofilm. De Forest's system differed in another way. He employed the film for recording the sound instead of the phonograph record. But whether or not these additions had anything to do with the subsequent success is beside the point; the public at this time was on the verge of being interested.

There is something very dramatic about this whole story. Here is the radio pioneer

who was a mere "voice crying in the wilderness," who was not able to popularize his broadcasting inventions, coming along and succeeding in the talking picture field where the electric light genius had become discouraged. Such experiences serve to better illustrate the fickleness of fame.

It is becoming well nigh impossible to give a comprehensive report on all the early broadcasting efforts. The number is apparently legion. Many other writers in the past have attempted to do likewise, and have met with similar experiences. Every mail brings in new anecdotes and pre-war broadcasting stories. One thing is certain: there were about as many broadcasting stations erected before the war and which passed out of the picture as there were after the so-called broadcasting era started in 1921. So we have decided to choose only those installations which were connected with well-known names, or which had some interesting story associated therewith.

DUBILIER'S BROADCASTING EXPERIMENT

There is no radio experimenter in existence to-day who has not heard of the name William Dubilier. So long has he been

identified with condenser manufacturing and fixed condensers of all sizes and descriptions that his name and condensers are practically synonymous. First he became famous as the guiding light of the old Dubilier Condenser Company, and later was associated with the Dubilier Condenser and Radio Corporation. Yet few except the old timers ever connect his name with early broadcast efforts, although he was one of the first. Dubilier's experiments were carried on up in the Northwest country. Seattle, Wash., papers of the time carried much news of the young inventor, and mention was made even in the editorial columns. "Bill" was initiated into the radio business through these first efforts back in October, 1910. The station was no second-rate affair either even though it didn't operate on any regular schedule. Reports were recorded in the daily press of good reception as far away as 75 miles. The electrician in the government navy yard reported excellent volume and quality at his location, a distance of 45 miles from Dubilier's antenna. And please don't overlook the fact that this reception was accomplished entirely on crystal sets with no amplification whatever. Some station!



2XK, a famous station during 1921-1923. E. J. Quinby is shown playing the organ and singing, while L. M. Cockaday operates the modulation control. Regular vocal and instrumental concerts were broadcast every Sunday evening.

Technical reports of the time state that Dubilier used a special type of "oscillating" spark of his own design. It was a very ingenious affair, according to all accounts, and served to stamp the imprint of outstanding ability on its inventor at that early date.

Then there was the radio telephone broadcasting station owned and operated by the John Wanamaker store in New York. This station commenced operation in May, 1914, using a rather unusual type of hydrogen arc light for generating the high frequency carrier wave. The old Wanamaker organization became famous, in the scientific world, through sponsoring scientific infants in several fields of endeavor. This is probably the first case of record where a department store employed radio to increase its public goodwill and prestige. Now many of the best stations are nurtured by mercantile organizations, and the Wanamaker store in Philadelphia still maintains its radio interest.

Up to about this time little or no thought had been placed on wavelengths. Amateurs and experimenters chose what ether channels they desired and plugged away with signal strengths governed only by the size of their pockets. Commercial communications between ships were being interfered with to such an extent that something had to be done. An international conference was called in 1912 to discuss the entire situation, and out of this grew certain regulations which governed affairs very well until the broadcast era started in 1921. This nebulous condition of affairs at the start explains the lack of wavelength and power data on early transmitting stations. The author can well remember his first radio transmitting experience back in 1912 at Min-

neapolis, Minn., when wavelengths were guessed at by turns on the helix rather than by instruments.

Of course, starting with the 1912 conference, the radio transmitting industry worked its way gradually out of the chaos. All known wavelengths were divided into three general groups for government use, commercial use, and amateur or experimental purposes. The classification between 600 and 1,600 meters was reserved for government work; the group of waves between 200 and 600 meters was set aside for commercial messages; while the channels below 200 meters were left to the amateur and experimenter. It was at this time that the United States was divided into nine radio districts for supervisory purposes. Government licenses had to be secured specifying power and wavelength for every station.

Shortly after the Panama-Pacific Exposition at San Francisco in 1915, Morton W. Stearns opened up a radio telephone station on Washington Heights, New York City, under the call letters 2AB. Successful tests were carried on for a considerable period of time until our entry into the war closed all independent radio operation. Speech and phonograph music were transmitted from time to time, and the music, on at

Heard a Concert, by Wireless.

Ether was busy on the evening of June 16, when an enjoyable concert was given under the auspices of the Super Radio Corporation, Station 2XK, New York City. Especially novel was the fact that the entertainers, all Yonkersites, assembled at the sending station, 2,674 Bayley Avenue, New York City, and rendered the program which was transmitted far and wide by wireless telegraphy. Samuel B. Mason, a foreman in the employ of the New York Telephone Company who has a fine receiving set at his home, 456 Bellevue Avenue, says he heard the concert at his residence, the vocal and instrumental music being transmitted very clearly. Exceptionally clear was the voice of the station operator who introduced the entertainers to their audience, gathered in all parts of the State.

The entertainers were the Rivoli Orchestra, the Rivoli Saxophone Quartet, Mr. Dennison, violin, and his accompanist, Mrs. Mocolist, organ. The concert, which included such popular selections as "Love's Old Sweet Song," "Mighty Lak a Rose," "I Used to Love You," "Sleepy Hollow Waltz," "Pekin," etc., began at 9:30 and lasted until 11:30.

Reproduction of a clipping from a Yonkers (N. Y.) paper of 1919. Certainly of historical interest!

least one occasion, was picked up at Morristown, N. J., for a dance. Stearns' station is mentioned because of an interesting fact and not because of the music and speech transmitted, which was no different from dozens of other experimental stations of the time which limited space prevents us from mentioning.

THE FIRST SPONSORED PROGRAM
The story runs something like this: A

Vol. 3, No. 2, Radio Design



Another view of 2XK. Phonograph music was featured every Thursday evening, and was highly popular with amateur listeners. Compare this pioneer station with huge plants in operation today.

certain phonograph inventor displayed his product at the World's Fair at the mentioned. He and his company were relatively unknown but, in spite of this, their instrument received First Prize at the exposition. It was called the Crippen Interpretone. Well, in the course of time, the Crippen Company heard of Morton Stearns' radiophone station. Conferences followed during which one of the new phonographs was promised as a gift if Stearns would only mention its name when he played it over the air. The machine arrived in due time and was played according to arrangements, accompanied by appropriate announcements. Thus, what was probably the first "sponsored" program was born—the beginning of modern radio advertising.

The next step finds us back with Lee de Forest, aided by Charles Logwood and Robert Gowan. Our last article shows how de Forest became rather discouraged on radio broadcasting as an entertainment business after his Metropolitan Opera House experiment. We also stated that this served to discourage others who had financial aspirations along this line. But here we are almost seven years later in the late Fall of 1916, back with the

Doctor, who is once more endeavoring to arouse public interest. The station on this occasion was located at New Rochelle, N. Y., and, of course, at this period had definite call letters. The call was 2ZK, and the wavelength was 420 meters. Sometimes the call letters 2SK were employed.

The most astounding feature of this particular station was the use of a vacuum tube as an oscillator in place of the old cumbersome electric arcs used in previous attempts. The "oscillions," as they were called, were blown in de Forest's own laboratory at Highbridge, in the Bronx. The tubes were operated in a red hot condition, attempts being made to cool them by blowers. "Charlie" Logwood made his first reputation on this job when he worked out the system of grid modulation for impressing the program on the carrier wave.

DANCE MUSIC BY RADIO!

Every evening during the winter witnessed a regular radio program transmitted for a range of 150 miles. It went out from nine to ten P. M., and varied from Edison Disc records, because of their volume and quality, to banjo selections by a well-known vaudeville performer of the

day, Harry Hicks. On one evening, special arrangements were made to send out the music for a dance in Morristown, N. J.,—apparently a similar stunt to that just described in connection with Stearns' station. Morristown must have been an up-and-coming community in those days! De Forest, himself, rigged up the "loud speakers" at the dance. The installation consisted of six earphones connected to horns. Great credit is due the designers and builders of 2ZK because, from the first night on the air to the forced closing on account of the war, there was not one breakdown in the operation. Quite a record considering some of the fiascos hung up by the so-called pioneering stations in 1921-22.

Until the close of the war, all radio entertainment was at a standstill, in fact, it just didn't exist. War necessity regulated all private transmitting and receiving equipment out of existence. But immediately following the close of hostilities, Lawrence M. Cockaday, creator of many famous circuits, technical editor of *Popular Radio*, and lately technical radio

editor of the New York *Herald-Tribune*, started a broadcasting station with the call letters 2XK. Twenty-five watts of power were used, employing a push-pull oscillator and push-pull modulator. Not only has that station gone down in history because of Cockaday's connection with it, but also because it was probably the first to employ a 100% modulation circuit. Programs consisted mainly of phonograph music, although once in a while a real treat was given the listener. On one occasion in the first year the station was operated, the Rivoli Theatre Orchestra crowded into the small studio to entertain the amateur listeners over a 700,000 square mile area. Newspaper accounts of this particular event also listed the Rivoli Saxophone Quartet. We hope "Larry" wasn't the first to put saxophones on the air. Just think of the ignominy of it.

The year 1920 found Charles Logwood back in the limelight—literally as well as figuratively, for "Charlie" was busy installing and operating a radio broadcasting station for the California Theater in San Francisco. Apparatus was ordered

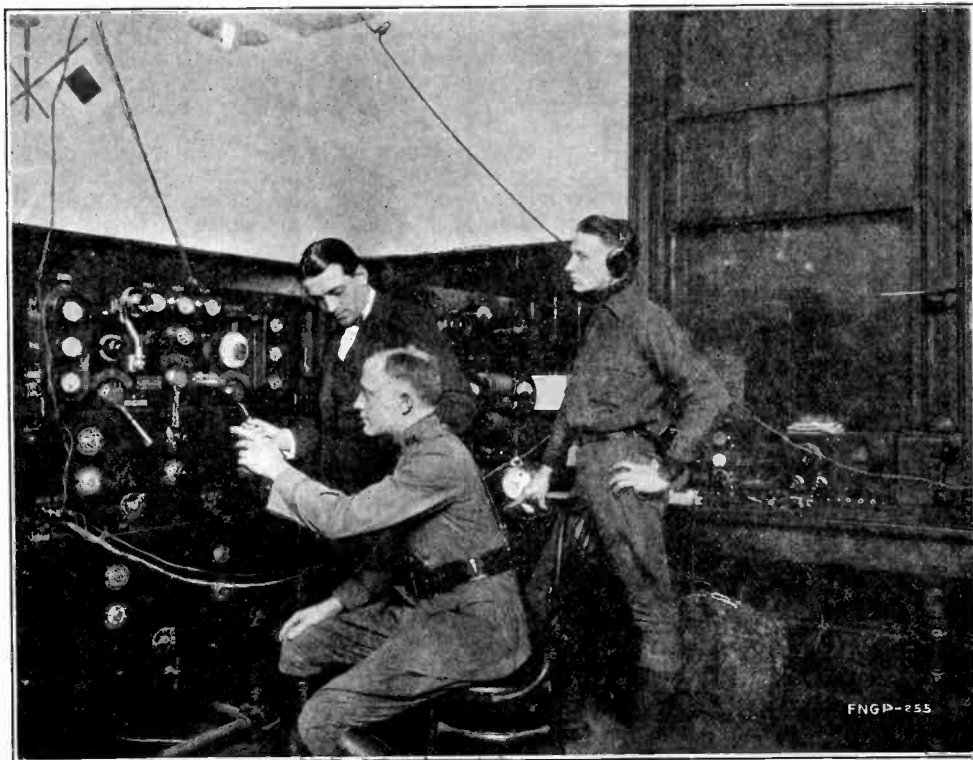

A rare photograph showing Richard Barthelmess, movie star, on the occasion of his radio debut over the Army broadcasting station on Bedloes Island, New York Harbor, during the winter of 1921. The apparatus shown is still in active use, but only for radio-telegraphic work.

from Lee de Forest, Inc., and Logwood was the company's representative on the scene. Much of the equipment was hand-made, a large portion of it being fabricated right on the job by Logwood himself.

The California Theater station was located over and behind the stage, and was reached via a rather long, vertical ladder. No studio was provided, but regular programs were sent out according to a published schedule. Even this installation was in operation before the advent of KDKA, which was officially opened for election returns by Frank Conrad on the night of November 2, 1920.

Radio broadcasting developed rapidly from then on. As many reasons for its sudden growth have been offered as there have been individuals to offer them. All are probably right, for the sudden popularization was undoubtedly due to all combined. There is, however, one great credit due to the Westinghouse Electric and Manufacturing Company, as we believe they were the greatest of all forces, which, combined, gave the necessary impetus to put broadcasting over. For the real broadcast boom didn't arrive for nearly a year after KDKA started,—not until Westinghouse had built a whole series of stations.

THE ARMY ENTERS THE PICTURE

But we are getting a little ahead of our story. In January, 1921, only a few weeks after KDKA started on its regular schedule, the U. S. Army Signal Corps opened up a powerful station, much better than many in operation to-day. The transmitting equipment, located on Bedloes Island, in New York harbor, in the very shadow of the Statue of Liberty, was operated with an input power of three kilowatts on a wavelength of 1,450 meters. Call letters WYCB were employed. It is interesting to note that most of these early stations went on the air for only one hour each night. That seemed to be standard practice in those days. Many notables were introduced to the radio listeners during those all too brief hourly programs from the Army station, among them being Richard Barthelmess, the famous moving picture star, and Jack Binns, famous radio pioneer. The amplifying equipment was designed by Lieutenant Howard S. Parrock. The station was operated by Edwin A. Redding, Jr., staff sergeant of the Signal Corps. In continual use to-day is that same transmitter, but only for the dot and dash code messages of the army.

After KDKA opened in November, 1920, it remained on a regular schedule one hour nightly. Similar to other stations which

had preceded it, a large local popularity was enjoyed. The Westinghouse Company had had lots of business on army radio apparatus during the war, and saw the commercial possibilities if the general public could be aroused. They set about that very task by erecting a series of stations on their various plants in different sections of the country. In September 1921, WBZ was set in operation at the Westinghouse plant in Springfield, Mass.—the following month WJZ was started at the plant in Newark, N. J., and in November of that year, the Chicago station KYW started on the Westinghouse works in that city.

The sudden surge of popularity can only be seen by viewing cold statistics. KWY of Chicago had just been completed in November, 1921. Two months later (January, 1922) there were 36 stations on the air, and by the end of the year there were 575. What chaos with all operating on or about 360 meters!

It was at this point that Herbert Hoover, as Secretary of Commerce, stepped in and added new laurels to his already long list of achievements. A series of voluntary conferences were arranged between all broadcasters whereby certain gentlemen's agreements were made for the broadcast industry, which had found itself in a "jam" through inadequate legislation. You see, the radio law of 1912 placed no curb on the number of stations; in fact, that law took no cognizance of broadcasting as such. For several years Mr. Hoover skillfully maneuvered these anomalous radio conferences until Congress became sufficiently aroused to enact proper laws. Mr. Hoover has always been much interested in the progress of radio. He was probably the first great public man to speak over the air when he first broadcast from KDKA in Pittsburgh on January 15, 1921.

CONCLUSION

This, we hope, will give you a bird's-eye view of broadcasting development. Many of the early stations have not been mentioned merely because there was nothing particularly interesting connected with them. Others that deserve mention there are undoubtedly, but we have not heard of them. This type of omission we know you will pardon. The present trend of broadcasting no one knows. We only know where we have been and not where we are going. If the picture presented herewith gives someone the necessary perspective to predict where we are going, these articles will have accomplished great good as well as offering some slight entertainment.

More New Parts for the Builder

Improved "Vaultype" Condensers; Power Units and Amplifying Transformers for the 250-type Tube; Microphone Transformer and "Pre-Selector" Coils.

WE ARE pleased to announce the appearance of a number of new Pilot products for the radio constructor and experimenter. These will be generally available in radio stores throughout the country by the time this issue of RADIO DESIGN reaches you.

NEW VAULTYPE CONDENSERS

The Vaultype condensers, which have already been on the market for several months, have been improved by the use of die-cast aluminum frames, which replace the pressed steel cases formerly used. The new cases are exceedingly strong and rigid, and may be fastened securely in any position without causing the condenser plates themselves to lose their alignment. The covers of the condensers, which were formerly also made of steel, are now being stamped of aluminum and are strengthened by a neat bead running around the top.

The electrical constants and overall physical dimensions of the condensers remain the same as before. The condensers are made in single, double, triple and quadruple units. Each section has a maximum capacity of .000365 mf. The calibration curve is of the centraline type, which strikes the best balance between straight line frequency and straight line wavelength. Each .000365 section is pro-

vided with a balancing condenser which, because it is grounded to the frame, may be adjusted with the fingers while the set is in actual operation. The insulation between the rotor and the stator is of molded bakelite.

For the benefit of those readers who are not familiar with the Vaultype condensers, we are again publishing the dimensions. The condensers are all 4 inches wide and $3\frac{1}{8}$ inches high, and vary in length as follows: No. 3021 single condenser $2\frac{1}{8}$ inches; No. 3042 double condenser, $4\frac{1}{8}$ inches; No. 3063 triple condenser $6\frac{1}{8}$ inches; No. 3084 quadruple condenser, $8\frac{1}{8}$ inches. The $\frac{1}{4}$ inch shaft extends $\frac{7}{8}$ of an inch from each end. Any combination of these condensers may be ganged by means of the Pilot No. 12-A condenser couplings.

Single Vaultype condenser—No. 3021
Code: YETEM.

Double Vaultype condenser—No. 3042
Code: ZENEG.

Triple Vaultype condenser—No. 3063
Code: ZEHUD.

Quadruple Vaultype condenser—No. 3084,
Code: ZARDA.

250 POWER UNITS

Because of the interest expressed by many readers of RADIO DESIGN, the various power units designed for the Pilot Public Address Amplifier (described in

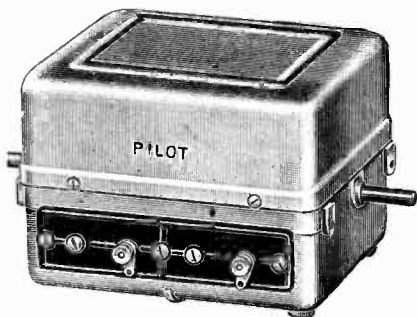

Outside view of the No. 3042 double Vaultype condenser. The single, triple and quadruple units are similar in appearance, differing only in length.

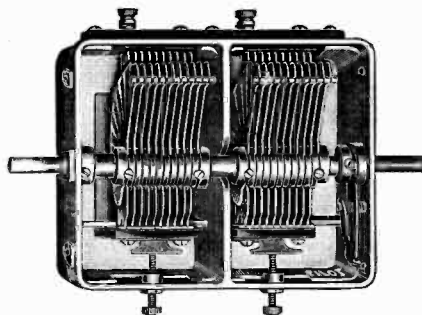

Inside view of the No. 3042 condenser, showing the one-piece die-cast frame, the tension adjusting screw at the right, and the compensating condensers at the bottom.

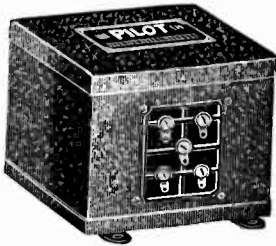

Appearance of the No. 441 transformer and the No. 444 condenser block.



The No. 970 resistor. The No. 969 is similar, but has no tap.



The No. 443 choke is like the No. 441 transformer, but has only two binding posts.

* * *

the Spring, 1930, issue) are being made up as separate units, for assembly into 250 power packs and power amplifiers of the constructor's own design. The power transformer has been given the catalogue number 441, the choke coil 443, and the condenser block 444. These instruments are extremely heavy and well-built, and are generously under-rated to enable them to operate over long periods without overheating or overloading. When used with a pair of 281 rectifier tubes, they make up ideal power packs for heavy-duty audio amplifiers and low-powered amateur short-wave transmitters.

The same size steel case is used for all three units. This is 5 inches by 4 3/4 inches by 5 1/4 inches high, and is finished in black Japanese lacquer. The connection plates are of molded bakelite, with screw terminals. The No. 441 transformer has two secondaries, 7 1/2 volts at 3 1/2 amperes, to light the filaments of the 281's, and 1,200 volts (center-tapped) at 140 milliamperes, for the plate voltage of one or two 210 or 250 tubes. The filament winding is not center-tapped.

The No. 443 choke has an inductance of 32 henries, at 145 milliamperes. The No. 444 condenser has three sections: 2 mf, and 3 mf. at 800 volts working, 5,000 volts flash test, and 3 mf. at 650 volts working, 3,600 volts flash test.

FILAMENT LIGHTING TRANSFORMER

The No. 441 power transformer is not provided with filament windings for the 250 or 227 tubes, the use of a separate heating transformer being highly advisable because of leakage in a common transformer. The new No. 446

transformer serves the purpose. It gives 7 1/2 volts at 3 1/2 amperes for one or two 210's or 250's, and 2 1/2 volts at 8 amperes for four or five 227's. The can is 5 1/4 inches high, 5 inches long, and 3 inches wide, is fitted with a bakelite terminal plate with screw connections, and is finished in black Japanese lacquer.

To complete a power pack using the new 250 units, it is necessary to have special heavy-duty output resistors. The main dividing resistor used in the Public Address Amplifier has a total resistance of 39,000 ohms, with a tap which divides the units into two sections of 12,000 and 27,000 ohms. The second resistor, which feeds the last 227 amplifier tube shown in the accompanying diagram, has a resistance of 47,000 ohms and no taps. Both resistors are wound on insulating tubing 4 1/2 inches long and 3/4 inch in diameter. Connections to the wire are made by means of straps encircling the tubes. The first resistance has the catalogue number 970, Code ZUTYH, and the second has the number 969, Code ZYDUC.

Power transformer for 250 tubes (for 115 volts, 50-60 cycles A. C. No. 441, Code: YIPUV.

Same transformer for 220 volts, 50-60 cycles A. C., No. 441A, Code YUTIJ.

32-Henry Choke Coil for 250 tubes, No. 443, Code YIUGM.

Filter condenser block for 250 tubes, No. 444, Code: YOBLO.

Filament lighting transformer for 250 tubes, for 115 volts, 50-60 cycles A. C., No. 446, Code: YUJOY.

Same transformer for 220 volts, 50-60 cycles A. C., No. 446A, Code: YUZME.

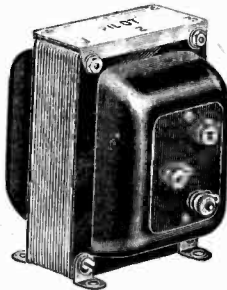

The No. 430 output transformer is a husky instrument.

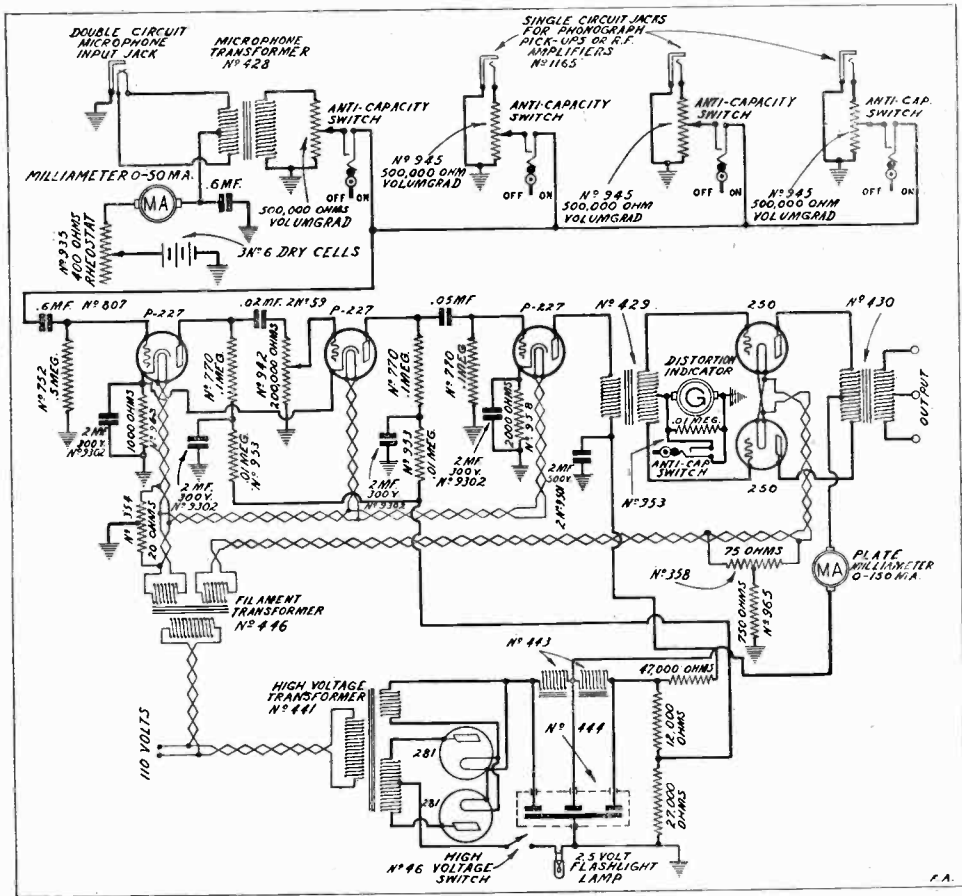

The lower part of this diagram shows how the new 250 power units are connected to form a power pack for a four-stage amplifier (center section) which will operate six auditorium model dynamic speakers for public-address work. The top section shows a control arrangement. This hook-up is practically identical with that used in the Pilot W-145 Public Address Amplifier. The values of all parts are indicated.

AMPLIFYING TRANSFORMERS

The high plate voltage and heavy plate current of the 250 tubes make the use of an ordinary push-pull output transformer impossible, as the windings quickly burn out under the load. To overcome the situation and to take advantage of the full possibilities of the 250 power tubes in push-pull, Pilot engineers have designed a pair of new push-pull transformers especially designed for this class of service. The input transformer, which has a center-tapped secondary, is contained in the same one-piece steel case used for the 422 series transformers. This can is 4 inches long,

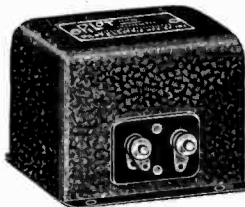

Appearance of the No. 428 microphone transformer and the No. 429 amplifying transformer.

2½ inches wide, and 2⅞ inches high, is sealed air-and-moisture-proof and is finished in black Japanese lacquer. This input transformer has a ratio of 1:1¼.

The output transformer is contained in a special large case which is 3¾ inches high, 2¾ inches wide, and 3⅝ inches thick. The secondary winding has a total impedance of 2,000 ohms and is centertapped. The impedance between the center-tap and either of the outside connections is 500 ohms. This arrangement permits the most advantageous connection of from one to six dynamic speakers. The input transformer has been assigned the catalogue

number 429, the output transformer 430.

An additional accessory that will prove very useful to radio constructors is the new Pilot No. 428 microphone coupling transformer, which is designed to couple any standard two-button microphone to the input grid circuit of the audio amplifier system. The primary is accurately center-tapped, to insure good quality of transmission. The No. 428 transformer uses the same case as the No. 422 series, the dimensions of which are given in the foregoing paragraph.



No. 236

PRE-SELECTOR COILS

The special coils used in the Pre-Selector receiver are now available separately as the No. 236. The set of four coils includes one antenna, one band-pass, and two inter-stage units wound on formalite tubes $2\frac{1}{2}$ inches long and 1 inch in diameter. The four special aluminum shields used in the receiver are supplied with the coils. The shields are pressed of one piece of aluminum, are 4 inches long and 2 inches square on end and are open on the long side. The No. 236 coils must be tuned by variable condensers of .000365 mf. capacity, being designed especially for the Vault-type condensers.

Push-pull input transformer for 250 tubes—No. 429, Code: YUOFT.

Push-pull output transformer for 250 tubes—No. 430, Code: ZADPA.

Microphone coupling transformer—No. 428, Code ZEEWP.

Pre-Selector coils, with shields—No. 236, Code, YUKVA.

THE PUBLIC ADDRESS AMPLIFIER

Since the appearance of the Spring issue of RADIO DESIGN, the Pilot company has decided to market the Public Address Amplifier only in completely assembled and wired form, at the standard retail price (in the United States) of \$350, minus accessories and F. O. B. Lawrence, Mass. No kits will be sold, as the assembly of the outfit involves the use of special tools and equipment not generally accessible to the individual constructor. However, the more important of the component parts, like the power transformer, filter units, etc., have been made available for sale separately for the convenience of builders who care to make amplifiers of similar design; these are described on the foregoing pages.

The amplifier accessories are also ready for the market. They are listed as follows: (Prices shown are list prices.)

Pilot Public Address Amplifier, completely assembled and wired, for 115 volts, 50-60 cycles A. C. without tubes or other accessories. No. W-145. Code: WYOWB.....	\$675.00
Same amplifier for 220 volts, 50-60 cycles A. C. No. W-145A. Code: YESSO.....	675.00
Amplifier accessories:	
Double button microphone, table type. No. 1101. Code: YHIMO.....	75.00
Floor stand for above microphone, maximum height $5\frac{1}{2}$ feet. No. 1102. Code: YOOVG.....	45.00
Phonograph turntable, electric motor drive, (Motor for 115 volts, 50-60 cycle A. C.) No. 1103. Code: YUGRA.....	45.00
Same turntable for 220 volts, 50-60 cycle A. C. No. 1104. Code: ZAWPY.....	45.00
$2\frac{1}{2}$ volt flashlight bulbs, used as high voltage fuses in power pack. No. F-43. Code: ZOOCH.....	.25

The "Auto Pilot"—a Broadcast Receiver for Your Car

(Continued from page 14)

twisting the little compensating condensers on the side of the Vaultype condenser.

Before closing the cover of the case, place the fourth piece of sponge rubber on the top of the Vaultype condenser. The cover will press down on the set and will hold it firmly in place.

ADDITIONAL OPERATING NOTES

To compensate for the increased drain on the storage battery, it is a good idea to increase the charging rate a few amperes. This is a very simple operation, and merely involves the adjustment of the third brush on the generator. Refer to the book of instructions that came with your car.

After the set has been in service a few days, it may be necessary to take up on the driving chains a notch or two, to keep the control accurate. You can do this in a few seconds by opening the receiver case and loosening the set screw on the condenser pulley.

In some cars an aerial strung between the axles may not be very effective, because of the shielding effect of the chassis. If you find this to be the case, tack a piece of copper screening to the inside top of the car, or string a piece of thin wire around the outer edge. Sometimes two aerials, one under the car and another in the top, give very much better results than one alone.

RADIO INTERNATIONAL GUILD



News and Notes of Doings of Individual Members and Chapters.

by ALBERT L. RUDICK,

Executive Secretary, Radio International Guild



THE various chapters of the Guild are beginning to be heard from. The organizers of these chapters are members who have shown their willingness to undertake this task, and a desire to take an active part in the work of the Guild.

* * *

ALBERT WILLIAMS, organizer of Chapter 48, at Marion, Indiana, recently sent in the names of eleven new members whom he had recruited. Mr. Williams expects to have a total membership of thirty-four by the time this issue of RADIO DESIGN goes to press.

This Chapter wants it known that they will welcome any visiting member of the Guild to their club rooms. If you should ever visit that town do not fail to drop in. Ask for Al Williams.

By the way, the Marion Chapter also expects to install a laboratory or workshop in connection with their club rooms, which will be open to members at any time. They make no secret of the fact that they are just as anxious to get girl members as they are to get young men.

* * *

THE mention of "girl members" brings us to the subject touched on in the last number of RADIO DESIGN. There now seems to be some question as to who really was the first lady member of the Guild, not that it makes any difference, but we must please the ladies at all events.

* * *

MRS. M. L. HARTLEY, of Orcutt, California, became a

member on October 15th, 1929. At that time she was Miss Anna Waddell, of Santa Maria. Mrs. Hartley and her husband are now busy with their amateur station 6DIU, located at Orcutt, Calif.

We are proud to have both Mr. and Mrs. Hartley as members. The picture of their station and their own pictures give a new angle on matrimonial bliss. When this charming couple adopted radio as their hobby they opened up a new avenue for couples of the future to follow.

* * *

The Hartleys hope to install a Super-Wasp in their amateur station very soon. We will all want to hear more about their progress, no doubt.

* * *

BRUCE GREEN, of Clinton, Iowa, would like to correspond with the other members of the Guild. His address is 1355 Caroline Avenue. He says that he would welcome letters from foreign members and will answer all correspondence.

* * *

JUAN LUGO, of 44 St. Augustine Street, Pta. de Tierra, San Juan, Porto Rico, wants to correspond with Spanish-speaking members. If you can write Spanish you might drop Juan a line.

* * *

MESSRS. R. V. Butler, of Deepdene, Melbourne, Australia, and P. A. Ball, of Melbourne, recently wrote us, expressing their resolve to foster the interests of the Guild to



Mr. and Mrs. M. L. Hartley

their utmost ability and to the mutual interest of the radio fraternity in Australia and America.

* * *

LESTER B. FLETCHER of Fletcher & Company, Limited, Montego Bay, Jamaica, British West Indies, agents for the Pilot Super-Wasp, has recently become a member of the Guild. Mr. Fletcher is a radio engineer and he is deeply interested in RADIO DESIGN, finding it invaluable.

* * *

MISS MURIEL MULLER, of Blue Point, Long Island, is another lady member of the Guild who should come in for some measure of recognition. Miss Muller enrolled in the Patchogue Chapter early in November. We salute Miss Muller.

By the way, the Patchogue Chapter has its headquarters with the Nassau Broadcasting Corporation. Nearly everyone connected with this broadcasting station, WPOE, is a member, all through the effort of Leslie Satterly.

* * *

MISS NELL YEATES, of Asheville, North Carolina (Box 365, if you must know), makes a very good suggestion that the official Guild pin be made in brooch form, for the lady members. We will have to look into this. Miss Yeates says that she is only a radio student just now, but finds RADIO DESIGN of great interest. She would like to get in touch with Guild members of other countries.

* * *

PORTLAND, Oregon, Chapter No. 55, through George W. Ballard, its organizer, just sent in the names of seven new members. Mr. Ballard says he is going to build up Chapter No. 55 and suits the action to the word. We will hear more from him and the Portland Chapter.

* * *

CHAPTER 28, of San Francisco, California, organized by John R. Bancroft, Jr., reports that 28 is coming in very strongly now. San Francisco evidently is right on the job.

* * *

THERE are over sixty chapters of the Guild in existence at the present time. If you would like to form a local chapter

in your own town, let us hear from you. There is nothing like it for those having a mutual interest in radio. You would be surprised to know how much you could do for each other.

* * *

ANTHONY M. PLANITZER, of Pittsburgh, Pennsylvania, has some very optimistic plans for his Chapter No. 27. Anthony makes the bold assertion that he will make the Pittsburgh Chapter the largest in the world. We are waiting to hear more from him.

* * *

WILLIAM J. LYNCH, of Coshocton, Ohio, is organizing a chapter of the Guild in his city. Mr. Lynch brought up the question among the fellows who visit his radio repair shop, and he says that it was carried with a unanimous vote.

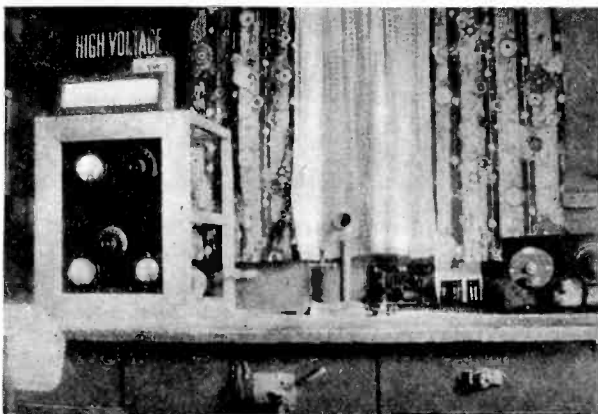

Station W6DIU, owned by Mr. and Mrs. M. L. Hartley, members of the Guild

JOHAN N. MACAULAY, Jr., of Phillipsburg, New Jersey, is the organizer of Chapter 60 of the Guild. His chapter is called the "Pilot Super-Wasp Short-Wave Club." Mr. Macaulay reports that his members are spending money to make this club successful. They are very wisely working with a local radio dealer who is technically qualified to give them many pointers. At the last writing, Mr. Macaulay expected to have between ten and fifteen members.

* * *

LEON LITVINE, of Brussels, believes he can be useful to the cause of the Radio International Guild by securing members in Belgium. We have been getting members from this country regularly, and the interest in radio there seems to be unlimited.

FREE! RADIO BARGAIN CATALOG



ALSO FREE RADIO GIFT

Send now for this new free radio catalog which saves you many dollars on radio outfits, kits, parts, tubes and accessories! Also TIME CONVERSION CHART FREE. Tells you instantly what time it is in any part of the world! Given free if your request for catalog reaches us this month.



234 - 236 SOUTH WELLS STREET, CHICAGO, ILL.

Genuine PILOT Products

20th Century has the new "Auto Pilot" kits in stock.

RADIO DESIGN

OFFICIAL ORGAN OF THE RADIO INTERNATIONAL GUILD

A whole year's subscription to "Radio Design" costs only fifty cents and includes membership in the Radio International Guild. You receive four copies of the magazine, a membership certificate, identification card and lapel pin. Fill out this convenient coupon TODAY.

U. S. stamps and money orders accepted. Foreign subscriptions must be paid by international money order.

Radio Design Publishing Co., Inc.,
103 Broadway, Brooklyn, N. Y.

Enclosed find fifty cents to cover one year's subscription to "Radio Design" and membership dues in the Radio International Guild.

Name.....

Street and Number.....

City and State.....

"Radio Amateur's Handbook"

By Francis E. Handy

Communications Manager, American Radio Relay League; and ROSS A. HULL, Associate Technical Editor, QST.

This is the sixth and latest edition of a book that has become so popular that it is generally referred to as the amateur's "bible." More than 75,000 copies have been sold to radio fans all over the world, and orders for it continue to arrive in every mail.

The handbook contains 211 pages and over 200 illustrations. It is written in clear, understandable English, and is free of all the confusing mathematics that no one ever reads. It was written for YOU, the practical experimenter and constructor who wants to know the how's and why's. Contains all the most advanced "dope" on short-wave reception and transmission. Postpaid **\$1.00**

We carry this book in stock, and can ship immediately.

Radio Design Publishing Co.
103 Broadway, Brooklyn, N. Y.

I will train you at home



to fill a **BIG PAY** Radio Job!

Here's Proof

If you are earning a penny less than \$50 a week, send for my book of information on the opportunities in Radio. It is free. Clip the coupon NOW. Why be satisfied with \$25, \$30 or \$40 a week for longer than the short time it takes to get ready for Radio.

Radio's growth opening hundreds of \$50, \$75, \$100 a week jobs every year

In about ten years Radio has grown from a \$2,000,000 to a \$1,000,000,000 industry. Over 300,000 jobs have been created. Hundreds more are being opened every year by its continued growth. Men and young men with the right training—the kind of training I give you—are needed continually.

You have many jobs to choose from

Broadcasting stations use engineers, operators, station managers and pay \$1,800 to \$5,000 a year. Manufacturers continually need testers, inspectors, foremen, engineers, service men, buyers, for jobs paying up to \$15,000 a year. Shipping companies use hundreds of Radio operators, give them world wide travel at practically no expense and a salary of \$85 to \$200 a month. Dealers and jobbers employ service men, salesmen, buyers, managers, and pay \$30 to \$100 a week. There are many other opportunities too.

So many opportunities many N. R. I. men make \$5 to \$25 a week extra while learning

The day you enroll with me I'll show you how to do 10 jobs, common in most every neighborhood, for spare time money. Throughout your course I send you information on servicing popular makes of sets; I give you the plans and ideas that are making \$200 to \$1,000 for hundreds of N. R. I. students in their spare time while studying.

Talking Movies, Television, Wired Radio are also included

Radio principles as used in Talking Movies, Television and home Television experiments, Wired Radio, Radio's use in Aviation, are all given. I am so sure that I can train you satisfactorily that I will agree in writing to refund every penny of your tuition if you are not satisfied with my Lessons and Instruction Service upon completing.

64-page book of information FREE

Get your copy today. It tells you where Radio's good jobs are, what they pay, tells you about my course, what others who have taken it are doing and making. Find out what Radio offers you, without the slightest obligation. ACT NOW.

J. E. SMITH, President
National Radio Institute Dept. OD47
Washington, D. C.

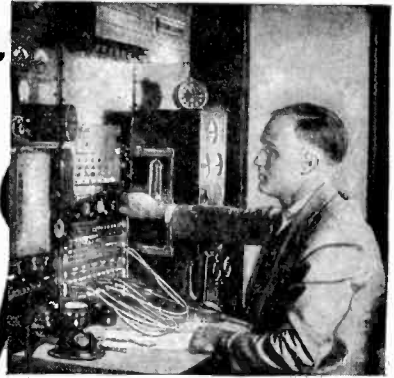

I will give you my new 8 OUTFITS of RADIO PARTS for a home Experimental Laboratory

You can build over 100 circuits with these outfits. You build and experiment with the circuits used in Crosley, Atwater-Kent, Eveready, Majestic, Zenith, and other popular sets. You learn how these sets work, why they work, how to make them work. This makes learning at home easy, fascinating, practical.

Back view of 5 tube Screen Grk'l A. C. set—only one of many circuits you can build.

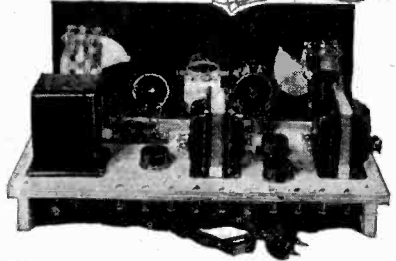

I am doubling and tripling the salaries of many in one year and less Find out about this quick way to

BIGGER PAY

FILL OUT AND MAIL THIS COUPON

TODAY

J. E. SMITH, President,
National Radio Institute, Dept. OD-47
Washington, D. C.
Dear Mr. Smith: send me your book.
This request does not obligate me.

Name
Address
City State

\$100 a week
"My earnings in Radio are many times greater than I ever expected they would be when I enrolled. They seldom fall under \$100 a week."
E. E. WINBORNE,
1414 W. 48th St.,
Norfolk, Va.



Jumped from \$35 to \$100 a week
"Before I entered Radio I was making \$35 a week. Last week I earned \$110 servicing and selling Radios. I owe my success to N. R. I."
J. A. VAUGHN
3715 S. Kingshighway,
St. Louis, Mo.



\$500 extra in 6 months
"I find I made \$500 from January to May in my spare time. My best week brought me \$107. I should have taken it long ago."
HOYT MOORE
R. R. 3, Box 919,
Indianapolis, Ind.

Lifetime Employment Service to all Graduates

PILOT PUBLIC ADDRESS AMPLIFIER

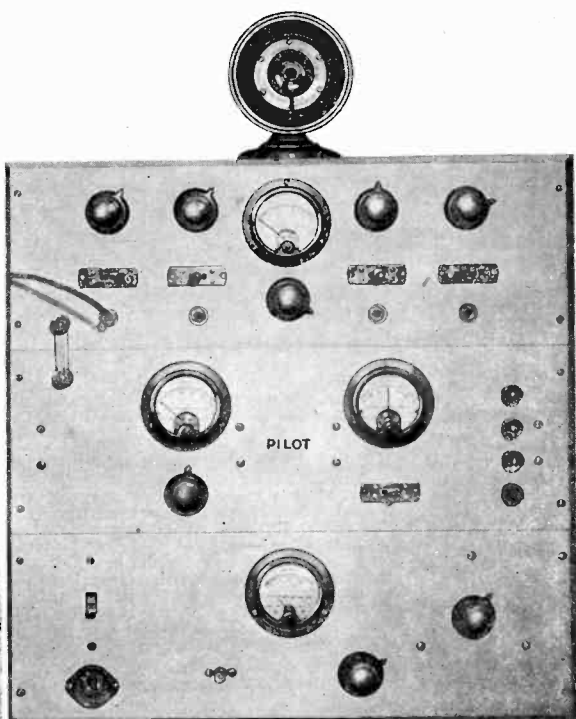

FOR commercially flawless sound reproduction, activated either by motion picture sound apparatus, direct speech, radio received programs or phonograph music. Easily operates six auditorium-model dynamics at full volume. Control system permits announcements simultaneous with musical output...Engineered on basically sound principles; substantially constructed. Utilizes 3-227-type, 2-250-type, and 2-281's...Available completely assembled, including 2 sets of tubes, phonograph pick-up and table-model microphone.

Prices and Detailed Information Upon Request
PILOT RADIO & TUBE CORP.

323 Berry Street, Brooklyn, N. Y.

234 So. Wells St., Chicago 1278 Mission St., San Francisco





FREE with the NEW RADIO NEWS

This Big Illustrated Volume Contains All You Want to Know about SHORT WAVES !

BECAUSE you and thousands of other radio men want all the latest dope on Short Waves, the technical staff of RADIO NEWS, in collaboration with the foremost S-W authorities, have especially prepared a complete, new, up-to-the-minute **SHORT-WAVE MANUAL** for you. Replete with illustrations, diagrams, charts and plans, and crowded with chapters by Lieut. Wenstrom, Hertzberg, Marshall, Spangenberg, Binneweg and other experts, this volume represents the last word in authentic short-wave data. You'll be fascinated with such features as:—

Breaking Into Amateur Transmitting S-W Transmitter for the Average Home and Purse

A Portable S-W Transmitter and Multi-Wave Receiver

The A.C. Operated Super-Wasp Crystal-Controlled 200 Watt S-W Transmitter

The Egert S-W Four Experiments on Ultra-High Frequencies S-W Stations of the World

For Real Thrills Get Down in the Amateur Wave Bands

In short, here's the book that describes, illustrates and explains everything — that gives you the complete and latest S-W data. And it's yours **WITHOUT COST!**

Why it's FREE !

RADIO NEWS has practically twice as many readers as any other radio magazine. But there are still a few of you

FREE Send for Yours **TODAY** →

radio men who don't realize what you are missing.

Do you know that, besides covering every other phase of radio, RADIO NEWS publishes many exclusive S-W features every month? Every issue keeps you posted on the latest S-W receiving circuits, up-to-the-minute S-W broadcast call lists, S-W receiver and transmitter designs, news from the amateurs, portables, etc., etc.? You absolutely need RADIO NEWS to keep abreast of all S-W developments!

Big Cash Saving — Gift FREE!

That's why, although we will sell thousands of these **SHORT WAVE MANUALS** for a substantial price, for a limited time you may have a copy **ENTIRELY FREE** as an inducement to try **RADIO NEWS**.

To introduce this outstanding leader of all radio magazines to you, we will send you the next eleven big numbers, almost a full year's subscription, for only \$2.—and will ship you the new 1930 **SHORT WAVE MANUAL**, postpaid, entirely **FREE!** You save 75c on the newsstand price of **RADIO NEWS** and get this invaluable S-W volume **WITHOUT COST!** Risk nothing. Mail coupon **TODAY!**

The **NEW RADIO NEWS**, Dept. P-330
381 Fourth Avenue, New York, N. Y.

Gentlemen: Send me, **ENTIRELY FREE**, postpaid, the new 1930 **SHORT WAVE MANUAL**, and enter my subscription for the next eleven big issues of **RADIO NEWS** at only \$2 which I enclose (regular newsstand price \$2.75). I understand you will cheerfully refund me \$2 and I may keep the S-W **MANUAL** if I am not more than satisfied.

Name

Address

City and State

Are you a Serviceman ? Engineer ? Dealer ? Experimentator ?

BIG PAY POSITIONS IN RADIO AND TELEVISION

*Summer Is the Time to Prepare!
Get Ready for a Good Job Next Fall!*

Radio is the largest and most rapidly expanding field ever opened to men and women of average education. Trained workers are in big demand. Much pioneering is yet to be done—new discoveries being made almost daily. Fame and fortune are easily within the possibilities of every diligent student. Summer is the time to prepare for a good job next Fall. Station WCFL, Chicago, seeks your good will—and can be of immense aid to you in getting started in the alluring field of radio and television. Here is the reason:

Station WCFL was built and is owned and operated by Organized Labor—the working men and women of America. They are now engaged in a desperate struggle for the preservation of the freedom of the air and for adequate radio facilities for the roiling masses. In this desperate battle against oppression, the wage earners need your friendship—your moral support. As a pleasant and profitable means of getting better acquainted, they suggest the study of radio and television. To gain your good will—

Station WCFL Makes this Astounding Offer:

**COMPLETE CORRESPONDENCE
COURSE IN RADIO AND TELEVISION**

**Membership in WCFL Radio Study Club
(Buy Supplies at Discount)**

Radio and Television Pocket Dictionary

Large Radio Schematic and Template

**WCFL Radio Magazine One Whole Year
(Publishes Answers to Students' Questions)**

*All
for
Only*

\$ 2

*You assume No Moral Obligation in Accepting
This Unusual Offer*

This complete radio and television course procured in any other way would cost you a lot of money. As a good-will project Organized Labor offers it to you for hardly more than the postage and mailing. This course is not an experiment. During the last school year more than 400 high schools used this course as standard text, and over 65,000 adult students were enrolled. WCFL has helped thousands of toilers along the road to increased earnings—and will help you get started, if you ACT TODAY.

Station WCFL (970 k. c.) is the "Voice of Labor"—the only station on the air that was paid for and is maintained by its listeners. It was the first station in the world to broadcast television on an aural wavelength, and has pioneered in short-wave and wireless transmission. The results of these costly experiments are now available to you at nominal cost through WCFL's Good-Will Project, and will

Help You to Big Pay in a Permanent Radio Position

WCFL, 623 South Wabash Ave, Chicago. Dept. D-1

For the attached Two Dollars enroll me in the WCFL Radio Study Club and send me the complete WCFL Radio and Television Course; also Radio and Television Pocket Dictionary, Loose-leaf Binder, Large Schematic and Template, and WCFL Radio Magazine for One Year.

Name.....

Street.....

Post-office..... State.....

**The Air Must
Remain Free**

WCFL Radio Magazine is the only publication fighting for the freedom of the air—the most serious question before the public. Whoever monopolizes broadcasting will dominate the nation. Freedom is at stake—the air MUST remain FREE!

PILOTRONS

ARE WORTH MORE

PILOTRON radio tubes are universally the choice of radio-wise purchasers who realize that one must pay a fair price for a quality product.

PILOTRONS, licensed by RCA, are built to give you your money's worth, and more. Each tube is honestly designed to render unflinching service without hum, crackle or distortion. Rigid construction and the scientific tests to which every tube is subjected insure ever-satisfactory operation.

To assure consistently satisfactory operation in ANY receiver stick a Pilotron in every socket and don't be "Sales-talked" out of it!

Buy a set of PILOTRONS today. They will delight you with their performance and long life.



PILOT RADIO & TUBE CORP.

323 BERRY STREET
BROOKLYN, N. Y.

234 So. Wells Street, CHICAGO

1278 Mission St. SAN FRANCISCO

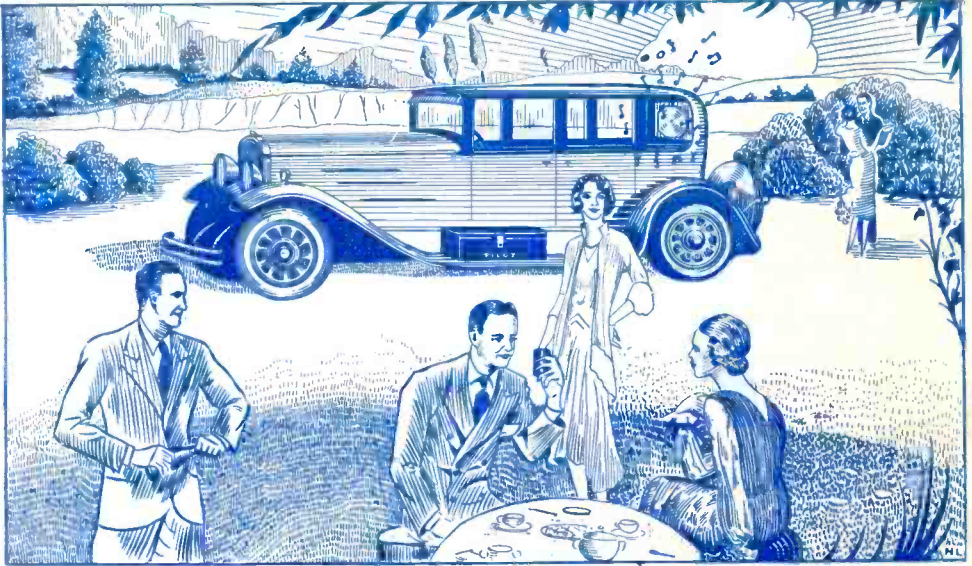

The "AUTO PILOT" goes on your running board and does not lessen the car's trade-in value when taken off to go on your next car

"Auto Pilot" Full Screen Grid Radio

LICENSED UNDER R.C.A. PATENTS

Increases Your Automobile Pleasure

Nobody will have a more up-to-date automobile than yours when you have assembled this powerful "AUTO PILOT" Screen Grid broadcast receiver kit, placed it on your running board in its attractive black japanned case and connected its remote control dial and speaker.

Even the specially designed PILOT "undercar" aerial attaches between the axles without necessity for harming your car's exterior or interior.

This new and advanced "AUTO PILOT" not only has every up-to-date feature of radio to assure you distance, selectivity, tone quality and volume—but the welfare and future trade-in value of your car has also been a chief consideration of design. The New "AUTO PILOT" makes a solid installation and is very convenient to operate, taking up no foot or seat room.

You Can Install the "Auto Pilot" in Your Car in An Evening

Four-224 A.C. Screen Grid Pilotrons comprising three stages of radio frequency and detector give the "Auto Pilot" tremendous pick-up and distance range.



Filament current drain from car's storage battery is only 4 amperes. Plate current is 20 milliamperes from three 45-volt "B" batteries.

Auto Pilot Kit
Complete with aerial
less Pilotrons and Speaker

\$47.50

**Special Compact
Cone Speaker**
\$7.50

Inquire of your local Pilot Radio Dealer or write direct to

PILOT RADIO & TUBE CORP.

323 BERRY ST., BROOKLYN, NEW YORK

Chicago Office: 234 South Wells St.

San Francisco Office: 1278 Mission St.

FACTORIES AT LAWRENCE, MASS.



PILOTRON RADIO TUBES

Endorsed by Professionals



2 New Radio Books

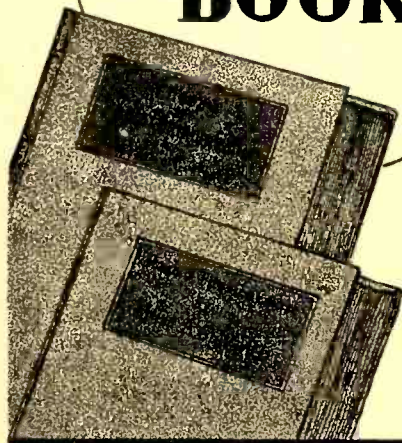

“Theory of Radio Communication”

By John T. Filgate

Formerly Instructor at U. S. Army Signal School

Published with approval of U. S. Army War Department, this is first public printing of the officers' radio manual used by U. S. Army Signal Corps.

A splendid technical textbook for advanced Radio Amateurs. 250 pages 200 illustrations. Postpaid anywhere..... **\$ 2.00**

“Radio Physics Course”

By Alfred A. Ghirardi

Electrical Engineer; Instructor in Radio and Electrical Engineering, Hebrew Technical Institute; Consulting Engineer, Pilot Radio & Tube Corp.; Associate Editor, “Radio Design”

A complete course, simple enough for the novice, yet technically correct, covering the entire range from radio fundamentals to short waves, television and the “talkies”. A valuable reference work of 360 pages with 300 illustrations. Postpaid anywhere..... **\$ 2.50**

These books Published Exclusively by

RADIO DESIGN PUBLISHING CO., Inc.
103 BROADWAY BROOKLYN, N. Y.

RADIO DESIGN PUBLISHING CO., INC.
103 BROADWAY,
BROOKLYN, N. Y.

Enclosed is \$2.00 for which send me a copy of “Theory of Radio Communication” at once.

NAME.....
ADDRESS.....
CITY..... STATE.....

RADIO DESIGN PUBLISHING CO., INC.
103 BROADWAY,
BROOKLYN, N. Y.

Enclosed is \$2.50 for which send me a copy of “Radio Physics Course” at once.

NAME.....
ADDRESS.....
CITY..... STATE.....

SPECIAL COMBINATION

OFFER

REGULAR PRICE \$3.00
OUR SPECIAL PRICE 2.00
SAVING \$1.00

"THEORY OF RADIO COMMUNICATION"

By John T. Filgate

Formerly Instructor at U. S. Army Signal School

Published with approval of U. S. War Department, this is first public printing of the officers' radio manual used by U. S. Army Signal Corps.

A splendid technical textbook for advanced Radio Amateurs. 250 pages, 200 illustrations.

AND

TWO YEARS' SUBSCRIPTION TO

RADIO DESIGN

OFFICIAL ORGAN OF THE RADIO INTERNATIONAL GUILD

which also includes membership in the
RADIO INTERNATIONAL GUILD.

"Theory of Radio Communication" sells regularly for \$2.00 alone. Now you can have it together with two years' subscription to "Radio Design" all for \$2.00.

THERE ARE A LIMITED NUMBER OF THESE BOOKS AVAILABLE. YOU MUST ACT QUICKLY IF YOU WISH TO TAKE ADVANTAGE OF THIS WONDERFUL OPPORTUNITY.

MAIL THIS COUPON WITH \$2.00

Radio Design Publishing Co., Inc.
Lawrence, Massachusetts, U. S. A.

Enclosed is remittance of \$2.00 for which please send me "Theory of Radio Communication". Also credit me with 2 years' subscription to Radio Design and 2 years membership in the Radio International Guild.

NAME

ADDRESS

CITY STATE

