

HUGO GERNSBACK, Editor

RADIO CRAFT

IN THIS ISSUE
Midget Television Preamp
Servicing Wind Generators

2,000-TUBE ELECTRON BRAIN
SEE PAGE 28



MAY

1948

30¢

CANADA 35¢

RADIO-ELECTRONICS IN ALL ITS PHASES



RCA scientists—pioneers in radio-electronics—apply the “radio tube” to communications, science, industry, entertainment, and transportation.

This “magic lamp” makes Aladdin’s look lazy

You will remember the fabulous lamp—and how it served its master, Aladdin. Serving you, today, is a real “magic lamp”... the electron tube.

You are familiar with these tubes in your radio, Victrola radio-phonograph or television set... but that is only a small part of the work they do. Using radio tubes, RCA Laboratories have helped to develop many new servants for man.

A partial list includes: all-electronic television, FM radio, portable radios,

the electron microscope, radio-heat, radar, Shoran, Teleran, and countless special “tools” for science, communications and commerce.

The electron microscope, helping in the fight against disease, magnifies bacteria more than 100,000 diameters, radar sees through fog and darkness, all-electronic television shows events taking place at a distance, radio-heat “glues” wood or plastics, Shoran locates points on the earth’s surface with unbelievable accuracy, Teleran adds to the safety of air travel.

Constant advances in radio-electronics are a major objective at RCA Laboratories. Fully developed, these progressive developments are part of the instruments bearing the name RCA, or RCA Victor.

When in Radio City, New York, be sure to see the radio, television and electronic wonders on display at RCA Exhibition Hall, 36 West 49th Street. Admission is always free. Radio Corporation of America, RCA Building, Radio City, New York City 20, N. Y.



RADIO CORPORATION of AMERICA



I BROKE INTO RADIO BY PRACTICING IN SPARE TIME WITH THE BIG KITS FROM N.R.I.

HOBERT HEAD



KIT 1

N.R.I. sends you Soldering Equipment and Radio parts; shows you how to do Radio soldering, how to mount and connect Radio parts; gives you practical experience.



KIT 2

Early in the course you build this Tester with parts N.R.I. sends. It soon helps you fix neighborhood Radios and earn EXTRA money in spare time.



KIT 3

You get parts to build Radio Circuits: then test them; see how they work, learn how to build special circuits, how to locate and repair circuit defects.

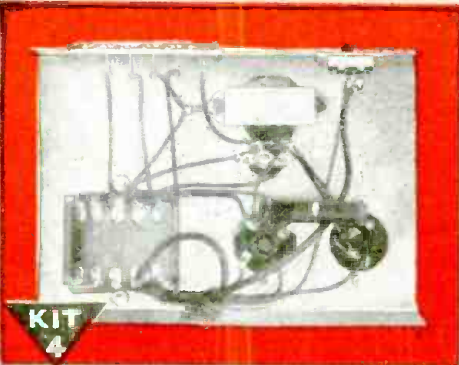

KIT 4

You get parts to build this Vacuum Tube Power Pack; make changes which give you experience with parts of many kinds; learn to correct power pack troubles.



KIT 5

Building this A.M. Signal Generator gives you more valuable experience. It provides amplitude-modulated signals for many tests and experiments.



KIT 6

You build this Superheterodyne Receiver circuit. You conduct FM (Frequency Modulation) experiments. You get more experience to help you win success in Radio.

LEARN RADIO by Practicing in Spare Time

Do you want a good-pay job in Radio—or your own money-making Radio Shop? Mail Coupon for a FREE Sample Lesson and my FREE 64-page book, "How to Be a Success in RADIO—Television, Electronics." See how N.R.I. gives you practical Radio experience at home—building, testing, repairing Radios with BIG KITS OF PARTS I send!

Many Beginners Soon Make Good Extra Money in Spare Time While Learning

The day you enroll I start sending EXTRA MONEY manuals. You LEARN Radio principles from my easy-to-grasp, illustrated lessons—PRACTICE what you learn with parts I send—USE your knowledge to make EXTRA money fixing neighbors' Radios in spare time while still learning! From here it's a short step to your own full-time Radio Shop or a good Radio job!

VETERANS

You can get this training right in your own home under G. I. Bill. Mail coupon for full details.

Future for Trained Men Is Bright In Radio, Television, Electronics

It's probably easier to get started in Radio now than ever before because the Radio Repair Business is booming. Trained Radio Technicians also find profitable opportunities in Police, Aviation, Marine Radio, Broadcasting, Radio Manufacturing, Public Address work. Think of even greater opportunities as public demand for Television, FM and Electronic devices continues to grow! Send for free books now!

Find Out What N.R.I. Can Do For You

Mail Coupon for Sample Lesson and my 64-page book. Read the details about my Course. Read letters from men I trained, telling what they are doing, earning. See how quickly, easily you can get started. No obligation! Just MAIL COUPON NOW in an envelope or paste it on a penny postal. J. E. SMITH, President, Dept. 8EX, National Radio Institute, Pioneer Home Study Radio School, Washington 9, D.C.

Our 34th Year of Training Men for Success in Radio
My training includes TELEVISION • ELECTRONICS • F M

Good for Both—FREE

Mr. J. E. SMITH, President, Dept. 8EX
National Radio Institute, Washington 9, D. C.
Mail me FREE, without obligation, Sample Lesson and 64-page book about how to win success in Radio—Television, Electronics.
(No salesman will call. Please write plainly.)

Name Age
Address
City Zone State
 Check If Veteran



APPROVED FOR TRAINING UNDER GI BILL

War Surplus Bargains Sold As Used Unless Otherwise Specified!

(HRU) DC POWER SUPPLY

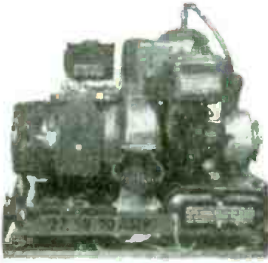

24-28 V. at 70 amp. 2000 watts gasoline engine generator with electric starter. Power supply which can be used to operate 24-28 V. equipment, start airplane engines,

charge batteries, as a welding machine, lighting system, or for amateur radio station. 21 1/2" x 17 1/2" x 24 5/8". Wgt., 115 lbs. **\$7250**
Includes 20 ft. plug-in cable.

INTERPHONE AMPLIFIER RL-7

Convert to high fidelity phone amp. or speech amp. Complete with tubes and dynamotor. for 24 V. DC operation. Used but in good condition.

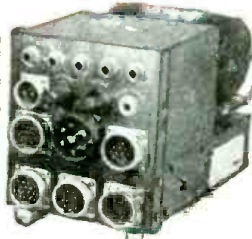

SPECIAL PRICE **\$195**

NEW WILLARD RECHARGEABLE STORAGE BATTERY



New 6 Volt battery in spill-proof clear plastic case, housed in metal case for easy mounting. Applicable for a wide range of uses where battery power is needed. Shipped dry. Uses standard battery electrolyte available everywhere.

Price, each.....\$4.00
In lots of ten, each.....\$3.35
Without metal case, each.....\$3.00
In lots of ten, each.....\$2.85



OXYGEN TANKS

These oxygen tanks, removed from surplus aircraft, have a capacity of 500 lbs. pressure. Type D2, with complete regulator assembly. Size of tank 22"x5". Wt. 7 lbs. **\$595**

TERMS: CASH WITH ORDER

AMERICAN SURPLUS PRODUCTS CO.

537 N. CAPITOL AVE.
INDIANAPOLIS, IND.



BRAND NEW SCR-625 MINE DETECTORS

ATTENTION, PROSPECTORS, MINERS, OIL COMPANIES, PLUMBERS, ETC.

Used by the Army to detect buried metallic mines. Its private use suggests the location of underground or underwater pipes, cables and ore-bearing rock, the location of metallic fragments in scrap materials, logs, etc., and the screening of personnel in plants for carrying of metallic objects. New, complete in original overseas packing container. Originally sold by War Assets for \$166.00. The U. S. Forestry Service has recommended procedure for using the SCR-625 Mine Detector to find concealed metal in tree logs and other timber products.

\$79⁵⁰

SCR-274N COMMAND SET

SCR-274N Transmitter and Receiver Assembly consists of 13 pieces which are: 4 dynamotors, 1 modulator, 1 remote control box, 2 transmitters, 3 receivers and one antenna relay unit and it has its own individual dynamotor. Each receiver employs 12 V. tubes. Each transmitter contains four 12 V. tubes and has a variable frequency and crystal calibrated master oscillator, driving two 1625 final amplifier tubes, 55-watt output, with built-in silver plated variable inductance antenna matching device. Oscillator and final stage have simultaneous tuning and the dial is directly calibrated in MC. Transmitters have slugged and capacity tuning, built-in high voltage and antenna switches. Modulator furnishes plate supply for transmitters and is equipped with a dynamotor for high voltage. Also supplied is one antenna relay with built-in antenna meter. Transmitters make ideal VFO driver unit. Easily converted to 110 V. 60 cycle operation. Wt., approximately 100 lbs. PRICE..... **\$24.75**

R-5/ARN-7 RECEIVER

Three bands 200 to 1750 KC. Complete with 17 tubes required. This set is ideal for conversion to home broadcast Receiver addition to ham shack, etc. Reported sold for many times the price when brand new. A Receiver that would be hard to pick up at **\$19⁹⁵** this price. ONLY

Control Head available \$2.50 ea.

PRICES F.O.B. INDIANAPOLIS



RADIO ALTIMETER APN 1

A complete 460 mc. radio receiver and transmitter which can be converted for ham or commercial use. Tubes used and included: 4-12SH7, 3-12SJ7, 2-6H6, 1-VR150, 2-935, 2-9004. Other components such as relays, 24 V dynamotor, transformers, pots, condensers, etc., make this a buy on which you can not go wrong. Complete as shown in aluminum case 18"x7"x7 1/4". **\$895**

NAVY CRV-46151 AIRCRAFT RADIO RECEIVER

INCLUDING CASE

\$1950

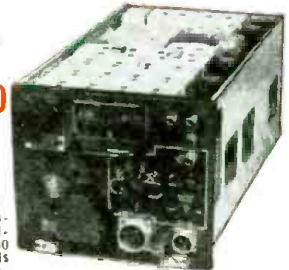

Four bands, including broadcast (195-9.050 KC). Circuit is six-tube super-heterodyne with mechanical band change or remote operated electrical band change. Remote band change and tuning controls included, making this set readily adaptable to mobile ham use. Powered from self-contained 24 V. DC dynamotor. The sets are complete with tubes, mounting rack and remote controls. No tables or plugs.

Special Bargains

BRAND NEW NAVY SURPLUS HOSPITAL TENTS

New fire resistant, heavy canvas, 16' wide, 50' long, 12' apex, 4' side walls. Complete except poles.

\$15000

ANTENNA RELAY UNITS

Switching Relay—Current Indicator BC-442-A. Consists of 50 mmfd vacuum condenser, 19.5 millivolt movement, current transformer and thermo couple (use with any rig).

\$195

MODULATOR UNITS OUT OF SCR-274-N COMMAND SETS

Complete with 4 tubes and dynamotor. Good condition.

\$295

TERMS: CASH WITH ORDER

AMERICAN SURPLUS PRODUCTS CO.

537 N. CAPITOL AVE.
INDIANAPOLIS, IND.

Make More Money in

Radio TELEVISION & ELECTRONICS

NOW!

Get these 2 BIG BOOKS

FREE!

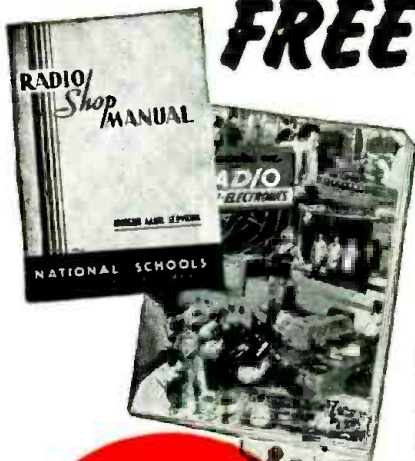

If you are already employed in the great Radio industry, you know how great the demand is for trained, experienced servicemen, operators and technicians. You know how fast the field is growing and how important it is to keep up with new developments in F.M., Television and Electronics. The Radio industry is alive with opportunity for the qualified technician whose knowledge is up-to-the-minute. You can be an FM and Television specialist . . . get into the lucrative Radio Service Field . . . own a business of your own. If you prefer, National Schools of Los Angeles, for over 40 years a practical resident and home study trade school, has put into effect its New 1948 Training Program. This program, adapted to National's Master Shop Method Home Study Course, can qualify you in your spare time as a Radio and Television technician. For details of this Program fill out and mail the coupon below.



You build this fine modern Superheterodyne Receiver and other units, with the complete standard parts we send you. This valuable equipment becomes yours to use and keep.

You learn by building equipment with standard radio parts we send you



NOW! New Professional Multitester Included!

This versatile testing instrument is portable and complete with test leads and batteries. Simple to operate, accurate and dependable. You will be able to quickly locate trouble and adjust the most delicate circuits. You can use the Multitester at home or on service calls. It is designed to measure AC and DC volts, current, resistance and decibels. You will be proud to own and use this valuable professional instrument.

SHOP METHOD HOME TRAINING from a Technical Trade Resident School

LEARN BY DOING

Work with Real Experimental Equipment furnished without Extra Cost as Part of your National Schools Training

National Schools brings its exclusive Shop Method of training right into your own home. You can learn the most up-to-date approved practical training projects, systems and modern circuits from the very beginning in your spare time. Here is sound and practical home training—the development of experienced instructors working with students right in the shops, NEW Television and Broadcast Studios and Experimental Laboratories of NATIONAL SCHOOLS—one of the most advanced technical trade education centers in the world.

Take Advantage Now of these Outstanding Features of National Schools' 1948 Training Program

1. National Schools' 1948 Course is planned to prepare you for real success in Radio Television and Electronics.
2. Experimental equipment supplied with the Course has been completely revised to give you the most up-to-date practical experience with new circuits, new units, etc., right in your own home.
3. New Television Lessons have been expanded to give you training in the latest developments in this important field.
4. The 1948 Course includes a Professional Multitester (shown above) for your use in spare or full-time Radio work.
5. National Schools gives you advanced training—the key to the better positions in Radio, Television, Electronics.
6. You are sent standard Experimental Equipment, including tubes and accessories, for building a modern Short Wave and Standard Broadcast Superheterodyne Receiver. All equipment becomes your personal property.
7. National Schools' 43 years of experience in Technical Trade Training . . . our modern shops and laboratories . . . highly trained instructors are back of your time-tested Training Plans for a brighter future.

BOTH HOME STUDY AND RESIDENT COURSES OFFERED

APPROVED FOR VETERANS

Check Coupon

Send Coupon and prove to yourself what YOU can do in RADIO and TELEVISION!

EXPERIENCE IS THE BEST TEACHER. You learn by experience with the exclusive National Shop-Method of Home Training. With the apparatus sent you, you actually build various types of standard equipment—a powerful superheterodyne receiver, a signal generator, an audio oscillator, low power Radio transmitter and other units. You make tests and conduct experiments that show you the why and how of Radio. You understand what makes the various elements of Electronics operate because you actually see them work for you. Not only do you gain splendid experience by this method of learning, but you receive valuable equipment you will use on the job in the practice of your profession as a Radio Technician. Mail the coupon and learn what this means to you.

G. I. APPROVED

NATIONAL SCHOOLS

LOS ANGELES 37, CALIFORNIA EST. 1905



FREE LESSON INCLUDED

MAIL OPPORTUNITY COUPON FOR QUICK ACTION

MEMBER: NATIONAL COUNCIL OF TECHNICAL SCHOOLS

MEMBER: NATIONAL HOME STUDY COUNCIL

NATIONAL SCHOOLS, Dept. RC-5

(Mail in envelope or paste on penny post card)

4000 South Figueroa Street, Los Angeles 37, California

Mail me FREE the two books mentioned in your ad, including a sample lesson of your course. I understand no salesman will call on me.

NAME AGE

ADDRESS

CITY ZONE STATE

Check here if Veteran of World War II

What Does it Take to Wake YOU Up?

● **The tremendous growth of radio-electronics is so rapid and spreading in so many directions that the demand for TECHNICALLY QUALIFIED radiomen has created a condition wherein there are many MORE GOOD JOBS than there are capable men to fill them.**

● **BY THE END of 1948 the total number of broadcasting stations (AM, FM and Television) will triple those since shortly before the war. Airlines and airports are rapidly installing new radio communications and radar equipment. Major railroads have adopted radio communications, as have large trucking and taxicab companies. Manufacturing is at an all-time high as millions of home receivers, broadcasting equipment, etc., are being produced. Television receivers are in mass production.**

All of this means that OPPORTUNITY IS HERE . . . Now!

Every page in this magazine could be filled with similar astounding facts concerning career opportunities available to trained radiomen. The point is, *what are you going to do about it?* Just figure out for yourself how many good jobs are waiting to be filled. You can't say, "I don't need more training." EVERY radioman needs to increase his technical knowledge if he wants to keep ahead of the competition that is bound to come . . . if he wants to go after—and GET—the better jobs that offer good money and personal security.

If you have a commonplace job. If you have the ambition to hold a position of greater responsibility with higher pay . . . then a CREI spare time program for self-improvement will help you accomplish your ambition at this opportune time. It costs you nothing to read the interesting facts. Write today for the outline of CREI courses and the free booklet, "CREI Training for Your Better Job in Radio-Electronics."

If you have had professional or amateur radio experience and want to make more money, let us prove to you we have the training you need to qualify for a better radio job. To help us intelligently answer your inquiry—PLEASE STATE BRIEFLY YOUR BACKGROUND OF EXPERIENCE, EDUCATION AND PRESENT POSITION.



MAIL COUPON FOR FREE BOOKLET

VETERANS: CREI TRAINING AVAILABLE UNDER THE "G. I." BILL.

CAPITOL-RADIO ENGINEERING INSTITUTE

An Accredited Technical Institute

Dept. RC-5, 16th and Park Road, N. W., Washington 10, D. C.
Branch Offices: New York (7): 170 Broadway • San Francisco (2): 760 Market St.

CAPITOL RADIO ENGINEERING INSTITUTE
16th and Park Road, N. W., Dept. RC-5, Washington 10, D. C.
Gentlemen: Please send me your free booklet, "CREI training for your better job in RADIO-ELECTRONICS", together with full details of your Home Study training. I am attaching a brief resume of my experience, education and present position.

CHECK ONE PRACTICAL RADIO-ELECTRONICS COURSE PRACTICAL TELEVISION

NAME

STREET

CITY ZONE STATE

I am entitled to training under the G. I. Bill.

Check field of greatest interest:

RADIO-ELECTRONICS BROADCASTING AND TELEVISION

AERONAUTICAL RADIO ENGINEERING

RECEIVER SERVICING INDUSTRIAL ELECTRONICS

**FM!
TELEVISION!**

To keep Ahead of the Game—

**Keep up with PHOTOFAC Folders—
The Key to Profitable, Progressive Servicing!**

Build the service data library that keeps you out ahead, abreast of all the newest radio developments. Have at your finger-tips the most accurate, uniform and practical servicing data—everything you need for easier, more profitable work. From the moment you get them, PHOTOFAC Folder Sets increase in value. They pile up increasing profits for you month after month, year after year. You can't afford to miss a single PHOTOFAC Set! Buy every issue regularly—it's the easy pay-as-you-use way to build the world's most practical service data library. Published 20 times per year. Price per Set, Only **\$1.50**

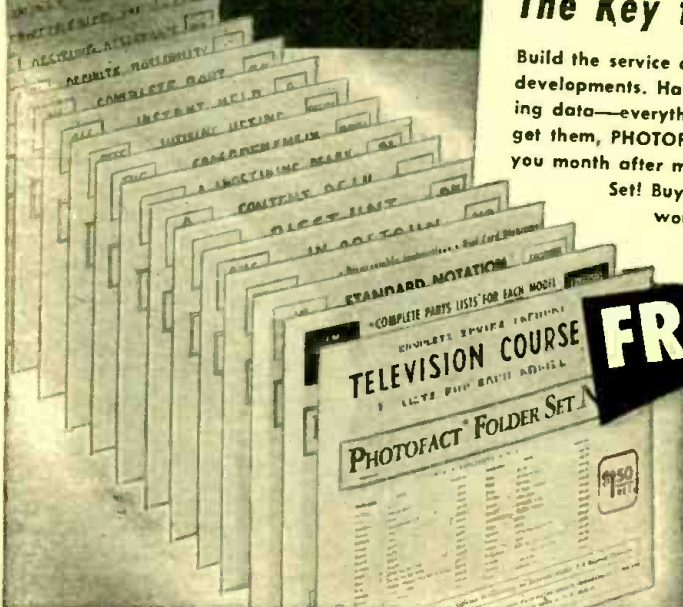

FREE

Cumulative Index to All Post-War Receivers

New Cumulative Index to all PHOTOFAC Folders now available! Send for this invaluable guide to the most practical and useful data available on all post-war radio receivers. Locates in a jiffy the Folder Sets you need for quicker, more profitable work. Ask your parts jobber today for a FREE copy, or use coupon below.



THESE HOWARD W. SAMS BOOKS EARN MONEY FOR YOU EVERY SINGLE DAY



**RADIO RECEIVER
TUBE PLACEMENT GUIDE**

The book that shows you exactly where to replace each tube in 5500 radio models. Covers receivers from 1938 to 1947. Each tube layout is illustrated by a clear, accurate diagram. Saves time—eliminates risky hit-and-miss methods. A handy pocket-sized 192-page book, indexed for quick reference. You'll use it profitably every single day! Order TODAY! ONLY **\$1.25**



**1947 AUTOMATIC
RECORD CHANGER MANUAL**

Nothing like it! Complete, accurate data on over 40 post-war models. Exclusive exploded views, photos from every angle. Gives full change cycle data, information on adjustments, service hints and kinks, complete parts lists. PLUS complete, accurate data on leading Wire, Ribbon, Tape and Paper Disc Recorders! 400 pages; hard cover; opens flat. Don't be without this manual. ONLY **\$4.95**



**DIAL CORD
STRINGING GUIDE**

The book that shows you the one right way to string a dial cord. Here for the first time, in one handy pocket-sized book, are all available dial cord diagrams covering over 2300 receivers, 1938 through 1946. Makes dial cord restringing quick and simple. Pays for itself in time saved on a single dial cord repair job. A "must" for every service bench and tool kit. Order your copies now. ONLY **\$1.00**

SEND FOR the FREE Cumulative Index to PHOTOFAC Folders covering all post-war receivers up to the present. You'll want this valuable reference guide.



PHOTOFAC VOLUMES

PHOTOFAC Folders are available in handy Deluxe volumes. Volume 1 covers all post-war models up to Jan. 1, 1947. Volume 2 covers models from Jan. 1, 1947 to July 1, 1947. Volume 3 covers models from July 1, 1947 to Jan. 1, 1948. Order from your parts jobber today. Your price, each Volume in Deluxe Binder. **\$18.39**



HOWARD W. SAMS & CO., INC.
INDIANAPOLIS 7, INDIANA

Export—Ad. Aurema—89 Broad St., New York 4, N. Y.—U. S. of America
Canada—A. C. Simmonds & Sons, 301 King St., East—Toronto, Ontario

PHOTOFAC SERVICE

"The Service that pays for itself over and over again"

- Mail This Order Form to HOWARD W. SAMS & CO., INC. 2924 E. Washington St., Indianapolis 7, Indiana. My (check) (money order) for \$.....enclosed.
- Send FREE PHOTOFAC Cumulative Index.
 - Send PHOTOFAC Sets Nos. (\$1.50 per set)
 - Send PHOTOFAC Volume 3 (including Sets Nos. 21 through 30) in Deluxe Binder.
 - Send Volume 2 (Sets Nos. 11 through 20).
 - Send Volume 1 (Sets Nos. 1 through 10), \$18.39 each.
 - Send.....SAMS' TUBE PLACEMENT GUIDE(S) AT \$1.25 per copy.
 - Send.....SAM'S 1947 AUTOMATIC RECORD CHANGER MANUAL(S) at \$4.95 each.
 - Send.....SAMS' DIAL CORD STRINGING GUIDE(S) at \$1.00 per copy.

Name.....
Address.....
City..... State.....

NEW *Hand-Size* LABORATORY

MODEL 666-HH VOLT-OHM-MILLIAMMETER

This new "hand-size" Triplett tester packs a laboratory of versatile service into a size that fits your hand and weighs only 1 1/2 lbs. In a handsome, streamlined, molded case, Model 666-HH has greater scale readability, new banana-type jacks, an assurance of low contact resistance, greater stability evolved through special new type resistors—plus other features. Delivers better results than many larger, costlier testers. It's ideal for servicemen, amateurs, engineers and technicians.

RANGES

D.C. VOLTS: 0-10-50-250-1000-5000 at 1000 ohms/Volt.
A.C. VOLTS: 0-10-50-250-1000-5000 at 1000 ohms/Volt.
D.C. MILLIAMPERES: 0-10-100-500 at 250 millivolts.
OHMS: 0-2000-400,000.
U.S.A. Dealer Net \$22.00

For descriptive Material write Dept. L5



Solve Your Service Problems Better - With TRIPLETT

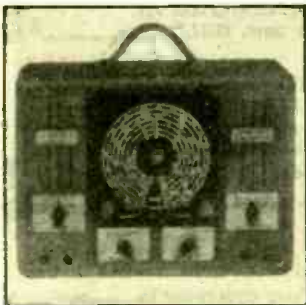

Model 3432—Illuminated dial Test Oscillator.
U.S.A. Dealer Net.....\$63.25



Model 3480—Combination Tube Tester Volt-Ohm-Mil-Ammeter.
U.S.A. Dealer Net.....\$89.75

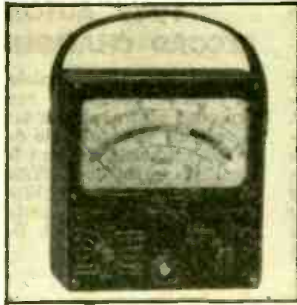

Model 625-NA — Wide Range Volt-Ohm-Mil-Ammeter.
U.S.A. Dealer Net.....\$45.00

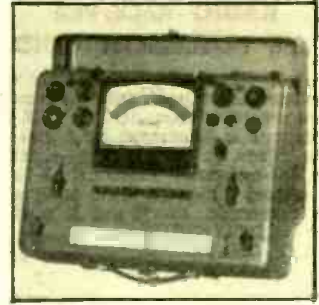

Model 3413—Tube Tester, with Speed Roll chart.
U.S.A. Dealer Net.....\$60.75

TRIPLETT ELECTRICAL INSTRUMENT CO. • BLUFFTON, OHIO

In Canada: Triplett Instruments of Canada, Georgetown, Ontario

NEW TRIPLETT TELEVISION TESTERS COMING
WATCH

Precision first...to Last



RADIO-CRAFT for MAY, 1948

HOW TO MAKE MONEY
in RADIO
ELECTRONICS
TELEVISION

**HOW TO READ
RADIO DIAGRAMS
AND SYMBOLS**

**SPRAYBERRY
ACADEMY
of RADIO**

**GET THESE 2 BIG BOOKS
FREE.**

**IF YOU
WANT TO LEARN
RADIO!**



FRANK L. SPRAYBERRY
famous Radio teacher of hundreds
of successful Radio men.

**I TRAIN YOU RIGHT BY SENDING YOU 8 BIG KITS OF
RADIO EQUIPMENT INCLUDING A POWERFUL 6 TUBE
SUPERHET RECEIVER AND 16 RANGE TEST METER!**

Radio job. Just mail the coupon for a FREE Sample Lesson and my big FREE book, "How To Make Money In Radio, Electronics, Television." It tells how I train you at home during spare hours by putting you to work building, testing, repairing Radio equipment. The Sprayberry Course teaches you Radio by working with 8 big kits of Radio parts I supply. You build a powerful 6 tube superhet Radio, a 16-range test meter, perform over 175 interesting, PRACTICAL experiments. My lessons are easy and interesting—you need no previous experience in Radio. I start you at the beginning... and give you valuable "bench" experience that sticks with you.

Soon after you start I send you my famous BUSINESS BUILDERS that help you earn EXTRA CASH getting and doing neighborhood Radio Service jobs while learning. You couldn't pick a better time to get into Radio. The Radio Repair Business is booming! Good Radio Service and Repair Shops are needed everywhere as millions of new sets are in use. Trained men are wanted for opportunities in Police, Aviation and Marine Radio, F.M. and Standard Broadcasting and Television. Manufacturers are looking for men who know Radio as production reaches new peaks. GET THE FACTS ABOUT YOUR FUTURE IN RADIO. MAIL THE COUPON TODAY for my FREE BOOKS!

LEARN HOW TO BUILD-TEST-REPAIR RADIOS By Working with YOUR HANDS!

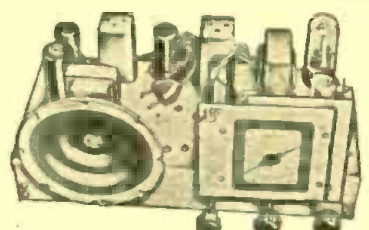

You really learn Radio the PRACTICAL way... when you build this big, powerful 6-tube Superhet Radio from parts I send you.

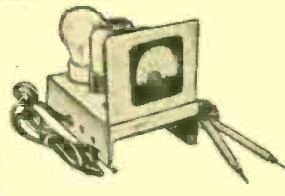

give you a fine, moving coil type Meter—with parts for a complete analyzer and Circuit Continuity Tester. "Trouble-shoot" with professional accuracy.

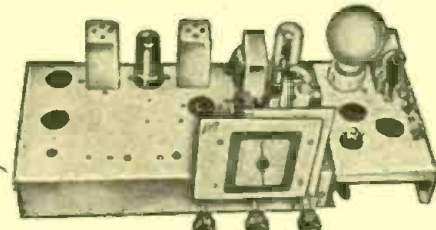

You don't have to buy expensive ready-made equipment. You get valuable experience building this Signal Generator and Multi-purpose Tester.

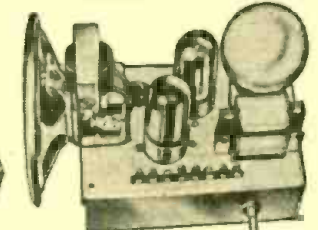

You construct this rectifier and filter, resistor and condenser tester, and really get on the Practical end of Radio.

LOW COST RADIO TRAINING STUDY AT HOME IN SPARE HOURS

Sprayberry Training costs surprisingly little! Easy monthly payments, if desired. Everything you need is furnished—nothing else to buy. With Sprayberry Training to back you up, you will be able to step into your own profitable Radio Service Business or go on to a big opportunity in Radio, Electronics or Television. The equipment I send you is yours "for keeps"—to use in your business or job. I have trained thousands of successful Radio men—and I can help you, too. Get the facts about Sprayberry Training—it's your first step to success, security and a bigger income in a field where you'll really enjoy your work. Fill out and mail coupon TODAY. I'll rush my two FREE books to you by return mail.

VETERANS: Approved for G. I. Training under Public Laws 16 and 346.

Sprayberry Academy of Radio
F. L. SPRAYBERRY, President
Room 2058, Sprayberry Bldg., Pueblo, Colorado

RUSH COUPON Today!

SPRAYBERRY ACADEMY OF RADIO
F. L. SPRAYBERRY, President
Room 2058, Sprayberry Bldg., Pueblo, Colorado
Please rush my FREE copies of "How To Make Money In Radio, Electronics and Television" and "How To Read Radio Diagrams and Symbols." No salesman will call.

Name _____ Age _____
Address _____
City and Zone _____ State _____
 CHECK HERE IF A VETERAN
(Mail in an Envelope or Paste on Penny Postcard)



Trained Radio men can step into their own profitable Radio Service Shop—or—



New developments are constantly opening new big pay job opportunities in Radio.

THE BEST FOR LESS

"Communications"

RADAR • AIRCRAFT AMATEUR • INDUSTRIAL

TEST SET 159TPX

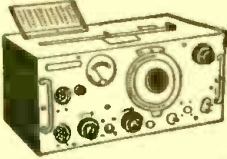

Measures frequency between 150 & 200 mc. by heterodyne method. Power of Xmttr can be directly measured. Measures DC voltages up to 500 Volts. Original operation on 110 V. 400 cy. but conversion kit makes it operable on 110 V. 60 cy. new, complete with tubes, crystal, cal. chart, antenna, meter & conversion kit and data for 110 V. 60 cy operation\$29.95

CATHODE RAY TUBES 5BP1 . . . \$1.20



3BP1—\$1.25 5FP7—\$1.75
3FP7—\$1.20 5JP2—\$4.00

24-Volt Filament Transformers

No. 2Z17, Input 110 volt, 60 cycles. Output 24 volt @ 3 amp. Size 3" x 3 1/2" x 3" (as shown) \$4.50



HEADSETS

Dynamic mike and headset combination. A high quality, efficient unit, used in B-19 tank Xmttrs. Mike and phones complete, new\$2.75
B-15 headset: 8000 ohms impedance, rubber cushions. Comes with 8' cord and plug PL 55. New \$1.95. Used, in good condition\$.60
HS 30 headset. Insert type headset cuts out background noise, and low impedance (500 ohms) assures efficiency and high fidelity. A MUST for every ham at this price\$.85
Xfmr to match 8000 ohms output\$.35

TRANSFORMERS

All Primaries—117 V 60 cycles
5102: 1080 vct @ 85 ma. 6.3 v. @ 1.2 amp. 6.3 v. @ 1.2 amp.\$2.35
5110: 1100 v. @ 70 ma, tapped @ 550 v. (for use with H.W. rect.)\$2.75

FILAMENT TRANSFORMERS

5123: 0.3 vct @ 5 amp, 6.3 vct @ 1 amp\$2.15
5109: 27 vct @ 8.5 amp, 6.3 v. @ 2.5 amp\$2.75
13163: 2.5 v. @ 1.75 amp. 5 v. @ 3 amp. 6.5 v. @ .6 amp. 6.5 v. @ 8 amp\$5.35
Doughnut Fil. Xfmr. Two 5.1 v. windings @ 5 amp. each. 15,000 volt test\$2.00
No. 5058: 0.3 VCT @ 2A, 6.3 VCT @ 2A, 6.3 VCT @ 2A\$2.25
No. 5100: 6.3 VCT @ 1.2 A. 5000 V test\$1.35
No. 5056: 6.3 VCT @ 9 A. 6.3 VCT @ 2.2 A\$2.50
No. 5057: 6.3 VCT @ 1 A, 5 VCT @ 3 A, 5 VCT @ 3 A\$2.50
UK 6880: 5 V @ 5.5 A, 3 V @ 5.5 A, 29,000 Volts Test\$24.50

ARC-5 ACCESSORIES CONVERSION COILS FOR ARC-5 TRANSMITTERS

M.O. Coils	P.A. Coils	Antenna Loading Coils	Freq. Range
\$1.00 each	\$1.00 each	\$.85 each	3-4 Mc.
#6025	#7247	#6034	4-5.3 Mc.
#6030	#9293	#6035	7-9.1 Mc.

CONVERSION KIT. consisting of 1-M-O coil, 1-P.A. coil, 1-ANTENNA COIL, in any one particular frequency range\$2.00
ARC No. 6558 variable receiving capacitor, 62 mm/section, 3 sections, .03" spacing, 8 rotors, Worm drive ratio 33:1\$1.75
ARC No. 4590, variable tuning capacitor, 22.4-115 mmf, .05" spacing, 11 rotors, Each\$1.00
ARC 5632 Var. Xmttr. capacitor, 20.2-117 mmf, .04" spacing, 16 rotors, worm drive: 96:1\$1.00
Single revt. mtg. racks\$1.00
Dual mtg. racks (revt.)\$1.50
Single shock mounts for rack\$.50
DUAL CONTROL BOXES FOR RCVRs\$1.00

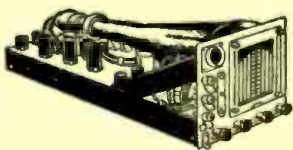

INDICATOR BC 704 A

Indicator. Part of Radar Set SCR 521. Makes an excellent foundation unit for a high gain scope. Has following tubes: 4-6AC7, 3-6HG6, and 1-5BP1 CR tube. Comes enclosed in metal shield. New, with all tubes, less power supply With wooden carrying case\$17.50

UNIVERSAL VIBRATOR TRANSFORMER

Input 6, 12, or 24 volts, 200 cycles. Secondary, 3 windings 120 volts at 75 mills each\$1.50

POWER CHOKES

6 Hy @ 150 ma.\$1.50
6 Hy @ 300 ma.\$3.25
1 Hy @ 800 Ma. 7.5 Ohms\$12.50
Dual Choke: 2.2 Hy @ 100 Ma.\$.50
Dual Choke: 7 Hy @ 75 Ma. 11 Hy @ 60 Ma.\$1.50
8.5 h @ 125 ma.\$1.50
25 h @ 65 ma.\$1.10

CROSS POINTER INDICATOR

Two 0-200 microampere movements, 3" case, many applications\$2.50

ANTENNA AN/122-A. Used in 4-element adcock arrays for high gain and directivity. Each diode element is 12' long, made of 3/8" tubing. Excellent for that new 6 or 2-meter beam. Don't miss this great value. \$5.65 each or 4 for \$20.00

ANTENNA AN/104-A. The famous ax-handle antenna, used with the SCR 322. Ideal for mobile quarter wave, because of its streamlined construction; or 2 units can be used to form a dipole for 2 meters or for TV and FM reception. Consists of copper sheath 21' long moulded about a wooden support, with 83-18 coax connector. \$7.75 ea., or 2 for \$13.50.

AN/128-A. For high gain and directivity on 2 meters. Consists of 2 vertical elements working against a square reflector, approx. 3"x4". Impedance is 50 ohms\$40.00

DYNAMOTORS



PE-73 CM(G.E.) Power supply for BC 375 Input: 28 VDC Output: 1000 VDC @ 350 Ma. New\$4.95
BD 77KM Power supply for BC 191 with spare fuse links, etc. Input 14 v.d.c. Output 1000 v. @ 350 ma. New\$3.95
Used, excellent condition\$9.95
MFRS: Write for quantity prices and discounts on above items.

PE 101-C Input 13/28 VDC @ 12.6/6.3 A. Output: 400 VDC @ 135 Ma., 800 VDC @ 20 Ma. 9 VAC @ 1.12 A, new\$3.49
PE 86 N, Input: 28 VDC, Output: 250 VDC @ 60 ma.\$1.95
PC 77, Input 12 VDC, Output 275 VDC @ 110 Ma. 500 VDC @ 50 Ma.\$3.25
DAO 33A Input: 18 VDC @ 3.2 A. Output: 450 VDC @ 60 Ma.\$2.45
DM 33: Input 28 VDC @ 7 a. Output: 540 VDC @ 250 Ma. Power supply for SCR 274 modulator\$3.95
DM 2350: Input: 27VDC @ 1.75 A. Output: 385 VDC @ 75 Ma.\$3.50
DM 21: Input: 14 VDC, Output 235 VDC @ 90 Ma. Power supply for BC 312\$2.49
PE 55, Input: 12 vdc @ 25 amp. Output 500 vdc @ 400 ma. (slightly used)\$4.95
MP 10 G Power supply, using 2 dynamotors. Input: 24-28 vdc. Output: 1000 vdc @ 400 ma, 230 vdc @ 100 ma. New, complete with relays, filters, etc. BENDIX\$40.00

B-19 power pack (dynamotor). Input: 12 vdc @ 9.4 amp. Output: 275 vdc @ 110 ma. 500 vdc @ 50 ma. New, complete in metal case with 2 plugs, filters, etc.\$5.95

DM 28-B, Input: 28 v.d.c. @ 1.25 amp. Output: 270 v.d.c. @ 70 ma. New, with enclosed terminal box\$3.25
ZA/USA 0515, Input: 12/24 v.d.c. @ 4/3 amp. Output: 500 v.d.c. @ 50 ma. Compact square shape, size: 7 1/4"x4 1/2"x3"\$3.95
ZA/USA 0516, Input: 12/24 v.d.c. @ 8/4 amp. Output: 275 v.d.c. @ 110 ma., 12 v.d.c. @ 3 amp. Compact square, size: 7 1/4"x4 1/2"x3"\$4.25

DM-25: In 12VDC 2.3A Out 250VDC 50 ma \$2.49
DM-42: In 14VDC, Out 515/1030 VDC 215/269 ma and 2/8VDC\$3.95

INVERTERS

PE 204-A, Input: 28 v.d.c. @ 38 Amp. Output: 80 volts @ 500 volt-amp, 800 cy. Leland Electric. New, complete with instruction book, relays, filters, etc.\$12.50
PE 218—Input: 25-28 v.d.c. @ 92 amp. Output: 115 volts, 1500 volt-amps, 380/500 cy. Leland Electric. New \$35.00; Used, good condition\$20.00

RELAYS

BO 6D35, DPDT, 18-28 vdc, contacts 10 amps @ 115 vac\$1.25
7220-34, Contactor: SPST, 24-28 vdc, contacts 400 amps\$1.20
1077BF, Antenna changeover, DPDT, 28 vdc. \$1.15
TELEPHONE TYPES
GR 204, DPST, 500 ohms, 24 vdc (Normally open)\$1.05
SC 5853 A, SPST w/apdt section, 24 vdc, 1000 ohms\$1.10
EE 89 Repeaters, for extending range of field telephono sets such as EE-8, etc. from 15 to 25 miles. New, with spare tube, less batteries\$18.50

Microwave Tubes

Tube	(Magnetrone)	Freq. Range	Pk. Pwr.	Out. Price
2J31		2820-2860 mc	285 Kw	\$10.00
2J21-A (725-A)		3345-3405 mc	80 Kw	\$25.00
2J22		3267-3333 mc	265 Kw	\$15.00
2J26		2992-3019 mc	275 Kw	\$15.00
2J31		2865-2892 mc	275 Kw	\$15.00
2J32		2820-2860 mc	285 Kw	\$15.00
2J33		2780-2820 mc	285 Kw	\$15.00
2J38	PKG. 3249-3263 mc		5 Kw	\$25.00
2J35	PKG. 9345-0405 mc		50 Kw	\$25.00
3J31	24,000 mc		35 Kw	\$17.50
W.E. 700-A	680-710 mc		100 Kw	\$30.00
W.E. 720-BY	2800		1000 Kw	\$25.00

MAGNETS for 2J21-A (725-A), 2J22, 2J26, 2J27, 2J31, 2J31, 2J32 and 3J31, each\$6.00

Field Strength (Gauss)	Distance Between Pole Faces	Pole Face Diameter	Price
4850	3/8"	3/4"	\$8.00
1500	1 1/2"	1 1/2"	\$8.00
1000	Adjustable	2 1/2"	\$12.00
(Electromagnet)	2 3/4" to 3"	3/4"	\$4.00

CERAMIC CAPACITORS

(Eric. Centralab) \$7.50 per 100

3 mmf	±5%	67 mmf	±20%
5 mmf	±5%	100 mmf	±3%
4 mmf	±5%	115 mmf	±3%
8.5 mmf	±5%	120 mmf	±3%
11 mmf	±5%	240 mmf	±3%
15 mmf	±2.5%	350 mmf	±3%
48 mmf	±2%	500 mmf	±15-30%
60 mmf	±20%	1000 mmf	±6%
60 mmf	±3%		

SILVER-MICA BUTTON CAPACITORS

(Eric. Centralab) \$9.50 per 100

185 mmf	±2.5mmf
175 mmf	±2.5mmf
500 mmf	±10mmf

BC 1267 XMTR-RCVR.

XMTR consists of tuned line pulse oscillator on 154-186 mc. Can be modified to operate on voice or CW, and put to work on the amateur 2-meter band. **RCVR** is a superhet with 2 stages of RF and 5 stagger-tuned I.F. stages (11 mc). Plenty of room on chassis for additional components and changes. Used, but in excellent condition\$27.50
Complete with power supply for operation from 117 v. 60 cycles\$42.50

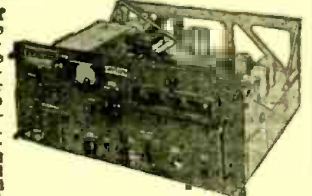

MOTOR DRIVEN SWITCH

Switch operates at 1800 rpm, using internal 24 VDC motor. Switch is DPDT, and was originally designed for automatic switching of YAGI radar antennas\$2.00

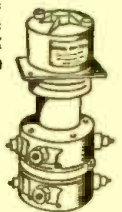

All merchandise guaranteed. Mail orders promptly filled. All prices, F.O.B. New York City. Send Money Order or Check. Shipping charges sent C.O.D.

COMMUNICATIONS EQUIPMENT CO.

131 C. Liberty St., New York City 7, N. Y. Digby 9-4124

Now IN YOUR OWN HOME *Learn*

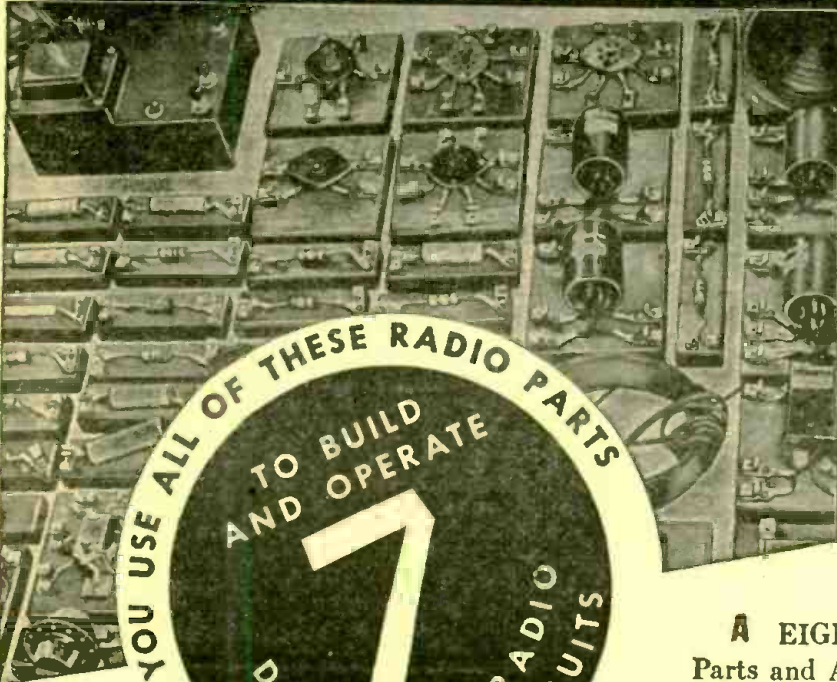

RADIO ELECTRONICS

The Practical
 "HOME-TESTED"
Modern "A-B-C" Way

YOU USE ALL OF THESE RADIO PARTS
 TO BUILD AND OPERATE
7
 DIFFERENT RADIO RECEIVING CIRCUITS

WITH THE HELP OF

A EIGHT Big Kits of Actual "Learn-by-Doing" Radio Parts and Assemblies with which you make 133 fascinating SHOP METHOD EXPERIMENTS in your own home! Imagine building 7 different Radio Receivers that operate!

B A 16 mm Home Movie Projector and Twelve Reels of "Learn-by-Seeing" Home Movie Films . . . for picture-clear, fast understanding of Radio Fundamentals!

C Modern, well-illustrated, Loose-leaf Lessons, prepared in clear, simple, understandable language . . . to guide you throughout your training!

NO PREVIOUS RADIO OR ELECTRICAL EXPERIENCE NECESSARY

DeForest's Training, Inc. provides every major home study aid to help you learn Radio-Electronics rapidly and thoroughly . . . to give you the *experience and confidence* needed for a responsible, Good-Pay Job, or to Start a Business of Your Own! Here is a REAL opportunity field for YOU . . . when you are a trained Radio-Electronics man! Just think of the tremendously exciting future ahead of FM Radio, Aviation and Broadcast Radio, Sound Motion Picture Equipment, Servicing and Sales of Radio Equipment, etc. Put *yourself* in this picture . . . See how you can benefit from a PRACTICAL training in this fascinating work! Think, too, of the coming possibilities ahead of Radar, Facsimile and Television. Send TODAY for the interesting, opportunity-revealing book, "Victory for You!" See how others probably no more talented or ambitious than you, have advanced in earning power after this training . . . how YOU can do it too! Mail the coupon NOW!

INCLUDING:

1. Simple Receiver
2. Two Tube Receiver
3. Tuned Radio-Frequency Receiver
4. Short Wave Receiver
5. Aviation Band Receiver
6. 4-Tube Superheterodyne
7. 5-Tube Superheterodyne with Magic Tuning Eye

... PLUS SCORES OF OTHER FASCINATING, INSTRUCTIVE RADIO-ELECTRONIC EXPERIMENTS

THEN GET THE HELP OF OUR EFFECTIVE EMPLOYMENT SERVICE

16 MM MOVIE PROJECTOR YOU USE "LEARN-BY-SEEING" MOVIES



DEFOREST'S TRAINING, INC. INCLUDES INSTRUCTION IN MOTION PICTURE SOUND EQUIPMENT, FM RADIO AND TELEVISION . . . RESIDENTIAL TRAINING IN OUR MODERN CHICAGO LABORATORIES ALSO AVAILABLE—ASK US FOR INFORMATION!

VETERANS!

Big things are happening at DeForest's Training, Inc. for veterans! See how you can prepare yourself WITHOUT COST for a GOOD JOB or a BUSINESS OF YOUR OWN in the vast Radio-Electronic opportunity field.

DeFOREST'S TRAINING, INC.
 CHICAGO 14, ILLINOIS

E. B. DEVRY, President
 DeFOREST'S TRAINING, INC.
 2535-41 North Ashland Ave., Dept. RC-E5
 Chicago 14, Illinois, U.S.A.

Send FREE "VICTORY FOR YOU!" BOOK, showing how I may make my start in Radio Electronics.

Name _____ Age _____

Address _____ Apt. _____

City _____ Zone _____ State _____

If under 16, check here for special information.

If a discharged Veteran of World War II, check here.

WATCH FOR JUNE ISSUE—SPECIAL FM NUMBER

MAY • 1948

Editorial: Applied Radio Circuits..... by Hugo Gernsback 17
 Radio-Electronics Monthly Review..... 18, 19
 Radio Thirty-Five Years Ago..... 80

Radio and Electronics

Electret Construction..... by Victor H. Laughter 20
 Electronic Visibility Meter..... by S. R. Winters 22
 12,000-Tube Electron Brain (Cover Feature)..... by A. Pascale 28

Amateur Radio

Efficient 100-Wattter..... by E. F. Harris, W8SJB 24
 WWV Schedule Changes..... 71

Servicing

Radio Set & Service Review (Midget Television Preamplifier)..... 31
 Servicing Wind Generators..... by Max Alth 33
 Serviceshop Tests Serviceshops..... by Eric Leslie 66
 Radioman on Wheels..... by Richard Laurence 78

Test Instruments

Miniature 3-Use Fixed Oscillator..... by William Lyon McLaughlin 26
 Laboratory-Type Oscillators..... by William B. Miller 27
 Wobulated Signal Generator..... by George W. Schultze 34
 Push-Button Signal Generator..... by Alfred Haas 37

Sound

Noise Reduction in A.F. Circuits..... by I. Queen, W2OUX 23
 Phase Inversion Circuits..... by J. W. Straede 32
 High-Fidelity Amplifiers..... by R. F. Scott 36
 Volume Expander..... 75

Construction

Light with a Memory..... by M. Gordon Moses 30
 Cheap and Effective Noise Limiter..... by Otto Wooley, W0SGG 80

Departments:

Transatlantic News..... by Major Ralph W. Hallows 38
 New Radio-Electronic Devices..... 40
 The Question Box..... 42
 Radio-Electronic Circuits..... 44
 Technotes..... 47
 Try This One..... 50
 New Radio-Electronic Patents..... by I. Queen 54
 World-Wide Station List..... Edited by Elmer R. Fuller 63
 Communications..... 83
 Book Reviews..... 87



Incorporating
 SHORT WAVE CRAFT® TELEVISION NEWS*
 RADIO & TELEVISION
 *Trademark registered U. S. Patent Office

HUGO GERNSBACK

- Editor-in-Chief*
 FRED SHUNAMAN, *Managing Editor*
 M. HARVEY GERNSBACK,
Consulting Editor
 ROBERT F. SCOTT, W2PWE,
Technical Editor
 ANGIE PASCALE,
Production Manager
 I. QUEEN, W2OUX, *Editorial Associate*
 ELMER FULLER, *Shortwave Editor*
 G. ALIQUO, *Circulation Manager*
 JOHN J. LAMSON,
Advertising Director
 ALFRED STERN, *Promotion Manager*

In Our Next Issue

SPECIAL ARTICLES ON ALL PHASES OF FM—THEORETICAL AND PRACTICAL, CONSTRUCTION AND SERVICING, FEATURE THE JUNE ISSUE.

On the Cover:



International Business Machines' 12,000-tube computer which does the work of more than 1,000 mathematicians.

Chromatone by Alex Schomburg from Harris & Ewing photo.

ABC PAID CIRCULATION 6 MONTHS PERIOD TO DEC. 31, 1947—102,688.

PRINTED FOR MAY ISSUE—153,000.



RADCRAFT PUBLICATIONS, INC. Hugo Gernsback, President; M. Harvey Gernsback, Vice President; G. Aliquo, Secretary

Contents Copyright, 1948, by Radcraft Publications, Inc. Text and illustrations must not be reproduced without permission of Copyright owners.

RADCRAFT PUBLICATIONS INC. • PUBLICATION OFFICE 29 Worthington Street, Springfield 3, Mass. Address all correspondence to N. Y. office. EDITORIAL AND ADVERTISING OFFICES 25 West Broadway, New York 7, N. Y. Telephone REctor 2-9690. BRANCH ADVERTISING OFFICES: Chicago: 308 W. Washington Street, Chicago 6, Ill. Tel. Randolph 7363. Detroit: Frank Holstein, Manager, Room 402 Lexington Bldg., 2970 West Grand Blvd., Detroit 2, Mich. Telephone Madison 7026-7. Los Angeles: Ralph W. Harker, Manager, 606 South Hill St., Los Angeles 14, Calif. Tel. Tucker 1793. San Francisco: Ralph W. Harker, Manager, 382 Market St., San Francisco 4, Calif. Tel. Garfield 1-2481.

RADIO-CRAFT, May, 1948, Volume XIX, No. 8. Published monthly on 25th of month preceding date of issue. Allow one month for change of address. When ordering a change, please furnish an address stencil impression from a recent wrapper. All communications about subscriptions should be addressed to the Circulation Manager, Radio-Craft, 29 Worthington St., Springfield 3, Mass., or 25 West Broadway, New York 7, N. Y.

SUBSCRIPTION RATES: United States and possessions, Mexico, Central and South American countries, \$3.50 a year; \$6.00 for two years; \$8.00 for three years. Canada, \$4.00 a year; \$7.00 for two years; \$9.50 for three years. All other foreign countries, \$4.25 a year, \$7.50 for two years; \$10.25 for three years.

FOREIGN AGENTS: Great Britain: Atlas Publishing and Distributing Co., Ltd., 18 Bride Lane, Fleet St., London E.C.4. Australia: McGill's Agency, 179 Elizabeth Street, Melbourne. France: Brenteno's, 37 Avenue de l'Opera, Paris 2e. Holland: Technisch Bureau Van Baerle, Bemelmans & Co., Heemsteedsche, Dreef 124, Heemstede. Greece: International Book & News Agency, 17 Amerikis Street, Athens. So. Africa: Central News Agency, Ltd., Cor. Rissik & Commissioner Sts. Johannesburg; 112 Long Street, Capetown; 369 Smith Street, Durban, Natal. Universal Book Agency, 70 Harrison Street, Johannesburg. Middle East: Stelmatsky Middle East Agency, Jaffa Road, Jerusalem. India: Susil Gupta (Distributors) Co., Amrita Bazar Patrika Lt., 14 Ananda Chatterjee Lane, Calcutta.

NOW! FAMOUS \$500 TELEVISION COURSE YOURS WITH PHOTOFAC FOLDERS!



Mr. Albert C. W. Saunders' background includes association with the Marconi Company, teaching experience at Harvard and M.I.T.; founder Radio Technician's Guild; full member I.R.E. Graduate, Portsmouth College, England. Mr. Saunders gave the first actual television demonstration in New England in 1935.

Famous Saunders' Course **EXCLUSIVE** in Howard W. Sams' PHOTOFAC

We have been able to prevail upon Mr. Saunders to transcribe his famous course on Television for PHOTOFAC *exclusively*. The only other way you can get this course is by paying \$500 and attending the Saunders School. *Now*—with PHOTOFAC at no extra cost to you—you can have this wonderful instruction that fits you for Television servicing!

Get Ready to Make Big Money in Television Servicing with This Practical, Successfully Proved Instruction!

NOW! AT NO EXTRA COST TO YOU—you can have the nationally-famous \$500 Saunders' Television Course! It's the world's finest training—*practical* down-to-earth training that actually prepares you for Television and keeps you 'way out ahead of the game. Here's the *first real help* in Television for Servicemen—brought to you *exclusively* by PHOTOFAC and PHOTOFAC alone! If you want to stay in Radio Servicing, you can't afford to miss a single installment of this amazing Television Course! Read every word of this announcement and then ACT!

Not Just a Book—A Complete Training Course in Television!

You get the actual \$500 Television Course, exactly as taught in the nationally-famous Saunders Radio & Electronics School at Newton, Mass. We literally bring this course to you in print—transcribed word for word from the original lectures, supplemented by graphic training aids, exclusive PHOTOFAC "exploded" views and hundreds of visual illustrations, prepared under Mr. Saunders' personal supervision. This is the *same* course attended by hundreds of established service technicians and by service personnel of leading set manufacturers—the *same* \$500 course!

First Installment Appears in PHOTOFAC Set No. 38!

The Television Course will appear in regular installments in each PHOTOFAC Folder Set, beginning with Set No. 38. Each installment will include the *right* amount of material so that you will be able to digest it easily and completely between issues. Instruction will be kept up-to-date and will include the latest information promptly as it is available on the subject. There's no need to wait now for books that will never cover the ground adequately, or to buy books that are obsolete already. Be sure to order PHOTOFAC Set No. 38 *now*—and begin to qualify yourself for Television!

PRACTICAL, CLEAR, EASY-TO-FOLLOW TELEVISION TRAINING

Experts in the field of Television and Radio training acclaim the famous Saunders Course. It is remarkable in its ability to simplify and explain the most complicated theory and practice. It describes the action of an electronic circuit so originally and simply that it can be visualized in an unforgettable manner. The Saunders Course avoids higher mathematics and engineering terminology beyond the experience of the practical man. You know where you are every step of the

way, and you bridge the gap between Radio and Television with quick, simple understanding that makes unfamiliar subjects easy to master. As you progress in the course, Television circuits will unfold and become as clear and understandable to you as the Super-heterodyne circuit. You will be able to follow and use effectively the practical servicing data on specific Television receivers prepared for you by PHOTOFAC. Get started in the Course today with PHOTOFAC Set No. 38.

Get Television Training Worth \$500—Plus Incomparable Photo- fact Service Data at the Cost of PHOTOFAC Alone!

Here's the chance of a lifetime that really fits you for a profitable, successful career in Television servicing. Just think of it—you get the world's finest radio service data in PHOTOFAC—at only \$1.50 per set—and at the same time you train practically and successfully for Television with the finest course available in the country—a course worth \$500.00 that *costs you nothing extra!*

**DON'T MISS A SINGLE INSTALLMENT OF
THIS TELEVISION COURSE! MAKE SURE
YOU OWN IT ALL! GET STARTED WITH
PHOTOFAC SET No. 38 TODAY...!**

*Yours! AT NO
EXTRA COST*

**\$500 TELEVISION COURSE BEGINS
IN SET No. 38. ORDER TODAY!**

HOWARD W. SAMS & CO., INC.
INDIANAPOLIS 6, INDIANA
Export—Ad. Aulenta—89 Broad St., New York 4, N.Y.—U. S. of America
Canada—A. C. Simmonds & Sons, 301 King St., East—Toronto, Ontario

PHOTOFAC SERVICE
"The Service that pays for itself over and over again"

Mail This Order Form
to your local Parts Distributor,
or to HOWARD W. SAMS & CO., INC.
2924 E. Washington St., Indianapolis 7, Ind.
My (check) (money order) for \$1.50 enclosed.

Send PHOTOFAC Folder Set No. 38, including the first installment of the famous \$500 Saunders Television Course.

Name.....

Address.....

City.....State.....

WE GUARANTEE SATISFACTION

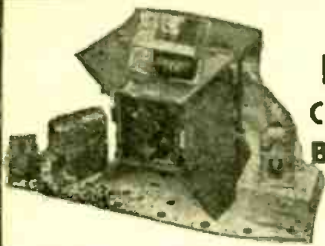

RADIO CONTROLLED BOMB-FIN
\$985

This unit was originally used to control a guided Bomb; it contains a 24-volt Willard rechargeable battery pack, which operates a gyroscope, and low geared reversible motor. The unit also contains a precision built 5-tube RF Receiver complete with dynamotor.

Shipped express, charges collect

Stock Up

WILLARD 7 VOLT BATTERIES **ONLY \$1.25 each**

Brand new, Compact, with great Built-in Hydrometer. Group several together for higher voltages. Uses Standard Electricals Guaranteed. Add 35c to cover postage and handling.

MT53B ANTENNA UNIT ONLY **\$195**



This unit contains a single pole double-throw vacuum switch, which is capable of handling RF potentials as high as 20 KV. When used in DC circuits, the switch will handle over 1 ampere at 5 KV. (These are Manufacturers Specs.)

The case is ideal for a portable mobile receiver or a small transmitter, as your control panel can be mounted behind the hinged door for protection. The case also has a built-in high voltage insulated antenna post. Dimensions are 6 1/2" x 7". Worth many times the price. Add 40c to cover postage and handling.

RCA ANTENNA REEL



MODEL M L-19611 **\$149**

A hand operated antenna Reel, for reeling in and out trailing antennas. Mfrd. by Continental Radio & Television Corp. under RCA License. Add 20c to cover postage & handling.

Shipped express, charges collect

12 VOLT 50 AMP. GENERATOR



AS LOW AS **\$795**

Less Pulley

OR **\$945**

With Pulley

These generators are excellent for truck or bus use. They also will make a fine power supply for your radio shack or nice light welder. Brand new in original boxes as pictured with pulley, \$9.45 each or with keyed shaft less pulley—\$7.95 each.

Shipped Express Collect

500' Telephone Wire now only **\$2.95**

3 conductor braided insulated copper and steel telephone wire. It is of copper for conductivity and steel for strength. Worth at least 3c per foot, yet due to an exceptional buy we can now offer it at less than 1c per foot.

(Shipped express charges collect)

PHANTOM ANTENNA



85¢

A transmitting antenna, for use on approximately 450 MC. Complete with standard coax connector. A weather-proof unit. (Add 25c to cover handling and postage).

1300' Rubber Covered Wire

ONLY \$18.00

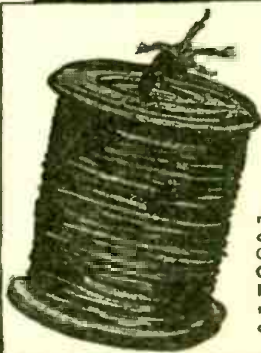

New 4 conductor 16 gauge rubber covered cable. Color coded. Used by United States Government as Field Telephone Cable. 1300 feet on steel reel. F.O.B. Our warehouse. Shipped motor freight or express shipping charges collect.

LOOP ANTENNA

LP-21-A

\$595

Used primarily on aircraft & Marine ADF Systems, Loop LP-21-A contains an electric motor and selsyn. These loops have been removed from salvage aircraft, but are guaranteed to be in excellent working condition.

Shipped Express Collect



Radio Compass



RS/ARN7 or 433G, either of these Radio Compass Receivers complete with tubes. Ideal for conversion for home reception. Used but good. A real buy at only \$17.25. (Shipped express collect)

\$17.25 each

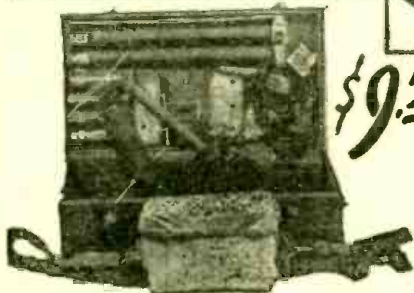

\$9.50

Mine Detector type AN-PRS-1 Brand new complete (except batteries) in original case. Each unit contains an instruction Manual. Good for detecting objects under the earth's surface. Requires one 6 volt and three 4.5 volt batteries. (Shipped express charges collect)

COMMAND RECEIVER

BC454 **\$395**
BC455

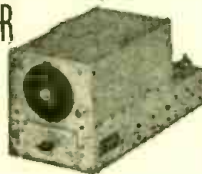

Your choice of either of these two famous Command Set Receivers. BC454 freq. range 3 to 6 MC or the BC455 6 to 9.1 MC. These sets are used, but in good condition. They are complete with tubes. Price—3.95 each.

(Shipped Express, charges collect)

IMPORTANT!

All merchandise subject to prior sale, minimum order \$2.00. No C.O.D. orders accepted. Michigan residents must add 3% State sales tax.



N. SILVERSTINE CO.

6532 EAST McNICHOLS ROAD DETROIT 12, MICHIGAN

"Seven Acres of Surplus"

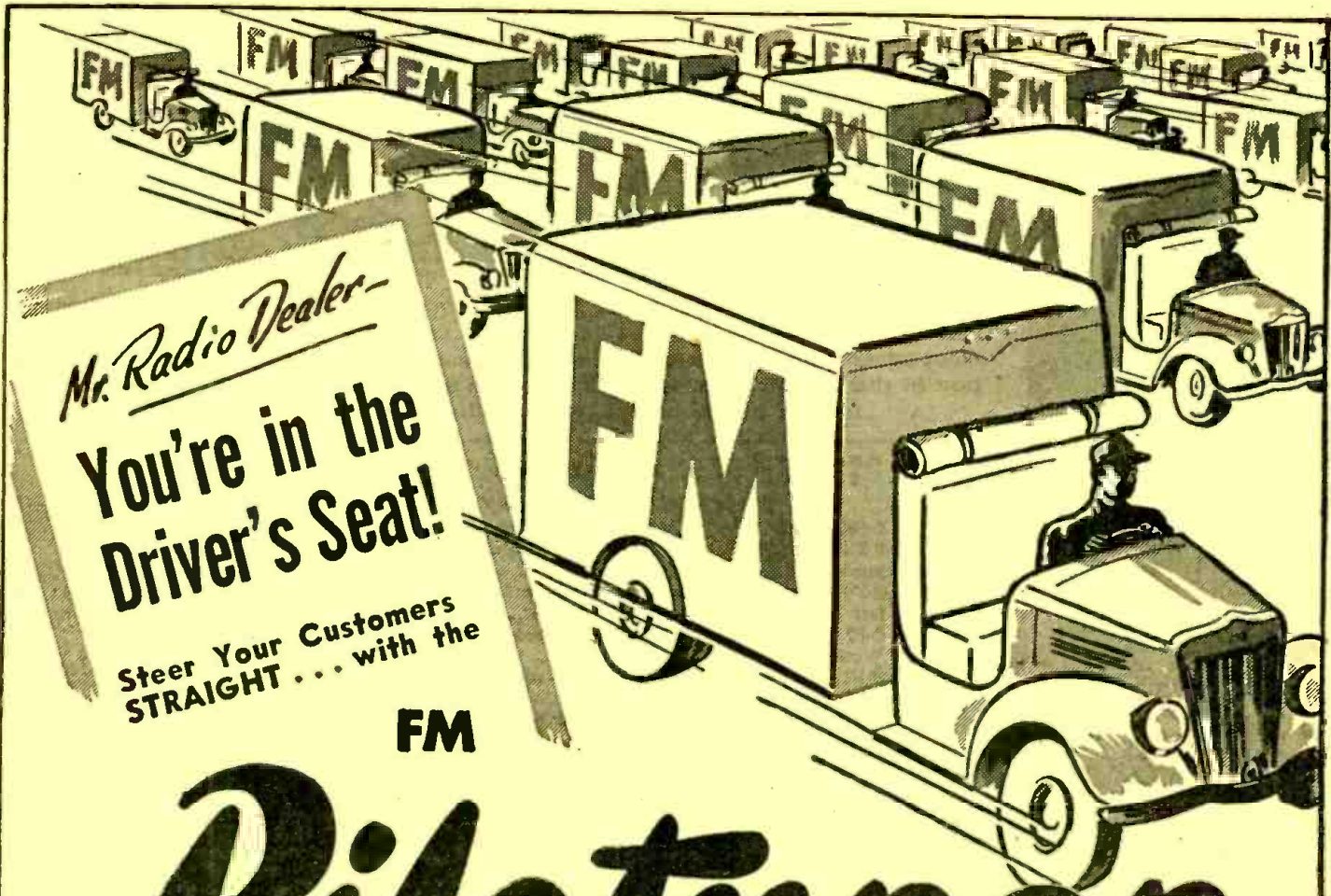

Mr. Radio Dealer—
**You're in the
 Driver's Seat!**

Steer Your Customers
STRAIGHT . . . with the

FM

Pilotuner

Where's FM headed, Mr. Radio Dealer? YOU decide.

WANT TO MAKE A FIASCO OF FM? . . . Then—go ahead . . . **SELL** second-rate, "almost-good-enough" FM equipment. But—be prepared for customer squawks, dissatisfaction . . . a bad name for FM . . . migraine headaches for yourself!

WANT TO "GO TO TOWN" WITH FM? Then—use the sensational **FM PILOTUNER**, as your standard of comparison, in testing all FM equipment. The Pilotuner has the last-detail quality . . . the thorough integrity . . . that do credit to **FM!**



Listed with Underwriters' Laboratory

to retail at

29.95

(Slightly higher west
 of the Rockies)

The **PILOTUNER** was a tremendous hit in '47 . . . With new FM stations opening at the rate of fifty a month, it's headed for an even greater '48! Stock it—feature it—get **YOUR** share of the big new business, new traffic! Send coupon for details.

PILOT RADIO CORP., 37-06 36th St., Long Island City, N. Y.

Send me full information concerning the FM PILOTUNER.

NAME

ADDRESS

CITY.....ZONE NO..... STATE.....

PILOT RADIO CORPORATION

37-06 36th ST., LONG ISLAND CITY, N. Y.

Makers of **PILOTONE RECORDS** • PIONEERS IN **FM & TELEVISION**



Esse Specials!

Do not fail to closely examine this list of bargains. We believe that every item listed below is a sensational value that soon can never be repeated. All equipment advertised herein is unconditionally guaranteed to the customer's satisfaction to this extent: Return any item advertised within five days after delivery for full refund except transportation charges (both ways).



(A) Filter condenser, G E Pyranol, oil filled 8 MFD @ 1000 volts DC working voltage, size about 1 1/2" x 4" x 5" high, shipping weight about 3 lbs. Brown porcelain stand-off insulator terminals NEW \$2.00

(B) Filter condenser, Sprague, oil filled, 8 MFD @ 1000 volts DC working voltage, size about 1" x 4" x 5" high, shipping weight about 2 lbs. NEW \$2.00

(C) Filter condenser, 8MFD @ 700 volts DC working voltage. Oil filled, well insulated terminals. Size about 2" x 4 1/4" x 5" high, with mounting flanges, gray metal case, shipping weight about 4 lbs. NEW \$1.25

(D) Filter condenser, Cornel-Dubilier 1 MFD @ 4000 volts DC working voltage, oil filled. Size about 2 1/4" x 4" x 7" high over all. Shipping weight about 4 lbs. Heavy stand-off insulator type terminals. NEW \$3.75

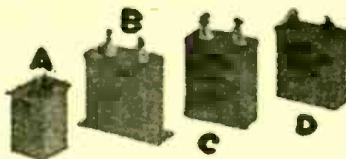

(A) Filter condenser, oil filled, 4 MFD @ 300 volts DC working voltage, size about 2" x 2" x 3 1/2" high, shipping weight about 2 lbs. NEW 35c

(B) Filter condenser, GE Pyranol, oil filled, 4 MFD @ 2000 volts DC working voltage, size about 1" x 4" x 5" high, shipping weight about 4 lbs. NEW \$3.00

(C) Filter condenser, Industrial Condenser Corp., oil filled, 1 MFD @ 3000 volts DC working voltage, size about 2 1/4" x 3 1/2" x 5" high, well insulated terminals. Shipping weight about 3 lbs. NEW \$2.00

(D) Filter condenser, Industrial Condenser Corp., oil filled, 4 MFD @ 2000 volts DC working voltage, porcelain insulated terminals, size about 2 1/4" x 3 1/2" x 5" high, shipping weight about 3 lbs. NEW \$2.50

METERS — Brand new and all checked for accuracy

0-500 MA DC 3 1/2" round NX35 Westinghouse	\$ 3.00
0-5 Amps RF 3 1/2" round NT35 Westinghouse Internal TC	4.50
0-3 Amps RF 2 1/2" round NT33 Westinghouse, less TC	3.50
0-10 & 0-250 MA DC combination round NX33 Westinghouse	2.50
0-10 & 0-250 MA DC combination round DW41 G.E.	2.50
0-2 volts full scale 2000 ohms/volt Volume Level meter, Westinghouse, round 2 1/2"	3.00
0-100 MA DC 2 1/2" round MD20001 McClintock	2.50
0-3 MA DC 3 1/2" square 327A Triplett	4.50
0-500 Volts AC 3 1/2" square 337A Triplett	6.00
0-2 Volts AC rectifier type 10,000 ohms/volt 327A Triplett 3 1/2" square	15.00
0-50 MA AC 337A Triplett 3 1/2" square	7.50
0-30 amps AC 3 1/2" round case, 331JP Triplett	6.00

RELAYS — All Brand New

110v 60 cycle Plunger type for door lock	\$.50
RBM DPDT 110 v 60 cycle, make before break	.75
Relay, 6 MA 5000 Ohm DC resistance, SPDT	.85
Leach type 1127-FR 110 V 60 cycle DPST	1.50
Automatic Electric Co. DPDT 24 v. DC 6 Amp silver tungsten Contacts	.40
Automatic Electric Co. Delay relay, 20 ohm, silver tungsten contacts	.40
Starter relay, 28 volt operated, heavy duty construction	.50
Switch, pushbutton type DPST on/off type, to fit standard switchbox, 10 amps at 250 volts	.25
Switch, toggle type, bat handle, DPDT heavy duty contacts	.35
Leaf type switch, 4 poles, single throw, single hole mounting	.25

TRANSFORMERS

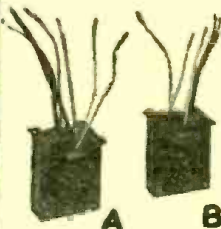

(A) Transformer, 110 volts 60 cycle input; output being two secondaries—each giving 14 volts @ 11 amperes, which can be used alone, in parallel, or in series for various voltage and current combinations. Size about 3 1/2" x 3 1/2" x 4" high. Ideal for operation of propeller pitch motors used for beam antenna rotation. Shipping weight 7 lbs. Manufactured for "Esse Radio Company." Brand NEW \$5.95

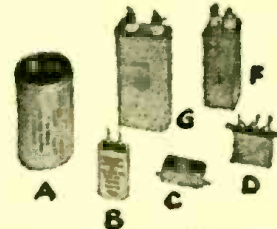

(A) Condenser, electrolytic, 100 MFD. @ 300 volts, 2 1/2" diameter, 4 1/2" high, metal can, shipping weight \$2.00 2 lbs. Brand NEW

(B) Filter Condenser, Tobe, oil filled, 1 MFD @ 600 volts DC working voltage, size about 1" x 1" x 2 1/2" high NEW 20c

(C) Condenser, bath tub type .1 MFD @ 1000 volts DC NEW 20c

(D) Condenser, Tobe, oil filled, 3 x .1 MFD @ 600 volts DC at .25c

(F) Filter condenser, Aerovox, oil filled, 2 MFD @ 600 DC working volts size about 1 1/2" x 1 1/2" x 5" high, shipping weight about 1 lb. NEW 35c

(G) Condenser, Cornel-Dubilier, oil filled, 4 MFD @ 1000 volts DC working voltage, size about 1" x 2 1/2" x 5" high, shipping weight 2 lbs. NEW \$1.75

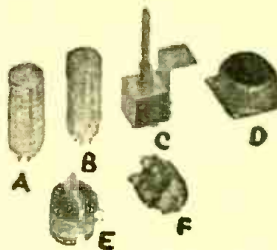

(A) Vibrator, Radiart VS-3, for 8 volt battery operation, used in vibrator supply PE104—which is used with BC654A transmitter-receiver. Type J-4 NEW \$1.95

(B) Vibrator, Radiart VS-3, for 6 volt battery operation, used in vibrator supply PE104—which is used with BC654A transmitter-receiver. Type J6 (probably exactly the same as [A]) NEW \$1.95

(C) Relay, 110 volt 60 cycle AC plunger type for door interlock NEW 85c

(D) Lord Shock Mount, heavy duty type, base size 3" square x 1 1/2" high—3/8" diameter bolt may be used NEW 35c

(E) Dual volume control wire-wound, each section 2500 ohms NEW 35c

(F) Toggle switch, bat handle, DPDT NEW 30c

CONDENSERS



Cornel-Dubilier—2MFD @ 1000 V DC. 1" Diameter 5" tall	NEW \$1.35
Cornel-Dubilier—4" MFD 600 V DC 1" diameter 5" tall	NEW \$1.00
Electrolytic 30 MFD @ 450 V DC Mallory F P aluminum can	NEW 50c
Electrolytic 40 MFD @ 450 V DC Mallory F P aluminum can	NEW 75c
Electrolytic, triple 20 MFD @ 25 V DC Mallory F P aluminum can	NEW 35c
Electrolytic, 30 MFD @ 150 V DC. Mallory F P aluminum can	NEW 35c
Paper, .05 MFD @ 400 V DC Solar	NEW 10c
Paper, .5 @ 400 V DC Aerovox	NEW 10c
Bath tub type, 3 MFD @ 50 V DC	NEW 10c
Bath Tub type, .1 MFD @ 1000 V DC	NEW 20c
Oil filled 3 x .1 MFD @ 600 V DC Tobe	NEW \$1.95
1.75 MFD @ 50 V DC	NEW 15c
.5 MFD @ 600 V DC	NEW 15c

30 MFD—300 V AC G.E. Pyranol	NEW \$3.00
Three gang trimmer condenser assembly, each adjustable 5 to 45 mmfds.	NEW 25c
Neutralizing, for 6 L 6 or 807 tube applications	10c
Variable tuning condenser, 7-17 mmfds 1 1/2" shaft, ceramic insulation, single hole mounting	20c
Padder type variable, 100 mmfds the maximum, screw driver slot in shaft for adjustment	NEW 20c
Padder type variable, 140 mmfds, maximum, screw driver slot in shaft for adjustment	NEW 20c
Mica condenser kit, kit of many values and assorted capacities and voltages, about 100 condenser per kit	NEW \$1.98
Electrolytic 1000 MFD @ 15 V DC 1/4" diameter x 4 1/2" high metal can	NEW 35c
Electrolytic, mounts in octal tube socket 10, 5 and 15 MFD @ 100 working volts DC. Aluminum can	NEW 50c
Electrolytic, 50 MFD @ 350 V DC Mallory F P aluminum can	NEW 50c



- (A) Condenser, mica, .25MFD @ 250 volts NEW 15c
- (B) Jack Box BC-631-B, size about 2" x 2" x 4", aluminum case, contains 10,000 ohm volume control, knob, Jones Barrier strip... Brand NEW 40c
- (C) Switch, push-button type DPST on/off type, to fit standard switch box, 10 amperes @ 250 volts NEW 25c
- (D) Micro-switch completely standard, metal grate well cast rated 15 amperes @ 115 volts normally open type, plunger has override feature. NEW 35c



RADIO MODULATOR

BC-424, made by Westinghouse, 110 volt 60 cycle AC operated. Size 9" x 14" x 9" high, weight about 30 lbs. packed. Has National Velvet Vernier Dial, Thordarson power transformer and chokes, tubes used and included are 6F6, 6J7, 6J7, 5W4 and 955. frequency about 190 megacycles. Comes with heavy steel case **\$2250**



BC-654-A—Receiver and Transmitter for frequencies 3800-5800 KC. Used but in good operating and mechanical condition. Worth many times the price for parts. Complete with all necessary tubes. Shipping weight 40 lbs. each \$29.75

- Microswitch, completely weather-proofed metal-clad or cased, rated 15 amps at 115 volts, normally open type, plunger has override feature NEW \$.35
- Battery type BA-38, 103.5 volts, used in Handie-Talkie, Mine detectors, or for any purpose where low current drain is required. Size 1" x 1" x 1 1/2" long. Outdated, but tests O.K. NEW 3.00
- Tube socket, RCA, for 866 or similar type tube bases NEW .35
- Tube socket, wafer octal type, excellent mica insulation NEW .10
- Tube socket for 813 type tube, Johnson type 237 NEW .60
- Tube socket, for Acorn type tubes, made by Millen Co. NEW .20
- Tube socket, porcelain octal type, less mounting ring NEW .10
- First IF transformer for BC348 type receiver, 915 kilocycles NEW 1.00
- Ohmite tap switch, model 111, 9 taps, non-shorting, will handle 10 amps at 115 volts NEW .35
- Kit of potentiometers, twenty-five assorted sizes, carbon and wire-wound NEW 2.25
- Resistor, voltmeter multiplier type, rated at 2 megohms 2 kilovolts insulation, 1 MA maximum current, about 1" diameter x 5 1/2" long, mounts in clips NEW .75
- Resistor, 100 watt type, 5 sections having 7500, 3000, 23, 23 and 750 ohms (total of 11,269 ohms) resistance. 1 1/4" diameter by 8 1/2" long NEW .35
- Cord CD-132, has PL-55 type plug and 9" cord, with spade type lug tips 35c
- Sylvania type 1N26 crystal NEW 35c
- Resistor 20 watt, one-half ohm NEW 10c
- Fuse holder for type 3AG fuses NEW 10c
- Amphenol co-axial chassis connector, new, type 83-1R 40c
- Amphenol co-axial junction connector, new type 83-1J 40c
- Amphenol co-axial angle plug adapter, used, type 83-1AP 40c
- Connector, bakelite insulation, male and female section, 6 pin polarized. Price 50c
- Canvas bag, moisture & fungus proofed, with carrying strap, leather re-enforced corners, weight 3 lbs, size 9" x 14" x 12" high. Ideal for tool case, for sportsmen, etc. NEW \$1.00
- HAND SET T-S-10-G—Sound powered telephone. No batteries required for operation: connect to any two wires, wire fence and ground, etc., by convenient clips included. Price NEW \$9.50 each
- ARGON BULBS—2 watt ideal for transmitter tuning, night light, etc. Price 35c each. \$3.00 per carton of ten.



BC-406-A Receiver—Brand new. Manufactured by Western Electric. 165 to 205 mc operation. IF frequency 19.5 mc. IF band width .7 mc. Easily converted for operation on other ultra-high frequencies. Operate from 110 V., 60 cycle, A.C. Worth many times this amount for tubes and parts. Tubes—one 5T4, two 68J7, four 6SK7, one 6N7, five 954's, one 955, one 6F7, one 6N7. Also contains small 110 V. operated **\$3450** motor.

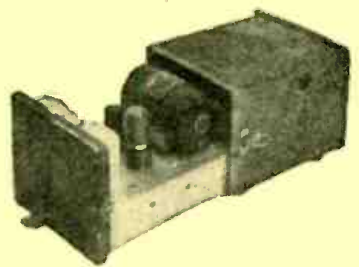

Interphone Amplifier, size 7" x 9" x 6" high, weight about 12 lbs. packed. Contains 6SJ7 and 6V6 tubes, 24 volt dynamotor. Use for phono or intercom amplifier. **\$375**

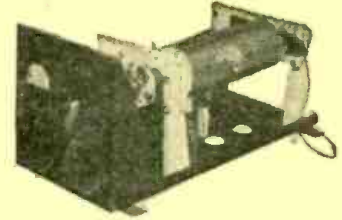

Antenna Tuning Unit BC-729-C, size about 9" x 9" x 19" overall, weight 24 lbs. packed. Contains 0-15 ampere RF ammeter 3 1/2" square case, Tuning Inductance, having 60 turns heavy wire on 3 1/2" dia. coil form, completely variable, also split stator coil with swinging link, vernier dial and revolution counter, will easily handle 500 watts of RF power. Will match up any length antenna to any common frequency for **\$950** amateur transmitters.

ESSE Radio Co
 130 W. New York St.
 Indianapolis 4, Ind.

Unless Otherwise Stated, All of This Equipment Is Sold As Used
CASH REQUIRED
WITH ALL ORDERS
 Orders Shipped F.O.B. Collect

Traffic is heavy under the street, too

Surely the busiest thoroughfare in the world is a telephone cable. But it is more than "telephone"; for these thousand or more wires, carrying sound and pictures at lightning speed, are highways for many different services.

Each one of these presents its own problems to Bell Laboratories scientists and engineers: for the telephone differs from television, and television differs from a radio program. And yet they have an essential unity: they

involve transmission of alternating currents, with frequencies from zero up to several million cycles. Each calls for new thinking, new ideas, new goals of accomplishment.

The diversity of the cable's many services speaks for the unity of Bell Laboratories' purpose. That is, to know the theory of communication so thoroughly, to practice the art so skilfully, that any transmission of sight or sound can reach its destination clearly, quickly, economically.

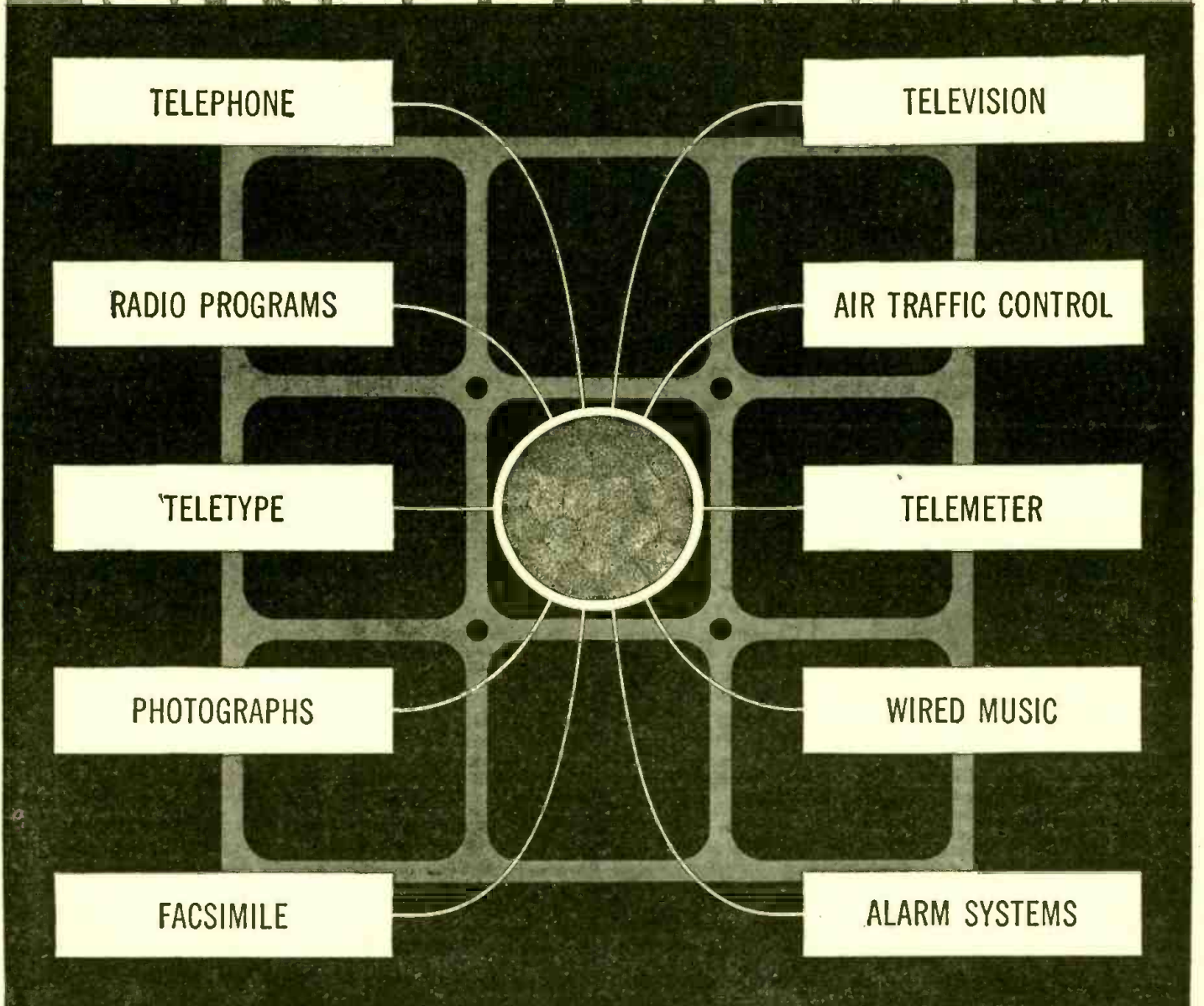
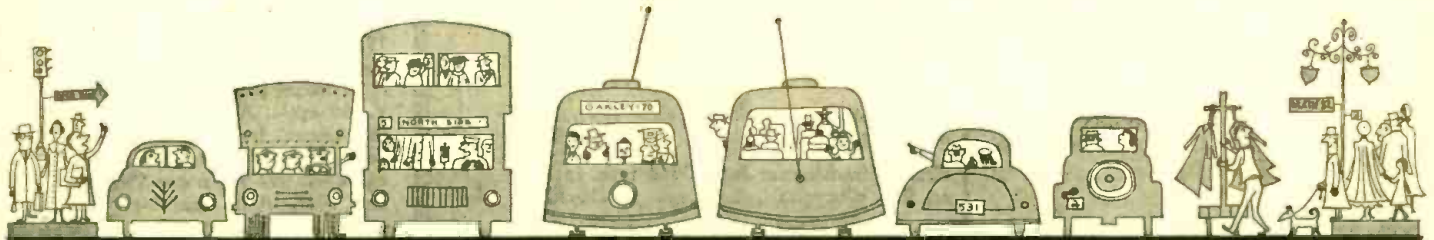

BELL TELEPHONE LABORATORIES

Exploring and inventing, devising and perfecting for continued improvements and economies in telephone service



APPLIQUÉD RADIO CIRCUITS

The next great radio advance is now in the making . . .

By HUGO GERNSBACK

THERE remains little doubt that the next few years will see a complete revolution in the building of our radio receivers, be they AM, FM or television.

It is certain that the wired radio receiver with its hundreds of wires and soldered connections will soon be completely outmoded.

The reason for this is elementary—from an economic standpoint wired and soldered radios are already dated, due to the tremendous labor costs. Then, too, receivers tend to become more complex as time goes on and the vast multiplicity of soldered connections no longer are workable. Servicing such sets is becoming more and more of a nightmare for that reason. Tracing circuits during trouble shooting is often a hopeless procedure and as the art progresses it becomes more hopeless both physically and economically.

At the present time top radio receiver manufacturers are racing toward the day when the wired component receiver will be replaced by something much simpler, which is cheap to assemble, and which will make servicing in the future a picnic—compared to our present receivers.

As reported in these pages repeatedly, the future receiver will either use a printed circuit in which the connecting wires are printed on a solid sheet of insulating material, or applied by some similar means. There are—and we mention only a few—the following:

Instead of printing the circuit it can be electroplated; it can be applied by the so-called silk screen process; or it can be done by spraying molten metal onto the surface.

Such new circuits also include the various resistors which are no longer solid blocks, but instead lines printed, sprayed, or applied to the surface by other means. An entire new art is springing up along these lines.

So far no "printed" radio sets have been produced for public consumption in the United States, but during the war there was great activity in this new art.

Dr. Cleo Brunetti, of the Bureau of Standards, outstanding exponent of printed circuits, produced many war radio sets where small size and guarantee of absolute performance were the prime considerations. These, however, were mostly along the miniature radio receiver lines. Standard receivers for home use, however, have so far not been produced.

In England one or two manufacturers have produced such radios, particularly those of the sprayed-circuit variety.*

Up to now there has not been an all-embracing term in the English language which would do justice to this new and very important art. Not all circuits are printed, nor are they plated, nor sprayed. Yet they all come under the same general classification.

We therefore advance the term "*appliqué*" (from the French)—rhymes with bouquet. The English dictionary defines the term as follows: "*Appliqué*—decora-

tive detail superimposed on a solid ground, as in 'appliqué work.'"

Similar terms are "appliquéd" and "appliquéing." This term is now being used in various industries, such as textiles for instance.

The nearest all-English term would be application—"the act of applying or laying on," but obviously this term cannot be used. We can use the new term in various ways as: *appliqué* radio receiver; *appliqué* radio circuits; *appliquéing* a circuit.

The great advantage of these new *appliqué* receivers is the fact that most handwork is done away with. *There are no soldered connections*—everything either being screwed on, riveted, or fastened by other mechanical means. This means that—as is now done in England—an entire radio set can be made by a robot; i.e., a machine that does all the work from beginning to finish, delivering the complete chassis at the other end of the production line. No human hand touches the chassis while being processed. This cuts manufacturing costs tremendously.

The enthusiastic proponents of the new art foresee the day when the average superheterodyne chassis, minus tubes and loudspeaker, can be sold for \$1.00—certainly less than \$2.00. The serviceman simply will take out the old chassis and discard it, replacing it with a new one. He will no longer hunt for hours to find a loose or intermittent connection—it will be far cheaper to install a new complete chassis with all its wiring, resistors, condensers, etc.

Some servicemen seem to think that this will ruin their business: Quite to the contrary, they will make *more* money because it will give them more time for installation and other radio work rather than wasting precious hours in hunting for open connections, blown condensers, burned-out resistors, and what not.

The future chassis will be light and small. It will weigh very little and will be completely foolproof. There will be few outside connections to be made to it, such as tubes, loudspeakers, etc.

Moreover, *the new appliqué radios will be equipped with miniature tubes*, for which they are ideally suited. To show how the wind blows, we quote the remarks recently made by L. W. Teegarden, vice-president of RCA Tube Department:

"Today a large portion of RCA Tube Department production is assigned to miniature tubes. About 90% of all receiving tube developments is on miniatures."

Appliqué radios will bring down the price of ALL radio sets and particularly television receivers. At the present time only about 30,000 video sets can be manufactured a month. With *appliqué* circuits, they can be manufactured by the hundred thousands per month, once the manufacturers have tooled up for the new art.

*See RADIO-CRAFT, September, 1947, issue.

COORDINATION of the efforts of radio technicians' associations is being undertaken under the leadership of the Federation of Radio Servicemen's Associations of Pennsylvania, the country's largest organization of radio technicians. Originating at a meeting held at Harrisburg in the early spring, the plan proposes to coordinate the objectives of member associations, to solicit the cooperation of all servicemen's associations with whom the Federation is in correspondence, and finally to invite participation in the organization's efforts to improve radio receiver servicing by servicemen and servicemen's associations wherever situated. The secretary of the Federation, Mr. John Rader of 704 Walnut St., Pittsburgh, Penna., was appointed secretary of the coordinating committee. Any interested individuals or organizations are requested to contact him.

The move toward coordination by the FRSA was prompted by a review of the opinions the radio technicians representing more than 16 states at the Philadelphia convention last January.

MICROWAVE GENERATION with conventional tubes was demonstrated by DeMornay Budd Inc. at the recent Institute of Radio Engineers Convention. Development is expected to expand vastly the use of microwave equipment, which has been hampered by the necessity of designing it around the scarce and expensive Klystrons and magnetrons.

Previously, ordinary tubes, available for other purposes, have been considered unsuitable for microwave generation because of excessive transit time and grid conductance. This development overcomes these two problems by making the transit time between cathode and plate correspond to some multiple of 360 degrees phase shift. An alternate development achieves similar results by making the transit time correspond to any odd number of half periods of oscillation.

RADIO-ELECTRONICS

The potentialities for this development are considered to be an "open sesame" to the very roomy microwave region for amateur, citizens and mobile bands, relay and communication and navigation functions.

METALLIC TECHNETIUM, chemical element number 43, has been isolated by Dr. Sherman Fried of the chemistry division of the Argonne National Laboratory, it was announced last month.

One of the last four of the 96 elements to be named, technetium is revealed to be a silvery substance similar to the other rare metals, rhenium, osmium and ruthenium, which are located near it in the periodic table of elements.

Two tiny quantities of the metal were prepared from compounds manufactured in the atomic furnaces at Oak Ridge and made available by Dr. G. W. Parker of the Clinton Laboratories. Dr. Fried reported the isolation of the new metal in a report to the Journal of the American Chemical Society.

PUBLIC REACTION indicates that radio is doing a good job, according to a survey made by the University of Chicago's National Opinion Research Center. The report released last month reveals that 70% of the people interviewed approved of the job being done by radio in their communities. Only 59% were as satisfied with their schools, 63% approved of their newspapers, and 42% were as pleased with their local governments.

A further study of the figures showed that 67% of the people were against government control of radio news, 76% opposed regulation of radio advertising, and 65% were opposed to government control of the programming of controversial issues.

TELEVISION COMPETITION is cutting into the movies and regular radio programs, Ed James stated in the *American Magazine* last month.

A survey of television set owners in New York by CBS disclosed that nearly half had attended movies less frequently since obtaining the set, and more than half reported there was no radio program they preferred to television. "Television," said one set owner, "is more entertaining than radio and more convenient than movies."

SIGNAL CORPS SCIENTISTS are preparing to explore the surface of the moon with radar in an attempt to map its mountains, valleys, and craters. They will use electronic improvements developed since January, 1946, when the Signal Corps first made contact with the moon from the Evans Signal Laboratory, Belmar, N. J.

The scientists said that the difficult part of the first experiment was in building a receiver sensitive enough to pick up the radar echo. Since then they have greatly increased the sensitivity of the receiver which will be used in the new experiments at Evans laboratory.

PRIVATE OPERATION of radio broadcasting in Canada is receiving strong public support, it was reported at the fifth annual meeting of the Canadian Association of Broadcasters last month.

A Dominion-wide poll completed last December showed that 60% of Canadians polled favored private operation of radio against 22% in favor of a government-operated system. Canada has at present both a government broadcasting company and privately-owned stations.

RADIO FURNISHED TIME to people in California during the power shortage last March. The lack of power forced the Pacific Gas and Electric Company to reduce its frequency, causing all electric clocks to run six or more minutes slow per day. As soon as the situation became known, the principal radio stations began giving time signals on each station break, enabling listeners to keep their clocks adjusted.

ACCURATE RADAR SPOTTING of planes is prevented by this wartime development in which the plane itself in effect, becomes a non-reflector of radar signals. U. S. patent No. 2,436,578, issued last month to Arthur Korn of Hoboken and Joseph Hess and Simon L. Ruskin of New York, covers this invention.

The plane is coated with a substance that is a poor or "scattery" reflector of radar waves. Three such substances are cuprous oxide and the elements selenium and tellurium. Various methods of applying the coatings, all involving rolling or pressure at fairly high temperatures have been devised.

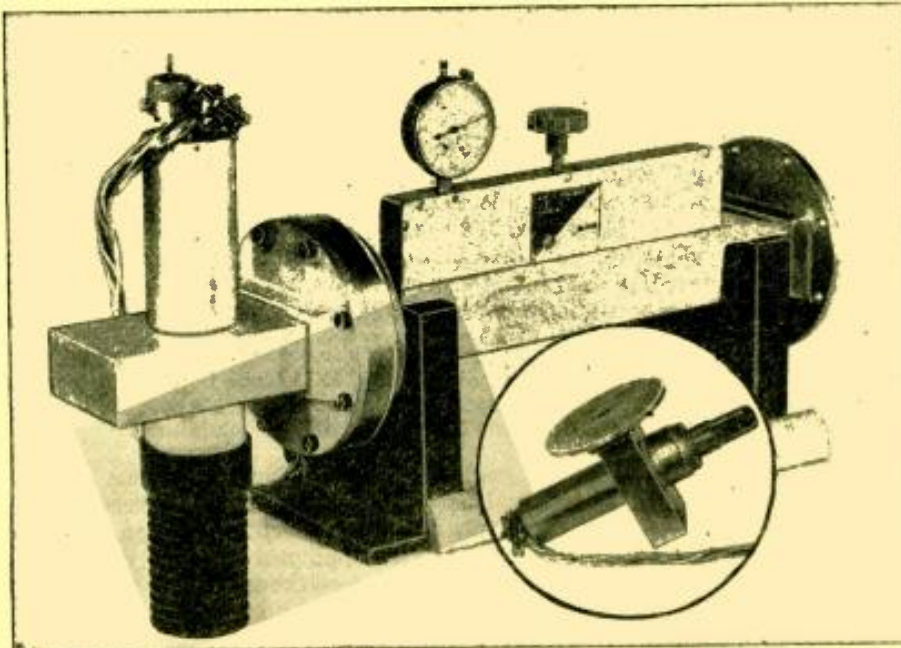

Equipment for generating power on microwaves with tubes now used at broadcast frequencies.

MONTHLY REVIEW

ATOMIC ENERGY will be used to power radio and television receivers in the future, David Sarnoff, President of the Radio Corporation of America predicted at Boston University Founders' Day ceremonies.

"A miniature power supply in capsule form may make possible radio receivers no larger than a wrist watch, and television sets that may be carried in the pocket like a camera," declared General Sarnoff. "When that day comes people may carry pocket-size radiophones that will enable them to communicate with home or office, no matter where they are."

These fascinating possibilities are not "just around the corner" General Sarnoff pointed out, but we shall see these promises fulfilled if the world is at peace and science is unfettered. Beyond today's horizon, he said, automobiles, tractors, airplanes, locomotives and ships may be powered also by small capsules of nuclear energy.

More optimistic on the subject of atomic energy is Dr. Edward U. Condon, who at the recent meeting of the Institute of Electrical Engineers in New York City predicted atomic power plants "within a year or two" and ships running on electric energy "within a decade." Atomic power plants are now under way at Oak Ridge, Tennessee, Chicago, Illinois, and Schenectady, New York, Dr. Condon told the assembled engineers, and it should be possible to realize experimental production of power within the next year or two. However, he believed that atomic power plants are likely to be too heavy for cars, planes or even railroad locomotives, though it is reasonable to believe that within a decade ships may derive their power from atomic piles.

A MICROWAVE RADIO relay system instead of the usual telephone lines is planned for the Rural Radio Network whose headquarters is in Ithaca, N. Y. The network expects to go on the air with three of its six FM stations early in May.

The new FM network, to be cooperatively supported by farmer organizations, will concentrate on the farm audiences in the agricultural areas of upstate New York.

THREE-YEAR LICENSES for FM stations will be issued beginning May 1, the FCC announced last month. This announcement complies with requests made by the Frequency Modulation Association. The Commission pointed out that it "recognized the rapid development of FM as meriting the statutory maximum license period."

First renewals will be for one, two, and three years to work into a staggered schedule of renewals by frequencies. Thereafter, all renewals will be for the three-year period, according to the FCC.

THE INSTITUTE of Radio Engineers held its 1948 convention March 22-25 at the Hotel Commodore and the Grand Central Palace, New York City. The meeting was the largest on record, with an attendance of 15,000, as compared to the 8,000 engineers who appeared at last year's convention.



Dr. B. E. Shackelford, 1948 IRE president.

It was necessary to subdivide the subjects discussed and hold meetings simultaneously in five auditoriums to accommodate the more than 130 papers read. A symposium on nuclear science which consisted of five talks and occupied a full morning session indicated the Institute's interest in this very important new branch of science.



Dr. R. L. Smith-Rose, IRE'S vice-president.

The exhibits of new radio equipment also reached record figures, with 188 manufacturers displaying their equipment at the Grand Central Palace.

A special luncheon March 23 honored

the new President, Dr. B. E. Shackelford, who with Dr. R. L. Smith-Rose as his vice-president, will lead the Institute in 1948.

THE RADIO PARTS SHOW will be held again at Chicago May 11, 12, 13, and 14. At this show, which is sponsored by the Association of Electronic Parts and Equipment Manufacturers, the National Electronics Distributors Association, the RMA, and the Sales Managers Club, all the leading manufacturers of radio and electronic components will exhibit their new products for the coming season.

It is believed that this year will see the industry's largest parts exhibition, and dealers, distributors and manufacturers expect to see a number of new developments, inventions and features which have been kept "under wraps" for release at the show.

TAPE RECORDINGS instead of discs will be used beginning April 25 for rebroadcasting of network programs by affiliates of the American Broadcasting Company during daylight saving time. This method will permit playbacks as needed with improved quality at lower costs.

Only regularly scheduled programs will be rebroadcast; outstanding special events will be aired live and when they occur.

"SNOWSTORM," a type of television interference that produces streaking on the television screen and is commonly produced by ignition interference has been found to be caused by the sun, it was reported last month.

Engineers of the British Broadcasting Corporation suspected the sun while they were tracing the cause of a brief but particularly violent snowstorm. A check with records of solar noises confirmed their suspicions.

TELEVISION RECEIVER production in February reached a new high level, the Radio Manufacturers' Association disclosed last month.

The manufacture of 35,889 sets in February brought the total number produced since the war to 250,937. The February television set output, 5,888 more than the January production, represented a 141% increase over the average 1947 monthly output.

TELEVISION WEATHER broadcasts are now being made on a daily basis. The ten-minute program, beginning at 6:05 pm, is carried over the Dumont stations in New York City and Washington, D. C.

EUROPEAN LISTENERS total between 150,000,000 and 175,000,000, according to a last month's State Department estimate. Over 100,000 of these are believed to have shortwave listening facilities.

THE MOTION PICTURE industry is planning to enter the television field actively, Frank Mullen, executive vice-president of the National Broadcasting Company, revealed at a press conference last month.

ELECTRET CONSTRUCTION

The author describes in detail the material, method and equipment for making electrets.

By VICTOR H. LAUGHTER

AN electret is a comparatively unknown scientific novelty which is the electrical counterpart of a permanent magnet. It consists of a slab of wax material that has been subjected to a strong electrostatic field while in the molten state. When the material is allowed to cool under electrical stress, a positive charge appears on one side and a negative charge on the other. These charges are retained for several years with little decrease in strength.

In 1925 Eguchi described a very interesting kind of electret made of equal parts carnauba wax and resin. These were melted and a high direct voltage applied while they were in the liquid state, the voltage remaining on until the mixture solidified. One theory of what occurs is that an orientation of the molecules takes place under voltage stress, this alignment being locked in by the cooling of the wax. The electret thus made shows a final positive charge on one side and a negative charge on the other. An electrostatic charge similar to the magnetic field of a permanent magnet, surrounds the electret. The writer has electrets three years old, apparently as active as when first made.

A unique feature is the action of the

positive charge. When first removed from the cooker, the electret usually shows a positive charge on the side that was next to the negative polarizing plate and a minus charge next to the plus plate. This relationship is expected and is according to the law "unlike poles attract and like poles repel." Later a reversal of poles occurs; the positive side becoming negative, and the negative side positive. Once made, this reversal is permanent. The result is that the polarity on the electret is the same as that of the charging voltage. The positive charge thus formed holds. This is contrary to usual action. Normally a positively charged surface attracts free negative electrons, building up a negative

charge. When first removed from the cooker, the electret usually shows a positive charge on the side that was next to the negative polarizing plate and a minus charge next to the plus plate. This relationship is expected and is according to the law "unlike poles attract and like poles repel." Later a reversal of poles occurs; the positive side becoming negative, and the negative side positive. Once made, this reversal is permanent. The result is that the polarity on the electret is the same as that of the charging voltage. The positive charge thus formed holds. This is contrary to usual action. Normally a positively charged surface attracts free negative electrons, building up a negative

Equipment

The equipment shown in Figs. 1 and 2 was used by the writer in making electrets. High voltage is supplied by a neon-sign-type transformer delivering 5,000 to 10,000 volts at not more than 10 ma. The rectifier tube is a WL-579-B. Equivalents such as the 72, 73, RK-705-A, and 8013 may be used. The filament transformer must have good high-voltage insulation between its windings and should handle the rectifier tube used.

The current through the mixture decreases as the mixture cools, and the supply voltage rises to its peak value

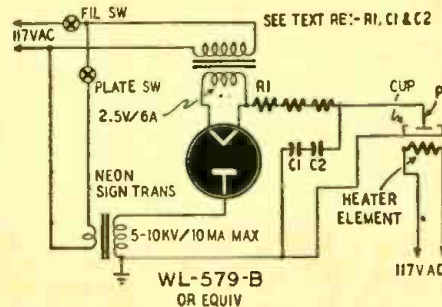

Fig. 2—A suitable high-voltage power supply.

space charge and thus shielding the positive effect. A crystal shows the negative shield. Just why the electret acts as it does is not known.

The electret offers a wide field for the experimenter. Possible applications in-

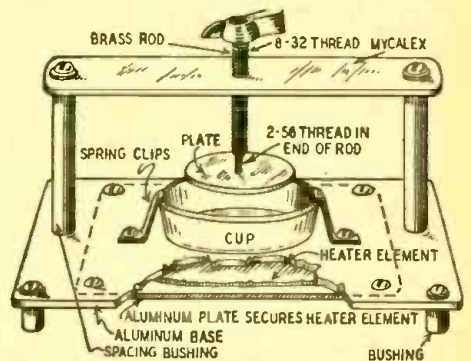

Fig. 3—The materials are melted in the cup.

causing breakdown between the plate P and the cup. The dropping resistor R1 is included to prevent this breakdown. It consists of a number of small resistors connected in series and has a total value of about 50 megohms. One or more resistors may be shorted to adjust the voltage. The filter condensers C1 and C2 have a total capacitance of about 500 μmf and may be either air or mica types. The amount of capacitance is not critical.

Details of one type of cooker unit are shown in Fig. 3. Its base is made from $\frac{1}{4}$ - or $\frac{1}{2}$ -inch sheet aluminum. An electric-iron heater element is mounted on the underside of the base and held in place with another sheet of aluminum.

Bushings support a mycalex strip which holds the plate. The strip is drilled and tapped at center for 8-32 threads. One end of a brass rod is threaded for an 8-32 nut. The other end is turned down and threaded for a 2-56 nut. The plate P is an aluminum disc about $1\frac{1}{4}$ inches in diameter and $1/16$ -inch thick, drilled and tapped at center for 2-56 screw. The cup is an aluminum drinking cup 2 inches in diameter and

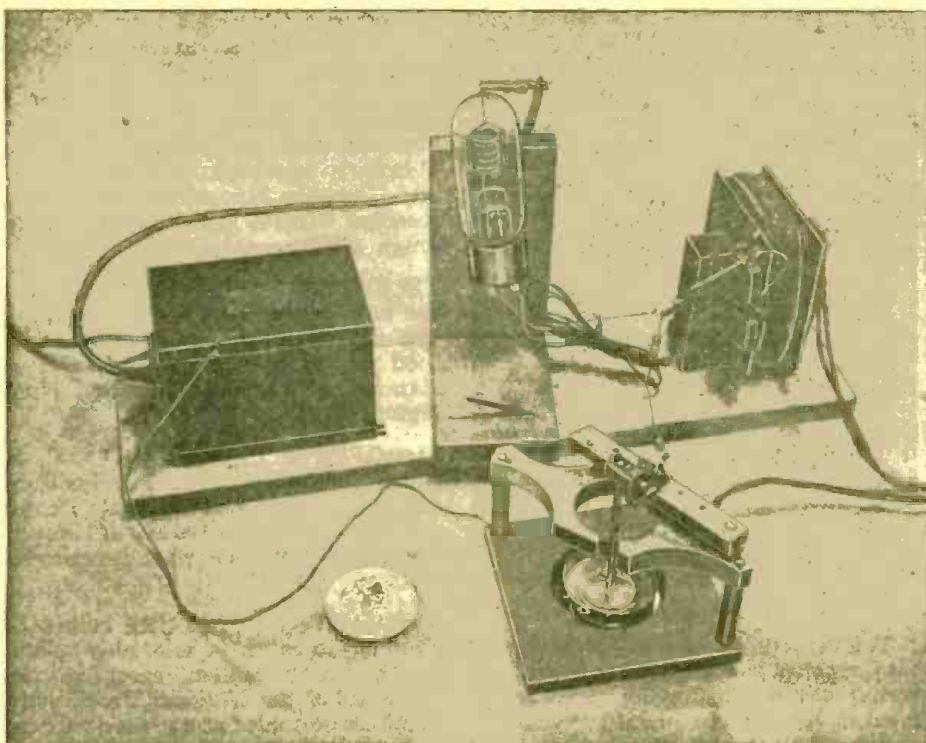

Fig. 1—Experimental set-up of one type of equipment used in the construction of electrets.

cut down to 1/2-inch height. Spring clips hold the cup firmly to the base. The cooker unit is simply a method for providing heat to a container holding the wax and a variable means for contacting the mixture, so you can change its construction any way you desire. The various electrical units should have separate switches so any desired operation can be selected. The writer has made several hundred electrets using sand pack, oil bath, gas heat and infrared, but prefers the type of heater shown here.

Materials for electret-making

The minimum material for making electrets consists of 1 pound of carnauba wax, 1 pound of resin, 1 pound of aluminum foil about .001-inch thick, a small can of silica gel or other dehydrant, and a quart can in which to keep completed electrets. Cut off a piece of foil and force down into and around the inside of the cup. Work smooth to remove wrinkles. Also wrap foil around the plate that is to contact the wax. The foil keeps the mixture from adhering to cup and plate, allowing easy removal. It can be stripped off later. Shave off about 2 teaspoonfuls of carnauba wax and resin. Place cup in position, run plate up out of way, and turn on only the heater.

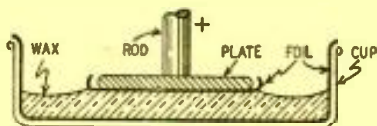

Fig. 4—Cross-section of melt ready to form.

Drop small quantities of the wax into the cup and stir the mixture with a rod as it melts. The depth of the wax should be about 3/16-inch for trial. Run the plate down until it contacts the melted wax. Connect the plate to the positive side of the high-voltage supply and the base to the negative side. The wax will wet the foil on the plate and allow backing up so that our final contact is about as shown in Fig. 4. Turn off the heater when the wax is thoroughly melted. Let the filament heat 15 to 30 seconds before applying plate voltage. The mixture should jump perceptibly when the high voltage goes on. If sparks break across from cup to plate, more resistance should be added to R1. Allow wax to cool to room temperature with voltage on. This should take 45 minutes to 1 hour. If for any reason you are dissatisfied with the product, remelt and remake. If the edges of cup are bent slightly, the cooled electret will break free and can be removed. Unscrew plate from rod and pry the electret off the plate with a knife blade. Strip off adhering foil and wrap in new foil. Place in the can—in which 1/2-inch of silica has been poured—until ready to test.

Testing electrets

The electrometer, a laboratory instrument, is the proper meter for testing electrets. Such meters are not generally available so other methods must be considered. The discharge test, as described here, can be made without cost and will

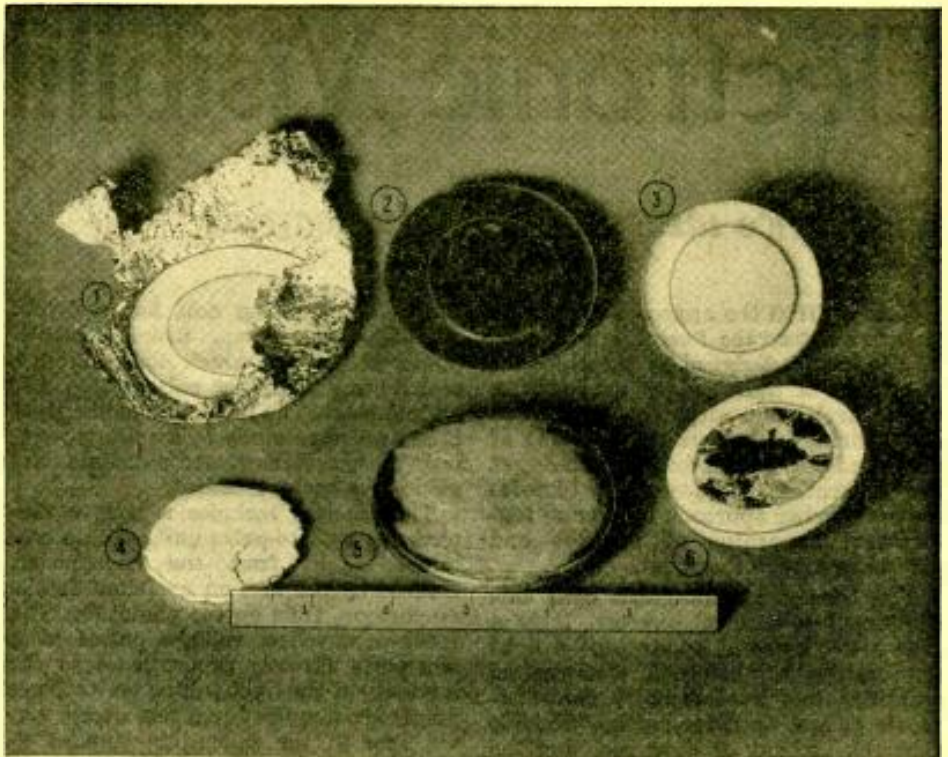

Fig. 6—A collection of typical electrets. Charge is preserved by foil "keeper" (No. 1).

reveal whether an electret is good or bad. To make this test, cut a disc of brass about .010-inch thick and slightly larger in diameter than the electret. See Fig. 5. Place the electret on a metal sheet (shown in Fig. 5 as COLLECTOR) resting on a block of insulating material. Hold the collector about 2 inches above the electret so that, when dropped, it will hit flat with the triangular part overhanging the electret coming in contact with the metal plate. What happens is that the collector, when dropped, travels through the electrostatic field, collects a charge which builds up, and is discharged when the triangle point contacts the metal plate.

HOW TO MAKE AN ELECTRET

A standard formula for electrets is Carnauba wax 45%, white resin 45% and white beeswax 10%.

Note that the collector has been cut with the triangular piece slightly longer than the thickness of the electret and bent down at an angle. The triangle section should be bent in or out for best spark action. *This test must be made in the dark.* Test both sides of the electret; one side will no doubt give a much heavier spark than the other. This is normal. Generally the heavier spark occurs on the negative side. The spark method is perfectly satisfactory as it indicates good or bad and, by the strength of spark, the comparative difference between electrets. A vacuum-tube voltmeter with an impedance of at least 1,000 megohms can be used and is of value for indicating positive and negative sides of an electret. This is a special type of instrument, however, and cannot be described in this article.

The wax mixture used by the writer

is composed of equal parts of carnauba wax and Halowax. Halowax can be secured from the Halowax Products Division, Union Carbide and Carbon Corp. The addition of the Halowax gives an ivory-white finish, with good shrinking properties, allowing easy removal from cup. The electret should have a high melting point to be of more general use. It is advisable to experiment with various kinds of plastics and waxes that have a high melting range. Glass has been suggested as a medium and preliminary tests show some conductivity. The actual arrangement of the furnace, electrodes, and leads is a serious problem for the experimenter.

It may be that actual conductivity is not important as the electrical stress will no doubt give the proper orientation. So far tests indicate that the electret must have a fairly hard and brittle finish. Likewise some carnauba wax, even though in minute quantity, must be included in the mixture. Some component of carnauba wax forms under the electrical stress the permanent characteristic of an electret, but just what this element is is not known. Electrets

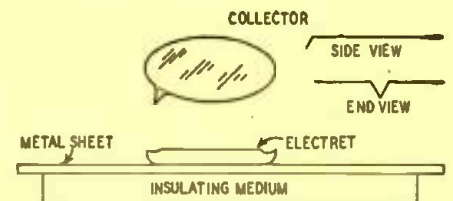

Fig. 5—Simple electret-testing equipment.

made without carnauba wax show only a temporary charge. It has been suggested that the carnauba shrinks when cooled, developing high internal stress resulting in a piezoelectric effect. This theory (if correct) indicates that certain kinds of glass should become electrets under proper treatment.

(Continued on page 82)

Electronic Visibility Meter

This device measures the air's clearness

By S. R. WINTERS

INDICATING the approach of fog six hours before the human eye sees it, this device designed by the National Bureau of Standards is a promising safety device for airports. It also can give reliable indication of the lifting of fog long before the naked eye can detect such clearance. The device can likewise control glaring approach lights and fog-dispersal apparatus at airfields and may have many other uses.

The Bureau of Standards calls this equipment a transmissometer. It is a four-in-one piece of apparatus—a light transmitter, a phototube receiver, an amplifier, and an indicator. This electronic gadget operates on the principle that the amount of light reaching the receiver from the transmitter is determined by the thickness of the fog or other obscuring atmospheric condition. The distance between the transmitter and receiver may be varied, but in practical tests good results have been achieved at ranges varying from 400 to 4,000 feet.

The transmitting unit has a 6-volt, sealed-reflector lamp, with a candle-power of 350,000, which differs from a sealed-beam headlight only in its cover and filament. The brilliancy of the light is controlled precisely by a voltage-regulating transformer. Adjustments are made by a series rheostat.

The receiver includes a lens, a diaphragm, a photo-pulse unit, and an amplifier. Light from the transmitter, focused by the lens on a pinhole in the diaphragm, falls on the phototube. The receiver develops voltage pulses at a frequency directly proportional to the intensity of the light falling on it. These pulses are amplified and sent over a signal line to the indicating unit. Frequency of these pulses ranges from 60 per second in fair weather to one every 20 minutes in thick fog.

The indicator consists of a two-stage amplifier, a frequency-measuring unit, and a calibrator. Since the latter operates from a standard power line, the calibration frequency is 60 cycles per

second. The two-stage amplifier boosts and sharpens the incoming pulses, as well as cutting down noise picked up by the transmission line. The frequency meter levels and averages these pulses, thereby giving a reading directly proportional to the pulse frequency which is proportional to the transmission of the atmosphere between the light source and the receiving unit.

The indicator unit affords both dial readings and a record on a revolving drum, and can operate as far as 10 miles from the receiver. This flexibility

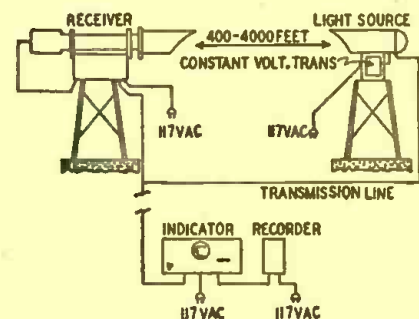

How the transmissometer equipment is set up.

permits installing the indicator in the airport control tower and also the use of more than one transmissometer to "finger" across various sectors of the airport, while having the various indications converge at a single point for central observation.

Experimental units of the transmissometer are in operation in studies on fog-dispersal measures, glaring approach lights, visibility, and airport lighting equipment. Five are functioning at the Joint Landing Aids Experiment Station at Arcata, California. Others are in use at the Civil Aeronautics Administration's Experimental Station, at Indianapolis, Indiana, and at the Naval Air Test Center of the Bureau of Aeronautics, for visibility and airport lighting equipment tests; and at the Tiffany Foundation, at Long Island, N. Y., under guidance of the National Defense Research Council.

The Bureau of Standards lists six main uses for its electronic brain-child in aviation: (1) for controlling high-intensity apparatus; (2) as a supplement to routine visual observations by a continuous record of atmospheric conditions; (3) as replacement for visual observations where trained observers or satisfactory lights are not present; (4) as a means of giving accurate indication of visual ranges over a limited area remote from the observer, especially in an approach zone; (5) as a method of registering variations and rate of change conditions of visual range; and (6) to afford precise indications of the visual ranges when visibility is poor.

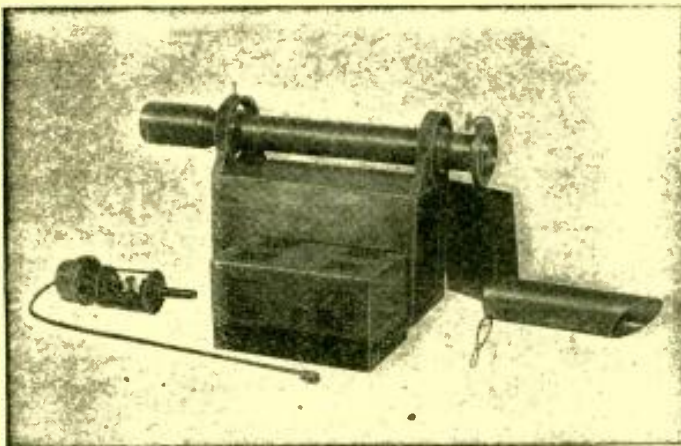

The receiver. Phototube and lens is at left. Telescope is for sighting.

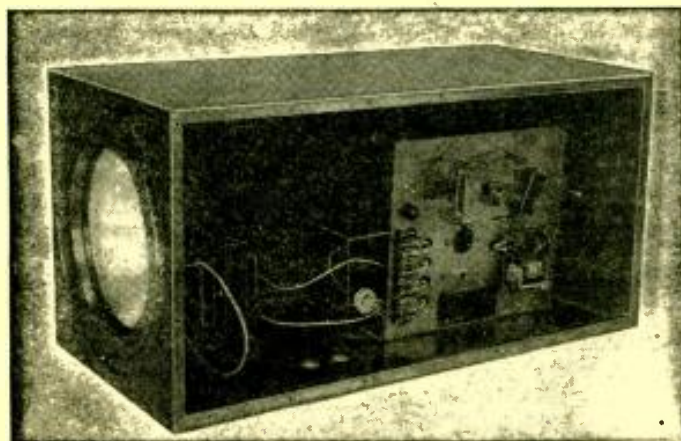

Transmitter consists of an auto-type lamp and means of regulating it.

Efficient 100-Watter

A transmitter which uses few tubes and components to achieve good results

By E. F. HARRIS, W8SJB



HERE is a 100-watt transmitter that has much to offer. It is simple and straightforward in circuit design and the almost miniature mechanical layout and the care taken to insure good looks has resulted in a unit which rivals professional models. The input power runs between 100 and 120 watts. If higher power is desired, this little unit is capable of pushing any final amplifier up to the allowable power limit on any band, from 80 to 10 meters. Because of this last feature, no modulator was included as an integral part of the transmitter.

To be compact, the transmitter had to be built around a physically small tube which could handle the required power input safely. An HK-24 was chosen for the job because it meets the requirements of size and power and is also very efficient at high frequencies. The other tubes are: 6L6 crystal oscillator, 5Z3 low-voltage rectifier, and two 816 rectifiers for the high-voltage power supply. A block diagram of the transmitter appears in Fig. 1.

The 6L6 in a harmonic oscillator circuit (Fig. 2) gives adequate output to drive the final amplifier on the fundamental, second, and fourth harmonics of the crystal. Feedback is obtained from the divider circuit formed by C1 and C2. Initially, C1 should be adjusted to give maximum output when the oscillator is used as a harmonic generator, and all that is necessary afterward is to choose the appropriate crystals and coils for the desired band and tune the plate tank to either the fundamental or desired harmonic of the crystal. The 60-ma pilot lamp in series with the crystal serves as a fuse to prevent crystal burn-out. It should glow dimly when the oscillator is operating straight-through and should barely light or not light at all during harmonic operation.

Keying is in the oscillator cathode return to ground. The note is clean and free from clicks and chirps, even on harmonics. The .01 cathode condenser bypasses the r.f. to ground when the key

is plugged into the jack. Omitting it will cause an appreciable loss of output, but, if c.w. operation is not desired, it may be omitted.

The oscillator is capacitance-coupled to the HK-24 final and provides sufficient drive on all bands. This type of coupling eliminates one tuned circuit, and is convenient to use.

The tank circuit of the final amplifier uses a 2,500-volt blocking condenser, which removes much of the danger of arcing in the split-stator tuning condenser. The neutralizing condenser is very small. It is actually one of the early disc-type neutralizing condensers de-

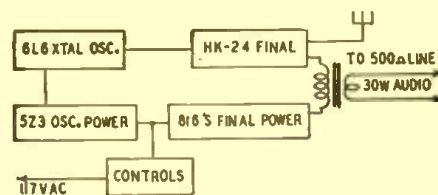

Fig. 1—A block diagram of the transmitter.

signed for use with 6L6's. The disc plates are the size of a quarter, and proper neutralization takes place with the plates set from $\frac{1}{2}$ to $\frac{3}{4}$ inch apart.

To avoid using fixed bias, a resistor is inserted in the filament return of the final amplifier. It provides sufficient cathode bias to limit the plate current to a safe value. This method is more convenient than battery bias, and the actual loss in plate voltage to the tube is less than 50.

A multitap modulation transformer is mounted on the chassis between the oscillator and final amplifier power supplies. The transformer taps were selected to match the final amplifier's impedance (between 9,000 and 10,000 ohms) to a 500-ohm line. The 500-ohm line terminals are brought out to a 5-prong female connector at the rear of the chassis. With this arrangement any audio amplifier which can deliver about 30 watts and has a 500-ohm output connection may be employed.

In case a separate modulator is desired, the transformer may be used to match the impedance of the modulator tubes to the final amplifier. The transformer may be left mounted on the transmitter chassis and the modulator plate leads run to it through the 5-prong connector at the rear of the transmitter chassis.

The oscillator power supply delivers 350 volts to the oscillator under a load of about 60 ma. The bleeder resistor across the output also acts as a voltage divider to supply 250 volts to the screen of the 6L6.

The final power supply uses a pair of 816's in a full-wave rectifier circuit. The plate transformer's rating is 1,800 v.c.t. at 250 ma and the filter choke is also rated at 250 ma. Since the current drain is 100 ma under full load, the voltage at the plate of the final amplifier is slightly over 1,000 v (measured). The filter condensers are 8 μ f, 600 working-volts each, and as the pairs are series-parallel connected they can easily handle the output of the rectifiers. A bleeder resistor is included to insure condenser discharge.

The metering and control circuits provide flexibility of operation, and the maximum utilization of the one panel meter. S1 is the a.c. line and filament switch. A 2- to 3-ampere fuse will, in the main line, give adequate protection. Switch S2 closes the center tap return of the high-voltage winding to ground

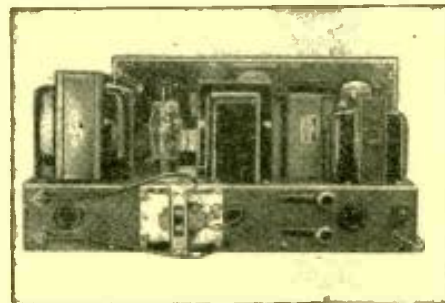

Compactness of the equipment is shown here.

in the oscillator power supply. It allows operation of the oscillator only when initially tuning up and also allows checking the frequency of the transmitter when listening to the receiver. Switch S3 is used in the initial tuning of the final amplifier. When it is on, a resistor is inserted in the primary lead of the high-voltage plate transformer to reduce the voltage on the HK-24 for tuning. It also energizes the relays Ry 1 and Ry 2. Throwing S3 to the off position after tuning has been completed shorts out the resistor and permits normal operation.

Switch S4 is the master send-receive switch. In the on position, high voltage is applied to the oscillator and power amplifier. It also connects the antenna to the transmitter (through Ry 2) and silences the receiver (through Ry 1). This system can readily be adapted to break-in operation.

S5 is a 2-pole, 3-position switch which connects a 150-ma meter across 50-ohm resistors inserted in the oscillator plate and final grid and plate circuits. The different currents may be read by merely rotating the switch to the desired position. The resistors do not affect the operation of the circuits in any way.

To neutralize the transmitter, turn it on and tune the oscillator to resonance. With the final plate voltage off, rotate the final plate tank condenser. If the HK-24 is not neutralized, the grid current will vary. Adjust the neutralizing condenser, and again rotate the tank condenser while watching the grid meter. The amplifier is neutralized when turning the tank condenser causes no change in grid current.

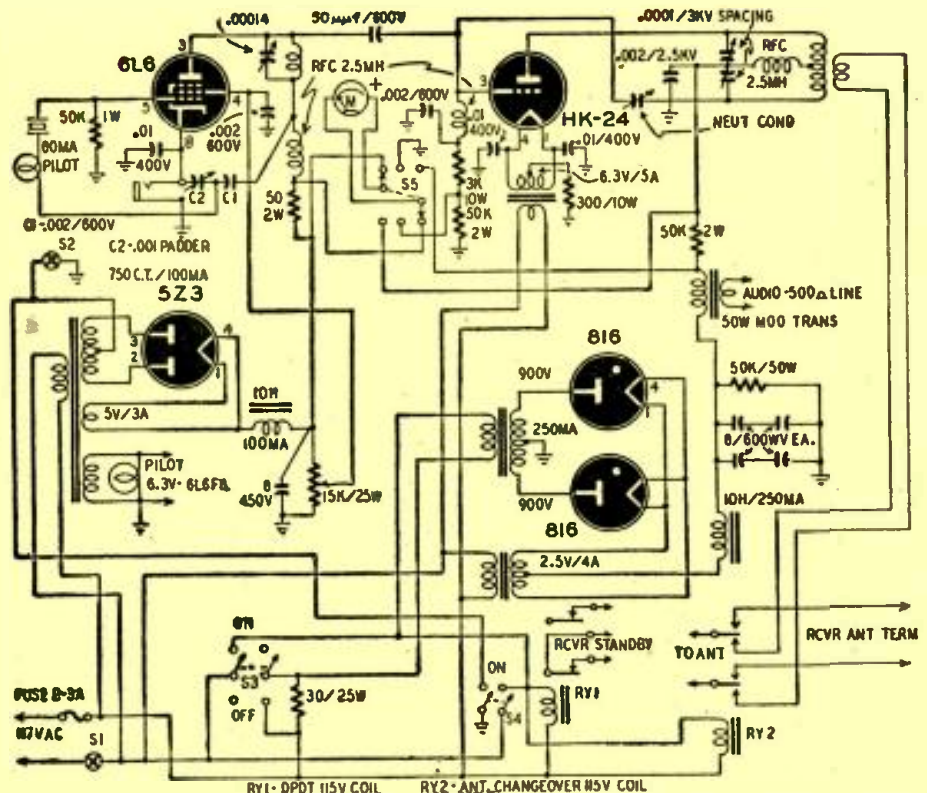

Fig. 2—The circuit is simple for a 100-watt. Provision is made for external modulation.

Amplifier Uses 6AD7 Inverter

THIS is the circuit of a good-quality phonograph amplifier with a total of 4 tubes. The amplifier uses a 6SJ7, a 6AD7, and a 6F6. The pentode section of the 6AD7 is driven directly by the 6SJ7 preamplifier. The triode section acts as a phase inverter and amplifier for a small portion of the signal from the 6SJ7 which it applies to the grid of the 6F6. Push-pull operation is thus obtained with a minimum of parts.

A low plate load resistor in the 6SJ7 stage insures good high-frequency response, and the 8- μ f decoupling condenser provides a slight low-frequency boost as its increasing reactance increases the effective load resistance for these frequencies. Separate attenuators are included for adjusting the low- and high-frequency response. The .005- μ f condensers from the output plates to the cathode are for absorbing sharp peaks. A small amount of inverse feedback is provided by the 3-meg-ohm resistors from the plates of the output tubes to the driving plates to correct any distortion in the output and to improve speaker damping.

A 6-inch and a 12-inch PM speaker are used for full-range reproduction. The small speaker operates on the higher frequencies where the reactance of the 4- μ f coupling condenser in series with its voice coil becomes negligible.

The output transformer has a plate-to-plate impedance of 10,000 ohms to match the impedance of the output tubes.

The tuner used with this amplifier is a conventional superheterodyne.

A d.p.d.t. switch is mounted on the amplifier chassis to switch the amplifier from the tuner to the phonograph pickup as well as cut off the B-plus supply to the tuner.

Careful layout is important. The transformers are placed for minimum hum pickup, and filament leads are twisted and run in the angles of the chassis. All the ground leads from each stage are returned to a single point. To prevent feed-back the grid and plate leads are short and well separated.

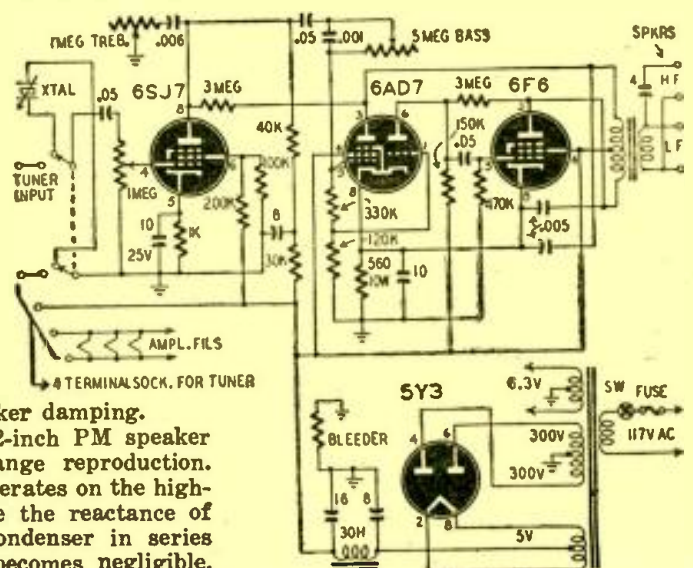

Band (mc)	Turns	Diameter (inches)	Length (inches)	Inductance (μ h)
3.5	25, No. 18	1 1/2	1 1/2	1.6
7	16, No. 16	1 1/2	1 1/2	5.7
14	8, No. 14	1 1/2	1 1/2	1.5
28	4, No. 14	1 1/2	1 1/2	.7

Or B & W JCL series

The HK-24 tank coil is designed to work properly into a low-impedance line. A doublet antenna fed with co-axial cable or a folded dipole fed by 300-ohm twin lead will give good results. In any case, the output of the transmitter may be link-coupled to a universal antenna tuner and used with any antenna. Coil data for the transmitter is given in tables I and II.

Band (mc)	Turns	Diameter (inches)	Length (inches)
3.5	26, No. 14	3	4
7	20, No. 14	2 1/2	4
14	10, No. 12	2 1/2	4
28	4, No. 14	2 1/2	4

1/8-inch copper tubing or B & W TCL series

Load the transmitter till the final's plate current reads 100 ma. The input is about 100 watts with this amount of current. The oscillator plate current should be about 50 ma and the HK-24 grid current between 20 and 30 ma.

Miniature 3-Use Fixed Oscillator

By WILLIAM LYON McLAUGHLIN



Component placement can be seen through the plastic case.

WITH so many monitors and signal generators on the market, this three-purpose oscillator makes its bid for fame only through its ultra-midget size.

As a simple signal generator, or as a monitor with phones in the circuit, it radiates a signal with terrific sock on any plate supply above seven and one-half volts. Its possibilities for c.w. with a key in the circuit are very interesting with B supply as high as 180 volts. The midget can also be used to calibrate crystals. The job has been tested on

fundamentals and harmonics to 30 mc, so will obviously go much higher.

The circuit is the well proven Pierce oscillator, similar to the "CGQ" used by the U. S. Navy during the war.

The Raytheon CK-507-AX was chosen because of its small size as well as its output possibilities. The Burgess K20 B-battery was used because of space requirements. The little ceramic condensers were used for the same reason.

Requirement number one is a transparent, plastic, standard-brand cigarette case. Upon completion of the unit the case is not completely closed. The cover is permitted to overlap the body by a little over one-eighth of an inch. The two parts are held firmly together by drilling three small holes in the case and cover and fastening them with the smallest possible brass wood screws. No screw is used on the end where the B-battery is placed.

At one end of the cover, immediately above the B-battery, a plastic-bodied crystal holder adapter has been placed. Its contact pins have been cut down to about 5/16-inch in length. Three holes are drilled in the cover: two for the pins and one in the center for engagement. This last requires a matching hole to be drilled and threaded in the crystal holder. The author used a 6-32 screw which is screwed up from inside the cover.

The smallest possible r.f. choke is then mounted inside the opposite end of the cigarette case cover, as close to the top as possible. It is well to solder the 10- μ f condenser and the leads to the choke before mounting it in the cover.

On one side of the cover, free from either the choke or the B-battery, a binding post is located. This supports the antenna, which is made from a piece of heavy wire shaped like an L, so that when not in use it can be dropped down alongside the case.

A Wirt sliding contact double-pole double-throw switch is mounted at one

end, bottom, of the case, opposite the B-battery. The ears of the switch are bent ninety degrees to the body and drawn through slots cut through the end of the case as close to the side walls as possible. The ears are then bent around to hold the switch firmly against the case. Even though only one side of this switch is used it was chosen because it was the smallest available. It is well to remove the lugs on the unused side and then cut the remaining lugs down to a size that will permit soldering on the leads. To allow for the movement of the switch button an oblong hole one-half inch long and one-quarter inch wide must be cut.

Two 3/32-inch holes are drilled 3/16 inch above the switch for the Fahnestock clips. The boss running up the end of the case will allow ample separation. As the width of the boss is about .08 inch the actual linear distance against current creepage is better than 1/8 inch.

The jumper can be made from a piece of hookup wire, twisted and soldered at one end to provide easy manipulation. This also permits attaching it to some point on the case to avoid mislaying it.

The tube pins are cut down to less than one-quarter of an inch. Pins P and G2 are soldered together. When assembly is completed the tube will be upside down next to the penlight cell and midway between the switch and B-battery. Care must be taken when closing the case to see that tube pins are kept about 1/32-inch from the lug of the choke.

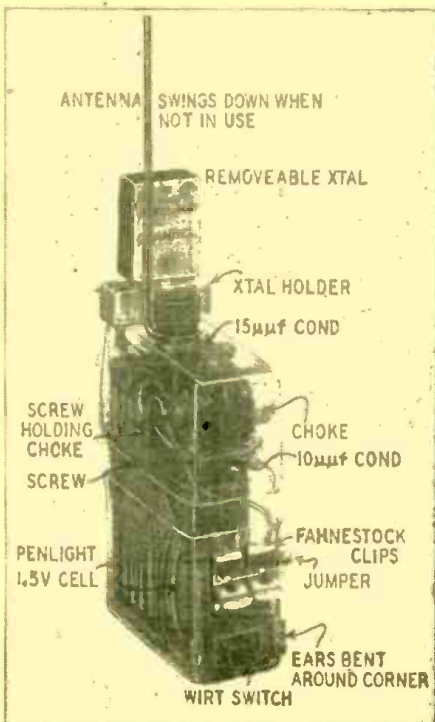

The crystal oscillator as it appears in use.

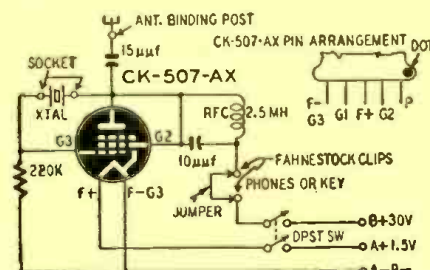

Schematic follows that of the Navy's "CGQ."

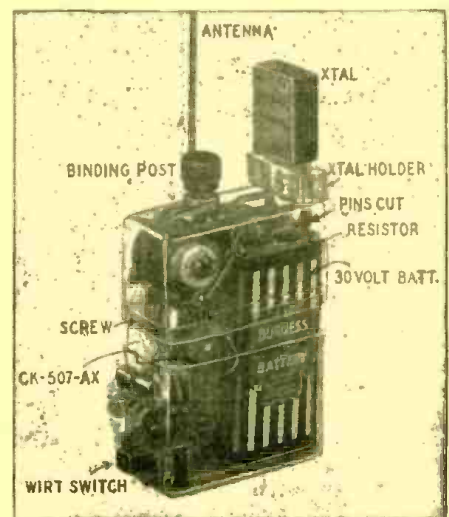

All parts are referred to in the two views.

Laboratory-Type Oscillators

By WILLIAM B. MILLER

SOME oscillators for use in the laboratory are very elaborate, using 10 or more tubes, crystal control and regulated power supplies. A few are extremely simple, like the *Hummer* used to supply tone for an a.c. bridge. This is a tuning fork kept in operation by an electromagnet. The magnet current passes through the primary of a transformer, while contacts on the fork make and break the circuit.

A laboratory oscillator is required to have better than ordinary stability, freedom from unwanted harmonics, and as pure a sine-wave output as possible (unless special types of wave forms are needed for specific purposes).

An often overlooked cause of frequency shift is the relative phase of the grid-cathode and plate-cathode voltages. This relative phase shift—brought about by changes in tube electrode voltages—shifts the oscillator slightly off resonance so that the tank circuit may produce a compensating phase shift. Voltage regulation prevents this trouble. Other ways are equally effective and less expensive, although regulation is much used.

The tank circuit should have a low L-C ratio, and the grid and plate tuned-circuit inductances should have maximum coupling in feedback and Hartley circuits. Sometimes phase shift between the tube and tuned circuit occurs if grid or blocking condensers have insufficient capacitance or if shunt-feed chokes have too low an impedance.

Frequency also varies with temperature. For this reason tank circuits should not be close to large resistors or other heat-producing components.

The dynatron circuit

The dynatron oscillator (Fig. 1), if provided with automatic amplitude control, is an excellent circuit for laboratory use unless frequencies higher than 50 or 60 megacycles are wanted. It is a

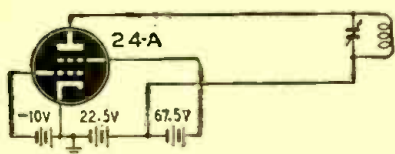

Fig. 1—Dynatron—early laboratory oscillator.

negative-resistance oscillator and depends on secondary emission from the plate for its operation. The screen grid is at a higher potential than the plate. In operation, an increase in plate voltage causes a decrease in plate current. This is a condition of *negative resistance*. Secondary emission from the plate creates this effect. The potentials on the grids (control and screen) control the number of electrons reaching the plate, while the plate voltage determines the velocity with which they strike it. The

higher this velocity (within the practical limits of operation) the more secondary electrons are liberated by the primary electrons striking the plate. These secondary electrons are drawn to the more positive screen. The effective plate current is the difference between the electrons from the cathode and the secondary ones lost to the screen. When the secondary emission is greater than the cathode emission an increase in plate voltage may cause a decrease in plate current, a condition of negative resistance.

If a tank circuit whose parallel resonant impedance is greater than the actual value of the negative resistance is connected to the plate, oscillation will occur. The amplitude may be varied by changing the control-grid potential. By keeping the amplitude low, the harmonic content of the output wave can be kept small.

Transitron oscillator

Another type of negative-resistance oscillator, the transitron (Fig. 2), is an improved dynatron. The main difference is the use of the suppressor-grid.

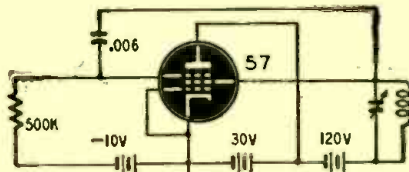

Fig. 2—An improvement over the dynatron.

It is negatively biased with respect to the cathode, and connected to the screen through a blocking condenser, so that its a.c. potential is the same as the screen's. A sudden increase in screen voltage raises the suppressor voltage, thereby permitting more electrons to go through it to the plate, usually maintained at a much lower voltage than the screen. These electrons are robbed from the screen current, with the result that the increase in screen voltage causes a *decrease* in screen current. If the screen (and suppressor) go negative, fewer electrons get through to the plate and more go to the screen. Again we have a condition of negative resistance, in which an increase in voltage causes a decrease in current, and vice versa.

Both the dynatron and transitron have frequency stability comparable to crystal-controlled oscillators that are not temperature-controlled.

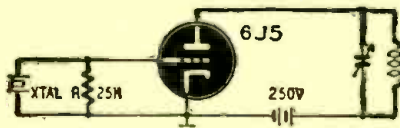

Fig. 3—Crystal oscillators are stable.

The best frequency stability is obtained with a crystal-controlled oscillator (Fig. 3).

Crystal oscillators

When a crystal is placed between two metal plates with a difference of potential applied to them, mechanical strains are set up in the crystal which cause it to produce an alternating voltage, of a frequency determined by the physical dimensions of the crystal itself. The bias resistor R in Fig. 3 controls the amplitude of the voltage through the crystal and prevents it from vibrating too violently. The Q of a crystal circuit is at

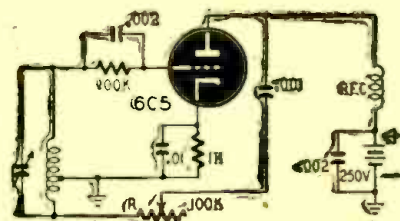

Fig. 4—The old familiar shunt-fed Hartley.

least 100 times that obtainable with commonplace capacitors and inductors. It therefore has a very sharp resonance curve, and it oscillates over only an extremely narrow range of frequencies. When its temperature is controlled with an oven, frequency variation can be kept within about two parts in ten million. Of course crystal-controlled oscillators can only be used for fixed frequencies.

A feedback oscillator is one that supplies its own input voltage of correct amplitude and phase. The Hartley (Fig. 4) is much used in the laboratory as it is easily adjusted, has excellent wave form, and oscillates over a wide range of frequencies. It is used particularly for audio and low radio frequencies. The tube, usually a triode, is operated as a class-A amplifier with self-bias.

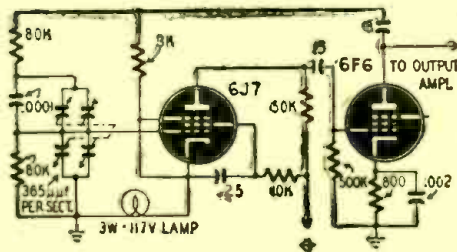
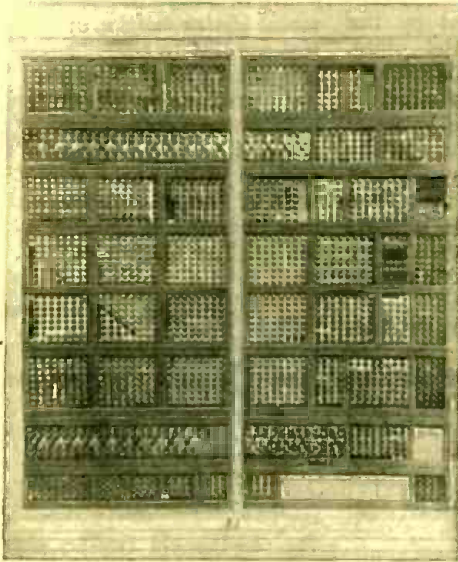

Fig. 5—Wien bridge; ideal for audio work.

R in this circuit is the resistance stabilization adjustment; it improves the frequency stability and wave form considerably at the cost of some reduction in efficiency. Since a change in the plate resistance of the tube causes a change in frequency, resistor R (usually from two to five times the value of the plate resistance) is high enough so that variations of plate resistance are of comparatively little consequence. Varying R controls the amplitude of oscillation.

(Continued on page 72)

12,000-TUBE ELECTRON BRAIN



A skilled mathematician with a desk calculator requires four years to do what the International Business Machines Calculator does in eight hours.

By A. PASCALE

Computer panels like these occupy more than 160 feet of wall space.

WOULD you like to compute the position of the moon involving the equations shown below in seven minutes?

EQUATIONS USED FOR COMPUTING THE POSITION OF THE MOON ON THE IBM SELECTIVE SEQUENCE ELECTRONIC CALCULATOR

I = NUMBER OF DAYS FROM DECEMBER 31, 1899

$$L = +0.75121 27392 0 + 0.03560 1,070 28460 I$$

$$+ 0.00000 00000 00004 12945 I^2$$

$$+ 0.00000 00000 00000 00000 01077 I^3$$

$$+ 0.00001 10108 \sin (0.53734 104 - 0.00001 01044 17 I$$

$$+ 0.00000 00000 00025 60 I^2)$$

$$+ 0.00000 00481 \sin (0.14222 222 + 0.00000 15362 28 I$$

$$+ [37 \text{ TERMS SIMILAR TO THOSE ABOVE}]$$

D = [33 TERMS SIMILAR TO THOSE ABOVE FOR L]

F = [40 TERMS SIMILAR TO THOSE ABOVE FOR L]

F = [8 TERMS SIMILAR TO THOSE ABOVE FOR L]

F = [36 TERMS SIMILAR TO THOSE ABOVE FOR L]

A = [3 TERMS SIMILAR TO THOSE ABOVE FOR L]

LONGITUDE = + 12960 00 I

$$+ [2369.902 + 0.00000 0294 I - 9193 A_1 + 0.0013] \sin (2D)$$

$$+ 22639.500 (1.00000 2208) \sin (1I)$$

$$+ 769 010 (1.00000 2208) \sin (2I)$$

$$- 868 111 (1 - 0.00000 00683 20 I) \sin (1I)$$

$$- 411 608 (1.00000 2708 + 139.978 A_1) \sin (2I)$$

$$- 0.010 (1.00000 2208) (1 - 0.00000 00683 20 I) \sin (2I + 3I + 2D)$$

$$+ [315 \text{ TERMS SIMILAR TO THOSE ABOVE}]$$

$$+ 0.019 \sin (0.84436 01544 + 0.00019 08338 8831 I)$$

$$+ 0.022 \sin (0.62973 18211 - 0.06590 17070 2163 I)$$

$$+ [582 \text{ TERMS SIMILAR TO THOSE ABOVE}]$$

63 = + 22609 07 (1.00000 2208) \sin (1I)

$$+ [194 \text{ TERMS SIMILAR TO THE ONE ABOVE}]$$

$$+ 0.020 \sin (0.103543 20294 - 0.02535 54072 5763 I$$

$$+ [39 \text{ TERMS SIMILAR TO THE ONE ABOVE}]$$

41AT = [154 TERMS SIMILAR TO THOSE ABOVE FOR 63]

M = [12 TERMS SIMILAR TO THOSE ABOVE FOR 63]

C = [146 TERMS SIMILAR TO THOSE ABOVE FOR 63]

LATITUDE = + 41AT + (18519.750 + C) (1 + 139.978 A_1) \sin (I + 63

$$- 0.00033 6892 (1 + 139.978 A_1) \sin (3I + 63)$$

$$+ 0.00000 0216 (1 + 139.978 A_1) \sin (5I + 63)$$

$$+ 0.00005 3996 M)$$

sin (PARALLAX) = + 3422.7000 + 186.5398 (1.00000 2208) \sin (1I)

$$+ [148 \text{ TERMS SIMILAR TO THE ONE ABOVE}]$$

$$+ 0.0012 \sin (0.72642 64891 + 0.03485 98579 9131 I$$

$$+ [80 \text{ TERMS SIMILAR TO THE ONE ABOVE}]$$

PARALLAX = + (1 - 0.00004 6747) \sin (PARALLAX) + 1/6 (sin (PARALLAX))

SUMMARY OF OPERATIONS REQUIRED FOR COMPUTING AND CHECKING ONE POSITION OF THE MOON

POINTS IN BASIC INPUT DATA AND INSTRUCTIONS	165,000
ADDITIONS AND SUBTRACTIONS	10,710
MULTIPLICATIONS	8,680
TABLE LOOK-UP OPERATIONS	1,870
LINES OF SEQUENCE INSTRUCTIONS REQUIRED	1,170
LINES OF SEQUENCE PERFORMED BY CALCULATOR	10,350

Yet it took only seven minutes, with the help of 12,000 electronic tubes, 21,400 relays and 40,000 pluggable connections, all at the disposal of the scientist,

to work this problem on the *IBM Selective Sequence Electronic Calculator*. Without this machine it would have taken 3 weeks.

The entire machine is made up of card reading tubes, sequence tubes, sequence relays, table look-up (for consulting reference tables), relay memory, meters, control relays, power distribution, tape memory, arithmetical unit, sequence interlocks, electronic memory, printers, card punches, and card readers, in addition to the control desk and pulse generator shown on our front cover. These are all housed in a specially-designed room, 40.6 feet wide x 86.6 feet long x 14 feet high, the walls of which are completely lined with panels of vacuum tubes and relays. These walls—with a number of pieces of floor apparatus, such as printers and control consoles—actually are the machine.

The calculating element of the machine adds, subtracts, multiplies and divides the numbers it receives. The machine can make 3,500 additions or subtractions of 19-digit numbers in a second; 50 multiplications of 14-digit numbers in a second, and 30 divisions of 14-digit numbers in a second. It has a storage capacity of 400,000 digits in tubes, relays and punched tapes. When punched cards are used for storage the capacity of operation becomes virtually unlimited.

Operation of the machine

Instructions are given to the machine by the scientist on punched cards or continuous card-stock tapes. The tapes are prepared in one of two ways—either by the machine itself or with an auxiliary tape punch which transcribes data from punched cards. When the instructions are given on punched cards the numeri-

cal data is converted electronically from the original decimal form to the binary-decimal form in which each digit is represented by a combination of the binary numbers, 8, 4, 2, 1, used by all the new giant electronic calculating machines.

As soon as the numbers are converted to the binary system, masses of neon lights carry on a fire-fly flickering at stupendous speed, while very intricate calculations are being made within the machine. The innocent onlooker is virtually overwhelmed by this display.

The machine follows the instructions on the cards or tapes and stores each intermediate result in a memory unit for later use in the course of the calculation. There are three means of storing numbers: electronic tubes (trigger circuits using 12SN7 tubes), relays and tapes. The relay and tape memory units are provided for general storage when large capacity is the dominant requirement. Electronic memory units are used in connection with the arithmetical unit where the need for speed predominates. But though the electronic system is more rapid, it cannot be used to the exclusion of tape and relay systems. If the present storage capacity of the machine, which is over 400,000 digits, were to be stored in electronic circuits it would be impracticable to house the machine in one building.

Not only does this machine add, subtract, divide and multiply, but it will also look up logarithm, trigonometric and other tables. If a table has to be referred to in the course of the calculation, the machine starts the tape of the desired table spinning. When the reference is reached, an electronic impulse stops it. The number then is stored in the memory section for future use.

The data for all computations and results obtained must flow to and from the arithmetical unit through any one of hundreds of channels throughout the machine, such as the reading and recording units and the great reservoir of stored results. Eight separate channels, each capable of transmitting simultaneously 19 decimal digits and an algebraic

sign, lead to and from the arithmetical unit. Traffic is directed along these channels to and from the other units by IBM electromagnetic relays. One of these relays, which is slightly larger than a conventional vacuum tube, can change twelve independent circuits in a few thousandths of a second. For some special problems it may even be desirable to change the whole mode of operation of the machine. This can be done in a few minutes by means of automatic control panels. About 40,000 pluggable connections on these control panels can be changed in units in a remarkably short time.

Problem results may be recorded either in punched card or in printed

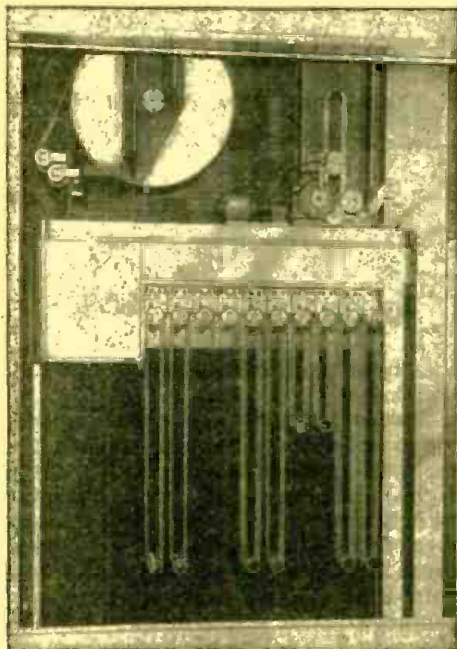

Punched-hole memory units use long tape rolls.

record form, or if desired, in both forms. Since the machine is being utilized primarily for research purposes and because calculation proceeds at such a high speed, it is necessary that the scientists know at all times what results are being obtained, so that modifying instructions may be injected whenever necessary. Provision was made, therefore, for the continuous printing of results throughout the calculation.

The console, or operation indicator and control desk (shown on the front cover) is used for keeping a check on the operation of the machine. Have you stopped to consider what an immense servicing problem it must be to locate a burned-out filament in this maze of vacuum tubes? The control desk is useful for trouble shooting. If a tube burns out, or anything else goes wrong mechanically, neon lights in the panel on the control desk assist the operator in finding and diagnosing the trouble. A check is then made in the faulty section, the trouble repaired, and the machine goes on with its work. Of course, the trouble will be discovered only when the machine has to make use of that particular panel in the course of the calculation.

The machine requires 180 kilowatts of electrical energy. All the alternating

current it uses is rectified by a large battery of rectifier tubes housed in cabinets in a room beneath the calculator. A large air-conditioning system is provided. It has a cooling capacity approximately equal to that required to air-condition completely a building containing 250,000 cubic feet of space. The system is capable of dissipating 200 kilowatts of heat.

The calculator is divided into three fire zones, each equipped with automatic temperature-detecting devices. Control of fire after detection can be either manual or automatic. Full release of the fire-extinguishing apparatus would discharge 32 tanks of CO₂ into the calculator units. The air conditioning and power supply would shut off automatically if gas were discharged. The instrument was built at a cost of \$750,000.

Many branches of industry will be greatly aided by this machine. In certain commercial statistical fields calculations have to be made where complicated sequences of operations must be handled one at a time. The operations can be so speeded up as to perform calculations which now are considered impractical due to the amount of time that would be involved.

The scientist will be the one most aided by it. What once took scientists years upon years to work out, now can be done in a few hours, freeing him for further research.

Greatest of all may be the effect of this new computer on the progress of atomic research. By performing the complex and laborious calculations required in the study of the atom, it will be a dominant factor both in keeping this country well ahead of all competitors in the military development of the atom and in speeding the day when atomic power will be available to peace-

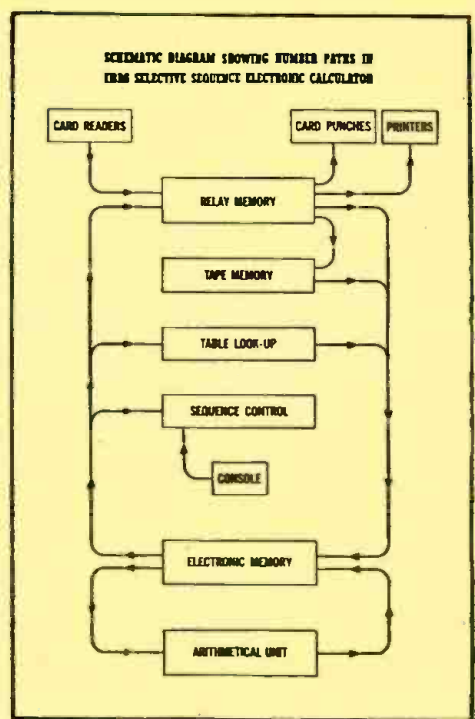

ful arts and industry.

But, it cannot, and never will, replace the human scientist as its purpose is only to follow his commands. If the incorrect instructions are given to it, it will follow them. The scientist is supreme over the great electronic calculator, which is his child to assist him in exploring the ever-profound depths of science.

As President Thomas J. Watson of IBM said: "This machine will assist the scientist in institutions of learning, in government, and in industry, to explore the consequences of man's thought to the outermost reaches of time, space and physical conditions."

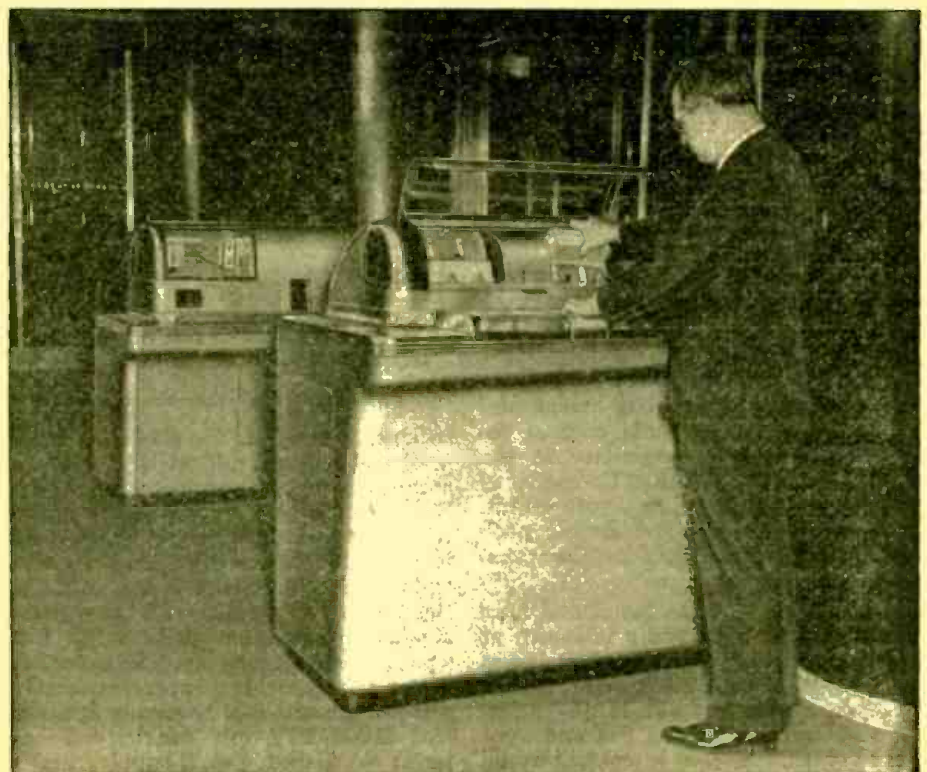

The card reader through which problems and instructions are introduced into the machine.

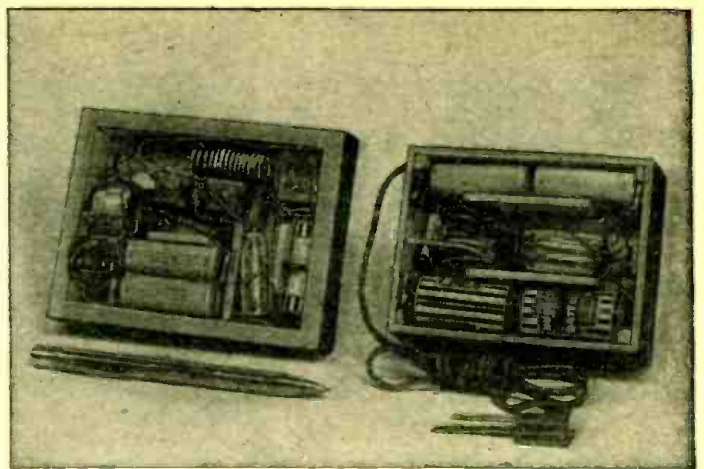
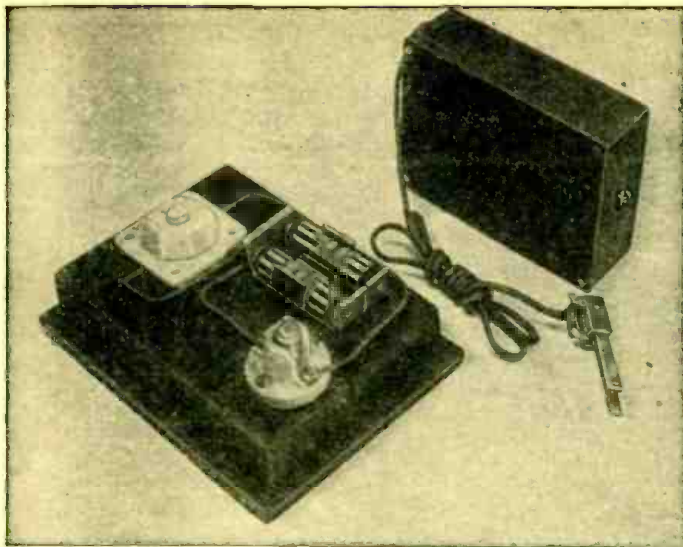

Left, Fig. 1—"The light with memory" and the secret transmitter.
Above, Fig. 2—Miniature components are used in the construction.

Light with a Memory

This remote radio control has several practical applications

By M. GORDON MOSES

It has always been everyone's secret desire to press a button at one point and cause something to happen at another point. With the advent of radio control, this old dream became a reality. For example, model airplane construction has been combined with radio to produce remote-controlled planes which glide and turn in the sky—all at the whim of the operator on the ground.

An unusual application of radio control is the "light with a memory." The effect is startling even to those well-versed in radio. Briefly, the stage setting is this: A small wooden panel, with push-button, flashlight lamp, and batteries mounted on top, is shown. The batteries, push-button, and lamp are wired in series so that when the push-button is pressed the lamp lights. Pushing the button several times, say five, the "magician" waves his hand over the panel. Lo and behold! The light mysteriously blinks the same number of times as the miracle-worker pressed the button. Spectators are then allowed to press the button any number of times they desire, and the light—virtually a light with a memory—repeats the flashes!

The base of the panel is hollow and contains a complete radio control receiver. A compact transmitter in the operator's pocket is pulsed by means of a leaf switch concealed in a vest pocket. The lamp in the receiver flashes each time a pulse is picked up from the transmitter.

A photograph of the panel and base as the spectators see them is shown at the left in Fig. 1. The mechanical design was influenced by the special use to which the device was put. It was necessary that the unit be as flat and compact as possible, so that spectators would not suspect its existence. However, it is

fundamentally a standard radio remote-controlled relay, and can be used in a variety of ways. The mechanical design can be modified to fit any particular application.

The push-button and miniature porcelain socket can be purchased in any electrical parts house, and the holder for the two penlight cells can be bought at a hobby supply store. The receiver with base removed is shown in Fig. 2, also at the left. Follow the placing of parts closely. The tuning coil consists of 14 turns of No. 14 tinned copper wire, wound to an inside diameter of 1/2 inch and spaced for an over-all coil length of approximately 1 1/2 inches. Fig. 3 is the

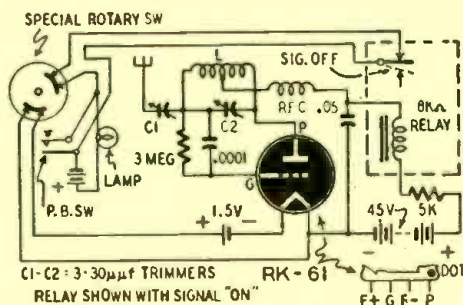

Fig. 3—Schematic of the miniature receiver.

receiver schematic. The .05- μ f condenser is of a flat paper midget type and was obtained from a hearing-aid dealer. The 100- μ f condenser is a silver mica. An r.f. choke was made by winding a single layer of No. 32 enamel wire over a 1/4-watt, 1-megohm resistor and soldering the winding in parallel with the resistor. A Sigma 8,000-ohm plate relay with s.p.d.t. contacts was used in a conventional self-quenching superregenerative detector circuit. Two Eveready Minimax No. 412-E 22 1/2-volt hearing-aid batteries furnished the B-supply, and a penlight cell provided the A-supply for

the miniature Raytheon RK-61 gas control triode.

Special attention is called to the unique rotary switch used to turn the receiver on and off. Shown in the upper right-hand corner of the panel, the switch consists of a 5/8-inch diameter disc of thin hardwood with two silvered brass segments glued on at spaced intervals. Four silvered brass wipers act as contact arms. A sketch of this switch is shown in Fig. 4. One of the wood screws used to hold the miniature porcelain socket on the panel is a dummy, and is actually used as a shaft to rotate the special two-circuit switch. One set of contacts goes to the filament circuit of the RK-61 tube, and the other set is in series with the contacts on the relay. Closing the rotary switch turns on the receiver and puts the relay contacts in parallel with the push-button switch mounted on top of the panel. More conventional switches are obtainable as band-change switches for short-wave receivers.

The antenna lead of the receiver is a 2-foot length of No. 22 d.c.c. magnet wire. Care must be taken not to bring any part of this lead too close to the tank coil and not to coil the antenna lead too much. The best arrangement is to run the lead around the inside of the hollow panel and bring the free end to

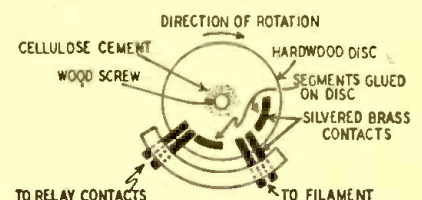

Fig. 4—This switch operates the receiver. rest between the B-batteries. If concealment is not necessary, it can be led
(Continued on page 81)

Radio Set and Service Review

Midget television preamplifier

THE great popularity of postwar television has caused many sets to be installed in areas where signal levels are not high enough for clear, stable pictures. In some instances set owners are further handicapped by not being able to put up adequate antennas. Very often weak signals can be boosted to satisfactory levels by inserting a preamplifier between the antenna and the antenna terminals of the set.

Several television preamplifiers are being made by various manufacturers and a number of independent servicemen—all of whom treat their circuits as trade secrets. All these preamplifiers use one or more stages; some require tuning and others do not. Many of these boosters, like the one we are about to describe, were designed from material appearing in the article, "Cathode-Coupled Wide-

the input frequency is so high that the grid lead has appreciable impedance.

The grounded-grid amplifier has several advantages, which make it useful as an untuned r.f. amplifier between the antenna and televiser. These are: Lower tube noise, output capacitance less than one-half of that of a conventional neutralized amplifier, and low input capacitance—a necessity for high transconductance. The low input and output capacitances result in greater band-width without manual tuning.

Construction

The circuit of the grounded-grid preamplifier is shown in Fig. 1. It is constructed on a chassis 2½ inches square and 1 inch deep. The three terminal strips are for input, output and power connections. Filament and plate voltages are taken from the low-voltage supply of the set.

The tube is a 6J6 with its triodes connected in parallel. The cathode and plate coils are wound so that combinations of distributed and circuit capacitances tune them to cover the first six television channels. The antenna transformer is mounted on a bracket near the input terminals. The output transformer is fastened to the chassis with a machine screw threaded into one end of its form.

The primary of the antenna transformer is designed to match a 300-ohm balanced transmission line. It is an 8-turn winding tapped at the center. The cathode coil has five turns interwound with the primary. The output transformer has a 10-turn plate winding with a 2-turn output link interwound at its lower end. Both transformers are wound with No. 34 enamel wire on 5/16-inch polystyrene tubing. All coils are close-wound. Use 300-ohm twin-lead between the preamplifier and the antenna terminals of the set.

The unit is so simple as to make it unnecessary—and almost impossible—

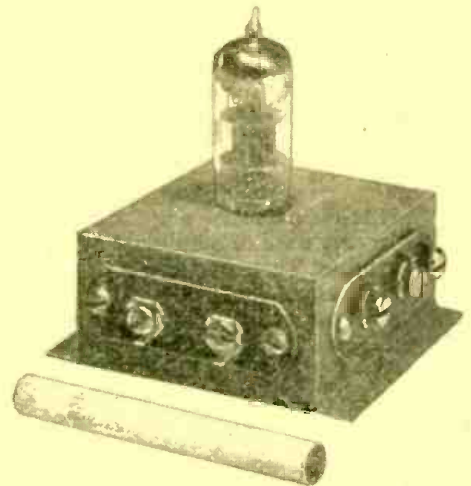

The preamp's dimensions are cigarette-size.

probably be well advised to follow the photograph closely—at least in his first model.

V.T.V.M. CALCULATIONS

THIS method of calculating the resistance values in a voltage divider may be useful to the serviceman who wishes to build his own vacuum-tube voltmeter.

As an example, assume that the desired ranges are: 3, 15, 150, 300, 600,

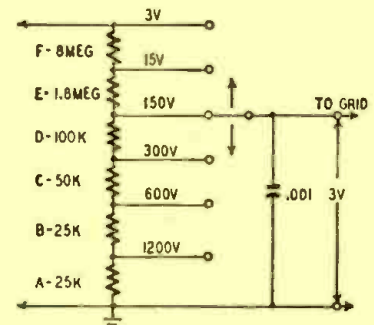

and 1,200 volts; the total input resistance is 10 megohms; and 3 volts are required on the grid of the tube for full-scale deflection. For the 1,200-volt scale, divide 1,200 volts by 10 megohms to find the current through the resistor A:

$$1,200/10 \text{ meg} = .00012 \text{ amp.}$$

Dividing the 3 volts (required for full deflection) by .00012 amp gives the resistance as 25,000 ohms. This is the value of resistor A.

For the 600-volt scale, the procedure is the same:

$$600/10 \text{ meg} = .00006 \text{ amp (through resistor B).}$$

Three volts divided by .00006 amp shows the resistance to be 50,000 ohms, which is the value of B plus A. Subtracting the value of A from 50,000 gives B as 25,000 ohms. By repeating the same procedure the remaining resistors are:

Scale (volts)	Resistor	Value
300	C	50,000 ohms
150	D	100,000 ohms
15	E	1.8 megohms
3	F	8 megohms

The total resistance is 10 megohms.



Under-chassis view, showing part placement.

Band Amplifiers," in the October 1945 issue of the *Proceedings of the I.R.E.*

Our booster, a 6J6 grounded-grid amplifier designed to operate on channels 1 through 6, amplifies the antenna signal two to four times while providing a substantial improvement in signal-to-noise ratio. It has several advantages. It does not require manual tuning; it is small enough to fit on the chassis or inside the cabinet of almost all television receivers and it does not require a special power supply.

The grounded-grid amplifier

The grounded-grid amplifier used in this circuit was developed to avoid neutralization when using high-frequency triode amplifiers. (See *Radio-Craft*, Nov., 1947, P. 32). The input signal is applied between cathode and grid, and the output voltage is developed across a load between plate and grid. The grid, either grounded directly or through a suitable bypass condenser, acts as a shield between the input and output circuits, thus forestalling oscillations until

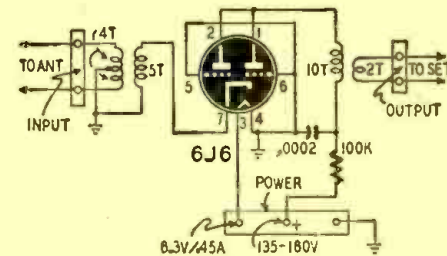

Fig. 1—The grounded-grid circuit is used.

to give any further construction details. An almost slavish adherence to original RCA development illustrated in the *I.R.E. Proceedings*, in regard to placement of parts, size of chassis and manner of making connections has been observed in more than one successful model. The constructor would therefore

Phase Inversion Circuits

Part I—The transformer type of inverter, with some variations on standard circuits

By J. W. STRAEDE*

PHASE inverters are devices commonly used in amplifiers and large radios. Their purpose is to provide two equal but antiphase alternating voltages which are usually applied to the grids of push-pull output tubes. They are also used in electronic test equipment, including watt-meters, distortion meters and special types of oscilloscopes.

The signal voltage required by the following stage and the suitability of the system for use with negative feedback, are among the several factors that must be considered in the choice of a phase-inverter circuit. Power may also be required by the output tubes, as in class-AB2 operation, and, finally, the cost may override all other factors, no matter how desirable they might be.

Phase inverters are classified according to the way the signal voltages are fed from one stage to another. Classifications are: (1) Inductively coupled, (2) Resistance-capacitance coupled, and (3) Direct coupled.

The oldest form of inductively coupled phase inverter is the transformer with a center-tapped secondary, or with two secondary windings—one for each grid. Other inductive systems use a center-tapped choke coil, and a transformer with no center tap but with the secondary voltage divided by a pair of equal resistors. These three circuits are shown in Figs. 1, 2, and 3,

Transformer coupling

Biggest drawbacks to the use of transformers are their cost, liability to hum pickup, and imperfect frequency response. Hum can be reduced by mounting them away from power transformers and chokes and by rotating them until a position of minimum hum is found. High-frequency peaks can be reduced by shunting the secondary with resistors (about 1/2 megohm), while things can be improved generally by using negative feedback in the driver stage.

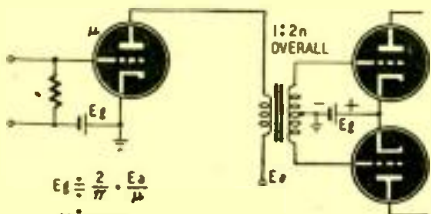

Fig. 1—Standard transformer-coupled circuit.

Advantages of transformer coupling are the large signal voltages obtainable, the low d.c. resistance in the grid circuits of the output tubes and its adapta-

*Lecturer in electronics and electro-acoustics, Melbourne Technical College, Australia.

bility for class-AB2 operation. In this case, the transformer usually has a step-down ratio to match the minimum grid input resistance of the next stage to the plate resistance of the driver. (Grid input resistance varies from values too large to bother about when the grid is negative to values as low as a few hundred ohms when the grid is very positive.)

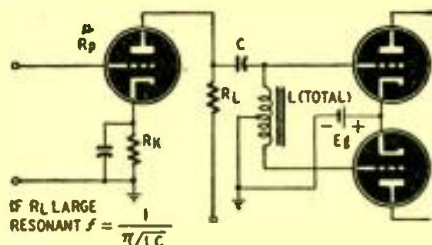

Fig. 2—Inversion with single tapped coil.

The gain M of the driver and the transformer is nearly equal to the product of the amplification factor and transformer ratio. The optimum grid bias

E_g is $\frac{2}{\pi}$ times the plate voltage divided by the amplification factor.

The center-tapped choke is a comparatively inexpensive device, but is full of faults, such as unbalance at very high frequencies, low response at very low frequencies, and low voltage output. It is still useful for compact car radios and small mobile amplifiers where only a limited frequency range is required. A good quality center-tapped output transformer can be used with fair results if it has enough inductance.

The low output voltage is due to the voltage drop across R_L (Fig. 2), together with the drop in effective load impedance also caused by R_L . If R_L is decreased to avoid the first defect, the second defect becomes more pronounced. At medium to high frequencies, the gain M approaches

$$\mu \left(\frac{R_L}{R_L + R_p} \right)$$

where μ is the amplification factor of the tube, R_L is the load resistance, and R_p is the plate resistance. The bass resonant frequency is given by

$$f = \frac{1}{\pi \sqrt{LC}}$$

The gain then is $\frac{\pi f L \mu}{2 R_p}$,

where L is the inductance of the choke in henries, and C is the capacitance of the condenser in farads.

Transformer with resistors

A transformer with resistors (Fig. 3) is often used as a makeshift, but is quite capable of good gain and frequency response if the output tubes require no driving power and if high grid-circuit resistance is permissible. The two resistors must be as nearly equal as possible and must be large to prevent high-frequency loss in the transformer and to present a reasonably large load impedance to the driver tube. This impedance is given by $\frac{2 R_g}{n^2}$, where n is the

step-up ratio of the transformer. The gain to each grid is then $\frac{n \mu R_g}{2 R_g + n^2 R_p}$.

If the driver is a low-impedance tube such as a 6C5 and the grid resistors are each 0.5 megohm, the gain is very nearly equal to $n \mu$ at mid-frequencies. At low frequencies the gain is 3 db down when the reactance of the transformer primary is equal to the plate resistance of the driver.

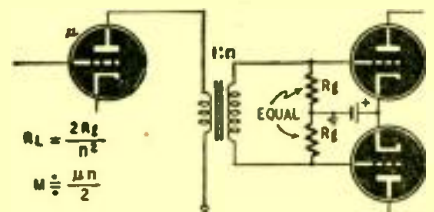
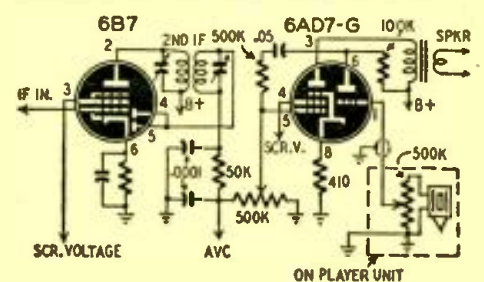

Fig. 3—How an untapped condenser is used.

A second article by Mr. Straede, in an early issue, will cover resistance-capacitance types of phase inverters.

PHONO PREAMPLIFIER

I have a small superheterodyne using a 6A8, 6B7, 6K6, and rectifier. I tried unsuccessfully to add a phono attachment by connecting it to the grid of the 6K6. The output of the pickup was too low for use without a preamplifier. I removed the 6K6 and wired in a 6AD7



as shown. The triode section is used as a preamplifier for the pickup without altering the performance of the set.

JOSEPH PRITCHARD,
Hamilton, Ont., Canada

Servicing Wind Generators

By MAX ALTH

THERE is little chance that one of us will ever be called on to service the 1,000-kw giant wind generator atop Grandpa's Knob near Rutland, Vermont. But we *will* be called upon sooner or later to service one of the more than a million wind-driven power plants in use today.

Wind-generator servicing is not hard. After the tower has been climbed, there is really nothing to worry about. These generators are very similar to automotive generators. In fact the first units, some of which are still being used today, were auto generators.

If called upon to install a plant, select a spot as close to the load and as unobstructed as possible. The prop on a 6-volt machine should be mounted at least 15 feet higher than any obstruction within a radius of 500 feet. The larger, 32-volt job requires a clearance of at least 30 feet above anything within $\frac{1}{4}$ mile. Higher up the air is smoother and will develop more power. Raising the *Wincharger* Model 3227 from 65 feet to 105 feet has been found to increase the power output 30%.

Since the lines from generator to load carry high current at low voltage, they should be kept as short as possible from the point of view of both voltage drop and wire cost. A 32-volt line carrying 40 amps should be at least No. 6 wire if it runs 100 feet, and No. 4 if it runs 200.

The tower should be erected plumb so that the generator doesn't tend to fall off to one side. It should be well grounded as otherwise it would be a natural target for lightning.

After the unit has been erected, the prop should be checked for balance and track. On a *windless* day, remove the brushes or tie them back with a piece of string, and give the prop a quarter turn, then another. If the same blade comes to rest in the down position every time, the prop is unbalanced.

Correct unbalance by loosening the prop in its haft or holder, and wriggling. If there isn't enough play for correction, drive a wood screw into the lighter arm. First locate the balancing spot for the screw by temporarily fastening the screw to the prop with a piece of adhesive tape. If the screw has to be more than 2 feet from the center, it's best to locate a better-matched pair of prop blades. Some props are equipped with counter balancing weights. An out-

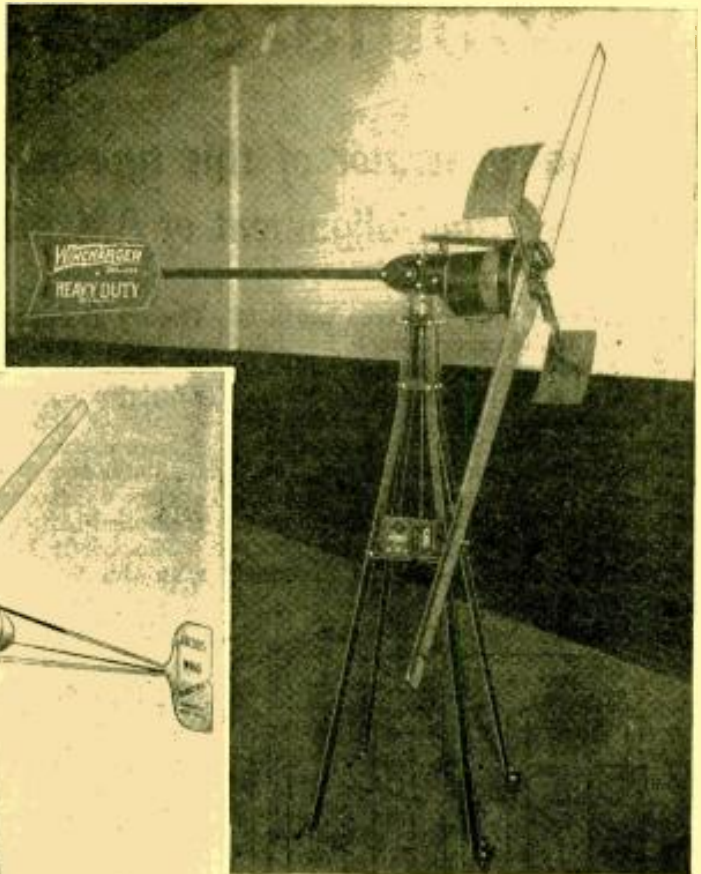
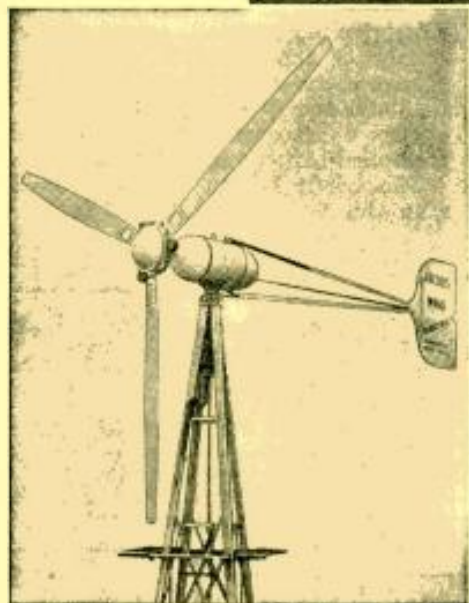

Above—The Wincharger; left—Jacobs Wind Electric, two common battery-charging units.

of-balance prop will vibrate the plant and shorten its life considerably.

Check the track by measuring carefully from inner edges of each blade, from equidistant points from prop end back to a fixed point on the tower. Correct by again wriggling prop, or by slipping a shim between prop and haft. Out-of-track blades make whistling noises and reduce prop efficiency.

Be sure the unit is lubricated before placing in operation; some of these units are packed and shipped dry.

Now let her go and watch the voltmeter. If it reads backward, or if the relay chatters, disconnect before relay is injured. Your wires may be reversed. If the wiring checks O.K., the polarity of the unit may have been reversed at the factory. Run the generator as a motor for a few minutes by connecting the storage battery to it. In some cases closing the relay by hand will make this connection; in others it will have to be done with a jumper. Check the diagram furnished with each generator first. A typical 32-volt hookup is shown in Fig. 1—the 6-volt jobs are even simpler.

Motoring the generator will not only correct the polarity of the generator but will also give you a general idea of the condition of the unit, whether or not the circuit is complete, etc.

Servicing established units

Complaints fall into 2 general categories: lack of immediate power, or insufficient power over a period of time.

If there is no power, first check the controls for proper adjustment, then run an ordinary continuity check up the

leads through the slip rings and slip-ring brushes to the generator proper. Check the position of the third brush, if the model has one. The brush may have slipped back. Check the other brushes for seating and tension. The commutator should have a dull-brown oxide sheen. If it is lightly scored, it may be repaired by holding sandpaper against the commutator and turning it. If the commutator is deeply scored, it will have to be turned down on a lathe. Light or deep scoring indicates hard spots on the brushes. They should be

(Continued on page 76)

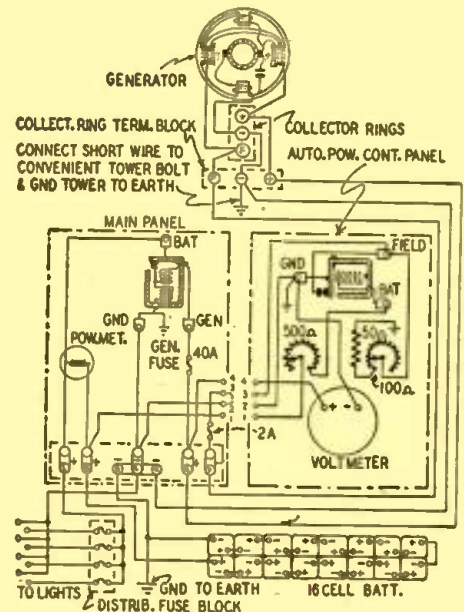

Fig. 1—Circuit of the Wincharger Model 3227.

Wobulated Signal Generator

A signal generator of this type is necessary for visual alignment of AM receivers

By GEORGE W. SCHULTZE

THE versatility and true worth of an oscilloscope cannot be fully realized until you have actually had such a device on your bench for some time and used it for servicing or development. Perhaps the most important of these applications is visual alignment of receivers, requiring a frequency-modulated sweep generator or "frequency wobbler." The frequency-modulated signal generator described

Theory of operation

Three operations are carried out in the frequency-modulated oscillator. An r.f. signal is generated; second, the frequency of the signal is varied by a change in the effective inductance in the oscillator tuned circuit; and third, the change in frequency is automatically controlled between fixed limits.

The triode section of V4 (Fig. 1) with the tank circuit L-C18 forms a

of steps are followed as are used in the output meter method. The output of our wobbler is injected into the receiver at the usual points instead of the fixed frequency signal, and the oscilloscope takes the place of the output meter. The oscilloscope should be connected across the detector load rather than across the output transformer. The pulse output is connected to the external synchronization post on the oscilloscope. The oscilloscope horizontal sweep is set for 120 cycles per second, which results in the trace from maximum to minimum frequency being superimposed upon the trace from minimum back to maximum.

The center frequency control C18a is adjusted to the required center frequency. R2 is set at about two-thirds maximum. R10 is set at or near maximum. If the i.f. stage being checked is considerably out of line, the double-trace response curve will appear as in Fig. 5. As the trimmers are adjusted to bring the transformer into alignment, the two traces will coincide, or approximately so, as shown in the oscillogram (Fig. 6). The shape of the response curve in the usual properly aligned transformer is of this general outline with a single smooth peak. High-fidelity receivers will have curves with a flat top or double peaks. During the above operations the frequency deviation control R10 should be adjusted to give a reasonably wide response curve without cutting off the ends.

The FM test signal is injected at the conventional points for checking the oscillator and r.f. circuits of the receiver. To obtain the necessary broadcast frequencies, a fixed-frequency signal from a conventional test oscillator is mixed in V4 with the FM signal to give the desired difference frequency. The response curves will be similar to those obtained from the properly tuned i.f. stages. The oscillator and r.f. adjustments are made for maximum height of response curve.

Whether the response curves will appear on the oscilloscope screen right side

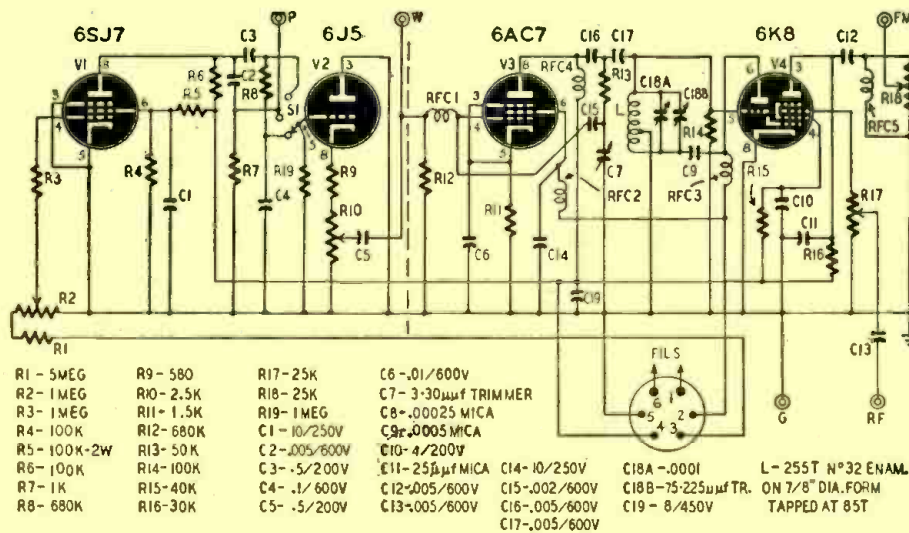

Fig. 1—Generator schematic. Radio-frequency chokes are of the large 60-millihenry type.

(Fig. 1) for use in alignment of AM receivers was developed and constructed by the author.

The following specifications were set up:

1. A center frequency variable from approximately 450 to 540 kc, giving an easily adjusted carrier frequency covering the i.f.'s of practically all modern AM receivers.
2. Frequency deviation adjustable from 0 to 30 kc. Such a maximum deviation will project the response curves of the i.f. and r.f. transformers in all AM receivers (including the high-fidelity ones) to zero response both sides of maximum.
3. Unit must be compact. Such a characteristic becomes a virtue on the average service bench.
4. Cost must be kept to a minimum.
5. Unit must be adequately shielded (as all good r.f. signal generators should be) to avoid radiation of unwanted signals to other equipment.

A separate power supply, connected to the wave generator by a multiconductor cable, was considered desirable. First, magnetic shielding is simplified. Second, by making the unit a universal power supply, it becomes an extremely useful tool for other activities as well.

simple Hartley r.f. oscillator. For a detailed account of the theory of operation of the reactance tube V3, the reader is referred to any of the standard texts. We can simply say that varying the control grid voltage of the reactance tube controls its effective inductance and, consequently, the oscillator frequency. If a low-frequency alternating voltage, say at 60 cycles, is applied to the control grid of the inductance tube, the output frequency from the oscillator will swing from a maximum to a minimum value, and back again, 60 times a second. It is desirable that the frequency change be linear to time. Such a triangular or "pyramid" wave (Fig. 2) is obtained across the integrating circuit R8-C4 (bottom tap on switch S1). The output from V1, a sine wave clipped to an approximate square wave (Fig. 3), appears at top tap of S1. The pulse formed across the differentiating circuit R7-C2 is available at point 2 of S1, and at the PULSE binding post (see Fig. 4).

V2 is merely a cathode follower buffer stage, and the hexode section of V4 is a mixer for injection of a fixed frequency signal when desired.

How generator is used

In visual alignment, the same series

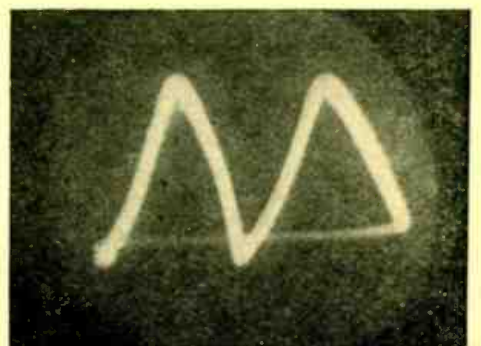

Fig. 2—Normal pyramid (time-linear) wave

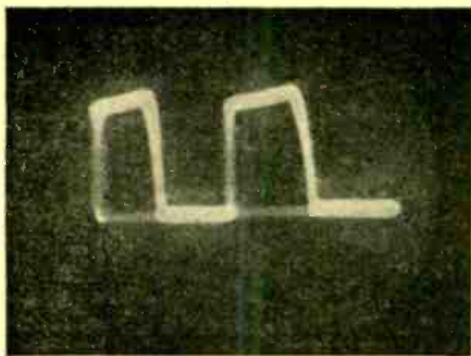

Fig. 3—Square waveform from the plate of V1.

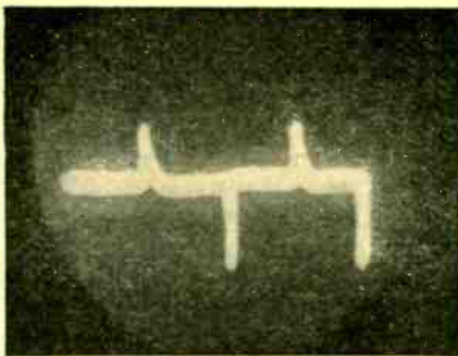

Fig. 4—Differentiated pulse output from V1.

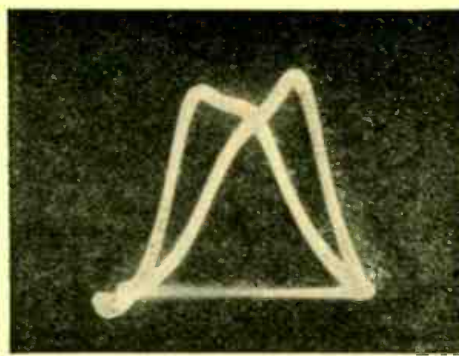

Fig. 5—Trace from a misaligned i.f. circuit.

up as shown in the oscillograms and drawings in this article, or upside down, depends upon the number of stages in the oscilloscope vertical amplifier, the orientation of the cathode-ray tube, and at what point in the receiver the test signal is taken off.

Construction

The FM signal generator was designed to go into a 7 x 7 x 7-inch enclosure. The low-frequency portion (6SJ7 clipper and the 6J5 buffer) is mounted in a 1½-inch deep horizontal steel chassis. The r.f. section, including the sockets for the 6AC7 reactance tube and the 6K8 mixer, is contained in a 2½-inch deep sheet-copper chassis, mounted vertically on the back edge of the steel chassis. This is clearly shown in the photographs (Figs. 7 and 8). The copper box is bent from 22-gage sheet, and the joints soldered. A copper back cover is secured with self-tapping screws. The same type of fastening is used to join the copper shield box to the bottom chassis. The panel can be either bakelite or (as shown) crackle-finish Masonite, 7 x 7 x 3/16 inches.

The power input socket, the binding posts, the potentiometers R2 and R10, and switch S1 are all mounted on the panel, as pictured below. The center frequency adjustment C18a and potentiometers R17 and R18 are located in the copper shield box with extension shafts extending to knobs on the panel. C18a must be insulated from the chassis by fiber washers, and the shaft couplings should be insulated. The five binding posts provide connections on the panel

for the FM output, r.f. input (constant frequency generator), ground, 60-cycle wave, and pulse. The 60-cycle wave post provides a convenient connection for checking the output of the clipper circuit, as well as affording access to the three types of wave form, as selected by S1, for other fields of use. As mentioned before, the pulse output is used to synchronize the time base sweep of the oscilloscope.

V3 and V4 are either metal tubes or externally shielded glass types. If metal tubes are used, be sure to ground the No. 1 pins (internal shield). This is especially important for the 6K8 mixer. The phase-splitting condenser C7 is fastened inside the top edge of the copper box with a hole provided for external screw-driver adjustment. The center frequency range adjustment C18b is mounted to allow trimming through a hole in the back cover.

Bare, tinned wire is best for most of the r.f. wiring. All leads should be as short and direct as possible. All ground leads from V3 and V4 are brought to common single chassis connections. The tank coil L was wound on a ⅝-inch outside diameter plastic cylinder 2½ inches long. The base end of the form was plugged with a wood disc cemented in place. A hole for a 6-32 screw was drilled through the center of the plug and a hex nut cemented on the inside. The coil was then mounted on the side of the copper shield box with a counter-sunk head machine screw. The lead from R18 to the panel binding post was shielded in order to avoid low-frequency pickup. The 60-mh choke RFC5 filters out any 60-cycle

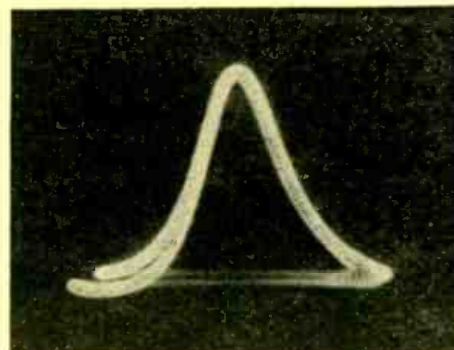

Fig. 6—The above circuit, properly aligned.

amplitude modulation present in the output from V4.

The panel is backed by an iron shield which provides an anchorage for the sheet-iron cover as well as magnetic
(Continued on page 74)

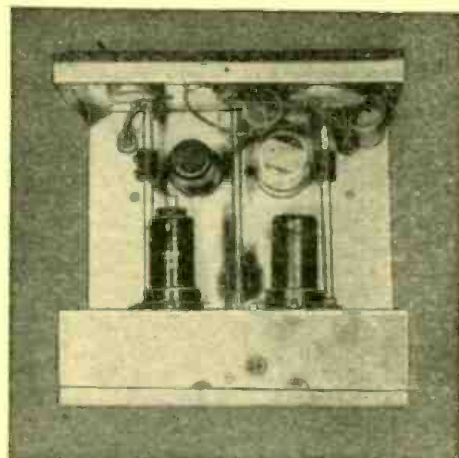
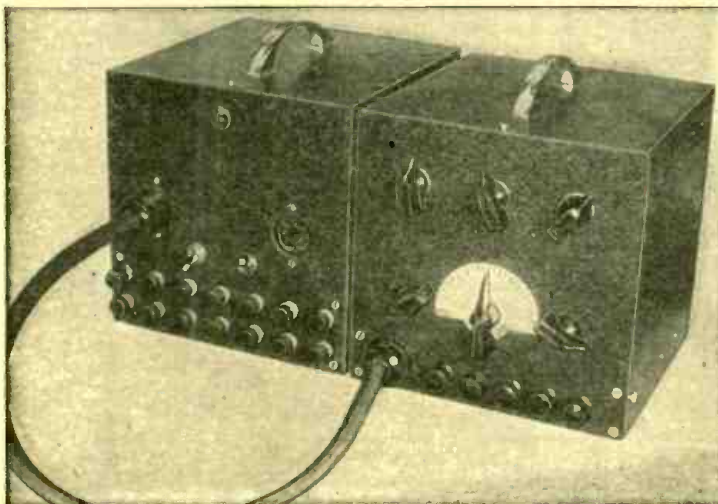

Fig. 7—Top view shows placement of parts.



Instrument and power pack present a pleasing uniform appearance.

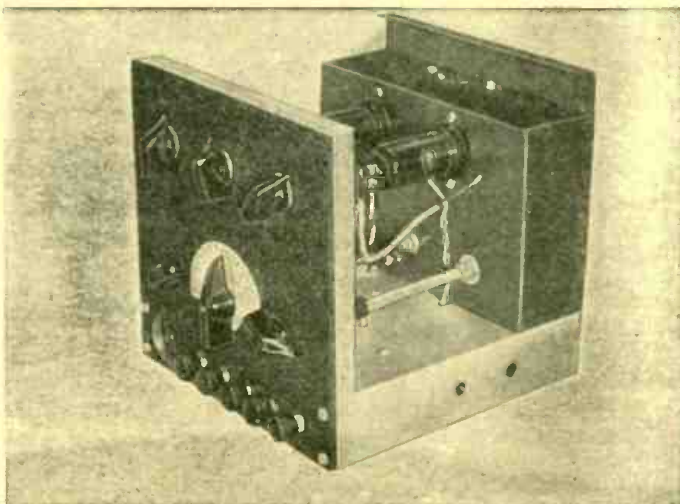
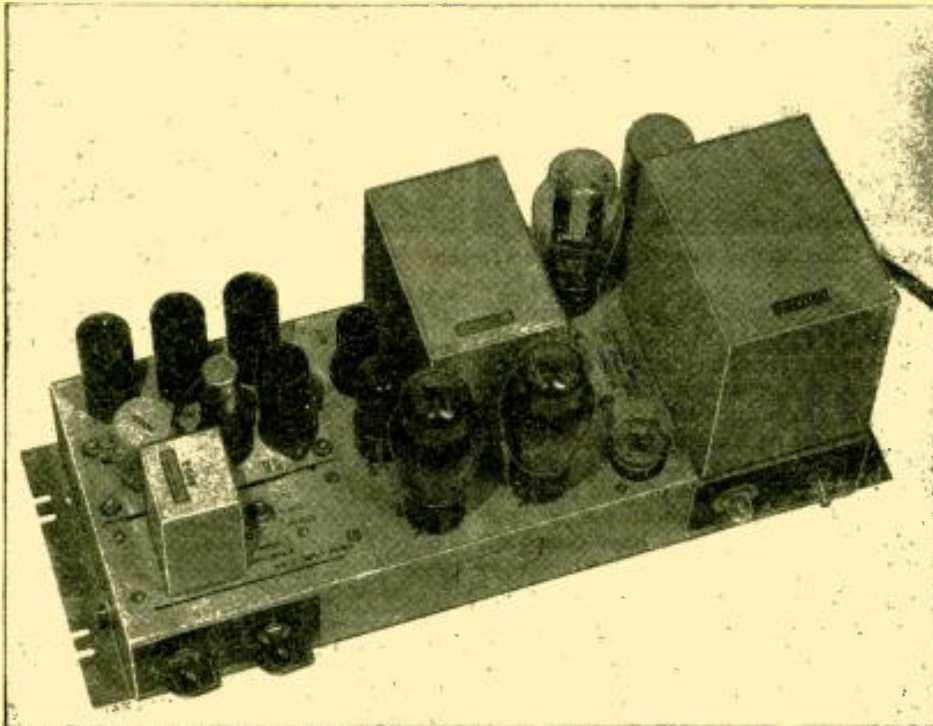

Fig. 8—Front view. Tubes mounted on subchassis are 6AC7 and 6K8.

High-Fidelity Amplifiers



Above is the Langevin 610-C, a typical example of high-fidelity audio amplifier design.

DESIGN of a wide-band amplifier calls for special compensating circuits to offset the drop in response at the high and low ends of the audio spectrum. As pointed out in a previous article (March, 1948), response begins to drop off noticeably at the high end of the band when the shunting capacitances present a reactance about five times as great as that of the plate resistance and the coupling and load resistors in parallel. Additional losses due to degeneration in cathode and screen circuits can also occur.

These factors can be compensated for by careful design. Assume that an audio amplifier is to be designed to deliver 3.5 watts of power with response flat within 1 decibel from 20 to 20,000 cycles. Input is to be .015 volt r.m.s., and distortion negligible. Circuit may be that of Fig. 1.

The power amplifier selected is a 2A3, because it can deliver 3.5 watts without distortion. Specifications call for 250 volts on the plate, 45 volts cathode bias, and a 2,500-ohm load. Transconductance is 5,250 micromhos.

Manufacturers recommend that the peak a.f. signal on the grid of a class-A power amplifier equal the d.c. grid bias. Therefore we must supply a 45-volt signal to the 2A3 grid. A 45-volt signal on the grid of this tube develops 132 volts peak across a 2,500-ohm plate load resistor with a stage gain of 2.93. The peak voltage across the load is found

from $E_{\text{peak}} = 1.414\sqrt{W \times Z}$, where W is output power and Z is load impedance. (The stage gain is equal to output voltage divided by input voltage.)

Our restriction to 1-db loss corre-

sponds to a voltage ratio of 0.8913/1 or 89.13% and indicates that the signal at any point in the amplifier must be always within 89.13% of its value at mid-band.

Circuit constants

A 750-ohm cathode resistor will provide 45 volts of bias under recommended operating conditions. This resistor must be bypassed with a condenser with sufficiently low reactance to limit cathode degeneration so output voltage will not drop below 89.13% of 132, or 117.7 volts. At this level, the stage gain G is 2.6. Since gain with degeneration G is

$$G1 = \frac{1}{1 + gmZk}$$

when $G1$ is gain without degeneration, gm is transconductance in mhos and Zk is cathode impedance, we may transpose the equation to solve for Zk :

$$Zk = \frac{G1 - G}{G \times gm}$$

substituting,

$$Zk = \frac{2.93 - 2.6}{2.6 \times .00525}$$

$$Zk = 23.03 \text{ ohms.}$$

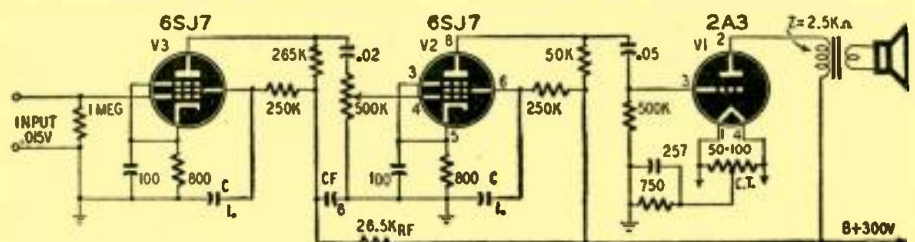

Fig. 1—A 20 to 20,000-cycle amplifier whose circuit constants are worked out in the text.

Second of a series on wide-band amplifier construction

By ROBERT F. SCOTT

Since the impedance of the parallel combination is to be about 23 ohms, and the value of the resistor is 750 ohms, it is obvious that the parallel impedance will be roughly equal to the reactance of the condenser. We can therefore simply find the capacitance that has a reactance of 23 ohms at the low-frequency limit (20 cycles). The condenser should have a minimum capacitance of 257 μ f.

This value may seem unreasonably large for a cathode condenser since it is seldom found in practice—even in video circuits—because other methods of low-frequency compensation are more commonly used.

A 500,000-ohm resistor is used in the grid circuit of the 2A3. This is the maximum permissible value according to tube manufacturers' specifications.

A voltage amplifier is needed to bring the input signal up to 45 volts peak. The 6SJ7 was selected from several tubes that will deliver this voltage because its high plate resistance and transconductance permit the use of a low plate coupling resistor and therefore its output is substantially level up to 20,000 cycles.

The high frequencies drop to 90% of mid-band level when shunting reactance (Xcs) is twice the equivalent resistance (Req) formed by plate, plate coupling, and grid resistors in parallel. Specifications permit the signal to drop to 89.13%. The 90% condition is within this limit, so we use its values to compute the value of the coupling resistor for the 6SJ7.

The shunting capacitance is the sum of the output capacitance of the 6SJ7, the input capacitance of the 2A3, and stray wiring capacitance. The output capacitance of the 6SJ7 is 7 μ f; the input capacitance of the 2A3 is $Cgc + (G + 1)Cgp$, where Cgc is grid-to-cathode capacitance (7.5 μ f), Cgp is grid-to-plate capacitance (16.5 μ f), and G is stage gain of the 2A3 (2.93 in this circuit). Assuming 10- μ f stray capacitance, the total shunting capacitance is 89.34 or 90 μ f. At 20,000 cycles, the reactance of 90 μ f is 88,495 ohms.

(Continued on page 56)

Push-Button Signal Generator

This European test oscillator circuit contains some ideas which have not been seen in American equipment

By ALFRED HAAS*

DESIGNED especially for outside servicing, this small 2-tube test oscillator is push-button operated, and the output is continuously variable in three steps. The frequency range is in four bands: 100 to 300 kc, 400 to 550 kc, 500 to 1600 kc, and from 6 to 18 mc.

The tubes are a 6K8 triode-hexode and a 12A7 diode-pentode. The diode section of the 12A7 serves as a half-wave rectifier for the B-plus voltage. The power transformer should be able to supply approximately 125 volts at 25 ma and 12.6 volts at 0.6 amp for the filaments. The heater of the 6K8 is connected across half the filament winding, or a 12K8 may be used and both tubes connected in parallel. Fig. 1 shows the circuit of the oscillator.

A 6-button d.p.d.t. push-button switch assembly is used for the band selector and control unit. The type of output is selected by pressing various button combinations as shown in Table I. Pressing No. 1 cuts off the audio, and pressing Nos. 1 and 6 together turns off the entire generator.

Output	Press
Modulated r.f.	2, 3, 4, or 5
Unmodulated r.f.	1 and 2, 3, 4, or 5
a.f.	6
off	1 and 6

The attenuator is a 500-ohm potentiometer and an L-network, providing three 40-db attenuation steps. The three taps are soldered to the output jacks which are insulated from the panel by ceramic washers. Since about 100 millivolts of r.f. is available, the outputs from the

jacks are 10 μ v, 1 mv, and 100 mv. The a.f. output is about 5 volts, so the outputs from the jacks are 500 μ v, 50 mv, and 5 v. The potentiometer permits continuous variation of output voltage in each range.

A neon bulb is connected across the filtered high-voltage supply to show the condition of the rectifier. It will start to glow about a half-minute after the generator is turned on. It is placed in a hole in the panel, so that no pilot lamp is necessary. A 50,000-ohm resistor in series with the neon bulb limits the current to a safe value. The 50-ma pilot bulb in the high-voltage lead acts as a

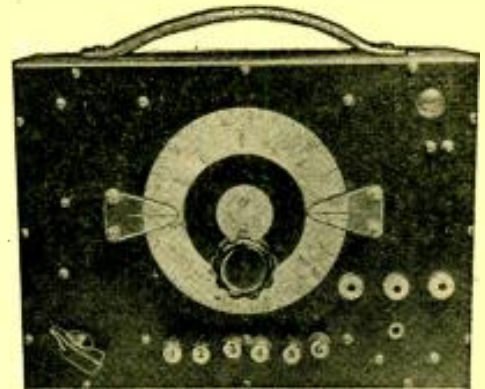

other one adjusted till the voltage across the 50,000 ohms is about 3, checked with a vacuum-tube voltmeter. This gives 50-60% modulation. An ordinary a.c. rectifier-type voltmeter may be used to read the total voltage, and the resistors proportioned to give the proper voltage drop.

The audio wave form may be checked on an oscilloscope if one is available, or by a vacuum-tube voltmeter across the a.f. transformer secondary. As the value

Push	L1	L2
5	100-300 kc, 480 turns, No. 36 d.s.c.	26 turns, No. 36 d.s.c.
4	400-550 kc, 78 turns, No. 36 d.s.c.	6 turns, No. 36 d.s.c.
3	550-1600 kc, 62 turns, No. 36 d.s.c.	5 turns, No. 36 d.s.c.
2	6-18 mc, 8 turns, No. 22 enamel	3 turns, No. 32 d.s.c.

fuse if the 12A7 rectifier current rises to much more than the maximum safe value of 30 ma.

The 6K8 is used as a plate-tuned oscillator, electron-coupled buffer amplifier, and mixer. The frequency is not affected by loading, and drift is negligible.

The pentode section of the 12A7 is connected as a Hartley-type audio oscillator with the screen grid tied to the plate. Inverse feedback provided by the unbypassed cathode resistor improves the wave form. The condenser across the primary of the audio transformer should be between .02 and .05 μ f for a 400-cycle note.

The a.f. voltage applied to the grid of the 6K8 is adjusted by the voltage divider across the secondary of the audio transformer. Two resistors are used, one of 50,000-ohm resistance, and the

of the cathode resistor is increased, the a.f. output voltage will also increase until a further increase of resistance causes a decrease in output voltage. Beyond this point, the output has a good wave form. The value of the cathode resistor should be slightly greater than the one corresponding to the peak reading.

No chassis is used for the oscillator, and all parts are mounted on the panel

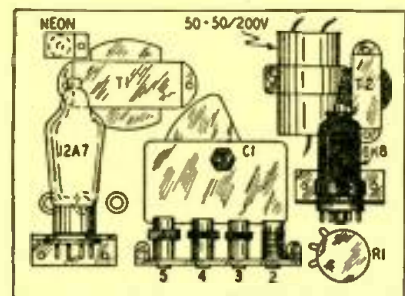

Fig. 2—Rear view, showing panel mounting.

(Fig. 2). The tubes are mounted on brackets made of 1/16-inch aluminum. The push-button assembly below the tuning condenser serves as a mounting base for the r.f. coils. This method insures extremely short leads between connections. The panel is made of 3/8-inch aluminum to give plenty of stiffness to the assembly, and the whole unit is enclosed in a metal cabinet for shielding.

The coils are wound on 1/2-inch forms with adjustable powdered-iron cores (Continued on page 60)

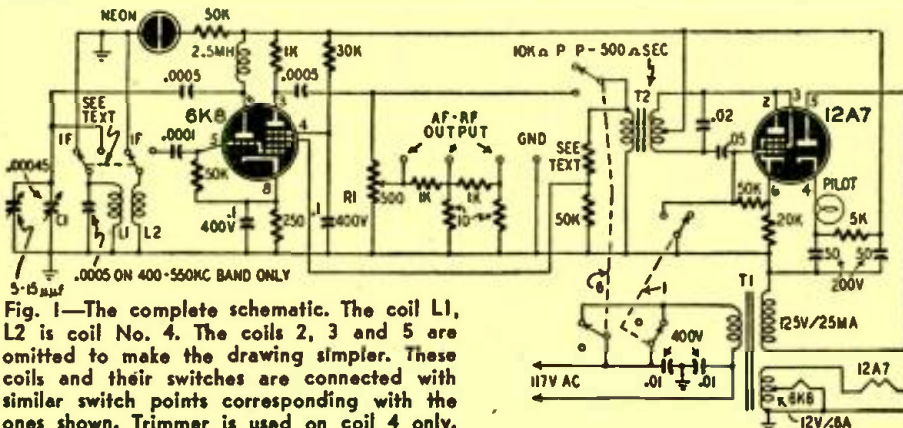

Fig. 1—The complete schematic. The coil L1, L2 is coil No. 4. The coils 2, 3 and 5 are omitted to make the drawing simpler. These coils and their switches are connected with similar switch points corresponding with the ones shown. Trimmer is used on coil 4 only.

Transatlantic News

By Major Ralph W. Hallows

RADIO-CRAFT EUROPEAN CORRESPONDENT



CURIOSLY television is making little appeal so far to Jacques Dubois, the French equivalent of John

Smith. There has been a regular television service in the Paris area for some little time, and not too bad a service either. Program times are: 1150-1205 (daily, except Saturdays and Sundays); 1600-1730 (daily, except Saturdays and every other Sunday); 2000-2130 (Tuesdays and Fridays). Times are GMT. Vision goes out on 46 mc with a peak carrier power of 30 kw, and sound on 42 mc with 5 kw behind it. Have any of you v.h.f. dx-ers picked up the audio part? I'd be rather surprised if you haven't, for v.h.f. is spanning enormous distances just now—a point to which I'll return later. The vision system is 455 lines per frame and 25 frames per second, so it will not suit American standard televisers. Either 25 frames per second or 50 frames interlaced are likely to be the standards of European countries for the frequency of their a.c. main supply is 50 cycles per second.

I don't know of any ready-for-service French televiser on the market. Certainly I have not seen one advertised in any French radio magazine. One sees a few kits of parts advertised, and there's an occasional article on how to build a televiser. But that's just about all. I believe that a few cathode-ray tubes with bigger screens than 2 to 4 inches are produced in France. The cost of the larger ones is prohibitively high. That may well be the reason why there are so few viewers of the programs of *Télévision Française*, the concern responsible for the present service.

Two novel circuits

Some of the new developments in broadcast receivers are a bit hard to evaluate. The technical value of some of them may be secondary to their advertising value. However, some of these "talking points" have real interest to the radioman.

The Bush *Bifocal Listening* is a variation of our old friend the local-distant switch. An arrangement for changing the i.f. bandwidth from 8-9 kc (distant stations) to about 12 kc (local) is linked to the volume control. On a loud local transmission the volume control is turned down and the greater bandwidth comes in. The phrase "bifocal listening"

was coined by Christopher Stone: "Just as my bifocal glasses enable me to see clearly at long or short distances, so my Bifocal radio gives me good listening on near or distant stations."

The Kolster-Brandes "bridge positive-negative feedback" links the feedback control and the volume control—rather, makes them one and the same thing. The output transformer is said to have a third winding, tapped and grounded at its center and connected across the volume control, as shown in the sketch.

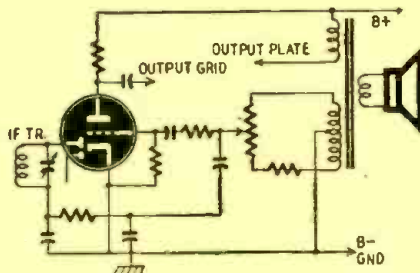

Bridge-positive feedback, approximate circuit.

Audio voltages from the transformer aid or buck those from the diode, according to the position of the control. When it is on dead center, there is no feedback. By moving it in either direction, positive or negative feedback may be applied. I can't, I'm afraid, give constants, as none have as yet been published and firms are, as a rule, rather sticky about releasing them. But the circuit doesn't look as if any values would be very critical. Experimenters may find it interesting.

The drawback is, of course, that as the sensitivity is increased on distant stations, distortion is automatically made worse. However, where great volume is required, as for dancing, extreme quality is not demanded, and where plenty of negative feedback is applied for high fidelity, the volume needed is as a rule not great.

And in Russia

The Russians are taking television very seriously. The technical development and the program services are, of course, both official matters there; so there can't be much doubt that television will be popular. If the authorities decide that television is good for the soul of Ivan Ivanovitch, he'll have to be keen on it, whether he likes it or not! An article in the Soviet magazine *Radio* gives an account of the expansion contemplated between now and 1950. In addition to the stations which have been working for some time in Leningrad and Moscow, new transmitters of moderately high power are to come into action at Kiev and Sverdbovsk. But that is a long way from being all. Assuming that a field-

strength of 1 millivolt per meter is required for good reception, it's calculated that the following service areas are obtainable from small transmitters with antenna systems 50-60 meters in height.

Transmitter output (watts)	Radius of service area (miles)
80	5
200	6.25
500	7.8
800	8.4
2,000	10.3

It must be remembered that in most parts of the U.S.S.R. there is comparatively little man-made static to cause interference with v.h.f. transmissions.

Now, here comes a very interesting idea. It is suggested, not only that transmitters rated up to 1,000 watts can be made from standard components by amateurs, but that they *should* be made all over the country. These stations (which can use air-cooled transmitting tubes) won't be owned or used privately. They'll be built and brought into action, in small towns, by the cooperative effort of local fans and will then be handed over to the municipal authorities to supply the television entertainment of the townsfolk.

That strikes me as a magnificent idea for getting a nation-wide television service going in the quickest possible time in a vast country which contains innumerable small towns and villages. The big snag seems to be not the technical, but the entertainment side. There's no provision for long-distance hookups; hence the programs must, presumably, be of local origin. My own feeling is that I'd pay quite a bit to be spared nightly entertainments by *my* local citizenry!

Long-range V.H.F.

I often think that the writers of radio textbooks published twenty or more years ago must feel like taking running jumps into the nearest and deepest lake when they re-read some of the statements that they once made in cold, hard print. You'll find it was stated in the 1920's that frequencies above 3 megacycles were unlikely ever to be of any great value for long-distance communications. More recent writers state categorically that the range of transmissions on frequencies above 30 mc cannot be much beyond the visual horizon. It has, in fact, often been declared that with v.h.f. transmissions there is no usable ground wave and no usable sky wave, the only serviceable kind of propagation being the direct wave.

Things move so rapidly in radio today that you hardly know where you are sometimes. If ever I write another radio

(Continued on page 70)

A GREAT **TRANSVISION** FIRST!

**NEW . . . Sensational TRANSVISION Development now offers
LARGE-IMAGE DIRECT-VIEW TELEVISION at low cost!**

BIGGEST VALUE in TELEVISION!

Model 10BL TELEVISION KIT with FM Radio
. . . Features Beautiful CABINET with BUILT-IN
LENS . . . Gives LARGE 120 Sq. In. Picture.

Roto-picture effect: Picture "rotates", giving the appearance of being in focus and clearly visible from every angle! Uses 10" Electromagnetic Direct-view Picture Tube.

Features new-type cabinet with built-in lens which magnifies, clarifies and heightens contrast of the picture. The lens also creates the effect of apparent rotation of the picture, so that when the observer moves, the picture still seems to be in focus and clearly visible from any angle.

ECONOMICAL KIT, EASY TO ASSEMBLE.

In point of value, this Television Kit provides the opportunity of acquiring a LARGE-IMAGE direct-view television set at a **VERY LOW PRICE**; also very economical from a tube replacement angle. This model is available in **KIT FORM**, for easy assembly; no technical knowledge required. Simple step-by-step instructions are included. *Saves as much as 50% over the cost of receivers with similar picture magnitude.*

TECHNICAL DATA: Model 10BL uses a 10" Electro-magnetic Direct-view Picture Tube; has complete F.M. Radio which comes completely factory-wired; receives all channels in any area; supplied complete with antenna and lead-in wire. The LENS is 15" x 11", giving a picture size of approx. 10" x 12" or 120 sq. in.; the highly-styled cabinet measures 26" wide x 17" high x 19" deep, available in Mahogany, Walnut or Blonde finishes.

PRICES: Transvision **MODEL 10BL** Television Kit, with FM, 10" tube, cabinet with built-in lens, antenna, 60 ft. lead-in wire **List \$359.00**
MODEL 12BL, same as 10BL except that it uses 12" tube, giving picture area of 130 sq. in. **List \$389.00**

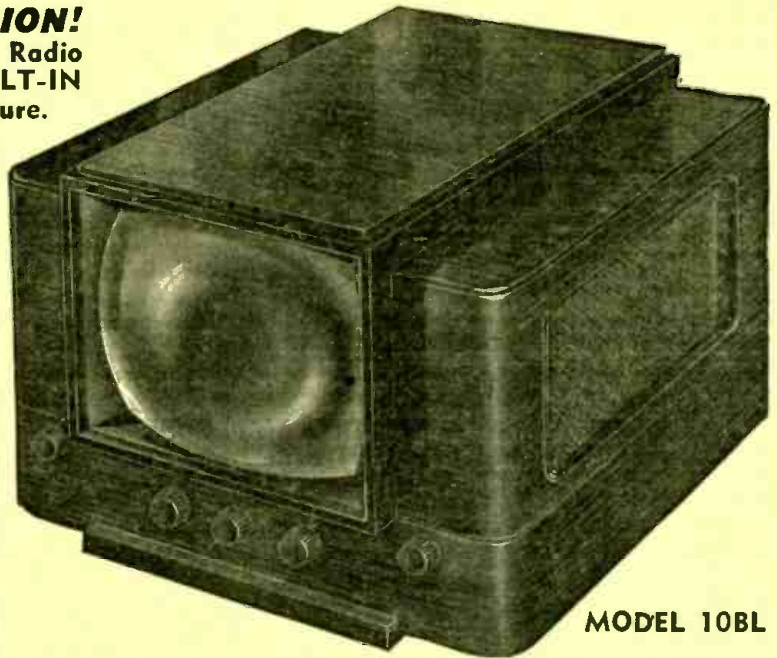

MODEL 10BL

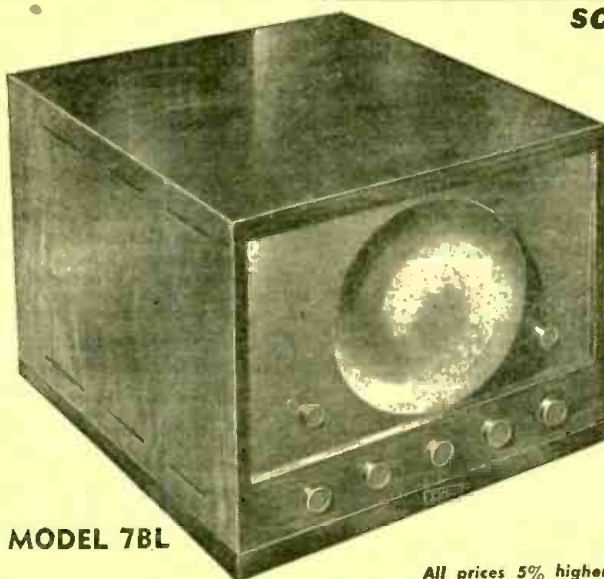

MODEL 7BL

SCOOP! New revolutionary **MODEL 7BL** Television Kit with specially designed **CABINET with BUILT-IN LENS.**

- Uses 7" Electrostatic Picture Tube
- Gives 50 square inch picture of superior quality

FEATURES: Though it has a 7" tube, the effect is equivalent to a 10" set because the built-in lens magnifies the picture. Also picture performance is superior because the lens clarifies and heightens contrast of the image. Picture "rotates" apparently, as the observer moves, giving the effect of always facing the observer. This is effective to a very wide angle. Pre-tuned for 5 channels.

PRICE: including cabinet with built-in lens, antenna, 60 ft. of lead-in wire **Net \$189.00**

TRANSVISION "SERVICE NOTES"

The Key to Successful Television Servicing

Transvision's "Service Notes" is a compilation of confidential Television Notes and Information, the product of experience with over 20,000 television receivers, now made available to the public. The "Service Notes" is a most valuable compilation of instructions and data on Magnetic and Electrostatic Television Receivers. Though compiled in the course of servicing Transvision Kits, the information is applicable to any type of television receiver. "SERVICE NOTES" is complete with photographs and diagrams. The information is worth a small fortune. The cost is low. **LIST \$2.95**



All prices 5% higher west of Mississippi; all prices fair traded.

For further information see your distributor, or write to:

TRANSVISION INC., Dept. RC, NEW ROCHELLE, N.Y.

See **TRANSVISION** at the **PARTS SHOW**: There will be a **SPECIAL TRANSVISION EXHIBIT** from May 10th through the 14th at the **SHERMAN HOTEL** (Chicago) in the **GOVERNOR'S SUITE!** Be sure to see the interesting new Transvision Developments in Television and F.M.

NEW

RADIO-ELECTRONIC DEVICES

TV BEAM-BENDER

Clarostat Manufacturing Co.
Brooklyn, N. Y.

The Beam-Bender is used with television cathode-ray tubes that require an external means of controlling loose ions. This permanent-magnet type is entirely self-contained and can be attached without tools, which also means elimination of the breakage hazard.



The unit consists of two ring magnets held in a nonmagnetic mounting collar. The magnets provide magnetic flux proportional to the required beam-bending function in the tube. The forward magnet, indicated by the arrow stamped on the mounting collar, is adjustable.

The assembly is slipped over the base of the tube and onto the right position on the neck. Three spring fingers provide an adjustable frictional fit.

Since there is no rubber or organic material in this assembly, there is no danger of the mounting adhering to the glass neck of the tube.—RADIO-CRAFT

MODERNIZATION UNIT

Radio City Products
New York, N. Y.

The models 120 and 125 are complete modernization units, designed to bring up-to-date many tube testers that have become obsolete.

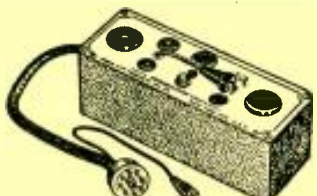

Each of these units has a flexible cable with a plug that is inserted into the local socket of the old tube tester. The new tubes are then tested in the sockets provided in the units. Sockets are included for the new miniature and subminiature tubes. Extra blank sockets and spaces are provided for additional new sockets, should new types of tube bases be brought out in the future. Tube-testing charts and data are supplied with the unit.—RADIO-CRAFT

V. T. VOLT-OHMMETER

Electronic Manufacturing Co.
Harrisburg, Pa.

The Model 110 vacuum-tube voltmeter is designed for servicing television receivers. The d.c. ranges are



0-3, 30, 150, 300, 600, 3,000, and 15,000 volts. On a.c. the ranges are 0-3, 30, 150, and 300 volts. The a.c. range is accurate up to 300 mc.

The entire unit is fungus-proofed to maintain stability over a long period of time.—RADIO-CRAFT

A.C. POWER PLANT

D. W. Onan & Sons, Inc.
Minneapolis, Minn.

A 3,500-watt, 50-60 cycle a.c. electric plant weighing approximately 54 pounds per kilowatt as Model 3CK-1R is one of a group employing the Onan "CK" air-cooled, 4-cycle, 2-cylinder gasoline engine as a prime mover.

The 3CK-1R has electric push-button starting, in the form of a special winding on the plant's generator which serves as the cranking motor during the starting cycle. A 12-volt automotive-type battery furnishes the starting power.



The air-cooled engine has a removable cast-aluminum engine hood to protect it from dust and water.

The new plants will produce about one-kilowatt hour of electricity per quart of gasoline.—RADIO-CRAFT

AUDIO AMPLIFIER

Newcomb Audio Products Co.
Hollywood, California

The Model E-10 amplifier uses push-pull 6V6 tubes in a multistage inverse feedback circuit. Power output is 10 watts at less than 5% distortion. The frequency response is from 50 to 10,000 cycles within 2 db.

Two inputs are provided: 2 megohms for a microphone, and 1/2 megohm for a phono pickup. The tone control is of the treble-attenuation type.

The unit consumes 60 watts and weighs 10 1/2 pounds. Its over-all dimensions are 5 3/4 x 10 3/4 x 6 1/2 inches.—RADIO-CRAFT



WELDED CHASSIS

E. F. Johnson Mfg. Co.
Waseca, Minn.

The new line of E. F. Johnson chassis has no overlaps at the corners. This new feature permits the locating of holes all the way to the corners. Volume controls, toggle switches, etc., can be mounted flush inside the chassis because of the single thickness feature. Rigidity and durability are assured by welded tie bars on the inside of the turned under bottom edge where they do not interfere with the mounting of components. Bottom plates may be fastened to the reinforced edges.—RADIO-CRAFT



STEP-DOWN TRANSFORMERS

Standard Electrical Products Co.
Dayton, Ohio

Staco step-down transformers permit operation of standard 115-volt, 50-60 cycle radios and other equipment from a 200-240-volt supply.

The transformers are built of high-quality silicon steel for cool operation. Coils are layer-wound and varnish-

impregnated. Each is tested at ten times its rated voltage and at three times the operating frequency.



The units are supplied with a 6-foot line cord and plug and a receptacle. Various sizes are available from 75 to 2000 watts.—RADIO-CRAFT

FM ADAPTER

Schuh's Radio Parts
Chicago, Illinois

This new FM adapter can be installed on any AM receiver to adapt it to narrow-band FM reception.



The unit is available in two models, 455 to 465 kc and 915 kc for use with BC-348 surplus receivers. The two tubes are a 6AK5 limiter and 6AL5 discriminator.—RADIO-CRAFT

TAPE RECORDER

Amplifier Corporation of America
New York, N. Y.

Model TP-800-C is one of a new series of portable tape recorders. It will record and play back frequencies up to 12,500 cycles, with less than 3% distortion. In addition, it contains an instantaneous start-stop clutch.

This model, and others in this series, can be adapted to automobile operation by means of a 6-volt d.c. inverter. They can operate in any position—even upside down.

The recorders are packed in two carrying cases.—RADIO-CRAFT

END-LINK COIL

Pittsburgh Coil Co.
Carnegie, Pa.

This adjustable end-link coil is designed to operate efficiently in a variety of circuits and with beam-power tubes. Moving the end link by hand varies the coupling to the rest of the coil. It can be substituted for standard fixed end-link coils if desired.

This coil is available in 75-, 150-, 250-, and 500-watt sizes.—RADIO-CRAFT

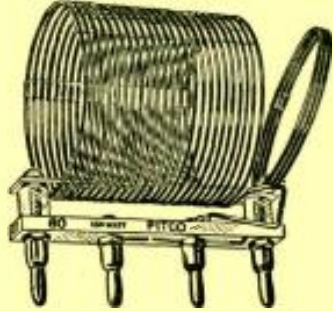

CONTACT MICROPHONE

Electro-Voice, Inc.
Buchanan, Mich.

Contact microphone Model 805 is designed for stringed instruments.

Frequency response of the pickup is 40 to 8,000 cycles. The output level is from 0.1 to 1 volt, depending upon the type of instrument. An inertia-type crystal, sealed against moisture and acoustic feed-back, is the generating element of the unit.

The microphone is 2 1/4 x 1 x 7/8 inches and weighs 2 ounces. It comes complete with a clip for attaching it to the instrument, and a 15-foot shielded cloth-covered cable.—RADIO-CRAFT

H.V. POWER SUPPLIES

Condenser Products Co.
Chicago, Illinois

The HiVolt PS-1 and PS-2 are hermetically sealed low-current power supplies for transforming 117 volts a.c. to 2,400 volts d.c. The PS-1 is designed to charge capacitors for use in electronic photoflash equipment. The PS-2 is intended for use in oscilloscopes and television receivers.

The supplies measure 3 3/4 x 3 3/16 x 5 1/2 inches and weigh 2 1/4 pounds. Humidity has no effect on the components.—RADIO-CRAFT



V. T. VOLTMETER

Electronic Instrument Co.
Brooklyn, N. Y.

The Eico Model 221 is a wide-range completely electronic vacuum-tube voltmeter and ohmmeter.

The a.c. and d.c. ranges are 0.5, 0-10, 0-100, 0-500, and 0-1,000 volts. The ohmmeter measures from 0.2 ohm to 1,000 megohms in five ranges. A wide-range decibel scale is included.

Accuracy is 2% on all ranges, and stability is such that zero drift is practically eliminated after a short warm-up period.—RADIO-CRAFT



MIDGET TRACER

Radex Corporation
Chicago, Illinois

The Pocketracer is a pocket-size signal generator that produces r.f. and a.f. signals simultaneously. The instrument is battery-operated and consumes only 150 ma from a 1 1/2-volt battery.

The unit is 5/8 inches long and 3/8 inch in diameter. The signal range is several inches.—RADIO-CRAFT



PHOTOELECTRIC CELL

American Scientific Company
New York, N. Y.

The Iris is a self-generating barrier-layer photoelectric cell capable of several hundred microamperes output, depending upon the intensity of the light.

It is a compact unit, firmly mounted on a piece of transparent plastic and is approximately 1 1/2 inches square. Two holes are provided for mounting.—RADIO-CRAFT

McMurdo
SILVER

Announces the NEW 900A VOMAX



Net Price
\$68.50

CONTINUOUS RESEARCH, study of thousands of cases of actual field experience now enable us to offer you the new 900A "VOMAX". Revolutionary as was the original, the new 900A forges far ahead in simplicity, dependability all-around *usability*.

Just 34 months ago McMURDO Silver Co. announced "VOMAX"—the first truly stable, ultra-high input resistance v.t.v.m. Lifting the v.t.v.m. out of the limited laboratory-application class, Silver engineering and use-experience made "VOMAX" the first *universal* v.t.v.m. Its acceptance was instant and overwhelming — for "VOMAX" will measure, at input resistance so astronomically high as not to "load down" any circuit to which it may be connected — d.c. volts, a.c., a.f., i.f. and r.f. volts, d.c. milliamperes and amperes, resistance and db. — all over tremendous range and with laboratory accuracy. Used in scores and hundreds by such competent organizations as the National Bureau of Standards, the Navy, Army, F.C.C., C.A.A., Veterans Administration, G. E., Western Electric Co. Recommended by Bendix, "VOMAX" is consistently copied, never equalled — stands today as "standard of comparison" for the entire industry.

In announcing the new "VOMAX" we think you'll agree that we can feel just a bit proud of having again done the impossible to give you the world's finest *universal* Laboratory Caliber Electronic Test meter at only Net \$68.50.

FEATURES

- Non-breakable glass 7" meter completely protected behind panel.
- Single hand-convenient probe gets into tight places, banishes usual snarl of easily lost and broken test leads.
- Newer — and fewer — miniature u.h.f. tubes.
- 51 ranges at highest available a.c. and d.c. input resistance.
- Absolutely stable—one adjustment sets meter zero for all ranges.
- No grid current error. Exclusive to "VOMAX", this vital feature is carried to new heights in new 900A.
- 24 d.c. ranges at 51 and 126 megohms, constant input resistance. 0 thru 3, 7.5, 12, 30, 75, 120, 300, 750, 1200 and 3000 volts. Polarity reversing switch.
- 6 a.c./r.f. ranges, 20 μ thru 300 mc., 20 megohms input resistance shunted by 7 mmfd. 0 thru 3, 12, 30, 120, 300 and 1200 volts.
- 3 db. ranges.—10/+10, +10/+20 and +20/+50 db.
- 6 resistance ranges. 0 thru 2000, 20,000 and 200,000 ohms. 0 thru 2, 20 and 2000 megohms.
- 6 direct current ranges. 0 thru 1.2, 30, 120, 300, 1200 ma. and 12 amperes.
- True vacuum tube meter in all but current functions. No low-resistance, frequency-erroneous copper oxide rectifiers.

Every good jobber features the new "VOMAX", new *super-sensitive* 905A "SPARX" Signal Tracer, 910 Universal Test Speaker & 18 Watt Universal Output Transformer, 906 FM/AM Signal Generator, new 909 and 911 TV and FM Sweep Signal Generators, 904 Resistance/Capacitance Tester. All, Laboratory Caliber Electronic Test Instruments at a price you can afford.

OVER 37 YEARS OF RADIO ENGINEERING ACHIEVEMENT

McMurdo Silver Co., Inc.

EXECUTIVE OFFICES: 1240 MAIN ST., HARTFORD 3, CONN.
FACTORY OFFICE: 1249 MAIN ST., HARTFORD 3, CONN.

YOU'LL WANT THIS ON YOUR DOOR!

This five-color decal identifies you as the man Sylvania is talking about—in the big new national campaign now under full steam in *Life*, *The Saturday Evening Post*, *Collier's*, *Radio Best*.

Display this decal on your door, your windows, your truck—to hook your store up with Sylvania's nationwide advertising.

The decal is yours for the asking . . . in 8-inch or 12-inch size . . . in any quantity you want!



GET THIS DECAL IN 8-INCH OR 12-INCH SIZE

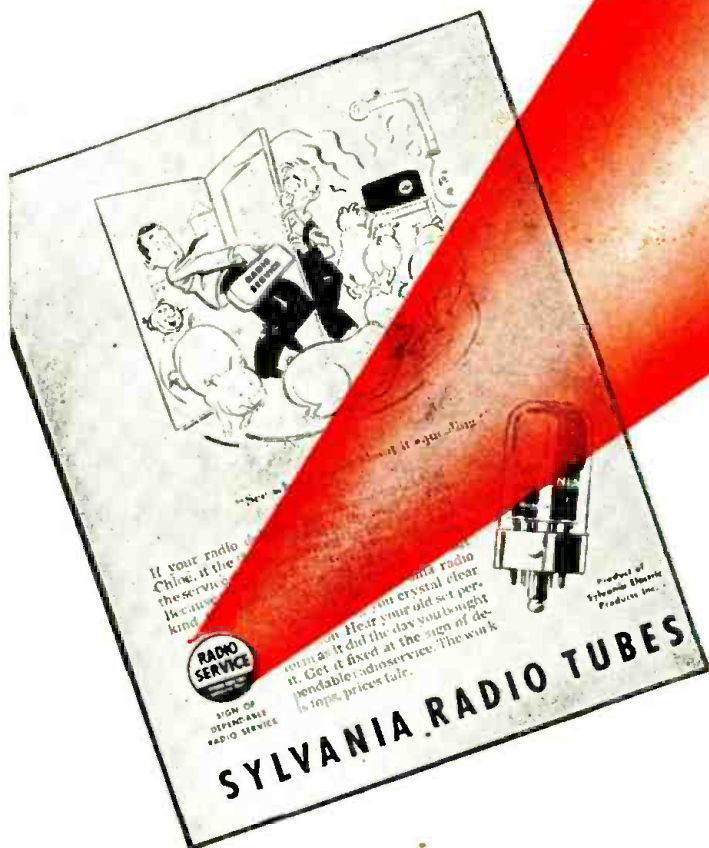

See for yourself how quickly this cartoon ad catches the eye. See how strongly it features the Radio Serviceman's decal—your decal!

In every Sylvania ad throughout 1948 . . . in four great, nationally-read magazines . . . your customers—and the people you want for customers—will see this decal over and over again. They'll look for it when their sets need servicing—be sure they see it on your store.

LOOK FOR THE JOBBER WHO DISPLAYS THIS COMPANION DECAL

He's the authorized Sylvania Distributor in your locality. He's ready to supply you with top-quality Sylvania Radio Tubes and Test Equipment, for the kind of servicing jobs that will keep your customers coming back to you.



SEND THIS COUPON

NOW FOR THIS **FREE**
SYLVANIA SERVICEMAN'S DECAL

SYLVANIA ELECTRIC

Radio Tube Division, Emporium, Pa.

MAKERS OF RADIO TUBES; CATHODE RAY TUBES; ELECTRONIC DEVICES; FLUORESCENT LAMPS, FIXTURES, WIRING DEVICES; ELECTRIC LIGHT BULBS

Sylvania Electric Products Inc.
Radio Tube Division
Advertising Dept., Room R-1305
Emporium, Pa.

Gentlemen:

Please send, free, the following quantities of the Sylvania Serviceman's decals:

..... 8-inch decals 12-inch decals

Name

Company

Address

City..... Zone #.....

State

Another Good Deal—From Mallory To You

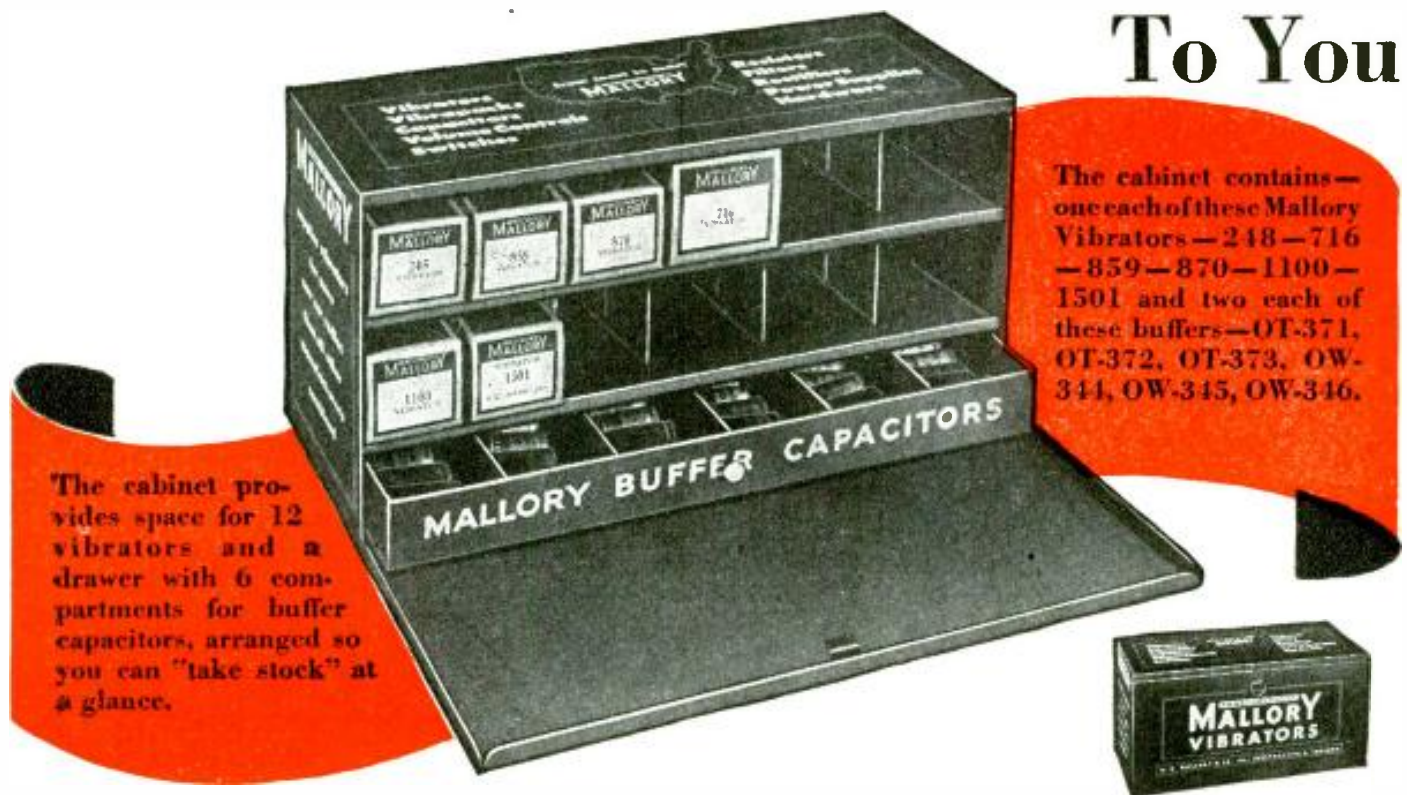

The Fastest Selling Vibrators in the Finest Line Made— The Mallory "2448 Vibrator Deal"

Mallory, first producer of the vibrator, builder of the sturdiest, most reliable vibrators made, offers you an attractive deal on this important replacement part. A fast moving selection of 6 vibrators, that will cover 75% of your requirements, together with an assortment of 12 buffer capacitors (2 each of 6 ratings), in an attractive metal cabinet at a net price of \$24.48 to the serviceman.

This is the serviceman's regular price for these parts; no charge is made for the cabinet. You sell the parts for \$40.80—make your full \$16.32 profit.

Your Mallory Distributor has them in stock for immediate delivery. Place your order now, and get this handsome, convenient cabinet for *your* shop.

More Mallory Vibrators are in Use Than All Other Makes Combined

WHAT WILL
MALLORY
DO NEXT?

See Us at
the Radio
Parts Show

P. R. MALLORY & CO. Inc.

MALLORY

CAPACITORS . . . CONTROLS . . . VIBRATORS . . .
SWITCHES . . . RESISTORS . . . RECTIFIERS . . .
VIBRAPACK® POWER SUPPLIES . . . FILTERS

APPROVED PRECISION PRODUCTS

P. R. MALLORY & CO., Inc., INDIANAPOLIS 6, INDIANA

BIG MONEY IN RADIO

SEE THESE BRAND NEW
RADIO BOOKS **FREE**

COYNE'S *New 5 Volume Set* "APPLIED PRACTICAL RADIO"



SEE SET
FREE
FOR
7 DAYS

JUST OFF THE PRESS!

You men who want to go places in Radio, and who know how much a solid working knowledge of the field helps to get the big money—this is IT! Over 1500 pages of down-to-earth Radio, from simplest principles to newest Television! It's all there easy to understand—how and why it works . . . how to construct, install, service. PA, short-wave, auto-radio, aviation, radio-phonographs, FM, testing instruments and trouble-shooting short-cuts, phototubes—you name it, COYNE'S got it, in "Applied Practical Radio"!

PRACTICAL! CLEAR! COMPLETE!

5 big volumes—1000 illustrations and diagrams, with step-by-step photographs which "break down" the equipment for you to show what makes it "tick". Up-to-the-minute, complete, easy to follow . . . written as only COYNE books are written!

GET THIS
BOOK
FREE
for LOOKING
AT SET



Brand New!
Explains circuits
of latest sets

VALUABLE BOOK FREE for Looking at 5-Volume Set

Send This Coupon
NOW

You must SEE these books to know how easy it is to prepare for the big jobs in radio. Here's our special offer:—we'll send the complete 5-volume set for your 7-Day FREE Examination. And with it, we'll include our valuable, new guide for all radiomen, "150 New Radio Diagrams Explained", absolutely FREE! If you keep the 5-volume Set all you pay is \$3.00 within 7 days after the books arrive and \$3.00 per month until \$16.75 is paid—or you can pay \$15.00 cash price. If you don't want the set, return it and you OWE NOTHING. But either way you keep the "150 Radio Diagrams Book" as a gift. That book is ABSOLUTELY FREE.

SEND NO MONEY REMEMBER: Coupon is not an order, just a request to see set free and get the FREE BOOK. But offer is limited, so act at once!

COYNE ELECTRICAL & RADIO SCHOOL (Founded 1899)
500 S. Paulina St., Dept. 58-T1, Chicago 12, Ill.

EDUCATIONAL BOOK PUBLISHING DIVISION
COYNE ELECTRICAL & RADIO SCHOOL
Dept. 58-T1, 500 S. Paulina St., Chicago 12, Ill.

O. K., send me immediately your new 5-volume set, "Applied Practical Radio" on 7 days free trial offer in Radio Craft. Be sure to include as a gift the book of 150 New Radio Diagrams Explained, absolutely FREE.

NAME AGE
ADDRESS
TOWN ZONE STATE

FREE BOOK

Technotes

. . . . PHILCO AUTO RADIOS

If the new models suddenly go dead, take a look at the i.f. transformers. Midget i.f. transformers are used in the models CR-4 and CR-6. There is very little clearance between the lugs and the can. If great care is not used when soldering leads to the lugs, solder will run down the lug and short to the can. On several sets I have found the plate or B-plus lugs shorted to the chassis.

HAROLD L. BLISS,
Francesville, Ind.

. . . . OSCILLATOR FAILURE

Some sets play perfectly in the shop yet suffer oscillator failure when the set is returned to the owner's home. To prevent this, I have a Variac and a.c. voltmeter in the line and lower the operating voltage on the set until the oscillator fails. If the set is a 3-way portable or a.c.-d.c. model, the oscillator will probably cut out between 80 and 90 volts input. If it cuts out above 90 volts, with normal B-voltages, try replacing the oscillator tube. If this does not cure the trouble, check the components in the oscillator circuit.

JOHN B. MOORE,
Lebanon, Tenn.

. . . . GROUNDING A.C.-D.C. EQUIPMENT

A.c.-d.c. apparatus may be operated safely when attached to ground if *only one wire* is plugged into the line. A good

ground is attached to the equipment and *only one terminal of the line cord* attached to the plug. (If the line cord is of the resistor type, the terminal with the resistor must be the one attached.) The plug is then inserted in the socket. If it is plugged in correctly, the equipment will operate. If the connection is wrong, no damage will be done, and the tubes will simply fail to light.

It is sometimes convenient to attach equipment to earth, and at other times there is danger of accidental grounding. This kink is useful in either case.

ERIC LESLIE,
New York, N. Y.

(This circuit will not work if the equipment has a negative return isolated from the chassis.—*Editor*)

. . . . ECHOPHONE EC-1 AND EC-1A

If the pilot lamp burns brightly and then burns out, look for a shorted bypass condenser at the plate of the 35L6. Replacement with a 600-volt unit prevents future breakdowns of this sort.

RICHARD LYTWYN,
Detroit, Mich.

. . . . INTERMITTENT COILS

Automobile sets and others sometimes develop intermittent noise from corrosion in the i.f., oscillator and r.f. coils caused by dampness. If the coils are in a plate circuit, shorting the plate to

ground through a 2,500-ohm resistor will draw enough current through the coil to open it permanently.

B. BUEHRLE, JR.
Ferguson, Mo.

. . . . BATTERY RADIOS

When the complaint is distortion in the audio section of farm or portable radios with 1.4-volt tubes, replace the output tube.

This should be tried even when the tube and all components check good. This trouble is very common in sets with 3Q5's.

JOHN MEDNANSKY,
Belle Fourche, S. D.

. . . . FIRESTONE 4-A-30

If the complaint is very poor volume, look for an open screen resistor to the 6SJ7 first audio tube. Poor volume with serious distortion is often caused by the 6K6 cathode resistor changing in value. Replace with a 450-ohm, 10-watt, wire-wound unit. Reception with push-button tuning only may be due to a shorted .01- μ f condenser from the screen of the 6SA7 to ground. Replace with a 600-volt condenser to prevent future trouble.

If the dial turns hard, look for misalignment in the guide pulley on the side of the chassis. Bending it back into alignment will remove the stiffness.

JOHN R. SIMPSON,
Gainesville, Fla.

A MUST FOR FM & TELEVISION SERVICE SHOPS!

*Now... AT A
SENSATIONALLY
LOW PRICE!
ECA QUALITY
FM & TELEVISION
Sweep Signal
GENERATOR
\$34⁹⁵
COMPLETE*

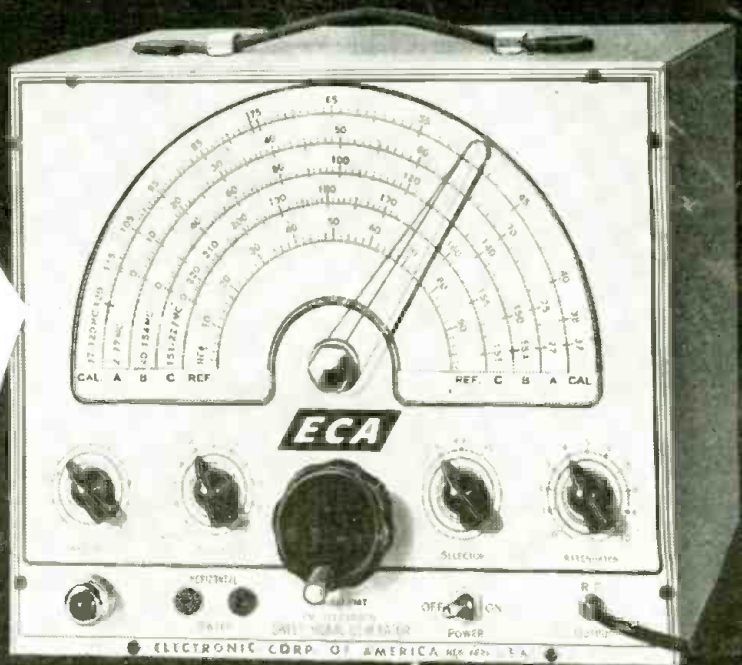

Here's great news for FM and TV Service Shops! A new, top quality sweep signal generator—product of a manufacturer with vast resources, advanced engineering "know-how", and wartime experience in producing test equipment—now available, **DIRECT FROM THE FACTORY**—at a phenomenally low price!

FRONT PANEL CONTROLS

- A — Sweep width 500 KC to approx. 10 MC
- B — Phasing control
- C — Tuning vernier control 10 to 1 ratio
- D — Selecto switch FM — RF — CAL
- E — RF Output control
- F — 60 cycle horizontal sweep output
- G — Amphenol RF output shielded connector

FREQUENCY RANGE 3 BANDS
(No band switching necessary)
(2 to 227 Megacycles)

- A — 2 — 77 MC
- B — 40 — 154 MC
- C — 151 — 227 MC
- D — Calibration and reference scales
- E — Dial scale length

TUBE LINEUP

- A — 6C4 — Fixed frequency modulated oscillator
- B — 6C4 — Continuously variable beat frequency oscillator
- C — 6C4 — Mixer — Cathode follower output tube
- D — 5Y3 — Rectifier tube

GENERAL INFORMATION

- A — High frequency insulation throughout
- B — Maximum output 500,000 U/V
- C — Power required 105-125 Volt 50-60 AC 35 Watts
- D — Power line filter built in
- E — Special Midline capacity tuning condenser
- F — Pilot light line indicator
- G — Generator output can be used either frequency modulated or pure RF



AM SIGNAL GENERATOR

8 RF bands. Frequency coverage 100KC-75MC. External modulation from 40 to 30,000 cycles. Internal modulation at 440 cycles. Phase shift audio oscillator and internal modulator. A.C. 105 to 120 volts, 50 to 60 cycles. Special Hammarlund variable condenser; 3 step RF attenuator continuously variable RF-AF attenuator control. Ultra

Pilot light line indicator. Cathode follower output tube. Modulator percentage continuously variable from front panel, internal or external, 0 to 100%. Heavy 16-gauge steel cabinet. Complete with 4 (standard brand) tubes. Amphenol co-axial connecting cable, ground cable, operating instructions and guarantee. **\$32⁵⁰**

RADIATION LOOP AND ALIGNMENT WAND



Provides loose coupling. Checks loop-oscillator tracking. Increases efficiency of receiver's alignment or mistracking. Enables the service engineer to make gain measurements. Professional appearance and results. May be used on any signal generator. Complete with operating instructions. **\$5⁹⁵**

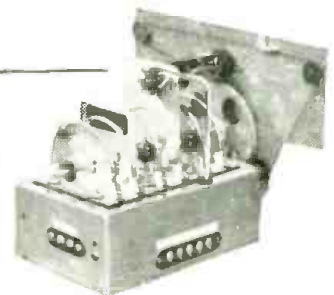

FM FRONTEND

Complete with 3 tubes, including Magic Eye. 88-108 MC. For use with 10.7 MC I.F.S., high Q resonant tuned lines. Heavy silver overlay on lines and contacters. High frequency insulation throughout I-RF stage, detector, and oscillator. Large 7" sliderule dial. Chassis floated, non-microphonic. **\$15⁹⁵**

BACKED BY ECA WITH R.M.A. GUARANTEE. WRITE FOR ECA CIRCULAR ON PARTS AND ADDITIONAL EQUIPMENT.

RUSH YOUR ORDER TODAY... TO INSURE PROMPT DELIVERY. ORDERS FILLED IN SEQUENCE AS RECEIVED. PRICES F.O.B., N. Y. C.

ELECTRONIC CORPORATION OF AMERICA

353 WEST 48th STREET • NEW YORK 19, N. Y. • PHONE: CIRCLE 6-1985 Cable Address: ECAEPLT



THE HOTTEST VALUES I HAVE EVER OFFERED

ROCK BOTTOM PRICES HIGHEST QUALITY

"ASTATIC" Quality CRYSTAL PICK-UP



This Low Price Actually Less Than The Replacement Cartridge Only \$1.75 each

MODEL D-9—Combining low cost with high performance standards. Ideal for manual record players. Used extensively for modern replacements. Mounting center adjustable to 6 1/2" or 7". Statuary Brown finish. Complete with 12" plain leads.
Model D-9 List price \$4.95
CL-407—Curved Arm Similar to above.

WRL MULTITESTER
REG. \$22.50
BIG SAVING \$14.95

Model MT 100
★ 30-60 DEGREE ANGLE
★ STAND IT UP OR LAY IT DOWN
RANGES—
DC Voltmeter—0-5-50-250-500 volts
DC Milliammeter—0-1-10-100 millia
AC Voltmeter—0-10-100-500-1000 volts.
Ohmmeter—Low range—0-500 ohms. High range—0-100,000-1 Meg-ohm.
METER
3 1/2" round bakelite case. Sturdy D'Arsonval movement.

ANTENNA & R.F. COILS
550-1500 KC
High gain type-high impedance primary—Bank lit wire wound.
ANTENNA COIL—Catalog No. V4600
R.F. TYPE—Catalog No. V64-501
OSCILLATOR COIL
Electron coupled 45-.465 KC each
Catalog No. 64-505

COMPACT AUDIO TRANSFORMER
3:1 ratio single plate to single grid. Max. P.I.T. current 10 ma. Many uses. Overall size 2" X 1 9/16" X 1 3/4". Mtg. cents 1-5/16" X 1 1/16".
Stock No. 9-396. Your cost 49c each.

UNIVERSAL OUTPUT TRANSFORMERS
Single or P.P. Plates to 2-15 ohm V. C. Pri. 2500 to 1300 ohms, 70 M.A., 8 watts, Mtg. Ctrs. 2 1/2".
Stock No. 9-382, your cost only 99c each.

AUDIO TRANSFORMERS
Interstage, types available immediately at real savings.
Sgl. P-P Grids, Impedance Pri-Sec. 3:1, Max. Pri. 10 ma., Mtg. Ctrs. 2", Stock No. 9-392, your cost 89c.

ICA — RADIART — RADELCO TOP QUALITY ANTENNAS

These high quality standard brand antennas are from our regular stock. We are simply making room for new merchandise. Don't delay—
When our present stock is depleted the price will be much higher—Your low price on any of the aerials below.
Only \$1.95
A Unimount underhood. Fits all Model Cars.
ICA "Traveller" 3 Section—20-85" Stock No. A-6801 \$1.95
A ICA "CLIPPER" 3 Section 23 1/2" to 72". Stock No. A-8802. \$1.95
A Radiart Underhood Mount 3 Sections 24 to 83". Stock No. C-383B1 \$1.95
A Popular Radiart Two Insulator Coil or Fender Mount 3 Section 24" to 63". Stock No. B-383A \$1.95
A Radelco DA-3-27 to 65". 3 Section Heavy Chrome finish Coil or fender mount. Stock No. C-DA-3 \$1.95
A Deluxe Radiart Adjustable angle. One No. Mount Fender Mount. 3 Section 24 to 63". Stock No. B-CP3-83 \$1.95

RESISTOR ASSORTMENT
100 Resistors

A useful assortment of economy-type carbon resistors. All are brand new and coded with standard RMA color code. Most popular resistance values in 1/2 watt sizes. Shpg. wt. 1 1/2 lbs.
Cat No. 7-29 98c

RESISTOR KIT—Outstanding value
100 assorted 1/2, 1 and 2 watt. Insulated Metalized I.R.C. Resistors.
Cat. No. 7-37 Each \$1.96
Kit—100 Micamold Mica Condensers Popular size bakelite mica capacitors. Unmarked, but all guaranteed perfect. High quality units at an unusual low price. Capacities range from .00005 mfd. to .0005 mfd.
Your Cost 98c

TRIMMER CONDENSER ASS'T.
20 Assorted Trimmers and Padders in regularly used capacities. All are mostly ceramic, standard type.
203—Your Cost 89c

BAKELITE KNOB KIT
50 Asst. bakelite knobs. Set screw type.
Stock No. 7-273 \$2.48

DYNAMIC SPEAKER
12" Electro Dynamic Reia speaker. Sturdily constructed. 8-8 Ohm voice coil 2500 Ohm Field.
Cat. No. 12-1131
Each \$4.95
In lots of 6, Each \$5.95

ALINCO 5" P.M. SPEAKER
Size Wt. (oz.) Price
3" 1 \$1.40
4" 1 1.45
5" 1 1.49
6" 1 1.79

O-1 Meter Value
0-1 D.C. millimeter 3 1/2" round bakelite case. The latest in meter design. Fine Foundation Unit. Hundreds of uses for this instrument. Complete with mounting hardware.
Stock No. 18-37
Your Cost \$3.95

TELEPHONE HANDSET
High quality unit. Magnetic phone approx. 1000 ohms impedance and single button microphone at 200 ohms. Convenient push to talk butterfly switch. Six foot heavy duty rubber covered cable with PL 69 plug.
Brand New Model H23U Your Cost \$3.95

Motor Starting Condenser Value
Aerovox oil filled condenser. 4mf. 440 volts AC. Working 600 volts. D.C. Working cylindrical container with 2 terminal lugs. Measures 4 1/2" high by 2 1/2" diameter. Fine for low power 2500's, amateur xmitters, motor starting, etc.
Cat. No. 18-849. 49c each.

SHURE T17B
Push Button Carbon Mike
98c
With Cord and Plug Value \$12.00

WORLD'S BEST RADIO BUY
WORLD'S BEST RADIO BUY
Check many other values in our 68 page catalog. Operates on ordinary house current. Clear tone—equipped with 1000 ohm. FREE TRIAL OFFER. If not completely satisfied after 15 days trial, return old money and we will refund 50% of your money. No way C.O.D. Weighs approximately 3 lbs.—shipped anywhere in U.S. through collect. We reserve the right to limit quantity.

Paper Tubular Condensers
BUY AT A FRACTION OF THEIR ORIGINAL COST

Standard Tubular By-Pass Condensers Waterproof, Long-Life, Phenolic wrapped and Phenolic end fill. Also double waterproof seal. Manufactured to same high specifications used in the famous V-Tube. Genuine lead non-inductive foil condensers. Unconditionally Guaranteed.

Cat. No.	Cap. Mfd.	500 Lots 400v	100 Lots 400v	Single Lots
27-837	.001	25.65	5.40	.06
27-838	.002	25.65	5.40	.06
27-839	.005	25.65	5.40	.06
27-840	.01	25.65	5.40	.06
27-841	.02	25.65	5.40	.06
27-842	.025	29.93	6.30	.07
27-843	.05	29.93	6.30	.07
27-844	.1	34.20	7.20	.08
27-845	.2	38.48	8.10	.09
		600V	6.30	.07
27-846	.002	29.93	6.30	.07
27-847	.0025	29.93	6.30	.07
27-848	.005	29.93	6.30	.07
27-849	.01	29.93	6.30	.07
27-850	.02	29.93	6.30	.07
		700V	6.30	.07
27-851	.0035	29.93	6.30	.07
27-852	.005	29.93	6.30	.07
27-853	.02	29.93	6.30	.07
		1000V	7.20	.08
27-854	.0025	34.20	7.20	.08
27-855	.0035	34.20	7.20	.08
27-856	.005	34.20	7.20	.08
27-857	.01	34.20	7.20	.08
		1200V	7.20	.08
27-858	.005	34.20	7.20	.08
		1400V	8.10	.09
27-859	.0025	39.43	8.10	.09
		1500V	8.10	.09
27-860	.0015	39.43	8.10	.09

On quantities of 100 or over condensers may be assorted in Lots of 25 to obtain maximum discount.

SMASH Values

ICA Univ. Line Cord	49c	
Hvy. Duty closed cir. Jack 11c		
7 1/2' App. Line cord & plug	19c	
Radio Noise eliminator	49c	
100' Stranded Aerial wire	29c	
Astatic xtal mike & std.	\$7.95	
Banana plug 8-32 thread	1 1/2"	5c
Banana plug 8-32 thread	1 1/2"	5c
Octal Mip Sockets	6c	
6-450 ohm dyn. speaker	\$1.49	
5-3000 ohm dyn. speaker	1.49	
1/2" pilot lite assembly	19c	
Horiz. Mount	19c	
Open type crystal detector kit	15c	
Neon lite 2 watt S-14	29c	
Edison base 1/2 watt pig tail leads, only	12c	
2 conductor rubber cable No. 22, per ft.	2 1/2c	
3 conductor rubber cable No. 22, per ft.	3 1/2c	
No. 14 Solid Cloth Cover wire, per ft.	1c	
No. 14 stranded cloth cover wire, per ft.	1 1/2c	
Heater Cord, per ft.	2c	
Hardware Ass't. spade, solder, lugs, 2 lbs.	99c	
Coil form grooved steatite 3" Dia. 5 1/2" Long. ea.	19c	
Antenna Loop, stranded replacement, each	39c	
VOLUME CONTROLS All shafts 1/2" Dia. 1/2" or Longer		
Cat. No.		
20-1263 5000 ohms, ea.	25c	
20-1261 100,000 ohms, ea.	25c	
20-1269 Dual 1 Meg., ea.	25c	
Potentiometer wire wound 4500 ohms 1/2" case.	39c	
Oil filled Condensers. Real buys. The types you fellows can use. Note: All condensers square cans except 600V type which is round inverted.		
4 mfd. 600V	59	
1 mfd. 1000V	79	
2 mfd. 1000V	1.19	
1 mfd. 1500V	.49	
1 mfd. 2000V	1.55	
.001-2500V mica	.69	
.002 8000V	.49	
TUBES All Tubes Brand New		
757L	\$2.49	
8005	3.95	
8005	4.95	
809	1.50	
807	1.35	
813	6.95	
811	1.95	
24G	.59	
814	4.50	
6AK5	.75	
815	2.25	
70% off list, all new Standard Brands		
6SH7	54c	
6AC7	54c	
6K6	40c	
6SN7GT	66c	
6SK7	45c	
12C8	79c	
12SG7	54c	
12H6	45c	
25Z5	40c	
6H6	45c	
6A6	66c	

FOR ALL ORDERS LESS THAN \$2.00 ADD 25c

Don't Delay—ORDER Today!

GET OUR 68 PAGE CATALOG FREE

World Radio Laboratories
INCORPORATED
Formerly Wholesale Radio Laboratories

49c CHOKE
Hermetic Seal Shielded 50 M.A., 100 ohm—Real Buy, only 49c. Case as Above size 2" X 2" X 3".

744 West Broadway - Council Bluffs, Iowa

TRY THIS ONE

TEST LEAD POLARITY

A bayonet plug attached to the ends of a pair of test leads makes it possible to switch them to different instruments without the need for observing polarity.

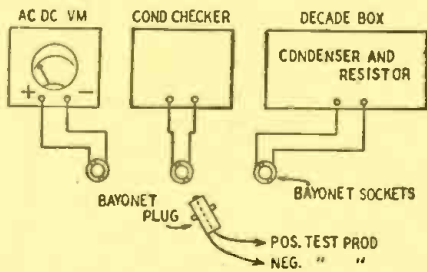

The negative lead is soldered to the shell of the plug and the positive lead attached to the center terminal. A bayonet socket is attached to each instrument. Inserting the plug into the socket makes the proper connection automatically.

JOHN J. MACGOWAN,
Minneapolis, Minn.

NOVEL BAND SWITCH

While constructing a two-band receiver, I used an idea for making the manual tuning control also serve as a band-switch control. The band switch was mounted at the rear of the chassis, its shaft directly in line with the tuning control shaft. The original tuning shaft was replaced with the blade of a Phillips-type screw driver, and the only other additions were a compression spring, a short Phillips-head screw, and two metal inserts salvaged from old knobs.

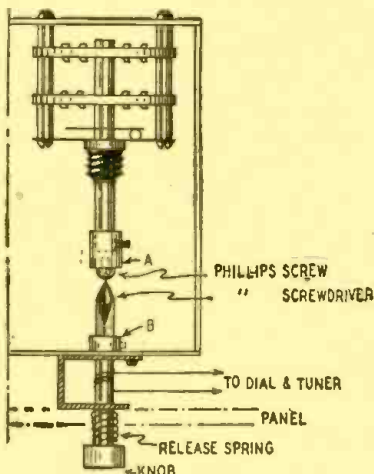

The screw was set in one end of insert A and soldered into place. The assembly was then attached to the band-switch shaft. The other insert B was then attached to the tuning shaft and placed to keep the driver point about 1/8 inch out-of-mesh with the screw.

To operate the switch it is necessary only to push the tuning knob in a bit and turn to the right or left. Upon release of pressure, the compression spring between knob and shaft bracket pulls the

screw-driver end out of mesh, and stations are tuned in normal way.

OLIVER HORNING,
Chicago, Ill.

WIRE STRIPPER

A metal photo clip makes a good wire stripper for hookup wire. Merely put the wire between the jaws of the clip, squeeze them together, and pull the wire out fully stripped.

This clip is also very handy for holding ends of wire together for soldering.

GEORGE WECHSLER,
Brooklyn, N. Y.

NON-SLIP LINE CORD

To anchor a thermoplastic-covered line cord simply and neatly inside the chassis, wind two or three layers of thin vinylite-covered wire onto the end of the line cord inside the set. With the flat side of a clean chisel-shaped soldering iron, heat the insulations of both the

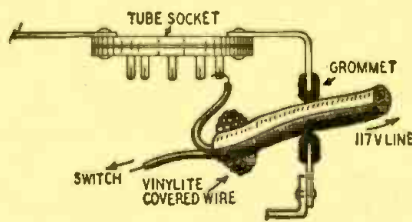

cord and wire till their surfaces merge. When the wires cool, a smooth resilient skin will cover the anchor knot.

LUDWIG FURTH,
London, England

ODD SIZE RESISTORS

When I cannot obtain an odd-size value of resistor, I make one as follows: Roughen the surface of a small strip of 1/32-inch sheet mica and paint a line with India ink down the length of each side. Wrap two turns of No. 24 wire around each end of the strip and hold them in place with a conducting cement to assure a good connection. (This cement is made of powdered graphite mixed with coil dope to form a medium paste.) After the cement dries, coat the entire unit with thinned coil dope.

One resistor made in this way measured 47 megohms. Other values can be obtained by varying the amount of ink used or the size of the mica strip.

CHARLES J. APPLGATE,
Champaign, Ill.

HEADPHONE REPAIR

When headphones become defective, almost always one of the coils is found to be open. This coil can be shorted out, allowing the current to pass through the other coil. The phones are less sensitive, but still usable till replacements can be obtained.

JOSEPH FIEDERER,
Worcester, N. Y.

ANTENNA SWITCHING

A simple doublet antenna is very effective for reducing noise on short-wave bands. However, an antenna of this type gives poor results on the broadcast band. To rectify this shortcoming, I used the arrangement shown, with good results. The switch is a 4-pole, 3-

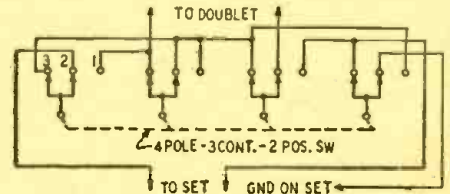

contact, 2-position type. Throwing it from the first position to the second converts the doublet to a T antenna and makes all the necessary changes in connections to the receiver.

OTTO WOOLEY,
Colorado Springs, Colo.

COIL WINDING TIP

It is usually hard to thread the end of a thin wire through the pin of a coil form. But if the wire is first threaded through the eye of an ordinary sewing needle, the needle then can be used to pass the wire through the hole in the pin.

RALPH WALTER,
Jersey City, N. J.

(The fine wire also might be soldered to the end of a heavier wire.—Editor)

DIAL CORD REPLACEMENT

When a dial cord is difficult to replace because of the position of the pulleys, a spoke from a bicycle wheel makes a good stringing guide. Use the head of the

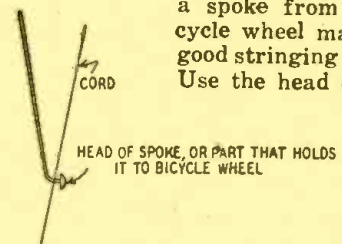

spoke to push or lift the cord over the pulleys that cannot ordinarily be reached.

GEORGE A. FELIX,
Valley Stream, N. Y.

FREQUENCY HALVING

It's easy to get on 80 meters even if you have only 40-meter crystals. Use a regenerative tetrode crystal oscillator, but plug an 80-meter coil into the socket of the plate tank circuit. The buffer and following stages should also use 80-meter coils. All the circuits are tuned to 80-meters, half the frequency of the 40-meter crystal.

Although tuning is somewhat critical, the stability is good and there are no chirps in the keying.

JOHN A. GLASS, W9SSW/Ø,
Bismarck, N. Dakota

MONEY BACK GUARANTEE — We believe units offered for sale by mail order should be sold only on a "Money-Back-If-Not-Satisfied" basis. We carefully check the design, calibration and value of all items advertised by us and unhesitatingly offer all merchandise subject to a return for credit or refund. You, the customer, are the sole judge as to value of the item or items you have purchased.

The Model 88-A COMBINATION **SIGNAL GENERATOR AND SIGNAL TRACER**

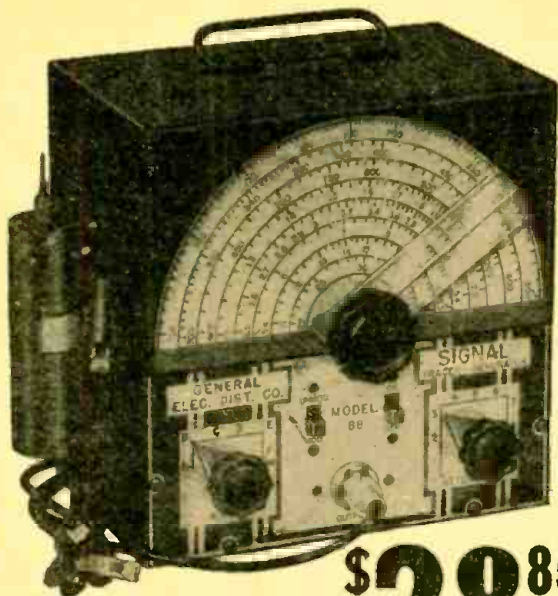

The Model 88 comes complete with all test leads and operating instructions.

ONLY \$28⁸⁵ NET

The ultimate in signal tracing procedure is achieved by the Model 88, for the use of this model, enables you to use either the broad-cast signal itself or the signal injected by the Signal Generator. This is especially useful of course when servicing "dead" or "intermittent" receivers. The Model 88 you will find is the greatest time-saver ever provided for by combining a full range Signal Generator and Signal Tracer into one unit the set up time for interconnecting, etc., is entirely eliminated.

Signal Generator Specifications:

- ★ Frequency Range: 150 Kilocycles to 50 Megacycles.
- ★ The R.F. Signal Frequency is kept completely constant at all output levels. This is accomplished by use of a special grid loaded circuit which provides a constant load on the oscillatory circuit. A grounded plate oscillator is used for additional frequency stability.
- ★ Modulation is accomplished by Grid-blocking action which has proven to be equally effective for alignment of amplitude and frequency modulation as well as for television receivers.
- ★ Positive action attenuator provides effective output control at all times.
- ★ R.F. is obtainable separately or modulated by the Audio Frequency.

Signal Tracer Specifications:

- ★ Uses the new Sylvania 1N34 Germanium crystal Diode which combined with a resistance-capacity network provides a frequency range of 300 cycles to 50 Megacycles.
- ★ Simple to Operate—Clips directly on to receiver chassis, no tuning controls.
- ★ Provision is made for insertion of phones of any impedance, a standard Volt-Ohm Milliammeter or Oscilloscope.

The Model S-35 **REFLEX PROJECTOR**

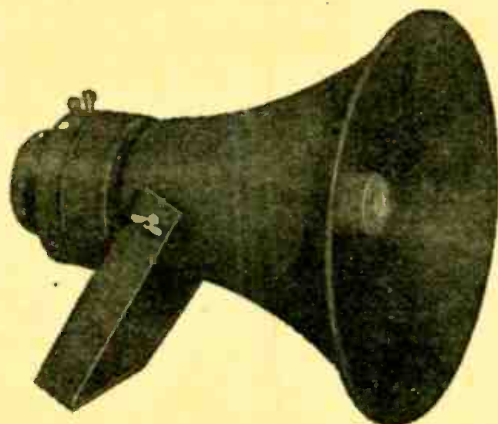

COMPLETE with built-in driver unit conservatively rated at 35 watts—will handle up to 55 watts without blasting.

For the sound technician who demands the best in reflex speakers. Heavy gauge non-corrosive aluminum in the main trumpet section completely eliminates blasting and blaring. The Driver is conservatively rated at 35 watts and can safely handle 55 watts without blasting. It incorporates a number of new improvements. The standard metal diaphragm heretofore used has been replaced with a new plastic diaphragm. This overcomes the resonant peaks of the old type; also, because the new plastic diaphragm is absolutely impervious to atmospheric changes whereas the old type was subject to atmospheric corrosion we are enabled to guarantee the unit for one year. Model S-35 provides a maximum of coverage with a minimum of power thus reducing installation costs.

SPECIFICATIONS:

POWER (CONSERVATIVE)—35 WATTS; AIR COLUMN — 3½ FT.; DISPERSION — 80°; POWER (PEAK)—55 WATTS; BELL DIAMETER—15"; IMPEDANCE—8 OHMS; FREQUENCY RANGE—130 TO 5000 C.P.S.; PROJECTION—¼ MILE; FINISH—ATTRACTIVE TWO-TONE CRYSTALLINE.

The Model S-35 Comes Complete with Built-in Driver Unit. ONLY

\$28⁵⁰

20% DEPOSIT REQUIRED ON ALL C.O.D. ORDERS

GENERAL ELECTRONIC DISTRIBUTING CO. DEPT. RC-4 98 PARK PLACE, NEW YORK 7, N. Y.

RADIOMEN'S HEADQUARTERS - WORLD WIDE MAIL ORDER SERVICE !!!

BUFRAD CAR RADIO ANTENNAS

All of our car radio antennas are made of triple plated Admiralty Brass Tubing, complete with low loss shielded antenna leads and high quality fittings.

SIDE COWL—BR-1, 3 sections extend to 66". Your price—single units—\$1.50; in lots of 12—\$1.35 ea.

SKYSCRAPER—BR-2 has 4 heavy duty sections that extend to 98". Your price—single units—\$2.45; in lots of 12—\$2.25 ea.

TILT ANGLE—BR-3, may be adjusted to all body contours. 3 sections extend to 66". Single unit price—\$1.50; 12 lot price—\$1.25 ea.

VERSATILE—BR-4, single hole fender or top cowl mounting may be adjusted to conform with all body contours. 4 sections extend to 56". Single unit price—\$2.90; 12 lot price—\$2.75 ea.

THE MONARCH—BR-5, single hole top cowl mounting, 3 sections extend to 56". Single unit price—\$1.90; 12 lot price—\$1.75 ea.

AFTER SEEING OUR ANTENNAS AND COMPARING, YOU WILL NEVER BUY ANY OTHER MAKE!

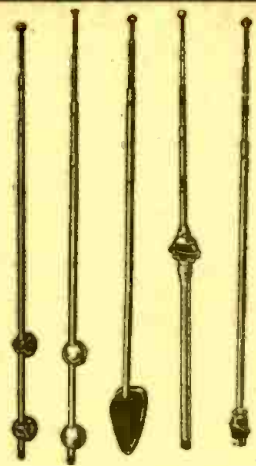

BR1 BR2 BR3 BR4 BR5

BENDIX SCR 522—Very high Frequency Voice Transmitter-Receiver—100 to 156 MC. This job was good enough for the Joint Command to make it standard equipment in everything that flew, even though each set cost the Gov't \$2500.00. Crystal Controlled and Amplitude Modulated—HIGH TRANSMITTER OUTPUT and 3 Microvolt Receiver Sensitivity gave good communication up to 180 miles at high altitudes. Receiver has ten tubes and transmitter has seven tubes, including two 832's. Furnished complete with 17 tubes, remote control unit, 4 crystals, and the special wide band VHF antenna that was designed for this set. These sets have been removed from unused aircraft and are guaranteed to be in perfect condition. We include free parts and diagrams for the conversion to "continuously variable frequency coverage" in the receiver.

The SCR 522 complete with 24 volt dynamotor sells for only \$37.95. The SCR 522 is also available with a brand new 12 volt dynamotor for only \$42.95.

\$9.95

TAKES ALL THREE BIG BARGAINS

1. AUDIO AMPLIFIER Undreamed of value. Uses 6V8's. Has 4 microphone inputs brought to jacks at rear panel. Various output impedances available at rear panel connections. Steel case with chrome handles. 9" long x 9" high x 6" deep. Tubes included. New in original carton. Shipping weight 20 lbs. **SUPER SPECIAL**—\$4.95 white supply lasts.

2. RADIO HEADSETS Latest supersensitive type with rubber earpieces. Every pair guaranteed perfect. \$5.99 per pair OR 3 PAIRS FOR \$1.00.

3. HOME WORKSHOP AT BARGAIN PRICE Accurate and precise 2 speed guaranteed hobby lathe, the essential machine for the home workshop. Sturdy enough for light production work or factory standby service. Supplied with 56" of beltting for connecting to any available electric motor or power take-off, such as on a jeep or tractor. Also included in this unbelievable offer are such accessories as a 1/2" drill chuck with specially hardened tool steel jaws, a 4" electric furnace high speed grinding wheel, a cotton buffing wheel with a large supply of buffing compound, and a 4" steel wire scratch brush. Your cost \$6.00. Sole export agent. Distributor inquiries invited.

ND C. O. D.'s—ORDER NOW—DON'T DELAY

AUTO RADIO DEALERS! ATTENTION!

Nationally advertised brand of 1948 car radio which will fit practically any car and every pocketbook. Six tube superheterodyne with three gang condenser and 8 1/2" speaker. \$32.20 for sample, or Dealer price \$29.97 each, in lots of two or more.

Here is an item that no serviceman who repairs auto radios should be without. Nationally advertised **ATR BATTERY ELIMINATOR** that supplies perfectly filtered 12 VDC or 6 VDC at 44 amp from 110 VAC.....\$36.00

RADIO SERVICEMEN!! Buffalo Radio Supply's lower prices mean increased profits for you. Order all of your needs from us and receive in return courteous service and first class merchandise at the lowest prices in the country.

- TUBES**—All types in stock, 60% off on all tubes if ordered in lots of 10 or more.
- TRANSFORMERS**—All types in stock. **AUTO-TRANSFORMERS**: Steps up 110v, or steps down 220v to 110v—\$1.95. **FIL TRANS.**: 6.3v, 20 Amps—\$1.98; Universal Output Trans-8 Watt—89c; 18 Watt—\$1.29; 30 Watt—\$1.69. **AUDIO TRANSFORMERS**: S. Plate to S. Grid, 8-1-79c; S. Plate to P.P. Grids—79c; Heavy Duty Class AB or B P.P. inputs—\$1.49; Midget Output for AC-DC sets—69c; **MIKE TRANSFORMER** for T-17 Shure microphones, similar to UTC output type—\$2.00 Stator SB or DB mike to line or grid—\$1.95.
- POWER TRANSFORMERS**—Half-shell type, 110V, 60 cv. Center-tapped HV winding. Specify either 2.5 or 6.3V filament when ordering.
- For 4-5 tube sets—850V, 40MA, 5V & 2.5 or 6.3V.....\$1.49
 - For 5-6 tube sets—850V, 45MA, 5V & 2.5 or 6.3V.....1.75
 - For 6-7 tube sets—675V, 50MA, 5V & 2.5 or 6.3V.....1.90
 - For 7-8 tube sets—700V, 70MA, 5V & 6.3 or two 2.5V.....2.35
 - For 7-8 tube sets—700V, 70MA, 5V & 6.3 (25 Cycle).....3.60
 - For 8-9 tube sets—700V-90MA, 5V-3A, 2.5V-3.5A.....2.85
 - 2.5-10.5A.....2.85
 - For 9-11 tube sets—700V, 5V & 6.3V-4A.....2.85
 - For 9-15 tube sets—600V, 150MA, 5V & 6.3V.....2.95
- CONDENSERS**—PAPER TUBULAR 600 WV.—001, .002, .005—8c; .01, .05—9c; .1—10c; .25—23c; .5—35c; **ELECTROLYTICS**: 8mfd 200v—20c; 10mfd 35v—20c; 30mfd 150v—23c; 20/20mfd 150v—35c; 30/20 150v—46c; 50mfd 150v—43c; 8mfd 475v—34c; 16mfd 350v—65c; **OIL CONDENSERS**: 4mfd 600v 49c; 2mfd 600v—29c; 3X.1mfd 600v—29c.

- SPEAKERS**—These PM speakers are the finest that are available. All have heavy oversize Alnico V magnets.
- 3 1/2".....\$1.15.....6 for \$6.60
 - 4".....\$1.15.....6 for \$6.60
 - 5".....\$1.10.....10 for \$9.50
 - 6".....\$1.50.....6 for \$9.70
 - 7" (Car Radio Size).....\$4.50.....6 for \$21.50
 - 8".....\$3.95.....6 for \$20.50
 - 8".....\$4.95.....6 for \$26.50
 - 10".....\$5.50.....6 for \$30.00
 - 12".....\$7.95.....6 for \$42.00

Cable Address: BUFRAD

FLOURESCENT LIGHT BALLASTS. Single 30 or 40 watt—\$1.68; Dual 40 watt High Power Factor—\$3.75.

HEADPHONES—Highest quality Signal Corps headsets with 12" cord and plug \$1.25, 5" rubber covered patchcords with phone plug and socket—45c.

LINE FILTERS—110V—each unit contains two 2 mfd. oil filled condensers and a 15 amp. iron core choke. This filter has innumerable uses such as oil burner line filter, etc. A ten dollar value for 98c.

RT-1579 consists of a three stage cascade 68J7's and 6F8 output stage high gain, high fidelity amplifier with 60 cycle, 110V power supply on the same 13 1/2"x14 1/2" chassis, which is protected by a substantial steel cover over tubes and parts. Made by Western Electric with typical quality components such as a husky power transformer and oil condensers, this unit is obviously intended to give years of trouble-free service with no more need for repairs than a telephone. Disconnecting one wire each, from the special input and output filters, will result in as high a fidelity amplifier as can be obtained. Your cost with tubes, diagram and parts list included \$14.95.

RT-1655—11 tube crystal controlled superhet receiver for 24-28V DC operation. Beautiful chassis and cabinet. Uses latest tube types including 7 miniature 6AJ5's. Tubes and schematic supplied. Only a few available at.....\$14.95

AT LAST YOU CAN AFFORD A LABORATORY STANDARD MICRO VOLTER

The famous Measurements Corp. Model 78B, 5 Tube Laboratory Standard Signal Generator (that sold now, FOB Boonton, N. J., for \$310.00 net) is available in perfect condition for 25 to 60 cycle, 115 V AC operation. Until now this is the sort of topflight lab equipment that discriminating buyers have only vainly hoped would be released at a bargain price. Worth every cent the manufacturer asks, but available FOB Buffalo while our limited supply lasts for only \$79.95.

Such companies as Admiralty Corp. and John Meek, Inc. have ordered from us and repeated many times on these 78 Model 78-B Standard Signal Generators for use in their labs and production frequency bands between 15 kilohm testing, and 250 megacycles.

"REMEMBER THAT A STANDARD IS ONLY AS RELIABLE AS ITS MAKER."

FILTER CHOKES. 200, 300, 400, 500 ohm light duty—59c; 200 or 300 ohm heavy duty—89c; 250 ma 35 ohm, made for U.S. Navy, fully shielded—\$1.95; 75 ohm 125 ma—25c or 25 for 54.25; "Meesner type" tapped filter chokes—25c; 8 amp. iron core A filter—25c; Choke-condenser combination, ideal to replace any size speaker field when installing PM speaker—79c.

110V. CIRCUIT BREAKERS of Magnetic type: Following Current Ratings in Stock: 1.25, 3, 4, 8 Amps. Please specify. \$1.95 each.

SEVEN ASSORTED I.F. TRANSFORMERS—\$1.08; Five Asted. Oscillator Coils—89c.

Selenium Rectifiers—Dry disc type 1 1/2", 1", 1.2 Amp. maximum, suitable for converting DC relays to AC, for supplying filament source in portable radios, converting DC meters to AC applications, and also may be used in low current chokes—90c.

Meyer Rectifier—Full wave, may be used for replacement, or in construction of all types of test equipment—\$1.25. Half wave—90c.

A HIGH GRADE CRYSTAL PICK-UP WITH THE PURCHASE OF EACH PHONO MOTOR AT \$4.95.

MICROPHONES—All nationally known brands. Bullet crystal—\$5.45; Bullet Dynamic—\$7.45; Mike Jr.—60c; Handy Mike—90c; Lapel Mike—83c; SHURE T-17 MIKES, with push to talk switch—99c.

20 ASSTD COIL FORMS, including 11 ceramic, 3 polystyrene, and 6 fiber, all useful sizes—50c.

VARIABLE CONDENSERS: 50 MMFD, 5 gang—\$1.95; 4 gang—\$1.49; 3 gang—83c; 7.5 to 20 MMFD, 1750v spacing, extra long shaft Hammarlund—69c; miniature variables, 25 MMFD—39c; 50 MMFD—49c; 75 MMFD—59c; 100 MMFD—69c; 140 MMFD—79c.

INTERRUPTION FREQUENCY COILS for super-regenerative receivers or the tremendously popular FM adapters for standard broadcast sets. Iron core with a resonant frequency of 50 KC—89c; Air Core, 100 KC—29c.

30 MC VIF VIDEO AMPLIFIER, double slug tuned—25c. **30 MC VIF VIDEO AMPLIFIER** PLATE COILS—Slug tuned—25c.

REMOTE CONTROL UNIT: Aluminum case 4x3x2" containing 2 potentiometers, triple pole switch, 4 knobs, gear mechanism, counter and phone jacks—59c.

MODULATION TRANSFORMERS—10 watt, metal case 98c; 30 watt, open-type, \$1.95; 40 watt, cast aluminum case, \$2.95; Class "B" input transformers, cast aluminum case, \$1.95; Transceiver audio transformers, 65c; Transceiver modulation transformers, 65c.

MINIATURE PLIERS-SET contains one of each of the following: Needle nose, flat nose, parrot nose, standard nose. All contained in a leatherette case. Your cost—\$1.98.

SOCKET WRENCH SET consisting of 5 sockets ranging in size from 5/16 to 1/2" and a handle—79c.

AUTOMATIC WIRE STRIPPERS will strip up to 1000 wires per hour, a handy tool for any service job—\$3.52.

CLOSING OUT THE FOLLOWING DESIRABLE ITEMS AT SACRIFICE PRICES TO MAKE ROOM IN OUR WAREHOUSE FOR INCOMING STOCK

- 5" "SO" RADAR P.P.I. SCOPE**, complete with 9 tubes including 807 tube in final power stage that provides deflecting current for magnetic yokes, Selyon motor and self-contained 110 V. power supply designed to run on the AC supply on LST and PT boats. Various ranges from 2 to 80 miles. The most satisfactory scope available for navigational radar or panoramic television applications. Nationally advertised as surplus at \$100.00 by others. Our price, only \$39.95.
- AIRCRAFT MARKER BEACON RECEIVER**—Complete with 3 tubes and sensitive relay to control external circuits from received signals. Just the receiver you have been waiting for to control models, open doors from a distance, etc. Priced at only \$6.95.
- LORAN INDICATOR OSCILLOSCOPE** complete with 26 tubes and a 5" cathode ray tube. Greatly superior to other scopes because the multivibrator circuit incorporated can be used to present two traces simultaneously on screen. Thus input and output of an amplifier stage can be viewed at same time on screen. Distortion is indicated conclusively by difference between input and output traces, while fidelity is made evident by identical traces. Government instruction manual included.\$39.95

TERRIFIC VALUE—PORTABLE ELECTRIC DRILL

(Sold at less than established factory price so we cannot mention brand name) Only \$19.95 equipped with 1/2" Jacobs Gear Chuck and Key. Not an intermittent duty drill, but a full size rugged tool. Most convenient type switch, natural grip handle, and balance like a six shooter. Precision cut gears—turbine type cooling blower—extra long brushes. No stalling under heaviest pressure because of powerful 110 Volt AC-DC motor and multiple ball thrust bearing. Other bearings self-aligning lifetime-lubricated Chrysler Oilite type. Made for toughest year-in and year-out service in plant or on construction jobs. Amazing perpetual factory guarantee assures you of a lifetime of trouble-free use. 25% deposit on C.O.D.'s. Full refund (you pay transportation) if not pleased with drill after trial. Minimum order \$3.00—All prices subject to change—25% deposit with C.O.D. orders

BUFFALO RADIO SUPPLY, 219-221 Genesee St., Dept. 5 C. BUFFALO 3, N. Y.

RADIOMEN'S HEADQUARTERS WORLD WIDE MAIL ORDER SERVICE!!!

DUE TO POPULAR DEMAND WE REPEAT THESE TERRIFIC BARGAINS

- Three assorted new MICROPHONES, including push-to-talk type\$1.49
- Ten assorted R. F. Chokes including high frequency types\$.35
- Five assorted AUDIO or FILTER CHOKES\$.99
- One Hundred assorted RESISTORS\$1.95
- Ten assorted JAN CABLE CONNECTORS, including SCR274,522 and BC375 types\$.99
- Six assorted OIL FILLED CAN TYPE CONDENSERS, all with mounting brackets\$1.49
- Ten assorted METAL & BAKELITE KNOBS—(no wooden knobs)\$.39
- Six assorted VARIABLE CONDENSERS, including butterfly types\$1.49
- Six assorted POWER and AUDIO TRANSFORMERS, all new\$1.98
- Six assorted isolantite and bakelite R. F. COILS, shielded and unshielded\$.99

The above ten assortments totaling over \$12.00 at the unbelievable bargain prices listed can be purchased together as one lot at a super-special total price of only \$10.00. All merchandise guaranteed to be as advertised.

RT1463 7 tube amplifiers containing 3-7F7, 1-7Y4, 3-7N7, 4 potentiometers, numerous resistors, filter and bypass condensers, filter chokes, power and audio transformers, and six sensitive plate relays. A military development that provided amazing stepless control proportional to correction required for ailerons, rudder and elevator, in the original application. A control amplifier of the ordinary type would deflect the rudder by some arbitrary amount when the ship was blown off the course to port or starboard. The result would either be that the correction was insufficient and the plane continued off course, or the correction would be too great, starting a series of tacks and would greatly increase fuel consumption and elapsed time in reaching the objective. This phenomenal unit, with its 3 amplifiers and six 5000 ohm relays in bridge circuits, will accurately control any 3 operations, related or unrelated, in minutely adjustable uniquely quantitative variations in either forward or reverse directions. 9"x7"x8" black crackle aluminum case. Brand new in original carton. \$5.95.

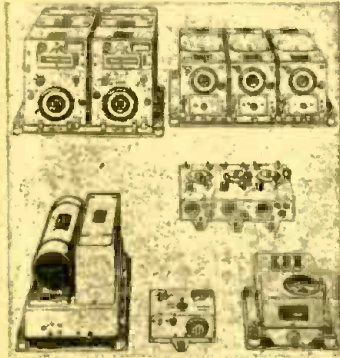

SCR-274N COMMAND SET

The greatest radio equipment value in history

A mountain of valuable equipment that includes 8 receivers covering 190 to 550 KC; 9 to 6 MC; and 6 to 9.1 MC. These receivers use plug-in coils, and consequently can be changed to any frequencies desired without conversion. Also included are two Tuning Control Boxes; 1 Antenna Coupling Box; four 28 V. Dynamotors (easily converted to 110 V. operation); two 40-Watt Transmitters including crystals, and Pre-amplifier and Modulator. 29 tubes supplied in all. Only a limited quantity available, so get your order in fast. Removed from unused aircraft and in guaranteed electrical condition. A super value at \$29.95, including crank type tuning knobs for receivers. Without these knobs the receivers can't be tuned, and are only useful for parts. Don't buy without knobs! We also include one 60 cycle, 110 to 24V filament transformer for receiver—FREE.

RECORDING AMPLIFIER, 3 stage, 110 V, 25 or 60 cycle high gain amplifier built by recently bankrupt manufacturer specifically for recording use. Transformer for low impedance wire recorder head or magnetic cutter included on chassis. Tone and volume controls and switches on chassis for playback, recording or use as public address amplifier. Complete with tubes\$9.95

SCR-284 TRANSMITTER-RECEIVER

This medium power transmitter and the accompanying 7-tube very sensitive receiver are naturals for 80 or 40 meter operation (phone or CW), on either fixed stations or mobile applications. These units are brand new and come complete with 17 tubes, key, microphone, 200 KC calibrating crystal and instructions and diagrams for use with up to 100 watts input to the final stage on 40 or 80 meters for either phone or CW, using vehicle or 110 Volt power supply. Your cost\$39.95

PE-109 32-Volt DIRECT CURRENT POWER PLANT

This power plant consists of a gasoline engine that is direct coupled to a 2000 watt 32 volt DC generator. This unit is ideal for use in locations that are not serviced by commercial power or to run many of the surplus items that require 24-32V DC for operation. The price of this power plant is only \$58.95. We can also supply a converter that will supply 110V AC from the above unit or from any 16-32V DC source for \$12.95.

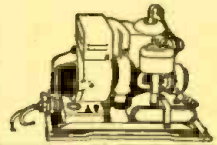

BRAND NEW INVERTERS AND DYNAMOTORS

- PE 6A: A 24 to 32 V DC input, to 80 V AC regulated output converter\$12.95
- PE 19A: A 24 to 28 V DC input, to 80 V AC at 800 cps output\$9.95
- (We include a stepup transformer with each of the above so that 110 V AC is available from either.)
- 27 V DC input 285 V DC @ 75 MA output96c
- 27 V DC input. Output 300 V @ 150 MA, 150 V @ 15 MA and 12 V @ 5 Amp.\$5.95
- 12 V DC input. Output 300 V @ 150 MA, 150 V @ 15 MA and 12 V @ 5 Amp.\$12.00
- 13 or 26 V DC input. Output 800 V DC, 400 V DC @ 135 MA, and 9 V AC\$15.00
- (By running on 6 V AC, 50 cycle input, with a small amount of DC for field excitation, the above dynamotor will provide a good source of 12, 24, 400 or 800 V DC.)

GENERAL ELECTRIC RT-1248 15-TUBE TRANSMITTER-RECEIVER

TERRIFIC POWER—(20 watts) on any two instantly selected, easily pre-adjusted frequencies from 435 to 500 Mc. Transmitter uses 5 tubes including a Western Electric 318 A as final. Receiver uses 10 tubes including 955's, as first detector and oscillator, and 3-7H7's as IF's, with 4 slug-tuned 40 Mc. IF transformers, plus a 7E7, 7E5's and 7F7's. In addition, unit contains 2 relays designed to operate any sort of external equipment when actuated by a received signal from a similar set elsewhere. Originally designed for 12 volt operation, power supply is not included, as it is a cinch for any amateur to connect this unit for 110V AC, using any supply capable of 400V DC at 135 MA. The ideal unit for use in mobile or stationary service in the Citizen's Radio Telephone Band where no license is necessary. Instructions and diagrams supplied for running the RT-1248 transmitter on either code or voice in AM or FM transmission or reception, for use as a mobile public address system, as on 80 to 110 Mc. FM broadcast receiver, as a Facsimile transmitter or receiver, as an amateur television transmitter or receiver, for remote control relay hookups, for Geiger-Mueller counter applications. It sells for only \$29.95 or two for \$53.90. If desired for marine or mobile use, the dynamotor which will work on either 12 or 24V DC and supply all power for the set is only \$15.00 additional.

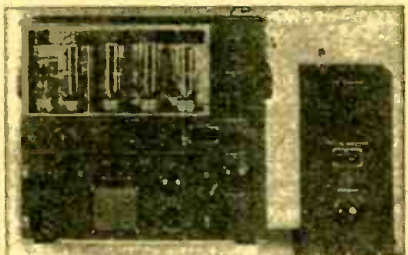

GENERAL ELECTRIC 150 WATT TRANSMITTER

Cost the Government \$1800.00
Cost to you \$44.50!!!!

This is the famous transmitter used in U.S. Army bombers and ground stations, during the war. Its design and construction have been proved in service, under all kinds of conditions, all over the world. The entire frequency range is covered by means of plug-in tuning units which are included. Each tuning unit and antenna tuning circuits—all designed and hand calibrated. POWER AMPLIFIER: Neutralized class "C" stage, using 211 tube, and equipped with antenna coupling circuit which matches practically any length antenna. MODULATOR: Class "B"—uses two 211 tubes. POWER SUPPLY: Supplied complete with dynamotor which furnishes 1000V at 350 MA. Complete instructions are furnished to operate set from 110V AC. SIZE: 21 1/2 x 23 1/2 x 9 1/2 inches. Total shipping weight 200 lbs., complete with all tubes, dynamotor power supply, five tuning units, antenna tuning unit and the essential plugs. These units have been removed from unused aircraft but are guaranteed to be in perfect condition.

Minimum order \$3.00—All prices subject to change—25% deposit with C.O.D. orders

Aluminum gear box 18x8x7 that contains two powerful electric motors and two matched gear trains, 62 gears in all varying in size from 1/2 to 4 inches in diameter. This unit is readily converted to rotate a beam antenna or any other similar usage.....\$3.00
BRAND NEW 110 V AC INPUT POWER SUPPLY, in grey enameled shock-mounted case 9" x 10" x 16". Several heavy duty resistors, 3 chokes, 4-1000 V and 600 V oil-filled condensers, 1 relay, 2-5U4's, 3 voltage regulator tubes, safety interlock, and several fuses are included in this regulated power supply at the bargain price of\$9.95

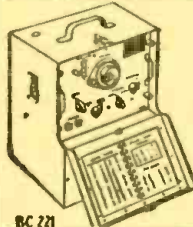

BC-221 FREQUENCY METERS with calibrating Crystal and calibration charts. A precision frequency standard that is useful for innumerable applications for laboratory technician, service man, amateur, and experimenter at the give away price of only \$36.95.

100 KC crystal calibrator kit containing everything that is necessary to construct a 100 KC osc. that will supply 100 KC marker points to your receiver so that it may be used for frequency determination. The 100 KC crystal is worth far more than the price that we are asking for the complete kit.
Kit 100K Plate and fil. voltage supplied by receiver\$9.95
Kit 100KA Same as above, including 110 VAC or DC self-contained power supply\$12.95

14-TUBE UHF SUPERHET RECEIVER—\$39.95



This beautifully constructed receiver was designed especially for Signal Corps communication service, and is one of the finest and most sensitive sets ever manufactured. Operating from 110V 60 cycles, this set has two tuned RF stages, tuned converter and oscillator, five I.F. stages, using iron-core I.F.'s, a diode detector, tuning eye, and a two stage amplifier that will drive a speaker or phones. The frequency range is 158-210 Mcs. It is a simple matter to operate on other bands by making a slight alteration in the tuning coils. A complete set of tubes is included with each receiver, along with a circuit diagram and parts list. The high-voltage power supply delivers 150 milliamperes, and is well filtered by a heavy-duty choke and three 7 Mfd. oil-filled condensers. This buy of a lifetime cost the government about \$700. Amateurs and experimenters will never again be able to purchase fine equipment at such a tremendous saving! See January *Radio-Craft*, Page 57, for complete conversion to television receiver.
Cable Address: BUFRAD

BUFFALO RADIO SUPPLY, 219-221 Genesee St., Dept. S C. BUFFALO 3, N. Y.

free radio book

RADIOS HAM P.A.

Mail coupon for buying guides to the best values in Radio, Ham and P.A. Equipment. Send too for the newest flyer jam-packed with bargains.

Spot-lite Values

25 Ceramicon Condensers

Provide ultimate stability. Temperature coefficient is determined by the ingredients of the ceramic di-electric; controllable to within very fine limiting values. Color coded. Flexible pigtail leads. Shpg. wt. 1 lb.

AP511—Your Cost..... **69c**

Crystal FM Converter

Change old FM (40-50 MC) to new FM in a few moments and at lowest cost. Efficient operation; this is a superior device. No loss of signal. Easy to install.

AP5700—
Your Cost **\$6.00**
Only



from **Safayette**

MAIL NOW

New York
100 SIXTH AVE.
110 Federal St., Boston 10
29 Central Ave., Newark 2

Safayette Radio

RADIO WIRE TELEVISION, INC.
Dept. JE-3, 100 Sixth Avenue, N. Y. 13

Send No. AP511 @ 69c each quantity ()
No. AP5700 @ \$6.00 each..... quantity ()

Enclosed: Check () money order ()
Send Catalog () New Flyer C42 ()

Name

Address

City Zone..... State.....

New Radio-Electronic Patents

By I. QUEEN

MULTIPLYING MACHINE

Jan A. Rajchman and George A. Morton,
Princeton, N. J.
(assigned to Radio Corp. of America)
Patent No. 2,433,237

Magnetrons are well known as generators of high-power microwave energy. Here they have another important use. A pair of magnetrons is used with associated apparatus as an instantaneous multiplying machine.

A simple relation exists between the magnetic field of a magnetron and its anode voltage, when the anode current is maintained constant. For this type of operation, the anode voltage E is proportional to the square of the corresponding field H . We may write

$$E_1 = KH_1^2 = K(a+b)^2;$$

$$E_2 = KH_2^2 = K(a-b)^2;$$

$$E_1 - E_2 = K(H_1^2 - H_2^2) = 4abK.$$

The third term of each equation simply emphasizes the fact that any two numbers (or quantities like 1 and 2) may be regarded as the sum and difference of two other numbers. For example, 9 and 5 are the sum and difference of 7 and 2.

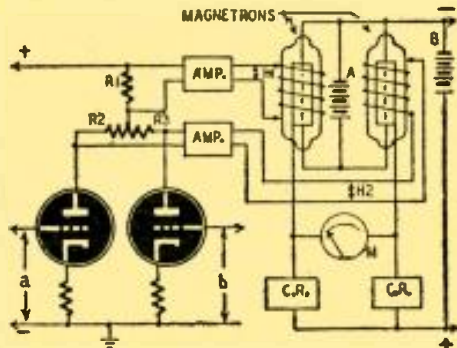

The equations show that if the magnetic field of one magnetron is made proportional to the sum of two voltages ($a+b$) and, if the field of the other magnetron is proportional to the difference ($a-b$), then the difference between anode potentials is proportional to the product ($a \times b$).

Referring to the circuit diagram, 2 triodes are used as class-A amplifiers. The input voltages are a and b , respectively. Both plate currents flow through $R1$ in the same direction, therefore the voltage across it must be proportional to $(a+b)$. Currents flow in opposite directions through the halves of resistor $R2-R8$, therefore the voltage across it is proportional to $(a-b)$. These voltages are amplified and then connected across the magnetron field coils.

It is clear that $H1$ is proportional to $(a+b)$ and that $H2$ is proportional to $(a-b)$. The anode current of each magnetron is held constant by a current regulator. Then, by the previous equations, the difference between anode potentials must be proportional to the product ($a \times b$).

To operate the calculator, input potentiometers are adjusted to apply desired potentials to the amplifying tubes. The product is read off at once on the calibrated meter M .

COIL TESTER

Joseph K. Thompson, Pittsburgh, Pa.
(assigned to Westinghouse Elec. Corp.)
Patent No. 2,432,948

This is an improvement in the method of testing coils by comparison. In the usual method the coils are placed on opposite legs of a transformer core in which an alternating field is produced. The coils are connected in series so that the current induced in one bucks that in the other. A meter connected in the circuit will read zero if the coils are identical.

Usual practice is to place the standard and unknown coil on the opposite legs of a U-shaped core. The a.c. winding is on the bottom of the U. A fourth and removable side completes the magnetic circuit. This method, while convenient, leaves air

gaps which are effectively in parallel with the usual leakage gap. Since the air gaps cannot be made exactly alike, the magnetic flux through the core legs is not the same.

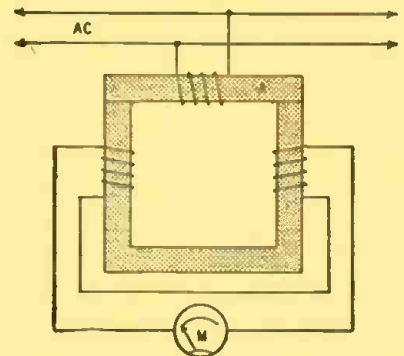

In this method the primary is wound on the removable side (A) of the core. The air gaps are now in series with the core, and cannot cause unequal flux through the core legs.

RADAR TELEVISION

James W. Gibson, Avenel, N. J.
(assigned to Western Electric Co.)
Patent No. 2,429,933

Radar and television may be combined to form images and scenes otherwise invisible to the naked eye. Short radio waves are directed against the desired target. Reflected energy is picked up and converted into electric currents. These are video currents which may be used to control a television receiver.

The reflected radio waves are focused by an electromagnetic lens made of material having a high dielectric constant. A porcelain lens can be designed to have a radius of curvature of 18 feet and a focal length of 8.74 feet. Such a lens forms an image 2 feet square from a scene 5 miles square at a distance of 50,000 feet.

The focused image is made to fall upon a mosaic within a vacuum pickup tube. This mosaic is made of tiny rectifying elements attached to a plate. Each element is spherical in shape. The exposed portions of each element are made of copper and the parts which contact the plate are of copper oxide. When electromagnetism travels through these elements, they induce currents which are rectified. Positive charges appear on the exposed parts, and the plate becomes negative.

An electron beam is caused to scan the mosaic as in a conventional television tube. As this beam strikes an element it causes the latter to discharge through resistor to ground and back to the tube cathode. These video currents are amplified and reproduced.

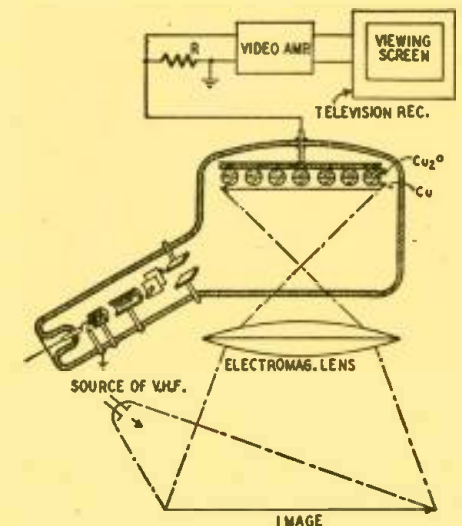



How to Pass FCC Commercial Radio Operator License Exams



I can train you to pass your FCC License Exams in a few short weeks if you've had any practical radio experience—amateur, Army, Navy, radio servicing, or other. My time-proven plan can help put you, too, on the road to success.

Let me send you FREE the entire story

Just fill out the coupon and mail it. I will send you, free of charge, a copy of "How to Pass FCC License Exams," plus a sample FCC-type Exam and Catalog A, describing opportunities for you.

Edw. H. Gullford, Vice President

FREE

Tells where to apply for and take the examinations, location of examining offices, scope of knowledge required, approved way to prepare for FCC examinations, positive method of checking your knowledge before taking the examinations.

Get your FCC ticket in a FEW SHORT WEEKS

IT'S EASY IF YOU USE CIRE SIMPLIFIED TRAINING AND COACHING METHODS AT HOME IN YOUR SPARE TIME

Look at the job opportunities you will have when you get your FCC ticket

- | | |
|----------------------------|------------------------|
| Forestry and conservation | Bus and truck fleets |
| Ambulances and hospitals | Police and fire depts. |
| Gas and electric utilities | Telephone companies |
| Gas and oil pipe lines | Merchant marine |
| Private automobiles | Highway Patrol |
| Street railways | Railroads |
| Taxicab fleets | Airlines |

Look at these average pay schedules for Broadcast Jobs
Reported by FCC Nationwide Survey

Position	Big Stations	Little Stations
Transmitter Engineer	\$4800	\$3000
Studio Engineer	5000	3650
Chief Engineer	7700	4300

Other jobs requiring FCC commercial licenses pay similar salaries.

Get your license easily and quickly and be ready for the \$3000 to \$7500 jobs that are open to ticket holders. CIRE training is the only planned course of coaching and training that leads directly to an FCC license. Your FCC ticket is recognized in all radio fields as proof of your technical ability. Employers often give preference to license holders, even though a license is not required for the job. Hold an FCC "ticket" and the job is yours!

Look what these students say:

"Thanks to this course, I now have a very good job in a local power plant's test department. I couldn't have obtained this job without the math and basic electrical theories in the first part of Section I of this course."

Stud. #2893N12

"I have been working for Police Radio Station WPFS in Asheville for five months since getting my second-class ticket."

Stud. #2858N12

"You may be interested to know that I am employed at the local broadcast station, where I am a transmitter operator. I took and passed the FCC examinations last February."

Stud. #2754N12

Don't Waste Valuable Time MAIL COUPON TODAY!

Don't put off getting this valuable information. Good jobs in radio need men like you. You can earn higher income, have a bank account, enjoy vacations, and have easier and better living. But you must have your FCC License. Hurry! Fill out the coupon right now and mail it. There is no obligation. You owe it to yourself to get the full story NOW.

Cleveland Institute of Radio Electronics

RC-5 Terminal Tower Cleveland 13, Ohio

Approved for Training under "G.I. Bill of Rights"



CLEVELAND INSTITUTE OF RADIO ELECTRONICS

RC-5 Terminal Tower Cleveland 13, Ohio

I want to know how I can get my FCC ticket in a few short weeks. Send me your FREE booklet "How to Pass FCC License Examinations" (does not cover exams for Amateur License) as well as a sample FCC-type exam and Catalog A, describing opportunities in Radio-Electronics.

NAME

ADDRESS

CITYZONE.....STATE.....

Veterans check for enrollment information under G.I. Bill.
NO OBLIGATION—NO SALESMEN.

University LOUDSPEAKERS

- can whisper, too!

And that's important because the primary purpose of any loudspeaker is to convey intelligence and not just make a loud noise. UNIVERSITY loudspeakers—with the highest conversion efficiency of any speaker of comparable size—not only give maximum sound output with minimum power input, but reproduce every detail and inflection of the voice at all levels from a whisper to a shout.

A JOB-RATED SPEAKER FOR EVERY APPLICATION!

REFLEX TRUMPETS



A wide variety available for every requirement—voice, music, paging and talk-back. Weather-proof, sturdy construction for years of dependable use.

DRIVER UNITS

Several high efficiency models with continuous power capacities up to 25 watts and response to 15,000 cycles. All unconditionally guaranteed for one year.



PAGING, CALL-BACK SPEAKERS



Available in many types and power ranges. Compact design, high conversion efficiency and high sensitivity. Standard voice coil impedances permit easy installation.

SUPER POWER SOUND PROJECTORS

Many sizes—100, 150 and 300 watts with conservative ranges to a few miles. Excellent quality even at full power. Ideal for installation in aeroplanes and church steeples.



EXPLOSION PROOF SPEAKERS



Radial and directional types for use in mines, refineries, railroads and shops. Immune to live steam, salt-spray or complete immersion. Power handling capacity 15 watts.

24 page technical catalog available on request.



UNIVERSITY LOUDSPEAKERS, INC.

80 SO. KENSICO AVE., WHITE PLAINS, N. Y.

★ = ★ = ★ = ★ = ★ = ★ = ★ =

SERVICE WITH A STAR

New LOW price... same HIGH quality

THE STAR TESTER

VOLT—OHM—MILLIAMMETER

\$24²⁵

An all-around tester with high quality features at an amazingly low price. Built for versatility and handiness. Gives you easy, accurate reading, with a 4 1/2", 400 microampere meter. Case is metal, crackle finished. Comes complete with batteries, test leads, and instructions for use.

DESIGN DATA

- 5-DC VOLTAGE RANGES—0 to 1000 volts
- 5-AC VOLTAGE RANGES—0 to 1000 volts
- 5-OUTPUT METER RANGES—0 to 1000 volts
- 4-DC CURRENT RANGES—0 to 1000 ma.
- 3-RESISTANCE RANGES—0 to 5 megohms
- DECIBEL RANGES—-10 to +54

You are using the best when you "Service with a STAR." Contact your dealer today or write us direct.

Literature available on all STAR products. Write for your copies today!

STAR MEASUREMENTS CO.

442 East 166th St., Dept. C-5, New York 59, N.Y.

★ = ★ = ★ = ★ = ★ = ★ = ★ =

BA BARGAIN SPECIALS

LOW LOW PRICE!

MASTER-REMOTE INTER-COM

Push button selection for 1 to 5 remote stations from this quality built 4 tube, 2 watt Master station. Several remotes can be "paged" at one time. Remote stations can originate call to Master. Very simple to install with any 3 conductor cable. Sturdy, good looking wood cabinets, walnut finished. Master 12 x 7 1/4 x 6 1/4", Remote 6 1/4 x 7 x 4"

No. 32A234X, Master Station and One Remote—ONLY \$29.95

No. 32A235X, Additional Remote Stations—ONLY \$7.88

No. 2A113, 3 Conductor Cable—100 Foot \$2.60

THE "DOUBLE TWENTY" FLUORESCENT UNIT

- Plugs in Any Outlet
- Hangs in Any Position
- Underwriter's Approved

Improved heavy steel, high reflection baked white enamel inside, gray outside. Hangs anywhere, with wire or chain, in a "jiffy." With 6 foot attached cord ready to plug in any outlet. Ideal for your hobby nook, repair shop, store, etc. Shipped complete with two 20 watt lamps. Size 25 1/4 x 9 1/4 x 5 3/4", wt. 10 lbs.

No. 30A60 \$8.28 Each

Spec. Each \$7.73

WRITE FOR YOUR COPY OF CATALOG No. 481 IF YOU DID NOT RECEIVE IT.

BA BURSTEIN-APPLEBEE Company

1012-14 M'GEE STREET, KANSAS CITY 6, MISSOURI

SPEAKER RECONING

ALL WORK GUARANTEED

3"—\$1.40	7"—\$1.95	15"—\$4.00
4"—1.40	8"—2.20	4x6—1.90
5"—1.50	10"—2.70	5x7—2.20
6"—1.65	12"—3.00	6x9—2.50

OXFORD RECONING SERVICE
1039 Selby Ave. St. Paul, Minn.

HIGH FIDELITY AMPLIFIERS

(Continued from page 36)

Since $X_{cs}/R_{eq} = 2$ at 90% level, Req equals 44,247 ohms. Plate resistance and grid leak are 1,000,000 ohms and 500,000 ohms, therefore we solve for the plate load or coupling resistor RL in the equation

$$R_{eq} = \frac{R_L \times R_p \times R_g}{R_L \times R_g + R_L \times R_p + R_g \times R_p}$$

where Rp is the plate resistance and Rg is the grid leak of the 2A3. The equation calls for a 51,019-ohm resistor. In practice we use a 50,000-ohm resistor.

Voltage amplifier stage

The 6SJ7 has a gain of 61.9, $G = gm \times R_{eq}$, and the signal on its grid voltage must equal its output voltage divided by its gain or $45/61.9 = 0.72$ volt peak.

When the low-frequency response is down 1 db from mid-band level, the reactance of the coupling condenser Xcc is one-half the resistance R formed by considering the grid leak of the 2A3 in series with the coupling and plate resistances in parallel. R equals

$$R_g + \frac{(R_p \times R_L)}{R_p + R_L}$$

We find R is 504,761 ohms, so Xcc is 1/2 R or 252,380 ohms. A .031-μf condenser has this reactance at 20 cycles. A larger condenser—a .05 μf for example—may be used.

The cathode bias (3 volts) for the 6SJ7 is developed across an 800-ohm cathode resistor. The value of the cathode bypass condenser is computed by following the methods applied to the 2A3.

The screen resistor drops the voltage on the screen grid to 100. Its value may be calculated from Ohm's law. Screen-grid degeneration is held to a negligible value by making $R_{sg} \times C$ equal or greater than $3/f$, when Rsg is the screen-grid resistor in ohms, C is the screen bypass in farads, and f is the lowest desirable frequency (20 cycles). A 250,000-ohm resistor was used in the circuit shown. Since $250,000 \times C$ equals $3/20$, C is .0000006 farad or 0.6 μf. Degeneration decreases as C is made larger, so a 1-μf condenser may be used.

A 1-megohm resistor is permissible in the grid circuit of the 6SJ7. Therefore one is used to decrease the shunting effect of capacitance across its input circuit.

Another stage

Our signal source develops .015 volt r.m.s. (.021 volt peak), so added gain is needed to raise this to the 0.72-volt level at the grid of V2. Another 6SJ7 was selected for the job, and circuit constants were designed in the same manner as those of V1 and V2. Note that the load resistor of V3 is much larger than that of V2. This is because Miller

(Continued on page 58)

A CHALLENGE—Order a model 247. Disregard the unbelievably low price and compare it on the basis of appearance, quality and performance to any other Tube Tester (ANY MAKE, ANY PRICE). If you are not completely satisfied with the model 247 after a 15 day trial, return it to us for full refund—no explanation necessary.

The model 247 is not surplus nor is it a hashed-over pre-war model. It is newly designed and incorporates new advances in Tube Tester design. Read the description below and order one today!

The New Model 247

TUBE TESTER



Model 247 comes complete with new speed-read chart. Comes housed in handsome, hand-rubbed oak cabinet sloped for bench use. A slip-on portable hinged cover is included for outside use. Size: 10 $\frac{3}{4}$ " x 8 $\frac{3}{4}$ " x 5 $\frac{3}{4}$ ".

ONLY
\$ 29⁹⁰
NET

Incorporates a newly designed element selector switch which reduces the possibility of obsolescence to an absolute minimum. Any pin may be used as a filament pin and the voltage applied between that pin and any other pin, or even the "top-cap."

The new free-point system described above permits the Model 247 to overcome the difficulties encountered with other emission type tube testers when checking Diode, Triode and Pentode sections of multi-purpose tubes, because sections can be tested individually when using the new Model 247. The special isolating circuit allows each section to be tested as if it were in a separate envelope.

The Model 247 provides a super sensitive method of checking for shorts and leakages up to 5 Megohms between any and all of the terminals. Continuity between various sections is individually indicated. One of the most important improvements, we believe, is the fact that the 4 position fast-action snap switches are all numbered in exact accordance with the standard R. M. A. numbering system. Thus, if the element terminating in pin No. 7 of a tube is under test, button No. 7 is used for that test.

THE MODEL 650—AN A.C. OPERATED

SIGNAL GENERATOR

RANGE: 100 KILOCYCLES TO 105 MEGACYCLES

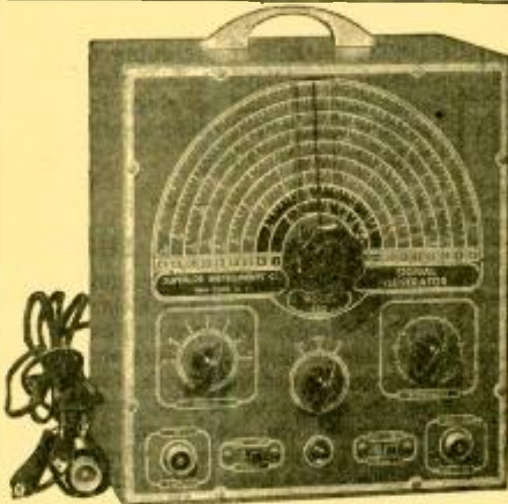

*RF obtainable separately or modulated by the Audio Frequency.

*Audio Modulating Frequency—400 cycles pure sine wave—less than 2% distortion.

*Attenuation—3-step ladder type of attenuator (T pad).

*Uses a Hartley Excited Oscillator with a Buffer Amplifier.

*Tubes: 6J5 as R.F. Oscillator; 6SA7 as modulated buffer and Mixer; 6SL7 as audio oscillator and rectifier.

Model 650 comes complete with coaxial cable, test leads and instructions. Housed in heavy gauge grey crystalline cabinet with beautiful two tone etched front panel. Size 9 $\frac{1}{2}$ " x 10" x 6".

\$39⁹⁵
NET PRICE:

The New Model 670 SUPER METER

A Combination VOLT-OHM-MILLIAMMETER plus CAPACITY REACTANCE, INDUCTANCE and DECIBEL MEASUREMENTS.

D. C. VOLTS: 0 to 7.5/15/75/150/750/1500/7500.—A. C. VOLTS 0 to 15/30/150/300/1500/3000 Volts.—OUTPUT VOLTS: 0 to 15/30/150/300/1500/3000.—D. C. CURRENT. 0 to 1.5/15/150 Ma.; 0 to 1.5 Amps.—RESISTANCE: 0 to 500/100,000 ohms, 0 to 10 Megohms.—CAPACITY: .001 to .2 Mfd., 1 to 4 Mfd. (Quality test for electrolytics).—REACTANCE: 700 to 27,000 Ohms; 13,000 Ohms to 3 Megohms.—INDUCTANCE: 1.75 to 70 Henries; 35 to 8,000 Henries. DECIBELS: -10 to +18, +10 to +38, +30 to +58.

THE MODEL 670 COMES HOUSED IN A RUGGED, CRACKLE-FINISHED STEEL CABINET COMPLETE WITH TEST LEADS AND OPERATING INSTRUCTIONS. SIZE 5 $\frac{1}{2}$ " x 7 $\frac{1}{2}$ " x 3".

\$28⁴⁰
NET

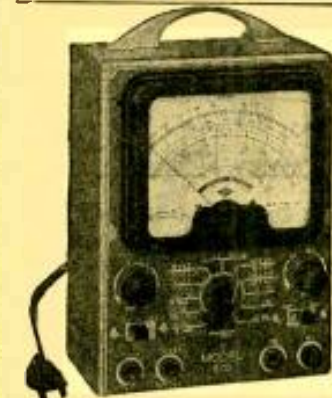

Available for Immediate Shipment From Stock—20% Deposit Required on All C.O.D. Orders

MOSS ELECTRONIC DISTRIBUTING CO.

DEPT. RC-5, 229 FULTON ST.
NEW YORK 7, N. Y.



Free

NEW COMPLETE *Concord* RADIO CATALOG 160 VALUE-PACKED PAGES

Mail coupon for FREE copy of this great, new Concord Catalog—a vast, complete selection of everything in Radio, Television, and Test Equipment. Thousands of items... latest 1948 prices. LOWER prices on finest-quality RADIO SETS, PHONO-RADIOS, RECORD CHANGERS, RECORD PLAYERS, RECORDERS—wire and disc. PORTABLES, AMPLIFIERS, COMPLETE SOUND SYSTEMS, TESTERS. Latest listings of all well-known, standard, dependable lines of radio parts and equipment. 4,212,014 SATISFIED CUSTOMERS CANNOT BE WRONG! Concord's quarter-century reputation for Customer Satisfaction is the reason Radio Men (the Experts who Know) keep coming back to CONCORD. At CONCORD, YOU MUST BE COMPLETELY SATISFIED or your money will be refunded.

CONCORD
RADIO CORPORATION
CHICAGO 7 ATLANTA 3
163 W. Jackson Blvd. 265 Peachtree St.
Downtown Chicago Branch: 223 W. Madison
Lafayette Radio Corp.

- 23 pgs. Radio and Television Sets • 62 pgs. Radio Parts
- 18 pgs. Sound Amplifiers and Accessories • 23 pgs. Ham Gear
- 9 pgs. Electronic Test Equipment

Mail COUPON TODAY!

CONCORD RADIO CORPORATION, Dept. 145
901 W. Jackson Blvd., Chicago, 7, Ill.
Yes, rush FREE COPY of the comprehensive new Concord Radio Catalog. (Please Print)

Name.....
Address.....
City & Zone..... State.....

ILLINOIS CONDENSER CO. NOW HAS UMP!



TYPE UMP

A popular replacement twist prong line of COMPACT, HERMETICALLY SEALED, efficient, dry electrolytic condenser, is now a member of the ILLINI line of highest quality capacitors.

The "Illini" UMP capacitors are now available at your local jobber. Our latest catalog, listing complete Illinois line, will be mailed to you upon request.



ILLINOIS CONDENSER CO.
1616 NORTH INDIAN STREET • CHICAGO 22, ILL.

SPECIAL AT ALMO



RCA DRIVER UNITS
Special RCA driver unit for trumpet or horn speakers. Rated at 25 watts continuous program level. Handles overload peaks with safety. High conversion efficiency and good low frequency response. Limited quantity; order now.

Your Cost
\$9.95



Your Cost
\$9.45

TRANSMITTER-RECEIVER BC-645

BC-645 ultra-high frequency transmitter receiver can be converted to operate on the 420 Mc band with few changes. It's surplus, brand new, packed in original carton—complete transmitter, modulator system and receiver. Comes complete with fifteen tubes. Well worth the price for parts.

10% Cash with Orders
ALMO
Covers the Globe
509 ARCH STREET
PHILADELPHIA, PENN.
Phone LO 3-9255

HIGH FIDELITY AMPLIFIERS

(Continued from page 56)

effect is negligible in pentodes. The shunting reactance between V3 and V2 is the sum of the output capacitance of V3, the input capacitance of V2, and stray capacitance. The gain of V2 is ignored in this case. Using constants from the tube manual and assuming 10- μ f stray capacitance, we find a 265,000-ohm coupling resistor may be used. This permits V3 to develop a gain of 242—about seven times more than is required in the specifications. The additional gain available from V3 is useful in overcoming circuit losses which may be caused by reduced operating voltages and component ageing.

Feedback and motorboating

Degeneration and motorboating are likely to occur when three or more amplifier stages are operated in cascade from a common power supply. This is caused by the plate circuits being coupled through the impedance of the power supply and is eliminated by using a decoupling filter Rf and Cf in the plate circuit of V3.

In a.f. circuits, decoupling constants are selected by making Rf equal to one-tenth the value of the coupling resistor—greater where power supply voltage permits. The decoupling condenser is selected to have a reactance of Rf/20 or less.

This method of designing decoupling filters is restricted to a.f. circuits. Reasons for this will be given in the next article which will cover amplifiers having a range of 6 mc.

UNIVERSAL D.C. SUPPLY

Most surplus radio equipment is designed to operate from either 12-, 24-, or 28-volt d.c. power supplies. Much of this can be used in mobile amateur and emergency stations with few changes in the circuit or control systems. Such equipment can be operated from its original dynamotors or vibrapack supplies without troublesome alterations or conversions.

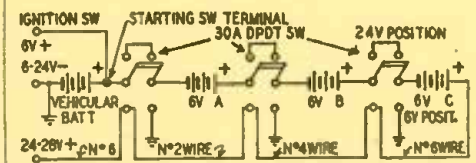

If 12-volt equipment is used, install a 6-volt storage battery in series with the vehicular 6-volt battery. Use a s.p.d.t. switch in place of the d.p.d.t. unit between batteries A and B. For 24- to 28-volt equipment, use 3 auxiliary storage batteries and switches as shown. The batteries are in series for 24-volt operation and in parallel for 6-volt service, charging from the automobile generator. The wire sizes shown on the diagram are the smallest that should be used under normal conditions.

C. A. LANPHEAR,
Waterloo, N. Y.

HEATHKIT SERVICE INSTRUMENTS

BUILD . . . LEARN . . . SAVE

Ideal for Schools, Training Courses,
Laboratories—Service Shops, Hobbyists.

HEATHKIT

SIGNAL GENERATOR KIT

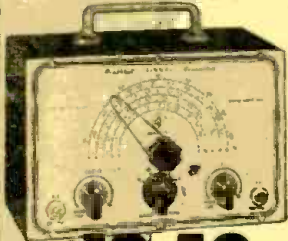

\$19.50

NOTHING ELSE
TO BUY

Every shop needs a good signal generator. The Heathkit fulfils every servicing need, fundamentals from 150 Kc. to 30 megacycles with strong harmonics over 100 megacycles covering the new television and FM bands. 110 V 60 cycle transformer operated power supply.

400 cycle audio available for 30% modulation or audio testing. Uses 6SN7 as RF oscillator and audio amplifier. Complete kit has every part necessary and detailed blueprints and instructions enable the builder to assemble it in a few hours. Large easy to read calibration. Convenient size 9" x 6" x 4 3/4". Weight 4 1/2 pounds.

HEATHKIT SINE AND SQUARE WAVE



\$34.50

NOTHING ELSE
TO BUY

AUDIO GENERATOR KIT

The ideal instrument for checking audio amplifiers, television response, distortion, etc. Supplies excellent sine wave 20 cycles to 20,000 cycles and in addition supplies square wave over same range. Extremely low distortion, less than 1%, large calibrated dial, beautiful 2 color panel, 1% precision calibrating resistors, 110 V 60 cycle power transformer, 5 tubes, detailed blueprints and instructions. R.C. type circuit with excellent stability. Shipping weight 15 pounds.

HEATHKIT SIGNAL TRACER KIT



\$19.50

NOTHING ELSE
TO BUY

Reduces service time and greatly increases profits of any service shop. Uses crystal diode to follow signal from antenna to speaker. Locates faults immediately. Internal amplifier available for speaker testing and internal speaker available for amplifier testing. Connection for VTVM on panel allows visual tracing and gain measurements. Also tests phonograph pickups, microphones, PA systems, etc. Frequency range to 200 Mc. Complete ready to assemble. 110 V 60 cycle transformer operated. Supplied with 3 tubes, diode probe, 2 color panel, all other parts. Easy to assemble, detailed blueprints and instructions.

Small portable 9" x 6" x 4 3/4". Wt. 6 pounds. Ideal for taking on service calls. Complete your service shop with this instrument.

HEATHKIT HIGH FIDELITY AMPLIFIER KIT

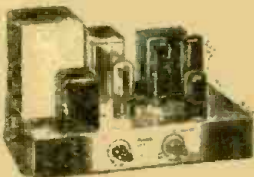

\$14.95

NOTHING ELSE
TO BUY

Build this high fidelity amplifier and save two-thirds of the cost. Push pull output using 1619 tubes (military type 6L6's), two amplifier stages using a dual triode (6SN7), and a phase inverter give this amplifier a linear reproduction equal to amplifiers selling for ten times this price. Every part supplied; punched and formed chassis, transformers (including quality output to 3.8-15 ohm voice coil), tubes, controls, and complete instructions. Add postage for 20 lbs. 12" PM speakers for above. \$6.95

NEW 1948 HEATHKIT 5 INCH OSCILLOSCOPE KIT



A necessity for the newer servicing technique in FM and television at a price you can afford. The Heathkit is complete, beautiful two color panel, all metal parts punched, formed, and plated and every part supplied. A pleasant evening's work and you have the most interesting piece of laboratory equipment available.

Check the features—large 5" 5B7 tube, compensated vertical and horizontal amplifiers using 6SJ7's, 15 volts to 30 M cycle sweep generator using 884 gas triode, 110 V 60 cycle power transformer gives 1100 volts negative and 350 volts positive.

Convenient size 8 1/2" x 13" high 17" deep, weight only 26 pounds.

All controls on front panel with test voltage and ext. syn post. Complete with all tubes and detailed instructions. Shipping weight 35 lbs.

Order today while surplus tubes make the price possible.

\$39.50

NOTHING ELSE
TO BUY

The NEW HEATHKIT VACUUM TUBE VOLTMETER KIT



The most essential tool a radio man can have, now within the reach of his pocketbook. The Heathkit VTVM is equal in quality to instruments selling for \$75.00 or more. Features 500 microamp meter, transformer power supply, 1% glass enclosed divider resistors, ceramic selector switches, 11 megohms input resistance, linear AC and DC scale, electronic AC reading RMS. Circuit uses 6SN7 in balanced bridge circuit, a 6H6 as AC rectifier and 6X5 as transformer power supply rectifier. Included is means of calibrating without standards. Average assembly time less than four pleasant hours, and you have the most useful test instrument you will ever own. Ranges 0-3, 30, 100, 300, 1000 volts AC or DC. Ohmmeter has ranges of scale times 1, 100, 1000, 10M and 1 megohm, giving range .1 ohm to 1000 megohms. Complete with detailed instructions. Add postage for 8 lbs.

\$24.50

NOTHING ELSE
TO BUY

HEATHKIT CONDENSER CHECKER KIT



A condenser checker anyone can afford to own. Measures capacity and leakage from .00001 to 100 MFD on calibrated scales with test voltage up to 500 volts. No need for tables or multipliers. Reads resistance 500 ohms to 2 megohms. 110V 60 cycle transformer operated complete with rectifier and magic eye indicator tubes.

Easy quick assembly with clear detailed blueprints and instructions. Small convenient size 9" x 6" x 4 3/4". Weight 4 pounds. This is one of the handiest instruments in any service shop.

\$19.50

NOTHING ELSE
TO BUY

A WORD ABOUT HEATHKIT INSTRUMENTS

All Heathkit service instruments are supplied complete in every way—grey crackle cabinets, 2 color calibrated panels, all tubes, test leads (where required) etc. All are 110 V transformer operated. Calibrations are complete and exact, 1% precision resistors are supplied where needed.

Heath engineers are ready to assist and advise. Heathkits are sold direct to customer, order from this ad. All are guaranteed.



The **HEATH COMPANY**
DEPT. C • BENTON HARBOR, MICHIGAN

SAVE \$ ON RADIO SURPLUS

ATTENTION: Prospectors, Explorers for Hidden Treasures!

Do you seek hidden treasures or rare metallic ores? If so, construct a U.S. Army Type of Metallic Mine Detector from these U.S. Army Mine Detector Amplifiers that we are offering at



ridiculously low prices. Complete Amplifier (as illustrated) (less tubes and batteries) with Battery case and cables. Cables, head-phone cord and jack (no phones). Complete Army wiring diagram. U.S. Army DETECTOR SET Amplifier Type ANPMS-1, C-2, 49 as described. Only **\$2.49**

No C.O.D.'s. Eveready 45 volt batteries No. 482, \$1.65 ea., 6 volt A. 73c. 2-IN5 tubes, 95c ea.

U.S. SIGNAL CORPS 5 METER SHORT WAVE XMTRS.

(72.2Mc) XMTRS and TUBE only, less mike, batteries and antenna. One 1 1/2 volt dry cell and 67 1/2 volts of B operates it. Just attach di-pole, key or mike, connect the batteries and it's ready to use. Signal Corps spec. wired with silvered wire, mica condensers, and precision resistors. Highly stable circuit with Lo-Loss silvered inductance. (Adjustable Padder) Schematic supplied. Converts easily to walkie-talkie and Ham bands. **\$3.25**

SELENIUM RECTIFIERS

Lots of 12.....65c Single Lots.....75c



GENUINE SIGNAL CORPS FEATHER-WEIGHT HEADPHONES WITH CORD AND PLUG 2000 OHMS—8000 OHMS IMPEDANCE.....\$1.00

SPRAGUE—CORNELL—DUBILIER OIL FILLED FILTER CONDENSERS

1.—MFD—1000 working volts. 4 for.....\$1.00

WEBSTER RECORD CUTTING HEAD

These units are all brand new and were made for a nationally advertised manufacturer to be in their quality Home Recording Radios. Size 1 1/2 x 2 1/2 ready to fit your cutting arm or bracket. SPECIAL.....\$2.95

3 BAND ALL-WAVE DIAL 6" DIAMETER.....75c

AMPLIFIER CHASSIS. SIZE 18"x8"x2 1/4". BLUE CRACKLE FINISH DRILLED FOR CONDENSERS—TRANSFORMER AND SOCKETS.....85c

STROMBERG-CARLSON, 3 BAND ALL-WAVE TUNING UNIT COMPLETE WITH TRIMMERS, BY-PASSES AND BAND SWITCH, READY TO INSTALL—DIAGRAM, etc.....\$3.75

8 OR 9 GANG PUSH BUTTON TUNING UNIT (PLEASE SPECIFY). COMPLETE WITH BUTTONS.....25c

24 VOLT D.C. AIRCRAFT MOTOR. APPROX. 1/8 H.P. ALMOST NEW.....\$1.50

U.S. AIR FORCE MICA COND. ASST. 100 PCS. \$1.25

Low-Loss-Short Wave Variable Condensers

1/4" Shaft Type
3 Plate—12-15 MMFD.....15c
5 Plate—20 MMFD.....20c
9 Plate—30-40 MMFD.....25c
14 Plate—35-60 MMFD.....35c
27 Plate—100-110 MMFD.....45c
37 Plate—150 MMFD.....50c
38 Plate—150-185 MMFD.....55c
53 Plate—210-21 MMFD.....60c

Lock Type Air Trimmer Variable Condensers

3 Plate—12-15 MMFD.....10c
5 Plate—20 MMFD.....11c
7 Plate—28-30 MMFD.....13c
8 Plate—30-35 MMFD.....13c
10 Plate—40 MMFD.....14c
13 Plate—50 MMFD.....17c
14 Plate—50 MMFD.....20c
20 Plate—90-100 MMFD.....25c
27 Plate—100-110 MMFD.....35c

3 BAND RADIO SET CHASSIS short wave continuous to broadcast. These chassis are incomplete. Manufacturer started them, went bankrupt. Chassis has variable condenser, filters, 6 tube super-het, all filament wiring complete. By-pass condensers, resistor, padders, band-changing switch, tone control, volume control, all wired ready, less transformers less 1F (IF 50c each, extra). This is for straight AC; may be converted for AC-DC.....\$2.50 each

6 TUBE 3 BAND AC-DC CHASSIS complete with filter condensers, volume control, dial drive, tone control, band switch, by-pass condensers, resistors, sockets, all wired ready for use with phone attachment (1F 50c each, extra).....\$2.00

SIGNAL CORPS FLEX. HOOK-UP WIRE ASST. contains approx. 150 ft. ast. colors, glass insulation, 1 lb.....25c

GENERAL ELECTRIC 60 CYCLE WATT HOUR METERS, slightly used, perfect condition, same as used in your home, 110-125 volts, 5 Amperes \$3.50 10 Amperes.....\$4.50. Glass enclosed \$1.00 extra



PHILCO MAGNETIC RELAY TAP SWITCH. Operates on 6 V DC—15 V AC. When contact is made relay operates rotary contact switch to 20 different contacts. Brand new.....80c

Philco rotary tap tone control, 3 position, including condensers. Only 1 wire to connect to grid of audio tube, 1/4" shaft.....25c

U.S. AIR FORCE RESISTOR ASST. 1/4-1/2-1 WATT—100 PIECES.....95c

OIL FILLED BY-PASS CONDENSER asst. removed from govt. apparatus—electrically perfect. dual 1-600 volt—5-600 volt. 25 piece asst.....\$1.00

I. C. A. 30 MH RF CHOKE.....25c

TELEVISION OR OSCILLOSCOPE POWER TRANSFORMER for use up to 5" tubes, 117 V. pri. 60 cy. 1-2 1/2 V-25 amp., 2-5 V 2 amp., 1-470 V-10 MI-1-750 V-CT—60 M.....\$2.95

GRIND YOUR OWN CRYSTALS—Pure Brazilian Quartz, all sizes and thicknesses—1/2 lb. package \$1.00

NATIONAL Velvet Vernier Dial Attachment—1/4" shaft—converts any dial to slow motion vernier.....75c

340 DEGREE DIAL with 10 push button attachment—1/4" shaft—Ideal for Xmitters—Sig Gen. or Osc. 49c

YAXLEY BAND SWITCHES—3 gang 3 posit. 3 band.....30c 5 gang 5 posit. 4-5 band.....40c

TRIMMER-PADDER ASST.—all Isolantite—singles, dual, triples—100 asst. pieces.....\$2.25

Signal Corps V. T. I receiving tubes \$1.00 per doz

Walkie-Talkie Telescoping Aerials—extends 36" 75c

MAGNAVOX DYNAMIC SPEAKERS—12"—1000 ohm \$3.95—8"—10,000 ohm.....\$4.35



P. A. SYSTEM WALL SPEAKER BDX, 8" diameter covering screen grille for hospital, factory or school installation. Will take up to 6" speakers, Each.....35c Lots of 25, each.....25c

Radio Hardware, nuts, bolts 632-832 solid brass cadmium plated—\$7.00 value. 4 lbs. for.....\$1.00

Spaghetti Assortment.....75c

SIGNAL CORP. TRANS. KEYS.....49c

4 PRONG WAFER SOCKETS—\$1.49 per C; 3c each

ISOLANTITE OCTAL WAFER SOCKETS—\$4.25 per C; 6c each

ISOLANTITE UNDER PANEL CLAMP SOCKETS—\$4.50 per C; 5c each

PHILCO 4 MF—800 V—1 1/2" CAN CONDENSER—\$8.00 per C; 10c each

W—L—10 WATT 1,000 OHM POWER RHEOSTAT 20c each

5-5 PRONG WAFER BAKELITE SOCKETS. \$2.50 per C

100 ASST. SOCKETS—4.5-6-7-OCTAL—\$3.50 per C

IRC—1,000 OHM WIRE WOUND PTDENT.—15c

30 HY-FILTER CHOKE SHIELD—49c; UN.—39c

100 ALLEN BRADLEY—1W—1/2" MEG RESIS. \$1.25

100 ERIE—1 WATT—2,000 OHM RESIS.....\$1.15

10 WIRE WOUND RES. KIT. 5-50 WATT ASST. 49c

2 METER RF CHOKES.....\$1.15

PHONO PICK-UP REST. RUBBER—1 HOLE M.T.G. 6c

YAXLEY 2,000 OHM WIRE WOUND RHEOSTATS 49c each.....\$1.00 per doz.

RCA-VICTOR NEEDLE CAPS—2 PIECE TOP & BOTTOM.....10c ea.

CARTER WIRE WOUND C.T. VARIABLE 20 OHM RECTIFIERS.....\$1.00 per doz.

G.E. TAPPED VOLTAGE DIVIDER—200 WATT—250 OHM—MOUNTED ON ASBESTOS BASE—TAPPED AT 180-205 OHMS.....25c

RCA 6 OHM POWER RHEOSTATS.....39c

RCA RUNNING BOARD AUTO AERIAL.....49c

PHILCO AUTO SUPPRESSORS—\$5.00 per C; 7c ea.

30 WATT—6L6 BEAM POWER AMPLIFIER KIT. COMPLETE KIT OF PARTS WITH ALL NECESSARY PARTS—TUBES—READY TO ASSEMBLE AND WIRE—NOTHING ELSE TO BUY—BUT SPEAKER AND MIKE. CHASSIS—20" LONG x 8 1/2" WIDE—5" HIGH CADMIUM PLATED STEEL EXTRA HEAVY PLATE SUPPLY—IS PROVIDED BY AN EXTRA HEAVY TRANSFORMER FILTER. BY PASS AND FILTER CONDENSERS. SOCKETS ALL READY MOUNTED ON CHASSIS. VOLUME AND TONE CONTROLS WITH SEPARATE AC SWITCH ARE PROVIDED. CIRCUIT IS THE LATEST TYPE OF PHASE INVERTER SYSTEM USING 1-5U4, 2-6L6, 1-6C5, 1-6SJ7, 1-6N7. CHASSIS HAS AMPLE ROOM TO WORK ON OR ADD MORE TUBES—TERMINAL STRIPS FOR MOUNTING RESISTORS, ETC., ARE ALSO PROVIDED, AND ALL PARTS ARE SIGNAL CORPS SPEC. BRAND NEW, NEVER USED BEFORE. A LARGE PICTORIAL DIAGRAM IS PROVIDED SO THAT A NOVICE MAY BE ABLE TO ASSEMBLE THIS KIT WITH EASE, MERELY BY FOLLOWING THE POINT TO POINT CONNECTIONS THAT ARE OUTLINED ON THE PRINT. COMPLETE 6L6 KIT, LESS SPEAKER.....\$18.95

RADIO EXPERIMENTER'S SURPRISE PACKAGE—CONTAINS BY PASS & FILTER CONDENSERS, SHORT WAVE TUNING UNITS, POWER AND AUDIO TRANSFORMERS, SOCKETS, RESISTORS, CHASSIS HARDWARE. OVER 15 LBS. OF VALUABLE PARTS.....\$4.95

TUBES—6SN7—45c; 53—39c; 2A7—39c; 55—39c; 117L7—59c; 27—25c; No. 15, same as No. 224—20c DRY ELEC. FILTER COND. ASST. CONTAINS 10 PIECES ALL BRAND NEW 150-450V.....\$1.10 6 ASST. WET ELECTROLYTIC CONDENSERS 59c

SIGNAL GENERATOR

(Continued from page 37)

(See Table II). The coil which covers the range from 400 to 550 kc has a 500- μ f fixed condenser across it to extend the low-frequency range.

There are four coils, covering a range from 100 kc to 18 mc. Only the 400-550-kc coil is shown. As shown, a lead from the grid of the 6K8 is run to the open terminal of one of the switches in each push-button unit, and one from the plate to that of the other switch. The hot ends of the two coils in each unit are connected to the moving arms of the switches, and the other ends of the coils to ground. The other open terminals of the switches are connected directly to grounds.

In the normal, or open, switch position, all coils are shorted to ground. Pushing any button from 2 to 5 puts the corresponding coil in the circuit and disconnects any coil that is already in the circuit. (Caution: do not push more than one coil button at a time. More than one coil in the circuit causes incorrect calibration.)

To save the work of winding, standard 175-kc, 455-kc, broadcast and short-wave coils of the commercial type may be used, with some change in the ranges. By removing turns or increasing their

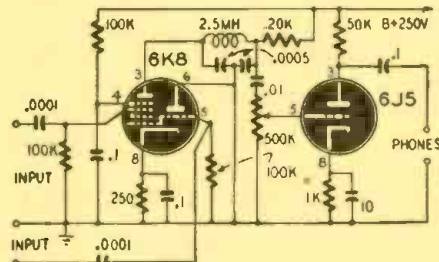

Fig. 3—Circuit of the calibration monitor.

number the proper frequencies may be covered and good oscillation characteristics obtained.

To permit changing tubes without having to recalibrate the oscillator, a 5-15- μ f trimmer condenser is connected in parallel with the main tuning condenser.

A 1-ma meter connected between the grid leak and the cathode of the 6K8 will read the oscillator grid current, which should be about 100 to 150 μ a. This current should vary as little as possible over the entire frequency range.

The oscillator may be calibrated by tuning the signal in on a properly aligned communications receiver and marking the frequency on the dial. Or the simple calibration monitor shown in Fig. 3 may be used in conjunction with an already calibrated signal generator. This monitor uses a 6K8 as a mixer and a 6J5 or 6C5 as an audio amplifier. The unmodulated signals from the oscillator and signal generator are injected into the two grids, and the signals listened to on the phones. When the signals zero beat, the frequency of the oscillator is the same as the signal generator's. By using this method, the oscillator can be calibrated point by point.

MINIMUM ORDER \$2.00 — NO C.O.D. SHIPMENTS — PLEASE INCLUDE POSTAGE
NEWARK SURPLUS MATERIALS CO. 324 Plane Street Dept. C Newark 1, N. J.

New 1948 and F.M. Manuals

BIGGEST BARGAIN IN RADIO DIAGRAM

Make these two new mammoth volumes your money-saving source for data on all recently released receivers. Learn about modern circuit developments, be ready to repair any new radio no matter how complex. You pay only \$2 for each of these large manuals. With these two volumes on your workbench there is nothing else to buy, nothing else to pay—a whole year of radio diagrams and service data yours for a couple of dollars total. Again **Supreme Publications** beats all competition and gives radio servicemen greatest bargains in service information. Other volumes for previous years described below. **No-risk** examination granted to servicemen.



F.M. and Television

Use this new giant manual of factory instructions for troubleshooting, repairing, and alignment of any 1947-1948 F.M. and Television set. Covers every popular make, including F.M. tuners, AM-FM combinations, and all types of television receivers. Detail circuit diagrams, theory of operation, test hints, alignment data, including both meter and oscilloscope methods. This is the material you need to fix any modern F.M. or Television set. Don't turn this profitable work away for lack of knowledge and information. Use this newest Supreme manual to save time and money on your very next F.M. job. Data presented on 192 large pages, 8½x11 in. Sturdy, manual-style binding. Just published. Special price.. **\$2.00**

New 1948 Manual

Be prepared to repair quickly all new 1948 receivers. In this big single volume you have clearly-printed, large schematics, needed alignment data, replacement parts lists, voltage values, and information on stage gain, location of trimmers, and dial stringing, for almost all recently released sets. Makes toughest jobs amazingly easy. Find faults in a jiffy. Speed-up all repairs. The time saved on your next job will pay the \$2 bargain price for the complete manual—after that you use it FREE. A worthy companion to the 7 previous volumes used by over 120,000 shrewd radio servicemen. New manual covers models of 42 different manufacturers. Giant size: 8½ x 11 in. 192 pages + index. Manual-style binding. Price, only.. **\$2.00**

FIND ALL RADIO FAULTS DOUBLE-QUICK

You can speed-up and simplify radio repairs with SUPREME PUBLICATIONS Manuals. Service radios faster, better, easier, save time and money, use these most-often-needed diagram manuals to get ahead, earn more per hour. For the remarkable bargain price (only \$2 for most volumes) you are assured of having in your shop and on the job, needed diagrams and other essential repair data on 4 out of 5 sets you will ever service. Every popular radio of all makes from old-timers to new 1948 sets, including F.M. and Television, is covered. Clearly printed circuits, parts lists, alignment data, and helpful service hints are the facts you need to improve

your servicing ability. Save hours each day, every day, begin to earn more by making repairs in minutes instead of hours. Let these manuals furnish you with diagrams for 80% of all sets. There is no need to spend large sums for bulky, space-wasting manuals, or to buy additional drawings every few weeks; be wise, use SUPREME Manuals to get the most in diagrams and service data for the smallest cost. Be money ahead with Supreme Publications.

Models Made by:

R.C.A., Zenith, Philco, Sears, Fada, Emerson, Belmont, Detrola, Crosley, G.E., Westinghouse, Arvin, Majestic, Stewart-Warner, Admiral, Delco, Stromberg-Carlson, Western Auto, Sparton, Motorola, and many others.

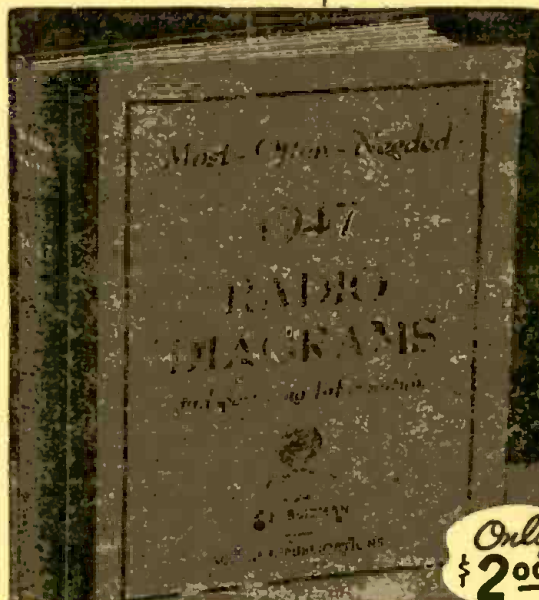

Use coupon to order manuals for examination
Include all popular sets from 1926 to 1948.

Select Supreme Diagram Manuals and Record Changer Books you want to examine. Send the convenient no-risk trial coupon. Use the manuals in your own home or shop for 10 days at our risk. Decide for yourself that Supreme Publications are the greatest values in service data. You must be completely satisfied, or return manuals and receive your money back.

Record Changers Manuals

Post-War Models

Service expertly all modern (1945-1948) record changers. Just follow simplified factory instructions to make needed adjustments and repairs. Hundreds of photographs and exploded views. Large size: 8½ x 11 inches. 144 fact-filled pages. Price only \$1.50, postpaid.

Pre-War Models

Just what you need to repair quickly thousands of pre-war (before 1942) automatic record changers, manual units, pick-ups, wireless oscillators, recorders, and combinations. Hundreds of mechanical and electrical diagrams. 128 large pages; size 8½ x 11 inches. Price, only \$1.50.

See Your Radio Jobber or Send Coupon →

Supreme Publications

PUBLISHERS OF RADIO BOOKS, MANUALS, AND DIAGRAMS

9 South Kedzie Ave.

Chicago 12, Illinois

RADIO-CRAFT for MAY, 1948

NO RISK TRIAL ORDER COUPON

SUPREME PUBLICATIONS, 9 S. Kedzie Ave., Chicago 12, ILL.

Ship the following manuals on trial under your guarantee of satisfaction or money-back.

- New F.M. and Television Manual.. \$2.00
- Post-War Record Changers..... 1.50
- Pre-War Record Players & Recorders 1.50

1948
 1947
 1946
 1942
 1941
 1940
 1939
PRICED AT ONLY \$2 EACH

- I am enclosing \$....., send postpaid.
- Send C.O.D. I am enclosing \$..... deposit.

1926-1938 — \$2.50

Name:

Address:

Our 26th Year



ATTENTION!! ALL SCR-522 OWNERS

Remote Control Boxes for SCR 522's. Brand New in Original Packing; Consists of 5 push button switches, 5 Western Electric Pilot Assemblies, with Pilot Bulbs and Dimmer, and lever Switch all finished in Black Crackle. Order yours Today for only **\$1.25 ea.**

Antenna Plug 46-PS-1 for 522A 15c ea.

STEEL CHASSIS	
10 x 17 x 3.....	\$1.38
8 x 10 x 3.....	87c
7 x 13 x 2.....	96c
10 x 14 x 3.....	\$1.35
11 x 17 x 8.....	\$1.86
13 x 17 x 3.....	\$2.22
7 x 7 x 2.....	63c
4 x 17 x 3.....	99c

STEEL CANS AND BOXES	
4 x 4 x 2.....	68c
4 x 5 x 3.....	78c
6 x 6 x 6.....	99c
12 x 7 x 6.....	\$1.68
15 x 9 x 7.....	\$2.35
11 x 12 x 8.....	\$2.25

% INCH STEEL PANELS	
5/8 x 19.....	87c
7 x 19.....	96c
8 1/4 x 19.....	\$1.10
10 1/2 x 19.....	\$1.22
12 1/2 x 19.....	\$1.46
14 x 19.....	\$1.62

% INCH ALUMINUM PANELS	
5/8 x 19.....	\$1.74
7 x 19.....	\$1.84
8 1/4 x 19.....	\$2.25
10 1/2 x 19.....	\$2.87

All above Black Crackle finish. Gray panels to order.

RELAYS CS—DIFFERENTIAL RELAY

Dual coil with armature pivoted between coils. All contacts normally open. Operates 220-250 Volts. 6000 Ohms each coil, contacts S.P.D.T. Controls rated 2 amps. at 110 VAC. Ideally suited for balanced or bridge type circuits where limited current or power is available. Will withstand 12 G Vibration up to 60 cycles at 35,000 feet altitude. **95c**



G.E. 2500 ohm 4 Ma SPDT 5 prong plug in type Hermetically sealed. Brand New \$.95

CLARE TYPE RY-2 Sensitive Relay 6500 Ohm SPDT Coil Wound with 35700 Turns of No. 39 Ea.95



TUBES

5BP1 CR Tubes 5" Green screen brand new.....	\$1.45
5BP4 CR Tubes 5" White screen brand new.....	1.43
3BP1 CR Tubes 3" Green screen brand new.....	1.45
832A Dual Beam Power Tetrode	2.15
6J6 H.F. Twin Triode50
3C24 Triode 100W Power output 6.3V Fil. @ 8 amp. Max. Plate 2000V @ 75 Ma. 39 ea. 10 for 3.50	

OIL FILLED CONDENSERS

1 Mfd. 600 VDC...35c	1 Mfd. 330 VAS. \$1.98
2 Mfd. 600 VDC...35c	0.1 Mfd. 7500 VDC. 1.50
10 Mfd. 600 VDC...98c	2x.1 Mfd. 7000 VDC. 2.00
2 Mfd. 1000 VDC...69c	.02 Mfd. 8000 VDC. .98

SPECIAL 16 Mfd. 400 VDC W.E.98
1 Mfd. 5000 VDC Solar	2.95

SELENIUM RECTIFIERS

FEDERAL TYPE Half wave 100 Ma. size.....	.50
FEDERAL TYPE Half wave 200 Ma. size.....	.60

Wire Wound Potentiometer

100,000 ohm, precision made. G.R. type, 25 watt, 6" diam. **\$1.95** ter. Brand new.



METERS

5-0-5 AMPS. D.C. charge & discharge scale, 2" RD.....	\$.69
0-1 AMP. R.F. G.E., 2" Rd. 2.45	
100 AMP-6 volt D.C. 3" Scale 4 1/4" square Gray finish with 100 AMP. shunt	2.95

If not rated 25% with order, balance C.O.D. All prices F.O.B. our warehouse New York. No order under \$2.00. We ship to any part of the globe

LEEDS RADIO CO.

75 Vesey Street
Cortlandt 7-2612

Dept. RCS
New York City 7

Quality - Price - Dependability

BC-645A 450MC X-Mitter-Receiver

BRAND NEW Complete with Tubes including 2-7E6, 2-6F6, 2-955, 4-7F7, 4-7H7, and 1-WE 816A door knob. Can be easily converted for Phone or CW on 420-450Mc Bands.



\$7.95
Each

DYNAMOTOR 5047

D.C. input 27.0 volts at 1.75 amps.
D.C. output 285 volts at .075 amps.
Continuous Duty Rating. Brand New.

95c
each

DM-43A DYNAMOTOR. Manufactured by G. E. New. Input 24v @ 23 amps. 7500 RPM; output 515/1030/2/8 v @ 215/260 milliamps; filtered. **\$2.95** Special

ITEMS YOU MAY BE LOOKING FOR

1N 23A Xtal Diodes, 35c ea. 3 for.....	\$1.00
ARC-5 Silver Plated Banana Plugs. Per doz....	.10
De Jur Wire Wound Pot 20,000 ohms. 12 watt....	.49
RS-8 Octal Sockets. Low Loss08
110V Pilot Assemblies 1" Bull's Eye Red39
1/4 watt Bayonet Base Neons20
1/25 watt Bayonet Base Neons08

MICA CONDENSERS

.01—600V Postage Stamp	
.003—2000V Postage Stamp	
.006—600V Postage Stamp	

Each 5c
100 for \$4.75

OUNGER TRANSFORMER

as per Schematic

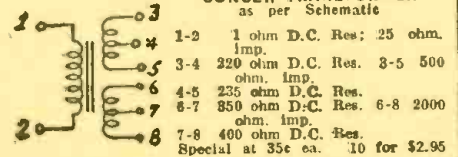

ing crystals (or properly biased diode tubes) connected oppositely and in parallel (Fig. 2). The a.f. currents are not rectified because they can flow in either direction. Each crystal has a fairly constant resistance when more than 0.5 volt is applied across it, but below this value its resistance rises sharply. When the voltage is very low, as it is when only background noise is present, there is practically no transmission. Medium and loud speech or music will pass freely, however, along with whatever noise may be present at the time. Such noise is then masked effectively by the desired signal.



Fig. 2—Parallel diodes control input levels.

This system reduces noise and requires only a simple circuit. Unfortunately, the output cannot sound exactly like the input since the transmission is non-linear. Harmonics and beats are introduced along with the original frequencies. However, spurious responses are at least one octave removed from

NOISE REDUCTION

(Continued from page 23)

its original frequency. Filters can therefore be used to eliminate the undesired harmonics.

Two filters are used for maximum effect, one at the input and the other at the output of the channel. Each is designed to attenuate response outside of a given octave. To cover the whole audio range, many separate octave-filtered channels in parallel must be used. However, the higher frequencies carry most of the noise, so the lower sound register (up to several kc) may be transmitted through a separate parallel channel with no need for noise reduction.

For home reproduction of phonograph selections two channels are sufficient. One can pass up to 3 kc with no noise reduction. The other can be an octave-filtered channel transmitting 3-6 kc. For still higher fidelity, more channels are required. One circuit has been designed with four channels. Three of them are filtered to transmit the following octaves

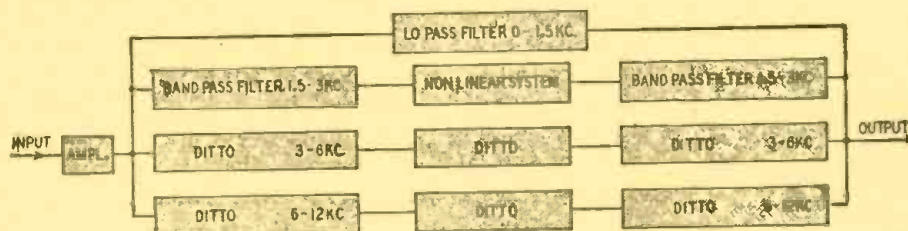

Fig. 3—Olson noise reducing system. Only two channels are required on home phonographs.

respectively: 1.5-3 kc; 3-6 kc; 6-12 kc. The other channel is a low-pass network which transmits frequencies below 1.5 kc. Block diagram appears in Fig. 3.

Advantages claimed for the octave-transmission system are: There is no audible "swish" due to time constants because the circuit operates instantaneously. Furthermore, the output level is identical with the input for volume greater than the threshold value. Finally, the circuit requires practically no maintenance and is easy to operate.

The author will be pleased to answer any questions in connection with the above article. Simply address I. Queen, care of this magazine.

POLARITY TESTER

On a.c. operated instruments, it is often necessary to determine the line polarity to avoid shocks and possible damage to meters and components. Determine which prong of the line plug must be grounded and solder one terminal of a small neon lamp to it. To the other terminal of the neon lamp attach a short piece of wire with an insulated phone tip at the end. Insert the plug into the outlet and touch the phone tip to the grounded plate or screws of the outlet box. If the lamp lights, reverse the plug.

The lamp is very small and fits neatly into a recess cut in the body of the plug. The plug is wrapped with transparent tape to hold the lamp firmly.

J. SIMRIN,
New York, N. Y.

WORLD-WIDE STATION LIST

Edited by ELMER R. FULLER

REPORTS were received this month from Gil Harris of Massachusetts; Charles Edwards of Massachusetts; Charles H. Fuller of New York; the Department of State; and the Canadian Broadcasting Corporation. Several new frequencies are now in use by the U. S. shortwave stations. The log this time went to press before the information was received and therefore the necessary changes were not made. The following information supplements that given in the list:

WRUW, Boston, on 11.720 to Central America from 1730 to 1900 and 2000 to 2400 hours, EST. WRUX, Boston, 17.750 to Europe from 1435 to 1715 hours. WLWR2, Cincinnati, 15.330 from 1800 to 2400 to South America. KCBF, Delano, 9.700 to Japan and China from 0400 to 0930 hours. KCBR, Delano, 9.750 to the Philippines and the East Indies from 0400 to 1005 hours. KCBF, Delano, 11.810 to Alaska from 2000 to 2200 and 2215 to 2400. KNBA, Dixon, 6.060, to

Hawaii from 0400 to 1005. KNBI, 6.120, to China and Japan from 0400 to 1005. KNBX, Dixon, 11.790, to China and Southeastern Asia from 0400 to 1005.

KNBX, Dixon, 15.250, to South Pacific islands from 0030 to 1700 and to South America from 1900 to 2400. WCDA, New York City, 11.830 to Mexico from 2000 to 2200. WCBN, New York City, 15.270 from 1115 to 1630 to Europe and to South America from 1645 to 1700. WCBX, New York City, 17.830 to Europe from 1115 to 1630; to South America from 1645 to 1700 and 1800 to 1900, and to Brazil from 2000 to 2200. WNRI, New York City, 18.160, to Europe from 1000 to 1800. WCRC, New York City, to Europe from 1100 to 1630; to South America from 1645 to 1700. KGEX, San Francisco, 11.730 to the Philippines from 0030 to 0345 and to the East Indies from 0400 to 1005. KWIX, San Francisco, 11.860, to Japan and Korea from 0400 to 0930. WGEO, Schenectady, 15.330, to Europe from 1115 to 1730.

Location	Station	Freq.	Schedule	Location	Station	Freq.	Schedule
UNITED STATES							
Boston, Mass.	WRUS	6.040	Mexican beam, 2000 to 2400	Boston, Mass.	WRUL	15.290	European beam, 1115 to 1715; South American beam, 1730 to 1900; Sundays to 1800
Boston, Mass.	WRUX	9.540	Central American beam, 1725 to 1800	Boston, Mass.	WRUX	17.750	European beam, 1135 to 1715
Boston, Mass.	WRUW	9.570	South American beam, 2000 to 2300	Boston, Mass.	WRUW	17.750	European beam, 1115 to 1430
Boston, Mass.	WRUS	9.570	European beam, 1430 to 1805	Boston, Mass.	WRUX	25.600	African beam, 1330 to 1700
Boston, Mass.	WRUW	11.720	Central American beam, 1730 to 1900; 2000 to 2400; Sundays, 1730 to 1800; 2000 to 2400	Cincinnati, O.	WLWS	6.080	West South American beam, 1900 to 2400
Boston, Mass.	WRUL	11.720	Central American beam, 2000 to 2400	Cincinnati, O.	WLWO	9.590	European beam, 1530 to 1700
Boston, Mass.	WRUW	11.730	European beam, 1435 to 1715	Cincinnati, O.	WLWS	9.700	South American beam, 1900 to 2400
Boston, Mass.	WRUA	11.790	European beam, 1430 to 1805	Cincinnati, O.	WLWS	11.700	European beam, 1515 to 1700
Boston, Mass.	WRUA	15.200	European beam, 1100 to 1400	Cincinnati, O.	WLW	21.700	North African beam, 1515 to 1700
Boston, Mass.	WBOS	15.210	European beam, 1100 to 1700; South American beam, 2000 to 2200	Cincinnati, O.	WLWR	11.710	South American beam, 1800 to 2400; Sundays 1900 to 2400
Boston, Mass.	WRUA	15.290	Central American beam, 2000 to 2400	Cincinnati, O.	WLW	11.790	South American beam, 2000 to 2200
				Cincinnati, O.	WLWK	15.250	European beam, 1200 to 1700

(Continued on page 64)

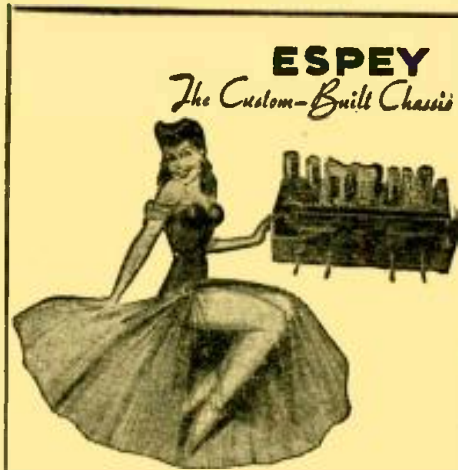

How many times have you wished you could replace that worn out AM set now housed in a beautiful, highly thought-of cabinet? At last it's possible—and at a price within the reach of everyone! The **ESPEY** line of custom-built chassis is designed for just such installations, as well as for custom-built and other special applications. Take the **ESPEY MODEL 7-B**, for instance. It's a top-quality AM-FM receiver, featuring high fidelity reception, illuminated slide rule dial, full tone control, and is wired for phonograph operation.

Its superheterodyne circuit contains 10 tubes plus a rectifier tube, and operates on 105/125 volts AC, 50/60 cycle. Furthermore, it's supplied ready to operate, with 10" speaker containing an Alnico No. 5 magnet, both AM and FM antennas, and all hardware needed to make the installation easy and complete.

For full details write to Dept. C

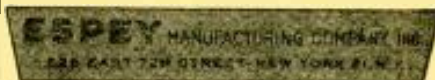

A LISTENING SHELL

An artillery shell that listens and records what it hears is the invention of three inventors in the New York area, Harvey Fletcher, John F. Muller and Karl D. Swartzel, Jr. The projectile was originally intended as a means for testing the possibility of producing audio-proximity fuzes for anti-aircraft shells, instead of the radio-proximity ones finally adopted. Compact, rugged microphones, hooked to recording apparatus, were installed in the noses of the shells to trace wavy lines representing the shells' own sounds, plus the noise of airplane motors which they might be approaching. The patent, No. 2,436,384, has been assigned to the Bell Telephone Laboratories.



Suggested by Glenn Parker, Whiteville, Tenn.

Frank BEAVER

"He services all the midget sets."

FLASHED

**DOWN — DOWN
GOES THE COST OF
TELEVISION**

**GENUINE BRAND NEW
R.C.A. TELEVISION KIT**



Now, for the first time you are offered a basic kit consisting of the finest essential components enabling you to build anything from a 7" to a 20" Television Receiver. These parts are the best the industry has to offer—All genuine R.C.A. Also included is a schematic diagram and a complete parts list of the minor components necessary to make up a complete TV receiver. Described and pictured below are the various components included in this sensational kit.

KIT CONSISTS OF:

- Deflection Yoke Type 201D1
- Width Control Type 201R1
- Horizontal Linearity Control Type 201R3
- Power Transformer Type 201T3
- Yoke Mounting Hood Type 201X1
- Focus Coil Type 302D1
- Vertical Output Transformer Type 204T2
- Filament Choke Type 204L1
- Television I.F. and Video Coil Kit Type 204X2
- Vert. Blocking-Oscillator Transformer Type 204T2
- Horiz. Blocking-Oscillator Transformer Type 204T3
- Horiz. Output Transformer Type 211T1

**SPECIAL
\$69.50
COMPLETE**

The parts in this kit, if purchased separately, would list at over \$139.00. Niagara saves you over 50%, or a big \$70.20. GET YOURS TODAY.

RADIO MAN'S SPECIAL

5" or 7" TELEVISION FOUNDATION KIT

HERE IS ONE OF THE BIGGEST BARGAINS EVER OFFERED IN TELEVISION FOUNDATION KITS.

This TELEVISION FOUNDATION KIT consists of the most essential (and expensive) parts needed in constructing a television receiver. Starting with the Hi. volt. power supply, for the scope, right through to the antenna. This kit contains: High voltage scope transformer (for 5" or 7" tube), 2X2 filament transformer, lo. volt. transformer for receiver, cathode ray filament transformer, filter choke, 6.3 filament transformer for 16 six volt tubes along with five volt transformer for the 5U4, the two hi. volt. filter condensers, blocking osc., transformer for all RF's sound and video I.F.'s, peaking coils and discriminator transformer. The rectifier tubes 2X2 and 5U4, the picture tube 5SP4, and an all aluminum dipole antenna are also included.

A 26 page instruction book, including a large 12 by 18 schematic diagram, theory of television, circuit functions, explanation of scanning, preliminary volt. measurements, parts lay-out and final adjustment of the television receiver which facilitates easy alignment without the use of elaborate test equipment comes with each unit.

If you are a radio man you will probably have all of the minor parts not included in this foundation kit. By following the classic schematic diagram and instructions you can thus build a television receiver at many dollars savings.

- The above Kit with parts as mentioned **\$34.75**
- The above Kit with 7EP4 for an additional **12.95**
- Remaining set of necessary tubes **14.95**
- Completely punched chassis for above Kit **5.50**

BRAND NEW 7EP4's

INDIVIDUALLY BOXED—STANDARD BRAND

A STEAL AT **\$17.95**

WRITE TODAY FOR OUR NEW TELEVISION FOLDER ON SPECIAL KITS, COMPONENTS, TUBES, AND OTHER TV SUPPLIES. BE SURE YOU ARE ON OUR SPECIAL TELEVISION MAILING LIST.

PLEASE PUT MY NAME ON YOUR TELEVISION MAILING LIST FOR SPECIAL TV BULLETINS.

NAME

ADDRESS ZONE.....

CITY STATE.....

NIAGARA RADIO SUPPLY CORP.

160 Greenwich St., New York City 6, N. Y.

WORLD-WIDE STATION LIST

(Continued from page 63)

Location	Station	Freq.	Schedule	Location	Station	Freq.	Schedule
Cincinnati, O.	WLWR	215.350	South American beam, 1800 to 2400; Sundays, 1900 to 2400	Washington	WWV	10.000	U. S. Bureau of Standards; continuously day and night
Cincinnati, O.	WLWR	115.350	European beam, 1300 to 1700	Washington	WWV	15.000	U. S. Bureau of Standards; continuously day and night
Cincinnati, O.	WLWR	215.850	North African beam, 1800 to 1700	Washington	WWV	20.000	U. S. Bureau of Standards; continuously day and night
Cincinnati, O.	WLWO	17.800	European beam, 1200 to 1515	Washington	WWV	25.000	U. S. Bureau of Standards; continuously day and night
Cincinnati, O.	WLWK	17.800	South American beam, 2000 to 2300	Washington	WWV	30.000	U. S. Bureau of Standards; continuously day and night
Cincinnati, O.	WLWS	121.850	European beam, 1200 to 1500	Washington	WWV	35.000	U. S. Bureau of Standards; continuously day and night
Cincinnati, O.	WLWS	221.850	North African beam, 1200 to 1500	U.S.S.R.			
Cincinnati, O.	WLWL	21.690	European beam, 1100 to 1700	Kiev		11.720	0700 to 0815
Delano, Cal.	KCBA	6.170	Guam-Philippine beam, 0400 to 0930	Konsermak		9.560	2100 to 2400
Delano, Cal.	KCBF	9.700	Japanese-Chinese beam, 0430 to 0930	Moscow		5.810	schedule unknown
Delano, Cal.	KCBR	9.700	Philippine-East Indies beam, 0400 to 1005	Moscow	RV15	5.340	2300 to 1000
Delano, Cal.	KCBR	15.180	South American beam, 1900 to 2400	Moscow		6.030	schedule unknown
Delano, Cal.	KCBA	15.150	Alaskan beam, 2215 to 0345	Moscow		9.680	1600 to 1745; 2315 to 2345
Delano, Cal.	KCBF	11.810	Alaskan beam, 2215 to 0345	Moscow		7.800	1300 to 1800; 1815 to 2100
Delano, Cal.	KCBA	21.460	South American beam, 1900 to 2400	Moscow		9.499	2300 to 0200
Dixon, Cal.	KNBA	6.060	Hawaiian beam, 0400 to 1905	Moscow		9.710	2300 to 0730
Dixon, Cal.	KNBI	6.120	Chinese-Japanese beam, 0400 to 1005	Moscow		11.620	1930 to 0800; 0600 to 0800; 0830 to 1300
Dixon, Cal.	KNBA	9.650	Hawaiian - Australian beam, 0230 to 0845; off Mondays	Moscow		11.780	0900 to 1000; 2000 to 2130; 2200 to 0100
Dixon, Cal.	KNBI	9.700	Chinese beam, 0230 to 0845	Moscow		11.880	0845; 1100 to 1600
Dixon, Cal.	KNBX	11.790	Chinese-Southeast Asia beam, 0400 to 1005	Moscow		11.880	1820 to 1930; 2000 to 2045
Dixon, Cal.	KNBX	15.250	South Pacific beam, 0630 to 1700; South American beam, 1900 to 2400	Moscow		15.320	0000 to 0500; 0530 to 0600; 0830 to 1100; 2300 to 2300
Dixon, Cal.	KNBI	17.770	South American beam, 2000 to 2300	Moscow		15.340	2200 to 0800; 1000 to 1100
New York City	WCBN	9.650	South American beam, 1900 to 2400	Moscow		15.320	0745 to 0815; 1820 to 1930; 2000 to 2130; 2300 to 0200
New York City	WNRX	9.670	Brazilian beam, 1800 to 1900; 2000 to 2300	URUGUAY			
New York City	WOOW	9.700	European beam, 1515 to 1800	Montevideo	CXA5	9.820	1530 to 2100
New York City	WCDA	11.730	Mexican beam, 2000 to 2300	Montevideo	CXA1	11.830	0800 to 2200
New York City	WNRX	11.830	European beam, 1400 to 1700	Montevideo	CXA1	11.900	1830 to 2115
New York City	WNRX	11.870	European beam, 1515 to 1800	VATICAN CITY	HVJ	5.370	1000 to 1100
New York City	WOOC	15.180	European beam, 1000 to 1400	VATICAN CITY	HVJ	11.740	0015 to 0025; 0630 to 0900; 1100 to 1145
New York City	WRCA	15.150	European beam, 1100 to 1700; Brazilian beam, 1800 to 1900; 2000 to 2300	VATICAN CITY	HVJ	15.130	0830 to 0930; 1100 to 1145
New York City	WCBN	15.270	European beam, 1115 to 1630	VENEZUELA			
New York City	WCRC	15.270	South American beam, 1900 to 2400	Barquisimeto	YV3RS	3.490	1630 to 2130
New York City	WNRE	15.230	European beam, 0500 to 1815	Barquisimeto	YV6RC	3.510	1300 to 2130
New York City	WNB	17.780	European beam, 1100 to 1400; South American beam, 1900 to 2400	Barquisimeto	YV3RN	4.090	0630 to 2200
New York City	WCBX		European beam 1115 to 1630; South American beam, 1645 to 1700; 1800 to 1900; Brazilian beam, 2000 to 2300	Caracas	YV5RY	3.380	0830 to 2230
New York City	WNR1	18.160	European beam, 1000 to 1800	Caracas	YV5RW	3.400	0630 to 2230
New York City	WOOW	21.500	European beam, 1100 to 1500	Caracas	YV5RX	3.500	0930 to 1400; 1530 to 2230
New York City	WCRC	21.570	European beam, 1100 to 1630; South American beam, 1645 to 1700	Caracas	YV5RS	3.530	0530 to 2230
New York City	WNR2	21.610	European beam, 1000 to 1500	Cere	YV1RY	4.770	1400 to 2130
New York City	WNRX	21.730	European beam, 1100 to 1830	Maracaibo	YV1RT	3.370	1730 to 2130
San Francisco	KGEI	9.530	Mid-Pacific beam, 0630 to 0530; Philippine beam, 0545 to 0930	Maracaibo	YV1RU	3.440	1900 to 2130
San Francisco	KWID	9.570	Chinese beam, 0700 to 1000	Maracaibo	YV1RV	4.750	1730 to 2130
San Francisco	KWIX	9.570	Alaskan beam, 2215 to 0345	Maracaibo	YV1RL	4.810	0630 to 2200
San Francisco	KGEI	9.670	South American beam, 2230 to 2400	Maracay	YV4RK	3.390	1800 to 2130
San Francisco	KBEX	11.730	Philippine beam, 0630 to 0845; Philippine - East Indies beam, 0400 to 1005	Merida	YV2RC	3.420	1800 to 2130
San Francisco	KWIX	11.860	Japanese-Chinese beam, 0400 to 0930	Puerto Cabello	YV4RQ	3.480	1700 to 2130
San Francisco	KWID	11.900	South Pacific beam, 0630 to 0830	Sae Christobal	YV2RN	4.830	1100 to 2130
San Francisco	KWID	17.760	South American beam, 1900 to 2400	Trujillo	YV1RO	3.310	1700 to 2130
San Francisco	KBEX	17.880	South American beam, 1900 to 2400	Valencia	YV4RP	3.460	1730 to 2130
Schenectady	WGEO	9.530	South American beam, 1900 to 2400	Valencia	YV4RO	4.730	1630 to 2130
Schenectady	WGEX	9.670	South American beam, 1900 to 2400	Valera	YV1RZ	4.840	1630 to 2145
Schenectady	WGEA	11.770	European beam, 1415 to 1805	YUGOSLAVIA			
Schenectady	WGEA	11.810	Brazilian beam, 2000 to 2300	Belgrade		9.420	0000 to 0230; 0630 to 0845; 1110 to 1125
Schenectady	WGEO	15.330	European beam, 1115 to 1730				
Schenectady	WGEX	17.880	European beam, 1100 to 1515				
UNITED STATES							
Schenectady	WGEA	21.590	European beam, 1115 to 1400				
Washington	WWV	2.500	U. S. Bureau of Standards; continuously				
Washington	WWV	5.000	U. S. Bureau of Standards; continuously day and night				

**"SPIRITED"
HANDY
TALKIE**



Simple way how to convert old Handy Talkie case into very "refreshing" utility.

—By Grego Banshuck

**WOOD
BASE**

Get Your ALLIED Catalog Now

172 Value-Packed Pages Including Everything New in Radio . . .

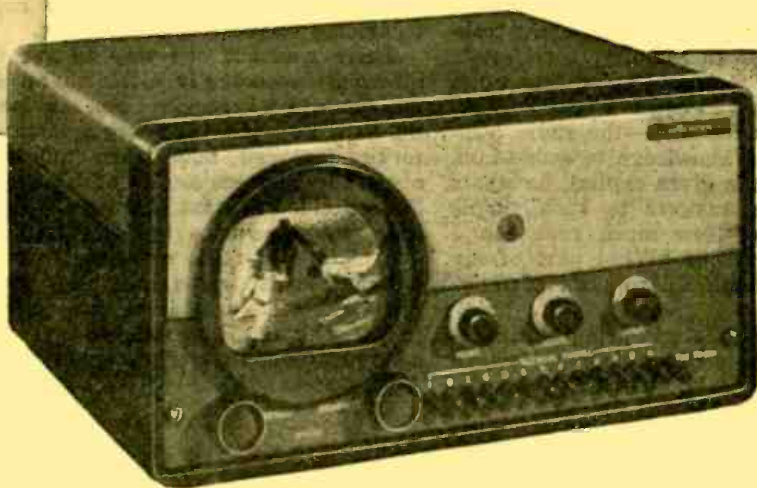

FIRST WITH TELEVISION by hallicrafters

Amazing Performance at Low, Low Cost!

Fully described in ALLIED'S latest Catalog—the new Hallicrafters Model T-54 Television Receiver for use in all television areas! Here's perfected, clear, sharp, bright Television at low, low cost. The 7" diameter viewing tube provides a brilliant picture 5½" long by 4" high—a full 23 square-inch picture area. Push-button tuning is factory pre-set to the 13 television channels. Receive the station in your area just by pressing the proper button. Easy to operate! Combined power switch and contrast control turns set on and regulates picture for best definition; brightness control adjusts for best viewing; brilliancy; horizontal and vertical controls frame picture properly; fine tuning with fmc range provides exact tuning of sound channel. FM audio channel circuit eliminates man-made static. Has built-in 4" x 6" oval PM speaker; plenty of audio output and exceptional tonal fidelity. Distinctively styled, completely self-contained in furniture steel cabinet finished in rich silver-gray with airodized top; handsome control panel in two-tone gray. Overall size, 20½" long, 9½" high, 16" deep. For 105-125 volts, 50-60 cycles AC. Complete with tubes and operating instructions. Underwriters' approved. Shpg. wt., 45 lbs.

NET, f. o. b. Chicago, Only **\$169.50**
 Easy Payment Terms: \$33.90 down, \$11.98 monthly for 12 months.



FREE

172-Page Buying Guide

MORE THAN 10,000 ITEMS

Everything in radio for everyone in radio! Complete lines of all leading makes of parts and equipment—all from one great, centralized source. For newest developments and best values, see your ALLIED Catalog.



TELEVISION & HOME RADIOS

A special selection of outstanding models—table radios, consoles, combinations, FM-AM—plus new Television, offered first by ALLIED at real savings. Hand-picked models—the choice of experts!



AMATEUR STATION GEAR

Here's heaven for the Ham! You'll find everything you need for your shack in the new ALLIED Catalog. See all the latest releases in receivers, transmitters, parts, station equipment—biggest Ham listings in radio!



NEW P. A. EQUIPMENT

Packaged, ready-to-use Sound Systems; amplifiers guaranteed for one full year; everything in speakers, microphones, P. A. accessories, intercom and recording equipment—leading headquarters for Soundment



Send for Radio's Leading Buying Guide

FREE



THE WORLD'S
 LARGEST
 RADIO
 SUPPLY
 HOUSE . . .

**ALLIED
 RADIO**

Everything in Radio
 and Electronics

ALLIED RADIO CORP.
 833 W. Jackson Blvd., Dept. 2-E-8
 Chicago 7, Illinois

- Send FREE New ALLIED Catalog.
- Ship Hallicrafters' T-54 Television Receiver. Enclosed \$..... Full Payment Part Payment (Balance C.O.D.)
- Send ALLIED Easy Payment Plan details and order blank.

Name.....
 Address.....
 City..... Zone..... State.....

Look!
Send for
FREE BULLETIN

Sent you every month. It's crammed full of real buys. A post card with your name and address brings it to you. You can't afford to miss its bargains. Mail your card today.

QUALITY ITEMS AT LOWER PRICES

OZA's at 73% OFF!
Until sold out—RSE offers 15000 new guaranteed OZ4 tubes. You know who made them—You can't go wrong at **59c**

GENERATOR CONDENSERS
Made by nationally prominent eastern manufacturer. Standard merchandise—.5 mfd— $1\frac{1}{2}$ " x $1\frac{1}{8}$ "— $5\frac{1}{2}$ " lead—slotted mounting strap. Present list \$1.00. Discount 87%. While 8000 last they're yours **13c**

UNIVERSAL PHONO CRYSTALS
One model will replace all the following types: L22, L25, L26, L27, L32, L40, L70, L75, L76, W41A, W42A, W57A. Size $1\frac{1}{8}$ " x $\frac{3}{4}$ " x $2\frac{3}{8}$ ". List price \$4.45. **THEY COST YOU \$1.39**
10 for \$12.90

.5 mfd—300 VOLT CONDENSERS
Made by one of the big four. $\frac{3}{4}$ " x $2\frac{1}{2}$ ", with tinned leads. New fresh stock—all guaranteed. Only 10,000 available at **6c each**
10 for 49c
100 for \$3.95

ORDER INSTRUCTIONS
Minimum order—\$2.00. 25% deposit with order required for all C.O.D. shipments. Be sure to include sufficient postage—excess will be refunded. Orders received without postage will be shipped express collect. All prices F.O.B. Detroit.

RADIO SUPPLY & ENGINEERING CO., Inc.
125 SELDON AVE. DETROIT 1, MICH.

Serviceshop Tests Serviceshops

By ERIC LESLIE

"**K**NOWLEDGE Precedes Intelligent Action." This old proverb is truer in radio than in almost any other branch of modern industry. The progressive radio technician is an avid reader of radio magazines, books and manuals and a steady patron of radio-electronic schools. These are available in quantity, so he has little difficulty in keeping abreast of the technical advances in radio.

But when it comes to setting up a business of his own—to actually establishing a service shop—the radio technician has no knowledge to guide him. Starting with a given capital, he wants to know the answers to such simple questions as "How much rent can I afford to pay?" or "What part of my investment should I devote to test equipment?"

One of the leaders in bringing technical knowledge to the radioman, Howard W. Sams of the PhotoFact Service, de-

cidied to prepare a study on this important serviceman's problem. He found that nobody had any facts on which such a study could be based. And there seemed no way to get them. Various surveys had turned up bits of information on the business side of radio servicing, but these scattered and unrelated items were of little use to the radio technician starting up in business.

There was but one way to get the information—actually establish an experimental radio service shop, and learn the hard way—the only way a would-be serviceman can now learn anything about the business angles of his trade. Sams decided to start his own shop and learn by experience the opportunities and pitfalls of radio servicing.

The first step was into one of the pitfalls. A likely location was chosen. It was selected to combine low rent with a large volume of traffic past the store. An apparently ideal spot was found at



Work on the new Sams' test bench. Left portion is part of a second identical bench used to double length. The large stock of meters represents part of Sams' equipment-testing program.

the crossing of two main traffic arteries and a store was rented.

Only after starting work in the new shop was it noted that other considerations than rent and prospective trade are important in selecting a location. The new place was noisy. The trackless trolley past the shop daily took hundreds of prospective customers past the door, but it also sent out high-power broadcasts with each shower of sparks from the overhead conductors. Flashing neon signs on the two filing stations across the intersection also made plenty of noise, as did those of the supermarket next door. "Signal tracing" showed that three doctors and one dentist—with X-ray machines—were located in the block. Sams wrote his heading for Lesson One: "Check your proposed location for noise as well as its business possibilities."

Lesson Two was a design project. Problem: To find or design an efficient and suitable workbench. Sams had learned from many servicemen that what the majority wanted was something relatively inexpensive. For those who could afford a higher-priced bench, there were excellent commercial models.

The designers abandoned tradition and struck out along revolutionary lines. The bench they produced consists of two parts—a flat top and a pair of shelves behind it. These shelves are the novel feature.

The back of the average bench is used as a panel for instruments. But most instruments used today are the portable type. In servicing FM or television sets—where two or three instruments may be connected to the same receiver—the mobility and flexibility of the portable instrument are especially important. This bench is designed for use with portable instruments. They can be stacked on the lower shelf at bench level and directly behind it, and used either in place or pulled out to best position. Those used less can be kept on the upper shelves.

Another point in favor of the shelves is that customers dislike to see their sets scattered over the floor, where someone may step through the loudspeaker. The shelves provide space for such radios. Receivers whose repair is temporarily interrupted—while waiting for parts, for example—can also be lifted to a shelf. This frees bench space and thus adds to virtual bench area.

Another feature the technician will appreciate is the overhang at the front. See drawing, Fig. 1. Much repair work is done sitting down, and the overhang provides kneeroom. There is an accompanying disadvantage—the drawers must be spaced a few inches below the bench top for accessibility. Shelf space in the compartments beside the drawers permit storage of parts, radios, or larger tools, depending on the serviceman's need and the other fittings of the shop.

The bench may be expanded by placing its end to the wall and putting a second bench on the other side of the shelf rack. Two repairmen can then work without getting in each other's way, but both within reach of instruments.

(Continued on following page)

SHOOTS THE WORKS!

AMSCO

BUILD YOUR OWN



6-tube super-het, 2-band receiver... slug tuning. We furnish blond, Swedish modern cabinet, slug tuner and dial plate. Also schematic with list of other parts required... \$2.95
Kit with all necessary parts to complete above... \$6.95
Less tubes

AMSCO KITS

BEAT THESE PRICES IF YOU CAN

100 Resistors 1/2 & 1 Watt	1.69
100 Mica Condensers asst.	2.89
100 By-pass Tubular Cond. asst.	5.89
25 Electrolytic Cond. asst.	3.29
50 Bath Tub Cond. asst.	2.59
20 Padder Cond. 1-2-3-4 asst.	.99
12 Variable Air Trimmer Cond. Gang asst.	1.49
20 Knobs asst.	1.39
25 Tube Sockets asst.	2.49
20 Wire Wound Resistors 5-10-25W asst.	1.89
6 Mike Buttons asst.	.89
20 R.F. Chokes asst.	.99
10 Volume Controls asst.	1.79
6 lbs. Hardware asst.	4.29
6 Chokes and Output Transformer asst.	.79

519 Items\$33.35
Above Kits Sold Separately... or the Entire Lot \$29.95 as Shown. Yours for Only

AND GET A MAGNESYN FREE!

REMOTE INDICATOR
1 T-22 Mike with Cord and Switch\$0.79

PHOTO-CELL AMPLIFIER



110V. 60 Cy. Drawer type. Has milliammeter on front panel. Complete with tubes 6V6, 6J7, 45, 80, VR105 \$9.95

PHOTO CELL RELAY CONTROL



Amplifier De Vry Complete with Tubes. \$9.25

MASTER CONTROL FOR RADIO



Compass Complete with meter. \$1.39

DYNAMOTOR (Slightly Used)

Input 24 V D.C. 12 Amp. 300 V. D.C. 26 Amp. Output 150 V. D.C. .01 Amp. 14.5 V. D.C. 5 Amp. with Voltage Regulator and Filter System \$2.95

BUTTERFLY TUNERS

80 to 300 Mc., 300 to 1000 Mc. New in cartons...\$1.89

PARABOLIC REFLECTORS

15" spun aluminum. Alzak fin. for 1200 Mc. Up. Pr.\$3.00

Remote Control Tuner
C-38/ARC5 Tuning head...
6 volume controls less switches39c
3 for \$1.00

TRIMMER AND PADDER

Condenser Assortment 20 for \$1

CONDENSER ASSORTMENT

Mica, Ceramic, Paper, Tubular, by-pass and Can. 100 for \$2.69

PUSH BUTTON ASSEMBLY



Can be used on most any standard radio. Complete with condenser and resistor... 4 stations79c

MICRO AMMETER

Beede 0-200 D.C.\$3.00

MILLI AMMETER

Beede 0-1000 MA.\$1.95

METER RECTIFIERS

Full Wave95c
Half Wave65c

RESISTOR ASSORTMENT

1/2 and 1 Watt... Asst. Ohmic values...
100 for \$1.69 500 for \$6.95

KNOB ASSORTMENT

25 Knobs, all popular... sizes\$1.00

SERVICE KIT

Kit includes assortment of:
100 Resistors 1/2 and 1-watt.
50 Condensers, paper, mica etc. electrolytic & can.
10 Switches, Toggle, Gang & Rotary.
100 ft. Spaghetti, various sizes.
12 Knobs, round and bar.
2 lbs. Hookup wire.
20 Fuses.
6 Volume Controls.
10 Type Sockets.
1 lb. Hardware (screws, nuts, lugs, etc.)
Wire Wound Resistors—10 & 25 Watt.
25 Connectors, Plugs, Ties.
10 Jacks (Phone) & Tip.
12 Padder Condensers.
12 Terminal Boards.
25 Ceramic Insulators.
2 Panel Lights (1 Neon).
1 Screw Driver.
1 Tube Puller.
2 Allen Wrenches.
2 Panel Fuse Holders.
4 Binding Post Strips, and many other valuable items.

Your Cost \$9.95 Complete



New Circular Available! WRITE TODAY

AMERICAN SALES COMPANY

7811 West 47th Street
Chicago, Illinois

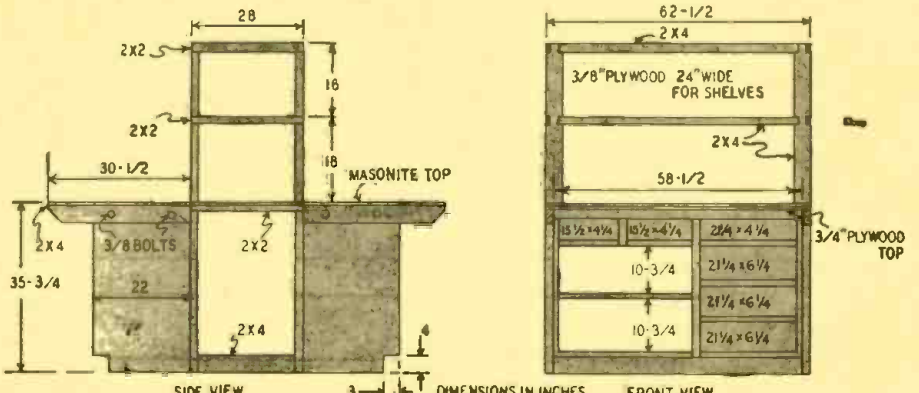
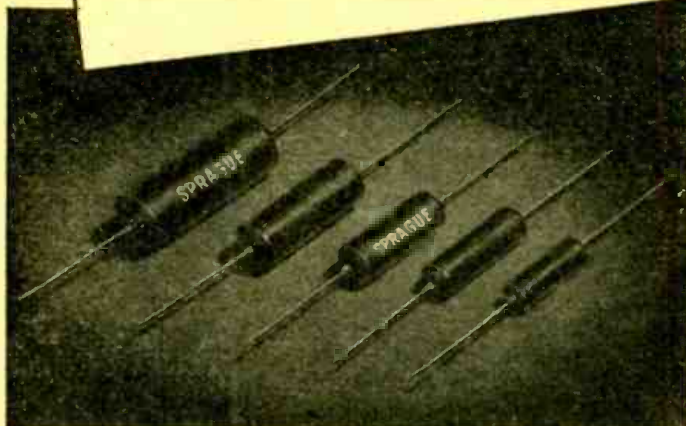
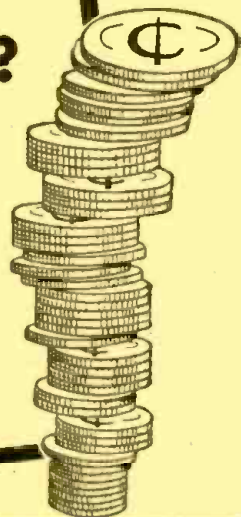

Fig. 1—The "kitchen cabinet" workbench, front and side views. Smaller areas on front view are drawers. Larger ones may be open shelves or be fitted with doors and back as closets.

Why play "PENNY-ANTE"... when your business is at stake?

A good reputation, like good-will, is built by many deeds, but may be destroyed by a single dissatisfied customer. Your reputation is too valuable to risk for the few pennies "saved"

by buying inferior or unknown "bargains." That's why we keep repeating "Your Reputation and your customers deserve the best!" And the best means Sprague.



SPRAGUE TM TUBULARS—The first truly practical MOLDED Paper Tubular Capacitors!

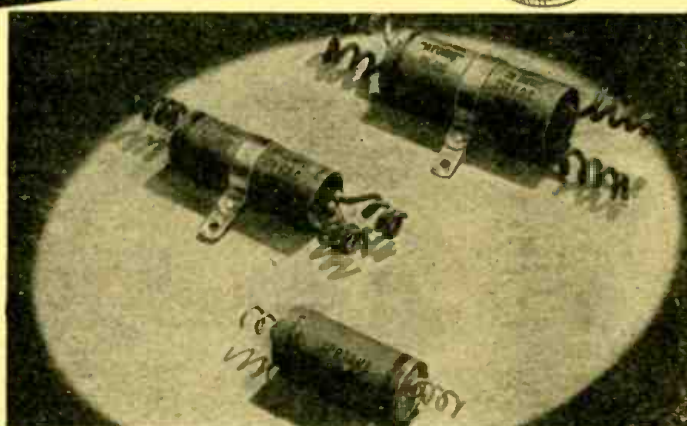

SPRAGUE ATOMS—Universal Midget Dry Electrolytics!

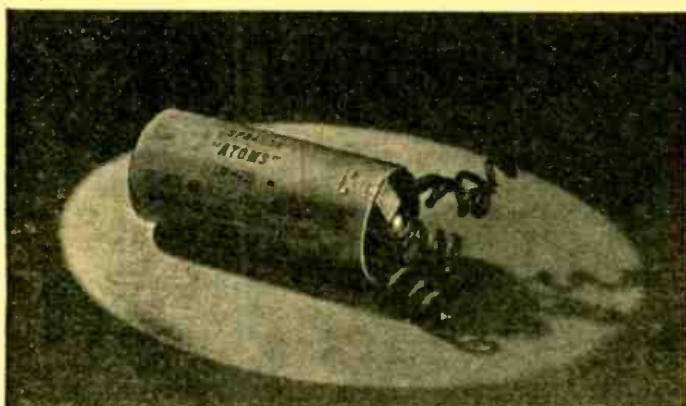

SPRAGUE LM—Universal Mounting Replacements!



SPRAGUE EL—Self-Mounting Midget Can Type!



Reach for a **SPRAGUE**
and **Know You're Right!**

THESE SPRAGUE PRODUCTS ARE UNCONDITIONALLY GUARANTEED!

When used at their capacitance and voltage ratings, these Sprague Products are unconditionally guaranteed to render satisfactory performance.

CAPACITORS

*KOOLOHM
RESISTORS

SPRAGUE

•T.M. Reg.
U.S. Pat. Off.

SPRAGUE PRODUCTS COMPANY, North Adams, Mass.
(JOBING AND DISTRIBUTING ORGANIZATION FOR THE PRODUCTS OF THE SPRAGUE ELECTRIC COMPANY)

THE PRICES SPEAK FOR THEMSELVES

TELEVISION

COAXIAL CABLE, 72 ohms, 100 foot roll...\$ 6.95
 COAXIAL CABLE, 72 ohms, 500 foot roll... 32.10
 TWIN LEAD-IN WIRE, 300 ohms, 100 foot roll 1.95
 TWIN LEAD-IN WIRE, 300ohms,1000footroll 17.50
 FOLDED DIPOLE ANTENNA, reflector type 7.25

FM CONDENSER & COIL KIT, with instructions and schematic diagram.....\$ 4.95
 INTERCOMMUNICATION SYSTEM, master & station complete with 8 tubes..... 17.97
 VOLUME CONTROLS, 50M ohms, 1/2, 1 or 2 Megs, all with switches..... .39
 OUTPUT TRANSFORMERS, match 50L6, 39c, push pull .. 55c, 6V6 ... 59c
 TOGGLE SWITCHES, SPST 15c, DPST 25c, DPDT.. 40c
 SELENIUM RECTIFIERS, 75 ma 49c, 100 ma. 59c

CONDENSERS

.001-600V...Per Hundred \$3.95
 .01-600V..... " " 4.40
 .05-600V..... " " 4.95
 .1-600V..... " " 7.20
 16-150V..... Each .24
 20-150V..... " .25
 20/20-150V..... " .29
 30-150V..... " .28
 50-150V..... " .35
 40/40/20-150V & 25V..... .44
 50/30-150V..... " .44
 8-450V..... " .27
 10-450V..... " .32
 16-450V..... " .36
 16/16-450V..... " .59
 20-450V..... " .39
 30-450V..... " .47
 40-450V..... " .54

RADIO TUBES—KNOWN BRANDS—BULK

80, 5Y3GT, 5Y4GT, 6C4, 9002.....Each \$.42
 35W4, 25Z5, 25Z6GT, 35Z5..... " .45
 6F5GT, 6J5, 6SA7, 6SK7, 6SQ7..... " .47
 36, 37, 77, 78, 6H6, 6D6..... " .49
 12AT6, 12BA6, 12BE6, 12SQ7..... " .49
 12SA7, 12SK7, 6F6GT, 75..... " .49
 6J7, 6K7, 6Q7, 6SF5, 6SN7..... " .55
 35A5, 35L6, 50B5, 50L6, 50Y6..... " .55
 43, 6A7, 6A8, 7B7, 25L6..... " .59
 OZ4, 6X5GT, 7F7, 7N7, 7Y4..... " .65
 1A5GT, 1A7GT, 1H5GT, 1T5GT, 1N6GT..... " .74
 1S4, 1R5, 1S5, 1T4, 3Q4, 3Q5, 3S4..... " .79
 14A7, 14B6, 14Q7, 35Y4, 50A5..... " .95
 1LN5, 6AC7, 6L6G, 70L7..... " .95
 1LC6, 1LH4, 1LA6, 117Z3, 117Z6..... " .95
 25A6G, 117LGT, 117N7GT, 117P7GT.... " 1.35

BROOKS RADIO DIST. CORP.-80 Vesey St., (Dept. A) New York 7, N.Y.

TRANSATLANTIC NEWS

(Continued from page 38)

book, I think I'll play for safety. In the final revision of the proofs, besides changing every "is" into "may be" and every "know" into "believe," I'll insert "probably" into most of the statements.

Recent investigations in Britain have shown that *v.h.f. transmissions can, and regularly do, travel in no less than three other ways than by the direct wave!* One of these, the atmospheric duct, has been known for some time; but it was regarded rather as a freak condition. It has nothing to do with ionization. What happens is that, under certain conditions, a kind of wave guide is formed between a layer of air (which may be at a height of only a few meters) and the surface of the earth. The new discovery is that this is no freak; it is a common state of affairs in fine settled weather, such as we had over here last summer. This accounts for the regular reception in Europe at ranges of 130-150 miles of frequencies up to 58 mc.

But it doesn't account for transmissions of similar frequencies which span distances up to 1,400 miles as they did for many months in 1947 when European *v.h.f.* transmissions interfered badly with one 43-45 mc television service. That has been shown convincingly to be caused by sporadic E-layer ionization, which is found to be pretty frequent in summer time in these latitudes. Sporadic E is a superionization of the lower reflecting layer, which occurs more often and more widely than was formerly suspected and is influenced by sunspot activity. Appleton has shown that it can be caused by meteoric dust. Strong sunlight can also bring it about.

And now for a quiz question for which no prize is offered. Two places, A and B, are 1,000 miles apart. One set of radio waves from A reaches B by reflection from the E-layer at a height of 65 miles; a second gets there by reflection from the F-layer at a height of 200 miles. Which set meets the reflecting layer at the larger angle?

Those that travel *via* the E-layer? Right! The bigger the angle the smaller is the chance that the waves have of going smack through the layer and the greater the chance that they will be reflected, supposing that each layer is ionized to an equal degree. It follows that *v.h.f.* waves which would escape into space and never come back to earth under ordinary conditions may be returned to earth by a superionized E-layer. The observed critical frequencies of sporadic E are such that the maximum range obtained in this way by *v.h.f.* is about 1,400 miles.

Well, there you are. Those who said that there would be no mutual interference between *v.h.f.* stations working on the same frequency, so long as they were 40-50 miles apart, were somewhat off the mark. Atmospheric ducts can cause such interference up to about 150 miles, sporadic E up to 1,400, and F-layer superionization up to 5,000 miles or more.

And those are the waves of quasi-optical range!

FREE RADIONIC CATALOG

TELEVISION SIMPLIFIED
 By Milton S. Kiver
 Newly revised, completely up to date. This outstanding book covers every phase of Television. Technical information in easy-to-read form. No mathematics. 173 pages. Shipped prepaid \$5.88

CHOCK FULL OF BUYS!

RADIO & TELEVISION PARTS - KITS
 PUBLIC ADDRESS INTERCOMMUNICATIONS - RECORDERS
 RECORD CHANGERS TEST INSTRUMENTS
 TUBES - AMATEUR EQUIPT - CHANCELLOR
 RADIOS - HARDWARE TECHNICAL BOOKS

A MUST for all
 • Service Dealers
 • Amateurs
 • Experimenters
 • Industrials
 • Institutions
 • Government Agencies

RADIONIC EQUIPMENT COMPANY
 170 NASSAU ST., NEW YORK 7, N.Y.
 Tribuna Theatre Entrance
 Tel. WOrth 2-0421 • Cable "CHANCELOR"

RADIONIC EQUIPMENT CO., Dept. 105
 170 Nassau Street, New York 7, N. Y.

Send at once your free catalogs, supplements and bargain lists as published—listing products of leading manufacturers of radio-electronic parts and equipment.

NAME

P.O. BOX or STREET

TOWN STATE.....

Do you need BINDING POSTS?

The XL PUSH POST with its Spring Action assures Constant Contact and quick connection. Manufactured in All Aluminum Type #2 at 12c each. Aluminum Body, Bakelite Top Type #1 at 15c each.

Types CP or NP. ALL BRASS—STAINLESS STEEL SPRING & PIN, PROVEN by 240 HR. SALT SPRAY TEST as NON-CORROSIVE at 28c each.

Manufacturers and Dealers Liberal Discounts

X. L. RADIO LABORATORIES
 420 West Chicago Ave., Chicago 10, ILL.

RISCO HAS IT
 All Changers Brand New

V. M. MIXER CHANGER
 PLAYS 10" and 12" records at the same time...\$15.50

DETROLA, \$13.75
G. L. RECORDERS
 Single Speed...\$22
 Dual Speed...\$25
 40% off on Recordings Recording Blanks.

\$15.50
 Above Easily Attached to Any Radio or CAN BE USED WITH AMPLIFIER BELOW

SERVICEMEN'S SPECIALS

100-INSUL. RES. KIT 1/4. 1. 2W.....\$1.45
 25-MICA COND.-CODED..... .50
 15-ASST. KNOBS..... .50
 15-ASST. BY-PASS COND..... .50
 15-ASST. SOCKETS..... .50
 10-ASST. VOLUME CONTROLS..... .50
 TEST LEADS, 50 IN. LONG..... .40
 NEON TESTERS..... .20
 ALLIANCE PHONO MOTORS..... 2.30
 ASTATIC L-70 or SEURLE GLIDER PICKUPS 1.75

PHONO AMPLIFIER
 3 TUBE AC-DC
 Wired Vol. & Tone \$2.75
 Control
 Uses 12SQ7, 50L6, 55Z5.
 Wired & Tested
 Set of 3 Tubes.....\$1.95
 Output Trans..... .30
 5" Alnico Spk..... 1.10

PHONO OSC-2-TUBE
 Wired & Tested
 2 Tubes-\$1.50..... \$2.75

25% on C.O.D. orders. Orders Filled as Received
 VISIT OUR NEW SHOW ROOM
 Free Catalog "C" Just Out
 We Specialize in Mail Orders
25 WEST BROADWAY N. Y. 7

RISCO ELECTRONICS
 WHOLESALE DISTRIBUTORS

RADIOMEN SERVICEMEN BEGINNERS
MAKE MORE MONEY EASILY—QUICKLY
\$250. WEEKLY POSSIBLE
 We Show You How Information Free
MERIT PRODUCTS
 216-32V 132 AV. SPRINGFIELD GARDENS 13, N.Y.

SHANEY'S
 New **20 STEPS to PERFECT AMPLIFICATION**

SEND 3c STAMP FOR POSTAGE

AMPLIFIER CORP. of AMERICA
 398-10 Broadway -- New York 13, N.Y.

WWV SCHEDULE CHANGES

Latest WWV schedules and services are contained in the Bureau of Standards letter circular LC 886, available without charge. WWV now transmits on the following carrier frequencies with power and modulation as stated:

carrier (mc)	power (kw)	modulation (cps)
2.5	0.7	440
5	8.0	440
10	9.0	440 and 4000
15	9.0	440 and 4000
20	8.5*	440 and 4000
25	0.1	440 and 4000
30	0.1	440
35	0.1	none

*0.1 kw for first 4 work days after 1st Sunday of each month.

Time signals are transmitted continuously on all above frequencies. Each second, except the 59th of any minute, is marked by a 5-cycle pulse of a 1000-cycle signal. It is heard as a faint tick each second, correct to within a microsecond. All of the r.f. and a.f. frequencies are correct to within one part in 50,000,000.

Tone modulation is applied for the first 4 minutes of each 5-minute period. Then c.w. code signals announce the next minute, using 24-hour notation. Midnight is 0000 and noon is 1200. For example, modulation starts at exactly 1 p.m. and stops at precisely 4 minutes past. Then code announces 1305 which is the next minute. At exactly 5 minutes past the modulation is resumed for exactly 4 minutes more. Then, at 9 minutes past, the announcement 1310 is made, etc.

The tone modulation is useful to servicemen for standardizing oscillators. The 440-cycle note can be used to standardize musical instruments since it represents the standard pitch A above middle C.

In addition to time signals and standard frequencies, ionosphere storm warnings are also transmitted. If such a disturbance is in effect or is expected within 12 hours in the North Atlantic area, a series of W's are sent following the time announcement at 19 and at 49 minutes past the hour. If normal conditions prevail a series of N's are sent instead. This service is useful for communication stations which may change to lower and more reliable frequencies to avoid fading and signal blackouts which usually accompany the storms.

ALARM CLOCK USES LIGHT

An electric alarm clock that will even awaken deaf persons is now on the market. In use, the bed lamp is plugged into the clock, and at the time set for the alarm, the lamp starts flashing on and off. A penetrating buzzer warning sounds seven minutes after the flashing starts. If the deaf person is not awakened, installation of a small photoflood bulb in the bed lamp is guaranteed to produce results in the most stubborn cases.



Stromberg-Carlson DYNATENNA

This famous-make FM antenna has been advertised and sold for many times the low price MID-AMERICA asks. Covers both FM bands. Delivers FM reception at its best. Complete with 60 ft. of 300-ohm twin lead-in. Line is standard approved flat-type, solid dielectric with weather-resisting insulation. Mounts anywhere easily... vertically or horizontally to match polarization of trans-

mitting station. Illustrated instructions and all necessary hardware. A screw-driver is only tool needed for assembly. Dynatenna is seamless, heat-treated, all aluminum... will withstand severest weather.

\$4.95

each
\$4.45 each
in lots of 3

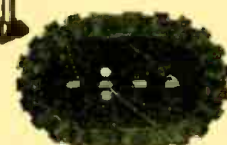

PERMEABILITY TUNER

Build a really HOT 5 or 6 tube AC-DC superhet receiver! Takes place of old-style gang condenser, rf and antenna coils: regular 455 KC intermediate frequency. Complete with permeability tuned oscillator coil, 4" x 2 1/2" x 2 1/2" diameter dial drive. Order MA-2167 Loop Antenna 15c; and MA-2914 drilled, punched Chassis 39c. MA-2167

\$1.24

CONTROL BOXES—19c Each!

MA-2135—5 position switch, volume control and jacks for PL-55 and PL-68. 3" x 4 1/2" x 2 1/4". Aluminum finish.

MA-2095—6 position, 5-prong female receptacle. Black crackle finish. 2 1/2" x 4 1/2" x 1 1/4".

MA-2136—Volume control, jacks for PL-55, PL-68. 2 1/2" x 3 1/2" x 1 1/4". Aluminum finish.

MA-2092—4-position switch. Aluminum finish. 2 1/2" x 2 1/2" x 1 1/4".

RG-8-U COAXIAL CABLE

Get your share of this fine-quality coaxial cable. Solid moisture-proof polyethylene dielectric; fully shielded. 52 ohms nominal impedance. Not sold in less than 100-foot lengths.

MA-5018—100 feet.....\$2.89

Coaxial Cable Connectors

PL-259—Low-loss connector for RG-8/U and RG-11/U, or use adapter for other coaxial cables. Silver-plated, machined brass. Inserts are low-loss mica. Exceptional quality at a low price. MA-2828. **29c ea.**

Use a PUNCHED CHASSIS!

Save time and effort with a punched chassis. Takes the hard work out of building receivers, amplifiers, etc.

MA-2913—16" x 5" x 2" 10 tube.....59c

MA-2907—10 1/2" x 3 1/2" x 1 1/2" 6 tube.....29c

MA-2910—14" x 6" x 2 1/2" 8 tube.....49c

MA-2911—10 1/2" x 3 1/2" x 1 1/2" 7 tube.....29c

MA-2903—10 1/2" x 5 1/2" x 3 1/2" 7 tube.....29c

MA-2912—10" x 3 1/2" x 2" 5-tube (for chassis lock sockets).....29c

MA-2914—10" x 5" x 2" 6 tube.....39c

MA-2915—5 1/2" x 1 1/2" 3 tube.....15c

ORDER FROM THIS AD!

Quantities are limited, so get your order in now! Minimum order shipped, \$2.50. Send 25% deposit, balance COD. Get on our mailing list to receive BIG BARGAIN BULLETINS that list latest, greatest buys in radio parts, electronic equipment. Send orders to store address, Desk RG-58

MID-AMERICA CO. Inc.
2412 S. Michigan Avenue
Chicago 16, Ill.

HARD-TO-GET PARTS

LEOTONE

WIRE & TAPE RECORDING COMPONENTS. Essential "hard-to-get" parts for units described in Radio News, Feb., '48.

WIRE RECORDING-PLAYBACK HEAD. Precision built. Three-Coil (voice, erase & bias); 4 pin plug-in type. Moulded bakelite case (1 1/2" x 1 1/2" x 3/8"), grooved to provide maximum contact and sensitivity..... **\$6.95**

WIRE SPOOL SPINDLE. Polished aluminum. Takes spool with 1 1/2" hole. 3/8" shaft hole; 3/8" deep..... **39c**

RM-4 RECORDING MOTOR. Heavy duty, 110V., 60 cycles. Adaptable to WIRE, TAPE or DISC RECORDING & PLAYBACK. 5/16" O.D. shaft. 3 1/2" sq., 2 1/2" deep. Less turntable, mtg. plate & drive wheel. Shpg. wt. 8 lbs..... **\$4.95**

PERMALLOY DUNCER LAMINATIONS. Hydrogen annealed. Specifically for use in constructing TAPE RECORDING-PLAYBACK HEADS. Per duncer containing laminations..... **40c**

ALNICO ERASE MAGNET. "U" shape; polished poles for TAPE or WIRE. 3/4" x 5/8" x 1/8". 3/16" gap. Send for latest illustrated "ALNICO MAGNET" supplement.

TUBES! TUBES! TUBES!

All in perfect condition, but in unsealed cartons. Most types in stock at up to 80% off list. Every tube guaranteed 90 days.

#20, 28, 27 or 31..... **\$2.29**
#42, 76, 77, 78, 6H6 or 6K7..... **.39**
#37, 39, 5Y4, 6C5, 6F5, 6J7, 6K8, 6SA7, 6SD7, 6SF5, 6SH7, 6SJ7, 6U7, 12SJ7, 12SK7, or 12SR7..... **.40**
#1A7, 6D8, 6X5, 7A7, 50, 50B5, or 50L6..... **.59**

TUBE CARTONS, Plain
Miniature (1 1/4" sq. x 3 1/2") Per 100..... **.98**
GT size (1 1/4" sq. x 3 1/2") Per 100..... **1.25**
Medium (1 1/4" sq. x 4 1/2") Per 100..... **1.49**
Large (2" sq. x 5") Per 100..... **1.79**

WHIP ANTENNA. 9 ft., flexible, lightweight (8 oz.). 10 sections, weatherproof finish..... **\$1.25**

RCA VICTOR POWER TRANSFORMER for models R-32, 45, 52 or 75. Unshielded..... **5.95**

"17" is YOUR LUCKY NUMBER!!!

Yes, Leotone's new JUMBO RADIO PARTS ASSORTMENT is the YEAR'S BEST BUY! 17 FULL POUNDS of new and dismantled radio and electronic parts—COILS, TRANSFORMERS, WIRE, HARDWARE, SPEAKER REPAIR PARTS, RESISTORS, CONDENSERS, etc., etc. All these AND MORE for **2.95** only..... **2.95**

T-30 THROAT MIKE & NECKBAND. Excludes outside noise, leaves hands free. 2 rubber set carbon buttons. All brand new..... **39c**

SPECIAL EACH..... **12 for 2.98**

THROAT MIKE CORD & SWITCH. Complete with 9 ft. rubber cord, PL-68 plug & JK-48 jack..... **39c**

EXPERIMENTAL TUBES. 20 assorted, receiving types for testing, research, etc. Fil. tested..... **1.00**

SENSITIVE RELAYS—FAMOUS MAKE. D.P.37, 3/16" silvered contacts with protective plastic housing. 18-28 V. DC. 100 ohm coil. Overall: 1 1/2" x 1 1/2" x 1 1/2" ea. 39c; 15 for 5.00.

RADIO HARDWARE TREASURE. An indispensable asst. of approx. 1000 nuts, screws, washers, etc. Price..... **.49**

TELEVISION SAFETY WINDOW for 7" tube. Clear, heavy, convex plastic. Molded flange for mtg. Each..... **.49**

PRECISION RESISTORS. ±1% wire-wound, famous makes. Ohmages 2.35, 1T, 24.5, 100, 130, 405, 840, 1740, 2500, 3300, 5200, 7800, 30K or 50K—each 35c; 3 for..... **1.00**

MEGOMHS: 1, 125, 2, 22, 4, 5, .6, or .75, ea..... **.49**

SPECIAL—1 megohm (1 watt)..... **.75**

VARIABLE CONDENSERS: 4 GANG, 20-250 mmf per sect. 1 sect. separately shielded. Silvered plates close right. 1/4" ball bearing shaft. 7 1/2" x 2 1/2" x 3 1/4". Shpg. wt. 4 lbs..... **.89**

2 GANG, 365 mmf per sect. 3/8" shaft. 2 1/2" x 2 1/2" x 1 1/2"..... **.75**

Get on our mailing list—Always something new!

A BETTER COME-BUY LEOTONE FACTORY REPAIR SERVICE ON ALL SPEAKERS & PHONO PICK-UP.

Minimum Order \$2.00—20% deposit required on all orders. Please add sufficient postage.

LEOTONE RADIO CO.

MAKERS OF CONES AND FIELD COILS
65-67 DEY STREET, NEW YORK 7, N.Y.
WORTH 2-0284-5
12,000 SQ. FT. OF RADIO PARTS



A 'NATURAL' FOR RADIO MEN!

Train for Good pay in ELECTRIC MOTOR REPAIR

The busiest, most profitable electrical service of all!

ELECTRIC MOTOR REPAIR is a big, 570-page training book that can quickly help you learn this important work at home—for only \$5 for the complete course. Written especially for beginners. Tells what to do—exactly how to do it. Everything is explained simply, thoroughly and understandably. Based on what can be learned from this big book alone, you can train for prompt, profitable service on practically every electric motor in common use.

AN UNCROWDED, BIG-PAY FIELD!

The electric motor repair expert is a valuable, well-paid man. There are big opportunities for the work almost anywhere. Statistics show there are 11 electric motors in the average small American home. Big homes have many more—in oil burners, air conditioners, record players, cleaners, refrigerators, clocks, mixers, fans, washers, etc. And there are millions more in industry! Good motor repair men are scarce. Even many big appliance shops must send motors back to the factory for repair or to motor specialists!

NO PREVIOUS TRAINING NEEDED

ELECTRIC MOTOR REPAIR book teaches you the work from the beginning. Every important step is demonstrated both in text and visually by more than 900 special illustrations. Quick reference guides show how to handle specific jobs. Widely used for training beginners and for daily reference in busy motor shops. Covers practically every modern motor type and BOTH mechanical and electrical motor control systems. Unique Duo-Spiral Binding divides book into 2 sections so that both text and related illustrations can be studied together.

BORROW IT FOR 5 DAYS

Send coupon now. Practice from **ELECTRIC MOTOR REPAIR** for 5 full days. See how interesting the work is—how rapidly it can be learned. Then, if not more than satisfied, return book and your money will be cheerfully refunded and no questions asked!

ALL THIS... for only \$5!

ELECTRIC MOTOR REPAIR includes complete discussions of motor parts, connections, reversing, trouble analyzing procedure, re-winding, etc. Gives full instructions on split phase motors; capacitor motors; regulator type; polyphase; alternating-current and direct-current types; universal, shaded-pole and fan motors; d-c generators; synchronous motors and generators, etc., as well as motor control units.



YOU CAN'T LOSE ON THIS OFFER!

Dept. RC-56, Murray Hill Books, Inc., 232 Madison Ave., New York 16, N. Y.

☐ Rush me a copy of **"ELECTRIC MOTOR REPAIR"** for which I enclose \$5 (\$5.50 foreign) or ☐ send C.O.D. (in U.S.A. only) for this amount and I will pay postman \$5 plus postal charge when he delivers book. If book is not what I need, I'll return it within 5 days and you guarantee to refund my \$5.

Name

Address

City & Zone..... State.....

MAY SPECIAL

RESISTOR KITS \$1.45
100 assorted carbon and wire wound resistors... 1/2 to 10 watt. Wide range of values. All standard items.

CONDENSER KITS \$1.75
50 assorted paper and mica condensers... all new... good value.

Wireless Phone Oscillator \$4.52

Operates as far as 100 ft. from radio and can be used with automatic record changer and players... complete with 2 tubes all wired and tested. Diagram.

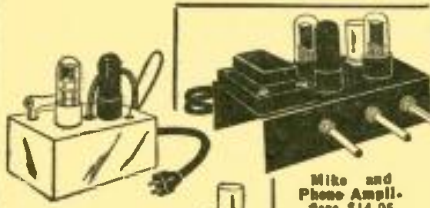

Phone Pre-Amplifier \$4.95
This unit is for G. E. Heluctance type cartridge. Completely wired, tested, Supplied with diagram, and tube 6SC7.

Micro and Phone Amplifiers \$14.95

This unit sold complete with power transformers, 3 tubes and 3 controls... all wired and tested. Diagrams supplied.

RADIO PARTS

Astatic Crystal Pickups	\$1.89
Astatic Crystal Cartridges, L-70A, L-26A, L-40	1.80
Selenium Rectifiers, 100 MA69
1/2 Mag. Volume Controls & Sw. Long Shaft35
Osc. Coil 128A715

STANDARD MAKE CONDENSERS

50x30-150v	\$.45	.01, .02, .05	\$.06
8x8-450v50	107
25-25v30	4" or 5" PM spk.	1.15
25-25v30	8" PM speaker	1.55
16-450v40	5" 450 ohm dynamic	with output 2.39

All prices F.O.B. N.Y.C.—On C.O.D. 25% Dep.

THE ROSE COMPANY

88 West Broadway, Dept. (C) N.Y.7,N.Y.

Just off the Press!
1948 Radolek RADIO PROFIT GUIDE



NEW COMPLETE RADIO PROFIT GUIDE FREE

RADIO REPAIR PARTS • TOOLS SOUND SYSTEMS • TUBES PHONO EQUIPMENT & SUPPLIES TEST INSTRUMENTS • ETC.

Big, new ENLARGED complete catalog showing thousands of Radio Bargains sent to you immediately. Helpful, money-saving buying information. Send coupon today!

BIG VALUES, LARGE STOCKS, FAST, DEPENDABLE SERVICE.

FREE... SEND TODAY

RADOLEK CO., Dept. C-058
601 W. Randolph St., Chicago 6, Ill.
Please send your Free Profit Guide Catalog and regular Supplements.

Name

Address

City

SAVE AT RADOLEK

LABORATORY TYPE OSCILLATORS

(Continued from page 27)

Resistance-capacitance oscillators

The resistance-capacitance tuned oscillator in Fig. 5 is used for the generation of audio frequencies. Frequency is controlled by an R-C network that provides regenerative coupling to a feedback amplifier. Main design points in this circuit are to use as few bypass condensers as possible and to make the ones used of high capacitance to minimize phase shift at very low frequencies. The amplifier must be designed for wide-band response to prevent phase shift at the higher frequencies and must also use a large amount of negative feedback. A 3-watt, 117-volt lamp is usually used in the cathode of the oscillator to provide the negative feedback. The lamp also automatically controls the amplitude.

Audio frequencies may be produced by a beat-frequency oscillator (Fig. 6),

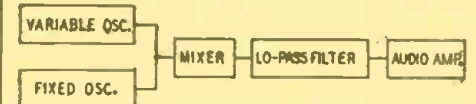

Fig. 6—A typical beat-frequency oscillator.

which is a combination of two r.f. oscillators, one fixed at about 100 kc and the other variable. The two outputs are fed into a mixer, then amplified. The difference between the 2 frequencies represents the audio output. A very wide range of frequencies extending well into the r.f. region can be covered with this type of circuit.

The b.f.o. has several drawbacks. The chief one is the tendency of the oscillators to "lock in" with each other at low frequencies. Unless filters are used together with careful design, cross-modulation of the higher harmonics occurs. For this reason the R-C feedback circuit is rapidly displacing the b.f.o.

Electron-coupled oscillator

Buffer stages are needed between most oscillators and their loads. A load connected to an oscillator changes the current in the tank circuit which in turn affects the frequency and might even stop oscillation entirely. If the load varies the oscillator will be adversely affected. The buffer stage can be eliminated by using an electron-coupled oscillator (Fig. 7). This is the Hartley circuit

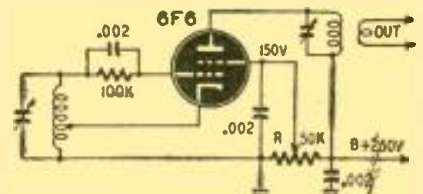

Fig. 7—Electron-coupled Hartley oscillator.

with a few changes. The screen grid is used as the anode and output is taken from the plate. The cathode is at an alternating potential above ground, but the screen is grounded.

The electron stream which reaches the plate is "modulated" at the frequency of

PROJECTION TELEVISION!

Convert your RCA 630 or Crosley 307 to this

OUTSTANDING TELEVISION CONVERSION OF 1948!

The gigantic picture this set is capable of projecting must be seen to be believed!

One set converted by a Los Angeles company, was demonstrated at the Shriner's

Temple in Los Angeles, during the Rose Bowl game. It was viewed by 4800 people at one sitting! A 12x16-foot rear projection plastic screen of our type was used.

F 1.9 TELEVISION PROJECTION LENS

Dimension—Length 7", Diameter 4 3/4".

F 1.9 EF. 5 in. (127.0 mm). This lens incorporates in barrel a corrective lens for use with a 5TP4 projection tube. It is easily removable for use with flat type tubes.

Lens can be utilized to project picture sizes from several inches to 7 x 9 feet. Made by Bausch & Lomb Optical Co. Dealers' Price \$125.00

30 KV RF POWER SUPPLY

Dimensions—Length 14", Width 11", Height 11 1/4".

This unit has a low voltage supply separate from high voltage pack. Low voltage DC supply has control which enables you to vary voltage from approximately 12 KV to 40 KV. Unit has focus control built in for use with 5TP4 projection tube. Dealers' Price, complete \$99.50

STAND FOR PROJECTION TELEVISION SETS

Dimensions—23" High, 25" Wide, 18 1/2" Depth. For use with RCA 630 chassis or Crosley table model sets. Unit mounted on ball bearing soft tired wheels. Depth is designed to accommodate RF Power Supply. Open grill allows free circulation of air. This stand a natural for mounting scopes and other lab. equipment for easy mobility. Specify whether for Television use or shop. Stand as shown in top photo. Dealers' Price \$31.50

REAR PROJECTION TELEVISION SCREENS

The screen surface consists of a conglomerate arrangement of microscopic plastic crystals that "Pin Point" the projected image providing unexcelled angular viewing with a minimum loss of projected light. It is estimated that there is a loss of approximately 10% of light viewing the image at 45 degrees off center. Light transmission percentages are controlled to obtain the maximum efficiency of the television optical projection system. The percentage of 80% of transmission has been determined as that providing maximum efficiency.

Stock sheets are available from 3x4 feet down. Specify inside dimensions of screen desired. If larger sizes are required, they can be made to order. Frames can be had on request, small sizes \$5.00—large sizes \$10.00. Dealers' Price of screen, per sq. foot \$4.50

Include 25% Deposit With Order. Balance C.O.D.

Pioneers in Projection Television
SPELLMAN TELEVISION COMPANY
 2898 JEROME AVENUE, NEW YORK 58, N. Y.

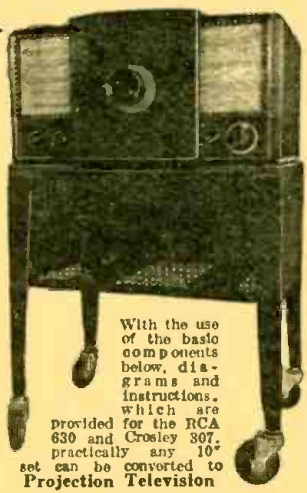

With the use of the basic components below, diagrams and instructions, which are provided for the RCA 630 and Crosley 307, practically any 10" set can be converted to Projection Television

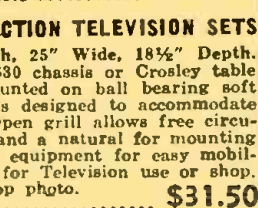

WOBBULATED SIGNAL GENERATOR

(Continued from page 35)

shielding. The binding posts, of course, must be insulated from the chassis. No pilot light was installed in the wobbler, as this feature was incorporated in the power supply. All power is carried from the power supply to the signal generator through a rubber-covered multiconductor cable.

The power supply

The power supply (Fig. 9) was designed for universal use. The case is identical in size to the FM signal generator. The transformer for the universal supply can be the type frequently used in tube checkers, providing a high voltage for B-supply and various voltages for filaments. The author removed the filament windings from a large receiver power transformer (noting the turns/volt ratio) which had excess space in the winding window. A new filament winding was then wound, providing taps at the proper points for filaments up to and including 35 volts.

Precise voltage regulation of the B-supply is usually desirable for applications such as our FM generator. The original model did not include this feature, although voltage regulators were tried in some of the tests. The two VR tubes and the 2,500-ohm dropping resistor R25 shown in broken lines may be added within the same cabinet. When the regulator tubes are installed, S3 should be a d.p.s.t. switch.

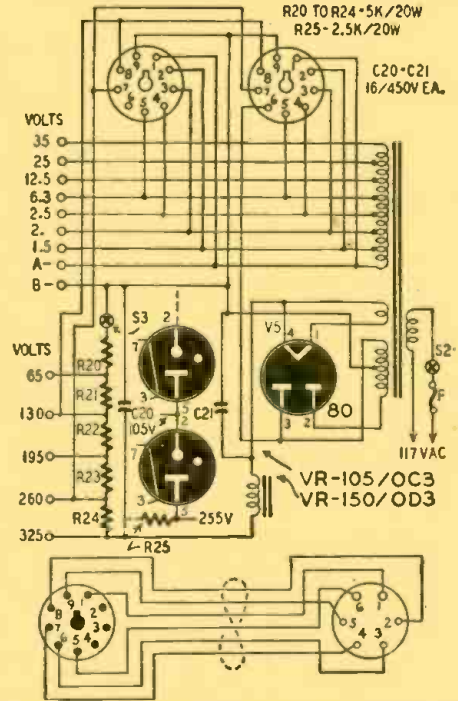

Fig. 9—The power supply and connecting cable. Note error in polarity of C20 and C21.

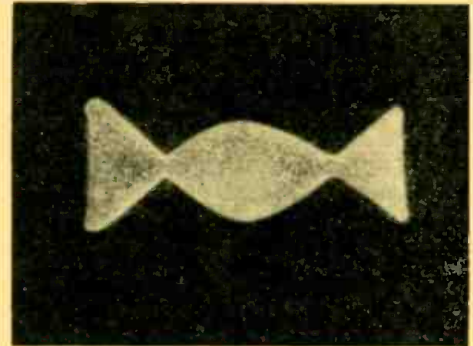

Fig. 10—How zero beat looks on 'scope screen.



Fig. 11—Positioning node to center of trace.

Adjustment and calibration

After the usual checks have been made on filament, plate, and screen voltages, the unit is ready for adjustment. First check both the input and output of the buffer tube V2 for proper form of all three wave shapes (Figs. 2, 3, and 4). The voltage gain of V2 will be slightly less than one, and the input and output wave forms should appear practically identical. While the wave shapes are being checked, the oscilloscope vertical input should be connected at the grid of V2 or V3 (binding post W). The square wave will show considerably greater amplitude than either of the other two, and great enough to allow production of a sizable trace without using the oscilloscope vertical amplifier. This method should be used to see the true shape of the square wave because the usual single-tube amplifier found in most oscilloscopes will distort such a wave shape. The triangular or pyramid wave is the one in which we are particularly interested.

Assuming everything has gone well so far, we now have linear triangular excitation for the frequency modulator. Start adjustment of this section of the unit with C7 at maximum (closed), R10 at maximum, and C18b partly open. The setting of C18b is unimportant for the moment. Connect the FM output to the oscilloscope vertical amplifier and adjust the oscilloscope sweep to 60 cps. Connect the output of a constant-frequency test oscillator (signal generator) to the r.f. terminal of the wobbler.

Slowly tune the test oscillator 100-200 kc both sides of 450 kc. When the frequency of the constant signal falls within the deviation range of our frequency modulation, zero beat will be evident as indicated in Fig. 10. As the constant-frequency signal is changed, the zero-beat point will move back and forth across the 'scope trace. By adjusting (and reading) the constant-frequency oscillator dial so that the zero-beat nodes occur at the ends of the trace, and again so that they coincide in the middle (Fig. 11), the amount of frequency

sweep can be determined. The desired maximum sweep is 60 kc or a deviation of 30 kc each side of the center frequency. The exact amount of maximum deviation is not critical as long as it is adequate.

The value of R13-C7 determines the relationship between the out-of-phase voltage on the reactance tube grid and its plate current. Adjust C7 to give the desired 60-ke sweep. When R13-C7 becomes too small, oscillation over part of the sweep cycle may be blanked, as evidenced by a 'scope trace such as Fig. 12, obtained on the oscillator plate. Parasitic oscillations and complete instability can also result. Extending the sweep too far will also give a non-linear grid potential vs. frequency characteristic for the reactance modulator.

The final adjustment consists of setting the range of center frequency, after which the dial on C18a can be calibrated. The center frequency of the FM signal output at any particular setting of C18a is determined as follows. The FM output is connected to the oscilloscope vertical amplifier. The constant-frequency generator signal is injected at the r.f. terminal of the wobbler. The oscilloscope horizontal sweep is adjusted to 120

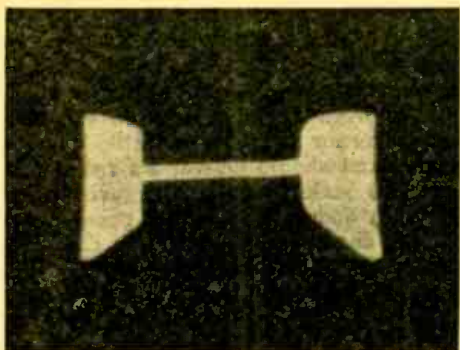

Fig. 12—Effect of making R13-C7 too small, cycles per second. When the constant-frequency signal lies within the deviation of the FM signal, a double trace will appear on the 'scope, each trace being one-half of Fig. 10. When the zero beat points on the two superimposed traces coincide at the center, the constant signal is at the same frequency as the center of the FM signal. C18b is adjusted to give the desired center or carrier frequency range as determined by readings taken at the maximum and minimum settings of C18a. Varying C18b, of course, moves the range up or down the scale of frequencies as well as widening or contracting the range somewhat. It may be necessary, therefore, to alter the inductance of L slightly.

With the end points at the desired values, it is now necessary only to set the constant frequency at, say, 5-kc intervals over the selected range, bring the zero beats together on the superimposed 'scope traces, and mark the dial on C18a. The spaces between the 5-kc marks can then be divided into five divisions to give 1-kc calibration. The calibration will be essentially linear. Final calibration should be done with all shields and covers in place. Needless to say, the calibration will be no better than that of the fixed-frequency test oscillator used.

VOLUME EXPANDER

You may want to try a simple volume expander which will increase the dynamic range of phonograph records or radio programs. The only materials required are two flashlight bulbs (3½-volt, green-bead lamp for 3-cell flashlight seemed to be the most satisfactory in the model constructed), two 1-ohm resistors (a 4-inch length of No. 26 nichrome wire makes a very satisfactory 1-ohm resistor), and enough wire to connect these components together (as shown in the diagram).

At low levels, the lamp filaments pass little current and are quite cold. The resistance is low (in the order of several ohms) thereby almost balancing the volume expander bridge circuit to pro-

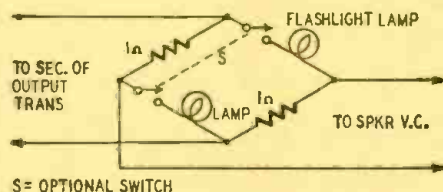

duce a small output to the loudspeaker voice coil leads. When the magnitude of the sound is increased, the lamp filaments heat up, and their resistance increases considerably, unbalancing the bridge circuit to produce a much greater output to the loudspeaker. In this way, changes in the dynamic level are accentuated.

To connect the volume expander to your radio or phonograph, disconnect the leads of the loudspeaker voice coil and insert the expander between the secondary of the output transformer and the voice-coil leads.

With the components used there may be too little or too much expansion to suit your taste. Substitute higher-voltage radio pilot lamps (such as 6-volt, brown-bead) to reduce the amount of expansion, or lower-voltage lamps to increase it. If you wish to use the expander for music only, a simple double-pole, single-throw toggle switch may be inserted in the circuit to break the legs of the bridge in which the lamps are inserted.

MILTON SNITZER,
Brooklyn, N. Y.

(This circuit is an adaptation of one developed by L. A. de Rosa and described on page 748 of the April, 1937, issue of *Short Wave & Television* and page 21 of the July, 1937, issue of *RADIO-CRAFT*, in which issues the system was described in some detail.)

USING OLD SPEAKERS

I have found a use for the old dynamic speakers that are often given away to servicemen. I use them as auxiliary speakers for a public address system and energize the fields from a dry-rectifier power pack inside the speaker housing.

BERNARD LEVINE,
Newburgh, N. Y.

(The resistance of the speaker field must be high enough to prevent excess current from passing through it and the rectifier.—*Editor*)

LEARN RADIO

LEARN FAST
LEARN RIGHT
AT A PRICE YOU
CAN AFFORD

A. A. Ghirardi

Easy-to-understand BASIC TRAINING FOR BEGINNERS

(Used by U.S. Army & Navy)

The best training costs the least! Actually, Ghirardi's famous 972-page **RADIO PHYSICS COURSE** book has given more Radio-Electronic beginners their start than any other book or course ever published. Contains complete basic training to fit you for a career in any phase of Radio-Electronics work. Over 300 pages make Basic Electricity easy to learn. Other subjects include: 36 Courses in Radio Transmission; Broadcast Stations; Receiving Units; Vacuum Tubes; Detection; Amplification; Photoelectric Cells; Short Waves—a total of 36 basic subjects. If broken into lessons and sold as a "course," you'd regard this big book as a bargain at \$50 or more! Over 500 illustrations. Use coupon. Read it for 5 days at our risk!

Only \$5
RADIO
PHYSICS
COURSE

36 Courses in
one giant book.

A Complete Course in RADIO-ELECTRONIC SERVICING

Learn professional service
work at home!

Study now for a good job as a Radio-Electronic service repair expert! It's easy to learn from Ghirardi's 1300-page, profusely illustrated **MODERN RADIO SERVICING** book that costs you only \$5 complete. Covers all phases of the work. Explains service test instruments and when, where and why to use each type. Even tells how to build your own. Tells how to troubleshoot all kinds of radios, analyze their circuits, test components, make all types of repairs, adjustments, installations, etc. Even explains how to start a successful radio service business. See Money-Saving Combination offer.

Only \$5
MODERN RADIO
SERVICING

Learn to be a Service
Expert — at home —
without an instructor!

CUTS SERVICE TIME IN HALF ON 4 JOBS OUT OF 5

Whether you repair radios professionally or only work with them occasionally, Ghirardi's **RADIO TROUBLESHOOTER'S HANDBOOK** can save you time and useless testing on almost any job! Just look up the make and model of the radio you want to fix. Book covers common troubles in over 4800 receivers by 202 manufacturers. Tells what to do — exactly how to do it. Over 300 additional pages contain charts, data, tube information, codes, etc., that will help you save time, do better work in repairing any radio ever made. 744 big, manual-size pages. Weighs almost 4 lbs. Use coupon. See Money-Saving Offer!

Only \$5

RADIO
TROUBLESHOOTER'S
HANDBOOK
NOT a 'study' book!

SAVE
MONEY!

Let **RADIO TROUBLESHOOTER'S HANDBOOK** save you time on common service jobs! Let **MODERN RADIO SERVICING** train you for truly professional radio-electronic service work. Get both big books for special price of only \$9.50 for the two. Use coupon.

5-DAY MONEY-BACK GUARANTEE

- Dept. RC-58, Murray Hill Books, Inc., 232 Madison Ave., New York 16, N. Y.
- Enclosed find \$..... for books checked; or send C.O.D. (in U.S.A. only) and I will pay postman this amount plus a few cents postage. In either event, if it is understood I may return books after 5 days if not satisfactory and my remittance will be refunded.
- RADIO PHYSICS COURSE \$5 (\$5.50 foreign)
- MODERN RADIO SERVICING \$5 (\$5.50 foreign)
- RADIO TROUBLESHOOTER'S HANDBOOK \$5 (\$5.50 foreign)
- MONEY-SAVING COMBINATION Both Modern Radio Servicing and Troubleshooter's Handbook for only \$9.50 for the two (\$10.50 foreign)

Name

Address

City & Zone State



Better Products for the Radio Industry

NEW G-C STATIC CHASER INJECTOR and POWDER



Tire static powder kits—improve auto radio reception. Eliminates wheel static interference. New powder is blown into all inner tubes—easy to use. For every car owner!

- No. 5604—Injector for G-C Static Powder List \$1.50
- No. 5605—G-C Static Powder Packet for 5 tires..... List \$1.00
- No. 5606—Kit—One Powder Packet and Injector..... List \$2.50



Have you seen the new G-C "Speedex" Wire Strippers... write for illustrated literature.

RADIO DIVISION DEPT. D

NEW G-C TUBE PULLER



Makes it easy to remove or insert miniature tubes... simple to operate. Inserts or extracts tubes where fingers will not reach—into hard-to-reach places. Saves time and money. Ends tube breakage, prevents burnt fingers.

- No. 5093—Miniature Puller..... List \$ 1.50
- No. 5093-D Display of 12..... List \$18.00

NEW G-C FIELD CHASS EZ



Holds almost any radio chassis in position! Has special reversible hooks for flanged type chassis or, to tilt chassis back if necessary. Made with slide adjustment—takes only 5 seconds to install. No parts to lose—will never wear out. A real convenience for the radio serviceman!

- No. 5207 Chass Ez..... List \$2.95

G-C Products are available at leading distributors. Write for your copy of our new illustrated catalog.

GENERAL CEMENT Mfg. Co., Rockford, Ill., U. S. A.

Manufacturers of over 3,000 products • Sales offices in principal cities

TUBES! TUBES! TUBES! THOUSANDS OF TUBES LOWEST PRICES!

[NEW, STANDARD BRANDS—QUANTITY PRICES ON REQUEST—MINIMUM ORDER \$5.00]

TYPE	PRICE	TYPE	PRICE	TYPE	PRICE	TYPE	PRICE	TYPE	PRICE	TYPE	PRICE
1A3	.96	6AC7	.99	6U5	.96	1622	1.75	723A/B	5.50	1625	.49
1A5	.49	6AG5	.99	6V6GT	.99	3523	.99	725A	12.50	1626	.49
1A7GT	1.10	6AC7	.99	6Y6G	.89	3525	.69	800	2.25	1629	.59
1B24	2.49	6AK5	.69	6X4	.98	36	1.10	801A	1.10	1631	1.49
1B38	4.50	6AL5	.99	6X5	.89	37	.69	802/RK25	1.49	1851	1.25
1G4	.44	6AQ5	.98	7AE7	.75	38	.89	803	8.95	2050	.90
1G5	.44	6AT8	.75	7B7	.69	39/44	.59	804	6.75	2051	.49
1G6	.98	6AU6	.89	7C4	1.50	41	.69	805	3.75	5514	4.75
1H4G	.98	6B4	1.29	7C5	.89	42	.64	807	1.25	7193	.39
1L4	.89	6B6G	.89	7F7	1.25	45	.64	808	2.95	8001	4.95
1R4/1294	1.29	6B6G	3.49	7L7GT	1.39	47	.90	808	2.95	8005	3.25
1T4	.58	6B8	.99	10Y	.69	50B5	.89	809	1.50	8011	2.95
1M5	.99	6C4	.64	12A6	.89	50L6GT	.75	811	1.95	8012	4.95
1N5GT	1.10	6C5	.51	12AH7	1.10	70L7	.89	812	3.00	8016	1.95
1LN5	1.92	6C6	.75	12AT6	1.10	71A	.69	812H	6.90	8020	5.95
1R5	1.10	6C21	12.95	12BA6	.89	75	.69	813	5.95	8025	2.95
1S5	1.10	6D4	.89	12BE6	.89	75T	2.39	814	4.39	9001	.89
2A3	1.39	6D6	.75	12C8	.89	77	.75	815	2.25	9002	1.49
2C22	.69	6F6	.79	12H6	.44	78	.75	826	1.75	9003	.49
2C26A	.78	6F6G	.80	12J5	.69	79	1.10	829A/B	2.95	9004	.49
2C34	.98	6F7	.96	12K8	1.25	80	.53	830B	5.25	9005	.98
2C40	2.60	6F8	1.10	12SA7GT	.99	82	.96	832A	39.50	9006	4.99
2C44	1.75	6G6	1.10	12SG7	.89	83V	.89	833A	1.15	9010	3.95
2D21	.75	6H6	.49	12SH7	.89	84	.75	836	2.50	9015	1.25
2E22	1.50	6J4	1.50	12S17	.79	85	.89	837	2.50	9024	1.25
2E25	3.95	6J5	.49	12SK7	.69	100TH	12.95	838	3.75	9024	1.25
2E30	2.25	6J6	.49	12SL7	1.10	100TS	3.00	841	.69	9024	1.25
2J32	20.00	6J7	.89	12SN7GT	.79	117L7	1.89	843	1.50	9024	1.25
2J33	20.00	6K6	.49	12SQ7GT	.99	117Z3	.89	845	3.75	9024	1.25
2J51	4.95	6K7	.59	12SR7	.79	117Z6GT	1.10	860	3.00	9024	1.25
2X2	3.49	6K8	1.25	12X3	.98	121A	2.65	861	50.00	9024	1.25
3A4	.49	6L6	1.25	14A7	1.10	205B	4.50	866A	.75	9024	1.25
3B7	.98	6L6G	1.20	14B7	1.10	211	.98	868	1.95	9024	1.25
3B22	4.95	6L7	.98	14H7	1.25	215A	3.00	872A	1.95	9024	1.25
3B24	.98	6N7	.89	14J7	1.25	217C	7.50	874	1.95	9024	1.25
3D6/1299	.89	6Q5	.98	14R7	1.10	250TH	17.50	884	.75	9024	1.25
3E29	2.95	6Q5G	.89	15E	1.50	304TL	2.49	923	.49	9024	1.25
3Q4	1.10	6Q7	.89	23D4	.49	307A	6.25	954	.49	9024	1.25
3Q5GT	.58	6R7	.89	23D6	.98	316	.89	955	.49	9024	1.25
3S4	.43	6SA7	.90	24G	.69	371A	1.39	956	.75	9024	1.25
4E27/257B	4.95	6S7	.85	25A6GT	.75	371B	.89	957	.49	9024	1.25
5R4GY	1.15	6SF5	.79	25L6GT	.75	394A	4.50	958A	.49	9024	1.25
5T4	1.25	6SG7	.79	25Z5	.75	417A	19.95	959	.49	9024	1.25
6AB7	1.25	6SH7	.39	25Z6	.98	446A	1.25	991	.39	9024	1.25
		6SJ7GT	.69	28D7	.75	450TH	17.50	1005	.39	9024	1.25
		6SK7	.79	30	.78	703A	7.50	1006	.39	9024	1.25
		6SL7	.89	32L7	1.50	705A	1.85	1613	.95	9024	1.25
		6SN7GT	.69	34	.98	715A	1.65	1614	1.39	9024	1.25
		6S07	.89	35L6GT	.75	715B	4.95	1616	.39	9024	1.25
		6SR7	.89	35Y4	1.10	717A	.69	1619	.98	9024	1.25
		6SS7	.75	35W4	.69	721A	3.95	1624	.98	9024	1.25

20% DEPOSIT WITH ALL ORDERS UNLESS RATED

NIAGARA RADIO SUPPLY CORP. 160 GREENWICH STREET
NEW YORK 6, N. Y.

WIND GENERATORS

(Continued from page 33)

replaced. Brushes should also be replaced if they have worn down to where they do not hold their proper position in the brush holders. The mica between the commutator segments should be below the level of the copper bars. If it is not, it should be undercut, as the raised mica will prevent the brushes from making proper contact with the commutator. An ordinary hacksaw blade of the right thickness may be used.

Incidentally, an open bypass condenser or arcing at the brushes—caused by several reasons including those mentioned above—will cause static on the radio.

Check the field for continuity and voltage. If the field current has to be turned way up and the third brush all the way into the direction of rotation to make the generator produce a nominal amount of current, or if the strongest wind doesn't suffice to bring the output up to normal, the armature is either open or shorted. In either case it should be sent to the manufacturer or a motor shop for test and repair.

Generator speed has to be up to normal before maximum output can be expected. It can be checked without using a tachometer, by observing the governor. If the wind is strong enough to make the governor act, the generator is up to speed and should deliver its rated output. To make certain the governor is actually operating, slow the prop by applying the brake used to lock the prop when the generator is not being used, and watch to see if the governor relaxes.

Some of the governors turn the prop out of the wind. Others change its pitch, and still others throw out vanes which act as air brakes. No matter what the principle, the action is the same. They keep the prop's speed from exceeding its rated level. For example, *Wincharger* Models 617 and 1217 are set for 1,100 r.p.m. Governors can be relied on to do their job when in good condition and their action unhampered.

Insufficient Power problems

Lack of power over a period of time can be traced to one or more of the following: improper adjustment of control equipment, lack of sufficient storage-battery capacity, an undersized plant, or a plant poorly located with respect to the wind. An unrealized load may cause a complaint of low power. An example is a refrigerator lamp that doesn't go out when the door is closed. The lamp might draw a mere 25 watts, but, running 24 hours daily, it would draw a sizable amount of power. Other examples are a partially shorted motor and an incorrectly rated electric iron, any or all of which may lead the plant owner to believe he is consuming less power than he actually is.

Going back to the adjustment of controls, the smaller types of generators use the simple third brush and reverse current relay adjustments and controls. The third brush is connected to the field

and supplies it with a portion of the current generated. Moving the brush against the direction of rotation increases the field strength and output.

The reverse current relay (left relay in Fig. 1) is a simple cutout relay with a dual coil arrangement. One coil of fine wire is shunted across the generator output, and another of heavy wire is in series with the load and the contacts. Both are on the same core. When the generator starts to deliver current, the shunt coil is energized and closes the relay, connecting the generator to the load. When the wind stops, the battery voltage tends to drive the generator as a motor. The current, reversing through the heavy coil, opens the relay and breaks the circuit.

A typical adjustment for a *Wincharger* 6-volt relay would be: closing voltage, or cut-in: 6.9 to 7.3 volts, reverse or opening current: 1.5 amperes.

These measurements can be made with voltmeter and a 20-0-20 ammeter. To simulate a no-wind condition, the brake can be applied slowly and the generator slowed down until the reverse current opens the relay.

The larger plants have slightly more complicated controls. They dispense with the third brush and control the voltage with compound-wound field or a rheostat in series with the field (or both). To cope with fully charged batteries some of the control panels have a relay with contacts in series with the field and shorting a trickle-charge control rheostat. This appears on the right side of Fig. 1. When the battery voltage comes up the relay opens, putting the rheostat in series with the field and so lowering the generator output to a predetermined level.

Incidentally, operation of these relays is affected by room temperature, which should be checked before corrections are made.

Lack of sufficient storage capacity usually leads to continually run-down cells. Run-down cells, operated continuously around 1.150 instead of up around 1.250, will sulphate—develop a hard film on the surface of the plates that prevents the plates from taking a charge. The cure (when it works) is a long, slow charge. Prevention technique is to watch the hydrometer reading and charge the cells once a month until they emit gas for a few hours. This will also equalize them and bring their specific gravity up until their charge is equal.

Lack of capacity leads to a high charge and high discharge rate which shortens the life of the battery. Further, a discharged battery will freeze at a much higher temperature than will a fully charged one.

A word of warning. *Take care when you climb the tower!* Make certain the guys are in place and secured. Make certain no one is going to fool with the controls and relays. The generator, run as a motor, can easily throw you off the tower. Disconnect the batteries before going up. *And stay off in a strong wind!* The brake which locks the prop may loosen, and let go. One whack from the revolving prop can cut you in two.

This vibrator replacement guide will bring you up to date on vibrator interchangeability. It is cross indexed in three ways to save your time and remove guess work. The first printing is limited so be sure to get your copy now.

Remember James vibrators work better and last longer because they feature exclusive (1) Patented Push-Pull Action (2) Frame-Mounted Cooler-Operation (3) Adjustable Contacts. Prompt shipment on all types.

Ask your Radio Parts jobber or write

JAMES VIBRAPOWR CO.

3224 W. Armitage Ave.

Chicago 47, Illinois

MONEY TALKS!

DOUGLAS OFFERS *The Lowest of Low Prices on the Map!*
TELEVISION KITS BY TRANSVISION

WE GUARANTEE A WORKING KIT!

Standard 12" Model. Picture size 75 square inches. 22 tubes and 12" picture tube. High fidelity FM sound reproduction. Advanced television circuit provides exceptionally clear pictures.	\$289.50*
12" Standard Television Kit	\$359.50*
12" Deluxe Television-FM Radio Kit	\$160.00*
7" Television Kit	\$165.00*
7" Republic Kit	\$199.50*
10" Republic Kit	
COMPLETE LINE OF TELEVISION COMPONENTS IN STOCK—'DEALERS' PRICES UPON REQUEST	
Douglas 5 Tube Superhot Kit—Complete with tubes, cabinet, all necessary parts. Your cost.	\$12.48
Phone Meter and pickup kit. Your cost	\$4.94
Resistor KK—100 assorted resistors 1/4, 1, 2 watt.	\$1.79
Detroit Automatic Record Changer—Plays 10" and 12" records. Enjoy almost 80 minutes of continuous music.	\$13.50
Special Low Price	\$21.00
Webster #50. Your cost	\$25.95
Webster #56 with automatic stop. Your cost.	

SPEAKER BUYS

4" Alnico slug PM	\$4.35	10" Alnico slug PM	\$4.85
5" Alnico slug PM	\$1.39	12" Alnico slug PM	\$6.95
8" Alnico slug PM	\$3.45		
Webster Model 80 wire recorder in compact carrying case comes with 3 wire spools, hand mike and instruction sheets	\$149.50		
R.C.P. MODEL 720 FM SIGNAL GENERATOR 10.7 mc for I.F. and 88 mc for the low end, 88 mc for midpoint and 168 mc for the high end of the FM band. Complete with tubes, instruction book and output cable. Your cost	\$19.95		
R.C.P. MODEL 710 GENERATOR for all standard Broadcast application. Frequency 456 kc., 465 kc., 1500 kc. and 550 kc. Broadcast band alignment is provided for by these fixed frequencies. Complete with tubes, instructions and output cable	\$17.95		
THREE-WAY PORTABLE KIT—A.C. D.C. and Battery. Complete with portable case, speaker and all necessary parts, including tubes. Your cost	\$17.50		
MARION 2" PANEL METERS 0-1 ma, 0-2 ma, 0-5 ma, 0-500 μ s. SPECIAL	\$3.95		
VOLUME CONTROLS			
1/4 meg, 1 meg, 2 meg, less switch, long shaft. Your Cost	26c		
1/2 meg with switch, long shaft. Your cost	35c		
50 asst. knobs, push on and set screw, plastic and wood. Your cost	\$1.98		

DOUGLAS RADIO SUPPLY COMPANY, INC.

DEPT. A-1

128 GREENWICH STREET

NEW YORK 6, N. Y.

Worth 4-0470-1

WRIGHT VERIFIED SPEAKERS

They Glorify the Tone

WRIGHT, Inc.

2234 University Avenue

St. Paul 4, Minn.

Radio - Television - Electronic Parts & Equipment Specials

TELEVISION-CATHODE RAY HIGH VOLTAGE

2000 volt D.C. Power Supply

Why bother with bulky and dangerous 60 cycle supplies or expensive R.F. power supplies when you can purchase a complete 2000 volt D.C. unit (not a kit), ready to plug into the 110 volt A.C. power line. The ridiculously low price has been made possible by a fortunate purchase of high quality components. These units are brand new, completely tested and guaranteed.

Price \$7.95

4000-6000 VOLT TELEVISION SUPPLY

Similar to the unit above, but has a much higher D.C. output voltage suitable for use with the new 7" and 10" television tubes.

PRICE\$12.50

TELEVISION BOOSTER!

Increases signal strength to the television receiver 16-18Db. Rejects unwanted off-channel interference. Simply installed by connecting in series with antenna terminals of receiver, self-contained power supply.

Three models available

- Model TVL—Channels 1 thru 6
- Model TVH—Channels 7 thru 13
- Model FM—88-108 Mc (FM Band)

Available in Walnut or Mahogany finish
Size 3" x 5" x 6"

Price \$26.95

SPECIAL!

Magnetic Recording Wire—1½ hour spool of GE steel recording and playback wire priced for quick sale \$1.95

PHOTO-ELECTRIC TUBE

GE type PJ23 sensitive gas phototube—suitable for regular and invisible infra-red light. Has four prong socket and Calcium light sensitive element.

Price \$2.95

Cathode-ray tube Mask and Mounting bracket for 5" tubes. Excellent for use with 5" television sets or oscilloscope.

Price \$0.25

Chrome panel escutcheon for above—4½" diameter opening—suitable for use with cathode-ray tubes or round dials.

Price \$0.25

TELEVISION PICTURE TUBE—9 inch electromagnetic type. This is the MW22-2 tube used by GE in their television sets. Can be used in other sets designed for electromagnetic deflection. Has standard 3 prong base.

Complete with instruction booklet..... \$13.95

A SCIENTIFICALLY DESIGNED PHONO SCRATCH FILTER

Resonated at approximately 4500 cycles effectively reducing objectionable needle scratch without altering the brilliancy of reproduction. Contains a HI-Q SERIES resonated circuit. Tested by means of an audio oscillator and an oscilloscope to give 22 db. attenuation with very low signal loss. Attenuation may be regulated by means of a SPECIAL MINIATURE gain control.

EASY TO ATTACH

Just two wires to clip on. Compact. Price \$1.65

THREE TUBE PHONO AMPLIFIER

An assembled unit ready for installation using tone and volume control and six feet of rubber cord

(Not including Tubes) \$2.95

With Complete Set of Tubes \$3.95

PHONO OSCILLATOR

Wireless phono oscillator transmits recording for crystal pick-ups or voice from carbon mike through radio without wires. Can also be used as an intercomm by using P.M. speaker as mike. Price (excluding tubes) \$2.95

With Complete Set of Tubes \$3.95

SPECIAL! SPECIAL!

Mammoth assortment of radio and electronic parts, not less than TEN POUNDS of new transformers, chokes, condensers, resistors, switches, coils, wire, hardware, etc. A super-buy for experimenters, servicemen, and amateurs for only \$1.25

Satisfaction guaranteed on all merchandise.
All prices F.O.B. New York City

WRITE FOR CATALOGUE

RADIO DEALERS SUPPLY CO.

135 Liberty St. New York, N. Y.

SPECIALS!

BC-454 COMMAND RECEIVER (274N Series)
3 to 6 MC—Complete with tubes—\$5.95
New

COMMAND TRANSMITTERS

(274N Series)—Complete with tubes & crystal
BC-457: 4 to 5.3MC \$5.95
BC-458: 5.3 to 7MC 5.95
BC-456 MODULATOR (Brand New) ... 2.95

RADIO PARTS

Assorted—100 mica condensers \$1.19
100 Resistors 1/3 to 1 watt95
100 Tubular bypass condensers, assorted
.01 to .1, all 600 Volt 4.69
Electrolytic condensers 50-30, 150 Volt
10 for 2.89
½ Meg. Volume Controls 1" shaft with
switch 10 for 3.00
½ Meg. Volume Controls 1" shaft with-
out switch 10 for 1.95
Crystal Pick-up, new light wt. ea. 1.79

Brand TUBES Brand NEW! TUBES NEW!

CATHODE RAY TUBES } \$1.19 each
SCP1 - SBP1 - SFP7 - BFP7 - BFP7 }
5BP4 \$1.95 each

RECEIVING TUBES

954 9006 12SR7 RK34 } 39c each
957 35W4 12K8 6SP7 } Lots of 50—10%
9003 12C8 2051 210 AC } discount
1625 }
1629 } 19c each
7193 }

304TL Transmitting tube
Brand New \$1.95 each

All Shipments F.O.B. Chicago
20% deposit required on all orders

ARROW SALES INC. Dept. D

59 WEST HUBBARD ST., CHICAGO 10, ILLINOIS
Telephone: SUPERIOR 8575

OUTSTANDING VALUES



Kit Model 210, a Three Way Port- able Receiver

Operating on either AC or DC or self-contained batteries . . . power switch conveniently located on front of set so that "battery" or "AC-DC" may be selected without opening case.

Five-inch Alnico 5 permanent magnet dynamic speaker, and case covered with beautifully grained leatherette. Price of Model 210 complete with tubes \$18.95



Multitester Kit Model M-3C

A versatile, compact multitester 4" x 7" x 3" using a 3½" rd. meter of 1000 ohms per volt sensitivity. Employs the following ranges: Volts AC or DC 0/5/-50/150/500/1500. Milliamperes D.C. 0/5/50/150. Ohms 0/2000/20,000/200,000. Price complete \$10.95

All kits accompanied by a detailed illustrated instruction sheet. Many other kit models available. Write for Catalog M.

Now ready! New educational pamphlet... complete and simplified diagrams and instructions on all our models.....50c

RADIO KITS COMPANY

120 Cedar Street New York 6, N.Y.

TELEVISION CONDENSERS

THAT CAN REALLY TAKE IT!

.10 Mf 2500v \$0.74	.05 Mf 5000v \$0.89
.10 Mf 3500v 0.83	.005 Mf 7500v 0.62
.005 Mf 5000v 0.60	.001 Mf 10000v 0.59

Many other sizes available. Write for descriptive folder. If not available at your dealer, order direct from factory.

UNITED CONDENSER CORP.

422-L E. 138th Street New York 54, N. Y.

RADIO-CRAFT needs more photos of service shops and service benches. We will pay \$6.00 for each 6x8- or 8x10-inch glossy photo accepted. Do not "dress up" your bench, but take a bona-fide photo, preferably with men working.

RADIOMAN ON WHEELS

By RICHARD LAURENCE

PAUL SKELTON, Vienna, Illinois, is a hard-working radioman. Like the great majority of the profession, he'll give you a competent job on your set, and a square deal on the price. With parts and tubes now generally available, 2-day service is the rule. So what? There are thousands of guys like that over the country! Well, there is a difference. Paul is one of the small but growing number of "servicemen on wheels"—his only means of getting about being a wheelchair.

An automobile accident seven years ago crushed his spine and left his legs permanently paralyzed. His health was gradually restored, and his physical needs were well cared for, but he was oppressed by the growing futility of a life that did nothing but exist from one day to the next.

The radio was his greatest source of enjoyment. One day about 3 years ago he switched on for fifteen minutes of news analysis. The old Motorola warmed up smoothly, gave with the commercial, then squeaked, grunted, and died. That was the last straw. The only radioman in town had gone to the army a month ago, and there was no other set in the house. New radios, of course, were only a memory.

There was a screw driver and pliers handy, and Paul figured a pile of junk was just as good as a radio that didn't work. At least that's what he thought until a lunatic's dream of parts, wires, and connections confronted him. Grabbing the chassis firmly with his left hand, he probed every accessible spot with his right index finger. A large metal tube was intriguing, and he took a good grip on the heavy wire leading to it. The shock wore off in about half a minute.

"It was pure luck," Paul told me, "but that Motorola played after I put it back in the cabinet. Sleep came hard that night, but it was because I felt so good; I had accomplished something useful! Pretty commonplace to the man who gets out and hits the ball every day, but a million bucks wouldn't have pleased



Paul Skelton on his way to pick up a radio.

me more. The next day I thumbed through the magazine ads of the various correspondence schools, and picked out one by the heads-or-tails method."

With the aid of the State Rehabilitation Commission, Paul enrolled with National Radio Institute, Washington, D. C. As far as he knew, ohm was something that rhymed with home, so the first lessons pushed him around a lot. Furthermore, the habit of work and concentration had dulled. It was easy to let attention drift away from pages packed solid with technical material. But the course kept hammering away at the chain idea—the radio is fundamentally a chain of stages that boost the strength from antenna to loudspeaker. At last light began to seep through the murk. The first kit of experimental parts came. That helped by giving him something solid to work with. There is nothing theoretical about a hot soldering iron.

Finally the vacuum-tube multitester supplied by the school was assembled, and Paul borrowed a tube tester, since test equipment was not yet available. That was good—he was practically a serviceman now. The lady next door dropped her little set and brought it over. She wanted it in a hurry. Six hours later he was covered with cold sweat and cursing himself, the radio, and that multimeter. The lady came back and looked the set over critically. "Is that little wire over there supposed to be loose?" she asked.

He turned the set on and touched the loose end of the resistor to the various terminals around it. On the third try—music! He knew then they hadn't been kidding when they said to take a minute to look the set over thoroughly before starting trouble shooting procedures.

Trouble shooting broke down on the next set too, and it was guess and test until a shorted coupling condenser showed up. With the realization that there was plenty more to learn, Paul turned back to the course. Experience and study gradually made servicing more simple, but now the tube shortage came into the picture. Fifty percent of the jobs had to be turned back unfixed because there is no substitute for a burned-out tube. The school sent a list of wholesale radio supply houses in the area, but a score of letters produced not a single tube. He thumbed through the Sears, Roebuck catalog until he came across their list of available numbers. A good many 6-volt and several series rectifiers and localts that could be substituted were there. Maybe it was technically dishonest to certify that those tubes were needed for equipment that was personally owned, but Sears, Roebuck kept him alive for the next year, and every tube they sent helped to put a radio back in working order.

Paul is over the hump now as far as technical knowledge is concerned. He now has a special wheelchair powered with a small gasoline motor, and which has gears, throttle, and brake completely hand-controlled. The tires are small 4-ply pneumatic, just like an automobile, and with this he is able to get out on the streets and go anywhere in town.

Thus he is able to pick up and deliver some small sets. Due to the fact that his sitting-up time is limited by the spinal condition, he has to do part of his work while lying on his side in bed. Try it sometime! However, he hopes to be able to stay up the whole day eventually, and do all his work sitting at the bench.

There is new, adequate test equipment in the shop now, and the money he has earned has enabled him to build up a stock of tubes, parts, and diagrams. Of course, there are plenty of aggravations. He can't follow a radio into the home and see that it is hooked up properly, nor can he go after the chassis from a console model. Similarly, a lot of profit is missed on installing and servicing auto sets. To realize their full potential, a person handicapped in this way should have an active partner or employee so that he can devote his time to bench work. But radio servicing has put Paul back on the road to being a useful, self-sufficient citizen, and he believes it offers perhaps the best opportunity of any available field. He knows that nothing else could be as satisfying.

OPPORTUNITY AD-LETS

Advertisements in this section cost 25c a word for each insertion. Name, address and initials must be included at the above rate. Cash should accompany all classified advertisements unless placed by an accredited advertising agency. No advertisement for less than ten words accepted. Ten percent discount six issues, twenty percent for twelve issues. Objectionable or misleading advertisements not accepted. Advertisements for June, 1948, issue must reach us not later than April 24, 1948.
Radio-Craft • 25 W. B'way • New York 7, N. Y.

RADIOS, RECORD PLAYERS, TUBES, PARTS. SEND for free bargain list. Hallmark, 594 Communipaw, Jersey City 4, New Jersey.

AMATEUR RADIO LICENSES. COMPLETE CODE and theory preparation for passing amateur radio examinations. Home study and resident courses. American Radio Institute, 101 West 63rd Street, New York City. See our ad on page 86.

26 YEARS' EXPERIENCE RADIO REPAIRING AT your fingertips. I've perfected simple system you can follow step by step. No formulas or calculations. Cuts repair time to minimum. Total price \$2.00 postpaid or COD. Moneyback guarantee. Ross Radio, 14815-J Grandriver, Detroit 27, Michigan.

PHONOGRAPH RECORDS 20c. CATALOGUE. PARAMOUNT, KQ-313 East Market, Wilkes-Barre, Penna.

NEW CARTONED TUBES 39c each. 100 ASSORTED for \$35.00. 1B5, 1B5, 1T4, 3V4, 3S4, 5Y3rt, 6A8rt, 6C5rt, 6K7gt, 6Q7gt, 6V6rt, 6SA7gt, 6BD7rt, 6BK7rt, 6SQ7gt, 6X5rt, 12A4gt, 12AT6gt, 12BA6, 12BE6, 12J5rt, 12K8, 12SA7rt, 12SK7gt, 12SQ7rt, 25L6gt, 32L7rt, 35B5, 35L6, 35W4, 35Z5, 47, 50B5, 50L6, 70L7gt, 80, 89, 117L7gt. Write for bargain flyer. Henshaw Radio Company, 3313 Delavan, Kansas City 2, Kansas.

RUBBER STAMPS, ETC., FOR SALE. COOKSON, Box O-R-C, Puxico, Missouri.

RADIOMEN, SERVICEMEN, BEGINNERS — MAKE more money, easily, quickly, \$250 weekly possible. We show you how. Information free. Merit Products, 216-32L 132nd Avenue, Springfield Gardens 13, New York.

YOU CAN ACCURATELY ALIGN SUPERHETERODYNE receivers without signal generator. Complete instructions \$1. Moneyback guarantee. Chas. Gates, Pecos 2, Texas.

WRITE DEPT. RC 20 FOR OUR LATEST FREE BARGAIN list of Radio and Electronic Parts. R.C. Radio Parts and Dist. Co., 733 Central Ave., Kansas City 6, Kansas.

MAGAZINES (BACK DATED)—FOREIGN, DOMESTIC, arts, books, booklets, subscriptions, pin-ups, etc. Catalog 10c (refundable). Clicerone's, 863 First Ave., New York 17, N. Y.

LANCASTER, ALLWINE & ROMMEL, 436 BOWEN Building, Washington 5, D.C. Registered Patent Attorneys. Practice before United States Patent Office. Validity and Infringement Investigations and Opinions. Booklet and form "Evidence of Conception" forwarded upon request.

WE REPAIR ALL TYPES OF ELECTRICAL INSTRUMENTS, tube checkers and analyzers. Hazelton Instrument Co. (Electric Motor Laboratory), 140 Liberty Street, New York, N. Y. Telephone—BARclay 7-4239.

LEARN ELEMENTS OF RADIO AT HOME. IDEAL course for beginners, \$15.00. Write Waca Radio School, 1421-J Sixth Street, S.E., Minneapolis 14, Minn.

AVIATION NEEDS EXPERIENCED RADIO MEN. Prepare at home in a few weeks for FCC-CAA radio licenses. Step into a big-pay job. Many opportunities for world travel. Write for details. Air Institute, RCM, Adams, Massachusetts.

TEST EQUIPMENT. TREMENDOUS SAVINGS. LIST free. Creat Corporation, Dept. C-2, 3949 Forest Park Blvd., St. Louis 8, Mo.

RUBBING CONES ON "NON-ADJUSTABLE" SPEAKERS quickly and easily repaired. Complete instructions 25c coin. Blake Radio, 2215 19th, Lubbock, Texas.

CASH FOR OLD ISSUE OF MODERN ELECTRICS, Popular Electricity. Q. S. T. Lipani, 157e Leverett St., Boston 14, Mass.

PLEASE TEAR OUT THIS ADV. AS REMINDER

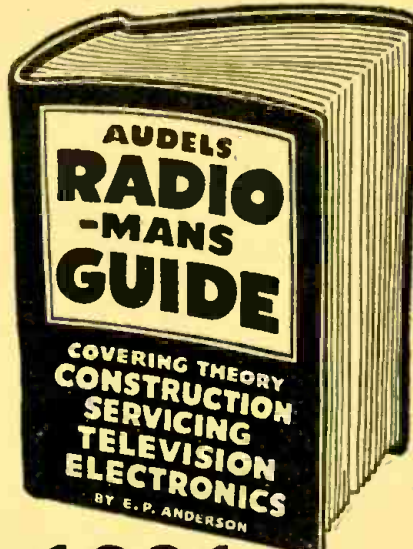

1001 RADIO FACTS AND FIGURES

AUDELS RADIOMANS GUIDE—914 Pages, 633 Illustrations, Photos, Wiring Diagrams, 38 Big Chapters, covering Radio Theory, Construction, Servicing, Including Important Data on Developments in Television, Electronics and Frequency Modulation, Review Questions and Answers, Calculations & Testing. Highly Endorsed—Indispensable for Ready Reference and Home Study.

\$4 COMPLETE • PAY ONLY \$1 A MONTH

Step up your own skill with the facts and figures of your trade. Audels Mechanics Guides contain Practical inside Trade Information in a handy form. Fully illustrated and Easy to Understand. Highly Endorsed. Check the book you want for 7 days' Free Examination.

Send No Money. Nothing to pay postman.

CUT HERE MAIL ORDER

AUDEL, Publishers, 49 W. 23 St., NEW YORK 10, N. Y.

Please send me postpaid for FREE EXAMINATION books marked (X) below. If I decide to keep them I agree to mail \$1 in 7 days on each book ordered and further mail \$1 monthly on each book until I have paid price otherwise, I will return them.

- RADIOMANS GUIDE, 914 Pages . . . \$4
- ELECTRICIANS EXAMINATIONS, 250 Pages . . . 1
- WIRING DIAGRAMS, 210 Pages . . . 1
- ELECTRIC MOTOR GUIDE, 1000 Pages . . . 4
- ELECTRICAL DICTIONARY, 9000 Terms . . . 2
- ELECTRICAL POWER CALCULATIONS, 425 Pgs. . . 2
- HANDY BOOK OF ELECTRICITY, 1440 Pages . . . 4
- ELECTRONIC DEVICES, 216 Pages . . . 2
- ELECTRIC LIBRARY, 12 vol., 7000 Pgs., \$1.50 vol. . . 1
- OIL BURNER GUIDE, 384 Pages . . . 1
- REFRIGERATION & Air Conditioning, 1280 Pgs. . . 4
- POWER PLANT ENGINEERS GUIDE, 1500 Pages. . . 4
- PUMPS, Hydraulics & Air Compressors, 1658 Pgs. . . 4
- WELDERS GUIDE, 400 Pages . . . 1
- BLUE PRINT READING, 416 Pages . . . 2
- SHEET METAL WORKERS Handy Book, 388 Pgs. . . 1
- SHEET METAL PATTERN LAYOUTS, 1100 Pgs. . . 4
- AIRCRAFT WORKER, 240 Pages . . . 1
- MATHEMATICS & CALCULATIONS, 700 Pgs. . . 2
- MACHINISTS Handy Book, 1600 Pages . . . 4
- MECHANICAL Dictionary, 968 Pages . . . 4
- AUTOMOBILE GUIDE, 1700 Pages . . . 4
- DIESEL ENGINE MANUAL, 400 Pages . . . 2
- MARINE ENGINEERS Handy Book, 1280 Pages . . . 4
- MECHANICAL DRAWING GUIDE, 160 Pages . . . 1
- MECHANICAL DRAWING & DESIGN, 1200 Pgs. . . 2
- MILLWRIGHTS & Mechanics Guide, 1200 Pgs. . . 4
- CARPENTERS & Builders Guides (4 vols.) . . . 6
- PLUMBERS & Steamfitters Guides (4 vols.) . . . 6
- MASONS & Builders Guides (4 vols.) . . . 6
- MASTER PAINTER & DECORATOR, 320 Pgs. . . 2
- GARDENERS & GROWERS GUIDES (4 vols.) . . . 6
- ENGINEERS and Mechanics Guide . . . 12
- Nos. 1, 2, 3, 4, 5, 6, 7 and 8 complete . . . 12
- Answers on Practical ENGINEERING . . . 1
- ENGINEERS & FIREMANS EXAMINATIONS . . . 1

Name _____

Address _____

Occupation _____

Employed by _____ R.C.F.

RADIO TUBES

For immediate shipment

R.M.A. Guaranteed
Below Distributor Costs
Individually Sealed Cartons

Type	Price
6K6GT	.40
6K5GT	.46
6V6GT	.46
6SA7GT	.46
6SJ7GT	.46
6SK7GT	.46
6SQ7GT	.46
6X5GT	.40
12SA7GT	.46
12SQ7GT	.46
12SK7GT	.46
12SJ7GT	.46
35L6GT	.40
35Z5GT	.32
50L6GT	.46

RATED ACCOUNTS—2% 10 DAYS
ALL OTHERS 2% C.O.D.
10% DISCOUNT ON LOTS OF 50 OR MORE

RAVAC ELECTRONICS CORP.

432—4th Avenue
New York 16, N. Y.

TECHNICAL KO's

OIL-FILLED CONDENSERS

.05 MFD	1000V	\$.28
.05	500V	.14
.1	2500V	.60
.1	7500V	1.85
2x.1	7000V	4.75
.12	15000V	6.95
.25	1000V	.35
.25	4000V	2.75
.25	6000V	4.00
10x.25	600V	1.08
.5	600V	.28
.5	1000V	.35
.5	2000V	.40
.75	2000V	.55
.77	330VAC	.35
1.0	1000V	.45
2.0	1000V	.60
4.0	600V	.60
4.0	1000V	1.00
5.0	220VAC	.65
6.0	600V	.70
8.0	600V	.80
8.0	1000V	1.75
10.0	600V	1.00
30.0	90VAC	1.40
50.0	330VAC	3.75

TRANSMITTING MICAS

.000025	2500V	\$.11
.00005	2500V	.14
.00005	3000V	.20
.00005	5000V	.25
.00007	2500V	.20
.00007	2500V	.20
.00025	2500V	.25
.00025	5000V	.25
.0004	2500V	.22
.0005	2500V	.22
.00072	5000V	.29
.0008	5000V	.29
.0011	2500V	.25
.0011	5000V	.29
.002	1200V	.17
.002	3000V	.22
.0025	1200V	.15
.0025	2000V	.28
.003	2500V	.30
.003	3000V	.28
.004	2500V	.36
.005	600V	.13
.005	3000V	.28
.006	2000V	.35
.008	1200V	.15
.01	600V	.13

Choke: 80ma-12H; 100ma-10H, 250 ohm \$1.50
Pots: 20K-50K, 100K .16
Pots: Dual 1 Meg. Dual 250K-50K .20
Shielded Wire No. 22 .50' for .65
Resistor Kit Assorted 1/2 & 1W...100 for 1.49
Bathtub Kit 3x 1, .5, .05 Etc. .10 for .59
Condenser Kit .01-.00001 .100 for 3.00
Micas .002, .005, Etc. All Values .08
.01 150V Paper (Midget) .60 for 1.00
0.1 600V Paper .8 for 1.00
6V6 Metal .30.29 12K8 Metal .30.25

\$2.00 min. order F.O.B. N.Y.C. Add postage
50% deposit, balance C.O.D. with all orders.
Manufacturers inquiries invited. Send for Flyer.
Prices are subject to change without notice.

TECHNICAL RADIO PARTS CO.
265 Greenwich St. Dept. RC-5 N.Y. 7, N.Y.

CHEAP AND EFFECTIVE NOISE LIMITER

NOISE limiters have been much in the news of late. Limiting is effective against the many types of sharp impulses that constitute most of the random racket heard in urban areas as well as a good portion of plain old static.

For maximum utility a limiter should be applicable to any existing receiver without alterations to the latter, inex-

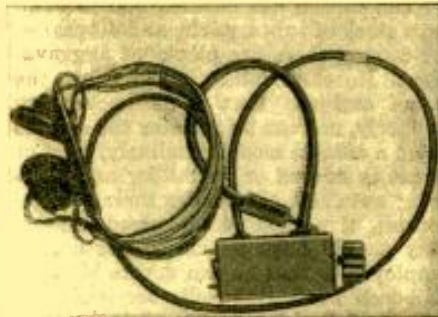

This limiter is a simple and compact device.

expensive, simple, and as usable for c.w. as for phone reception.

This simple noise limiter can be constructed for as little as two dollars at current prices. However, the average experimenter already has most of the parts in his junk-box, with the possible exception of the crystal diode. A 1N21 crystal was used because it was available, but any equivalent type may be readily substituted.

The principle of this type limiter is as follows: the diode is biased at 1 1/2 volts by the dry cell and does not conduct until the audio voltage exceeds the bias voltage. When the signal exceeds the bias, the diode conducts, short-circuiting the headphones for the duration of the noise impulse. This amount of bias allows a 3-volt audio signal which is a comfortable signal in the headphones.

The switch enables the operator to cut the limiter out of the circuit at will. It is wired so that it opens with the threshold control at the minimum-resistance setting. The variable resistance permits the best setting to be made for any set of conditions.

The unit does a splendid job on c.w. operation. There is a small amount of audio selectivity, but the most impressive result is the a.v.c. action. Tuning across strong local c.w. signals is no longer an ear-splitting experience. Furthermore, it is possible to copy signals through static or man-made noise that

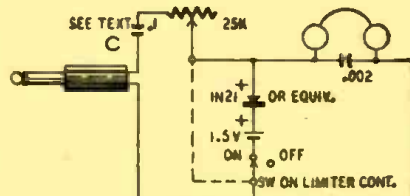

A crystal and flashlight cell form a limiter.

would ordinarily make reception impossible.

The limiter is built into a discarded i.f. can, although it can be made in several other ways as well. The parts are wired together, and the cables attached. The unit is then pushed into the can

with the control shaft brought out through a hole in the closed end. Line the can with stiff paper to avoid short circuits between can and wiring.

The size of condenser C is determined by experiment and will vary with some receivers depending upon the output circuit. In this model it is 0.1µf. There is no drain on the dry cell, and it should last a year or two.

The limiter works best with a strong signal. In use the receiver audio gain is advanced to the point where headphone volume fails to increase in proportion to the gain setting. This is the point where limiting begins.

The dx hunter will find this limiter a fine protection against tin ears caused by tuning in powerful stations while scanning the shortwave bands. It has no effect on the weak signals but holds the strong ones down.—Otto Woolley WØSGG

NOVEL CODE OSCILLATOR

A dual-triode, high-frequency miniature tube is used in this code oscillator. The circuit is simple and can be constructed compactly because it does not use a transformer. A 45- or 67 1/2-volt battery is more than enough to operate this oscillator with good output into a

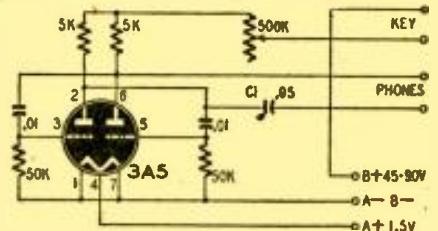

pair of headphones. If a speaker is desired, increase the voltage to 90.

The pitch is varied by using different values for C1. The pitch is lowered by using a smaller capacitance.

RALPH DAY,
Moncton, N. B., Canada.

Radio Thirty-Five Years Ago

In Gernsback Publications

HUGO GERNSBACK

Founder

Modern Electrics	1900
Electrical Experimenter	1913
Radio News	1919
Science & Invention	1920
Radio-Craft	1929
Short-Wave Craft	1939
Wireless Association of America	1908

Some of the larger libraries in the country still have copies of ELECTRICAL EXPERIMENTER on file for interested readers.

From the ELECTRICAL EXPERIMENTER, May 1914.

How to Calibrate E. I. Co. Slide Plate Condensers by C. Laager

Design and Construction Details of Radio Antennae, Part II, by H. W. Secor

The Wireless Society of London Hertzian Wave Collisions

Boston Talks With Nagasaki by Wireless

Signals Via Wireless 6,000 Miles

Wireless Currents on Metallic Conductors

LIGHT WITH A MEMORY
(Continued from page 30)

straight out. Frequency can be changed by adjusting the trimmer condenser in parallel with the tank coil; the relay plate current is controlled in part by the antenna trimmer.

A base of 1/4-inch plywood, hollowed to receive part of the relay, is affixed to the bottom of the panel by small brass screws. The receiver base is felt-lined, and both receiver and transmitter housings were painted with black crinkle-

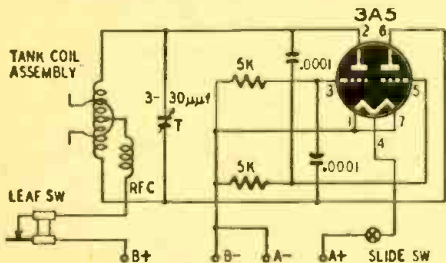

Fig. 5—Schematic of the secret transmitter.

finish lacquer. The hollow panel was built up of white pine.

Any small h.f. oscillator can be used. The one employed here was a type 3A5 twin triode in a push-pull circuit. Fig. 5 is the schematic, and a photograph of the transmitter with covers removed is shown at the right in Fig. 2. Two No. 412-E batteries were used to save space. A length of flexible 2-conductor wire is lead out of the transmitter to a leaf-type switch. The tank coil is 8 turns of No. 12 bare copper wire, 5/8-inch inside diameter, and a one-turn coil covered with insulation acts as an antenna and coupling coil. The r.f. choke is similar to the one in the receiver. Two C-cells in series with a slide switch furnish the filament supply. To conserve space the condensers and resistors are soldered directly onto the base of the tube.

The receiver unit is turned on just previous to the demonstration by rotating the dummy screwhead with a screw driver. The operator then explains the wonders of the light—emphasizing the waving of the hand over the lamp. After the spectator has pushed the push-button the desired number of times, the operator secretly pulses the transmitter with the concealed leaf switch, and the fun begins. The ultra-compact size of both units precludes the possibility of any radio device, especially in the minds of those steeped in radio theory. As a further convincing demonstration, the spectators may be allowed to hold the panel in their own hands.

CORRECTION

The grid coil L1, in the phono oscillator diagram on page 77 of the January, 1948, issue, is shown with a direct short circuit across its terminals. The diagram should show a 365-μf condenser inserted in the lead which shorts L1. A standard-size condenser or a small mica compression type may be used.

Our thanks to Mr. Thomas A. Stoner of Wauwatosa, Wisconsin, for this correction.



FASTER SIGNAL TRACING!

Signalette

MULTI-FREQUENCY GENERATOR

Generates R.F., I.F. and AUDIO Frequencies, 2500 cycles to over 20 megacycles, using new electronic multivibrator radar principle. Completely self-contained—fits coat pocket or tool chest. Just plug into A.C. or D.C. LINE AND CHECK RECEIVER SENSITIVITY, AUDIO GAIN, R.F. and I.F. touch-up, auto radio aerial peaking or shielding, breaks in wires, stage by stage signal tracing, tube testing by direct comparison, etc., etc. Sturdy construction, handsome appearance! See at your distributor or write for details. Shipping wt. 13 ozs.

Recognized Jobbers—wire, write for details.

PRICE **\$9.95** at distributor or postpaid direct.
CLIPPARD INSTRUMENT LABORATORY, INC.
Dept. C 1125 Bank Street, Cincinnati 14, Ohio

IF YOU CAN'T GET TO GOVT. SALES, THE BEST THING TO DO IS, SEND FOR OUR . . .

SPECIAL GOVT. RADIO SURPLUS ASSORTMENT

We buy large quantities of these items, divide them into choice assortments which we know you would be glad to have for this price if you could see them.
\$25.00

MONEY BACK GUARANTEE!

On a deposit of \$5.00, we will ship you C.O.D. (Balance \$20.00 Freight Collect) an amazing quantity of surplus radio items, subject to your inspection and approval. Unless you are more than pleased, return to us, freight collect. Your money refunded immediately. All it will have cost you will be the freight charges one way! This is the cheapest way to buy War Surplus Radio material. In fact, you can probably sell just a few of the items you don't need, to more than cover cost of the entire lot. Our warehouses are filled with thousands of choice Govt. Surplus Radio items. The cost of inventorying, itemizing, grouping, etc. would only multiply their cost to you. Therefore, we make this offer. However, if you mention a few items you desire, we will try to include them in the assortment. Send for our special Value Bulletins on Radio and Photographic Supplies. Tell us your wants.

THE ABELL DISTRIBUTING CO.

7 E. Biddle St. Dept. 4 Baltimore 2, Md.

BEST BUYS AND BEST SERVICE AT SENCO'S New Headquarters!

LOOK AT THESE TUBE VALUES!

EVERY TUBE IN CARTON		R.M.A. GUARANTEED	
Type	Each	Type	Each
0Z4	69c	6SQ7GT	44c
1A3	45	6SG7	44
1A5GT	59	7A4	53
1A7	59	7B6	58
1U5	36	7B7	44
1V	45	7F7	49
1L4	55	7N7	49
1T4	69	7Y4	44
1S5	69	7X7	44
2A7	49	7AF7	44
2A5	65	12A6	35
2A6	49	12A6GT	45
2X2	35	12AT6	50
3A4	69	12BA6	50
3S4	69	12BE6	50
5U4G	50	12J5GT	35
5W4GT	40	12J7GT	45
5Y3GT	40	12K7GT	45
5Y3G	42	12K8	65
5Y4G	40	12Q7GT	45
5X4G	40	12SA7GT	40
5Z4	59	12SF7	39
6A7	50	12SQ7GT	40
6A8GT	49	12SK7GT	45
6AC5	98	12SR7	39
6AC7	65	12SJ7GT	55
6AK5	74	14A7	65
6AG7/6AK7	89	14B6	59
6B7G	55	24A	49
6C4	29	25	47
6C5GT	40	35	57
6C6	45	32	58
6C8G	37	29	71A
6F6GT	45	39	75
6H6	45	39	76
6J6	55	50	77
6H6GT	45	39	80
6J5GT	45	39	83V
6J7GT	42	38	85
6K6GT	45	39	99V
6K7GT	49	39	99X
6K7G	50	41	25L6GT
6L6G	79	69	25Z5
6Q7GT	47	39	25Z6GT
6S7	59	48	35W4
6U7G	35	25	35Y4
6V6GT	45	39	35Z3
6X5GT	49	39	35Z5GT
6SA7GT	44	37	35L6GT
6SH7GT	40	32	35/51
6SJ7GT	44	37	50L6GT
6SK7GT	49	39	11Z6GT
6SL7GT	49	47	50B5
6SN7GT	49	47	32L7GT

POPULAR BRAND
12" PM SPEAKER WITH 21 OZ. MAGNET
6V6 push pull output transformer mounted on speaker with cord and plug attached **\$8.95**
COMPLETE

REAL SPEAKER VALUES

3 1/2" Cone 4" Sq. Frame	\$1.19 ea.
4" P.M. Speaker	1.19
5" P.M. Speaker	1.15
5 1/2" Cone 6" sq. Frame	1.55
6" P.M. Speaker	1.55
8" P.M. Speaker	2.75
12" P.M. Speaker	4.95

Standard Brand AC PHONO MOTOR AND PICKUP
60 cycles, 115 volts, with Turntable. Complete
\$4.35
FREE NEEDLE CUP with motor and pickup

CATHODE RAY TUBES

3FP7	\$1.19 ea.
5GP1/5BP1	1.19 ea.
5FP7	1.49 ea.

IF TRANSFORMERS
Midget Type 456 KC Input-Output.
Medium Size 456 KC I F Coils—Input and Output.
ONLY 49c EACH

25% deposit on all orders, balance C.O.D., F.O.B. New York
SENCO RADIO, Inc.
73 West Broadway, N. Y. 7, N. Y.
TELEPHONE BEEKMAN 3-6498

Electrets in general

Electrets made in heated sand, the heat being brought up slowly and the charging voltage allowed to stay on until the sand cools to room temperature, are the most consistent in their characteristics. The quicker the wax is melted and the shorter the charging and cooling period, the quicker the electret reverses. Some electrets will never show a positive polarization. Both sides may indicate a minus field though one side will usually show much greater charge than the other. A quickly made electret is more prone to show this effect than one made slowly. Some electrets were made with raw high a.c. These were generally minus on both sides. Some of these minus-type electrets are over three years old and are just as active as those made in the conventional manner.

Electrets are extremely subject to moisture. Dipping in a moisture-repellent solution has been tried with poor results. A very good and practical method for keeping electrets is to wrap them in foil and place in can with a dehydrant.

Electrets show the greatest charge if tested immediately when removed from their short-circuiting foil wrap. Repeated discharge tests show a gradually diminishing spark. This, when considered with moisture effects, indicates a use where the unit can be enclosed almost to a short circuit and, if possible, space included for renewable dehydrant. A condenser mike or phono pickup could be made in this manner. Electrets have been made from the size of a 25-cent piece to 4 inches in diameter, and apparently the size can be increased. Thus, perhaps, a large diameter electret can be used as a condenser loudspeaker. The charge can be placed on wax from any angle that physical conditions will allow, therefore indented areas can be molded in so as to allow free vibration of the diaphragm. As an alternative, small electrets can be assembled in the same plane of polarization to any desired area, with air space included, giving the same field as a one-piece unit. The voltage to use for charging electrets of any size is that just under the breakdown point.

It should be understood that the electret represents a static charge and is not a source of power in the usual sense. We must do work in front of the surface to get an indication. The polarization is not a surface effect. The writer has shaved an electret from .18-inch thickness down to .120-inch and could still get a good spark discharge.

A group of finished electrets is shown in Fig. 6. No. 1 has foil partially removed and illustrates manner of wrapping. Nos. 1, 3, 4, and 6 are made with carnauba and Halowax; No. 2 with carnauba and resin; and No. 5 with carnauba, resin, and Halowax. No. 6 has top plate left in position as when charged. No. 4 is cracked badly due to quick cooling.

LOOK! 3¢

**THAT'S ALL!
A POSTAGE STAMP
1 S O . K .**

"Powerful Pete"

**POCKET SCREW DRIVER WITH
LUCKY 4-LEAF CLOVER DESIGN . . .**

**LIMIT
ONLY ONE
TO A
CUSTOMER**

OLSON practically gives away the slickest pocket piece you ever saw! A hardened steel tool, big as a half dollar, that fits four sizes of screws and drives them with amazing power! Engraved with four-leaf clover design! Sturdy key chain attached! Send OLSON a 3c stamp and get "Powerful Pete" pronto. Use the coupon below.
(THIS OFFER GOOD ONLY IN U.S.A.)

**Order your RADIO PARTS
from OLSON**

and get lightning Service!

Brother, you really get SERVICE from Olson! Our whirlwind electric Letter Opener opens 12,000 letters per hour. Our mailing system is geared for ACTION, so that every order we receive is shipped out the SAME DAY. And every order is handled ACCURATELY, too, so you get exactly what you want when you want it. Send the coupon below for our FREE Bargain Bulletin, and try OLSON next time you order Radio Parts and Equipment.
MAIL THIS COUPON TODAY!

OLSON RADIO WAREHOUSE, INC.

73 E. MILL ST., DEPT. 121, AKRON, OHIO

I enclose 3¢. Send me one "Powerful Pete" Screw Driver with Key Chain, and the FREE Olson Bargain Bulletin.

NAME _____

ADDRESS _____

CITY _____ STATE _____

COMMUNICATIONS

NO LICENSING IN BRITAIN

Dear Editor:

I have to thank you for your letter dated November 20, with the advance clipping *Should Servicemen be Licensed?*

The problems which may make necessary the licensing or control of the radio service trade in the U.S.A. are apparent over here, but we do not admit that state or official control will be necessary, and it is certainly not desirable.

We are able to handle the matter in another way, since the trade is well organized at all levels in the Radio Manufacturers Association, the Radio and Television Retailers Association (with its affiliated organizations, the Scottish Radio Retailers Association and the Northern Ireland Radio Retailers Association) and the Guild of Radio Service Engineers. My organization is the accepted representative body for the employed radio service engineer throughout the British Isles, and we have comprehensive agreements with the above-mentioned organizations as to wages and working conditions. Various standing joint committees deal with other aspects, such as juvenile technical training (apprentices), trade practices, etc.

It has been recently agreed to set up a Radio Service Trade Register, with representatives from all the organizations concerned forming the Register Council. Minimum technical requirements have been laid down, and all engineers are invited to apply for registration.

The trade has agreed to recognize as qualified radio service engineers only those whose names appear on the Register, and a Certificate of Registration will be issued. Suitable propaganda will be undertaken to bring the meaning of the Register home to the general public. There seems to be no doubt that this scheme will eventually give us the control necessary to eliminate the undesirable elements.

It should not be necessary to add that, although the Register is sponsored by the various trade organizations, it is open to all who can prove their competence, whether members of their appropriate associations or not.

J. H. CORBETT, *Secretary*
Guild of Radio Service Engineers,
Holland-on-Sea, Essex, England.

I LIKE R-C BECAUSE . . .

Dear Editor:

I have been reading and enjoying your magazine for several years. There are several reasons why I like RADIO-CRAFT.

1. The R-E MONTHLY REVIEW and NEW PATENTS present an excellent coverage of the current trends in radio.

2. Your articles, such as December's *Radio-Piloted Flight* gives food for thought about new possibilities for electronic developments.

3. RADIO-CRAFT is not primarily a service journal. Your policy of printing

RADIO-CRAFT for MAY, 1948

BONAFIDE VALUES



SHURE
T17B

Push Button
Carbon Mike

88¢

With Cord
and Plug

2 TUBE PHONO
OSCILLATOR



Complete with tubes, 35Z5,
12SK7. Use with record player,
and tune in on any radio.
Complete. . . . \$4.75
All Wired \$4.95

3 Tube PHONO
AMPLIFIER Volume and tone control ALL WIRED with Tubes \$4.95



DETROLA
AUTOMATIC
RECORD
CHANGER

Plays 10 & 12
inch records automatically. Crystal pickup SPECIAL . . . \$14.49

WEBSTER RECORD CHANGERS \$25.95

Model #156—Plays 12 Ten or 10 Twelve inch records. AUTOMATIC STOP—CRYSTAL PICKUP. Reg. \$42.70.

Model #156-27—Same as above with G.E. Reluctance pickup and pre-amplifier, \$7 extra.

GENERAL INDUSTRIES
HOME RECORDING UNIT



A low priced recording and playback unit to cut records up to 10 inches. Plays 10 & 12 inch records. Consists of 10" turntable, cutting head and crystal pickup on a base plate 15" wide and 10" from front to back. VALUE \$39.95

1/2 MEG. Vol. Control Switch49c ea.
100 ass't. resistors \$1.49

25% Deposit, Bal. C.O.D. Plus Charges

Write for Latest Catalog

BONAFIDE RADIO CO.

89 1/2 Cortlandt St., Dept. J, N.Y. 7, N.Y.

LAKE DELUXE CHANGER



Revolutionizes the Industry!
A SENSATIONAL SELLER!

11 OUTSTANDING FEATURES:

- Positive Intermix
- Service Adjustments Eliminated
- Minimizes Record Wear
- Single Knob Control
- Plays ALL Records
- Completely Jam-proof
- Records Gently Lowered on Spindle—not dropped
- Automatic Shut-off on last record

● Pick-up arm may be grasped at any time.
Dimensions: 13 13/16" W x 12 1/4" D x 7 3/4" H No. 118A4 YOUR NET \$2873

WEBSTER CHANGER Model 56 \$26.66 NET
WEBSTER CHANGER Model 50 \$21.17 NET

FREE

DEALERS AND SERVICEMEN:
Write for our NEW 16-page 1948 illustrated catalog on radio parts, tubes, accessories, cabinets, sets, electrical appliances, etc. Get on our mailing list today! Dept. c

LAKE RADIO SALES CO.

615 W. Randolph Street, Chicago 6, Ill.

30,000 RADIO SERVICE- TECHNICIANS READ



EVERY MONTH

RADIO MAINTENANCE today fills a breach that has existed in the radio field for a long time. Already 30,000 servicemen read RADIO MAINTENANCE every month because it is devoted entirely to the Radio Service Technician.

The RADIO MAINTENANCE staff specializes in the preparation of articles on every phase of Radio Maintenance in series form which may be filed and used for reference. The leading articles cover everything for the radio serviceman on Television, FM and AM; Test Equipment; Electronic Appliances; Tools; Antennas; Alignment; Troubleshooting; Repair; Construction; Pick-ups and Sound Amplification and Reproduction Equipment. Also, in RADIO MAINTENANCE each month there are departments on hints and kinks, the latest news of the trade, review of trade literature, radiomen's opinions, new products and news from the organizations. All articles are presented in a step-by-step precision style, clearly illustrated, with schematics, accurate photographs, specially prepared drawings, white on black charts, color diagrams, isometric projections and exploded views.

RADIO MAINTENANCE is not sold on newsstands

Binders in beautiful green simulated leather stamped in gold are now available for your RADIO MAINTENANCE magazines — see the current issue of RADIO MAINTENANCE for information.

RADIO MAINTENANCE MAGAZINE RCS
460 Bloomfield Avenue,
Montclair 5, N. J.

Please send me RADIO MAINTENANCE for
 1 year at \$3.00 Bill me later
 2 years at \$5.00 Payment enclosed

Name

Address

City—State

*Occupation

Title

Employed by

*Independent Serviceman — Dealer Serviceman—
Service Manager—Dealer—Distributor—Jobber.

BOLAND & BOYCE INC., PUBLISHERS

"I belong to the radio of the month club."

RADIO-CRAFT for MAY, 1948

Address RADIO CARTOONS, RADIO-CRAFT, 25
West Broadway, New York 7, N. Y.

GREEN

NOW AVAILABLE! Full Range Reproduction

one or two new commercial circuits a month gives the technical information necessary on current manufacturing practices without cluttering up the

RADIO SCHOOL DIRECTORY

PRACTICAL TECHNICAL TRAINING

SPECIALIZE in 6 months to 3 years

COURSES

SERVICE

- 6 to 12 Months
- Electricity
- Welding
- Refrigeration
- Heating

TECHNICIAN

- 1 to 2 Years
- Electricity
- Radio
- Electronics
- Refrigeration, Heating and Air Conditioning

PROFESSIONAL

- 3 Years
- Electrical Engineering Bachelor of Science Degree
- Major in Machinery or Electronics

Train in Electronics, Radio, Electricity for a substantial career in industry—or a business of your own. Prepare in one year to be a Technician—or in two additional years secure a Bachelor of Science Degree in Electrical Engineering with major in Electronics. More than 35,000 former students in industries the world over. 1,538 students now enrolled from 48 states and 13 overseas countries. Faculty of 72 specialists. Write for catalog and Personal Guidance Questionnaire—also mention course in which you are interested.

Terms start JULY, September, January

MILWAUKEE
SCHOOL of ENGINEERING
A TECHNICAL INSTITUTE

Dept. RC 548

North Broadway, Milwaukee, Wis.

RADIO OPPORTUNITIES

WRCI SPECIALIZED TRAINING—the "training-with-a-purpose"—DOES increase one's earning power. For example, well-paying positions of responsibility now held by WRCI graduates include:

BROADCAST ENGINEER-OPERATORS
(AM & FM broadcast stations)

FLIGHT RADIO OFFICERS
(transoceanic airlines)

RADIO-TELEVISION SERVICING TECHNICIANS

RADIO SERVICE SHOP OWNERS

COMMERCIAL RADIO OPERATORS
(police, CAA, airlines)

MERCHANT MARINE RADIO OFFICERS

With this proved record of successful training and placement, WRCI offers you, too, the best type of PRACTICAL training—under the supervision of radio and television specialists. Approved for veteran training. Non-veterans accepted. Send for free illustrated booklet "F"—no obligation, of course.

WESTERN RADIO COMMUNICATIONS INSTITUTE

341 West 18 St., Los Angeles 15, California

RADIO ENGINEERING!

Complete Radio Engineering Course. Bachelor of Science Degree. Courses also in Civil, Electrical, Mechanical, Chemical, Aeronautical Engineering; Business Administration, Accounting, Secretarial Science. Graduates successful. 64th year. Enter June, Sept., Jan., March. Write for catalog.

DEGREE IN 27 MONTHS

TRI-STATE COLLEGE 2456 College Ave. ANGOLA INDIANA



RCA INSTITUTES, Inc.

Offer thorough training courses in all technical phases of **Radio and Television**

DAYS-EVENINGS WEEKLY RATES

VETERANS: RCA Institutes is approved under G. I. Bill of Rights

For Free Catalog Write Dept. RC-48

RCA INSTITUTES, Inc.

A Service of Radio Corporation of America
350 WEST 4TH STREET NEW YORK 14, N. Y.

THIS COUPON MAY PROVE TO BE THE KEY TO YOUR SUCCESS IN ELECTRONICS

MELVILLE RADIO INSTITUTE

The Progressive Radio School
Managed by Radio Men

Licensed by the N. Y. State Board of Education
RECOGNIZED BY INDUSTRY
APPROVED FOR VETERANS

CUT IT OUT! FILL IT OUT! MAIL IT OUT! — NOW!

MELVILLE RADIO INSTITUTE RC
Melville Bldg., 13 W. 46th St., N. Y. 19, N. Y.

Send me without obligation information about your intensive courses:

- Radio Technician
- Radio & Television Servicing
- Radio Communications
- Fundamental Radio Mathematics

My Name.....

Address.....

WANTED

Men and Women to Fill Top Radio Jobs!

Worried about your future? Longing for a career that means more money . . . success? It's yours if you hurry to fill the great demand for qualified radio personnel needed everywhere. Train now to be an announcer, disk jockey or radio technician. Complete day and night time classes. Hundreds of thrilling jobs await you—key positions in radio stations, airlines, and maritime service. Free placement service offered. Write for our catalog outlining the courses offered.

Approved for Veterans

Don Martin School of Radio Arts

1655 North Cherokee St. Hollywood 28, Calif.

SHORT CUT **CODE SPEED**
Be an Expert

Learn to be a Telegraph or Radio Operator. Qualify for amateur or commercial license. Intensely interesting work—good pay. Learn at home or wherever you are, quickly, easily, with the famous Candler Code Speed System. Book of particulars Free.

CANDLER SYSTEM CO. Denver 1, Colo.
Dept. 3-E, Box 928.

TELEVISION 1948!!

Train at an Institute that pioneered in TELEVISION TRAINING since 1938. Morning, Afternoon or Evening Sessions in laboratory and theoretical instruction, under guidance of experts, covering all phases of Radio, Frequency Modulation, Television, lead to opportunities in Industry, Broadcasting or own Business. Licensed by N. Y. State. Approved for Veterans.

ENROLL NOW FOR NEW CLASSES

Visit, Write or Phone

RADIO-TELEVISION INSTITUTE

480 Lexington Ave., N. Y. 17 (46th St.)
PLaza 3-4585 2 blocks from Grand Central

A CAREER WITH A FUTURE! TELEVISION

SHOP WORK • SHOP TECHNIQUES • THEORY • FULLY EQUIPPED LABORATORIES

- RADIO SERVICE & REPAIR
- F. M. & TELEVISION
- TRANSMITTER COURSES

Preparing for F. C. C. LICENSES

- RADIO TECHNOLOGY

MORNING • AFTERNOON • EVENING CLASSES • MODERATE RATES • INSTALLMENTS

AVAILABLE UNDER G. I. BILL

DELEHANTY SCHOOL OF RADIO • ELECTRONICS • TELEVISION
105 EAST 13th STREET, NEW YORK 3, N. Y. • DEPT. R
LICENSED BY STATE OF NEW YORK

LEARN RADIO!

IN ONLY 10 MONTHS
PREPARE FOR A GOOD JOB!
COMMERCIAL OPERATOR (CODE)
BROADCAST ENGINEER
RADIO SERVICEMAN

Television Servicing—15 Months

Veterans get \$130.00 Equipment
SEND FOR FREE LITERATURE
BALTIMORE TECHNICAL INSTITUTE
1425 Eutaw Place, Dept. C, Baltimore 17, Md.

CORRESPONDENCE COURSES IN RADIO and ELECTRICAL ENGINEERING

ELECTRICAL ENGINEERING Get good grasp of wide electrical field. Prepare yourself at Low Cost, for secure future. Modern course, so simplified anyone can understand quickly.

RADIO ENGINEERING Extra fine course in radio, work. Trains you to be super-service man. Real vacuum-tube technician. Servicemen needed badly. Diploma on completion. Many graduates earning big pay.

Send postcard for Free Copies of school catalog, full details, all about deferred payment plan, experimental kits, etc. **\$25** Either Course

Lincoln Engineering School, Box 931-C-111, Lincoln 2, Nebr.



RADIO COURSES

Preparatory, Service, Broadcast, Television, Marine Operating, Aeronautical, Frequency Modulation, Radar.

Classes now forming for the summer term
June 1. Entrance exam. May 17.
Veterans. Literature.

COMMERCIAL RADIO INSTITUTE
(Founded 1920)
38 West Bliddle Street, Baltimore 1, Md.

Hollywood Experts Help You **Make Good in RADIO-TELEVISION** at Home

Direct from Hollywood, nerve-center of broadcasting. Television, Radio and Sound activities, comes R-T-A's time-proven and tested home training. Here at last—easy to learn, home instruction that quickly qualifies you for steady, good-pay jobs or your own Radio business. 10 big kits of radio parts given at no extra charge. Get full details at once! Send postal for FREE BOOK "How to Make Good in Radio-Television." R-T-A APPROVED FOR VETERANS.

RADIO TRAINING ASS'N OF AMERICA, Dept. RCD
5620 Hollywood Blvd. Hollywood 28, Calif.

COMMUNICATIONS

NO LICENSING IN BRITAIN

Dear Editor:

I have to thank you for your letter dated November 20, with the advance clipping *Should Servicemen be Licensed?*

The problems which may make necessary the licensing or control of the radio service trade in the U.S.A. are apparent over here, but we do not admit that state or official control will be necessary, and it is certainly not desirable.

We are able to handle the matter in another way, since the trade is well organized at all levels in the Radio Manufacturers Association, the Radio and Television Retailers Association (with its affiliated organizations, the Scottish Radio Retailers Association and the Northern Ireland Radio Retailers Association) and the Guild of Radio Service Engineers. My organization is the accepted representative body for the employed radio service engineer throughout the British Isles, and we have comprehensive agreements with the above-mentioned organizations as to wages and working conditions. Various standing joint committees deal with other aspects, such as juvenile technical training (apprentices), trade practices, etc.

It has been recently agreed to set up a Radio Service Trade Register, with representatives from all the organizations concerned forming the Register Council. Minimum technical requirements have been laid down, and all engineers are invited to apply for registration.

The trade has agreed to recognize as qualified radio service engineers only those whose names appear on the Register, and a Certificate of Registration will be issued. Suitable propaganda will be undertaken to bring the meaning of the Register home to the general public. There seems to be no doubt that this scheme will eventually give us the control necessary to eliminate the undesirable elements.

It should not be necessary to add that, although the Register is sponsored by the various trade organizations, it is open to all who can prove their competence, whether members of their appropriate associations or not.

J. H. CORBETT, *Secretary*
Guild of Radio Service Engineers,
Holland-on-Sea, Essex, England.

I LIKE R-C BECAUSE . . .

Dear Editor:

I have been reading and enjoying your magazine for several years. There are several reasons why I like RADIO-CRAFT.

1. The R-E MONTHLY REVIEW and NEW PATENTS present an excellent coverage of the current trends in radio.

2. Your articles, such as December's *Radio-Piloted Flight* gives food for thought about new possibilities for electronic developments.

3. RADIO-CRAFT is not primarily a service journal. Your policy of printing

RADIO-CRAFT for MAY, 1948

BONAFIDE VALUES



SHURE
T17B

Push Button
Carbon Mike

88¢

With Cord
and Plug

2 TUBE PHONO
OSCILLATOR



Complete with tubes, 35Z5,
12SK7. Use with record play-
er, and tune in on any radio.
Complete. All Wired \$4.75

3 Tube PHONO
AMPLIFIER Vol-
ume and tone con-
trol ALL WIRED with Tubes..... \$4.95



DETROLA
AUTOMATIC
RECORD
CHANGER

Plays 10 & 12
inch records au-
tomatically. Crys-
tal pickup SPE-
CIAL \$14.49

WEBSTER RECORD CHANGERS \$25.95

Model #156—Plays 12 Ten or 10 Twelve inch records. AUTOMATIC STOP—CRYSTAL PICKUP. Reg. \$42.70.

Model #156-27—Same as above with G.E. Reluctance pickup and pre-amplifier, \$7 extra.

GENERAL INDUSTRIES
HOME RECORDING UNIT



A low priced re-
cording and play-
back unit to cut
records up to 10
inches. Plays 10
& 12 inch re-
cords. Consists of
10" turntable,
cutting head and

crystal pickup on a base plate 15" wide and
10" from front to back. VALUE \$39.95

\$19.95

1/2 MEG. Vol. Control Switch.....49c ea.
100 asst. resistors\$1.49

25% Deposit, Bal. C.O.D. Plus Charges
Write for Latest Catalog

BONAFIDE RADIO CO.

89 1/2 Cortlandt St., Dept. J, N.Y.7, N.Y.

LAKE DELUXE CHANGER

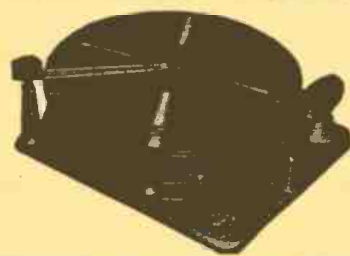

Revolutionizes the Industry!
A SENSATIONAL SELLER!

11 OUTSTANDING FEATURES:

- Positive Intermix
- Service Adjustments Eliminated
- Minimizes Record Wear
- Single Knob Control
- Picks-up arm may be grasped at any time.
- Plays ALL Records
- Completely Jam-proof
- Records Gently Low-erod on Spindle—not dropped
- Automatic Shut-off on last record

Dimensions: 13 13/16" W x 12 1/4" D x 7 7/8" H No. 116A4 YOUR NET \$2873

WEBSTER CHANGER Model 56 \$26.66 NET

WEBSTER CHANGER Model 50 \$21.17 NET

FREE

DEALERS AND SERVICEMEN:

Write for our NEW 16-page 1948 Illustrated catalog on radio parts, tubes, accessories, cabinets, sets, electrical appliances, etc. Get on our mailing list today! Dept. C

LAKE RADIO SALES CO.

615 W. Randolph Street, Chicago 6, Ill.

30,000 RADIO SERVICE- TECHNICIANS READ



EVERY MONTH

RADIO MAINTENANCE today fills a breach that has existed in the radio field for a long time. Already 30,000 servicemen read RADIO MAINTENANCE every month because it is devoted entirely to the Radio Service Technician.

The RADIO MAINTENANCE staff specializes in the preparation of articles on every phase of Radio Maintenance in series form which may be filed and used for reference. The leading articles cover everything for the radio serviceman on Television, FM and AM; Test Equipment; Electronic Appliances; Tools; Antennas; Alignment; Troubleshooting; Repair; Construction; Pick-ups and Sound Amplification and Reproduction Equipment. Also, in RADIO MAINTENANCE each month there are departments on hints and links, the latest news of the trade, review of trade literature, radiomen's opinions, new products and news from the organizations. All articles are presented in a step-by-step precision style, clearly illustrated, with schematics, accurate photographs, specially prepared drawings, white on black charts, color diagrams, isometric projections and exploded views.

RADIO MAINTENANCE is not sold
on newsstands

Binders in beautiful green simulated leather stamped in gold are now available for your RADIO MAINTENANCE magazines — see the current issue of RADIO MAINTENANCE for information.

RADIO MAINTENANCE MAGAZINE RCS
460 Bloomfield Avenue,
Montclair 5, N. J.

Please send me RADIO MAINTENANCE for
 1 year at \$3.00 Bill me later
 2 years at \$5.00 Payment enclosed

Name

Address

City—State

*Occupation

Title

Employed by

*Independent Serviceman — Dealer Serviceman—
Service Manager—Dealer—Distributor—Jobber.

BOLAND & BOYCE INC., PUBLISHERS

GREEN SAVES YOU MONEY

DRAKE NO. 55 SOLDERING IRON
60 Watt with 5/8" Tip
Highest quality Nichrome used in porcelain element. Excellent for home use, complete with 6 ft. heater cord, rubber plug and small stand. Gun metal finish.
SPECIAL 97c

A REAL SPECIAL
4 PRONG UNIVERSAL TYPE VIBRATORS
Standard type replacement for Philco, Motorola, etc. List \$3.55.
EXTRA SPECIAL **98c**

TUBE SPECIALS
Brand New Standard Brands

	List	Our		List	Our
	\$2.65	\$.98	50B5	2.80	.70
1LN5	2.20	.68	10A2	1.80	.72
OZ4	1.15	.45	137L7GT	3.90	1.58
35Z8GT	1.50	.60	12AR6T	1.80	.72
50L6GT	1.80	.72	75	1.50	.60
125A7GT	1.80	.60	354	1.80	.72
125K7GT	1.50	.60	7C5	1.80	.72
125Q7GT	1.15	.45	6AB7/1853	2.65	1.26
35W4	2.65	.79			
6J8					

MINERVA "Challenger" Model 410A
FULL SIZE TABLE MODEL
Unsurpassed in power, tone and all-around performance. Featuring—4 tubes plus selenium rectifier, full I.F. amplification, 5" Alnico speaker, built-in loop antenna, full vision slide rule dial **\$12.75 NET**

SPECIALS

Bundle of 24—8" lengths Spaghetti... \$.18
Famous make Crystal Microphone with table stand 4.95
100 Ma Selenium Rectifier74
20 Mfd 150 V Tubular Condensers34
Kit of Antenna & RF Coils (broadcast band)55
3 Tube Phono Amplifiers, uses 50L6, 35Z5, 12SQ7 Tubes, less tubes 2.95
Mica Condenser Kit, 25 popular sizes... 1.19
SP/ST Toggle Switch, hat handle16
DF/DT Toggle Switch, long neck39
50/80 Mfd 150 V Tubular Condenser... .59
AC-DC Chokes, small size, 250 ohms... .39
Open Circuit Phono Jack22
Mazda Pilot Bulbs #40, 41, 44, 46, 47, 51, 65 (Box of 10)44
8 Mfd 450 V Tubular Condenser33
Kit of 100 assorted Resistors, 1/2 W, 1W, 2W, \$12.50 list 1.95
Single Pentode output49
Single 50L6 Output44
20/20 Mfd 150 V Tubular Condenser, flex leads49
Dial Cord, medium gauge, Nylon, 100 ft. .98
30 Mfd. 450 V Tubular Condenser59
Test Leads, flexible, 50" long, Phone Tips or needle points (specify)45

ALL MERCHANDISE BRAND NEW and 100% GUARANTEED. STANDARD BRANDS.
No Seconds! No Rejects! No off-brands!
20% Deposit required with C.O.D. Orders. All orders FOB New York. Minimum orders \$2.00.

GREEN RADIO DISTRIBUTORS
THE HOUSE OF BARGAINS
Electronic Supplies & Equipment
482 SUTTER AVE. DICKENS 2-4444 BROOKLYN 7, N.Y.

NOW AVAILABLE! Full Range Reproduction



A revolutionary development in amplifiers cleverly designed to defy obsolescence and amazing in its performance. New circuits, new materials and new processes are actually combined in this one amplifier to produce the most satisfying musical amplifier the world has ever known. If you are one of those discriminating persons for whom anything less than the best is a disappointment, you are one for whom the ACA-100DC was designed. Send for technical literature.

AMPLIFIER CORP. of AMERICA
398-10 Broadway • New York 13, N. Y.

MIRACLE KIT VALUES!

PHONO OSCILLATOR 2-TUBE KIT
Hi-gain with microphone jack and all parts including Tubes \$2.75
10 WATT 4 TUBE HI-GAIN 6L6 AMPLIFIER KIT
Separately controlled Mike and Phono Inputs. All parts including Tubes, etc. Less Tubes \$6.95
UNIVERSAL TROUBLE SHOOTER KIT
Locates every service trouble. All parts including case, test leads, plug, 2 1/4" x 9" x 3" \$3.95
PHONO AMPLIFIER KITS
3 Tubes—all parts including Tubes \$4.25
2 Tubes—all parts including Tubes \$2.95
5 TUBE AC/DC SUPERHET RADIO KIT
All parts including 5" Heavy Duty Speaker, Dial, 5 full size Tubes \$10.25
Write for lists of bargains in Radio and Electronic parts. Also free data, circuits designed by ROBT. G. HEZOG.

Universal/general corp.
365 Canal St., New York 13 (Dept. C-R) Walker 5-9642

RADIO TESTING EQUIPMENT REPAIRS
All types and models expertly repaired and calibrated
FREE ESTIMATES
METROPOLITAN ELECTRONIC & INSTRUMENT CO.
42 WARREN ST. NEW YORK 7, N. Y.
write for FREE catalogue of all types and makes of liberal priced testing equipment

WHY PAY MORE?

SIGNAL GENERATOR
only \$12⁹⁵



456 KC—465 KC—600 KC—1400 KC

A new, compact, accurate, inexpensive, well-built Signal Generator, Model 522, is now ready for immediate delivery. The 522 is calibrated against crystal controlled standards within 1% accuracy, for the above frequencies. Two open switch positions are provided for the addition of special frequencies for individual needs of the user. This excellent unit is ideal for on-the-spot checking and aligning. The 522 is isolated for safe use on AC DC sets. Alignment of short wave band possible due to strong even harmonics of 1400 KC—2800 KC—5.6 MC—11.2 MC.

- COMPLETE WITH TUBES
- READY TO OPERATE
- COMPACT, CRACKLE
- FINISH CABINET
- TWO OPEN CHANNELS FOR ADDITIONAL FREQS.
- INDIVIDUAL TRIMMERS FOR RE-CALIBRATION
- SHIELDED OUTPUT LEAD
- FULLY GUARANTEED—FULL INSTRUCTIONS

WRITE FOR DESCRIPTIVE LITERATURE
CONSTANT ELECTRIC
112 CORNELIA ST. B. 11th Fl. N. Y.

one or two new commercial circuits a month gives the technical information necessary on current manufacturing practices without cluttering up the pages with circuits that the non-serviceman reader will ever use.

4. Your coverage of test equipment is good. But how about more frequency meters, oscilloscopes, and signal generators? And why not a discussion of new circuits used in commercial equipment?

In brief, you have a well-balanced magazine.

K. E. FORSBERG,
Sauk Center, Minn.

A CHANGER USER REPLIES

Dear Editor:

Jack King, in his article, *Selling A Radio*, in the December, 1947, issue, expressed amazement at the popularity of record changers. Surely the reason for this popularity is obvious.

I don't believe that anyone who plays a single record at a time ever hears more than the middle of the record. The beginning and end are obscured by his dashing to the phonograph, changing the record, and finally dashing back to the cozy armchair for another few minutes, and so on and on.

I have used a changer for the past 12 years or more and wouldn't think of using a manual record player, no sir!

Is a changer unreliable? Only if it is misused! And the maintenance costs? A drop of oil once in a while, that's all.

The only thing that amazes me are the weird arguments against changers by people who don't seem to have a clear idea what they are talking about.

R. G. YOUNG,
London, England

DON'T WASTE GOOD SPACE!

Dear Editor:

Please, please stop wasting space—valuable space—in RADIO-CRAFT telling servicemen how to run their business. And this stuff about licensing servicemen! They license doctors and lawyers—but they don't guarantee their continued excellence. Let the good servicemen go about their business unperturbed. The service field will never be crowded for the GOOD serviceman.

Don't print so many how-to-build articles that ordinary people can never hope to build—like the 17-tube FM receiver. I'll bet that not 25 of your readers built it. Why not concentrate on more simple educational articles?

H. W. SMITH, Radio KNAF,
Fredericksburg, Texas.

(What say, servicemen and constructors?—Editor)

IMPROVED SIGNAL TRACER

Dear Editor:

In the February, 1947, issue you published details of the probe tracer, with which diagram I've been experimenting ever since. You would probably be interested in the final (or at least, the latest) result.

For its size and efficiency, the original is possibly the best tracer diagram

you have published, to say nothing of its low cost. All parts except the tube and batteries came from the junk-box.

The latest result, built into an overnight case, is used with a separate probe and ground clamp, the tube and all parts being in the case, which also holds the headphones and probe. Of several probes tried, the most satisfactory one was made with an old crystal detector with the *Intermittent Tip* described in the August, 1946, issue. This combination will pick up easily a signal anywhere in the radio (or from an antenna coil on the bench, for that matter) with a strong local station, and from the audio end of the radio will drive a small p.m. speaker.

I find a 20-megohm grid leak works much better than the 2-megohm in the original. I also changed the 500,000-ohm volume control to one of 250,000 ohms. Otherwise the hookup remains the same except for the necessary changes in using it with a separate probe.

Finally I hooked a milliammeter in the plate circuit with a double-throw switch, providing both visual and aural checks. All of which adds up to a mighty efficient and easily portable tracer. More power to RADIO-CRAFT!

R. C. SANDISON,
Denver, Colorado.

LIKES CRYSTAL SET

Dear Editor:

I built the *Modern Midget Crystal Set* described in the January issue. It is the best-performing crystal set I have ever

made, and I have been experimenting with these sets for more than 25 years.

This receiver separates stations like a superhet and the volume it delivers for its size is amazing. I can operate a small speaker on a signal from a 5,000-watt station 5 miles away.

The sensitivity is so good that hooking the antenna to a metal bridge lamp gives reception almost as loud as with an outdoor antenna.

Mr. Grace's idea of using two secondaries appears to be the secret of the performance of this set. Funny we never thought of trying that!

JOSEPH AMOROSE,
Richmond, Va.

PORTABLE ANTENNA

Dear Editor:

The one drawback to my 2-tube regenerative portable receiver was that it needed a rather long antenna. After tacking a small plate of galvanized iron on the heel of each shoe and connecting them in place of the antenna I found that the set pulled in the locals satisfactorily when I walked on the damp ground.

BEN GREEN, JR.
Tuscaloosa, Alabama

(Here at last is the true portable, rotatable antenna. But what happens on a boardwalk or clean dry sand? On second thought, the equipment could be used as a soil analyzer, the strength of signals showing the conductivity characteristics of the ground immediately below.—Editor)

The June RADIO-CRAFT will be a special FM number, full of articles on FM theory, FM construction and FM servicing. The most popular FM receivers and tuners will be reviewed and there will be a new and up-to-date list of FM stations.

RESERVE THIS ISSUE AT YOUR NEWSDEALER'S TODAY



"I belong to the radio of the month club."

STOCK REDUCTION CLOSE-OUTS FAMOUS BRAND NAMES

Terrific Savings! Buy at Distributor Cost!

Tubes	Lots of 10		Tubes	Lots of 10	
	Each	Each		Each	Each
OZ-4	0.85	0.79	6N7	0.82	0.72
1A7GT	0.54	0.45	6SA7GT	0.44	0.37
1H5GT	0.59	0.45	6SC7GT	0.50	0.40
1J6GT	1.10	1.00	6SK7GT	0.44	0.37
1N5GT	0.50	0.40	6SN7GT	0.55	0.47
1Q5GT	0.79	0.70	6SQ7GT	0.47	0.42
1S4	0.79	0.70	6V6GT	0.50	0.40
4S5	0.79	0.70	10-Y	1.00	0.90
1T4	0.50	0.40	12SK7GT	0.45	0.37
2A4G	0.75	0.68	12SQ7GT	0.40	0.32
3Q5GT	0.79	0.70	35L6GT	0.55	0.45
5Y3GT	0.40	0.37	50L6GT	0.55	0.45
6B4A	1.10	1.00	70L6GT	1.49	1.40
6D6	0.45	0.37	75	0.50	0.40
6G6	0.79	0.70	77	0.35	0.27
6H6	0.45	0.40	80	0.38	0.32
6K6GT	0.40	0.37	2050	0.80	0.50
6J5GT	0.55	0.50	9003	0.40	0.31

Prior orders will get preference. All shipments 25% deposit with order, balance C.O.D. F.O.B. St. Louis, Missouri.

CREST CORP., Dept. C-1

3949 FOREST PARK BLVD., ST. LOUIS 8, MO.
WRITE FOR OUR COMPLETE CATALOG ON RADIO PARTS AND EQUIPMENT.

ELECTRONIC VOLT-OHMMETER

\$1185

110 VOLTS AC 20 RANGES

0/5/10/50/100/500/1000/5000 volts DC and AC. 0-1,000,000,000 ohms in six overlapping ranges. Sensitivity: over MILLION OHMS per VOLT on 5 volt range.

POSTPAID

Complete kit includes all component parts, tubes, punched and drilled chassis and beautifully enameled panel. Easily assembled and wired.

Special slideback circuit developed during war by scientist at the California Institute of Technology gives amazing sensitivity and flexibility while completely eliminating necessity of batteries and expensive meter. Each instrument is individually calibrated. Dial scale over nine inches long!

In addition to performing the usual volt-ohm functions, this instrument easily measures these voltages: SUPERHET OSCILLATOR, AVC, APC, TRUE GRID BIAS AT THE GRID, BIAS CELLS without affecting the circuit. Measures the exact leakage resistance of INSULATION, TUBES, CONDENSERS. It can be used with a signal generator for SIGNAL TRACING.

STERLING ELECTRONIC COMPANY
BOWLING GREEN, KENTUCKY

50,000 RADIO SERVICEMEN CAN SAVE MONEY BY COMPARING THESE TYPICAL JOYCE VALUES

TUBES - 60% or More Off List
STANDARD BRANDS-Individually boxed

5Y3 TUBES10 FOR \$3.30
35Z5 TUBES10 FOR \$3.90
35W4 TUBES10 FOR \$3.90
12SQ7 TUBES10 FOR \$4.90
50L6 TUBES10 FOR \$5.30
Cond. Std. Br. 30-20 Mfd. 150V. 10	FOR \$4.90
Vol. Cont .5 Meg. W.Sh. (Med.Sh.)	10 FOR \$4.90

10 FOR \$4.90

INCLUDE THIS AD WHEN ORDERING

Write for Free Illustrated Bargain Bulletin

JOYCE RADIO DISTRIBUTING

Box 2068

Hollywood 28, Calif.

SUPER-SPECIALS

FROM OUR FREE CATALOG

5 TUBE KIT: 50L6, 35Z5, 12SA7-K7-Q7....	\$2.75
5 TUBE KIT: 50B5, 85W4, 12AT6-BA6, BE6....	2.75
ACORN TUBES 964, 955, 956, 957, 958A....	.49

WRITE FOR FREE CATALOG

20% Dep., Bal. C. O. D.

COMMERCIAL RADIO

DEPT. C2

36 Brattle Street, Boston 8, Mass.

\$3.00 FOR CARTOON IDEAS

RADIO-CRAFT prints several radio cartoons every month. Readers are invited to contribute humorous radio ideas which can be used in cartoon form. It is not necessary that you draw a sketch.

No electrical or radio definitions wanted. Some of these were published in the past, but the subject is about exhausted.

All checks are payable on publication.

Address: RADIO CARTOONS, RADIO-CRAFT, 25 West Broadway, New York 7, N. Y.

RADIO SCHOOL DIRECTORY

PRACTICAL TECHNICAL TRAINING

SPECIALIZE in 6 months to 3 years

COURSES

- SERVICE**
6 to 12 Months
- Electricity
 - Welding
 - Refrigeration
 - Heating
- TECHNICIAN**
1 to 2 Years
- Electricity
 - Radio
 - Electronics
 - Refrigeration, Heating and Air Conditioning
- PROFESSIONAL**
3 Years
- Electrical Engineering Bachelor of Science Degree
 - Major in Machinery or Electronics

Train in Electronics, Radio, Electricity for a substantial career in industry—or a business of your own. Prepare in one year to be a Technician—or in two additional years secure a Bachelor of Science Degree in Electrical Engineering with major in Electronics. More than 35,000 former students in industries the world over. 1,538 students now enrolled from 48 states and 18 overseas countries. Faculty of 72 specialists. Write for catalog and Personal Guidance Questionnaire—also mention course in which you are interested.

Terms start JULY, September, January

MILWAUKEE
SCHOOL OF ENGINEERING
A TECHNICAL INSTITUTE

Dept. RC 548

North Broadway, Milwaukee, Wis.

RADIO OPPORTUNITIES

WRCI SPECIALIZED TRAINING—the "training-with-a-purpose"—DOES increase one's earning power. For example, well-paying positions of responsibility now held by WRCI graduates include:

- BROADCAST ENGINEER-OPERATORS (AM & FM broadcast stations)
- FLIGHT RADIO OFFICERS (transoceanic airlines)
- RADIO-TELEVISION SERVICING TECHNICIANS
- RADIO SERVICE SHOP OWNERS
- COMMERCIAL RADIO OPERATORS (police, CAA, airlines)
- MERCHANT MARINE RADIO OFFICERS

With this proved record of successful training and placement, WRCI offers you, too, the best type of PRACTICAL training—under the supervision of radio and television specialists. Approved for veteran training. Non-veterans accepted. Send for free illustrated booklet "F"—no obligation, of course.

WESTERN RADIO COMMUNICATIONS INSTITUTE

341 West 18 St., Los Angeles 15, California

RADIO ENGINEERING

DEGREE IN 27 MONTHS

Complete Radio Engineering Course, Bachelor of Science Degree. Courses also in Civil, Electrical, Mechanical, Chemical, Aeronautical Engineering; Business Administration, Accounting, Secretarial Science. Graduates successful. 64th year. Enter June, Sept., Jan., March. Write for catalog.

TRI-STATE COLLEGE 2458 College Ave. ANGOLA INDIANA



RCA INSTITUTES, Inc.

Offer thorough training courses in all technical phases of

Radio and Television

DAYS-EVENINGS WEEKLY RATES

VETERANS: RCA Institute is approved under G. I. Bill of Rights

For Free Catalog Write Dept. RC-48

RCA INSTITUTES, Inc.

A Service of Radio Corporation of America
350 WEST 4TH STREET NEW YORK 14, N. Y.

THIS COUPON MAY PROVE TO BE THE KEY TO YOUR SUCCESS IN ELECTRONICS

MELVILLE RADIO INSTITUTE

The Progressive Radio School
Managed by Radio Men

Licensed by the N. Y. State Board of Education
RECOGNIZED BY INDUSTRY
APPROVED FOR VETERANS

CUT IT OUT! FILL IT OUT! MAIL IT OUT!—NOW!

MELVILLE RADIO INSTITUTE RC
Melville Bldg., 15 W. 46th St., N. Y. 19, N. Y.

Send me without obligation information about your intensive courses:

- Radio Technician
- Radio & Television Servicing
- Radio Communications
- Fundamental Radio Mathematics

My Name.....

Address.....

WANTED

Men and Women to Fill Top Radio Jobs!

Worried about your future? Longing for a career that means more money... success? It's yours if you hurry to fill the great demand for qualified radio personnel needed everywhere. Train now to be an announcer, disk jockey or radio technician. Complete day and night time classes. Hundreds of thrilling jobs await you—key positions in radio stations, airlines, and maritime service. Free placement service offered. Write for our catalog outlining the courses offered.

Approved for Veterans

Don Martin School of Radio Arts

1655 North Cherokee St. Hollywood 28, Calif.

SHORT CUT



FREE BOOK

famous Candler Code Speed System. Book of particulars Free.

CANDLER SYSTEM CO.

Dept. 3-E, Box 928. Denver 1, Colo.

CODE SPEED
Be an Expert

TELEVISION 1948!!

Train at an Institute that pioneered in TELEVISION TRAINING since 1938. Morning, Afternoon or Evening Sessions in laboratory and theoretical instruction, under guidance of experts, covering all phases of Radio, Frequency Modulation, Television, lead to opportunities in Industry, Broadcasting or own Business. Licensed by N. Y. State. Approved for Veterans. ENROLL NOW FOR NEW CLASSES

Visit, Write or Phone

RADIO-TELEVISION INSTITUTE

480 Lexington Ave., N. Y. 17 (46th St.)
Plaza 3-4385 2 blocks from Grand Central

A CAREER WITH A FUTURE! TELEVISION

- SHOP WORK • SHOP TECHNIQUES • THEORY • FULLY EQUIPPED LABORATORIES
- RADIO SERVICE & REPAIR
 - E. M. & TELEVISION
 - TRANSMITTER COURSES
- Preparing for F. C. C. LICENSES
- RADIO TECHNOLOGY
- MORNING • AFTERNOON • EVENING CLASSES • MODERATE RATES • INSTALLMENTS AVAILABLE UNDER G. I. BILL

DELEHANTY SCHOOL OF RADIO • ELECTRONICS • TELEVISION
105 EAST 13th STREET, NEW YORK 3, N. Y. • DEPT. R
LICENSED BY STATE OF NEW YORK

LEARN RADIO!

IN ONLY 10 MONTHS
PREPARE FOR A GOOD JOB!
COMMERCIAL OPERATOR (JOB)
BROADCAST ENGINEER
RADIO SERVICEMAN

Television Servicing—15 Months

Veterans get \$130.00 Equipment
SEND FOR FREE LITERATURE
BALTIMORE TECHNICAL INSTITUTE
1425 Eutaw Place, Dept. C, Baltimore 17, Md



CORRESPONDENCE COURSES IN RADIO and ELECTRICAL ENGINEERING

ELECTRICAL ENGINEERING Get good grasp of wide electrical field. Prepare yourself at Low Cost, for secure future. Modern course. So simplified anyone can understand quickly.

RADIO ENGINEERING Extra fine course in radio, public address, photo-electric work. Trains you to be super-service man, real vacuum tube technician. Servicemen needed badly. Diploma on completion. Many graduates earning big pay.

Send postcard for Free Copies of school catalog, full details, all about deferred payment plan, ex. Courses experimental kits, etc.

WRITE \$25 Either

Lincoln Engineering School, Box 931-C-111, Lincoln 2, Nebr.



RADIO COURSES

Preparatory, Service, Broadcast, Television, Marine Operating, Aeronautical, Frequency Modulation, Radar.

Classes now forming for the summer term
June 1. Entrance exam. May 17.
Veterans. Literature.

COMMERCIAL RADIO INSTITUTE

(Founded 1920)
38 West Biddle Street, Baltimore 1, Md.

Hollywood Experts Help You **Make Good in RADIO-TELEVISION** at Home

Direct from Hollywood, nerve-center of broadcasting, Television, Radio and Sound activities, comes R-T-A's time-proven and tested home training. Here at last—easy to learn, home instruction that quickly qualifies you for steady, good-pay jobs or your own Radio business. 10 big kits of radio parts given at no extra charge. Get full details at once! Send postal for FREE BOOK "How to Make Good in Radio-Television." R-T-A APPROVED FOR VETERANS.

RADIO TRAINING ASS'N OF AMERICA, Dept. RCD
5620 Hollywood Blvd. Hollywood 28, Calif.

BOOK REVIEWS

THE RADIO AMATEUR'S HANDBOOK (Twenty-fifth Edition—1948), by Headquarters Staff of the American Radio Relay League. Published by the American Radio Relay League. Flexible fiber covers, 6½ x 9½ inches, 608 pages plus an 8-page index and a 144-page manufacturers' catalog. Price \$2.00 in U. S. A., its Possessions and Canada; \$2.50 elsewhere.

It is indeed difficult to review "The Handbook" for we feel that it is too well known to need an introduction. We cannot imagine anyone with an interest in radio without at least one edition in his possession.

The latest edition of the handbook has 25 chapters—four more than last year. We cannot compare these editions by counting chapters. This year, the editors have found several opportunities to combine theoretical and construction material. For example: the material that was in the chapters on radio-frequency power generation and transmitter construction in previous editions has been combined in a chapter on high-frequency transmitters. When theoretical and practical material is correlated in this way, the reader is often able to grasp difficult ideas that he is unable to understand from orthodox texts.

In addition to the usual transmitter and receiver circuits, there are five new chapters devoted exclusively to v.h.f., u.h.f. and microwave techniques and equipment. The vacuum-tube data tables have been brought up to date to include the latest tubes.—*R.F.S.*

ELEMENTS OF RADIO SERVICING, by William Marcus and Alex Levy. Published by McGraw-Hill Book Co. Stiff cloth covers, 6½ x 9½ inches, 475 pages. Price \$4.50.

Written to provide needed information on radio servicing especially for the beginner, the authors assume that the reader already has a knowledge of radio theory, but theory is reviewed wherever they feel it would clarify a procedure.

The book is clearly and comprehensively written and profusely illustrated with pictures and schematics of typical circuits and modern receivers. Complete summaries and study helps, together with questions dealing with actual service problems, are found at the end of almost every chapter.

Outstanding features are the stage-by-stage analyses of the different receiver circuits and components, discussion of the faults most likely to develop, and explanations of the testing procedures used to locate them.—*H. W.*

RADIO

TECHNICIAN and RADIO SERVICE COURSES
FM and TELEVISION

AMERICAN RADIO INSTITUTE

101 West 63rd St., New York 23, New York

Approved Under GI Bill of Rights
Licensed by New York State

PREPARING FOR FEDERAL RADIO OPERATOR EXAMINATIONS, by Arnold Shostak. Published by Prentice-Hall, Inc. Stiff cloth covers, 5¼ x 7¾ inches, 404 pages. Price \$3.75.

This book was written expressly for the student who is preparing to take the examinations for commercial radio operator's licenses.

The questions which appear in the book are taken from the FCC's pamphlet, "Study Guide and Reference Material for Commercial Radio Operator's Examinations." Selections of questions from this pamphlet make up each examination. Following each question is its answer, given in the most simple and direct form, yet designed to give the student the background on the theory or practice involved.—*H.W.*

HOWARD W. SAMS RADIO RECEIVER TUBE PLACEMENT GUIDE—Covering Most 1938 to 1947 Receivers, compiled and published by Howard W. Sams & Co., Inc. Stiff paper covers, 5¼ x 8¼ inches, pages not numbered. Price \$1.25.

The problem of replacing tubes in unmarked sockets of radio receivers is simplified by this new book. It contains 1,880 diagrams showing the socket locations of almost 5,400 different sets produced under 107 trade names. The book is also useful in identifying a tube whose type number has been worn off before being removed from the set.—*R.F.S.*

PRACTICAL AMPLIFIER DIAGRAMS, by Jack Robin and Chester E. Lipman. Published by Os-tronic Publications. Spiral binding with flexible paper covers, 8½ x 11½ inches, 41 pages of diagrams and 59 pages of parts lists and instructions. Price \$2.00.

Schematic diagrams, parts lists, and instructions for building 45 different types of audio amplifiers are included in this book. The diagrams include a hearing aid, recorder and playback amplifiers, public address systems, phono amplifiers, intercommunicators, and transmitter modulators. The intercommunicator diagrams are for battery, a.c.-d.c., and quick-heating a.c. models. The amplifiers range from a 1-tube, 1-watt job to a 75-watt multi-channel amplifier.

Most of the circuits described are designed to pass frequencies between 50 and 12,000 cycles. There are some high-fidelity circuits designed to pass frequencies up to 20,000 cycles.—*R.F.S.*

V RADIO ENGINEERING

FM—Television—Broadcast

Police Radio, Marine Radio, Radio Servicing, Aviation Radio and Ultra High mobile applications. Thorough training in all branches of Radio and Electronics. Modern laboratories and equipment. Old established school. Ample housing facilities. 7 acre campus. Small classes, enrollments limited. Our graduates are in demand. Write for catalog.

Approved for Veterans

VALPARAISO TECHNICAL INSTITUTE

Dept. C VALPARAISO, INDIANA

TRADIO-ETTE

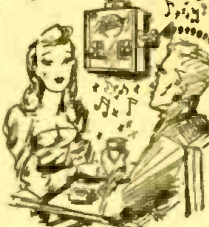

Here's the **KEY** to more profits every day!

Here's one of the finest business opportunities in years. You can cash in on the fact that people like radio with their meals. That's why Tradio-ette—a small, compact coin-operated radio designed for restaurant and tavern booths—has become so nationally popular. Plays 15 minutes for 10c.

Small Investment Thousands of high-yield locations are available if you get in on the ground floor. Only a small investment needed to operate this lucrative full or part time business. Tradio is the nation's leading manufacturer of coin-operated radios.

For Complete Details . . .
Contact Us Today
WRITE Dept. U-5

TRADIO, Inc. ASBURY PARK NEW JERSEY

MORE FEATURES

for your money in this miniature

AM SUPERHET TUNER

With self-contained Power Supply

by "Adaptol"



Adaptol offers the outstanding buy in compact, efficient AM Superhet Tuners (540 to 1700 KC). Here are just a few of the useful applications:— Highly suitable for use in conjunction with wire and tape recorders . . . Installed in record player, makes phono-radio combination . . . Has many experimental uses . . . Tuner for custom-built radios . . . For modernizing obsolete radios and PA systems . . . For conversion of military, foreign and short wave receivers to broadcast band at the flick of a switch.

CIRCUIT FEATURES—Self-contained power supply for 110V. AC-DC 60-60 cycles . . . Three tube circuit of conventional design, using the latest miniature and dual purpose tubes . . . Permeability tuned drift-free LF's. **COMPACT**: Approximately 4½" x 3½" x 3¾".

Last price \$20.00 complete with tubes. Add 6% west of Rockies. FOB Brooklyn, N. Y. See your local distributor, or write for further information to:
ADAPTOL CO., 120 New Lots Ave., Brooklyn, N. Y.

Somewhat More Silent Than a TOMB!



It's Impossible to Hear a Mallory Control Operate!

Even super-sensitive meters, built for the U. S. Navy to inspect delicate electronic communication equipment, do not show an audible sound level when Mallory carbon controls are tested.

Mallory carbon controls give you totally silent operation—the tapers are smooth and accurate to assure maximum adjustment in the

proper ranges—the overall resistance values are uniform and the life of the control is the longest ever provided. This kind of quality keeps customers satisfied.

Mallory has given you so many "firsts" in the

field of radio-electronic replacement parts that you know Mallory products are the finest that can be produced! Sell them with confidence, install them with ease. The Mallory line of Volume Controls, Capacitors and Vibrators has been standardized; they are a profitable line to stock.

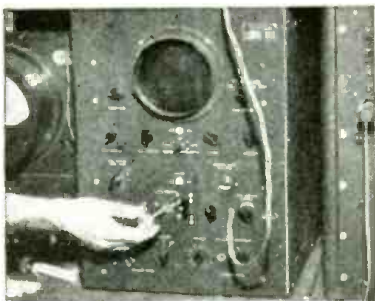

Meter used in the noise level test. Readings were taken on volume controls of all leading manufacturers. Mallory controls gave no audible sound, registered 22% below all others in inaudible sound vibrations.

"Good Service for Good Business"

A business plan that will raise the earnings of radio-electronic servicemen. One important item in the plan is a unique system for following up your customers for repeat orders.



And there are ways of linking your name with the Mallory trade mark, to get the benefit of Mallory advertising. Better ask your distributor about it!

WHAT WILL
MALLORY
DO NEXT?

See Us at
the Radio
Parts Show

P. R. MALLORY & CO. Inc.
MALLORY

CAPACITORS . . . CONTROLS . . . VIBRATORS . . .
SWITCHES . . . RESISTORS . . . RECTIFIERS . . .
VIBRAPACK* POWER SUPPLIES . . . FILTERS

*Reg. - U.S. Pat. Off.

APPROVED PRECISION PRODUCTS

P. R. MALLORY & CO., Inc., INDIANAPOLIS 6, INDIANA



This New IRC JUNIOR Control Cabinet Belongs on Your Bench



Here's one selection of 9 "hot-number" controls, switches and shafts you'll use every day! The new IRC Junior Control Cabinet contains 9 of the most-used 1/2, 1 and 2 meg. type D controls with the added adaptability of the tap-in shaft feature—plus 4 switches and 4 special shafts.

This inexpensive assortment of popular controls will save you time and money, and reduce your need for exact replacements. Factory-packed in a handsome four drawer cabinet of sturdy cardboard. Cabinet attractively finished in blue, yellow and silver with twelve individually identified compartments. Order the new inexpensive JUNIOR Control Cabinet from your IRC Distributor today. International Resistance Company, 401 N. Broad Street, Philadelphia 8, Pennsylvania. In Canada: International Resistance Company, Ltd., Toronto, Licensee.

HERE'S WHAT YOU GET

	IRC Control Type No.	Resistance	Purpose
5	D13-133	500,000 ohms	A
1	D13-133X	500,000 ohms	B
1	D13-137	1.0 meg.	A
1	D13-137X	1.0 meg.	B
1	D13-139	2.0 meg.	A

Purpose: A-Tone or Audio Circuit control;
B-Tapped for tone compensation.

SWITCHES

3	#41	S.P.S.T.
1	#42	D.P.S.T.

SHAFTS

1 Type "A" double-flatted tap-in shaft is included with each control—plus:

3 Type "E" with universal knurl for special type push on knobs.

1 Type "H" with universal groove for many Delco, RCA, Sears-Roebuck and Westinghouse models.

INTERNATIONAL RESISTANCE COMPANY



Wherever the Circuit says 