

SPECIAL TELEVISION NUMBER

HUGO GERNSBACH, Editor

RADIO CRAFT



SEE PAGE 28

RADIO-ELECTRONICS IN ALL ITS PHASES

JAN
1948

50¢
CANADA 60¢

RADIO-ELECTRONICS IN ALL ITS PHASES

"THE hottest ham performance ever at this price . . ." That's the verdict of amateurs who have had a chance to try Hallicrafters new Model SX-43.

This new member of the Hallicrafters line offers continuous coverage from 540 kilocycles to 55 megacycles and has an additional band from 88 to 108 megacycles. AM reception is provided on all bands, except band 6, CW on the four lower bands and FM on frequencies above 44 megacycles. In the band of 44 to 55 Mc., wide band FM or narrow band AM just right for narrow band FM reception is provided.

One stage of high gain tuned RF and a type 7F8 dual triode converter assure an exceptionally good signal-to-noise ratio. Image ratio on the AM channel on band 5 (44 to 55 Mc.) is excellent as the receiver is used as a double superheterodyne. The new Hallicrafters dual IF transformers provide a 455 kilocycle IF channel for operating frequencies below 44 megacycles and a 10.7 megacycle IF channel for the VHF bands. Two IF stages are used on the four lower bands and a third stage is added above 44 megacycles. Switching of IF frequencies is automatic. The separate electrical bandspread dial is calibrated for the amateur 3.5, 7, 14, and 28 megacycle bands.

Every important feature for excellent communications receiver performance is included.

Model **SX-43**



\$169⁵⁰

FEATURES FOUND IN NO OTHER RECEIVER AT THIS PRICE

- ALL ESSENTIAL AMATEUR FREQUENCIES FROM 540 kc to 108 MC
- AM - FM - CW RECEPTION
- IN BAND OF 44 TO 55 MC: WIDE BAND FM OR NARROW BAND AM . . . JUST RIGHT FOR NARROW BAND FM RECEPTION
- CRYSTAL FILTER AND EXPANDING IF CHANNEL PROVIDE 4 VARIATIONS OF SELECTIVITY ON LOWER BANDS
- SERIES TYPE NOISE LIMITER
- TEMPERATURE COMPENSATION FOR FREEDOM FROM DRIFT
- PERMEABILITY ADJUSTED "MICROSEY" INDUCTANCES IN THE RF CIRCUITS
- SEPARATE RF AND AF GAIN CONTROLS
- EXCEPTIONALLY GOOD SIGNAL-TO-NOISE RATIO
- SEPARATE ELECTRICAL BANDSPREAD CALIBRATED FOR THE AMATEUR 3.5, 7, 14 AND 28 MC BANDS

BUILDERS OF *Skyfone* AVIATION RADIOTELEPHONE



hallicrafters RADIO

THE HALLICRAFTERS CO., MANUFACTURERS OF RADIO AND ELECTRONIC EQUIPMENT, CHICAGO 16, U. S. A.
 Sole Hallicrafters Representatives in Canada:
 Regent Majestic Limited, Toronto-Montreal



KIT 1 (left) I send you Soldering Equipment and Radio Parts; show you how to do Radio Soldering; how to mount and connect Radio parts; give you practical experience.

(left) Early in my course I show you how to build this N. R. I. Tester with parts I send. It soon helps you fix neighborhood Radios and earn EXTRA money in spare time.



KIT 2

You can get this training in your own home under G. I. Bill. Mail coupon for full details.



Be a RADIO Technician

Learn by PRACTICING in Spare Time

with **BIG KITS** of **RADIO PARTS** I send you

KIT 3 You get parts to build Radio Circuits; then test them; see how they work; learn how to design special circuits; how to locate and repair circuit defects.

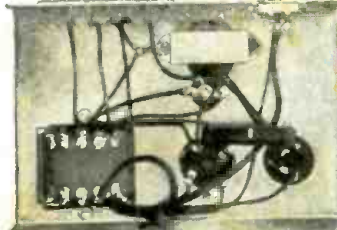

KIT 4 You get parts to build this Vacuum Tube Power Pack; make changes which give you experience with packs of many kinds; learn to correct power pack troubles.

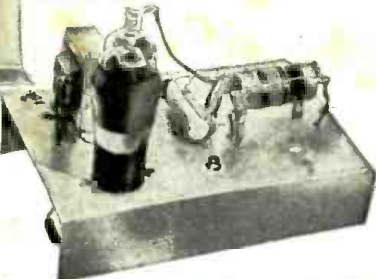

KIT 5 Building this A. M. Signal Generator gives you more valuable experience. It provides amplitude-modulated signals for many tests and experiments.



KIT 6 You build this Superheterodyne Receiver which brings in local and distant stations—and gives you more experience to help you win success in Radio.

Do you want a good-pay job in the fast-growing Radio Industry—or your own Radio Shop? Mail the Coupon for a Sample Lesson and my 64-page book, "How to Be a Success in Radio-Television-Electronics," both FREE. See how I will train you at home—how you get practical Radio experience building, testing Radio circuits with **BIG KITS OF PARTS** I send!

Many Beginners Soon Make Extra Money in Spare Time While Learning



J. E. SMITH, President National Radio Institute

The day you enroll I start sending **EXTRA MONEY** manuals that show how to make **EXTRA** money fixing neighbors' Radios in spare time while still learning! It's probably easier to get started now than ever before because the Radio Repair Business is booming. Trained Radio Technicians also find profitable opportunities in Police, Aviation, Marine Radio, Broadcasting, Radio Manufacturing, Public Address work. Think of even greater opportunities as public demand for Television, FM, and Electronic devices continues to grow. Send for **FREE** books now!

Find Out What NRI Can Do For You

Mail Coupon for Sample Lesson and my **FREE** 64-page book. Read the details about my Course, letters from men I trained; see how quickly easily you can get started. No obligation! Just **MAIL COUPON NOW** in an envelope or paste it on a penny postal. J. E. SMITH, President, Dept. 8AX, National Radio Institute, Pioneer Home Study Radio School, Washington 9, D. C.

Our 34th Year of Training Men for Success in Radio

Sample Lesson **FREE**
64 Page Book **FREE**

Mr. J. E. SMITH, President, Dept. 8AX
National Radio Institute,
Washington 9, D. C.

Mail me **FREE** Sample Lesson and 64-page book about how to win success in Radio and Television-Electronics. (No salesman will call. Please write plainly.)

Name Age.....

Address

City State.....

(Please include Post Office zone number)

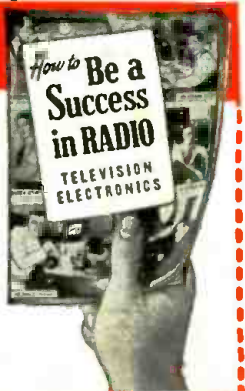

Approved for Training under GI Bill

My Course
Includes Training in
TELEVISION • ELECTRONICS
FREQUENCY MODULATION

25 Super Value RADIO KITS!

Every radio man will recognize the unusual values represented by these new Wells Kits. Parts assortments of the most popular types have been picked from our vast stocks of brand new, guaranteed Government material. In many cases, you will notice the value of just one item exceeds the cost of the whole kit. Whether or not you have an immediate use for these kits, they are made up of the sort of material that is always useful.



K100 RELAY KIT

6-Assorted A.C. and D.C. relays. 7 to 14,000 ohms. 3 to 20 ampere contact rating..... **\$2.95**



K101 VOLUME CONTROL KIT

12-Carbon volume controls. 100 ohms to 7 megohms..... **\$1.95**



K102 VOLUME CONTROL

12-Wire wound volume controls. 5 to 70,000 ohms. 3 to 5 watt rating..... **\$2.95**



K103 PHONE PLUG AND JACK KIT

2-PL55, 2-PL68, 2-PL54 plugs. 2-JK26 and 4 other jacks to match above plugs..... **\$1.95**



K104 AIR TRIMMER CONDENSER KIT

10-Trimmer condensers, 1/2 to 120 mmf..... **\$1.95**



K105 METAL TUBULAR CONDENSER KIT

16-Tubular condensers. .001 to 1. MF. 100 to 1600 volt..... **\$2.35**



K106 MICA CONDENSER KIT

10-Silver Mica and 10-Moulded mica condensers. 4 1/2 mmf. to 01 MF..... **\$2.75**



K107 CERAMIC CONDENSER KIT

12-Ceramic condensers. 1 to 7500 mmf. 500 volt minimum. Zero and negative temperature coefficient..... **\$1.75**



K108 ROTARY SWITCH KIT

10-Ceramic and Bakelite rotary switches. 1 to 10 poles. 2 to 12 positions..... **\$2.75**



K109 CARBON RESISTOR KIT

100-Insulated resistors. 100 ohms to 2 megohms. 1/4 to 1 watt. 5 to 20% tolerance..... **\$1.75**



K110 WIRE WOUND RESISTOR KIT

10-Wire wound resistors with ceramic core. 3 to 35,000 ohms. 8 to 20 watts..... **\$1.35**



K111 WIRE WOUND RESISTOR KIT

10-Wire wound resistors. 5 to 75,000 ohms. 20 to 50 watts..... **\$1.75**



K112 ADJUSTABLE WIRE WOUND RESISTOR KIT

10-Adjustable resistors. 3 to 15,000 ohms. 10 to 50 watts..... **\$2.05**



K113 COIL AND CHOKE KIT

25-R.F., A.F., I.F., and antenna coils and chokes..... **\$2.45**



K114 CRYSTAL KIT

10-Crystals with holders. 186.3 kc. to 4,000 kc..... **\$1.85**



K115 KNOB KIT

50-Bakelite knobs. Push-on and set-screw types..... **\$1.85**



K116 MOULDED PAPER CONDENSER KIT

12-Moulded paper condensers. Most popular sizes. .005 to .1 MF. 100 to 600 volt..... **\$1.45**



K117 BAKELITE TUBE SOCKET KIT

15-Sockets. 4, 5, 6, 7 and 8 contacts..... **\$1.00**



K118 CERAMIC TUBE SOCKET KIT

10-Ceramic sockets. 4, 5, 6, 7 and 8 contacts..... **\$1.45**



K119 NEON LAMP KIT

10-Standard neon lamps. NE2, NE11, NE15, NE16, NE51..... **\$1.35**



K120 CODE PRACTICE KIT

1-High frequency buzzer. 1-J37 telegraph key..... **\$1.45**



K121 JEWEL LIGHT KIT

3-110 volt jewel light assemblies. 4-6 volt assemblies plus 3 extra jewels..... **\$2.10**



K122 HEAD SET KIT

1-Head set type H532. Single receiver with strap, cord and plug..... **95c**



K123 COAXIAL CABLE

100 ft. RG8U coaxial cable..... **\$2.95**

K124 COMBINED KITS

All kits K100 to K123.
One of each..... **\$38.45**

With the exception of a few heavier kits such as K100, K108, K111, K112, K123, all will be shipped via parcel post if you add 10c for postage for each kit. Otherwise shipment will be made via express.

Be sure to write for our brand new Amateur Catalog H200C. It's full of excellent values in radio equipment and parts.



Order Direct or Through Your Local Jobber

320 N. LA SALLE ST., DEPT. Y, CHICAGO 10, ILL.

NEW!

in 1,000 pages:

All data and basic knowledge in radio and electronics digested into 12 sections... in a complete, quick to find, easy to read, handbook form.

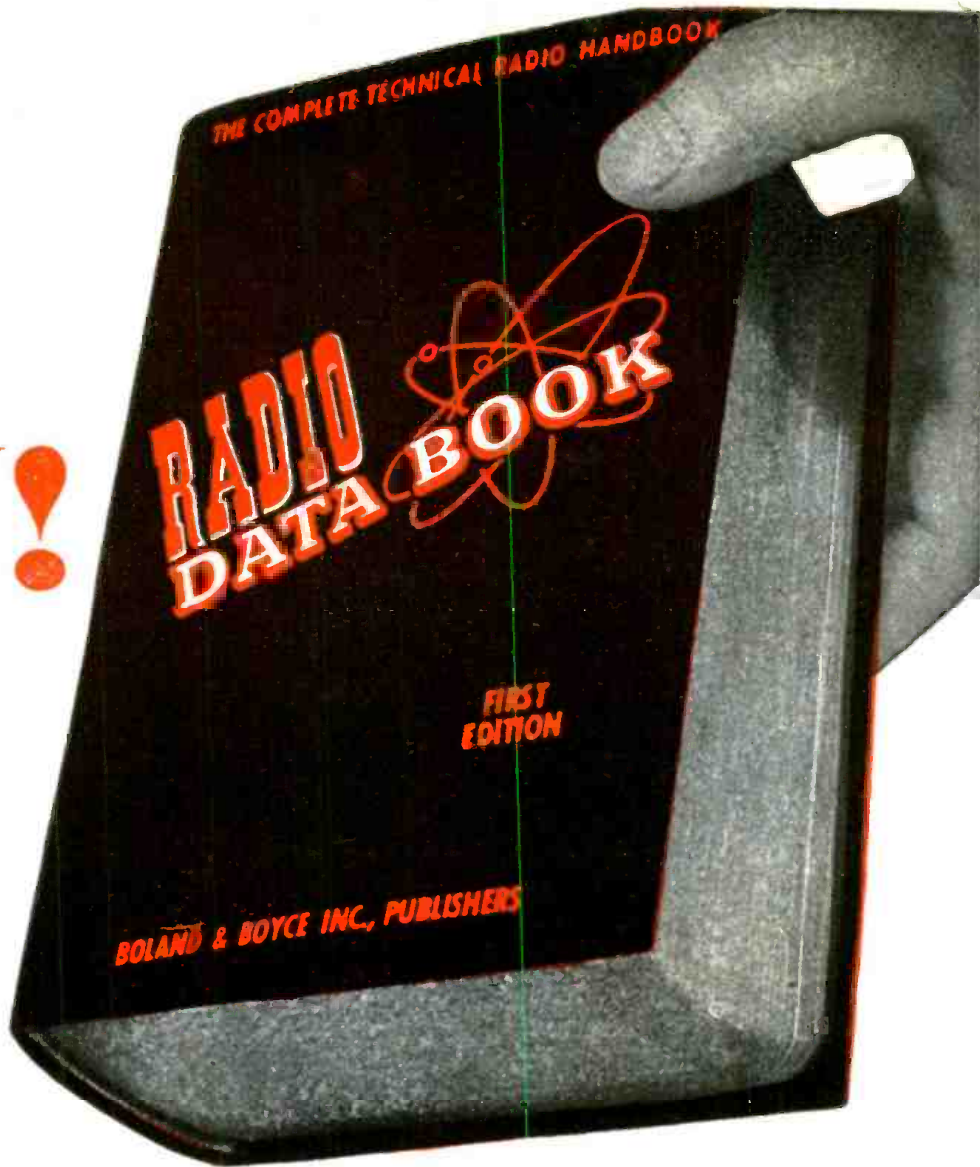

Handsomely bound in RED and GOLD

Plan every operation in radio and electronics with the *Radio Data Book*. This new radio bible will be your lifelong tool... you will use it every day, on the board, at the bench, in the field! Use it for construction, troubleshooting and testing. The RADIO DATA BOOK will be your invaluable aid in design, experiment and in layout. It will help make your production better, faster and easier. In any and every operation in radio and electronics, you will use the RADIO DATA BOOK!

The RADIO DATA BOOK is a work of complete authority, prepared by engineers with many years of practical experience. They have been assisted by the Boland & Boyce staff of editors skilled in preparing electronics manuals for the U. S. Signal Corps for many years. These men have worked for several years gathering material for this book... all the knowledge of radio principles and operation... all the statistics... all the newest developments in electronics... every possible angle and detail. Eighteen months were spent digesting this material into the most concise, the clearest, and the most readable form. The result is this invaluable manual... The RADIO DATA BOOK. Whether you use this book for general reference, for scientific instruction, or for education, one thing is certain—the practical help, the daily usefulness you will derive from it will prove to be worth many, many times its astonishingly low price!

Advanced Sale... first printing, Only 10,000 available... To make sure to get your RADIO DATA BOOK, mail your order **NOW!**

12 complete books in one only \$5.00! Less than 42c per book!

MAIL THIS COUPON TODAY!

BOLAND & BOYCE INC., PUBLISHERS
460 BLOOMFIELD AVE. MONTCLAIR 3, N. J.

Please send me a copy of
THE RADIO DATA BOOK Enclosed is \$5.00.

NAME

ADDRESS

CITY ZONE

STATE

BOLAND & BOYCE INC., PUBLISHERS

CONTENTS

Each section is a COMPLETE coverage of its subject... 12 sections... 12 books in ONE! 1000 pages... Schematics... Accurate photographs... Specially prepared drawings... White on black charts... Diagrams... Isometric projections and exploded views.

- Section 1. **THE 150 BASIC CIRCUITS IN RADIO.**
Every circuit is analysed and explained in a Johnny-on-the-spot reference for any occasion.
- Section 2. **COMPLETE TEST EQUIPMENT DATA.**
Know more about the test instruments you now have... Find the new ones you want to buy... They're All in here—impartially described!
- Section 3. **TESTING, MEASURING AND ALIGNMENT.**
Simplified operation of the Oscilloscope... See what's happening inside any radio circuit... Dynamic alignment—AM, FM and TELEVISION made easy with the Oscilloscope... Scientific use of the Vacuum Tube Voltmeter, Signal Generating Equipment and other basic instruments.
- Section 4. **ALL ABOUT ANTENNAS.**
AM-FM-Television... design, installation, characteristics, construction and feed.
- Section 5. **SOUND SYSTEMS.**
Planning, installing and servicing a PA System. A complete chapter on every component... How to select and combine components... estimating costs... even acoustic requirements!
- Section 6. **ELECTRICAL AND PHYSICAL CHARACTERISTICS OF RADIO COMPONENTS.**
Know the size, the power, the shape! A quick reference on the construction and design of any circuit or equipment.
- Section 7. **COMPLETE TUBE MANUAL: Receiving, transmitting and Commercial.**
A flick of the pages brings you to all the data and ratings of any tube model!
- Section 8. **CHARTS, GRAPHS AND CURVES.**
Quick calculation devices... Plotting curves, nomographs, rules and tables for speedy solutions to radio problems.
- Section 9. **CODES, SYMBOLS AND STANDARDS.**
Handy reference to all radio symbols and abbreviations; code symbols, phrases and characters... Where you want them... When you want them!
- Section 10. **50 TESTED CIRCUITS DESIGNED FOR OPTIMUM PERFORMANCE.**
Find any circuit you want with complete parts lists and specifications... One tube receivers to complete AM, FM and Television receiver circuits... Amplifiers... Transmitters... Test Equipment and Control Circuits... All with the latest engineering refinements.
- Section 11. **DICTIONARY OF RADIO AND ELECTRONIC TERMS.**
- Section 12. **RADIO BOOK BIBLIOGRAPHY.**



IN BUYING RADIO PARTS Demand This SEAL of QUALITY of America's Radio Storehouse



LOWEST PRICES • HIGHEST QUALITY • NO WAR SURPLUS

GENERATOR CONDENSERS



PHILCO part No. 61-0177-5 mfd.— $\frac{1}{2}$ " x $1\frac{1}{2}$ "—4" lead-slotted mounting strap for easy installation—Standard Merchandise—not war surplus—Present list price \$1.00.
Our special—**over 85% off** **14c**

OUTPUT TRANSFORMERS

Clean stocks—long leads—mounting feet—made to fit where you need them.
For 6FG-6K6—to 4 ohm voice coil—size 2" x $1\frac{1}{2}$ " x $1\frac{1}{4}$ ".
50L6-35L6-25L6 to 4 ohm voice coil $1\frac{1}{4}$ " x $1\frac{1}{2}$ " x $1\frac{1}{4}$ ".
Specify quantity of each type you need at.....



49c

CATHODE CONDENSERS



10 Mfd. at 25 working volts— $\frac{1}{4}$ " x $1\frac{1}{4}$ " tubular type—aluminum cans—overall cardboard sleeve—tinned leads—quality construction by a national manufacturer—backed by the famous R. S. & E. guarantee—list price 79c. Priced to make you money at 12c each lots of 10 for..... **108** 100 for..... **900**

MULTI-USE WIRE

An old favorite—back again! Stranded No. 22 tinned wire—glass "ROCKBESTOS" 1000 volt insulation—fireproof aircraft wire—a war-time development—at this low price you can use the best—



100 feet..... **45c** 1000 feet..... **389**

AEROVOX GL 8-600



Genuine Aerovox 8 mfd.—600 volt working—inverted screw mounting—aluminum can $1\frac{1}{2}$ " x $\frac{1}{2}$ "—6" insulated leads. List Price \$4.00—quantity limited—order now on this one time item at only..... **99c**

MODEL 451A AC-DC Volt-Ohm-Milliammeter



A dependable instrument of wide utility—sensitivity 1000 ohms per volt.
Ranges: Volts AC, DC, and Output Ranges, 0-10/50/100/500/1000; Ohms full scale, 500,000; Ohms center scale, 7200.

NET complete with batteries **1490**



MODEL 312 Volt-Ohm-Milliammeter

An economy pocket meter featuring a 2" moving vane meter.
Reads: AC-DC volts, 0-25/50/125/250; Mills AC-DC, 0-50; Ohms, 100,000; mfd., .05-15
Jacks provide range selection.

NET Complete with cord and plug..... **675**

Start Your Own RADIO SERVICE SHOP

as low as **9950**

Complete Starting-In Business Stocks of
**TEST EQUIPMENT, TUBES,
PARTS, TOOLS, EVERYTHING**

Write, Wire, Phone for Full Details

PHONO PICKUP CRYSTALS

Standard types—Set Manufacturers close-out—**all Guaranteed**



Shure P30—Shure's newest and finest—osmium tipped permanent needle—1.8 volts output—fits standard mounting holes.
List Price \$7.50 You pay us **269**



SHURE P93—W57A—pin type terminals— $\frac{1}{4}$ oz. pressure—1.6 volt output—6000 cycle cut off.
List price \$4.45—our Special..... **198**



Astatic L-70—new postwar design—solder terminals— $\frac{1}{4}$ oz. pressure—1 volt output—4000 cycle cutoff.
List price \$5.55—we quote you... **198**

Pep-Up PHILCO CHANGERS

At last! All the parts you need to restore brilliant tone and volume to "sick" changers! You'll need all three items—sell your customer a 100% reconditioning job—
Selenium cell only, no holder..... **\$1.80**
Sapphire needle only, no mirror..... **\$1.20**
Special original equipment lamp..... **27c**
RECONDITIONING KIT—all three above items—postpaid—special at..... **321**

RADIO RULE



Here is a clear 6" plastic rule—a necessity for radio students, draftsmen, hams, all who desire cleaner, more precise work—National advertised at \$2.00. Order yours **35c** today postpaid only

SEND FOR FREE CATALOG

JEWELLED PILOT LIGHT ASSEMBLIES

- Miniature bayonet socket
- Mount in 1" hole
- Lamps removable from front of panel
- Available in red, green, or amber—quantities limited—order now



List Price \$1.30
At RSE'S 85% off—you **19c** pay
Back again—by popular demand!

Triplet 606B-VOLTAGE TESTER



Checks voltage and polarity. Range: 0-440 AC-DC volts—definite indications for 115, 220, and 440 volt lines. Separate polarized vane for AC or DC indication. Built in test leads. Excellent for checking wiring, fuses, general factory installation and maintenance. Every plant—every electrician needs several at this low price. Regular net 16.67 **895** Special at.....



Triplet VOLTMETERS

Panel meters by Triplet! Top quality instruments—new—boxed—five popular types—priced right—your chance to get those meters you've always wanted—

MODEL 332—0-150 A.C. volts—3" round flush mounting black brass case.
MODEL 231—0-150 A.C. volts—2" round flush mounting bakelite case.
MODEL 237—0-150 A.C. volts—2" square flush mounting bakelite case.
MODEL 221—0-30 D.C. volts 2" round flush mounting bakelite case.
MODEL 324—0-400 D.C. volts—3" round projection mounting—bakelite case.
Supply limited—order now—list models you desire. **295** EACH

RESISTANCE LINE CORDS



Standard 3 terminal 135 ohm AC-DC cords—sturdy construction—flexible— $5\frac{1}{2}$ " long—complete with plug—for sets having approximately 69-75.2 volts drop in the filaments—Regular list price 1.17—

Only 33c

Include full remittance with orders of \$3.00 or less. Include 25c deposit with all C.O.D. orders of \$3.00 or more. All shipments sent express collect if postage is not included. Prices subject to change without notice.
BE SURE TO INCLUDE SUFFICIENT POSTAGE. EXCESS WILL BE REFUNDED.

RADIO SUPPLY & ENGINEERING CO., Inc.

125 SELDEN AVE. DETROIT 1, MICH.



If you want to
LEARN RADIO
 I offer you the finest,
 most practical training
AT LOWEST COST!



I TRAIN YOUR MIND BY PUTTING YOUR HANDS TO WORK!
 You Get 8 Big Kits of Radio Parts and Equipment, Including a Two-band 6 Tube Super Receiver! 16-Range Meter for Testing!



**INVESTIGATE
 SPRAYBERRY TRAINING
 FOR YOUR OWN GOOD!**
MAIL COUPON FOR 2 FREE BOOKS!



SPRAYBERRY ACADEMY OF RADIO
 F. L. Sprayberry, President
 Room 2018, Pueblo, Colorado

Please rush my FREE copies of "How to MAKE MONEY in RADIO, ELECTRONICS and TELEVISION" and "How to READ RADIO DIAGRAMS and SYMBOLS."

Name..... Age.....
 Address.....
 City..... State.....

Check here if a Veteran.

(Mail in envelope or paste on penny postcard)

VETERANS Approved for G. I. Training under Public Laws 16 and 346.



FREE!

NEW COMPLETE *Concord* RADIO CATALOG

160 Value-Packed Pages of the Latest and Best in RADIO • TELEVISION • Electronic Equipment!

The Only Complete Up-to-the-Minute Catalog of Radio Parts — Sets — Amplifiers — Testers — Ham Gear — Kits • Immediate Shipment.

TROUBLE-FREE SERVICE from STANDARD BRAND PARTS
 RCA • Amperite • Simpson-Jensen • Stancor
 • Ohmite • Shure • Bliley • Dumont • IRC •
 Triplet • Sprague • Cornell-Dubilier •
 Meissner...and hundreds of other brands
MAIL COUPON FOR FREE COPY

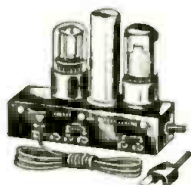

Phono Oscillator

New design uses series plate modulation, only two tubes instead of the usual three. Phono motor and pick-up connect directly to oscillator. Plays records through radio by simply tuning in the oscillator on your radio as you do your favorite station. Complete with tubes. \$4.95
C22546



Alnico "V" 12" PM Dynamic Speaker

12" PM dynamic speaker with 6.8 oz. Alnico V permanent magnet; 1" voice coil with 6-8 ohms impedance. Capacity is 14-18 watts. For all general applications. \$5.95
5B7010



4 MFD 600 volt Oil Type Capacitor

Oil filled and impregnated. Single hole mounting. Size 4 1/4 x 1 1/4". 4 mfd., 600 working volts, DC. \$59c
5B3164



Crystal Pickup

Quality crystal pickup mounted in arm for 10" and 12" records. Mounting included. Requires 1/2" hole. Shielded lead and cartridge case. Aluminum die cast arm finished in smooth dark brown. With semi-permanent needle. \$1.59
X143



IF Transformer

High gain permeability tuned IF transformer. 375 KC normal peak. Screwdriver adjustment. 5 solder lugs at bottom. 1 1/2 x 1 1/2 x 2 1/2". 2 spade mounting. 1 1/4" mounting centers. \$3.50
5B5129—30c each, 10 for.



Oil Impregnated Paper Condenser

Cylindrical type can, solder lug connector. 2 mfd. at 600 WV DC. Size 1 1/2" dia. x 2 1/4". \$2.9c
5B3238



GI Phono Motor

Model LX. Insulated for quiet operation. Oilless bronze bearings. Two pole high speed motor. 9" turntable. 78 r.p.m., 110 volt, 60 cycle. \$2.49
C22531



Crescent Record Changer

Single posted changer plays 10 twelve-inch records or 12 ten-inch records. Rejects any record desired. Can be operated manually. Tone arm can be moved at any time without damage. Mounted in brown metal case with ventilating louvers, and hole cut for mounting speaker. Changer is finished in two tone brown. \$16.95
5B9573

CONCORD

RADIO CORPORATION

CHICAGO 7
 901 W. Jackson Blvd.

ATLANTA 3
 265 Peachtree St.
 Downtown Chicago Branch: 229 W. Madison
 Lafayette Radio Corp.

Concord Radio Corporation, Dept RC-18
 901 W. Jackson Blvd., Chicago 7, Ill.

Yes, rush FREE COPY of the comprehensive new Concord Radio Catalog.

Name.....

Address.....

City..... State.....

30,000

Successful Radio Service Technicians Read RADIO MAINTENANCE Every Month

RADIO MAINTENANCE is the magazine of ideas and information for profitable service shops. It helps maintain secure, high quality operation. Where you find **RADIO MAINTENANCE**, you'll find successful servicing!

Each month **RADIO MAINTENANCE** brings you the latest developments in television, radio and electronics by top experts in the field. Each article, each department is carefully edited and presented to help you in your daily work. All these articles are invaluable as reference material; and all the articles together will form a complete reference library on everything in the radio servicing business. In the coming year, **RADIO MAINTENANCE** will bring you a complete series on each of the following: AM—FM—Television—Signal Tracing and All Test Equipment—Low Cost Business Promotion Methods—Sales Techniques for Servicemen—How to Make Huge Profits in the Sound Installation Business. Each article in a series will be a compact unit in itself—combined with the others of its series, they form a complete education—a complete service library—to bring you prestige, profit and security in your own radio servicing establishment. (A subscription to **RADIO MAINTENANCE** is tax-deductible, too!)

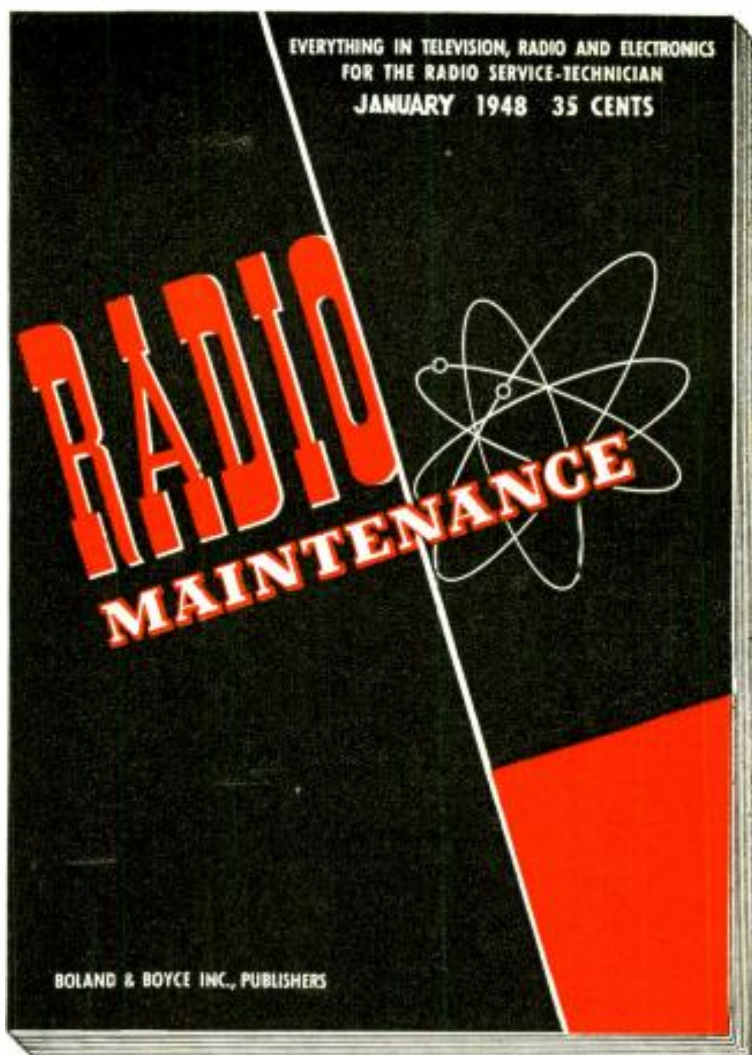

Sales Technique Series

Any service-technician can improve his business by improving his sales technique. *No service technician can afford not to!* Selling power is all important—and can mean the difference between a successful service shop and a complete failure. **RADIO MAINTENANCE** is, therefore, scheduling a complete coverage of this vital subject in its Sales Techniques Series. These articles will cover personal sales approach to customers . . . basic principles of radio advertising . . . planning local and large scale promotion campaigns . . . how to select proper media for your advertising . . . window and shop decoration for customer appeal . . . how to get bigger jobs and every other detail needed to sell yourself and your business to your community. Sales techniques have been developed to a top-notch degree of efficiency and effect—but many radio service technicians are not using this essential factor. Get the information you need for selling power by subscribing to **RADIO MAINTENANCE** now!

FM Series

FM continues to grow more and more rapidly. **RADIO MAINTENANCE** is keeping pace with this development in its series on FM. Our readers have enthusiastically received our previous articles on this subject and are asking for more. Every article will give thorough coverage—completely illustrated—of a specific phase of FM. All these articles will form a complete reference library on the subject—a library that will always be up-to-date—always handy—providing easy-to-understand information by top experts. **RADIO MAINTENANCE** rapid, trouble-free servicing techniques are here applied to FM. The latest type of test equipment is explained and illustrated. All circuit diagrams are clear and easy to follow. With this invaluable reference library you will have the advantage in FM. Get your subscription order to **RADIO MAINTENANCE** in today and every servicing advantage will be yours!

Binders in beautiful green simulated leather stamped in gold are now available for your **RADIO MAINTENANCE** magazines—see the current issue of **RADIO MAINTENANCE** for information.

Every issue of **RADIO MAINTENANCE** contains information you want . . . Every day is **RADIO MAINTENANCE** day in your shop . . . Send in the coupon today—your first issue will be mailed to you immediately!



RADIO MAINTENANCE MAGAZINE
460 Bloomfield Ave.
Montclair 5, N. J.

Please send me **RADIO MAINTENANCE** FOR

- 1 year at \$3.00
- 2 years at \$5.00

check enclosed bill me later

BOLAND & BOYCE INC., PUBLISHERS

Name
Address
City-State
*Occupation
Title (Service Mgr., etc.)
Employed by

*Business or professional classifications are required to serve you better. Each subscriber will profit by writing one of the following classifications in space indicated.
INDEPENDENT SERVICEMAN — DEALER SERVICEMAN — SERVICE MANAGER — DEALER — DISTRIBUTOR — JOBBER
State your trade or occupation if not listed.



This New IRC JUNIOR Control Cabinet Belongs on Your Bench



Here's one selection of 9 "hot-number" controls, switches and shafts you'll use every day! The new IRC Junior Control Cabinet contains 9 of the most-used ½, 1 and 2 meg. type D controls with the added adaptability of the tap-in shaft feature—plus 4 switches and 4 special shafts.

This inexpensive assortment of popular controls will save you time and money, and reduce your need for exact replacements. Factory-packed in a handsome four drawer cabinet of sturdy cardboard. Cabinet attractively finished in blue, yellow and silver with twelve individually identified compartments. Order the new inexpensive JUNIOR Control Cabinet from your IRC Distributor today. International Resistance Company, 401 N. Broad Street, Philadelphia 8, Pennsylvania. In Canada: International Resistance Company, Ltd., Toronto, Licensee.

HERE'S WHAT YOU GET

	IRC Control Type No.	Resistance	Purpose
5	D13-133	500,000 ohms	A
1	D13-133X	500,000 ohms	B
1	D13-137	1.0 meg.	A
1	D13-137X	1.0 meg.	B
1	D13-139	2.0 meg.	A

Purposes: A-Tone or Audio Circuit control;
B-Topped for tone compensation.

SWITCHES

3	#41	S.P.S.T.
1	#42	D.P.S.T.

SHAFTS

1 Type "A" double-flatted tap-in shaft is included with each control—plus:

3 Type "E" with universal knurl for special type push on knobs.

1 Type "H" with universal groove for many Decca, RCA, Seors-Roebuck and Westinghouse models.

INTERNATIONAL RESISTANCE COMPANY



Wherever the Circuit says 



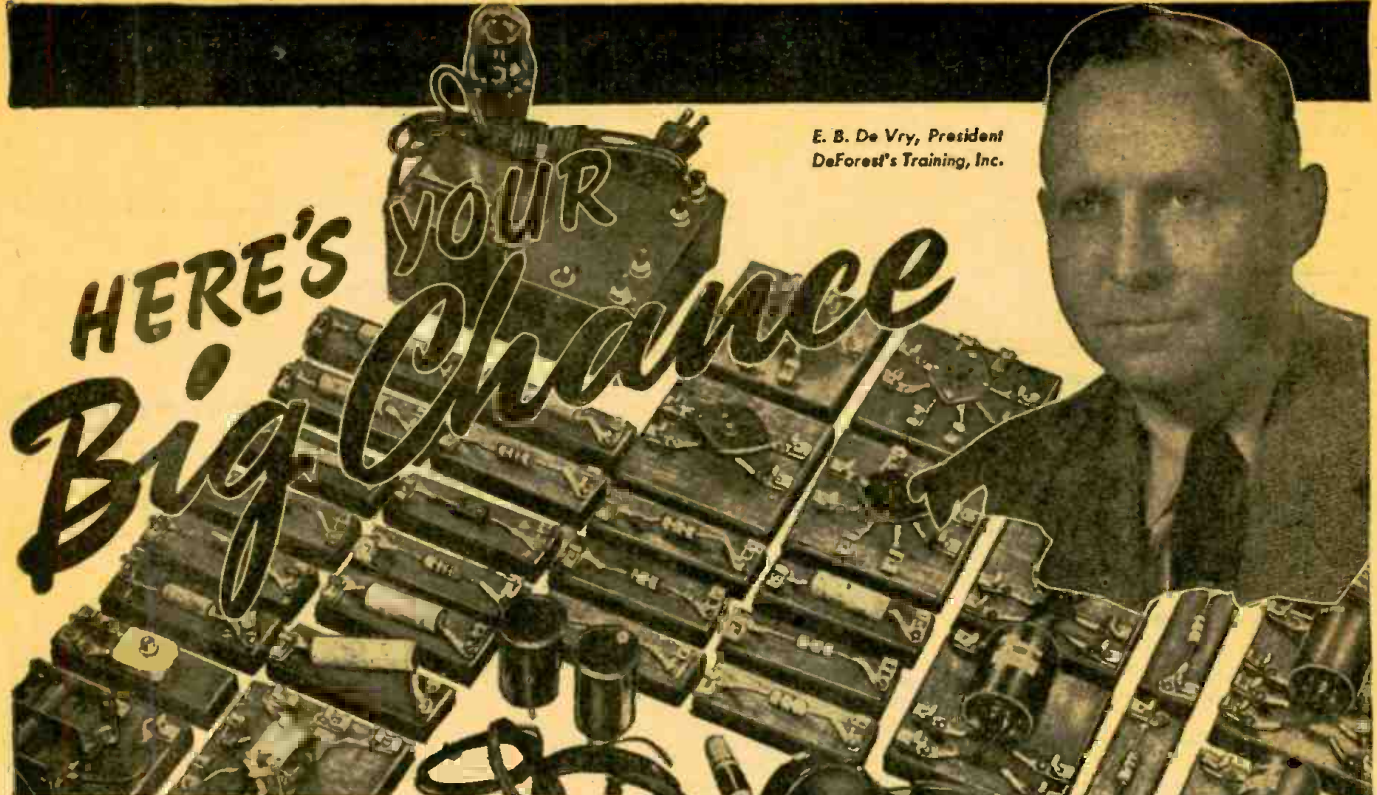

E. B. De Vry, President
DeForest's Training, Inc.

HERE'S YOUR Big Chance

Profit Through Training in RADIO-ELECTRONICS

Prepare at HOME or in our CHICAGO LABORATORY to get REAL MONEY, a BETTER JOB, or a BUSINESS OF YOUR OWN

Our business is helping men . . . and young men . . . get into a well-paying future in the highly profitable fields of RADIO-ELECTRONICS. During the past sixteen years we have trained many men who desired better jobs or businesses of their own. We can effectively provide you with this same opportunity either in our new, modern Chicago laboratories or in the privacy of your own home.

TAKE YOUR CHOICE

If you choose to come to Chicago, we shall find comfortable living quarters for you. If you train at home, we shall send you modern, practical equipment. In either of these two methods, you will have the supervision of some of the finest instructors in the country. Fill in coupon below and we shall send you, absolutely FREE, full information about our program of building men for better opportunities in RADIO-ELECTRONICS. DeForest's Training, Inc. also includes instruction in FM Radio, Television and Industrial Electronics.

If you prefer to remain at home, you receive eight (8) big kits of radio parts and assemblies from which you can work out dozens of fascinating radio circuits to gain practical experience in your own home. In addition, you receive a 16 mm. motion picture projector and 12 information-packed reels of film which help you learn faster . . . easier. You also get modern looseleaf lessons with handy fold-out diagrams.

EMPLOYMENT SERVICE

When you complete your training our effective Employment Service helps you get started toward a real future. Mail coupon below today . . . do not delay.

VETERANS

Both our (1) Chicago Laboratory and (2) Home Study training are accepted under the "G. I. Law." If you qualify, the Government will pay cost of either training you select.

MAIL THIS OPPORTUNITY COUPON NOW!

Mr. E. B. De Vry, President
DeForest's Training, Inc.
2533 N. Ashland Ave., Dept. RC-01
Chicago 14, Illinois

Please show me how I may get started toward a good job or a business of my own in Radio-Electronics.

Name.....Age.....

Address.....Apt.....

City.....Zone.....State.....

If under 16, check here for special information.

If a discharged Veteran of World War II check here.

DeForest's Training, Inc.

CHICAGO,
ILLINOIS

Associated with the DeVRY Corporation
Builders of Movie & Electronic Equipment

JANUARY • 1948

Editorial: Reversible Television by Hugo Gernsback 17
 Radio-Electronics Monthly Review 18, 19

Television

Progress in Television by Dr. Vladimir K. Zworykin 20
 1948 Televiser Parade 23
 Nation-wide Television Is Now in the Making by Dr. Allen B. Du Mont 26
 Filters Aid Television by Dr. Thomas T. Goldsmith, Jr. 28
 Television Equipment 29
 Television Is Here—What Now? by Louis Gerard Pacent 31
 C. Francis Jenkins—Television Adventurer by George H. Clark 32
 Television Steps Out! by Will Baltin 35
 Television as a Useful Art 36
 Double Modulation—An Aid to Television? by E. Aisberg 39
 Block that Ghost! by Jordan McQuay 40
 British Televisers by Ralph W. Hallows 43
 Television and FM Antennas by H. Winfield Secor 45
 A Good Televiser from War Surplus by Ernest J. Schultz W2MUU 57
 Kickback Power Supply by W. H. Buchsbaum 59
 U.S. Television Stations in Operation 90
 Recent Television Books 132
 Television Frequency Channels 133

Servicing

Radio Set & Service Review (RCA 630TS) 48
 Servicing Televisers by Milton S. Kiver 50
 Television Trouble Chart 54

Test Instruments

Universal Speaker for Field or Bench by Sidney S. Fleischman 53
 This Signal Generator Is Pocket Size by Charles Urban 64
 Precision Frequency Meter Uses 3 Oscillators by B. J. Cederqvist, OH2NL 68
 Direct-Current Milliammeters in Radio Servicing by Oscar E. Carlson 70
 Combination Test Instrument by J. V. Roberson 73

Sound

Hi-Fi Tuner Tribulations by James R. Langham 61
 Smallest Hearing Aid Uses Printed Circuits 66
 12-Volt Amplifier by John W. Straede 71

Construction

5-100 Meter Mighty Mite by Bob White 62
 Whip Tuning Motor by Harry Winfield 65
 A Modern Midget Set by W. H. Grace 72
 Power for the BC-312 by Guy Black 74

Departments

World-Wide Station List Edited by Elmer R. Fuller 47
 Transatlantic News by Ralph W. Hallows 56
 The Question Box 76
 Radio-Electronic Circuits 78
 Try This One 80
 New Radio-Electronic Devices 82
 Technotes 88
 New Radio-Electronic Patents by I. Queen 94
 Book Reviews 143

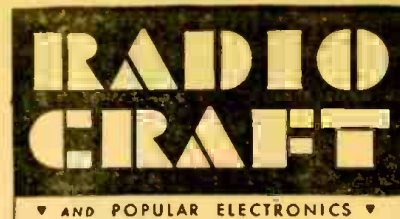

Incorporating
 SHORT WAVE CRAFT TELEVISION NEWS
 RADIO & TELEVISION

HUGO GERNSBACK

Editor-in-Chief

FRED SHUNAMAN, *Managing Editor*

M. HARVEY GERNSBACK,
Consulting Editor

ROBERT F. SCOTT, W2PWG,
Technical Editor

ANGIE PASCALE,
Production Manager

I. QUEEN, W2OUX, *Editorial Associate*

ELMER FULLER, *Shortwave Editor*

G. ALIQUO, *Circulation Manager*

JOHN J. LAMSON,
Advertising Director

ALFRED STERN, *Promotion Manager*

In An Early Issue

SIMPLE INDUCTION BRIDGE
 SUNSPOTS AND RADIO
 I-KW DIELECTRIC HEATER

On the Cover:



A novelty motif marks this month's cover. See page 28 for a complete explanation.

Chromatone by Alex Schomburg from photo by Warren Z. Z. Illes.



RADCRAFT PUBLICATIONS, INC. Hugo Gernsback, President; M. Harvey Gernsback, Vice President; G. Aliquo, Secretary
 Member Audit Bureau of Circulations

Contents Copyright, 1947, by Radcraft Publications, Inc. Text and illustrations must not be reproduced without permission of Copyright owners.

RADCRAFT PUBLICATIONS, INC. • PUBLICATION OFFICE 29 Worthington Street, Springfield 3, Mass. • EDITORIAL AND ADVERTISING OFFICES 25 West Broadway, New York 7, N. Y. Telephone REctor 2-9690.

BRANCH ADVERTISING OFFICES: Chicago: 308 W. Washington Street, Chicago 6, Ill. Tel. Randolph 7363. Detroit: Frank Holstein, Manager, Room 402 Lexington Bldg., 2970 West Grand Blvd., Detroit 2, Mich. Telephone Madison 7026-7. Los Angeles: Ralph W. Harker, Manager, 606 South Hill St., Los Angeles 14, Calif. Tel. Tucker 1793. San Francisco: Ralph W. Harker, Manager, 582 Market St., San Francisco 4, Calif. Tel. Garfield 2481.

RADIO-CRAFT, January, 1948, Volume XIX, No. 4. Published Monthly on 25th of month preceding date of issue. Allow one month for change of address. When ordering a change, please furnish an address stencil impression from a recent wrapper. All communications about subscriptions should be addressed to the Circulation Manager, Radio-Craft, 25 West Broadway, New York 7, N. Y.

SUBSCRIPTION RATES: United States and possessions, Mexico, Central and South American countries, \$3.50 a year; \$6.00 for two years; \$8.00 for three years. Canada, \$4.00 a year; \$7.00 for two years; \$9.50 for three years. All other foreign countries, \$4.25 a year, \$7.50 for two years; \$10.25 for three years. Entered at Post Office, Springfield, Mass., as second-class matter under the Act of March 3, 1879.

FOREIGN AGENTS: Great Britain: Atlas Publishing and Distributing Co., Ltd., 18 Bride Lane, Fleet St., London E.C.4. Australia: McGill's Agency, 179 Elizabeth Street, Melbourne. France: Brentano's, 37 Avenue de l'Opera, Paris 2e. Holland: Technisch Bureau Van Baerle, Bemelmans & Co., Heemsteedsche, Dreef 124, Heemstede. Greece: International Book & News Agency, 17 Amerikis Street, Athens. So. Africa: Central News Agency, Ltd., Cor. Rissik & Commissioner Sts. Johannesburg; 112 Long Street, Capetown; 369 Smith Street, Durban, Natal. Universal Book Agency, 70 Harrison Street, Johannesburg. Middle East: Steimatzky Middle East Agency, Jaffa Road, Jerusalem. India: Susil Gupta (Distributors) Co., Amrita Bazar Patrika Lt., 14 Ananda Chatterjee Lane, Calcutta.

**WE BRING NATIONAL SCHOOLS
TO YOU FOR
HOME TRAINING IN
RADIO
TELEVISION & ELECTRONICS**



RADIO SHOP AT NATIONAL

BROADCAST STUDIO AT NATIONAL

Partial View of the Facilities that Stand Behind Your National Schools Home Training

TELEVISION STUDIO AT NATIONAL

Since 1905

**For Over 42 Years
One of America's
Leading Trade Schools**

**NATIONAL SCHOOLS SHOP METHOD
HOME TRAINING WILL START YOU RIGHT**

We will train you today to get started tomorrow in one of the thousands of opportunities opening in the field of Radio, Television and Electronics. The Home Radio Service Field continues to grow. Television is here . . . Television Broadcasting facilities are being rapidly expanded. Television sales, service, installation and maintenance requirements are more and more important from day to day. Electronics is an important factor in many applications for utility, safety, accuracy and convenience. Airlines are finding new uses for Radio bringing new benefits to air transportation. Ships at sea are employing Radar together with other conventional Radio apparatus for ship-to-shore communications and safety. Frequency Modulation is modernizing Radio Broadcasting, offering static-and-interference-free reception in the home. The list of Radio applications is almost endless, and every one represents increasing opportunities in our modern world for the **RADIO, TELEVISION AND ELECTRONICS TECHNICIAN WITH A SOLID TECHNICAL BACKGROUND.**

YOU CAN BE A NATIONAL SCHOOLS MAN

It is not a question of opportunity but rather how to take advantage of existing opportunity. Only proper training can make these opportunities a reality. National Schools of Los Angeles, one of the oldest and largest technical trade schools in the United States, offers you Shop Method Home Training, a proved method that builds qualified technicians. Here is Home Training that **BRINGS RESULTS.**

Behind all training from National Schools stands a permanent faculty of experienced instructors and engineers. These men are daily teaching resident students right in our own Shops and Laboratories. From first hand experience with students here at school, our instructors understand the needs and ambitions of men like you. All of our instructors, both Home Study and Resident, have ideal facilities to make your training practical, up-to-the-minute, interesting. It takes years of experience to know how to train men, especially in the practical technical trades. Established almost 50 years ago, National Schools has a rich background of experience to help you to take full advantage of the opportunities in the Radio, Television and Electronics Industry.



**Begin Training at Home
Later Come to Our Shops and
Laboratories in Los Angeles
—If You Prefer**

National's Master Shop Method Home Training in Radio, Electronics and Television is **COMPLETE** in itself. No other training is necessary; but, some men do prefer to take a short experience course here in our resident shops and laboratories, at the end of their Home Study training. They find it helpful to spend a short period of time in our modern Broadcasting Station, or our New Television Laboratories and Studios, or our Extensive Radio Servicing Shops—as well as other departments covering every specialized phase of the Radio Industry.

You are welcome to take advantage of this additional instruction if you wish. If you are interested, check the coupon below. Full details will be sent you by return mail. National Schools' **OUTSTANDING FACILITIES MAKE IT POSSIBLE TO OFFER THE FINEST POSSIBLE TECHNICAL TRADE TRAINING IN RADIO, TELEVISION AND ELECTRONICS.**

**You Get All This Radio
Experimental Equipment to
Use and Keep at Home!**

LEARN BY DOING is the basic principle of National's Shop Method Home Training. We send you standard Radio parts for an interesting series of experiments which demonstrate the fundamentals of Radio, Television and Electronics. The very essence of this training is **EXPERIENCE**—you get actual experience by building many different types of circuits. You build a fine, long distance **MODERN SUPER-HETERODYNE RECEIVER**, signal generator, low-power Radio transmitter, audio oscillator, etc. This practical work develops your knowledge of Radio step by step, makes you a practical Radio Technician.



VETERANS

During the war, National trained enlisted men under contract with the War Department. Both the Armed Forces Institute and Marine Corps Institute used our lesson texts on a wide scale. Now, we are training veterans, both resident and home study, through the Veterans Administration. If you are a veteran of World War II—and qualified for training under the G.I. Bill of Rights, check the coupon for special information.



**G. I. APPROVED
NATIONAL SCHOOLS
LOS ANGELES 37, CALIFORNIA EST. 1905
MAIL OPPORTUNITY COUPON FOR QUICK ACTION**

NATIONAL SCHOOLS, Dept. RC-1
4000 South Figueroa Street, Los Angeles 37, California

Mail me **FREE** the two books mentioned in your ad, including a sample lesson of your course. I understand no salesman will call on me. I have checked below the plan which interests me.

NAME AGE

ADDRESS

CITY STATE

(Include your zone number)

I am interested in home study only.
 Send information on your Combined Home-Study and Modern Resident Shop Training.
 Veteran of World War II.

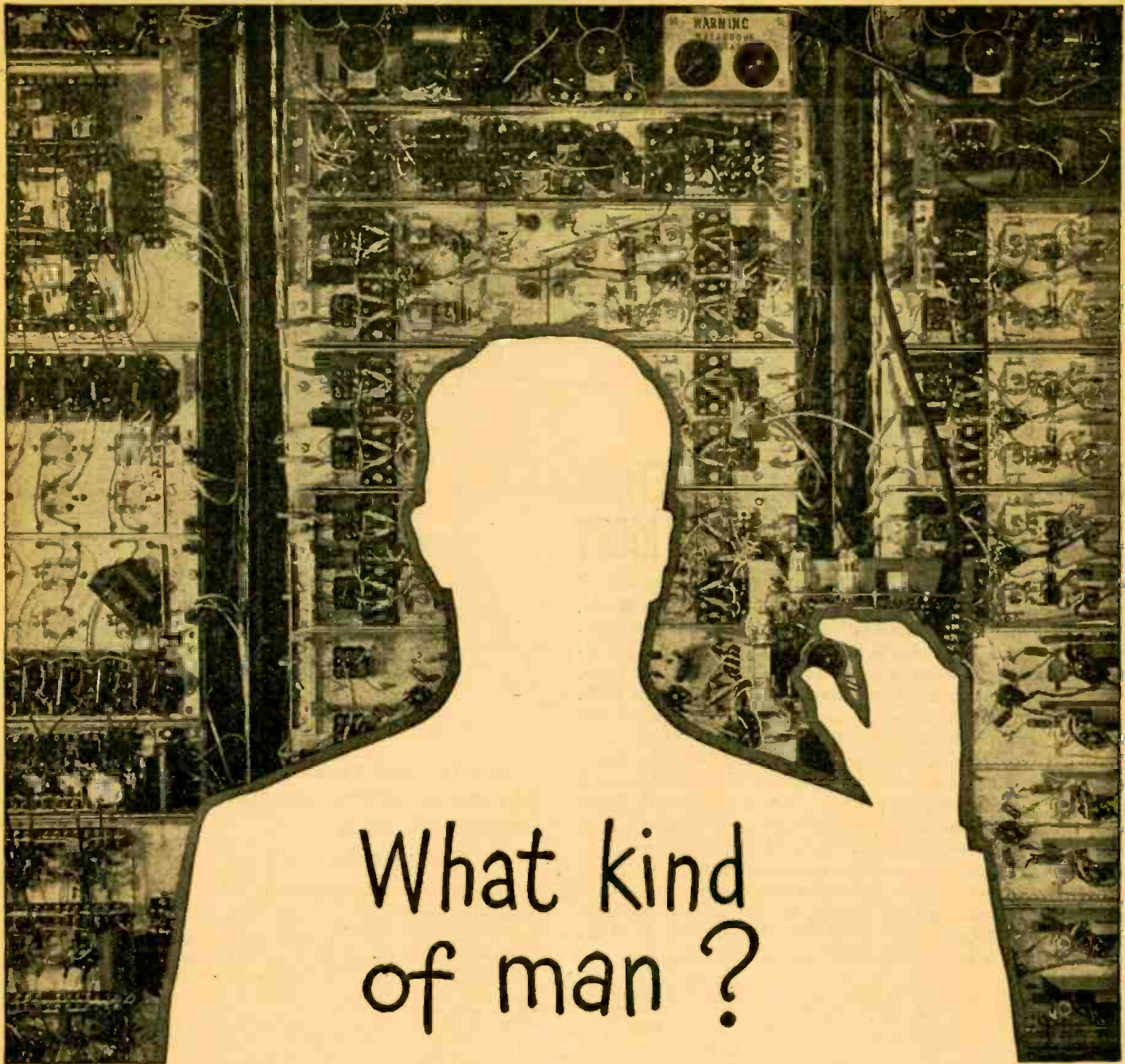

WHAT KIND of men are the 2,300 scientists and engineers of Bell Telephone Laboratories?

Men of many types, working in different fields of research, may contribute to each development.

But all have certain characteristics in common: Good minds as a foundation, many years of learning in the fundamentals of their science and the methods of research, and a co-operative attitude — for without co-operation of individuals these products of research could never be produced.

Above all else, however, they have “the spirit to adventure, the wit to question, and the wisdom to accept and use.”

That kind of men can produce the finest telephone equipment in the world — and have done so.



BELL TELEPHONE LABORATORIES

EXPLORING AND INVENTING, DEVISING AND PERFECTING FOR CONTINUED IMPROVEMENTS AND ECONOMIES IN TELEPHONE SERVICE

RADIO-CRAFT for JANUARY, 1948

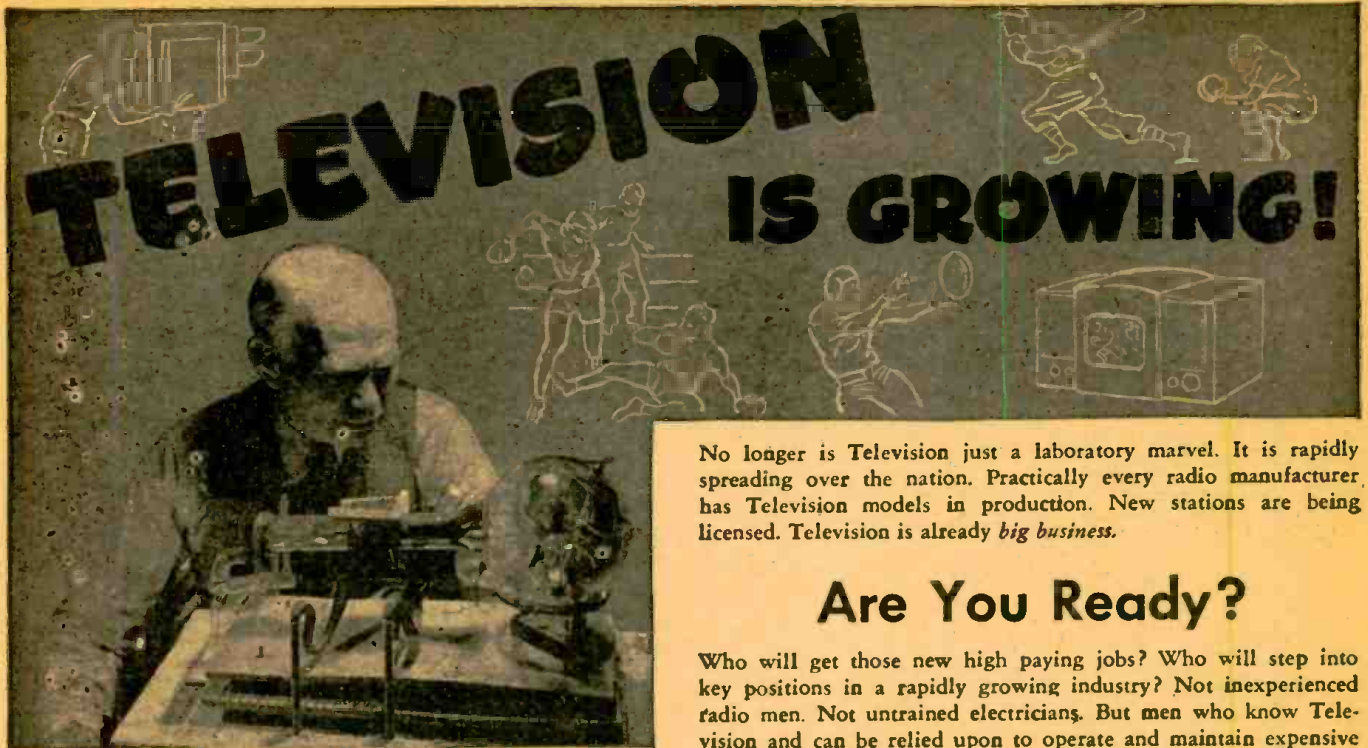

Dr. Lee de Forest

No longer is Television just a laboratory marvel. It is rapidly spreading over the nation. Practically every radio manufacturer has Television models in production. New stations are being licensed. Television is already *big business*.

Are You Ready?

Who will get those new high paying jobs? Who will step into key positions in a rapidly growing industry? Not inexperienced radio men. Not untrained electricians. But men who know Television and can be relied upon to operate and maintain expensive equipment!

American Television—A Great Training Institution!

American Television has pioneered in Television research. Its directors have made fundamental contributions to the industry. Dr. Lee de Forest, our Director of Research and Training, is known throughout the civilized world as the "Father of Radio" through his invention of the radio tube. U. A. Sanabria, President and founder of American Television, Inc. invented the Interlace Scanning System which is now the standard of all Television. Most recently, a revolutionary new circuit which corrects a common television defect known as "ghost images" has been developed by J. M. Sanabria, head of American Television's Manufacturing Division.

Most Elaborate Training Laboratories

Every modern type of equipment obtainable has been installed for instruction purposes in what we believe to be the most extensive and elaborate Television training facilities in the world. You will find complete operating studios with the new sensitive cameras and their associated equipment. A corps of highly qualified instructors will guide your study.



Start Learning TELEVISION at Home—FREE!

Prepare yourself for the endless opportunities in Television the new "American" way. Now, for the first time, you may discover in advance of entering school, just how your abilities fit into Television. If you qualify under the simple rules, you will be given a complete preliminary home study Television course absolutely free and without obligation.

Your success with the course will not only help you to decide for yourself what phase of Television you like best but will also aid us in qualifying you for residence training.

We prefer that all new resident students take this free course as it provides excellent preparation for residence study. However, there is no obligation on your part to enroll for residence training when you complete the home study course.

We urge you to take advantage of this splendid opportunity at once. Just write your name and address on a penny postcard and say: "I am interested in your free Television Course". Do it today! This offer is necessarily limited.

Approved for Veteran Training



American Television, Inc.

5050 BROADWAY

CHICAGO 40, ILLINOIS

HERSHEL

STARTS THE YEAR WITH BARGAINS GALORE—
MORE—MORE—MORE FOR YOUR MONEY!



BRAND-NEW AUTOMATIC
DIRECTION FINDER

Radio Compass SCR 269-F

Complete with Component Parts

The Radio Compass SCR 269-F was designed to be the primary radio navigation for the U.S. Army and Navy Air Forces. Constant reception is possible day or night so that fixes can always be made to establish the plane's or ship's location.

Plotting fixes is accomplished by selecting two or more stations and plotting these on the navigation map. The point of intersection of these lines indicates the location of the craft.

This equipment comes complete with 17 tubes, superheterodyne receiver which is tunable from 200-1750 KC. in 3 bands. A complete instruction book for operation and maintenance accompanies this equipment. J254...\$75.00

BRAND NEW BC 522 TRANSMITTER AND REC.

Transmitter output 8-9 W., voice amplitude modulated on any one of 4 Xtal controlled frequencies. Receiver is readily switched to either of the 4 present Xtal controlled channels. Tubes used: (2)832, (3)12A6, (1)6G6, (2)6SS7, (1)12J5GT, (1)12C8, (1)9002, (3)9003, (1)12AH7GT, (3)12SG7. Super-Special—complete with tubes. J217...\$29.95

CONDENSERS

Cap MFD	Working volt	Your cost
1	1000 oil... J220A	44c
8	600 oil... J220B	95c
2	600 oil... J220C	49c

BC 733-D RADIO RECEIVER

A part of aircraft blind landing equipment manufactured by W. E. Operates on any one of its pre-determined Xtal controlled frequencies in the range of 108-120MC. Contains 10 tubes, 3 of which are W.E. 717A's, and Xtals. Ideal receiver for conversion to 144MC. ham band or mobile telephone bands. For 24 VDC operation. 14 1/2" x 7" x 4 1/2". Complete with tubes J225...\$9.95

Dynamotor DA-3A

Input—28 VDC., 10.5 amps. Output—300 VDC., 260 amps. 150 VDC., .010 amps 14.5 VDC., 5 amps. 25 lbs. J210...\$150

HIGH SPEED PHOTO-FLASH

TUBE



12,000,000 lumens light output. Stops all action. Ignition coil included on back of bulb. 10,000 flashes. Diagrams furnished. J222...\$8.95. Complete line of GE photo flash tubes in stock.

AZIMUTH CONTROL

Dial calibrated 360 degree face ideal for antenna rationalizing indicator. 60-1 ratio with switch J216 49c



BUTTERFLY CONDENSERS



Oscillator assembly 76-300MC. with acorn tube socket mounted on condenser. J239A \$1.95
Type B- frequency range 300-1000MC. J239B... 95c
BC4 antenna condenser 105-330MC. J239C \$1.95
Oscillator 105- 330 MC J2390...\$1.95

BC 923 RECEIVER

This narrow band FM receiver operates from 26-41MC. It has 4 separate RF channels all of the same frequency, and each one individually tuned. These channels, in turn, are connected to a selector switch, which enables choosing desired pre-setting on any of the 4 RF sections. This equipment has a built-in 1000KC. Xtal controlled calibrating oscillator. Complete with 16 tubes. 1000KC. Xtal dynamotor, and speaker J202...\$24.95



TOGGLE SWITCH



D.P.S.T. 30 amps. In black bakelite case J223...39c

SQUIRREL CAGE BLOWER



2" outlet, 110 AC. Silent ball bearing motor with mounting bracket. J258...\$7.95

FILAMENT TRANSFORMERS

110V. 60 Cy. Pri. sec.-5V.—3A. Shelled case J260A...\$1.49
110V. 60 Cy. Sec.: 2.5V. at 5.25A. Shelled case J260B...\$2.45

Sockets for acorn tubes... J270A...19c
Powdered iron—3/4 slug... J270B...10c
Jacks—PL55 or PL68... J270C...15c
3 lbs. Assorted Hardware J270D...\$1.00
Earphones, 2000 ohms, used J270E...69c
Johnson sockets No. 210 25W... J270F...39c

RADIO RECEIVER AND TRANSMITTER BC-620-A

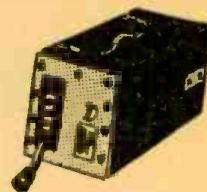

Radio set BC 620-A is a portable low power frequency modulation set, capable of dependable communication. Frequency range 21.-27.9 MC. Either of 2 Xtal controlled pre-set frequencies may be chosen by throwing the channel switch. The change from receiving to transmitting is made by pressing a button on the hand-set microphone. The fact that this equipment incorporates the latest FM. circuit makes it adaptable to uses in locations where noise levels are extremely high.

Power requirements for receiver are as follows: "A" supply —1.5V. at 7 amps. "B" supply—90V. at 25 milliamperes. Transmitter 7.5V. "A" at .3 amps and 150V. "B" at 45 milliamperes.

This equipment is used depot stock, is in good condition and comes complete with the following tubes: (1)VT 177 or 1LH4, (1)VT 178 or 1LC6, (4)VT 179 or 1LN5, (2)VT 182 or 3B7/1291, (1)VT 183 or 1R4/1294, (4)VT 185 or 3D6/1299. J200...\$9.95

OSCILLATOR 144 MC.

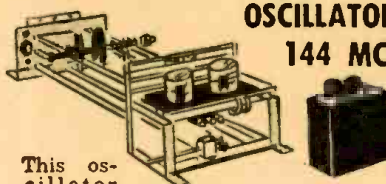

This oscillator has a frequency range of 140-200MC. It incorporates push pull 826 long lines oscillator. It has facilities for varying the sliding bars and also vernier tuning. The unit is silver-plated for efficiency. Comes complete with tubes and filament transformer for same J207 \$4.95

TUBES

813	\$5.95
VR150	69c
955	65c
9002	89c
RK60	95c
9001	89c
6J4	\$1.50
5FP7	\$1.95
7BP7	\$2.95
9LP7	\$3.95
872A	\$1.95
9004	49c
9006	59c
50B5	89c
VT127A	\$2.95
35W4	69c
3AP1	\$1.95
3BP1	\$1.95
6J5	49c
5BP1	\$3.95
6H6	59c
1T4	59c
3Q4	59c
6SN7	59c
3S4	44c
5W4—SW4	44c
6SA7	44c
1G5	44c
12H6	44c
6SH7	44c

BN IFF Transmitter and Receiver



Widely used on 144MC. and now also successfully used as a television receiver, this being made possible by the wide band 30MC. IF. channel and video amplifier. Being sold at this exceptionally low price for the encouragement of television. Original diagram furnished. Less tubes and power transformer. 100 lbs. J227...\$9.95

SPST Relay. 24V. 528 ohm. Coil contact rating 5 amp. Packed 2 to a carton. J228A...49c
Coaxial Solid copper tubing. 30 ft. J228B...\$2.95
30-20 MFD. solar condenser. 150V. tubular J228C...49c
Assorted tubular oil filled condensers up to 5 MFD. J228D...15 for \$1
Westinghouse oil 1 MFD. 6000V. WVDC J228E...\$7.95
Brand new BC 375 transmitter, GE, 150W. with dynamotor J228F...\$49.95
Assorted high frequency chokes... J228G...25 for \$1
Assorted resistors. 1/2W. fully insulated in popular ohmage J228I...100 for \$1.49
Thordarsen T48003. 2H-7H 550 MA. swing choke 4 1/2" x 5 1/2" x 5 1/2" square, black, crackle case J228J...\$5.95
Wafer sockets. 4, 5, 6, 7, and 8 prong J228K per 100 \$2.95
Assorted knobs. Push on wood and plastic. J228L...\$1.95

DYNAMOTOR UNIT

Duo output Dynamotor. PE-101-C input voltage 12-24V. Output voltage 400V. at 135 MA.. 800V. at 20 MA., and 9V at 1.1 amps. J226...\$2.95

MICHIGAN CUSTOMERS ADD 3% SALES TAX—ITEMS OVER 5 LBS. SHIPPED EXPRESS COLLECT—ORDER BY CATALOG NUMBER

HERSHEL RADIO CO.

5249 GRAND RIVER, DETROIT 8, MICH.

SEND ENOUGH MONEY TO COVER POSTAGE AND HANDLING CHARGES—TERMS: F.O.B. DETROIT—MINIMUM ORDER \$2.00

SEND FOR
FREE BULLETIN!
20% DEPOSIT

Radio Electronic Parts from HERSHEL RADIO COMPANY— your assurance of MORE FOR YOUR MONEY throughout the year!

Model ZA Instrument Landing Equipment

When used in conjunction with Navy RU7 12V. supply or RU14 supply series, receiving equipment is adapted to receive the signals transmitted by YB or model IL instrument landing ground equipment. These signals are converted to visual indications to the pilot of his position with respect to a premeditated approach. In original carton.....J214....\$12.95

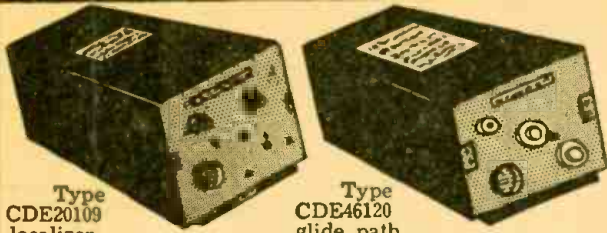

Type CDE20109 localizer signal converter with mounting base

Type CDE46120 glide path receiver with mounting base

Type CDE-22316 landing indicator



Type CDE impedance adapter with mounting base



Type CDE620-25 junction box with mounting base



Glide path receiver antenna

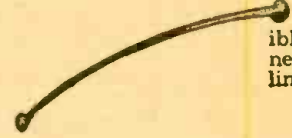

Flexible connecting line



Type CAY223-16 landing indicator



Type CAY223-16 landing indicator



Transmitter AVT-112

Designed to operate from 6, 12, or 24V. source. Although the units are supplied for 6V. and 12V. operation—conversion to the 24V. type is easily effected by making minor changes. Frequency range 2.5-6.5 MC. 5 3/8" x 6 1/4" x 4 7/8". 6 lbs. J208A...\$12.95

Receiver AVR 20-A

Receiver to match AVT 112 J208B...\$12.95
\$12.95 EACH or \$25.00 A PAIR

SPRAGUE CONDENSER

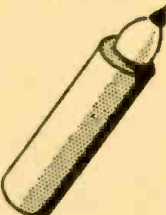

.1 MFD
7000V
J219 . \$1.95

BC 630-CA FM RECEIVER (Narrow Band)

This receiver, so widely used in tanks, has a frequency coverage of 20-28MC. It contains 10 tubes and a built in squelch circuit. Tuning is accomplished by either dial or 10 station push-button selector switch. Complete with tubes and speaker J204...\$19.95



Bendix SELSYN Motor C78248

Bendix selsyn motor C 78248—110V. AC. 60 Cy. Synchronized differential..... J205...\$3.95



GENERAL ELECTRIC METER



Type DO41, 0-1 MA. meter scale graduation 0-5 DC. Kilo V. and 0-10 MA. BC J232...\$3.95

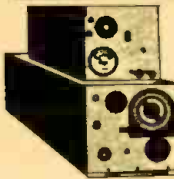

BCAR 230 TRANSMITTER

Including 4 tubes and RF amps meter

BC AL 229 RECEIVER

Including 6 tubes. Used in aircraft. Both units with coils for only..... J266...\$9.95

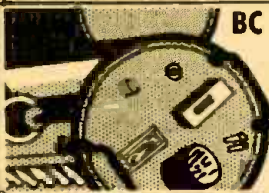

BC 39-A RECEIVER AND TRANSMITTER

This equipment brand new and in original sealed carton. IF strip can be used on television. APG 5 contains; (1)829, (1)2C43, (1)2C40, (2)2V2A, (1)1N21B Xtal. (1)5Y3, (2)9-3, (1)VR105, (8)6AK5, (1)6AL5, (1) Blower, (1) Adjustable vacuum spark gap J218...\$24.95

IKW MODULATION TRANSFORMER

RCA Mod. Trans. conservatively rated at 550W. audio to modulate that new KW rig. Audio Watts—550 Sec No 1- 450 Mills. Ser No. 2- 80 Mills turns ratio—Pri: Sec No. 1- 1.1 Pri Sec No. 2 top-25:1. Impedance ratio—Pri: 1-1:1 sec. Pri: Sec No. 2-25:1 Pri. Sec No. 2 top- 625:1 DC. resistance—Pri: 135 ohms Sec No. 1, 112 ohms; Sec No. 2, 99 ohms. Transformers insulation tested: Pri. 8000V.; Ser No. 1- 11. 000V.; Ser No. 2- 2000V. to the rest of coils and core. Primary center tapped for class "B" modulators. Sec. No. 2 will carry 80 mils to modulate screens of beam power or screen grid tubes. Primary will match any class "B" tubes up to 10,000 ohms plate to plate, such as 810's, 751's, 8005's, ZB120's, 203's, HY51Z's 211's, 813's, 828's, 805's, and 203Z's 9 1/2" wide, 7 1/2" deep, 7 1/4" high. Heavy channel iron mounting brackets. 40 lbs. J257...\$14.95



TRANS TUNING UNIT BC-375

Each unit has 3 double spaced unit cond., approximately 65 MMFD. coils, SW chokes, national velvet dials and assorted mica condenser 2500 WVDC. over \$50.00 in parts! J201...\$1.75

POWER TRANS.



Primary 110V. 60 Cy. Sec: 700V. ea. side of center at 80 MA. 6.3V. at 1.2 amps. 5V. at 3 amps. Hermetically sealed. 6" x 3 1/2" x 3". J248...\$1.95



CAPACITY WAVE METER



For BC1072A. tuning range 144-250 MC. Complete with 9002, 9006, 6U5 tubes..... J215A \$4.95
Power supply for above, less tubes... J215B...\$4.95

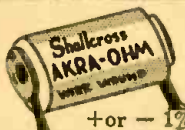

+ or - 1%



BC 702-A TRANSMITTER Enclosed in metal case.

(4)2X2 tubes, (1) squirrel cage blower, 12-24V., .02-800V., 25 MA. 2" meter. 2-.01 at 5000 VDC.....J221...\$9.95

1 meg. J264 89c

75,000 ohm Bleeder 200W...95c

CORONA BALLS

Grid and plate connections for VT 127-250 TH, etc. Round ball type. Heat dissipating. Silver-plated J263...50c Doz.

ARR7 Airborne Version of Hallicrafter SX28A

With 3 RF stages (1 re-radiation suppressor R-F). 12 tubes. Motor and manual tuning 5 meter F-selectivity control. Xtal filter. AVC phasing control, ANL, etc. Also furnishes video output for scope, panoramic output for scanning. Power requirements: 270V. at 135MA. In sealed cases..... J269...\$129.00



MICHIGAN CUSTOMERS ADD 3% SALES TAX—ITEMS OVER 5 LBS. SHIPPED EXPRESS COLLECT—ORDER BY CATALOG NUMBER

HERSHEL RADIO CO.

SEND FOR
FREE BULLETIN!
20% DEPOSIT

5249 GRAND RIVER, DETROIT 8, MICH.
SEND ENOUGH MONEY TO COVER POSTAGE AND HANDLING CHARGES—TERMS: F.O.B. DETROIT—MINIMUM ORDER \$2.00

HERSHEL HEADLINES!

**GREATER SAVINGS!
HIGHER QUALITY
MERCHANDISE!**

BK 22K RELAY



Used in conjunction with SCR 269-F. Changeover contains 29V., step relay, 5 deck, 6 position switch. 12V. D.P.S.T. J256...\$2.95

VARIABLE CONDENSER



6 gang—silver-plated. Sec No. 1 350 MMFD., Sec No. 2, 3, 4, 5, 60 MMFD., Sec No. 6 80 MMFD. J260... 89c

5 GANG VARIABLE CONDENSER



5 Gang, approx 50 MMFD. per section with individual air-tuned padders, 18 to 1 vernier drive J243...\$1.95

INTERPHONE AMPLIFIER BC 667

This equipment ideal for amplification of audio frequencies. Comes complete with 3 6V6GT tubes and 28V. dynamotor. Size: 9" x 9" x 5" J203...\$3.95



PYRANOL CAPACITOR



General Electric. 1 MFD. 5000 VDC. 4" x 4 1/2" x 3 3/4" J229 \$2.95

Thordarsen Plate Transformer



110 or 120V.—60 Cy. input; output 500V. ea. side of center, tapped at 400V., 180 MA. Cast iron case J206...\$4.95

BC 223-AX TRANSMITTER



Complete with tubes and tuning unit covering 80 meter ham band, including frequencies charts, less Xtals J255...\$12.50

ROTARY TAP SWITCHES



Kit of 12 switches J242...\$1.85

LIP MIKE



With head band and cord J230 95c

30 MC IF TRANSFORMER



Slugged tune...J237...29c

OVERLOAD RELAYS



Patter and Brumfield Relay 1, 5000 ohms, coil current 10 MA., Relay 2, 110V. 60 Cy. AC. coil S.P.D.T. J236...\$1.95



Containing 110 AC. relay, 3 miniature sockets with tube shields, 5 condensers, and 6 resistors. 3" x 5" x 1" J233...\$1.95

CHASSIS

Frequency METER

Xtal controlled check points. Frequency range 100-120 MC., including 5 tubes and Xtals. Operates from 110V 60 Cy. supply. Ideal precision instrument for high frequency measurement. Used, in good condition J268...\$24.50



Thordarsen 300MA



Thordarsen 300MA. power transformer — 110 or 120V. 60 Cy. input—secondary 500/ct/500, tapped at 400/400, extra bias winding 200/ct/100 at 50 MA. 18 lbs. J209...\$4.95

6MH 500MA 200 MFD AT 10V.



Pie wound on ceramic form J253...19c

Round can — 5/8" x 2" J231...14c

ICR TYPE HE



100W. bleeder consisting of 5 sections. 750 ohms, 23 ohms, 23 ohms, 3000 ohms, 7500 ohms, total — 11,269 ohms. J246 49c

COPPER WELD WIRE



3000 #18 feet J240...\$2.95

Paper Condenser



.05-.05-.05, 300 VDC. In round can approximately 1" x 1" J252...50c Doz.

T17 CARBON MIKE



Like new J235...89c

POWER TRANS.



Ideal filament transformer. 110V. 60 Cy. 220V. at 50 MA. 6.3V. at 1 amp. 6.3 at 2 amp. at 6.5 amps. 6" x 4 1/2" x 5". 11 lbs. J271...\$1.29

DISCHARGE RESISTOR



GE thyrite type SF, V. AC. DC. J245...95c

MICA CAPACITOR

.002 MFD., 3000 VDC. J241...49c

THORDARSEN CHOKE



10 Hy At 200MA.—shelled case J238...\$1.85

SCOPE TRANSFORMER



110V. Pri: 60 Cy. Sec: 4000V. at 10 MA. 6" x 4" x 3 1/2" J265 \$3.95

COLLINS FILTER CHOKE



6 HY. 150MA. DC. res. 100 ohms. Test V. 2500 J234 \$1.69

TRANSFORMER



Audio osc. transformer with output and feedback winding J244 95c

MATCHING TRANSFORMER



500 ohms to grid, hermetically sealed J251...69c

VOLTAGE REGULATOR



Carbon pile, magnetic type, coil current, 105 MA. load max. 5 amps. at 18.25V... J249...95c

CERAMIC INSULATORS

High voltage feed through J259 \$1 doz.



IF TRANS.



Mounted in aluminum shield can 1500 KC. with air trimmer, impedance coupled type. J275A... 95c

RHEOSTAT AIRCRAFT POWER

25 WATT



25 Ohms - 1 Amp Maximum J 282 69¢

RHEOSTAT AIRCRAFT POWER

50 WATT

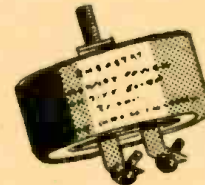

30 Ohms 1.7 Amps Maximum J 283 95¢

SCC NICHROME RESISTANCE WIRE



11.9 Ohms per ft: Wire Size 36 Average 1 1/2 to 2 lbs to a spool. J 281...\$1.49 spool

Electrolytic Condenser



32 MFD - 450 WVDC-Round Paper Covered Aluminum Can J 280.....95¢

MICHIGAN CUSTOMERS ADD 3% SALES TAX—ITEMS OVER 5 LBS. SHIPPED EXPRESS COLLECT—ORDER BY CATALOG NUMBER

HERSHEL RADIO CO.

**SEND FOR
FREE BULLETIN!
20% DEPOSIT**

5249 GRAND RIVER, DETROIT 8, MICH.

SEND ENOUGH MONEY TO COVER POSTAGE AND HANDLING CHARGES—TERMS: F.O.B. DETROIT—MINIMUM ORDER \$2.00

Coming new television developments...

IN the December, 1909, issue of my first magazine, *Modern Electrics*, I wrote an article: "Television and the Telephot." This was possibly the first time that the word *television* was used in any technical article.

The article began as follows:

The principle of television may be briefly stated thus: A simple instrument should be invented which would reproduce objects placed in front of a similar instrument (called Telephot) at the other end of the line. In simple language, it should be possible to connect two mirrors electrically, so that one would show whatever object is placed before the other and vice versa.

As in a mirror, the objects must be reproduced in motion (at the far-off station). The theory further requires that both instruments (one at each end) must be reversible, that is, each instrument must receive as well as transmit.

A good parallel of this requirement is found in the ordinary Bell telephone receiver. As is known, the Bell receiver (without the use of a microphone transmitter) will receive as well as transmit, that is, one can talk in a receiver and also hear the other party, using one and the same instrument.

In the Telephot it should be possible to see the party at the other end while that party should see you—both through the medium of your Telephot.

Unlike the mirror, however, you should not be able to see your own picture in your own Telephot. In this the Telephot differs from the mirror analogy.

The above was written 38 years ago. Since then television has made a great deal of progress, thanks to photoelectric cells and the cathode-ray tube, neither of which were known in 1909.

While television is with us today, much remains to be accomplished technically before it can become as universal an instrument as the present-day radio receiver. That this will be achieved in the foreseeable future, I do not doubt in the least.

As I see it, the obstacles in the way of television today are the following:

One of the major ones is the comparatively high present cost of television receivers. The ideal of a television receiver in every home in the U. S. requires a price range around \$75 to \$100 for the popular models. With mass production of telesets, this goal will probably be reached in less than 5 years.

Today, television manufacturers will throw up their hands in horror at such a price prediction—yet they know that if the American system of free broadcasting—advertising sponsored—is to prevail in television, as it does in broadcasting, then there must be a television audience in the tens of millions, against less than 150,000—our present audience.

Yet, the future looks exceedingly bright for television. Prices are coming down. New inventions, new processes, new ideas are appearing at an astonishing rate. American ingenuity is once again out in full force—soon the results will be apparent.

REVERSIBLE TELEVISION

By HUGO GERNSBACK

Take for instance the cathode-ray tube—the heart of the television receiver. A 20-inch tube costs \$150.00 today—just the tube alone. No wonder a big set costs over \$750. But the tube price will soon go down below \$25! The reason? Present-day tubes are made of costly Pyrex glass. The glass "bottle" alone costs \$75, F.O.B. the glass factory. But why use fragile glass?

Several laboratories are now hard at work on metal cathode-ray tubes, with a glass front for the viewing side. Not much is revealed about this development—it's still under thick wraps. But I do know that this single new improvement may well revolutionize television receivers in the near future.

Believe it or not, a \$5 seven-inch cathode-ray tube—now listing at \$30 to \$50—is on the horizon during the next few years.

So far no television receivers have been mass-produced. Our manufacturers are even now trying to perfect ways and means to streamline production. Remember, telesets are infinitely more difficult to assemble than ordinary radio sets. For one thing, a television set is in reality 2 sets, one for the video (the television part), the other the audio (the sound part).

But the video end—due to the high voltages employed as well as the high-frequency components—is much more difficult to assemble than a radio. Perhaps doing away entirely with present-day wiring assembly methods* will bring mass production and lower price levels.

While television in the home is now assured, let us not overlook other and just as important uses of the new art which are now evolving.

Let us turn back to my 1909 article, part of which was quoted at the beginning of this page. I said, "The theory (television) further requires that both instruments (one at each end) must be reversible, that is, each must receive as well as transmit."

In the 38 years of television progress, this condition has not been attained. (Continued on page 92)

*See RADIO-CRAFT, September, 1947, page 20.

TELEVISION PROGRAMS and telephone conversations are now being beamed from New York to Boston via microwave. The experimental radio relay system was formally opened by the Bell System on November 11.

The two terminal points of the radio relay system are the headquarters building of the American Telephone and Telegraph Company's Long Lines Department at 32 Avenue of the Americas in New York and the Bowdoin Square building of the New England Telephone and Telegraph Company at Boston.

Between terminal points, the microwave beam makes 8 jumps via 7 intermediate radio relay stations spaced about thirty miles apart. To secure the unobstructed view between antennas necessary in microwave transmission, the stations are built on hilltops: Jackie Jones Mountain, 5 miles west of Haverstraw, N. Y.; Birch Hill, about 3 miles south of Pawling, N. Y.; Spindle Hill, 5 miles north of Waterbury, Conn.; John Tom Hill, at Glastonbury, Conn.; Bald Hill, 5 miles east of Stafford Springs, Conn.; Asnebuskit Mountain, 5 miles northwest of Worcester, Mass.; and Bear Hill at Waltham, Mass.

On the roof of each radio relay station are 4 antennas, 2 facing along the route

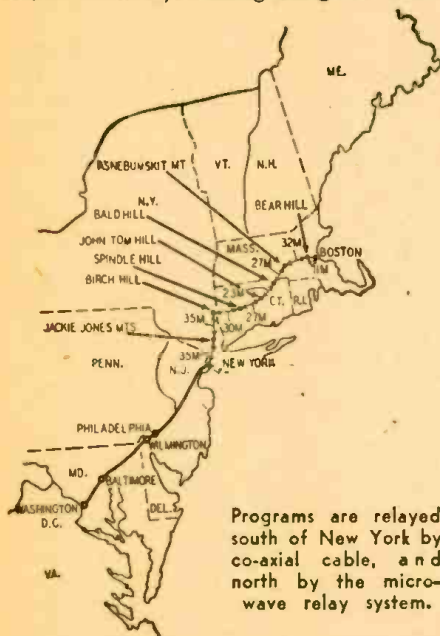

toward New York, 2 facing along the route toward Boston. This allows for 2-way operation—with one antenna of each pair for transmitting, the other for receiving. The antennas are ten feet square and incorporate a metal lens capable of focussing the microwave signals into a sharp beam.

The initial equipment comprises a regular and a spare circuit in each direction. For operation of these 2 circuits, frequencies in the range 3700 to 4200 megacycles have been assigned by the Federal Communications Commission. Each circuit carries a signal band width of about 5 megacycles.

Terminal equipment capable of carrying 240 simultaneous telephone conversations will be installed for experiment next spring, and it is expected that more channels will be added later.

RADIO-ELECTRONICS

SEAGOING TELEVISION became a fact last month with the installation of a receiver on the pilot boat *New Jersey*, which works out of New York Harbor. According to officials of the Radio Corporation of America, which made the installation, this is the first permanent marine installation. A television receiver was installed on the liner *President Roosevelt* in 1940, but that installation was strictly experimental.

It is expected that the televiser will be a great help to morale aboard the boat, where as many as 35 pilots may be waiting for assignment to incoming or outgoing ships. Good signals from all three New York stations were reported while the *New Jersey* was cruising off Ambrose Light, 20 miles from Manhattan.

TWELVE TELEVISION SETS in Chicago Catholic parishes, and television receivers in the church halls of the People's Church and the Faith Presbyterian Church have been installed, General Electric announced last month.

Primary purpose of the plan, according to Bishop Sheil of Chicago, is to make television reception of football games, hockey matches and similar programs available to young people under church auspices. Later the equipment may be used by adult groups.

TELEVISION EQUIPMENT was used for the first time in testing high-thrust rocket motors on the Pacific Coast, General Electric officials announced last month.

A television camera watched the rocket motor tests and sent its "eyewitness" report to observers comfortably seated in a conference room where they saw the operations on a viewing screen far removed from the test pits.

This is only one of many industrial applications where television should be of tremendous value because it will allow "closeup" study difficult and often impossible to obtain with other methods, stated C. A. Priest, manager of the G-E transmitter division at Electronics Park, pointing out that limitations of present methods of test viewing are manifold. Observation block houses restrict viewing to either the direct method through laminated safety

glass which becomes clouded from close-range effects of propellant fumes, or indirect method using mirrors which in addition to becoming clouded limit range of vision and introduce distortion.

The television method has many advantages. Safety is assured by the remoteness of the viewing operation, picture light intensity and definition are far superior to direct viewing through glass, and shock-proofed cameras can be mounted adjacent to the rocket unit for viewing intimate details. Other advantages of the television method are important to the test engineers. The close-up view provided by the television camera allows the engineers to detect in time to stop the test firing any evidence of fuel leaks or malfunctioning of the system which could result in an explosion and major damage to the rocket motor and its entire test setup. Continual observation of the rocket and exhaust flames during the firing period also enables the test engineers to note any irregularities in mixture ratio.

TABLE MODEL TELEVISERS will outsell consoles almost 2 to 1 during the next year, according to 64 New York dealers queried in a survey sponsored by Allen B. DuMont Laboratories.

According to the survey, table-top models are expected to account for 63.3% and consoles for 36.7% of total set sales. In the dealers' opinion, 57.2% of all television receivers sold during the next twelve months will have television only; 20.8% of the units sold will have television in combination with FM and AM; and 22% will have television with AM, FM, and phonograph.

Eighty-eight percent of the dealers in the survey noted that in making purchasing decisions, male customers have the most to say about the brand.



Television camera in place, ready to observe rocket motor in action.

MONTHLY REVIEW

RADAR may set off photo flashbulbs carried in planes, General Electric officials warned last month. G-E factories have accordingly been instructed to ship no more flashbulbs by air.

General Electric said recent experiments have established that the lamps, with the exception of the primer type, can be ignited by high-energy short-wave electro-magnetic radiation such as is encountered from radar transmitters.

John M. Chamberlain, Civil Aeronautics Board safety-bureau director, stated there was no indication as yet that small air-borne radar sets, like those that must be installed by Feb. 15 in all passenger planes, are likely to set off the bulbs. These sets are to be installed to give pilots information about terrain and to warn when planes come too close.

Presumably even large ground radar transmitters would be effective only over a range of a few feet.

RADAR PIONEER Sir Edward Appleton has been awarded the 1947 Nobel Prize in Physics. His researches have been of great direct importance to communications as well as radar.

A pioneer investigator of the ionosphere or "radio roof" surrounding the earth, Sir Edward proved by direct experiment the existence of the layer of ionized atoms 115 miles or so high, present both day and night, which reflects short radio waves at night.

His later work with radio reflections led directly to *radiolocation*, as radar was originally called in England, and his work was one of the underlying factors of Britain's early radar preparedness which was so decisive in the early stages of the last war.

The invisible reflecting layers of the ionosphere have been the subject of intensive research since their existence was proved. Today calculation of their

height is important in determining the best frequencies to use for radio communication over great distances.

FM POLICE RADIO installed in 150 patrol cars and other vehicles of the Brooklyn (N.Y.) police department gives that borough one of the largest 2-way police communications systems in the United States. RCA engineers, who made the installation, reported that the system also includes a 250-watt FM station transmitter, powerful enough to reach all parts of the borough.

The system provides for instantaneous 2-way communication between one or more cars and the dispatcher's office. Using the call letters WRQP, the station transmitter operates on a frequency of 39.58 megacycles, while the mobile transmitters operate on two different frequencies: 37.22 megacycles for the eastern, and 39.38 megacycles for the western part of the borough.

RADIO TRADE-IN allowances may be merely a cover for unethical trade practices, the Better Business Bureau warned last month. Dealers or even manufacturers may inflate list prices, then offer a trade-in allowance inflated to the same extent as the list price of the new equipment, thus falsely leading the buyer to believe he is receiving an exceptional bargain.

Kenneth B. Wilson, operating manager of the Bureau, pointed out as one of a number of examples, a case in which dealers in one large city offered a \$30 trade-in allowance on old radios to purchasers of a certain FM-AM radio-phono combination. The advertisement stated that there would be "no quibbling over age, make or condition" of the old radio. Just prior to that, the manufacturer of the FM-AM combination had advertised his set at a price \$30 over its former regular list price.

RADAR NAVIGATION may be hampered by archaic laws under which a radar-equipped vessel involved in a collision may be held liable for damages, Vincent A. Catoggio, New York marine lawyer, warned last month. The inland and international navigation rules, which were adopted in 1897, provide that a vessel shall slow down to "moderate speed" in a fog. "Moderate speed" has been interpreted by the courts to mean a speed that will permit a vessel to stop "within the limits of visibility."

Since one of the most important features of radar is that it permits greater speed in fog, this ruling would negate much of its value, unless courts would decide that the visibility of radar could be considered a substitute for the traditional "rule of sight."

CITIZENS RADIO will soon become an actuality with the help of printed circuits and new high-frequency tubes. A transceiver already tested and about to be put in production by Gross Electronics Co. operates on the 460-470 mc band. It was exhibited by its developer Al Gross, president of the company, at the recent printed-circuit symposium in Washington.

The radios will be sold in pairs tuned to their own private frequency within the 460-470 megacycle range, the Citizens Radio Band, thus reducing eavesdropping. Each set is a self-contained transmitter and receiver.

They will sell at less than \$200 a pair. Volume production eventually should bring the price down to about \$100.

Performance varies under different conditions. On ground level in the city, the equipment has operated satisfactorily for distances up to four miles. Tests made in various cities resulted in perfect reception over varied distances among city blocks. In a ground to plane test, it made good contact between Cleveland Airport and Sandusky, 60 miles away.

The transmitter and receiver of the civilian walkie-talkie weighs 11 ounces with antenna, is 6 inches long by about 3 inches wide by 1¼ inch thick. With batteries and leather case, the overall weight of each set is little more than two pounds.



Sir Edward Appleton at one of his pieces of technical equipment.

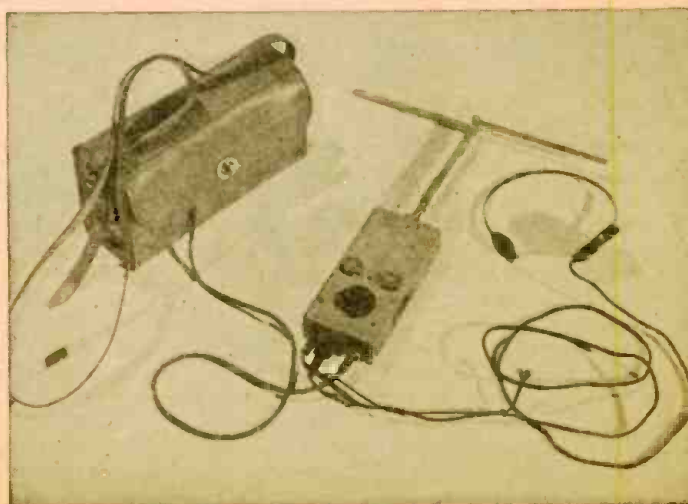

First of the Citizens Radios is this little two-pound transceiver.

Progress In Television



America's foremost television-inventor, pioneer and engineer reviews recent developments

By DR. VLADIMIR K. ZWORYKIN

Dr. Zworykin, shown holding the image orthicon, is one of the engineers whose work created the science of television. He is still pioneering in the television art, as well as in other advanced fields of radio and electronics.

THE end of the war emergency has seen the beginning of two developments in the television field in America. The first is utilization of the accumulated experience of the war and prewar years to create an extensive, high-quality television broadcasting service. The second is the application of television techniques to an ever-increasing number of peacetime industrial uses, a process which is bound to result eventually in further advances in broadcasting technique.

The first development is reflected in the increasing numbers of station-operating licenses issued by the Federal Communications Commission, the opening of new concentric cable and radio relay links between stations, heavy receiver production schedules, and the blossoming of the characteristic television dipole antennas over the landscape.

By midsummer of 1947 there were 12 television broadcasting stations in operation and a larger number under construction. Some 70,000 receivers had been installed. The tools of this television system are tried and tested. Following the same pattern of private sponsorship as American radio broadcasting, television programs provide black-and-white transmissions with a 525-line, interlaced scanning pattern. Electronic storage pickup tubes—in particular the *iconoscope* and the *image orthicon*—are employed both in the studio and for spot pickup. In the receivers, *kinescopes* serve to reproduce the image both for direct viewing and for screen

projection. These elements play a central role in most of the television equipment to be considered.

The most important common feature of the pickup tube under consideration, the storage principle, is illustrated in Fig. 1. The light image of the scene to be transmitted is projected on a photosensitive, insulating surface—the *target* or *mosaic*. This surface is capacitively coupled to a metal backing, the signal plate. The light image builds up, by photoemission, a charge image on the insulating surface. This charge image is scanned by an electron beam. As a particular picture element is scanned, the charge stored in the element by photoemission during the preceding picture period is released and provides the picture signal current from the signal plate behind the mosaic to the video amplifier input.

In the iconoscope the scanning beam has a velocity corresponding to an accelerating voltage of about 1,000. For this velocity the secondary-emission ratio of the photosensitive surface is much larger than unity. Accordingly the beam brings a scanned element to an equilibrium potential which is sufficiently positive with respect to neighboring collecting electrodes so that all secondary electrons but one per primary electron are forced to return to the element. Under such circumstances only a small fraction of the secondary electrons and photoelectrons emitted by the element reach the collecting (anode) coatings on the tube walls. A majority of those which are not returned to the ele-

ment of origin are redistributed over the remainder of the mosaic surface. This both reduces the efficiency of operation, and hence the sensitivity, of the pickup tube and distorts the charge image formed on the mosaic by photoemission. In practice, this distortion is rectified by the monitoring engineer by adding appropriate "shading signals" to the picture signal.

The orthicon—short for orthiconoscope or "true iconoscope"—remedies these drawbacks by reducing the velocity of the scanning beam on its approach to the target to such an extent that the secondary emission ratio of the latter falls below unity; the equilibrium potential of the target is now slightly below the potential of the cathode of the electron gun, and the beam deposits just enough electrons on the target to neutralize the positive charge stored by photoemission. The returning beam electrons, just like all the photoelectrons and secondary electrons emitted by the target surface, are collected by the anode.

Although the orthicon is, consequently, considerably more sensitive than the iconoscope, perfectly linear in its response to illumination, and free from spurious signals, it falls short of an ideal storage tube in two respects: (1) at very high light levels the tube operation becomes unstable, since the target may become sufficiently positive to pass over to its high-voltage equilibrium point under the scanning beam; (2) the signal level is still sufficiently low so that noise introduced by the first stage of the amplifier may impair the quality of the transmitted image.

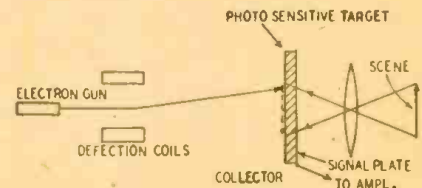

Fig. 1—The storage action of a pickup tube.

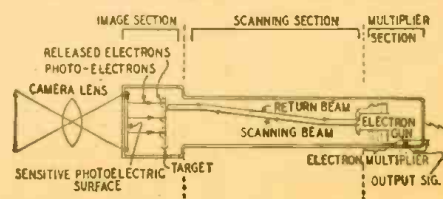

Fig. 2—How the image orthicon tube operates.

The image orthicon

In the image orthicon¹ (Fig. 2), the instability at high levels is removed by providing a target screen at a voltage only slightly above the equilibrium potential of the target to collect the electrons emitted by the latter. This makes it impossible for any portion of the target to become sufficiently positive to result in unstable operation. Furthermore, the signal level of the output is raised both by inserting an image tube section ahead of the target and employing a secondary-emission multiplier for the noise-free amplification of the signal current. The methods of beam focusing (by a longitudinal magnetic field) and of beam deflection (by superimposed transverse fields) are similar to those employed in the orthicon. They are designed to produce a low-velocity spot

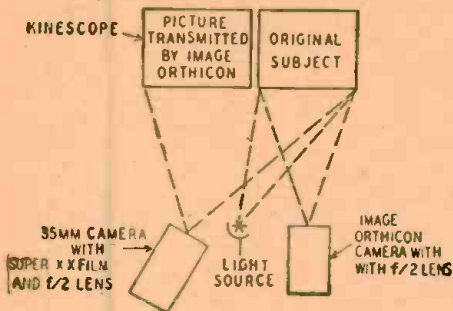

Fig. 4—Experiment on orthicon sensitivity.

which is sharply focused at all points of the target. Magnetic deflecting fields are employed throughout in the image orthicon, so that the beam electrons which fail to be deposited on positively charged portions of the target return along paths close to the incident beam to the area of the anode disk surrounding the beam-defining aperture. Here they eject secondary electrons. The electrostatic fields surrounding the anode disk are such that these secondary electrons are drawn over into the first stage of a "pin-wheel" secondary-emission multiplier which surrounds the gun structure. Repeated secondary-emission multiplica-

1. A. Rose, P. K. Weimer, and H. B. Law, "The Image Orthicon—A Sensitive Television Pickup Tube," *Proc. Inst. Radio Engrs.*, Vol. 34, pp. 424-432, 1947.



tion at the vanes of 5 successive pin-wheels results in a total gain from 200 to 500. The amplified return-beam current, representing the difference of the constant scanning-beam current and the variable picture-signal current, provides a high-level input for the succeeding video amplifier.

The formation of the charge image on the target presents some new features. The light image of the scene is projected on a transparent photocathode, which is maintained approximately 300 volts negative with respect to the target. The photoelectrons emitted as a result are accelerated and focused by the longitudinal magnetic field on the target, ejecting a multiplicity of secondary electrons. Picture elements of the target which correspond to bright portions of the image assume consequently a positive charge; the secondary electrons are drawn to a high-transmission, 20-40-mesh-per-millimeter, metal screen placed just in front of the target.

The target itself is a very thin, high-conductivity glass film, stretched on a metal frame. Although potential differences between its faces are substantially neutralized by conduction in the course of a frame time, leakage from picture element to picture element is too slight to result in an appreciable reduction in the contrast and resolution of the picture.

Fig. 5—Results of the experiment of Fig. 4.

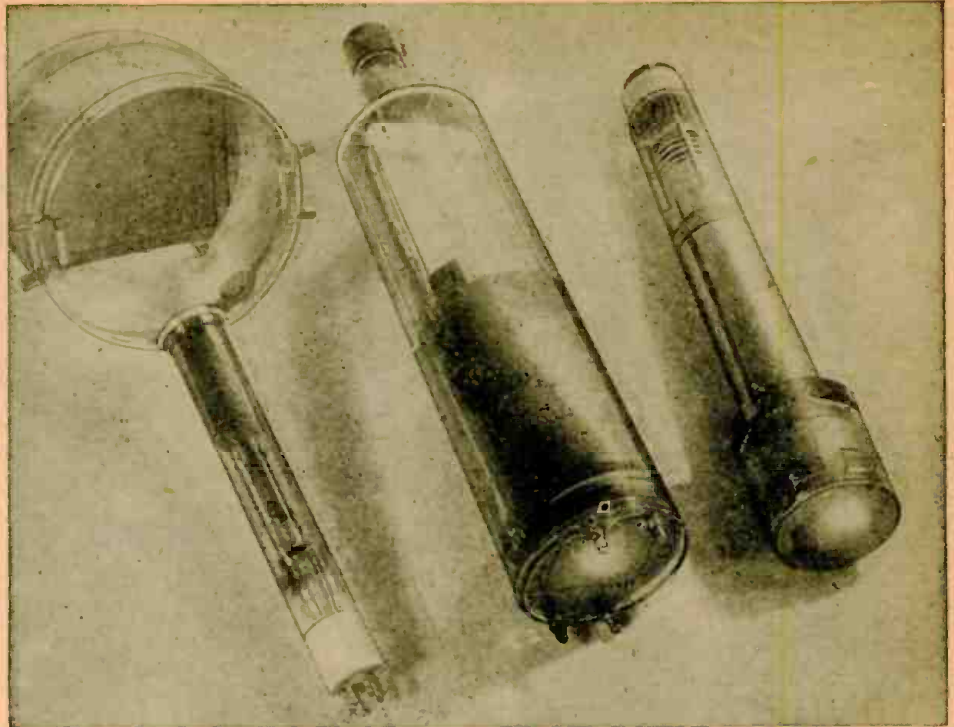

Fig. 3—Iconoscope, orthicon and image orthicon. Size decreases as sensitivity increases.

The relative dimensions and general structure of the 3 pickup tubes discussed are well brought out by Fig. 3. Increasing complexity of construction has not brought increase in bulk.

The extraordinary sensitivity of the image orthicon is illustrated by the experiment shown in Fig. 4. An image orthicon camera and a photographic camera employing high-sensitivity (Eastman Super-XX), 35-mm film were both trained on the same subject. A television

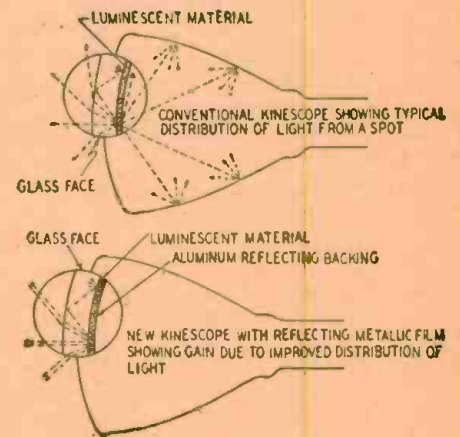

Fig. 6—Effect of aluminizing screen surface.

receiver connected to the image orthicon camera was placed next to the subject. Both cameras were provided with f/2 lenses and exposed for 1/30 second (corresponding to the standard television frame time). The result of attenuating the illumination provided by a 40-watt incandescent lamp with neutral filters is shown in Fig. 5. It is seen that the subject is recorded by both cameras only at the maximum subject brightness of 2 foot-lamberts or, approximately, 2 millilamberts. At the lower intensities only the television image remains, which is still readily recognizable when the il-

(Continued on following page)

lumination has been reduced to a hundredth of its original value.

The viewing tube, or kinescope, has undergone only minor changes in recent years. The most important of these have increased the image brightness of projected television pictures. Considerable gains have been recorded both in the light emission of the projection kinescopes themselves and in the efficiency of the optics employed to project the pictures.

Enhancement in the emission of the projection tubes has been achieved by depositing a thin metal film—transparent to the beam electrons but reflecting for light—over the surface of the luminescent screen. The optical effect of such a film on light emitted backward by the luminescent screen is indicated in Fig. 6. In a tube with an untreated screen this light, which is lost for the formation of the image, may in part reach other portions of the screen, reducing contrast. The metal film² both adds this light to that emitted in a forward direction and prevents this contrast reduction. An even more important factor with high-voltage operation is that the metal film, maintained at anode potential, prevents the screen from charging negatively.

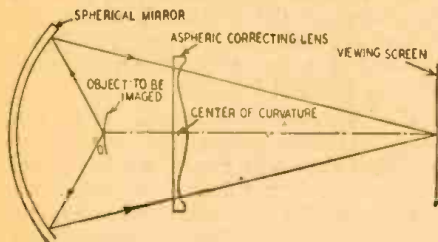

Fig. 7—Principle of Schmidt optical system.

Without such a film this charging process may reduce by a large factor the kinetic energy with which the electrons impinge on the screen so that the energy available for conversion into light is greatly decreased. A final advantage of the metal film is that it absorbs nega-

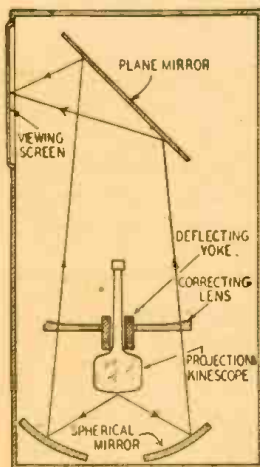

Fig. 8—Schmidt-type television projection set.

tive ions originating in the cathode region of the gun, preventing the appearance of "ion spot" without requiring special ion-trapping arrangements.

2. D. W. Epstein and L. Pensak, "Improved Cathode-Ray Tubes with Metal-Backed Luminescent Screens," *RCA Review*, Vol. 7, pp. 5-10, 1946.

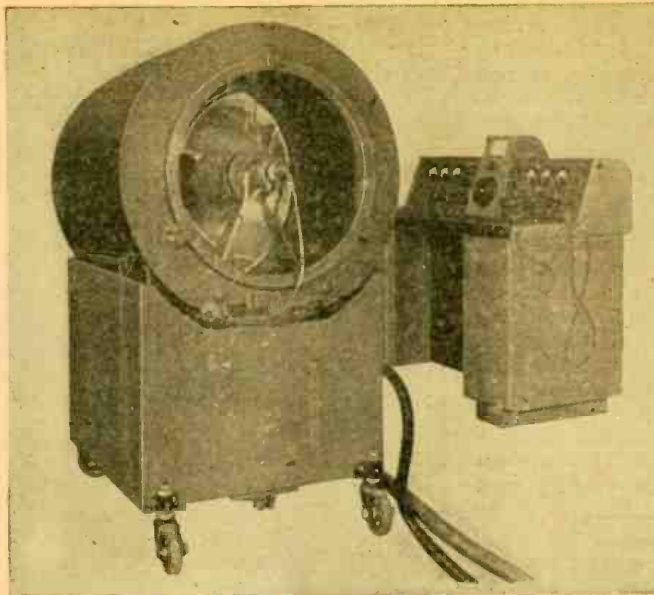

Fig. 9—Large projection televiser designed for 5 x 7-meter screen.

Reflective systems

The substitution of reflective projection systems with aspheric correction for the conventional projection lenses has led to gains by a factor from 5 to 7 in the optical efficiency of projection systems.³ The principle of the new optical system is shown in Fig. 7. The television image formed on a curved kinescope face is projected by a concentric spherical mirror on the viewing screen. Such a system is spherically symmetrical about the common center of curvature of mirror and tube face, and hence provides an image field free from optical defects apart from spherical aberration. If the latter is corrected by placing a weak aspheric lens at the center of curvature, there results a wide-angle, large-aperture system free from all lower-order optical defects. The preparation of the aspheric lens, it is true, presents a difficult mechanical problem. However, a plastic molding technique makes it possible to prepare large numbers of such lenses from a single steel master. This procedure has rendered it economically feasible to employ reflective projection systems in home receivers, arranged as shown in Fig. 8. The image on the tube is projected upward and deflected by a 45° mirror onto a vertical directional viewing screen. The optical efficiencies of such systems have been found to range from 18 to 35%, as compared to 4-5% for an f-2 projection lens. Fig. 9 shows an earlier television projector operating on the same principle, but designed to cover a motion picture theater screen 5x7 meters in dimension.

The equipment described so far primarily finds application in current television broadcasting and reception. However, its utility is by no means limited to broadcast television. Numerous other uses may be conveniently grouped under the heading "industrial television."

Many other uses for television

An application of obvious importance

3. D. W. Epstein and I. G. Maloff, "Projection Television," *J. Soc. Motion Picture Engrs.*, Vol. 44, pp. 443-455, 1945.

is the employment of television equipment to observe industrial processes which are either inaccessible or dangerous to human beings; the Bikini atomic bomb observations are a relevant example. Other uses are deep-sea observations and the surveillance of boilers in power plants. A similar type of application is the watching of a series of widely separated, automatic substations from a conveniently located central point. Here television

enables one individual to observe simultaneously events taking place at widely separated points. The converse problem, of permitting a group of individuals, too large for direct viewing, to observe the same point is met not only in broadcast television, but also in department stores, to let customers view fashion exhibits at widely separated sections of the store; at conventions, to permit an overflow audience to watch the proceedings; and, perhaps most significantly, in medicine, to give consulting and visiting physicians an



Fig. 10—Television camera at Johns Hopkins.

intimate view of an operation without interfering with its progress. Fig. 10 shows a television camera suspended for this purpose directly above the operating table in an operating room of the Johns Hopkins University Hospital.

Television techniques also find valuable application in fields which, at first sight, seem only very remotely related. One of these is projection microscopy. Many years ago the ultra-violet and infra-red sensitivities of the iconoscope and the image tube were utilized to per-

(Continued on page 127)

1948 Televiser Parade



Emerson table model teleaset has 52 sq. in. image. Tunes in all TV channels.



RCA television FM-AM-phonograph console; 52 square inch image; automatic record changer.

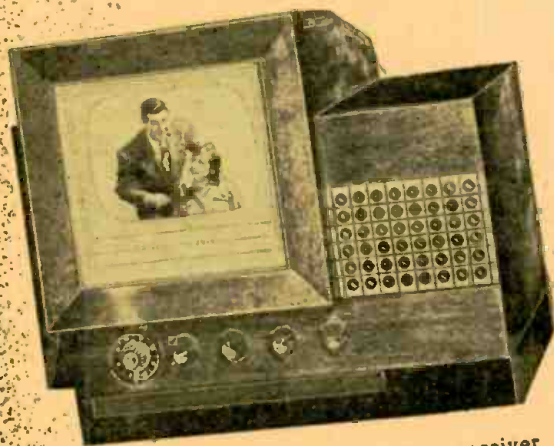

Philco table model television receiver with 10-inch tube, has 54 square inch image.



Garod receiver with 10-inch tube. Provides AM and FM reception; has automatic record changer.

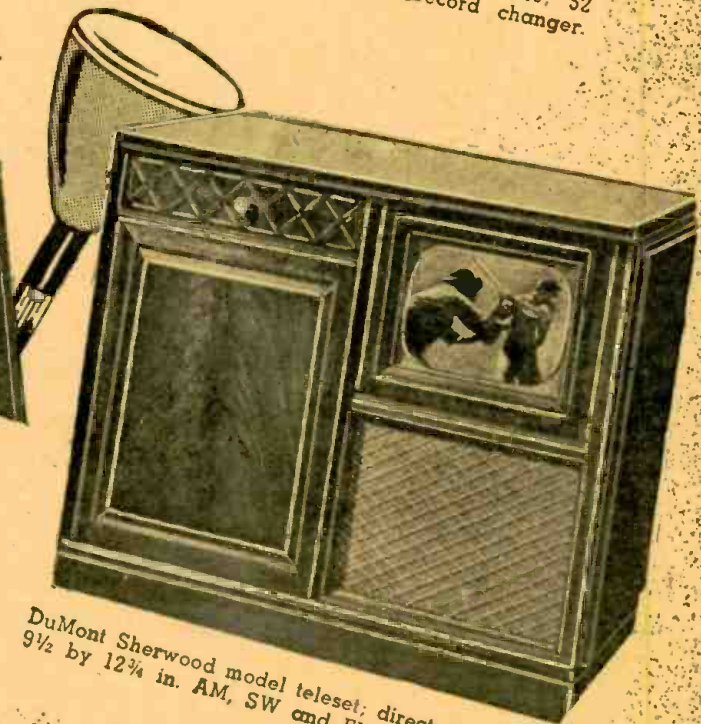

DuMont Sherwood model teleaset; direct-view image 9 1/2 by 12 3/4 in. AM, SW and FM; record changer.

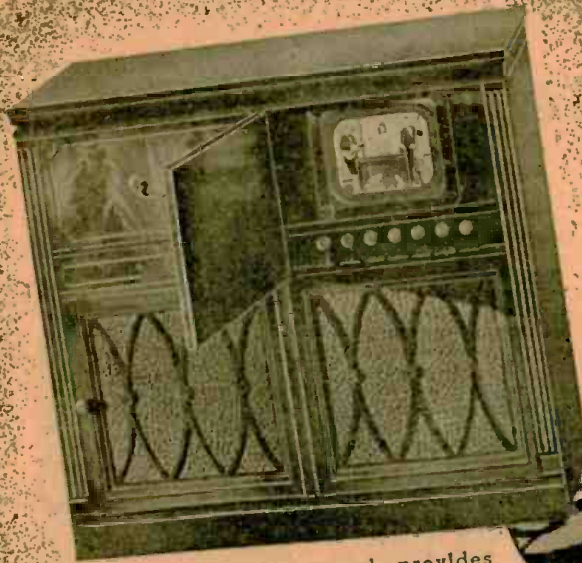

Bendix television console provides AM-FM reception and phonograph.

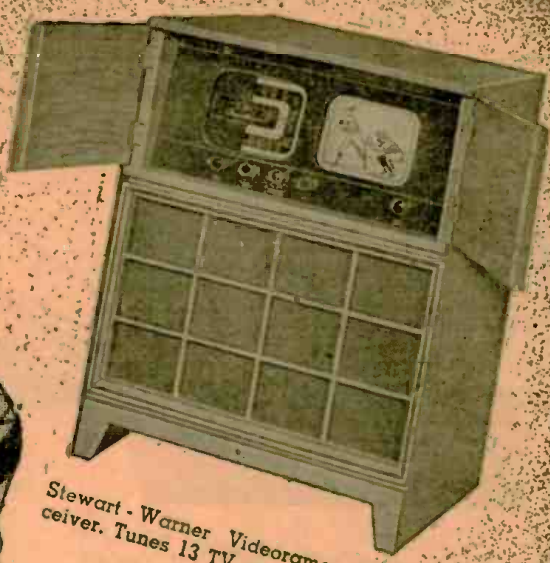

Stewart-Warner Videorama TV receiver. Tunes 13 TV and BC channels.

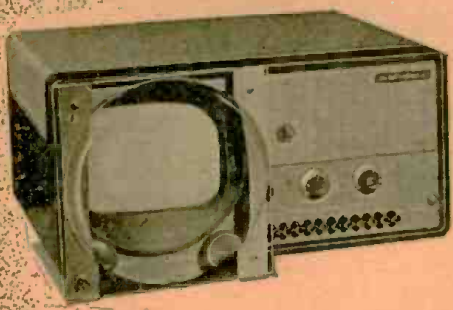

Left—Hallicrafters table model TV set has 7-inch image. 13-channel push-button tuning. Has gray and silver metal cabinet. Right—Espy TV3K television table receiver presents an extremely neat appearance.



General Electric model 802 TV set is a direct-view AM-FM and phono console. Image 48 sq. in.

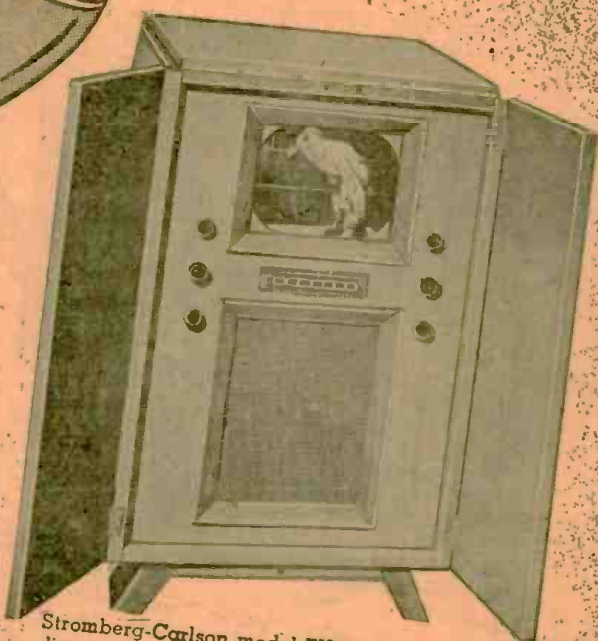

Stromberg-Carlson model TV10L set has 10-inch direct view image. Seven channel, motor tuning.

Remington 12-inch tube television receiver, covers all FM channels. Another model has 15-inch tube.



United States Television large screen (19 by 25 inches) TV set; intended for public places.

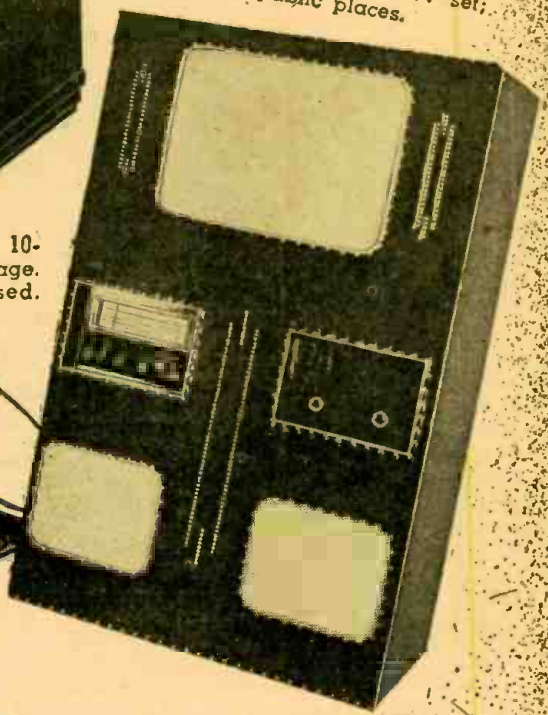

Farnsworth table model has 10-inch tube, 52-square-inch image. An AM adapter can be used.

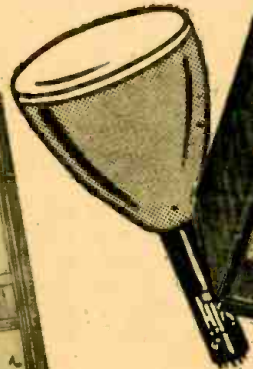
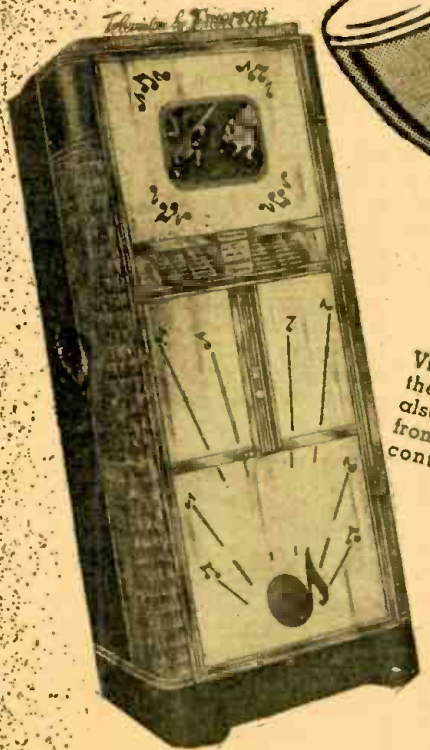
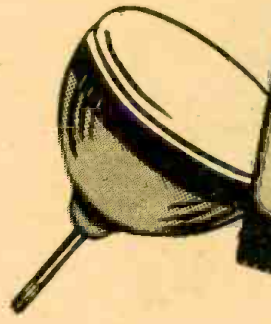

Belmont table set with 7-inch picture tube. Covers all 13 TV channels and employs 21 tubes. Provides FM reception. The cabinet measures 14 1/2 by 21 by 16 inches.

Videograph-Emerson coin-in-the-slot television receiver - also supplies music and song from phonograph records. Table control is also available.

Transvision 12-inch tube television "Kit" set. Picture size 75 sq. in. Factory-tuned R.F. unit. All TV channels covered. 22 tubes. Home assembly.

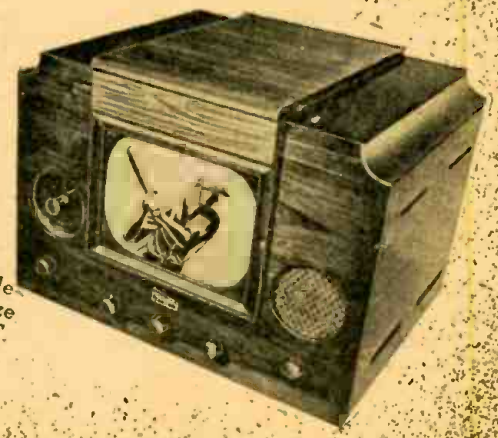

Nation-Wide Television

is now

in the Making

By DR. ALLEN B. DU MONT



Allen B. Du Mont is a television pioneer largely responsible for the commercialization of the cathode-ray tube and oscilloscope and president of the Allen B. Du Mont Labs., Inc., manufacturers of television receivers and transmitters, cathode-ray tubes, and oscilloscopes; owners of Du Mont network with Du Mont-John Wanamaker studios and Stations WABD (New York) and WTTG (Washington).

SOONER or later, and probably sooner than generally expected, it will be immaterial whether you live in New York or Pumpkin Center so far as satisfactory television entertainment is concerned. For in due course television will become nationwide. Smaller cities and rural areas will have their local telecasting services. Topflight television programs originating in leading centers will be piped to dozens and later hundreds of telecasting stations dotting this nation from coast to coast, following in the footsteps of the great broadcasting networks. Nationwide telecasting will spell nation-wide sale of television receivers. Realization of that dream is already in the making.

That the commercialization of television has been slow, no one can deny. The end of 1947 still saw telecasting services concentrated in a mere handful of leading centers—New York, Philadelphia, Washington, Schenectady-Albany, Chicago, St. Louis, Los Angeles, Detroit, and Cleveland. Fifteen stations were operating in those metropolitan areas. However, 56 more telecasting stations were authorized and under construction, so that a total of 41 cities and areas should shortly be enjoying visual programs.

Meanwhile, at the receiving end, there were less than 10,000 television sets in

soldering irons and delicate connections. Between 125,000 and 150,000 sets were built and delivered last year, plus an unknown number of miscellaneous kit-assembled receivers as well as receivers put together by local custom-set builders. Therefore we can accept the fact that 1947 definitely dates the birth of *commercialized* as distinguished from *experimental* television. From here on we can expect rapid expansion and extension. Television is at last on its way!

So far, television has been concentrated in the 6 metropolitan areas chosen by the pioneer telecasters—New York, Philadelphia, Washington, Schenectady-Albany, Chicago, and Los Angeles—plus the newcomers in Detroit, St. Louis, and Cleveland just starting on their telecasting career. It is particularly significant that 79% of television set production in 1947 went into the New York metropolitan area, leaving only minor allotments to other areas already enjoying telecasting service. This means that even the enormous increase in production anticipated for 1948—perhaps topping a million units if general business conditions remain good—will still fall far short of meeting the demands of the old and new telecasting areas.

The telecasting range

That leading metropolitan areas will continue to forge ahead with their tele-

use at the start of 1947. The majority were rendering yeoman service in bars and grills, restaurants and clubs, and in other public places, while the homes boasting television entertainment were to all intents and purposes public places too, so far as immediate neighbors and friends were concerned. But during the year the leading manufacturers got their production lines rolling. Deft-fingered girls took the place of clumsier males in wielding screw drivers and wrenches, pliers and wire strippers,

casting stations goes without saying. Broadcasters, newspapers, department stores, theatrical interests, and others are willing and ready to step in with telecasting services as and when the proposition looks like a money-maker.

Until recently, however, limited service range was taken for granted. The would-be telecaster figured on a reliable coverage of 25 miles radius, and perhaps another 25 miles thrown in for good measure. Potential audiences were figured within such concentric circles. The economics of station investment, operation, and anticipated returns were worked out on that basis. Television engineers themselves were insistent that, given an elevation of around 500 feet for the transmitting antenna to dominate the surrounding terrain, 25 to 50 miles was good coverage. The city folks and those in the suburbs could take satisfactory television service for granted. But rural areas were quite apt to be out of luck. Perhaps television was not for them.

Fortunately, more recent telecast experiences have broadened the horizons. The 3 telecasting stations in New York City—WNBT (National Broadcasting) atop the Empire State Tower, with about a 1,300-foot elevation; WCBW (Columbia Broadcasting) atop the Chrysler Building, 950-foot elevation; and WABD (Du Mont) atop 515 Madison Avenue, 700-foot elevation—are being received as a regular thing at distances up to 75 miles and beyond. Thus an enormous rural area about this great city is covered by television programs.

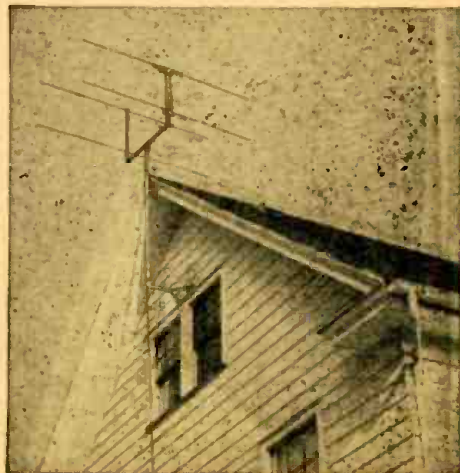

Two-deck television antenna with reflector, commonly used in remote receiving locations.

Better aeri- als, as well as television receivers of higher sensitivity, have increased telecast coverage. At the transmitting end, improved antennas such as the bat-wing turnstile have been introduced, beaming the radiated signal in the horizontal plane instead of dissipating it into the sky where it can do little or no good so far as the remote television receiver is concerned.

By such concentration, the new transmitting aeri- als are now stepping up radiated power gain from 3 to over 9 times by actual measurement. In other words, a 5-kw transmitter now has the effective signal strength of an earlier 15- to 45-kw transmitter. Such tremendous gain is reflected in higher signal strength at the receiving aerial, which in turn provides brighter, better contrasted images, and good sound reproduction, especially at remote points.

Meanwhile, considerable progress is being made with receiving aeri- als. The earlier simple dipole with or without reflector is making way for stacked dipoles and even an impressive array of dipoles of different sizes to cover television and FM bands from the lowest to the highest frequencies—44 to 216 megacycles. Some aeri- als are masterpieces of pipe-fitting, far more conspicuous than the conventional dwelling that supports them.

More care is being taken with transmission lines, especially the matching of impedances of line and set input, for minimized losses. In Du Mont receiver installations, the Cosgrove folded dipole with supplementary members or "horns" has proven satisfactory in covering all television and FM bands in most localities, although some of the more elaborate stacked dipoles and reflectors of assorted sizes will doubtless be required in stretching telecasting coverage beyond our customary service ranges.

Dr. Thomas T. Goldsmith, Director of Research for the Du Mont Laboratories, and the writer, occasionally accompanied by others interested in such studies, have done considerable work in long-distance television reception. The author's Chrysler sedan has been equipped with a gasoline-driven a.c. generator, collapsible pipe mast, and various aerial rigs, as well as a standard television receiver, to make receiving tests at re-



All New York City's television stations were picked up in the Catskills with this antenna.

ote points. The New York television stations have been received in the Catskills and the Poconos, at Montauk Point on the end of Long Island, and at Atlantic City, or over distances considerably beyond 75 miles. Various types of dipoles have been tried, as well as rhombic antennas which, while requiring more space than can be provided in crowded localities, compensate for such handicaps by requiring relatively little elevation. Some of the results of these long-distance television reception experiments will soon be released.

Some distance from the nearest movie theater, away from the numerous distractions of the city, with plenty of evening time to spare, certainly the rural family is the ideal television audience. And television engineers intend to include that group in the metropolitan area of television.

The remoter areas

But what of the small town—the secondary city—the trading center which means so much to the surrounding rural area but does not rate among the so-called metropolitan centers? Will television come to these spots, too?

Until this past year, the telecasting investment was considered well up in the six figures—and we mean all dollars and no cents. We talked glibly of a quarter to half a million dollars for a telecast transmitter and associated equipment. That's a lot of money. So much that only monied individuals or organizations could even think of going into the telecasting business, and then only in leading metropolitan areas with large populations to justify the program sponsor's money.

Yet there are a dozen or more small towns and secondary areas for every leading city and primary metropolitan area. The writer's organization soon sensed this situation when approached by individuals and organizations from small centers who had some money to invest but not the sums being talked about for large cities. Quite evidently this telecasting proposition had to be cut down to the right size for the smaller telecasters. So the engineers got to work boiling down telecasting equipment until the irreducible minimum was attained for satisfactory telecasting service over a range of 15 to perhaps 50 miles, depending on transmitting antenna height and the nature of the surrounding terrain.

Such a boiled-down telecasting setup has been developed by the writer's organization. At a total investment well under \$100,000, including all essential camera, movie pickup, control, audio, lighting, transmitting, high-efficiency antenna and tower, and even test equipment, the telecaster is soon ready for business. The 2 image orthicon cameras are used for studio live-talent pickups, movie pickups, and outside work. The 500-watt video and 250-watt audio transmitters provide adequate coverage at the start, and can be added to later by way of r.f. amplifiers, ultimately attaining a dual transmitter of 5-kw video and 2.5-kw audio rating, or even higher.

Here at last is basic gear. The small telecaster can get on the air. The investment is kept at a minimum while the commercial angle is being worked out over the first year or two. Video programs can be placed on the air while local folks install their television receivers. As the audience grows, the telecaster can step up his transmitting and studio facilities with a minimum of obsolescence. The whole scheme makes for a sound economic balance. Certainly the basic television gear, as exemplified by this Du Mont television package and corresponding offerings of RCA, G-E, and other builders of equipment, is attracting widespread attention and will soon be opening up many areas that otherwise would be passed over by telecasters.

The program problem

So far, we have discussed getting satisfactory television signals to large and small cities, urban and rural areas, near and remote locations, alike. But what about the programs such signals will carry? *After all, it's the show that counts.*

Television productions are relatively costly. Live-talent studio presentations, to be worthy of a real audience, call for skilled performers, writers, directors and scenery artists in front of the camera, and for cameramen, control-room operators, microphone-boom, dolly and lighting attendants, and others behind it. Television shows call for actors who can memorize their lines. Obviously,

(Continued on page 136)

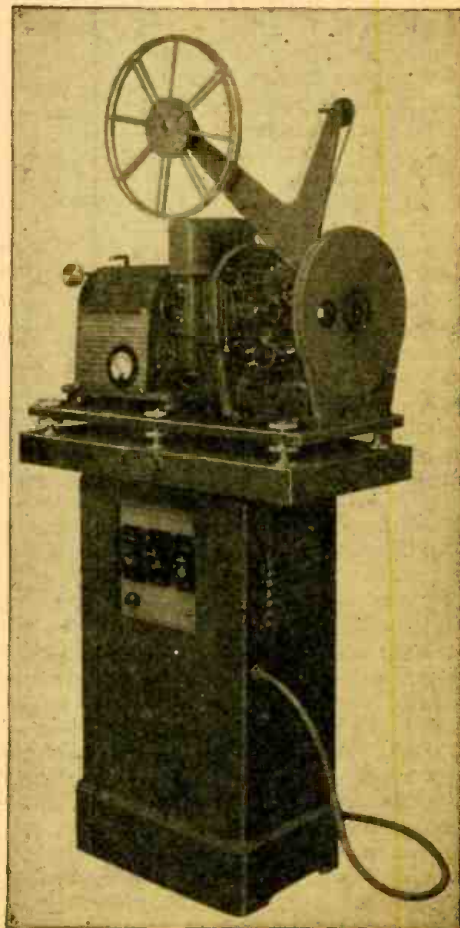

A movie machine designed to project images which are picked up by a television camera.

Filters Aid Television

Transparent films improve contrast of television images in lighted rooms

By Dr. THOMAS T. GOLDSMITH, Jr.*

A SHEET of semitransparent material placed in front of a television cathode-ray tube improves the viewing conditions for the picture under many circumstances. Such a sheet of material is frequently called a *neutral-density filter*. This filter may take, for example, the form of a thin sheet of plastic in which a pigment material has been added to give the effect of smoked glass. The amount of pigment determines the density of such a screen and thus controls the amount of light which can be transmitted through it.

If the receiver is in a well-lighted room, the presence of the filter may definitely enhance the contrast range of the picture. In other words, the dark portions of the picture appear darker when the filter is used than they would if the filter were removed and the room illumination were allowed to fall directly on the screen. The filter absorbs much of this room light and prevents its striking the screen with full intensity. Accordingly, the light coming from the cathode-ray tube reaches the eye of the observer under more nearly the conditions which would occur in a darkened room.

Let us now define that light which comes from the cathode-ray tube fluorescence as the *television light*. Then we can define the surrounding room illumination as *ambient light*. Thus we have *television light* and *ambient light* to consider. In a completely darkened room, only the television light is of consequence and a picture will appear to have good contrast range. However, it is not desirable to use a television receiver in a fully darkened room because under dark-room conditions the human eye tends to change its iris opening quickly in accordance with the light changes in the television picture. This causes considerable eye fatigue. In a reasonably lighted room the eye remains partially stopped-down because of the presence of ambient light, and the picture can still be seen to good advantage with the

brightness available from modern cathode-ray tubes.

A picture from a direct-viewing television receiver is quite acceptable in a reasonably lighted room even without a neutral filter. However, in some cases, the location of lamps in a room causes light to fall directly on the face of the

A filter having the characteristic of transmitting approximately 10% of the light which falls on it is quite suitable for television performance. Under some conditions, a less dense filter which (for example) passes 30% of the light may be used. Usually it is preferable to employ in a neutral filter a pigment which

has a colorless grey appearance and which uniformly attenuates light of all colors. In this way the actual color of the fluorescent screen is not materially changed. Some people prefer a slight tint for the filter, to give the picture a soft green, soft blue, or soft rose effect. We might say that the viewer is looking at television through "rose-colored glasses."

Neutral filters have been used widely in the optical industry for many years. They were discussed very intensively in connection with color television, and have been used quite successfully for enhancement of black-and-white television outdoor installations. The pictures have considerably improved contrast when viewed in sunlight. It is desirable for the filter to have sufficient mechanical

strength to withstand wind and weather. It may be incorporated directly in the glass as a pigment or may be attached permanently to the glass surface either inside of the tube or on its outside surface. However, under some conditions it is desirable to make such a filter optional, and then a detachable separate sheet of filter material is found to be more desirable.

A cathode-ray television tube generally appears white in the presence of room illumination even before the video signal produces further light. The neutral filter in effect allows the screen to appear more nearly black. The fluorescent light increases the whiteness to produce highly contrasting pictures. Thus we can say that a black-face cathode-ray tube would be the most ideal reproducer. The neutral filter approaches this condition and is thus a useful aid for television reception which may well come into general use.

THIS MONTH'S COVER

This month's cover was one of the most difficult subjects we have tackled in many years. It is of the type called an INFINITE picture, one picture within another AD INFINITUM.

Here we see Powers' model Dorothy Sparkman, holding the largest commercially made television tube, which measures 20 inches in diameter. Her right hand holds the smallest practical television tube, which measures 3 inches in diameter. The identical picture appears on both the small and the large tubes.

To show the visual effect of the various colored filters, as explained in Dr. Goldsmith's adjoining article, a hand was posed in front of the large television tube with 4 different colored filters. The colors used would depend to some extent on the tastes of the viewer and the predominant tone of room decorations.

It should be understood distinctly that no attempt is made here to show color television, which so far has not been achieved commercially. To understand better how the colored filters work, the adjoining article should be read.

How was this cover made? Perhaps you can puzzle it out for yourself. It is believed that this is the first time a cover of this type was made for a technical publication.

—H. GERNSBACK

cathode-ray tube from the lamps or by reflection from walls or furniture. Under these conditions, the neutral filter improves the appearance of the picture. The ambient light passes through the filter and strikes the fluorescent surface of the cathode-ray tube. The light is then scattered from the white fluorescent screen and returns through the neutral filter to the eye of the observer. Thus the ambient light has passed twice through the neutral filter and is considerably weakened. On the other hand, the television light starts at the fluorescent screen and passes *only once* through the neutral filter. In this way the picture appears crisper and with more contrast between blacks and whites than would be the case without the filter.

The absolute brightness of the television picture is reduced by the presence of the filter, but improved contrast obtained by partial exclusion of ambient light more than offsets this loss of brightness.

*Director of Research, Allen B. Du Mont Laboratories, Inc.

TELEVISION EQUIPMENT



Fig. 1 (left) - Du Mont Image Orthicon Control and Monitor used to compensate for differences in scene brightness. Fig. 2 (below) - RCA Visual Monitor Converter.



Fig. 3 - "Big Dishes" for microwave television relay. Devised by General Electric Co. engineers for reflecting television signals between relay stations.



Fig. 4 - Another G.E. television idea - the "chicken brooder" antenna for picking up programs from mobile units. 16 times better than simple dipole.



Fig. 5 - A streamlined 56 lb. television camera devised by General Electric suitable for studio or outdoor pickup. Has 3 lenses and mobile dolly.

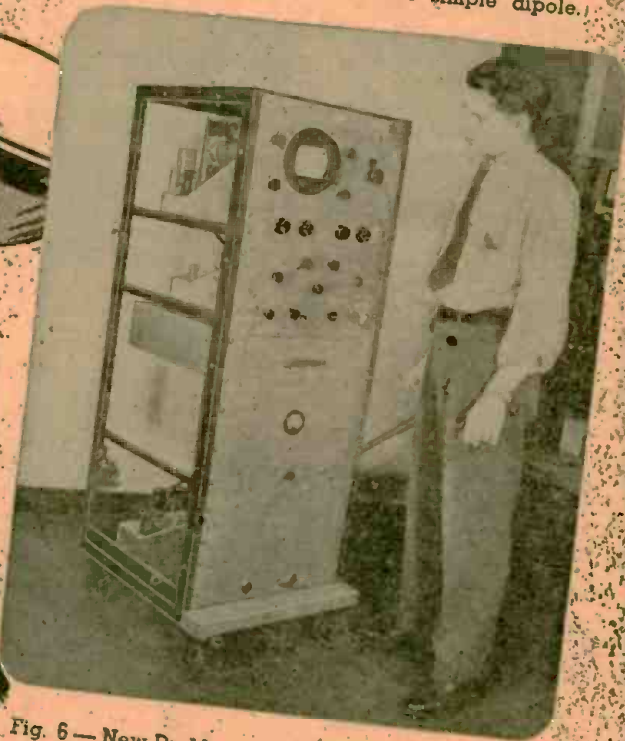

Fig. 6 - New Du Mont oscillograph facilitates television wave form studies. Analyzes image down to a line and shows duration and wave shape.

TELEVISION EQUIPMENT

(continued)

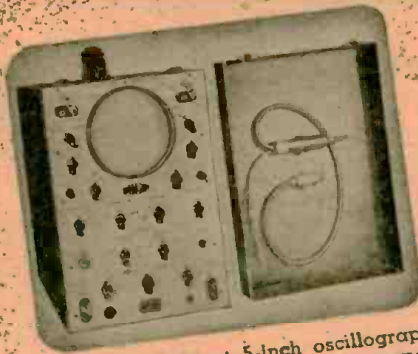

Fig. 7—DuMont 5-inch oscillograph for observing audio and video frequency signals, including pulses and square waves.



Fig. 10—Large 20-inch DuMont television tube with magnetic deflection and focus. Face curvature radius 30 inches. Picture area 12 $\frac{7}{8}$ by 17 $\frac{1}{4}$ inches. For large screen, direct-viewing teletests.

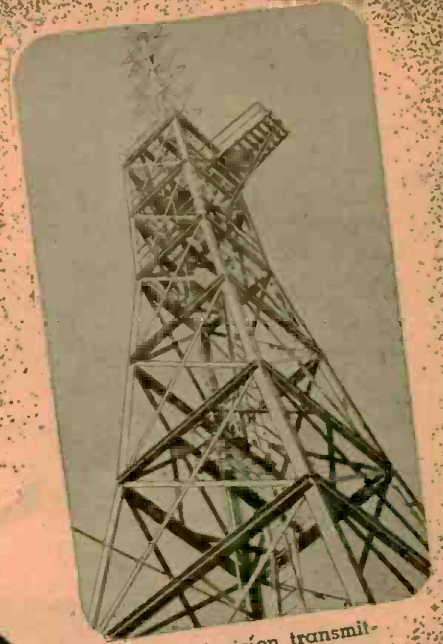

Fig. 11—Television transmitting antenna of DuMont station WABD, in New York City.



Fig. 8—Studio control console at DuMont television station WABD in New York Wanamaker store.

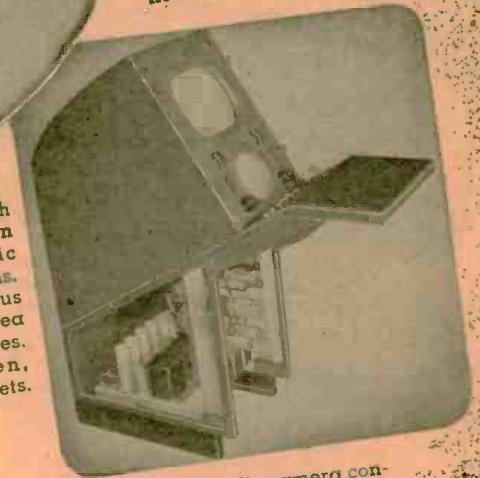

Fig. 12—RCA studio camera control—permits operator to monitor quality of picture signal.



Fig. 9—RCA mobile television truck, equipped with reflector for relaying signals to pickup station.



Fig. 13—5 kw 12-channel RCA image and sound television transmitter. Control desk in foreground.

TELEVISION IS HERE—

WHAT NOW?

By LOUIS GERARD PACENT

IN MARCH, 1931, I wrote in an article for Hugo Gernsback's *Television News*, Volume 1, Number 1, that television was *not* just around the corner, in contradiction to the opinion of many in the industry, and the then enthusiastic publicity. History speaks for itself; there is no need to comment further on that article.

Now 16 years later, thanks to accelerated war radar research, television is really here, but *what now?*

While it is true that many are buying television sets, and most restaurants and bars in television centers like New York and Philadelphia provide television for their patrons, something must be done to put television on a proper foundation before the general public will buy for home use.

The chief difficulty in the way of making television a mass means of entertainment is the *cost* of television receivers. When a televiser made to sell at \$400 or so is called a "cheap" model, and average receivers sell at \$1,000 to \$2,500, there is no reasonable hope that a majority of medium-income families will install one in the near future. The price of receivers *must come down* if the number of television homes is to go up at the tempo it should.

The cost of cathode-ray tubes for replacement should be considered, too. When the owner of a televiser finds he has to pay from \$50 to \$150 or more for a new viewing tube, his enthusiasm for television may get a bad blow.

The present small-screen models cannot fill the need for low-priced television entertainment. The more television I see, the more I am convinced that *entertainment begins with the large screen*. Despite the improvements in brightness achieved on small-screen sets, a greater amount of concentration is necessary to view a program than on large-screen receivers. Entertainment requires relaxation—a chance to lean back and watch the show, not lean forward and concentrate on the screen. (With the present size of television audiences, there is a second point in favor of the large screen. It relieves the spectator of the necessity of craning his neck to watch the program over the shoulder of some other member of the group.) *The future of television is tied up with the large-screen receiver.*

A program for television

Unless the following is done without delay, television will not be, in my judgment, on an equal footing with sound broadcasting:

1. Group all the television transmitters of a given locality on *one tower* high enough to serve an area 90 miles in radius.
2. *Increase the output power* to 50 or 100 kilowatts.
3. Design a *master television receiving set antenna* for apartment-house installations.
4. *Lower the cost* of television receivers.
5. *Increase the size* of the television screen to 18 x 24 inches at reasonable prices.
6. Design *compact projection-type receivers* with simple inexpensive television tubes and optical systems.
7. *Lower the replacement cost* of television tubes.
8. *Improve programs.*

To some, these suggestions may sound

impossible of realization for many years, but they are in the cards. With concerted action by the industry they can be made a reality in time to save this gigantic business, destined to grow into one of the biggest of the new postwar industries, from a serious temporary downfall toward which it will surely head otherwise. Engineering thinking, without too much promotion, will be needed before we have the service and the product at a price the public expects and demands.

The great number of engineers, scientists, and technicians who are out of the government services, and who are now devoting their knowledge to electronics and particularly to radar and television problems, can and will help greatly to solve the problems facing the television industry.

LOUIS GERARD PACENT

Mr. Pacent is one of the earliest pioneers of electrical and radio communication. Since 1910 he has been actively engaged in the radio and electronic engineering fields and was one of the pioneer radio manufacturers, a designer of the all-powered sound motion picture equipment and the holder of many patents on electronic devices.

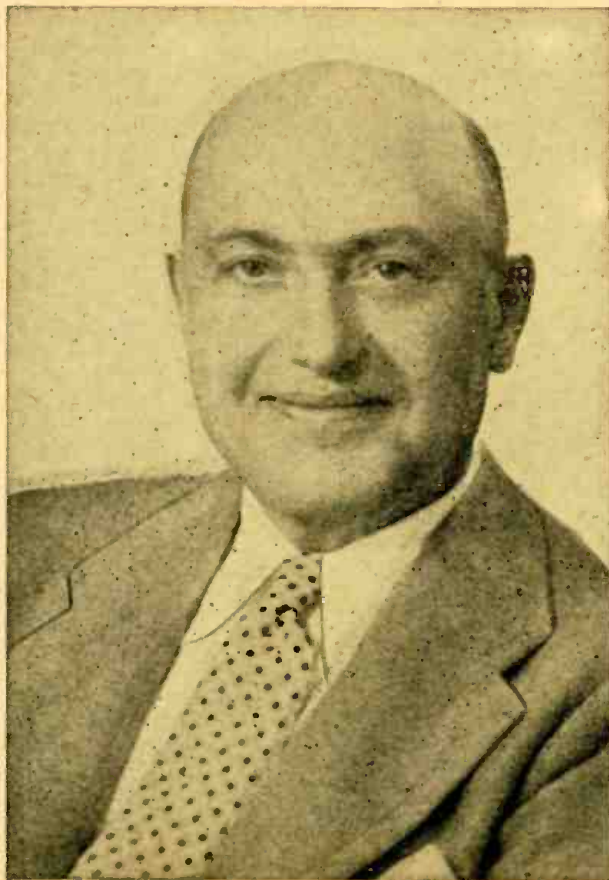

Mr. Pacent is a Fellow of the American Institute of Electrical Engineers; Fellow of the Institute of Radio Engineers; Fellow of the Society of Motion Picture Engineers; Fellow and Past President of the Radio Club of America; Member of the Acoustical Club of America; Member of the Board of Examiners and Committee on Communication of the A.I.E.E. and the recipient of the I.R.E. Engineering Key. He was also awarded the War Department Certificate of Appreciation in recognition of his engineering services to the United States Signal Corps.



Portrait of Jenkins during his active period.

CHARLES FRANCIS JENKINS (1867-1934) of Washington, D. C., was one of radio's most colorful personages, and in his chosen realm of "seeing via the ether" America's best known, most loved pioneer. He was indefatigable in his efforts to create a new art and novel means of serving it, and his personal interest in those with whom he worked, whether in the laboratory or via the web of wireless, was so vital that he made friends everywhere, from the amateurs who listened and looked in to the higher officers of Washington's officialdom.

When Bell brought out the telephone

C. Francis Jenkins -- Television Adventurer

By **GEORGE H. CLARK**
Radio Historian

in 1876, the idea of voice-over-wires was followed up by a flood of ideas for sight-over-wires. Strangely enough, these were in general very similar to some of the earlier television principles that followed later. Jenkins was an avid reader of books and magazines of a technical nature, even as a lad, and perhaps some of these primitive plans were noted by him and stored away in his mind.

He came to Washington as a Civil Service employee, and was appointed clerk to the head of the U. S. Life Saving Service, now the U. S. Coast Guard. Passing over the "Government slave" phase of his life, his entry into the world of engineering and of invention was by way of the motion picture field. In 1895 he created and built a moving picture machine, and exhibited it that same year before the Franklin Institute. They thought so highly of it that three years later he was awarded the Elliott Cresson Gold Medal of the Institute, the citation terming this "Phantoscope" "the first successful form of projecting machine for the production of life-size moving pictures from a narrow strip of

film containing successive phases of motion." The original device is now in the National Museum, Washington. His interest in the flickering images was so great that he founded the Society of Motion Picture Engineers in 1916 and was its first president. The Society is now international in scope.

Yet even while he was polishing up his projector for its display in Philadelphia, its use in wireless communication was already in his mind. In 1894 he wrote an article for the July 25th issue of *Electrical Engineer* on the subject of transmitting pictures by wire. The later transfer to the field of radio was inevitable, by the law of genetic descent.

In 1921 he set up a small research laboratory in Washington, surrounded himself by a picked force of young and extremely enthusiastic helpers, and plunged with his characteristic dynamic energy into the investigation and practical construction of transmitting and receiving apparatus.

At that time, Nipkow's disc scanner was universally used for picking out one element of a picture at a time at the sending end and for synchronous reconversion at the receiving end. That device Jenkins adopted. His first task was to teach himself the simple mysteries of scanning, and then the more difficult techniques of making a record. But his mind was far ahead of this work, and even in those elementary days he predicted home movies by radio, prophesying that an "entire opera may some day be shown in the house without hindrance of muddy roads." (Apparently he did not believe that the art of road-building would go ahead as fast as radio and television!)

He then began specific invention, his first venture being the transmission of still pictures by wireless and their reproduction in recognizable form on paper or other medium at a distant point. This, of course, was facsimile radio, or photoradio. His first demonstration on December 12, 1922, was before officials of the U. S. Navy, including Admirals S. S. Robison and H. J. Ziegemeier, Captain J. T. Tompkins, Commander S. C. Hooper, and Lieut. Commanders E. H. Loftin and H. P. LeClair. A report of this demonstration was printed in the *Washington Star* of January 14, 1923.

By 1924 Jenkins had greatly improved his technique, particularly by means of his prismatic ring scanner, which, unlike the scanning disc, provided a receiver picture without lines or dots appearing in it, i.e., of photographic

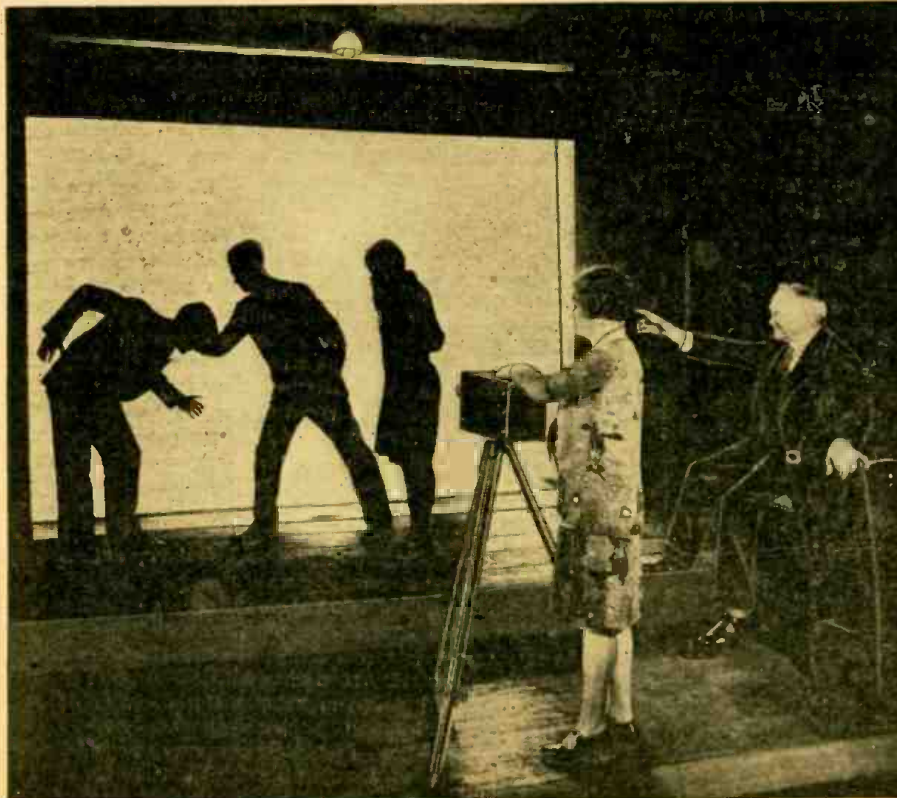

Underwood & Underwood, Washington, D. C.

Jenkins invented a new method of photographing silhouettes for early television broadcasts.



Movie film used in Jenkins' broadcasts.

value. On June 15, 1924, Jenkins made his first 100-line radio photograph, one of the first subjects being a photograph of President Coolidge.

1924 was a telephoto year, for not only was the work described above going on, but the A. T. & T. Co. had stepped into the picture, sending electrical pictures via wire from Cleveland to New York on May 20.

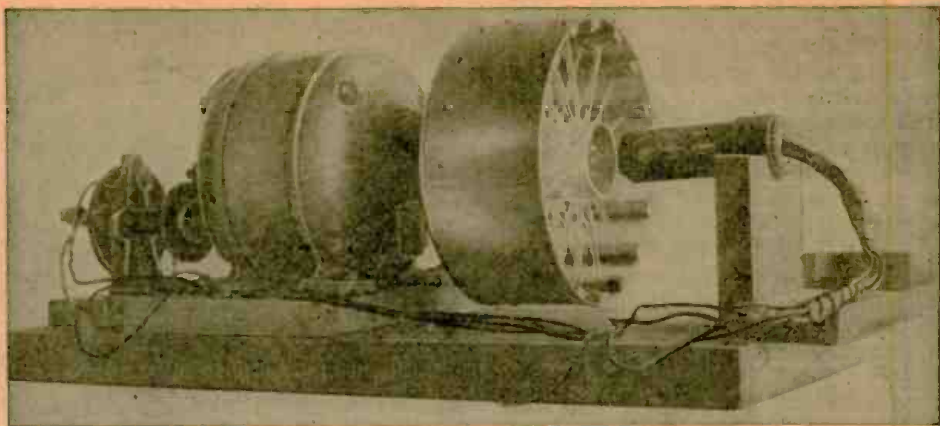

The Jenkins-de Forest drum scanner was the most highly refined television receiver to use mechanical scanning principles. It had four spirals of holes and a multiple neon lamp, light from which was "piped" to the holes in the drum through quartz rods to avoid loss.

does not appear in the records of the day, the fine Italian hand of Captain Hooper (now Rear Admiral, U.S.N., Ret.) functioned invisibly in all these tests, for it was he, as the Navy's chief protagonist of matters radio, who organized and approved this test.

What did they see? Not much. A small rotating fan, imitating a Dutch windmill, started, stopped, reversed, as air was blown on it from an unseen source. Finally, a chief petty officer at NOF, by direction of Admiral Robison, stood before the television transmitter and wiggled a message to his superiors standing before the radiovisor in the Jenkins' laboratory. (Captain Hooper, at least, was able to read the message!) Said Mr. Jenkins of this demonstration, "Congratulations were in order, but they seemed to be given in a rather awed manner, as the unfathomable possibilities of this new extension of human vision came to be more and more realized."

Mr. Jenkins further commented, "This first public demonstration of June, 1925, was duly heralded in the

press. But there was no spontaneous response from the public until the A. T. & T. sent pictures of living persons from Washington to New York over their wires. No wires were available to me, so I have used wireless." (As if he hadn't intended to use wireless from the very beginning!)

An amateur scans amateurs

As yet, Jenkins had made no effort to interest the public, or at least the amateurs (who were the radio public of that day), in "home reception." That was probably because there was no appreciation of the possible monetary benefit that might ensue; sales of sets to the Navy had a much more immediate enticement.

But Jenkins was a youngster at heart, and still younger youngsters worked under him, so in time he decided to install a broadcast transmitter for radio-movies (plus announcements) on the amateur band. Station 3XK (later W3XK) was approved by the FRC, and four channels were assigned—to over-

(Continued on following page)

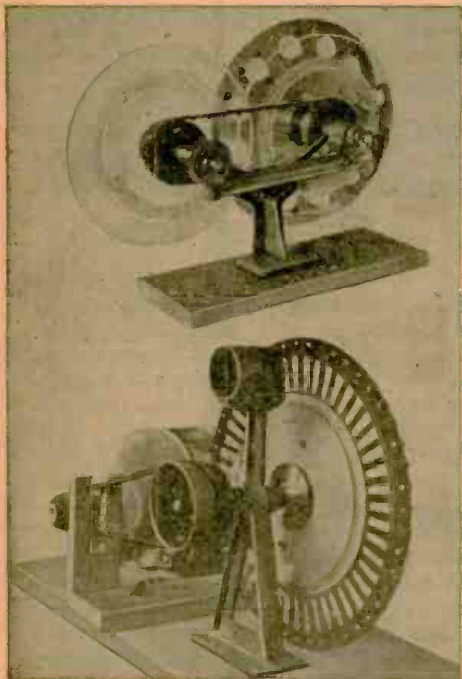

The upper scanner employs the prismatic ring.

Radio movies at last!

In the following year, Jenkins graduated to radio-movies, even if they were only silhouettes. His first laboratory demonstration of *radio-vision*, a term which he had coined for "the transfer of pictures via the ether," had been on June 14, 1923. Now, in 1925, he was ready to proceed on a broader scale. On March 31, movies by radio were sent from a standard moving picture machine to a small screen on a distant radio receiver. This was a room-to-room experiment; but early in the week of June 3, 1925, he decided that a public demonstration was in order. The transmitting on this occasion was done by courtesy of the U. S. Navy from its Naval Laboratory station NOF, at Anacostia, with the receiver in the Jenkins Laboratories.

Present were George M. Burgess, director of the Bureau of Standards; Secretary of the Navy Curtis D. Wilbur; Admiral S. S. Robison; Captain S. C. Hooper, U.S.N.; Judge S. B. Davis, Department of Commerce; and W. D. Terrill, Radio Division, Department of Commerce. Incidentally, although it

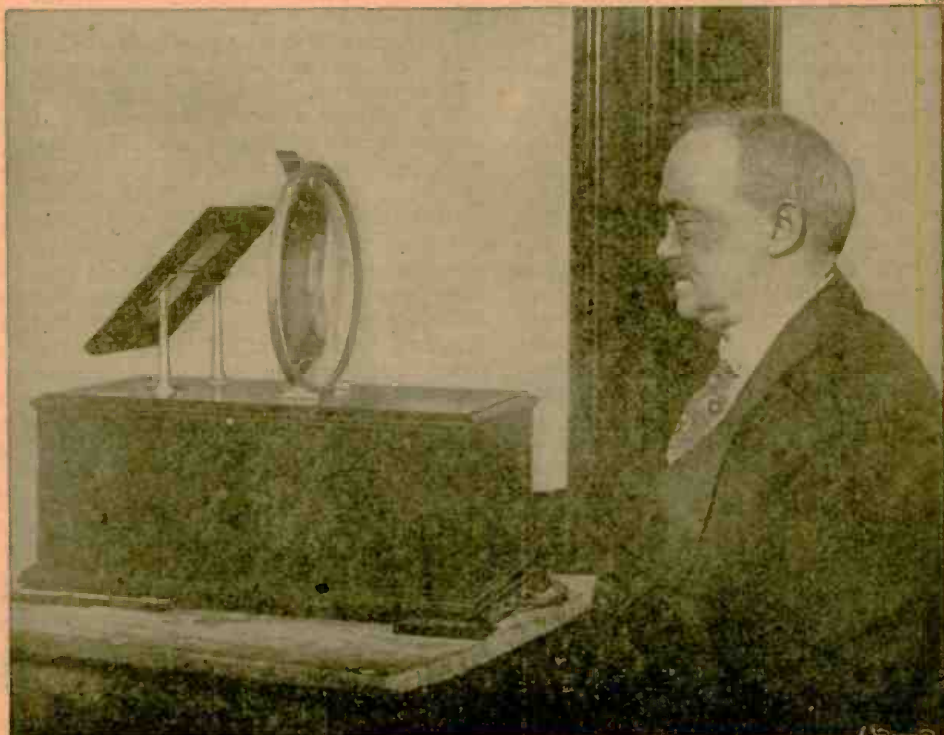

The drum receiver was considered at the time to be a great advance in the art of television.

come skip distance on the short waves used. The first Jenkins radio movie, or radio silhouette, was broadcast on July 2, 1928. During the "talk" part, amateurs were asked to write and give their opinion of the broadcast and tell how it was received, and those who "heard" only were urged to equip their short-wave code receivers with Jenkins picture attachments (discs, motor, light, etc.). Many of them did so, but it was rather difficult for them to lay out, and construct their own spiral discs, although Jenkins gave them full instructions both via broadcasts and by mail on request. So after a short time he manufactured an inexpensive picture attachment and sold it at less than cost. This consisted of a neon lamp, disc, and synchronizer, to be mounted on a synchronous motor.

At first, and for a long time, only silhouettes were broadcast. These seemed perfectly acceptable to the amateurs, most of whom were "kids" either actually or at heart. To produce these silhouettes, Jenkins set up a studio of his own, unique in the movie art, where silhouette movie films could be made as cheaply as ordinary movie films. The stars were recruited from his laboratory staff, except those parts taken by children. Among the latter was little Jane Marie, who came to be known all over the continent as "the little girl bouncing the ball." The studio director was Miss Florence Anthony, (later married to the late George Clark, then a prominent business man of Washington).

Another silhouette well received by the "lookers-in" was "The Old Dutch Girl" of the cleanser ad. A large picture of the Dutch Cleanser can was also televised, showing an early appreciation of commercials. "Possibly," wrote Jenkins in a memo, "we can put in silhouette the little fat boys of Campbell's Soup." Other silhouettes were "The Washwoman," "The Crook," the little girl skipping a rope and then putting it away and turning somersaults, another little girl, Miss Constance, who must have been very clean for every night she washed her doll's clothes and hung them on a line to dry "in a drying breeze," as Jenkins termed it. Then, last but by no means least, was Jacqueline, who did athletic dances with Master Fremont. (I wonder who's tripping her now?)

"Our audience," said Jenkins later, "in those primitive days of 1928 was between 18,000 and 20,000." Letters ranging from Malden, Mass., ("got your picture through the entire transmission despite local severe lightning") to Cedar Rapids, Ia. ("have received every one of your broadcasts"), and even further, south and west, told the story of Jenkins and his unpaid amateur laboratorians. These young home-scientists cared most for the technical pleasure of looking and recognizing, just as later in voice-broadcast days they cared only to receive and log the voice reception, however inane the content. (QST, please note!)

All these transmissions of line pictures were on the amateur wave of 46 meters. "Silhouettes only were sent," said Jenkins, "so that the picture frequency band could be kept within the legal limit, 10 kc. Later, a band 100 kc

wide—4,900 to 5,000 kc—was assigned to us by the FRC so that we could broadcast half-tone movies."

Crude though this early television was, it made its impression as a possible growing art. For example, the *New York Tribune* of June 16, 1925, viewed with alarm as follows:

Before lending any further aid to Jenkins, the Government should consider its (television's—G.H.C.) effect on posterity. It means stagnation to transportation industries when it becomes unnecessary to go anywhere to see anything. In fact, it is in a way a scientific accomplishment of the notion of Mahomet that the mountain should come to him . . .

Opinions differed, as note this quote from *The Grid* de Forest house organ, 1929:

The success of the Jenkins Washington station for television attracted the attention of financiers, and a financier of New York and Palm Beach undertook the merchandising, under the corporate title of the "Jenkins Television Corporation" of the devices developed by the Jenkins Laboratories.

The new control was in the hands of the de Forest Company, of which the Jenkins Television Corporation (of New Jersey) was a subsidiary. On September 27, 1929, the de Forest directors had authorized the purchase of the television company's stock, at the rate of 1 share de Forest common for 1 3/4 shares of Jenkins. Mr. Jenkins retained his control of the Jenkins Laboratories in Washington, and was vice-president till 1930, when he resigned.

The resignation was partly due to his poor health at the time, partly because he was not "in the saddle" any more, partly because those in the saddle did not cooperate with him and felt they were possessors of a white elephant.

Drum replaces scanner

Before describing the career of the new company in New Jersey, let us consider some of the major developments made by Mr. Jenkins while he was still his own boss. Chief of these are the drum receiver, the plate transmitter and receiver, and the prismatic ring.

The drum receiver was a refinement of the disc scanner, and removed many defects inherent in the latter. In the place of a huge rotating disc with helical holes, he substituted a drum, 6 inches in diameter, the circumferential band of which was pierced with 4 rows of holes, each row being arranged helically. All in all, there were 48 scanning apertures. Inside the drum was a neon light system, not with 1 glow-plate, but with 4 arranged end to end and connected to a commutator so that each plate or "target" was lighted in unison with the

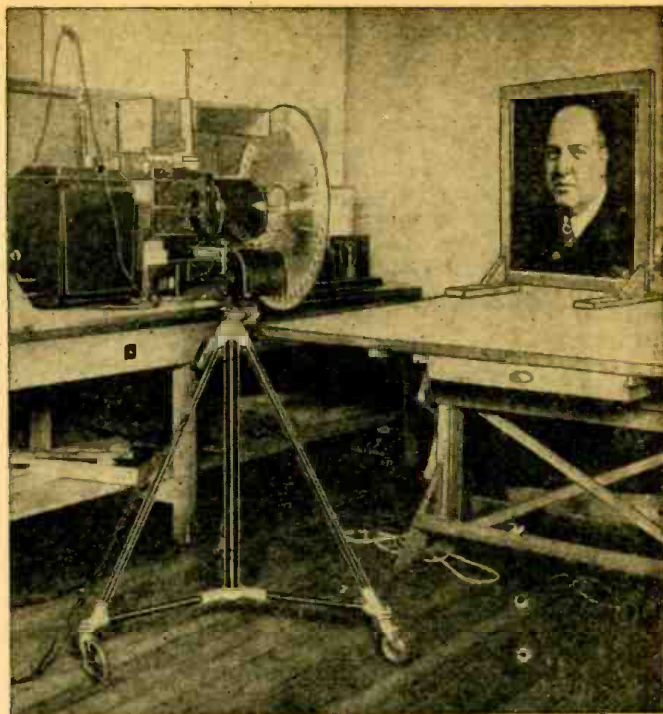

Jenkins' improved lens-type Nipkow scanner, set up to scan photo of W. T. Barkley, who was then vice-president of the de Forest Radio Co.

rotation of one row of holes on the drum. This complicated structure made it possible to have each target much more brightly illuminated—since lighted only for a short time—than if a single target were lighted continuously.

To conserve the light—which was placed some distance from the periphery of the drum, and not directly adjacent to the rotating element as in the case of the disc—quartz rods acted as "pipes" to carry the light directly outward without scattering. A drum 7 inches in diameter with 6 helical turns gave a 3-inch picture, twice the area of any picture available with a 36-inch disc, and much brighter. "The drum receiver with quartz rods," said Jenkins in the *Journal of the Society of Motion Picture Engineers* in 1930, "is the best television receiver known. It makes bigger and brighter pictures with simpler mechanism and less amplification than any other form. How long it will remain the best form of receiver no one knows, for thousands of engineers, my own included, are feverishly at work on the problem." Those were prophetic words! "His own engineers" did not succeed, nor did the much better trained de Forest engineers, in making a receiver that would be acceptable in commercial television. It remained for the electron to solve the problem, much as perhaps in the near future the atom may dissolve it!

There is this to be said: that the drum receiver was a product of elegance and—within its limitations—of efficiency. That it was not commercially practical can be ascribed partly to the fact that its inventor was not a particularly commercial-minded person.

Beginning of the end

One of the engineers working "feverishly" on the problem was C. E. Huff. (Continued on page 120)

Television Steps Out!

The new art is repeating the history of broadcasting on a grander scale

By WILL BALTIM*

TELEVISION'S tremendous potential, which has been pent up for so many years, will burst forth across the United States this year with force that will rock the inertia and indifference out of a lot of people. Television talk has been bantered about for so long that it is little wonder that millions of Americans living in the vast hinterlands, who have yet to see a television image sweep across the face of a cathode-ray tube, still accept this new art with the proverbial grain of salt.

Twenty-six years ago when radio broadcasting began to enlist adherents through the magic of a cat's whisker, a crystal, and a pair of headphones, a skeptical public was equally disbelieving. Only after the doubter got a "dose of listening" did he fully realize that a new wonder had been achieved for him to own and enjoy.

Television is finally breaking out of its shell and is now on its way to becoming a principal service. With nearly 150,000 television receivers in the hands of the public as 1947 faded into oblivion, television had at long last ceased to be an experimenter's delight. It is now a commercial product with enormous untapped possibilities.

A recent survey made by the Television Broadcasters Association, Inc., indicated that in 1922, radio's first big year, there were 100,000 radio receivers in use in the United States. In 1947, a comparable year for television, 150,000

*Executive Secretary-Treasurer, Television Broadcasters Association, Inc.

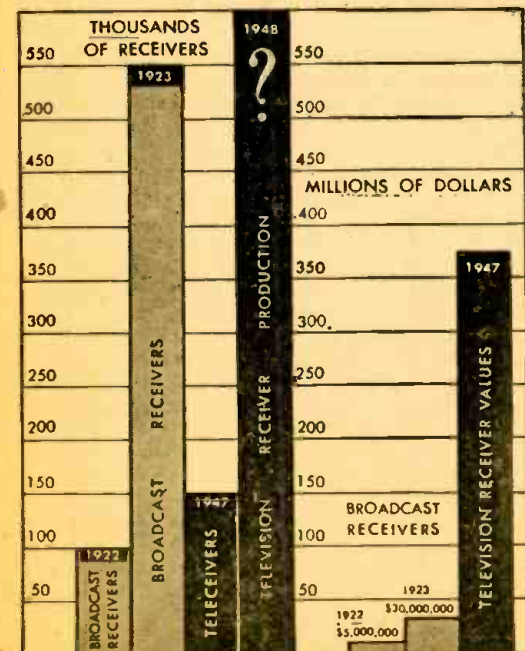

Graphic comparison of radio and television.

television sets were in use. In 1923 there were about 550,000 radio sets in homes and public places. The estimate for television this year runs well over 750,000 receivers.

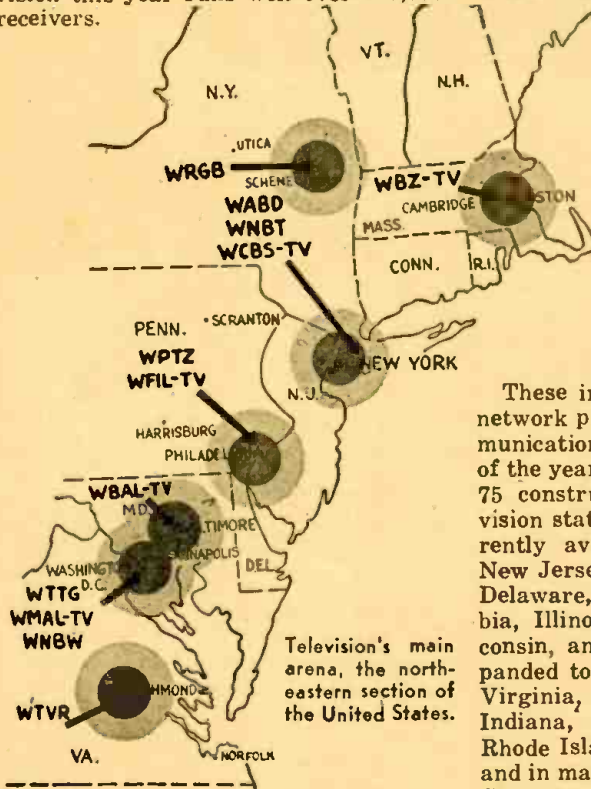

In dollar volume, the comparison between radio yesteryear and television today lifts the eyebrow high on the dome. For example: the dollar volume in radio receivers at retail levels in 1922 approximated \$5,000,000. The dollar volume in television at the same levels last year amounted to a staggering \$74,000,000! In 1923 radio's dollar volume totaled \$30,000,000. In television, the estimate for this year exceeds \$387,000,000!

Hence, the strides made by television to date are already far ahead, comparatively, of radio, presaging a popular future for this newest of twentieth-century miracles.

Television brings into the home a veritable potpourri of entertainment,

information, culture, and education. Ask any man who owns a television set. The effect of televiewing on the present army of set owners parallels—and surpasses—the enthusiasm of the early radiophone dxers.

The mere fact that television receivers will be abundantly available this year does not tell the whole story of the impending expansion. Unless television stations are operating, the market for receivers is negligible. No one knows this better than a television industry leader—and there are several factors at work to ensure their operation.

These include new station operators, network planners, and the Federal Communications Commission. At the close of the year, the FCC had granted nearly 75 construction permits for new television stations in 25 states. Service currently available in New York State, New Jersey, Connecticut, Pennsylvania, Delaware, Maryland, District of Columbia, Illinois, Michigan, Missouri, Wisconsin, and California soon will be expanded to include Massachusetts, Ohio, Virginia, Florida, Texas, Louisiana, Indiana, New Mexico, Oregon, Utah, Rhode Island, the State of Washington, and in many other sections of the United States.

It is estimated that between 35 and 40 television stations will be operating in at least 18 states by the end of 1948 and that an additional 35 will be in full operation within the following year. Not

(Continued on page 108)

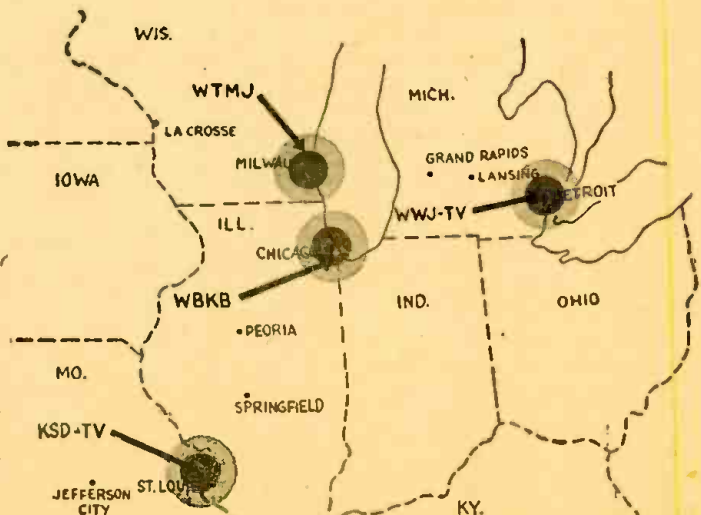

Four stations in the midwest are the nucleus of a Central United States group of television stations which will be increased very soon.

TELEVISION

as a

USEFUL ART



1



3



4



2

Television may become more important in our daily life than as an entertainment medium. In education, medicine, business and heavy industry experiments already made point the way to important advances in the near future. Hundreds of students can view an operation, goods can be shown to housewives in a dozen cities, dangerous industrial processes be viewed safely on the television tube's screen.

Fig. 1 shows an RCA Image Orthicon camera set up in the balcony of Johns Hopkins hospital to televise a "blue baby" operation. The camera is equipped with 4 turret-mounted lenses. Images from this camera, and one mounted directly above the operating table, were relayed by co-axial cable to 10 RCA-Victor television receivers distributed on 3 floors of the hospital, to permit over 300 surgeons to view the operation clearly. Fig. 3 shows the Orthicon camera mounted over operating table. Fig. 2 shows surgeons watching an operation televised in New York City; the receivers were located several blocks from the hospital.

Fig. 4 - WABD's (New York) cameras give students in New York and Washington (WTTG) a close-up of a radioactive specimen in the hands of Dr. Clark. The Telecast was carried to Washington by coaxial cable.



5

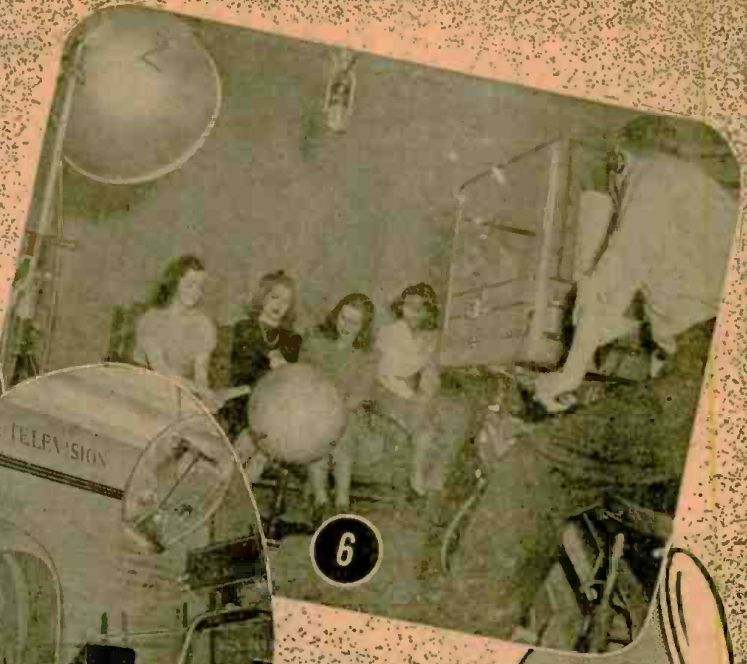

6

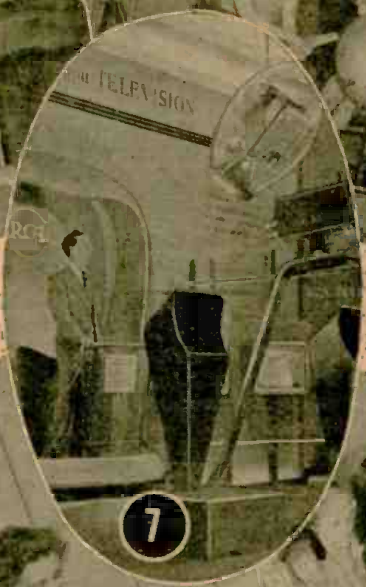

7

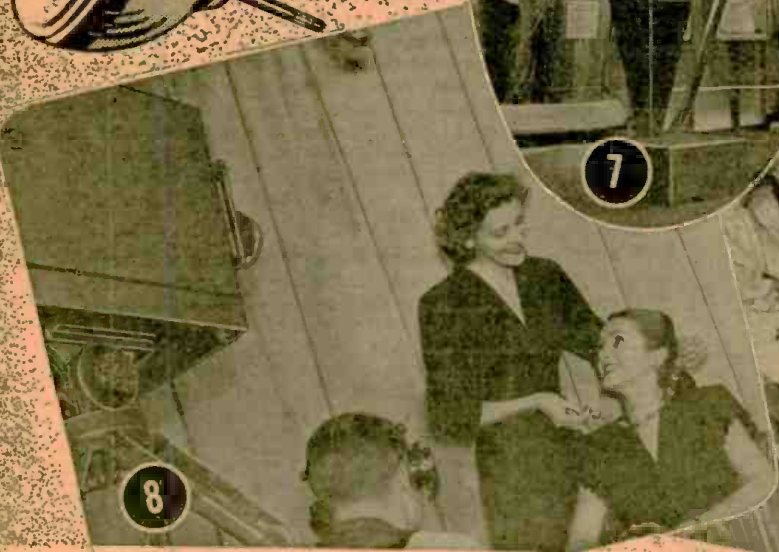

8



9

Fig. 5 shows a group of students attending the remote radioactivity lecture by television receiver, using the Du Mont system. The future possibilities in the telecasting of lectures and demonstrations are limitless, and students all over the country will be able to hear and see scientific lectures and demonstrations by famous people. Fig. 6 shows a class in geography being telecast in the studios of WRGB (General Electric Co.) Schenectady.

Fig. 7 illustrates television exhibit at the RCA Building in New York City, where the latest cameras and receivers are shown to the public.

Figs. 8 and 9 show the application of television to large stores (Gimbels store in Philadelphia), using RCA equipment. Sales possibilities with television are legion... merchandise of various kinds can be displayed in every department of a large store, and the power of the television screen to eventually introduce new products right into the home is almost unimaginable.

Fig. 10 shows another new use for television — identifying signatures on checks. The teller can flash a check on the screen in the bookkeepers' department for verification — a system actually in use in the Franklin Square National Bank, Long Island, N. Y.



10

TELEVISION

as a

USEFUL ART

(continued)



Undersea Television at Bikini—The television camera was mounted in a water-proof steel shell suspended on cables as shown (12) above. The television equipment was installed aboard the U.S.S. Coucal, during a scientific resurvey of the area where two atomic bombs were exploded last year. Photo (11) at left shows Richard E. Frazier and John P. Gould; engineers who installed and operated the equipment. The camera viewed the scene through the window in the shell cover. *Official U. S. Navy Photo.*

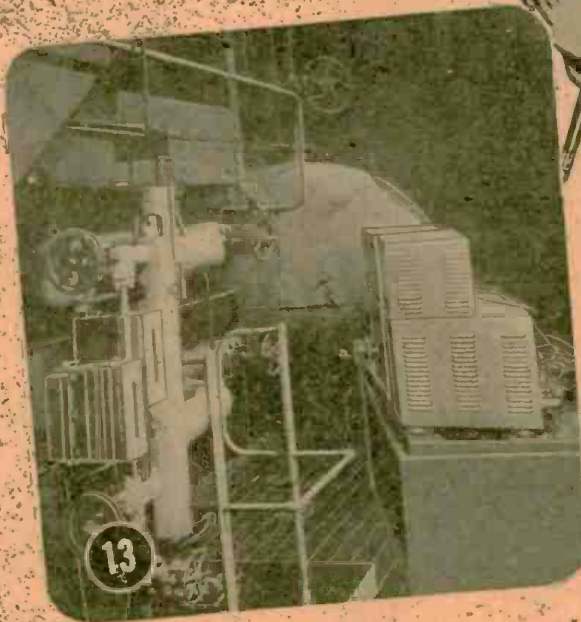

Televising Boiler Gauges at a Distance—Photos 13 and 14 below show television camera set up in front of boiler gauges (left), and television receiver screen in engineers office (right), at Hell Gate station of Cons. Edison Co., of N. Y. The Utiliscope was developed by Farnsworth Telev. and Radio Corp.

Double Modulation — An Aid to Television?

By E. AISBERG
Editor, *Toute la Radio*, Paris

TWO kinds of signals must be transmitted in all present systems of television: 1. The *video-frequency* signals, which translate electronically the successive light values of the image analyzed; 2. The *synchronizing* signals, which are divided into *line pulses* and *frame pulses*, and which assure simultaneous movement of the electron beam in the television camera at the transmitter and in the cathode-ray viewing tube at the receiver.

Because the carrier can transmit only 1 modulation at a time, these 2 types of signals are transmitted *successively*. At the end of each transmission of video frequency which serves to reproduce the light values of one line, a short impulse constitutes the line-synchronizing pulse; at the end of each complete image, or frame, a series of short impulses constitute the frame-synchronizing pulse. Under the present standards, the line pulses occupy 18%, and the frame pulses 7.5%, of the total time of transmission.

Altogether, approximately a quarter of the transmission time is taken up by synchronizing signals. During this time, the screen remains dark. Several inconveniences result from this. First, the average brilliance of the image is re-

duced one-quarter, compared to what it would be if the luminous spot were *constantly* present. Further, for equal definition, the video frequency is higher, which causes an increase in the width of the modulation bands with all the inconveniences which accompany it.

Finally, the synchronizing signals, especially when transmitted by amplitude modulation, are very sensitive to static disturbances (notably those of electric lights, motors, and automobile or airplane ignition systems) so that synchronism is easily impaired.

All these troubles would disappear if it were possible to transmit vision and synchronizing signals *simultaneously*.

Double modulation principle

The 3 principal modulation systems which serve to incorporate a signal into a carrier of higher frequency are: amplitude, frequency, and phase. Till now each of these systems has been used *separately*. But there is no reason why the same carrier cannot be modulated *simultaneously in frequency and amplitude*. Thus it might carry at the same time 2 varying voltages (Fig. 1), each of which might be independent of the other. It is possible to imagine many applications of this principle. For example, 2 radio programs could be broadcast on the same carrier, the one amplitude, the other frequency-modulated. Or again, a single program could be divided into 2 channels, one being reserved for the low and middle notes, the other for the higher ones. We can also imagine music being transmitted on one channel, and the second transmitting a voltage which would control volume expansion (dynamic range). Technicians can easily suggest many other applications of this principle.

The same principle can be used as the basis of a new television system, free of the inconveniences mentioned above, and which will have other substantial advantages. Instead of transmitting the vision and synchronizing signals alternately, we can transmit them *simultaneously* by using the 2 systems of modulation.

The video-frequency signals might be transmitted continuously by amplitude modulation. At the same time, the synchro-

nizing signals could be transmitted by frequency modulation. Of course, the modulation percentage would have to be limited to a point where the carrier would be able to carry the transmission of synchronizing signals at all times. Note that this is not a point of inferiority to existing systems in which the modulation percentage of video-frequency signals must be limited to assure the correct functioning of the synchronizing signal separation tube. (According to present standards, the modulation percentage is limited to 75%.)

In this system the entire time is devoted to the transmission of light values. Thus the average brilliance of the image is increased. Further, frequency modulation is little affected by static or electrical interference, so stability of synchronization would be increased notably.

Instead of transmitting synchronization in the form of brief impulses (which considerably widen the modulation bands), it can be in the form of interrupted variable voltages occupying the whole time of transmission.

Let us see how we can utilize these principles in concrete fashion.

Double modulation transmitter

The transmitter is represented schematically in Fig. 2. The image is analyzed by an orthicon camera (for example). Sweep is determined by the saw-tooth voltages supplied by the 2 time bases: the high-frequency horizontal base affecting the analysis of the lines; and the vertical base, of a much lower relative frequency, assuring the succession of lines and the passage from one image to the next.

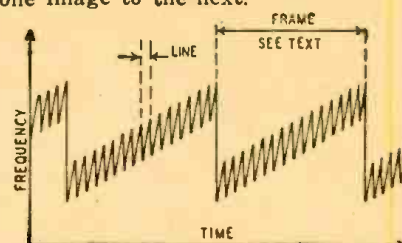

Fig. 3—Effect of two time bases on frequency.

The photoelectric voltages collected in the conventional manner are amplified in a video amplifier and *amplitude-modulate* the high-frequency voltage from the master oscillator. But the frequency of the master oscillator is varied by a reactance tube, which is simultaneously influenced by the voltages from the 2 time-bases. Thus *frequency* of the carrier wave varies as shown in Fig. 3. Note that the carrier is subjected to variations of relatively small amplitude but high frequency by the line time base, (Continued on page 134)

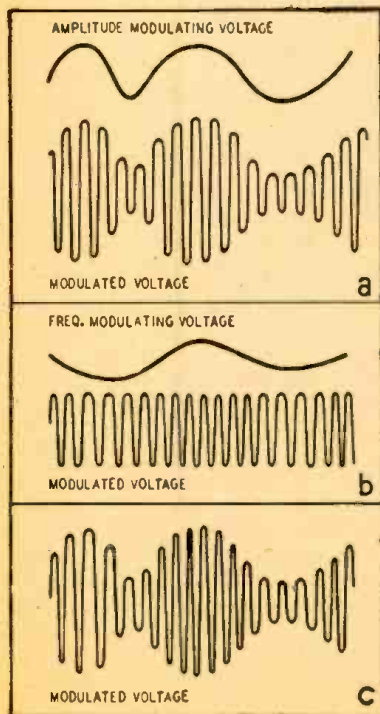

Fig. 1—Frequency and amplitude modulation combine to form a doubly-modulated carrier.

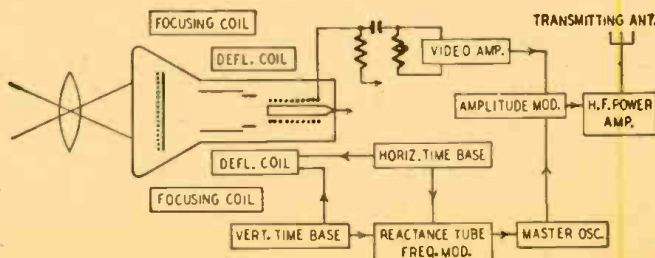

Fig. 2—A block diagram of the proposed transmitting system.

BLOCK THAT GHOST!

Care and skill in making the antenna installation makes the difference between good and bad images

By JORDAN McQUAY

THE chief complaint among new television-set owners is the presence of one or more overlapping images on the picture screen, resulting in a consistent double exposure (Fig. 1) or triple-exposure (Fig. 2) effect. Since the displaced images duplicate the main picture image in every respect, and usually with less intensity,

they are appropriately known as *ghosts*. Their presence is *not* the fault of the picture tube or the television receiver. They are due entirely to inadequate or improper installation of the television antenna.

Elimination of these ghosts may require only *proper* siting and orienting of the existing antenna. Should this

prove fruitless, a more directional type of antenna must be substituted and properly installed.

Regardless of the location—whether town or country, city or industrial district—it is possible to receive television pictures entirely free of ghost interference. Such reception can be achieved only by considering the specific problems of each television location.

Ghosts now present in existing television systems can be blocked or eliminated by means of the same general method used for *new* installations. The work requires a practical knowledge of antennas and reflected waves. Siting is performed by two men, equipped with tools and patience.

Direct and reflected waves

The high-frequency waves used in television are similar in many respects to ordinary light waves. They travel in straight lines until their path is obstructed. The receiving antenna should be installed sufficiently high and in the clear so that it intercepts these *direct waves*. This means that the transmitting antenna of the television station should be visible, or "almost" visible, from the site of the receiving antenna. Reception may be possible when objects or surfaces partially obstruct the path of the direct wave, but usually the received signal is very weak.

Again similarly to light waves, the straight-line paths of television waves are affected by any kind of obstruction. Usually, the waves are diverted or reflected upon striking an object or surface. Much as a billiard ball is reflected angularly by a soft cushion, these waves, after reflection, continue their journey in a different angular direction, depending upon the original direction of the wave and the structural nature of the interfering object or surface. The waves lose some of their energy each time they are reflected. However, when reflected by *large* surfaces—such as steel buildings, storage tanks, or even mountainsides—very little energy may be lost.

Since many signals are radiated simultaneously and in all directions by the transmitting antenna, there is always a possibility that some of these reflected waves may reach the site of the receiving antenna (Fig. 3).

If the receiving antenna is not sufficiently directional, it will accept both the *direct* signal and the *reflected* signals. The frequency of both is the same, and therefore the television receiver—no matter how efficient or expensive—cannot differentiate between them.



Fig. 1—Double-image ghost caused by direct and a reflected signal.



Fig. 2—A triple-image ghost shows there are two reflected signals.

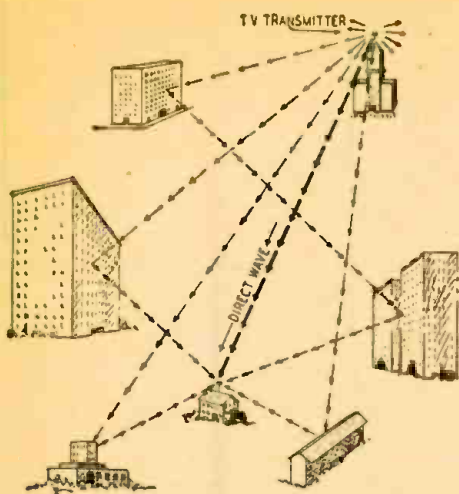

Fig. 3—Where the television ghosts are born.

The unwanted signals must be eliminated by the antenna system.

Since *any* reflected wave travels a greater distance than the direct wave, the additional time consumed causes the reflected signal to arrive *later* than the direct signal. The delayed signal appears on the picture tube as an *additional* image, which is always displaced horizontally and *to the right* of the direct image. The amount of this displacement

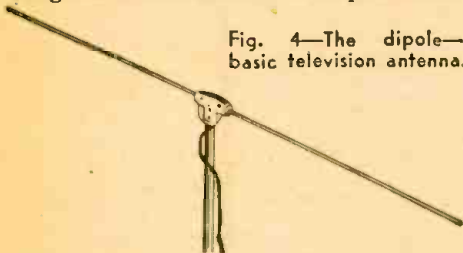

Fig. 4—The dipole—basic television antenna.

is a direct function of the additional time required for the reflected signal to travel the additional distance, with respect to the direct signal. If this additional distance is very small, the resulting displacement on the picture tube may be so small that it produces merely a blurry out-of-focus effect. More often, reflected signals travel considerably greater distances than the direct signal, resulting in more-or-less distinct multiple images on the television screen, as shown in Figs. 1 and 2.

These unwanted signals may be reflected by any number of types and kinds of large surfaces and objects. For this reason, ghost images are usually troublesome in the industrial or metropolitan districts of cities.

However, the general method of elimination of ghosts is the same for *all* types of television installations.

Proper siting

Since ghost images are the result of reflected signals arriving from directions which differ from that of the direct signal from a transmitter, their appearance on the picture tube is due entirely to *insufficient directivity* of the existing antenna.

This does not necessarily mean that another type of receiving antenna must be substituted immediately, because in *many cases* the existing antenna is improperly sited, improperly oriented, or *both*, due to careless or indifferent work at the time of the original installation.

Therefore, the first logical step in blocking ghost reception is to make certain that the existing antenna is sited and oriented to *obtain the best possible reception* at the particular location.

At least two technicians or servicemen are needed to make a satisfactory television installation. The following more-or-less standard procedure is used to site and orient properly *any* type of television antenna.

One man, holding a pole upon which is mounted the antenna, is located on the roof of the house or building. The portable antenna is connected to the television receiver by a lead-in, which is loose and long enough to reach any location on the roof. A second man is located at the picture tube of the receiver to observe comparative signal strengths of the direct image and any ghost images. Some means of direct communication—such as a portable telephone or intercom—is used between the two men. Tests are conducted while the desired television station is on the air.

With the antenna held horizontally and broadside toward the direction of the station, the man on the roof explores various possible antenna sites, while the observer at the set notes comparative signal strength data for each of the various roof locations.

If 2 television stations are to be received with the same antenna, the entire procedure is duplicated for each station, and a suitable average or compromise location is selected as the best site for 2-channel reception. A similar process is used for 3- and 4-channel reception. However, antennas designed for multi-channel operation—such as folded dipoles—are susceptible to ghosts, since they lack sufficient directivity.

When the best site has been determined, the antenna is temporarily mounted so that it can be rotated in azimuth. Again using the 2-man coordination system, the antenna is revolved while changes in the received image are observed at the image tube. Some ghost effects will disappear and reappear as the antenna is rotated. The object of this search is to locate a bearing position of the antenna which provides maximum strength for the direct wave, and the least interference due to wave reflections. At such a bearing position, the antenna is fixed in place, and is then considered to be properly sited and oriented. Usually, but not always, objectionable ghost effects are greatly minimized or completely eliminated by this process.

If, with the antenna properly installed and with all other components of the system functioning normally, ghosts still appear on the picture screen, a more directional antenna is required for ghost-free reception.

Ghost effects

Although unwanted for normal television reception, the consistent appearance of ghosts on the picture screen *during the installation* can be utilized to good advantage, since the images provide considerable information concerning the nature and origin of the reflected waves. This data is obtained di-

rectly from the picture tube of the set, without additional analyzing equipment or expensive paraphernalia. Once determined, the information is used in selecting the proper type of directional antenna to block or eliminate the ghost signals.

When the direct image and the reflected image are well separated on the picture screen, this indicates that the signals are converging at the antenna from 2 widely different directions. In such cases, the unwanted signal usually can be effectively blocked with an antenna having only a slight amount of increased directivity.

On the other hand, if the direct image and the reflected image are only displaced slightly, or if they are so close together that they cause a blurry effect, this indicates that the signals are arriving at the antenna from almost the same direction. In such cases, an extremely directional antenna is required to separate (in angle) the desired from the undesired signal.

When the intensity of the ghost image is weak in comparison with the direct image, the reflected signal is more easily blocked with a simple directional antenna. When the intensity of the ghost image is stronger than the direct image,

(Continued on following page)

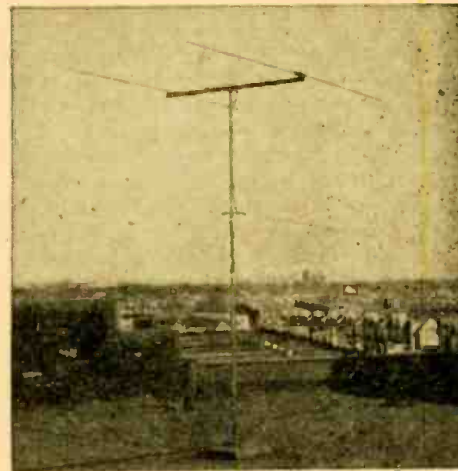

Service Division, Philco Corp.
Fig. 5—This simple antenna is often good.

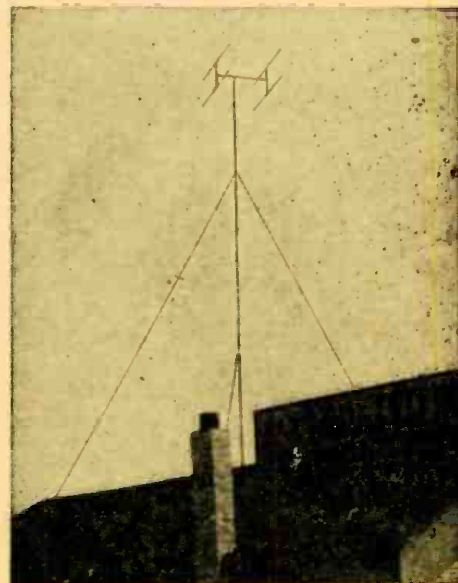

Fig. 6—Double doublet is highly directive.

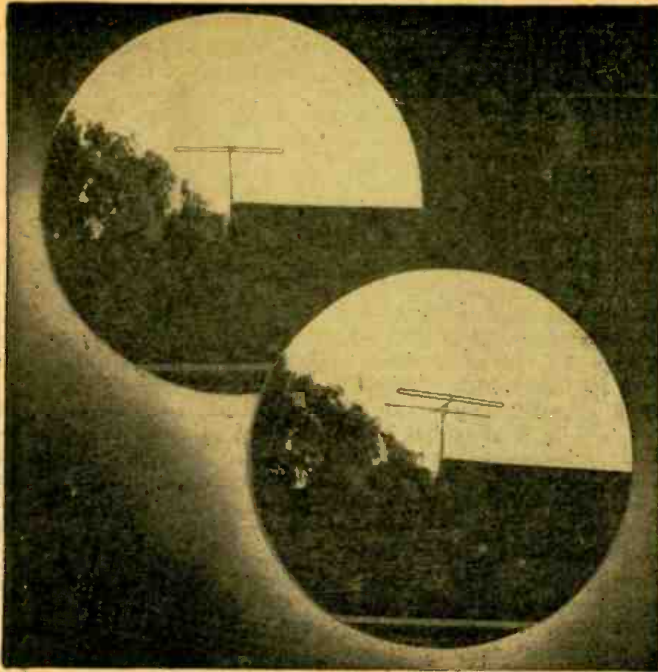

Photo by Ward Products

Fig. 7—Folded dipoles can be ghost free on only one channel.

it is sometimes possible to orient the antenna with respect to the *reflected* signal—rather than the *direct* signal—if the direct signal can be blocked satisfactorily so as to prevent interference with the desired (reflected) signal.

By turning or rotating the antenna at the roof site while observing the comparative strength or intensity of the direct and reflected images, it is often possible to identify the true bearing or direction of the *source* of the reflected waves—such as buildings, tanks, etc. When the source of trouble is known, it is often easier to deal with its effects.

This and other information can be determined directly from the picture tube, *regardless of the type of antenna*, provided the antenna has been properly sited according to the general installation procedure.

When a more directional antenna is required for ghost-free reception, this previously determined site *may* prove

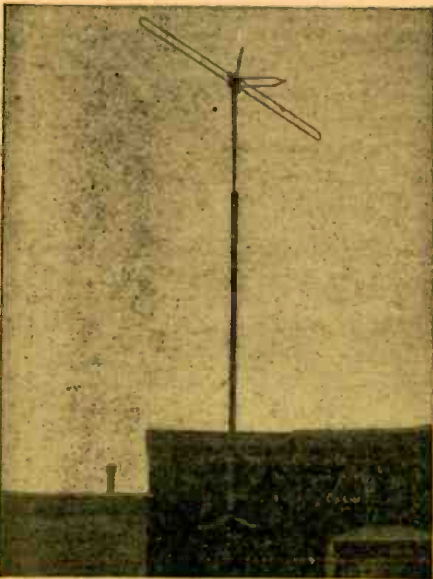

Fig. 8—The Duoband operates on all channels.

adequate for the new antenna as well. However, this roof location is not necessarily the best site for *all* types of television antennas. Therefore, any of the following types of directional antennas selected for installation must be *individually* sited and oriented according to the standard installation procedure.

Basic types of antennas

There is no "ideal" antenna suitable for *all* kinds of television installations, because of the specific directional requirements and the individual nature of

each location. In general, the *best* antenna is the simplest and most economical antenna which provides ghost-free reception for a particular location.

The simplest antenna—with the least directivity—is the fundamental, half-wave, resonant dipole (Fig. 4). Although tuned, this antenna is made only broadly resonant to prevent degeneration (loss of clarity and definition) of the high-frequency side-band components of the received direct signal. The dipole has an impedance of about 72 ohms at its center, and is always erected in a horizontal position.

A simple half-wave dipole is sometimes adequate for rural or suburban installations, where ghosts are rare. More complex and directional antennas are needed for good reception in the metropolitan and industrial areas of large cities, where multiple-signal reflections are prolific and troublesome.

It is conventional practice to use this lightweight dipole as the initial step in all *new* television installations, according to the standard procedure given previously. In some cases, it provides satisfactory reception and can be permanently installed at the location. In many cases, it is found inadequate because of its lack of directivity. Since the dipole is bidirectional, there is also the possibility that reflected waves may strike the antenna from the rear (Fig. 3). This directional inadequacy is remedied by adding either a reflector or a director. These *parasitic elements* convert the single dipole into a 2-element antenna with considerably improved directivity.

The reflector is a rod about 5% longer than the dipole, placed parallel and a quarter-wave *behind* it. The resulting 2-element antenna (Fig. 5) is sufficiently directional to block all *weak* reflected signals which arrive at a *wide* angular difference with respect to the direct wave.

When a director is used in place of a reflector, the action is almost identical. The length of the director rod is about 5% *shorter* than the dipole, and is placed parallel and a quarter wave *in front* of it. As in the case of the reflector, the complete 2-element antenna has good directivity.

Greater directivity can be provided with a 4-element antenna, known as the double doublet (Fig. 6); it is also known as a stacked array of two 2-element antennas. This consists of 2 dipoles, one above the other and connected in phase, and 2 reflector elements, one above the other and unconnected. The combination is a good one. It discriminates against undesirable ground reflections, thus providing a more distinct picture than is possible with a single dipole-and-reflector unit. The double doublet is broadly resonant, so broad that it might be classified with the wide-band or special types of antennas which follow. It has very pronounced directivity characteristics which make it extremely effective in blocking unwanted ghosts. It is frequently possible to minimize or eliminate ghost effects merely by changing the symmetrical position of one or more of the antenna elements, even by setting them at an angle with the strict horizontal. Again, it is important to realize that every television installation must be treated *individually* according to the specific directional problems posed by each location.

Folded dipoles

The directional characteristics of the folded dipole are about the same as those of the simple dipole. Somewhat similarly, the folded dipole can be used alone or with a reflector (Fig. 7), depending upon the degree of directivity desired. (Continued on page 128)

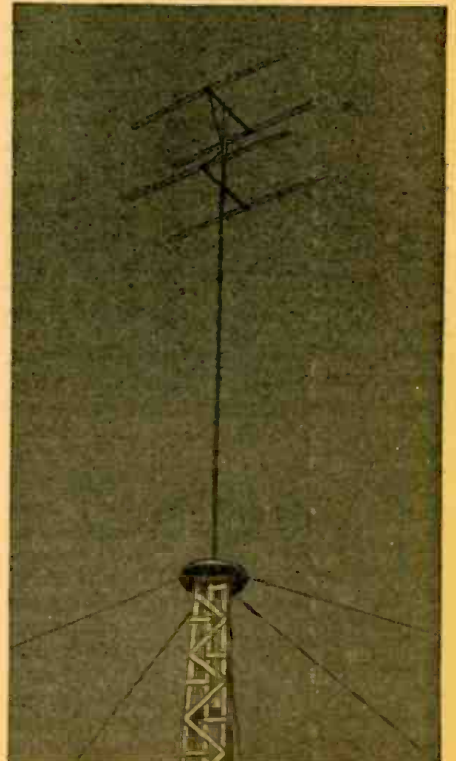

Fig. 9—A wide-band, highly directive antenna.

British Televisers

A wide range of television receivers are now being manufactured in Britain

By RALPH W. HALLOWS

JUST over 50 different models of television receivers were shown by manufacturing firms at the Radio Exhibition last October. Picture sizes ranged from 7 x 5 inches to 22 x 19 inches and prices from \$204 to \$6,000. The \$204 outfit is the Pye table model, which receives only vision and the accompanying sound and shows an 8 x 6-inch image. Six thousand dollars is the price tentatively put on the Baird Grosvenor! This is an all-wave radio-auto-phonograph with a 22 x 19-inch picture shown on a flat screen by means of a large back-viewing tube, with its gun set at an angle to the long axis of the tube. Its radio side covers long, broadcast, and short waves in 11 full-scale

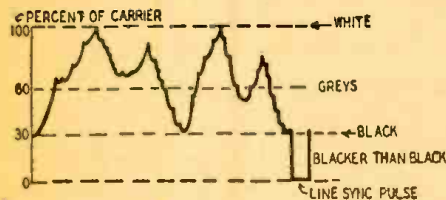

Fig. 1—British television modulation method.

tuning ranges. Though it was undoubtedly the showpiece of the exhibition, I doubt whether this giant set will go into regular production in its present form. There are, though, two others in the "millionaire" class for which you can place your order, if you're prepared to pay the price. The first of these is the Dynatron K329, an all-wave radio-auto-phonograph with a 10 x 8-inch picture

and a price of \$1,577; the second, also an all-wave radio-auto-phonograph, but with a 20 x 16-inch picture, is the HMV 1852 at \$1,752, of which more later.

There are two noteworthy general trends in the design of televisers today, compared with those of prewar years.

First, there is now no attempt to produce at rock-bottom price a set which might be called a televiser because it shows some kind of small, hazy picture. Before the war there were receivers, priced as low as \$100, which could be used by means of v.h.f. adaptors in conjunction with ordinary broadcast receivers. Equipped with 3-inch cathode-ray tubes, they certainly presented images on their screens. But these images, with their defective interlacing, lack of steadiness, and poor contrast were often mere travesties of what was transmitted from the television studio. Despite its low price, there was very little market for this kind of televiser. Those who had predicted that television would become popular when something like an equivalent of the crystal-detector radio receiver was available were proven to be just about as wrong as it was possible to be.

Second, designers have realized that the man in the street wants an image of reasonable size in his vision receiver. No set offered now shows a picture smaller than 7 x 5 inches; the great majority of our sets present images approximately either 8 x 6 inches or 10 x 8 inches on their screens.

Manufacturers are still in doubt as to what kind of televiser, apart from

picture size, the public wants. Some time ago it was believed that to be really popular a television set must incorporate an all-wave radio receiver. The idea was that Mr. and Mrs. Everyman wanted a home entertainment box that would bring in anything on the air in the way of pictures, speech, or music. Now there is some doubt about this. The present view is that they much prefer to have the ordinary radio receiver for broadcast programs and a separate specialized receiver for television. The great majority of the televisers now offered here handle only vision and the accompanying sound. I am inclined to believe that this will be found to be the solution of the problem, at any rate for the next few years. The broadcast radio receiver and the set which is a televiser and nothing else can both be made up in compact form. The all-wave radio plus television receiver is much more bulky, and the all-wave radio-phonograph-televiser is a rather formidable piece of furniture for the modern living room.

British television systems

Just one word about our vision transmissions before we go on to consider some British televisers in detail. Unless the main differences between the British system and those used in the United States are understood, it may be difficult to make sense of the schematics which follow. The first and most important difference is that British transmissions would produce a negative image—blacks and whites being interchanged—on the screen of an American receiver. With us white corresponds to 100% modulation, black to 30% modulation and the various greys to degrees

(Continued on following page)

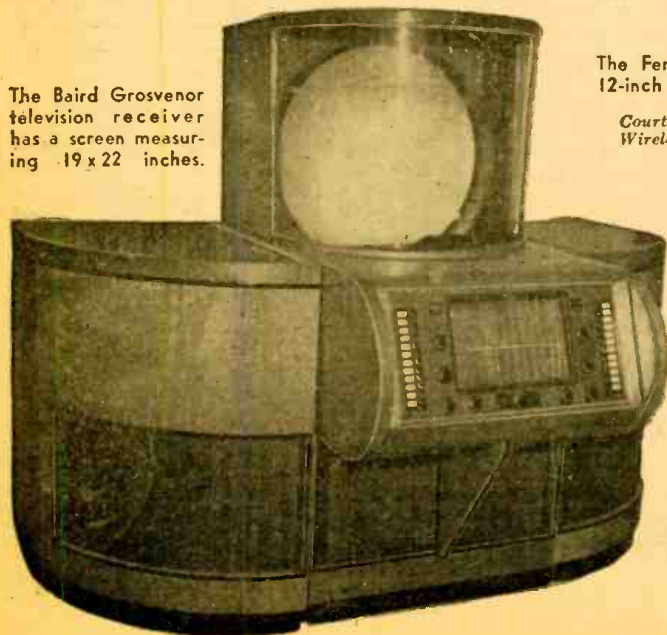

The Baird Grosvenor television receiver has a screen measuring 19 x 22 inches.

The Ferranti receiver uses a 12-inch tube and 2 speakers.

Courtesy E. Aisberg and Wireless World (London)

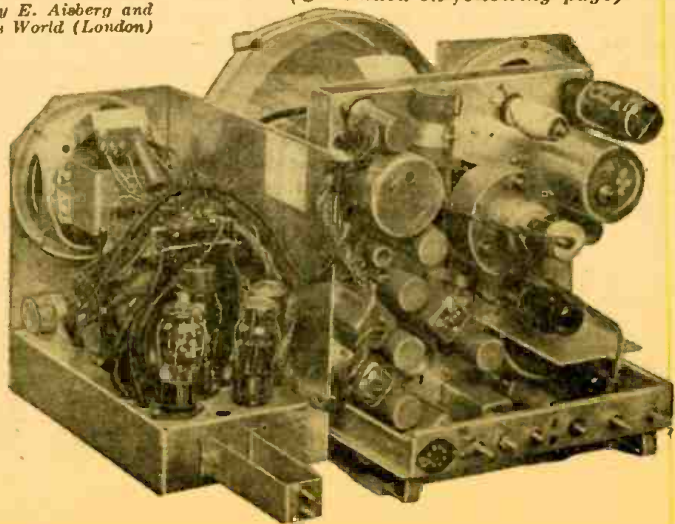

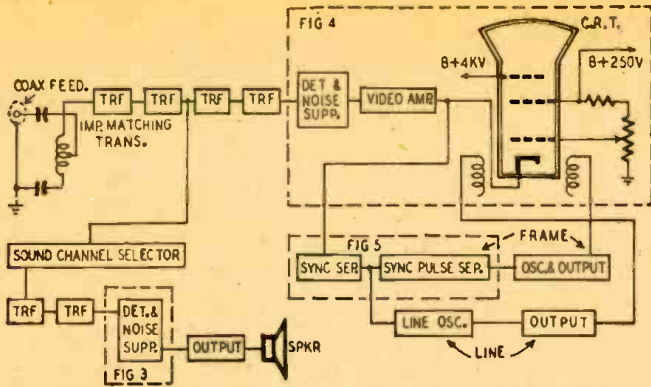

Fig. 2—The Pye televiser uses t.r.f. sound and vision circuits.

of modulation between a little above 30% (dark) to a little below 100% (pale). Our line and frame synchronization pulses are produced by dropping the modulation from 30% to zero and are thus "blacker than black." Fig. 1 shows diagrammatically the modulation corresponding to one line of a scan. In the British system each image is built up by 405 lines. It consists of 2 interlaced frames, each of 202½ lines. There are 50 frames and 25 complete images a second, the frequency of our standard a.c. being 50 cycles.

Though it is our least expensive televiser, the Pye (of whose circuit Fig. 2 gives a block diagram) is one of the most ingenious. It gives clear, steady pictures and is simplicity itself to handle, for the only 2 control knobs on the outside of the cabinet are for sound volume and picture brilliance. As the block diagram shows, sound and television channels each have 4 stages of r.f. am-

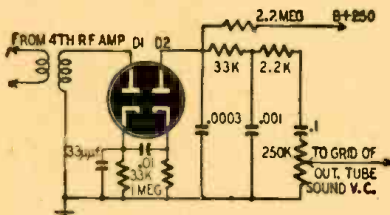

Fig. 3—Pye sound detector, noise suppressor.

plification, the first 2 stages in the set being common to both and sound being tapped off after the second by a pre-tuned selector circuit. Fig. 3 shows in detail the circuits of the double-diode used as sound detector and noise suppressor. On account of the very small values of the load resistor and capacitor of V1 (the detector) voltages due to automobile interference peak sharply. The output of V1 is taken from its cathode and applied to the cathode of V2. The plate of V2 is positive so it normally conducts. The adjustments are such that it does conduct so long as any

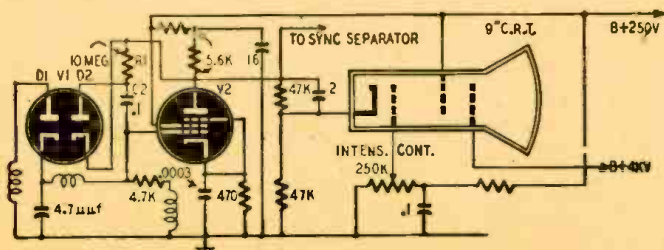

Fig. 4—Pye receiver's interesting video interference suppressor.

audio signal of normal amplitude is applied from the detector or to its cathode; but when a high interference voltage peak is applied to it, its cathode is driven more positive than its plate, and it ceases to conduct.

A dozen interesting features on the television side could be described. I must, however, confine myself to the video amplifier with the preceding double-diode (Fig. 4) and the frame pulse separator (Fig. 5). They show two further clever uses of that versatile tube, the double-diode. Look now at Fig. 4. The very small (4.7µmf) capacitance in the cathode of the first (detector) diode of V1 supplies h.f. compensation. The second diode D2 serves as suppressor of interference from auto ignition systems. This diode is shunted across the resistor

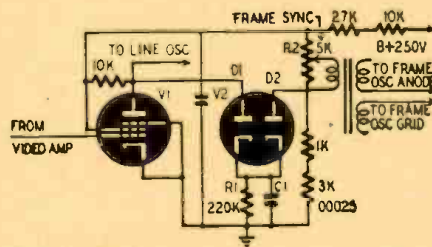

Fig. 5—Vertical sync separator circuit.

R1, which, with C2 in series, is connected between grid and plate of V2, the video amplifier. The voltage variations in the plate circuit of V2 are applied to the cathode of the cathode-ray tube. Since those which produce whites in the image must make the cathode less positive with respect to the grid (which is the same thing as reducing the negative bias on the grid), it follows that at this stage the signal must be such that the whites are represented by negative swings and the synchronization pulses by sharp positive rises. The plate of V2 is also connected direct to the cathode of the second diode of V1. During a picture signal the diode D2 is normally nonconducting, and C2 keeps the voltage steady at about the peak white value; the amount of negative feedback in V2 is then minute. But when a signal peak due to ignition interference comes along, the cathode of D2 is driven negative. The diode conducts and considerable negative feed-

back occurs in V2, this suppressing the interference.

The third double-diode (V2, Fig. 5) acts in a novel way as frame synchronization pulse selector. You will recall that, in the plate circuit of the video amplifier, the picture impulses of the signal swing negative and the sync pulses positive. The grid circuit of the sync separator V1 contains a d.c. restoring network not shown in Fig. 5. This tube is closed during the negative picture part of each line and conducts only on the sync pulses. These appear, of course, as negative voltages in its anode circuit, which feeds D1 of V2 direct. During the picture part of each line when the sync separator is closed, the anode of D1 is at a higher positive potential than that of D2. D1 then conducts, but D2 does not. As C1 charges, the cathode potentials of both diodes become almost equal to that of the plate of D1. Along comes a sync pulse, dropping the plate potential of D1. Because of the time constant of R1-C1, the potential of the 2 cathodes falls more slowly. The time constant is such that a short line-synchronization pulse does not drop it far enough to cause D2 to conduct. The tube therefore makes no response to such pulses. The long frame-synchronization pulses, however, are accepted since their greater duration allows sufficient time for D2 to become conductive. R2 forms the frame sync control.

A medium-priced receiver

Another example of the moderately priced televiser is the Bush T91 console (block diagram of television portion in Fig. 6) which sells at \$288. The sound channel, tapped off from the out-

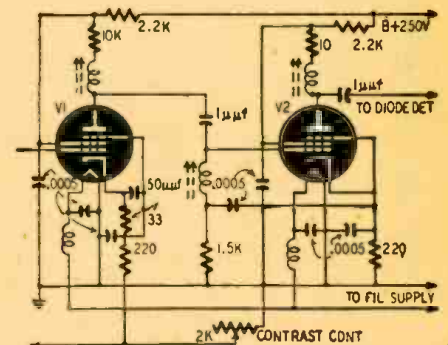

Fig. 7—R.f. tuning system of Bush televiser.

put of the second r.f. amplifier, is a superheterodyne with a triode-hexode frequency changer plus pentode i.f. plus double-diode-triode detector, a.v.c. and

(Continued on page 138)

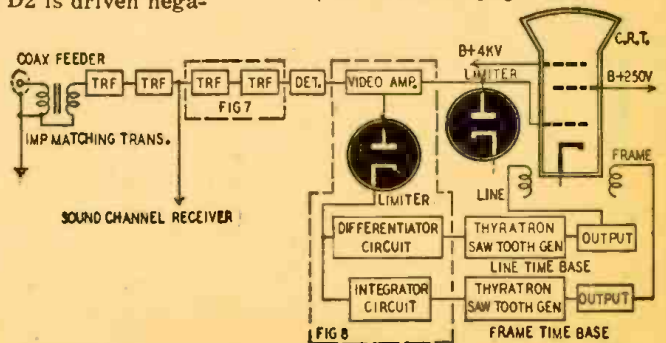

Fig. 6—Block diagram of the Bush T91, a medium-priced receiver.

TELEVISION AND FM ANTENNAS

By H. WINFIELD SECOR

RECEPTION of television and FM signals calls for special antennas capable of intercepting high-frequency waves with maximum efficiency over a broad frequency band. Most antennas designed for this service are based on the simple dipole of Fig. 1.

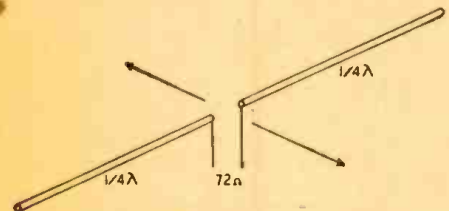

Fig. 1—The dipole, simplest and basic antenna.

The combined length of the 2 rods (or tubes) is equal to $\frac{1}{2}$ the wave length, minus a correction (about 6% for high frequencies) to compensate for the so-called end effect. (The electrostatic capacitance at the ends of a half-wave dipole, and also the fact that the velocity of the wave or current is slowed down in traversing a conductor, requires the dipole to be slightly shorter than the electrical wave length in space.)

The formula for computing the length of the half-wave dipole is:

$$L \text{ (in feet)} = \frac{462}{f}$$

where f is the frequency in megacycles to which the antenna is to tune. F is ordinarily the geometric center of the

band to be received: 97.6 mc for the 88-108-mc FM band; 62.2 mc for the center of the lower television band; 195 mc for the center of the upper television band. (The geometric center of a band is found by taking the square root of the product of the frequencies at the extremities of the band. Thus for the FM band it is equal to $\sqrt{88 \times 108}$, or 97.6 mc.) Sometimes an antenna is cut to the frequency of the weakest station to be received, instead of to the center of the band.

The lengths of dipoles, reflectors, and directors for various frequencies is given in megacycles in the chart of Fig. 2. To calculate the dimensions of an

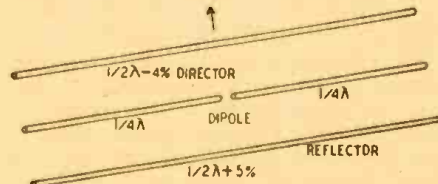

Fig. 3—Directional reflector-director-dipole.

antenna for the center of the FM band (call it 98 mc) for example we read across from 98 mc on the left-hand side of the chart until the horizontal line strikes the curve marked *dipole*, then look down to *length in inches*. There we find 56.7 inches for the length of the dipole (both legs), or 28.3 inches for each leg. The length of the reflector, if wanted, is found to be 59.4, and the director length 54.4 or roughly 59 1/2 and 54 1/2 inches, respectively.

The impedance of a simple dipole is approximately 72 ohms. It may be

matched by a 50- to 100-ohm transmission line. Fig. 3 shows how a reflector or director can be added to the dipole to increase the gain in a forward direction. Maximum gain direction is indicated by the arrow. For television reception the reflector is usually spaced $\frac{1}{4}$ wave length behind the dipole, to give broader tuning. The *reflector* is made 1.05 times the length of the dipole. The *director* element provides still greater gain in a forward direction. It is made 0.96 times the length of the dipole. Adding these elements makes the antenna response curve much sharper. The off-resonance response falls off quite rap-

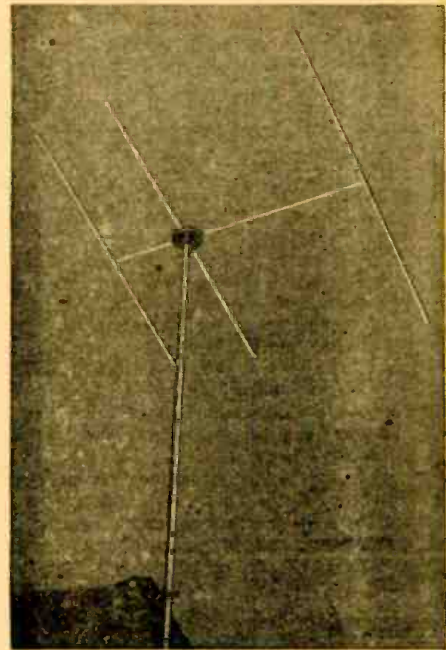

Fig. 4—A commercial type 3-element antenna.

idly. Fig. 4 is an interesting example of a dipole with director and reflector.

The folded dipole at Fig. 5 provides a broader frequency response than a simple dipole, and is being widely used for both FM and television reception. It has an impedance of about 300 ohms, and is easily matched by a 300-ohm line. Most television and FM receivers have an input impedance of 300 ohms, so the match is good.

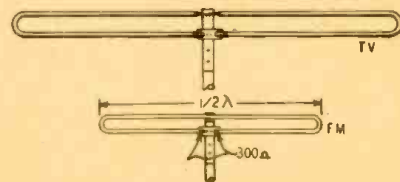

Fig. 5—Folded dipoles are becoming popular.

The vertical distance between the top and bottom elements of the folded dipole is made less than $\frac{1}{4}$ wave length, and averages 3 to 4 inches. To improve

(Continued on following page)

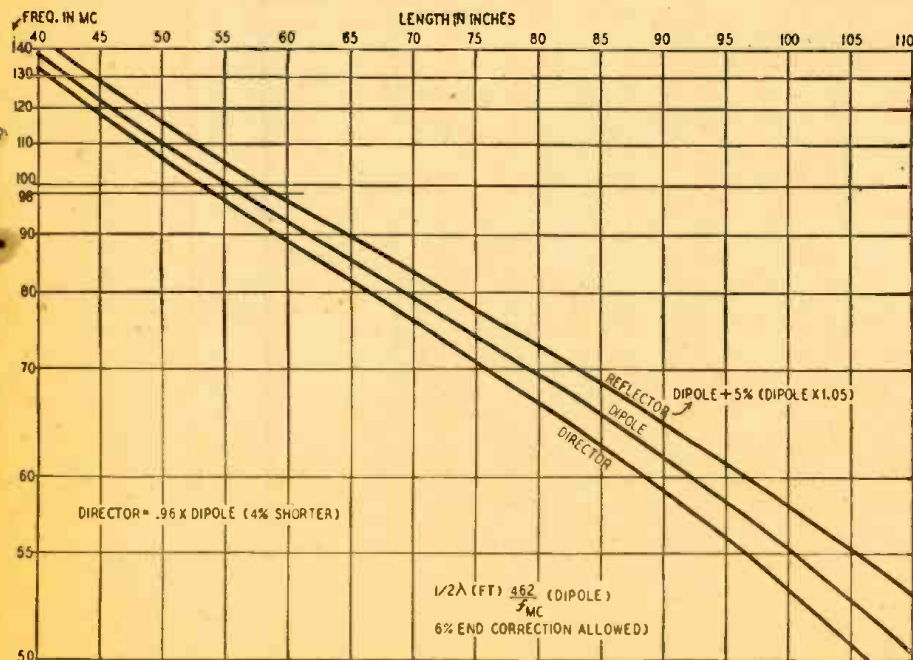

Fig. 2—The correct length of FM and television antennas can be calculated from this chart.

the gain in a forward direction, a reflector is often placed $\frac{1}{4}$ wave length to the rear of it. The surge impedance is about 250 ohms for this combination, but it can still be matched by a 300-ohm line, as a mismatch as great as $2\frac{1}{2}$ to 1 is tolerated in many television installations.

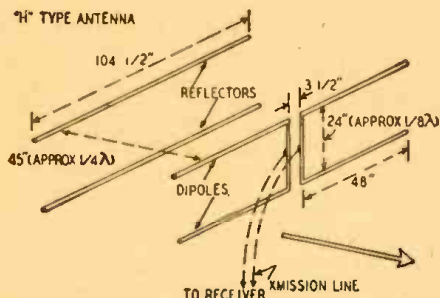

Fig. 6—Double dipole is sharply directional.

A double dipole, with reflectors, for TV reception is shown in Fig. 6. The arrow indicates the direction of maximum reception. The average surge impedance in this antenna is 200 ohms.

One of the broadest tuning antennas is the double cone type of Fig. 7, the



Fig. 7—The cone is a basic wide-band antenna.

nearest commercial approach to which is the fan type now coming into favor. The length of each cone is 0.36 wave length; the base of each cone subtends an angle of about 22 degrees. The cones can be wire cages or be made of thin sheet metal. The surge impedance is about 68 ohms at the center of the antenna and may be matched by a 72-ohm line.

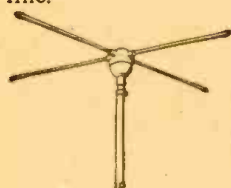

Fig. 8—The cross, an antenna type used where non-directional reception is desired.

The cross-type antenna (Fig. 8) is one of the newer designs and is non-directional. Two dipoles are interconnected by a quarter-wave phasing loop.

The tubes for the dipoles may be $\frac{3}{8}$ to $\frac{1}{2}$ inch in diameter of aluminum or dural stock. The limbs of the dipoles are often made telescopic, to permit adjusting the length to suit a given frequency.

Transmission lines

The principal types of transmission lines are twisted pair, the new plastic twin lead, and co-axial cable. Twisted pair (surge impedance 72 ohms) is the least efficient, but costs the least; the flat twin lead is efficient, but it may at times pick up interference; the co-axial cable is very efficient and free from interference pickup, but is expensive.

The flat twin lead is available in 75-, 100-, 150-, and 300-ohm impedances. Co-axial cable comes in a variety of impedances, such as 50, 75, and 93 ohms.

Two lines may be connected in parallel to halve the impedance.

Locating the antenna

The higher the better—is a good rule for high-frequency as for all other antennas. Although the theoretical maximum transmission range is the optical horizon, some bending of the waves takes place through the atmospheric layers, and the formulas given below (including the chart of Fig. 9) take this refraction or bending of the waves into account. The formula for calculating the reception distance in miles is:

D (miles) = $1.41 \sqrt{H}$ (feet), where H is the height of the transmitting antenna. The receiving antenna is assumed to be at ground level. If the receiving antenna is high, the range is increased proportionately; and the formula below can be used for computing the probable maximum distance for regular reception.

$D = 1.41 \sqrt{H_t} + 1.41 \sqrt{H_r}$, where H_t = the height in feet of the transmitter antenna, and H_r = the height in feet of the receiving antenna.

The distance over which v.h.f. signals may be heard varies considerably; this fall, one of the editors of this magazine had occasional (but not regular) reception from a dozen 88-108-mc FM stations, 150 to 500 miles away, using a simple dipole about 35 feet high. The calculated regular range for some of these stations was about 50 miles, so reception was probably due to freak reflections in a sunspot maximum year, or in some cases due to greater than normal bending of the waves at the horizon. The distance over which v.h.f. signals can be heard regularly does not vary greatly. The formula gives a good average value.

Long-distance reception

For v.h.f. reception at the extreme limits of the regular service area of a

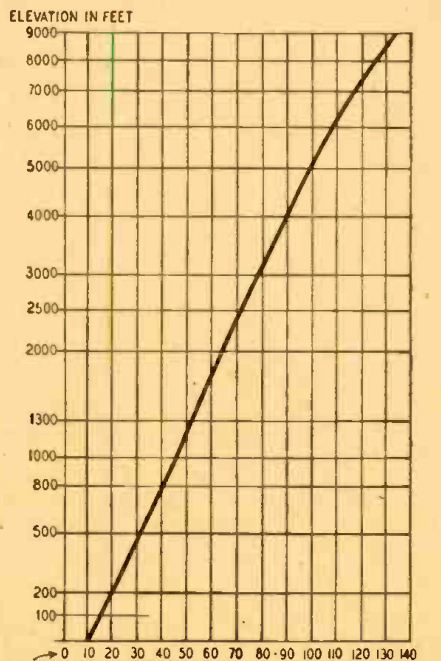

Fig. 9—Chart shows range vs antenna height.

station, the dipole antenna may be raised to an extra high elevation, but this is not always possible.

A rhombic antenna is suitable for television or FM reception, as it covers a very wide band of frequencies, 60 megacycles for example when the antenna is designed for it. The rhombic is very sensitive to weak signals and is strongly directive. Charts and formulas for designing rhombics for different frequencies are given in radio textbooks and a number of special antenna handbooks are also published.

A single wire several wavelengths long is another possible antenna for long-distance reception.

New types of h.f. antennas

Designers of h.f. antennas have developed a number of novel types, with broad frequency coverage.

The Andrews Di-Fan TV and FM antenna is designed to intercept a broad band (all the TV and FM frequencies from 44 to 216 mc). The antenna is used with a 300-ohm line, and a performance curve shows it to be superior to a folded dipole.

Another new departure is to combine 2 antennas in a single unit, one for the reception of the lower h.f. channels and

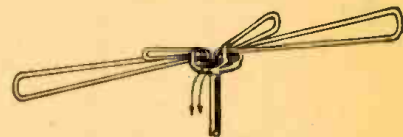

Fig. 10—A folded dipole for two frequencies.

the other for receiving the upper h.f. channels or frequencies. The 2 antennas are suitably joined by a special impedance-matching section. An array of this pattern is the Brach type 338 FM and TV (Fig. 10). The bands covered are 44-108 and 174-216 mc. It uses a 300-ohm line. Two folded dipoles are used.

The cross-type antenna for omnidirectional FM reception is favored by several manufacturers, notably Brach and The Workshop Associates. The upper and lower dipoles which form the cross are joined through a quarter-wave matching section. A 300-ohm twin conductor or cable usually connects the cross antenna to the receiving set. The joint impedance of the combination is about 125 ohms.

An adjustable V-type antenna is featured by Pre-max. The arms can be set at various angles to suit changes in polarization of the received wave. The impedance varies from 100 to 200 ohms, but may be matched by a 300-ohm line. The arms are of the proper length to resonate at the center of the FM band. (See Fig. 11.)

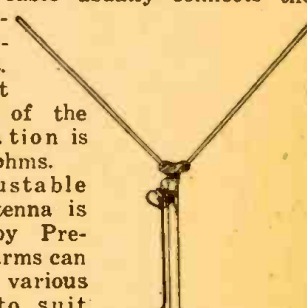

Fig. 11—The adjustable-V antenna.

(Continued on page 126)

WORLD-WIDE STATION LIST

Edited by ELMER R. FULLER

WELCOME to the new year, and may it bring you all kinds of happiness and good luck; and the best in dx. May it give you a renewed spirit to go after that dx. Reports for the past month have been much better and more useful than during the fall. Perhaps winter is having its usual good effect upon the short-wave bands. Reports have been received from Gil Harris of Massachusetts; Charlie Fox of Indiana; Charles Sutton of Ohio; Stathis Linardos of New York City; Joe Stanks of New Jersey; S. K. Steinfeld of Louisiana; R. C. Berens of Pennsylvania; John Winkler of Michigan; Bill Moore of Pennsylvania; the U. S. State Department; the Canadian Broadcasting Corporation; J. B. Yates of New York; the Australian News Agency of New York City; and the British Broadcasting Corporation.

Berne, Switzerland seems to be very active lately on 11.865 megacycles, being reported by nearly every observer. They are beamed to Australia on this frequency but come in very well on the east and west coasts. Their present schedule is Monday, Tuesday, Thursday and Friday, 0215 to 0330; and Tuesday 1000 to 1100. They are also heard to North

America 2030 to 2230, EST. Reports of reception may be sent directly to the station in Berne, Switzerland.

Paris is now being heard very well on the east coast on 11.845 megacycles from 2100 to sign-off at 2245. They are also heard on this frequency from 1045 to 1130 but with much poorer results than at the later hour. This transmitter offers the best reception from France at the present time.

OLR3A from Prague, Czechoslovakia is being heard very well on 9.550 megacycles. We have not learned their schedule, but they have been heard as early as 1430 and have been known to sign off at 1700. The news is given in English at 1545 and 1645 hours. VLB9 in Shepparton, Australia, is being heard in the late afternoons with the news in English at 1530. The frequency is 9.615 megacycles. "The Voice of Australia" is also heard beamed to North America from 1000 to 1115 and 1500 to 1630 daily on 11.760 megacycles. The call used on this frequency is VLA8.

XMTA from Changsha, China, has been heard on the east coast at 0550 on 12.220 megacycles with a fair signal. This is a very good catch and was reported to us by Gil Harris. He also re-

ports hearing PZR in Paramaribo, Surinam on 10.970 megacycles at 1717 hours with music. PJC1 in Willemstad, Curacao is being heard consistently on 7.250 megacycles from 1630 to 2130; but they are also on from 1130 to 1230 hours. We would like some reports on these hours so that we may check on their schedule for this noon broadcast.

EPB in Teheran, Iran, is being heard at 0715 on 15.100 megacycles. LKQ in Norway is being heard on 11.735 megacycles at 0800. A transmitter in Finland was reported being heard on 9.495 megacycles at 0710. PCJ in the Netherlands has been reported in the 25-meter band using 11.730 megacycles at 1820. Has anyone else heard this station? It was reported from the east coast in November. FHE3 from Dakar is reported by Charles Sutton at 0215 on 11.712 megacycles and is also reported as being heard at 1500 to 1600. SBP in Stockholm on 11.700 megacycles at 0140; and SDB2 in Stockholm on 10.780 megacycles at 2000 to 2100.

Inca, Peru is heard on 9.815 megacycles from 2000 to 2400 with a power of 150 watts.

All schedules are Eastern Standard Time.

Freq.	Station	Location and Schedule	Freq.	Station	Location and Schedule	Freq.	Station	Location and Schedule
11.720	CKRX	WINNIPEG, CANADA; 1000 to 2000	11.870	WNRA	NEW YORK CITY; European beam, 1715 to 1800	11.900	CXA10	MONTEVIDEO, URUGUAY; 1830 to 2115
11.720	OTC	LEOPOLDVILLE, BELGIAN CONGO; 0530 to 0730	11.870	Munich II	MUNICH, GERMANY; European beam, 1200 to 1700	11.930	GVX	LONDON, ENGLAND; 0515 to 0530; 0600 to 0630; 1700 to 0730; 0745 to 0900
11.720	WRUW	BOSTON, MASSACHUSETTS; Central American beam, 1730 to 1900	11.880		MOSCOW, U.S.S.R.; 2200 to 0600; 0720 to 1900	11.960	HEK4	BERNE, SWITZERLAND; 1645 to 1715 except Saturdays
11.720	WRUL	BOSTON, MASSACHUSETTS; Central American beam, 2000 to 2400	11.880	LRR	ROSARIO, ARGENTINA; 0800 to 1800	11.970	FZI	BRAZZAVILLE, FRENCH EQUATORIAL AFRICA; 0000 to 0230; 0445 to 0800; 0930 to 1030; 1100 to 2030
11.730	WRUL	BOSTON, MASSACHUSETTS; European beam, 1410 to 1700	11.880		MOSCOW, U.S.S.R.; 2200 to 0230	11.990	CSX	LISBON, PORTUGAL; 0800 to 1000
11.730	KGEX	SAN FRANCISCO, CALIFORNIA; Philippine beam, 0030 to 0345; 0400 to 1005	11.890	KWIX	SAN FRANCISCO, CALIFORNIA; Japanese-Chinese beam, 0400 to 0930	12.000	CEI186	SANTIAGO, CHILE; 0600 to 0800; 1600 to 2300
11.740	COCY	HAVANA, CUBA; 0630 to 0100	11.900	KWID	SAN FRANCISCO, CALIFORNIA; South Pacific beam, 0015 to 0630			
11.740	CEI174	SANTIAGO, CHILE; 1700 to 2400	11.900	XGOY	CHUNGKING, CHINA; 0500 to 0630; 1045 to 1145			
11.740	HVJ	VATICAN CITY; 0915 to 0025; 0930 to 0900; 1100 to 1145						
11.750	GSD	LONDON, ENGLAND; 1215 to 1800; 1815 to 1200						
11.770	WGEA	SCHENECTADY, NEW YORK; European beam, 1515 to 1805						
11.770	KNBI	DIXON, CALIFORNIA; South American beam, 1900 to 2400						
11.780	HP5G	PANAMA CITY, PANAMA; 0745 to 1000; 1200 to 2230						
11.780		MOSCOW, U.S.S.R.; 0900 to 1000; 2000 to 2130; 2200 to 0100						
11.790	WLWO	CINCINNATI, OHIO; South American beam, 2000 to 2200						
11.790	WRUA	BOSTON, MASSACHUSETTS; European beam, 1430 to 1805						
11.790	KNBI	DIXON, CALIFORNIA; Chinese beam, 0230 to 0345; 0400 to 1005						
11.810	KCBF	DELANO, CALIFORNIA; Alaskan beam, 2215 to 0345						
11.810	WOOW	NEW YORK CITY; European beam, 0500 to 0715						
11.810	WGEA	SCHENECTADY, NEW YORK; Brazilian beam, 2000 to 2200						
11.820	GSN	LONDON, ENGLAND; 2300 to 0030; 0100 to 0500; 1030 to 1430; 1700 to 2030						
11.830	WCBN	NEW YORK CITY; Caribbean beam, 1715 to 1745; Mexican beam, 1800 to 0100						
11.830	WNRX	NEW YORK CITY; European beam, 1400 to 1700						
11.830		MOSCOW, U.S.S.R.; 2200 to 0600; 0730 to 0845; 1100 to 1600						
11.830	CXA19	MONTEVIDEO, URUGUAY; 0600 to 2200						
11.830		CONSTANTINE, ALGERIA; 0030 to 0300; 1200 to 1800						
11.840		MANILA, PHILIPPINES; Rast Asia beam, 0400 to 1005						
11.840	VLC7	SHEPPARTON, AUSTRALIA; 0800 to 0915						
11.840		PARIS, FRANCE; 0000 to 0045; 0100 to 0145; 0545 to 0615; 1045 to 1130; 1315 to 1730; 1830 to 2345						

(Continued on page 106)

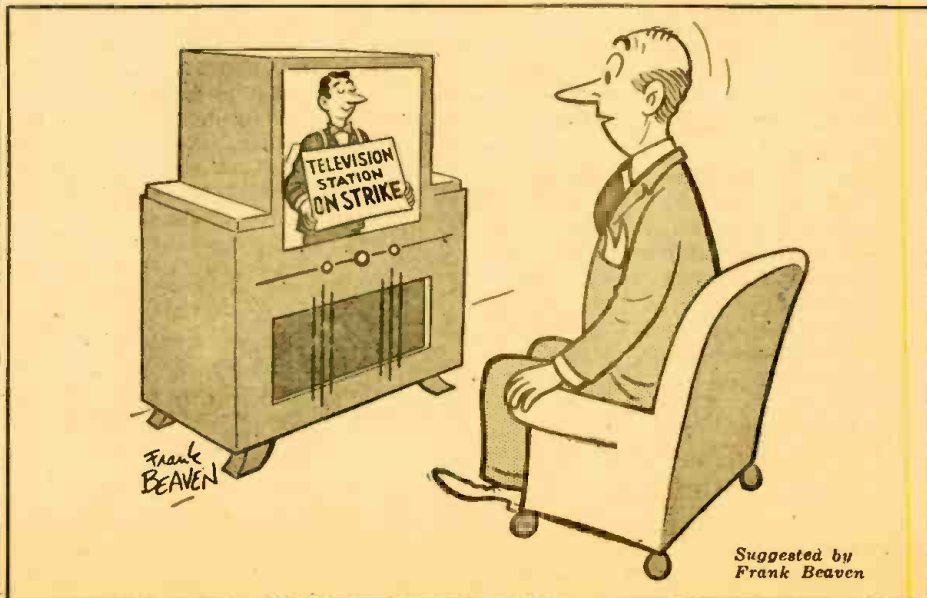

Suggested by Frank Beaven

Radio Set and Service Review



◀ RCA 630TS Television Receiver

THE RCA Model 630TS is a 30-tube, table-model television receiver with a 10-inch direct-viewing cathode-ray tube which produces a picture 8½ inches wide and 6¾ inches high. It is self-contained and receives signals on channels 1 through 13 with true FM reception of audio signals. Designed for operation from 117-volt, 60-cycle lines, it consumes 320 watts.

Seven operating controls are conveniently placed on the front panel. Symmetrical panel layout and concentric shafts on 6 controls simplifies operation of the set. The brightness, horizontal and vertical hold, contrast, volume and on-off switch, station selector, and fine or vernier tuning controls are on the panel. The vernier control provides a variation of ± 300 kc on channel 1 and 750 kc on channel 13.

The sound channel

The receiver's sound channel shares a 6J6 r.f. amplifier, 6J6 converter, and 6J6 oscillator with the video channel. There are then two 6BA6 21.25-mc i.f. amplifiers, a 6AU6 limiter, and a 6AL5 discriminator that feeds into an audio amplifier consisting of a 6AT6 and a 6K6-GT. The power amplifier develops 2.5 watts of undistorted power in a 5-inch speaker.

The video channel

Four 6AG5's are used in the 25.75-mc video i.f. amplifier stages. They are stagger-tuned to provide a 4-mc band width. The video detector uses half of a 6AL5 and works into a 2-stage video amplifier. The other half of the 6AL5 is the d.c. restorer. The second video amplifier drives the grid of the 10BP4 cathode-ray tube.

Sync signals are taken off the plate of the d.c. restorer and applied to a 6SK7 sync amplifier with such polarity that noise pulses greater than the sync are effectively eliminated. The output of the sync amplifier is positive. When these signals are applied to the grid of the 6SH7 sync separator, the video and blanking signals are removed, leaving only sync signals. These are properly polarized and clipped by the second sync amplifier, half of a 6SN7. The vertical pulses are passed through an integrating network to the vertical b.t.o. (blocking tube oscillator). The 6J5 vertical oscillator is coupled to the grid of a 6K6 which further amplifies the de-

flexion signal and couples it to the vertical deflection coil.

The 6K6 horizontal oscillator produces sine waves of opposite polarity on the plates of the 6AL5 horizontal sync discriminator. Horizontal sync pulses from the second sync amplifier are passed through a differentiating network to the center tap on the secondary of T108, so that when the horizontal sync pulses and the horizontal oscillator are in phase, the output of the discriminator is zero. When the oscillator is out of phase, the discriminator develops a voltage that is applied to the grid of the 6AC7 reactance tube. This tube is across the oscillator winding and effectively varies the inductance to bring the oscillator back into phase with the sync pulses.

In some instances, the transmitted sync pulses may be unintentionally phase-modulated. Under these conditions, it may be difficult for the discriminator to follow variations in phase, and the picture will shift rapidly back and forth horizontally. If this trouble arises, and it has been determined that it is caused by phase modulation and not some maladjustment in the set, remove the connector from between terminals 2 and 3 on the sync link (J10 on the rear of the chassis) and place it between terminals 1 and 2. This connects condenser C171 into the circuit and increases the speed of the discriminator response, thus producing a more stable picture.

The horizontal oscillator generates sine waves between its cathode and screen grid. Its peak-to-peak grid voltage is in the order of 130. This high grid drive produces a square wave in the plate circuit. The oscillator plate is connected to a discharge tube (one-half of a 6SN7) through a differentiating network, C176 and R202.

The discharge tube shapes the wave form so the horizontal amplifier output tube produces the proper current in the horizontal deflection coil. A special output transformer matches the deflection coil and provides a source of energy for operating the kickback power supply for the anode of the picture tube. The operation of this circuit is discussed in the article *Servicing Televisers* on page 50 of this issue.

The low-voltage power supply delivers filament, plate, and bias voltage for the receiver. It uses two 5U4's in parallel delivering 400 volts d.c. at 290 ma. A 62-ohm speaker field coil is used with 160 μ f of filter capacitance.

Servicing and installation

A number of controls, other than the i.f. and r.f. adjustments, are important

to proper operation of this television receiver. These seldom require adjustments and are not mounted on the front panel. The horizontal centering, focus, vertical linearity, horizontal oscillator frequency, height and horizontal drive controls are on the rear of the chassis and have knobs for adjustments. Other controls are: width (rear chassis—screw driver adjustment), horizontal linearity (top chassis—screw driver adjustment), horizontal oscillator phase (bottom chassis adjustment), focus coil (top chassis—wing-nut adjustment), ion trap coil (top chassis—thumb-screw adjustment), and deflection coil (wing-nut adjustment from top of chassis).

Be careful when installing or servicing this or any television receiver. Voltages are lethal, and an imploding cathode-ray tube can do serious damage and cause personal—even fatal—injuries. *Do not install, handle, or unpack a cathode-ray tube without wearing heavy gloves and shatterproof goggles.* All persons not so equipped should be kept at a safe distance. The bulb of the tube is highly evacuated, and any undue pressure or scratches on the bulb can cause the glass to rupture.

Be careful when servicing the set with protective covers removed. There is danger of contacting high voltage, and **HIGH VOLTAGE IS DANGEROUS!**

For servicing this receiver, the manufacturer recommends a signal generator, sweep generator, oscilloscope, and electronic voltmeter.

The signal generator should provide frequencies between 19.75 and 27.75 mc, and 45.25 and 215.75 mc. The output on these frequencies should be adjustable and at least 1 volt maximum. If the signal generator is not crystal-controlled, a heterodyne frequency meter with crystal calibrator is required for checking the generator's accuracy. Make voltage measurements with an electronic voltmeter equipped with a high-voltage multiplier probe to permit measurements up to 10 kv. An r.f. sweep generator, covering from 18 to 30 mc with 1-mc sweep and from 40 to 90 mc and 170 to 225 mc with a 10-mc sweep, is required for use with an oscilloscope. The 'scope should

(Continued on page 140)

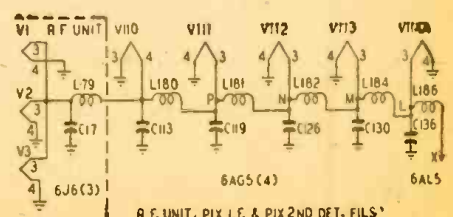

Some of the filaments have special circuits.

SERVICING TELEVISERS

The more common faults in a vision receiver and how to locate and remedy them

By MILTON S. KIVER

A TELEVISION receiver is two-receivers in one: a sound receiver and a "sight" receiver. Whatever occurs within the set must flash a trouble signal in the loudspeaker or the cathode-ray image tube, or both. It remains then for the serviceman to interpret such signals and correct the trouble.

The major servicing divisions of a television receiver are shown in Fig. 1. The type of signal present in each circuit is indicated, together with the front-panel and secondary controls. The diagram reveals that sound and video signals follow a common path only in the r.f. section of the receiver. Thereafter the two signals separate and follow individual paths.

The audio system leads to the loudspeaker; the video system to the cathode-ray tube, which also receives voltages from the horizontal and vertical deflection systems and the high-voltage power supply. In many of the newer sets, the high-voltage power supply is essentially part of the horizontal deflection system. This trend toward the flyback method of generating high voltages is on the upgrade.

To the intelligent serviceman these facts will immediately suggest the following:

1. If a circuit defect affects one system but not the other, the fault lies somewhere between the point where the audio and video signals separate and the end of the system affected.

(For example, a set brought in for repair worked normally on the sound but produced no images on the screen. Ob-

viously the defect existed in some stage of the video system. Just as obvious was the fact that the front end of the set was operating normally because both audio and video signals were present there. One of the video i.f. tubes was found to be defective.)

2. A defect affecting both systems must exist in circuits which are common to both. Common stages include the r.f. amplifier, the mixer and oscillator tubes, and the low-voltage power supply.

3. The final image is a composite of several different voltages acting on the cathode-ray tube. Each voltage possesses its own definite characteristics, and from these indications the proper section of the receiver can be identified.

These are the essential servicing facts that the serviceman must know to tackle a television receiver effectively. Typical receiver troubles are analyzed in the following paragraphs to show how the analysis is carried from output indication to the specific stage and component. Whenever possible, the defect will be tied in with the television receiver schematic shown on page 49, which will be referred to as Fig. 2. The set shown is the latest RCA table-model receiver 630TS, employing 30 tubes, a 10-inch cathode-ray tube, flyback-type high-voltage power supply, and a phase-synchronized horizontal deflection system. The circuit was chosen because its design is followed by many radio manufacturers, all of whom are RCA licensees.

The test equipment required for a thorough servicing job consists of:

1. R.F. SWEEP GENERATOR with the following characteristics:
 - (a) Frequency ranges:
 - 15 to 30 mc with sweep width adjustable to 10 mc;
 - 40 to 90 mc with a 10-mc sweep width;
 - 170 to 225 mc with a 10-mc sweep width.
 - (b) Output constant on all ranges and on all attenuator positions.
 - (c) Output variable up to 1 volt.
2. CATHODE-RAY OSCILLOSCOPE with a wide-band vertical deflection system.
3. VACUUM-TUBE VOLTMETER with a high-frequency probe permitting reliable measurements up to 250 mc.
4. SIGNAL GENERATOR capable of providing individual frequencies from 15 mc to 225 mc. This generator will serve to establish definitely the location of frequency points on the i.f. and r.f. response curves, to produce marker signals, and to peak trap circuits and individual tuning coils, when necessary.

Before we begin the analysis, a word first about checking tubes. They are by far the most common source of trouble in television receivers. This does not mean that, as soon as a receiver is brought into the shop, the tubes are all immediately yanked out and tested. What is meant is that, as soon as a defect is traced to a certain section of the receiver, the tubes in that section are tested first.

R.F. system defects

A defect in the r.f. system, which can include the antenna and lead-in transmission line, is indicated by no picture, sound, or sync. On the screen, only the scanning raster is seen. The absence of both video and audio immediately points to the r.f. system where both signals follow a common path. Check tubes V1, V2 and V3 in this section. (Fig. 2.) Measure the oscillator grid voltage. The value should be between 4.5 and 6.5 volts. If these indications are normal, then a sweep (FM) signal generator should be connected across the input terminals and set at the audio carrier frequency. If the trouble lies in the antenna or transmission line, a single audible note will be obtained from the loudspeaker. Physical examination of the antenna system will generally reveal any broken conductors.

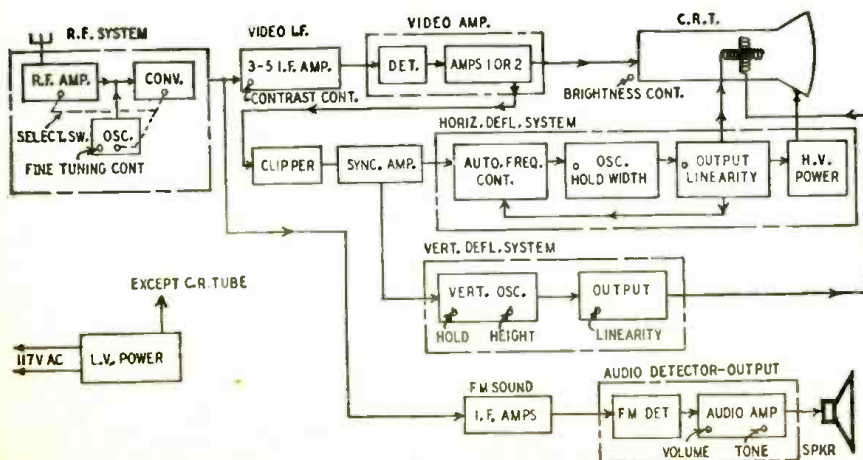

Fig. 1—Block diagram of typical televiser. Some sets have controls in addition to these.

Trouble seldom arises in the tuned circuits of the r.f. stages. However, if one of the coils should open up, it can usually be detected by switching the set to a higher channel. Doing this automatically cuts out the defective coil, permitting the receiver to function normally again. If no stations are operating at the higher frequencies, loosen the transmission line and brush its end leads across the receiver input terminals. Bursts of noise will be heard in the loudspeaker (yes, even with FM), and flashes of light will appear on the screen. If the signal path is broken at any point in the r.f. system, these interference or noise voltages will be unable to pass and there will be no indication, either in the loudspeaker or on the screen.

An inoperative oscillator can usually be detected by noise heard in the loudspeaker and noise flashes visible on the image screen. No station is received in any position, and no oscillator grid voltage can be measured.

These are the primary difficulties that beset the front-end portion of the receiver.

Audio i.f. and a.f. system

Troubles arising in the audio portion of the receiver manifest themselves by the absence of sound from the loudspeaker and the appearance of a normal image on the screen. The defective stage can be localized, 9 out of 10 times, by tapping the grid terminals of each tube in the audio system in turn, starting with the audio output tube and working back progressively toward the receiver mixer. So long as the portion of the audio system is working, a thumping noise will be heard from the output when the finger taps the grid of a tube. This method of quick testing will work with most FM systems. When the results of the test are inconclusive, the use of a sweep signal generator is recommended. The method of testing now becomes one of signal tracing, noting where the passage of the signal becomes blocked.

Another difficulty sometimes encountered is distorted sound output (or no sound at all) coupled with poor image quality. The cause of this lies in the oscillator. Due to heat, dust, or prolonged operation, the oscillator frequency may drift sufficiently to detune the FM and distort the video signal. The solution is a realignment of each oscillator coil. On jobs of this sort, it is best

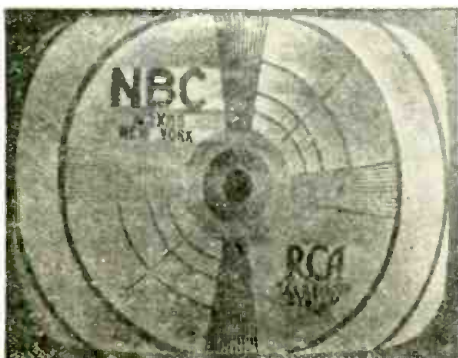

Fig. 3—A pattern due to oscillator trouble.

to keep the set working in the shop for two to three days to make certain that the trouble does not reappear.

Video and video i.f. amplifiers

1. Large objects and letters appear smeared in image (see Fig 3), but sound comes through clear and undistorted. If the sound is unaffected, the trouble must be in the video system. The path exclusively devoted to the video signal contains the video i.f. amplifiers, the video detector, and the video amplifiers. Smearing in an image indicates poor low-frequency response or tube distortion. Therefore, the trouble is probably in the video amplifiers where special-frequency compensating networks are employed.

Check defective coupling, bypass condensers, or grid load resistors in the video amplifiers, V115 and V116. Check C138, C140, C141, C223B, R138, R142, R143, R148, etc. Smearing may be due to an overloaded video amplifier or a defective component affecting the low-frequency response. Overloading of the video amplifier may arise because of insufficient bias on the control, resulting in grid current. Check the bias and possible grid current of V115 and V116 (Fig. 2).

2. Loss of fine detail and blurring of small objects. This defect is most apparent when the station test pattern is received; the vertical wedges are not sharp and clear, and adjustment of the focus control does not clear up the difficulty.

The fine detail in a television image is a function of the higher frequencies. Detail losses may be due to improper alignment of the r.f. and i.f. tuned circuits; defective video amplifier tubes

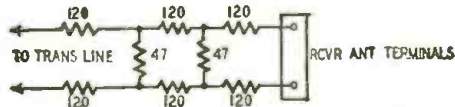

Fig. 4—Attenuation pad for weakening signal.

V115 and V116; defective peaking coils L187, L188, L189, L190, L191 and L192; and finally, defective interstage coupling condensers, such as C138, C140 and C141. It is well to remember that lower-priced receivers are generally designed for less than the full 4.0 mc video response. Consequently, the images in these sets will not contain as much detail as those produced in more carefully designed receivers.

3. High distorted image, especially when the contrast control is in maximum position. Sound, however, is clear. The contrast control is a gain control employed in the video i.f. system (R131, Fig. 2). If the image can be partially restored to normal by lowering the setting of the contrast control, it is an indication that too strong a signal is being received. Alter the position of the antenna or insert an attenuation pad between end of transmission line and receiver input terminals. (See Fig 4.)

If the distortion cannot be corrected by the contrast control the grids (possibly even the contrast control) have become grounded, causing all tubes con-

trolled to operate at maximum amplification. Check grid bias of each i.f. tube.

4. Appearance of dark horizontal lines across an image (Fig. 5) may be due to either a poorly filtered powered supply or the existence of audio voltages at the image tube control grid. The fol-

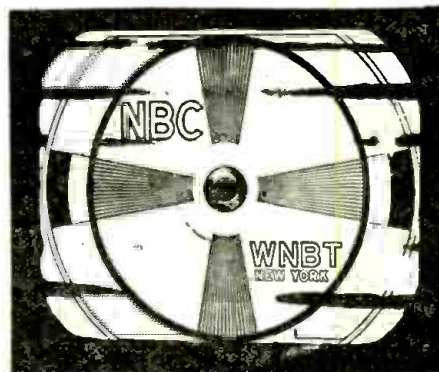

Fig. 5—Poor filtering causes this pattern.

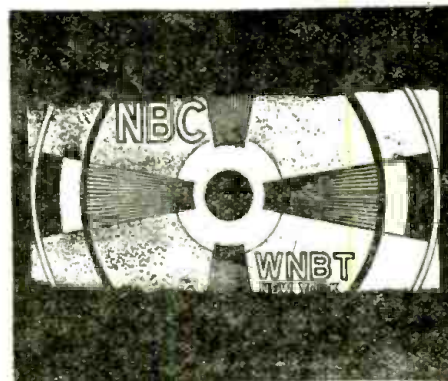

Fig. 6—Another pattern due to poor filtering.

lowing procedure will demonstrate how the source can be determined quite readily:

a. *Poorly filtered low-voltage power supply.* Two stationary, wide black bars will appear across the screen accompanied by an audible hum from the loudspeaker. The low-voltage power supply is common to both systems. The cause will be traced to a defective filter condenser in the low-voltage power supply. (See Fig. 6.)

b. *Audio voltages at the grid of the image tube.* The dark lines produced vary in intensity. Sound signal is partially or totally distorted. This immediately points to some component in the r.f. stages. To correct, adjust the FINE TUNING control. When the same visual indication is obtained, with a normal sound output, the source of trouble is in the video i.f. stages. Realign the audio trap circuits. C15 is the FINE TUNING control. T2 and T105 are the audio traps in the video system.

The image tube

1. Cathode-ray tube screen is brightly illuminated and brightness control is ineffective; sound is normal. Image appears thin and washed out but is held perfectly in place by the sync pulses.

Again a defective stage in the video system is indicated, according to ordinary reasoning. This time, however, the trouble is at the cathode-ray tube. The

(Continued on following page)

reasoning is: A weak signal will produce a thin, watery image, but this is always accompanied by noise spots (snow in the image) and poor synchronizing action. Since neither of the two latter are present, the bias control (brightness knob) of the cathode-ray tube must be the cause. Check the voltage between the control grid and cathode of the image tube. Check the brightness control R152 for continuity. If this potentiometer is good, try another cathode-ray tube. There may be leakage between the image tube grid and cathode. A gassy tube will produce the same symptoms.

2. Picture is small; mask not completely filled. Picture size is controlled by 2 factors: the vertical and horizontal deflection voltages, and the deflection yoke placement. Check the latter first by moving the deflection yoke along the neck of the tube. If this still doesn't produce the proper-size image, check the B-plus output of the low-voltage power supply. Too low voltage can be



Fig. 7—Deflection yoke is improperly placed.

the cause. When the image is small in one direction only, check the output of that particular deflection system.

3. Picture is on slant. (See Fig. 7.) For electromagnetic deflection tubes, rotate deflection yoke; for electrostatic deflection tubes, turn the tube to level up the picture.

4. No raster shows on screen. Check alignment of ion trap L203 and L202. Coils may be reversed, improperly positioned, or open. An additional cause producing the same absence of raster is

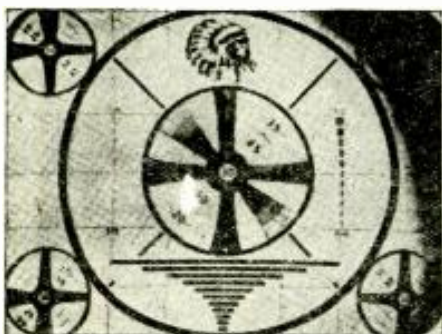

Fig. 8—The ion trap position is incorrect.

noted in the section dealing with horizontal deflection.

5. The appearance of a dark area on one edge of the screen can be traced directly to an improper alignment of the ion trap. (See Fig. 8.)

Vertical deflection faults

1. Thin horizontal line indicates a lack of vertical deflection voltage, just as it does in any oscilloscope. Check the vertical oscillator and vertical amplifier tubes. If these are in working condition, measure the voltage in these circuits. With power off, make resistance and continuity tests.

2. Picture "bounces" when set is jarred or heavy trucks pass nearby. Check all tubes in vertical system for microphonics. Best test is to replace each tube, in turn, with one known to be good.

3. Picture height is insufficient, but width is correct. If the set is functioning normally, adjustment of the height control will produce the proper picture height. Inability of the control to produce the desired height may be due to one of the following defects:

a. Defective vertical amplifier tube V122;

b. Lowered plate and screen voltages on vertical amplifier and vertical oscillator tubes V121 and V122.

4. A picture compressed at top indicates poor linearity of the vertical deflection voltage. The vertical saw-tooth deflection wave is developed in V121, amplified by V122, and then applied to the vertical deflection coils. Poor linearity, then, must be due to defects in these 2 circuits. Try correcting the image by adjusting R178, the vertical linearity control. However, if these adjustments fail, change the vertical output tube V122. If the defect still persists, check (preferably replace) C158, R174 (where deflection wave is produced), and C222B, C221C. Each of these components could affect the form of the vertical deflection voltage. Finally, grid, plate, and screen voltages should be checked against the manufacturer's recommended values. Line overlapping or image compression in the vertical direction can be due to lowered tube potentials.

5. Inability to center image vertically. (This analysis may also be applied to the horizontal centering control.)

a. *Electrostatic Deflection Tubes.* Open resistor in centering network. Check the contacts on the control potentiometer first. Then check continuity to cathode-ray tube socket from the centering resistors. Test for dirty contacts at socket of cathode-ray tube.

b. *Electromagnetic Deflection Tubes.* Test for open resistor in centering network. Measure the voltage across the centering control. If this is low, measure the low-voltage B-plus. A low value at either point can produce a restricted centering range. Finally, if all these points check properly, the trouble may lie in the cathode-ray tube itself. The electron gun may have become tilted due to some sudden jarring of the tube. In Fig. 2, the vertical and horizontal centering control resistors are R81 and R21.

Horizontal deflection

Most of the television receivers currently manufactured employ the *flyback* method of developing high accelerating potentials for the cathode-ray tube. Consequently, any trouble affecting the horizontal deflection system will usually

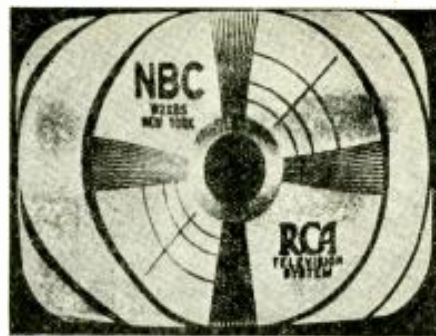

Fig. 9—Horizontal linearity circuit defect.

kill the high voltage, eliminating all visible traces from the cathode-ray tube screen. When all the tubes in a television set are lit and the cathode-ray tube is dark, the serviceman should first concentrate on the horizontal deflection system. Sound will be heard in the loudspeaker.

It is well to distinguish between a dark screen which is due to no high voltage, and a screen containing a scanning raster but no image. The latter difficulty, when accompanied by a normally functioning audio system, indicates a defective video system. In this case, the horizontal deflection system and the high-voltage power supply are both operating satisfactorily, as evidenced by the appearance of the scanning raster.

1. Lines in image are bent or elongated. (See Fig. 9.) This indicates a defect in the horizontal linearity circuit. Adjust the horizontal linearity control L201 according to the manufacturer's recommendations. If this fails, change the horizontal output tube V126 and the reaction scanning or damping tube V128. Check the saw-tooth generating network. (C179, R210 and R187). Finally, check all resistors and condensers directly associated with the horizontal linearity control.

2. Light vertical strips down left-hand edge of image are generally due to a defective damping tube V128. In the circuit of Fig. 2, C181 and R209 also may be at fault. With this defect, the picture may sometimes fold back on itself at the left-hand side.

The appearance of a dark vertical strip instead of a light strip generally can be traced to the horizontal output tube V126 or to an improperly adjusted horizontal drive control.

Interpretation the key

The key to television servicing is the serviceman's ability to interpret what he sees on the image tube and hears from the loudspeaker. The foregoing discussion illustrates how the effect is first studied by comparing the audible and visible outputs of the receiver and then deducing where the defect is. This process will be speeded up with experience and by a thorough knowledge of what each particular stage contributes toward the formation of the final image. The serviceman *must know* how a television receiver operates.

One final thought concerning television receiver servicing. The horizontal and vertical deflection systems develop distinctive wave forms which can be

(Continued on page 130)

Universal Speaker For Field or Bench

By **SIDNEY S. FLEISCHMAN***



All indications are on the instrument's panel.

It is a rarity when a test instrument manufacturer comes up with an instrument that can really be called different. This instrument, completely self-contained, is a universal test speaker. Included in it, in addition to the speaker, are a resistance-capacitance substitution decade, continuity tester, and output meter.

It has been designed, not as an auxiliary test instrument, but as a basic unit to be used in conjunction with other equipment for both rapid and efficient radio service work.

The test speaker section uses a simple method of speaker matching with a specially designed universal output transformer, which matches load impedances up to 25,000 ohms (Fig. 1). Dynamic and permanent magnetic types of speakers can be tested equally well. The various load impedances are selected from the chart on the front panel. (This feature in itself is most desirable, since the chart cannot be lost as instruction sheets sometimes are.)

A serviceman who suspects an open field can open the field circuit and easily select the proper field impedance from 500 to 2,500 ohms by plugging a pair of test leads into the proper tip jacks.

If the output transformer is suspected of being defective, open the primary circuit of the defective transformer and connect the test leads from the tip jacks marked INPUT to the plate and the B- of the output tube. Proper selection of the input with tip jacks 1, 2, and 3 de-

pends entirely upon the output tube or tubes and the circuit being tested. Connection can be made to either push-pull tubes or single-ended stages. The load resistance and input jacks are selected according to the chart on the front panel.

A speaker suspected of having a defective voice coil can have a new voice coil substituted by plugging into the tip jacks marked V.C. The leads from the output transformer to the defective voice coil are opened and the connection made across the secondary of the output transformer in the receiver under test. Both capacitance and resistance substitutions are available on the front panel. Six resistance values of 400, 50,000, 100,000, and 500,000 ohms and 2 and 5 megohms are available, as well as 7 capacitance values, .001, .01, .05, 0.10, 0.25, 30, and 50 μ f. These values, when used for grid-bias, coupling, bypass, and filter purposes, are perhaps the most common ones used in servicing. Simple continuity tests of resistance and capacitance are also available.

The line cord, located at the rear of the cabinet, should be plugged into any 117-volt a.c., 60-cycle source. Test leads are connected from the tip jacks marked "RES. and CAP." to the component under test. Be careful when handling the test leads, since some line potential is across the test leads during the continuity tests.

Condenser leakage can also be tested with the neon indicator. An open condenser is indicated by failure of the neon

to light. If the condenser is shorted, the neon tube glows continuously. A leaky condenser is indicated by a series of rapid flashes, the percentage of leakage being determined by the rapidity of the flashes. Resistors can be tested for continuity in the same fashion. When checking resistors, the neon indicator glows continuously, the brilliancy of the neon varying with the resistance.

An output meter is also incorporated in the instrument. The receiver should be aligned in the conventional manner, the brilliancy of the neon tube being continuously observed. Maximum brilliancy indicates full and proper alignment.

Details of the physical construction of this instrument may be seen in the photographs. The condensers used in the instrument are rated at 600 volts, with the exception of the 2 electrolytic condensers which are rated at 150 volts. The resistors are rated at $\frac{1}{2}$ watt. The voice coil of the speaker is 3.5 ohms, but this is immaterial since the speaker is fixed and the transformer varied. The tapped resistor, a heavy-duty, wire-wound type, is mounted on the side of the speaker. This resistor is tapped at 500, 1,000, and 1,500 ohms, the 2,500-ohm tap being the full-length or maximum resistance. It is used when making field replacements or substitutions. The entire unit is mounted on the front of the panel, the rear of which is easily accessible by removing the 6 panel mounting screws, and is housed in a grey wrinkled metal can measuring 10 x 7 x 5 inches.

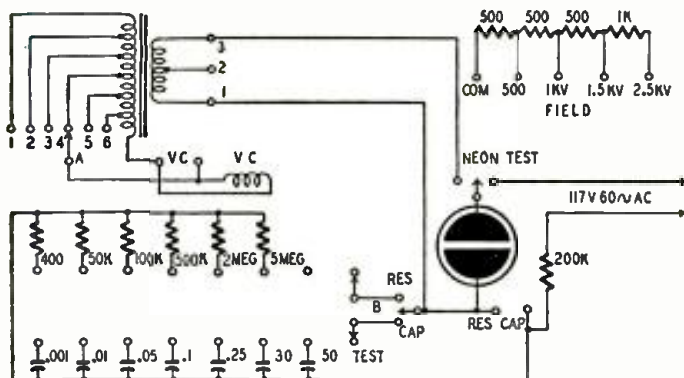

As can be seen from the schematic, this is not simply a test speaker, but also has facilities for substituting condensers and resistors, as well as for continuity tests (with the neon tube). This makes it more versatile for use in the field and a real timesaver on the bench.

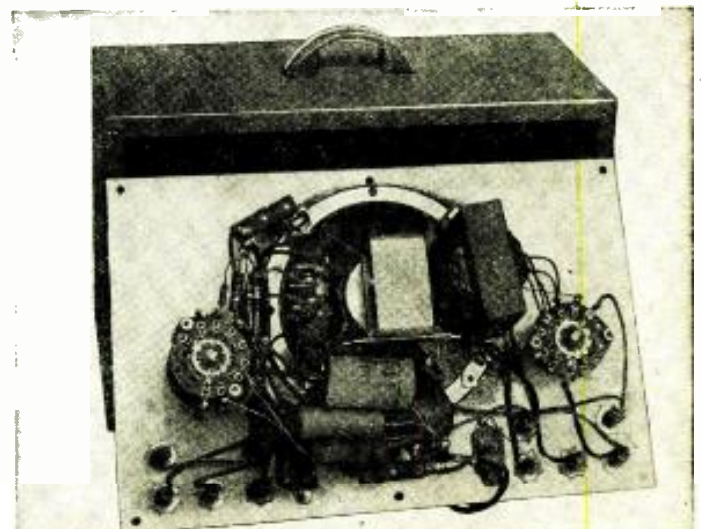

Rear view of the speaker panel, on which all components are mounted.

TELEVISION TROUBLE CHART

The screen of an improperly-operating television receiver is literally a sign board pointing out probable locations of the trouble. Special test patterns which are transmitted by television stations from time to time, particularly at the beginning of a broad-

cast, help the radioman find the defect. In the chart below, which was prepared by engineers of the *National Radio Institute*, the effect on the television screen is described in the left-hand column. Its probable cause is listed in the middle column, and the likely

remedy is given at the extreme right. Unless otherwise indicated, you may assume that the sound section of the receiver is operating normally and that all picture characteristics except those mentioned in the left-hand drawing are essentially normal.

OBSERVED EFFECT	PROBABLE CAUSES	REMEDIES
1. No image, pattern or spot on C-R tube even when brilliancy control is fully advanced.	1. Failure of high-voltage power pack. Excessively high negative bias on C-R tube grid. Image or pattern is entirely off the screen. Defective C-R tube.	1. Check high-voltage power pack. Check C-R tube bias. Check settings of beam centering controls. Try another C-R tube.
2. No image. Raster is present. Back traces are visible when brilliancy control is advanced, and are stationary.	2. Defect in video amplifier or its power supply connections. (Stationary raster indicates synchronizing impulses are controlling sweep circuits.)	2. Check tubes, parts and leads in the v.f. amplifier between the clipper connection and the C-R tube.
3. No image. Raster is present. Back traces are visible when brilliancy control is advanced, but are moving.	3. Defect in video i.f. amplifier, video detector, video amplifier stages ahead of clipper input connection.	3. Check tubes, parts and leads in signal and supply circuits of suspected stages. (Moving raster indicates synchronizing impulses are not controlling vertical blocking oscillator.)
4. No image. NO SOUND. Raster is present. Back traces are visible when brilliancy control is advanced, but are moving. Telecaster is known to be on air.	4. Defect in receiving antenna, preselector, oscillator or mixer-first detector. (Moving raster and absence of sound indicates that no signals are getting through the mixer-first detector output circuit.)	4. Check tubes, parts and leads in signal and supply circuits in and ahead of mixer-first detector. Check the low-voltage power supply serving these stages. Check the antenna system.
5. Only a spot on C-R tube screen. (No saw-tooth voltage on horizontal and vertical deflecting plates.)	5. Failure of power pack which serves sweep system. Defect in any voltage supply lead or part which is common to both horizontal and vertical sweep channels.	5. Check power pack serving sweep system, particularly the rectifier tube and filter condensers. Check common voltage supply connections to both sweep channels.
6. Horizontal line only. (No sawtooth voltage on vertical deflecting plates.)	6. Failure of the vertical sweep channel, due to a defect in the vertical blocking oscillator stage or between this stage and the vertical deflecting plates.	6. Check tubes, parts, leads and supply voltages, working from vertical blocking oscillator to vertical deflecting plates.
7. Vertical line only. (No saw-tooth voltage on horizontal deflecting plates.)	7. Failure of horizontal sweep channel, due to a defect in the horizontal blocking oscillator stage or somewhere between this stage and the horizontal deflecting plates.	7. Check tubes, parts, leads and supply voltages, working from horizontal blocking oscillator to horizontal deflecting plates.
8. Insufficient picture width. (Horizontal sweep voltage too low.)	8. Improper setting of horizontal size control. Defective tube, defective part or improper supply voltages in horizontal saw-tooth sweep oscillator stage or horizontal sweep output stage.	8. Adjust horizontal size control. If picture is still too narrow, check tubes, parts and supply voltages in horizontal output stages.
9. Insufficient picture height. (Vertical sweep voltage too low.)	9. Improper setting of vertical size control. Defective tube, defective part or improper supply voltages in vertical saw-tooth sweep oscillator stage or in vertical sweep output stage.	9. Adjust vertical size control. If picture is still too short, check tubes, parts and supply voltages in vertical saw-tooth sweep oscillator stage and vertical output stage.
10. Picture not centered with respect to mask. (Shifted to one side, to top or to bottom.)	10. Improper setting of vertical or horizontal beam centering control, giving improper bias on deflecting plates. Electromagnetic deflecting coils improperly positioned.	10. Adjust beam-centering controls. Adjust positions of electromagnetic deflecting coils; always turn off power when working on deflecting coils.
11. Picture is tilted with respect to mask.	11. Magnetic deflecting coils are not properly oriented. Electrostatic deflection type of C-R tube is not properly oriented.	11. Rotate electromagnetic deflecting yoke or entire C-R tube until the tilt is eliminated. Turn off power when making adjustments.
12. Two narrow, full-height pictures side by side, separated by a black vertical bar.	12. Horizontal sweep circuit is operating at one-half normal frequency due to improper setting of horizontal hold control.	12. Increase frequency of horizontal blocking oscillator by adjusting horizontal hold control.
13. Two short, full-width pictures one above the other, separated by a black horizontal bar.	13. Vertical sweep circuit is operating at one-half normal frequency due to improper setting of vertical hold control.	13. Increase frequency of vertical blocking oscillator by adjusting vertical hold control.
14. Right-hand half of picture superimposed on left-hand half.	14. Horizontal sweep circuit is operating at twice normal frequency due to improper setting of horizontal hold control.	14. Decrease frequency of horizontal blocking oscillator by adjusting horizontal hold control.
15. Bottom half of picture superimposed on top half.	15. Vertical sweep circuit is operating at twice normal frequency due to improper setting of vertical hold control.	15. Decrease frequency of vertical blocking oscillator by adjusting vertical hold control.
16. Entire picture slips or moves up or down. Picture is clear, with normal contrast and no abnormal interference patterns.	16. Vertical sweep channel is not "holding on to" vertical synchronizing impulses. Pulses at the input of the saw-tooth sweep generator may be too weak.	16. Check for defective parts or tubes in the vertical sweep channel, the frequency separator, the clipper and any synchronizing impulse amplifier stages if adjustment of the vertical hold control does not clear up the trouble.
16A. Same as above but with interference patterns.	16A. Excessively strong static or man-made interference pulses may be taking over control of the vertical sweep channel, or video signals may be getting through the clipper and affecting the vertical sweep generator.	16A. Listen to the vertical sweep output with headphones (high voltage off); video signals in this sweep channel may give a raspy tone instead of the usual steady tone (some sweep generator circuits will not pass video signals, so this test is not conclusive.) Adjust the hold controls.

OBSERVED EFFECT	PROBABLE CAUSES	REMEDIES
17. Entire picture slips or moves up or down. Picture is dim, with poor contrast and interference patterns.	17. The v.f. signal at the input to the clipper is too weak, indicating trouble somewhere ahead of the clipper, a poor antenna system, or too low signal strength at the receiver location.	17. Check all tubes and parts for defects which could cause low gain in stages between the clipper input and the antenna. Check the antenna system for signal pickup and interference pickup. Readjust vertical hold control.
18. Part of the picture (usually at the top) is highly distorted and shifted in a horizontal direction. Rest of picture is clear, with normal contrast and no abnormal interference patterns. No vertical movement.	18. Horizontal sweep channel is not "holding on to" horizontal synchronizing impulses, with result that picture "tears." Pulses may be too weak at the input of the saw-tooth generator. Video signals may be getting through the clipper and affecting the horizontal sweep generator.	18. Check for defective parts or tubes in the horizontal sweep channel, the frequency separator, the clipper and any synchronizing impulse amplifier stages if adjustment of the horizontal hold control does not clear up the trouble.
19. Part of the picture is highly distorted and shifted in a horizontal direction. Picture is dim, with poor contrast and interference patterns.	19. The v.f. signal at the input to the clipper is too weak, indicating trouble somewhere ahead of the clipper, a poor antenna, system or too low signal strength at the receiver location.	19. Check all tubes and parts for defects which could cause low gain in stages between the clipper input and the antenna. Check the antenna system for signal pickup. Readjust horizontal hold control.
20. All parts of picture are fuzzy—not clearly defined—and fine details are blurred.	20. Electron beam may not be properly focused on C-R tube screen, due to improper focusing electrode (first anode) voltage.	20. Adjust focus control for maximum clearness of sharply defined lines in picture. If this does not help, check the focus control and associated parts in the voltage divider of the C-R tube power pack.
21. Only the fine details in the picture are blurred or absent. Particularly noticeable on distant scenes or long studio shots.	21. Loss of higher video frequency components, due to attenuation of these components somewhere in the receiver. Consider whether it is due to original limitations in receiver performance.	21. Check alignment of video i.f. coupling units. Look for defects in the coils, condensers, resistors, and leads of coupling and equalizing circuits in the video i.f. amplifier, video detector and v.f. amplifier.
22. Picture is smeared, with white or black shadows at the right of each object.	22. Loss of lower video frequency components, accompanied by excessive phase shift at low frequencies.	22. Look for a shorted low-frequency compensating resistor in a v.f. amplifier load circuit, or an open plate or screen grid by-pass condenser in the v.f. amplifier. Look for defect in the coils, condensers, resistors and leads of video i.f. and v.f. coupling units and in low-frequency compensating circuits.
23. Vertical retraces are visible in picture.	23. Brightness and contrast controls are not properly set, or signal intensity at C-R tube input is inadequate.	23. Lower the setting of the brightness control and advance the contrast (gain) control. If normal brilliancy cannot be secured without having retraces visible, check all video signal circuits for a defective part. Check antenna pickup and television signal strength at antenna location.
24. Insufficient contrast between light and dark portions of the picture.	24. Inadequate signal strength at input of C-R tube. Sound i.f. carrier may be beating with video i.f. carrier in video detector to give a strong 4.5 mc. signal which brightens entire picture. Defective C-R tube or d.c. restorer.	24. Advance the contrast (gain) control and readjust the brightness control. Check sound i.f. rejector circuit in video channel. Look for defect in d.c. restorer circuit. Try a new C-R tube.
25. Excessive contrast between light and dark portions of the picture.	25. Excessive signal strength at input of C-R tube, due to contrast (gain) control being advanced too far, excessive signal input to receiver.	25. Lower the contrast control setting. Lower any sensitivity controls which are present in receiver.
26. Objects at left and right sides of image or at center appear wider or narrower than normal.	26. Non-linear horizontal sweep.	26. Adjust bias on horizontal sweep output tube until trouble is eliminated. Check horizontal saw-tooth sweep generator and horizontal linearity control circuit.
27. Bright vertical band along left side of picture.	27. Horizontal flyback time is too long. Picture signal is modulating electron beam as it approaches the left side of the picture during a slow horizontal retrace.	27. Look for a defective part in the horizontal saw-tooth sweep generator, particularly the parts which govern flyback time. Check for excessive capacity between horizontal deflecting plate leads and chassis. In a gaseous triode sweep generator, the current-limiting resistor may be too large.
28. One or two wide dark horizontal bands on picture. If receiver and telecaster are on different power line systems, these bars may move slowly up or down.	28. Excessive power line a.c. hum or ripple in video amplifier.	28. Check filter condensers in video and C-R tube power packs for opens and loss of capacity. Check plate and screen-grid by-pass condensers in v.f. amplifier. Check v.f. tubes for cathode to heater shorts.
29. Many irregularly-positioned horizontal black and white bars or geometric patterns on picture.	29. Sound signals are getting into the video channel and causing "cross talk."	29. Readjust the vernier tuning control. Check the sound i.f. rejector circuit at the video i.f. input. Look for open by-pass condensers if a common power supply serves both sound and video sections.
30. A pattern of fine lines or short diagonal bars appears on the picture at irregular intervals, and may or may not move.	30. Excessive dlathemy interference. Carrier of police, amateur or aircraft station beating with video carrier. Intermittent high-frequency oscillation in video channel of receiver.	30. Trouble is external interference if it disappears when a television signal generator is connected in place of the antenna. Try new antenna position, or use a directive antenna oriented for minimum interference.
31. Moving white and black splotches or spots on picture and momentary loss of either vertical or horizontal synchronization.	31. Ignition interference due to automobile or other equipment employing a spark coil for ignition.	31. Move antenna farther away from street, and rotate for a maximum signal-to-noise ratio. Use a directive antenna.
32. Snowstorm effect on entire picture.	32. Signal strength at receiver input is too low; to get a picture, gain must be advanced so far that normal atmospheric interference and tube hiss affects picture.	32. If reception was normal at one time and television transmitter has not been changed, check antenna system. Check tubes, parts and voltages in preselector stage and mixer-first detector stage.
33. Dark brown or black spot in center of picture.	33. Bombardment of center of C-R tube screen by ions which come from the electron gun but are not controlled by the deflecting systems, destroying the fluorescent material in this region.	33. Replace C-R tube.
34. Ghost images in picture.	34. Signals are arriving at the receiving antenna over two or more different paths from the telecaster. Signals are being reflected back and forth in the transmission line due to improper match.	34. Change the position of the receiving antenna, or use a directive antenna so as to pick up signals over only one path. Match the receiver input to the transmission line.

(Continued on page 133)

Transatlantic News

By Major Ralph W. Hallows

RADIO-CRAFT EUROPEAN CORRESPONDENT



As had been anticipated, the Radio Exhibition proved a great success. During its ten days' run 440,320 people were admitted, and on several occasions the crowds inside the hall were so dense that doors had to be closed and "House Full" notices posted. On the whole the visitors got good value for their money, though some who expected to find clear evidence of revolutionary progress in broadcast receivers as a result of wartime developments were a little disappointed. For, apart from a few "stunts" never likely to reach the production stage, nothing in the broadcast line could have been called spectacular. Nothing, that is, of the kind to hit the listener right in the eye and make him say, "Well, things certainly have advanced in radio since I was last here eight years ago." One cynic was heard to remark that the only really notable advance was in prices!

Actually improvements and advances in radio were shown in plenty, as any visitor with a little knowledge of the subject soon realized. The mechanical side of receivers is far better (the war taught many things about making sets that stand up to hard service); the efficiency of components and of circuits is higher, ingenious design has enabled 4 tubes to do the work of 7 or 8. One point of great interest was the cleverness with which many makers contrived to substitute easily obtainable materials for those now scarce, without impairing either appearance or efficiency.

Being a dx addict, I was specially drawn to the communication receivers, very few of which have been seen in our radio stores up to now. The types now appearing are high standard, and the most exacting dx man could hardly want anything better. Some are moderately priced and simple, without such frills as S-meters or switch-in crystal control; but even these feature high sensitivity, oscillator stability, and good band-spread tuning. The best of the new communication receivers seem to have almost everything that one could ask for in a long-distance set. The General Electric BRT400, for instance, can be adjusted by a switch to any one of 6 degrees of selectivity between 0.5 and 9 kc, crystal control coming into action on the 3 narrowest band widths.

Thirteen tubes are used, including several of the glass-based type. There are 6 wave-bands, and on each the effective length of the tuning scale is over 16 feet. This is real band-spreading!

Telephone television

At first thought it might not seem possible that the wide band of frequencies needed for television modulation could be sent successfully over ordinary telephone lines, designed to deal with nothing higher than the 3,000-4,000 cycles a second required for the transmission of clearly intelligible speech. Nevertheless such lines are being used most successfully now in Britain for television outside broadcasts. Recently designed transportable repeaters make it simple to adapt subscribers' lines to exchanges and junction lines between one exchange and another for the purpose.

London now has a co-axial cable, specially laid and adjusted for television, which runs under many of the chief streets and can be tapped into at suitable points. It is very useful; but it was soon found to fall far short of meeting all requirements. More and more outside broadcasts were wanted from places which might be several

miles from the nearest point of the cable. The mobile radio link is available, but there are localities in which it cannot be used on account of interference. Near airports, for example, 2-path reception is liable to occur—by the direct ray and by reflection from low-flying planes. Something had to be done about it. The answer was clearly *not* to run co-axial branches here, there, and everywhere. That would have been far too costly a business. The price of a co-axial cable and the cost of laying it are by no means the only expenses involved. Such a cable does not deal satisfactorily with very low frequencies, for on them its screening is unable to exclude interference noise. Before very low frequencies can be sent over a cable, they must be transposed, just as the accompaniment of a song may be transposed to a higher key by the pianist to suit a singer. The whole vision frequency band must be shifted upward so that it contains no picture impulses below 300 kc. That means complicated and expensive apparatus.

British subscriber telephone lines are of 6½-lb wire (6½ lbs per mile), insulated, lead-sheathed cables. The junction lines are similar, except that they
(Continued on page 104)

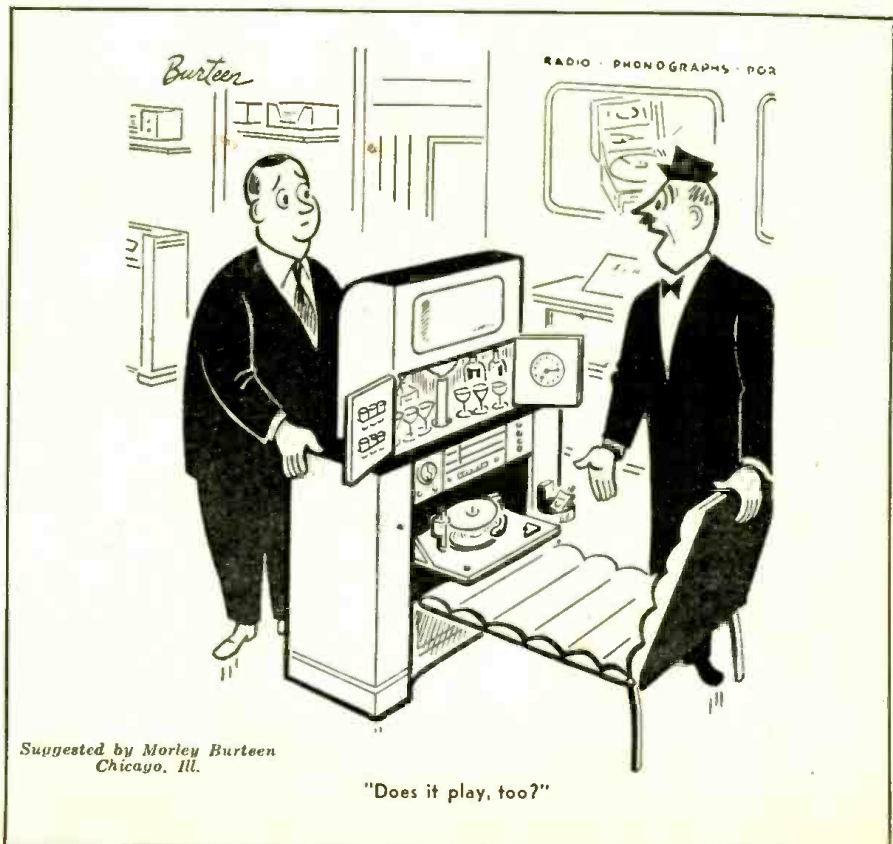

Suggested by Morley Burteen
Chicago, Ill.

"Does it play, too?"

The hot side of the filaments are connected together through small r.f. chokes made by winding about 19 turns of No. 23 enamel wire close on a 1-megohm 1-watt resistor.

In the first experimental setup, it was difficult to tune from one station to another as each coil of the i.f. strip was tuned individually. This disadvantage was overcome by using ganged tuning condensers in place of the trimmers shown in the diagram. This arrangement makes a satisfactory video receiver but a separate receiver is required for sound. We revamped an old Meissner FM converter for the job.

The second receiver

After experimenting with the t.r.f. circuit, we decided to give the superhet type of receiver a trial. A survey of the surplus scene disclosed that several receivers were available and decided in favor of the BC-1068-A. Only a few modifications are needed to convert this receiver for television, but several additions are necessary. The television stations in New York City at the present time occupy channels 2, 4 and 5 which are 54-60, 66-72 and 76-82 mc respectively. The BC-1068 tuning range was calibrated from 155 to 200 mc and we hoped that by the addition of shunt capacities, the r.f. section could be made to tune the range. This hope proved short-lived as subsequent tests showed that with enough capacity to tune in the lowest frequency station, we could not reach the highest frequency channel.

After giving more consideration to the subject, we decided that a simple oscillator-mixer combination with band switching could be installed with considerably less effort than taking apart the r.f. sub-assembly and rewinding all the coils. The r.f. sub-chassis and front panel were removed as shown in the photographs. The bottom shield of the

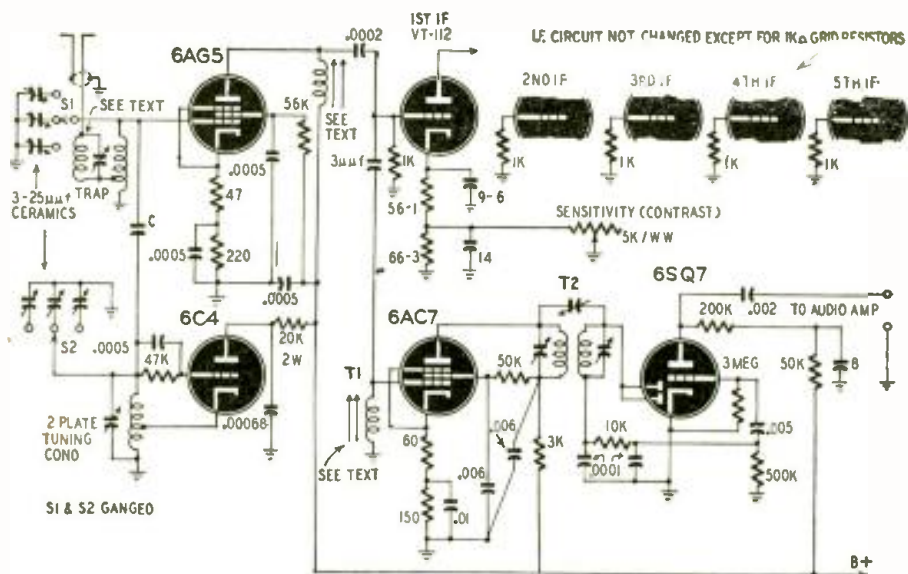

Fig. 3—The modified BC-1068-A, which was used as front end of the circuit finally adopted.

r.f. section was retained and used as a chassis for the audio i.f. and amplifier unit.

A new front end, consisting of a 6AG5 mixer and 6C4 oscillator, Fig. 3, was wired up. The antenna coil has 4 turns of No. 14 wire ½ inch in diameter and ¾ inch long. This coil is tapped 1 turn from the ground end. The oscillator coil has 3 turns of No. 14 wire ½ inch long and ½ inch in diameter tapped 1 turn above ground. The parallel-tuned trap in the antenna lead (if needed) consists of 5 turns of No. 14 ½ inch in diameter and ¾ inch long tuned by a 3 to 30-µµf trimmer. Coupling between the mixer and oscillator is through gimmick C. This consists of 2 pieces of cambric-insulated hookup wire twisted together for about 1 inch.

The antenna and oscillator coils are tuned by switching pretuned 3-25-µµf ceramic trimmer condensers across them. A 2-plate variable condenser is permanently connected across the oscillator to provide vernier tuning for the audio channel.

We removed the first i.f. transformer of the BC-1068-A, consisting of

parts No. 55, 95 and 101, designed to work from a diode mixer, and installed transformer No. 99; with condenser No. 5-3 removed from the tuning-eye, in the mixer plate circuit. To keep leads short, mount the 6AG5 and 6C4 close to the first i.f. transformer as shown in the photograph of the r.f. chassis.

The i.f. channel of the BC-1068-A was used as is with minor additions. We shunted a 1000-ohm resistor between each i.f. grid and ground and inserted a 5,000-ohm contrast or sensitivity control in the cathode circuit of the first i.f. amplifier. The 6H6 second detector is converted, as in Fig. 4, to a video and sync pulse detector.

We replaced the video amplifier tube, 6SH7, with a 6AG7 and installed circuit components to supply the correct voltages. The 6SN7 cathode follower circuit was disconnected and the tube socket rewired for a synchronizing pulse amplifier using a 6AC7.

The sweep oscillator circuits and high-voltage power supply were built on a separate chassis with the cathode-ray tube mounted on top. The whole chassis is then fastened with brackets to the top of the 1068 receiver. Three controls, (Continued on page 75)

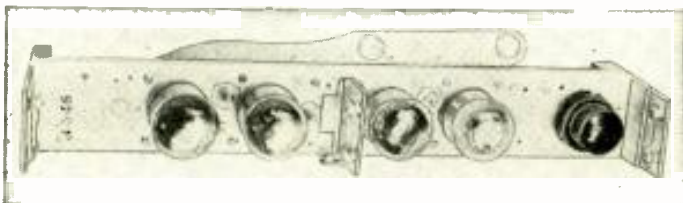

This is the 60-mc i.f. strip used in the t.r.f. video receiver.



Converted BC-1068. R.f. circuits at right, sound channel at center.

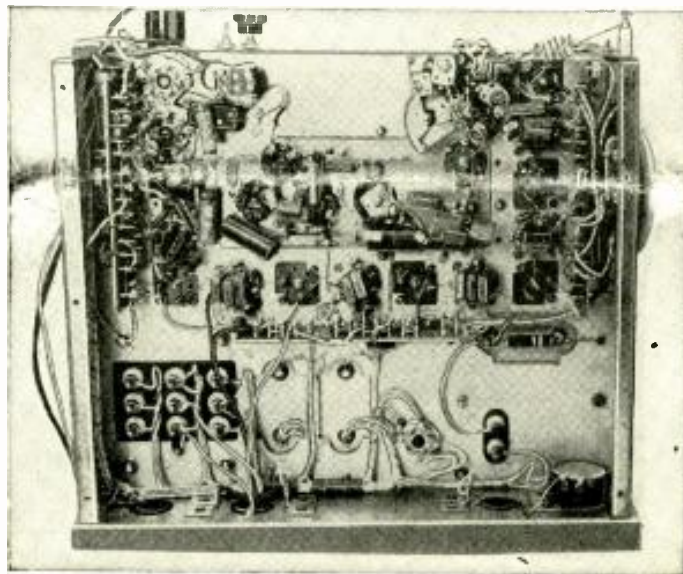

Bottom of r.f. chassis. The sensitivity control is at lower right.

Kickback Power Supply

*Several television receivers use
r.f. high-voltage supply systems*

By W. H. BUCHSBAUM

ALL television receivers using cathode-ray tubes of a screen diameter of 10 inches or more require a second-anode voltage from 9,000 to 15,000. All tubes of this size are built for magnetic deflection, instead of for the electrostatic deflection used in smaller tubes. The high voltage requires a special transformer and a special filter system. If it is to be obtained from the 60-c.p.s. power line, relatively large condensers are needed to smooth out the rectified a.c. These condensers, as well as such a 60-c.p.s., 10,000-volt transformer, are expensive.

Another method of obtaining high voltage uses an r.f. oscillator, step-up transformer and rectifier, and an r.f. filter. This frequently used system has the disadvantage of greater cost and more components and, therefore, more possibilities for failure. R.f. power supplies are also likely to interfere with the video signal and produce an undesired pattern on the screen of the cathode-ray tube.

Magnetic deflection requires large currents to set up magnetic fields strong enough to deflect the electron beam in the cathode-ray tube. These currents are obtained with a step-down transformer as are the large sound currents in the voice coil, produced by the sound output transformer.

The flyback or kickback high-voltage power supply utilizes a single transformer to provide the required large

current for the deflecting coils and also the second-anode voltage. We shall now see how, by an ingenious system and various conventional circuits, a voltage of about 9,500 volts and currents which reach a peak of 0.5 ampere are obtained with an input of only 350 volts d.c. at about 60 milliamperes. To provide a picture at the present standards of 525 lines per frame and 30 frames per second, using interlaced scanning, we need a force to sweep the electron beam horizontally at a frequency of 15,750 c.p.s. and vertically at 60 c.p.s. Furthermore the beam has to be moved from left to right relatively slowly and from right to left very fast, downward slowly, and upward very fast. The movement from right to left and from the bottom of the picture to the top is called the retrace, or flyback. For a 10-inch cathode-ray tube this horizontal flyback should be of 8 microseconds duration. The vertical flyback time is longer, but during both these intervals the cathode ray tube is blanked out, due to the blanking pulses contained in the video signal.

To have a magnetic scanning field vary in strength and polarity to give the above results, we need a saw-tooth current of 15,750-c.p.s. frequency and another saw-tooth current of 60-c.p.s. frequency, flowing through 2 sets of coils positioned around the neck of the cathode-ray tube. These coils are called the *deflecting yoke*.

When a saw-tooth current flows through a resistor, the voltage across it is a saw-tooth voltage (Fig. 1-a). A saw-tooth current flowing through a pure inductance would give a square wave voltage across it (Fig. 1-b), but

every inductance contains some resistance so that in practice the saw-tooth current through a coil produces the voltage shown in Fig. 1-c, which is really a combination of a square wave and a saw-tooth wave. Such a voltage is obtained from a multivibrator or blocking oscillator by permitting the square wave to charge a condenser through a resistor. Naturally, the value of this condenser and resistor combination has to conform to the charging and discharging time of the square-wave frequency, i.e., 15,750 c.p.s. or 60 c.p.s.

Fig. 2 shows a typical circuit for obtaining such a voltage wave. It employs a blocking oscillator transformer T1, the oscillator tube V1 and the discharge tube V2, which is coupled directly to the grid of V1. The condenser C3 and resistor R4 shape the saw-tooth—square-wave combination which is then applied to the grid of the amplifier V3. This has to be a powerful tube. Usually one or two 807's in parallel or the specially designed 6BG6 are used for the horizontal sweep amplifier. The cathode resistor R6 provides some degeneration, thus keeping the gain of this stage at a safe limit. By varying the screen voltage and, therefore, the amplification. This potentiometer, as well as R3, which controls the plate voltage on the discharge tube V2, are usually mounted on the rear of the chassis and control the sweep width and the linearity to some degree. Plate voltage is supplied to the amplifier V3 through the primary of the deflection transformer. This deflection transformer, especially the one for the horizontal sweep (15,750 c.p.s.), has to be of special construction to pass all harmonics because the harmonic content determines the sharpness of the saw-tooth waves. Most of these transform-

(Continued on following page)

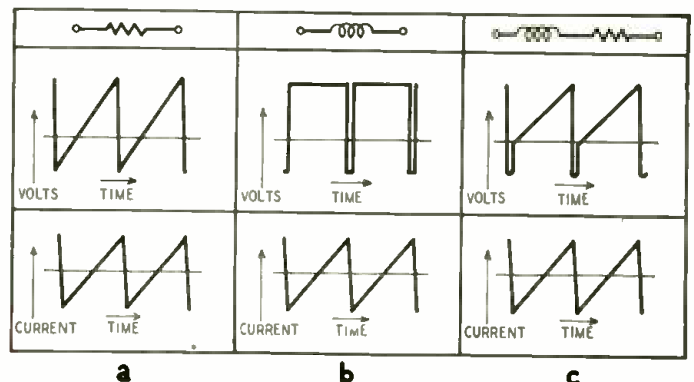
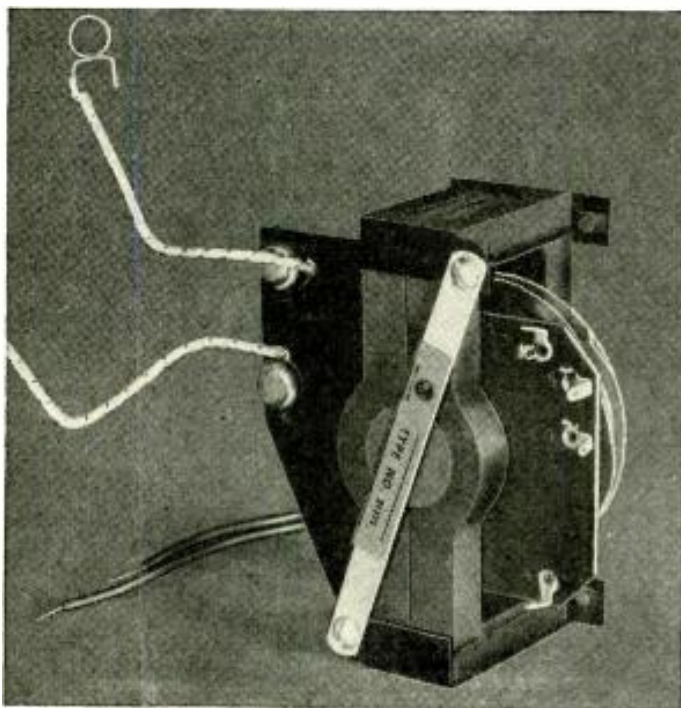

Fig. 1—Voltage and current waves in resistive-inductive circuits. Left—The high-voltage transformer of the flyback power supply.

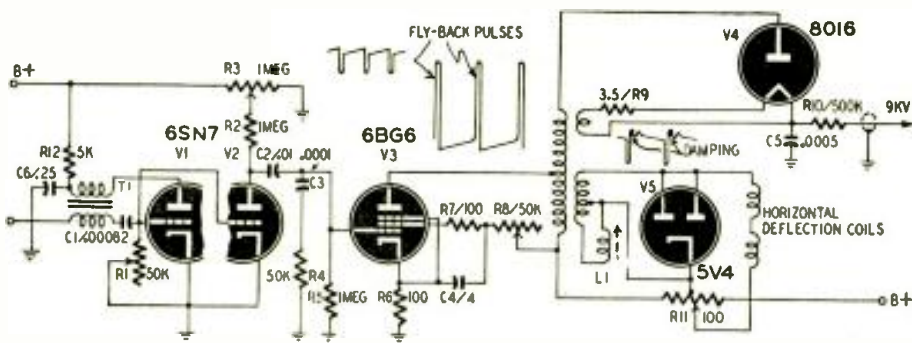

Fig. 2—This simple kickback high-voltage supply illustrates the principles discussed.

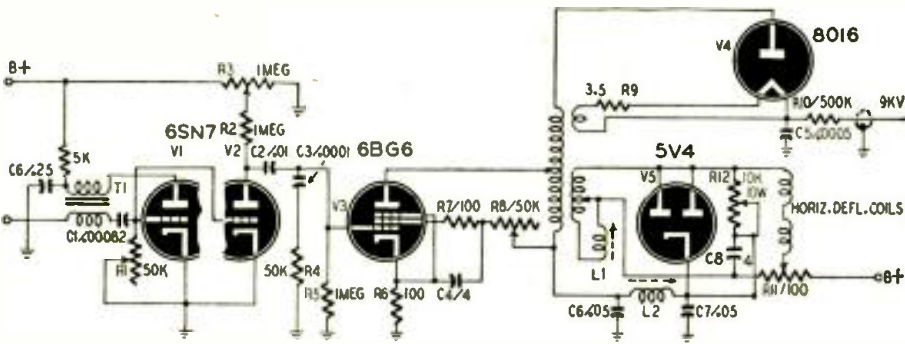

Fig. 3—Commercial model of kickback power supply as used in some recent teleceivers.

ers are wound on a molded powdered-iron core and use Litz wire. The transformer inductance increases the voltage of the rapid flyback pulses very greatly compared to the slower saw-tooth voltage. In Fig. 2 we see the saw-tooth voltage containing the flyback pulse as originally determined by the charging condenser C3 and R4. On the plate of the amplifier tube this same voltage appears inverted and the flyback pulses of much greater amplitude.

In actual practice the flyback pulses may reach as much as 6,000 volts. It is those high-voltage flyback pulses which are utilized to obtain the second-anode voltage. An additional winding on the primary acts like an autotransformer, stepping the voltage of these pulses up to 10,000. Then this voltage is applied to a rectifier V4, rectified, and filtered through the filter formed by R10 and C5, which is usually a 500- μ mf, 10,000-volt condenser. The capacitance between the second-anode coating on the inside of the cathode-ray tube and the grounded outside coating provides the second part of this π -filter.

Filament voltage for the rectifier tube V4 is usually obtained by placing a 2-turn loop in the field of the horizontal output transformer. Since the filament voltage has to be 1.25 volts and a tolerance of $\pm 20\%$ is the maximum permitted, the location of this loop is somewhat critical. To standardize this position, the RCA horizontal output transformer (RCA No. 211T1, see photograph) has 2 small bakelite discs which hold the filament loop in place. A 3.5-ohm resistor R9, is placed in series with the filaments to prevent excessive current drain and to prolong the life of the rectifier tube. Keep in mind that this loop is hot—9,000 volts d.c. Usually this loop is constructed of No. 18 polyethylene-covered wire which can easily

withstand the high potential.

Most tube sockets do not provide sufficient insulation for the high voltage. Therefore it becomes necessary either to place the socket of the rectifier tube on well-insulated stand-offs, or to provide a bakelite or lucite mounting plate. On a dry day, 9,000 volts will arc over about $\frac{1}{2}$ inch of air and over as much as $\frac{3}{4}$ inch when the humidity rises to 90%. Care must be taken to keep all high-voltage leads and connections at least 1 inch away from any grounded point. Corona may also appear if any sharp edges or very thin conductors leave the high-frequency current insufficient space on the surface of the metal. This may easily be recognized by a hissing noise and by the sight of small bluish needles which seem to stick out of the metal right into space. Smooth round joints and large-diameter wire are the best cures for corona.

In Fig. 2 the secondary of the transformer is connected to both horizontal deflecting coils and also to the center-tapped potentiometer R11 and a small shunting inductor L1. This potentiometer, one side of which is connected to B-plus, provides a small direct current through the deflecting coils. This small direct current adds or subtracts from the saw-tooth current and thus regulates the relative position of the electron beam in the cathode-ray tube. It is usually mounted in the rear of the chassis. Each television receiver has such a horizontal and vertical centering control.

The shunting inductor L1 is provided to make up for any nonlinearity caused by the current drain of the high-voltage winding which otherwise would tend to unbalance the transformer primary. This coil is permeability-tuned and may be adjusted for better horizontal linearity.

A duo-diode is connected directly across the secondary of the horizontal output transformer. Its function is to prevent any damped oscillations, and it is therefore called a damping tube. When large currents surge backward and forward through an inductive circuit, there is a tendency to continue this surging motion, just as a spring that is pushed down by a weight momentarily tends to bob up and down for a while. Such damped oscillations are very undesirable, since they would sweep the electron beam several times back and forth at the left side of the picture before resuming the sweep from left to right. The diode V5 acts as an open switch until the plates are driven positive by the rebound of the flyback pulse. When the plates go positive, this tube draws current. All this rebound current which would otherwise flow through the deflecting coil is thus shunted out by the diode and cannot act on the electron beam on the cathode-ray tube.

Only a few conventional rectifier tubes can pass a current of such a magnitude even if only for a few microseconds. The type 5V4 shown in our illustration has recently been reclassified since it was found to be the most economical tube for this purpose. Another type tube, the 6AS7G, was originally developed just as a damping tube, but its high price makes its application unwarranted.

The circuit of a kickback high-voltage power supply as used in the latest commercial models is shown in Fig. 3. The blocking oscillator transformer, discharge tube, and saw-tooth amplifier are as in the preceding diagram of Figure 2. The high-voltage autotransformer winding with the subsequent rectifier and the filter system remain the same, but some parts have been added in the secondary circuit. D.c. plate and screen voltage for the saw tooth amplifier are now obtained through the centering control R11, the transformer secondary, and then through resistor R12 which shunts the damping tube. Next this d.c. travels through coil L2 and then branches off into the primary to the plate and the screen resistor to furnish screen potential. The purpose of this arrangement is to gain additional d.c. voltage. Here is how it is done. The filter consisting of L2 and the condensers C6 and C7 prevents any saw-tooth current from the transformer primary from entering the secondary directly and, at the same time, prevents any of the saw-tooth current in the secondary from interfering with the primary circuit. The tapped resistor R12 is usually adjusted at about 6,000 ohms and shunts the damping tube.

When a rebound pulse drives the plate of the damping tube positive, the current flowing through it charges condensers C7 and C8. Condenser C7 is of such value that a 15,750-c.p.s. pulse tends to keep it charged at all times. In other words, the filter consisting of L2, C7, C8 and the damping diode act just like a regular rectifier and filter and provide a d.c. output voltage. This d.c. voltage is in addition to the regular

(Continued on page 86)

Hi-Fi Tuner Tribulations

By JAMES R. LANGHAM

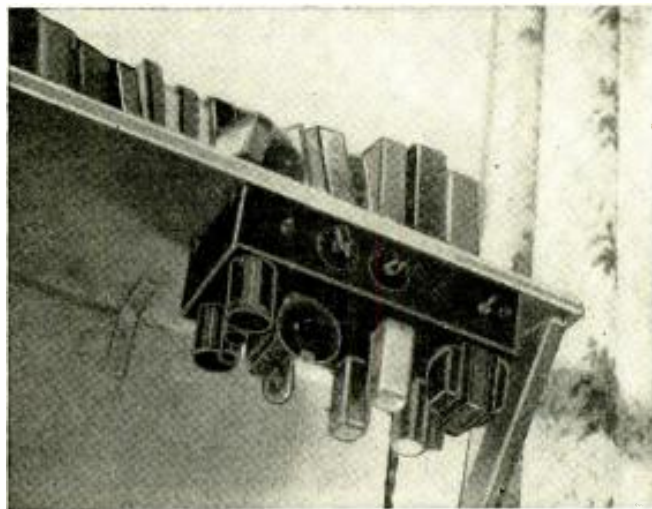

The upside-down mounting is a space-saving arrangement.

BEFORE we moved to San Diego we used a simple little t.r.f. tuner. Very simple. All there was on the chassis was a single r.f. amplifier and an infinite impedance detector. That was, as I say, before we moved to San Diego.

One of the features of San Diego is its proximity to Mexico—Mexico has its own broadcasting stations. The Mexican stations aim their stuff to where the moneyed listeners are. Naturally. That means they beam their stuff up north with lots of power. And they pick their frequencies as closely as possible to those of the big network stations of this country so as to catch as many listeners as possible. Their frequency control is not so rigorous down there and if they drift even closer to the big gringo stations—quien sabe?

The XYL was the first to kick about it. She couldn't get the Sunday symphony over KNX, the Los Angeles CBS station. There was a Mexican station cluttering up Haydn with recorded western tunes.

"Okay," I told her. "Okay. As soon as I get time I'll fix it up."

KNX has 50 kilowatts and is about 125 miles north of San Diego. "I'll peak it up a bit."

A simple little t.r.f. without even a.v.c.—nothing to it. Set the oscillator to 1500 and peak it up. I did. Then I tuned to KNX and right in the middle of the CBS program was that nostalgic little ballad of the wide open spaces: "You Are My Sunshine."

Well, I looked into the matter. The call letters of our Mexican station were XERB, and it beamed its signal north with a 50-kw final feeding a 2-element array. Its assigned frequency was 20 kc away from KNX. I'm not saying they drifted toward KNX because I made no measurement of their frequency.

At that time KNX was the only Columbia outlet for southern California, and the XYL had to have her Sunday symphony: It was wartime and new radios just weren't. I decided to build a wave trap.

Supers are selective

An oatmeal box and some 30-36 wire made a nice high-Q coil which I resonated with about 5 or 6 micromikes of

silver-mica condenser. I still think it helped some, but the XYL claimed it just cut down the over-all level and left the symphony-to-Gene Autry ratio the same. At any rate it wasn't what you'd call satisfactory.

A fellow up where I worked had an old superhet chassis in his garage that he let me have (for \$15.00, the robber!), and I spent several off hours getting parts to make it play. There was no cabinet, no dial, no speaker, and no r.f. stage; but it was a radio. I scored the

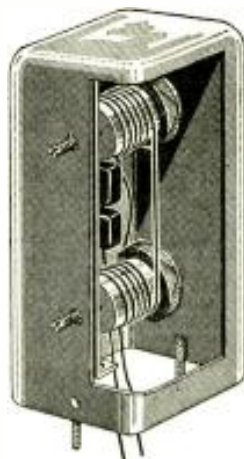

Electric "tune control." Six turns are wound clockwise around i.f. primary and secondary.

42 audio and tapped off the diode to get into my own amplifier.

Man alive, was that thing lousy! I lined it up without a scope and it kept spilling over and oscillating. Some ship's c.w. came booming in through the i.f., and there was plenty of converter noise. The only time the XYL would use it was when she wanted to listen to KNX. The rest of the time she would switch back to the simple little t.r.f. deal.

I couldn't get a 3-gang condenser then, so I re-wired the output socket into an untuned r.f. stage. That cut down on the converter noise. Then I borrowed a 'scope and wobulator and flat-topped the thing. I stopped the oscillation by tin-snipping a shield from the XYL's tea canister (she made a few remarks about that) and stopped the c.w. by picking an i.f. where there were no ships.

We were living in cramped quarters then, and it was a little inconvenient to have both tuners around—one broad and one sharp. The XYL had a regular octopus of clip leads that she used to juggle around. First the NBC programs on the t.r.f., then the CBS symphony on the super, and then back to the t.r.f. for something else. All this had a faintly audible background of comment about shoemakers' children and radio engineers' wives.

One of her friends inherited a fantastic radio about then. It had a nicked chassis, a lovely dial, more knobs than some transmitters, and cost around \$2,000. The XYL readily admitted ours sounded better on some stations but: "It has variable-band-width, i.f. coils in it. I looked in back and it has a cam that pushes the coils closer and further apart. Couldn't you rig us up something along that line?"

A variable I. F. amplifier

That was a worthy thought. Over-coupling would broaden the band very nicely, but how could I control it? I wanted it sharp on KNX and broad over the rest of the dial. I took one of the i.f. cans off and apart and tried to figure out a way. No go.

Then the XYL got another good idea. "Why," she asked, "do it mechanically? What if you did it electrically? Maybe wind some extra turns on both primary and secondary. On a switch or something."

Inside an hour we had both i.f. coils apart and were arguing about how many turns. We couldn't count the turns already on the coils and I guessed 10 would be right. The XYL thought 2.

As a compromise we added 3 clockwise turns to the primary, brought up the wire and added 3 clockwise to the secondary, then brought the ends down to twist together. Then we put the whole thing back together and fired it up.

It worked. It broadened the band but not enough. You could hear the treble creep in when the ends were twisted together.

Off came the coils again. Off came the cans. Off came the 3 turns and on went 10 turns. By the time I had finished

(Continued on page 87)

5-100 METER MIGHTY MITE

*This two-tube superregenerative receiver
uses 3S4's and polystyrene plug-in coils*

By **BOB WHITE**



The little radio can operate a loudspeaker.

THIS midget battery-operated receiver employs 2 type 3S4 miniature radio tubes which function as a sensitive superregenerative detector and a pentode audio amplifier. Seven specially designed plug-in coils give the receiver a continuous range of 5 to 100 meters. The circuit is shown in Fig. 1.

The receiver is 3½ inches high, 3½ inches wide, and 2½ inches deep. It weighs less than 1 pound. After the 1½ x 3½ x 2½-inch aluminum chassis was marked and drilled, the midget audio transformer and 3 miniature tube

sockets were mounted on the chassis, and the tuning condenser (a 100- μ f air padder) and potentiometer were mounted under the chassis. The front panel was made from a sheet of white celluloid ½-inch thick. On this were mounted the phone jacks, the tuning dial marker, and the optional pilot light jewel and bracket. The panel was fastened securely to the chassis with 2 screws after the important parts were mounted.

Stranded flexible wire, preferably with rubber insulation, should be used for the filament, amplifier, aerial, and battery leads. Solid hook-up wire is best for wiring the detector. A careful job of soldering is essential.

For headphone reception the receiver will operate with 30 to 67½ volts on the plates, but for loudspeaker operation the latter voltage is required. The B-battery in the model pictured can be replaced easily because of the snap connections. As Fig. 2 clearly shows, a large soldering luglike connector fits over each of the positive caps of the cells, and a sharp spearlike wire

soldered to the flexible battery lead fits between the zinc case and the cardboard container.

How the coils are made

The plug-in coils were made from polystyrene insulator cups, which are available as war surplus. A cup before being converted is pictured with the other coils. To make the coils, the following instructions should be carefully followed: Stiff wire about the same size as the pins used in miniature tubes is required. It should be straightened and cut into lengths about 3 inches long.

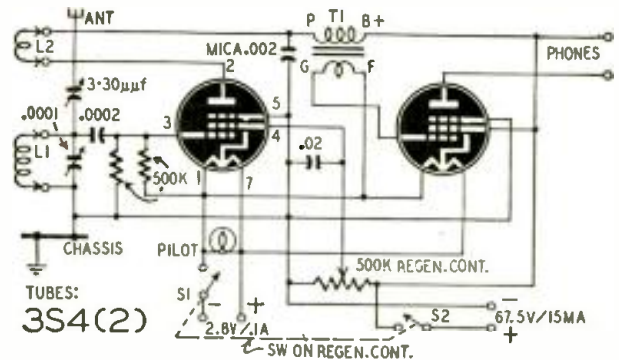
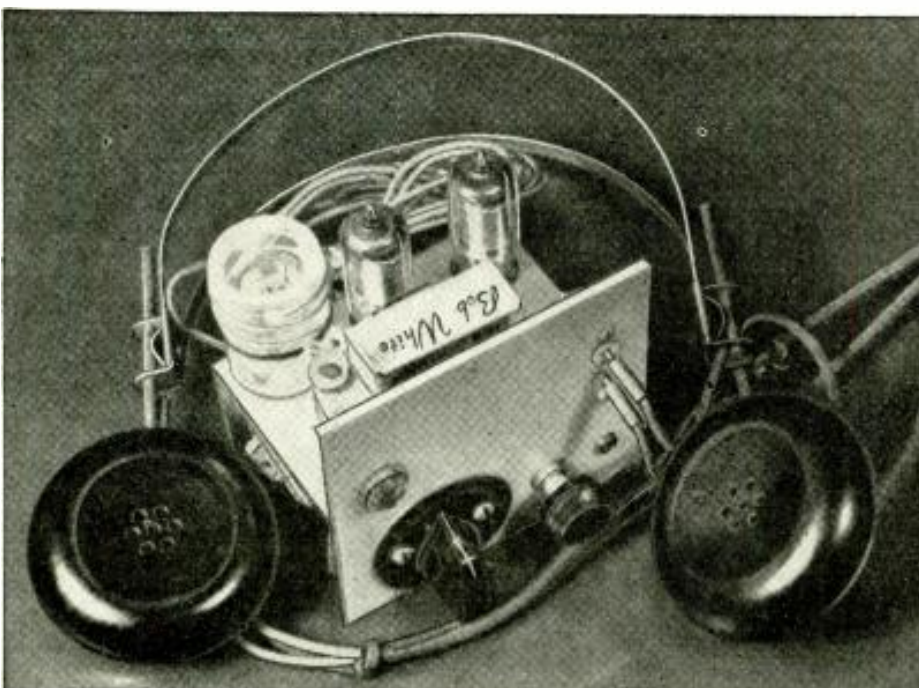

Fig. 1—The circuit. T1 is a midget audio transformer.

The bottom of each transparent cup is placed directly on top of a miniature socket, and the place where the pins should go through the bottom to fit holes 1, 3, 5, and 7 is marked with a pencil. The cup is then marked upside down, and the markings on the inside are indented on the bottom with a sharp center punch. An additional mark must be made to show in what direction the coil is to be plugged into the socket. (See Fig. 3 for coil details.) Although it is not necessary, a hole smaller than the wire may be drilled to help in the placement of the 4 pins. Hold the wire against the mark, or hole, with pliers, and touch a small-tip soldering iron to the wire, being careful not to touch the cup with the hot iron. The polystyrene cup will become soft, and the hot wire can be pushed through the form easily. Leave about ½ inch of wire protruding from the base. After the wire cools, it can be bent at the inside of the base to rest snugly against the wall of the cup. Applying the soldering iron on the inside to the part of the bent wire parallel to the base will force the horizontal section to sink into the base slightly so that it will be permanently, rigidly placed. After installing all 4 wires, straighten and trim the pins so that they will fit the socket properly.



The whole miniature receiver rests comfortably inside the headband of a pair of phones.

Next drill holes for the coil leads and follow the data given in the coil table. The leads of the coils are twisted around the stiff pins and then soldered. Push the hot wire and connection into the side of the cup on the inside to make it a permanent job. Trim the excess pin wire off above the connection. With the 5-6½-meter coil the grid winding is the same size wire as the pins so there is no need to solder the coil to the pins. After testing the coils, coat them with coil dope. CAUTION: If the soldering iron or drops of hot solder fall on the polystyrene cup, it will mar the finish; also, do not use solvent to clean the coil form because it will make the plastic sticky.

Operating hints

The receiver is provided with a d.p.s.t. switch on the superregeneration control; this eliminates the necessity of disconnecting the batteries when they are not in use. The pilot lamp can be unscrewed

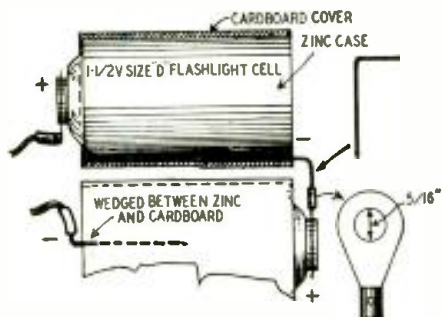

Fig. 2—The connectors for the A-batteries.

when desired for conserving the filament battery.

The receiver will not function properly if the batteries are not in good condition. Howling of the amplifier with the plug-in coils removed is most probably due to an old B-battery with high internal resistance. Fading of the signal after a few minutes or lack of pep is usually a sign of weak filament cells, and can be cured immediately by replacing them.

PLUG-IN COIL DATA TABLE

Plate coil and grid coil are wound in the same direction. Diameter of all coil forms is 1½ inches.

Approx. Wave Length (meters) of Coil	Grid Winding L1	Plate Winding L2
5-6½	2 turns spaced No. 18 wire	2¾ turns close No. 22 enameled wire
6½-9	2 turns spaced No. 22 enameled wire	3¾ turns close No. 22 enameled wire
9-13	3 turns spaced No. 22 enameled wire	5¾ turns close No. 28 cotton-covered wire
13-20	4¼ turns spaced No. 22 enameled wire	7¾ turns close No. 28 cotton-covered wire
20-40	7 turns close No. 22 enameled wire	7¾ turns close No. 28 cotton-covered wire
38-75	13 turns close No. 22 enameled wire	12¾ turns close No. 28 cotton-covered wire
65-110	21 turns close No. 28 cotton-covered wire	28 turns close No. 36 cotton-covered wire

When the super-regeneration control is advanced clockwise, it will first cause the receiver to regenerate. This type of oscillation is suited for c.w. reception. The point just below oscillation can be used for phone reception on the lower frequencies if a standard aerial is employed. When the control is advanced further, the receiver will super-regenerate. The detector in this condition is very sensitive and somewhat broad tuning. Any increase of the control beyond this point will be of no benefit.

To protect your ears when phones are used, turn down the control before changing coils.

The high-frequency coils will probably not oscillate over the entire range of the tuning condenser.

The aerial need be only 3 feet long for satisfactory reception of foreign stations. To stabilize the detector at ultra-high frequencies, it is necessary to use a 3-foot ground wire connected to the chassis. With superregeneration on the lower frequencies, a high-pitched squeal may be heard. It can be eliminated by using a longer aerial and tightening the antenna trimmer condenser. If the detector fails to oscillate at high frequencies, loosen the antenna coupling condenser.

During tests conducted in Los An-



The little allwave radio is not as large as its own B-battery.

geles, England and Australia have been received with good loudspeaker volume.

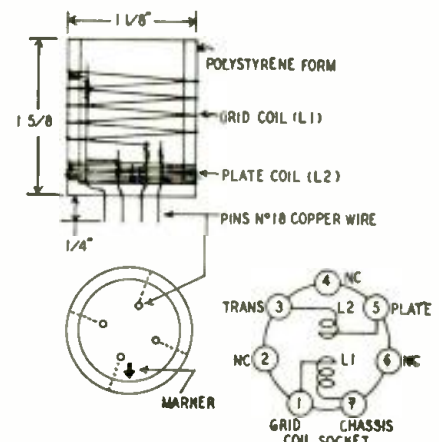

Fig. 3—Construction of the plug-in coils.



Rear-chassis view, with coils removed. The six shown cover the band from 5 to 100 meters.

This Signal Generator Is Pocket Size



◀ **New Model has interesting Hartley Oscillator circuit and neon tube**

By CHARLES URBAN *

POCKET signal generators have been described in articles from time to time. In almost all cases these devices used high-frequency buzzers with inductive and capacitive components to produce radio-frequency hash more or less confined to certain bands of operation. Such devices are limited where accurate radio diagnosis or alignment is required. This generator has been designed as a portable tool for rapidly estimating radio work to be done or to facilitate repairs made in the field. Its small size, operation on either a.c. or d.c., and high power output make it ideal to be carried in a serviceman's tool kit or in his pocket. The circuit design of the pocket generator maintains calibration even under rough treatment, an important factor not generally found in larger shop equipment.

The generator produces a modulated r.f. output equal in power to that of the conventional bench signal generator. This is made possible by using the miniature 12BA6, whose characteristics are identical with those of larger tubes commonly used to produce radio-frequency energy.

Space is saved by using a neon bulb to develop the a.f. modulating voltage. The bulb's oscillation is controlled to produce a note in the neighborhood of 400 cycles per second. The note produced by a neon-tube oscillator has a musical quality because of the numerous harmonics in its complex wave.

The 4 spot frequencies provided may be used in the servicing and alignment of more than 85% of all AM receivers built in the last 15 years and (to the best of our knowledge) all receivers built in the last 2 years. These 4 frequencies are 456 and 465 kc for the intermediate frequencies, and 550 and 1500 kc for the extremes of the broadcast band.

The new selenium rectifiers lend themselves to more compact design—therefore one of them was chosen, and

an a.c.-d.c. circuit selected. Line voltages are isolated from the output and from the case, preventing any difficulties when working on other a.c.-d.c. equipment. The attenuator has been found especially useful in alignment work.

Hartley oscillator circuit

The circuit (Fig. 1) is a modified Hartley or electron-coupled oscillator. It is very stable, as can be verified by varying the supply voltage from 85 to 140 volts and observing the lack of drift. Such stability is of paramount importance in alignment work with a portable instrument which is subject to the differences in line voltage found in the field. The stability is due to choice of tube, relationship between the plate and screen voltages, and the series cathode resistor. The 12BA6 tube is the miniature equivalent of a 12SJ7.

The oscillator coil is a conventional broadcast-band oscillator coil designed for Hartley operation with a 6SA7 tube in a circuit with an intermediate frequency of 456 kc. The 4 switch positions of the frequency-selecting system add capacitance across the coil, reducing the frequency. The 80- μ f trimmer remains across the coil at all times. The 3 lower frequency steps add capacitance in parallel with it.

All trimmers are of the compression type with ceramic bases. Those for the lower frequencies are shunted with fixed mica or ceramic units. The capacitance range is such as to give the maximum val-

ues shown on the schematics, though the proportions supplied by the fixed and variable parts may be varied somewhat. Any instability in the overall operation of an oscillator designed according to this circuit is likely to be due to poor mechanical construction of the trimmers. Other capacitance changes, such as those due to temperature variations, for example, would vary the frequency so slightly as to be not detectable on a highly selective receiver. Frequency change caused by an increase or decrease of a few micro-microfarads is very small when the total capacitance is in the order of several hundred micromicrofarads.

Suppressor modulation allows the neon tube's output to be introduced across a high impedance. This is necessary, since otherwise the neon tube will be loaded, and "pulling" and low-frequency oscillation—or no oscillation at all—will result.

The audio oscillator

The neon tube is connected in the familiar relaxation oscillator circuit.

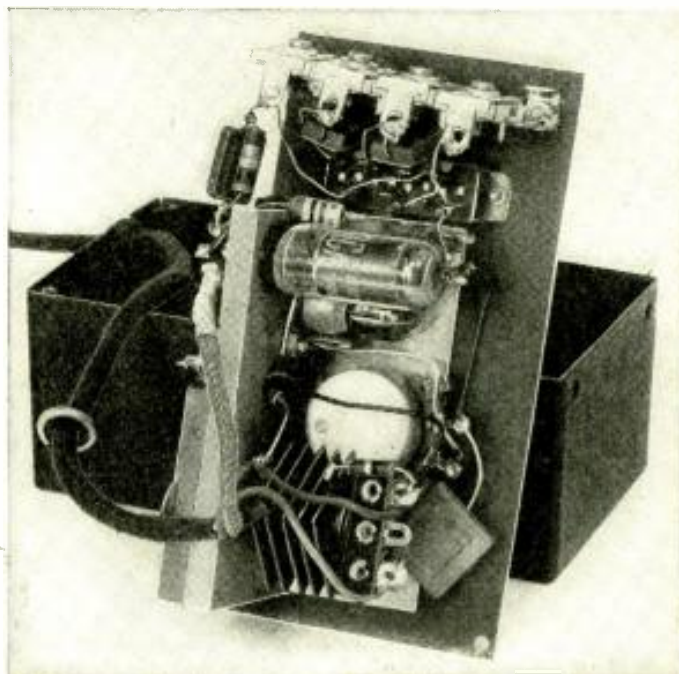

An inside view of the small generator. The audio oscillator is a neon lamp and is seen just behind the 12BA6.

*Design Engineer, Radio City Products Co.

consisting of a resistor in series with, and a capacitor in parallel with it, the whole placed across a d.c. source. (See Fig. 2.) Current flows through the resistor and charges the condenser. Until the condenser is charged, the flow of current through the resistor produces a voltage drop which keeps the voltage across the neon tube too low for ignition. As the condenser approaches full charge, its voltage rises and the tube

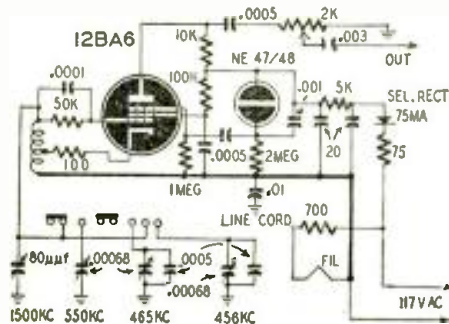

Fig. 1—Circuit of the 4-frequency generator.

“fires.” The condenser then discharges through the tube and is ready for the next cycle. Frequency of oscillation is controlled by the voltage, the resistance in series with and the capacitance across the neon tube. Increasing either the capacitance or resistance reduces the frequency.

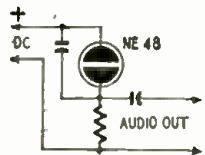

Fig. 2—The neon-tube oscillator. The output capacitor may vary between .0005 and .05 μf.

The series resistance not only acts as part of the time-constant circuit; it puts a high impedance in the path back to the power supply so that oscillation is not immediately damped out.

Neon bulbs may be found to have ignition and extinction voltages differing from one another by several volts. If the voltage across the bulb is too high (or the series resistance too small), it may not oscillate. The designer of such an oscillator can detect this trouble by listening as the unit is shut off. Immediately after the line voltage is interrupted, a growling noise can be noted in the receiver. It will last a few seconds and disappear. It is due to the voltage falling off in the filter condensers and passing the proper voltage (momentarily) for neon-tube operation.

If the voltage in the circuit is too low at all times, the tube does not glow. Remember, however, that during proper operation only one of the plates glows and the glow is not very bright.

The power supply

The selenium rectifier may be of the 100-ma or 75-ma type. Both are now generally available. The 75-ohm resistor acts to prevent excessive surge currents from damaging the rectifier or filter condenser. It acts also as a fuse to protect the rectifier in case of condenser breakdown. The 5,000-ohm resistor and two 20-μf condensers provide ample filtering.

The B-minus—which in an a.c.-d.c. device is one side of the line—is isolated from the chassis and the metal case. A .01 condenser between the B-minus point and chassis prevents electrostatic effects which might cause hum modulation of the oscillator and serves as a return for the r.f. circuit, which is grounded by connecting one side of the trimmers and output attenuator to chassis. It was felt that it was safer to bring one side of the trimmers to chassis than to B-minus, as the exposed metal plates of trimmer condensers might accidentally contact the chassis or the case. Should they be connected at the same time to the B-minus, this would place the case at line potential, which would be dangerous. Connecting them to chassis makes for safety.

A dropping resistor is needed for the 12-volt, 180-ma filament of the 12BA6.

A linecord type was chosen, to keep heat out of the case. The tube's dissipation is surprisingly low—it develops less heat than the selenium rectifier. Temperature rise has not been found troublesome.

Normal B-voltage will be in the order of 135 volts with an input of 115 volts a.c.

To align the instrument, tune a radio receiver to 1500 kc and adjust the first trimmer till the modulated r.f. of the generator is centered on the dial setting. Repeat with the second trimmer for a receiver setting of 550 kc. For 456 and 465 kc tune the receiver to 912 and 930 kc respectively and adjust the generator till the 2nd harmonic is accurately set to these frequencies. The harmonics are strong and may be used, not only as an aid to alignment of the instrument, but also in construction and servicing short-wave equipment.

Whip Tuning Motor

By HARRY WINFIELD

THE simplest tuning motor, without an armature, brushes, rings, or commutator, is the so-called “whip” motor shown in Photo 1. It depends upon the whip action of a leather strap which causes a smooth metal drum to rotate.

This type of tuner, with 2 motors for bidirectional rotation, may be found in a number of war surplus stores. The author built a simpler one from an old electric bell. It is pictured in Photo 2.

The bell used for the tuning motor should be a fairly husky one, such as a Faraday type, if the motor is to be capable of turning a 2- or 3-gang tuning condenser. The model illustrated was tested successfully on 8 to 10 v d.c. and also on 12 to 15 v a.c. The lamp was a dropping resistor from 117v a.c.

The strap was a short piece of soft leather, fastened to a piece of rubber band at the rear end. The front end had a hole pierced through it so as to slip over the end of the bell armature. As the bell vibrates, the brass disc, over which the belt or strap rests lightly, begins to turn slowly. The action is really uncanny to those who have never seen the whip motor in action.

Adjustment of the play between the armature and the magnets needs careful attention, so that the maximum whip action is exerted on the leather strap resting against the brass or other metal drum. Fiber or bakelite drums may be used, but the author used brass in his model. The strap may be a piece of fabric or cloth, with a thin strip (or pieces) of cork glued to the inside surface.

The whip motor is unique, and experimenters will undoubtedly find pleasure in building models for various purposes. If you have a couple of old electric bells in your odd-parts box, you can put them to work in one of these motors.

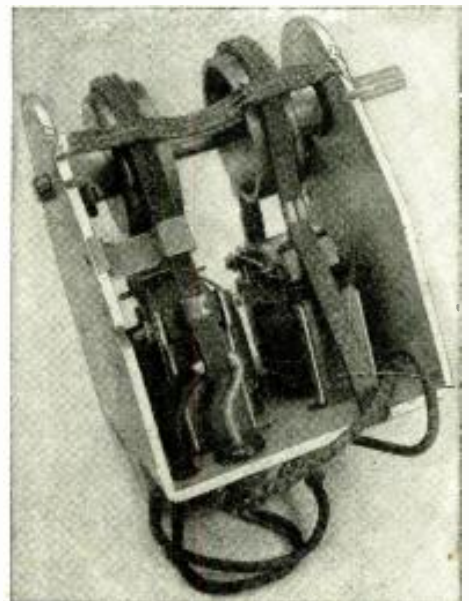

Photo 1—A bi-directional whip tuning unit. One wheel turns to the right, the other left.

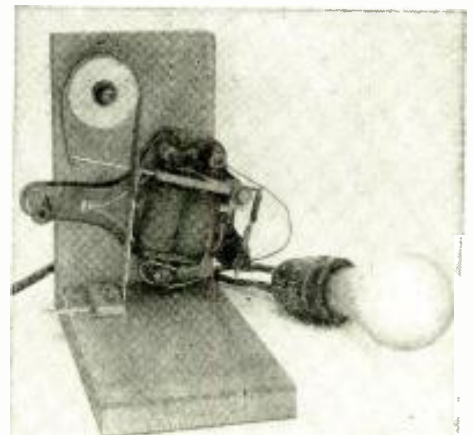

Photo 2—The discarded-doorbell whip tuner. The lamp is a resistor for dropping voltage.

Smallest Hearing Aid Uses Printed Circuits

The little case measures
4 $\frac{1}{8}$ x 2 $\frac{3}{8}$ x $\frac{7}{8}$ inches



THIS hearing aid is the first civilian device to use the famous wartime printed circuits. This is reasonable. Hearing aids have to be compact and they have to be rugged. The printed circuit was designed to fit in the nose of a small-caliber shell (where there is little waste space) and to be fired from a gun—tougher treatment than the most abused hearing aid has to take.

The new hearing aid, manufactured by Allen-Howe Co., is a 3-tube device whose circuit (Fig. 1) is in no way out of the ordinary. Mechanically it has few features in common with older instruments. The whole circuit is sprayed on a steatite wafer 1 $\frac{1}{2}$ x2 $\frac{1}{4}$ x3/32 inches in size, on which are also mounted the 3 small tubes.

What formerly was a complicated jumble of wires, resistors, inductors, and condensers—a total of 173 parts—has given way to a single amplifier unit of printed wiring and parts, occupying but a fraction of the space heretofore used. The third-dimensional effect of the usual electric circuit has been practically eliminated.

A feature of the printed circuit is that many of the components are actually manufactured in the process of "wiring up" the equipment. The entire manufacturing process is carried out in 4 simple steps:

First, silver ink is brushed over a silk screen stencil onto a clean steatite plate or chassis. The resulting pattern on the ceramic is the exact circuit desired, but, instead of the copper wire ordinarily used in electrical circuits, a group of silver lines appears. The ink or paint consists of finely divided silver or silver oxide mixed with a binder to make a paste and thinned with a solvent such as acetone.

After application of the circuit pattern, the plate is heated to a temperature of between 1,300° and 1,500° f. This process bonds the silver permanently to the ceramic.

Second, the resistors are painted or sprayed through a second stencil, designed to make them fall into exactly the right places in the circuit. The resistor paint consists of a conducting material such as powdered graphite and an inert or nonconducting material such as mineralite or powdered mica. The plate is then baked in an oven at 300° f. to cure the resistors so their values will not change in use.

Third, the small, disc-like condensers are then applied directly to the wiring on the plate. The condensers measure from $\frac{1}{8}$ to $\frac{1}{4}$ inch in diameter and are .04 inch thick.

Fourth, the device is assembled by adding the new subminiature vacuum tubes, small transformer, miniature microphone, batteries, 3-position tone

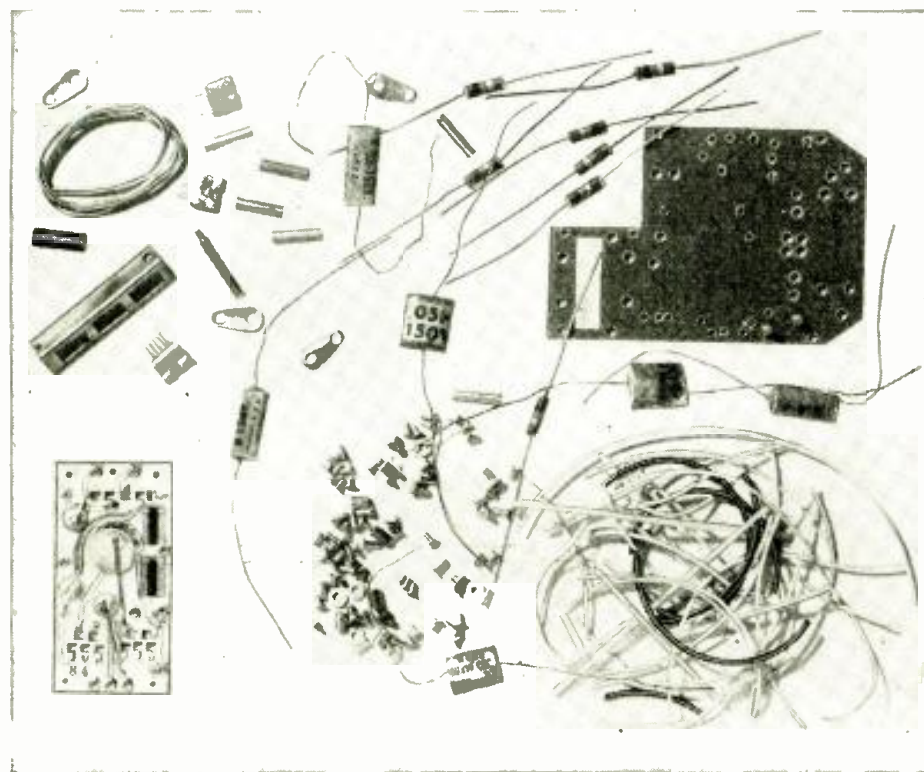

The new hearing aid—whose chassis appears in the lower left-hand corner—compacts into little more than 1 x 2 inches the whole tangle of components shown in the rest of the photograph. The standard hearing aid chassis alone is several times as large as the complete ceramic unit with all its parts sprayed and printed on. Altogether 173 components and pieces are replaced by the printed circuits of the new unit.

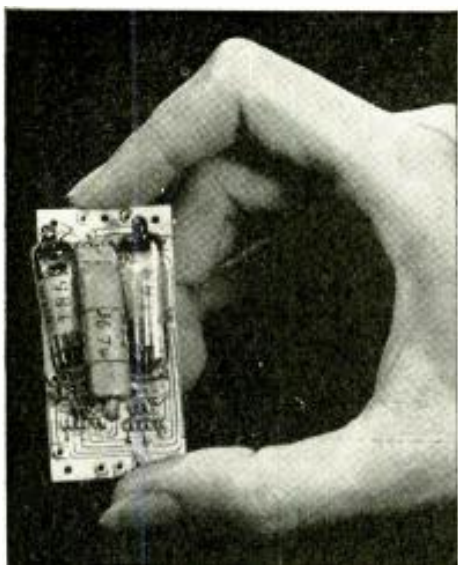

True size of the amplifier is emphasized by comparison with woman's hand which holds it, and which—to many eyes—it exaggerates.

control, volume control, and an ingenious plug-in arrangement which makes possible the use with a single assembly of a choice of the 3 types of receivers—crystal, magnetic air conduction and bone conduction. The entire assembly is housed in an anodized aluminum case.

The 3 kinds of receivers are part of an ingenious arrangement which adapts the one instrument to a wide range of hearing impairments. A crystal earphone is used for persons who require a great proportion of highs, and a magnetic unit for those whose hearing is most impaired in the lower registers. In combination with the 3-position tone control, almost any desired frequency-response characteristic thus can be secured.

The third type of receiver is a bone-conduction unit for use in cases where the inner ear does not function. The instrument is adjusted for varying degrees of hearing sensitivity simply by changing the output tube. High-power, regular, and low-power output tubes may be used. Gain at its best is good. With a 1-millivolt input, the circuit delivers an output of 1.3 volts.

Altogether 48 combinations of frequency characteristic and volume are available—a large enough number to cover practically any individual case

the acoustic consultant may encounter.

The greater part of the space in the case is taken up with batteries. Smaller batteries could no doubt have been used to reduce the size of the instrument still further, but the factor of battery longevity was felt to outweigh any advantages of greater compactness. In the photo at right, the bottom of a standard Mallory cell is visible at upper left. This is the A-battery. The B-battery is an Eveready Mini-Max of the hearing-aid type. The output transformer is at top right. The 2 controls—tone and gain—are seen at the bottom of the case. Between them is the receptacle for the plug-in arrangement. This is normally the top of the instrument, though apparently the photographer and artist were not aware of the fact, to judge by the lettering on the 2 batteries. The back of the unit is (naturally) toward the back of the case, and the 3 tubes are on the other side.

The front and back of the ceramic "chassis" are shown below—slightly larger than life size. The tubes are held in ingenious socket which occupies practically no space, yet holds the wire terminals of the tubes securely and makes an excellent electrical connection. The rectangular black areas are resistors, and are covered by a transparent insulating coating which may be seen in the photos. The back of the set contains most of the condensers. It is just possible to see that the large center one is a pair of condensers in series, a small disc over a large one, with 3 terminals. Connections to the outside circuits are made at the eyelets near the edge of the plates, and other eyelets are used to carry connections through the chassis from front to back. Connections to the condensers are made of strips of heavy foil or thin metal, silver-soldered to the condensers and to other connectors, or simply to the end of a printed-silver conductor.

The instrument is so rugged that servicing probably will be confined largely to replacing tubes and batteries. Should anything go wrong with the amplifier itself, the printed circuit reduces repairing to the simple operation of slipping in a new unit. This can be done on the spot. Persons who have had to wait while their units were sent back to

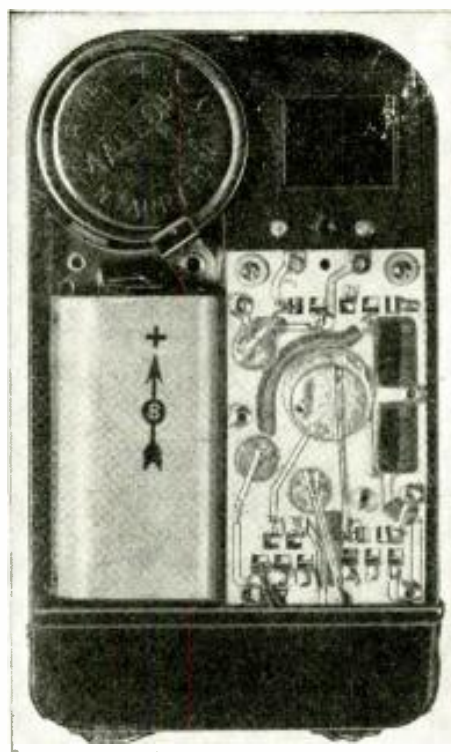

Rear view of the device with its cover off. A complete description is given in the text.

the factory for repair will appreciate this improvement.

The set is a natural development of the printed circuits developed during the war for proximity fuzes by Dr. Brunetti and his staff. Credit is given by the makers of the instrument also to Alfred S. Khouri, project engineer for Centralab, designers and builders of the first printed circuits and to Joseph J. Knouse, who supervised development of tubes for the proximity fuze and who is now chief engineer of the Allen-Howe Corporation.

The hearing-aid field is obviously a "natural" for the printed circuit. Its inherent advantages are especially applicable to that instrument. But it will not be long before the printed circuit makes its appearance in other equipment, where either ruggedness under rough usage or vibration, compactness, or trouble-free operation are important.

Photo at right shows front view; photo at left shows back view.

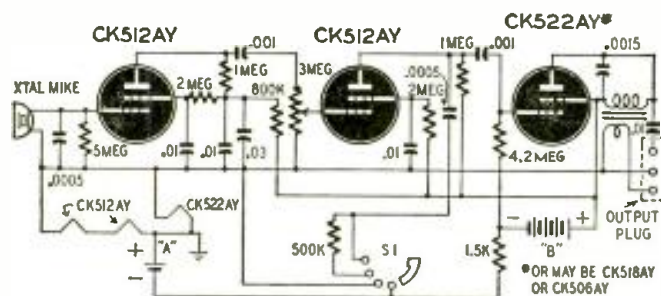
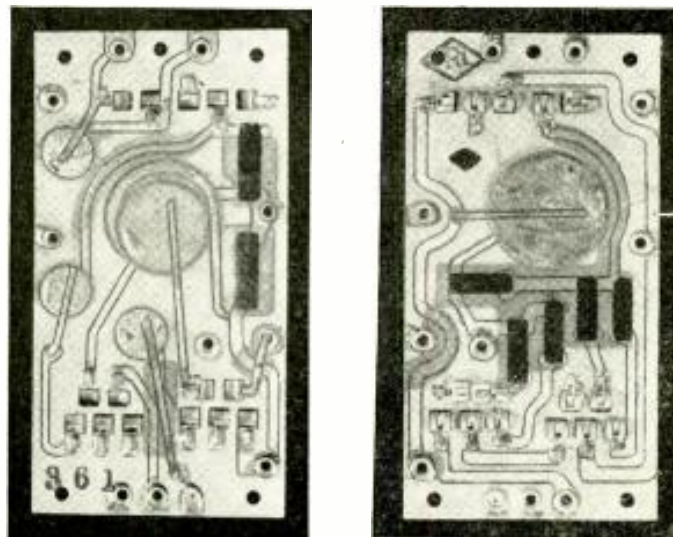

Fig. 1—The schematic of the hearing aid might be that of a standard instrument—or in fact that of a small amplifier of any kind. The volume control is in the second tube grid circuit, to work at higher noise levels and thereby reduce relative noise. The combination plug receptacle at right permits use of either crystal, magnetic or bone-conduction earphones.



Precision Frequency Meter

Uses 3 Oscillators

The built-in calibrator makes this a laboratory-precision instrument



A freqmeter for radio station or laboratory.

ALMOST universally, amateur radio regulations require that some means be provided for accurately measuring the transmitter frequency. However, frequency measuring equipment is conspicuously absent from the average amateur station; even when the operator makes a practice of band-edge operation. It has been proved to many that you must not rely heavily on a receiver or transmitter of doubtful calibration accuracy in determining transmitter frequency or band limits.

This heterodyne frequency meter is designed for accurate measurements in the amateur bands and will satisfy exacting requirements for accuracy. Its versatility and accuracy make it equally useful in other classes of radio stations, laboratories and other installations where accurate measurements must be made over a wide range of frequencies. The factors involved in the construction and calibration of such equipment may be applied to variable frequency transmitter control systems as well.

A block diagram of the unit is shown

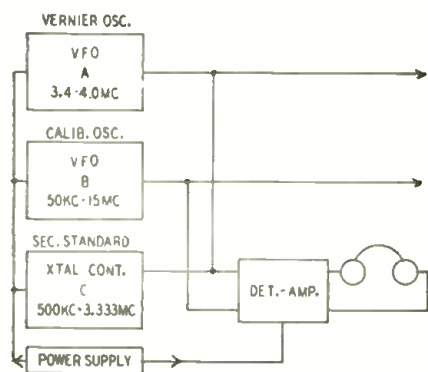

Fig. 1—Block diagram of the frequency meter.

in Fig. 1. Oscillator A is a variable-frequency oscillator tuning from 3.4 to 4.0 mc in 200-kc steps. The calibrating oscillator, B, tunes from 50 kc to 15 mc in 6 steps. It determines the approximate frequency of a signal being received on a receiver or applied to the input terminals of the heterodyne detector. Oscillator C is a crystal controlled secondary standard using 500-kc and 3.333-mc crystals. Signals from all oscillators are applied to the heterodyne detector and to external binding posts. By using the fundamentals and harmonics of the 3 oscillators, it is possible to measure accurately the frequency of any signal between 50 kc and 30 mc or possibly higher (depending on the strength of the harmonics).

The vernier oscillator

The vernier oscillator (Fig. 2) is the heart of the instrument, it is highly stable against mechanical, electrical and thermal changes. Its precision dial, with lens system, permits frequency measurements to within 50 cycles on the fundamental ranges of the unit. A high-C electron-coupled oscillator with a 37 tube assures stability against voltage variations. About 450 μf are required to tune the 4- μh coil to the high end of the tuning range. The coil, L1, consists of 12½ turns of No. 14 wire on a 1-inch ceramic form. The windings are spaced the diameter of the wire or to tune to 4.0 mc when shunted with 400 μf . The cathode tap is made about 3½ turns from the ground end of the coil. More about the cathode tap later.

When the oscillator is operating at its highest range, 3.8 to 4.0 mc (A), L1 is tuned by C6 and paralleled by the series combination of the main tuning condenser, C7 and padder C3. On the lower ranges, B and C, 3.6 to 3.8 and 3.4 to 3.6 mc respectively, trimmer condensers C4 and C5 are added to the tank capacity and padders C1 and C2 are switched in parallel with C3. The padders are adjusted to spread the tuning ranges over the desired space on the dial. In each case, the padders are adjusted to provide an additional 20 kc on each end of the calibrated tuning range when the tuning condenser, C7, is varied through its entire range. This

makes the calibrated tuning range fall on the most linear part of the capacity-frequency curve of C7.

High accuracy and linear calibration curves depend on the values of trimmers and padders. Condenser C1 is a 100- μf mica shunted with a 5 to 30- μf trimmer adjusted to 24 μf . Units C2 and C5 are 3 to 100- μf padders set at about 40 μf . C3 is an 80 to 200- μf padder set at 115 μf . C4 is a 75- μf mica shunted with a 30- μf padder set at 17 μf . The fixed tank condenser, C6, has a capacity of 380 μf . A 2-plate variable condenser is connected across C6. It has negligible capacity and is used for front-panel control of minor frequency variations. It is controlled by the knob at the right of the optical system on the main tuning dial. All fixed capacities in the tuning circuit are mica units and the trimmers are ceramic condensers.

The dial of the oscillator is divided into 270 divisions over 180 degrees. The control knob is finely divided with 10 main divisions over 360 degrees. This control is connected to the main dial through 10-to-1 gears. One division on the main dial corresponds to 890 cycles on any range. The calibrated knob makes it easy to adjust the frequency to within 50 cycles or better.

The calibrating oscillator

The calibrating oscillator is in the center of the chassis. Its tuning ranges are: A, 50 to 150 kc; B, 150 to 350 kc; C, 350 to 1000 kc; D, 1 to 2.5 mc; E, 2.5 to 7 mc; F, 7 to 15 mc. The band switch has 7 positions: 1, marked 0, turns this oscillator off. The coils are tuned by a 2-section 18 to 480- μf condenser. The sections are used in parallel for the three lowest ranges. A 5-plate 20- μf midget variable shunts the larger condenser and is a bandspread condenser when one is needed. This is controlled by the calibrated knob at the lower right of the front view.

Six cathode-tapped test oscillator coils are used. (The author used European coils not available in the United States, but standard American test oscillator coils can be used, though the frequency ranges may differ somewhat from those given above. Coil manufacturers put out sets of test oscillator coils ranging from 50 kc to 20 mc.—*Editor.*)

The secondary standard

The frequency standard is used for checking the calibration of the variable oscillators and to provide check points on a receiver. The circuit is a tuned-plate oscillator using an EF9, a European tube that can be replaced with a 6S7-G without changing circuit constants. The frequency of such oscillators varies slightly with tank-circuit tuning, making it possible to adjust the output frequency to exactly 500 kc or

3.333 mc by beating with a signal from a harmonically-related radio station. If this does not provide enough variation, adjust the air gap in the crystal holder one way or the other.

Detector—a.f. amplifier

The heterodyne detector is a 6A8. Signals from the vernier and standard oscillators are fed in on the No. 1 grid and from the calibrating oscillator to the control grid. Beat notes between any combination of fundamentals and harmonics appear across the plate load resistor. These are coupled to the 37 a.f. amplifier tube through the volume control shown in the upper left corner of the front view. Signals are amplified and fed to the phone jack on the panel. A 2.5-mh choke and a .002- μ f condenser prevent r.f. from being radiated by the phone cord.

The vernier and crystal oscillators are connected to an output jack through a 1500-ohm resistor and a 500-ohm attenuator. This prevents the output from masking signals on a receiver and reduces signals fed to the mixer for comparison. The calibrating oscillator is fed to another jack without a variable attenuator.

Oscillator compensation

A 380- μ f condenser was used for C6 and a precision thermometer inserted in the oscillator compartment. When the unit was tuned to 3500 kc, the frequency drifted positive about 800 cycles with a 2-degree Centigrade change in frequency. This is equivalent to a .024- μ f capacity change. C6 was replaced with a 175- μ f condenser having a negative temperature coefficient of .0007- μ f per μ f per degree Centigrade. This was shunted by a 150- μ f mica and a trimmer adjusted to 55 μ f. The drift was reduced to 225 cycles for a 2-degree temperature change. We replaced the 175- μ f temperature compensator with one of 185 μ f and the same coefficient and the curve became flat after the initial warm-up as shown in curve C of Fig. 3. Curve A is the frequency-temperature curve without compensation. Curve B is the result of partial compensation.

The coil and tuning elements are in a metal box insulated on the outside

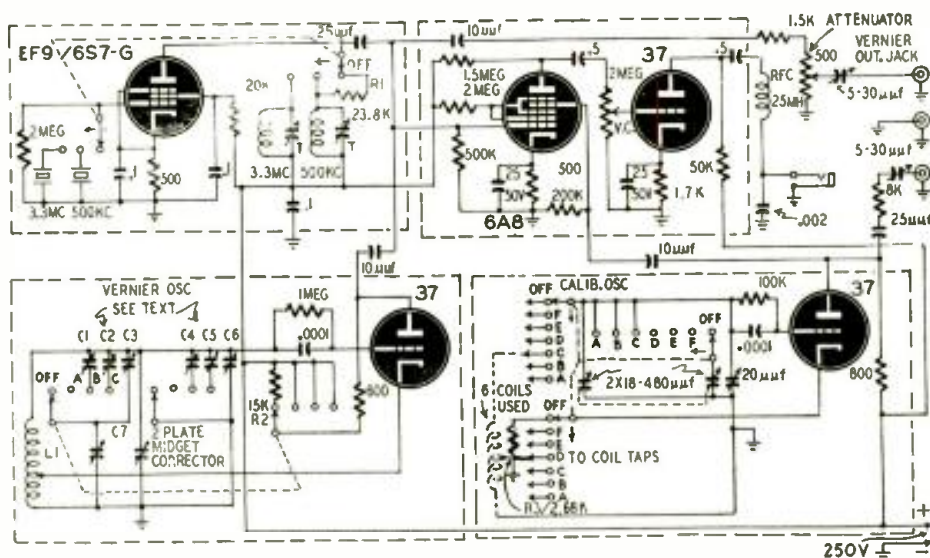

Fig. 2—Schematic. The coils are represented by a single dashed one. The bottom jack is the output from the calibrating oscillator.

with a layer of Masonite. Trimmers and padders are adjusted through holes in the side of the box. The holes are sealed after the unit is calibrated and compensated.

The calibrating oscillator is not compensated. It is in an uninsulated metal box painted with white paint. This reflects some of the heat radiated by the tubes and transformer.

Compensation against changes in the power supply load was accomplished by inserting R1, R2 and R3 in the circuits when their respective oscillators are off. These are selected to reduce the plate currents to equal those when the oscillators are operating.

(The position of the cathode tap on L1 is also a factor of stability against voltage changes. Adjust the cathode tap to a point where a 10-volt plus or minus variation in line voltage will have little effect on the frequency.—Editor)

Operation

Adjust crystals in the standard oscillator to proper frequency by comparing with signals from harmonically-related broadcast signals or WWV. This oscillator holds its frequency well and need not be checked very often.

The 7th and 8th harmonics of the 500-ke crystal will fall at 3.5 and 4.0 mc and can be used to check the calibration of the vernier oscillator. The 3.333-mc crystal can be used to check
(Continued on page 118)

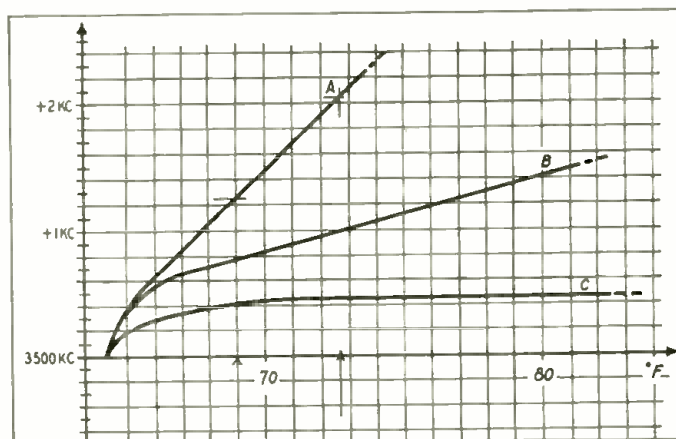
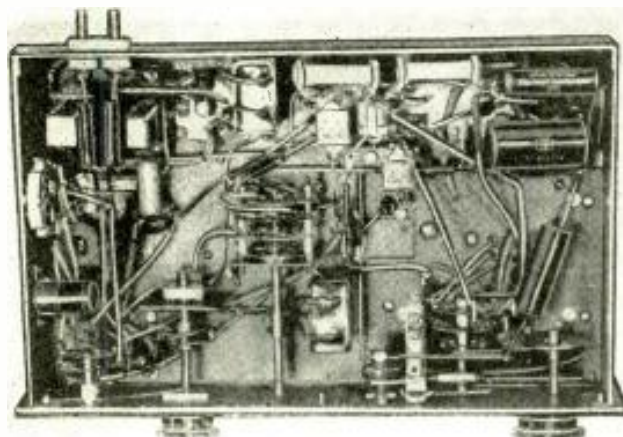
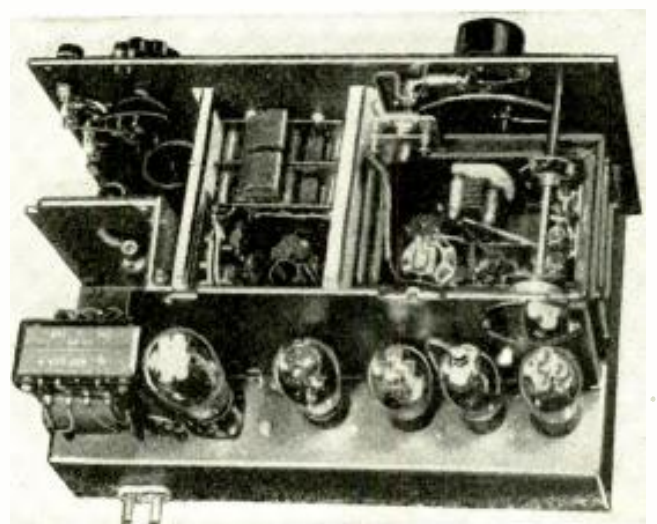

Fig. 3—Effect of temperature compensation on vernier oscillator.



Wiring is simple. Under-chassis controls and switches are shown.



The oscillators are shielded from each other by metal compartments.

Direct-Current Milliammeters In Radio Servicing

By OSCAR E. CARLSON

MANY articles on voltmeter and multimeter construction have appeared in this and other technical magazines. These articles usually refer to a certain specific value of milliammeter as the fundamental movement. More than one experimenter who has wished to build the equipment described has had a milliammeter of a different range and has not known how to adapt the circuit constants to his own instrument.

When measuring d.c. voltages in radio receivers, it is safe to obey the following arbitrary "rule of thumb": *The meter current for full scale should be no more than 5% of the current which normally flows in the circuit across which the voltage is measured.* This should be remembered and adhered to, or there is danger of considerable error.

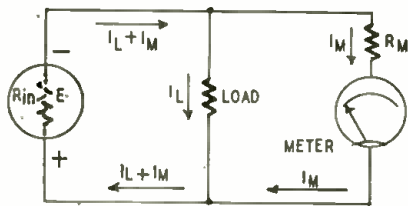

Fig. 1—Effect of meter on circuit voltages.

To illustrate this, assume a circuit like Fig. 1. Current flowing through the internal resistance R_{in} of the voltage supply will cause the supply voltage to drop as the load increases.

With the meter disconnected, the voltage across the load is $E - R_{in}I_L$. Upon connection of the additional load represented by the meter and multiplier resistance R_m , the voltage across the load becomes $E - (R_{in}I_L + R_{in}I_M)$. The error introduced therefore decreases as R_m increases, being zero if the meter resistance is infinite.

Nearly all d.c. voltages in radio receivers are developed across some resistor or a combination of ohmic resistance and impedance.

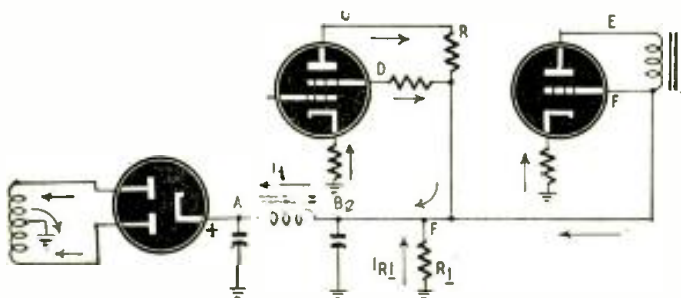

Fig. 2—Current distribution in power supply and part of a receiver.

Typical receiver voltages

The d.c. voltage distribution from a rectifier power supply is shown in Fig. 2. Current (electron flow) is indicated by the arrows in that figure. Total current is flowing at points A and B.

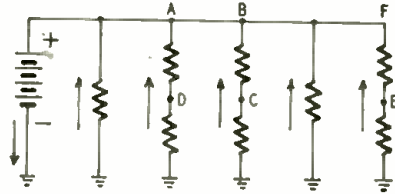

Fig. 3—Equivalent resistive circuit, Fig. 2.

Smaller currents making up this total flow at points C, D, E, and F. An equivalent resistive circuit is Fig. 3.

A voltmeter from points D, C, or E to ground then places a shunt resistance from the measured point to ground. A voltage drop between the measured point and the source voltage at A, B, or F due to the increased current flow across AD, BC, or FE causes the voltages to be lowered at points D, C, or E.

The current flowing to points A, B, or F may be from 40 to 150 milliamperes, depending upon the type of radio receiver. Using our 5% rule for a 40-ma

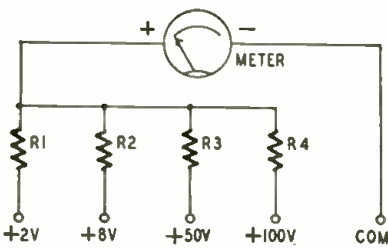

Fig. 4—A simple heavy-drain battery tester.

supply allows us a 2-ma drain for our voltmeter. A 2-ma meter would require a 500-ohm meter multiplier to limit current to 2 milliamperes when connected across a source of voltage of 1 volt. This is a 500-ohm-per-volt meter. A 0-100-volt meter using a 0-2-ma meter would then require a 50,000-ohm multiplier resistor. For a measurement across a source normally supplying 100 milliamperes, we could use a 0-5-ma meter and thus have a sensitivity

in the order of 200 ohms per volt.

Thus, for voltage measurements across the average radio receiver power supply, supplying 50 to 60 milliamperes, a 0-2-ma meter is the highest practical range that may be used as a voltmeter.

But suppose you have on hand a 5- or 10-ma meter and wish to make fairly accurate and meaningful voltage analyses. Remove a portion of the load from the power supply, for example, by disconnecting a plate and screen circuit which draws a 10-ma load. In an a.c. receiver we can do this by removing the selected tube from the socket. You may then measure the supply voltage with a voltmeter using a 0-10-ma meter. (The meter sensitivity would be 100 ohms per volt.) Adding a 50,000-ohm resistor in series with the 10-ma meter as a current-limiting resistor would make a 50-volt voltmeter. This would allow us to trouble-shoot the power supply and filter circuits with fairly accurate indications

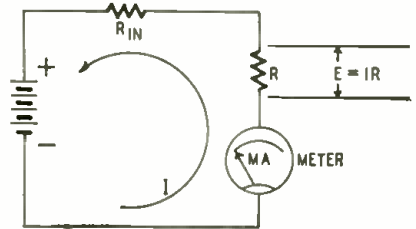

Fig. 5—Measuring voltage with milliammeter.

of what the voltages are, or would be, with the circuit restored to normal by reinserting the tube.

Make good battery testers

Such a voltmeter made from either a 10-ma or even a 50-ma meter is admirably suited to testing radio A- and B-batteries, since it imposes sufficient load to allow normal voltage drop through the batteries' internal resistance. Such a test on batteries is a better indication of their condition than a test with a 1,000-ohm-per-volt or higher instrument. In fact, when testing such batteries with a 1,000-ohm-per-volt or higher instrument, it is preferable to shunt a resistor across the battery to simulate the receiver load, and then measure the voltage developed across that resistor. B-batteries should be tested with about a 20-ma drain and A-batteries with a 50-ma drain. The necessary shunt resistor may be determined from Ohm's law as follows:
Shunt $R = \frac{\text{Battery voltage (new)}}{\text{Specified current in amps.}}$

As an example for a 45-volt battery with 20-ma drain:

$$\text{Resistor} = \frac{45}{.02} = 2,250 \text{ ohms.}$$

Fig. 4 illustrates a battery tester of the above type which may be made from a 0-5, 0-10, or a 0-100-ma meter. The unit using the 0-100-ma meter should not be used in conjunction with any
(Continued on page 85)

12-VOLT AMPLIFIER

By JOHN W. STRAEDE

THE amplifier described in this article is of interest for several reasons, possibly the most important being its extreme efficiency. The plate efficiency of the amplifier itself is good (35 watts of plate input giving 18 watts of audio power, equivalent to about 25 watts of usable power). The power pack—being vibrator powered—is also of high efficiency. For an average, mobile amplifier putting out 14 to 18 watts, the drain on a 6-volt battery is about 15 amperes or 90 watts. In this case the drain is just over 5 amperes from a 12-volt battery—only 64 watts. And the output is greater, effective output being nearly doubled.

To gain this degree of efficiency, only standard parts are used with the exception of the 2 vibrator transformers, each of which has a standard primary but a 175-volt, 100-ma secondary. The lower the ratio between the windings of a transformer, the more efficient it can be made. The 12-volt, 3-ampere split-reed, synchronous vibrators are standard, the split reed being necessary to connect the outputs in series to give the needed 350 volts.

Besides being extremely compact, the amplifier itself has a number of novel circuit features such as the 1-tube electronic mixer recently described in RADIO-CRAFT. Class AB₂ operation is provided for the 6L6 output tubes, but it is arranged that operation in the grid current region is only momentary; It is provided to allow for the peaks present in speech signals. Many of these peaks are clipped because of overload. Retaining them makes the reproduced sound more natural. Because little power is to be provided for the 6L6 grids, the coupling transformer has a higher ratio than usual. The over-all ratio of primary to entire secondary is 1 to 1½. In the

transformer used, the primary inductance was 21 henries.

Decoupled, semifixed bias on the output stage also helps to provide momentary powers much greater than the rated output. A 24-microfarad condenser and 1,000-ohm resistor have a time constant of approximately 1/40 second, so for brief intervals of time the amplifier acts as if with fixed bias.

Large bypass condensers (2 of 24-μf) have a similar influence on the voltage of the 6L6 screen grids.

Automatic volume control (partly compression, partly limiting) has the very desirable effect of allowing the

are fed. Amount of control voltage can be regulated by a potentiometer or by a fixed voltage divider consisting of 0.2- and .075-megohm resistors in series.

Tone control system

The compactness of the amplifier allows no room for conventional tone controls, so a couple of switches are employed. One attenuates the highs by

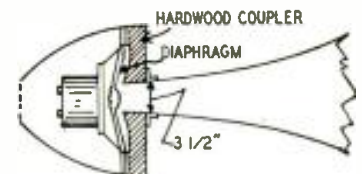

Method of coupling speakers to large horns.

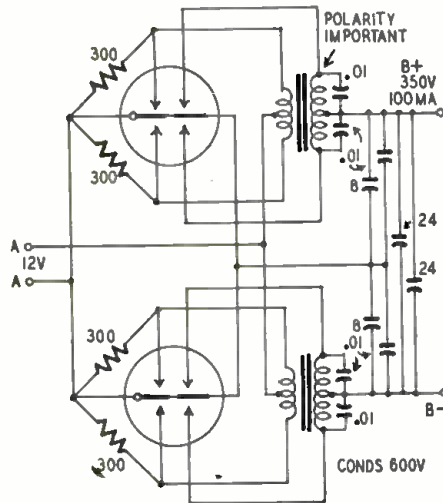

Two vibrator units in parallel are employed.

amplifier to be run at high volume levels without excessive overload. The necessary control voltage is obtained by rectification of part of the signal supplied to one of the output tubes. The d.c. voltage thus obtained controls the gain of the pentode into which both inputs

connecting a .005-μf condenser from the 6B8G plate to chassis while simultaneously connecting an extra condenser across the output. The other switch attenuates the lows by inserting an extra coupling condenser in series and by reducing the capacitance of the 6J5 cathode condenser. Even with highs and lows not attenuated (by pressing the switches), there is a certain amount of frequency restriction. This is good and is deliberately provided because there is little use in having an amplifier turn out notes which the speaker can't handle or which cannot be heard at a reasonable distance.

To conserve output power it was decided to run separate 3-conductor, high-impedance lines direct from output tubes to each speaker. There is a safety link in each speaker plug so that the 6L6 screen voltage is removed if both speakers are disconnected.

Negative feedback is employed on the driver stage to make up for the sudden decrease in load when the output tubes start to draw grid current. Shunt resistors across the transformer secondary help to stabilize the load.

American readers may wonder why tube sockets are so commonly employed as input and output sockets in Australia. Well, they're cheap, and those of one particular make are very reliable indeed. Their main disadvantage is their bulk.

(Continued on page 98)

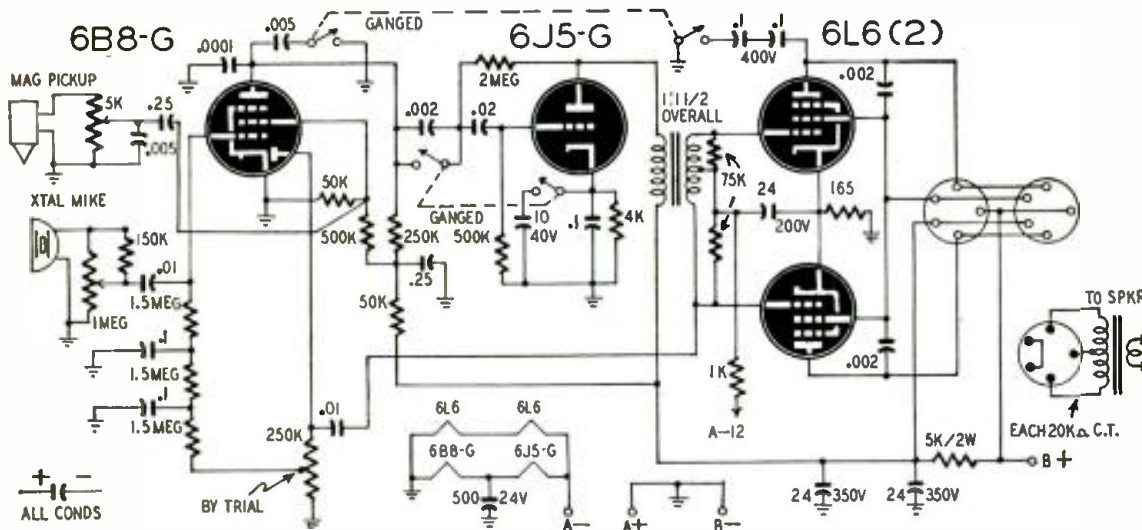

The high-efficiency battery-powered amplifier uses an electronic mixer and a simplified tone control system.

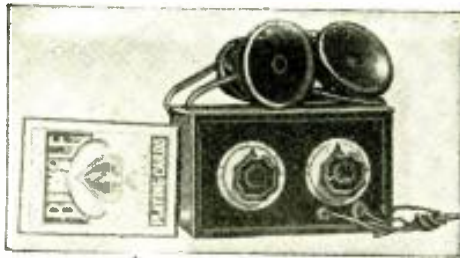

A Modern Midget Set

Sub-postcard size crystal radio

By W. H. GRACE

DESPITE present-day advanced electronics, there are tens of thousands of crystal receivers in daily use in the United States alone. Naturally there are very valid reasons for this. There is no upkeep cost, and the fidelity of tone and clarity of crystal rectification are hard to beat.

The panel of the modern midget receiver described below is only slightly larger than a deck of ordinary playing cards. On one high-powered local station it operates a sensitive magnetic speaker with sufficient volume to be enjoyable several feet from the speaker. Three other locals can be heard on the loudspeaker with somewhat less volume. The physical dimensions are shown

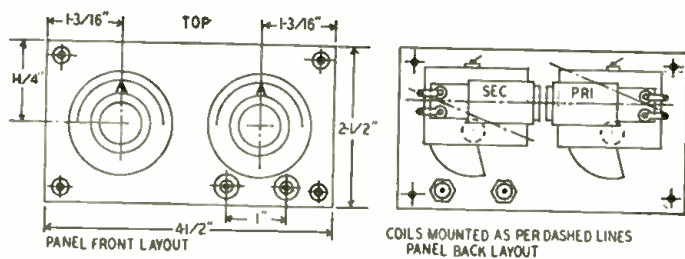

Fig. 1—Coupling may be varied by sloping coils (see dashed lines).

clearly in the accompanying diagram (Fig. 1). The cabinet fits completely around the bakelite panel upon which all the components are mounted. The depth of the small wooden cigar-box cabinet is great enough to clear the condensers and coils. Antenna and ground connectors are short lengths of stranded, insulated wire passing directly through 2 holes in the back of the cabinet. Four small wood blocks are glued into the corners of the cabinet for the panel mounting screws.

The circuit is a time-tested one, but the coils used will require some explanation. These coils are one of the secrets of this little set's performance and make possible its efficiency despite such miniature form.

Preparing the coils

The first step is to procure 2 standard BC antenna coils with high-impedance primary windings and bankwound *Litz* (*Litzendraht*) wire secondaries having approximately 250- μ h inductance. Disconnect the 2 secondary leads from the lugs at the end of the coil form. These coils are wax impregnated, and the secondary lead adjacent to the primary is wrapped 1 full turn over and around

the lattice-wound primary coil. These little coils are readily obtainable for a few cents at most good radio parts stores.

(If a few minutes are spent studying the construction of the coil, there is no trick to freeing this connection without injury to the fine wires composing the *Litz* cable. See Fig. 2). When both secondary leads are disconnected, lay them back across the secondary winding out of harm's way for the time being. Should the wax be hard, it can be softened quite easily by the application of heat from direct sunlight or by holding a heat lamp or electric iron near it for a short time. The wax is to be softened, not melted.

Next either unwind the primary coil

or remove it by cutting across the wire with a very sharp knife. Only the *Litz* secondaries are used, one as the primary in the antenna circuit and the other as the secondary in the detector circuit. Resolder the 2 leads from the secondaries back to their respective lugs on both coils. Be sure that all the fine enameled wires of the *Litz* cable are unbroken and that all are joined together at the terminal lug. If this is not done, losses will be introduced which will impair the results.

Circuit details

Two midget variable condensers are used to tune the 2 circuits. Each section is of 365- μ mf capacitance. The primary series condenser uses both stator sections, thus doubling the capacitance by connecting both stators together. The secondary condenser uses just 1 stator section; the other is left unconnected. The circuit is shown in Fig. 3.

These condensers were used because they are easily obtainable in many radio stores at very reasonable cost and are of a low-loss type which works well in a crystal set.

The condensers are mounted by 1 threaded bolt directly on the panel, and the coils are attached with skinned hell

wire to the condensers by direct soldering. This arrangement is very simple, as the electrical connections provide the mechanical support for the coils as well. Only 1 lead of the primary coil goes to the condenser, but a dummy lead supplying the needed additional mechanical support is soldered from the condenser frame to one of the unused lugs on the coil form to stiffen the coil mounting mechanically. Both coils are mounted in inductive relationship to each other. If additional selectivity is required, a slight bending of the coil supports will loosen the coupling. Once the coupling is adjusted to your antenna and location, no further attention is necessary.

The detector unit chosen was a germanium diode rectifier, the 1N34. These units are very compact and sensitive. One wire lead from the diode is soldered to a terminal of the phone jack, and the remaining lead goes directly to the end of the secondary coil nearest the primary, with which it is inductively coupled as shown in the diagram.

Phones, aerial, and ground

An excellent pair of high-impedance phones are absolutely a must for best results with any crystal receiver. Procure the best magnetic-type headset you can afford. It will prove a wise investment. Be very cautious of the war surplus bargain headsets so common at present; many are of improper impedance and design for crystal-set needs.

Good aeriels and grounds are needed for peak performance of this receiver. Use only a good water-pipe ground. Solder the ground lead to the pipe if possible; otherwise attach it with a clean groundpipe clamp. The ground wire should be of at least bell-wire size.

Keep the ground wire as short as practical because excessive length appears to decrease the selectivity. Multiple grounds may well be experimented with. Three or more different grounds often increase the volume noticeably.

The antenna is most important, and the following suggestions apply to any crystal receiver. It is recommended that the aerial be between 125 and 150 feet long, of tinned copper wire, solid or stranded making little difference. No. 14 enameled wire also may be employed, but all joints must be soldered and both ends insulated with at least double insulators. Keep lead-in wire and the aerial proper as far away from all objects as the layout allows with as few right-angle bends as the job requires.

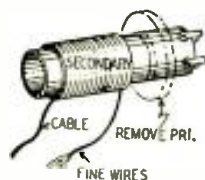

Fig. 2—Coil detail.

Combination Test Instrument

J. V. ROBERSON

A VERSATILE tester which can be used as a signal generator, signal tracer, phono amplifier, wireless oscillator, or a receiver can be made easily and economically from a small 5-tube super-heterodyne receiver. Necessary switches and jacks can be mounted on the rear of the chassis. Alterations are confined to the first and second detector circuits. Changes are shown as heavy lines in the diagrams.

If possible, select a receiver with a 455- or 456-kc i.f. channel. Intermediate frequencies are reasonably well standardized, and such sets can be used for i.f.-signal tracing on other sets using the same i.f.

Signal tracer

For use as a signal tracer, connect a common ground between the tester and the set to be tested, throw S1 to NORMAL, and plug a single-conductor probe into J1. Tune the tester to a clear channel. The probe can be used to trace i.f. signals between the first detector plate and the detector input of the set under test. Sets using 455- or 456-kc i.f. can be aligned by applying the probe to the output of the set's i.f. system and aligning its trimmers for maximum signal in the speaker of the tester.

For a.f. testing, insert the probe in J3 and tune the tester to a clear channel with S1 in normal position.

Signal generator

To use the tester as a signal generator covering the broadcast range throw S1 to TEST. This disconnects the antenna circuit and places its tuning condenser in parallel with that of the oscillator, thus lowering the frequency to roughly that shown on the tuning dial. The signal is modulated by a relaxation oscillator using a 1/2-watt neon lamp. It is turned on or off by S2. Output is available at J1. An audio test signal may be taken from J2.

(It is advisable to calibrate the oscil-

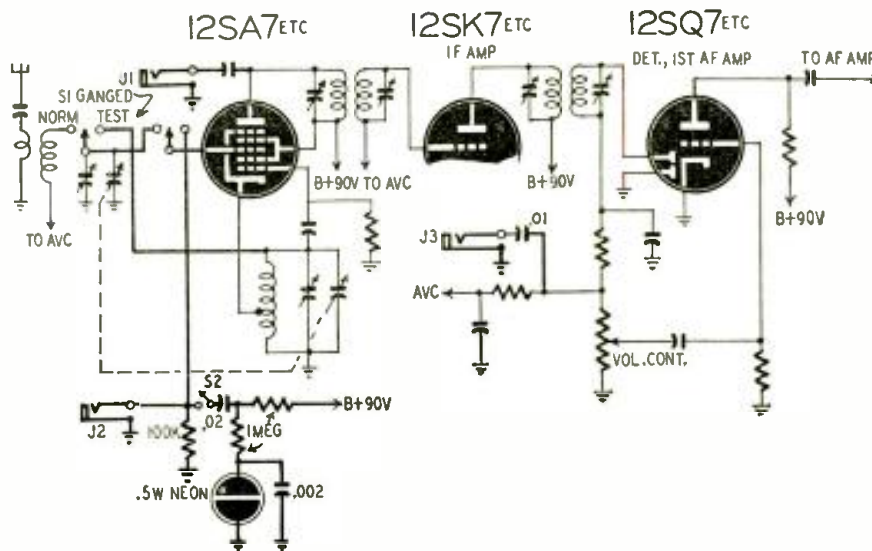

Switching makes this a signal generator, signal tracer, phono oscillator or an amplifier.

lator, using a chart to show the exact frequencies as compared with dial indications.—Editor)

Modulated i.f. signals are available at J1 by placing S1 in NORMAL position and tuning in a signal.

Phono oscillator-amplifier

Convert the unit to a phono oscillator by removing the neon lamp and connecting a phono pickup to J2. Connect a short antenna to J1 if one is needed. Opening S2 will increase the gain and remove the possibility of hum.

Connect the phono pickup to J3 and adjust the tester for a.f. signal tracing, and you have a small phono amplifier.

(The receiver selected for the tester should be a.c.-operated if possible. This will prevent trouble when making connections to a.c.-d.c. sets. If it is necessary to use an a.c.-d.c. model as a tester, be sure to observe polarity when connecting the common ground. Connect a small 117-volt lamp to a pair of test leads and connect between the 2 chassis. If the light glows, reverse the line plug on one of the units.—Editor)

CHASSIS CRADLE

A good chassis cradle can be made from a few pieces of chemical laboratory equipment and 2 large C-clamps. Obtain 2 burette clamps with swivel jaws and 2 large ring stands. These can be had from scientific supply houses.

Discard the jaw assembly from the burette clamps and retain the base or support clamps. Select a bolt or threaded rod that will screw into the

support clamp and weld one end to the center of a C-clamp. Screw the support clamp and C-clamp together and mount on a ring stand. The C-clamps are used to grip the chassis. Vertical and angular adjustments permit the chassis to be suspended above the work bench at a convenient angle.

J. A. BURNETT,
Tarleton Station, Kan.

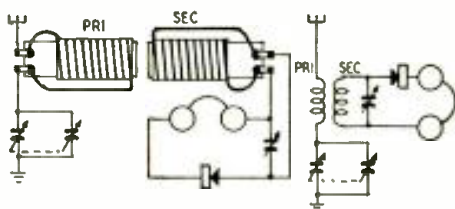

Fig. 3—Circuit of the midget crystal radio.

Get the aerial as high in the air as possible. Doubling the height will in many cases more than double the volume and number of stations received. If your location does not lend itself to a single-wire stretch of at least 100 feet, try 3 wires stretched fanwise as long as you can arrange them and you may still get

good results. Each location will have its own best arrangement.

The operation of the receiver is so simple it hardly needs explanation. Turn the left-hand knob until a signal is heard, then turn the right-hand knob until resonance between the 2 circuits is established and loudest volume is obtained. A few moments of experiment will familiarize the listener with the synchronization of the dials.

If the set is to be used within 50 miles of a station, there should be little difficulty in receiving with good headphone volume. My set is located about 17 miles from New York City, and 18 local stations have been heard. Ottawa, Buffalo, Cincinnati, Washington and

Richmond also have been heard without any particular effort. WCBS has sufficient strength to operate a sensitive magnetic speaker with surprising volume for a crystal set, and several other locals often produce a signal of enough magnitude to be heard on the speaker. High-resistance magnetic speakers are hard to procure today as the PM speaker is the present type made for electric sets. PM speakers are not suitable for use with this set.

It may interest the reader to know that the writer thought he was through with crystal sets back in 1914 but just got nose to see what a modern crystal receiver could do in this day of super-powered broadcast transmitters.

POWER FOR THE BC-312

This easily obtained war surplus receiver can be converted to a 117-volt a.c. set

By GUY BLACK

MANY a short wave listener or amateur, after looking over the supply of high-frequency receivers, has decided to buy an army surplus set, particularly if his budget limits him to less than one hundred dollars. While these sets do not have the appearance, range of frequencies, or convenience of commercial sets, they are ruggedly built, sensitive, and selective.

One of the most common surplus sets is the BC-312—with various letters attached after the number, signifying different models. The differences are not great. The BC-312-A had a thermostatically controlled heater in the oscillator compartment, and a noise balancing network in the antenna circuit. The latter feature was retained in the BC-312-C, the next model, but was dropped from all later models. Models with the letters A, C, D, E, F, G, all have crystal filters but later models were sometimes supplied with them and sometimes without. On models with letters after the G, 24-28-volt operation is designated by the letter "X," as in BC-312-NX.

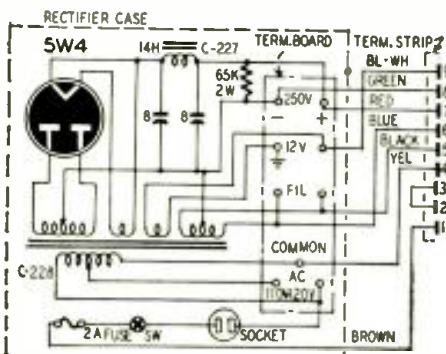

Fig. 1—The RA-20, designed for the BC-312.

Most BC-312's were designed to work from a 12-volt battery, and if 7.5 amperes is available, they may be so used. The connections are easy to make. If a plug is available to fit in the large socket on the front panel, connect 12 volts minus to pin D, and 12 volts plus to pin T. These are the two large pins in the socket. In addition, lug 8 on the terminal strip near the front right corner of the chassis must be grounded, which is easily done by connecting it to the bus bar running about 2 inches away. The lug is plainly marked. Without the plug it is necessary to connect 12 volts plus to lug 5, and 12 volts minus to lug 6.

At least 2 models of the BC-312, the HX and NX, were designed to operate from 24 to 28 volts, and of course will not operate from a 12-volt battery. If you are having trouble with your set, examine the dynamotor name plate,

where there will be a notation of the correct operating voltage.

Most amateurs will want to convert these receivers to a.c. operation, and they are fortunate because the Signal Corps made provision for doing this. In this respect the BC-312 is superior to the more common BC-348 receiver, which was designed to operate from 24 to 28 volts only. By merely substituting the Signal Corps rectifier RA-20 in place of the dynamotor, the BC-312 is converted to the BC-342, designed for 110-volt a.c. operation. In fact, on many sets the name plate for the receiver is inscribed on both sides, one side reading BC-312 and the other reading BC-342. Fortunately some of these rectifiers are available on the surplus market. To install them, merely unsolder the dynamotor unit, remove the 2 bolts in the hinges and the 2 bolts connecting the standoffs to the chassis. Remove the metal plate at the back of the cabinet, through which the power plug must come. Before placing the RA-20 in position, it is best to solder the connections to the terminal strips, since at this stage there is more room to work. Before soldering, however, examine the under side of the terminal strip to see if there are not 2 jumpers, one connecting lugs 1 and 2, another connecting lugs 3 and 4. If so, remove these before connecting the rectifier.

The connections to be made are as follows:

- Lug 1 brown wire
- Lug 4 yellow wire
- Lug 5 black wire
- Lug 6 blue wire
- Lug 7 red wire
- Lug 8 green wire
- Lug 9 black wire with white tracer

In addition, solder a jumper from lug 2 to lug 3.

After arranging the excess wire, (which should be left on so it will be possible to work on the receiver without disconnecting the power supply) and fastening down the power supply make sure that there is a 2-ampere fuse in the fuse holder, and that nothing is shorted in these close quarters. The tube specified, VT-97, is a 5W4.

A home-built power pack

Those who cannot obtain an RA-20 can very easily build a suitable power supply. By removing the dynamotor and its filter it should be possible to build the power supply in the case and mount it inside the receiver as is done in the BC-342.

Building a power supply has some advantages. Larger filter condensers can be substituted for the dual 8-microfarad condenser used in the RA-20. The circuit is given in Fig. 1 for RA-20, with the parts identified by their Signal Corps nomenclature. It may be possible to get an exact replacement transformer or choke. The transformer would be particularly desirable, because of the two 12-volt windings. It will not be possible to obtain a commercial transformer with these filament voltages, but the same result can be obtained by connecting two 6-volt filament windings in series. In doing this, the phase re-

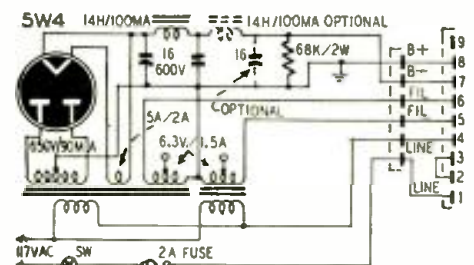

Fig. 2—Circuit with 12-volt filament supply.

lationship of the two windings should be noted since the voltages of the windings may cancel each other. The transformer must supply at least 90 milliamperes at 265 volts in addition to having two six-volt windings supplying at least 1.5 amperes each.

One side of the pilot lamp circuit is grounded, so it is not possible to use the same winding to supply voltage for the pilot lamps as is used for the filaments. Since the dial is plainly marked it is best to ignore this difficulty, although if a separate winding were available of course it could be used for this purpose. The pilot lamps need not be 6 volts each in this case, nor does the extra winding need to be 12 volts. Bearing in mind that lamps are in series, any voltage lamp could be used if a winding with twice this voltage is available. A suitable power supply which could be built on a separate chassis is shown in Fig. 2. There is no switch shown in the diagram, because the power supply can be controlled by the on-off switch on the front of the receiver.

Revamping the X types

There are a number of BC-312-HX and NX sets around also. It is not possible to use the rectifier RA-20 with these models without making a few circuit changes first. Since the filaments are connected for 24-volt operation it is also rather awkward to heat the filaments,

(Continued on page 84)

the horizontal positioning, vertical positioning and the focusing potentiometers carry high voltage and must be insulated from the chassis. This can be done in a number of ways. We made an end panel out of Lucite for the scope chassis and used it to support the 3 potentiometers.

The parts on the upper chassis are from an oscilloscope foundation kit. It furnished the 5CP1 tube, its shield, high voltage transformer, 2X2 rectifier, a filter condenser, sockets and caps for both tubes. The cost was about \$15.00. These parts are all available as surplus and can be bought individually if desired. A voltage-doubling circuit was wired in the chassis and can be used if desired. It supplies voltage for the intensifier anode, producing a brighter but smaller picture. In operation the addi-

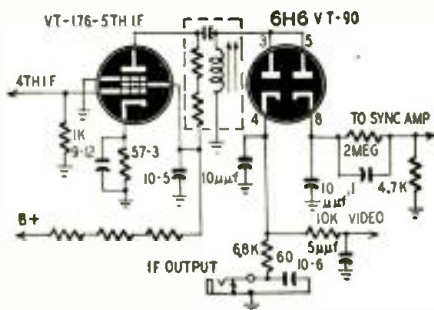

Fig. 4—6H6 is video and sync pulse detector.

tional brightness is seldom considered essential except in daylight viewing or in a brightly illuminated room. Although a 5CP1 tube is shown, a black-and-white tube such as a 5BP4 or 7EP4 can be used.

The sound channel is mounted on the metal plate which originally shielded the r.f. tuner. The first sound transformer T1 was made from the former input i.f. transformer and is a simple solenoid wound as in Fig. 5-a. There are 58 turns No. 30 d.s.c. jumble-wound to occupy 1/4 inch.

It serves a dual purpose, as it is a series trap, preventing the audio from causing picture interference. The interstage T2 transformer was made from an air-tuned i.f. transformer constructed as shown in Fig. 5-b. Each winding has 40 turns No. 30 enameled wire spaced to

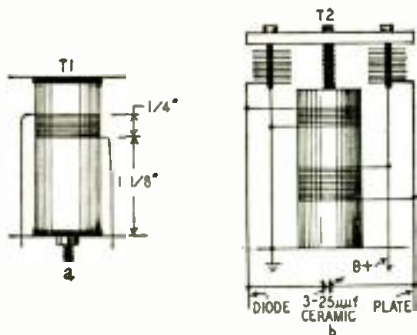

Fig. 5—Coil details are given in the text.

5/8 inch on a 5/8-inch form. Although a volume control is shown in the audio chassis, it is not used, the volume being controlled at the external audio amplifier. We intended at first to include an output audio amplifier on either the BC-1068 chassis or the picture chassis, but decided it was impractical when the

A GOOD TELEVISER

(Continued from page 58)

load already imposed on the power supply was considered. The transformer is undoubtedly oversized for the job and no heating takes place even after hours of operation. However, since a good audio system was already available, it was pointless to tax the transformer to the limit by adding the additional drain of a power amplifier.

As the spare holes and sockets the photographs of the picture chassis show, we experimented with many different types of sweep oscillators and amplifiers and the circuit of the ones shown give about the best linearity and ease of adjustment. Plenty of drive is available to accommodate a 7-inch picture tube and nothing but "scope" tube socket rewiring is needed to make the change.

Receiver alignment

Alignment of the receiver is simple. The BC-1068 receiver i.f. is already aligned and requires only a slight bit of touching up for optimum picture quality. The sound channel is aligned by connecting an audio-modulated 6.25-mc signal generator to the 6AG5 converter grid and tuning the audio i.f. transformers for maximum output. If no signal generator is available, the hit-and-miss system of trimming the audio i.f.'s will work when a television picture is being viewed on the screen.

No instruments are required to align the r.f. section, although a wavemeter would be useful in setting the oscillator to the approximate desired frequency. The frequency of the local station and its operating schedule can be obtained by calling the station itself or by consulting the newspapers for programs. As a rule, to facilitate alignment and adjustment procedures, stations transmit a test pattern before scheduled programs and in some instances, maintain a regular test pattern schedule. The pattern is usually accompanied by an audio carrier modulated by a steady note to help adjust the sound system. Initial alignment is made with a pair of headphones plugged into the i.f. output jack on the 1068. With an antenna connected, set the vernier oscillator condenser to

half capacity, rotate the bandswitch to the desired position and the sensitivity control to maximum. Rotate the oscillator trimmer which is in use very slowly till a loud hum-modulated signal is heard in the phones. Reduce the sensitivity to a lower level and peak the antenna trimmer for maximum. Then tune the sound for optimum clarity with the vernier capacitor. Center the square pat-

tern on the screen with the centering controls and focus for finest lines with the focusing control (*Caution*—these 3 controls have high voltage on them and should have insulated extensions or be cut off and adjusted with an insulated screwdriver.) Adjust the horizontal and vertical size controls to make the square pattern the desired size, and the oscillator controls to lock the lines in place. The low-frequency oscillator controls the vertical lines and the high-frequency oscillator the horizontal lines. With a moderate signal level no difficulty is encountered in making the oscillators "sync in." However, the sensitivity control cannot be set too high on a strong signal or the picture will be distorted. Correct adjustment of the "brightness" control will erase the retrace lines visible when the control is set too high.

The trimmers have a range wide enough to cover the first five television channels. The operator may select the position of the bandswitch to correspond with any channel he desires. Only 3 channels were provided—one for each station active in the New York area. A switch with more than 3 positions can be installed to accommodate as many other channels as desired.

The antenna used for the set is a simple 80-inch dipole made of tubing and fed with a co-ax cable, however, any type of antenna may be employed. A change in the input circuit should be made if a higher impedance type of feed line is to work efficiently.

Very satisfactory reception has been obtained from the three stations in New York, WCBS-TV, WNBT and WABD, with the receiver in Bayside some 14 miles away. As the sensitivity control is advanced only a fraction of maximum, there is little doubt that good results could be had at greater distances. Some interference attributed to a high-band FM station was seen in the form of vertical lines when observing WABD. This was removed by inserting a parallel tuned trap in the antenna feed.

We have had many hours of enjoyment with the television receiver and gained much useful information concerning the operation of circuits somewhat apart from ham radio through its development.

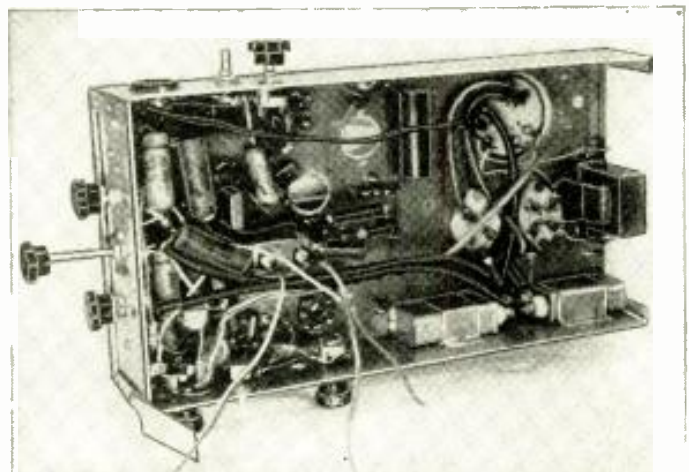

Picture chassis, bottom. Position and focus controls at left, vertical size and hold at top, horizontal size and hold at bottom.



Question Box queries will be answered by mail and those of general interest will be printed in the magazine. A fee of 50c will be charged for simple questions requiring no schematics. Write for estimate on questions that may require diagrams or considerable research. Six to 8 weeks is required to draw up answers involving large schematics.

TWO-TUBE SUPERHETERODYNE

? I am planning to build a 3-way portable superhet using a 6A8 and a 6F7, with a selenium rectifier for a.c. operation. Please supply me with a diagram.—L.T., New York, N. Y.

A. Here is the diagram you request. The tubes specified are not too applicable to battery operation. The filaments are connected in series and require a 12-volt A-battery capable of supplying

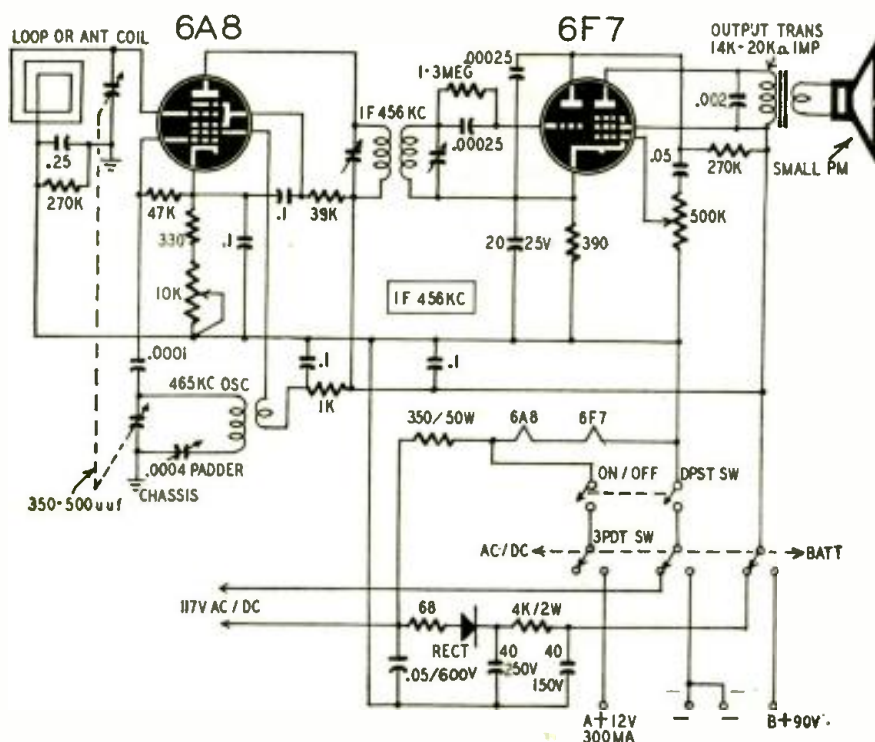

An a.c.-d.c. 2-tube superheterodyne usable (with limitations) as battery receiver.

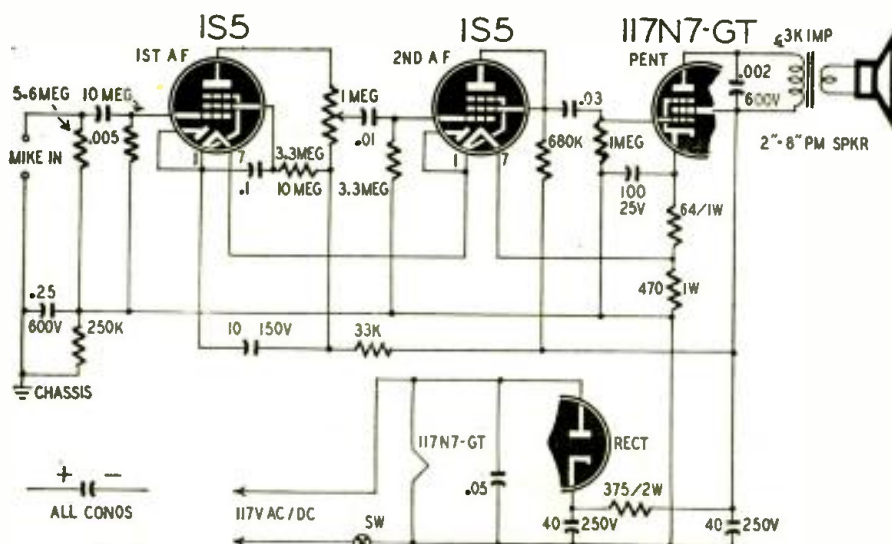

Miniature a.c.-d.c. amplifier. Dry-cell tube filaments run on 117N7 cathode current.

300 ma. They may be connected in parallel and operated from a 6-volt 600-ma battery with a 185-ohm, 100-watt dropping resistor for a.c. operation.

The 6A8 converts the incoming signals to the intermediate frequency, and they are detected by the triode section of the 6F7. Detection is at the intermediate frequency, though there is no i.f. amplification.

This set, because of its limited selectivity, probably will work better in isolated areas with a number of strong stations.

MIDGET PA SYSTEM

? I would like to have a diagram of a small public address amplifier using a 117N7 and one or two 1S5's as voltage amplifiers.—C.B.C., Toronto, Canada.

A. The amplifier diagram printed here will supply 1 watt or slightly more when used with the average crystal mike or pickup. Filament voltage for the 1S5's is taken from a tap on the cathode resistor of the power amplifier. Grid leads should be short and isolated from a.c. circuits by shielding.

Hum is sometimes a problem in amplifiers of this type, and it may be necessary to by-pass the No. 7 filament prong of each of the 1S5's to the negative lead with 100- μ f condensers. Their working voltage may be low, about 3 or 6 volts.

SIX-VOLT POWER SUPPLY

? Please print a diagram of a power supply delivering between 375 and 400 volts at 200 ma or more. The supply is to be operated from a 6-volt storage battery, using a nonsynchronous vibrator.—M.T., Hawaii

A. If standard vibrator transformers are to be used, two power supplies must be operated in parallel to deliver the necessary current. Each supply uses two 6X5's connected as half-wave rectifiers feeding into a common filter. The buffer condensers C3 and C4 will require some experimenting to arrive at the correct values for the vibrator and transformers used. Vibrator buffer condensers having values between 0.002 and 0.01 μ f and designed for 1,600 to 2,000 volts should be tried. The value should be adjusted for minimum vibrator current and minimum sparking at the points. C1 and C2 should be of the 4-terminal type designed for low r.f. impedance as

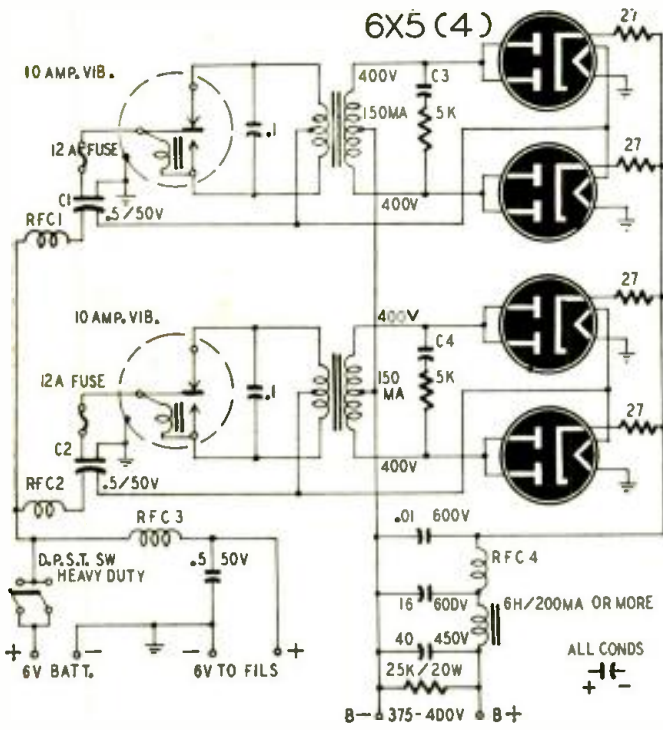

this type is more efficient for "hash" suppression.

PHONO OSCILLATOR

I want to build a battery-operated phono oscillator with separate channels for phono and microphone input. I want to use miniature tubes throughout. Can I use a 1R5 oscillator and 1U5's or 1S5's as voltage amplifiers?—A.H., Boelus, Nebraska.

A. This circuit will give good results. Shield all grid and plate leads up to the grid of the second 1U5.

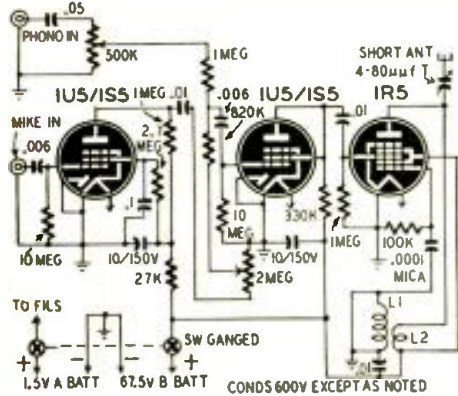

L1 is a standard single-layer antenna or r.f. coil designed for the broadcast band. The tickler winding consists of about 20 turns of No. 30 enameled wire wound at the lower end of L1. The unit should be operated between 550 and 650 kc to obtain greatest distance and keep within FCC regulations.

SCRATCH SUPPRESSOR

I have a small amplifier and would like to add a nondiscriminating scratch suppressor circuit such as the one devised by Mr. Shaney some time ago. My amplifier uses a 6SK7 speech amplifier and phase inverter. Please include a preamplifier if one is needed. I plan to take supply voltages from the amplifier power supply.—G.R.F., Gadsden, Ala.

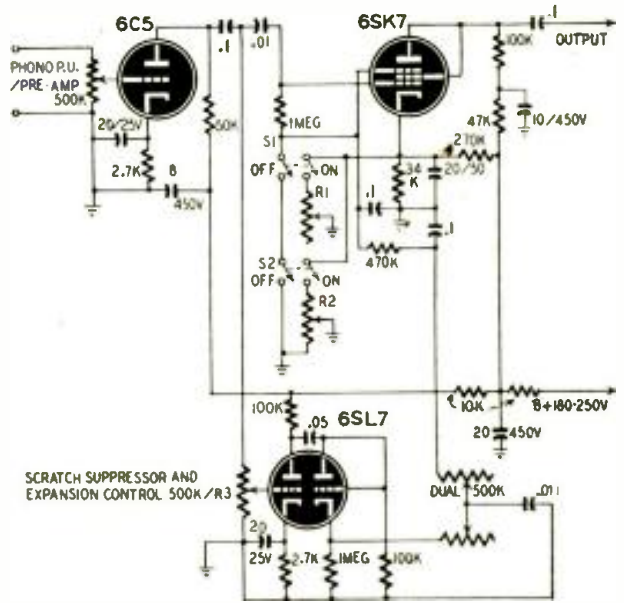
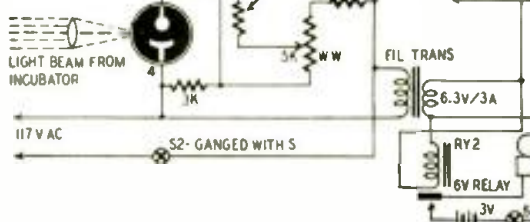

Left—Six-volt power supply. Above—Expander-scratch suppressor.

A. Here is the diagram you request. Volume expansion and variable time delay have been included in the circuit for your convenience. Scratch suppression and expansion are controlled by R3, and the variable time delay by the dual 500,000-ohm control in the return circuit of the 6SK7 suppressor. If the latter feature is not desired, the dual control may be replaced with single 500,000-ohm units with slotted shafts. These should be adjusted for best performance. R1 and R2 are 25,000 ohms each. They are adjusted to give low noise and good expansion range. S1 and S2 are expander and scratch suppressor switches, respectively.

Ry1 which rings the upper alarm. In the event of power failure, the armature of Ry2 drops out, closing the circuit to a battery-operated alarm. The sensitivity of the unit is controlled by the amount of light and the setting of the 5,000-ohm control in the bleeder circuit. Ry1 is a sensitive relay that will throw at 10 ma or less. Insert a suitable resistor at A to limit the current to a value that can be carried safely by the relay that you select. An adjustable 5,000-ohm, 25-watt resistor will be about the value to use. Ry2 is a 6-volt relay with normally closed contacts.

ADDING A WIRERECORDER

I have a Model A Wirerecorder and a 15-watt amplifier. Will you draw a diagram showing how the 2 units can be combined.—G.Z., Cicero, Ill.

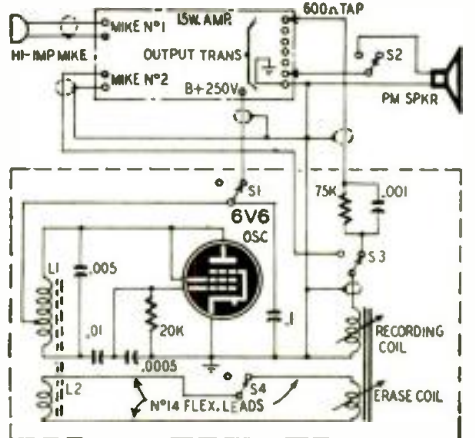

A. Here is the diagram requested. The equalizer and bias-erase oscillator are shown. S1, S2, S3, and S4 are ganged and are used for changing from recording to playback operations. This switch is shown in the recording position. L1 is the oscillator coil. It is 450 turns of No. 28 enameled wire, tapped at 150 turns from the grid end. This coil is wound on a 3/8-inch form 1 inch long with a powdered-iron core. L2 is 23 turns of No. 20 enamel, close-wound on top of L1.

RADIO-ELECTRONIC CIRCUITS

THREE-TUBE REFLEX SUPERHETERODYNE

Illustrated here is a circuit of a 3-tube reflex receiver that is simple and easy to construct and compares favorably with some 5- or 6-tube sets.

The circuit uses a 6SA7 as oscillator and mixer; 6B8 i.f. amplifier, diode detector and reflexed first a.f. amplifier, and a 32L7 power amplifier and rectifier. The antenna and oscillator-tuned circuit components are standard values designed to work with a 456-kc i.f. amplifier.

tube for further amplification. The amplified a.f. signal appears across the 100,000-ohm resistor in series with the primary of T2 and is taken off at this point and applied to the grid of the 32L7 power amplifier.

The remaining diode of the 6B8 is used to supply a.v.c. voltage for the mixer tube. All other circuit functions are conventional.

This set has a tendency to overload on strong local stations. This may be

NOVEL AUDIO OSCILLATOR

Designed for use in radio servicing and for code practice, this audio oscillator is built around a 2-terminal Crosby oscillator which works into a 2-stage audio amplifier.

The tuning circuit consists of L1, a small a.c.-d.c. filter choke or the primary of a small audio transformer, and a .002- μ f condenser. Lower frequencies are tuned by switching additional capacitance across the coil. Output is taken from the cathode of the 6SC7 and fed to the grid of the 6SQ7.

A keying jack is provided in the speaker voice coil circuit of a universal output transformer. When a key plug is inserted, a 2,000-ohm resistor is connected in series with the voice coil. Closing the key shorts the resistor.

I use this unit with a tape machine and have a receptacle in the 117-volt circuit for connecting the motor of the tape puller.

The power supply is conventional. A small transformer delivering about 250 volts to each rectifier plate at 50 ma works well. I use a dynamic speaker with its field coil in the filter circuit. A PM speaker may be used if a small filter choke is provided.

JAMES C. SOUKUP,
Minot, N. Dak.

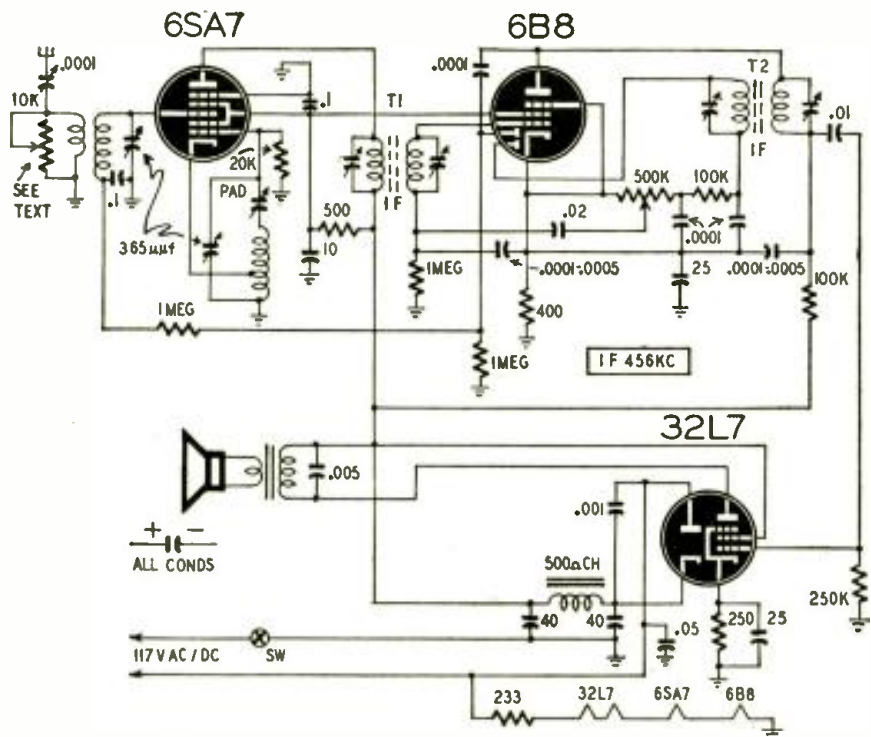

The i.f. signal is taken from the secondary of the second i.f. transformer T2 and detected by one of the diodes of the 6B8. The a.f. component of the signal is fed back to the control grid of this

eliminated by connecting a 10,000-ohm control across the primary of the antenna coil as shown.

BOB WEBB,
Ashville, N. C.

PUSH-PULL TWO-TUBE AMPLIFIER

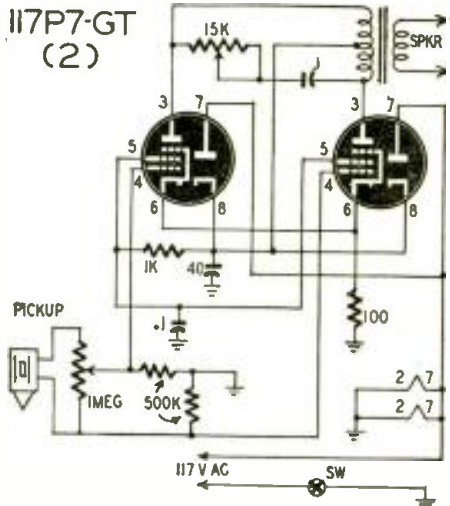

A minimum of parts and space is required by this phono amplifier.

It uses two 117P7 tubes with the pentode sections connected in push-pull and the rectifier sections in parallel. The crystal pickup used with this unit should have at least 1.5 volts output. Neither side of the crystal cartridge should be grounded to the frame. If the pickup is provided with a shielded lead, this should be replaced with 2 ordinary wire leads.

Ample room volume and good tone quality will be obtained if a good PM speaker and baffle are used with the amplifier, as well as high-quality parts throughout. Otherwise the volume is likely to be too low.

CARLETON PHILLIPS,
Corning, N. Y.

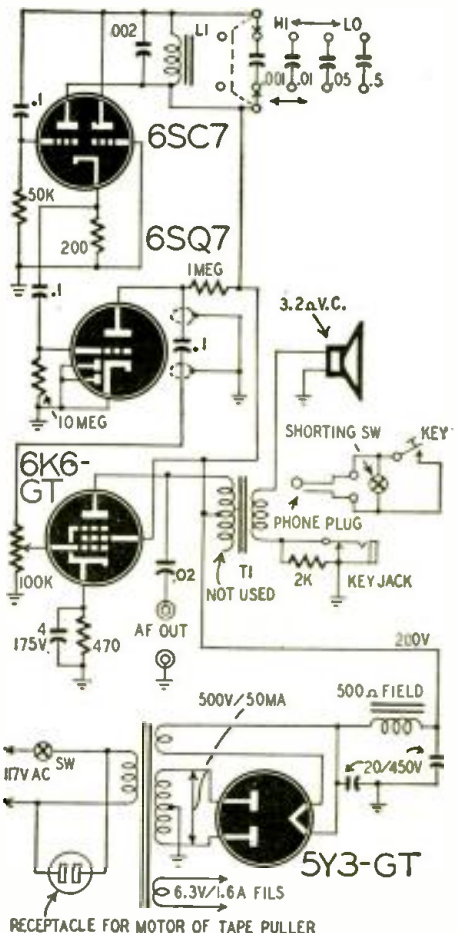

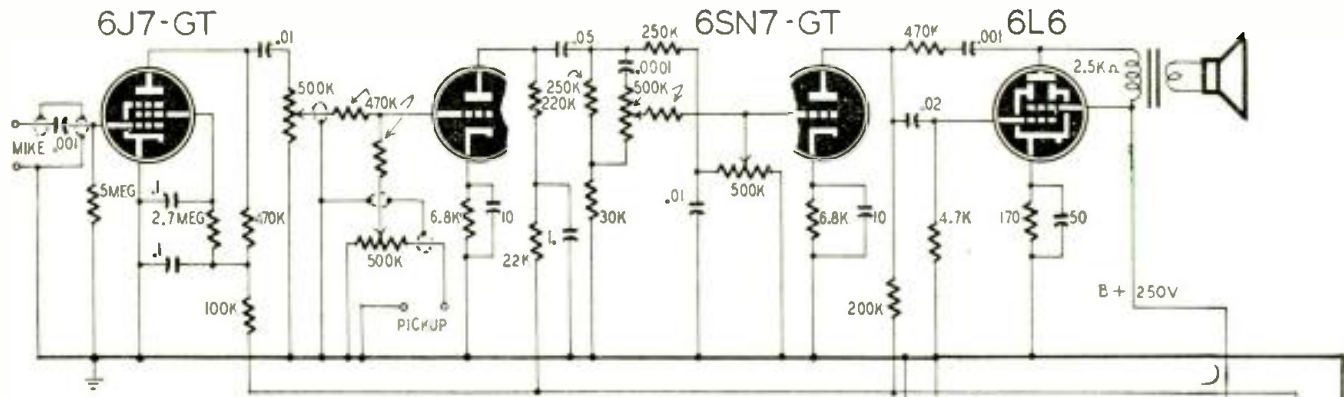

BELGIAN AMPLIFIER

The amplifier shown is suitable for low-power public address applications or for use as a phonograph and mike amplifier in the home. Individual volume controls for mike and pickup are provided in the grid circuit of the first section of the 6SN7, and bass and treble tone controls are in the second section.

The amplifier is described in *La Radio Revue*, (Antwerp, Belgium). It uses a power transformer with primary taps for a.c. voltages most commonly encountered in Europe. Over-all frequency response is improved through inverse feedback between the plate of the 6L6 and the plate of the preceding stage.

20-METER CONVERTER

This converter is designed to enable its user to receive 20-meter signals with any receiver tuning to 1600 kc. It has a preselector stage to improve sensitivity and image rejection. It can be built on a 10 x 5 x 1 1/2-inch chassis.

A 3-gang, 25- μ f-per-section, variable condenser is used for tuning, which is facilitated by a slow-motion dial. Each section of the tuning condenser is shunted with 30- μ f trimmers. A 50- μ f midget variable is used for band-setting in the oscillator circuit. The output of the oscillator is connected to grid No. 1 of the 12SA7. A short piece of hookup wire is connected to the No. 3 grid, and 1 turn is wrapped around the lead to grid No. 1.

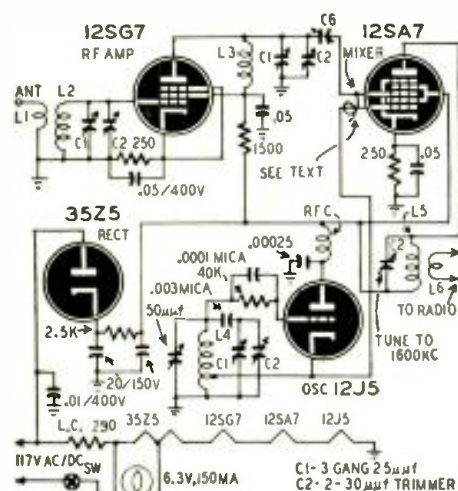

The main tuning coils are wound on 7/8-inch forms. L1 is 4 turns of No. 24 wire wound 1/16 inch below L2. L2 consists of 12 turns of No. 19 wire spaced the diameter of the wire. L3 is the same as L2. The oscillator coil L4 has 10 1/2

turns of No. 19 wire spaced the diameter of the wire and tapped 1 turn above ground. The output coil L5 is a standard single-layer broadcast coil. L6 is 10 turns of No. 24 wire wound at the lower end of L5. The ends of L6 are connected to a terminal strip for connections to the antenna circuit of the receiver.

Allow the converter to warm up and connect it to the antenna terminals of the receiver. Set the oscillator band-set condenser about half open and vary the tuning gang until a signal is heard. Adjust the r.f. and output trimmers for maximum output. Adjustments on the high end of the range should be made on a commercial station and on the low end on WWV's 15-mc signal.

W. G. ESLICK,
Casper, Wyoming

6-VOLT PHONO AMPLIFIER

Ideal for mobile or emergency use or for use in areas away from power lines, this low-power phono amplifier is used with a spring-driven phono motor but a 6-volt d.c. motor can be used if desired.

The transformer and synchronous vibrator were salvaged from an old automobile radio. The r.f. chokes and efficient shielding prevent vibrator hum and hash. The chokes in the low-voltage leads are made by winding 2 layers of No. 18 wire on a form 1/2 inch in diameter. There are 35 turns on each layer. The r.f. choke in the B-supply is a winding from a 456-kc i.f. transformer.

A cover plate is used on the bottom of the chassis. An under-chassis shield separates the power supply from the a.f.

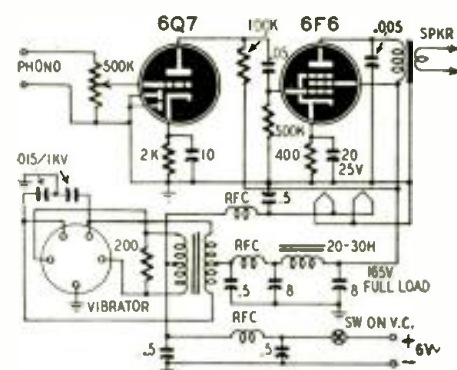

components. The vibrator is a Mallory 245 or equivalent. W. G. ESLICK,
Casper, Wyoming.

PHONO PREAMPLIFIER

The circuit of this preamplifier was developed for use with the G-E variable reluctance and Caltron phono pickups. I don't think that you can beat it for

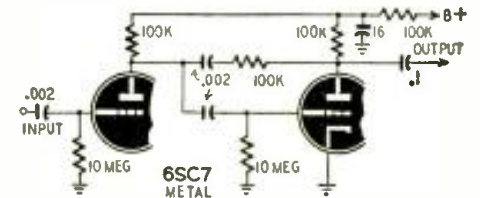

simplicity. It uses a 6SC7 with its sections in cascade. Contact bias is used on each grid and the cathode is grounded. The feedback circuit gives some bass boost, as the reactance of the .002- μ f condenser increases with decreasing frequency.

C. MCCLESKEY,
Baton Rouge, La.

10-METER SUPERREGEN

The circuit of this 10-meter superregenerative receiver can be used for world-wide reception. I use two 32-foot antennas at right angles to each other and select the one giving best results in the desired direction.

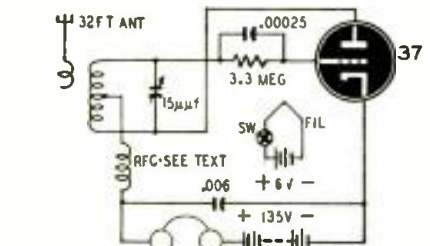

The grid coil has 30 turns of No. 14 wire on a 1/2-inch form. The turns are spaced to cover the desired tuning range. The antenna coupling coil is 2 turns of wire close to the grid end of the tuned coil. The r.f. choke consists of 100 turns of No. 34 d.s.c. wire on a 3/8-inch dowel.

J. E. WALDEN,
Miami, Fla.

ILLINOIS CONDENSER CO.

NOW HAS **UMP!**

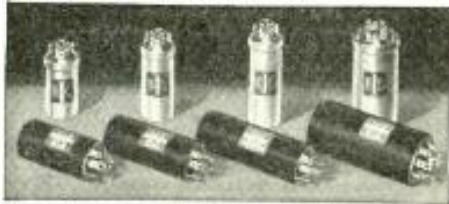

TYPE UMP

A popular replacement twist on long line of COMPACT, HERMETICALLY SEALED, efficient, dry electrolytic condenser, is now a member of the ILLINI line of highest quality capacitors.

The "Illini" UMP capacitors are now available at your local jobber. Our latest catalog, listing complete Illinoi line, will be mailed to you upon request.



ILLINOIS CONDENSER CO.
1816 NORTH TREMPER STREET • CHICAGO 22, ILL.



IF YOU'RE INTERESTED in a steady year-in-and-year-out income—a substantial share of financial security for you and your family—you'll get in on the ground floor of this flourishing industry. You can build a lucrative business of your own NOW with TRADIO, the radio functionally-designed for coin operation in hotels, hospitals, tourist camps, motor courts, etc. Men and women like yourself all over the country are finding it a natural for big earnings and a steady income.

TRADIO ★ Tried ★ Tested ★ Proven

TRADIO has pioneered in this profitable postwar industry. Today, there are more TRADIOS installed throughout the country than any other coin radio.

Send for complete information and free illustrated brochure today. We'll put you in touch with the distributor in your territory if you'll phone Asbury Park 2-7447 or write Dept. U-1.



TRADIO, Inc. ASBURY PARK NEW JERSEY

TRY THIS ONE

C-R DECADE BOX

Here is a simple capacitor-resistor decade box that I have found useful in radio servicing and experimenting. It consists of a single-pole, 12-position switch and one each of the most commonly used condensers and resistors. One condenser and one resistor are tied to each of the switch points and the other ends connected to common connections for condensers and resistors respectively.

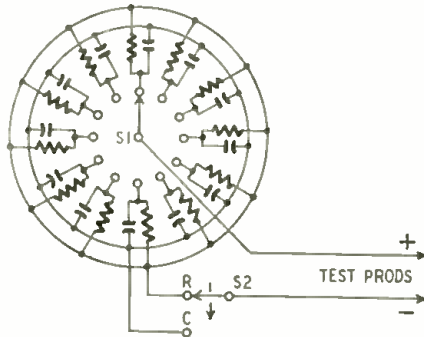

The arm of the switch is connected to one test prod and the other prod is connected to the common condenser or resistor lead through a s.p.d.t. switch.

It is possible to connect other components such as coils, speakers, and chokes to S1 and use a multi-position switch in place of the s.p.d.t. unit shown.

WILHELM PEDERSEN,
Haugesund, Norway.

IMPROVING INTERCOMS

It is often desirable to increase the volume of one or more remote stations of an intercommunications system. Additional amplifiers can be used but they complicate the system and are not always practical. Try using a larger speaker and notice the improvement. Larger speakers are easier to drive since the cones offer less mechanical resistance and move a greater volume of air.

HAROLD PALLATZ,
Brooklyn, N. Y.

REPAIRING CARBON MIKE

Here is a method for replacing the buttons of carbon microphones. I replace the old button with one taken from a double-button throat mike—they are plentiful at radio-surplus stores.

Remove the button from the throat mike by removing the metal retaining ring. After removing all the button assembly from the telephone mike, place the new button, metal side to the diaphragm under the bracket. A spacer is cut from cardboard or thin

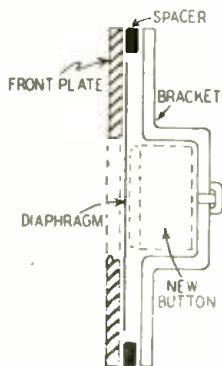

RADIO-CRAFT wants original kinks from its readers, and will award a one year subscription for each one published. We are especially interested in ideas which are illustrated with drawings or snaps, and make a liberal allowance for photos. Send your new ideas to RADIO-CRAFT today!

leather and mounted between the bracket and front plate to equalize the pressure on the button. Draw the sections together evenly and tightly. These buttons should not be used with more than 1½ volts.

L. L. DARLING, JR.,
Norwich, Conn.

USEFUL TIME SAVER

A china-marking pencil can be very useful in a radio service shop. In many cases, neither tube sockets nor chassis of a radio are marked with tube types and if the tubes must be removed from the set for testing, valuable time may be lost in getting them back in the correct sockets.

A marking pencil of this type is also useful in writing installation notes or other data directly on the surface of a tube. This generally last much longer than gummed labels.

STEWART HENRY,
Dalhousie, N. B.

NOVEL MIKE SUPPLY

This circuit eliminates batteries when using a carbon mike. The primary of the mike transformer is connected in the cathode circuit of the output stage across the biasing resistor. The values

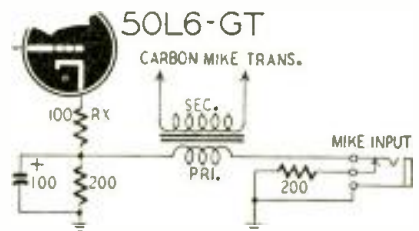

shown are for a 50L6, but the circuit can be adapted to many other output tubes by changing the value of Rx.

W. L. WARDEN,
Barboursville, W. Va.

WIRELESS PHONO KINK

I find it bothersome and inconvenient to use the conventional trailing antenna on my wireless record player. I get away from this type of antenna by connecting a good 500-µfd condenser between antenna terminal and one side of the power line. Try both sides of the line, and use the one giving the best results. It is also worth while to try reversing the power plug on the receiver or phono unit.

ROGER E. HIEL,
Fitchburg, Mass.

(A 1-kv mica condenser is safe and should work well.—Editor)

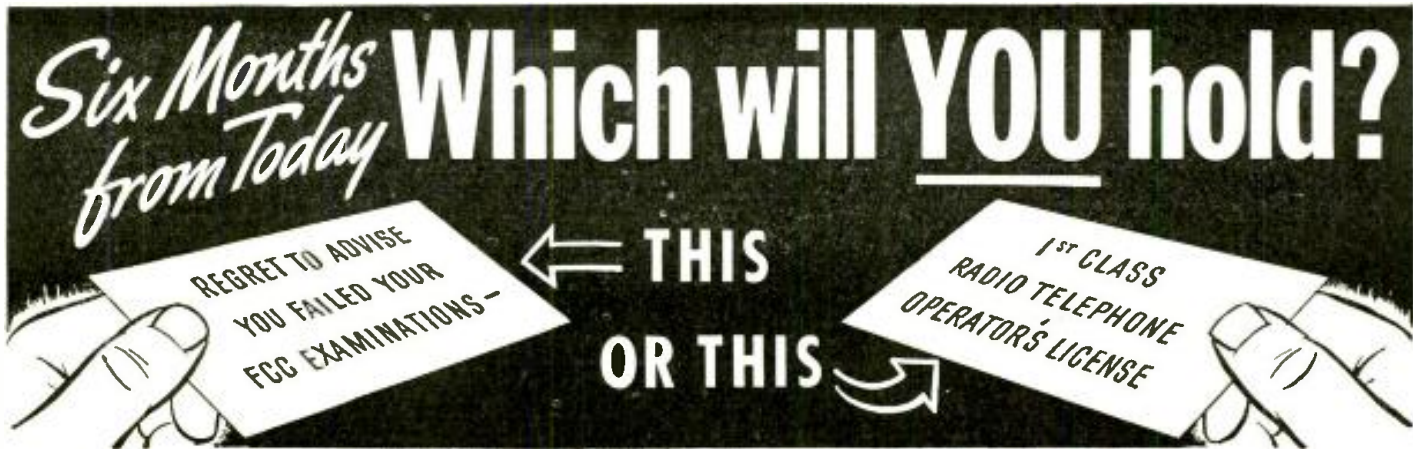

WANT YOUR FCC COMMERCIAL LICENSE IN A HURRY?

Use CIRE Training and Coaching Service—and Get Your “Ticket” in a Few Short Weeks!

Thousands of new jobs are opening up—FM, Television, Mobile Communication Systems—These are only a few of the radio fields which require *licensed* radio technicians and operators.

Get your license without delay—Let Cleveland Institute prepare you to pass FCC license examinations, and *hold the jobs which a license entitles you to*, with CIRE streamlined, *post-war* methods of coaching and training.

Your FCC Ticket Is Recognized in ALL Radio Fields as Proof of Your Technical Ability.

More than ever before an FCC Commercial Operator License is a sure passport to many of the better paying jobs in this New World of Electronics.

Employers frequently give preference to the license holder, even though a license is not required for the job. Hold an FCC “ticket” and the job is yours!

HUNDREDS OF SATISFIED, SUCCESSFUL STUDENTS

“I have taken the first class phone license examination and received my first class ticket last Saturday May 31. In closing I must say yours is an excellent radio course, and I really appreciate your help and the fine service you have rendered me.”

Student #2876N12

“I passed the FCC examination in radiotelephone 2nd class, at Detroit on June 3rd, and I want to thank you for your ready assistance as my instructor on Section 1 of Nilson's Master Course.”

Student #2779N12

“I have had my 1st class radiotelephone license since March of this year, and plan to continue with your course since I find it a great help in studying transmitters.”

Student #2779N12

“After sending in Lesson E I took the commercial operator's license examination for 2nd class radiotelephone, and passed O.K. I received the license last week.”

Student #2772N1

FREE BOOKLET—Tells you the Government requirements for all classes of FCC COMMERCIAL licenses. (Does not cover Amateur License examinations). Use coupon below for Booklet B.

OTHER CLEVELAND INSTITUTE HOME STUDY COURSES OFFER COMPLETE TECHNICAL RADIO TRAINING FROM LOW-LEVEL TO COLLEGE-LEVEL, FOR THE RADIOMAN WITH PRACTICAL EXPERIENCE!

COURSE A—MASTER COURSE IN RADIO COMMUNICATION

A complete course covering the technical fundamentals of radio-electronics, for the radioman who wants a general review. Includes preparation for Broadcast station employment.

COURSE B—ADVANCED COURSE IN RADIO COMMUNICATION ENGINEERING

A genuine college-level radio engineering course, completely mathematical in treatment. For the advanced radioman with considerable practical experience and training.

COURSE C—SPECIALIZED TELEVISION ENGINEERING

An advanced college-level course for the radioman who has had formal training equivalent to A and B.

These three courses in radio-electronics offer a complete, thorough technical training for the radioman who wants to cover the field. Available separately or combined.

FREE CATALOG—Describe all Cleveland Institute home study courses—tells of CIRE unique, post-war methods of training. Use coupon below for Catalog A.

**How To Pass
FCC
LICENSE
EXAMINATIONS**

CLEVELAND INSTITUTE
OF
RADIO ELECTRONICS
Terminal Tower • Cleveland, Ohio

**Don't Delay—
Write Today!**

HOW TO PASS Commercial Radio Operators' FCC LICENSE EXAMINATIONS...

CLEVELAND INSTITUTE OF RADIO ELECTRONICS

Contractors to the Canadian Broadcasting Corporation

RC-1 TERMINAL TOWER CLEVELAND 13, OHIO

CLEVELAND INSTITUTE OF RADIO ELECTRONICS
RC-1 TERMINAL TOWER, CLEVELAND 13, OHIO

Gentlemen: Please send me your Booklet B, "HOW TO PASS THE FCC COMMERCIAL LICENSE EXAMINATIONS" and information about your home study course for preparation for FCC License Examination. (Does not cover Amateur License examinations.)

Please send me your Catalog A, describing all of your home study radio-electronics courses. I desire training in course A B C.

Veterans check for enrollment information under G-1 Bill. NO OBLIGATION—NO SALESMEN.

NAME

ADDRESS

CITYZONE.....STATE.....

NEW

RADIO • ELECTRONIC DEVICES

TELEVISION ANTENNA

LaPointe-Plascomold Corp.
Unionville, Conn.

The VEE-D-X is a long-distance television antenna designed for service in so called "fringe areas" and beyond. It has high forward gain and minimum pickup from sides and rear. The array is fundamentally a broad band antenna, but can be modified to give higher gain with reduction in band width.

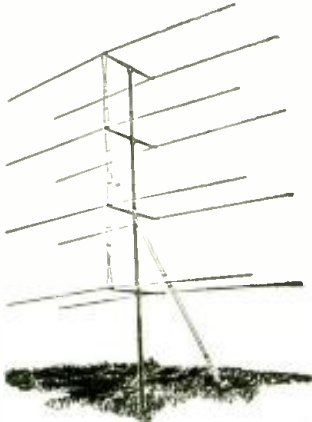

A Q-section matches the antenna to transmission lines of from 50 to 600 ohms impedance. Connections to the antenna are made with screw terminals or co-axial connectors, depending on the type of line.

Aluminum castings are used at all points of strain, and aluminum tubing is used for elements. It can be mounted on a 2-inch pipe without guys on the antenna proper. The unit weighs about 25 pounds and can be erected in approximately a half hour.—RADIO-CRAFT.

TELEVISION CAPACITOR

Cornell-Dubilier Electric Corp.
South Plainfield, N. J.

A television voltage-doubler capacitor T-121 with a dual .075- μ f capacitance and voltage rating of 7,500 volts, d.c. is designed for use in television receivers and is equally suited for precipitator, voltage-doubler and photo-flash power supplies.



It is a compact unit, built into a rectangular container 3 3/4 x 4 9/16 x 5 1/2 inches, with the over-all height of 8 1/2 inches to the top of the terminals. It is equipped with brackets for upright or inverted mounting. Dykanol impregnated and filled, its hermetic seal assures efficient operation under all atmospheric conditions. The metallized glass terminals are solder-sealed with solder lug connections. The capacitor is equipped with voltage-divider discharge resistors.—RADIO-CRAFT.

COMBINATION TESTER

Precision Apparatus Co., Inc.
Elmhurst, L. I., N. Y.

The Electronic Test Master includes a tube tester and a push-button-

operated a.c. and d.c. multimeter.

The tube test circuit subjects tubes to individual element potentials swept over a complete path of operation, on a sinusoidal time base, covering a wide range of plate family characteristic curves. The path of operation is indicated on the meter in the terms REPLACE—WEAK—GOOD.

The circuit accommodates up to 12 elements, and tests all standard receiving and low-power transmitting tubes, including acorns, noval 9 pins, dual-capped h.f. amplifiers, etc. A free-point, 12-lever element selector is provided.

The set tester circuit is push-button operated and has 34 a.c. and d.c. ranges as well as testing facilities for radio A-, 8-, and C-batteries under dynamic load. All standard set testing functions are available at 2 polarized tip jacks. It has a 400 μ a, 4 3/8-inch meter. All circuits are insulated from the power line. All ranges are self-contained.



A.c., d.c., and output voltage ranges are 0-6-12-60-300-1,200-3,000 volts. Direct-current ranges are 0-600 μ a, 0-60-300-1,200 ma, and 0-12 amperes. Resistances to 10 megohms are metered in 4 ranges. There are 6 decibel ranges from 20 to 64 db.—RADIO-CRAFT.

THERMISTOR BRIDGES

Sylvania Electric Products, Inc.
New York, N. Y.

The new Type T8N-7SE and T8N-6SE thermistor bridges provide r.f. power measurements up to 2 milliwatts at frequencies up to the shorter microwave regions.

Type T8N-7SE is designed for continuous duty at normal laboratory ambient temperatures where measurement in S, X, and K microwave bands may be made accurately with suitable r.f. measuring heads. The bridge is independent of frequency but should be used with appropriate thermistor mount. Two-milliwatt scale sensitivity is essentially linear, but a calibration curve is required for each r.f. head used.

The instrument, designed for 100-130-volt, 60-cycle a.c. input is rated at 25 watts, weighs 14 pounds, and measures



8 x 8 1/2 x 10 inches. Tube complement includes one 6X5GT/G, two VR-105's and one VR-150.

Type T8N-6SE thermistor bridge which requires external oven and thermistor mount, contains a Wheatstone bridge circuit with 3 precision resistor arms and externally mounted thermistor; a stabilized 2,000-cycle source for the

bridge; a stable d.c. source for substitution measurement of r.f. power; and an amplifier. It is independent of frequency and can be used as a balanced or unbalanced bridge providing accurate full-scale meter readings from 25 microwatts to 2 milliwatts.

It is designed for 115-volt, 50-cycle a.c. input and is rated at 150 watts, exclusive of external oven. It weighs 54 pounds exclusive of oven and thermistor mount, and measures 10 1/4 inches high, 21 inches wide, and 15 inches deep. Tube complement includes seven 12J5's, three 6Y6G's, two 5U4G's, three 12SH7's, and two VR-90's.—RADIO-CRAFT.

ALL-WELDED SOLENOID

General Electric Co.
Schenectady, N. Y.

For use where powerful pull is needed in a small space, such as in appliances, pinball machines, safety devices, trip mechanisms, and vending machines this new small all-welded solenoid develops a maximum pull of 0.26 lb. in a 1/2-inch stroke. It operates on 110 volts, 60 cycles.

An L-shaped mounting bracket permits horizontal or vertical mounting. Frame and bracket are welded together. The silicon steel frame laminations are welded together. Welding reduces eddy-current losses, since the welds are outside the magnetic flux path.

The removable coil is sealed inside a plastic housing. It is paper-layer-wound, heat-treated to remove moisture, and impregnated with a plastic.

Plunger laminations of silicon steel are welded. A new type of pole shaver, brazed into place, provides maximum quietness at a lower watt consumption.—RADIO-CRAFT.

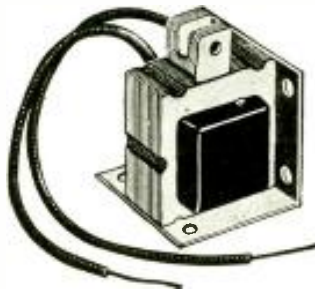

TUBE CHECKER

Weston Electrical Instrument Corp.
Newark, N. J.

The Model 798 Type 5 tests all receiving tubes, voltage-regulator tubes, and low-power thyratrons. It provides proportional mutual conductance ranges of 12,000, 6,000 and 3,000 micromhos under conditions which closely resemble actual operation. "Good-Bad" readings, also, are provided. Sixty-cycle a.c. potentials are used on tube elements, thereby approaching the zero plate load conditions most desired for mutual conductance tests. An internal 5-kc signal is applied to the control grid, and the resulting plate component of the h.f. signal is measured on a meter.

The tube checker weighs 23 pounds in its aluminum case and operates on 105-125 volts, 50 to 60-cycle a.c.—RADIO-CRAFT.



PORTABLE AMPLIFIER

Webster-Chicago Corp.
Chicago, Ill.

The Model 6 portable amplifier has an 8-watt push-pull circuit, with 3 tubes and a rectifier. Output is delivered through an 8-inch Alnico-5 speaker. It is especially suitable for use with the Model 65 portable record changer, or as an external amplifier and speaker for a Model 80 wire recorder.

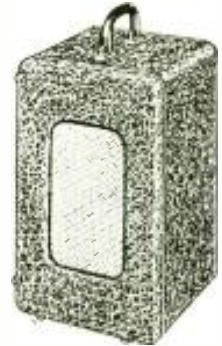

The unit has separate tone and volume controls, with the on-off switch on the tone control. The control panel is recessed so that knobs are flush with the outside of the case. Suitable space for pickup and power cords is provided. The 15 3/4 x 9 1/2 x 9 1/4-inch case is finished in burgundy leatherette. The amplifier operates on 105-125 volts 50-60-cycle a.c. only. It weighs 18 pounds.—RADIO-CRAFT.

MOBILE TRANSMITTER

Eastern Amplifier Corp.
New York, N. Y.

The Model 600 mobile transmitter is designed as a self-powered unit with 10 watts output on frequencies between 27 and 30 mc. It uses a 2E30 crystal oscillator-doubler, one 2E30 in the power amplifier and another in the modulator stage, and an OZ4 rectifier. It features push-to-talk operation with no stand-by current. The antenna tuner will match any antenna from 10 ohms to several thousand ohms.

The unit, complete except for crystal and microphone, measures 10 1/2 x 6 x 6 1/2 inches. It is in a crackle-finished, shock-mounted box. Primary power is from a 6-volt vehicular storage battery.—RADIO-CRAFT.



U.H.F. CONVERTER

Columbus Electronics, Inc.
Yonkers, N. Y.

Model HFC 610 is available in 2 ranges: 27 to 30 megacycles, and 50 to 54 megacycles. It embodies a 6AK5 high-gain r.f. amplifier stage, a 6AK5 mixer, and a 6C4 stable oscillator. This converter has a self-contained, regulated power supply. It provides sharp tuning and separation between stations, low internal noise, image-free reception, and smooth tuning. It has a directly calibrated dial.—RADIO-CRAFT.



PHOTOFACT PUBLICATIONS

World's Most Practical Radio Service Data

HELPS YOU EARN MORE ON THE JOB!

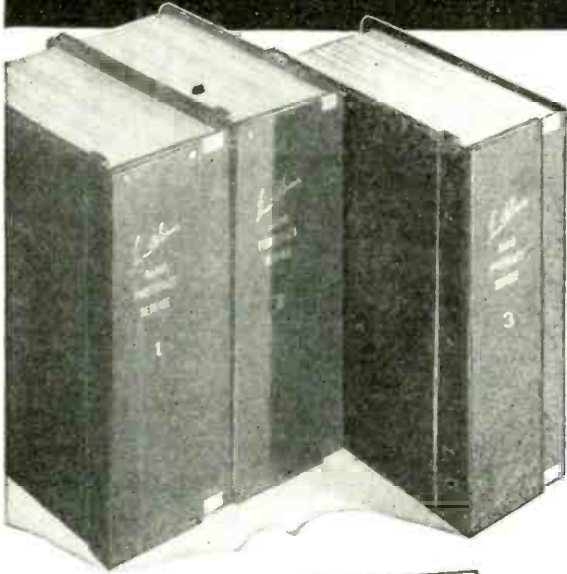

READY NOW! PHOTOFACT VOLUME 3

New companion to popular Volumes 1 and 2 to bring your file of post-war receivers right up to January 1948! The most accurate and complete Radio Data ever compiled . . . an absolute *MUST* for all Servicemen. Everything you need to know for faster, more profitable servicing, in handy, unified form—large size schematics with the exclusive PHOTOFACT Standard Notation; photo views keyed to parts lists and alignment data; complete listings of parts values and proper replacements; alignment, stage gain, circuit voltage and resistance analysis; coil resistances; dial cord stringing; disassembly instructions; record changer analysis and repair instructions. Send in your order today for the *only* Service data that meets your *actual* needs!

Volume 1. Covers all post-war models up to Jan. 1, 1947.

Volume 2. Covers post-war models from Jan. 1, 1947 to July 1, 1947.

Volume 3. Covers post-war models from July 1, 1947 to Jan. 1, 1948.

YOUR PRICE, EACH VOLUME, IN
EASY-TO-USE DELUXE BINDER . . . **\$18³⁹**

SPECIAL OFFER To All Servicemen Whose PHOTOFACT Folder Files Are Incomplete . . .

If you haven't a complete file of all PHOTOFACT Folder Sets to date, you can trade in the Folder Sets you now own for complete Volumes at amazingly low cost. Write us today for details of this special offer, stating what Sets of Folders you now own (use coupon below).

Howard W. Sams 1947 Automatic Record Changer Manual

Nothing like it! COVERS MORE THAN 40 DIFFERENT POST-WAR MODELS. Absolutely *accurate, complete, authoritative*—based on actual study of the equipment. Shows exclusive "exploded" views, photos from all angles. Gives full change cycle data, information on adjustments, service hints and kinks, complete parts lists. Shows you how to overcome any kind of changer trouble. PLUS—for the first time—complete, accurate data on leading WIRE, RIBBON, TAPE, and PAPER DISC RECORDERS! 400 pages; hard cover; opens flat. Don't be without this manual. **ONLY . . . \$4.95**



Howard W. Sams Dial Cord Stringing Guide

There's only one *right* way to string a dial cord. And there's only one book that shows you how. It's the Howard W. Sams DIAL CORD STRINGING GUIDE. Here, for the first time, in *one* handy pocket-sized book, are all available dial cord diagrams and data covering 1938 through 1946 receivers (over 2300 models). Licks the knottiest dial cord problem in a matter of minutes. This low-cost book is a "must" for servicing. You'll want one for your tool kit and one for your shop bench. Order today. **ONLY . . . 75c**



ON SALE AT YOUR LOCAL JOBBER'S TODAY



FREE! New PHOTOFACT Cumulative Index

Latest Cumulative Index to all Sets of PHOTOFACT Folders now available! Your guide to more than 2700 receiver models and chassis (1946 and 1947 models). Ask your parts jobber for FREE copy, or write us direct.

HOWARD W. SAMS & CO., INC.
INDIANAPOLIS 6, INDIANA

Export—Ad. Auriema—89 Broad St., New York 4, N. Y.—U. S. of America
Canada—A. C. Simmonds & Sons, 301 King St., East—Toronto, Ontario

PHOTOFACT SERVICE

"The Service that pays for itself over and over again"

Mail This Order Form

to HOWARD W. SAMS & CO., INC.
2924 E. Washington St., Indianapolis 6, Indiana.

My (check) (money order) for \$ enclosed.

- Send PHOTOFACT Volume 3 (including Sets Nos. 21 through 30) in DeLuxe Binder, \$18.39.
- Send Volume 2. Send Volume 1 (each in DeLuxe Binder, at \$18.39 per volume).
- Send . . . SAMS' 1947 AUTOMATIC RECORD CHANGER MANUAL(S) at \$4.95 each.
- Send . . . SAMS' DIAL CORD STRINGING GUIDE(S) at \$0.75 per copy.
- Send FREE PHOTOFACT Cumulative Index.
- Send details of your Special Trade-in Offer. I own PHOTOFACT Sets Nos.

Name

Address

City State

Now Available! 8 HOURS OF CONTINUOUS PLAY WITH THE MAGNETAPE* RECORDER!



Now — record and play back on this amazing instrument any sound that can be heard, and many that cannot — from a concert hall symphony to the beat of your heart. Simple interchangeable capstans provide a choice of three tape speeds for high fidelity, medium fidelity, or up to 8 hour voice recording. The ideal recorder and playback unit for home, office, industry, and broadcast station.

Other standard and portable models of shorter playing duration also available. Write today for our free illustrated catalog featuring our complete series of Magnetape Recorders and accessory equipment.

Send 25c. in stamps or coin for A.C. Shaney's new booklet, "Elements of Magnetic Tape Recording — and 999 Applications." Trademark

AMPLIFIER CORP. of AMERICA

398-10 Broadway, New York 13, N. Y.

STOP, LOOK and LISTEN*
to the new
UNIVERSITY TWEETER



*For High Fidelity at Lowest Cost!

You'll be amazed at the difference this tweeter can make in the tone quality of any good radio or phono. And it's quick and easy to install. Just attach two wires to the voice coil terminals of your present speaker and you have full range speaker response right up to 15,000 cycles. There are three models to choose from—a handsome walnut cabinet, and single or dual unmounted units. Prices from \$20.00. For details write to UNIVERSITY LOUDSPEAKERS, INC., 80 South Kensico Avenue, White Plains, N. Y.

University Loudspeakers

POWER FOR THE BC-312

(Continued from page 74)

unless you are lucky enough to find a 24-volt transformer. One surplus item which will give approximately 24 volts is available and will work well for this or any other receiver requiring this voltage. It is a replacement part for the Collins TCS-12, and supplies 16.6 volts and 12.6 volts center-tapped. By using one half of the 12.6-volt winding in series with the 16.6 volts, one can get 22.9 volts, which will work very well for filaments.

It is also easy to change the wiring in the HX and NX so that only 12 volts is required for the filaments. To make these changes, remove the receiver from its case, and disconnect the dynamotor. Locate the filament lead from the beat frequency oscillator socket to the socket of the first i.f., connecting the filaments in series; both tubes are identified on the top of the chassis, although the beat frequency oscillator is completely enclosed and its socket is not accessible. On all tubes in this set, pins 2 and 7 are the filament connections. Disconnect this wire at the first i.f. socket, and connect it to condenser C78, plainly marked and in the very center of the part of the chassis exposed by the removal of the dynamotor. Connect the terminal on the first i.f. socket to which this wire was connected to C79, which is in the same bathtub type container as C78. Next, short out resistor RS-267, a long flat object fastened to the front panel, in front of the coil compartments. Both terminals are exposed and are easy to reach.

Next it is necessary to dig into the r.f. section. Take out the tubes, behind the condenser, and unscrew the 8 screws holding the cover plate—4 on the back and 4 on top. Four more screws must be removed to loosen the subchassis. Ease the grid leads down into their holes, and turn the chassis

so as to expose the wiring. Remove the wire connecting the filaments of the first and second r.f., which are identified on the top of the subchassis. To each of the terminals just disconnected, fasten about 6 inches of wire, and twist these two wires together. Be sure you can identify them, however. At the end of the subchassis is a small vertical terminal strip containing the filament leads and others. By tracing the leads it is easy to discover which they are, and to connect the 2 wires so as to have 2 complete filament circuits, one including the mixer and second r.f., the other including the first r.f. and the high-frequency oscillator. It is not

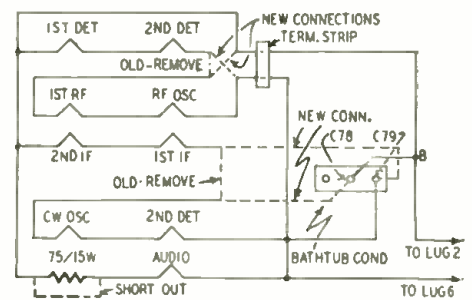

Fig. 3—Filament wiring for BC-312-HX and NX.

necessary to open the oscillator shield can to make these connections. Fig. 3 shows the original and the revised wiring of the HX and NX filaments. After replacing the subchassis and shield, making sure not to foul the grid leads and keeping the filament leads away from the other wiring as much as possible, the HX and NX can be treated like any 12-volt model of the BC-312. An RA-20 or a specially made power supply, as described above, can be used. The dial lamps should be replaced with 6-volt lamps, although the old 12-volt lamps will work fairly well.



E. V. Schwartz
Los Angeles, Calif.

"Must have made a mistake in the wiring somewhere!"

D.-C. MILLIAMMETERS

(Continued from page 70)

shunt resistance nor to measure the voltage of the batteries when they are being used in the radio receiver. Values of the resistors are:

METER RANGE & RESISTOR VALUES

Resistor	0-5 Ma	0-10 Ma	0-50 Ma	0-100 Ma
R1	400 ohms	200 ohms	40 ohms	20 ohms
R2	1,600 ohms	800 ohms	160 ohms	80 ohms
R3	10,000 ohms	5,000 ohms	1,000 ohms	500 ohms
R4	20,000 ohms	10,000 ohms	2,000 ohms	1,000 ohms

Let us look at Fig. 2 again. We have determined the voltage from the power supply across the portion of the circuit where the total current is available for the measurement. We wish, however, to

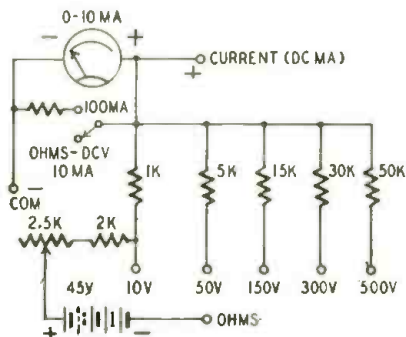

Fig. 6—A multitester useful in many circuits. Resistance of shunt is 1/9 that of the meter.

get a complete voltage check. From Ohm's law we know that $E=IR$. Therefore, if we insert a milliammeter in the circuit as in Fig. 5 and measure the current I , the voltage across R is IR . If in Fig. 2 we measure the current at C and know, or measure, the value of the plate resistor R , we can determine the voltage across R . The plate voltage at C is then the supply voltage minus the drop across R . This may be done for all plate and screen voltages.

Thus, by proper use of a milliammeter, a serviceman or experimenter can make fairly accurate voltage measurements of the d.c. voltages in a radio receiver. And he is not limited to that magic 0-1 ma meter he has wished for. A complete d.c. multitester circuit using a 0-10 ma meter is shown in Fig. 6. This includes an ohmmeter circuit which will measure accurately from 0 to 500,000 ohms. Two current ranges are provided, and the instrument should prove adequate for testing and servicing by the method outlined. Lower or higher values of meters may be used by proper change of circuit constants. A 5-milliamper meter would require multipliers of half the value of Fig. 6, and a 22.5-volt battery with the same ohmmeter resistors.

The experimenter may with the aid of this article put some of those old meters to work. He will realize, of course, that such instruments are limited in application, as outlined above. There is a very good reason for using 1,000-ohm-per-volt (or even 20,000-ohm-per-volt) meters, if the would-be user has them on hand or can obtain them easily. But for occasional experimental use, for measuring odd voltages and currents when no regular meter is available, and especially for use as battery testers, larger meters can be very useful.



GHOSTS that haunt your television customers can be laid at rest. Workshop antennas, *custombuilt for television*, eliminate ghosts, fading, noise and interference. In many locations the "signal strength" of ordinary "broad-band" antennas is insufficient for sharp detail and contrast. Workshop TV antennas, because of their inherent high gain and precise impedance matching, provide clear, brilliant reception. Even on adjacent channels their performance is exceptional.

FEATURES

- Three elements for "high-gain" performance.
- Engineered for each channel, but sufficiently broad-band to cover all present channels (should be installed for the weakest channel).
- The "feed point" is completely protected from the weather by a rugged plastic head.
- Elements made of 1/2-inch duralumin tubing.
- Rigid tubular steel mast 7 1/2 feet high. No guy wires necessary. Withstands high winds and ice loading.
- Streamlined design makes clean-cut, attractive installation.

AVAILABLE AT YOUR DEALER

DEALERS...

You know and we know that almost any "AM wire" will bring in TV if it is close to the transmitter. For the suburbs or out-of-town installations a Workshop TV antenna will bring in a much stronger signal. This means increased sales opportunities for you — plus superlative reception that you can sincerely recommend. Your local jobber has Workshop antennas. Get in touch with him or write direct.

THE WORKSHOP ASSOCIATES, INC.

Specialists in High Frequency Antennas
66 Needham Street · Newton Highlands 61, Mass.



EXTRA ELECTRIC CHARGE FOR TELEVISER?

Extra charges for electric power where television sets are connected to the line have been made in Connecticut, engineers of the Radio Manufacturers' Association charged last month.

The action of two Connecticut cities, Wallingford and Norwich, was cited by L. C. F. Horle, chief engineer of the Association, who reported that the Public Utilities Commission of Connecticut had permitted the Borough Electric Works of Wallingford to charge \$2.50 extra a month for electric power where a television receiver is installed, on the assumption that added power was required.

Earlier it had been reported that

owners of sets in Norwich have been required to pay \$1.26 extra on their monthly bills, not as a direct charge for electricity, but for having the set connected to the line.

Mr. Horle said that a survey of fifteen sets showed that power demand "contrasts not at all with the demand and power factor of many domestic appliances whose wide usage at normal power rates effectively destroys any sound basis for distinctive rates for television receivers."

The feeling among the radio officials was that the power companies were defeating their own best interests by discouraging the use of sets.

KEY TO A PRACTICAL UNDERSTANDING OF ELECTRICITY

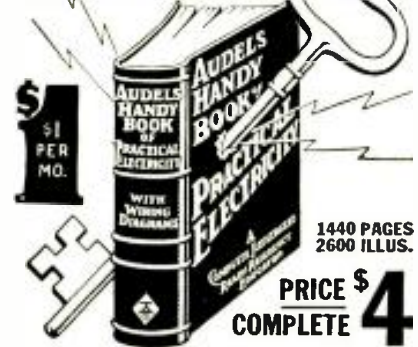

1440 PAGES
2600 ILLUS.

PRICE \$4 COMPLETE

● **AUDELS HANDY BOOK OF ELECTRICITY** for Maintenance Engineers, Electricians and All Electrical Workers. A quick, simplified, ready reference handy book, giving complete instruction and practical

● **INSIDE TRADE INFORMATION ON** rules and laws of electricity—maintenance of electrical machinery—A.C. and D.C. motors—armature winding and repair—wiring diagrams—house wiring—power wiring—cable splicing—meters—batteries—transformers—elevators—electric cranes—railways—bells—sign flashers—telephone—ignition—radio principles—refrigeration—air conditioning—oil burners—air compressors—welding and many modern applications explained so you can understand. All indexed for ready reference.

To get this assistance for yourself, simply fill in and mail the **FREE EXAMINATION COUPON** below.

.....

AUDEL, Publishers, 49 W. 23 St., NEW YORK 10, N. Y.

Please send me "Audels Handy Book of Practical Electricity" for free examination. If satisfactory, I will send you \$1 in 7 days, then \$1 monthly until \$4 is paid. Otherwise I will return it.

Name _____

Address _____

Occupation _____

Employed by _____ RCF

500 FORMULAS TO SUCCESS

MANY million dollar firms started with a single formula, for which they paid a big price. Here you have 500—no less—tried and tested formulas, recipes and processes for making things . . . all at the ridiculously low price of 25c.

Here is your opportunity to start a business with but a few dollars' capital and with undreamed of profits in prospect. You can also use these formulas in your own home to cut household expenses to the bone, for you can put them to use in your workshop to cut costs as much as 100%.

Quit paying out many dollars in profits to manufacturers, wholesalers, and dealers, when you can make the same thing yourself for a few cents. It's so easy when you follow our simple instructions.

66 PAGES, 3200 WORDS IN TEXT. Send for "500 FORMULAS AND RECIPES" today. Enclose 25c, that's all! You won't be asked for another cent now or later. Sold on a money-back guarantee.

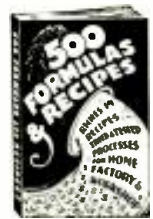

NATIONAL PLANS COMPANY
P. O. BOX 26 R, STATION N, New York 23, N. Y.

Get Started in Radio



10 "HOW-TO-DO-IT" BOOKS

Get a solid foundation in radio by means of these 10c timely text books. Each clearly written, profusely illustrated, contains over 15,000 words. You'll be amazed at the wealth of information packed into these handy books. Excellent for reference—ideal for technical library. Your money back if not satisfied.

- 5 BOOKS for 50c**
10 BOOKS for \$1.00
- Sent to You Postpaid**
- No. 1—How To Make Four Doerle Short Wave Sets
 - No. 2—How To Make The Most Popular All-Wave 1 and 2 Tube Receivers
 - No. 3—Alternating Current for Beginners
 - No. 4—All About Aerials
 - No. 5—Beginners' Radio Dictionary (Leading Terms)
 - No. 6—How To Have Fun With Radio
 - No. 7—How To Read Radio Diagrams
 - No. 8—Radio for Beginners
 - No. 9—Simple Electrical Experiments
 - No. 10—Television
- Remit by check or money order—Register letter if you send cash or stamps.

RADIO PUBLICATIONS
25A West B'way, New York (7)

KICKBACK POWER SUPPLY

(Continued from page 60)

B-plus flowing through this circuit, so that we actually gain a small amount of voltage.

The name *power feedback* has been given to this circuit. It has proven its economy in many instances. The centering control has been slightly changed so that it no longer requires a center tap, but that tends to make the adjustment somewhat one-sided.

The greatest disadvantage of the kickback high-voltage power supply is the rather tricky adjustment and the relatively poor regulation of the high-voltage section. To adjust it for best operation it is necessary first to set the saw-tooth amplitude control R3 to maximum sweep amplitude, then adjust the screen resistor R8 for best linearity and maximum brightness. Next the 2 permeability-tuned coils L1 and L2 are set for the best linearity and size, and damping resistor R12 is set for linearity and size. Once these controls are set, it will be necessary to repeat this procedure to obtain the best possible picture. When all these adjustments are made and a good picture is received, it should not be necessary to manipulate these controls again.

The slightly poor regulation of this type of power supply will be noticeable only when the adjustments outlined above have not been made properly. It will show itself as a difference in size between a bright and a dark picture. If the controls are set properly, this effect will become practically invisible.

In conclusion it may be said that the outstanding advantage of a kickback high-voltage power supply lies in its economy, not only in the number and price of the components involved, but

also in power consumption, which is a very important factor when designing a small table-model television receiver. Further advantages are in the fact that it is very unlikely that a collapse of the sweep could leave a bright spot on the face of the cathode-ray tube, which would burn a hole in the fluorescent screen. Actually, this is possible with this type of high-voltage supply only if an open circuit exists between the secondary and the deflecting coils, something that will happen only in rare instances.

It can be seen from the above description that such a system lends itself readily to the mass production of small table models and many types of console models as well. As a matter of fact, the latest RCA 10-inch table model, as well as the Philco and some television kits, use a kickback high-voltage power supply, and many other manufacturers are planning its use for their new models.

EMERGENCY FIELD SUPPLY

It is often necessary or desirable to use an electrodynamic speaker with an amplifier designed for use with PM units. This can be done by passing the plate current of the output tube through the field of the speaker before it goes to the output transformer. If the amplifier has a push-pull output stage, connect the speaker field between the B-plus and the center tap of the output transformer. An 8- μ f condenser across the field will give higher volume and better quality, but may be omitted without harmful results.

A. D. DENTON,
Herts, England



Frank BEAVER

Suggested by Marcel Strudler, Tel-Aviv, Palestine

"There must be some leakage."

HI-FI TUNER TRIBULATIONS

(Continued from page 61)

both i.f. transformers the XYL had rigged up a dual rotary switch on the underside of the chassis. She had a rod running back and a switch placed very nicely under each i.f. hole. A nice deal except for putting transformers back.

This time it was a wee bit too broad. Stations ran into each other. Six turns would be about right, I said. "There are 4 positions on this switch," the XYL commented. "Maybe we could have 4 band widths?"

I was thinking. If adding clockwise turns to each coil would increase the coupling and broaden the band, then adding clockwise to one and counter-clockwise to the other should decrease

tion right on the nose. Then the XYL twisted the switch and you could hear the highs coming in a step at a time.

The next day I took the tuner to the lab where I worked (over the XYL's protest) and ran some curves at lunch time. It looked fine.

The next Sunday the XYL didn't switch tuners once. She listened to the NBC programs in the broad position and they were fine. The program fairly sparkled. Almost as nice as with the t.r.f. At noon she tuned in KNX on the No. 1 position. On No. 2 there were some highs and no Mexican station. On No. 3 there were more highs and still no Mexican music. She turned to No. 4 and there were still more highs and still no XERB with Bob Wills.

"What the hell?" We looked at each other with arched eyebrows.

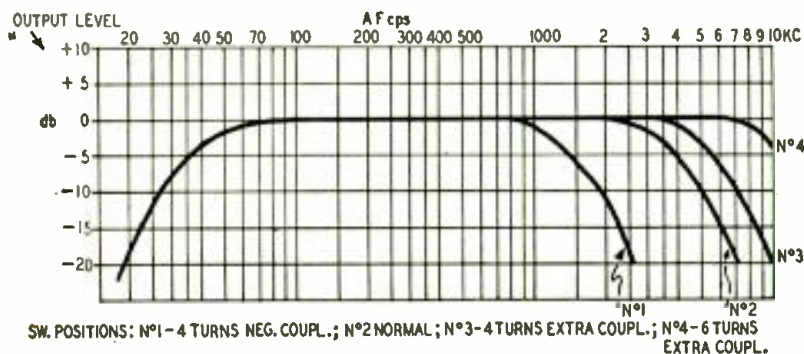

Fidelity curves of the receiver with the selectivity control in each of its four positions.

the coupling and sharpen the band. A sharp position would be handy for alignment and also for tuning stations right on the nose. "Okay," I said. "This time I'm all set. We'll fix it up right."

I got out the 30-36 wire and I laid the turns in deeply. To the No. 1 position I wired 4 turns clockwise on the primary and then 4 turns counterclockwise on the secondary. No. 2 I left open. No. 3 had 4 turns clockwise on both primary and secondary. No. 4 had 6 turns clockwise on both primary and secondary.

It worked! Beautifully. In the narrow position it was a cinch to get any sta-

tion right on the nose. She deliberately went hunting for XERB on the dial. I'll be damned if they weren't off the air! What's more, they didn't come on again.

I got my draft notice about then so I quit the job. Before I left we drove down into Mexico to see XERB. Their antenna tower was knocked down and broken. The stub end stuck up in the air about 10 or 15 feet.

I don't know yet whether a windstorm or a low-flying plane or what that did it, but XERB was off the air for some time. Maybe some other music lover went down and sabotaged the tower. I never did find out!

RADIONIC ELECTROMIX

Eddy Current was a conductor on a *Wave train* which used to pass over the *Wheatstone Bridge*. One day, passing down the aisle he saw a *standing Wave* and found a seat for her. She told him her name was *Jenny Rator* and asked him the *transit time*. Eddy got *shunt-excited* and his heart started *motorboating*. He asked her if he could be a *wave guide*. Seeing his *thermal agitation*, her *admittance* got the better of her, and she told him she already had a boy friend named *Mike Rofarad*. In well-modulated tones she told him she was *biased* against *Mike* because his *input capacity* needed a *volume control* and unless he *limited* his *amplitude* he always got *loaded*. At this *cross talk* Eddy *Current* saw her *driving point* and said he would try to be a *converter* for *Mike Rofarad*. At noontime, at the *Antenna Feed* he was putting a *pi-section* into his mouth with a large *insertion loss* when he saw *Mike*. He was *stagger-tuned* as

usual and was finding it difficult to maintain his *vertical position*. His *stability* was poor and he was highly *unbalanced*. Suddenly he yanked out an *electron gun*, focused it at *Eddy Current*, and pulled the *trigger*. The *shot effect* was terrific. When the *space charge* had cleared away, a large *cavity* was found in the *ground*, and *Mike Rofarad* had disappeared. When Eddy saw *Jenny Rator* that night, he told her what had happened. Her *crystal eyes* watered and in the *intensity* of her grief she nearly had a *breakdown*. Then Eddy began to *sweep* her off her feet. Eyeing her *characteristic curves* he pledged her undying *fidelity* and presented her with an *intensifying ring*. Feeling the *mutual induction* between them, they decided to try *critical coupling*, and were hence *matched* by a preacher. Then they went out to celebrate, got *saturated*, and became a very *twisted pair*.

—E. A. Uttendorfer.

FORGE AHEAD IN RADIO

with the aid of these

3 GREAT BOOKS

"U.H.F. SIMPLIFIED"

"F.M. SIMPLIFIED"

"TELEVISION SIMPLIFIED"

by

MILTON S. KIVER

Associate Instructor of Radio,
Army Air Forces

Not a wasted word—not a complicated phrase—just an enlightening, fast-reading, well-organized collection of basic facts in this

MODERN RADIO LIBRARY!

Now, for the first time, available on a money-saving combination offer!

This complete library of present-day radio enables you to cash in on the tremendous possibilities that exist in this highly lucrative field. In each book the author breaks down a typical receiver into its individual parts, explaining in simple English the construction and purpose of each element of equipment and the part it plays in the operation of the set. There are complete directions for installing, troubleshooting and repairing every type of equipment. Hundreds of vivid illustrations show every detail of construction and operation. Every method, every circuit is made crystal clear.

These three great books are indispensable in your shop or library; they form a natural, closely related family of facts that work hand in hand to lead you to greater success in radio.

For free examination of this three-volume library of modern radio, mail the coupon below.

INSPECT THESE REMARKABLE BOOKS AT OUR EXPENSE!

MAIL THIS COUPON

D. VAN NOSTRAND COMPANY, INC.
250 Fourth Ave., New York 3, N. Y.

Please send me, for free examination, the MODERN RADIO LIBRARY. Within 10 days I will return the books or send you \$4.95 followed by three monthly payments of \$3.00 each. (If you send \$13.95 within ten days we will pay postage.)

NAME

ADDRESS

CITYZONE.....STATE.....

RC-Jan. 1948

TECHNOTES

... TELEVISION SETS

When adjusting television sets, it is difficult to watch the picture and manipulate the controls, in back, at the same time. I overcome this difficulty by using a flexible cable about 2 feet long with a coupling on one end and a knob on the other. Tighten the coupling on the control shaft. The controls can then be adjusted one at a time while standing in front of the set.

H. ACKERMAN,
Brooklyn, N. Y.

... EMERSON 522

Complaint: Severe hum, loudest with the volume control set for *minimum* volume. Tubes checked good. Filter condensers could not have caused the trouble, because then the hum would have been loudest for maximum setting of the volume control. By tapping all components and connections, I located a high-resistance joint at the cathode pin of the 12AT6 socket. A slight heater-to-cathode leakage will develop a voltage across such a faulty connection, thus varying the bias on the grid of the tube. Cleaning and resoldering the connection cured the trouble.

JOE FIEDERER,
Worcester, N. Y.

... EMERSON GC448

One complaint on these sets is that they play on batteries but not on a.c. or d.c. lines. I find that resistors R16 and R17, 1500 and 950 ohms respectively, often increase in value. These units are easily located since they are mounted upright near the 117Z4 rectifier. Replacing them with 10-watt units of proper value cures the trouble.

W. O'BRIEN,
Fulton, N. Y.

... GASSY BEAM TUBES

Sometimes a 35L6 or similar tube in a.c.-d.c. sets goes slightly gassy and causes distortion. When replacements are not immediately available, try reducing the grid leak to 75,000 or 100,000 ohms. The lowered resistance reduces the voltage drop when the grid draws current.

LOUIS PASTORE,
Peterboro, Ont.

(Be sure to replace the original grid leak when the tube is replaced.—*Editor*)

... SPEAKER MOUNTING

When installing a radio with detached speaker in an old car, it is often quite a problem to find a suitable spot for the speaker.

I have solved this problem satisfactorily by mounting the speaker on the heavy fiberboard liner on the inside of the side cowl. Cut a hole in the liner and mount the speaker between the liner and cowl. If a finished grill is not available, make one from fine screen wire. The large enclosed space surrounding the speaker improves its tone quality.

HARRY W. BOOZ,
Hopewell, Va.

TWO GREAT OLSON MONEY-SAVERS

OHM CHEST

with 100 Insulated Resistors

This handsome Chest has 20 compartments, 10 in the base and 10 in a removable tray. Walnut finish; brass hinges and fastener. Contains 100 resistors stamped with resistance values, 5 ohms to 20 megohms, 1/2 watt to 2 watts, color coded. Every size is popular!



\$4.95

COMPLETE

Send for our FREE MONTHLY BARGAIN BULLETIN

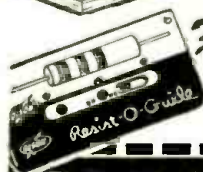

Free with each Ohm Chest ordered, you get our "Resist-O-Guide" free. Revolving wheels in color show all resistance values.

CAP CHEST

with 27 "Akrad" Condensers

A terrific buy! We want you to try the amazing new Olson "Akrad" Condensers, so we pack 27 "Akrads" (a \$31.45 List Value) in a beautiful walnut-finish wood chest with hinged lid and 6 compartments—and send you the whole works for only \$9.95. Wow! Order now!

CONTENTS:

QUAN.	CAP.	VOLTAGE	LIST	TOTAL
2	10	25	\$0.75	\$1.50
2	25	25	.85	1.70
5	20	150	.95	4.75
5	40	150	1.10	5.50
4	20-20	150	1.30	5.20
5	10	450	.95	4.75
4	16	450	1.35	5.40
Walnut Finished Chest				2.65
TOTAL				\$31.45

\$9.95

COMPLETE

GUARANTEE

Use 5 Olson "Akrads." If for any reason you are not satisfied, you can return the rest with Cap Chest and get back the \$9.95 and postage.

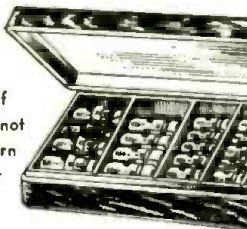

OLSON
RADIO WAREHOUSE inc.
73 E. MILL ST.
Dept. 112
AKRON, OHIO

- Send me _____ Ohm Chests with 100 Insulated Resistors in each, at \$4.95.
- Send me _____ Cap Chests with 27 "Akrad" Condensers in each, at \$9.95.
- I enclose \$ _____ Send my order C.O.D. Olson pays the postage. I will pay the postage.

NAME _____

(Please Print)

ADDRESS _____

(Please Print)

CITY _____

STATE _____

THE FIRST...and still the best All-Electronic SWEEP GENERATOR!

FOR FM · TELEVISION · RADAR

Continuous range between 500 Kc. and 110 Mc. For laboratory, school or production alignment of all wide band electronic equipment. Sweep range adjustable from 10 Mc. down to 5 Kc. at any frequency within above range. Input 110 V., 50-60 cycles, A.C., 60 watts. Two INTERNAL "markers" at 1 and 10 Mcs. Main dial marked in megacycles/sec. Attenuator will reduce output to about 30 microvolts.



Simple to operate ★ .1 volt max, 500 Kc. to 110 Mcs., 100 ohms, 10 mc. Sweep width. ★ Internal 1 and 10 Mc. markers. ★ Covers new FM bands and commercial television channels. ★ Compact (14 1/2" x 8" x 8") ★ Light (only 16 lbs.)

UNITED STATES TELEVISION MFG. CORP.

3 West 61st St., New York 23, N. Y. Circle 6-4255

RADIO ★ TELEVISION ★ ELECTRONIC PRODUCTS

FM INSTALLED IN CINCINNATI BUSES

FM receivers have been installed in public busses by the city of Cincinnati, for the enjoyment of passengers. The sets will be operated for one-hour periods daily for a one month test period. Technicians believe it will be possible to provide music at a level high enough

to give passengers entertainment and yet not loud enough to interfere with conversation.

An automatic volume control specially designed for the receiver holds the level normal whether the busses are near or far from the transmitting station.—G. L.

Opportunity Ahead — but, for TRAINED MEN Only!

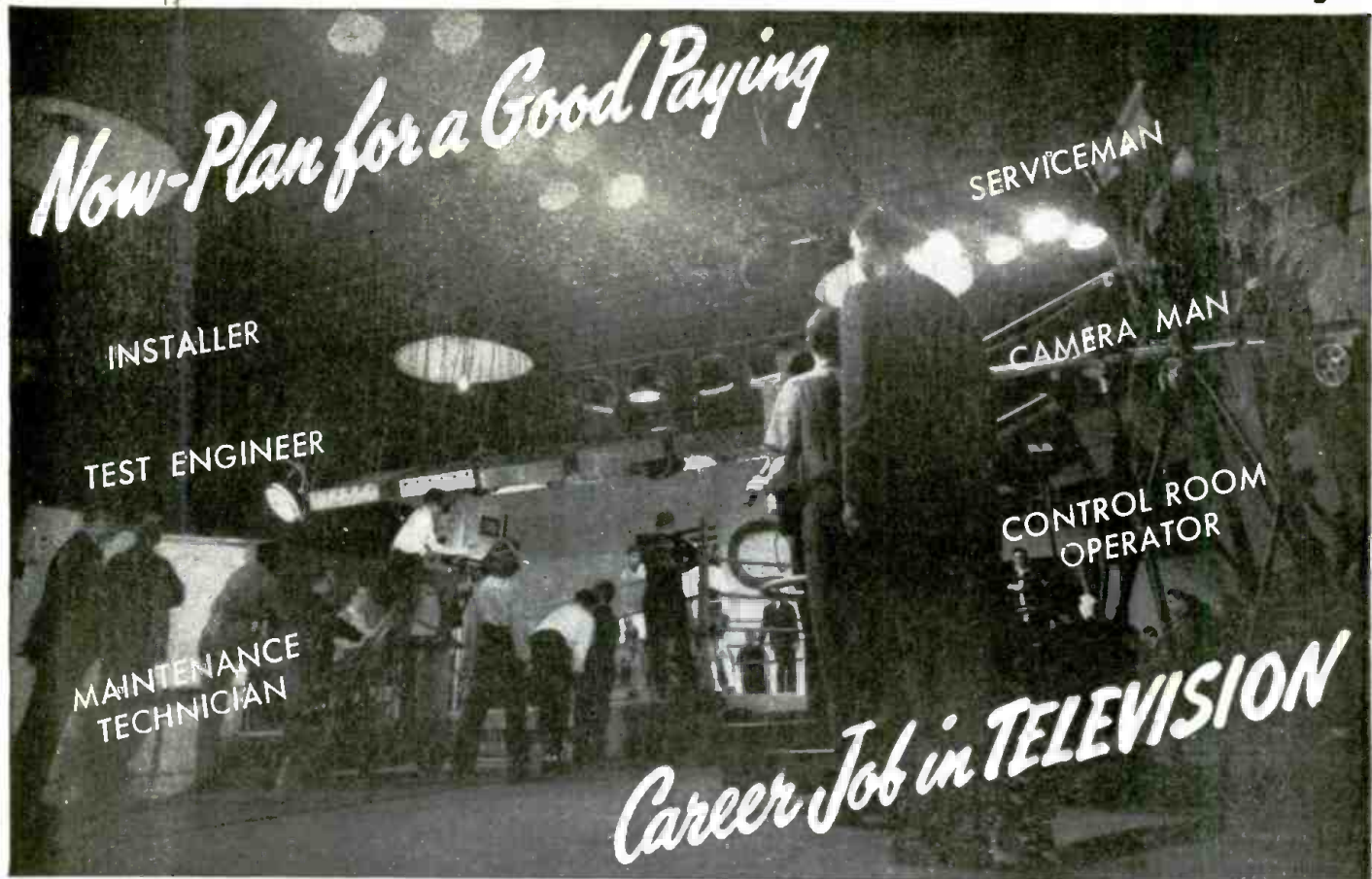

CREI Practical Home Study Courses in PRACTICAL TELEVISION Can Help You Advance in this Expanding Field!

You can make your own opportunity in Television, if you start preparing *now*. No need to tell you how fast this great new field is expanding—or, of the great number of jobs that are being created. If you are in Television now, expect to be, or wish to get in, CREI offers the very training you need to help accomplish your aims.

CREI can show you the way with convenient spare time study at home that gives you the up-to-date technical background you *must have* for Television. CREI courses are designed to give you a thorough grounding in basic principles and take you step-by-step through the more advanced subjects of Television and its related fields. It must be remembered that all new electronic developments have their roots in past techniques. CREI training is basic and helpful in your daily work right from the start. You will learn about and understand such subjects as: Optics; Pulse Techniques; Deflection Circuits; RF, IF, AF and Video Amplifiers; FM; Receiving Antennas; Power Supplies; Cathode Ray, Iconoscope, Orthicon and Projection Tubes; UHF Techniques, Television Test Equipment, etc.

No matter how complete, or how limited your radio experience, CREI has a practical course of training for you based on twenty years experience in training professional radiomen. The facts about CREI, our courses, and what we can do for you, are described in our 24-page booklet. It is well worth reading. Send for it now.

VETERANS! CREI TRAINING AVAILABLE UNDER THE "G. I." BILL!

Capitol Radio Engineering Institute

An Accredited Technical Institute

DEPT. RC-1 16TH AND PARK ROAD, N. W., WASHINGTON 10, D. C.

Branch Offices: New York (7): 170 Broadway • San Francisco (2): 760 Market St.

RADIO-CRAFT for JANUARY, 1948

FREE! Sample TELEVISION LESSON

See for yourself. Let us send you the actual lesson on "PICK-UP TUBES — ICONOSCOPE and IMAGE DISSECTOR TUBES". See how interestingly and clearly we present the subject of fundamental pick-up tubes of the television camera. You'll see how simple it is to improve your ability with CREI.

MAIL COUPON FOR FREE BOOKLET & SAMPLE LESSON

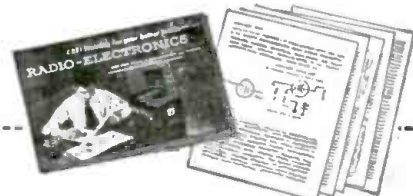

CAPITOL RADIO ENGINEERING INSTITUTE

16th & Park Rd., N.W. Dept. RC-1, Washington 10, D. C.

Mail me ONE FREE sample lesson and your 24-page booklet, CREI Training for Your Better Job in Radio Electronics". I am attaching a brief resume of my radio experience, education and present position.

Check One PRACTICAL TELEVISION

Course: PRACTICAL RADIO-ELECTRONICS

NAME _____

STREET _____

CITY _____ ZONE _____ STATE _____

I am entitled to training under the "G.I." Bill.

NEW SERIES 16



5 WAVE BANDS

IMPROVED NO-DRIFT FM
in the Sensational **1948**

MIDWEST RADIOS

Separate Chassis Like This Powerful SERIES 16 AM-FM MODEL OR Beautiful Radio-Phono Consoles Available

The SYMPHONY GRAND RADIO-PHONOGRAPH AM-FM CONSOLE

A truly magnificent instrument that offers new, Improved No-Drift FM, 5 Wave Bands, Automatic Intermit Record Changer that handles both 10" and 12" records, 14" Fanzone Speaker, and exclusive Midway Tri-Magnadyne Cool System and Cub-Rite Tone Section. Luxurious cabinets. Other Console and Table Models with Series 16, 12, and 8 Chassis.

EASY TERMS **30 DAYS TRIAL**

SEND FOR FREE CATALOG **BUY DIRECT FROM FACTORY AND SAVE!**

FILL IN COUPON AND MAIL TODAY OR JUST SEND YOUR NAME AND ADDRESS ON A POSTCARD

MIDWEST RADIO CORPORATION
Dept. 38-P, 909 Broadway, Cincinnati 2, Ohio
Please send me your new FREE 1948 Catalog.

NAME.....
STREET.....
CITY..... ZONE ... STATE

S.S.S.

"Servicing by Signal Substitution"

Learn about this modern dynamic approach to radio servicing with ONLY BASIC TEST EQUIPMENT.

... Fully described in a 120 page book available from your Precision Distributor or factory at 35¢.

... Schools are invited to inquire regarding quantity orders from our Educational Division.

PRECISION APPARATUS COMPANY INC.
ELMHURST 4, N. Y.

Manufacturers of Fine Test Equipment
RADIO • TELEVISION • ELECTRICAL • LABORATORY

COMPOUND VIEWING SCREEN

The viewing screen of a projection type television receiver may be a complex affair, RCA engineer I. G. Maloff told the Optical Society of America at their recent Cincinnati meeting. One such screen is a sandwich of 2 transparent plastic lenses and a sheet of plastic with a silica opacifier in it.

Two 15 x 20 inch lenses, used for the front and back of the screen, concentrate the light in the desired viewing field. The rear piece is a "Fresnel" field lens—a thin Plexiglass sheet molded with a series of fine, concentric, circular ridges, somewhat like the surface of a phonograph record. The front of the screen is a multiple-element lens of nar-

★ ★ ★ ★ ★ ★ ★

STAR TUBE-CHECKER

MODEL TE-1

★ \$ **29⁹⁵** ★

★ **Best Buy Today** ★



No other checker like it for size, quality, price. Individual pin switch arrangement enables calibration of any tube made... now or in the future. Provides line check. Rugged, portable metal cabinet measures only 7" x 8" x 3 1/2" and weighs only 4 pounds net. Extremely easy to operate. Complete charts provide data for checking 570 tubes.

Order one today from your dealer, or write to:

STAR MEASUREMENTS CO.
442 East 166th St., New York 56, N. Y.

★ ★ ★ ★ ★ ★ ★

FOR CASH OR CREDIT NEWARK VALUES LEAD THE FIELD!

Authorized Distributors of ALL STANDARD MAKES OF RADIO AND ELECTRONIC EQUIPMENT TELEVISION SETS, KITS & PARTS PUBLIC ADDRESS & SOUND EQUIP'T.

TAKE ONE YEAR TO PAY for Equipment Totalling \$75 or Over 20% Down—12 Monthly Payments*
*Plus 6% Carrying Charge—Send for Order Blank

NEW YORK Offices & Warehouse 242 W 55th St. NY 19
NEWARK ELECTRIC COMPANY, INC.
CHICAGO 323 W Madison St. Chicago 6, Ill.
New York City Stores: 115-17 W. 45th St. & 212 Fulton St.

U. S. TELEVISION STATIONS IN OPERATION

STATION	CHANNEL
WRGB General Electric Co, Schenectady, N. Y.	4
WABD Du Mont Television, New York, N. Y.	5
WNBT National Broadcasting Co., New York, N. Y.	4
WCBS-TV Columbia Broadcasting System, New York, N. Y.	2
WPTZ Philco Corporation, Philadelphia, Penna.	3
WFIL-TV Philadelphia Inquirer, Philadelphia, Penna.	6
WTTG Du Mont Television, Washington, D. C.	5
WMAL-TV Evening Star, Washington, D. C.	7
WNBW National Broadcasting Co., Washington, D. C.	4
WBAL-TV Hearst Radio, Baltimore, Md.	11
WTVR Havens and Martin, Richmond, Va.	3
WBKB Balaban and Katz, Chicago, Ill.	4
WWJ-TV Detroit News, Detroit, Mich.	4
WEWS Scripps-Howard Co., Cleveland, O.	5
KSD-TV St. Louis Post-Dispatch, St. Louis, Mo.	4
WTMJ Milwaukee Journal, Milwaukee, Wis.	3
KTLA Paramount Pictures, Los Angeles, Calif.	5
WBZ-TV Westinghouse Radio Stations, Inc., Boston, Mass.	4

TELEVISION IN SCHOOL

Television has been made a regular part of the general school program in the Nutley (N. J.) High School. A receiver specially adapted for classroom use was presented to the Board of Education by a local manufacturer, Industrial Television, Inc. A large-screen direct-viewing receiver, its viewing tube and loudspeaker are set up on a platform which may be rolled out onto the auditorium stage when needed, then moved back into the wings after use. Controls are installed in a separate unit permanently mounted backstage.

Quadrupling of the service area of Philco's television station WPTZ in Philadelphia is expected when the station's new 552-foot tower is put into service. According to Ernest B. Loveman, company vice-president in charge of television, the new tower will bring television signals within reach of more than 4,000,000 people.

Supreme Publications New 1948 Diagram Manual

Here is your money-saving source for all popular, recently released diagrams of new 1948 receivers. Learn of modern circuit developments, be ready to repair any new radio no matter how complex. Millions of 1948 radios will be sold — you will have to service them right now, through this year, and for many years to come. The total cost is only \$2.00 for this giant volume—nothing else to buy, nothing else to pay, covers a whole year of radio diagrams. Read about other volumes for previous years described below. “No-risk” examination granted to servicemen.

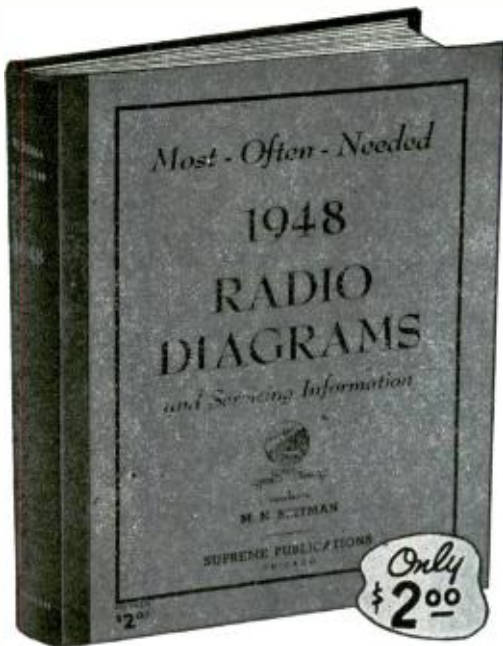

Amazing Bargain Offer in Diagram Manuals

NEW MANUAL OF ALL POPULAR 1948 SETS

Models Made by:

R. C. A., Zenith, Philco, Sears, Fada, Emerson, Belmont, Detrola Radio, G.E., Majestic, Admiral, Stewart - Warner, Arvin, Westinghouse, United Motors, Wards, Delco, Western Auto, Stromberg - Carlson, Sparton, Motorola, Gamble, Crosley, and many others.

Be prepared to repair quickly all new 1948 receivers. In this big single volume you have clearly-printed, large schematics, needed alignment data, replacement parts lists, voltage values, and information on stage gain, location of trimmers, and dial stringing, for almost all recently released sets. A worthy companion to the 7 previous volumes used by over 120,000 shrewd radio servicemen. New manual covers models of 42 different manufacturers. Giant size. 8½x11 inches. 192 large pages + index. Manual style binding. **Bargain price, postpaid, only \$2.00**

FIND ALL RADIO FAULTS IN HALF-TIME

Speed up and simplify all radio set repairs with Supreme Publications Manuals. Service radios faster, better, easier, save money and time, use these most-often-needed diagram manuals to get ahead, earn more per hour. At the remarkable bargain price (only \$2 for most volumes) you are assured of having in your shop and on the job, needed diagrams and other essential repair data on 4 out of 5 sets you will ever service. Every popular radio of every make from old-timers to new 1948 sets, is included. Clearly printed circuits, parts lists, alignment data, and helpful service hints are the facts you need to improve your servicing ability. Save hours each day, every day, begin to earn more by doing radio work double-quick, let these eight volumes furnish diagrams for 80% of all sets. See pictures of these attractive manuals above. Each volume has between 192 and 240 pages, large size 8½ x 11 inches. Manual style binding. Send “no-risk” coupon today. You are guaranteed complete satisfaction.

RADIO SERVICING COURSE-BOOK



Learn new speed-tricks of radio fault finding, case histories of common troubles, servicing short-cuts, extra profit ideas. Many large lessons on the use of regular test equipment, explanation of signal tracing, television, recording dope. Many active servicemen used this reduced price radio training for brush-up and study of new service methods. Recently printed with new information on signal-tracing, television, visual alignment, P.A., photo-cells, etc. Complete, 22 lessons, size 8½ x 11 inches, 224 pages. With self-testing questions and index. Greatest bargain. Postpaid, only..... **\$2.50**

Simplified Radio Servicing by Comparison



Revolutionary different COMPARISON technique permits you to do expert work on all radio sets. Most repairs can be made without test equipment or with only a volt-ohmmeter. Many simple, point-to-point, cross-reference, circuit suggestions locate the faults instantly. Covers every radio set—new and old models. This new servicing technique presented in handy manual form, size 8½x11 inches, 84 pages. Over 1,000 practical service hints, 26 large, trouble-shooting blueprints. Charts for circuit analysis, 114 tests using a 5c resistor and a small condenser. Developed by M. N. Beltman. New edition. Price only..... **\$1.50**

ADVANCED RADIO SERVICING

New giant 3-in-1 volume of 30 lectures will add years of valuable experience to your present radio knowledge. Practical help on the business side of radio. Improve your store or shop. How to get free advertising. Lectures on test equipment, circuits, testing technique, television topics, P.M. theory and servicing instructions. Written for servicemen who want to get ahead of competition. Use M. N. Beltman's 19 years of radio experience to your own advantage. Complete, 30 lectures, assembled in manual form, illustrations, circuits, tips, ideas, hints. Sent postpaid, only..... **\$3.00**

See Your Radio Parts Jobber or Send Coupon →

Supreme Publications

PUBLISHERS OF RADIO BOOKS, MANUALS, AND DIAGRAMS

9 S. Kedzie Ave. • Chicago 12, Illinois

RADIO-CRAFT for JANUARY, 1948

NO RISK TRIAL ORDER COUPON

SUPREME PUBLICATIONS, 9 S. Kedzie Ave., Chicago 12, ILL.

Ship the following manuals: (Satisfaction guaranteed or money back)

- | | | |
|---------------------------------------------|-------------------------------------|----------------------------------------------------------------------|
| <input type="checkbox"/> 1948 | PRICED
AT ONLY
\$2.00
EACH | <input type="checkbox"/> Radio Servicing Course-Book @ \$2.50 |
| <input type="checkbox"/> 1947 | | <input type="checkbox"/> Simplified Radio Servicing @ \$1.50 |
| <input type="checkbox"/> 1946 | | <input type="checkbox"/> Advanced Radio Servicing @ \$3.00 |
| <input type="checkbox"/> 1942 | | |
| <input type="checkbox"/> 1941 | | <input type="checkbox"/> I am enclosing \$..... send postpaid. |
| <input type="checkbox"/> 1940 | | <input type="checkbox"/> Send C.O.D. I am enclosing \$..... deposit. |
| <input type="checkbox"/> 1939 | | |
| <input type="checkbox"/> 1926-1938 @ \$2.50 | | |

Name:

Address:

LEONARD'S

WINTER PRICES

BEST VALUE HAZELTON

MULTI TESTER RANGES



AC Volt 0-1500
DC Volt 0-1500
DC Mills 0-150
Resistance 0-300,000

\$11.75

ELECTRONIC MEASUREMENTS VOLOMETERS



101A 3" METER **\$17.50** NET
Model 101B
OPEN FACE 4" METER **\$20.35** NET
OPEN FACE PORTABLE
101AP 3" Meter **\$21.50** net
101BP 4" Meter **\$24.95** net

—LATEST— STAR MEASUREMENT TUBE TESTER

Quick operation—with Rotary Selector and lever switches tests all tubes up to 117 volts. Also tests individual sections such as diodes, triodes, pentodes, etc.



\$29.95 NET

RECORD CHANGERS

WEBSTER 56—Automatic Stop \$26.66
DETROLA 14.50
SEEBURG—2 Post 22.95

RCA CRYSTAL MIKE with table stand **\$4.95**

12" P.M. SPEAKER 20 OZ. ALNICO MAGNET **7.75** NET

61.6 Push Pull or Push Pull Parallel 50 watt. Completely shielded. 250 mill primary 5000 ohms—etc. 2-4-8-15-500 ohms. **\$5.19**
H-57—Special Lim. Quan.

PHONO MOTOR and PICKUP KIT

SPECIAL **\$4.95**

Complete

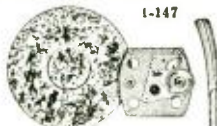

Crystal pick-up—Top quality constant speed motor. Motor Assembly only. \$3.95
Send 25% deposit with order—bal. see Express Collect. Orders under \$5.00 send check or money order plus postage

LEONARD RADIO INC.
69 CORTLANDT ST.
NEW YORK 7, N.Y.

NEW RADIO-ELECTRONIC PATENTS

By I. QUEEN

V.H.F. RECEIVING SYSTEM

Harold B. Stott, Glen Olden, Pa.
(assigned to Radio Corp. of America)
Patent No. 2,428,300

Greatest signal-to-noise ratio is obtained when an antenna is erected as high as possible above its surroundings and when the leads to the receiver are short. This is true especially at the higher frequencies. Generally it is not possible to satisfy both conditions at the same time.

One solution to the problem is disclosed and illustrated here. The mixer stage is placed within an enclosure adjacent to the antenna and is connected to the receiver itself by a single co-axial or parallel lead transmission line. This line feeds power to the mixer stage, transmits oscillator output to the mixer, and also transfers the i.f. mixer output to the receiver. In addition, the line feeds an a.c. voltage to tune the antenna circuit.

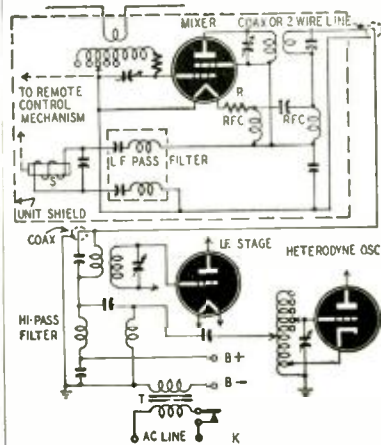

The d.c. plate supply for the mixer is connected across the transmission line as shown. This voltage also supplies filament power after being dropped through R. Voltage from the local oscillator is applied to the mixer input through the line and heterodynes against the incoming r.f. to produce the usual difference frequency. The i.f. voltage is transmitted back along the line and appears at the i.f. transformer at the other end. Note that a high-pass filter prevents it from affecting the oscillator.

The low-voltage secondary of a line transformer T is connected in series with B-. This voltage actuates the winding of an a.c. solenoid S. The solenoid filter prevents passage of d.c. or r.f. The solenoid is part of a step relay in which a plunger advances a ratchet gear each time the key K is depressed. This control tunes the antenna circuit in synchronism with the oscillator to the desired channel.

The relatively low i.f. suffers only negligible attenuation along the transmission line. The loss of power at the oscillator frequency is unimportant, since this voltage may be increased as necessary.

SUPER-HIGH-FREQUENCY WATTMETER

John Evans, Kingston, N. J.
(assigned to Radio Corp. of America)
Patent No. 2,427,094

Ordinary power meters are ineffective at very high frequencies, and thereupon indirect methods must be used. Some laboratories measure power by the heat which is generated. The heat is applied to a thermocouple which converts the power to electricity.

This is an improved method for measuring power at super-high-frequencies without the need
(Continued on page 96)

In New Jersey...

.. it's **VARIETY** ..

TRANSVISION

12" TELEVISION KIT

STANDARD MODEL—Picture size 7 1/2 square inches, 22 tubes and 12 inch picture tube. High fidelity FM sound reproduction. Advanced television circuit produces exceptionally clear pictures. **DE-LUXE MODEL**—with Superb Built-in FM Radio.
12" Standard Television Kit \$289.50*
12" DeLuxe Television—FM Radio Kit 359.50*
12" Television Kit 169.00*
(*complete with tubes, less cabinet)
Cabinet for 12" Television Receiver 44.95
Complete Line of Television Components
Dealers' Prices on Request



NEW! PREMIER Model 570 MICROMASTER Band Spread Dial SIGNAL GENERATOR

For testing and aligning BROADCAST, SHORTWAVE, FM and TELEVISION RECEIVERS. Exclusive Band Spread Dial geared to the tuning condenser and main dial, giving a total scale length of approximately 60 inches. Three color dial directly calibrated in Kilocycles and Megacycles. Range 75 KC—50MC. Up to 150 MC on 5th harmonic. Size: 15 1/2" x 12 1/2" x 5 1/2".
COMPLETE WITH TUBES AND CO-AXIAL CABLE \$54.75 NET



RADIO KITS

These are real radio kits. Metal chassis, condensers, resistors, tubes, etc.
1 Pal One Tube AC-DC Kit No. T-10 \$ 5.95 net
2 Tube AC-DC Kit No. RT-20 7.95 net
3 Tube AC-DC Receiver Kit No. RT-3 12.95 net
4 Tube 4 Band AC-DC Receiver Kit No. BX-4 23.70 net
5 Tube AC-DC Superhet Kit No. S-500 15.90 net
5 Tube Two Band AC-DC Superhet Kit No. S-520 18.45 net
4 Tube AC-DC TRF Receiver Kit No. T-400 13.95 net
3 Tube Code Practice Audio Oscillator Kit (P-10) 6.25 net
4 Tube AC-DC Amplifier Kit No. AM-40 Crystal Radio Kit No. CX-1 8.95 net
Vacuum Tube Volt Ohmmeter Kit No. VT-99 34.50 net
Wireless Phone Oscillator Kit No. PH-20 4.70 net
NATIONAL NC57 RECEIVER \$89.50
We carry a full line of National receivers and parts

ESPEY CHASSIS AND KITS

7B—11 Tube Superhet for AM/FM. \$140 list.
RT11 8 tube A. C. Broadcast and 100 106.50 list
9A—Six tube AC-DC short-wave and Broadcast bands. 56.50 list
Espey Basic Television Kit 59.50 list

VIBRATOR SPECIALS

Standard 4-prong, replacing E.L. 1703, ATH 324, Mallory 294, Radiart 5300. **10 for \$8.89**
99c each

AUTO ANTENNAS, Chromo Plated, Admiralty brass, shielded Polyethylene cable with black Vinylite cover, slide coil mount. **10 for \$16.95**
3 sections—66"—\$1.95 each

SUPERIOR Model 670

Super-Meter

A Combination Volt-Ohm Milliammeter plus Capacity Reactance Inductance and Decibel Measurements.

Complete with test leads and instructions **\$28.40**



Write Dept. RC-1, 20% Deposit with order required. Please add sufficient postage. Excess will be refunded

Variety **ELECTRIC CO., Inc.**
601 Broad St., Newark 2, N. J.

A Fortunate Few

CAN OWN SUCH A
TELEVISION RECEIVER

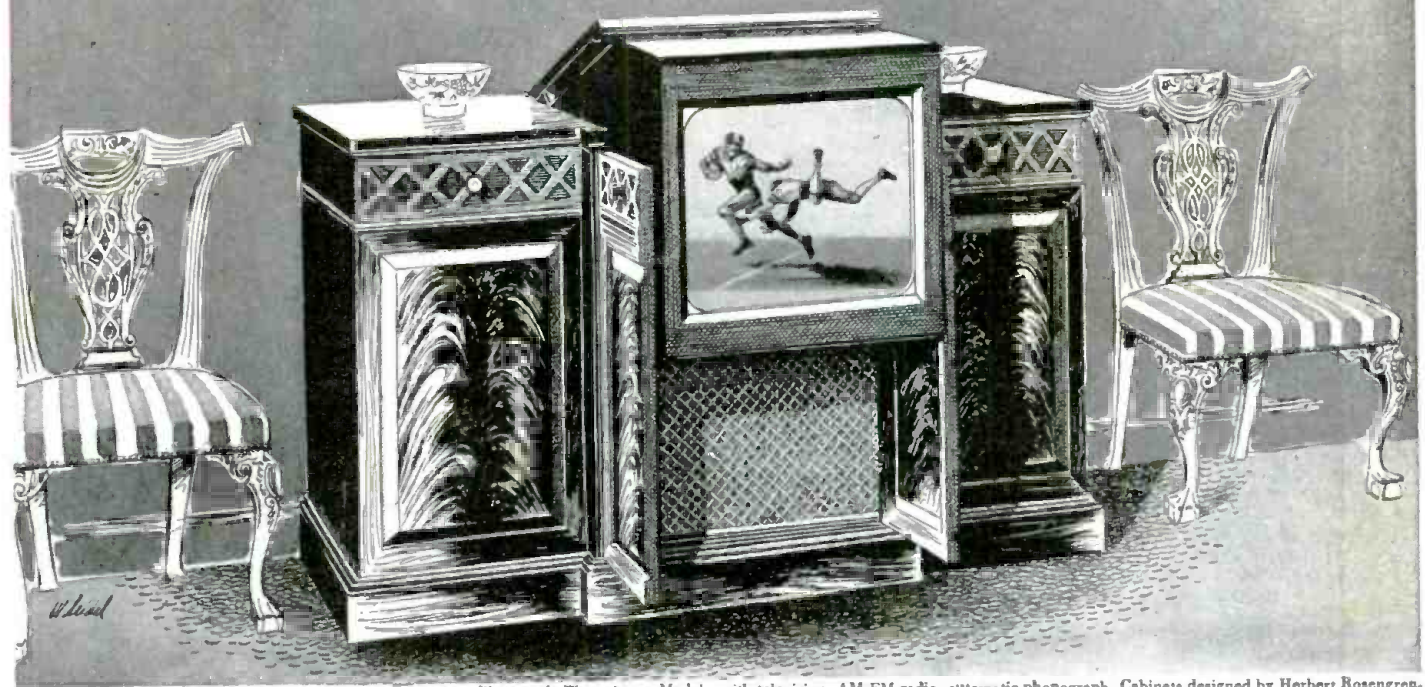
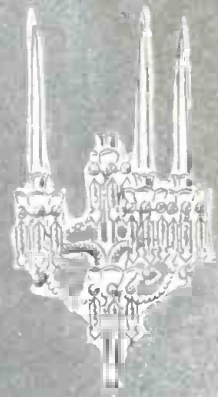
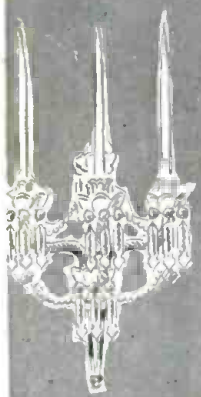

Illustrated: Westminister Model—with television, AM-FM radio, automatic phonograph. Cabinets designed by Herbert Rosengren.

In Du Mont's Salon and Drawing Room models you will see television at its finest . . . a brilliant picture on a large screen, clear and undistorted. Matching the picture quality is unsurpassed sound reproduction, whether on television, standard radio, FM, or radio-phonograph.

Visit your nearest Du Mont dealer.

DU MONT

First with the Finest in Television

BUILD YOUR OWN SIGNAL TRACER

and Save!!



MODEL CA-12 Kit includes ALL PARTS assembled and ready for wiring, circuit diagram and detailed operating data for the completed instrument.

\$24⁸⁵ NET

20% DEPOSIT REQUIRED ON ALL C.O.D. ORDERS

We are pleased to announce we have obtained an exclusive franchise to distribute the well known Model CA-12 Signal Tracer in kit form. The Model CA-12 sells regularly for \$34.85, here is your opportunity to save \$10 with the added advantage of complete familiarity of design and operation made possible when you build your own instrument.

THE MODEL CA-12 KIT COMES COMPLETELY ASSEMBLED. Can be wired in 30 minutes. Components and circuit guaranteed to meet the following:

FEATURES:

- ★ COMPARATIVE INTENSITY OF THE SIGNAL IS READ DIRECTLY ON THE METER—QUALITY OF THE SIGNAL IS HEARD IN THE SPEAKER.
- ★ SIMPLE TO OPERATE—ONLY ONE CONNECTING CABLE—NO TUNING CONTROLS.
- ★ HIGHLY SENSITIVE—USES AN IMPROVED VACUUM-TUBE VOLTMETER CIRCUIT.
- ★ TUBE AND RESISTOR CAPACITY NETWORK ARE BUILT INTO THE DETECTOR PROBE.
- ★ BUILT-IN HIGH GAIN AMPLIFIER—ALNICO V SPEAKER.
- ★ COMPLETELY PORTABLE—WEIGHS 8 POUNDS—MEASURES 5 1/2" x 6 1/2" x 9".

GENERAL ELECTRONIC DISTRIBUTING CO. Dept. RC-1, 98 Park Place
NEW YORK 7, N. Y.

for calibrated thermocouples. In addition the generated heat is constantly compared with a known source so that changes are detected at once. A U-shaped glass tube is partially filled with mercury under gas pressure from each end. At each end of the tube there is a resistor. Terminals from one resistor are available for external connection.

One end of the glass tube is placed within the wave guide where power is to be measured. At this end the resistor is one-half wave length long and thus acts as an antenna to pick up maximum

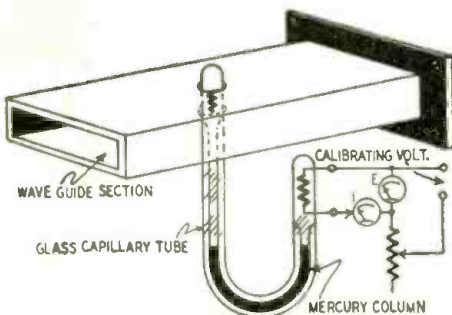

power from the wave. The generated heat causes the gas at this end to expand and thus lower the level of the mercury column as compared to the height on the other side of the tube. At the same time, however, an alternating current is applied to the other resistor thus expanding the gas on this side. When the mercury column on each side has the same height, the r.f. power is equal to the a.c. power which may be read on the meters.

BEVERAGE INSPECTION

Paul Weathers, Upper Darby, Pa.
(assigned to Radio Corp. of America)
Patent No. 2,427,319

All bottling plants require some form of inspection for possible foreign particles. With this apparatus it is possible to perform the inspection

NEW RADIO-ELECTRONIC PATENTS

(Continued from page 94)

automatically and rapidly, and to reject those bottles which contain undesired particles.

A suitable mechanism holds each bottle and spins it rapidly for a short time at about 1,700 revolutions per minute. Then the spin is abruptly stopped, while the contents continue to move due to centrifugal force. Each bottle comes to rest in front of a light beam which shines through it and on to a photoelectric cell. Particles within the bottle interrupt the light beam as they move, thus generating a signal. The larger particles are responsible for stronger signals; and since they interrupt the beam for a longer period, they generate lower frequencies than smaller particles. These signals are applied to an amplifier. To produce the same signal on larger particles as on the smaller ones the amplifier's frequency response curve rises sharply. Since the smallest particles of interest will generate a frequency of approximately 300 cycles per second, the amplifier is designed for a sharp cutoff beyond this point.

The amplifier output is applied to a gas tube, for example an OA4-G, which operates a relay at breakdown. This occurs when a bottle contains large particles and thereupon causes a strong signal. Automatic apparatus then may reject the bottle by shunting it out of the normal path.

HIGH HARMONIC GENERATOR

Joseph C. Ferguson, Fort Wayne, Ind.
(assigned to Farnsworth Tel. & Radio Corp.)
Patent No. 2,427,204

Pentodes and beam-power tubes generate strong 3rd harmonics. In this invention these harmonics

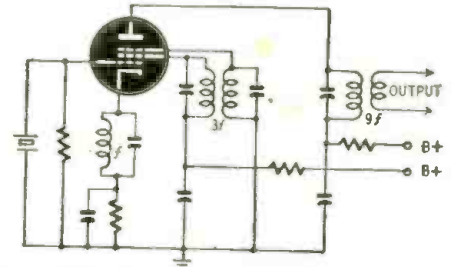

are used to advantage to give a high harmonic output. (Continued on page 135)

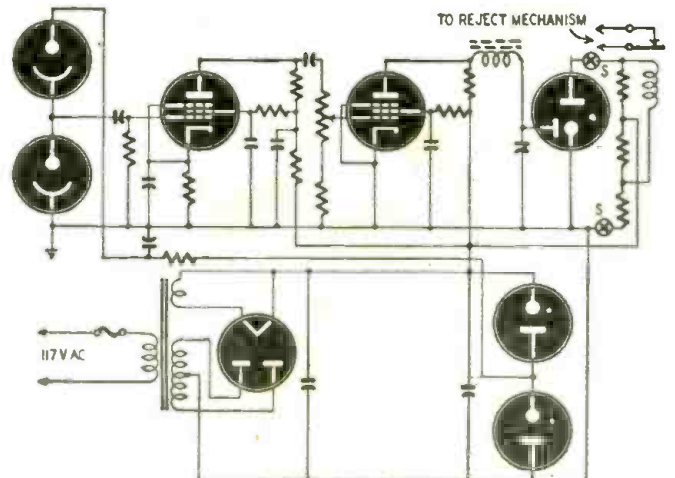

A BRIGHTER FUTURE FOR YOU

With These
New Rider
Publications

INSIDE THE VACUUM TUBE



By John F. Rider. A new approach and technique that makes its message easy to understand. A solid, elementary concept of the theory and operation of the basic types of vacuum tubes based on the electro static field theory. The book, which covers diodes, triodes, tetrodes, and pentodes, presents a clear physical picture of exactly what is happening in a vacuum tube.

A goldmine for the student; a must for servicemen, amateurs and engineers. 425 Pages—\$4.50.

RADAR

The complications have been removed in this entertaining book explaining Radar. Non-technical, but authentic. 80 pages, profusely illustrated, only \$1.00.

THE METER AT WORK



How each type of meter works and how each is used in the field to best advantage. Covers whichever phase of the subject the reader is interested in. 152 Pages—138 Ill.—\$2.00.

VACUUM TUBE VOLTMETERS



Explains the theory upon which the functioning of the different types of v-t voltmeters is based, and also the practical applications of these instruments. Includes a bibliography consisting of 145 international references. 180 Pages—111 Illustrations—\$2.50.

SERVICING RECEIVERS BY RESISTANCE MEASUREMENT

Discusses series and parallel combinations of resistances and the distribution of currents and voltages, providing the basis underlying the circuit arrangements used in various types of radio receivers. 203 Pages—\$2.00.

AUTOMATIC FREQUENCY CONTROL SYSTEMS



Basic operation of discriminator and Automatic Frequency control circuits is detailed in first part of book. Descriptions of systems used in commercial receivers are fully described in second part. 144 Pages—102 Illustrations—\$1.75.

ALIGNING PHILCO RECEIVERS



Complete and detailed information for aligning every Philco model from 1929 to 1941.
VOL. I—1929 to 1936—176 Pages—\$2.00
VOL. II—1937 to 1941—200 Pages—\$2.00

A-C CALCULATION CHARTS

By R. LORENZEN. Students and engineers will find this book invaluable. Simplifies and speeds work involving AC calculations. Contains 146 charts. Covers AC calculations from 10 cycles to 1000 megacycles. —\$7.50

AN HOUR A DAY WITH RIDER SERIES—96 PAGES..... (each) \$1.25

D.C. VOLTAGE DISTRIBUTION IN RADIO RECEIVERS—The applications of Ohm's law, practically interpreted in terms of how circuits are employed in radio receivers.
"ALTERNATING-CURRENTS IN RADIO RECEIVERS"—This book familiarizes you with the different forms of alternating currents in receivers. Basic facts.
RESONANCE AND ALIGNMENT—The importance of the subject in relation to all communication systems, and the clarity of this text, have sold over 30,000 of this title.
AUTOMATIC VOLUME CONTROL—An easy to understand explanation of how avc is utilized in radio receivers.

LEARN RIGHT WITH RIDER!

FOR 17 YEARS, PUBLISHERS EXCLUSIVELY FOR THE RADIO AND ELECTRONIC INDUSTRIES

Just Out **FM TRANSMISSION AND RECEPTION**

by John F. Rider and Seymour D. Uslan

CHAPTER HEADS

Fundamental Considerations • Frequency Modulation • Essentials of F-M Transmitters • Transmitters of Today (Wide Band and Narrow Band) • The Transmission of F-M Signals • F-M Receiving Antennas • The F-M Receiver • Alignment of F-M Receivers • Servicing of F-M Receivers

Over 300 Fact-Packed Pages
Paper Cover Stock \$1.80
Hard Back Cloth \$2.70

Also 2 NEW RIDER 99's

Each Over 130 Pages Each ONLY 99¢

PA INSTALLATION AND SERVICING
Provides the answers on what to do and what not to do in making low power public address installations. All embracing in scope.

UNDERSTANDING VECTORS AND PHASE
Considering the wide use of vector presentations to convey latest technical information in the radio field, every man in the technical branch of the industry should possess an appreciation of their significance.

THE CATHODE-RAY TUBE AT WORK



By JOHN F. RIDER. Presents a complete explanation of the various types of cathode-ray tubes, and what role each element within the device plays in making voltages and currents visible. The only book of its kind! 338 Pages. 450 Illustrations—\$4.00.

UNDERSTANDING MICROWAVES

By VICTOR J. YOUNG. Foundation for understanding microwave radio and radar. Explained simply. Design and Operation of waveguides, magnetrons, klystrons, antennas, etc. Section I covers theory; Section II, terms, ideas, and theorems. 385 Pages. Liberally Illustrated. \$6.00.

SERVICING BY SIGNAL TRACING



Explains approved system of diagnosing faults in radio receivers and all kinds of communication systems. The method was introduced by the author of the book, John F. Rider. The system has won endorsement by individuals and associations the world over as well as technical branches of our government. 360 Pages—188 Illustrations—\$4.00. Spanish edition—\$4.00.

THE OSCILLATOR AT WORK



Shows how various oscillator circuits function and methods to improve their performance. Also describes the r-f and a-f oscillators used as signal sources. Covers laboratory test methods, and other related tests. 256 Pages—167 Illustrations—\$2.50.

Out in Jan!

BROADCAST OPERATOR'S HANDBOOK

by HAROLD E. ENNES, Engineer, Station WIRE

Here are coordinated facts, standards of good operating practice written by an operator in operators' language.

TABLE OF CONTENTS

PART I OPERATING IN THE CONTROL ROOM AND STUDIO

Chapter 1. What You're Up Against, 2. Are Mechanical Operations Apparent? 3. Keeping Sound "Out of the Mud," 4. You're Often a Producer, Too, 5. Put That Mike There.

PART 2 OPERATING THE MASTER CONTROL

Chapter 6. Where Split Seconds Count.

PART 3 OPERATING OUTSIDE THE STUDIO

Chapter 7. Remote Control Problems, 8. Remote Versus Studio Pickups, 9. Remote Musical Pickups, 10. Eye-Witness Pickups and Mobile Transmitters, 11. The Live Symphony Pickup.

PART 4 OPERATING THE TRANSMITTER

Chapter 12. Operator's Duties, 13. Programs Are Entertainment, 14. Measuring Noise and Distortion.

PART 5 WE'RE OFF THE AIR

Chapter 15. Emergency Shutdowns, 16. Why Preventive Maintenance, 17. Preventive Maintenance Instructions.

PART 6 TECHNICALLY SPEAKING

Chapter 18. Control Room and Studio Equipment, 19. The Broadcast Studio, 20. Transmitter and Transmission, Book Bibliography.

Appendix.
288 Pages..... \$3.30

**CHECK THE BOOKS
YOU NEED AND
GET THEM TODAY!**

JOHN F. RIDER PUBLISHER, Inc.

404 FOURTH AVENUE (DEPT. B), NEW YORK 16, N. Y.
Export Agent: Rocke International Corp., 13 E. 40th Street, N.Y.C. Cable ARLAB

Publishers of
RIDER MANUALS

BEAUTY FOR DUTY

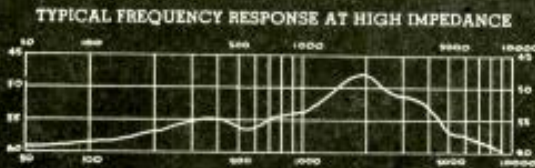
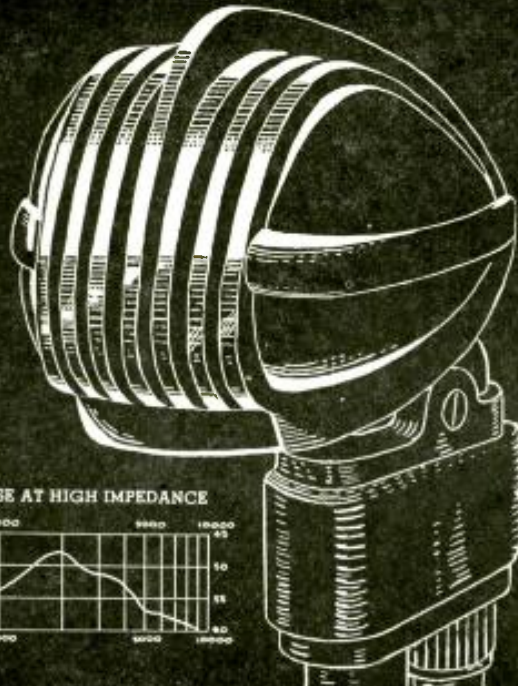

THE TURNER MODEL 33D DYNAMIC

The Turner 33D Dynamic microphone is designed with an exceptionally smooth wide-range response and high effective output. It is ideal for both voice and music pickups where quality of reproduction is desired. Engineered with Alnico magnets and Turner precision diaphragm for maximum sensitivity. The entire circuit is well shielded to prevent extraneous pickup. Modern streamline design and rich satin chrome finish matches the quality of its performance. Recommended for recording, public address and call system, and amateur work. Also available as Model 33X with high quality crystal circuit.

SPECIFICATIONS

- Level** 54db below 1 volt/dyne/sq. cm. at high impedance.
- Response** Flat within ± 5 db from 30 to 9000 c.p.s.
- Impedance** 50, 200, 500 ohms, or high impedance.
- Directivity** . . . Semi-directional. Non-directional when tilted full 90°
- Cable** 20 ft. shielded, removable cable set.
- Coupler** Standard $\frac{5}{8}$ "—27 thread.

WRITE FOR COMPLETE TURNER CATALOG

THE TURNER COMPANY

902 17th Street N. E.

Cedar Rapids, Iowa

FOR ACCURACY, RELIABILITY, AND SOUND PERFORMANCE
TURN TO MICROPHONES BY TURNER



Microphones licensed under U. S. patents of the American Telephone and Telegraph Company, and Western Electric Company, Incorporated. Crystals licensed under patents of the Brush Development Company.

12 VOLT AMPLIFIER (Continued from page 71)

The power supply

The power pack is entirely enclosed in metal and is located behind the amplifier. Each vibrator is of the synchronous type, but operation is reliable because each handles less than $2\frac{1}{4}$ amperes though its maximum rating is 3 to $3\frac{1}{2}$ amperes.

Inputs of the 2 packs are in parallel, but their outputs are in series. Each output is smoothed by a low-voltage electrolytic while the total output has a bank of 24-microfarad, 500-volt electrolytics across it. Originally the pack had a filter choke and fewer electrolytics, but the choke was removed to give higher output voltage and better regulation. An extra 12 volts is obtained by putting the pack in series with the input voltage.

Buffer condensers absorb the peaks due to the vibrators and can be of somewhat lower voltage than usual, 600-volt working or 2,000-volt test being sufficient if a reliable make is chosen.

When the amplifier and pack are assembled in their case, two 5-ampere switches control the battery currents supplied to filaments and pack. The switch for the pack acts as a stand-by, cutting the total battery drain down to 1.2 amperes, yet keeping the tubes heated and ready for immediate use.

This amplifier was designed to work with certain accessories, and it is important that the correct types of microphones, pickups, and loudspeakers be used. As inputs a Shure 707A crystal-diaphragm microphone and a medium-impedance magnetic pickup similar to the Garrard E were used. Output was fed to a pair of 8-inch PM speakers, the cones of which were stiff and straight-sided, the acoustical resistance of the exponential horns removing any peaks.

Part of the efficiency of the speakers is due to the way they are coupled to the metal horns, which are 24 inches long, 24 inches in bell diameter, and $3\frac{1}{2}$ inches in throat diameter. Turned hardwood pieces act as acoustic transformers between the diaphragm and horn throats.

The combination of a.v.c., semi-Class-AB2 operation, semifixed bias, and improved speaker efficiency results in a very high acoustic output with comparatively low battery drain.

SIMPLE PROBE

Recently I built a signal tracer which required a .00025- μ f condenser in the probe. I tried inserting it in a test prod, but the condenser was too large. Having a discarded fountain pen on hand, I removed the pen point and bladder, inserted a bolt about 1 inch long in the hole, and fastened the condenser to it, then, I drilled a hole on the other end for the shielded wire. This makes a probe which is neat yet requires only a few minutes to construct.

GENYO TAJII,
Madrone, Calif.

R4-ARR2 RECEIVER



FINEST QUALITY

"Communications"

LOWEST PRICES

TEST SET 159 TPX



I'HF receiver, approx. 300 mc with following tubes, 7-9001's, 3-6AK5's, 1-12AB, New \$17.50
 W/dynamotor \$19.20
 W/dynamotor for filaments \$19.00

PE 73 CM Power supply for BC 375.

Input: 28 VDC. Output: 1000 VDC @ 350 Ma. Starting relay, filter, etc. \$4.95

Mfrs.: Write for quantity, prices & discounts on above item.
 BD 77, Power supply for BC 191. Input: 14 VDC. Output: 1000 VDC @ 350 Ma. New, with spare fuse links, etc. \$5.95

DYNAMOTORS



PE 101C, Input: 13/26 VDC @ 12.6/6.3 A. Output: 400 VDC @ 135 Ma., 800 VDC @ 20 Ma. (9VAC @ 1.12 A.) \$3.49
 PE 86 N. Input: 28 VDC. Output: 250 VDC @ 60 Ma. Westinghouse w/Filter \$1.95
 Without Filter \$1.60
 PC 77, Input: 12 VDC. Output: 275 VDC @ 110 Ma. 500 VDC @ 50 Ma. \$3.25
 DAG 33 A. Input: 18 VDC @ 3.2 A. Output: 450 VDC @ 60 Ma. \$2.45
 DM-33A. Input: 28 VDC @ 7 A. Output: 540 VDC @ 250 Ma. Power supply for modulator of SCR 274 N \$3.95
 Dyn. Model 23350. Input 27 VDC @ 1.75 A. Output: 285 VDC @ 75 Ma. 1.75
 DM-21: In 14VDC 3.3A Out 235VDC 90 ma. with filter \$2.59
 DM-25: In 12VDC 2.3A Out 250 VDC 50 ma. \$2.49
 DM-34: In 14VDC 2.8A Out 220VDC 80 ma. \$2.49
 DM-42: In 14VDC. Out 515/1030 VDC 215/260 ma & 2/8 VDC \$3.95
PE206-A ROTARY INVERTER Input 27 1/2 volts at 38 amps. Output: 800 volts at 500 volt amperes. New complete with enclosed starting relay, voltage regulator, filters, and spare fuse links, etc. 10 1/2" x 5 1/2" x 11 1/2". Wt. 36 lbs. With instruction book. \$12.50



POWER SUPPLY RA 105 A.

Operates on 117 V, 60 cycles. Output voltages: 2000 VDC, 510 VDC, 415 VDC, 300 VDC, 290 VDC, 5.3 V A C
 Size: 10" H x 23 3/4" L x 18 1/2" D. Weight: 118.5 lbs. New, complete with tubes \$40.00

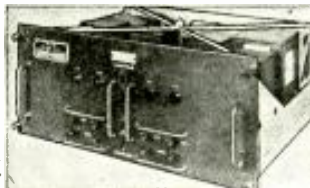

INDICATOR I-221. New. Remote antenna direction controller & indicator, using 2 5-watt motors, 360 deg. rotation. Operates on 117 VAC. 60 c.p.s. with tubes. New \$50.00

Mounting rack (FM79) for above 3 units with blower. APX size 4'x2'x2' \$35.00

Control unit RC 1073 consists of pulse generator, and a wavemeter which measures frequencies from 150 to 210 mc. The pulse generator makes an excellent square wave generator with variable pulse-widths. The wavemeter can be modified into a I'HF oscillator, 117 VAC, 60 c.p.s. operation \$50.00

ANTENNA, AN 128 A NEW. 2 parallel vertical dipoles working against a square reflector. Impedance is 50 ohms. Broad band bass. Makes an ideal antenna, with high gain & directivity on 2 meters APX 5'x4' \$40.00

Complete Set RC 118 Xmtr & Receiver BC 1267 & power supply RA. 105. Both units with tubes, used, in excellent condition \$47.50

COMPLETE TRANSMITTER AND RECEIVER RC145 RC 1267 RA 105 A, Indicator I 221, may be operated as independent units, or the complete set of components combined to form a unit may be purchased at this special price—with mounting rack FM 79, crated \$190.00 Gov't cost. \$5000

MOTOR DRIVEN SWITCH Switch operates at 1800 rpm, using internal 24 VDC motor. Switch is DPDT, and was originally designed for automatic switching of YAGI radar antennae \$2.00

INDICATOR BC 704 A Indicator, Part of Radar Set SCR 521. Makes an excellent foundation unit for a high gain scope. Has following tubes: 4-6AK7, 3-6GH6, and 1-5BP1 CR tube. Comes enclosed in metal shield. New, with all tubes, less power supply \$24.95

MINE DETECTOR AN/PRS I Will indicate buried metallic & nonmetallic objects, such as water pipes, sewer pipes, tree roots, water pockets, etc. Uses earphones and meter for aural and visual indicators. Operates on principle of changes in radiation resistance. An ideal gadget for campers, geologists, home-owners. New, complete \$12.75 With Batteries \$21.65

HEADSETS Dynamic mike and headset combination. A high quality, efficient unit, used in B-19 tank Xmtrs. Mike & phones complete, new \$2.75 HS 30 HEADSET: A feather-weight headset with insert type phones that cut background noise to a minimum. Low impedance (500 ohms) assures efficiency & high fidelity. \$8.50 Matching transformer to match 500 ohms to 8000 ohms output \$3.50 R-15 headsets: 8000 ohms impedance, rubber cushions. Comes with 8' cord & plug PL 55. New \$1.95 Used, in good condition \$60

Measures frequency between 150 & 200 mc. by heterodyne method. Power of Xmtr can be directly measured. Measures DC voltages up to 500 volts. Original operation on 110 V, 400 cy. but conversion kit makes it operable on 110 V, 60 cy. new, complete with tubes, crystal & conversion kit and data for 110 V, 60 cy operation \$55.00

TRANSFORMERS
 All primaries 117 V, 60 cycle. Filament Xfmr's:
 #5058: sec #1: 6.3V @ 2 A CT; sec #2: 6.3V @ 2 A CT @ 3 A CT \$2.45
 #5126: 5V @ 3 A CT, 5V @ 3 A CT, 5V @ 6 A CT, 5V @ 6 A CT \$3.25
 #5100: 6.3V CT @ 1.2 A, 5000 volt test \$2.45
 #5085: 6.3V NCT @ 1.0 A, 6.3V NCT @ 1.5 A \$1.85
 #5057: 6.3V CT @ 1 A, 5V CT @ 3 A, 5V CT @ 3 A \$2.75
 #UX 6890: 5V @ 5.5 A, 5V @ 5.5 A, 29.00 V test \$24.50

VIBRATOR TRANSFORMER
 Input: 24 v, 12 v, or 6 v. Output: Two 120 v windings @ 1.75 amp. Plus 11 v winding. Ea. \$1.50

SPECIAL
 Transformer to supply filaments of equipments using 12-volt tubes. Input: 117 V 60 cy. Output: 26 Volts @ 2 A \$1.50

CHOKES
 6 Hy @ 150 Ma \$2.00
 6 Hy @ 300 Ma \$4.50
 1 Hy @ 800 Ma, 7.5 ahrs \$9.95
 Dual choke, 2.2 Hy @ 100 ma \$.90
 Dual choke, 7 Hy @ 75 Ma, 11 Hy @ 60 Ma \$1.95
 8 Hy @ 125 Ma \$1.95
 25 Hy @ 65 Ma \$1.25

Tuning Units
 From TCE & GP-7. Ideal basis for EVO rig. Ranges: A 350-800 kc, B 800-1500 kc, E 1,525-6,5me, F 6.2-9.05me. Complete set of 5 Units F. Each \$11.00
 Units A,B,E. Each \$2.75
 Units A,B,E. Each \$2.00

From BC 191 & BC 375 TU 6B, 3000 kc, TU 9B-7700 kc, TU 9B-7700 to 10,000 kc, TU 10B-10,000 to 12,500 kc, TU 22 B 350 to 650 kc. Will supply closest unit to Specified Frequency at time of shipment. Each, \$2.75

OIL CONDENSERS
 .25 mf @ 20 KV, Aerovox \$17.50
 1.5 mf @ 6000 V DC Aerovox 12.50
 1 mf @ 25 KV 60.00
 .5 mf @ 25 KV 40.00

MICA
 .08 mf @ 1500 VDC, Sprague MX60 \$11.50
 .03 mf @ 2000 VDC, CD 551A 50 12.75
 .05 mf @ 2000 VDC, Sangamo, G1 12.75
 .00015 mf @ 20 KV, Aerovox 150-103 25.00
 .001 mf @ 20 KV, Sangamo G3 25.00
 .0051 mf @ 15KV, Sangamo G4 \$25.00
 .000 mf @ 10KV, Sangamo G3 \$17.50
 .002 mf @ 15KV, Sangamo Isolating Capacitor, Cornell-Dubilier PL 1417 106-110 mmf @ 10KV At Osaka Each \$3.50

MFRS: Send your requirements for Inductors, Micacs, Hardware, Resistors, & connectors

INSULATORS
 #581
 #584
 #582
 #650
 #48-C

#49: Lapp-bowl feed thru. Similar to National NS 3 Made of high quality glazed porcelain. Fits 2 1/2" hole. 6 3/4" L x 3" diam. \$1.50
 #581: Feed-thru. Made of stearite. Similar to National NS 1. Fits 1 3/4" hole. 3" L x 1 3/4" diam. Ea. \$.49 or 4 for \$1.50
 #582: Antenna feeder support. Holds twinex line also. 3" L x 1 1/4" diam. Hole size: 3/8" Each \$.17 or 10 for \$1.00
 #581: Same as #582, except hole is 1 1/4" Long. Each \$.12 or 12 for \$1.00
 #48C: Antenna support insulator. Made of fine quality stearite, with nickel plated reinforced ends. Non-corrosive. 4" L x 1/2" diam. Ea. \$.25
 Antenna Feed Thru Insulator: 3" cup shaped pair with flexible whip antenna mounting. Can be used either as feed-thru or whip & mast base. A MITST at this low price \$1.00

Power Unit Type 15

Complete power supply for SCR 522. Input 12VDC. With starting relay, blower, etc. Totally enclosed. Wood case \$7.89



GIBSON GIRL EMERGENCY XMTR

Transmits automatic SOS signal on 500 kc emergency wave. Can be manually keyed to transmit additional information. No Batteries required. Hand cranked. \$25.00
 With kite, parachute, etc. \$35.00

MICROWAVE TUBES

3331 (1 cm) \$17.50
 Magnet for 3331 8.00
 2332 (10 cm) 25.00
 Magnet for 2332 10.00
 2138 (10 cm) with magnet 37.50
 WE700A (L band) 45.00
 WE720BY (S Band) 1000 KW. 25.00
 2K25 723AB Klystron 7.75
 QK 59, QK 60, QK 62 Tunable packaged Magnetrons, 10 cm., ea. 45.00
 Small Quantities of Other Types. Write for Information.

MacKay Radio Transmitter

Model 167-BY. A CW Xmtr with range 2 to 24 mc. Power output: 200 Watts from 2 to 16 mc, 150 Watts from 16 to 24 mc. Complete, with 110 VDC rotary power supply \$350.00

Cross Pointer Indicator

Two 0-200 microampere movements. 3" case, many applications \$2.50

All merchandise guaranteed. Mail orders promptly filled, prices F.O.B. N. Y. C. Send Money Order or Check. Rated Concerns send P.O. Shipping charges only send C.O.D. Send for Flyers.
COMMUNICATIONS EQUIPMENT CO.
 131-C LIBERTY ST., NEW YORK 7, N.Y. TELEPHONE DIGBY-9-4124

Now At Your Dealer's

With the Webster-Chicago Model 79, you can make your own wire recorder, recorder-radio combination or, hook it up to your rig . . . record radio programs, messages, contacts. It has literally hundreds of uses!

And here's good news! A new and improved Webster-Chicago circuit makes it easy to connect the Model 79 to existing amplification circuits. See the Webster-Chicago Wire Recorder Foundation Unit at your dealer's today.

WEBSTER CHICAGO WIRE RECORDER FOUNDATION UNIT

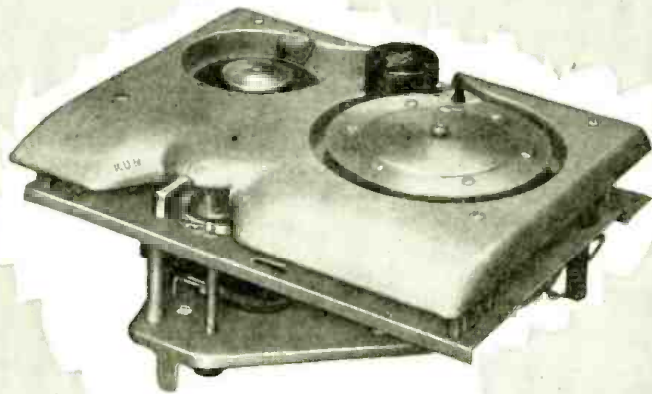

WEBSTER CHICAGO

5610 BLOOMINGDALE AVENUE

CHICAGO 39

VERIFIED SPEAKERS

"They Glorify the Tone"

WRIGHT Inc.

2234 University Avenue

St. Paul 4, Minnesota

ROTA-BASE

NEW HANDY LAB. DIAL actually gives a "frons" picture of radio tube connections. INSTANTLY, ACCURATELY. No more valuable time lost thumbing pages or on lengthy readings. Filament, Grid, Plate, cathode, etc., to more than 300 tube types are shown. NOW ONLY \$1.00 postpaid, or sent C.O.D. plus postage. Order TODAY, money refunded if you are not delightfully pleased.

REED MFG. CO.

11350Z Burbank Blvd. N. Hollywood, Calif.

PEN-OSCIL-LITE

Extremely convenient test oscillator for all radio servicing; alignment • Small as a pen • Self powered • Range from 700 cycles audio to over 600 megacycles u.f. • Output from zero to 125 v. • Low in cost • Used by Signal Corps • Write for information.

GENERAL TEST EQUIPMENT

38 Argyle Ave. Buffalo 9, N. Y.

CONDENSER CHECKERS

When aligning shorted variable condenser plates, I connect a flashlight battery and bulb in series, connect them across the sections of the condenser and adjust the plates until the lamp remains dark while the condenser is varied from minimum to maximum capacitance.

A simple test for variable or paper condensers is to place them in series with a 20- or 30-watt lamp and a 117-volt a. c. line. If a variable condenser is shorted, the lamp will light until the short is cleared. A shorted paper condenser will cause the lamp to glow brightly. A good condenser will cause a dim glow, the brightness depending on its capacitance. A very high capacitance will make the lamp glow brightly. Once you are accustomed to the series-lamp test, you will be able to judge the capacitance of the condenser by the brightness of the glow it produces. In rare cases, an open condenser may cause a dim glow if its leakage is high.

HARRY WINFIELD,
New York, N. Y.

(Mr. Victor Buchanan of Mason City, Iowa, has another suggestion for locating the point of contact in shorted variable condensers in radio receivers. He disconnects all leads from the condenser and connects the stator plates to a plate of the rectifier tube in the power supply. An insulated knob is placed on the shaft and the condenser plates opened all the way. When the power is turned on, the condenser is closed until sparks are observed between the plates. Power is turned off immediately, and the condenser plates examined closely. Small dark spots indicate the points of contact.—Editor)

SIGNAL GENERATOR

Intermediate and standard broadcast frequencies are tuned by a 365- μ f condenser in this very useful signal generator.

The low-frequency coil L1 is a jumble-wound, center-tapped winding of 500 turns of No. 28 or 30 enamel wire on one end of a 1-inch form. (A center-tapped secondary of an i.f. transformer may be used if available.) The broadcast coil L3 is 60 turns of No. 28 enamel wire tapped at the center. The output coil L2 has 5 turns, and is wound in the space between the tuned coils.

VICENTE ANT. JEANNOT V.,
Ciudad Trujillo, Rep. Dom.

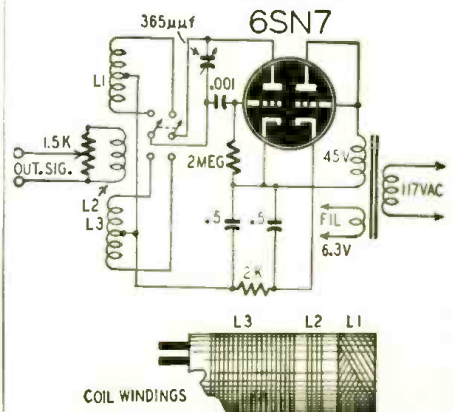

**BIGGEST SAVINGS
IN HISTORY!**

RADIO KITS and PARTS

BUY THE PROGRESSIVE UNIT WAY!

Our prices for radio kits and parts have always been amazingly low. NOW, mass sales have made possible even further drastic reductions through our revolutionary PROGRESSIVE UNIT Plan.

The Progressive Radio Kit, for instance—earlier

reduced from \$19.75 to \$14.75—can now be purchased at a cost of *two kits* for \$28.15 and *three kits* for only \$41.50!

Buy the PROGRESSIVE UNIT way and save \$\$\$\$\$\$! See below for our Progressive prices on individual items.

Progressive AMPLIFIER KIT

This newest Progressive Kit—complete with all parts, tubes and a 12-inch speaker—will enable you to build a newly-designed, high fidelity, humless amplifier for phonograph, AM or FM tuner or microphone.

Regulated power supply maintains constant voltage supply. DC heater supply, whether amplifier is used on

AC or DC, provides humless operation by eliminating cathode-heater leakage hum. Contains degenerative feedback for improved frequency response, balanced phase inverter and push-pull beam power output. Every stage thoroughly decoupled to improve low-frequency response and prevent motor-boating. Tone control completely varia-

ble. Six-tube performance. Uses 1-VR 105, 1-12SL7, 2-50L6's and two selenium rectifiers.

PROGRESSIVE UNIT PRICES ON AMPLIFIER KIT

1 kit	\$25.75
2 kits	49.50
3 kits	69.00

IDEAL AMPLIFIER FOR YOUR TELEVISION KIT

NOW BUILD 15 RADIOS

COMPLETE
KIT
\$14.75



ABSOLUTELY NO KNOWLEDGE OF RADIO NECESSARY
YOU NEED NO ADDITIONAL PARTS

THE PROGRESSIVE RADIO KIT is the ONLY COMPLETE KIT. Contains everything you need. Instruction Book, Metal Chassis, Tubes, Condensers, Resistors and all radio parts. The 36-page book written by expert radio instructors teaches you to build radios in a professional manner. You start with one-tube receivers, then build two-tube receivers, then three-tube receivers. (The three-tube receivers are equal to four-tube receivers because of the addition of a selenium rectifier.) You then construct a powerful public address system which will

permit you to address large audiences. Then you make three different transmitters so you can get a real thrill out of being on the air. Before you are done with this kit, you will have built 11 receivers, 1 Public Address System and 3 transmitters.

SPECIAL FREE OFFER

Electrical and Radio Tester sent absolutely FREE with each Progressive Radio Kit. PLUS FREE membership in Progressive Radio Club. Entitles you to free expert advice and consultation service with licensed radio technicians. Write for further information or ORDER your KIT NOW!

PROGRESSIVE UNIT PRICES ON RADIO KIT

1 Kit	\$14.75
2 Kits	28.15
3 Kits	41.50

RADIO PARTS SCOOP!

NO SURPLUS—ALL PARTS GUARANTEED BRAND NEW!

PHONES—Single Head Set
1000 Ohms, D.C. Reg. Price \$1.65
Buy 1 for \$1.10 and save 55c
Buy 2 for \$1.90 and save \$1.40
Buy 3 for \$2.55 and save \$2.40

CONDENSER KIT
50 paper tubular condensers. Values from .002 mfd. to .1 mfd. 400 v.d.c. to 600 v.d.c. Regular Price \$5.00
Buy 1 kit for \$1.95 and save \$3.05
Buy 2 kits for \$3.80 and save \$6.20
Buy 3 kits for \$5.55 and save \$9.45

RESISTOR KIT
100 carbon resistors. 1/4 watt. RMA color coded. Values from 330 ohms to 2.2 megohms. Regular Price \$5.00.
Buy 1 kit for \$1.50 and save \$3.50
Buy 2 kits for \$2.80 and save \$7.20
Buy 3 kits for \$3.90 and save \$11.10

SELENIUM RECTIFIERS
Regular Price \$1.10
Buy 1 for 79c and save 31c
Buy 2 for \$1.54 and save 66c
Buy 3 for \$2.25 and save \$1.05

12" ALNICO SLUG SPEAKER
Regular Price \$8.00
Buy 1 for \$5.60 and save \$2.40
Buy 2 for \$10.80 and save \$5.20
Buy 3 for \$15.95 and save \$8.05
(No more than 3 to a customer)

ELECTROLYTIC CONDENSERS
20-20 mfd. 150 W.V.DC. Regular Price 75c
Buy 1 for 30c and save 45c
Buy 4 for \$1.16 and save \$1.84
Buy 7 for \$1.96 and save \$3.25
Buy 10 for \$2.65 and save \$4.85
40-40 mfd. 150 W.V.DC. Reg. Price \$1.05
Buy 1 for 45c and save 60c
Buy 4 for \$1.70 and save \$2.50
Buy 7 for \$2.80 and save \$4.55
Buy 10 for \$3.80 and save \$6.70
450 W.V.DC. Reg. Price \$1.25. Buy 1 for 65c and save 60c. Buy 2 for \$1.24 and save \$1.26. Buy 3 for \$1.74 and save \$2.01.

ANTENNA AND RF COIL SET
(Broadcast Band) Reg. Price \$1.00
Buy 1 set for 59c and save 41c
Buy 2 sets for \$1.10 and save 90c
Buy 4 sets for \$2.08 and save \$1.92

VARIABLE CONDENSER
(420-420 mfd.) Regular Price \$1.80
Buy 1 for \$1.45 and save 35c
Buy 2 for \$2.60 and save \$1.00
Buy 3 for \$3.60 and save \$1.80

Famous Make SOLDERING IRON
55 watts 110/120 volts. Regular Price \$2.50
Buy 1 for \$1.90 and save 60c
Buy 2 for \$3.80 and save \$1.40
Buy 3 for \$5.10 and save \$2.40

Radioman's Combination LONG NOSE PLIERS and CUTTERS 6"
exceptional quality. Hydrized for extra toughness. Diamond-tested cutters. Regular price \$1.95
Buy 1 for \$1.45 and save 50c
Buy 2 for \$2.70 and save \$1.20
Buy 3 for \$3.60 and save \$2.25

PROGRESSIVE RADIO TOOL KIT
A Progressive Electronics Special. Contains 55 watt 110/120 volt soldering iron, radioman's combination long nose pliers and cutters, amber handle screw driver, Polystyrene alignment tool. Regular Price \$4.95
(No more than 3 kits to a customer)

Buy 1 kit for \$3.25 and save \$1.70
Buy 2 kits for \$6.10 and save \$3.80
Buy 3 kits for \$8.70 and save \$6.15

MAIL COUPON TODAY

PROGRESSIVE ELECTRONICS Co., DEPT. RC-9
22 Havemeyer St., Brooklyn 11, New York

SIRS: Please send me the following

.....

Enclosed find check or money order (postage prepaid) for \$..... Send C.O.D. (I will pay postage). Send additional information on radio kit.

NAME

ADDRESS

CITY ZONE STATE

NEWCOMB

MANUFACTURER OF AMERICA'S TOP QUALITY AMPLIFIER

ANNOUNCES the NEW E-SERIES

A LOW-PRICED LINE OF SUPERIOR UTILITY
AMPLIFIERS

THE maker of the incomparable K and H Series of quality amplifiers has designed and produced the new E-Series with the same high quality materials and workmanship, to produce the best low-priced 10-, 17- and 25-watt amplifiers ever offered. Included in the line are phono tops and portable assemblies. The E-Series fills the need of those who want a superior, dependable amplifier, but who must confine their purchases to the lower-price range. Here are amplifiers that fill all the requirements of standard utility applications, priced within reach of all.

MODEL E-10: An outstanding value in the public address market, the E-10 delivers a full 10 watts from push-pull 6V6 tubes in a multi-stage inverse feedback circuit . . . has inputs for microphone and phonograph and a full range tone control.

49⁵⁰ RETAIL

With tubes less cover.

MODEL E-17: 17 watts of undistorted audio from push-pull 6L6 tubes. Inputs for a microphone and phonograph . . . Full range tone control . . . Multi-stage inverse feedback.

79⁵⁰ RETAIL

With tubes and cover

MODEL E-25: A really fine utility amplifier for better performance, more dependable operation. Full range tone control, 25 watts of undistorted power and inputs for 2 mikes and a phonograph make the E-25 easily applicable to most sound jobs. Inverse feedback assures lowest distortion.

99⁵⁰ RETAIL

With tubes and cover

(Prices slightly higher east of the Rockies.)



Send for Specifications

AUDIO PRODUCTS CO.

Dept. C, 6824 Lexington Avenue • Hollywood 38, California

RECORDS

LATEST & HARD-TO-GET BACK NUMBERS

Some slightly used and some brand new—Victor, Bluebird, Columbia, Okeh, Decca, Capitol, etc. Such artists as Glenn Miller, Benny Goodman, Harry James, Bing Crosby, Frank Sinatra, Gene Autry, Duke Ellington, Fats Waller, Guy Lombardo, Andrews Sisters, Kate Smith, Ink Spots, Mills Bros., etc.

BIG PROFITS Your opportunity to cash in on this new field that is sweeping the country. Specify the type of music that sells best in your territory such as Swing, Sweet Music, Cow-boy, Hill-billy, Polkas, Blues, etc. Your price \$13.50 per hundred records, f.o.b. Chicago. All shipments made within 48 hours.

CHAS. HOODWIN CO.

4419 Broadway, Dept. A7, Chicago 40, Illinois
World's Largest Dealers in Used Records

VIDEO

Amazing Television Handbook. How to construct, install, operate, service, sight and sound receivers. How video is growing. How a transmitting station works. How receiver works. How to build receiver. How to erect antenna. How to install. Trouble shooting. Video dictionary. Three separate 15" x 16" assembly stage diagrams. Written by a master, in simple language. 96 pages, 71 illustrations, heavy glossy paper, spiral binding lies flat. Only \$1. Your money back in 10 days if not delighted. **HURRY.** Write Norman W. Henley Publishing Co., Dept. R.C., 17 West 45th St., New York 19, N. Y. Send for Catalog of Technical Books.

Licenses for television receivers in Britain cost approximately \$8.00 per year—twice as much as the Britisher has to pay for an ordinary radio receiver.

PHONO PRE-AMPLIFIER

Many record players fail to give satisfactory volume when connected directly to the a.f. system of some radios. This simple, inexpensive pre-amplifier can be added to various sets to give the necessary signal boost. If it is constructed carefully, there should be no trouble with hum or feedback.

The output is connected to the high side of the volume control or to the grid

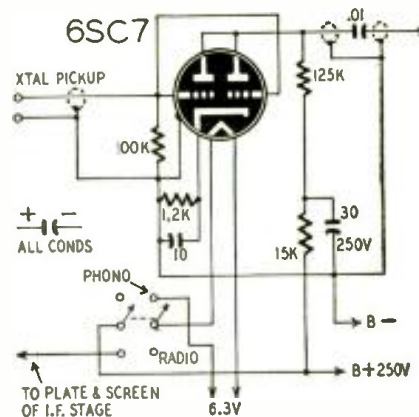

of the first a.f. amplifier of the radio. If the volume of the receiver is controlled in some section other than the audio circuit, then the 100,000-ohm resistor in the grid circuit of the 6SC7 may be replaced with a variable control with the arm tied to the grid. Be sure to shield the leads to and from the control.

Operating voltages are obtained from the set. When the switch is thrown to PHONO it opens the screen and plate-supply leads to one or more i.f. or r.f. stages and puts voltage on the filament of the 6SC7.

This pre-amplifier may also be found useful in a straight record player, especially if a magnetic pickup or some of the new low-output high-fidelity pickups are used or if for any other reason output is low.

ALAN SMITH,
Shaftsbury, Vt.

CRYSTAL PICKUP SUBSTITUTE

While serving overseas as a sound and movie serviceman, I needed a replacement cartridge for a crystal pickup. None were to be had. As a substitute, I used a Signal Corps receiver R-30, a part of a headset HS-30. After disassembling the receiver I removed the projection from the cap and used a reamer to enlarge the resulting hole slightly. A small hole was drilled in the back of the bakelite housing for mounting on the pickup arm.

The diaphragm was reinserted in the cap, and a needle holder, taken from a discarded crystal cartridge, was soldered to the diaphragm. The needle holder passes freely through the hole in the cap. The unit is assembled and bolted to the pickup arm with a small bolt through the hole in the back. Leads from the unit are connected to the amplifier input. If the high notes sound tinny, a thin cardboard washer placed between the cap and the diaphragm will remedy the condition.

H. E. MORSE,
Columbia, S. C.

**f a tube
mplete
MMETER**

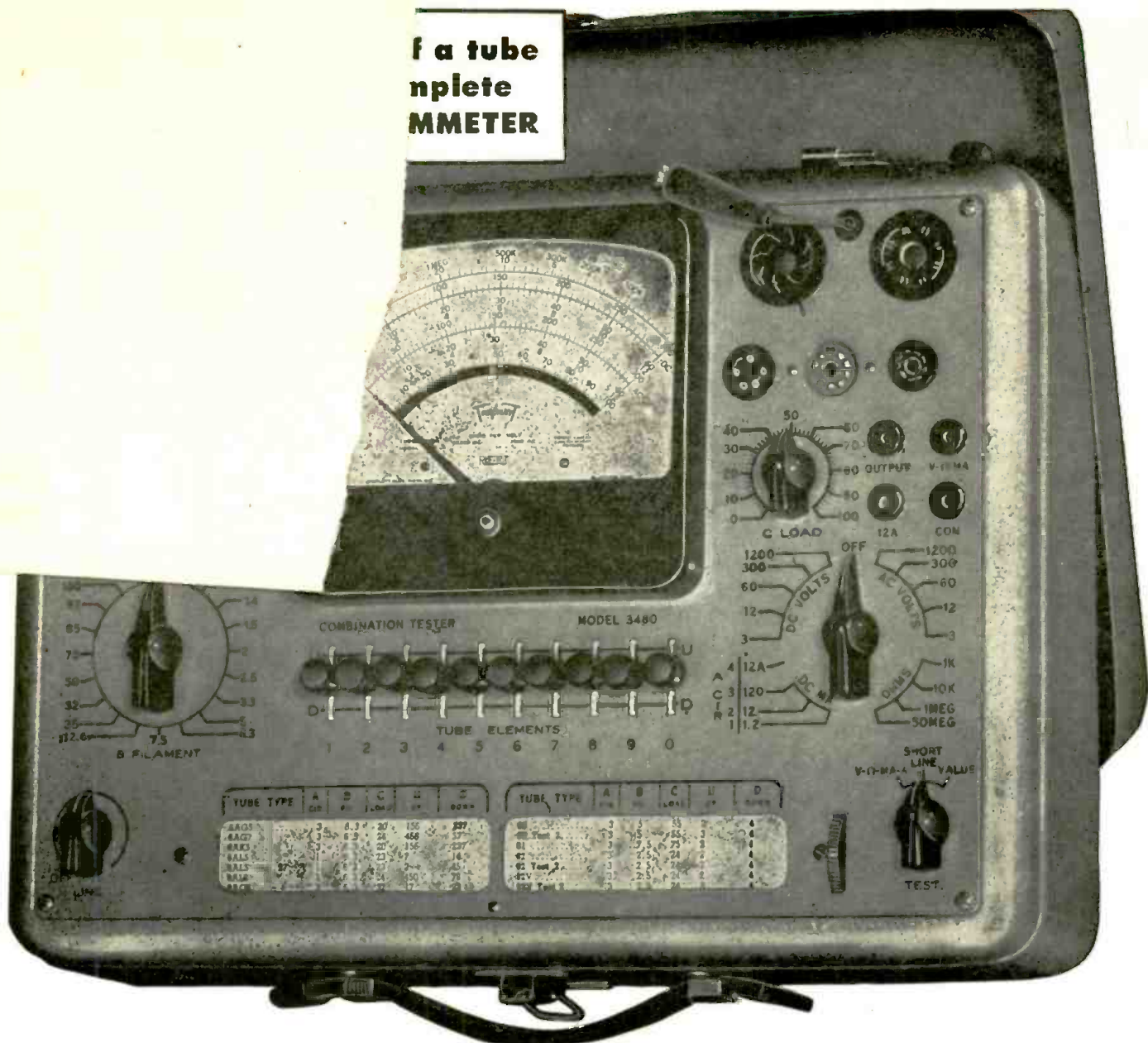

Look at that picture again. There are twenty-three distinct features to give you everything you need in a combination tester.

Note the new up-to-the-minute, no back-lash roll chart, for quick, complete and accurate reference. Note the individual sockets for *all* tubes, including the new 9-prong and hearing aid types. Exclusive lever-switching provides individual control of each tube element, and enables you actually to "picture" your circuit!

Note the complete Volt-Ohm-Mil-Ammeter—18 ranges on a large 6" meter to cover all your requirements. With Model 3480 you've got a tester that's good for dozens of jobs, beautiful...and a standard for accuracy. Buy it at your jobber. Or write for bulletin No. 3480. Address Dept. L18.

Model 3480
Combination Tube Tester
and Volt-Ohm-Mil-Ammeter

TRIPLETT ELECTRICAL INSTRUMENT COMPANY, BLUFFTON, OHIO





FASTER SIGNAL TRACING!

Signalette

MULTI-FREQUENCY GENERATOR

Generates R.F., I.F. and AUDIO Frequencies, 2500 cycles to over 20 megacycles, using new electronic multi-vibrator radar principle. Completely self-contained—fits coat pocket or tool chest. Just plug into A.C. or D.C. LINE AND CHECK RECEIVER SENSITIVITY, AUDIO GAIN, R.F. and I.F. alignment, auto radio aerial peaking or shielding, breaks in wires, stage by stage signal tracing, tube testing by direct comparison, etc., etc. Sturdy construction, handsome appearance! See at your dealers or write for details.

Recognized Jobbers—wro. write for details of territory open!

PRICE
\$9.95
at dealer
or F.O.B.
Cincinnati.

**CLIPPARD INSTRUMENT
LABORATORY, INC.**

Dept. C 1125 Bank Street,
Cincinnati 14, Ohio

January Specials

Volume control kits (25 assorted)\$1.95
Resistor kit 100 assorted (1/2, 1, 2 watt)	1.49
Pilot lights (50 assorted)2.25
Knob kit (25 assorted)1.95
Socket kit (25 assorted)1.95
Selenium rectifier—100 mil85
Auto vibrator, standard 4 prong95
Crystal pick-up arm2.25
Television or FM lead-in wire 300 Ohms, 100 feet2.70
General instrument automatic rec. changer14.95
Variable condensers, 2 gang—45675
New army headphones—6 ft. cord. PL 55 plug1.49
Bleeder resistor 100K ohms—150 W.29
Paper cond. 2 mfd. 800 W.V.29
Punched chassis 6 tube19
Condenser 5 mfd. 330 v A.C.49
Rubber covered lead-in wire, 1000 ft.1.95
Green & Yellow lamp cord two cond. 1000 ft.7.50
Punched Television chassis, 11x17x369
Chestlite type lantern95
Radio kits, 5 tube super with tubes14.95
Army PL55 plug and cord39
Cable type suppressors09
Wilcox CW3 receiver12.95
Heavy duty, p.m. outside speaker9.95
Univ. 8 watt output trans85
100 watt soldering iron2.49
Speaker, 6 x 9 oval, 450 ohm field2.49
Condenser—2 mfd. 400 v paper29
Vibrator GE 2 volts1.95
Cone repair patch kit59
6 volt 40 ma 650 C. T. POWER TRANS.	2.49
Automatic solder feeder1.95

10% Cash with Orders

Covers the Globe

509 ARCH STREET
PHILADELPHIA, PENN.

Phone LO 3-9226

TRANSATLANTIC NEWS

(Continued from page 56)

are of 10- or 20-lb wire. Experiments, made over short distances at first, gave promising results. The telephone pairs introduced some phase distortion, but this could be ironed out by all-pass equalizers. There was heavy attenuation of the highest frequencies, but to maintain them was merely a matter of using amplifying repeaters at sufficiently short intervals. Today, outside broadcasts regularly take place with up to 8 miles of ordinary telephone lines in the link between the television camera and the main transmitter. Combined equalizing and repeater units, weighing under 150 lbs apiece, are used. With these inserted every 1 1/2 miles, a vision frequency band of 2 mc is transmitted. This gives a good, clear picture. The better definition of the full 2.7-mc band could be obtained by the use of more repeaters, but results with present methods have been so satisfactory that it has not been thought worth the additional expense. Future developments may well permit television to make wide use of long-distance telephone land lines. Such a development would be a big step toward the solution of the problem of providing nation-wide television service.

Some sunspots!

When will the present sunspot cycle reach its maximum? Some expect it to do so by the end of this year; others give the cycle the best part of 2 years from now before it reaches its peak. Meantime, as H. W. Newton of Greenwich Observatory told a recent meeting of the Royal Astronomical Society, it has produced the biggest spot ever recorded on the sun's disk, a fiery maelstrom over 100,000 miles in diameter. Further, it has already seen more solar activity than any other premaximum period in the last hundred years.

Curiously enough, it has hardly run true to form from the radio point of view. There have been short-wave blackouts, but they have not been so numerous nor so severe as one might have anticipated. Britain was remarkably free from thunderstorms during the past summer and static was less

troublesome than might have been expected.

Short-wave reception during a magnetic disturbance usually provides some interesting experiences in this country. The Canadian and northern U. S. stations are, as a rule, the first to fade out. When this happens, the South American stations often come in with great strength. This is perhaps not surprising when you consider that the North Magnetic Pole has a great-circle bearing about 20 degrees west of north from Britain, and that the greater part of the United States lies between great-circle bearings a good deal north of west. A due west great-circle bearing from London runs just about through the Panama Canal! And did you know this one? The North and South Magnetic Poles are a very long way from being antipodes of one another. That being so, there can be only 2 great-circle paths (rather wide ones, since the poles are areas and not points) between them, the long one and the short. The short path runs close to the British Isles. Magnetic disturbances are centered at these poles, and that may be why stations with a northwesterly great-circle bearing from us so quickly disappear at such times.

Loudspeaker "color"

Every high quality enthusiast knows that ideally the radio receiver should have no "tone" of its own. It should reproduce faithfully sounds made in the broadcasting studio without adding any coloration. He knows equally well that actually individual receivers definitely do place their own stamp on the reproduction of music. To a trained ear two different receivers, each rated electrically and electromechanically as being in the highest fidelity class, do not reproduce a given musical passage in precisely the same way. Each gives the music its own unmistakable color.

Light has been thrown on this difficult point at a meeting of the Physical Society by Dr. E. G. Richardson. He has established after much research and experiment that the characteristic

(Continued on page 110)

A MULTIVIBRATOR TROUBLE-SHOOTER

This a.c.-d.c. multivibrator can be used for trouble shooting by signal injection and gives good results, with little drop

in signal from the middle a.f. range to 30 mc. It is handy for checking a.f., i.f., and r.f. stages of radio receivers.

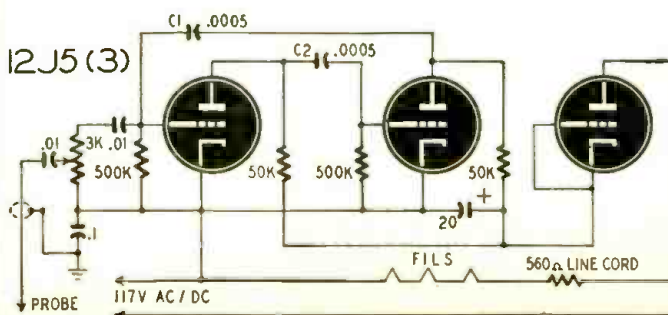

Other tube types can be used if they have the same current requirements and a suitable line-cord resistor is used. The fundamental frequency can be changed by changing C1 and C2.

C. N. PETERSON,
Valparaiso, Ind.



If You Haven't a Copy—Get
ALLIED'S Latest Supplement
ALL THE NEWEST RELEASES!
BIG SAVINGS ON SPECIALS!

FREE

Typical ALLIED Special Values!



PHONO MOTOR BARGAIN
 A sturdy, dependable phono-motor—at a really low price. Motor has oversized bearings, forced ventilation. Constant speed—cushioned for quiet operation. Rim-driven, felt-flocked 9" turntable. Mounting depth below plate 3 1/4". For 110 volts, 60 cycles A.C.
85-428. ONLY... \$2.98



4 WATT PHONO AMPLIFIER
 Top value. Easily handles 10" PM speaker. Inverse feedback for truer fidelity; built-in output transformer. Use with any phono-motor, crystal pickup and PM speaker. Supplied with 1-6SL7GT, 2-25L6GT, 1-25Z6-GT. 5 1/4" x 4" x 4 3/4". For 105-125 volts AC-DC.
83-071. ONLY... \$12.75

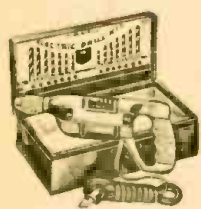

EAGLE DRILL KIT
 A perfect light-duty 1/4" electric drill, complete with 14 popular size drills for iron, steel, wood, plastic. 1100 rpm motor; self-lubricating oilite bearings, heavy chuck, 7 foot cord. In sturdy case for easy carrying. For 115 volts AC-DC.
46-027. ONLY... \$15.95

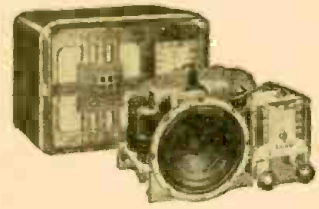

KNIGHT RANGER KIT
 Ultra-modern Superhet—nothing like it at the price. Covers 550-1600 Kc.; built in loop antenna; latest 5" PM dynamic speaker; handsome walnut plastic cabinet. Easy to build. Complete with all parts, tubes, full instructions. 83-273.
\$14.95



20 WATT HI-FI PHONO AMPLIFIER
 For high-fidelity reproduction. Inverse feedback; adjustable automatic volume expansion; bass and treble tone controls, dual input; high gain; frequency response. +1 db from 20-20,000 cps. For 110-120 volts 60 cycles A.C. Size: 17 1/4" x 11 1/4" x 9 3/8". 93-103.
ONLY... \$59.95

For your complete guide to Everything in Radio, use this new, value-packed Supplement together with ALLIED'S big 164-page Catalog. Here are all the latest developments in Radio and Electronics—plus popular, top-quality merchandise at reduced, money-saving prices—all specially selected for Servicemen, Engineers, Amateurs, Sound Men, Builders, Experimenters. If you haven't a copy of this valuable Buying Guide, send for one today!

NEW! IN ALLIED'S LATEST SUPPLEMENT

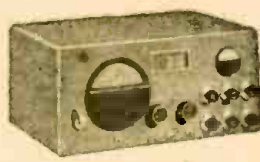

HALLCRAFTERS SX-43
 Less Speaker, \$169.50



NATIONAL NC-57
 Complete, \$89.50

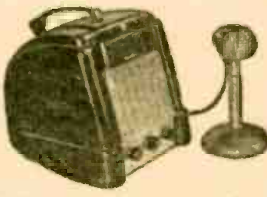

RCA WIRE RECORDER
 Complete, \$130.00



HALLCRAFTERS S-47
 Less Speaker, \$200.00

GET THESE LEADING CATALOGS



ALLIED RADIO CORP.
 833 W. Jackson Blvd., Dept. 2-A-8
 Chicago 7, Illinois

- Send FREE ALLIED SUPPLEMENT.
- Send FREE 164-Page ALLIED CATALOG.

Enter order for.....

..... \$..... enclosed.

Name.....

Address.....

City..... Zone..... State.....

ALLIED RADIO
Everything in Radio and Electronics

WHY PAY MORE?

equip yourself for the **RICH FM BUSINESS** in your community for only **\$19.95**



FM SIGNAL GENERATOR MODEL 720

R. C. P. scores another first with this new low-cost accurate, pocket size FM Signal Generator! Start cashing in now on the rich FM business in your community—not by investing 100 dollars—or even 50—but with only \$19.95. Order this extra profit-building FM Signal Generator from your R. C. P. jobber today. Only \$19.95 for an accurate instrument that permits you to align and service FM receivers.

- ★ Complete with tubes ready to operate
- ★ Pocket size 3" x 6" x 2 3/4"
- ★ Completely shielded and isolated from line
- ★ Calibration, accurate within 1% for fixed frequencies of 10.7, 88, 98 and 108 mc.
- ★ Individual trimmers for recalibration
- ★ Equipped with shielded output lead

Many other outstanding features, too. If your local jobber can't supply your needs, use convenient coupon below.

Also Model 710 for AMI Small—compact—accurate. It's the ideal job for "on-the-spot" aligning, trouble-shooting, estimating and repairs. Fixed frequencies: 1500 and 550 kc; 456 and 465 kc. Safe for AC and DC operation. Pocket size 3"x6"x2 3/4". Complete with tubes, output cable, etc., ready to operate at the remarkably low price of \$17.95!

Send for R. C. P.'s complete new catalog of economy-priced, quality-built precision instruments. Before you buy any instrument—see R. C. P. first! It's best for every test.

RADIO CITY PRODUCTS CO., INC.

152 West 25th Street, New York 1, N. Y.

RADIO CITY PRODUCTS COMPANY, INC.

Dept. RCI, 152 W. 25th St., New York 1, N. Y.

Gentlemen:

Please rush the following information to me:

- () Descriptive bulletin on Model 720, and 710.
- () Catalog No. 129 of complete R. C. P. line.
- () Name and address of nearest R. C. P. jobber.

NAME

ADDRESS

CITY ZONE ... STATE

Do you need

BINDING POSTS?



The XL PUSH POST with its Spring Action assures Constant Contact and quick connection. Manufactured in All Aluminum Type M at 22c each. Aluminum Body, Bakelite Top Type St at 15c each.

Types CP or NP, ALL BRASS—STAIN-LESS STEEL SPRING & PIN. PROVEN by 240 HR. SALT SPRAY TEST as NON-CORROSIVE at 28c each.

X. L. RADIO LABORATORIES
420 West Chicago Ave., Chicago 10, Ill.

A radar and IFF network which would completely protect the continental United States from air raids is planned for use in any emergency, James Forrestal, Secretary of Defense, revealed last month.

WORLD-WIDE STATION LIST

(Continued from page 47)

12.080	MOSCOW, U.S.S.R.: 0800 to 1100	17.710 GRA	LONDON, ENGLAND: 0600 to 0815
12.090 GRF	LONDON, ENGLAND: 2300 to 1615; 1700 to 2030	17.730 GVQ	LONDON, ENGLAND: 0100 to 0500; 0800 to 1215
12.210	VIENNA, AUSTRIA: 1145 to 2030	17.750 WRUW	BOSTON, MASSACHUSETTS; European beam, 1130 to 1400
12.250 WXFDD	ADAK, ALASKA: 1800 to 0100	17.760 KWID	SAN FRANCISCO, CALIFORNIA: South American beam, 1800 to 2400
12.260 TFF	REYKJAVIK, ICELAND: Sundays, 0900 to 0930	17.760	PARIS, FRANCE: 0700 to 0900; 1100 to 1230
12.440 HCJB	QUITO, ECUADOR: 0500 to 1000; 1400 to 2330; Sundays, 0700 to 1630; 1700 to 2200	17.770 OTC	LEOPOLDBRUNNEN, BELGIAN CONGO; 0500 to 0930; 1130 to 1645
13.050 WNRI	NEW YORK CITY; European beam, 0600 to 1800	17.770 WOOW	NEW YORK CITY; European beam, 1700 to 1815
13.050 KCBR	SAN FRANCISCO, CALIFORNIA. Oriental beam, 2215 to 0100	17.780 WNBI	NEW YORK CITY; European beam, 1100 to 1800; South American beam, 1900 to 2400
14.390 VR6AA	PITCAIRN ISLAND, SOUTH SEA ISLANDS: 0450	17.780 KCBR	DELANO, CALIFORNIA; Japanese-Chinese beam, 2330 to 0345
14.560 WNRX	NEW YORK CITY; European beam, 0600 to 1800	17.790 GSG	LONDON, ENGLAND: 0500 to 1030
15.000 WWV	WASHINGTON, D.C.; U.S. Bureau of Standards; frequency, time, and musical pitch; broadcasts continuously day and night	17.800 WLWO	CINCINNATI, OHIO; European beam, 1200 to 1700
15.110 GWG	LONDON, ENGLAND: 0000 to 0400; 0600 to 1015; 1100 to 1315; 1500 to 1800	17.800 OIX5	LAHTI, FINLAND: 0130 to 0200; 0500 to 0545; 0800 to 1700
15.110 HCJB	QUITO, ECUADOR: 0500 to 1200; 1830 to 2230	17.800 KRHO	HONOLULU, HAWAII; Chinese beam, 0245 to 0345; Japanese-Philippine beam, 2030 to 0200
15.120 HVJ	VATICAN CITY: 0830 to 0930; 1100 to 1145	17.810 GSV	LONDON, ENGLAND: 0100 to 0400; 0500 to 1430
15.130 WOOC	NEW YORK CITY; European beam, 1900 to 1800	17.800 WLWK	CINCINNATI, OHIO; South American beam, 2000 to 2200
15.130 KGEI	SAN FRANCISCO, CALIFORNIA: Alaskan-Chinese beam, 1700 to 1945	17.820 CKNC	MONTREAL, CANADA; 0830 to 1500
15.130 KCBA	DELANO, CALIFORNIA; South American beam, 1900 to 2400	17.830 WCBX	NEW YORK CITY; European beam, 1100 to 1630; South American beam, 1800 to 1900; Brazilian beam, 2000 to 2200
15.140 GSF	LONDON, ENGLAND: 2300 to 0400; 0500 to 0815; 0930 to 1745	17.830 VUDI0	DELHI, INDIA: 0430 to 0700; 0745 to 0800; 2215 to 0215
15.150 WRCA	NEW YORK CITY; European beam, 1100 to 1215; 1300 to 1700; Brazilian beam, 1800 to 1900; 2000 to 2200	17.840	BRUSSELS, BELGIUM: 0500 to 0630; 0945 to 0115; 1000 to 1245
15.150 KCBA	DELANO, CALIFORNIA; Alaskan beam, 2215 to 0345	17.880 KGEX	SAN FRANCISCO, CALIFORNIA; South American beam, 1900 to 2400
15.150 Munch II	MUNICH, GERMANY; East European beam, 1245 to 1800	17.880 WGEX	SCHENECTADY, NEW YORK; European beam, 1100 to 1700
15.150 SBT	STOCKHOLM, SWEDEN: 0130 to 0215; 0600 to 0700; 1000 to 1315	17.950 WLWLI	CINCINNATI, OHIO; European beam, 0645 to 1545
15.160 JZK	TOKYO, JAPAN: 1730 to 1815	17.950 WLWLI	CINCINNATI, OHIO; North African beam, 0645 to 1545
15.170 TGWA	GUATEMALA CITY, GUATEMALA: 1200 to 2000	18.020 GRQ	CINCINNATI, OHIO; South American-Central American beam, 2115 to 2215 except Sundays
15.180 GSO	LONDON, ENGLAND: 2300 to 1200; 0230 to 0445	18.080 GVO	LONDON, ENGLAND: 0100 to 0500; 0630 to 0845; 0900 to 1430
15.180 CKCX	MONTREAL, CANADA: 0800 to 1200	18.130 PMC	LONDON, ENGLAND: 1030 to 1245; 1300 to 1500
15.190 TAQ	ANKARA, TURKEY: 0000 to 0200; 0415 to 0730	18.160 WNRI	BATAVIA, NETHERLANDS INDIES: 2330 to 0930
15.200 WRUA	BOSTON, MASSACHUSETTS; European beam, 1100 to 1400		NEW YORK CITY; European beam, 1000 to 1700
15.210 WBOS	BOSTON, MASSACHUSETTS; European beam, 1100 to 1745; South American beam, 2000 to 2200		
15.220 JTL3	TOKYO, JAPAN: 1800 to 0230		
15.230 VLG6	MELBOURNE, AUSTRALIA: 2100 to 2300		
15.230	MOSCOW, U.S.S.R.: 2200 to 2400; 0530 to 0830; 0915 to 0930; 1030 to 1330		
15.250 WLWK	CINCINNATI, OHIO; European beam, 1200 to 1700		
15.250 KRHO	HONOLULU, HAWAII; Philippine beam, 0230 to 0345		
15.250 KNBX	DIXON, CALIFORNIA; Chinese-Japanese beam, 0400 to 1005		
15.250 WLWR2	CINCINNATI, OHIO; European beam; can beam, 1800 to 2400; Sundays, 1900 to 2400		
15.260 GSI	LONDON, ENGLAND: 0400 to 0430; 1030 to 1400		
15.270 WCBN	NEW YORK CITY; European beam, 1200 to 1630		
15.270 WCRC	NEW YORK CITY; South American beam, 1900 to 2400		
15.270 WCBN	NEW YORK CITY; European beam, 1200 to 1630		
15.280 WNRE	NEW YORK CITY; European beam, 1100 to 1800		
15.290 WRUA	BOSTON, MASSACHUSETTS; Central American beam, 2000 to 2400		
15.290 WRUL	BOSTON, MASSACHUSETTS; European beam, 1130 to 1400; 1410 to 1700; South American beam, 1730 to 1900		
15.290 VUDII	DELHI, INDIA: 0045 to 0115; 0200 to 0400; 0500 to 0700; 0730 to 0745		
15.300 GWR	LONDON, ENGLAND: 0600 to 0900; 1045 to 1330; 1400 to 1430; 1700 to 1800		
15.310 GSP	LONDON, ENGLAND: 2345 to 0030; 0100 to 0500; 0600 to 0815; 1200 to 1315; 1615 to 1845		
15.310 VLC4	SHEPPARTON, AUSTRALIA: 2045 to 2145; 0010 to 0045; 1730 to 1800; 1900 to 1915; 2200 to 2225		
15.310 HERG	BERNE, SWITZERLAND; Saturdays, 1000 to 1200		
15.320	MOSCOW, U.S.S.R.: 2200 to 2300; 0000 to 0500; 0530 to 0800; 0830 to 1100		
15.330 WGEO	SCHENECTADY, NEW YORK; European beam, 1200 to 1805		
15.330 KNBX	DIXON, CALIFORNIA; South Pacific beam, 0030 to 0345; South American beam, 1900 to 2400		
15.330 KCBA	DELANO, CALIFORNIA; Philippine beam, 0400 to 0930		
15.340	MOSCOW, U.S.S.R.: 2200 to 0800; 1000 to 1100		
15.350 WLWR2	CINCINNATI, OHIO; North African beam, 1300 to 1700		
15.350	PARIS, FRANCE: 0700 to 0900		
15.350 WRUA	BOSTON, MASSACHUSETTS; North American beam, 1100 to 1800; Central American beam, 2000 to 2400		
15.450 GRD	LONDON, ENGLAND: 0100 to 0500; 0600 to 0700; 1700 to 1845		
15.590 FZI	BRAZZAVILLE, FRENCH EQUATORIAL AFRICA; 0445 to 0800; 0930 to 1030		
17.440 HVJ	VATICAN CITY: 0715 to 0845		
17.530 FZI	BRAZZAVILLE, FRENCH EQUATORIAL AFRICA: 0000 to 0130; 0445 to 0745; 1100 to 1700		
17.700 GVP	LONDON, ENGLAND: 0800 to 1115; 1200 to 1600		

(Continued on page 127)

We are daily showing radiomen and beginners all over U. S. A. and Canada how to

MAKE BIG MONEY QUICKLY—EASILY

Our files bristle with letters of thanks. Why be satisfied with low income? What if you lost your job or business, or became ill and can't go to work? We have eye-opening information waiting for you, free. Write Today.

MERIT, 216-32J 132nd Avenue
Springfield Gardens 13, New York.

Come to the Great

SHOPS OF COYNE

where you learn by doing



RADIO

ELECTRONICS—TELEVISION

in a Few Short Weeks

To Succeed in Television, You Need All-Around Radio Training!

Trained Radio men needed now. Get Radio training and be ready for a real future. Learn on actual equipment at Coyne. Free employment service to graduates. Many earn while learning. If you are short of money, ask about Student Finance Plan. Now added **Training in Electric Refrigeration**. We are also equipped to train those who qualify under G. I. Bill. Men with Physical Disabilities may qualify for training at no cost to them for tuition and subsistence.

SEND COUPON FOR FULL DETAILS

B. W. COOKE, President
COYNE ELECTRICAL & RADIO SCHOOL
500 S. Paulina St., Dept. 18-8H, Chicago 12, Ill.
Send Big Free Book; also details about Coyne Part-Time Employment and Student Finance Plan.

NAME.....AGE.....
ADDRESS.....
CITY.....STATE.....

**I'll Prove That
THE WORLD'S BEST
RADIO-ELECTRONIC TRAINING
Costs the Least!
SATISFACTION or YOUR MONEY BACK!**



A. A. Ghirardi
Author of the
most widely
used books in
Radio training
history.

1. THIS "AUTOMATIC TEACHER" shows exactly how to REPAIR OVER 4800 RADIO MODELS . . . in half the usual time

Ghirardi's **RADIO TROUBLE-SHOOTER'S HANDBOOK** quickly helps you diagnose and repair common troubles in over 4800 receiver models and automatic record changers of 202 different manufacturers. Tedious testing is eliminated. This big, 4 lb. book contains special troubleshooting and service data for almost every radio in use today. It helps you make

repairs with only a few simple tools . . . **AND IN HALF THE USUAL TIME.** Just look up the make and model of the radio you want to fix. 4 times out of 5, the **HANDBOOK** tells exactly what repairs are needed—exactly how to make them. Pays for itself in time saved on the first job! Thousands of servicemen use it every day. Enables you to repair cheap sets profitably. Ideal for training new helpers.

ELIMINATES TEDIOUS TESTING

But this is only the beginning! In addition, **RADIO TROUBLE-SHOOTER'S HANDBOOK** gives you dozens of helpful charts; hundreds of pages of service data; tuning alignment information; transformer hints; tube data, color codes, labels, etc.—all designed to help you repair any radio ever made easier **AND TWICE AS FAST!** Not a "study" book! You simply look up what you need to know. Everything is carefully indexed. You can find exactly the data you need in an instant. Only \$5—on our **MONEY-BACK GUARANTEE** that protects you absolutely.

2. LEARN PROFESSIONAL RADIO SERVICING BY SCIENTIFIC METHODS for only \$5

MODERN RADIO SERVICING is A. A. Ghirardi's complete home-study guide to professional Radio-Electronic work of all kinds. It teaches you how to make preliminary trouble checks on complicated jobs; how to analyze any circuit quickly and scientifically; exactly where, when and how to use all basic test instruments; and how to interpret their readings to track down the trouble.

INSTRUMENTS—TROUBLESHOOTING—REPAIR

Nowhere else can you get this kind of professional training; faster, easier, and at less cost, than in this giant, 1300-page book. More widely used than any book of its kind. Thousands of successful service men got their start from it. Written so you can easily understand it at home without an instructor.

or for men already in the business who want a real "refresher" course. Prepares you for the rich service opportunities that only those having the real "know-how" of scientific methods can hope to grasp. 706 photos, diagrams, drawings and charts make study fast and easy. Weighs over 3½ lbs. Only \$5—and you don't actually risk a cent!

Ideal for service beginners

ONLY \$5

each for these giant training course books

Sold singly or as a group at these low prices as long as the present supply lasts.



3. BASIC RADIO-ELECTRONICS FOR BEGINNERS. 36 Courses in One!

No Lessons to Wait for Only \$5 complete

No matter what part of **ELECTRONICS - RADIO - TELEVISION** work you plan to enter, a knowledge of fundamentals is essential. Ghirardi's famous 972-page **RADIO PHYSICS COURSE** book gives exactly the training you need—at a price you can afford. If broken into monthly lessons and sold as a course, you'd regard it as a big bargain at \$50 or more. However, you buy it for only \$5—you complete it as fast as reading time permits.

NO PREVIOUS TRAINING NEEDED

Ghirardi's **RADIO PHYSICS COURSE** book has given more beginners their start in Radio-Electronics than any other book or course. It takes you step by step through the entire training. Nothing is omitted or condensed. It is the equivalent of 36 separate courses. Everything is explained as simply as A-B-C. Ask almost any Radio-Electronic man about it. He'll

know the book—and 9 out of 10 experts, as proved by an actual survey, recommend it as the finest, most complete Radio-Electronic book available at any price. Contains 972 pages; 508 easily understood illustrations, and 856 Self-Test Review questions. Only \$5 for the entire course in this handy, 1-volume form. **5-DAY MONEY-BACK GUARANTEE.**



MONEY-SAVING OFFER!

Get the two big Ghirardi service books for only \$9.50 (\$10.50 foreign.) Let **RADIO TROUBLESHOOTER'S HANDBOOK** save you time and money on common service jobs. Let **MODERN RADIO SERVICING** train you for professional service work of all kinds! See Money-Saving Offer in coupon!

5-DAY MONEY BACK GUARANTEE

DEPT. RC-18, MURRAY HILL BOOKS, INC.,
232 Madison Ave., New York 16, N. Y.

Enclosed find \$ for which send me the Ghirardi Book(s) indicated below; or send C.O.D. (no foreign C.O.D.'s) and I will pay postman this amount plus a small postal charge when he delivers my package. If the books are not entirely satisfactory, I'll return them within 5 days and you guarantee to refund my money.

RADIO PHYSICS COURSE \$5 (\$5.50 foreign)
 MODERN RADIO SERVICING \$5 (\$5.50 foreign) **RADIO TROUBLESHOOTER'S HANDBOOK** \$5 (\$5.50 foreign)

MONEY SAVING COMBINATION OFFER;
Both Modern Radio Servicing and Radio Troubleshooter's Handbook, only \$9.50 for the two (\$10.50 foreign).

Name

Address

City & Zone State

START THE NEW YEAR RIGHT *with a* **Walter Ashe** TRADE-IN DEAL

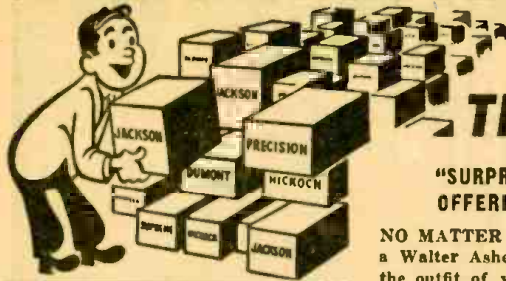

"SURPRISE" TRADE-IN ALLOWANCES OFFERED ON YOUR USED EQUIPMENT

NO MATTER what your preference in Test Equipment, a Walter Ashe Trade-In deal will enable you to obtain the outfit of your choice at a really important saving! With every reputable make and model to choose from simply indicate your preference and tell us what you have to trade. We'll respond with an extra liberal offer that's sure to please you. For top allowances on your used equipment see Walter Ashe first . . . before you make that trade. Act now. Wire, write or phone today!

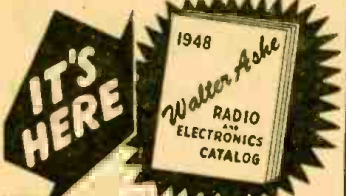

IT'S HERE!—the greatest Radio and Electronics Catalog in Walter Ashe history! Nearly 150 pages . . . a virtual encyclopedia of the latest and best in ham gear, test equipment, components and supplies for every conceivable purpose; In addition you'll find helpful, informative data such as frequency charts, color guides, formulae and many other interesting and useful features. Better order your free copy of the big, new 1948 Walter Ashe Catalog today. No bargain conscious Radio Serviceman or Dealer can afford to be without it. So don't delay! Just print your name on a penny postal and write "catalog" on the message side of the card. Your free copy of the 1948 Walter Ashe Catalog will be sent postpaid by return mail.

ALL THE BIG NAME BRANDS OF TEST EQUIPMENT IN STOCK Ready for Immediate Delivery

FOR PRIORITY DELIVERY OF THE 1948 ARRL "RADIO AMATEURS HANDBOOK" AND EDITORS AND ENGINEERS "RADIO HANDBOOK" PLACE YOUR ORDER NOW!!!

AMAZING BARGAINS in Top Condition, Slightly Used Test Equipment. Write for list of good-as-new merchandise now available.



PE-103A DYNAMOTOR

BRAND NEW IN ORIGINAL OVERSEAS Shipping crates. One of the best buys on the SURPLUS market. Get yours now before the supply runs out. 6 or 12 Volts DC Input; 500 volts DC @ 160 MA output. Complete with heavy duty rubber covered battery cable, overload switches, relays and filtering circuit. Shpg. Wt. 8 1/2 lbs. ONLY \$9.95 Cannon P8-CQ-12S Power Plug for above. Regular \$1.80. Shpg. Wt. 1/4 lb. ONLY 95c

SURPLUS HS-23 used PHONES. The regular ARMY AIR FORCE Headset that has been selling at many times this sensationally low price. Electrically perfect, but show signs of being slightly used. 8000 ohms impedance. Leather headband, and rubber cushions. Shpg. Wt. 2 lbs. ONLY 98c Extra HS-23 Headphone cushions. Shpg. Wt. 1/2 lb. per pr. ONLY 25c



TYPE HS-16A ARMY SURPLUS phone. Canvas web headband and long standard type cord. Packed in original shipping boxes. Shpg. Wt. 3 lbs. ONLY \$1.47

Write for complete list of Super Bargains in Surplus Equipment.

SURPLUS T-17B CARBON MIKES A single button carbon hand mike with push button handle. Complete with cord and plug, brand new in factory boxes. Shpg Wt. 3 lbs. ONLY 69c

TIME PAYMENTS AVAILABLE

ALL PRICES FOB ST. LOUIS

REMEMBER your trade-in's worth more at the Walter Ashe store. So get Walter Ashe's offer before you make that trade.

W0JWD W0WTM W0PGI W0ULH W9NRF W0QDF W0IYD

Walter Ashe RADIO CO.

1125 PINE ST. • ST. LOUIS 1, MO.

THE PRICES SPEAK for THEMSELVES

RADIO TUBES—KNOWN BRANDS—BULK

	EACH
80, 5U4G, 5Y3GT, 5Y4GT	.42
35W4, 25Z5, 25Z6GT, 35Z5	.45
6F5G, 6F6GT, 6J5, 6SA7, 6SK7, 6SQ7	.47
12BE6, 12BA6, 12AT6, 12SK7, 12SA7, 12SQ7	.49
6H6, 6J7, 6K7, 6Q7, 6SF5GT, 6SN7GT	.55
5Z3, 35A5, 35L6, 50B5, 50L6	.55
43, 6A7, 6A8, 6V6GT, 25L6GT	.59
OZ4, 6X5GT, 7A8, 7B4, 7B5, 7B7	.65
1A5GT, 1A7GT, 1H5GT, 1N5GT, 1R5, 1R4, 1R5	.74
1T4, 3Q4, 3Q5GT, 50A5, 14A7, 14B6, 14Q7	.79
6AC7, 6L6G, 25A6G, 35Y4, 117Z6GT	.95
1LA6, 1LE3, 1LN5, 70L7, 117L7GT, 117N7GT	1.35

ELECTROLYTIC CONDENSERS

	EACH
10—150 V	.22
20/20—150 V	.26
30—150 V	.28
40/40/20—150 V, 25 V	.44
8—450 V	.27
10—450 V	.32
16—450 V	.36
16/16—450 V	.59
20—450 V	.39
30—450 V	.47
40—450 V	.54
.05—3000 V	.69

WIRE — WRITE — PHONE

BROOKS RADIO DISTRIBUTING CORP.

80 VESEY STREET (DEPT. A), NEW YORK 7, N. Y. (Cortlandt 7-2312)

TELEVISION STEPS OUT!

(Continued from page 35)

all cities in the states listed will have television service immediately. Areas with the heaviest concentration of population will come first within the range of video stations; other areas will obtain this service subsequently.



This station, plus experimental transmissions from W6XAO, represents Pacific Coast television.

To bring the best in television entertainment to multitudes living away from urban centers, network planners are (Continued on page 114)

Amsco Presents

1948 GREATEST VALUE SERVICE KIT

Kit includes assortment of:

- 100 Resistors, 1/2 and 1 watt.
- 50 Condensers, paper, mica, electrolytic and can.
- 100 ft. Snaggett, var. sizes.
- 12 Knobs, round and bar.
- 20 Fuses.
- 6 Volume Controls.
- 10 Tube Sockets.
- 1 lb. Hardware (screws, nuts, lugs, etc.)
- 12 ww resistors, 10 watt.
- 10 Switches, toggle, gang, and rotary.
- 25 Connectors & Plugs.
- 10 Jacks (Phone) & Tip.
- 12 Padder Condensers.
- 12 Terminal Boards
- 25 Ceramic Insulators.
- 2 Panel Lights (1 neon)
- 1 Screw Driver.
- 1 Tube Puller.
- 2 Allen Wrenches.
- 2 Panel Fuse Holders.
- 4 Binding Post Strips.
- and many other valuable items.

Your Cost **\$9.95** Complete

FREE—"Experimenter's Kit" "1 Pr. Headphones" or "1 lip mike" with first 500 orders.

WRITE FOR OUR LATEST CIRCULAR FEATURING LOWEST PRICES ON RADIO & ELECTRONIC PARTS & EQUIPMENT.

AMERICAN SALES CO.

1811 W. 47th St. Chicago 9, Ill.



THE TELETRAP eliminates FM and amateur interference from your television image. Covers two ranges simultaneously 40-60 Mc and 80-115 Mc. Model 1005A List Price \$10.00

The simplest FM Converter converts FM sets for the 40-50 Mc band so that they will receive New 88-108 Mc signals. Simply connects in the antenna lead-in. No Power needed. Model 1002A List Price \$10.00

Your inquiries invited

CRYSTAL DEVICES CO.

1819 BROADWAY
NEW YORK 23, N. Y.

SENSATIONAL VALUES

The New Model 247

TUBE TESTER

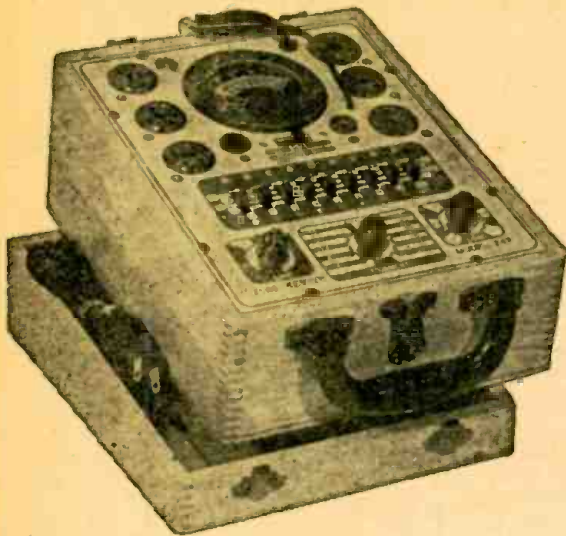

Features: The Model 247 incorporates a newly designed element selector switch which reduces the possibility of obsolescence to an absolute minimum. Any pin may be used as a filament pin and the voltage applied between that pin and any other pin, or even the "top-cap".

The new free-point system described above permits the Model 247 to overcome the difficulties encountered with other emission type tube testers when checking Diode, Triode and Pentode sections of multi-purpose tubes, because sections can be tested individually when using the new Model 247. The special isolating circuit allows each section to be tested as if it were in a separate envelope.

The Model 247 provides a super sensitive method of checking for shorts and leakages up to 5 Megohms between any and all of the terminals. Continuity between various sections is individually indicated. One of the most important improvements, we believe, is the fact that the 4 position fast-action snap switches are all numbered in exact accordance with the standard R. M. A. numbering system. Thus, if the element terminating in pin No. 7 of a tube is under test, button No. 7 is used for that test.

Model 247 comes complete with new speed-read chart. Comes housed in handsome, hand-rubbed oak cabinet sloped for bench use. A slip-on portable hinged cover is included for outside use. Size: 10 3/4" x 8 3/4" x 5 3/4".
ONLY

\$29⁹⁰
NET

The New Model 650 SIGNAL GENERATOR

RANGES:

100 Kilocycles to 35 Megacycles on Fundamentals.
25 Megacycles to 105 Megacycles on Harmonics.

- ★ RF obtainable separately or modulated by the Audio Frequency.
- ★ Audio Modulating Frequency—400 cycles pure sine wave—less than 2% distortion.
- ★ Attenuation—3-step ladder type of attenuator (T pad).



- ★ Uses a Hartley Excited Oscillator with a Buffer Amplifier.
 - ★ Tubes: 6J5 as R.F. Oscillator; 6SA7 as modulated buffer and Mixer; 6SL7 as audio oscillator and rectifier.
- Complete with coaxial cable, leads and instructions.

\$39⁹⁵

The New Model CA-11 SIGNAL TRACER

SIMPLE TO OPERATE . . . BECAUSE SIGNAL INTENSITY READINGS ARE INDICATED DIRECTLY ON THE METER!

- ★ SIMPLE TO OPERATE—only 1 connecting cable—NO TUNING CONTROLS.
- ★ HIGHLY SENSITIVE—uses an improved Vacuum Tube Voltmeter circuit.
- ★ Tube and resistor-capacity network are built into the Detector Probe.
- ★ COMPLETELY PORTABLE—weighs 5 lbs. and measures 5" x 6" x 7".
- ★ Comparative Signal Intensity readings are indicated directly on the meter as the Detector Probe is moved to follow the Signal from Antenna to Speaker.
- ★ Provision is made for insertion of phones.



THE MODEL CA-11 COMES HOUSED IN A BEAUTIFUL HAND-RUBBED WOODEN CABINET. COMPLETE WITH PROBE, TEST LEADS AND INSTRUCTIONS.
\$18⁷⁵
NET

The New Model 670 SUPER METER

A Combination VOLT-OHM-MILLIAMMETER plus CAPACITY REACTANCE, INDUCTANCE and DECIBEL MEASUREMENTS.

D. C. VOLTS: 0 to 7.5/15/75/150/750/1500/7500.—A. C. VOLTS 0 to 15/30/150/300/1500/3000 Volts.—OUTPUT VOLTS: 0 to 15/30/150/300/1500/3000.—D. C. CURRENT. 0 to 1.5/15/150 Ma.; 0 to 1.5 Amps.—RESISTANCE: 0 to 500/100,000 ohms, 0 to 10 Megohms.—CAPACITY: .001 to .2 Mfd.; 1 to 4 Mfd. (Quality test for electrolytics).—REACTANCE: 700 to 27,000 Ohms; 13,000 Ohms to 3 Megohms.—INDUCTANCE: 1.75 to 70 Henries; 35 to 8,000 Henries. DECIBELS: -10 to +18, +10 to +38, +30 to +58.

THE MODEL 670 COMES HOUSED IN A RUGGED, CRACKLE-FINISHED STEEL CABINET COMPLETE WITH TEST LEADS AND OPERATING INSTRUCTIONS. SIZE 5 1/2" x 7 1/2" x 3".



\$28⁴⁰
NET

Available for Immediate Shipment From Stock—20% Deposit Required on All C.O.D. Orders

MOSS ELECTRONIC DISTRIBUTING CO.

DEPT. RC-1, 229 FULTON ST.
NEW YORK 7, N. Y.

LEEDS RADIO

In Our 25th Year

QUALITY!! DEPENDABILITY!! PRICE!!

FULL WAVE BRIDGE RECTIFIERS

Type A: 54V. AC in. 39V. D.C. out @ 1.2 amp. Signal Corp. # 4D0238 Special \$1.50
 Type B: 144V. AC in. 96V. D.C. out @ 1.1 amp. Signal Corp. # 9D0612B Special 2.50

GENERAL RADIO CO. VARIACS

Type 200B: .170KVA 0-135 output @ 1.5 amp \$12.50
 Type V-5 .860KVA 0-135 output @ 7.5 amp 18.50
 Type V-5MT as above but Table Mtg. 25.00
 Type V-10 1.775KVA 0-135 output 15 amp 33.00
 Type V-10M as above but for Table Mtg. 48.00
 Variacs Available up to 7KVA

RADIO TRANSMITTER & RECEIVER APS-13

410 - 420 Mc: light weight fully enclosed, 30 Mc. IF complete with tubes 5-6J6; 9-6AG5; 2-2D21; 1-VR-105; Schematic supplied with each unit. Only **\$11.95**



A Tremendous Buy!

24 Conductor R.C. Cable; Each Conductor colored & insulated with Jones Plugs Approximate Weight 6 lbs. **ONLY 75¢ EACH**

LABORATORY POTENTIOMETER

Wire wound 100,000 ohm, 25 watt, 6 inch diameter; made to General Radio Co. specifications. **\$1.95**



These Oil Filled Condensers Cannot Be Duplicated At Our Price

3 x 0.2 MFD Tube 4000V.D.C.	\$.98
7 MFD G.E. 350VAC	.98
16 MFD W.E. 400 VDC	.98
1 MFD Solar 5000VDC	2.95
2 x 1 MFD 7500VDC	2.00
.02 MFD 8000 VDC	.88

CONTROL BOX 522 Transceiver—consists of 5 push button switches, 5 W.E. Co. pilot lite assemblies and lever switch, all mounted in box. Brand new. **\$1.25**

ARMY RADIO PHONES



They're Weather — Water and Shock Proof When we say they are made to Army specifications, that's enough assurance they must be of best quality. Use them for recording, for battery-less phone, for pocket size set loud speaker or talk through your radio set. We bought a good many of these Radio Phones, they are brand new, and cost a great deal more than you can get them for. A complete dynamic set. A wonderful buy for only **\$1.95**

SUPER SPECIAL CRYSTAL MICROPHONE CARTRIDGE DANDY for replacement or make your own mike by placing into box. A tremendous value—Only **69¢**

VARIABLE CONDENSERS

100MMFD Double Bearing, Silver Plated, Isolantite Insulation. Can Be Ganged Either End. **10 for \$2.50**

25 MMFD Balanced Stator, one Hole Mtg. Isolantite Insulation, Polished Plates. Swell for VHF **29¢ ea. 10 for \$2.50**

¼ Watt BAYONET BASE NEONS **20¢ ea. 6 for \$1.00**

STEEL CHASSIS		
10x17x3	\$1.38	11x17x3 \$1.86
5x10x3	.87	15x17x3 2.22
7x13x2	.96	7x7x2 .63
10x14x3	1.35	4x17x3 .99
STEEL CANS AND BOXES		
4x4x2	.68	12x7x6 \$1.68
4x5x3	.78	15x9x7 2.35
6x8x6	.99	11x12x8 2.25
½ INCH STEEL PANELS		
3¼x19	.86	10¼x19 \$1.22
5¼x19	.87	12¼x19 1.46
8¼x19	1.10	14x19 1.62
¾ INCH ALUMINUM PANELS		
3¼x19	1.38	8¼x19 2.25
5¼x19	1.74	10¼x19 2.87

All Chassis, Boxes, and Panels Finished in Black Crackle, Grey Panels Furnished on Order Only.

If not rated 25% with order, balance C.D.D. All prices F.O.B. our warehouse New York. No order under \$2.00. We ship to any part of the globe.

LEEDS RADIO CO.

75 Vesey Street, Dept. RCJ
 Cortland 7-2612 New York City, 7

TRANSATLANTIC NEWS

(Continued from page 104)

timbre of a musical instrument is determined, not by the sustained vibrations of its string (or column of air) and those of its wood or metal body, but by what he calls the "starting up vibrations." In other words, every musical instrument has its own particular way of getting into its stride when producing a note. It is this initial process which determines its own special tone. His experiments showed (and they confirm and are confirmed by results obtained by Professor F. A. Saunders of Harvard) that even a trained ear cannot detect whether a sustained note is being produced by, say, a viola or a clarinet, so long as the listener is not allowed to hear either the beginning or the end of the note.

Richardson's experiments with organ pipes showed that the metal of which they are made has no effect on the sustained notes produced—one could not tell one kind from another. But each pure metal and each alloy has its own special way of settling down to a steady rate of vibration and of coming to rest after vibrating.

Tone is then entirely a question of transients — of the method of transition from rest to vibration and from vibration to rest. To apply these discoveries to the radio comes to just this: No matter how good we make the electrical parts of our receivers, the starting and stopping vibrations of the loudspeaker cone of the cabinet on any note are almost bound to add some color to the reproduction. Even if electrical perfection were attainable, those bits of fabric and of wood or plastic which form essential parts of today's radio receiver would still be there to balk the striver after genuine high fidelity.

A sad thought; though fortunately the human ear is so accommodating that few radio sets sound as bad in practice as strict acoustic theory says they should!

COMMAND RECEIVERS (274N SERIES)

Complete with tubes

	Used	New
BC-946-B; 520 to 1800 KC	\$12.95
BC-453-A; 190-550 KC	6.95
BC-454-A; 3 to 6 MC	3.95
BC-455-A; 6 to 9 MC	3.95

COMMAND TRANSMITTERS

(274N Series) Complete with tubes and crystal

	Used	New
BC-698; 3 to 4 MC	\$7.95
BC-457; 4 to 5.3 MC	3.95
BC-458; 5.3 to 7 MC	3.95
BC-459; 7 to 9.1 MC	3.95
BC-456 MODULATOR	BRAND NEW \$2.95

RADIO PARTS

Assorted—100 mica condensers	\$1.19
100 Resistors ½ to 1 watt95
100 Tubular bypass condensers, assorted04
to .1, all 600 Volt	4.69
Electrolytic condensers 50-30, 150 Volt.	10 for	2.89
½ meg. Volume Controls 1" shaft with switch	1.00
½ Meg. Volume Controls 1" shaft without switch	10 for	3.00
Cryvic pick-up, new light wt.	10 for 1.95
	ea. 1.79

TUBES

6V6	12J5	12S17GT	
6X5	6AT6	6A6	
6AQ7	6SF7	10AC Neon	
35W4	5Y4	12K8	
12AT6	12BE6	6SN7	Lots of 50
12SR7	12A6	6N6	
1625	12CB	36	10% Discount
Amperite 10T1	6SJ7	8G6G	

SCOPE TUBES

3AP1	\$1.19	3FP7	\$1.19
5FP7	1.98	7BP7	1.98

All Shipments F.O.B. Chicago

20% deposit required on all orders

ARROW SALES INC. Dept. D

59 WEST HUBBARD ST. CHICAGO 10. ILLINOIS

Telephone: SUPERIOR 5575

BONAFIDE VALUES



SHURE
T17B
Push Button
Carbon Mike

98¢

With Cord
and Plug
Value \$12.00

SHURE
CRYSTAL
MIKE

\$6.95

With Stand,
Base and
7 Ft.
Cable
Value
\$18.50



HAZELTON INSTRUMENT CO. MODEL 100

Pocket Multimeter 2" Movement, 1000 ohms PV, A.C. Volts 0-15, 150, 1500; D.C. Volts 0-15, 150, 300, 1500; Ohms 0-3000, 300,000; Mills 0-1.5, 15, 150 **\$9.95**



DETROLA AUTOMATIC RECORD CHANGER

Plays 10- and 12-inch records. Enjoy almost 30 minutes of uninterrupted music. Special Low Price **\$14.49**

Webster #50	\$21.09
Webster #56 with automatic stop	25.95
Seeburg 2 post changer	21.97
Maguire, 2 post automatic stop	11.95



2 TUBE PHONO OSCILLATOR

Complete with tubes. 35Z5, 12SA7. Use with record player, and tune in any radio.

Complete. **\$4.75**
All Wired

3 Tube PHONO AMPLIFIER Volume and tone control. ALL WIRED with Tubes \$4.95
 ASTATIC Pick Up Model L-70 per ft. 2.25
 A.C. Phono Motor 2.25

SPEAKER BUYS

4" Heavy Alnico Slug PM	\$1.35
5" Heavy Alnico Slug PM	1.39
8" Heavy Alnico Slug PM	4.95
10" Heavy Alnico Slug PM	5.95
12" Heavy Alnico Slug PM	7.85

5 TUBE AC-DC KIT

Superhet radio kit—complete with plastic cabinet, standard AC-DC tubes. Instructions. **\$14.95**

STANDARD MAKE TUBE KIT

Consists of 35Z5, 50L6, 12SA7, 12BK7, 12SQ7 **\$3.50**

CONDENSERS C.D., SOLAR, ETC.

20-20 MFD—150 v.—Lot of 6	\$.35
40 MFD—150 v.—Lot of 639
40 MFD—450 v.—Lot of 679
50 Assorted Mica Condensers—lot of 6	2.29

MISCELLANEOUS

HS-30U Hearing Aid type Earphones	\$.98
Signal M-100 Brass Key79
92 Ohm Twin Coaxial Cable	per ft. .09
5G5U Coaxial Cable	per ft. .06
½ meg. Vol. controls & switch	Lot of 6 .49
100 Assort. IRC Resistors	1.79
Trim—P-16 Headphones	1.95
8 Section Telescopic Aerial with clamping brackets with heavy lead	1.95
Model 680—5000 ohm per volt—volt-ohm milliammeter. Regular \$28.50	19.75
B-45 All wave Signal Generator	27.75
Dial light with "dimout"29 ea. 4 for 1.00

25% Deposit, Bal. C.O.D. Plus Charges
 Write for Latest Catalog

BONAFIDE RADIO CO.

89½ Cortlandt St., Dept. G, N. Y. 7, N. Y.

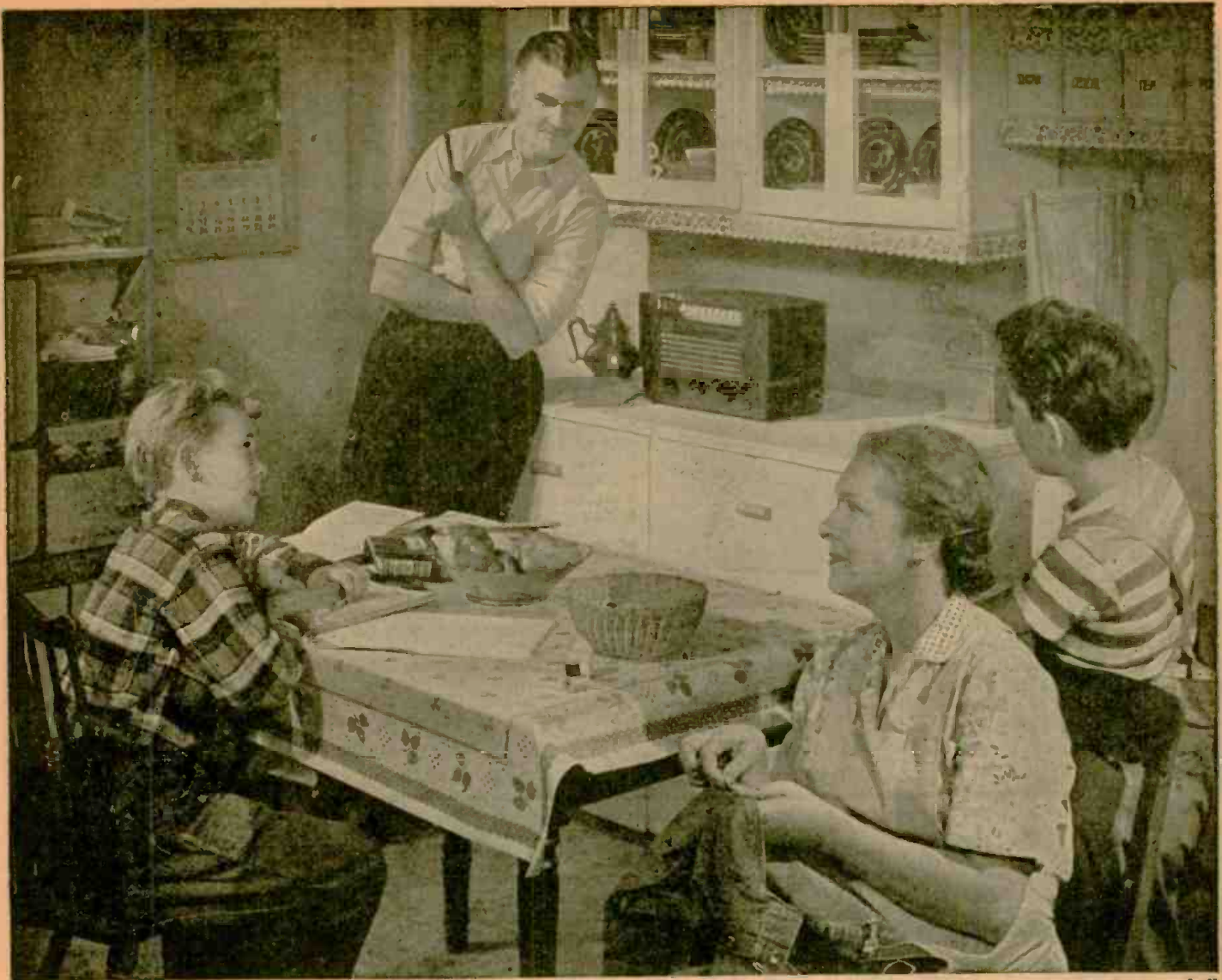

"Our American concept of radio is that it is of the people and for the people."

Freedom to LISTEN - Freedom to LOOK

As the world grows smaller, the question of international communications and world understanding grows larger. The most important phase of this problem is *Freedom to Listen* and *Freedom to Look*—for all peoples of the world.

Radio, by its very nature, is a medium of mass communication; it is a carrier of intelligence. It delivers ideas with an impact that is powerful . . . Its essence is freedom—liberty of thought and of speech.

Radio should make a prisoner of no man and it should make no man its slave. No one should be forced to listen

and no one compelled to refrain from listening. Always and everywhere, it should be the prerogative of every listener to turn his receiver on or off, of his own free will.

The principle of *Freedom to Listen* should be established for all peoples without restriction or fear. This is as important as *Freedom of Speech* and *Freedom of the Press*.

Television is on the way and moving steadily forward. Television fires the imagination, and the day is foreseen when we shall look around the earth from city to city, and nation to nation,

as easily as we now listen to global broadcasts. Therefore, *Freedom to Look* is as important as *Freedom to Listen*, for the combination of these will be the radio of the future.

The "Voice of Peace" must speak around this planet and be heard by all people everywhere, no matter what their race, or creed, or political philosophies.°

David Sarnoff

President and Chairman of the Board,
Radio Corporation of America.

*Excerpts from an address before the United States National Commission for UNESCO.



RADIO CORPORATION of AMERICA

FREEDOM IS EVERYBODY'S BUSINESS

RADIO-CRAFT for JANUARY, 1948

111

**NOW AVAILABLE FOR
IMMEDIATE DELIVERY**

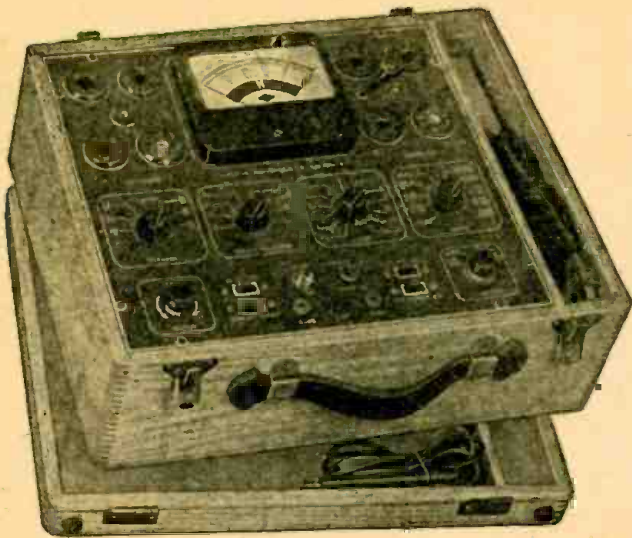

Model 777 operates on 90-120 Volts 60 cycles A.C. Housed in beautiful hand-rubbed cabinet. Complete with test leads, tubes charts and detailed operating instructions. Size 13" x 12 1/2" x 6".

\$59⁹⁵
NET PRICE

20% DEPOSIT REQUIRED ON ALL C.O.D. ORDERS

The New Model

777

20,000 OHMS PER VOLT!!

SET TESTER

Tube Tester Specifications:

- Tests all tubes including 4, 5, 6, 7, 7L, Octals, Loctals, Television, Magic Eye, Thyratrons, Single Ended, Floating Filament, Mercury Vapor Rectifiers, New Miniatures, etc. Also Pilot Lights.
- Tests by the well-established emission method for tube quality, directly read on the scale of the meter.
- Tests leakages and shorts of any one element against all elements in all tubes.
- Tests both plates in rectifiers.
- Tests individual sections such as diodes, triodes, pentodes, etc., in multi-purpose tubes.
- New type line voltage adjuster.

V.O.M. Specifications:

- D.C. VOLTS: (At 20,000 Ohms Per Volt)
0 to 7.5/15/75/150/750/1,500 Volts
- A.C. VOLTS: (At 10,000 Ohms Per Volt)
0 to 15/30/150/300/1,500/3,000 Volts
- D.C. CURRENT:
0 to 1.5/15/150 Ma. 0 to 1.5 Amperes
- RESISTANCE
0 to 5,000/50,000/500,000 Ohms 0 to 50 Megohms
- DECIBELS: (Based on zero decibels equals .006 Watts into a 500-Ohm line.)
-10 to + 18 db., + 10 to + 38 db., + 30 to + 58 db.

GENERAL ELECTRONIC DISTRIBUTING CO.

Dept. RC-1, 98 Park Place
New York 7, N. Y.

ANNOUNCING: THE TELE-SWEEP
(MODEL TSW-50)

FOR TELEVISION



**A SWEEP GENERATOR
For Everyone**

Here is a Sweep Generator for every need and pocket book. The TELE-SWEEP-TSW50 is ideal for alignment of FM and TV Receivers with a minimum of time and effort.

CHECK THESE FEATURES

- SWEEP WIDTH 500 KC to 10 MC
- COMPLETE FREQ. COVERAGE in four bands 5 to 100 MC and 170 to 216 MC
- TEST PROBE for point to point checking
- OUTPUT 1 Volt. Max.

See the TELE-SWEEP at your jobber's Now.

IT'S SENSATIONAL!

Further technical information on this and other vision products furnished on request.



**\$68.50
NET**

Price Slightly Higher on West Coast
VISION RESEARCH LABORATORIES
8-750 Lefferts Blvd.
Richmond Hill, L. I.
N. Y.

NEW RCA TUBE MANUAL

The long-awaited new edition of the RCA tube manual has now been published. The RC-15, as the new book is called, was put on the market at the beginning of December. The present edition is the first since 1939.

In addition to greatly expanded coverage in its regular sections, the new edition presents information on new developments in FM, up-to-the-minute technical data on miniature receiving tubes, and installation and application information on the latest model television broadcast receivers.

The sections on tube and circuit theory have been expanded to 55 pages. The Circuit Section, illustrating a wide variety of electron-tube applications, has been thoroughly revised. The complete Receiving Tube Classification Chart has been brought up to date. In this quick-reference chart receiving-tube types are classified by cathode voltage and tube function, and types with similar characteristics are grouped.

Formulas and examples for the calculation of power output, load resistance, and distortion for A1, AB-1, AB-2, and B classes of service have been included and cover both single-ended and push-pull amplifiers using either triodes or pentodes.

New application data including circuits on ratio detectors, discriminators, limiters, and multivibrators are presented.

List price of the new RCA Receiving Tube Manual remains \$.35.

GOVERNMENT SURPLUS

If you cannot get to the Government Sales of War Surplus Radio Equipment, the next best thing to do is to buy our SPECIAL \$25.00 GOVERNMENT RADIO SURPLUS ASSORTMENT.

We buy large quantities of these items all over the country, divide those items we don't have in large quantities into choice assortments for which we know you would gladly pay \$25.00 if you could see them.

On a deposit of \$5.00 we will ship you COD (balance \$20.00) freight collect, a large quantity of Government Surplus Radio Items subject to your inspection. If, after inspection, you are not more than satisfied, return to us, freight charges collect and all it will have cost you will be freight charges one way. We will then refund your initial payment of \$5.00. You should be able to dispose of a few of the items that you may not need for the entire cost.

This is the cheapest way we can sell you War Surplus Radio Material. Our warehouses are filled with thousands of choice Government Surplus Radio Items. Lot of them we do not have in sufficient quantity to advertise nationally and the cost of inventorying, itemizing, corresponding, etc., would only increase their cost to you; therefore we make this offer. If you wish to mention a few items you desire, we will endeavor to include them in the assortment.

THE ABELL DISTRIBUTING CO.

7 E. Biddle Street, Baltimore 2, Maryland

TEST CRAFT Instrument Co. *Proudly presents*
 THE NEW MODEL TC-48

COMBINATION TEST SPEAKER

A High Quality Instrument At An Unbelievably Low Price!



SPECIFICATIONS

RESISTOR CONDENSER TESTER: 110 Volt A.C. power source for basic indications of either shorts and opens in both resistors and condensers. Leakage indication for condensers only.

CAPACITY SUBSTITUTION: 7 capacity values available, .001, .01, .02, .05, .10 at 600 volts and 30 mfd. and 50 mfd. at 150 V. Provides substitution of by-pass coupling and electrolytic condensers.

RESISTOR SUBSTITUTION: 6 resistance values available, 400, 50K, 100K, 500K, 2 meg. and 5 meg. at 1/2 watt. Provides substitution of grid bias and other types of resistors.

OUTPUT METER: Neon type of output indicator for receiver alignment.

UNIVERSAL AND SUBSTITUTION SPEAKER: Field:—500-1000-1500 and 2500 ohms at 175 ma. Speaker:—Permanent magnet type. Voice Coil:—2.8 ohms. Input:—Single or push pull.

THIS UNIT COMES HOUSED IN A RUGGED, BATTLESHIP GRAY, CRACKLE-FINISHED, STEEL CABINET, COMPLETE WITH FULL OPERATING INSTRUCTIONS, READY TO OPERATE ON 110-125 Volts A.C., 50-60 Cycles, SIZE: 7"x11"x5".

Available at your regular radio parts jobber. If your jobber cannot supply you, send your order directly to us.

A COMBINATION TEST SPEAKER

*plus resistor tester
 plus condenser tester
 plus resistor substitutor
 plus condenser substitutor
 plus output meter*

No need to carry the speaker to your shop in servicing any radio from the small midget to the most elaborate console. Any output tube or tubes can be matched simply by rotating input switch to tube listed and rotate field switch for proper impedance and proceed with testing. External voice coil connection permits testing of set speaker to determine if output transformer is open or shorted.

A MUST FOR EVERY RADIO
 SERVICEMAN AND ENGINEER

\$27.50

NET PRICE

Now Available for **IMMEDIATE SHIPMENT**

TEST CRAFT INSTRUMENT CO.

42 WARREN STREET

NEW YORK 7, N.Y.

"The Kit for the Millions"

NO TECHNICAL KNOWLEDGE REQUIRED FOR ASSEMBLY!

TRANSVISION

... Tops in quality ... Tops in value!

TELEVISION KITS

SCOOP! All Transvision 12" STANDARD Kits can now be had equipped with superb FM RADIO at the extra cost of only **\$7.95**

(Not to be confused with De Luxe model which has continuous tuning)

12" TELEVISION KITS—Standard and DeLuxe Models

Picture size 1½ times larger than with 10" tube . . . A big 75 square inch picture! Sharp, steady picture achieved with advanced Transvision television circuit. Picture has remarkable brightness even in lighted room (no darkening of room is required). IDEAL FOR HOME or COMMERCIAL INSTALLATIONS.

12" TRANSVISION TELEVISION KIT Standard Model . . . **FEATURES:** 12" picture tube . . . Picture size 1½ times larger than with 10" tube . . . RF Unit designed for 13 channels: factory wired and pre-tuned for 7 channels (no areas have been assigned more than 7 channels; however if desired, up to 6 more channels may be added at very nominal cost) . . . 4 mc bandwidth for full picture definition . . . High fidelity F. M. sound reproduction . . . picture size 75 square inches . . . 9000 volts second anode potential for brightness and contrast . . . maximum picture, sensitivity (better than 50 microvolts) . . . 22 tubes and 12" picture tube, antenna, lead-in wire, etc. (Cabinet extra, if desired). LIST \$289.00

12" TRANSVISION TELEVISION KIT DeLuxe Model with Superb Built-in F.M. RADIO. Same characteristics as the Standard Model, plus the following **ADDITIONAL FEATURES:**—50-216 mc continuous tuning . . . Covers the entire F.M. band and all 13 television channels . . . Cut-off switch eliminates unused tubes when set is used only as F.M. receiver . . . LIST \$359.50

TRANSVISION ALL-CHANNEL R.F. UNIT

FACTORY PRE-WIRED and TUNED . . . For use in Building your own custom-made television receiver . . . for any 7", 10", 12", 15", or 20" Kit.

Transvision all-channel R.F. unit is factory pre-wired and tuned for 7 channels* (covers all channels in lower and higher bands in any single area operating presently or in the future). Average sensitivity 20 microvolts; has R.F. stage before oscillator: complete with 3 tubes; 1-6AK5, 1-6AK6, 1-6C4; input impedance—300 ohms, balanced to ground. Size—9½" deep, 4¾" high, 6¾" wide. *NOTE: No single area is scheduled for more than 7 channels. However, 6 more channels can be added to this unit, if desired, at nominal factory cost. It is not expected that these additional 6 channels will be required for several years . . . LIST \$37.95 Same R.F. Unit, plus FM Band . . . LIST \$47.95

TRANSVISION FEATHERWEIGHT SOLDERING IRON

NOTE THESE NEW, REMARKABLE FEATURES: Weighs only 3 ounces (without the cord) . . . Delivers working output of 200 watt iron at fraction of current normally consumed by heavier irons . . . Heats up in 20 seconds . . . Finger-Tip button control . . . Cool grip . . . Retains heat (with switch off) up to one minute . . . Featherweight permits long periods of soldering without fatigue . . . Economical—intermittent control feature prevents tip corrosion and necessity of frequent cleaning . . . Long, thin tip permits soldering in tight corners . . . Tips are interchangeable to suit work at hand . . . For operation on 110V, 60 cycles. Complete with 6 volt transformer . . . LIST \$13.95

All prices listed above are 5% additional west of the Mississippi. All prices are fair traded.

See your local distributor or for further information write to Dept. R.C.—

TRANSVISION, INC.
385 NORTH AVE., NEW ROCHELLE, N. Y.



12" KIT (Table Model)

ALL TRANSVISION KITS ARE COMPLETE—Nothing more to buy! . . . All Transvision Television Kits are COMPLETE with all tubes, including picture tube, wired and pre-tuned RF units and IF's, high gain folded dipole antenna with 60 ft. lead-in cable, wire and solder.

TRANSVISION TELEVISION CABINETS Beautiful, sturdily built cabinets with handsome rubbed wood finish. Fully drilled.
12" Table Model Cabinet . . . LIST \$44.95
12" Console Cabinet with compartment for record changer . . . LIST \$85.00
7" Table Model Cabinet . . . LIST \$32.50

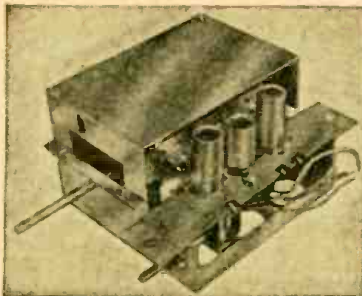

ALL-CHANNEL R-F UNIT



Featherweight Soldering Iron

TELEVISION STEPS OUT!

(Continued from page 108)

now plowing into the ground thousands of miles of concentric or co-axial cable capable of carrying televised images from coast to coast and making possible networks similar to those that have been spun by radio stations into a gigantic web. Television images bound on highly directional microwaves over a series of towers from New York to Boston. Later they will be sent from New York to Chicago—and beyond.

The Federal Communications Commission has hitched its wagon to the star of television expansion and is cooperating with broadcasters to develop this potentially gigantic service. With such a co-operative effort in full swing, there is no doubt that 1948 looms big for television.

Although home television is the vogue, there is feverish behind-the-scenes activity in the motion picture industry to introduce theater-size television at your favorite movie house. In the East and Far West, it may happen early this year.

The revolution that marked the end of the silent era of movies undoubtedly will appear insignificant to the advances in entertainment which theater-type television will bring to the screen of the average movie house.

The march of television progress has begun; it cannot be halted; it Will not be stymied. Television is here!

FREE

UP TO THE MINUTE BUYING INFORMATION

Radio Repair Parts
Sound Systems • Tools
Kits • Phono Equipment
Tubes • Test Instruments
Experimenters Supplies

REGULAR SUPPLEMENTS KEEP YOU POSTED

Catalog sent immediately upon request. Price and Data Supplements, issued regularly, assure you of up-to-the-minute information—give exact and current data you need for profitable buying. Send the coupon today for this helpful buying service.

BIG VALUES, LARGE STOCKS, FAST, DEPENDABLE SERVICE.

FREE . . . SEND TODAY

RADOLEK CO., Dept. C-128
601 W. Randolph St., Chicago 6, Ill.
Please send your Free Profit Guide Catalog and regular Supplements.

Name _____
Address _____
City _____ Zone _____ State _____

SAVE AT RADOLEK



At Last! - A High Quality

POWERFUL—COMPLETE SOUND SYSTEM

FOR ONLY \$92⁵⁰

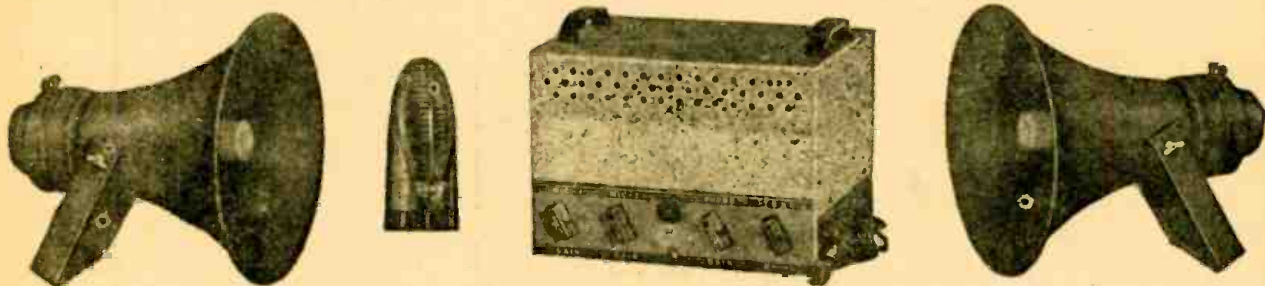

The Complete Moss P.A. System Includes:

1 DELUXE 25 WATT AMPLIFIER
2 POWERFUL 35 WATT REFLEX PROJECTORS

1 SHURE MODEL 718A "VERSATEX" CRYSTAL MICROPHONE
PLUS 50 FT. OF CABLE, PLUGS, CONNECTORS, ETC.

At last, one single system, designed to meet the requirements of most indoor and outdoor installations, offered as a complete package at a sensationally low price. Check the specifications of this most versatile system, then check the values of the various components included. We know you'll be amazed at this truly sensational value. Please note none of the items included are "surplus". All parts are standard and guaranteed. Like all other Moss Values this System is offered with the understanding it may be returned for full credit or refund if it does not meet with your complete approval after a 10-day trial.

The complete Moss P.A. system will efficiently meet the following P.A. installation requirements:

INDOOR:

- (A) Large size auditorium accommodating up to 5000 persons (low noise level).
- (B) Medium size dance-floor accommodating up to 1000 persons (medium noise level).
- (C) Medium size Fight Arena (high noise level).

- (D) Medium size skating rink (high noise level).

OUTDOOR:

- (A) Large outdoor meeting accommodating up to 3000 persons (low noise level).
- (B) Small Ball Park (high noise level).
- (C) Small stadium (medium noise level).

Amplifier Specifications

TUBES—2-6SC7, 2-6L6, 1-5U4G, 1-6X4.
CHANNELS (3)—2-Mic Gain 125DB, 1-Phone 87DB.
RESPONSE—40-12000 cycles plus or minus 7DB.
OUTPUT IMP.—2-4-8-15-500 ohms at both "Speaker Terminals." Strip or sockets. Handles 2 microphones.
OUTPUT POWER—25 Watts 3% dist. 35 Watts peak. Hum level 57DB below output.
DUTY—Continuous—PROTECTION—Fused 2 amp. slow blow.
CASE—Steel two-tone black and silver crackle. Blue panel White letters.
CAPACITORS—Oil coupling condensers and hermetically sealed electrolytic filter condensers.
SOCKETS—Output and rectifier sockets stainless steel.
DIMENSIONS—8 3/4 x 10 x 14 1/4 inches.
POWER INPUT—110-125 Volts 60 cycles.

Reflex Projector Specifications

POWER (CONSERVATIVE) — 35 WATTS
POWER (PEAK) — 55 WATTS
FREQUENCY RANGE — 130 to 5000 C.P.S.
AIR COLUMN — 3 1/2 FT.
BELL DIAMETER — 15"
PROJECTION — 1/2 mile
DISPERSION — 80°
IMPEDANCE — 8 ohms
FINISH — Attractive two-tone crystalline

Microphone Specifications

Model 718A "Versatex" is an extremely versatile high-output diaphragm type crystal microphone. The "Versatex", the versatile crystal microphone, is suitable for placement on table top, or other flat surface; it fits conveniently in the palm of the hand for use as a hand microphone; and it may be used on a conventional floor stand. The "Versatex", the versatile crystal microphone, has typical semi-directional properties. The crystal used is a Bimorph unit with special process moisture-proofing.

The Moss P.A. System comes complete with amplifier, projectors, microphone, connectors, cables, plugs, etc.

ONLY \$92⁵⁰

10% deposit required with C.O.D. orders

MOSS ELECTRONIC DISTRIBUTING CO.

Dept RC-1, 229 FULTON STREET, NEW YORK 7, N. Y.

RADIOMEN'S HEADQUARTERS - WORLD WIDE MAIL ORDER SERVICE!!!

Minimum order \$3.00—All prices subject to change—25% deposit with COD orders

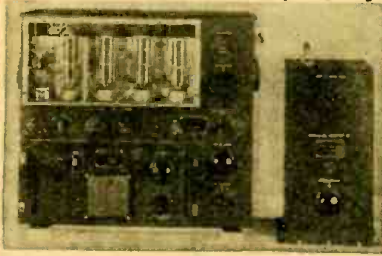

GENERAL ELECTRIC 150 WATT TRANSMITTER

Cost the Government \$1800.00
Cost to you \$44.50!!!!

This is the famous transmitter used in U.S. Army bombers and ground stations, during the war. Its design and construction have been proved in service, under all kinds of conditions, all over the world. The entire frequency range is covered by means of plug-in tuning units which are included. Each tuning unit has its own oscillator and power amplifier coils and condensers, and antenna tuning circuits—all designed to operate at top efficiency within its particular frequency range. Transmitter and accessories are finished in black crackle, and the milliammeter, voltmeter, and RF ammeter are mounted on the front panel. Here are the specifications: **FREQUENCY RANGE:** 200 to 500 KC and 1500 to 12,500 KC. (Will operate on 10 and 20 meter band with slight modification). **OSCILLATOR:** Self-excited, thermo compensated, and hand calibrated. **POWER AMPLIFIER:** Neutralized class "C" stage, using 211 tube, and equipped with antenna coupling circuit which matches practically any length antenna. **MODULATOR:** Class "B"—uses two 211 tubes. **POWER SUPPLY:** Supplied complete with dynamotor which furnishes 1000V at 350 MA. Complete instructions are furnished to operate set from 110V AC. **SIZE:** 21½x23x9¾ inches. Total shipping weight 200 lbs., complete with all tubes, dynamotor power supply, five tuning units, antenna tuning unit and the essential plugs. These units have been removed from unused aircraft but are guaranteed to be in perfect condition. **BENDIX SCR 522—Very High Frequency Voice Transmitter-Receiver—100 to 156 MC.** This job was good enough for the Joint Command to make it standard equipment in everything that flew, even though each set cost the Gov't \$2500.00. Crystal Controlled and Amplitude Modulated—**HIGH TRANSMITTER OUTPUT** and 3 Microvolt Receiver Sensitivity gave good communication up to 180 miles of high altitudes. Receiver has ten tubes and transmitter has seven tubes, including two 832's. Furnished complete with 17 tubes, remote control unit, 4 crystals, and the special wide band VHF antenna that was designed for this set. These sets have been removed from unused aircraft and are guaranteed to be in perfect condition. We include free parts and diagrams for the conversion to "continuously variable frequency coverage" in the receiver. The SCR522 complete with 24 volt dynamotor sells for only \$37.95. The SCR 522 is also available with a brand new 12 volt dynamotor for only \$42.95.

AUTOMATIC WIRE STRIPPERS will strip up to 1000 wires per hour, a handy tool for any service job—\$3.52. Six Foot Asbestos Insulated Flat Iron Cord, one end has a male plug, the other end has a standard flat iron socket. Your price—50¢ each or 10 for \$4.

Miniature piler set contains one of each of the following: Needle nose, flat nose, parrot nose, standard nose. All contained in a leatherette case. Your cost—\$1.98.

METER RECTIFIERS—Full wave, may be used for replacement, or in construction of all types of test equipment—\$1.25. Half Wave—90¢.



MICROPHONES—All nationally known brands. Bullet crystal—\$5.45; Bullet Dynamic—\$7.45; Mike Jr.—60¢; Handy Mike—90¢; Lapel Mike—93¢; SHURE T-17 MIKES, with push to talk switch—99¢.

20 ASST'D COIL FORMS, including 11 ceramic, 3 polystyrene, and 6 fiber, all useful sizes—50¢.

VARIABLE CONDENSERS: 350 MMFD, 5 gang—\$1.95; 4 gang—\$1.49; 3 gang—83¢; 2 gang—79¢; 7.5 to 20 MMFD, 1750v spacing, extra long shaft Hammarlund—69¢; miniature variables, 25 MMFD—39¢; 50 MMFD—49¢; 75 MMFD—59¢; 100 MMFD—69¢; 140 MMFD—79¢.

FLOUORESCENT LIGHT BALLASTS, Single 30 or 40 watt, \$1.68; Dual 40 watt High Power Factor—\$3.75.

HEADPHONES—Highest quality Signal Corps headsets with 12" cord and plug \$1.25. 5" rubber covered patch-cords with phone plug and socket—45¢.

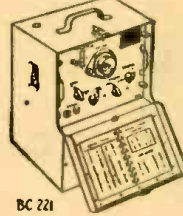

BC-221 FREQUENCY METERS with calibrating Crystal and calibration charts. A precision frequency standard that is useful for innumerable applications for laboratory technician, service man, amateur, and experimenter at the give away price of only \$36.95.

- Six assorted POWER and AUDIO TRANSFORMERS, all new \$1.98
- Ten assorted R. F. Chokes including high frequency types \$.35
- Five assorted AUDIO or FILTER CHOKES \$.99
- One Hundred assorted RESISTORS \$1.95
- Ten new JAN CABLE CONNECTORS, including many popular types \$.99
- Ten assorted WIRE-Wound BLEEDERS, 50 and 100 Watt, many with taps \$2.49
- Six assorted OIL FILLED CAN TYPE CONDENSERS, all with mounting brackets \$1.49
- Ten assorted METAL & BAKELITE KNOBS—(no wooden knobs) \$.39
- Six assorted VARIABLE CONDENSERS, including butterfly types \$1.49

The above nine assortments, totaling over \$12.00 at the unbelievable bargain prices listed; can be purchased together as one lot at a super-special total price of \$9.95, a value so incredible that you will rub your eyes as you read this, our new year get-acquainted offer. All merchandise guaranteed to be as advertised.

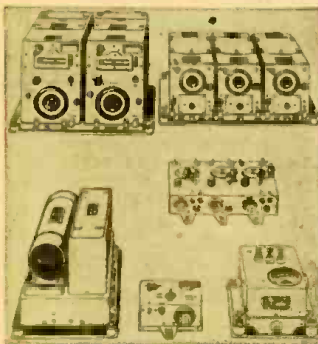

SCR-274N COMMAND SET

The greatest radio equipment value in history

A mountain of valuable equipment that includes 3 receivers that use plug-in coils, and consequently can be changed to any frequencies desired without conversion. Also included are two Tuning Control Boxes; 1 Antenna Coupling Box; four 28V. Dynamotors (easily converted to 110V. operation); two 40-Watt Transmitters including crystals, and Preamplifier and Modulator. 29 tubes supplied in all. Only a limited quantity available, so get your order in fast. Removed from unused aircraft and in guaranteed electrical condition. A super value at \$29.95, including crank type tuning knobs for receivers.

- Westinghouse 9 Amp. R. F. METER with special linear scale \$3.89
- Outdated EVEREADY 90 Volt and 1½ Volt Battery Pack. This is a unit larger than an auto battery. Regular price \$12.00! Your cost \$1.49
- Outdated BRIGHT STAR standard flashlight cells. Carton of 48 \$1.00
- 1947 Edition Editors & Engineers Radio Handbook. Regularly \$2.50, now \$1.79
- 1947 Edition Amateur Radio Relay League Handbook. Regularly \$1.25, now \$.89
- We are overstocked on the following Rider's Manuals
- Rider's A. C. Calculation Charts (Complete coil and transformer design data). Regular price \$7.50. Temporarily reduced to \$5.00
- Rider's Automatic Record Changers and Recorders. Regularly \$9.00, now \$5.95
- ICA #1081 BLACK BAKELITE POINTER TYPE KNOBS. Regular List 20¢ each 25 for \$1.00

RT-1579 consists of a three stage (cascade 6SJ7's and 6F6 output stage) high gain, high fidelity amplifier with 60 cycle, 110V power supply on the same 13½x14½ chassis, which is protected by a substantial steel cover over tubes and parts. Made by Western Electric with typical quality components such as a husky power transformer and oil condensers, this unit is obviously intended to give years of trouble-free service with no more need for repairs than a telephone. Disconnecting one wire each, from the special input and output filters, will result in as high a fidelity amplifier as can be obtained. Your cost with tubes, diagram and parts list included—\$14.95.

We also offer the RT-1579 with a Raytheon Magnetic Voltage Regulator already installed beneath the cover. Imagine an amplifier complete with tubes, built to Western Electric quality standards, and immune to line voltage variations besides, making it perfectly suited for the most difficult industrial, circus, carnival, or commercial installations, offered for a total price of only \$19.95, our price for both units.

BUFFALO RADIO SUPPLY, 219-221 Genesee St., Dept. 1C, BUFFALO 3, N. Y.

Cable Address: BUFRAD

RADIOMEN'S HEADQUARTERS WORLD WIDE MAIL ORDER SERVICE!!!

AT LAST YOU CAN AFFORD A LABORATORY STANDARD MICRO VOLTER

The famous Measurements Corp. Model 78B, 5 Tube Laboratory Standard Signal Generator FOB Boonton, N. J., that sold new for \$310.00 net, is available in perfect condition for 26 to 60 cycle, 115 V AC operation. Until now this is the sort of top-flight lab equipment that discriminating buyers have only vainly hoped would be released at a bargain price. Worth every cent the manufacturer asks, but available FOB Buffalo while our limited supply lasts for only \$79.95.

Such companies as Admiral Corp. and John Meck, Inc., have ordered from us and repeated many times on these 78 generators for use in their labs and production line testing. "REMEMBER THAT A STANDARD IS ONLY AS RELIABLE AS ITS MAKER."



Model 78-B Standard Signal Generator. Two Frequency Bands between 15 and 250 megacycles.

TRANSMITTING RF CHOKES, 4 PIE, 350 Ma.—25c or 5 for \$1.60
 INTERRUPTION FREQUENCY COILS for super-regenerative receivers or the tremendously popular FM adapters for standard broadcast sets. Iron core with a resonant frequency of 50 KC—39c; Air Core, 100 KC—29c.
 30 MC IF TRANSFORMERS, double slug tuned—25c VIDEO AMPLIFIER PLATE COILS—Slugg tuned—25c. REMOTE CONTROL UNIT: Aluminum case 4x3x2" containing 2 potentiometers, triple pole switch, 4 knobs, gear mechanism, counter and phone jacks—59c.
 MODULATION TRANSFORMERS—10 watt, metal case, 98c; 30 watt, open-type, \$1.95; 40 watt, cast aluminum case, \$2.95; Class "B" input transformers, cast aluminum case, \$1.95; Transceiver audio transformer, 65c; Transceiver modulation transformers, 65c.
 LINE FILTERS—110V—each unit contains two 2 mfd. oil filled condensers and a 15 amp. iron core choke. This filter has innumerable uses such as oil burner line filter, etc. A ten dollar value for 98c.

\$995

TAKES ALL THREE BIG BARGAINS

- 1. AUDIO AMPLIFIER** Undreamed of value. Uses 6V6's. Has 4 microphone inputs brought to jacks at rear panel. Various output impedances available at rear panel connections. Steel case with chrome handles. 9" long x 9" high x 6" deep. Tubes included. New in original carton. Shipping weight 15 lbs. SUPER SPECIAL—\$4.95 while supply lasts.
- 2. RADIO HEADSETS** Latest supersensitive type with rubber earpieces. Every pair guaranteed perfect. \$50 per pair OR 3 PAIRS FOR \$1.00.
- 3. HOME WORKSHOP AT BARGAIN PRICE** Accurate and precise 2 speed guaranteed hobby lathe, the essential machine for the home workshop. Sturdy enough for light production work or factory standby service. Supplied with 56" of belting for connecting to any available electric motor or power take-off, such as on a jeep or tractor. Also included in this unbelievable offer are such accessories as a 1/4" drill chuck with specially hardened tool steel jaws, a 4" electric furnace high speed grinding wheel, a cotton buffing wheel with a large supply of buffing compound, and a 4" steel wire scratch brush. Your cost \$6.00. Sole export agent. Distributor Inquiries Invited.

RT1463 7 tube amplifiers containing 3-7F7, 1-7Y4, 3-7N7, 4 potentiometers, numerous resistors, filter and bypass condensers, filter chokes, power and audio transformers, and six sensitive plate relays. A military development that provided amazing wireless control proportional to correction required, for airplanes, rudder and elevator, in the original application. A control amplifier of the ordinary type would deflect the rudder by some arbitrary amount when the ship was blown off the course to port or starboard. The result would either be that the correction was insufficient and the plane continued off course, or the correction would be too great, starting a series of tacking that would greatly increase fuel consumption and elapsed time in reaching the objective. This phenomenal unit, with its 3 amplifiers and six 5000 ohm relays in bridge circuits, will accurately control any 3 operations, related or unrelated, in minutely adjustable uniquely quantitative variations in either forward or reverse directions. 9"x7"x8" black crackle aluminum case. Brand new in original carton \$12.95, or used \$9.95.

SCR-284 TRANSMITTER-RECEIVER—This medium power transmitter and the accompanying 7 tube very sensitive receiver are naturals for 80 or 40 meter operation (phone or CW), on either fixed stations or mobile applications. These units are brand new and come complete with 17 tubes, key, microphone, 200 KC calibrating crystal and instructions and diagrams for use with up to 100 watts input to the final stage on 40 or 80 meters for either phone or CW, using vehicle or 110 Volt power supply. Your cost \$39.95



GENERAL ELECTRIC RT-1248 15-TUBE TRANSMITTER-RECEIVER

TERRIFIC POWER—(200 watts) on any two instantly selected, easily pre-adjusted frequencies from 435 to 500 Mc. Transmitter uses 5 tubes including a Western Electric 316 A as final. Receiver uses 10 tubes including 955's as first detector and oscillator, and 2-7117's as IF's, with 4 slug-tuned 40 Mc. IF transformers, plus a 7H7, 7E6's and 7F7's. In addition unit contains 8 relays designed to operate any sort of external equipment when actuated by a received signal from a similar set elsewhere. Originally designed for 12 volt operation, power supply is not included, as it is a cliché for any amateur to connect this unit for 110V AC, using any supply capable of 400V DC at 135 MA. The ideal unit for use in mobile or stationary service in the Citizen's Radio Telephone Band where no license is necessary. Instructions and diagrams supplied for running the RT-1248 transmitter on either code or voice, in AM or FM transmission or reception, for use as a mobile public address system, as on 80 to 110 Mc. FM broadcast receiver, as a Facsimile transmitter or receiver, as an amateur television transmitter or receiver, for remote control relay hookups, for Geiger-Mueller counter applications. It sells for only \$29.95 or two for \$53.90. If desired for marine or mobile use, the dynamotor which will work on either 12 or 24V DC and supply all power for the set is only \$15.00 additional.

ARMY BC-312 COMMUNICATIONS RECEIVER

This receiver covers the frequency range of 1.5 MC to 18 MC in six direct reading bands. The dial, that is driven with split gears to prevent backlash, has 4500 logging divisions per band with approximately 600 divisions on the 20 and 40 meter ham bands and 1000 divisions on 80 meters. Two stages of RF before the converter in this set give it a very high signal to noise ratio and maximum sensitivity. Outstanding features of this receiver are: BFO with pitch control send receive relay, jacks on the front panel for headphones and speaker output, and mike and key inputs. All tubes are standard 6 volt types. This receiver was designed to withstand rough usage in the field and for operation from vehicles while in motion, so it is ruggedly constructed and contains a dynamotor power supply—Your cost \$49.95. Conversion kit to 110 V AC is available for \$6.50

PE-109 32-Volt DIRECT CURRENT POWER PLANT

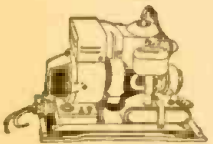

This power plant consists of a gasoline engine that is direct coupled to a 2000 watt 32 volt DC generator. This unit is ideal for use in locations that are not serviced by commercial power or to run many of the surplus items that require 24-32V DC for operation. The price of this power plant is only \$59.95. We can also supply a converter that will supply 110V AC from the above unit or from any 16-32V DC source for \$29.95.

TRANSFORMERS—All types in stock. AUTO-TRANSFORMER: 110v to 220v, or steps down 220v to 110v—\$1.95. FIVE TRANS: 6.3v, 20 Amps—\$1.98; Universal Output Trans. 8 Watt—89c; 18 Watt—\$1.29; 30 Watt—\$1.69. AUDIO TRANSFORMERS: S. Plate to S. Grid, 3:1—79c; S. Plate to P.P. Grids—79c; Heavy Duty Class AB or B, P.P. Inputs—\$1.49; Midset Output for AC-DC sets—69c; MIKE TRANSFORMER for T-17 Shure microphone, similar to UTC mic type—\$2.00. Stancor SB or DB mike to line or grid—\$1.95.
 POWER TRANSFORMERS—Half shell type, 110V, 60 cy. Center-tapped HV winding. Specify either 2.5 or 6.3V filament when ordering.
 For 4-5 tube sets—650V, 40MA, 5V & 2.5 or 6.3V.....\$1.49
 For 5-6 tube sets—650V, 45MA, 5V & 2.5 or 6.3V.....1.75
 For 6-7 tube sets—675V, 50MA, 5V & 2.5 or 6.3V.....1.90
 For 7-8 tube sets—700V, 70MA, 5V & 0.3 or two 2.5V.....2.35
 For 7-8 tube sets—700V, 70MA, 5V & 6.3 (25 cycle).....3.60
 For 8-9 tube sets—700V 90MA, 5V-3A, 2.5V-3.5A.....2.85
 For 9-11 tube sets—700V, 100MA, 5V & 6.3V.....2.95
 For 9-15 tube sets—600V, 150 A, 5V & 6.3V.....2.95

CONDENSERS—PAPER TUBULAR 600 WV—001, .002, .005—8c; .01, .05—9c; .1—10c; .25—23c; .5—36c; ELECTROLYTICS: 8mfd 200v—20c; 10mfd 31v—20c; 20mfd 150v—23c; 20/20mfd 150v—35c; 30/20 150v—46c; 50mfd 150v—43c; 8mfd 475v—34c; 10mfd 350v—65c; OIL CONDENSERS: 4mfd 600v—49c; 2mfd 600v—29c; 3X1mfd 600v—29c.
 FILTER CHOKES: 200, 300, 400, 500 ohm light duty—59c; 200 or 300 ohm heavy duty—89c; 350 ma 35 ohm, made for U.S. Navy, fully shielded—\$1.95; 75 ohm 125 ma—25c or 25 for \$4.25; "Meissner type" tapped filter chokes—25c; 8 amp. iron core A filter—25c; Choke-condenser combination, ideal to replace any size speaker field when installing PM speakers—79c.
 110 V. CIRCUIT BREAKERS of Magnetic type: Following Current Ratings in Stock: 1.25, 3, 4, 8 Amps. Please specify. \$1.95 each.
 Seven Assorted I.F. Transformers—\$1.98; Five Assd. Oscillator Coils—69c.
 SPEAKERS-PM dynamic type—4"—\$1.55; 5"—\$1.55; 6"—\$1.95; 8"—\$3.95; 10"—\$5.95; 12"—\$7.50.

CLOSING OUT

THE FOLLOWING DESIRABLE ITEMS IN "AS IS" CONDITION AT SACRIFICE PRICES TO MAKE ROOM IN OUR WAREHOUSE FOR INCOMING STOCK.

947A ONE KILOWATT HIGH FREQUENCY TRANSMITTER. This relay controlled transmitter includes a 115V, 60 cycle power supply, protected by 8 magnetic circuit breakers, that alone is worth more than the price we are asking for the whole rig, even on today's surplus market. On the front panel are six 3 1/2" GE or Weston meters, including 250 MA, 50 MA, 1000 MA, 150 V AC and 1500 V DC at 1000 ohms per volt for screens and plate. The rack-type 21" x 15" x 26" unit contains six amplifier and rectifier tubes aggregating over \$60.00 at WAA current wholesale prices. Western Electric's price to the government was \$1500.00. Shipping weight 500 lbs. Your cost at close-out price \$39.95

BC-412 5" RADAR OSCILLOSCOPE. Easily converted to a first class lab scope or to an excellent home television receiver using the instructions in the August 1947 RADIO NEWS. Furnished with a brand new 51P4 tube for the television application or a brand new 5B1P1 for the scope application. Specify your choice. Sold at close-out price \$29.95

5 INCH RECEIVER INDICATOR SCOPE. This unit, originally sold by Western Electric for \$2500.00 includes a 13 tube receiver with 7 IF stages; 2 tube multivibrator sweep generator; 2 tube sweep amplifier; video amplifier; pedestal impulse and sweep generator, and 115 volt, 60 cycle supply with 2 x 2 for high voltage. Equipped with more than 15 tubes of the 43 originally used and including a brand new scope tube in original carton. Makes a wonderful laboratory instrument and is better adapted for television than any other war surplus item. Reduced close-out price \$39.95

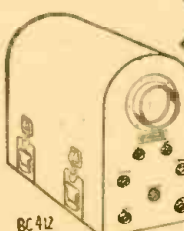

BC-412

SELENIUM RECTIFIERS—Dry disc type 1 1/2" by 1" 1.2 Amp. maximum, suitable for converting DC relays to AC, for supplying filament source in portable radios, converting DC meters to AC applications, and also may be used in low current choppers—90c.
 "SO" RADAR P.P.I. OSCILLOSCOPE, complete with 9 tubes. This unit contains magnetic deflection yokes, Selayn motor, and self contained 110 V power pack designed to run on the AC supply on LST and PT boats. Various ranges from 2 to 80 miles. The most satisfactory scope available for navigational radar or panoramic television applications. Uses 867 tube in final power stage that provides very deflecting current. Your Cost \$39.95
 "SO" RADAR ECHO BOXES. The perfect calibrated curvy w/w meter \$10.00
 LORAN INDICATOR OSCILLOSCOPE. Including 26 tubes with 5" cathode ray tube. Gov. instruction manual supplied with each of these \$37.95
 2" OSCILLOSCOPE complete with tubes and brand new \$9.95

BUFFALO RADIO SUPPLY, 219-221 Genesee St., Dept. 1C. BUFFALO 3, N. Y.

Cable Address: BU-RAD

SENCO A Gold Mine of SAVINGS!

R.M.A. GUARANTEED TUBES
EVERY TUBE IN A CARTON

955 ACORN TUBE 19c
Famous brand detector amplifier
oscillator tube—Brand new

Each	Lots of 10 Ea.	Each	Lots of 10 Ea.
1A5GT	.59 .49	7C6	.44 .35
1S5	.69 .55	7C7	.44 .35
1T4	.69 .55	7Y4	.44 .35
1U5	.36 .30	7X7	.44 .35
1V	.45 .39	7AF7	.44 .35
1L4	.55 .49	12A8GT	.45 .37
2A5	.65 .55	12AT6	.50 .45
2A6	.79 .69	12BA6	.50 .45
2X2	.79 .72	12BE6	.50 .45
3A4	.69 .59	12J5GT	.49 .39
3Q5GT	.55 .50	12J7GT	.45 .39
5U4G	.50 .40	12K7GT	.45 .39
5W4GT	.40 .36	12K8	.65 .59
5Y3GT	.40 .35	12Q7GT	.45 .39
5Y3G	.42 .33	12SA7GT	.40 .32
5Y4G	.40 .37	12SQ7GT	.40 .32
5X4G	.40 .37	12SK7GT	.45 .35
6A7	.50 .45	12SJ7GT	.55 .49
6A8GT	.49 .37	24A	.49 .39
6AC5	.98 .92	26	.39 .30
6AC7	.65 .60	27	.42 .37
6AK5	.74 .69	41	.40 .35
6AG7/6AK7	.89 .79	42	.42 .38
6B7G	.55 .49	43	.54 .49
6C5GT	.40 .35	45	.49 .39
6C6	.45 .32	47	.49 .39
6C8G	.37 .29	56	.49 .39
6D6	.45 .37	57	.45 .39
6F6GT	.45 .39	58	.45 .39
6H6GT	.45 .39	71A	.39 .29
6J5GT	.45 .39	75	.50 .39
6J7GT	.42 .38	76	.45 .39
6K6GT	.45 .39	77	.35 .27
6K7GT	.49 .39	78	.35 .27
6K7G	.50 .41	80	.40 .38
6L6G	.79 .69	83V	.99 .89
6Q7GT	.47 .39	84/6Z4	.45 .36
6S7	.59 .48	85	.49 .45
6U7G	.35 .25	25L6GT	.49 .39
6V6GT	.45 .39	25Z5	.49 .45
6X5GT	.49 .39	25Z6GT	.45 .39
6SA7GT	.44 .37	35W4	.43 .40
6SJ7GT	.44 .37	35Z3	.44 .35
6SK7GT	.44 .37	35Z5GT	.43 .39
6SL7GT	.49 .47	35L6GT	.45 .39
6SN7GT	.49 .47	50L6GT	.50 .45
6SQ7GT	.44 .37	117Z3	.55 .45
6SG7	.44 .39	117Z6GT	.89 .76
6ZY5G	.45 .39	50B5	.42 .32
7B7	.44 .35	32L7GT	.59 .49

829 PUSH PULL Twin Beam Power Amplifier Tube **\$1.49 ea.**

Famous Brand 6 Volt 4 Prong Auto Vibrator \$1.19 ea.

OUTPUT TRANSFORMERS

50LB.....45c ea. 5Q5.....45c ea.
6V6.....50c ea.

All Sturdily Constructed

I F TRANSFORMERS

Midget type 456 kc input output.....49c ea.
Medium size 456 kc I.F. coils input output.....49c ea.



AC PHONO MOTOR AND PICKUP

60 cycle 115 volts **\$4.35**

Complete with Turntable
FREE NEEDLE CUP WITH EACH MOTOR AND PICKUP

SPEAKERS

4" PM\$1.19 6" PM\$1.55
5" PM\$1.15 8" PM\$2.75
12" PM\$5.49
4 x 6.....\$1.89

F. P. CONDENSERS

All Popular Makes Fresh Stock

15 x 15 mfd at 450 w. v.69c ea.
20 x 20 x 20 mfd at 150 w. v.69c ea.
10 x 10 mfd at 450 w. v. & 20 mfd at 25 w. v.71c
20 x 20 mfd at 450 w. v. & 20 mfd at 25 w. v.89c
60 x 60 mfd at 150 w. v. & 25 mfd at 50 w. v.78c
20 x 20 mfd at 300 w. v. & 25 mfd at 20 w. v.82c

OAK RECORD CHANGER

One of the most popular Record Changers in use today. Plays 12-10" records or 10-12" records automatically—Fast change cycle. Simple, foolproof, compact, 2-post—noiseless motor. Featherweight crystal pickup. **\$15.95**

VOLUME CONTROLS

250,000 ohms tapped with switch 3" shaft **44c**
500,000 ohms tapped with switch 3" shaft **44c**
1 meg ohms tapped with switch 3" shaft **EACH**
2 meg ohms tapped with switch 3" shaft **44c**
500,000 ohms with switch 2 1/4" shaft ...40c ea.

BRAND NEW WILLARD

*20-2 2 VOLT STORAGE BATTERY & 2 VOLT VIBRATOR

Used in General Electric model 2530 charge A PACK Portables. Suitable for all Farm Radio sets. Both sets bored, individually priced. Battery alone 2.49
Vibrator alone..... .99 **\$3.99** (Complete)



25% Deposit on All Orders—Bal. C.O.D.
All Prices F.O.B. New York City
WRITE FOR LATEST BULLETIN

SENCO RADIO INC. 96 WARREN ST. NEW YORK 7, N. Y.
TELEPHONE BEEKMAN 3-6498

FREQUENCY METER

(Continued from page 69)

the calibrating oscillator. (If a 2.5-mc crystal is substituted, its even harmonics will fall at 5, 10, 15 mc, etc., making it easier to check against WWV and other standards.—Editor)

To measure frequencies in the amateur bands, use the vernier oscillator. Connect a short antenna to its output jack and loosely couple to the receiver input circuit. Adjust the oscillator for zero beat with the signal and read the frequency from the dial and multiply the figure by the order of the harmonic. If the signal is not in the range of harmonics of the vernier oscillator, use the calibrating oscillator to adjust to zero beat. If the frequency is below 3.4 mc, compare harmonics of the calibrating oscillator with the fundamental or harmonic of the vernier oscillator. Higher frequencies are measured by zero beating with the fundamental of the calibrating oscillator and comparing its harmonics with those of the vernier oscillator. For example: Assume a frequency of 5.125 mc; not in the harmonic range of the vernier oscillator. Adjust the calibrating oscillator to zero beat. Its second harmonic, 10.250 mc with the third harmonic of the vernier oscillator when it is set at 3.4 mc. Other harmonics of both oscillators may be used if care is taken not to confuse them and thereby misread the result.

To measure the exact frequency of a nearby transmitter, connect a short antenna to the jack from the appropriate oscillator, to pick up the signal jack. Use phones to indicate zero beat between signal and oscillator. Determine the frequency by zero beating with the fundamental or harmonics of the vernier oscillator or by combinations of beats between the oscillators in the instrument and the transmitter harmonics.

The unit can be used as an unmodulated signal generator by using the calibrating oscillator and coupling to the desired circuit. Close coupling to a load does not disturb the calibration. It can also be used as an audio frequency generator by producing beats between any two of the oscillators. The voltage output is taken from the phone jack. The signal level will be low but is usually strong enough to be useful under most conditions.—B. J. Cederqvist, OH2NL

FCC License Learn Radio

How to prepare for theory exam in four weeks. **COPYRIGHTED METHOD OF STUDY FREE.**

WRITE

BOND RADIO

BOX 41, STEUBENVILLE, OHIO

EASY TO LEARN CODE

It is easy to learn or increase speed with an Instructograph Code Teacher. Affords the quickest and most practical method yet developed. For beginners or advanced students. Available tapes from beginner's alphabet to typical messages on all subjects. Speed range 5 to 40 WPM. Always ready—no QRM.

ENDORSED BY THOUSANDS!

The Instructograph Code Teacher literally takes the place of an operator-instructor and enables anyone to learn and master code without further assistance. Thousands of successful operators have "acquired the code" with the Instructograph System. Write today for convenient rental and purchase plans.

INSTRUCTOGRAPH COMPANY

4701 Sheridan Rd., Dept. RC, Chicago 40, Ill.

Bright future for television is seen by Frank M. Folsom, executive vice-president of RCA Victor. "By the end

FMT ★ FM TUNER Permeability Type

SPECIFICATIONS: An Oscillator-Mixer tuning the 88-108 MC. FM broadcast band. Permeability tuning-high "Q". One V.H.F. miniature tube employed—output equals 2 and 3 tube combinations. No drift after 30 second warm up. Sensitivity below 10 uv/m. FMT unit requires 2 1/2" x 1 1/2" space on chassis—less than an FM tuning condenser. Feeds into 10.7 MC or other I.F.'s. Dipole and serial connections. Completely assembled, and calibrated. Connect 3 voltage wires and it is ready to operate. Don't be satisfied with a box tuner on your radio, or some gadget in your aerial for the best FM reception. Assemble your own FM receiver, or build the FMT into your FM-45 receiver, and operate on the new band. Set makers, kit suppliers, and home radio builders will find the FMT economical, and a time saver in producing a high quality, dependable FM receiver. Introductory price (less tube) \$6.50 postpaid. Tube extra \$1.66. Instructions supplied with each unit.

Established 1922 **ORDER TODAY** J-M-P Mfg. Co. Zone 10, Milwaukee, Wisc.

of 1948," he says, "it is estimated that there will be 750,000 television receivers in the United States.

SPRAGUE TRADING POST

SWAP—BUY
OR SELL

FOR SALE—Meisner, 150B transmitter complete with exciter, tubes, coils, manuals, accessories and spare parts, phone and cw 150 watts output, ready to go, in perfect working order, \$275. D. C. Smyth, W1BOE, 14 Norwood St., Portland 5, Me.

FOR SALE—BC342-N a-c receiver like new, \$60; Neat 150w. c-w transmitter and power supply coils for 20, \$100; CML 2 meter converter and power supply, \$30; converted SCR522, 2m transmitter and power supply, \$38. Lyman C. Willard, Jr., WYDQB, 937 Bolling Ave., Norfolk, Va.

WANTED—Utah Add-a-unit transmitter kits, will consider separate units or all 5 complete. Jack D. Clement, Jr., W6NTR, 6612 Andros Ave., Van Nuys, Calif.

FOR SALE—Components of ham station. BX-28 receiver, \$150; National NTX-30 transmitter, \$70; S-20-R receiver, \$40; Supreme scope, E. Harris, W9KNK, 3319 Catalpa, Chicago 25, Ill.

FOR SALE—Slightly used postwar Hallcrafters S-38 receiver in A-1 shape, \$10. C. J. Johnson, 605 E. Second Ave., Mitchell, S. Dak.

WILL TRADE—New Mallory 6.44v, 1.5 amp. output dry-disc rectifier. Want meter size rectifier or low range a-c meter. Also have telegraph vibroplex and Morse telegraph transmitter, both needing some repairs, for trade. A. P. Nielson, 1521 W. 62nd St., Seattle 7, Wash.

FOR SALE—National HRO receiver RAS-3, rack mounted with power supply and speaker in 40" open frame rack. Have 9 sets of coils 50kc to 30,000kc, \$75 f.o.b. C. H. Campen, WSLVC, 3413 Gwynns Falls Parkway, Baltimore 16, Md.

WANTED—Inbred international code practice tapes for automatic photoelectric keyer. Edwin Conrad, 900 Guy Bldg., Madison, Miss.

FOR SALE—Hallcrafters SX-28 receiver, with matching speaker in new condition. \$175 F.O.B. Robert Wickham, Route 1, Beloit, Kans.

FOR SALE—Precision 920P tube and set tester, Vornax V7VM crystalline signal generator, set of Rider's Manuals, battery charger and voltohmmeter, all nearly new, in perfect condition, \$300. Harry Altman, 3989 Coolidge Ave., Culver City, Calif.

FOR SALE—Hallcrafters CVR S-41-G like new; 6 tube a-c-dc superhet tube including rectifier tube covers, 550kc to 300 mc/cycles in 3 bands, \$30. L. Latterman, Jr., 211 Mohawk St., Utica 3, N. Y.

WANTED—Old issues of Modern Electric, Popular Electricity, Q.S.T. 1919 and 1920. Cash or will swap for other old issues. J. T. Lipani, 157B Leverett St., Boston 14, Mass.

FOR SALE—Two new BC348-N army radio receivers converted to a-c current with matched speaker in cabinet, \$80 ea. Perfect. Roscoe J. Bailey, Weston, W. Va.

FOR SALE—FB7XA with National pre-selector and power pack, 80-40-21-10 bandspread; all now bypass and filter condensers, \$45. Wilbert Schwark, W9IHG, 193 West 12th St., Fond du Lac, Wis.

FOR SALE—G.I. Dual speed home recording mechanism, turntable, recording head, pickup head but less amplifier, \$25. Used only few times. S. Graham, RFD No. 1, Lincoln Park, N. J.

WILL TRADE—New Hallcrafters S-38 FM-AM covers 2 & 6 meters, comb from 27.5 mc to 143 mc in 3 bands with tubes and shock mounting less speaker. Want good camera in like condition as Leica, Kodak Mestral II or good reflex camera. E. G. Kistner, 3112 "D" Berkeley Drive, Philadelphia 29, Pa.

FOR SALE—Stewart-Warner cabinet radio, 8 tubes, chassis and speaker only, \$30 C.O.D. or will trade for FB7 nat. Frank Bow, 3131 N. Perch St., Philadelphia 33, Pa.

Cut yourself a bigger slice of the profitable business of minimizing radio INTERFERENCE from FLUORESCENT LIGHTS



Thanks to the Sprague IF-37 Interference Filter, it's easy to cut radio noises caused by fluorescent lights to the vanishing point. There's a lot of profitable service business to be obtained in this field — and one good way to get it is to display this big Sprague easel card on your counter. The card contains six IF-37 Filters and tells customers how they effectively reduce radio interference from fluorescent lights — even the kind that is con-

ducted through power lines to remote fixtures.

Order a supply of filters and cards from your Sprague jobber today. Cash in on this fast-growing business. One Sprague IF-37 Filter installed according to directions on each fluorescent fixture does the trick. And, in addition to selling IF-37's to customers, don't fail to use them to filter fluorescent lights in your own store, thus assuring better, quieter radio and television demonstrations!

Sprague IF-37 Filters Are Underwriters Approved

FOR SALE—Factory wired and aligned television i.f. containing both picture and sound channels; postwar design using 2 6BA6's, 2 6AB6's, and 2 6AL5's, \$32.50. Hartland B. Smith, W9VVD, 467 Park Ave., Birmingham, Mich.

FOR SALE—Preamp/ifier for Caltron 300 or 301 phono pickup, complete with 7F7 tube and instructions for connection to any amplifier or radio. \$5. Donald Wentworth, R.F.D. No. 2, Franklin, Neb.

FOR SALE—Complete NC-100 ASD radio receiver, range 200 to 400 kilocycles and 1300 to 30,000 kilocycles; power supply 115v, 50 or 60 cycles, or 25 cycles; excellent condition, \$120. Gabriel Cassetta, 352 S. Duquesne Ave., Duquesne, Pa.

WANTED—B & W 160 meter HDVL KV swing link coil. H. A. Davison, W9VEF, 115 Bensyl Ave., Danville, Ill.

FOR SALE—Minerva tropic master, 8 tube 2 band radio receiver; tuning ranges, 550 to 1600 kc, 5.5 to 18 mc; totally enclosed in gray metal cabinet, perfect, \$39 or will trade for test equipment. Maxim Appliances, 320 S. Central, Bartow, Fla.

WANTED—Sargent receiver II, universal 9.5 to 20,000 meters; state condition and price. Panchen Moore, 1787 Flagler Ave., N. E. Atlanta, Ga.

FOR SALE—New 861 tube, 872, 805, 03Z, 805, 830, 03A and others; CTC hermetically sealed transformers and chokes, new, not surplus. Want BC610 transmitter complete and working. State price delivered in York; also 6 propeller pitch motors. Nelson K. Stover, W3BBV, 1357 Hill St., York, Pa.

SELL OR TRADE—Pair of 2 meter transmitter-receivers, one portable and one 110v ac with built-in speakers for standby and Western Electric handsets, never used. Also Motorette motor scooter like new. Want Hallcrafters receiver and transmitter. W. T. Strippling, Box 912, Kermitt, Texas.

SELL OR TRADE—Two Jensen type D-151 bass reflex peri-dynamic enclosures, new in original shipping cartons. Less than cost, or what have you? Bert E. Ziesch, 1340-143 W. Grand Ave., Wisconsin Rapids, Wis.

WANTED—SX-25, SX-17 or similar receiver. Will answer all letters. John S. Forrester, 230 W. 79th St., New York 24, N. Y.

FOR SALE—TR-4 on 2 meters, worked over 150 miles for WIKLN, spare HY75, HY615, AC power supply by Abbott, 6 volts dc power supply, \$30. McMorrow, 132 Oakwood Ave., Troy, N. Y.

FOR SALE—10" original Vibroplex Bug, used but in excellent condition. \$5. M. E. Kunkle, Box 81, Harrison City, Pa.

FOR SALE—Instructograph, standard spring wound model with oscillator, 10 tapes, headphones, less batteries, \$25. Marc Moynaux, Jr., 402 S. Conception St., Mobile 21, Ala.

FOR SALE—Hallcrafters SX-24 with speaker, complete coverage 540 Kc. through 43.5 Mc. in A-1 condition; aluminum elements for 10 meter 3 element beam and home built R-934 less coils, \$90. John E. Horton, Jr., 2407 Harriet St., Racine, Wis.

FOR SALE—Hallcrafters sky champion S-20R in perfect condition with W-E phones, \$55. Maurice Ergang, 34 Hillside Ave., New York 34, N. Y.

WANTED—342 or 348 receiver in good condition and converted to AC operation. Julio Beliber Arroyo, % Pan American Airways, Inc., San Juan, Puerto Rico.

FOR SALE—RAK7 communications receiver with 110v power supply, \$40. D. M. Perkins, 106 N. Park Circle, Elkton, Md.

FOR SALE—Hallcrafters S-22R, new; will sell for \$50. Lloyd E. Matter, 900 High St., Williamsport, Pa.

FOR SALE—Broadcast monitor equipment including high quality speakers, amplifiers, professional recorder, FM-relay receiver, etc. Write for list. George E. Beggs, Jr., School Lane, Warrington, Pa.

FOR SALE—Webster-Chicago 80 wire recorder with volume and recording level indicator, complete with microphone and 3 spools of wire, \$140, or what have you? Nina Bodenham, Riceville, Iowa.

FOR SALE—Hallcrafters SX-28 receiver excellent condition, \$150. Chester M. Luchessa, W6BRV, 817 Jackson St., Albany 6, Calif.

FOR TRADE—Patterson 16 Communication receiver with 5 band receivers; 535 kilocycles to 37 mc/cycles (8 to 550 meters), all in good working condition. Need good signal generator and voltohmmeter. John P. Goncel, 713 N. Pelham Road, Jacksonville, Ala.

FOR SALE—Complete BC610 audio system speech amp-driver-modulator to modulate KW rig, also SX25 receiver and 450TLS. Want 100th's, 35T's. George Pasquale, 9421 Thornhill Road, Silver Spring, Md.

WANTED—SX25A. Will trade NC200 in excellent condition and pay difference. Chuck Boryswech, W2GWQ, 1068 President St., Brooklyn 25, N. Y.

FOR SALE—RME-45 communications receiver, \$150. C. E. Wampole, 1827 Pearl St., Anderson, Ind.

WANTED—Coils for 20-40-80 meter ham bands to fit BC610 exciter. Give price and details. C. H. Schindler, 103 Pine St., Perryville, Mo.

FOR SALE—BC-701-A receiver, complete with 12 tubes, \$35; also 1-150 d-c volt-meter, \$1.75; dynamic speaker, \$5; 58, 35/51, 2A7, 2B7, 27, 80, 2A5 and 47 tubes, \$35 ea. Robert Berles, 16106 Kedzie Ave., Harvey, Ill.

FOR SALE—Federal transmitter tenro 500 watt c-w converted for 10 meter amateur band, with all tubes, \$150, and brand new Turner U98 dynamic mike on stand, \$25. Ernie's Radio, 402 N. 3rd St., Hamilton, Ohio.

WANTED—Ham receivers reasonably priced, no surplus. Best Radio Shop, 3349 Fulton, Cleveland 9, Ohio.

FOR SALE—NC100X with S-meter and 10" matching speaker, \$75. W2BVL, 123 Park Place, Schenectady, N. Y.

FOR SALE—SX-25 in very good condition, just completely checked. Want HRO, 1946 model or older. Malcolm N. Wiseman, 216 Elm St. N. W., Washington 1, D. C.

FOR SALE—New post-war Tri-let 1621 tube tester, \$35; 7 volumes RCA service notes, 1931-1938, \$6; and Clough-Brennie 185 unimeter, in metal cast, perfect, \$35. Winter Sales & Service, Spooner, Wis.

Sprague Products Company, North Adams, Mass.

JOBBER DISTRIBUTING ORGANIZATION FOR PRODUCTS OF SPRAGUE ELECTRIC CO.

ASK FOR SPRAGUE CAPACITORS and *KOOLOHM RESISTORS by name!

*Trademark Reg. U. S. Pat. Off.

TELEVISION PARTS and EQUIPMENT SPECIALS!

10" TELEVISION KIT



A fine 10" television kit which has been designed around a new 10" tube. We guarantee this circuit to be the simplest to build and give results comparable to the most expensive sets sold.

- R F Unit wired at factory
- 4.0 MC bandwidth
- 26.4 MC trap tuned I.F. transformers
- FM Sound using a discriminator
- Very stable hold circuits
- More than 52 square inches of picture area
- Price complete with all tubes, less cabinet,

\$184.50

Above kit with cabinet, as illustrated, \$210.50

TELEVISION-CATHODE RAY HIGH VOLTAGE 2000 volt D.C. Power Supply

For an unbelievable low price, we can supply a completely filtered television or cathode ray 2000 volt D.C. power supply. Why bother with bulky and dangerous 60 cycle supplies or expensive R.F. power supplies when you can purchase a complete 2000 volt D.C. power supply (not a kit), ready to plug into the 110 volt A.C. power line. The ridiculously low price has been made possible by a fortunate purchase of high quality components. These units are brand new, completely tested and guaranteed. Here are the advantages:

- Low cost
- 2000 volts D.C. at 1 ma.
- Safe
- Small size
- Completely wired and tested
- Ready to connect to your television set or other equipment
- Will operate from 110 volts, 25 to 60 cycles.

PRICE **\$7.95**

At small additional cost, we can furnish these units to operate from 110 or 220 volts D.C. lines or 220 volts A.C.—any frequency. Write for quotation, giving us your requirements.

"FEATHERLITE"—TELEVISION ANTENNA

Frequency modulation and amateur antennas. Outstanding Features: Wide band response, Pre-tuned (no length adjustment required). Uses low power factor dielectric.

Easy to install. Can be rotated to eliminate "Ghost" (multipath distortion) and obtain maximum directivity. Can be titled for correct polarization angle. All metal construction. Guy wire supports. "Featherlite" Dipole

F. M. Model 88-108 MC	PRICE \$3.55
Television Model 44-216 MC	PRICE 4.45
60 feet 300 ohm twin lead	PRICE 1.65

"FEATHERLITE" DIPOLE AND REFLECTOR

Recommended for use where outside influences such as heavy motor traffic and excessive interference, require a special antenna installation.

Because of the design of these Dipoles they will increase signal strength received from forward direction and attenuate noise and interference from the rear, and prove these features:—Optimum back to front ratio. Does not require adjustment of antenna or reflector length. Rotates for maximum directivity. Attenuates interference signals.

F. M. Model 88-108 MC. PRICE \$6.25
Television Model 44-216 MC. PRICE \$8.75
Extra for 60" twin lead 300 ohm line. \$1.65

"FEATHERLITE" FOLDED DIPOLE

Under special circumstances such as operation at the limits of the service range and multiple antenna installations the "Featherlite" Folded Dipole antenna is recommended. It has all the features previously mentioned plus the following:

300 ohm impedance to match standard transmission line, maximum transfer of energy, high signal output.

F. M. Model 88-108	PRICE \$4.45
Television Model 44-216 MC.	PRICE \$6.95

All Prices are
F. O. B.
New York City

RADIO DEALERS SUPPLY CO.

135 Liberty St., New York, N. Y.

Available, a large stock of radio parts, test equipment, etc., at attractive prices.
Write for free catalogue.

WE SHIP
ANYWHERE
PROMPTLY

TELEVISION ENCYCLOPEDIA

by Stanley Kempner

The first non-technical reference book published on television in all its major aspects, by a leading writer on television.

Television Encyclopedia has 87 illustrations, is 384 pages long. It includes:

(1) *Historical survey of television*, marking the important milestones in its development.

(2) *Who's Who of Television*. Biographical sketches of the leading figures in television's history.

(3) *Glossary of technical and trade terms*. Television's vocabulary.

(4) *Survey of television's merchandising prospects*. A valuable appendix.

(5) *Bibliography*. Most extensive in print by far, on all types of literature in the field.

Of special interest to those having a career or hobby interest in radio, television, electronics. Also, advertising, publicity, publishing, home furnishings (manufacturing, wholesaling, retailing).

Invaluable as reference book for libraries, schools, research agencies.

Send \$6.50 (plus 2% sales tax in N.Y.C.) for your copy now.

Fairechild Publishing Co.

8 E. 13th Street, New York 3, N. Y.

C. FRANCIS JENKINS—TELEVISION ADVENTURER

(Continued from page 34)

man, of the de Forest television subsidiary. In July, 1929, he recommended that the drum type of scanner be dropped. The drum receiver, he said, caused the neon tube to burn out in a few hours, due to its being run at a very high intensity to compensate for the 60% loss of light in transmission through the quartz tubes. The commutator also introduced disturbances which had to be filtered out of the receiving set, and was also subject to delicate timing adjustments.

At about the same time, a prominent publicity engineer similarly attacked the work of the Jenkins organization as a whole: "I am perturbed at the progress made by others in the television field compared with that of the Jenkins organization: A year ago, at Lexington, Mass., I saw better pictures than Jenkins shows today . . . The RCA 60-line pictures are very good, better in detail than the Jenkins pictures . . . All others are showing half-tones while we play around with silhouettes . . . The work of Bell Labs. is far ahead of anything

we can dream of today . . . The Jenkins prizefight film is years behind what others are showing; it is so poor that I shouldn't care to invite newspaper men to see it. . . . It is only from true friends that you can learn the truth, so pardon my frank criticism . . ."

In 1930 shortly after this frank denunciation, Jenkins was asked to design a new receiver. He submitted the old drum type with quartz rods, which would not be acceptable to the radio public. His career as an inventor, or rather as an up-to-date designer, was ended, and his frenzied efforts to "beat the field" affected his heart. In August, 1931, it was reported that he was seriously ill, and that his life was despaired of. Three years later, after a lingering illness, he passed away.

(Continued on following page)

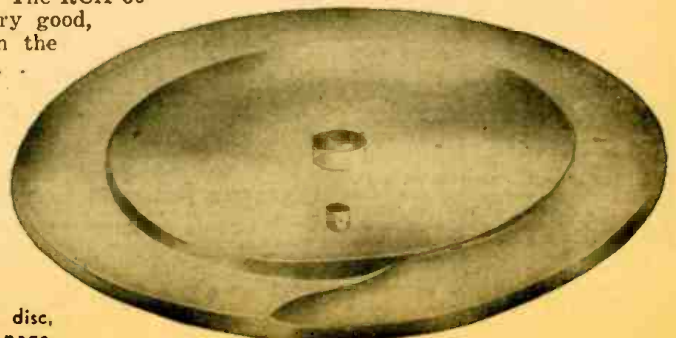

The prismatic scanning disc, described on opposite page.

The prismatic ring

One important element in Jenkins' early apparatus deserves full description here, since no clear explanation has been heretofore published of its nature and the method of its functioning; that is, the prismatic disc or ring.

This consisted of a glass disc (or ring) of selected mirror plate, ground along its outer circumference in a graduated way. From one end to a point half-way round it had its base outward; from this half-way point around to the other end it had its base inward. The warp from one end to the other was gradual. A beam of light passing through this device, when it was rotating, was caused to oscillate, having its hinged action fulcrumed in the plane of rotation of the prism ring. The oscillation was always in the plane of the diameter of the disc from the point where the light passed through the prismatic section.

In effect, the prismatic ring was comparable to a solid glass prism which changes the angle between its sides, "giving to a beam of light passing there-through a hinged or oscillating action on one side of the prism while maintaining a fixed axis of the beam on the other side of the prism," to quote the inventor directly.

A beam of light passing through a prism is bent toward its base. By mounting 2 disc prismatic rings so that their axes intersect at right angles, the beam can be bent both up and down, and left and right. Nearest the photograph to be scanned is the ring which bends the beam vertically, the other bends it horizontally. The second prism makes 100 revolutions to one of the first.

"For transmitting radio-pictures," said Jenkins, in his book entitled *Vision by Radio*, "we slice up the picture (figuratively) into slices .01 inch wide, by sweeping the picture across the light-sensitive cell with these rotating prismatic rings. With each downward sweep the picture is moved .01 inch to the right, until the whole picture has crossed the cell . . . The cell converts the light strengths into corresponding electrical values . . . In receiving, with the rotating prismatic rings we draw lines with a point of light across a photographic plate, varying the density as this is done by reason of the varying strength of the incoming signal.

"For sending radio-photographs the picture is projected with a magic lantern through 4 overlapping prismatic rings, 2 of which in rotation sweep the picture vertically across the light-sensitive cell, at the same time that the image is being moved laterally by the other pair of prisms. The light cell in its housing changes the different light values of the picture into electrical values. A rotating perforated disc between lens and cell changes the direct current into interrupted direct current, which is then sent through the amplifying transformer."

The reference to "4 overlapping rings" means that for horizontal as well as vertical prism scanning each disc really consisted of 2 placed side by



Espey Television Training Kit

Learn television through this unique "assembly line" procedure. Modern circuits and postwar design make up-to-the-minute training an absolute necessity. This ESPEY television training kit will help you understand and gain a working knowledge of TELEVISION—the latest development in electronics. FREE with every kit—a new type of pictorial instruction book, giving easy-to-follow, step by step method. No previous knowledge of television necessary to build—and LEARN from—this ESPEY kit.

FEATURES

- 18 tubes, including 15 miniatures.
- 3 stage, stagger tuned pix i.f.
- 2125 Mc sound i.f. Trap tuned.
- Balanced FM discriminator.
- Portable—weighs only 17 lbs.
- Uses 3" low-cost cathode ray tube. Magnifier makes 20 sq. in. picture.
- Can be aligned with ordinary test oscillator and V. T. Voltmeter.

KIT INCLUDES: all i.f., power, blocking oscillator transformers, chokes, capacitors, resistors, controls; speaker, and sockets riveted into place on punched and welded chassis. All tubes are easily-obtainable types available through Distributors everywhere.

FOR FURTHER DETAILS
WRITE TODAY TO:

ESPEY MANUFACTURING COMPANY, INC.

528 EAST 72ND STREET-NEW YORK 21, N. Y.

WAR SURPLUS SPECIALS

- SCHOOLS—EXPERIMENTERS—AMATEURS—
SERVICE MEN, ETC.
- #1—6 TUBE BEACON RECEIVERS—incorporates superheterodyne circuit; Three gang planetary drive tuning condensers; 1-6K7 RF; 1-8SA7 Conv. Osc.; 1-6SK7 IF; 1-6SP7 Det.-1st. audio; & 2-25L6's output. COMPLETE WITH TUBES & IN GOOD OPERATING CONDITION \$3.95
 - THE TUBES ALONE ARE WORTH THE PRICE ASKED. Complete with tubes & in good operating condition \$4.75
 - #2—5-TUBE BEACON RECEIVERS—Same as above except tube line-up as follows: 1-6K7; 1-8SA7; 1-6SK7; 1-6SQ7; & 1-2BD7 dual pentode pwr. output. COMPLETE WITH TUBES & IN GOOD OPERATING CONDITION \$3.95
 - #3—MARKER BEACON RECEIVERS—75MC.; 1-12CB & 1-12SQ7 tubes & SENSITIVE ADJUSTABLE RELAY—Closes at 4 ma. & opens at 2 ma. May be used to control external circuits from received signals, or to control models; open doors from a distance, etc.
 - COMPLETE WITH TUBES & SENSITIVE RELAY A SPECIAL \$2.95
 - ALL THREE UNITS HOUSED IN SMALL ALUMINUM CABINETS.
- 25% must accompany C.O.D. orders—ENCLOSE POSTAGE FOR PARCEL POSTS.
E. L. LUTTRELL "RADIO"
FORREST CITY, ARKANSAS

RADIO & ELECTRONIC BARGAINS

Triple 75 ohm T Pad 3 watts long shaft #L02 \$1.49
Weston 3/4" Type 301 50-0-50 ma # M11... 3.49
Hi Voltage Trans. 115v 50-60 c in 1200v 12 ma
out #T31 2.25

Write for additional bargains in parts and kits designed by ROBERT G. HERZOG.

Universal/general corp.

Dept. C-R
365 Canal Street, New York 13 Walker 5-9642

NEW LOW PRICES

TUBES—5Y3GT, .38, 35Z5, 35W4, ea. \$.42
TUBES—50L6, 12SA7, 12SK7, 1250755
TUBES—50B5, 12AT6, 12BA6, 12BE665
SAPPHIRE PHONO NEEDLE (List \$2.50)99
KNOB KIT—20 Ass'd Set Screw & Sp. Types . . .99
DIAL CORD KIT—100 Ft. Ass'd & 6 Springs . . .1.35
RESISTOR KIT—100 Ass'd 1/3 to 1 Watt1.95
BY PASS COND. KIT—35 Ass'd .005 to1.95
FILTER CONDENSERS—20-20 MFD. 150 V.44
SPRAGUE—40-20 MFD 150 V. FP Type55
RADIOS—5 Tube '48 Model (Nat. Known)14.95

Write Today for Bargain Bulletin
RADIO DISTRIBUTING CO., Pasadena 18, Cal.

side, overlapping, for optical correction. In the first prismatic rings there had
(Continued on page 124)

Coast-to-coast network television within 2 years is predicted by NBC executive Frank E. Mullen.



ESSE Specials!

RU-16GF-11

Transmitter & Receiver—12 Volts. (Do not confuse this with RU-17GF-12 which is 24 Volts.)

Transmitter frequency 3000-4525 and 6000-9050 Kc. Frequency changes by means of plug-in coils.

Receiver frequency 195-13,575 Kc. Frequency changes by means of plug-in coils.

Power output 12 watts on voice, CW, or MCW.

Dynamotor input 12 V. DC at 10 amps.—output 435 V. at 143 Ma., well filtered.

Mounted on rack about 13"x31" (transmitter and receiver shock-mounted). Has receiver remote tuning control with cable, junction box, receiver switch box, test meter and cord, antenna relay unit, instruction manual, and all tubes. All coils included.

Shipping weight approximately 100 lbs.

We have but a few of these left and will sell them at this bargain price of \$49.75

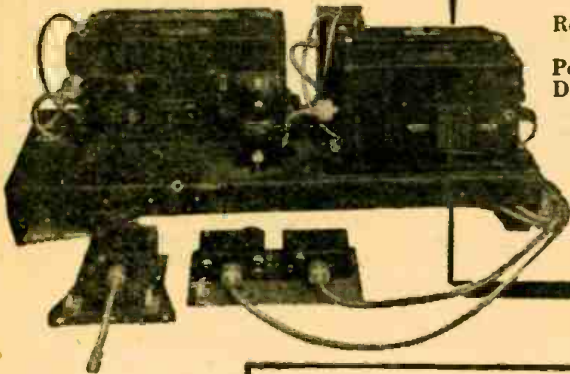

AIR COMPRESSOR

Made by the Cornelius Manufacturing Company. This small compressor will pump pressure up to 1500 lbs. per square inch. Compressor is 3-stage type air-cooled, powered by a 24 V. DC motor. This is one surplus item which your shop cannot afford to be without. Ideal for use with airgun, small paint sprayer, and numerous other applications.

This fine precision-built compressor only \$12.95 ea.

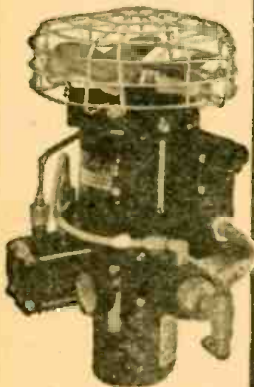

RADAR TRANSMITTER

T-39/APQ-9

Contains many excellent parts for the VHF experimenter such as a cavity oscillator using 2-RCA 8012 tubes rated at full output to 500 Mc. Tubes are forced air cooled by 24 V. DC motor, which is easily converted for 110 V. AC operation. Other valuable parts such as a pair of 807's, 2-6AC7, 1-931 and 1-6AG7 tubes; ceramic switch, potentiometers, gears, revolution counter, etc.

PRICE \$12.50

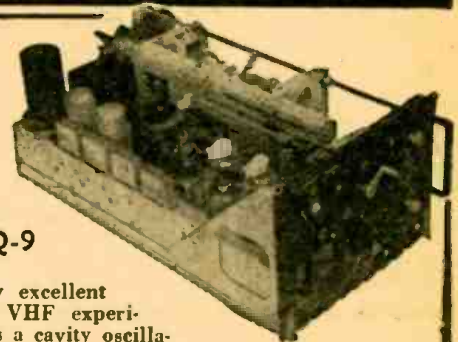

RADIO TUBES

We're overstocked —
we're unloading

7C5	each—	\$.35
7F7	each—	.35
7Y4	each—	.35
6V6	each—	.35
CW-931	each—	.35
30 (VT-67)	each—	.35
(Hi-freq.-low-loss base)		
6SN7	each—	.35
VT127A	each—	3.75
OZ4	each—	.70
12A6	each—	.35
1625	each—	.35
1629	each—	.35

All tubes checked before shipment.



CP-11/ APS-15

Contains following tubes: 13-6SN7-GT's, 3-6SA7-GT's, 1-5Y3-GT. 1: 24 V. motor and blower (blower will operate on 110 V. 60 cy.), 4 one megohm precision wire-wound resistors, 80-86 Kc. crystal, numerous other transformers, condensers, etc. Shipping weight approximately 25 lbs.

Price \$9.95

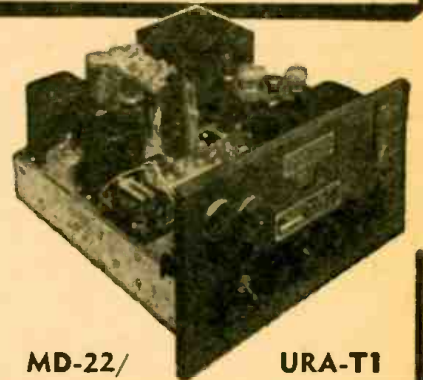

MD-22/

URA-T1

MODULATOR

Comes in metal carrying case. Size approximately 7"x12"x16". Operates from 6 or 12 V. DC or 110 V. 60 cy. AC. Was used by the Army as a source for jamming, by random noises, keying, or bagpipe systems. Contains 1-6SN7, 1-6V6, 1-6X5, 1-2050, and 3-991 tubes. Has jacks for microphone, output monitoring or connection to transmitter. Hams, experimenters, or servicemen can easily modify this to use as a source of audio power.

Price \$12.95

2-METER BEAM ANTENNA

Portable or fixed, manually operated or can be used with beam motor, for use in 100-156 Mc. band. Easily adapted for ham or experimental use. Contains tuning unit which matches output of transmitter to antenna, 18' steel mast with brass tube containing co-ax cable and fittings inside steel mast (OD color), "H" frame for holding dipoles, 3 sets (4 per set) dipole rods, compensator or sense antenna for "H" frame, 2 steel truncated cones used as antenna support and feed-through, 360 degrees bearing indicator, and handwheel for rotating. Brand new packed in six boxes, total weight approx. 600 lbs. Limited quantity and in much demand.

Place order now **\$147.50**



ANTENNA KIT 2A-264-126

Consists of 1 canvas bag containing 20 ceramic insulators each 3" long—1 1/4" dia. with screw-in type eyelets, one covered wire 5' long, 1 covered wire 10' long, 1 covered wire 35' long, 2 covered wires 25' long each, 5 covered wires 20' long each, (all wires included have 1/8" thimbles and 6" connecting leads at each end), wire 150' long, (all of this is stranded copper wire covered with weather-proof insulation). Brand new, packed in original boxes. Can be useful to any ham, serviceman or experimenter.

Each kit **\$6.75**

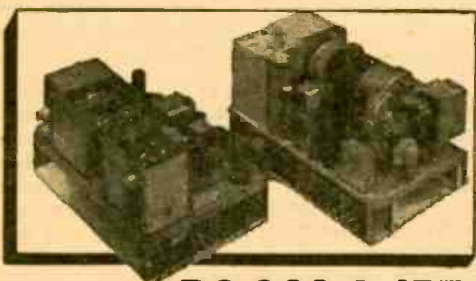

BC-966-A IFF

A 2-meter transmitter and receiver. Contains following: Pioneer Gen-E-Motor—18 V. input, 450 V. 60 Ma. output; 65 watt—40 ohm resistor; 1 Mfd. 1000 V. condenser; 4—10W current relays; 4—7193, 7—6SH7, 3—6H6; Eclipse Carbon pile type voltage regulator; etc. Requires only slight modification for 2-meter operation.

Price **\$4.75**

UHF MOTOROLA ANTENNA

Antenna for 27-42 Mc. complete with matching sections, 100 ft. amphenol transmission line, guy wires and 8 ft. shipping box as shown. Brand new. **\$35.00**

ROTATOR MOTOR FOR YOUR BEAM ANTENNA

24-33 V. AC or DC operated. Reversible—only 3 wires required. Approximately 1/4 RPM. 7056 to 1 gear reduction (no free swing). Powerful motor. Rugged precision gear train, and sturdy thrust bearing—will support and turn any ham beam. Weather-proof housing. Motors are easily converted into an FB beam rotator! Conversion data included. Rugged motor as pictured. . . . **\$9.95**

Same type motor only lighter constructed (not pictured) . . . **\$8.95**

Either of above motors with antenna mounting plates welded on—\$4.00 extra.

All equipment advertised herein is unconditionally guaranteed to the customers satisfaction to this extent: Return any item advertised within five days after delivery for full refund except transportation charges (both ways).

ESSE

Radio Co

130 W. New York St.
Indianapolis 4, Ind.

Unless Otherwise Stated, All of
This Equipment Is Sold As Used
CASH REQUIRED
WITH ALL ORDERS
Orders Shipped F.O.B. Collect

Announces
A New
LEOTONE Department!
HEARING AID COMPONENTS

These famous make units have many audio applications where space is limited.

- **BONE CONDUCTOR RECEIVER.** Sensitive dynamic type, suitable as **PILLOW** or **MINIATURE SPEAKER** or as **CONTACT** (musical pick-up) **MIKE**. 1 1/4" x 3/4" x 1/2" 2.95
- **CRYSTAL MICROPHONE.** Sensitive diaphragm type. Small size (1 1/4" O.D., 1/4" deep) Ideal for **REGULAR** or **CONTACT MIKE** or as **PILLOW SPEAKER**. Rubber shock-mid. metal frame. Less housing69
- **MIDGET OUTPUT TRANSFORMERS.** (13/16" x 3/4" x 1/2") One of the smallest made. High imped. to voice coil. Use in personal & portable sets, intercoms, etc.49
- **ALNICO V MAGNETIC PHONE UNITS.** (HS-30 headset replacement) Wide freq. response & sufficient volume for use as **PM** or **PILLOW SPEAKER**; **DYNAMIC** or **CONTACT MIKE**. 1/2" O.D. 1/2" deep39
- **MIDGET AUDIO CHOKES** 13/16" x 3/4" x 1/2" 4500 ohms DC resist. Many uses: filter, imped. coupling, etc.49

- 1 RPM HAYDON MOTORS. 110V. 60 cycle. 2.2W. Many timing applications. 2" O.D. x 1 1/4" 1.95
- 250 RPM DELCO MOTORS. 27V. DC. 5A O.D. 1 1/4" x 3 1/4" ALNICO PM field. 1.95
- 1/4 HP REVERSIBLE TURRET MOTOR. 3000 RPM. 27V. DC shunt field. 2.3A. O.D. 4" x 7" 3.95

- MERCURY SWITCH. 1A @ 110V. SPST. Silent action, non-inductive. O.D. 1/2" x 1 1/4"39
- STEEL ANTENNA SECTIONS. 39" x 1/2" O.D. Screw together to any length. Per sect.39
- NEON GLOW LAMPS (GE) 1/25 watt. 115V. Min. bay. base.08; 15 for 1.00

POWER RHEOSTATS
STANDARD BRANDS



- 25 watt—10, 25, 50, 100, 175, 250, 350 or 1250 ohms89
- 50 watt—2, 25, 40, 50, 250, 300, 500, 3K, 7500 or 10K ohms 1.29

HVY DUTY WIRE-WOUND
ALL WITH SHAFTS

- 25 watt—10, 25, 50, 100, 175, 250, 350 or 1250 ohms89
- 50 watt—2, 25, 40, 50, 250, 300, 500, 3K, 7500 or 10K ohms 1.29

HANDY RADIO PARTS KITS

- #3—Moulded Bakelite Condensers. 50 asstd. .0001 to .2mfd. 200-600WV. Clearly marked. 2.95



- 4—Tubular By-Pass Condensers. 50 asstd. .001 to .2mfd. 200-600WV. Standard bands 2.49

- 27—PRECISION RESISTORS. ± 1% wire-wound (Weston, Shallerross, etc) 1 watt. 10 asstd. 1.98

- 15—WIRE-WOUND RESISTORS. 15 asstd. ohmage. 5 to 20 watts.98

- 28—ROTARY SELECTOR SWITCHES. Six asstd. Standard makes. Multi-deck & ceramic insul. 1.75

- TUBES: Perfect condition, but in unsealed cartons. Most types in stock at up to 80% off list. Every tube guaranteed 90 days—
- #20, 27, or 4629
 - #42, 45, 75, 76, 77, 78, 80, 89, 5Y3, 6H6 or 6K739
 - #35, 36, 37, 39, 84, 5Y4, 6C5, 6F5, 6J7, 6U7, 6V6, 6SA7, 6SK7, or 12SK749
 - #1A7, 1H3, 1N5, 1R5, 6A3, 6U5, 6X5, 7A7, 7C5, 7C6, 7Y4, or 50B559

Get on our mailing list—Always something new!

PROMPT EXPERT SERVICE ON ALL SPEAKER AND PHONO PICK-UP REPAIRS
Min. Order \$2.00—20% Deposit Required on All Orders. Please Add Sufficient Postage.
WRITE DEPT. RC-1

LEOTONE RADIO CO.
MAKERS OF CONES AND FIELD COILS
65-67 DEY STREET, NEW YORK 7, N.Y.
WORTH 2-0284-5
12,000 SQ. FT. OF RADIO PARTS

TELEVISION COMPONENTS
for
DEPENDABLE performance

TELEVISION TRANSFORMERS—Used in television receivers, oscilloscopes, test equipment and high voltage, low current power supplies.

FREED NO.	HV AC VOLTS	DC MA	RECT V	A	FIL V	A	LIST PRICE
F-950	1700	4	2.5	2.			\$10.25
F-951	2000	2	2.5	1.75	6.3	.9	\$12.10
F-952	2500	2	2.5	1.75	6.3	.9	\$13.35

TELEVISION TRANSFORMERS — Used for a plate supply in television receivers (12 and 15 inch tube)

FREED NO.	HV AC VOLTS	CT DC MA	RECT V	A	FIL V	A	FIL V	A	LIST PRICE
F-960	775	225	5	3	6.3	1.75	6.3	10	\$14.80
F-961	800	300	5	3	5.	6.	12.6	10ct	\$30.75

TELEVISION TRANSFORMERS

FREED NO.	DESCRIPTION	LIST PRICE
F-970	Horizontal Blocking Oscillator Tr.	\$4.50
F-971	Vertical Blocking Oscillator Tr.	\$4.25
F-972	Vertical Output Tr. for Magnetic Deflection CRT	\$8.50
F-973	Horizontal Output Tr. for Electrostatic Deflection CRT	\$4.50

Send for catalog

FREED TRANSFORMER CO., Inc.
DEPT. R
72 SPRING ST., NEW YORK 12, NEW YORK

C. FRANCIS JENKINS
(Continued from page 121)

been a slight error, which was corrected by Jenkins by using 2 rings, (one with a plus error and one with a minus error) and cementing the 2 rings together.

The prismatic rings were not intended for radio movies at first, but for a high-speed continuous camera (as opposed to the ordinary intermittently moved film), and were so described by Jenkins at the Montreal meeting of the SMPE in May, 1920.

The prismatic ring device was really a deflection apparatus, or, in other words, a scanner. It took the place of the scanning disc but was continuous in operation rather than intermittent. Jenkins was very proud of this device, because it emphasized elegance in the solution of scanning. Simply speaking, he used an "interposed variable prism" instead of a helical scanning disc. It was a very complete and technically elegant device even though complicated and expensive.

Jenkins the man

The indomitable will and faith which C. Francis Jenkins always exhibited are clearly evidenced by his oft-expressed statement, "If a thing is very difficult, it is as good as accomplished; if it is impossible it will take a little time." The same idea is shown in his treat-

ment of two brilliant scientists whom he obtained from one of the great laboratories of the country. "They did not last long with us," said Jenkins later, "because they spent too much time proving why it wouldn't work instead of figuring how to do it."

He wanted his assistants to carry out his ideas implicitly, even when they were impractical or even impossible. He sur-



Fresh BEANER
Suggested by: Grego Banskuck, New York City



PS-1



CH-1



FV 1



CH-1

rounded himself in his Washington laboratory with young men and women, "because," he said, "if Jenkins tells them it can be done, they believe it." This had much to do with his final failure, for a few trained engineers in his employ might well have been able to carry his plans from an amateur to a practical status.

However, he gave full credit to these idolizing assistants. After he had succeeded in broadcasting radio movies in 1929, he stated in his dedication of his book *Radio Movies and Television*, published in that same year:

"This thing is done, the long pull is ended. We are broadcasting radio-movie entertainment to thousands, and the credit, in no small measure, is due to the clever and charming young folks who have worked with me—Sybil L. Almand; Florence M. Anthony, Vera T. Hunter, John N. Ogle, Stuart Jenks, Paul Thomsen and Elwood Russey."

He was a man of great vision, with the courage of his convictions, of indomitable will and boundless energy. He loved his fellow men, and was in turn respected by all who knew him and loved by those who had the opportunity of being associated with him. But he had great defects: he was an amateur first and last, and to him inventions were playthings; he would not have others with him who might translate his devices into more practical form, but insisted that they be made by his "adoring assistants" exactly as he directed. Burning with ambition, he admitted no thought of fault or failure, and when he had reached the high point of the old scanning technique, he could not go beyond. Others did.

During his life span, he built the prototype of the moving picture projector now in every movie theater; he invented the spiral-wound all-pasteboard container still so universally used; and as his contributions to radio and television, the foregoing pages will suffice. He was a member of the Franklin Institute, the American Association for the Advancement of Science, the National Aeronautic Association, and was founder and first president of the Society of Motion Picture Engineers.

Pasted in his Washington laboratory was the motto:

"They said it couldn't be done, but he, poor fool, didn't know it and went ahead and did it!"

which is another form of the common expression:

"People saying it can't be done are constantly being interrupted by people doing it."

And, as Zworykin might have said: ". . . by people doing it better!"

The foregoing abstract has been obtained from Mr. Jenkins' three published books—[*Vision by Radio* (1925), *Radio Movies and Television* (1929), *The Boyhood of an Inventor* (1931)]; from *Proceedings of the Society of Motion Picture Engineers*; and from numerous other publications; but chiefly from data copied by the author from Mr. Jenkins' scrapbooks, by permission of the late Mrs. Jenkins, and through the kind intermediation of Miss Florence Anthony, former assistant to Mr. Jenkins and later companion to his wife. Many of the photographs accompanying this article were likewise obtained through the courtesy of Mrs. Jenkins.

TELEVISION INDUSTRIES

This Sensational Picture IF & Sound IF Strip developed by our engineering staff and enables you to build a 10"-12" 15" - 20" Direct View or Projection Type Receiver with FM Sound Supplied with a 13 Channel RF Front End Unit

PICTURE IF & SOUND IF STRIP

PATENTS PENDING

Chassis Size
4 1/2" x 13" x 5"

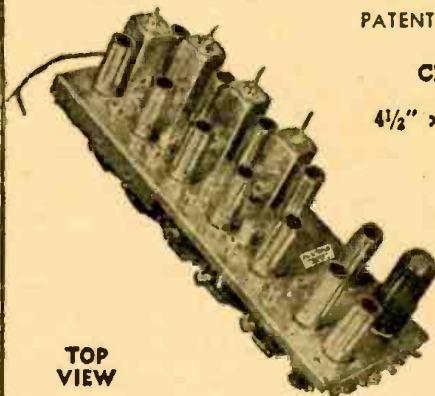

TOP VIEW

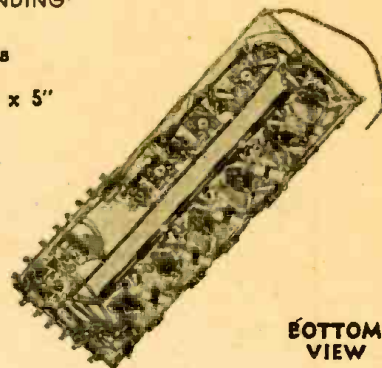

BOTTOM VIEW

1. PICTURE IF STAGES

Five picture IF stages of amplification and second detector

2. SOUND IF STAGES

Two IF stages with limiter and discriminator

3. VIDEO STAGES

Two stages of Video with a frequency response of 4.5 mc/s

4. ONE D.C. RESTORER

5. IF FREQUENCY

Audio 21.25—Picture 25.75

6. TUBES

5—6J6—Picture IF Amplifier

1—6J6—Picture IF Amplifier & Detector

1—6AU6—1st Video Amplifier

1—6K6gt—2nd Video Amplifier

1—6AU6—Limiter

1—6AL5—D.C. Restorer

1—6AL5—Discriminator

2—6BA6—Sound IF Amplifier

Picture IF Band Width 4.5 mc/s

• All the Above Circuits and tubes are contained on 1 chassis. • Front End Unit on separate chassis. • Both Picture IF & Sound IF delivered completely wired, tested, tubed, and matched ready for use.

FRONT END

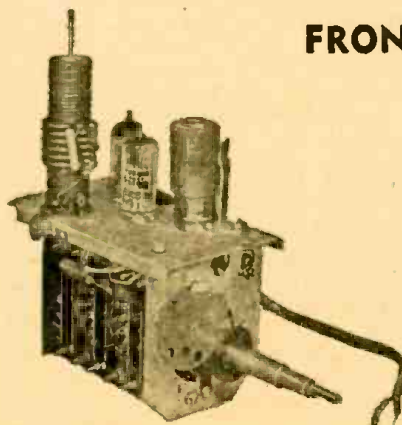

The Front End covers channels from 44 to 88 mc/s and 174 to 216 mc/s (13 channels). Matched antenna input for 300 ohm line. Tubes: 1-6J6 RF Amplifier 1-6J6 Converter 1-6J6 Oscillator

PRICE **\$119.50**

DEALERS NET

Contact Us for your Local Distributor

TELEVISION INDUSTRIES

540 BUSHWICK AVE.
BROOKLYN 6, N. Y.

HEATHKIT AMPLIFIER KIT



\$14.95

Build this beautiful push pull 25 Watt amplifier and save two-thirds of the cost. Every part supplied. RCA power transformer, oil filled condensers, 4 tubes (one dual type). Tone control, output transformer, etc., excellent fidelity, phase inverter, and chassis punched and formed. This amplifier is ideal as public address set or high quality phanograph radio amplifier. Add postage for 20 pounds.

HEATHKIT TRANSMITTER KIT



**Complete KIT
\$19.50**

A best buy in an amateur transmitter kit. Circuit uses latest post war improvements, can be modified to cover 80-40-20-10 meters with 25 Watt output. Comes complete with 80 meter crystal, speech amplifier, 80 meter coil, four tubes, cabinet, beautiful panel and all additional parts needed less power supply. Blueprints and instructions included. Power supply kit \$10.00 additional. Add postage for 20 pounds, 8 pounds for power supply.

SCR-269F AIRCRAFT RADIO COMPASS

Brand new SCR-269F compass, complete less inverter at less than WAA wholesale. Complete in original cartons.

\$34.95



HEATHKIT SIGNAL GENERATOR KIT



Complete kit to build a fine service instrument. Supplies fundamentals 150 KC to 30 MC. Complete with beautiful panel, cabinet, tubes, controls, coils, blueprints and instructions. Supplies RF, modulated R.F., and AF. Build it yourself and save two-thirds the cost. Add postage for 8 pounds **\$19.50**

T32 TABLE MICROPHONE

One of the Army's best. Built by Kellogg, ideal for factory call system, public address, amateur use. Brand new in original cartons, **\$2.95** add postage for 5 lbs.



COMMAND SET ACCESSORIES



110V power supply kit with 24 volt filament, no wiring changes inside set, punched chassis and volume control **\$5.95**
5" PM speaker with output transformer, matching headphone output..... **\$2.80**
Dual receiver rack FT 277A with connecting plugs..... **\$1.00**
Shock mount for above rack..... **\$1.00**
Single transmitter rack..... **\$1.00**

TRANSFORMERS AND CHOKES

We are preparing a catalog listing over 100,000 transformers. Write for list. Thousands as low as 25c each.

AN/APN-1 RADIO ALTIMETER

Brand new complete units at less than WAA wholesale, supplied with antenna plugs, indicator, switch, etc., limited quantity available, in original cartons..... **\$39.50**



TS-16 APN Test sets sold only with quantities of 50 or more **\$89.50**

PE-125 AX POWER SUPPLY UNIT

Companion power supply unit to the BC-223 transmitter and BC-312 receiver. Supplies 500V at 160 MA from either 12 or 24 volt input. A beautiful unit, complete with relays, fuses, filters etc. Brand new, in original crates **\$9.95**



The HEATH COMPANY

BENTON HARBOR, MICHIGAN

TWO NEW HIGHS IN VALUE

Kit model FM-7, a splendid, low-priced, self-contained table model Frequency Modulated Radio Receiving Kit



Complete with tubes, speaker and beautiful Bakelite cabinet. The FM-7 has a frequency response of 86-110MC, can also be used as a TUNER with a high quality amplifier. A phonojack is provided in the rear of the chassis

with double pole, double throw switch for feeding signal to either the radio speaker or to the phonojack. An additional jack for connecting extra loud speaker is included. The R.F. section of kit is pretuned at factory. This kit uses 2 I.F. stages, 1 limiter and 1 discriminator. Miniature tubes used throughout. Price of Model FM-7 complete as described **\$29.95**



Kit Model 210, a Three Way Portable Receiver

Operating on either AC or DC or self-contained batteries... power switch conveniently located on front of set so that "battery" or "AC-DC" may be selected without opening case.

Five-inch Alnico 5 permanent magnet dynamic speaker, and case covered with weather tested aircraft material. Price of Model 210 complete with tubes. **\$18.95**

All kits accompanied by a detailed illustrated instruction sheet. Many other kit models available. Write for catalog M.

Now ready! New educational pamphlet... complete and simplified diagrams and instructions on all our models..... 50c

RADIO KITS COMPANY

120 Cedar Street, New York 6, N. Y.

TELEVISION AND FM ANTENNAS

(Continued from page 46)

A multiple FM folded-dipole antenna, as designed by Rauland, is shown in Fig. 12. It has 7 folded loops or dipoles arranged horizontally, and it tunes to all frequencies from 88 to 108 mc. The center of each loop is spot-welded to the ground plate. The antenna requires no special orientation. The broad directivity pattern is shown in Fig. 13. The average standing wave ratio is 2, and the surge impedance 300 ohms.

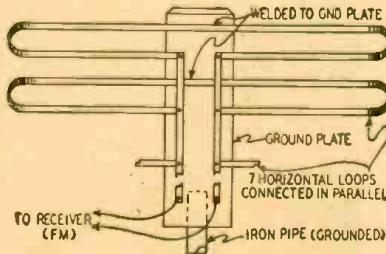

Fig. 12—Part of a multiple doublet antenna.

The double dipole and reflector array shown in Fig. 6 is peaked for 62 mc (center of the lower television band). As the curve of Fig. 14 shows, the surge impedance varies from 100 ohms at the lower end of the band, to 350 ohms at the upper end, the average impedance being about 200 ohms. The standing wave ratio is also shown; if this falls

(Continued on page 138)

Every Radio
Serviceman Needs
This **FREE**

68
PAGES

AC-DC

BALLAST

TUBE MANUAL

To get YOUR FREE COPY of this indispensable manual (value \$1.50) merely mail in to JFD Radio Dial Belt flaps from JFD Radio Dial Belt envelopes; include 10c in postage to cover mailing cost. (Buy your JFD Dial Belts and Belt Kits from your nearest parts jobber.)

JFD's new 68-page Ballast Manual is a treasury of information for Radio Servicemen and Dealers — Lists more than 3000 radio ballasts — ACDC Ballasts for Fluorescent lights and electrical appliances — 220 volt to 110 volt Stepdown Ballasts.

Send 12 Envelope Flaps to:

J.F.D. MANUFACTURING CO. INC.

4109-4123 FT HAMILTON PKWAY, BKLYN 19, N. Y.

PROGRESS IN TELEVISION

(Continued from page 22)

mit the eye to see enlarged images of microspecimens formed with these invisible radiations. The flying-spot microscope, shown schematically in Fig. 11, serves instead to present the greatly enlarged microscope images to extended audiences, with a brightness which is independent of the illumination of the specimen. For this purpose a television scanning pattern formed on the very-short-persistence fluorescent screen of a cathode-ray tube (a "flying-spot tube") is imaged by a high-resolution optical

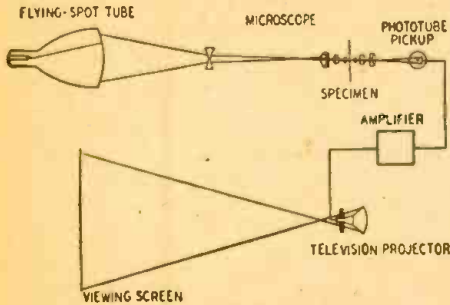

Fig. 11—Action of the flying-spot microscope.

microscope to greatly reduced scale on the microspecimen. The transmitted light is directed by a second microscope objective onto the cathode of a multiplier phototube. The amplified output signal of the latter modulates the beam current in the kinescope of a television projector which forms a greatly enlarged image of the microspecimen on a screen, its deflection being synchronized with that of the flying-spot tube.

Many of these developments are still in an experimental stage. However, they illustrate the fact that television broadcasting represents but one phase of the application of television techniques. Industrial television offers a possibly even broader range of opportunities to the researcher and experimenter and may be expected to develop into a tool of increasing value in the coming years.

WORLD-WIDE STATION LIST

(Continued from page 106)

20.000 WWV	WASHINGTON, D.C.: U.S. Bureau of Standards
21.470 GSH	LONDON, ENGLAND: 0500 to 1215
21.460 KCBA	DELANO, CALIFORNIA: South American beam, 1900 to 2400
21:500 WOOW	NEW YORK CITY: European beam, 1100 to 1500
21.530 GSJ	LONDON, ENGLAND: 0500 to 0815
21.550 GST	LONDON, ENGLAND: 1030 to 1130
21.570 WCRC	NEW YORK CITY: European beam, 1100 to 1630
21.590 WGEA	SCHENECTADY, NEW YORK: European beam, 1200 to 1500
21.610 WNRA	NEW YORK CITY: European beam, 1000 to 1700
21.640 GRZ	LONDON, ENGLAND: 0600 to 0900
21.650 WLW82	CINCINNATI, OHIO: North African beam, 1200 to 1500
21.650 WLW51	CINCINNATI, OHIO: European beam, 1200 to 1500; South American beam, 1900 to 2400
21.690 WLWLI	CINCINNATI, OHIO: European beam, 1100 to 1700
21.730 WNRX	NEW YORK CITY: European beam, 1100 to 1330
21.740 KCBF	DELANO, CALIFORNIA: Japanese-Chinese beam, 1700 to 2330
21.750 GVT	LONDON, ENGLAND: 0100 to 0500; 1030 to 1130
25.000 WWV	WASHINGTON, D.C.: U.S. Bureau of Standards; continuously day and night
26.100 GSK	LONDON, ENGLAND: 0615 to 1000
30.000 WWV	WASHINGTON, D.C.: U.S. Bureau of Standards; continuously day and night
35.000 WWV	WASHINGTON, D.C.: U.S. Bureau of Standards; continuously day and night

Multiple Range Continuous Indicating PORTABLE TACHOMETER



This unit is of the centrifugal mechanical type and is designed to show INSTANTANEOUSLY and CONTINUOUSLY the speed or change in speed of any revolving shaft or surface. No stop watch or other mechanism required.

- Three ranges in R.P.M., and three ranges in F.P.M.
 - Low Range 300-1,200 (Each division equals 10 R.P.M.)
 - Medium Range 1,000-4,000 (Each division equals 20 R.P.M.)
 - High Range 3,000-12,000 (Each division equals 100 R.P.M.)
- Large open dial 4" diameter.
- Ruggedly constructed for heavy duty service.
- Ball bearing and oilless bearings—require no lubrication whatsoever.
- Readily portable—Fits neatly into palm of hand.
- Gear shift for selecting low, medium and high ranges.
- Greatest accuracy—meets Navy specifications 18-T-22, Type B, Class A.
- Complete with the following accessories:
 - 1—Steel tip
 - 1—Conical Rubber tip metal mounted
 - 1—Rubber lined metal cone tip
 - 1—Peripheral Rubber wheel 1 ft. in circumference
 - 1—Extension Rod
 - 1—Small size convex rubber tip, metal mounted
 - 1—Operating instruction

Made by Jones Motrola, Stamford, Connecticut. Comes complete in blue velvet lined carrying case; 7 1/4" L x 4" H x 5" W. List Price \$75.00—Surplus—New—Guaranteed.

Your Cost \$24.50 fob. N. Y.

Portable (Chronometric) TACHOMETER



Jaeger Watch Co. Model #43A-6

- Can be used for speeds up to 20,000 R.P.M.
- Can be used for lineal speed measurements to 10,000 F.P.M.
- Ideally suited for testing the speeds of motors, particularly of fractional horse power, generators, turbines, centrifugals, fans, etc.
- Very small Torque—requires practically no power to drive.
- Unequaled Readability 2" Open face dial—each division on large dial equals 10 R.P.M.; each division on small dial equals 1,000 R.P.M.
- Greatest Accuracy—meets Navy specifications—guaranteed to be within 1/2 of 1%.
- Results of test reading remain on dial until next test taken.
- Push button for automatic resetting.
- Complete with the following accessories:
 - 1—Large pointed rubber tip
 - 1—Large hollow rubber tip
 - 1—6" circumference wheel tip
 - 1—Operating Instructions
 - 1—Temperature Correction chart

The combination of the above features will give accurately, within a few seconds, by direct reading, the R.P.M. of shafts or the lineal speeds of surfaces without any accessories or timing of any kind. Each unit comes complete in a red velvet lined carrying case 5" x 3 1/2" x 1 1/4". Net List Price, \$75.00—Surplus—New—Guaranteed.

Your Cost \$24.50 fob. N. Y.

D.C. MICROAMMETERS

100-0-100 microampere—zero center—approximately 950 ohms resistance—W.E.—3 1/2", rd fl bako case—concentric style	\$6.50
200 microampere mvt—G.E. DO-41—Knife edge pointer—sc mkd "Set Carrier"—supp with paper V.O.M.A. sc—3 1/2", rd fl bako case	\$4.95
500 microampere mvt—G.E. DO-41—sc cal 0-20 KV—supp with paper V.O.M.A. sc—3 1/2", rd fl bako case	\$4.95
400 u mvt—approximately 500 ohms resistance—Triumph—sc cal 0-3, 0-15 and 60 v MA—1" Rect fl bako case—Knife edge pointer	\$5.50
McClintock 2" rd ring, mounted metal case—0-700 microamperes D.C.—Full scale 0-100 microamperes D.C. Half scale, 0-1 MA A.C. Full scale and 1 1/2 Volts A.C. Complete with self contained half wave rectifier. Black scale, luminous markings, scale 0-10	\$2.50

SPECIAL METERS

Frequency Meter—Dual Range—covers frequency ranges from 48 to 52 cycles and 58-62 cycles—J.B.T. 30-F—Dual element. Vibrating Reed type—1 1/2 V—3 1/2", rd fl metal case	\$5.95
Voltage Polarity Phase Rotation Tester—Tripiett 337 AVP—Checks 115, 220 and 440 line voltages—locates open circuits, blown fuses, damaged wiring, etc. Indicates whether A.C. or D.C. and polarity of D.C.—Checks phase rotation to determine direction of rotation of motors, operation of controls, etc.—Consists of a 3" square meter and a small polarized vane movement in a small handy sized case—Complete with 36" leads with test leads	\$8.50
Running Time Meter—G.E. SKTS—10-15 Volts, 60 cycle—totals up to 99,999 hrs—3 1/2", rd fl bako case	\$3.50
DECIBEL METERS—Weston 301, Type 21, 3 1/2", rd fl bako case, minus 10 to plus 6, 6 MW., 600 ohms; General purpose type 0.5-0.7 Second to final reading, 45-62% overthrow, 5000 ohms internal resistance at ODB	\$3.50
DB Meter—W.H. RC 35—minus 10, plus 6 ODB—1.897 V, 6 MW—600 ohms—3" square	\$4.50

All items are Surplus—New—Guaranteed. C.O.D.'s not sent unless accompanied by 25% Deposit. Orders accepted from rated concerns, public institutions, etc., on open account. The above is only a partial listing of the many items we have in stock. Send for free circular. MANUFACTURERS, EXPORTERS, DEALERS—we invite your inquiries.

MARITIME SWITCHBOARD

336 Canal Street

Worth 4-8217

New York 13, N. Y.



If you are an experimenter, ham or otherwise—if you have a yen for self-constructed apparatus, you'll appreciate both of these handy, popular works. They are practical, easy-to-follow books, designed entirely for the man who likes to put things together. The methods recommended for constructing each piece of equipment have been proved sound and effective by actual experience. The instructions are written in a style easy to follow; supplemented with helpful illustrations—photos shot from various angles, carefully drawn schematics, etc.; also a list of parts.

These two books (descriptions follow) are but two of the ten volumes of the RADIO-CRAFT LIBRARY SERIES, all topnotch, up-to-date reference works which you should own. The cost, 50c per copy, is trifling when you consider the wealth of benefit you get out of each. Order them today—fill out the coupon below.

NO. 35—AMATEUR RADIO BUILDER'S GUIDE

This book is a treat for the ham who gets a kick out of building his own equipment. The results will be a credit to any ham shack. Just look at the range of apparatus described. The first section is devoted to high-grade superhet receivers; the second section to various type transmitter circuits, ranging from a small flea-power rig that may be stowed away in a little bag to a deluxe job running well over a quarter-kilowatt. A small microwave transmitter is included. The last section is devoted to station accessories such as rotary antennas, preselectors, and frequency meters. The following are actual chapter heads: *Miniature Communication Set; An Advanced 15-Tube Set; Economy Receiver; 50 Watts on C.W.; Beam Power 3; 430 mc with a 6F4; A.C.-D.C. Transmitters; Power-Supply Design; Roof-Top Rotary Beam; A Signal Booster; A.C.-D.C. Frequency Meter.*

NO. 36—RADIO TEST INSTRUMENTS

You will find many good reasons why you as an experimenter should use this book to help you build test instruments:

To supplement your factory-built instruments with a more complete line.

To have stand-by instruments on hand while regular ones are out on jobs.

To provide small portable instruments for outside jobs and thereby permit the commercial instruments to stay on the bench.

To gain valuable experience building your own instruments.

You will be surprised at the variety of instruments in each field covered in this book. Chapter heads tell their own story: *A Versatile Tester; Electronic Multichecker; A Compact Multitester; Portable Shop; A Sensitive Tracer; Midget Signal Tracer; Triode-Probe Tracer; The Capacitester; A Capacitance Meter; Capacity Bridges; The Transigenerator; A Wide-Range Generator; Simple Audio Generator; Dynamic Tube Checker; Modernizing Old Testers; V.T.V.M. Adapter; Meterless Voltmeter; V.T.V.M. & Oscillator.*

SEE YOUR RADIO DEALER. IF HE CAN'T SUPPLY YOU

MAIL THIS COUPON

RADCRAFT PUBLICATIONS, Dept. 18
25 West Broadway, New York 7, N. Y.

Send me the volumes (50c each, postpaid) checked. My dealer is unable to supply.

No. 35—Amateur Radio Builder's Guide No. 36—Radio Test Instruments

8 OTHER BOOKS 50c EACH

No. 29—Handy Kinks and Short Cuts No. 33—Amplifier Builder's Guide
 No. 30—Unusual Patented Circuits No. 34—Radio-Electronic Circuits
 No. 31—Radio Questions and Answers No. 37—Elementary Radio Servicing
 No. 32—Advanced Service Technique No. 38—How to Build Radio Receivers

I enclose.....

Your Name Address.....
(Print Clearly)

Radio Dealer's Name Address.....

BLOCK THAT GHOST!

(Continued from page 42)

For general television use, the folded dipole has several advantages. It has an impedance (center) of 300 ohms, which permits exact matching with standard 300-ohm ribbon lead-in. Because of this relatively high impedance the folded dipole has a wide band-pass characteristic, which permits operation over a wide range of frequencies. Although resonance is determined by the length of the folded dipole, the dimension is not critical. For this reason, the folded dipole—sometimes known as a wide-band antenna—has only fair selectivity.

This sacrifice of selectivity also affects, to a lesser degree, the directivity of the antenna. Therefore, it is more difficult to block unwanted ghost signals with any of the conventional types of folded-dipole antennas.

Although this antenna is usually capable of receiving several television

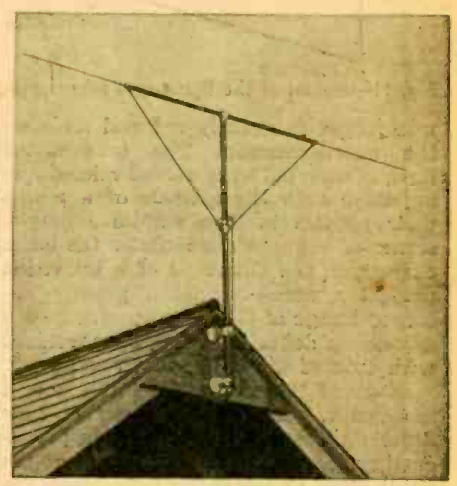

Photo by Premax Products
Fig. 10—Extended-V, an all-channel antenna.

channels, ghost-free reception of only one channel is certain. When a folded dipole is oriented for ghost-free reception from one station, such a fixed position of the antenna will rarely provide ghost-free reception of the other television channels, since the locations of the transmitting stations and all of the various sources of image reflections will be different with respect to the site of the receiving antenna. Any attempted use of folded-dipole antennas for reception of more than one television station must be based on a compromise orientation which, from the outset, precludes any possibility of ghost-free reception on all of the desired channels.

An important variation of the basic folded dipole—known as the Duoband antenna (Fig. 8)—has a bat wing addition to a normal dipole, permitting wide-band operation of the antenna in both the high- and low-frequency television bands. Admittedly, there is only slight improvement in the directivity of antenna on any of the channels in the low-frequency band. When used on any of the high-frequency channels, however, the small bat wings provide a very sharp directional pattern, permitting

ghost-free reception on at least 1, and sometimes 2, of the so-called upper channels. If greater directivity is needed on any of the lower channels, a more-or-less conventional reflector element is attached a quarter wave behind the large folded dipole.

A combination of 4 folded dipoles, connected in phase (Fig. 9), provides exceptionally high directivity over a wide range of operating frequencies. As for all types of folded dipoles, however, its chief drawback is that when the antenna array is oriented for ghost-free

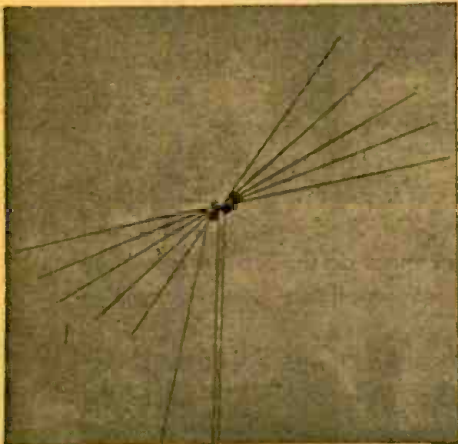
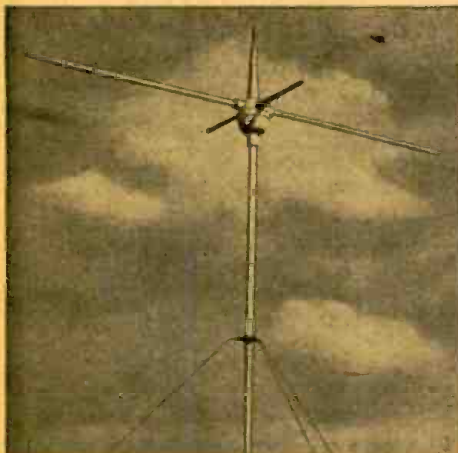

Fig. 11—The Di-Fan, not highly directional. reception on one channel, multiple-image interference may often hopelessly mar reception on other television channels.

Special types

A number of other antennas have been designed for all-channel reception, but only a few of these special types are sufficiently directional to provide ghost-free reception of a single channel.



Kings' Electronics

Fig. 12—This antenna turns to best position.

The extended V-type dipole (Fig. 10) combines some of the better features of the simple dipole with an ability to operate equally well on any television channel. Entirely ghost-free reception is usually possible on one channel, depending on the orientation of the antenna. This is the only television antenna which compensates for the wave distortion normal to all television signals, and therefore gives a much clearer picture. With an impedance rating of 300 ohms, a standard transmission line can be connected directly to the antenna.

Another wide-band type of antenna

TELEVISION TRANSVISION KITS

A magnificent 12 inch television kit that can be built easily and quickly. Performance that will shatter all previous conceptions of television quality and value. It's the TOPS IN TELEVISION.



No knowledge of television or radio required to construct this newest Transvision Triumph. All difficult circuits are preassembled, wired, tested and aligned. No test instruments or other equipment are needed. Soldering iron, cutting pliers and screwdriver are the only tools used. **\$289.00 List Price**

Radionic also offers a sensational new television kit equipped with a 15" tube. **\$348.75 List Price**

WRITE FOR DEALER'S PRICES

All Transvision Kits and Parts Carried In Stock

WEBSTER-CHICAGO WIRE RECORDER

The Famous Webster Wire Recorder Chassis. Records temporarily or permanently up to one hour on one spool of wire. Requires small amplifier (Broadcast set audio systems may be used), mike and speaker. Webster Model 79



\$52.34

Complete Recorder and reproducer in attractive portable carry case. Webster Model 80 **\$149.50**

GE Variable Reluctance Pickup **\$4.67**

Pickup arm for Webster 56 Record changer to accommodate above pickup **\$1.20**

FREE RADIONIC CATALOG

Write TODAY for your FREE Radionic Parts & Equipment Catalog. It's a MUST for all service dealers, amateurs, experimenters, industrials, institutions and government agencies.

RADIONIC EQUIPMENT COMPANY

TRIBUNE THEATRE ENTRANCE 170 NASSAU ST., N. Y. 7
CABLE "CHANSLOR" TELEPHONE: WOrth 2-0421

TERMS: FULL PAYMENT or 25% deposit. Balance C.O.D. F.O.B. New York.

It's RADIONIC for RELIABILITY

TELEVISION PARTS

RCA 201 x 1 Mounting Hood	\$1.62
202 D 1 Focus Coil	5.34
204 T 2 Vertical Output	5.29
201 D 1 Deflective Yoke	8.08
211 T 1 Horizontal Output and I.V. Transformer	9.96
204 T 1 Horizontal Output	13.52

Complete Line on Teletron transformers, Focus Coils and Yokes in stock.

Chancellor Low Voltage transformer—450 V. @ 150 ma; 6.3 V. @ 10 amps; 5 V. @ 5 amps **\$6.60**

Chancellor High Voltage Transformer—2500 V @ 4 ma; 6.3 V. @ .6 amps 2.5 V. @ 1.75 amps. **\$5.39**

Amphenol 300 ohm transmission line 3c per foot (100 ft. for **\$2.75**)

Birnback Indoor Flexible Folded Dipole Television and FM Antenna. Complete **\$1.03**

Camco Television Antennas T31, "Featherlite" Dipole **\$5.00**

T32, "Featherlite" Folded Dipole **5.88**

T34, "Featherlite" Folded Dipole with reflector **9.70**

Sprague Tubular Condensers 2500 Volt Working.

.05 } 73c .002 62c
.03 }

Peaking Coils 150 uh. 12c, 250 uh. 12c

Mica Condensers 10, 25, 50, 100, 250, 500 mmt; any assortment .001, .002, .005 mfd. 500 V. working **20 for \$1.00**

Ceramicon Condensers 3, 5, any assortment. 10, 25, 50, 100, 500, 1000 mfm. **20 for \$1.00**

Ceramicon Trimmers 3 to 13, 5 to 20, 4 to 30, 7 to 45 mfm. Any assortment (6 for **\$1.00**)

Carbon Resistors (Insulated) 1/2 watt, Standard values 200 ohms to 10 megohms (50 for **\$1.00**)

1 watt, as above (40 for **\$1.00**)

Sockets Low loss phenolic with mounting ring. (15 for **\$1.00**)

RADIONIC EQUIPMENT CO., Dept. 101
170 Nassau Street, New York 7, N. Y.

Send immediately your latest catalog and supplements listing products of Radio's leading manufacturers of parts and equipment, and numerous special items at bargain prices. Also include special Television information.

Name
Street P.O. Box
Town Zone State

is the Andrew Di-Fan (Fig. 11) which operates with equal efficiency on any television channel. It has characteristics similar to the previous type, but is somewhat less directional. Ghost-free reception is usually possible on one channel, depending on the antenna orientation.

Last, but by no means the least in importance, is a rotatable television antenna (Fig. 12) which can be oriented by remote control (from the receiver) to provide ghost-free reception on any desired television channel. In operation, the antenna is rotated with the receiver switched to the desired channel. By observing the received image (or images) on the picture tube, the antenna can be properly oriented for optimum or ghost-free reception. A fixed antenna can then be installed in many locations.

Amazing! POCKET OR PURSE SIZE

New RADIO

WORLD'S SMALLEST RADIO KNOWN!
We only 1/4 lb. Beautiful Silver Black plastic case. Has Inductive Slide Tuner—W4 Crystal Diode—NO TUBES, BATTERIES OR ELECTRIC "PLUG IN" NEEDED! Should last for years!

GUARANTEED TO PLAY

on local stations if complete instructions sent are followed. Use it at home, in bed, in many offices, hotels, cabins—most anywhere! HUNDREDS OF SATISFIED CUSTOMERS ALL OVER THE WORLD!

SEND ONLY \$1.00 (Cash, M.O. Check) and pay postman \$2.99 plus delivery fees on arrival or send \$3.99 for Post Paid delivery. Complete as shown—ready to play with self contained personal phone.

WONDERFUL GIFTS FOR CHILDREN! Order now at this low bargain price—Prompt shipment on orders sent now—today! Be the first to get YOUR Pocket Radio! (All foreign orders \$5.00 U.S. cash with order!)

Pa-Kette Radio Co., Inc. Dept. RC-1 Kearney, Mo.

Demand for quality radios is creating shortages in dealers' stocks. Large numbers of small table models are still loading down the shelves, but winter production of better-class console models is not expected to meet the demand.

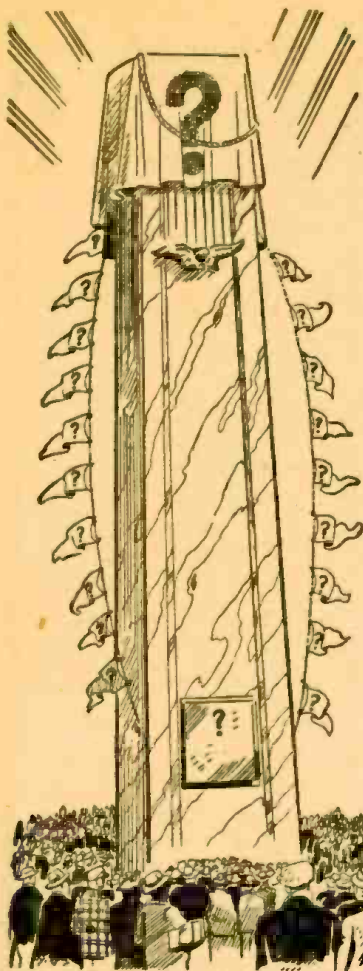

WORTH-WHILE WAITING FOR!

The **HICKOK** Television Alignment Generator is coming

This new signal generator—ready soon—will be the last word for servicing the increasingly large number of Television receivers. It will be made to the usual high HICKOK standards and will incorporate all the features for perfect servicing and long, trouble-free life. And best of all, it will be moderately priced! Cheap generators cannot do the job on Television—but HICKOK advanced design and assembly methods allow this unit to be sold far under the high priced bracket.

Just wait until you see what it can do! Then you'll agree that it will pay you to delay your decision to buy a Television generator until you see the HICKOK. Write now for descriptive literature.

THE HICKOK ELECTRICAL INSTRUMENT CO.
10531 DUPONT AVENUE • CLEVELAND 8, OHIO

TECHNICAL KO's

Television/Scope Power Supply Complete!
8500v 5Ma 6.3V 2A, 2.5V 3.5A, .25MFD
4000V \$8.89
Power Xformer 850VCT, 750VCT @
200 Ma, 5V 3A, 6.3V 5A..... 4.14
Power Xformer Stancor P-6335 700VCT
@ 120 Ma, 5V 3A, -6V 3A. Reg.
\$8.20 list 3.95

6V6 Metal \$.89	6 L6 Metal ... \$.95
12SQ7 Metal .. .40	12K8 Metal49
.01—150V. Paper 60 for 1.00	
.02—1600V. Paper (Mallory)..... 10 for 1.00	
.1—600V. Paper 10 for 1.00	
.002, .005—600V Mica08	
Condenser Kit .01—00001, Ass't. 100 for 3.00	
Bathub Kit 3x1, .5, .1, etc. 10 for .89	
Resistor Kit— $\frac{1}{2}$ and 1W. Ass't. 100 for 1.49	
Rect. Selenium, G.E. 28V. 300M75	
Choke, Thordarson 12H—80Ma 250 ohms 1.09	
Choke, 10H 100Ma 250 ohms. 1.09	

OIL-FILLED G. E. C. D., ETC.		TRANSMITTING MICAS	
80 MFD 330 V AC	\$2.35	.0015	5000 V \$.95
10 600 V	.80	.002	2500 V .27
8 600 V	.70	.003	2500 V .33
4 1000 V	1.75	.001	2500 V .18
4 600 V	.50	.004	2500 V .36
4 1000 V	1.00	.00005	2500 V .11
2 1000 V	.60	.0005	2500 V .15
1 7500 V	2.49	.002	3000 V .66
.5 2000 V	.40	.00005	5000 V .95
.25 4000 V	2.75	.00072	5000 V .85
.12 15000 V	6.95	.00025	5000 V .95
.25 6000 V	4.00	.0008	5000 V .95
.1 2500 V	.95	.005	3000 V .95
.05 1000 V	.15	.006	2000 V .95

\$2.00 min. order F.O.B., N.Y.C. Add postage
50% deposit, balance C.O.D. with all orders.
Manufacturers Inquiries Invited.

TECHNICAL RADIO PARTS CO.
265 Greenwich St. Dept. K-1 N.Y. 7, N.Y.

SERVICING TELEVISERS

(Continued from page 52)

checked readily with an ordinary oscilloscope. Consequently, it is to the serviceman's advantage to become familiar with these wave forms and to check their form each time trouble has been traced to either of these two systems. Typical wave forms found in the deflection circuits of the RCA receiver are shown in Fig. 10. Section A of the figure is at terminal A of T108 sync. discriminator transformer (95 volts peak-to-peak). B is the plate of the horizontal oscillator, 225 volts peak-to-peak (pin 3 of V125). C is the plate of the horizontal

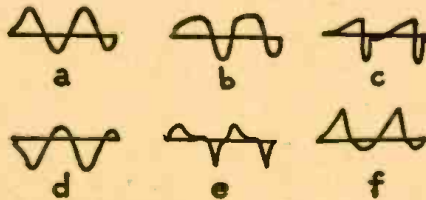

Fig. 10—Waveforms are an aid to servicing.

discharge tube, pin 5 of V120-B (78 volts peak-to-peak). D is the cathode of the horizontal oscillator control, pin 5 of V124 (1.5 volts peak-to-peak). E is the input of the horizontal discharge tube, junction of C176, C177, and R202 (100 volts peak-to-peak); and F the cathode of the horizontal output, pin 3 of V126 (11.5 volts peak-to-peak). For other sets, wave forms may be slightly altered. Manufacturers, realizing their importance, have shown a tendency to

Every Radioman Needs--

"RANGE MASTER" MODEL 10

The 8-in-1 Service Instrument

A precision instrument for RADIO TESTING, Appliance Repairing, Service Calls, Amateur and Experimental Work.



"RANGE-MASTER" covers these 25 ranges.

- (1) CAPACITY .001-1, .01-1, 1-10 Mfd.
- (2) A.C. CURRENT 0-.150, 0-.15, 0-15 amps.
- (3) A.C. VOLTAGE 1 10 100 500 1000 volts.
- (4) D.C. VOLTAGE 10 100 500 1000 volts.
- (5) D.C. CURRENT 1 10 100 1000 milliamps.
- (6) RESISTANCE 0 to 10,000 100,000 1 megohm.
- (7) Special High range ohmmeter to 2 megs and 20 megs.
- (8) Sensitive A.C. microammeter to 900 microamps.

TELEVISION SERVICEMEN... why Guess, measure! This is the only instrument in its class that can be used as an OSCILLOSCOPE CALIBRATOR. A standard bleeder will deliver 1-10-100 accurate RMS volts from A.C. line.

Available in KIT form, or assembled.
Complete KIT and Instruction \$17.95 net
Bench Model (assembled) 23.50 net
Foundation Meter with 3-color scale, schematic and operating instructions .. \$7.85 net
Test leads85

Ask your local distributor, or write to Dept. R.C.
BRADSHAW INSTRUMENTS CO.
942 Kings Highway, Brooklyn 23, N. Y.

include wave form diagrams in their servicing bulletins. Often the voltage shapes in all sections of the receiver are shown, although experience has indicated that only the deflection systems lend themselves readily to this form of analysis.

MONEY BACK GUARANTEE — We believe units offered for sale by mail order should be sold only on a "Money-Back-If-Not-Satisfied" basis. We carefully check the design calibration and value of all items advertised by us and unhesitatingly offer all merchandise subject to a return for credit or refund. You, the customer, are the sole judge as to value of the item or items you have purchased.

The Model 88-A COMBINATION SIGNAL GENERATOR AND SIGNAL TRACER

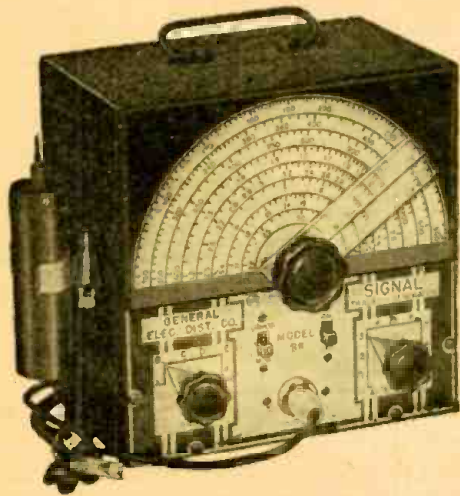

We're prepared for the demand we know will be created by this long overdue combination of the two units which have always been used together. The ultimate in signal tracing procedure is achieved by the Model 88, for the use of this model, enables you to use either the broadcast signal itself or the signal injected by the Signal Generator. This is especially useful of course when servicing "dead" or "intermittent" receivers. The Model 88 you will find is the greatest time-saver ever provided for by combining a full range Signal Generator and Signal Tracer into one unit the set up time for interconnecting, etc., is entirely eliminated.

Signal Generator Specifications:

- ★ Frequency Range: 150 Kilocycles to 50 Megacycles.
- ★ The R.F. Signal Frequency is kept completely constant at all output levels. This is accomplished by use of a special grid loaded circuit which provides a constant load on the oscillatory circuit. A grounded plate oscillator is used for additional frequency stability.
- ★ Modulation is accomplished by Grid-blocking action which has proven to be equally effective for alignment of amplitude and frequency modulation as well as for television receivers.
- ★ Positive action attenuator provides effective output control at all times.
- ★ R.F. is obtainable separately or modulated by the Audio Frequency.

Signal Tracer Specifications:

- ★ Uses the new Sylvania 1N34 Germanium crystal Diode which combined with a resistance-capacity network provides a frequency range of 300 cycles to 50 Megacycles.
- ★ Simple to Operate—Clips directly on to receiver chassis, no tuning controls.
- ★ Provision is made for insertion of phones of any impedance, a standard Volt-Ohm Milliammeter or Oscilloscope.

The Model 88 comes complete with all test leads and operating instructions.

\$28⁸⁵
NET

ONLY

The New Model 450 TUBE TESTER

Speedy operation — assured by the newly designed rotary selector switch which replaces the usual snap, toggle, or lever action switches.



SPECIFICATIONS

- Tests all tubes up to 117 volts. • Tests shorts and leakages up to 3 Megohms in all tubes. • Tests both plates in rectifiers. • New type line voltage adjuster. • Tests individual sections such as diodes, triodes, pentodes, etc., in multi-purpose tubes. • Noise Test—detects microphonic tubes or noise due to faulty elements and loose internal connections. • Uses a 4½" square rugged meter. • Works on 90 to 125 volts 60 cycles A.C.

EXTRA SERVICE—May be used as an extremely sensitive condenser Leakage Checker. A relaxation type oscillator incorporated in this model will detect leakages even when the frequency is one per minute.

\$39⁵⁰
NET

20% DEPOSIT REQUIRED ON ALL C.O.D. ORDERS

The New Model M-50 AN ACCURATE POCKET-SIZE VOLT-OHM-MILLIAMMETER

(Sensitivity 1000 ohms per volt)



Specifications

- 4 A.C. VOLTAGE RANGES: 0-15/75/300/1500 volts.
- 4 D.C. VOLTAGE RANGES: 0-15/75/300/1500 volts.
- 2 D.C. CURRENT RANGES: 0-15/150 MA.
- 2 RESISTANCE RANGES: 0-10,000 ohms; 0-1 Megohm.

Model M-50 comes complete with test leads & all operating instructions.

\$12⁵⁰
ONLY

GENERAL ELECTRONIC DISTRIBUTING CO. DEPT. RC-1, 98 PARK PLACE, NEW YORK 7, N. Y.

NEW WILLARD RECHARGEABLE STORAGE BATTERY



New 6 Volt battery in spill-proof clear plastic case, housed in metal case for easy mounting. Applicable for a wide range of uses where battery power is needed. Shipped dry. Uses standard battery electrolyte available everywhere.

Price, each \$4.00
Lots of Ten 3.35
Without metal case, each 3.00
Lots of Ten 2.85

NAVY CRV-4615

AIRCRAFT RADIO Receiver

INCLUDING CASE

\$16⁵⁰



Four bands, including broadcast (195-9,050 KC). Circuit is six-tube superheterodyne with mechanical band change or remote operated electrical band change. Remote band change and tuning controls included, making this set readily adaptable to mobile ham use. Powered from self-contained 24 V. DC dynamotor.

The sets are complete with tubes, mounting rack and remote controls. No cables.

All Merchandise is War Surplus and is Sold as Used—unless otherwise specified.

ARC-4 TRANSMITTER and RECEIVER

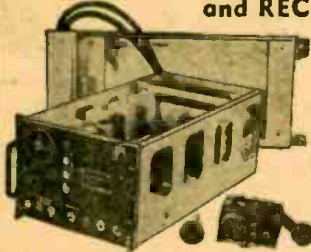

INCLUDING CASE

\$19⁹⁵

Operates on any of its 4 predetermined crystal controlled frequencies in the range of 140 MC. Complete with tubes, remote control, junction box, shock mounting base and connecting plugs. This unit is ideal for amateur UHF or mobile telephone. Operates from self-contained 24 V DC dynamotor. 12 V available upon request.



RADIO ALTIMETER APN/1

A complete 460 mc. radio receiver and transmitter which can be converted for ham or commercial use. Tubes used and included: 4-12SH7, 3-12SJ7, 2-6HG, 1-VR150, 2-955, 2-9004. Other components such as relays, 24 V dynamotor, transformers, pots, condensers, etc., make this a buy on which you can not go wrong. Complete as shown in aluminum case 18" x 7" x 7".

\$8⁹⁵

All Prices F.O.B. Indianapolis
TERMS: CASH WITH ORDER

AMERICAN SURPLUS PRODUCTS CO.

537 N. CAPITOL AVE.
INDIANAPOLIS, IND.

RECENT TELEVISION BOOKS

The Future of Television, revised edition by Orrin E. Dunlap, Jr. Harper & Brothers, 1947
Here Is Television, by Thomas Hutchinson Hastings House, 1946
Radio Broadcasting and Television, an annotated bibliography, by Oscar Rose H. W. Wilson Co. 1947
Servicing of Television Receivers Philco Corporation, 1946
Teletesting and Color, by Kingdon S. Tyler Harcourt, Brace & Co. 1946
Television for Beginners, by James R. Cameron Cameron Publishing Co. 1947
Television—The Eyes of Tomorrow, by William C. Eddy, Prentice Hall, Inc. 1945
Television Handbook for Projectionists RCA Service Company, 1945
Television—Papers on Television published in the RCA Review, Volume III, 1938-1941. Volume IV, 1942-1946 RCA Review
Television Primer of Production and Direction, by L. A. Sposa, McGraw-Hill Book Co. 1947
Television Programming and Production, by Richard Hubbel, Murray-Hill Books, 1945
Television—the Revolution, by Robert E. Lee Essential Books, 1944
Television Show Business, by Judy Dupuy General Electric Co. 1946
Television Simplified, by Milton S. Kiver D. Van Nostrand Co., Inc. 1946
Television Standards and Practice, by Donald G. Fink, McGraw-Hill Book Co. 1943
Television Techniques, by Hoyland Bettinger Harper & Brothers, 1947
Television—Today and Tomorrow, by Lee de Forest, Dial Press, 1942
Time Bases, by O. S. Puckle John Wiley & Son, 1943

OPPORTUNITY AD-LETS

Advertisements in this section cost 25c a word for each insertion. Name, address and initials must be included at the above rate. Cash should accompany all classified advertisements unless placed by an accredited advertising agency. No advertisement for less than ten words accepted. Ten percent discount six issues, twenty percent for twelve issues. Objectable or misleading advertisements not accepted. Advertisements for February, 1948, issue must reach us not later than December 24, 1947. Radio-Craft • 25 W. 87th St. • New York 7, N. Y.

AMATEUR RADIO LICENSES, COMPLETE CODE and theory preparation for passing amateur radio examinations. Home study and resident courses. American Radio Institute, 101 West 63rd Street, New York City. See our ad on page 142.

MAGAZINES (BACK DATED)—FOREIGN, DOMESTIC. aris. Books, booklets, subscriptions, pin-ups, etc. Catalog 10c (refund). Cicero's, 863 First Ave., New York 17, N. Y.

RADIOMEN, SERVICEMEN, BEGINNERS—MAKE more money easily. \$250 weekly possible. We show you. Information free. Merit, 216-32L, 132nd Avenue, Springfield Gardens 13, New York, New York.

WRITE DEPT. RC 20 FOR OUR LATEST FREE BAR- gain list of Radio and Electronic parts. R.C. Radio Parts and Dist. Co., 733 Central Ave., Kansas City 6, Kansas.

FM TELEVISION ANTENNAS, HAM PARTS, TUBES, Bargain list. Wholesale Supply, 347 Lunenburg St., Fitchburg, Mass.

YOU CAN ACCURATELY ALIGN SUPERHETERODYNE receivers without signal generator. Complete instructions \$1. Moneyback guarantee. Chas. Gates, Pecos 2, Texas.

KNOW MORE THAN THE NEXT MAN BY SUBSCRIB- ing for PRACTICAL WIRELESS, Britain's foremost radio monthly. Only \$2.00 yearly. Articles by leading technicians cover new developments in British and European radio-television field, and include constructional details of latest receivers and statistical data on all "ham" activities. Important circuits described and analyzed with explanatory diagrams and drawings. Free advice by experts on your knottiest problems; practical "kinks" from readers, news from every corner of the radio world, etc. Keep right ahead! Send \$2.00 for 12 issues to Subscription Manager, PRACTICAL WIRELESS (Dept. 7), Tower House, Southampton Street, Strand, London, W.C.2, ENGLAND.

RUBBER STAMPS, ETC., FOR SALE COOKSON, Box O-RC, Puxico, Missouri.

8 ASSORTED CRYSTALS, CATWHISKERS, INSTRUC- tions, "Radiohulder," Catalog—all 25c. Laboratories, Eyo-U, San Carlos, California.

WIRING DIAGRAMS, INSTRUCTIONS AC OPERA- tion BC-191; BC-375; BC-312; BC-342; BC-348; BC-624; BC-625; each set in SCII-274; others, 50c in coin per set. NO NEED to rip up filament circuits on above and other equipment—we have brand new 26 volt, 3/4 amp filament transformers for only \$1.35 postpaid. REACTRON CO., 422-C E. 138th Street, N. Y. 54, N. Y.

TIME-DELAY SWITCH, GIVES YOU TIME TO GET in bed before the light goes out. Fits standard switch box. \$2.00 postpaid. Radio Roy, 144 S.E. 83rd Ave., Portland 16, Oregon.

26 YEARS' EXPERIENCE RADIO REPAIRING AT your fingertips. I've perfected simple system you can follow step by step. No formulas or calculations. Quick repair time to minimum. Total price \$2.00 postpaid or COD. Moneyback guarantee. Ross Radio, 14615-J Grandriver, Detroit 27, Michigan.

TUBULAR ELECTROLYTICS
Fresh stock Fully guaranteed

20 mfd. 150 V.	10 for \$1.79
20-20 mfd. 150 V.	10 for 2.49
8 mfd. 450 V.	10 for 1.85

Postage extra. 25% deposit on COD.
Write for our free bargain lists featuring "AMERICA'S BEST BUYS"

POTTER RADIO CO.
1312-1314 McGee St. Kansas City 6, Mo.

LAKE DELUXE CHANGER

Revolutionizes the Industry!
A SENSATIONAL SELLER!

11 OUTSTANDING FEATURES:

- Positive Intermix
- Service Adjustments Eliminated
- Minimizes Record Wear
- Single Knob Control
- Plays ALL Records
- Completely Jam-proof
- Records Gently Lowered on Spindle—not dropped
- Automatic Shut-off on last record

- Pick-up arm may be grasped at any time and changer will not be thrown out of adjustment
- Resonance-free ball bearing tone arm
- Easily operated—any child can do it

Dimensions: 13 13/16" W x 12 1/4" D x 7 3/4" H No. 116A4 YOUR NET **\$28⁷³**

FREE DEALERS AND SERVICEMEN: Write for our NEW 16-page 1948 illustrated catalog on radio parts, tubes, accessories, cabinets, sets, electrical appliances, etc. Get on our mailing list today! Sent. c

LAKE RADIO SALES CO.
615 W. Randolph Street, Chicago 6, Ill.

NOW AVAILABLE!
Amplifier for GE pickup

New circuits for the first time enable you to attain full benefit from the new General Electric Model DL 1RM 6C Variable Reluctance Magnetic pickup. Employs an exclusive, humless (DC on heaters) pre-equalized pre-amplifier to produce the most satisfying musical amplifier the world has ever known. If you are a perfectionist, you are the one for whom the ACA-100GE was designed. Send for technical literature.

AMPLIFIER CORP. of AMERICA
398-10 Broadway • New York 13, N. Y.

Television Frequency Channels

(Lower TV band)		
No. of Channel	Freq. Covered Mc.	Center of Channel Mc.
1	44-50	46.9
2	54-60	56.9
3	60-66	63
4	66-72	68.9
5	76-82	79
6	82-88	85

Center of the lower TV band—62.2 mc

(Upper TV band)		
No. of Channel	Freq. Covered Mc.	
7	174-180	
8	180-186	
9	186-192	
10	192-198	
11	198-204	
12	204-210	
13	210-216	

Center of the upper TV band = 194.1 mc.
Fm broadcast band = 88 to 108 mc. Center of band = 97.6 mc. (98 approx. value).

BUILT-IN TELE LINES

Installation of transmission line for a television antenna in new houses was advocated recently by Dan Halpin, sales manager for RCA Victor television receivers. Inclusion of wiring for television would give the builder an important new selling point and serve as reassurance to the prospective buyer against added expense later, he said.

A 300-ohm transmission line would run from the room where the television receiver is to be used to the attic or upper portion of the building. This transmission line can be terminated in a standard electrical outlet box at the receiving point, and run through the partitions like bell wire, requiring no conduits nor sheath. A length of approximately 20 feet of the line should be left coiled in the attic for future connection to the antenna.

The line should be covered with standard loom or other insulating tubing where it enters the standard electrical single outlet box at the receiving location. It may be tacked to the studding or other framework of the house with standard fibre head telephone tacks.

The wire cannot be run nearer than three inches to metal laths, pipe, or other conducting material.

The terminating outlet for the line should be adjacent to a power outlet capable of furnishing 120 volts, alternating current, 60-cycle, 400-500 watts. About 100 feet of transmission line will be required for the average residence.

TELEVISION TROUBLE CHART (Continued from page 55)

OBSERVED EFFECT	PROBABLE CAUSES	REMEDIES
35. Picture appears momentarily, then disappears. Sound is unchanged.	35. Loose connection in a video signal circuit.	35. Look for loose connections, particularly in leads to C-R tube socket.
36. Picture scrambles for a while without changing in average brightness, then returns to normal.	36. Loose connection or defective tube in the scanning system.	36. Look for loose connections in clipper or frequency separator if scrambling occurs.
37. Picture is trapezium-shaped (not rectangular).	37. Deflecting system is out of balance.	37. In a balanced electrostatic deflecting system, check the output tubes in each sweep channel. In an electromagnetic deflecting system, look for shorts between turns in a deflecting coil.

The above chart is reprinted from the *National Radio News* (National Radio Institute, Washington, D. C.)

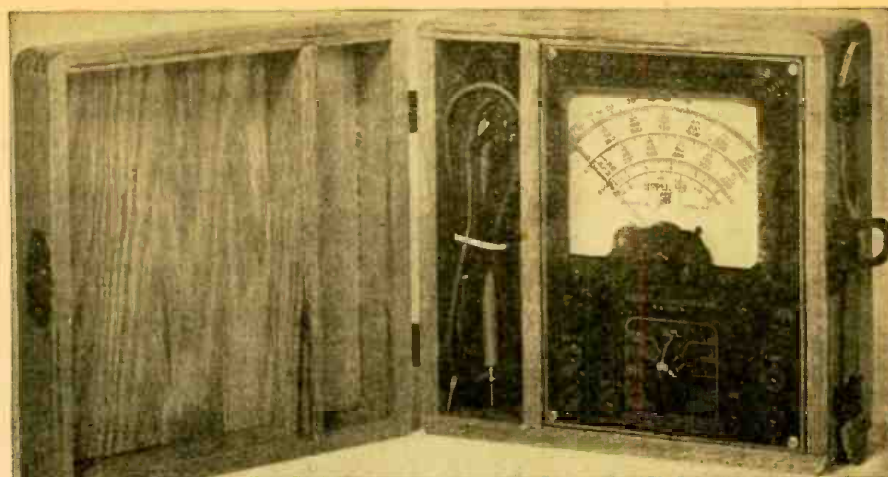

E. M. C. Gives Maximum Measurement Value Per Dollar
COMPARE Model 120 with ANY other 20,000 ohms per volt instrument!

Model 120 Gives you—

1. WIDEST resistance range (.2 ohm to 300 meg.)
2. HIGHEST AC voltage sensitivity (10,000 ohms/volt)
3. LOWEST PRICE \$29.95 for open face model, \$34.95 for Model 120-P (portable)

FOR FURTHER INFORMATION WRITE TODAY TO DEPT. C.

ELECTRONIC MEASUREMENTS

CORPORATION

423 Broome St., New York 13, N. Y.

GOING IN FOR TELEVISION WORK?

Then you need a frequency-sweep signal generator to get a clear pattern on any set you build, service, or install. This unit will save its own cost in a very short time by eliminating time-wasting blundering and hit-miss methods of television alignment and checking.



Specifications

- Tubes: 6C4-Osc #1, 6C4-Osc #2, 6AG5-Mixer, 6AG5-Cathode Follower, 5Y3-Rectifier
 - Mean Frequency Range: 5-100mc. 170-216 mc (covers television and FM IF and Broadcast Frequencies)
 - Sweep Width: Variable from 500 KC-10 mc
 - Maximum Output: 1 Volt
 - Output Impedance: 100. 10 ohms
 - RF Probe for Point to Point check
 - Electro-mechanical sweep mechanism
 - Terminated coaxial output cable
- Furnished complete with tubes, probe and output cable and instruction booklet.

\$68⁵⁰

TELEVISION PICTURE TUBE

We have an exceptional buy in a 9-inch electromagnetic cathode ray tube. The MW22-2 is an exact replacement for the nine inch tubes used in GE Television Receivers. This tube may be used in practically any receiver designed for electromagnetic deflection.

CHARACTERISTICS MW22-2

- Heater Volts—6.3
- Heater Current—6 amps
- Fluorescent Screen—White-Medium persistence
- Anode 2 volts—5000 Max.
- Anode 1 volt—250 Max.

These are brand new GE types—at the unbelievable LOW price of

\$13⁹⁵



EDLIE ELECTRONIC, Inc.

135 LIBERTY STREET, NEW YORK, N. Y. Tel. BArlay 7-4763



BASIC 10" TELEVISION KIT



1. Sound IF Transformers (2)
2. Schematic diagram
3. 1st PIX IF
4. 2nd PIX IF
5. Cathode Trap
6. Discriminator Transformer
7. 3rd and 4th PIX IF
8. Video Series Peaking Coil
9. Video Shunt Peaking Coil
10. Video Series Peaking Coils (2)
11. Video Shunt Peaking Coils (2)
12. Filament Chokes (5)
13. Power Transformer
14. 13 Channel "Front End"
15. Deflection Yoke
16. Width Control
17. Horizontal Linearity Control
18. Yoke Mounting Hood
19. Focus Coil
20. Iron Trap Magnet
22. Vertical Output Transformer
24. Vertical Blocking Oscillator Transformer
25. Horizontal Synchronizing Disc. Transformer
26. Horizontal Output and H.V. Transformer
27. Stamped Chassis

All are exceptionally well known parts. In fact they lead the television field. All these major components cost you only

\$115⁰⁰

R.F. POWER SUPPLY

- 6 K Volt Unit completely wired **\$17.95**
 10 K Volt Unit completely wired **\$24.95**

LAST MINUTE SPECIALS!

- 866A rectifier 2 for **\$1.50**
 S.C. J-45 code key with cord, 3 for **\$1.00**
 10 ft. 7 cond. viny. cable ... 4 for **\$1.00**
 Dual .1/7500 V. oil cond. ... each **\$1.11**

25% deposit, balance C.O.D.

Please include sufficient payment for transportation. Own payment will be refunded.

Write to Dept. RC-1

Holiday Greetings to
All Our Friends

Standard Parts Corp.

235 MAIN ST. HEMPSTEAD, N. Y.

DOUBLE MODULATION

(Continued from page 39)

and to greater swings at a lower frequency by the frame time base.

Thus, the current supplied to the transmitter's r.f. power amplifier is modulated simultaneously in amplitude by the video frequency and in frequency by the line and framing signals.

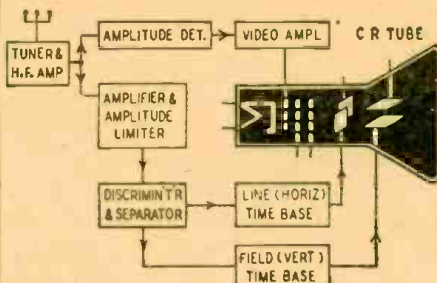

Fig. 4—Receiver hookup for proposed system.

The r.f. tuner and amplifier section of the receiver (Fig. 4) is conventional. It must be able to receive the whole band of modulated frequencies with negligible attenuation. Its output is divided into 2 channels: Channel one is applied to a normal detector of amplitude modulation (a diode for instance). The detected voltages reproduce the video-frequency signals of the transmitter. After ordinary amplification, they are applied to the deflecting yokes of the tube.

The second channel includes an amplifier and limiter which brings all amplitudes to a single level. Amplitude modulation is thus eliminated, and only frequency modulation remains. This is detected by a standard discriminator, which produces voltages having the same form as the frequencies of Fig. 3.

The components of these voltages are separated into 2 parts by a suitable filter: the higher frequency one (line synchronizing signals), and the lower frequency one, (frame or image pulses). These components are applied to the corresponding time bases to assure perfect synchronization of the receiver.

Suppression of the time base

But is it necessary to maintain the 2 time bases in the receiver? We believe they are no longer indispensable in such a system as this.

As we have noted above, the frequency-modulation channel transmits, not quasi-instantaneous pulses, but voltages which have the actual form of those produced by the time bases of the transmitter. It is therefore possible, after separating and amplifying them, to apply them directly to the deflecting elements of the receiver's cathode-ray tube. (The drawing shows a tube with electrostatic deflection, but, of course, there is nothing against the use of electromagnetic deflection in such a system.)

Technicians know how often time bases are a cause of trouble. They will appreciate the advantages to be obtained by replacing them with simple amplifiers. If any irregularities should occur in the sweep circuits of the transmitter,

TELEVISION COIL KIT



Complete **\$23⁵⁰**

LOOK AT THESE FEATURES!

- Video IF Bandwidth of 4.25 MC that can operate ANY size picture tube with maximum resolution.
- Five stages Video IF permeability tuned with sound and adjacent channel rejection traps in shielded cans.
- 6 Channel RF Tuner, permeability tuned mounted on switch assembly plate.
- FM Sound Discriminator for TRUE FM.
- Can provide Video Operation for 10, 12, 13 or 20-inch picture tube upon further construction.
- Video Peaking Chokes to maintain bandwidth.
- Detailed Construction Manual & Parts List with every kit, for 20 Tube, 7 in. Telev. Isot. Set.
- Continued Service Bulletin.

ORDER DIRECT OR THRU LOCAL DEALER TERMS

Shipped Parcel Post prepaid on receipt of check or money order. Or P.P. Collect on receipt of 25% deposit with order, balance COD.

RAY-LECTRON CO.

706 Tenth Avenue
BELMAR, N. J.

GREYLOCK

A Dependable Name in
RADIO TUBES

GT, Glass, and Miniature Types.
 125A7, 125K7, 125Q7, 50L6, 12AT6, each 39c
 12BA6, 12BE6, 35W4, 50B5, each 39c
 1R3, 1R5, 1R6, 354, 3Q4, 6AK5, 6AC5, 6AC7, each 49c
 6AQ5, 6BE6, 6BA6, 6AU6, 6BJ6, 6X4, each 59c
 32L7, 70L7, 117L7, each 59c
 All Tubes carry RMA 90-Day Guarantee

PM SPEAKERS

4" Alnico No. 5 each \$1.19
 5" Alnico No. 5 each 1.29

TERMS: Net COD. No order accepted for less than \$5.00

WRITE FOR BARGAIN CATALOG

GREYLOCK ELECTRONIC SUPPLY CO.
30 Church Street New York 7, N. Y.

ELECTRONIC VOLT-OHMMETER

\$11⁸⁵
 110 VOLTS AC 20 RANGES
 0/5/10/50/100/500/1000/5000
 volts DC and AC. 0-1,000,000,000
 ohms in six overlapping ranges. Sensi-
 tivity; over MILLION OHMS per
 VOLT on 5 volt range.

POSTPAID Complete kit includes all component parts, tubes, punched and drilled chassis and beautifully enam- elated panel. Easily assembled and wired.

Special slideback circuit developed during war by scientist at the California Institute of Technol- ogy gives amazing sensitivity and flexibility while completely eliminating necessity of batteries and ex- pensive meter. Each instrument is individually cali- brated. Dial scale over nine inches long!

In addition to performing the usual volt-ohm functions, this instrument easily measures these voltages: SUPERHET OSCILLATOR, AVC, AFC, TRUE GRID BIAS AT THE GRID, BIAS CELLS with- out affecting the circuit. Measures the exact leak- age resistance of INSULATION, TUBES, CON- DENSERS. It can be used with a signal generator for SIGNAL TRACING.

STERLING ELECTRONIC COMPANY
BOWLING GREEN, KENTUCKY

TEST EQUIPMENT

AUDIO SIG. GENERATOR: 20-20,000 Mfz. by RCA, Espey, GE, for Lab use with square and rec. sine wave. 12 tube circuit with res. cap. tuned oscillator, direct read dial, res. coupled amplifier sect. w/P.P. output, an output trans. w/var. imp. secondary used for sine wave output, a square wave forming section & amplifier voltage reg. pur. sup. 110-220AC. Associated output attenuators. Orig. value \$425.00—Surplus Barkain. Like New \$62.50
 TRIPLETT 4-56C: tube checker, set analyzer voltohmmeter & cap. checker comb. with output & DC voltohmmeter. 3 meters in one carrying case w/adapters, prods. used. Close Out Special \$52.50. Orig. value \$139.00.
 McCONNELL 3834 Germantown Ave., Phila. 40, Pa. RA-56033

they would be faithfully reproduced (in this system) so that no distortion whatever would result.

Finally, it is easy to imagine the application of the principle of velocity modulation to the system described. We know that it is possible to improve the contrast of the image by increasing the speed of the spot in the darker parts of the image and slowing it down in the brighter portions. Nothing prevents the use of these speed variations by applying a fraction of the photoelectric voltages of the transmitter to its line time base and to the reactance tube. The same speed variations in the horizontal sweep then would be reproduced faithfully in the receiver.

The principle of double modulation seems to have numerous applications in the field of television.

RADIO ELECTRONIC PATENTS

(Continued from page 96)

A crystal of the piezo-electric type is connected between grid and ground of the pentode or beam-power tube, and the cathode circuit is tuned to approximately the same frequency. Therefore oscillations are generated at the crystal frequency. The screen circuit is tuned to the 3rd harmonic, and this harmonic is transferred to the secondary of the transformer which is also tuned to the same harmonic.

This tuned transformer eliminates most of the fundamental voltage and applies a relatively pure wave to the suppressor to modulate the electron stream. The plate circuit is tuned to the 3rd harmonic of this frequency (which is the 9th harmonic of the crystal frequency). This high harmonic is found to be relatively strong in the output, because of the tube characteristic.

See Quad for supplies



METERS

0-1 M.A.D.C. 3". With 0-10 M.A. shunt \$3.65
 0-200 D.C. Micro-Amp. 2". Gruen, 3.25
 0-150v. A.C. 2". Westinghouse 3.25

TUBES—ALL NEW—JAN—GUARANTEED

10% discount in lots of 10 or more							
6AK5 .59	GAG5 .59	9006 .49	5U4G .49	6X5GT .59			
2C26 .19	6V6GT .59	6H6 .49	6J5 .49	6E5 .59			
3E29 (829B) 2.75	6L6G 1.25	6L6GA 1.25	2X2/879 .69	6SN7GT .39			
	5BPI 3.00	5BPI 3.25	3API 2.75	832A 2.00			

TRANSFORMERS and CHOKES

All primaries 115v. 60 cycle. All cased with ceramic stand-offs. NEW.

#1 400-220-0-220-400 at 125 M.A., #2, 3, 4, 5v. at 2A., #5 6.3v. at 2A. 3.95
 #6 6.3v. at .3A., #7 6.3v. at 3A. 2.95
 #1 5v. at 5.32A., #2 5v. at 5.32A. 2.95
 #1 6.3v. at .6A., #2 6.3v. at 9A. 2.45
 #1 6.3v. at .6A., #2 6.3v. at 6.4A. 2.50
 #1 2100v. at 10M.A. for Scope 2.95
 #1 710v.c.t. at 150M.A., #2 490v. at 1.5M.A. 2.95
 #1 735v. at 5M.A., #2 2.5v. at 3A. 1.49
 15 Henry, 330 Ohm, 85M.A.95
 59 Henry, 850 Ohm, 100M.A. 49.50
 500w. Sola Constant Voltage Transformer

OIL FILLED TRANSMITTING CONDENSERS

Standard makes—Metal cased—Ceramic stand-offs—with Straps

12 MFD. 660v.A.C. (2,000v.D.C.)	G.E. Pyranol	4.95
1MFD. 3600v.D.C.	5MFD. 750v.A.C.	.98
2MFD. 1000v.D.C.	7MFD. 800v.D.C.	.69
4MFD. 600v.D.C.		.59

2MFD. 5000v.D.C. 2.49
 7MFD. 600v.D.C. .59

11 M.C. I.F. Transformers, 4M.C. Bandwidth, SET of 5 2.95
 Right angle CO-AX connectors, Amphenol #83-1AP29
 B.C. 1267-A NEW 29.95
 RA. 106-A NEW 24.50
 RC-148-C, both units, New 47.50

Sorry—NO C.O.D. All prices F.O.B. our Warehouse. CHICAGO
 All items subject to prior sale. New circular now ready.

QUAD ELECTRICAL SUPPLY

1650 NORTH DAMEN AVENUE

CHICAGO 47, ILLINOIS

FIX ANY RADIO

Amazing New Invention



Find radio faults double-quick with this new simplified method. Repair all radios in minutes instead of hours. Revolutionary, different Comparison technique permits you to do expert work immediately. Most repairs can be made without test equipment. Simplified point-to-point, cross-reference, circuit suggestions locate faults quickly and easily.



CHARTS, BLUE-PRINTS, TESTS, PICTURES, HINTS, JOB-SHEETS

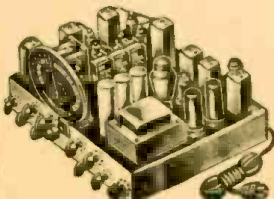

Learn time-saving trouble-shooting short-cuts; find any radio fault with ease. Follow the tests shown on 24 large circuit blue-prints. Over 1,000 practical repair hints. For all types of radios. Hundreds of simplified tests using a 5c resistor and any filter condenser. Introductory material for beginners and to serve as review for experienced radio men. Several chapters on test equipment. Complete plan in manual form, 63 job sheets, data on all tubes, large size: 8 1/2 x 11 inches, 84 pages. Schematics, pictures, charts. Sold on no-risk trial. Use coupon to order.

NO TESTERS NEEDED REPAIR ANY RADIO IN MINUTES

This newly developed method tells you how to locate the source of trouble in any radio set without equipment. Make needed tests, measure voltage, trace the signal, by using only a 5c resistor, small condenser, and a crystal detector. Inject signals without any signal generator. Test parts by the new Comparison method. Test tubes without equipment. Repair any radio expertly following simplified picture plans. Improve your radio servicing ability. Data on all sets, portables, AC-DC, FM, recorders, intercoms, P.A. Examine and apply the plan for 10 days without obligation or risk. Send trial coupon today

NO RISK TRIAL ORDER COUPON

SUPREME PUBLICATIONS

9 S. Kedzie Ave., Chicago, 12, Illinois

Ship postpaid the new complete Simplified Radio Servicing by Comparison Method manual for 10 days' examination. I am enclosing \$1.50, full price. I must be entirely satisfied or you will refund my total remittance.

NAME:
 ADDRESS:

Technicians Everywhere
agree that when
BETTER AMPLIFIERS

are made,
it's A. C. Shaney who's
"a-go-in' to make them"

A. C. Shaney, long known as the outstanding designer of high-quality amplifiers, and his associates at the Amplifier Corp. of America, are getting ready to announce the completion of the finest line of public address and electioneering amplifier equipment ever produced.

New standards of quality and workmanship, new circuits, new materials, and new manufacturing processes have been combined to make this soon-to-be-announced amplifier line the answer to all requirements. Specifications and performance ratings of these popular-priced models will equal or surpass those formerly found only in high-cost, custom-built equipment. And Amplifier Corp. of America will guarantee every amplifier for 5 full years—an expression of confidence that only the country's leading and most thorough manufacturer of the most modern amplifier designs would dare make.

You can't afford to buy any amplifier until you have investigated the new concept in amplifier design and construction offered by A. C. Shaney and the Amplifier Corp. of America.

Join the many thousands who are "watching and waiting" for the latest in amplifiers from

**AMPLIFIER CORP.
of AMERICA**

398-10 Broadway, New York 13, N.Y.

A postal card will put you on our mailing list to be among the first to know.



Combination Signal Tracer
and Electronic Volt Ohm
Meter with Germanium
Crystal Probe

Model 730

Range: AC-DC 1v to 3000v (7 bands.)
Zero center scale for F.M. alignment.
Ohm Scale: 10 Ohms to 10 Megohms.
Frequency Range: Audio to 110 MC.
Input: 100 Megohms AC or DC.
Tubes: 6X4, OA2, 6AQ5, 2-12AU7,
8-A4522.

High gain Signal Tracer with enclosed speaker. No amplifications needed in receiver—no hum.
8" illuminated dial.

**\$89.95
Net**



Write for catalog sheet

Coastwise Electronics Co., Inc.

130 North Beaudry Ave., Los Angeles 12, Calif.
New York Office & Warehouse
258 Broadway, New York 7, N. Y.

NATION-WIDE TELEVISION

(Continued from page 27)

once the performance is underway, there can be no interruption in the action. There can be no retakes. There can be no prompting. That means many more hours of rehearsing than actual time on the air. It all adds up to real money.

There has been a tendency during 1947 for some leading telecasters to subordinate their studio activities to outside pickups such as sports, news events, and "magazine" features. At least such programs "just happen" and can be televised as they are found. To be sure, sporting events often call for handsome payments for the television rights, but the popularity of televised sporting events is such that there is no dearth of sponsors to foot the bill.

From the metropolitan centers, then, must come most of the studio productions and the major sporting events as well as the big news events. This means a television network. Such a network can be either of the as-it-happens kind or of the recorded-on-film kind, just as in sound broadcasting there is the actual network and in addition the electrical transcription.



Orthicon camera for small telecasters—can be used both for outside pickup and studio work.

Already the beginnings of the television network of tomorrow have been made. The A. T. & T. co-axial cable between New York and Washington, with Philadelphia and Baltimore along the way, already is being used for network purposes, mainly by NBC and Du Mont. Such co-axial cables are being extended in the Middle Atlantic, South, and Mid-West States. Nevertheless, many gaps still remain to be closed before coast-to-coast telecasting can be even approximated. Meanwhile, several organizations seeking less costly means of piping syndicated television programs have turned to ultra-high-frequency radio relaying,

Get a new
**ELECTRIC SOLDERING IRON
FREE**

and assemble your own
MAGI-KLIPS
RADIO & ELECTRONIC EXPERIMENTER'S KIT



This is the same MAGI-KLIPS Kit—complete with all parts—that we sell ready assembled for \$29.75.

In knocked-down form with full instructions for assembly, it is now available at the **\$19.75** new low price.

complete with a new Electric Soldering Iron—the ideal iron for wiring your unassembled MAGI-KLIPS Kit.

Remember, you build 18 different experiments with your MAGI-KLIPS Kit. You actually teach yourself radio and electronics and have a lot of fun at the same time.

RADIO RECEIVER, HOME BROADCASTER, PHOTOELECTRIC RELAY, CODE PRACTICE OSCILLATOR, SIGNAL TRACER, REMOTE CONTROL RELAY, Phonograph Transmitter, Inter-communication Amplifier, Code Transmitter, Radio Frequency Oscillator, Telephone Line Amplifier, Electronic Switch, Phonograph Amplifier, Temperature Control Relay, Contact Detector, Electronic Metronome, Interval Timer (one-shot), Interval Timer (repeating).

PHONO-AMPLIFIER KIT

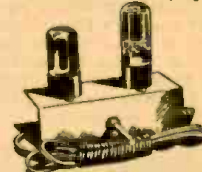

A real bargain. Uses 35Z5 and 50L6. Complete diagram and instructions for assembling. Also good for call system.
Kit Form \$1.85
Wired and Tested. 2.45
Tubes for above.. 1.65

CODE PRACTICE OSCILLATOR KIT

Learn the code! Get your ham ticket! Uses 50L6, 35Z5, 4" PM speaker. Tone and volume controls. Ideal for classroom instruction. Complete diagram and assembly instructions.
Kit Form \$2.85
Speaker and Transformer for above 1.95
Tubes for above 1.65
Wired and Tested, with Tubes and Speaker.... 6.00

Terms: 20% deposit, balance C.O.D.
Send for your copy of FREE booklet, "Electronics Made Easy."

DEER & TAYLOR COMPANY
Dept. C 1342 Milvia St. Berkeley 9, Cal.

TELEVISION RECEIVER—\$1.00

Complete instructions for building your own television receiver. 16 pages—11"x17" of pictures, pictorial diagrams, clarified schematics, 17"x22" complete schematic diagram & chassis layout. Also booklet of alignment instructions, voltage & resistance tables and troubleshooting hints.—All for \$1.00.

CERTIFIED TELEVISION LABORATORIES
5507-13th Ave., Brooklyn 19, N. Y.

notably G-E and Philco, while the Bell System is supplementing its co-axial lines with radio relays. The NBC-G-E tieup between New York and the Schenectady-Albany area is made in 4 radio-relay jumps—from the Empire State Building to Mount Beacon to Round Top (in the Catskills) to Helderberg Mountain (near Schenectady) and

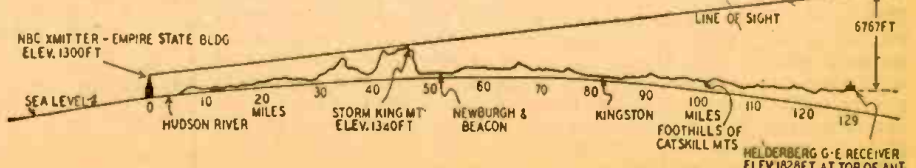

Earth contour and line of sight along General Electric's New York-Schenectady relay route.

then into the main G-E transmitter, the radio relaying transmitters being strictly automatic or nonattended. It may be that these relay transmitters may serve local telecasting stations along the route in the future, branching out the network. Philco in Philadelphia has been retransmitting WNBT (New York) programs by means of relay transmitters.

In the matter of television networks, however, there is a time factor quite as well as distance. The important news event doesn't wait upon the convenience of the television audience. Most news events occur during the day, yet television audiences gather in the evening. Consequently, such news events must be recorded on special film, and telecast at such times as meet with the convenience and pleasure of the television audience. Much of the syndicated program material is bound to be handled by special television films from here on. Please note that word "special." Already television is developing its own film-recording technique. Leading telecasters have their own film camera crews. Most of the films are of the 16-mm size, for it has been found that this small film does just about as well as the more cumbersome and costly 35-mm theater film.

Means are available for filming programs directly off the monitor screens. Such recordings have heretofore been used mainly "for the files," or for studying program techniques and performances in considerable detail. They are now good enough to be used for syndicating purposes. Thus telecasts originating in metropolitan studios or remote pickups may be available to affiliates of a group or network within a matter of hours or days.

So much for the big-city stuff which the smaller telecaster will want to handle. There never will be a scarcity of local programs. Certainly the football game between the local high school team and that in the adjoining town always carries greater weight than a big-league game. The telecaster will want to cover such local happenings either by direct telecasting or by 16-mm film recordings for transmission during evening hours. Prominent citizens will appear before camera and mike in the studio. Amateur players will jump at the chance of being televised. The local television station will be to the community what its local newspaper has ever been—the local pride and joy.

So again the writer points out that eventually it will be immaterial whether you live in New York or Pumpkin Center so far as satisfactory television entertainment is concerned. In due course television must become nation-wide. That dream is well along toward realization.

NEW HALLICRAFTERS MODEL T-54 TELEVISION RECEIVER. Price \$169.50
Production is scheduled for the first of the year. Place your order with us now for early delivery. Remit in full or send a 20% deposit with order.
6X-48 Now available from stock \$169.95
New Meissner 8 tube FM Converters in Wood Case 28.33
New Portable history sets with Short Wave 69.00
Browning AM-FM complete tuner chassis 142.00
Garrard Model RC-60 Deluxe Changers 69.50
Thornston 10 Watt Hi-Fi Volume Expansion Amplifier Kit, complete with tubes 50.00

ARROWHEAD RADIO & TELEVISION SUPPLY CO.
3216 "D" St., San Bernardino, Calif. Phone 255-81

GE Better Products for the Radio Industry

Ne-O-Lite Tester — Spray Kit Inspection Lite — Alignment Kit



G-C INSPECTION LITE

Just the light for service work. Lights up hard-to-see corners. For 110 Volt AC or DC
No. 705. List \$1.50

G-C FELT KOAT FLOCK FINISH SPRAY KITS

Easy to apply flock for refinishing turntables, cabinets, grilles, etc. Kit contains specially designed spray gun, 2 colors flock, undercoats, thinner, brush, instructions, etc. No. 180-2. List \$10.75



Have you seen the new G-C "Speedex" Wire Strippers... write for illustrated literature.

RADIO DIVISION



G-C NE-O-LITE TESTER

For testing fuses, appliances and any electrical circuits. 90 volts to 550 V. A.C. or D.C.
No. 5100. List 50c

G-C NO. 5025 PROFESSIONAL ALIGNMENT KIT

Complete alignment and neutralizing kit in steel box. Has every tool to service any set. 30 tools.
List \$19.95



G-C Products are available at leading distributors. Write for your copy of our new illustrated catalog.

GENERAL CEMENT Mfg. Co., Rockford, Ill., U. S. A.

Manufacturers of over 3,000 products • Sales offices in principal cities

RED HOT SPECIALS

Limited quantity for immediate shipment—while they last

8,000 OHM DUAL HEADSET H-16/U

Priced at **\$1.89**

Include 25c to Cover Cost of Postage



Light, durable, and efficient phones featuring a permanent magnet with an 8000 ohm transformer built into each unit. Moulded soft neoprene earcup shaped to snugly and comfortably envelop the entire ear. Steel headband with new type adjustable sliding brackets allow earcups to be extended or retracted. Cover plates constructed of lightweight magnesium. No removable parts to become loose or lost. Especially suited to hams and commercial operators, recording engineers, aircraft pilots and similar exacting applications. Hi-Impedance, extremely sensitive. May be used as sound powered interphones without use of a battery. Can even be used with simple xtal to make a complete radio receiver.

Carbon Throat Microphone

This microphone will work into any 200 ohm impedance input circuit. Has adjustable strap to fit any neck. In operation this microphone is strapped around the throat thereby facilitating full freedom of both hands and head movement. Ideal for ultra high frequency mobile work for hams. Can also be used as a hi-grade Carbon Mike by simply drilling three holes in case. Sensitivity of this mike equal to mikes costing \$10 and \$15. Supplied with strap, 10' cord and plug.
Your Cost



49c

Combination Offer

Both Items **\$2.25**
Include 25c to Cover Cost of Postage

20% deposit on all orders unless rated.

NIAGARA RADIO SUPPLY CORP.

160 GREENWICH ST., NEW YORK 6, N. Y.

All prices F.O.B. N. Y. C. Write for latest Bulletin 10RC



NOW *Smooth* FOR YOUR SILENT PROJECTOR Economically

\$5995

Convert your 16mm silent projector to sound (regardless of make) with Apex sound head & radiofilm adapter. Guaranteed excellent performance. Write today for free information.

APEX VIDEO • 12209 U Bradford St. • Roscoe, Calif.

PROJECTION TELEVISION

Adapt your present RCA, GE, Crosley, Philco television receiver for a 6x8 foot projected picture with the addition of a 30 KV-RF power supply and a 5TP4 projection lens assembly. Complete pictorial construction details of the 30 KV supply and projection system based on actual New York tavern installations described in booklet just published at \$2 each, postpaid.

PERFORMANCE RADIO CO.

2898 Jerome Avenue, New York 58, N. Y.

SMASH Values from MID-AMERICA

Look at these sensational buys in brand-new, unused, top-quality radio parts and electronic equipment. You've never seen big buys like these before! And that's only the beginning. These values are but a few of the hundreds and hundreds of items Mid-America has in stock right now. Write for free catalog. You'll save money!



DACO Tube Tester

Tests performance, leakage and shorts in ALL receiving tubes, even sub-miniature and vacuum PLUS provision for tubes that may be invented. Durable construction is fully shielded; dust-proof case, high-visibility meter, illuminated chart; no books or charts to be misplaced. Simple, fast operation with positive contact slide-switches; tests EVERY tube element. 110-volt AC. 16 1/2" x 14 1/2".

MA-2193. \$2950

PORTABLE DACO TUBE TESTER

Same construction and operating features as counter model. Enclosed in sturdy case with durable black leatherette covering. 12 1/2" x 12 1/2" x 6". MA-2194. \$3250

PHONO AMP and RECORD CHANGER



Inexpensive phono amplifier and record changer with "big set" features. Positive-action Crescent changer handles 10" and 12" records without jamming; finger-tip eject button. Lightweight counter-balanced pickup arm with Shure crystal and lifetime floating sapphire needle. 78 RPM constant-speed motor. 5" PM speaker and high-quality amplifier complete with tubes. Base measures 15 1/2" x 12 1/2" x 6". MA21. \$2395. Base with motor, turntable and record changer. MA-2192. \$1495

Great Parts Value!

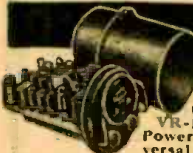

Indicator Amplifier AM-61. All brand-new, valuable parts. 15 popular tubes, including: 6SL7GT, 6X4, 6AR5, 6SN7GT, 6Y3GT, 8016. Powerful compact blower, universal wound for 22-30 volts AC or DC. Resistors, filter by-pass condensers, sockets, connectors, etc. MA-2102. \$895



15" HIGH-FIDELITY DYNAMIC SPEAKER

Husky 25-watt dynamic speaker for use where perfect reproduction is desired. Ideal for both indoor and outdoor installations. 12,500 ohm field. 16 ohm voice coil. Regular \$40.00. \$1895. Dist. MA-2190.

FM and HAM ANTENNA



AN-104-B. K-wave at 100-156 MC; formerly used with SCR-522, 274-N, ARC-5. A pair make an excellent broad-band dipole for FM reception. Coaxial connector in base. Very sturdy; use anywhere. MA-2153. \$39c

Battery Audio Amplifier



Telephone Repeater EE-99-A, designed for telephone and intercom systems; either portable or fixed station. Complete with tubes, battery cable and plugs, carrying case and strap, less batteries. Brand new. MA-E99. \$1995

FREE CATALOG

Order now—right from this ad! Send 25% deposit—we ship C.O.D. for balance plus postage. Write, too, for Mid-America's big, complete catalog that lists hundreds and hundreds of hard-to-get items—ALL AT UNBEATABLE LOW PRICES! Mail orders and catalog requests to store address—Dept. RC-18

MID-AMERICA CO. Inc.

STORE: 2412 S. MICHIGAN AVE. CHICAGO 16, ILL.
WAREHOUSE: 2307 S. ARCHER AVE. CHICAGO 16, ILL.

TELEVISION AND FM ANTENNAS

(Continued from page 126)

somewhere between 2 and 3, it is considered a fair value.

The Tricraft Products Co.'s antenna, developed in conjunction with the Bel-

All elements of the antenna are securely grounded to the support member, which permits grounding it to ensure lightning protection.

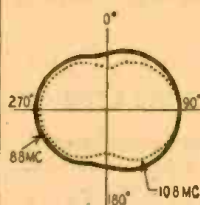

Fig. 13.

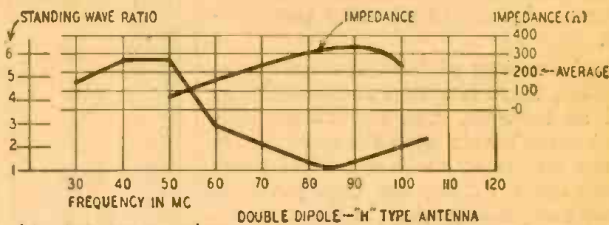

Fig. 14—Antenna impedance vs frequency. Mismatch may cause ghosts.

mont Radio Corp., uses 2 dipoles (see Fig. 15) to cover the 2 TV bands and also FM. It is matched by a 300-ohm line. A relatively thin dipole, (which is a half-wave long at 70 mc) is placed near a relatively thicker dipole cut to a half wave at 128 mc. The short, thick dipole is connected at its ends through inductive rings to the approximate mid-points of the thin, long dipole section.

In the lower television band the antenna acts like a broad-band folded dipole tuned to approximately 65 mc, with the thin member resonant at about this frequency, and the short heavy antenna end loaded by the inductive rings at its ends. In the higher TV band, the long thin dipole is 1 1/2 wavelengths in the center of the band, and the short member is end-fed by means of the inductive rings connecting it to the long member, so that the currents flow approximately in phase in the 2 dipoles.

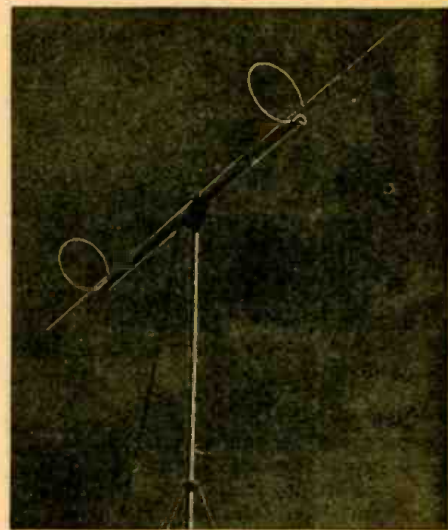

Fig. 15—Interesting-looking two-band antenna.

BRITISH TELEVISERS

(Continued from page 44)

first a.f. plus pentode output type. Almost its only departure from the normal is the use of 725 kc as the intermediate frequency.

On the television side, the 4 r.f. stages are the tuned-plate, tuned-grid variety (except that the grid of the second r.f. amplifier is untuned) illustrated in Fig. 7, so arranged that the circuits form capacitance-coupled bypass filters. The preset tuning is done by movable brass cores. The video amplifier and its associated circuits, seen in Fig. 8, have some original features. At the plate of the video amplifier the vision signal is positive, i.e., the picture-painting voltage variations are positive swings and those forming the synchronization pulses negative. The plate output of this tube (V1 in Fig. 8) is applied direct to the grid of the cathode-ray tube. A second output, this time of negative form, is developed across the cathode resistor and applied to the plate of limiter diode V2. In the output of this

tube the sync pulses are positive. The sorting out of short line-sync and long frame-sync pulses is done by feeding them to the grid of the thyatron of the line time base through a differentiating circuit and to that of the frame time base through an integrating circuit. Another diode limiter is connected between the grid and cathode of the cathode-ray tube. It is adjusted by a preset control to prevent the input from exceeding the peak white level. Auto ignition interference is thus kept below the level at which it could cause white splashes.

An interesting set in the higher-priced class is the Sobell T.107 which costs \$684. In this case the purchase (Continued on page 141)

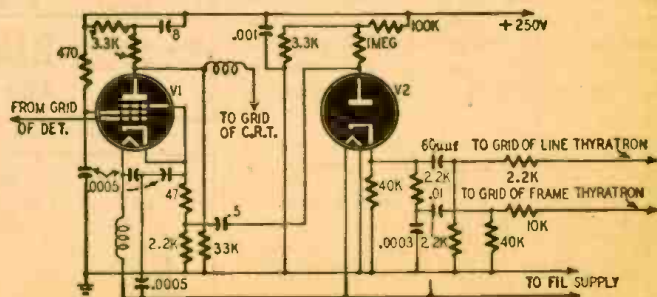

Fig. 8—Video signals come from plate, sync signals from cathode.

AN UNBELIEVABLE VALUE!

12 VOLT 50 AMP. GENERATOR



AS LOW AS **\$7.95**
Less Pulley
OR ONLY **\$9.45**
With Pulley

These generators are excellent for truck or bus use. They also will make a fine power supply for your radio shack or nice light welder. Brand new in original boxes as pictured with pulley, \$9.45 each or with keyed shaft less pulley—\$7.95 each.

Shipped Express Collect

1/4 MILE STAINLESS STEEL RECORDING WIRE **\$1.49** only

.006 Stainless Steel recording wire. New on original spools as used by Army and Navy recorders. Each spool contains at least 1/4 mile of wire. Can be used on standard wire recorders. Add 25c to cover handling and postage.

GENUINE GOVERNMENT SURPLUS

RCA ANTENNA REEL



MODEL **\$1.49**
M 1-19611

A hand operated antenna Reel, for reeling in and out trailing antennas. Mfd. by Continental Radio & Television Corp. under RCA License. Add 20c to cover postage & handling.

Shipped Express Collect

RG-8/U COAX CABLE

RG-8/U is the ideal cable for feeding receiving and transmitting antennas for all frequencies up to 250 MC and can be used up to 3000 MC and down to DC. New in 100' lengths, less than ever before, only **\$3.95**.

Shipped Express Collect

CHECK THESE VALUES

Transformers 110 volt. to 6v 2.25 amps, new **\$1.49**
Add 15c to cover postage and handling

24" Headphone cord complete with lugs **\$.09**
Add 10c to cover handling and postage

Continuity Tester with 12 extra penn light cells **\$1.95**
Add 15c to cover handling & postage

Throat Mike, complete with cord and switch **\$.95**
Add 15c to cover handling & postage

N6A Gunsight containing a F1.9 lens system plus a mirror and many other valuable parts **\$1.00**
Add 25c to cover handling & postage.

Microphone switch and cord **\$.25**
Add 10c to cover handling & postage

DM32A Dynamotor Input 28v at 1.1 amps, output 250 v at .06 amps **\$.89**
3 for \$1.95
Add 35c to cover handling & postage

5# Radio Parts Assortment, guaranteed satisfactory **\$1.00**



RADIO CONTROLLED BOMB-FIN

\$9.85

This unit was originally used to control a guided Bomb; it contains a 24-volt Willard rechargeable battery pack, which operates a gyroscope, and low geared reversible motor. The unit also contains a precision built 5-tube RF Receiver complete with dynamotor.

Shipped express, charges collect

500' **\$2.95**
3 CONDUCTOR TELEPHONE WIRE

3 conductor Braided insulated copper & steel telephone wire. It is made of copper for conductivity, and steel for strength. Worth at least 3c per ft. Yet due to an exceptional buy, we can now offer it at less than 1c a ft.

Shipped Express Collect

SPARE PARTS KIT **49c**

For CDE 60050 Test Oscillator contains 1 coupling cap. 1000 mm Pd. 300V D.C., 1 Inductor, R.F. 2.5 uh, 0.07 ohm, D.C. Res., 1 Resistor 75 ohm, 5%, 1 potentiometer 1000 ohm 2w, 1 push button switch, and 1 Vibrator 12V. Add 20c to cover postage and handling.

LOOP ANTENNA LP-21-A **\$5.95** ONLY



Used primarily on aircraft & Marine ADF Systems, Loop LP-21-A contains an electric motor and selsyn. These loops have been removed from salvage aircraft, but are guaranteed to be in excellent working condition.

Shipped Express Collect

CODE KEYER



TG-10-B **\$17.50** only

This practice Code Keyer contains a 7 tube 110 volt 60 cycle Amplifier plus an electric eye tube. It also contains a 110 volt 60 cycle motor which runs your code tape through at the rate of 5 to 25 words per minute. The amplifier would make an excellent P.A. system and the motor would turn a timeable very nicely. Used but in good condition.

Shipped Express Collect

ZA-1 LOCALIZER SIGNAL CONVERTER



CDE-20109 **\$1.95** ONLY

Contains 2 tubes 6F8G and 6C8G, several carbon resistors, 2 wire wound resistors, 2 precision resistors, 3 transformers, 3 set volume controls and other valuable parts. Add 40c to cover handling and postage.



TIME DELAY RELAY **\$1.49** only

A current relay S.P.D.T. Type B-9. Manufactured by Guardian Electric Co., Mrs. Part No. 34464. New in original cartons. Add 15c to cover handling and postage.

NO C.O.D. ORDERS

MINIMUM ORDER \$2.00 • ALL PRICES F.O.B. OUR WAREHOUSE • MICHIGAN SALES ADD 3% TAX

N. SILVERSTINE CO.

6532 EAST McNICHOLS ROAD
DETROIT 12, MICHIGAN

Surplus

Bargains

RADIOMEN!
GET THIS
Brand New! **Valuable Book**
OF "150 NEW
RADIO DIAGRAMS
EXPLAINED"
FREE

100% Satisfaction Guarantee

"I personally guarantee that at the end of 1 year from date of receipt, my 'Applied Practical Radio' set will have earned for you at least 10 times its cost, or you may return it and I'll return every cent you paid."

B. W. Cooke, Pres.



Here's a sensational "get acquainted" offer! This big, new book, "150 New Radio Diagrams Explained" is yours, absolutely FREE. It contains circuits and data on the latest Radio and Television sets. Easy-to-read, 8 1/2 x 11" size, with full instructions on how to read and use diagrams. Belongs in every radioman's kit.

HOW TO GET YOUR FREE BOOK

You get this book Free just for looking over — without cost or obligation—the sensational new 5-volume Coyne set "APPLIED PRACTICAL RADIO". It's just off the press. Here's everything you want to know about radio, from basic principles to up-to-the-minute Television and

FM I PA, short-wave, aviation-auto radio, multi-bands, tele-transmission, testing instruments and trouble-shooting short-cuts, phototubes, etc., all clearly explained. Shows how to construct, install, service all types of apparatus. Step-by-step photos break equipment down before your eyes! Newest testing methods. Hundreds of subjects, over 1500 pages, almost 1000 illustrations, diagrams. Written for home training and field reference—so complete, so up-to-date and practical that every man interested in radio should see it.

SEND NO MONEY You can see how much your future, without cost or obligation. I'll send "APPLIED PRACTICAL RADIO" postpaid, for you to look over for 7 days FREE—and with it, the Radio and Television Diagrams book as an outright Gift! This book is yours to keep free whether or not you decide to keep the 5-VOLUME SET!

Use Coupon Now!

YOU ARE NOT BUYING THE 5-VOLUME SET WHEN YOU SEND THIS COUPON. You are merely asking to see the books free for 7 days. Free Book Offer is limited — so mail coupon today.

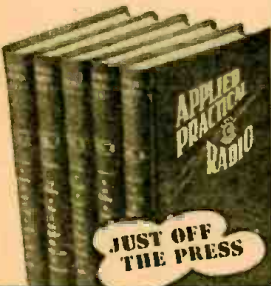

JUST OFF THE PRESS

FREE BOOK COUPON

B. W. Cooke, Pres., Coyne Electrical & Radio School 500 S. Paulina St., Dept. 18-T1, Chicago 12, Illinois

Send me the NEW 5-Volume Coyne Set, "APPLIED PRACTICAL RADIO" for FREE examination. Also send "150 New Radio Diagrams Explained" as a FREE gift. In 7 days I'll either return the 5-book Set and owe nothing or pay \$3 then and \$3 a month until \$16.75 is paid—or I'll send the cash price of \$15.00.

NAME AGE

ADDRESS

TOWN ZONE..... STATE.....

() Check here if you want to pay postman cash price of \$15.00 (you save \$1.75) on delivery. Same Money Back Guarantee after 7 days' trial.

RADIO SET AND SERVICE REVIEW

(Continued from page 48)

have wide-band vertical amplifiers, an input calibrating source, and a low-capacitance probe.

When complete alignment is required, it can be performed most conveniently in the following order: 1. video i.f. traps; 2. video i.f. transformers; 3. sound discriminator; 4. sound i.f. transformers; 5, 6. r.f. and converter lines; 7. oscillator line; 8. converter grid trap; 9. retouch video i.f. transformers; 10. sensitivity check. Complete step-by-step alignment procedure is given in the manufacturer's booklet. It is complex, requiring 52 separate steps, and the manufacturer's instructions should be studied carefully before starting the work and referred to constantly during the process of alignment.

REVERSIBLE TELEVISION

(Continued from page 92)

endorsement, signature, etc.
Restaurants—between captain (or headwaiter) and chef.
Department stores—between customer and stockroom, to pick out items not in stock at counter, etc. A customer in a special booth—provided for this purpose—can "shop" via television, ordering a long list of merchandise from stockrooms in a minimum of time.
Hospitals—doctor or intern, in a fraction of time now required, can make his round of the patients by seeing and talking to them. (Teleset at foot, or side, of bed.)
Newspaper offices—editors can read last rush proof via television. Composer props "copy" in front of teleset, editor then reads it without leaving his office.
Industrial plants—inspection and verification of visitors at gate—reception office from office in plant.
 But why go on? You can make your own list of uses—it is unending.

LITZ WIRE

Magnet Wire

★ **LARGE STOCK** ★

MAGNET WIRE, Incorporated

25 WEST BROADWAY

Worth 2-2497, Beekman 3-8465

Cable Address: "Magnetwire, New York"

NC HAM RECEIVERS

NC-101X: with 5 meter, 11 tube sup het xtal filter 10-20-40-80-160 meter bands. 1 RF 2 IFs AVC CW oscil noise limiter incorporated in tone control; PW dial 50 to 1 ratio band spread over entire dial, min. undistorted output 10 watts built-in power sup., automatic coil changing. Orig. value \$243.00. Only a few available in excellent like new condition. Complete w/all tubes, xtal L/speaker \$67.50

NC-101XA: same as above but with direct reading dial in excellent like new condition. Comp. L/spk \$100.00. 100 assorted condensers 1, .05, etc. \$3.00

McCONNELL 3834 Germantown Ave Phila., Pa. RA-5-6033

SIGNAL - TRACER - GENERATOR



- ★ Two Instruments in one
- ★ Simple to operate
- ★ A Remarkable Instrument
- ★ Cuts Servicing Time 1/2
- ★ Pencil Thin Probe
- ★ A.C. - D.C. Operated

This instrument permits following the signal subtly through the receiver from the antenna to the speaker, a sure method of locating the cause of trouble. PLUS a signal generator that delivers a strong A.F., I.F. AND R.F. signal, permitting the serviceman to align and trace any portion of receiver under test. Generator frequency 1000 cycles to 25 megacycles. Uses a multivibrator network.

A few faults that can be traced and isolated with instrument

- ★ Distortion
- ★ Fading
- ★ Loss of Gain
- ★ Oscillation
- ★ Intermittent Operation
- ★ Open Coils
- ★ Weak or Shorted Tubes
- ★ Hum and Noise

A.C.-D.C. Ready to operate, with instructions. \$16.50

See Your Local Jobber
 If he can't supply you write us direct
 Write for free literature

CONSTANT ELECTRIC

112 CORNELIA STREET BROOKLYN 21, N. Y.

P. M. DYNAMOTORS

6.3V. input gives 240V 100 MA. conservative rating. Operate transmitter or receiver. Replaces vibrator, transformer and rectifier. Versatile unit. Brand new, sealed cartons. Mfg. ratings 12/24V inp. 500V \$4.50 out. F.O.B.

E. H. PALLME 375 OAK PL. MINEOLA, N. Y.



SPECIAL! SPECIAL! SPECIAL!

Highest Grade Standard Output Transformers, Push-Pull 50L6 to 4 ohm Voice Coil 49c
 Single 50L6 to 4 ohm Voice Coil 39c
 Single 42, 43, 6V6, to 4 ohm V.C. 42c
 Filter choke 300 ohm, 70 mills, 10 hy 39c

● include sufficient money for postage; unused postage refunded. ● 20% deposit with order, balance C.O.D. Minimum order \$3.00.

Write for Giant Bargain Catalog.

BUYERS SYNDICATE

786 Carew Street Springfield, Mass.



BARGAIN SPECIAL

'Tops' in Headphones
 At a Fraction of Original Cost

8000-ohm impedance, highly sensitive. Best quality Alnico magnets in molded black bakelite cases, concealed terminals. Headband fully adjustable, leather covered spring steel 12" cord with PL54 plug attached at side out of way. Jack and rubber cord supplied to extend length to 5 1/2 ft.



Extremely lightweight, only 9 oz., with removable rubber ear cushions of comfortable design Brand New—a 13.50 Value.

Stk. No. 17A37, Special Per Pair \$1.95
ORDER NOW, from this ad Add Postage



FREE Catalog

Many other BARGAINS in this BIG NEW 1948 B-A Catalog.

Latest developments in Radio and Electronic parts and devices, newest Ham gear.

Write if you have not received it—Cot. No. 481 FREE on request.

BURSTEIN-APPLEBEE
 1012-14 M'GEE STREET, Company
 KANSAS CITY 6, MISSOURI

RADIO SCHOOL DIRECTORY

PREPARE NOW FOR SKILLED JOBS IN RADIO AND ELECTRONICS

If you want to grow with a growing industry—Investigate

TELEVISION • FM • RADIO-ELECTRONICS

STUDY and WORK at a school established by the leaders of the Radio and Television industry to train personnel for expansion ahead

Leaders of Industry on BOARD OF TRUSTEES

John Shepard, Chairman of the Board, Yankee Network
William B. Dolph, Exec. V.P. American Broadcasting Stations
Hamilton Hoge, Pres. United States Television Mfg. Corp.
Herbert L. Pettay, Exec. Dir. W. H. N.
R. L. Duncan, President • W. B. Campbell, Vice Pres.

PRACTICAL SHOP WORK ON BRAND NEW EQUIPMENT

Here's a school that's really practical because it was established by the practical radio and television leaders listed above. Equipped with the latest word in television, radio and F.M. (complete television studio and equipment in operation at school), manned by skilled teachers who stress learning by doing, the Radio-Elec-

tronics School of New York has been acclaimed by Radio & Television executives and leaders for its practical laboratory method of training skilled men to fill the personnel needs of this ever expanding industry.

Licensed by the State of New York
Free placement service.

IMMEDIATE ENROLLMENT—Approved for Veterans Under the G. I. Bill

Morning, afternoon and evening sessions. Open daily from 8 a. m. to 9 p. m.
Sat. 9 a.m. to 2 p.m.

Visit us today for full facts or write for free catalog RC

RADIO ELECTRONICS SCHOOL OF NEW YORK

62 BROADWAY, NEW YORK 4, N.Y. BOWling Green 9-1120
Owned and Operated by the Radio-Electronics Institutes of America

PRACTICAL TECHNICAL TRAINING

SPECIALIZE in 6 months to 3 years

COURSES

SERVICE

- 6 to 12 Months
- Electricity
- Welding
- Refrigeration
- Heating

TECHNICIAN

- 1 to 2 Years
- Electricity
- Radio
- Electronics
- Refrigeration, Heating and Air Conditioning

PROFESSIONAL

- 3 Years
- Electrical Engineering Bachelor of Science Degree Major in Machinery or Electronics

Train in Electronics, Radio, Electricity for a substantial career in industry—or a business of your own. Prepare in one year to be a Technician—or in two additional years secure a Bachelor of Science Degree in Electrical Engineering with major in Electronics. More than 35,000 former students in industries the world over. 1,538 students now enrolled from 48 states and 13 overseas countries. Faculty of 72 specialists. Write for catalog and Personal Guidance Questionnaire.

Terms start January, April, July.

MILWAUKEE
SCHOOL of ENGINEERING
A TECHNICAL INSTITUTE

Dept. RC-1-48

North Broadway, Milwaukee, Wis.

CAREERS in RADIO

INTENSIVE COURSES—Thorough, technical education for progressive men and women.

1. RADIO TECHNICIAN—The MRI General Course. Includes F.M. & Television. Prepares for FCC Broadcast Licenses.
2. RADIO & TELEVISION SERVICING—Prepares for employment as Repairman on Standard Broadcast, F.M. & Television Receivers.
3. RADIO COMMUNICATIONS—Prepares for FCC Operators' License. Leads to position as Merchant Marine or Flight Radio Officer; Commercial Operator.
4. FUNDAMENTAL RADIO MATHEMATICS—The MRI Preparatory Course. Required pre-training for students lacking a basic mathematical background.

MELVILLE RADIO INSTITUTE

MELVILLE BUILDING
15 WEST 46TH ST., N. Y. 19, L.O. 4-0340
"The Radio School Managed By Radio Men"

Licensed by the State of New York

MELVILLE RADIO INSTITUTE

MELVILLE BUILDING
15 West 46th St., N. Y. 19, N. Y.

GENTLEMEN: RC

Send me FREE information about your school.

Name.....

Address.....

MAIL THIS COUPON NOW

A CAREER WITH
A FUTURE!

TELEVISION

Shop Work • Shop Techniques • Theory
FULLY EQUIPPED LABORATORIES

- RADIO SERVICE & REPAIR
- F. M. & TELEVISION
- TRANSMITTER COURSES
Preparing for F.C.C. LICENSES
- RADIO TECHNOLOGY
A Junior College Level Course preparing for positions in Radio-Electronic Engineering Field.

MORNING • AFTERNOON • EVENING CLASSES
MODERATE RATES • INSTALLMENTS

Available Under G. I. Bill
COME IN AND SEE OUR STUDENTS AT WORK

DELEHANTY SCHOOL OF

RADIO • ELECTRONICS • TELEVISION
105 EAST 13 ST., N. Y. 3, N. Y. • DEPT. T
LICENSED BY STATE OF NEW YORK



RADIO COURSES

Preparatory, Service, Broadcast, Television, Marine Operating, Aeronautical, Frequency Modulation, Radar.

Classes now forming for mid-year term
Feb. 21st. Entrance Exam. Jan. 12th.
Veterans. Literature.

COMMERCIAL RADIO INSTITUTE

(Founded 1920)
38 West Biddle Street, Baltimore 1, Md.

TELEVISION

Practical and Theoretical Technicians Course, covering all phases of Radio, Frequency Modulation, Television, leads to opportunities in Industry, Broadcasting or own Business. Day and Eve. Sessions. Licensed by N. Y. State. Approved for Veterans.

ENROLL NOW FOR NEW CLASSES

Visit, Write or Phone

RADIO-TELEVISION INSTITUTE

Pioneers in Television Training Since 1938
480 Lexington Ave., N. Y. 17 (46th St.)
Plaza 3-4585 2 blocks from Grand Central

LEARN

RADIO

Get F.C.C. License

RADIO — TELEVISION
Repairing

Classes start every month

Our organization engaged in TECHNICAL TRAINING for 27 Years
LITERATURE ON REQUEST

BALTIMORE TECHNICAL INSTITUTE
1425 Eutaw Place, Balto. 17, Md.

APPROVED FOR VETERANS

Radio Technician and Announcers

A practical 15-month course in First Class Radiotelephone Operation and Announcing is offered by Don Martin School of Radio Arts. Most stations these days require combination men. We specialize in this type of training and maintain a placement bureau for our graduates. Serving the industry for 10 years, the School of Radio Arts can train you. Write for our catalogue outlining the courses offered. Classes can be arranged so you can do part time work on the side.

APPROVED FOR VETERANS
DON MARTIN SCHOOL OF RADIO ARTS
1655 North Cherokee St. Hollywood 28, Calif.

BRITISH TELEVISERS
(Continued from page 138)

price includes complete maintenance and servicing for two years by the makers. The set is an all-wave radio and tele- viser contained in a console cabinet. When it is in use as a radio receiver, the cathode-ray tube is concealed by a sliding ground-glass panel, on which ap- pears the illuminated tuning scale of whatever wave band is selected by the wave-change switch. The tuning indi- cator is a spot of light traveling over the scale. On raising this panel and pushing it back into the cabinet, the screen of the 12-inch tube is exposed. The picture is 10 x 8 inches. Like sev- eral other British televisers, the Sobell has single-side-band operation on the television channel. This facilitates the separation of sound on 41.5 mc from



The Sobell T-107 is one of the better televisers.

television on 45 mc and makes for in- creased stage gain because of the nar- rower band width. A noteworthy feature is the use of what the makers term a "spotter" stage. The video amplifier feeds positive picture impulses direct to the grid of the cathode-ray tube. Its output is also connected to the cathode of the tube through a diode so biased that it does not conduct on normal sig- nals. When a peak due to auto ignition interference occurs, the diode conducts and delivers a "whiff" of positive poten- tial to the cathode, thus making the cathode-ray tube grid negative with re- spect to it. The electron beam is dammed back for an instant, with the result that a small black spot is produced on the screen. This is less noticeable and cer- tainly far less offensive to the eye than a large defocused white splotch.

The only set to use projection methods for obtaining a large image is the HMV 1852. In this a 4-inch cathode-ray tube with 25,000 volts on the second anode is employed in conjunction with a mod- ified form of the Schmidt system.

The electrostatic cathode-ray tube, seen in many of the televisers of former years, is never used today. The Cossor and Ferranti sets strike out on a line of their own by using permanent mag- nets with adjustable shunts for focus- ing the electromagnet tube.

New ... **JUST OFF THE PRESS!**
TELEVISION CATALOG

Send for
Your
COPY TODAY!

TELEVISION

NIAGARA RADIO SUPPLY CORP
160 Greenwich St., New York 6, N. Y.

"TELEVISION IS HERE TO STAY."

If you are thinking in terms of Television— whether you own a receiver or planning to build one—get Niagara's new giant Television catalog—all in one complete and comprehensive booklet on everything for Television. Kits, Com- ponents, Test Equipment, Antennas and miscel- laneous—We have them all—Make us your TELEVISION HEADQUARTERS—you will save yourself considerable time and money. Clip the coupon and mail today.

Please send a copy of your new Television book- let to:

NAME

ADDRESS

CITY ZONE STATE

NIAGARA RADIO SUPPLY CORPORATION
160 Greenwich St., New York 6, N. Y.

JANUARY SPECIALS

SPEAKERS

5" Alnico 5 Magnet, 98¢
P.M. each
10 for \$9.50

6" 2.15 oz. Alnico 5 Magnet, \$1.69
P.M. each
10 for \$15.00

All other sizes in stock, at money saving prices.

Volume Controls

1 MEG. volume control with switch and long shaft, ea. 49¢
6 for \$2.75

15 Assorted Volume and Tone Controls (less switches) \$1.95

RESISTOR KIT

100 Insulated Resis- tors, 1/2, 1 & 2 Watt \$1.95

PHONO SUPPLIES

Crystal Pickup Arms... \$1.98
Phono Motor and Turn- table 2.95
I.F.'s 455 KC. 39¢

CONDENSERS

Tubular Paper (500 V. Test)	Mfg.	Price Ea.	Per 100
.01	.08	\$ 6.50	
.02	.08	6.50	
.05	.10	8.00	
.1	.12	9.00	
.25	.17	13.50	
.001	.08	6.50	
.002	.08	6.50	
.005	.08	6.50	
.006	.08	6.50	
.5	.26	22.50	

"Illinois" Electrolytics

Mfd.	VDC	Price each
10	25v	.30
100	25v	.48
12	50v	.34
16	150v	.36
20	150v	.38
24	150v	.38
30	150v	.40
50	150v	.48
8	450v	.38
10	450v	.42
16	450v	.54
20	450v	.60
40	450v	.80
100	15v	.45

"Illinois" Duals

16-16	150v	.50
20-20	150v	.52
30-30	150v	.60
40-20	150v	.60
50-30	150v	.68
8-8	450v	.68
10-10	450v	.74
20-20-20	150v	.84

10% discount on all electrolytics if purchased in lots of 10 or more. Mica Condensers, all sizes, 8c each.

25 lbs. SURPLUS ELEC- TRONIC PARTS \$5.00

A gold mine of parts for repairmen, amateurs, and experimenters . . . sockets, condensers, resistors, transformers, coils, hardware, wire, etc., etc. An outstanding bargain in usable parts! Send \$5.00 cash, check or M.O. today! (Pay small express charges on receipt.)

Minimum order \$3.00—20% with order. Balance C.O.D.—WRITE FOR CATALOG. TWO CONVENIENT PLACES FROM WHICH TO ORDER. PLEASE ADDRESS DEPT. C3

ELECTRONIC DISTRIBUTORS, INC.
620 W. Randolph St., Chicago 6, Ill.

ELECTRONIC PARTS CORP.
436 W. State St., Milwaukee 8, Wisc.

Use A
MODEL 6

KILOVOLTAGE FOR YOUR

TELEVISION POWER SUPPLY



4000-6000 Volts D.C.
Filtered & Shielded
*IT'S SAFE. No 60 cycle a.c. means no dangerous high capacity condensers.

*Does a PERFECT JOB with the 7GP4: the new, brighter 7JP4: the just out 10" electrostatic tubes.
*Guaranteed 3 months.

*ECONOMICAL. Com- pare cost of transformer, filter condensers, recti- fier and insulation.
\$17.95
C. B. MFG. CO.
412 W. 37 St., N.Y. 18, N.Y.

RADIO SCHOOL DIRECTORY

(Continued)

RADIO ENGINEERING

Complete Radio Engineering Course. Bachelor of Science Degree. Courses also in Civil, Electrical, Mechanical, Chemical, Aeronautical Engineering; Business Administration, Accounting, Secretarial Science. Graduates successful. 64th year. Enter Jan., March, June, Sept. Write for catalog.

DEGREE IN 27 MONTHS

TRI-STATE COLLEGE 2418 College Ave. ANGOLA INDIANA



RCA INSTITUTES, Inc.

Offer thorough training courses in all technical phases of Radio and Television

DAYS-EVENINGS WEEKLY RATES

VETERANS: RCA Institutes is approved under G. I. Bill of Rights For Free Catalog Write Dept. -RC-48

RCA INSTITUTES, Inc. A Service of Radio Corporation of America 75 VARICK STREET NEW YORK 13, N. Y.

SOUND RECORDING SCHOOL

A practical 9 months' course in Sound Fundamentals, Recording, and Sound Transmission measurements; in a laboratory containing transmission sets, oscillators, square wave generator and intermodulation analyzer, and other equipment.

Two complete recording studios assimilating broadcast, motion picture and commercial sound recording, under the direction of H. M. Tremaine

Approved for Veterans

DON MARTIN SCHOOL OF RADIO ARTS 1655 Cherokee St., Hollywood, Calif.



CORRESPONDENCE COURSES IN RADIO and ELECTRICAL ENGINEERING

ELECTRICAL ENGINEERING Learn how to work in wide electrical field. Prepare yourself at low cost, for secure future. Modern course, so simplified anyone can understand quickly.

RADIO ENGINEERING Extra fine course, in radio, work. Trains you to be super-service man, real vacuum-tube technician. Servicemen needed badly. Diploma on completion. Many graduates earning big pay.

WRITE about deferred payment plan, ex- \$25 Either school catalog, full details, all Course material, etc. Lincoln Engineering School, Box 931C-107, Lincoln 2, Neb.



CODE SPEED Be an Expert

Learn to be a Telegraph or Radio Operator. Thousands of men needed. Intensely interesting work—good pay. Learn at home or wherever you are, quickly, easily, with the famous Candler Code Speed System. Book of particulars free.

CANDLER SYSTEM CO. Dept. 3-A. Box 928. Denver 1, Colo.

RADIO

TECHNICIAN and RADIO SERVICE COURSES FM and TELEVISION

AMERICAN RADIO INSTITUTE

101 West 63rd St., New York 23, New York

Approved Under GI Bill of Rights Licensed by New York State

FM-RADIO-TV TRAINING FREE BOOKLET NOW AVAILABLE

This new booklet gives you the facts you want to know before you enroll in any school. Profusely illustrated, interesting and factual. Enables you to check why WRCI SPECIALIZED TRAINING METHODS are outstanding in the West; why WRCI laboratory trained specialists are preferred for responsible high paying positions in the fields of Radio Communications and Radio-Television Servicing. Choose your school with care; read this 16 page booklet before you enroll anywhere. Our course is approved for veteran training. Get your free copy of this revealing booklet now. Send a penny postcard or letter today. Please mark it Dept. 1 for quick service, and address:

Western Radio Communications Institute 631 West Ninth, Los Angeles 15, Calif. Member Los Angeles Chamber of Commerce

BOOK REVIEWS

THE FUTURE OF TELEVISION, by Orrin E. Dunlap, Jr. Published by Harper & Brothers. Stiff cloth covers, 6 x 8 1/2 inches, 194 pages. Price \$3.00.

The author, one of the country's pioneer authorities on radio and television, uses present-day facts to deduce the probabilities of television's future. Prediction as such is rejected in favor of showing the nontechnical reader just what the situation is at present and what trends have led to it, then letting him produce the lines into the future on his own personal chart.

The development of television as an industry is first traced, showing the effect of business competition, increasing technical knowledge, and government regulation on its growth. Home television brings the author nearer to pure prediction than any of the other chapters. The ultimate type of multiple-dwelling antenna is discussed, as well as television's effect on the viewer's ordinary radio-listening habits.

Television's probable effect on the movies and theater, the outlook for sound broadcasting, news and sports events, and television as an educational medium are discussed.

The final chapters, a history of television, are especially interesting, particularly the appendix, which is in chronological form.

TELEVISION, Volumes III and IV, edited by Alfred N. Goldsmith, Arthur F. Van Dyck, Robert S. Burnap, Edward T. Dickey and George M. K. Baker. Published by RCA Review. Paper or cloth covers, 6 x 9 1/4 inches. Volume III, 486 pages, Volume IV, 510 pages. Price, per volume, paper, \$1.50, cloth, \$2.50.

These books are the first post-war publications in the Technical Book Series published by RCA Review. Each is a compilation of television papers and other material that have appeared in publications of the I.R.E., the Society of Motion Picture Engineers, McGraw-Hill publications, the Optical Society of America, the American Academy of Political and Social Science, the RCA Review and other papers on the subject that have not been published in other publications.

Volume III covers the progress and development of television from 1938 to 1941. Its material is presented in four sections: Pickup, Transmission, Reception and General. In some instances, the original material was summarized or condensed; not, however, in such a way as to detract from the value of the articles.

Volume IV is prepared along the lines of Volume III and contains slightly more material. This book describes television progress from 1942 to 1946. Color television and military television have been added to the material covered.

A television bibliography, listing nearly 300 technical papers on television and related subjects that have appeared in one or more of 30 publications, will be of particular interest to those doing television research.—R. F. S.

HAM & EXPERIMENTER BARGAINS

at Lafayette

RADAR DRIVER UNIT BC1080B consists of:

1 FILAMENT TRANSFORMER 8.3V @ 8.5A No C.T. 2-5V @ 3A
1 PLATE TRANSFORMER 400-0-400 @ 200 MA 200-0-200 @ 65 MA
1 PLATE & FILAMENT TRANSFORMER 350-0-350 @ 26 MA 5V @ 3A (All 115V 60 cycle Prim.)

2 FILTER CHOKES

5 4mfd. 600V G.E. Pyronol Condensers
1 4mfd. 1000V G.E. Pyronol Condensers
1 .5mfd. 5000V G.E. Pyronol Condensers
3 1mfd. 500V G.E. Pyronol Condensers
1 Relay S.P.D.T. 100 ohm D.C. coil

Pulse type output Transformer & a flock of Resistors, Mica Condensers, R-F Chokes, Fuse Holders & Fuses, Tube sockets—3 for 829's, all in rack & panel.

Mfg. Assembly 12 1/4" x 21 1/4" Panel 19" x 13" x 4" Hi Chassis & End Brackets

Value of parts at surplus prices—\$40 to \$50 YOUR COSTall for \$ 8 95

Shpg. wt. 70 lbs.

RAYTHEON CHOKE & TRANSFORMER COMPONENTS



X43



X45



X44



X49



XPS707

OUTPUT TRANSFORMER

X43-600 ohm line to 6 ohm VM—17db level 2 1/2"x1 1/2" diam. YOUR COST 79c

CHOKES

X44-7.5 henrys, 20 ma., 330 ohms, DC resistance. 2 1/2"x1 1/2" diam. Your Cost 49c
X45-8.6 henrys, 125 ma., 161 ohms, DC resistance. 3 1/4"x3 1/2"x3 3/4". Your Cost \$1.29

FILAMENT TRANSFORMER

X49-6.3V @ 22 amps., 6.3V @ 2.4 amps. CT. 6.3V @ 2.25 amps., 6.3V @ 0.6 amps. CT. 4 1/4"x4 1/2"x4 3/4". Your Cost \$2.95

PLATE & FILAMENT TRANSFORMER

Primary 115V 60cycle, Secondary #1—876V CT. 0.016j amps. Secondary #2-5V, 3 amps. 15 lbs. XPS707—Your Cost Only \$2.95

3E29 (829B) BEAM POWER TUBE \$2.95 XPS416—Your Cost Only

Send for latest bargain flyer chock full of these and other bargains

DEPT. JA8

Lafayette Radio

(RADIOD WIRE TELEVISION, INC.)

100 SIXTH AVE., N. Y. 13
110 FEDERAL ST., BOSTON 10
542 E. FORDHAM RD., BRONX 58
24 CENTRAL AVE., NEWARK 2, N. J.

"TAB"

That's A Buy



CONSISTS OF TWO JAN NEW 866A TUBES TRANSFORMER GARDNER ELEC. CASED 2.5V 10 AMP. 115V/60cy Input, H.V. Insitd 9000V wkg similar to SCR274 MODULATOR less tubes... 1.89 VAC Test: Same mfg as KENYON T389-SOCKETS CERAMIC JOHNSON 224.

- "TAB" SPECIAL \$5.95
 TRANSFORMER ONLY for Two 866A's \$3.95
 872A's COMBINATION TRANSF. sockets 12.00
 872A TRANSFORMER 115 60CY 6.95
 ART/13 COLLINS SPEECH Amplifier & tubes \$4.95
 Pilot light 1" & S6/116V bulb Two for .98
 C'TAB for S.C. Technicians & Diagrams
 TM for BC221 & 211 \$1; BC312 Maint 1.00
 DIAGRAMS-ARCS; SCR522; SCR274; BC 348, BC191, BC375, BC624 & 625 ea. 4.70
 BOOK ON ALL OF THE ABOVE 1.45
 GIBSON GIRL BC778/pc SCR578 *LN 4.95
 BC212 Tank Interphone tubes & dyn *LN 3.95
 COILS for BC191/TUS, 7, 8, 9, 10 each 2.70
 WILCOX RCVR CW3 & coils New 10.95
 COILS CW3 5to10 or 9to16mc's @ 2.70
 BC457-458-459/ARCS Xmitter LN @ 5.95
 BC456 pc SCR274 MODULATOR less tubes 1.89
 APS13 XMITTER RCVR *LN less tubes 5.95
 B1206 BEACON RCVR 200-400KC *LN 4.95
 BC453. RCVR pc SCR274/190-550KC *LN 6.95
 BC454/3-6mc or BC455/6-9mcs/RCVR *LN 4.50
 SOUND POWERED TELEPHONES per pair 19.90
 ONE meg precision 1% resistors 88¢ @ 10 for 6.99
 AUTOSYN #11 OF 24-2V/60cy ea 3.95
 AUTOSYN Type 5/50V/2 for 115V/60cy ea 4.95
 AUTOSYN Type 5/115V-60cy NEW 2 for 18.00
 GR566 WEMTR 0.5to150mcs/600to2mtrs. 29.95
 ANTENNA S.C.Multisection 16ft \$2.95; 19ft 3.49
 Same 22ft \$4.25; 25ft \$6.95; 28'6" 7.95
 SEND FOR "TAB"GRAMS & ARGAIN CATALOG
 38PI \$1.89; 2AP1 \$1.95; 7BP \$2.90;
 304TL 3.75; 5BP1, 5BPA/2.25; 12DP7 4.00
 BAND PASS FILTERS 60-90-150 cycle, each 1.95
 CONDOR VARIABLE 90MMFD/Spilt-stator. .98
 KIT G&P TUBE CAPS 1/4, 3/4, 9/16", 50 for 1.49
 KIT SOCKETS 8, 7, 6, 5, 4 prong etc. 50 for 2.49
 KIT COIL FORMS Thrd small MF, 50 for 1.00
 KIT IRON CORE SLUGS & SCREW, 50 for 1.00
 KIT ELASTIC STOP NUTS ASSTD, 75 for 1.00
 KIT LUG LARGE RADIO Type.....100 for 1.00
 KIT LUGS SMALL RADIO Type.....500 for 1.00
 KIT MOTOR BRUSHES ASSTD.....100 for 1.00
 KIT VITREOUS WV RESISTORS.....20 for 1.00
 KIT CONTROLS Pots AB/J asstd.....10 for 2.00
 KIT ROTARY SWITCHES ASSTD.....8 for 1.75
 KIT POWER RHEOSTATS 25&50watt 6 for 8.49
 KIT KNOBS ASSTD & BUSHINGS 25 for 1.25
 KIT FUSES BUSS&L.F. ASSTD.....300 for 1.95
 KIT GROMMETS RADIO asstd.....100 for 1.09
 KIT SPAGHETTI SLEEVING asstd 75 ft for 1.00
 KIT SILVER CONDENSERS 50 for 1.50
 KIT SILVER MICRA CONDENS. 50 for 2.00
 KIT RESISTORS 1/2 & 1W/50to2meg, 100 for 2.50
 6AK5/50; 6AC7/54; 2X2/49; 6SH7/31;
 211/59; 6CA/20; 614/1.80; 723/2.95
 8013A/2.00; 2D21/81; 2051/70; 531/25.00
 5-MFD/600WV oil condens & brackets... 2 for .98
 RELAY SENS SPDT/4 ma/700 ohm/5A 1.95
 RELAY CONTACTOR 4 PNO/110V/60c/35A 6.95
 BLOWER & Transf. 115V/60c/100CFM 5.95
 KIT CERAMICON CONDORS asstd.....15 for 1.00



NEW WILLARD PLASTIC STORAGE BATTERY NON-SPILL B554 ER27-2/20-2 2 FOLT/30 Amp. hrs. Ball Indictor used in SCR593/728A. GE Portables "TAB" SPECIAL \$1.79 TWO FOR \$3.30 WILLARD B3206/U Non-Spill 2V/26AH \$1.29 Two for \$2.25 TEN for \$10.00 BOTTLE ACID QT. 95c ONE Gal (95oz) \$2.95 Ship acid (R'EXP) only WRITE for DAILY TAB-GRAM

- L83 SPKRS CASED & TRANS. *LN \$3.95, NEW 4.95
 PPL6 Hi-Fi output 2.5/6.5/15.5/62/250ohms 3.95
 UTC LINE AUTOFORMER LVM-11/30 Watt 3.95
 FOXBORO GRAPHIC STRIP Recorder..... 39.95
 CRYSTAL DIODE IN34 @ \$1.39; 5 for 10.00
 55.75; 10 for 10.00
 TIME DELAY RELAY 35-45sec/115V, 10AMP 1.49
 VIBROPLEX SPEEDKEY *LN \$3.95; NEW 5.95

\$2 Min. Order F.O.B. N.Y.C. Add Postage & 25% Deposit. Worth 2.7230. Money Back Guarantee
 DEPT. IRC, SIX CHURCH STREET
 NEW YORK 6, N. Y., U.S.A.
 Corner Church & Liberty Sts., Room 200

Advertising Index

Abell Distributing Company	112
Allied Radio Corporation	105
Almo Radio Company	104
American Sales Company	108
American Surplus Products	132
American Television, Inc.	13
Amplifier Corporation of America	84, 132, 136
Apex Video Company	137
Arrowhead Radio & Television Supply Company	137
Arrow Sales, Inc.	110
Walter Ashe Radio Company	108
Audel Publishers	86
Bell Telephone Labs.	12
Boland & Boyce, Inc., Publishers	3, 7
Bonafide Radio Company	110
Bond Radio	118
Bradshaw Instrument Company	130
Brooks Radio Distributing Company	108
Buffalo Radio Supply	116, 117
Burstein-Applebee Company	140
Buyers' Syndicate	140
C. B. Mfg. Company	141
Capitol Radio Engineering Institute	89
Certified Television Laboratories	136
Cleveland Institute of Radio	81
Clippard Instrument Laboratory, Inc.	104
Coastwise Electronics	136
Communications Equipment Company	99
Concord Radio Corporation	6
Constant Electric	140
Coyne Electrical School	106, 140
Crystal Devices Company	108
Dear & Taylor	136
DeForest's Training Institute	9
Allen B. DuMont Labs., Inc.	95
Edie Electronic, Inc.	133
Eichel Electronic Corp.	144
Electronic Distributors, Inc.	141
Electronic Measurements	133
Espe Manufacturing Company	121
Espe Radio Company	122, 123
Fairchild Publishing Company	120
Freud Transformer Company	124
General Cement Manufacturing Company	137
General Electronic Distributing Company %	112, 131
General Test Equipment Company	100
Greylock Electronic Supply Company	134
Hallcrafters Company	Inside Front Cover
The Health Company	126
Norman H. Henley Publishing Company	102
Hershel Radio Company	14, 15, 16
Hickok Electrical Instrument Company	130
Charles Hoodwin Company	102
Illinois Condenser Company	108
Instructograph Company	118
International Resistance Company	8
JFD Manufacturing Company	126
J.M.P. Manufacturing Company	118
Lafayette Radio	143
Lake Radio Sales Company	132
Leeds Radio Company	110
Leonard Radio, Inc.	94
Leotone Radio Corp.	124
E. L. Luftrell "Radio"	121
McConnell	134, 140
McCurdo Silver Company	92
Magnet Wire, Inc.	140
P. R. Mallory & Co., Inc.	Inside Back Cover
Maritime Switchboard	127
Merit Products	106
Mid-America	138
Midwest Radio Corp.	90
Moss Electronic Distributing Co.	109, 115
Murray Hill Books, Inc.	107
National Radio Institute	1
National Schools	11
Newark Electric Company	90
Newcomb Audio Products Co.	102
Niagara Radio Supply	137, 141
Olson Radio Warehouse	88
Opportunity Adlets	132
Pa-Kette Radio Company, Inc.	129
E. H. Palme	140
Performance Radio Company	137
Potter Radio Company	132
Precision Apparatus Company	90
Progressive Electronics Company	101
Quad Electrical Supply	135

RADIO SCHOOL DIRECTORY . . . See Page 142, 143

American Radio Institute	106
Baltimore Technical Institute	111
Candler System Company	120
Commercial Radio Institute	121
DeLahanty Institute	126
Lincoln Engineering School	4
Don Martin School of Radio Arts	93
Melville Radio Institute	129
Milwaukee School of Engineering	114
RCA Institutes	134
Radio Electronics School of New York	100
Radio Television Institute	100
Tri-State College	100
Western Radio Communications Institute	100



ASSEMBLING COIN RADIOS

Thousands of dollars have been made during the past year by wide awake radio service men who have installed coin radios in Hotels, Hospitals, Motels and Tourist Cabins. Great demand—No experience necessary.



Just 3 Steps

Average Profit \$25 Per Set

If Sold Outright
 Much More If Operated on a Rental Basis!
 We supply complete chassis with 6 tubes, quarter coin slot and one or two hour timer ready to place in walnut cabinet. Furnished with footproof lock and coin box. Fill out order blank and mail to:

EICHEL ELECTRONIC CORP.
 EVANSVILLE 8, INDIANA

FILL OUT...MAIL

EICHEL ELECTRONIC CORP.
 EVANSVILLE 8, INDIANA

No. PLEASE SHIP ME: Amt.

Cabinets with lock @ \$6.75	
6 Tube Chassis @ \$16.50	
Timers @ \$6.50	

I understand the above three items include all the parts for your latest model coin operated radio.

Name.....
 Street No.....
 City and State.....

John F. Rider, Publisher, Inc.	97
Howard W. Sams Company, Inc.	83
Senco Radio, Inc.	118
N. Silverstine	139
Simpson Electric Company	Back Cover
Sprague Products Company	119
Sprayberry Academy of Radio	5
Standard Parts Corp.	134
Star Measurements Company	90
Sterling Electronic Company	134
Supreme Publications	91, 135
"TAB" Technical Apparatus Bldrs.	144
Technical Radio Parts Company	130
Television Industries	125
Test Craft Instrument Co.	113
Tradio, Inc.	80
Transvision, Inc.	114
Triplett Manufacturing Company	103
Turner Company	98
United States Television Manufacturing Co.	88
Universal General Corporation	121
University Loudspeakers, Inc.	84
D. Van Nostrand Co., Inc.	87
Variety Electric Company	94
Vision Research Laboratories	112
Webster-Chicago Corporation	100
Wells Sales, Inc.	2
The Workshop Associates, Inc.	85
Wright, Inc.	100
X. L. Radio Laboratories	106

Quiet as a Moonbeam Falling on Velvet

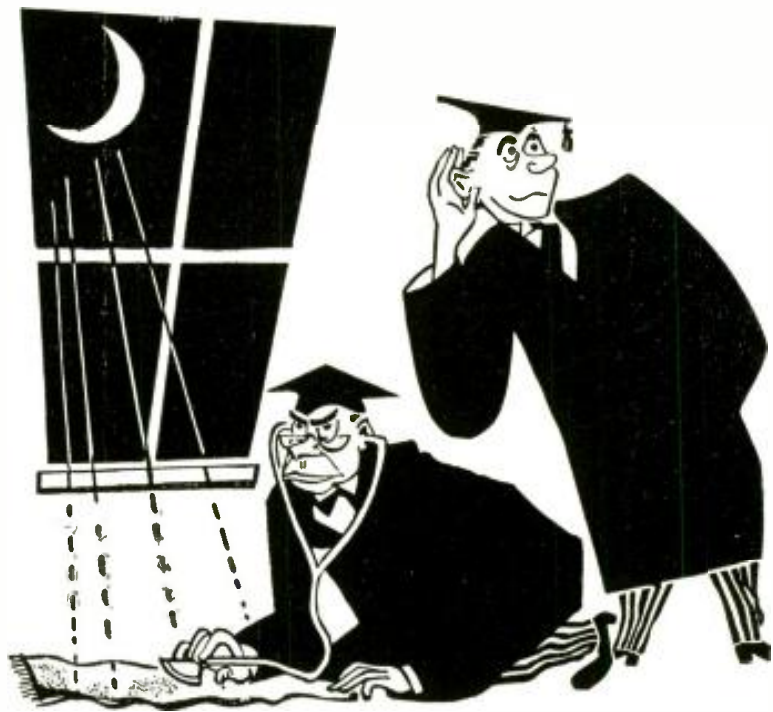

It's Impossible to Hear a Mallory Control Operate!

Ultra-sensitive sound testing meters built for the U. S. Navy prove that the noise level of the Mallory control in operation is so low as to be totally inaudible!

Contact with the talcum-fine carbon element is made by a special Mallory Alloy that passes over it smoothly and silently.

You can use Mallory Volume Controls, Capacitors and Vibrators with complete confidence. They are carefully built to assure ease of installation and complete customer satisfaction. Mallory's standardized range of sizes and types makes the Mallory line a profitable line to stock.

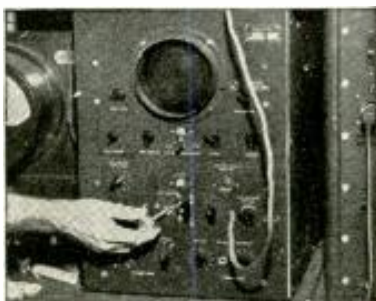

Meter used in the noise level test. Readings were taken on volume controls of all leading manufacturers. Mallory controls gave no audible sound, registered 22% below all others in inaudible sound vibrations.

The things you look for in a control are low noise level, long life, accurate resistance values and smooth, uniform tapers. Competitive tests prove that Mallory leads the field on all four points!

"Good Service for Good Business"

A Mallory plan to build business for radio-electronic service shops.

There's a unique customer follow-up system that will produce repeat business. There's a close tie-in with the Mallory trade mark. Ask your distributor about it!



P. R. MALLORY & CO. Inc.
MALLORY

CAPACITORS . . . CONTROLS . . . VIBRATORS . . .
SWITCHES . . . RESISTORS . . . RECTIFIERS . . .
VIBRAPACK® POWER SUPPLIES . . . FILTERS

Reg. U. S. Pat. Off.

APPROVED PRECISION PRODUCTS

P. R. MALLORY & CO., Inc., INDIANAPOLIS 6, INDIANA

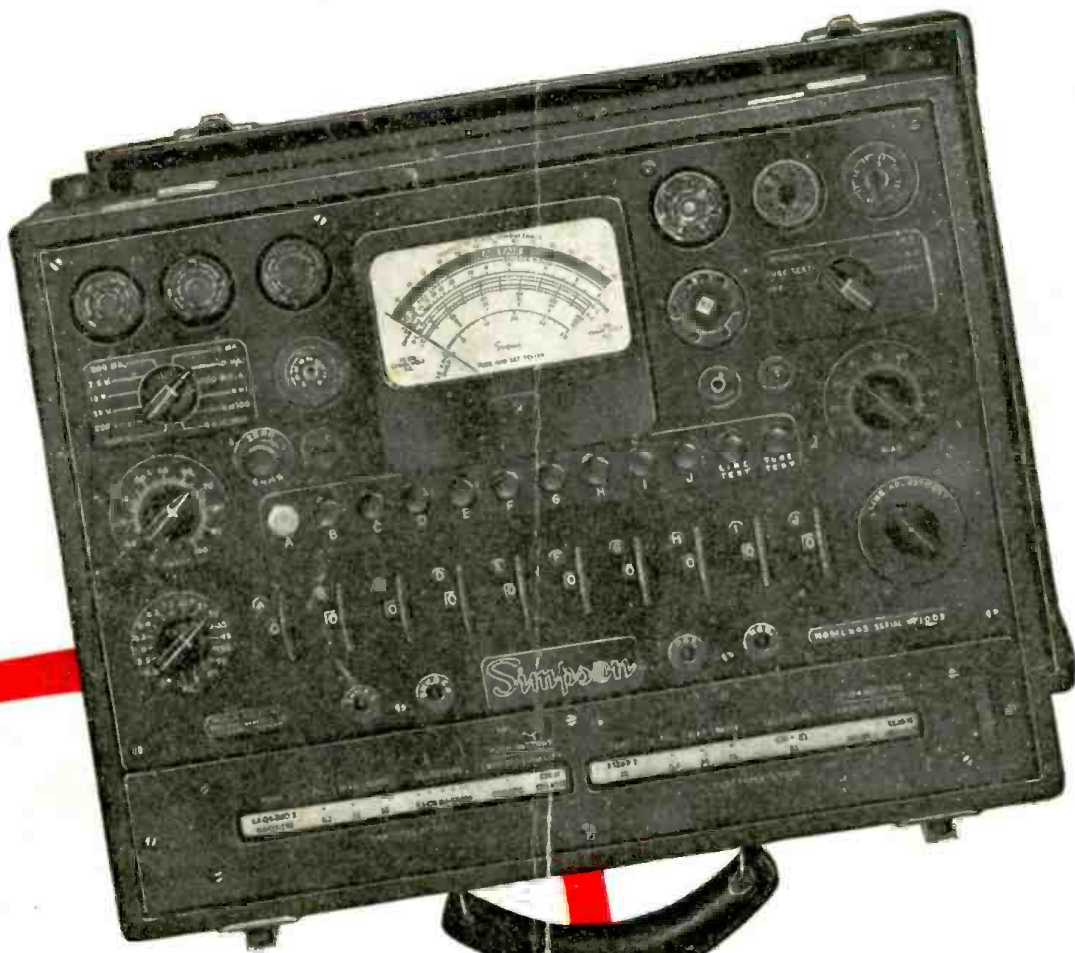

SIMPSON MODEL 445

... Combining a 20,000 ohms per volt Set Tester and a Plate Conductance Tube Tester

Model 445 embodies a *tube* tester of the plate conductance type. The dial indicates percentage of rated plate conductance which can also be considered as percentage of mutual conductance since, in most cases, the amplification factor remains constant. When a tube test is finished the Simpson Automatic Reset mechanism clears the meter for the next test. Just press the button and instantly all switches, both push button and rotary, return to normal automatically. Sockets for all types of tubes are provided, including the new 9-pin miniature; also the sub-miniature as used in hearing aids, etc.

The volt-ohm-milliammeter *set* tester provides the ranges that have made the Simpson Model 260 the most famous set tester in the world. At 20,000 ohms per volt D.C., it has no peer for sensitivity in its price range. Model 445 is housed in a durable, easy-to-carry case. Its panel is of heavy molded bakelite with all letters and figures recessed and filled in white for easy reading.

ASK YOUR JOBBER

TUBE and SET TESTER...

with the famous Simpson "No Backlash" Roll Chart

RANGES

- Volts (20,000 ohms per volt D.C., 1000 ohms per volt A.C.): 0-2.5, 10, 50, 250, 1000, 5000.
- Milliamperes (D.C.): 0-10, 100, 500.
- Microamperes (D.C.): 0-100.
- Decibels (5 ranges): -10 to +52 DB.
- Output (A.C. volts): 2.5, 10, 50, 250, 1000, 5000.
- Ohms: 0-2000 (12 ohms center)
- 0-200,000 (1200 ohms center)
- 0-20 megohms (120,000 ohms center)

SIZE: 16" x 12½" x 6¾". WEIGHT: 9 LBS.

SHIPPING WEIGHT: 12 LBS.

Dealer's Net Price \$110.00

SIMPSON ELECTRIC COMPANY

5200-5218 West Kinzie Street, Chicago 44, Illinois

In Canada, Bach-Simpson Ltd., London, Ont.

