

RADIO'S GREATEST MAGAZINE

K

# RADIO-CRAFT

Incorporating

## RADIO & TELEVISION

HUGO GERNSBACK, Editor

### SPECIAL Radio War Number

**CHURCHILL HEARS  
U.S. PARATROOP RADIO**  
See page 713

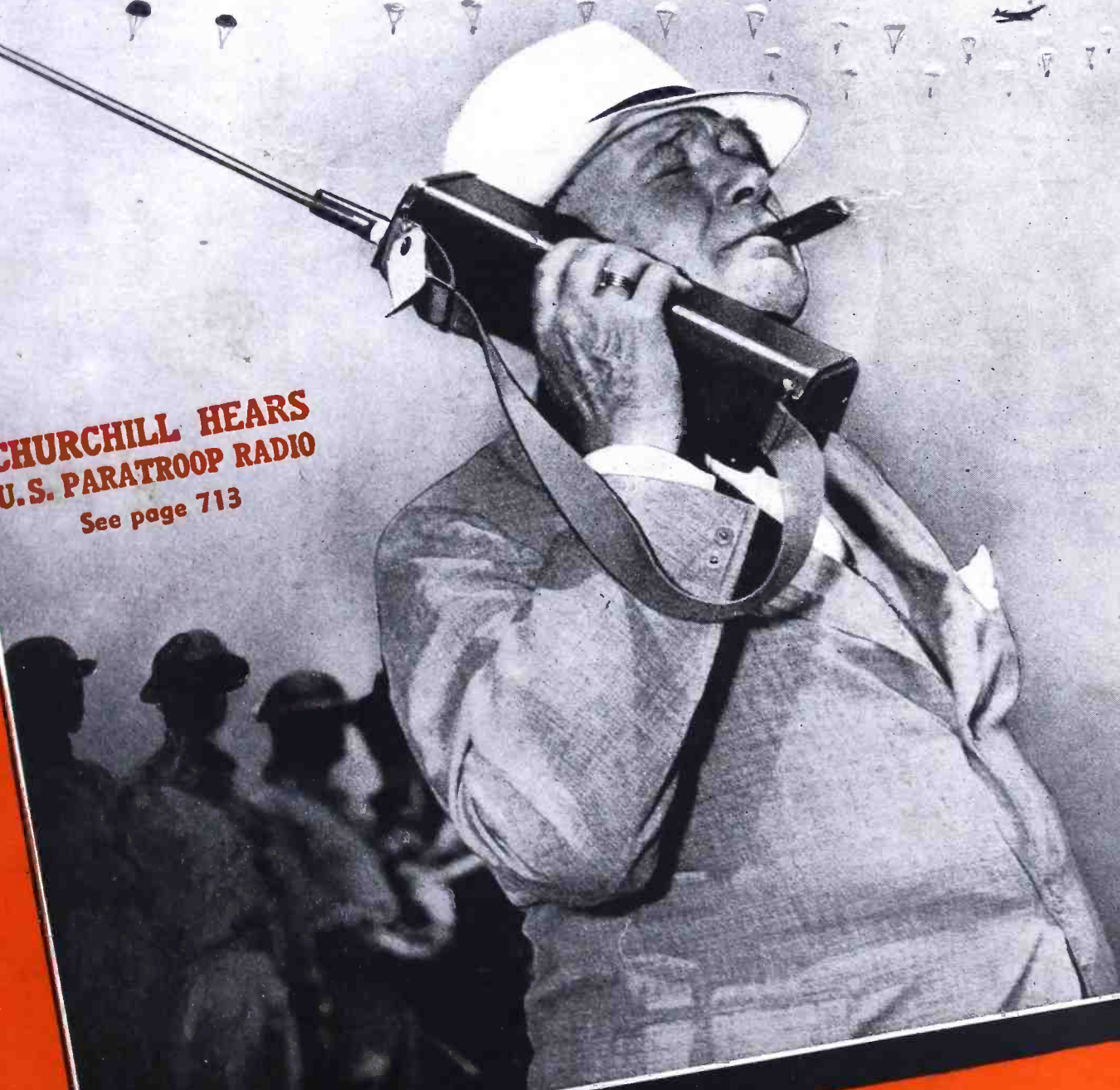

SEPTEMBER

25¢

CANADA 30¢

1942

OVER 125 ILLUSTRATIONS



*Panoramic* **RECEPTION!**  
**THE VISIBLE SPECTRUM**  
**OF RADIO FREQUENCIES**

Research and development engineering in the Hallicrafter laboratories goes constantly forward . . . keeping ahead of the fast moving pace of today's defense requirements for communications equipment.

Panoramic reception is only one of the many new developments Hallicrafters will be the first to introduce when short wave equipment is again available for civilian use.

**the hallicrafters co.**  
 CHICAGO, U. S. A.  
*Keep Communications Open!*

J. E. SMITH  
President  
National Radio  
Institute  
Established  
27 Years

# I WILL TRAIN YOU TO START A SPARE TIME OR FULL TIME RADIO SERVICE BUSINESS WITHOUT CAPITAL

I Trained  
These  
Men

I Trained  
These  
Men

## YOU Build These and Other Radio Circuits with Standard Radio Parts I Send You With My Course

I send you SIX BIG KITS of Standard Radio Parts as part of my Course. With them you conduct SIXTY sets of experiments, build, test and align Radio circuits, and get the experience needed to make extra money while learning.



### Super-heterodyne Receiver

with preselector, oscillator-mixer, first detector, intermediate frequency stage, diode detector-a.v.c. stage and audio stage, which you build from parts I send you in my SIX Big Kits.

**Measuring Instrument** you build early in the Course. This instrument, known as the N.R.I. Tester, is a vacuum tube voltmeter and multimeter with a sensitivity better than 20,000 ohms-per-volt. You will be able to make the following measurements: a.c. volts up to 550 in 4 ranges; d.c. volts up to 450 in 4 ranges; d.c. currents up to 45 ma. in 2 ranges; resistance values up to 100 meg. in 4 ranges; output measurements of receivers in 4 ranges.

### F. M. Signal Generator

really a miniature frequency-modulated transmitter. With it you study frequency modulation, the newest method of Radio communication.

### A. M. Signal Generator

The circuit is exactly like the signal generator the serviceman uses. It provides an amplitude-modulated Radio signal for experimental purposes.

### \$600 BEFORE GRADUATING, KITS HELPED

"From your Experimental Units I learned how electricity worked, how to connect the three stages of a Radio together, also the practical basis for the operation of different parts of a set. I made about \$600 or \$700 before I graduated." S. G. PIERSON, Box 71, Dry Creek, W. Va.



## SAMPLE LESSON FREE

Get my Sample Lesson "How Radio Programs are Sent from the Studio to Your Home." It traces a Radio program from the studio microphone to your loudspeaker. 32 diagrams, pictures and photographs explain every step clearly. You learn the appearance and use of Radio parts, learn to read simple diagrams, become acquainted with coils, condensers, resistors, power supplies, sound, modulation, R. F. and A. F. circuits. See for yourself how complete, how practical my Lesson Texts are. MAIL THE COUPON—NOW.

## These Men Have SPARE TIME BUSINESSES



"I repaired many Radio sets when I was on my tenth lesson. I really don't see how you can give so much for such a small amount of money. I made \$600 in a year and a half, and I have made an average of \$10 a week—just spare time." JOHN JERRY, 1729 Penn St., Denver, Colo.

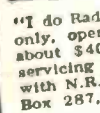

"I do Radio Service work in my spare time only, operating from my home, and I net about \$40 a month. I was able to start servicing Radios 3 months after enrolling with N.R.I."—WM. J. CHERMAK, R. No. 1, Box 287, Hopkins, Minn.



"I am doing spare time Radio work, and I am averaging around \$500 a year. Those extra dollars mean so much—the difference between just barely getting by and living comfortably."—JOHN WASHKO, 97 New Cranberry, Hazleton, Penna.

## These Men Have FULL TIME BUSINESSES



"For several years I have been in business for myself making around \$200 a month. N.R.I. to thank for my start in this field."—ARLIE J. FROEHNER, 300 W. Texas Ave., Goose Creek, Texas.



"I went into business for myself six months after enrolling. In my Radio repair shop I do about \$300 worth of business a month. I can't tell to me."—A. J. BATEN, Box 1169, Glade, water, Texas.



"I started Radio in the Marines in 1917. I also built sets in the early days of Radio. Later I started studying Radio for a living. I recommend N. R. I. Training to any man no matter how long he has worked in Radio. I now have my own business."—CHARLES F. HELMUTH, 16 Hobart Ave., Absecon, N. J.

The men above are just a few of many I have trained at home in spare time to be Radio Technicians. Today they are operating their own successful spare time or full time Radio businesses. Hundreds more of my men are holding good jobs in practically every branch of Radio, as Radio Technicians or Operators. Aren't these men PROOF that my 50-50 method of training gives you, in your spare time at home, BOTH a thorough knowledge of Radio principles and the practical experience you need to help you make more money in the fast-growing Radio industry?

### Train This Practical N. R. I. Way "Learn It, Do It, Prove It"

My Course is NOT just "book-work" training! No indeed! You get practical experience with Radio parts and test equipment almost from the start. First, you LEARN the fundamental facts about Radio parts and circuits by reading my Lesson Texts, prepared especially for home study training. Next, you DO what you have learned, by working with these parts and circuits. Doing with your own hands and seeing with your own eyes makes you remember what you learn. Finally, you PROVE what you learn by making measurements with your test equipment before and after you change your Radio circuits or adjust your Radio parts.

### You Get SIX Large Kits of Standard Radio Parts

In all, I send you Six Large Practical Kits which contain more than 100 Standard Radio parts, including tubes, condensers, resistors, punched chassis bases, a meter, a soldering iron, solder, hook-up wire, hardware and a host of other Radio parts. With all these, you perform 80 different sets of experiments—you make hundreds of tests and measurements and secure a wealth of practical experience. You build the N. R. I. Tester (see column at left), and learn how to use it to measure voltage, current, and resistance. You build dozens of different Radio receiver and transmitter circuits one after another, and secure practical experience with each. You learn how to recognize, locate and repair troubles in Radio circuits.

### Beginners Quickly Learn to Earn \$5, \$10, A Week Extra in Spare Time

I show you, too, how to get practical servicing experience at home. Many begin doing real Radio work in their neighborhood only a few months after en-

rolling. Furthermore, right from the start I begin sending you Practical Job Sheets—over three dozen in all—which give plans and directions for doing increasingly more profitable Radio servicing jobs. This is why so many of my students start building their own spare time Radio businesses while still learning, and make \$5 to \$10 a week extra.

### It's Smart to Train for Radio Now— for Good Jobs Like These

Radio is one of the country's busiest industries. The 882 U. S. broadcasting stations employ Radio Technicians with average pay among the country's best paid industries. Radio manufacturers are getting millions of dollars worth of Government orders. The Radio repair business is booming; due to shortage of new home and auto Radio sets (there are 57,400,000 in use), giving good full-time and spare-time jobs to thousands; offering many opportunities for Radio Technicians to open their own Radio businesses without capital—on spare time earnings. The U. S. Government needs Operators and Technicians for civilian Radio Jobs. Aviation, Police, Marine, Commercial Radio and Loudspeaker Systems offer good pay jobs for trained men. Television promises good future opportunities. My Course can lead you to a good job in any of these profitable fields.

### Extra Pay in Army, Navy, Too



Men likely to go into military service—soldiers, sailors, marines—should mail the Coupon Now! Learning Radio helps men get extra rank, extra prestige, more interesting duties, much higher pay! Also prepares for good Radio jobs after service ends. IT'S SMART TO TRAIN FOR RADIO NOW!



MAIL THE COUPON NOW—for a Sample Lesson and 64-page book FREE. Get the details of how I can give you practical training to be a Radio Technician at home in your spare time. Find out about my Course, my 6 Big Kits of Radio Parts. Read letters from more than 100 men I trained, so you can see what they are doing and earning. MAIL THE COUPON in an envelope, or paste it on a penny postcard.

J. E. SMITH, President  
Dept. 2HX  
National Radio Institute  
Washington, D. C.

### TRAINING MEN FOR VITAL RADIO JOBS

## GOOD FOR BOTH 64 PAGE BOOK FREE SAMPLE LESSON



J. E. SMITH, President, Dept. 2HX  
National Radio Institute, Washington, D. C.

Without obligating me, mail your Sample Lesson and 64-page book FREE. I am particularly interested in the branch of Radio checked below. (No salesman will call. Write plainly.)

- Radio Service Business of My Own
- Service Technician for Radio Stores and Factories
- Spare Time Radio Servicing
- Auto Radio Technician
- Aviation Radio
- Operating Broadcasting Stations
- Army, Navy Radio Jobs
- Operating Police Radio Stations
- Operating Ship and Harbor Radio

(If you have not decided which branch you prefer—mail coupon for facts to help you decide.)

Name ..... Age .....

Address .....

City ..... State ..... 2FR

# RADIO-CRAFT

Incorporating

**RADIO & TELEVISION**

**HUGO GERNSBACK**  
*Editor-in-Chief*

**HARRY CONVISER**  
*Managing Editor*

**G. ALIQUO**  
*Circulation Manager*

**Contents AUG.-SEPT., 1942 Issue**

**VOLUME XIII -- NUMBER 12**

Mailbag .....	708
Editorial: U. S. Radio War Effort..... by Hugo Gernsback	711
The Radio Month in Review.....	712

## WARTIME RADIO

RCA's All-Out for Victory.....	714
Wartime Engineering..... by Dr. Alfred N. Goldsmith	715
Radio and Electronic Devices Are Westinghouse War Weapons	716
G.E.'s War Work to Yield Post-War Benefits.....	718
Mobilized Condensers..... by The Engineering Department, Aerovox Corporation	719
Farnsworth Research Aids War Program.....	719
Air Corps Radio University..... by Major J. R. Johnston	720
The Radio Coat.....	721
Servicing—Second Front for Radio in War.....	722

## RADIO SCIENCE

New Ideas in Radio Must Be Interchanged..... by Arthur Van Dyck	723
New Radio Developments Described to I.R.E.....	723
New Scanning Electron Microscope Revealed to Radio Engineers.....	724

## SERVICING

Wartime Solder..... by E. M. Kolman	725
Wartime Transformer Rewinding..... by Fred Shunaman	726
How to Construct a Signal Generator..... by William Moreland, Jr.	728
Military Needs Bring Changes in Radio Processing..... by H. A. Williams	729

### RADIO SERVICE DATA SHEET:

No. 325 G.E. Musaphonic Radio-Phonograph Combination— Model 30.....	730
Measuring Resistance with a Voltmeter..... by John L. Belfi	732
Crosley Scraps '43 Line for Military Radios.....	732

## SOUND

Improved FM Speaker System..... by Benjamin Olney	734
A Simple Bass and Treble Tone-Control Unit.... by E. J. Connor	736
Phonograph Needles in Wartime..... by V. Daniels	736

## ENGINEERING

The Cathode Follower..... by J. H. Hargreaves	737
Standards of Measurement..... by Willard Moody	738

### IN THE NEXT ISSUE

- A Complete 2<sup>3</sup>/<sub>4</sub> x 4-Inch Receiver
- Practical Transformer Design Data
- Radio Direction Finders
- How a Voltmeter May Be Made to Read Watts

### DEPARTMENTS, ETC.

Mailbag .....	708
The Radio Month in Review.....	712
RADIO SERVICE DATA SHEET (See Servicing).....	730
Latest Radio Apparatus.....	740
Book Reviews.....	767

### RADIO & TELEVISION

A Junk-Box C-Bias Supply..... by C. W. McComas	742
Intermediate-Frequency Communication..... by Franklin Williams, W6LUE	742
Direction Finders in Automobiles..... by Willard Moody	743
Filter Talk..... by M. D. Brill	744
Radio Hook-Ups.....	754
The Boys Who Listen.....	755
Radio Kinks.....	758
Radio Patents Review and Digest.....	762

★

Published by Radcraft Publications, Inc. Publication office: 29 Worthington Street, Springfield, Mass. Editorial and Advertising Offices: 25 West Broadway, New York City. Chicago Advertising Office: RADIO-CRAFT, 520 North Michigan Avenue, Chicago, Ill.

RADIO-CRAFT is published monthly, on the first of the month preceding that of date; subscription price is \$2.50 per year in U. S. (In foreign countries, 75c additional per year to cover postage; Canada, 50c additional.) Entered at the post office at Springfield as second-class matter under the act of March 3, 1879. All communications about subscriptions should be addressed to: 29 Worthington Street, Springfield, Mass., or Director of Circulation, 25 West Broadway, New York, N. Y.

★

#### Foreign Agents:

London—Gorrings's American News Agency, 9A Green St., Leicester Square, W. C. 2, England.

Paris—Messageries Dawson, 4 Rue Faubourg, Poissonniere, France.

Melbourne—McGill's Agency, 179 Elizabeth St., Australia.

Dunedin—James Johnston, Ltd., New Zealand.

★

Text and illustrations of this magazine are copyright and must not be reproduced without permission of the copyright owners.

★

Copyright 1942 Radcraft Publications, Inc.



## So much—So quickly... **BY RADIO!**

Radio is the voice and ear of modern war.

Radio follows the flag and the fleet—locates the enemy—flashes urgent orders—safeguards the convoy—guides the bomber—directs the artillery—manoeuvres the tank.

From submarine to flying fortress, from jeep to

anti-aircraft gun, radio is on watch, always ready to speak and to listen—to give warning and to guide.

Radio brings information and relaxation to the free—courage and understanding to the oppressed.

Radio fights on every front!



### **Radio Corporation of America**

PIONEER IN RADIO, ELECTRONICS, TELEVISION

RCA BUILDING, NEW YORK, N. Y.

*The Services of RCA:* RCA Manufacturing Co., Inc. • R.C.A. Communications, Inc.  
Radiomarine Corporation of America • RCA Laboratories • National Broadcasting Co., Inc.  
Blue Network Co., Inc. • RCA Institutes, Inc.

Streamlining

# SYLVANIA SERVICEMAN SERVICE

by  
**FRANK FAX**



A lot of fellows tell me that replacing worn-out parts is a ticklish problem these days.

Duplicating tubes is particularly tough. Very often the entire circuit or the wiring set-up of the chassis has to be changed.

That's why the new Sylvania Base Chart should be just what the doctor ordered. Like earlier editions, it provides a complete cross-index of all Sylvania tube types and bases.

But more than that — this handy and popular guide can now be used in three different ways: as a wall chart, a pocket booklet, or in the service kit.

You can get the Base Chart right away by writing to me, Frank Fax, Dept. C-8, Hygrade Sylvania, Emporium, Pa. Remember, it's free.

There's no charge, either, for many of the invaluable sales helps on the list below. And the others are available at cost price. Select the ones you need and write for them now.

- |  |  |
|--|--|
| 1. Window displays, dummy tube cartons, timely window streamers, etc. (From your Sylvania jobber only) | 16. Technical manual                         |
| 2. Counter displays  | 17. Tube base charts                         |
| 3. Electric clock signs  | 18. Price cards                              |
| 4. Electric window signs   | 19. Sylvania News                            |
| 5. Outdoor metal signs   | 20. Characteristics sheets                   |
| 6. Window cards  | 21. Interchangeable tube charts              |
| 7. Personalized postal cards featuring timely topics   | 22. Tube complement books                    |
| 8. Imprinted match books   | 23. Floor model cabinet                      |
| 9. Imprinted tube stickers   | 24. Large and small service carrying kits    |
| 10. Business cards   | 25. Customer card index files                |
| 11. Doorknob hangers   | 26. Service garments                         |
| 12. Newspaper mats   | 27. 3-in-1 business forms                    |
| 13. Store stationery   | 28. Job record cards (with customer receipt) |
| 14. Billheads  | 29. "Radio Alert" Post-cards                 |
| 15. Service hints booklets   | 30. Radio Caretaking Hints to the Housewife  |

# SYLVANIA

RADIO TUBE DIVISION  
HYGRADE SYLVANIA CORPORATION

## 12-YEAR-OLD CONTRIBUTOR

Dear Editor:

I was certainly surprised when I received a copy of *Radio-Craft*, and saw you had produced my drawing as I had originally made it. On reading your letter I noticed I won a year's subscription to your fine magazine, and I thank you very much.

I have already built a one-tube battery set which works very well. I spend much of my time experimenting and will write you if I have something I think will interest you.

BILLY HOPKINS,  
Muscatine, Ia.

Dear Billy:

(We are eager to see your drawings and description of your one-tube battery set for possible publication in *Radio-Craft*. We believe our young readers—perhaps even our old-timers—will benefit from your experiments, which, judging from your July contribution, should prove worth while.—*Editor.*)

## TO MOODY AND BABCOCK

Dear Editor:

Although Mr. Moody and I have carried on a good argument for some time, those letters of mine, that are now in the Mailbag, can be thrown in the waste basket, if you please.

His agreeing on one point in my argument, the most important one at that, has taken all the fight out of me. I have no further desire to argue with the gentleman.

His letter to the editor in the June issue of *Radio-Craft*, stating his change of mind and contradicting the opinions expressed in his letter to the editor in the May, 1941, issue of *R-C* is most welcome.

We hope this will pave the way for a discussion on good fellowship between competitive servicemen. I refer to his post-script.

As for Private W. J. Babcock, deep in the heart of — — — — —, he seems to have led with his chin in the same issue of *R-C*.

Private Babs: Army restrictions prohibit my discussing the difference between Army radio service and civilian customer requirements, Army signal generators and civilian servicemen's peanut whistles, Army radio receivers and civilian tune-ins.

At this time I am restricted from publishing technical articles and making public statements concerning radio theory and practice.

You may be sure though, there will be a letter from me to you via the editor or the Mailbag after the war is over.

HOMER C. BUCK,  
Detroit, Mich.

## LIKES MOODY'S ARTICLES

Dear Editor:

I just read the May issue of *R-C*. The article "What Happens in Resonant Circuits" was especially interesting. I would like to see more articles of similar nature.

The March FM issue was very interesting. How about a television issue of a similar nature?

The *Radio Patents Review* is my favorite department. Here's hoping war-time restrictions won't prevent its publication.

Keep up the good work.

MAURICE WERNER, W8WJX,  
Erie, Pa.

## I.R.E. INFORMATION

Dear Editor:

I would like to obtain the address of the Institute of Radio Engineers and information as to the qualifications required to become an associate member of that organization.

I should like to thank you at this time for the many valuable articles in your magazine, from which I have gained much useful information and data. I believe *Radio-Craft* to be an invaluable aid to the Radio Serviceman and Experimenter.

ALEX E. DWORKIN,  
Montreal, Quebec.

(An applicant for associate membership in the I.R.E. must be at least 21 years old, of good character, and be interested in or connected with the study or application of radio science or the radio arts. Junior grade is available to qualified applicants between the ages of eighteen and twenty-one. You may write to the Institute of Radio Engineers, 330 West 42d St., New York, N. Y., for additional information and for the name and address of the secretary of the local section in your vicinity.—*Editor.*)

## FM STATIONS

Dear Editor:

Please send me a copy of the latest list of FM outlets as compiled by FM Broadcasters, Inc., and as promised on page 569 of *Radio-Craft* for May.

FREDERICK E. WARD,  
Cataumet, Mass.

(This list appeared in the July issue of *Radio-Craft*, page 674.—*Editor.*)

## GIVE BEGINNERS A BREAK!

Dear Editor:

I have been a reader of your magazine for some time, and believe me it is swell. Keep up the good work!

I believe, as does Gerald Chase, of Burford, Ont., Canada: Give the beginners a break! This letter, in the May issue, expresses my feeling for the beginner. The beginner needs encouragement. We were all beginners once and we know how a pat on the back helps. All the budding "hams" do not prefer fone, so the transmitters' circuits can be simple C. W. circuits.

Let's have more elementary electricity articles with hints, circuits and constructional data; also antennas, short- and ultra-short-wave dope.

Your magazine is F.B. Long live *Radio-Craft*.

J. M. DEFACE, JR. (W5KIJ),  
Dallas, Texas

(We are glad to receive suggestions of this kind, since they enable us to select the kind of articles *Radio-Craft* readers want. Perhaps some of our old-timers can dip into their bag of experience and draw up some beginner's data.—*Editor.*)

## WANTS PLANE DETECTOR

Dear Editor:

I am one of the many spotters in this section. We are trying to find a suitable plane detector for our post. I would like to know if we could buy the one described in the June issue and whom from, or we would like a circuit diagram from which I could construct one. Please let me know.

WM. P. GIVENS,  
Arnold, Pa.

(Information on the plane detector may be obtained from The Zadig Patents, Middletown, Conn.—*Editor.*)

**SUGGESTIONS TO OPA**

Dear Editor:

Have just read "Timely Suggestions to Your Customers on Care of Sets" (pg. 607 June '42 *Radio-Craft*) and on first thought decided to have some cards printed with this information along with my "ad" but after re-reading next to last paragraph decided it would be attempted suicide to distribute such MIS-INFORMATION. I am surprised that the Consumer Division, Office of Price Administration would distribute such information.

The paragraph referred to reads: "Insist that HE fix the set at your home. RELIABLE service shops have portable testing and repair equipment for home calls." To me the author of this list of SUGGESTIONS just doesn't know anything about servicing or customers or he would not have incorporated this suggestion in an otherwise fair but altogether unnecessary list of suggestions. In the first place, if the RELIABLE serviceman could make repairs in the home why would he carry the overhead expenses of a service shop? How many radios are located in homes that have a bench or table where the set can be turned up, around or over to make repairs? If a table or bench can be found, how about the service outlets for soldering iron, tester, etc.? What housewife wants her living room messed up with the smell of solder, burnt rubber, etc., to say nothing of the hot solder drops on the rug, table or chair? Don't forget also that some wet electrolytics will leak when turned upside down and it doesn't take much of this "juice" to spot a rug or piece of polished furniture. Of course, I always seal wet condensers before turning them upside down, but maybe all Servicemen don't. Aside from all this, the SUGGESTIONS have already advised the customer to call a RELIABLE Serviceman, and what RELIABLE Serviceman is going to all the trouble necessary to remove a radio set from the customer's home unless he knows it is absolutely necessary to do so. He certainly won't do this just to change a tube, put on a new service plug, etc. In view of all this, why invite the customer to argue with the Serviceman as to whether or not the set should go to the shop for repairs. It just don't make sense to me and I think the O.P.A. should correct the suggestions accordingly.

Perhaps it would also be a good idea for the O.P.A. to issue some timely suggestions to the customers on "How to take care of your Radio Serviceman," and I would like to suggest the following as a starter:

Make sure, after you have placed a call for the Serviceman, that you will be at home or have someone there so he won't have to make two or three calls before finding some one at home.

Make sure that your radio is cleared of all pictures, vases, lamps, etc., and does not look like the novelty counter at the 5 & 10. He is a clumsy ox and is not used to handling such delicate articles.

Make sure that Junior is sent out to play, so the Serviceman won't have to keep his good eye on his valuable equipment while he is checking your set.

Make sure that there is at least one 60-watt bulb in some of the lamps. The little 10-watters don't give much light. He doesn't have more than two hands at best and to hold test prods, balance the radio and hold a flashlight is almost too much for the old boy.

Make sure—and this is exceedingly important—that you have the money to pay for the repairs, unless you have an established charge account, and don't think that because you have a charge account at the

corner grocery or drug store that your credit is good with the Serviceman. He may operate on a cash basis and any calls back to collect for work already finished are expensive.

E. M. PACE,  
PACE'S RADIO SERVICE,  
Vicksburg, Miss.

**ELECTRONIC-ORGAN FAN**

Dear Editor:

I have recently arrived in the States from Great Britain, and a few days ago purchased a copy of your publication *Radio-Craft*. I read with interest your article on the "Electronic Organ" which was unfortunately (Part II Conclusion). I hope it is possible to obtain the previous copy from you.

Your publications are full of very interesting data, much of which is quite new to me, and I shall follow same with pleasure during my stay here.

L. A. C. CLARK, R.A.F.,  
Coral Gables, Florida

**JUNK-BOX TESTERS**

Dear Editor:

As a Serviceman I would like to see more junk-box constructional testing apparatus such as condenser analyzers, meggers, oscilloscopes (simple), electronic multi-meters, etc., all simple and from junk box to save on purchase of parts.

N. C. GIBBS,  
Jacksonville, Fla.

**NOTICE**

This is the August-September issue of RADIO-CRAFT. Due to the fact that this is a SPECIAL RADIO WAR NUMBER, a great deal of difficulty was encountered in obtaining all the information necessary for this important issue. So much time was lost in contacting manufacturers and others, on account of censorship, etc., that it became necessary to combine two issues into one.

Subscribers on record will have their subscriptions lengthened by one month to make up for the loss of one issue.

THE PUBLISHERS.

**THE TELEGRAPHONE AGAIN**

Dear Editor:

An article in the *Newark (N.J.) Evening News* on "recording sound on wire" reminded me of a similar article I had read in the *Electrical Experimenter* (published by Mr. Hugo Gernsback). The article claimed invention and not just development of the device. I looked up your article—it appeared in the June 1915 issue of *Electrical Experimenter* on page 51—and again found it most interesting.

W. A. OGLESBY,  
Bloomfield, N. J.

**WANTS NEW HOOK-UPS**

Dear Editor:

In reading the June issue of *Radio-Craft* I came across the letter of Art Knowles and enjoyed his writing very much. Also, I am somewhat along the same line as he is. I have been reading your magazines for about one and a half years and have enjoyed every one of them immensely.

In reading recent issues I have found fewer diagrams for experimenters, and as for myself I should like to see more dia-

grams for the boys who "mess" around with radio, trying new circuits, etc.

In the old *Radio & Television* there were diagrams sent in by the readers, offering others the chance to try what they had made. I had a great time trying the different diagrams from time to time and I am sure there are others who feel as I do.

What do you say? Can't we have some more of the diagrams.

CHARLES WHITE,  
Fort Worth, Texas

**HELP WANTED**

Dear Editor:

I have a Silvertone radio in my shop that is weak. I have checked and have had three other servicemen check it and as yet have not fixed it.

If you have any case histories or valuable help, please send it. It is a Silvertone 4586.

H. T. YOUNG,  
Huntington, W. Va.

**BASS BOOSTERS**

Dear Editor:

I was particularly interested in a letter by Art Knowles, of Bay City, Michigan, in the department "What Our Readers Think" in the June 1942 issue of your splendid publication. Although I have many back issues I have none covering volume expanders or L. M. Barcus' Add-on-Bass Booster which he mentions.

I constructed the modern "Hi-Fi" amplifier as described on page 722 of the April 1941 issue of *Radio & Television* and am well pleased with it. However, I should like to have information on a volume expander circuit suitable for use with this and all the dope on the L. M. Barcus' "Add-on-Bass Booster."

If you can assist me in getting this information I would appreciate it very much.

HARVEY PEART,  
Ottawa, Canada

(The October 1936 and November 1936 issues contained the article by Mr. Barcus entitled "How to Make a Direct-Impedance Bass Booster." The January-February 1942 issue contained an article by Mr. Bob Stang entitled "Simple Tone Equalizer" which may be of interest to you.—Editor)

**FM EXPERIMENTER**

Dear Editor:

I am just an experimenter and was wishing to make some test analyzer to get started. I bought your June issue of *Radio-Craft*. The article on a "service test panel" by Edgar Boles gave me a good idea. Instead of using 2 76's I used 2 56's and a 2E5 for an indicator.

*Radio-Craft* has helped me a great deal also in the new field of FM. Please publish more articles on FM. Keep out the "ham" articles.

JOHN MORGAN,  
Kingston, Pa.

**ARMY RADIO SERVICEMEN**

Dear Editor:

I agree with Pvt. W. F. Babcock (June issue letter on Army radio servicemen). Give us more dope on radio and transmitters that are used by the Army.

As I am in the Air Forces, I would like to know a little more about transmitters and receivers. I would like some articles on trouble shooting and repairing. I am sure all the Army radio men would be appreciative if you could help us do a better job.

PVT. FRANK TOMASEK,  
Lake Charles, La.

# PRACTICAL RADIO INFORMATION

Including Frequency Modulation—Television, etc.

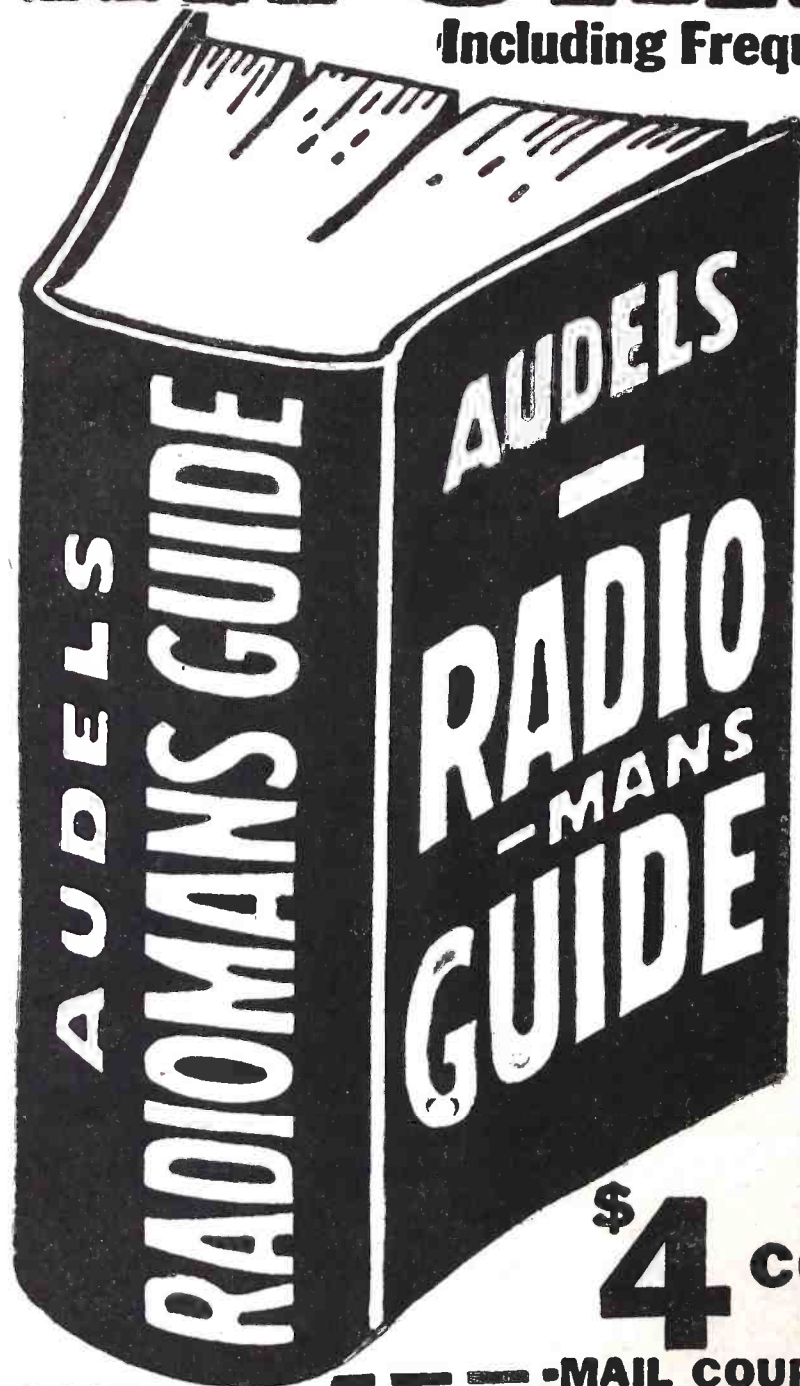

Inside Information for all Servicemen—Aircraft Pilots, Students.

**772 PAGES, 400 DIAGRAMS**

is complete—gives Authentic Principles & Practices in Construction, Operation, Service & Repairs. Covers clearly and concisely Radio fundamentals—Ohm's Law—Physics of sound as related to radio science—Measuring instruments—Power supply—Resistors—Inductors—Condensers—Transformers and examples—Broadcasting stations—Radio Telephony—Receivers—Diagrams—Construction—Control systems—Loud speakers—Antennas—Auto Radio—Phonograph pickups—Public Address Systems—Aircraft & Marine Radio—Radio Compass—Beacons—Automatic Radio Alarms—Short Wave—Coil Calculations—Testing—Cathode ray oscillographs—Static Elimination—Trouble Pointers—Underwriter's standards—Units & tables. REVIEW QUESTIONS—Ready Reference Index.

**\$4**

**COMPLETE • PAY \$1 A MO.**

To get this practical information in handy form—Fill in and

MAIL COUPON TODAY

**AUDELS, Publishers; 49 West 23rd St., New York**  
Mail AUDELS NEW RADIOMAN'S GUIDE for free examination. If O. K. I will send you \$1 in 7 days; then remit \$1 monthly until \$4 is paid. Otherwise I will return it.

Name \_\_\_\_\_ R.C.F.

Address \_\_\_\_\_

Occupation \_\_\_\_\_

Reference \_\_\_\_\_

**Please Note!**  
If you do not wish to mar this page by clipping coupon—send letter or penny postcard instead.



---

---

# RADIO-CRAFT

*Incorporating*

**RADIO & TELEVISION**

---

---

"RADIO'S GREATEST MAGAZINE"

*. . . U. S. Radio  
War Industry Is  
Over the Top . . .*

## U. S. RADIO WAR EFFORT

*By the Editor* — HUGO GERNSBACK

**W**HEN the final chapter of the present war is written, future historians will chronicle with satisfaction the fact that one of the vital industries responsible for winning the war was unquestionably the American Radio Industry.

Changing almost overnight from a peace-time to a war-time basis, the U. S. Radio Industry has performed one of those war-time miracles which are typical of American enterprise.

When late in 1941 radio manufacturers were told that they had to change their entire set-up to an all-out war effort, little comment was made, but there was much thinking and planning.

While these lines are written, the American Radio Industry has gone over the top with flying colors. Unlike other industries, there have been practically no strikes whatsoever and the War Department has experienced little or no bottlenecks, so far as radio materiel is concerned. In times of peace, the entire radio industry had a turnover of over one billion dollars annually. What the turnover will be for the first war year cannot be divulged now, for military reasons, but the output is huge—unbelievably so.

As the writer has stated editorially for many years, long before any one thought about this war—radio in all its complex phases in modern war is just as important as airplanes, tanks and guns. Indeed, none of these could be operated efficiently without radio nowadays. Modern warfare makes terrific demands upon radio, and new refinements and new inventions are a daily routine today.

The layman, and indeed, most of our radio readers, would be astonished to know all the important new radio inventions which have recently been made, many of them already in use to further our war effort. There is no question whatsoever that when victory finally has been achieved, radio will be voted a high place in the list of war machines that made victory possible.

The U. S. Radio Industry found out almost immediately at the start of their conversion program, that it is one thing to manufacture radio receivers for peace-time purposes, but quite another to manufacture radio materiel for war uses. The two bear little relation to each other. Thus, for instance, in peace-time, radio receivers were not normally manufactured to work efficiently in humid tropics of over 100 degrees and in temperatures of 40 degrees below zero; but that is exactly what the requirements are for war-time radio sets. They must be made in such a manner that they can stand almost submersion in water, the most humid hot temperatures, or the most vicious cold. Our troops fight in every corner of the world and very frequently they have

to be where temperatures are both abnormally high or low. Thus, in Egypt for instance, the daytime temperature is often 100 degrees and over, and the nights frequently are near freezing—depending upon the season of the year. On top of this, sandstorms are encountered which would play havoc with an ordinary radio set not built for such wear and tear.

Then we have tank radios and airplane radios, all of which are subject to severe mechanical shocks. That again means a radical departure from a peace-time radio set. Indeed, military radio communication receivers bear little resemblance to a peace-time radio. The entire construction varies, as the set simply must not fail to operate under almost any given condition. Ordinary materials just will not stand up under these unusual conditions. For this reason, the engineering on all combat radio receivers is a difficult undertaking in itself. Not only that, but the raw materials which now go into radio receivers must also be different from those used before Pearl Harbor. Substitutions must be made not only for the most unusual conditions, but the engineer today also must think of rubber, tin, copper and other shortage items, and this is a heroic task all by itself.

Fortunately, the American Radio Industry has risen to the occasion and has gone over the top with flying colors. While not all problems have been solved, by any means, it may be said that all the important production problems have been met satisfactorily, and we also know that with few exceptions, all American radio materiel has stood up excellently under the most aggravating conditions possible.

Under adverse conditions, coupled with war-time pressure, the American Radio Industry has taken every obstacle in its stride, and it has grown amazingly in the process.

Astonishingly much new radio gear is being turned out day and night, holidays included,—much of it so secret that even the workmen who are constructing it do not know what it is all about.

There are many radio surprises for the enemy and still more are in the making.

Several issues of this magazine could be filled with all of the new radio accomplishments, and once the war is won, the pages of RADIO-CRAFT will bristle with U. S. Radio War Inventions—which we guarantee will take your breath away—and at the same time will fill one of the glorious chapters of American inventiveness, patriotism and endeavor.

## A Digest of News Events of Interest to the Radio Craftsman

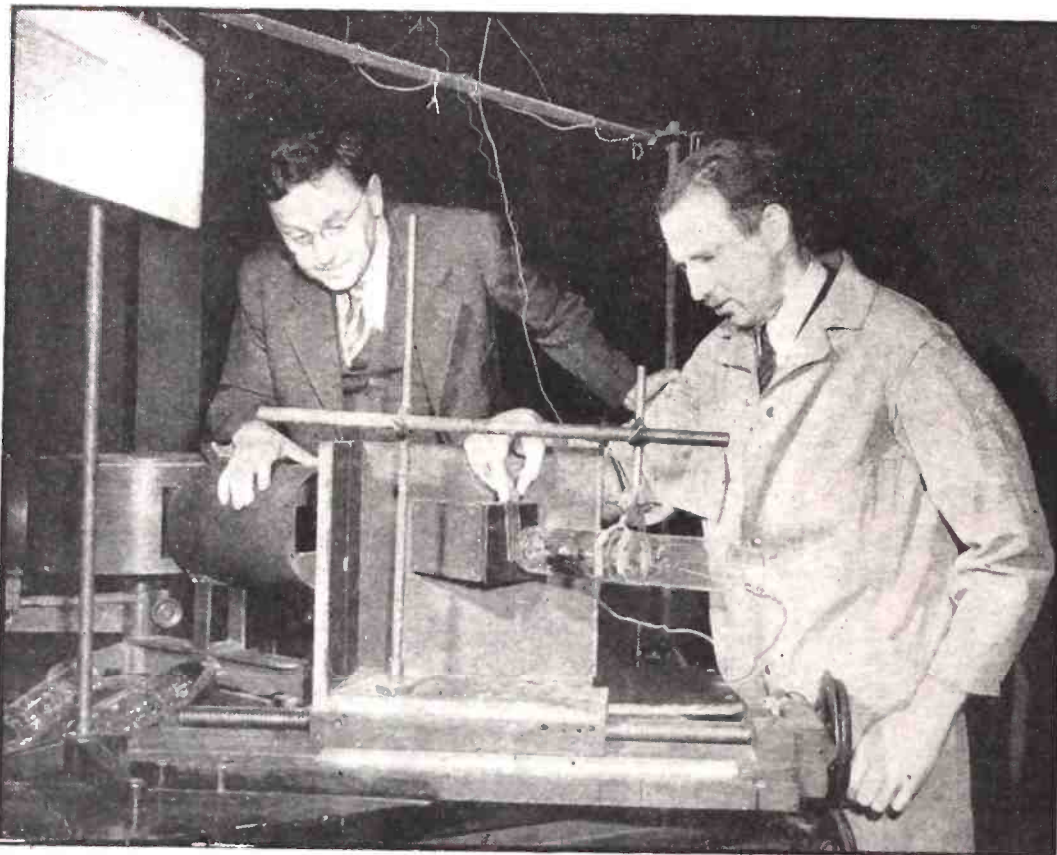

Dr. H. C. Rentschler (left), director of the Westinghouse lamp research laboratories at Bloomfield, N. J., and inventor of the ultra-violet meter, watches a test of his instrument being made by D. E. Henry, electronics engineer. Rays produced by a mercury-vapor lamp are spectroscopically analyzed into different bands, so that these may be counted separately, since their sun-tanning powers are different.

### NEW ELECTRONIC "EYE" TO MEASURE U. S. SUNFALL

**S**ENSITIVE new electronic "eyes" developed by Westinghouse engineers to see and record invisible ultra-violet rays in sunshine will soon begin their first daily measurements of "sunfall" in the United States to study its effect on the wartime health of the nation, it was reported last month.

The new sun-measuring instruments eventually will operate in 20 of the world's first solar observation posts to be set up for a nationwide ultra-violet study by the United States Weather Bureau. Located in Weather Bureau stations, the observation posts will be scattered over a 1,000 mile stretch of land running from Texas northward through the Mississippi Valley to the colder regions of the mid-West.

First sun metering will get underway soon at Central Park and LaGuardia Field, in New York City, and in Boston and Cambridge, Mass., to record the amount of ultra-violet which penetrates through the haze of big metropolitan centers. These figures may eventually make it possible to forecast for several days in advance the intensity of sunfall over a city, Weather Bureau officials believe.

Ultra-violet sunfall measurements will be made available by weather stations to farmers, agricultural schools, meteorologists and physicians throughout the country. In agricultural studies and crop surveys, solar ultra-violet data may prove as important as soil analysis is now, engineers believe. Meteorologists may use the measurements to discover what effect, if any, ultra-violet radiations in the upper stratosphere have on weather conditions on the earth.

In appearance, the ultra-violet sun meter resembles a long, oversized radio tube. At

the upper end of the instrument is a flat metal button about the size of a half dollar and surrounded by a circular wire electrode. The metal in its refined state is sensitive only to that portion of the ultra-violet in sunlight which produces sunburn. The sun's rays, striking the surface of the disc in a nearly perfect vacuum, cause the metal to release a stream of photo-electrons which travel to the electrode. This current is so small that it must be expressed in millionths of watts, or microwatts.

From the electrode, photo-electrons pass to a tiny condenser, actually an "electronic bucket" which stores up the energy over a period of seconds and then releases it in a single charge across an electrical circuit in the tube. Each time the condenser discharges its quota of photo-electrons, a sensitive relay "trigger" registers a sharp click which reveals that a known quantity of ultra-violet is reaching the earth. The number and frequency of clicks provide research men with the total quantity for any given period of time.

"Many of the effects of the sun's invisible ultra-violet rays on human health are still a scientific riddle to research men mainly because of a need for uniform and dependable instruments to measure solar radiations. Statistics taken from various climate zones and compared with the health statistics of those zones will be one way in which research men can study the effect of ultra-violet on humans. Such studies could be aimed at determining what preventive or curative effect, if any, sunlight has on such diseases as tuberculosis and rickets and the relationship between liberal exposure to ultra-violet and general health," the inventor, Dr. H. C. Rentschler, said.

### HIGH-SCHOOL STUDENTS OFFER WIN-THE-WAR IDEAS

**A**MERICAN high-school boys and girls have come through with 10 top-notch suggestions on how scientific methods and devices can be used to help win the war, Science Clubs of America announced last month. Their ideas have been turned over to the National Inventors Council with the recommendation that they be given serious study.

The youngsters, ranging in age from 16 to 18, were graduated from high schools in June. They were among over 10,000 who entered a national Science Talent Search, and were in a group of 40 who came to Washington, D. C., to enter final competition for Westinghouse scholarships. Science Service is sponsoring the Science Talent Search.

All the suggestions deal with specific ways in which scientific methods and principles can aid the fighting forces of the United Nations.

An electronically controlled bomb sight was suggested by Paul Joseph Barthel, 18 years old, from Reitz Memorial High School, Evansville, Ind.

Buoys equipped with listening devices and radio apparatus would detect the sound of a submarine's engines and send out a warning, according to the plan of William Dorrance Worthington, 17, from Camden High School, Camden, N. Y.

Robert Edward Phillips, 18, of Herbert Hoover High School, Glendale, California, would use the sound of a boat's engines to explode mines, while his schoolmate, William Denman Calhoun, 16, has detailed plans for a rocket bomb.

An incendiary bomb using the principle of the "oxygen lance" was designed by Wolf Karo, 18, from Utica Free Academy, Utica, N. Y. Homer Frederick Davis, 18, of the Frewsburg, N. Y., High School, has submitted the design of an internal combustion engine different from those in general use, and Robert Greiff, 16, of the Brooklyn, N. Y., Technical High School, plans to run machine shops by photo-electric cells.

Making alcohol from materials common in the United States is the ambition of Gilbert Dehnkamp, 16, of the Hinsdale, N. Y., Central High School, who submitted a detailed scheme of the chemical process he has chosen.

Hugo Korn, 16, from Tuley High School, Chicago, Ill., has two ideas, one for a detector to be used in airplanes to spot factories in enemy country by infra-red radiation, the other for an aerial camera which could be used in bad weather conditions.

High scholastic and aptitude ratings gained by 300 of the Science Talent Search entrants have brought about a recommendation to every college and university in the United States that they be considered for regular scholarships, Science Clubs of America officials announced. Lists of these boys and girls, all of whom displayed special interest in scientific courses, have been sent to college heads. Already one state university has offered scholarships to four boys and girls who won honorable mention in the contest. Of the 40 who come to Washington July 12 to 15 to take final tests, one boy and one girl will win a \$2400 scholarship each and 18 others will win \$200 each. While in the capital, they will visit scientific institutions and other points of interest.

## ROYAL NAVY MEN GET GIFTS OF SPECIAL RECEIVERS

Portable radio sets for ships' crews which do not give away positions to the enemy are now in use in Britain's Royal Navy.

The Navy has received more than 15,000 sets and £25,000 (about \$100,000) raised by voluntary subscriptions has been spent by the Admiralty in supplying them. Corvettes, minesweepers, sloops, submarines and torpedo-boats are among the small craft whose ship's companies can now listen in when off duty. As the sets are shielded they do not re-radiate and so do not disclose the ship's position to the enemy.

The manufacturers made several modifications in a standard portable radio, giving it an exceptionally strong cabinet and fitting up a chassis that the set would be able to stand up to the many hard knocks likely to be received under service conditions. It has roughly 800 separate parts.

No storage battery is necessary and the dry batteries used give 240 hours service. The makers have been able to issue fresh batteries at the rate of 1,000 a week, and 10,000 tubes have been sent out in the last twelve months. The Royal Air Force has been supplied with 5,000 sets and the Army has had 8,000. They are being used in many remote districts of Britain as well as in Iceland and the Middle East.

The manufacturers carried on production of sets throughout the "blitz," although their factory and workshops were actually razed to the ground and many essential parts and machine tools were destroyed. Despite these difficulties, they have been able to carry on, and there are now more than 100,000 of their sets in use.—(From RADIO-CRAFT'S London Correspondent)

## AIR-RAID WARDENS INSTRUCTED BY TELEVISION



Schenectady County (New York) civilian defense officials have established seven official television posts throughout the county for the instruction of air-raid wardens via television. Programs are received by television receivers loaned to Schenectady defense officials by the General Electric Company.

Programs originated by NBC's television station WNBT, in New York, are picked up by a G.E. television relay station (the

## SIGNAL CORPS LIBRARY FOUNDED IN CAPITAL

Announcement was made last month that a Signal Corps Reference Library has been established in Washington by Major General Dawson Olmstead, Chief Signal Officer of the Army. A committee of friends of the Signal Corps Library, under the chairmanship of Lt. Colonel W. L. Hallahan, 48 Wall Street, New York, will assist the Chief Signal Officer in carrying out plans for collecting up-to-date technical and scientific items for inclusion in the new library.

Nationally known engineering societies have pledged their co-operation in making available books and periodicals that would be difficult to obtain through commercial outlets. Harold Osborne, president of the American Institute of Electrical Engineers, has organized a committee within the Institute to assist the Signal Corps in selecting the nucleus of the library. The field of interest covers electronics, radio, telephone, telegraph, engineering, electricity, meteorology, physics, chemistry, electron microphotography, photography (still and motion), cryptology, signal communication, pigeon breeding and training, direction finding equipment and many other technical subjects.

Technical books and pamphlets on the foregoing subjects may be shipped directly to the Signal Corps Reference Library, Office of the Chief Signal Officer, War Department, Washington, D. C. Contributors should make use of the special book-mailing rate of one and one-half cents a pound, not to exceed seventy pounds in any one package.

## COVER FEATURE

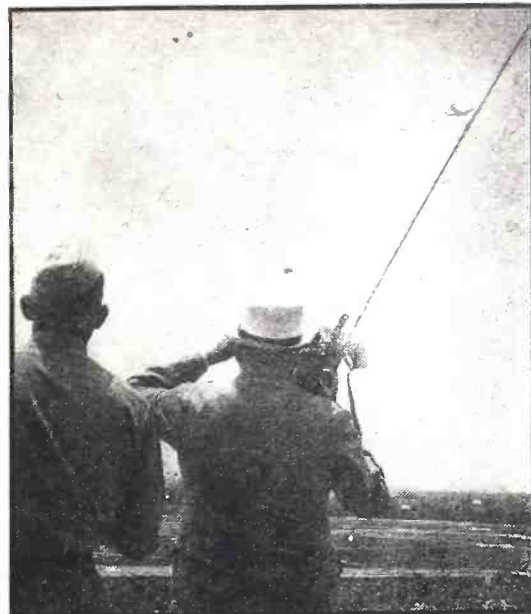

## CHURCHILL AT U.S. MANEUVERS

Prime Minister Winston Churchill holds a "walkie-talkie" portable two-way radio to his ear and listens to orders coming from jump commanders of paratroops who may be seen in the sky during maneuvers at Fort Jackson. This demonstration of America's war training was one of many witnessed by Churchill.

## 2-WAY RADIOS NEEDED FOR U-BOAT PATROL

Vice-Admiral Adolphus Andrews, commander of the Eastern Sea Frontier, last month urged all owners of radio-telephone equipment to make their sets available to his command. Ship-to-shore phone units are needed for small boats being used by the Navy and Coast Guard to hunt Axis raiders.

"The initial response has been encouraging," Admiral Andrews said, "but a greatly increased volume of offers is absolutely essential if the Americans manning these small boats are to have proper radio-telephone equipment for their mission.

"From 800 to 1,000 sets are needed. I urge every amateur radio operator, every boat or airplane owner and every dealer who has a standard-make ship-to-shore radio telephone to let us know. We need every set we can get for our small-boat fleet."

Owners who offer their radio-telephone sets for sale in response to the Navy's request not only will be doing a patriotic service, they will also be enabled to raise ready cash and dispose of equipment which they cannot use during the war anyway, Navy officials point out.

"Remember that hundreds of Americans are using their yachts, private power boats or fishing vessels in this anti-submarine patrol," Admiral Andrews said. "They are risking their lives; it certainly isn't much to ask that they be equipped with the ship-to-shore radio demanded for their work."

General requirements are for complete radio-telephones, for sets of standard make, of 2,000 to 3,000-kilocycle range and 12-watt output or more.

Owners offering sets should mail in full data from the nameplate, giving full descriptive details. Information should be mailed, not telephoned, to the Eastern Sea Frontier Headquarters, 90 Church Street, New York, N. Y.

In response to letters the Navy will send a radio expert to inspect suitable sets and, if they are found satisfactory, will make a purchase offer.

# RCA'S ALL-OUT FOR VICTORY

**T**HE story of radio's role in the war is the story of radio's great advance in the period from 1914 to 1942. When the first World War broke out in 1914, this country was largely dependent upon foreign-owned cables for communications with many important sectors of the world.

The records of that war noted that "the grim business of war gave great impetus to the art of radio transmission," a comment that was to be indisputably confirmed in the years that followed. In fact, the developments in radio during the first World War were so considerable that America could not stand by and see the peace-time applications of this art grow and flourish under foreign ownership and direction.

In 1919, the Radio Corporation of America was formed to serve the interests of the public and the government with the express aim of establishing an all-American worldwide radio-telegraph system that would give the United States pre-eminence in radio, ashore and afloat, so that no longer would America be dependent on foreign countries in communication with other nations and with its own outlying possessions, merchant marine, battle fleets and any American Expeditionary Force.

Development of the radiotelephone during World War I was the forerunner of broadcasting in the 'Twenties. Radio became an instrument "of the people, by the people, for the people," and the foundation was laid for a billion-dollar national industry.

When, in 1941, war again came to the United States, the RCA organization of more than 30,000 workers was prepared to do its full part in "the most tremendous undertaking in our national history." Typical of this preparedness was the planning and instituting of a program of conversion of plant, machinery and man-power from a commercial to a war-production basis, following the outbreak of war in Europe in September, 1939. Today, plants of the RCA Manufacturing Company are "arsenals" of radio apparatus essential to the military and naval forces of the United States and its Allies. The slogan all along the production line is "Beat the Promise for Victory!" This means production and delivery of equipment ahead of schedules.

New manufacturing equipment has been installed and hundreds of workers have been trained for new jobs in the all-out effort to meet the radio industry's production requirements of the war.

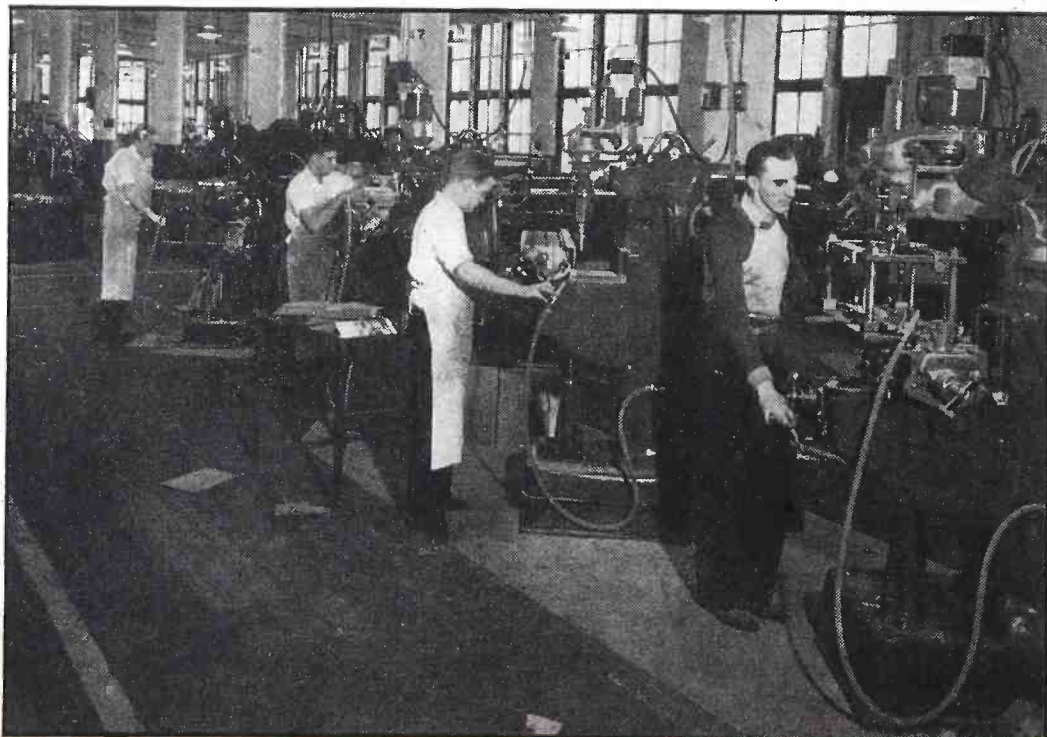

Radiophoto circuits have kept pace with the shifting scenes of the war. This picture shows RCA radiophoto equipment at the time the new circuit was opened between New York and Cairo. The first photograph received over this circuit showed King Farouk of Egypt and Alexander Kirk, American Minister.

Work hours have been increased, and production accelerated. As a result, the Navy's highest award—the "E" pennant that means "Excellent—Well Done!"—now flies above a plant of the RCA Manufacturing Company.

## MEETING CRITICAL MATERIALS PROBLEMS

One important phase of production engineering is the development of alternates for critical materials. The use of nickel-plated steel, properly treated and made into tubes under closely controlled conditions, effects a 95 per cent saving of nickel. Monel, an alloy of nickel and copper, has been successfully replaced by either nickel-plated or silver-plated steel. The laboratories are well on the way to replacing brass with steel, and even the tin content of solder has been reduced. Alternates for aluminum have been found in brass, zinc, plastics and cast or formed iron and steel. In tubes, alone,

yearly savings of 1½ tons of tin, 12 tons of aluminum and 440 tons of brass have already been effected. Cardboard, coated with copper foil, for tube shields, saved RCA 74 tons of aluminum in 1941. Even steel was knocked down to previous manufacturing requirements by the use of iron, coated, in some instances, with metals of high electrical conductivity.

Now it is becoming necessary to find alternates for alternates in some instances, as in the case of plastics. Hard, durable proxies for plastics are now being made from compounds of shredded wood, cardboard scraps and sulphite pulp.

## KEEPING THE NATION INFORMED

Broadcasting is a powerful factor in this war, which strikes directly at civilian populations. By radio our citizens receive reports on the progress in mobilizing the nation's man power, and in the gearing of civilian life to a war economy. They hear the voices of our military and naval leaders. Radio aids in the sale of war bonds, and in keeping the rest of the world informed of our aims and efforts. It is helping to build an air-minded young America, and to improve our international relations. It conveys information on nutrition and the preservation of health, and assists in the development of every possible element of war morale.

The war has emphasized the value of international short-wave broadcasting, which today is the only link of communications with Axis subjugated peoples. The international short-wave beams of American broadcasters are spearheads of truth, penetrating those areas of the world where truth is locally blacked out. Today, NBC alone directs to Europe and South America programs in ten languages, and operates 1,379 program-hours a month.

## CONTACT WITH WAR ZONES

Radiotelegraph circuits normally are operated by RCA Communications to fifty-one countries, providing the United States with an international web of communication. In time of war these circuits assure continued contact with outposts near and far, regardless of enemy activity or control over intervening seas or territories.

The necessities of war emphasize the importance of the flexibility, as well as the directness, of these RCA circuits. When Paris fell, direct communication with France was switched to Lyon, and later to Vichy. When war broke out in the Pacific, RCA was in communication with the Far East through Honolulu, Manila, Batavia, Chengtu and Chungking. To the last two mentioned cities in China, Kunming has since been added.

After RCA's Manila station was destroyed to prevent seizure by the Japanese, direct communication with the Philippines was maintained for a considerable time through the RCA station on the island of Cebu. Chungking was linked directly with San Francisco, instead of through Honolulu. Within the last eighteen months new RCA radiotelegraph circuits have been established between the United States and Australia, New Zealand, Cairo, Brazzaville, in French Equatorial Africa, and Noumea, New Caledonia.

## RADIOPHOTO SERVICE EXPANDED

The scope and technique of RCA Communications' Program Transmission Service has been greatly increased. Through this service, war news, bulletins and comments by American reporters in foreign places are delivered to American networks for broadcasting. The RCA Radiophoto

(Continued on page 750)

# WARTIME ENGINEERING

By DR. ALFRED N. GOLDSMITH

It is not my desire to do anything more than to offer some suggestions that may help each of us and our country. I shall try to give practical advice, frankly expressed, and based on the needs of the present emergency. If occasionally my candor seems somewhat harsh, I know you will understand that these are no times for "pussyfooting" and that my only object is an attempt at genuinely friendly helpfulness.

We owe a great debt to the United States, our own country, which is now engaged in a life-and-death struggle with destructive and ruinous forces stemming backward from stark savagery and barbarism. These forces represent a viewpoint which is the antithesis of freedom of thought, integrity and dignity of the individual, and the granting of opportunity to each of us for self-advancement and personal growth. They would represent the stultification and destruction of all that we have been taught to accept as the basis of an ordered, calm, and ambitious life.

The emergency we face is indeed a serious one. Through a combination of incredulity on our part that such violent and unscrupulous aims could exist in our modern world, and through a lack of foresight, "it is much later than we think." Thus time must now be compressed, and extraordinarily much must be accomplished in a brief space. What has been done by our opponents during a decade must be equalled and surpassed by us within a few years. But we have no alternative to accomplishing something which will be almost a miracle. For we shall "hang together or hang separately."

But this does not in the least mean that we must hasten hysterically, fall into a panic, or rush into disorganization. Quite the contrary. It means only that we must face our jobs and the future with steadfast bravery, a cool acceptance of conditions, and a stubborn determination which will overcome all obstacles. Given these qualities, our success and the victory of our country is assured.

## THE ENGINEERING VIRTUES

Every engineer from time to time should try to assess himself frankly and honestly. Self-analysis and self-judgment are stepping stones to greater strength and wider achievement. In wartime or peacetime, the esteem of our fellows and our success in a worldly sense will largely depend on the extent to which we possess and practice certain qualities and methods. There is no use in refusing to analyze ourselves. Our fellow workers and directors will do so in any case, and there is no purpose in trying the ostrich trick of hiding one's head in the sand. Better to determine one's limitations, vigorously try to remove them, and then to walk with our heads high.

Steady work is an amazing instrument for achieving results. Sweat is the best possible lubricant to keep the wheels rotating. Mere ideas in the abstract lead hardly anywhere. To get results, it is necessary to keep going, and planning, and working even when one is very weary and there is a great temptation to sit back and "take it easy." This last is a fatal fault in an engineer. It is inconsistent with our dignity, our loyalties, and our future success.

There is no good reason for worrying too much about toil. Relatively few people have been ruined by hard work but many



Dr. Alfred N. Goldsmith, Consulting Engineer, Radio Corporation of America.

have failed through laziness. Lack of application is a costly national or personal luxury. Maybe we have had too much of it in the past; but certainly now is not the time for it.

Doing the same thing over and over is well enough in its way, but it is not enough during times of stress when unusual results are necessary. Then originality becomes particularly important. Practice imaginative thinking. If you have an idea, carefully cultivate it in detail. Then try to find flaws in it, viewing it with real detachment and in a critical mood. Try to think up numerous alternative ways of accomplishing the same thing. Then compare the various ideas which occur to you as to their respective and comparative merits and faults. Such comparisons lead to a wise and practical decision. Learn to think creatively and in a prolific way. Any man can expand his capabilities in these directions by trying, just as he can develop stronger muscles by exercise. Never be afraid to discard ideas which seem inappropriate or faulty, or accept new ideas, even though radical, if they seem necessary and practical.

One of the worst faults that an engineer can have is vagueness, the concealment of facts, or the lack of courage to face facts. Avoid silence where the communication of information is required. And avoid loose or incomplete information where definite statements are needed. We should try to tell the whole story. Science and engineering need the "truth, the whole truth, and nothing but the truth." Substitute candor for double talk, which latter is alike the bane of engineering, politics, and many another field. Engineering does not need "verbal glamour boys"; it demands really creative workers with a genuine output.

## ENGINEERING METHODS

In order to reach a certain desired result, as engineers you may apply inductive methods, deductive methods, or both.

The inductive method is principally used by scientists and engineers in major or minor research projects where the experimenter is working at or near the boundaries of available knowledge and is trying to dis-

cover really new physical or chemical facts, methods, or laws.

Deductive methods, as might be anticipated, apply more usually in development work. Sometimes, when laws are well established as to their validity, scope, and completeness deductive work runs smoothly and to the satisfaction of the experimenter. However, this is usually the case only in long-established and well-covered fields. In general, even clever deductive reasoning requires caution and keen analysis at each stage.

Sometimes both inductive and deductive methods are used or mixed in handling the same problem. It generally takes an experienced worker with a wide knowledge of his subject, much experience, keen facilities of observation, and something of what we call (for want of a better term) "intuition" to handle such a problem by the use of the mixed methods. But it can be done and it frequently saves a great deal of time and effort. Intuition seems to be a sort of inner guidance or inspiration, dependent upon accumulated knowledge of a subject, and stimulated by the need for accomplishment and the urgent requirements of a situation.

It is a good idea in determining our methods to study carefully our own capabilities and preferences. As a general rule, the man who is most at home in research work and does it most naturally and best, is not so capable a development man as he likes to think he is. Similarly, the skilled development or design man who by instinct and experience develops equipment and methods readily may be a less effective pure research worker than he believes himself to be. For these reasons, every experimenter or designer should study his own capabilities carefully and impartially, if that is possible, and find out what type of work he does best. He should then endeavor to be assigned to that sort of work.

Further, if a man finds that he does his best work in a given sphere of activity, after he has carried any job to the point where it is about to pass out of that sphere into the next region, he should willingly turn it over to the next man for further work or completion. To speak in a blunt but friendly way, don't try to hog the development road—you may merely block traffic. Many a good research man has stuck to a job long after a development man should have taken it over and turned it into a commercially useful article. Often enough a development man has gone further into detailed design or manufacturing problems than is desirable or, on the other hand, has slipped back into research work where it would have been better to refer the unsolved problem again to a research specialist.

## METHODS OF ATTACKING PROBLEMS

Let us suppose that a problem has been submitted to us or a job assigned to us. What should be done next? While there are no general rules in the nature of a universal panacea that cures all ills, here are a few hints. In a long experience in such matters, they have proved to be sometimes useful.

In general, it is very helpful to start out by finding out *what is known*. That is, search for and thoroughly study the existing information on the subject. Don't depend too much on your memory for facts, figures, or methods. Even the most experi-

(Continued on page 748)

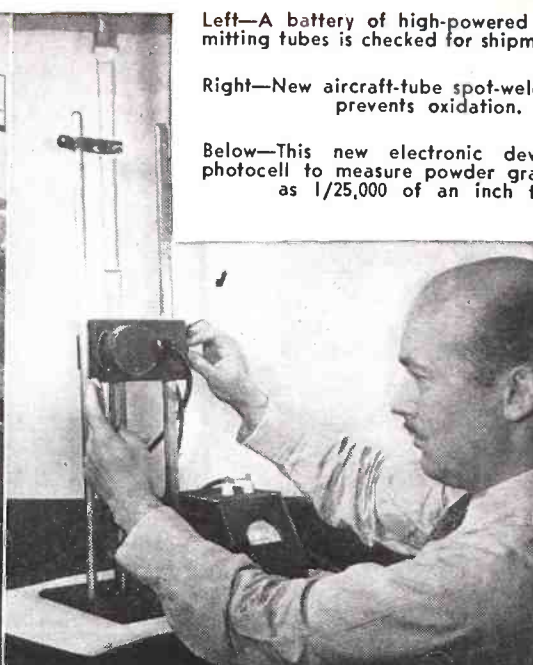

Left—A battery of high-powered radio transmitting tubes is checked for shipment to Navy.

Right—New aircraft-tube spot-welding method prevents oxidation.

Below—This new electronic device uses a photocell to measure powder grains as small as 1/25,000 of an inch thick.

# Radio and Electronic Devices Are Westinghouse War Weapons

**W**ARTIME developments in the communications field will exert a vast influence on design and construction of post-war radio apparatus. Lessons learned in production of special radio equipment developed for military purposes will probably find many important applications in homes and industry.

This is the prediction of Walter C. Evans, vice-president of the Westinghouse Electric and Manufacturing Company, as he surveys activities of his company's Radio Division in the war effort. The number of Westinghouse employees engaged in turning out radio apparatus has more than doubled in the past year, he reports, and production has been expanded from one plant to three.

"Just as the first World War ushered in the present era of commercial radio broadcasting, the radio industry is certain to gain after this war by the utilization of a number of new principles and techniques which have been developed for war requirements," the executive said.

Radio research men today are working on developments which will prove as startling when peace returns as the telephone and electric light were in an earlier generation, according to Dr. W. H. McCurdy, manager of radio engineering for the Westinghouse Lamp Division. "Now enlisted for the duration, these devices, like the telephone and electric light, may some day change the mode of living for millions of Americans," he said.

Westinghouse has been able to improve production of precision sets called for in Government requirements. All such sets are built with extreme accuracies and strength, because they must operate in all kinds of weather and over a wide range of altitudes. When on sea duty they are exposed to corrosion by salt air and must be protected accordingly. They must be strong enough to stand up under the severe service they get when vessels roll and pitch in storms and when subjected to concussion of gunfire.

While the full productive capacity of

the Westinghouse Radio Division is turned to the war—on a 24-hour basis—in a small corner of one plant a five-kilowatt transmitter, contracted for before the war, is being completed for station WABI, Bangor, Me. It is of the type developed in 1941, equipped with metal rectifiers, all air-cooled tubes, stabilized feedback in audio system, variable compressed gas condensers and complete fuseless overload protection. Similar transmitters were installed at WINS, New York, N. Y.; WNBZ, Binghamton, N. Y.; WCSH, Portland, Me.; WCAO, Baltimore, Md.; and KGDM, Stockton, Calif.

## ELECTRONIC METHOD SPEEDS WAR WORK

By combining a number of simple parts familiar to all radio experimenters, engineers have been able to produce new devices or "tools" to control or speed up production.

Using only a glass tube, a photocell, a light source, and a milliammeter, P. R. Kalischer, Westinghouse research metallurgist, can determine grain sizes of metallic powders as small as 1/25,000 inch in about 1/30 the time usually required for such an analysis. Since the quality of a metal part produced by powder molding is dependent on the uniformity of the metal grains, this determination of particle-size distribution is especially important.

Photocell and light source are mounted on opposite side of the glass tube, and the output of the photocell is read by the milliammeter. To analyze a powder specimen, Kalischer mixes 1 gram of it in the tube with 100 cubic centimeters of acetone, to which a small amount of a wetting agent (isopropyl xanthate is one of the best) is added. The tube then is clamped between the photocell and the light source. As the particles settle, the liquid clears and transmits more light to the cell.

From timed readings of cell current a time-opacity curve is plotted for that specimen. By comparing this curve with similar

curves for standard powders of known particle size, Kalischer can determine both average particle size and relative quantities of particle of different sizes in the test specimen.

The usual method of measuring particle size is to float the powder in glycerine and measure the settling time. Such a test requires about 8 hours, and does not give accurate information about relative quantities of grains of different sizes. The simplified Kalischer method takes only 15 minutes.

Use of a wetting agent is important, because it helps the acetone to surround each metal grain completely. Without it, the settling rate might be affected by tiny air bubbles surrounding the grains.

To increase production and safeguard quality of steels treated in atmosphere furnaces, an electronic tube developed by Westinghouse electronic research engineers provides a continuous check on the purity of the hydrogen gas flowing over the metal. (See July issue of *Radio-Craft*, page 649). Such scientific control is especially important where the dew point of the treating gas must be maintained in the critical region of  $-40^{\circ}$  C. to  $-70^{\circ}$  C., or for precise furnace conditions such as required for bright annealing, and for chemical processes, using purified dry hydrogen or similar controlled gases.

To give the metal proper characteristics, steel is often heated in an atmosphere of highly purified hydrogen that is practically free of moisture and oxygen. Ordinarily, to measure moisture in the gas where dew points are less than  $0^{\circ}$  C., a cooled and polished metal plate is inserted in the gas stream and the temperature noted when condensation of moisture first occurs. However, below  $-40^{\circ}$  C. this method becomes largely guesswork and even skilled testers disagree on values of the same gas. The electronic method, insures reliable and accurate determination of moisture and oxygen content in hydrogen (or disassociated ammonia) gas.

In operation, the gas flows through a

2-element tube containing a tungsten filament and plate. Electrons flying from the hot filament to the plate continually bombard the gas. If the gas is pure dry hydrogen all the electrons reach the plate. But any oxygen or water vapor in the gas, immediately picks up some of the electrons and forms negative ions, thereby reducing the electron current. This change of current in the plate circuit indicates the degree of impurity in the gas (see diagram).

**ADVANCE OF ELECTRONIC DEVICES**

Wartime research is speeding up the arrival of an Age of Electronics, a new era in which man will harness the power of electrons to run great industries, eradicate diseases and create new wonders in transportation and communication.

The new Age of Electronics had dawned in research laboratories long before the start of World War II. It is fully under way now, advanced perhaps half a century by the determination of American engineers to build the weapons that will win the war. Today the products of electronics research are being turned against the Axis. Tomorrow they will multiply their usefulness to combat ignorance, poverty and drudgery.

Engineers have put the invisible electrons to work at such widely separated tasks as killing germs, smashing atoms, X-raying high-speed bullets in flight, generating new sources of light, and improving radio and controlling industrial machinery.

**NEW EYES AND HANDS**

Some electronic tubes, the photo-electric cells, serve as eyes and hands for industry. Faster than any human reflex, they can count objects at the rate of 50,000 a minute. They can sort a ten-center cigar from a nickel one, automatically pick out a good poker hand or nab a thief in the act of cracking a safe. Such tubes are masters at the art of detection and their jobs range from locating icebergs at sea to providing damning evidence that a motorist has exceeded the lawful speed limit.

Other jobs electronics research has made possible are the production of magnesium from sea water, doubling the speed of aluminum production, X-raying bullets as they crash through armor plate and providing a gentle barrier around a baby's crib to prevent the attack of deadly germs. Radio, television and the transmission of photographs by electricity are familiar applications of electronic devices. Both "black light" and the cold fluorescent lamps depend on electronic principles for operation, as do the plotron, or artificial fever tube, the kenotron, which permits the precipitation of smoke and dust, and the Sterilamp, used to destroy bacteria and mold spores. All these electronic devices are operated by the use of glass or metal tubes which create and control a stream of electrons—infinite, negatively charged particles of matter. A radio tube is the most familiar electronic tube, but there are hundreds of others, devised to perform myriad functions.

**INDUSTRIAL USES**

Quality is as much an American demand as mass production—but maintaining quality under the pressure of high-speed production poses many problems of manufacturing control that Westinghouse electronics research is helping to solve.

These controls are industry's eyes, ears and fingers—but far exceeding in keenness and nimbleness even the best of human faculties. They are the intricate family of electronic phototubes—all the variations of the "electric eye" that opens doors, protects

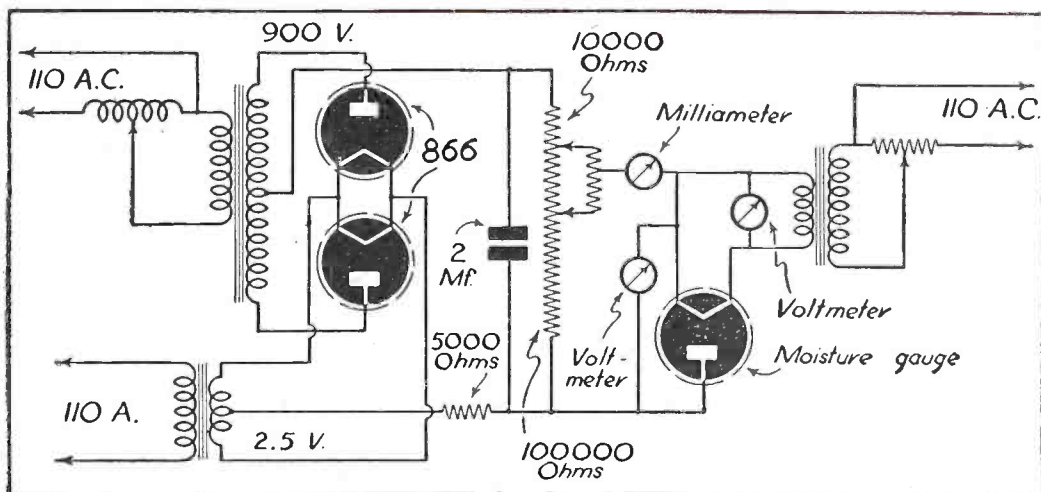

Circuit connections of electron-tube moisture indicator. The milliammeter in the plate circuit shows when moisture or oxygen flows through the detector tube. The unit can be made automatic in control.

machine-tool workers from injury, and delivers a perfectly printed newspaper.

The tubes are used in two general ways. Under one system, such as counting objects coming off a production line, a beam of light which activates the tube is interrupted when the assembly line item gets in its path. This automatically operates a counter. A similar tube may be used to activate one of many other devices employed in industrial and mechanical control.

The second system utilizes reflected light on the cathode of the tube. This method makes possible a continuous, automatic check on the color of products coming off an assembly line, for example, because every color and shade of color has a different light reflective value. It insures absolute uniformity of the color of fabrics from a loom. It checks the perfect register of colors in color-printing processes, and sorts cigars for uniformity, and matches enameled parts.

Phototubes also guard the safety of factory workers, by shutting off machines when a worker's hand comes too close to a

moving part. They open kitchen doors and automatically maintain illumination levels inside buildings by opening and closing skylights and turning electric lamps on and off.

**METAL PRODUCTION SPEEDED**

A barrel-sized steel tank that sifts electrical charges through a pool of mercury is speeding production of two vital war metals by helping to "rescue" magnesium from the ocean and to extract aluminum from mineral bauxite. This "electrical alchemist"—known as the Ignitron—10 years ago was only a laboratory curiosity, but now is an important industrial tool for producing the lightweight metals urgently needed for military aircraft.

Millions of pounds of magnesium are now being extracted from sea water pumped from the Gulf of Mexico. Magnesium hydrate is precipitated from the water, converted into magnesium chloride and reduced to magnesium by an electrolyzing process employing an Ignitron. About

*(Continued on page 753)*

The modified rectifier tube being inserted in socket.

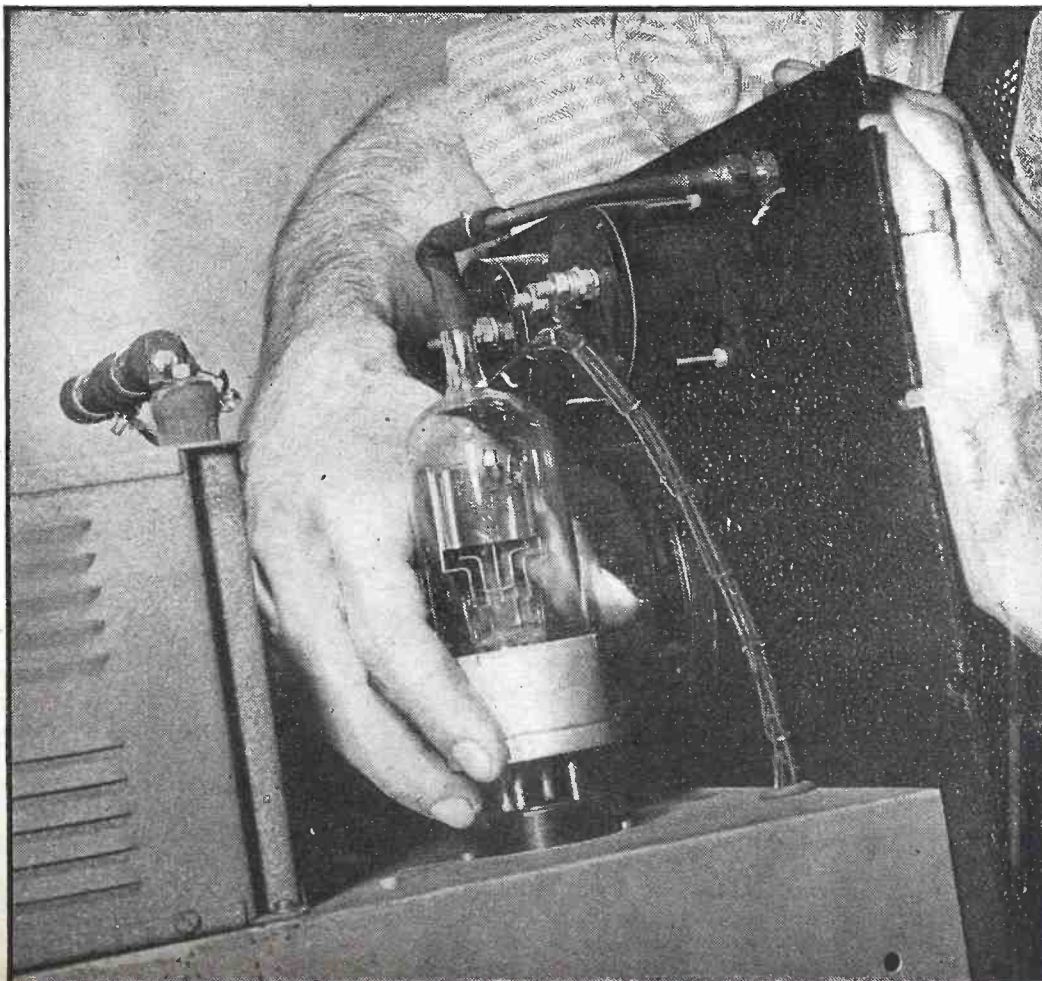

## G.E.'S WAR WORK TO YIELD POST-WAR BENEFITS

**A**LARGE share of the radio and similar electronic equipment now being used by the armed forces of the United States and their allies is being manufactured by General Electric, a pioneer in this field.

The company is now producing by assembly-line methods vast quantities of this equipment, and its factory and laboratory facilities have been enormously increased.

Most of the radio work being done in the G.E. factories and laboratories is of a secret nature, but here is a typical way in which G.E. engineers are working to produce better equipment with alternate materials now that war requirements have compelled the reduction in the use of metals and other vital materials.

The use of aluminum in two-way radio equipment after "Pearl Harbor" was reduced 57 per cent, and similar reductions were made in the quantity of steatite, copper, rubber and other strategic materials. In spite of this reduction, the use of other materials and new designs actually improved the performance of the two-way radio equipment.

Many persons think of the word substitute as meaning something less desirable, inferior, or ordinary. Few would associate the word with better performance, better quality. Yet in this case, that is what the word means.

### RECEIVER SELECTIVITY INCREASED

For instance, in eliminating certain aluminum parts, including trimmer capacitors and IF cans, and going to powdered-iron-core transformers, the selectivity of the receiver of the two-way radio equipment was improved, as was the ease of tuning.

The workers in the General Electric radio factories are fully aware of the need

for beating the Axis powers and have initiated and are carrying out programs designed to impress upon fellow employees the important work they are doing. Such programs and their favorable effect on war production should not be underestimated.

The work in the electronic laboratories is being devoted entirely to the war effort and, therefore, little can be said of its nature. It can be pointed out, however, that the war has enormously increased the scope and extent to which electronic devices are being used because these devices not only save manpower but also can do many jobs better than man. As broadcasting was electronics' contribution to better living after the last war, so too will the science make an equal contribution to the post-war world, according to G.E. engineers. Radio men, therefore, will be particularly interested in the future of this comparatively new science, and many of them are contributing to its advancement.

### RADIO BEAMS AS AIDS

Development and use of radio waves that resemble light waves, and which can be formed into beams and made to do things that cannot be done with light, will be among electronics' post-war contributions. Radio beams of the newer high-frequency waves will, for example, provide a method of locating aids to navigation, as well as locating obstacles when these can not be seen. Thus navigation of ocean liners and aircraft will be aided.

Today the navigation of ocean liners is in many ways based on vision, which in turn is based on the use of light and sight. The steering of a proper course is largely a matter of noting position of shoreline, lighthouses, and buoys. Avoidance of collision also is largely based on seeing. But night reduces the effectiveness of these aids to navigation and fog often renders them

useless. The new radio waves will penetrate smoke, fog, clouds and storms as light can not.

G.E. engineers point out that electronics will bring us blind landings. In the not distant future, airplanes which are now able to fly blind between airports will also be able to make blind landings in fog as thick as London's and there will be no danger of collision. When the pilot of the future approaches his destination and finds the airport hidden under a blanket of fog, instead of having to fly on to the nearest open field he will merely turn on his electronic blind landing equipment. Through his headphones he will hear signals telling him where to start his glide for a perfect descent that will bring his plane down on the runway.

### SIGNALS TO FLASH ON SCREEN

Before his eyes there will be an illuminated screen, much like the screen in a television set. On that screen from second to second will flash unmistakable signals, telling the pilot whether he is losing altitude fast enough, or too fast. He will know just where he is at every instant, not how high above sea level, but how high above the airport. Several blind landing systems are being developed by various agencies, but all of them depend on the electronic tube.

Right now, electronics is helping to produce better airplanes faster, according to G.E. authorities. Electronic tubes control the flow of power for a new electric welding process that can sew together sheets of aluminum for the wings of our bombers almost as you would sew together two pieces of cloth on a sewing machine. Certain parts of our great bombers and pursuit planes can be produced in half the usual time with this new electronically controlled welding process.

### CONDENSER FOIL IMPROVED

Electronic tubes are helping in the production of radio tubes and parts. Modern radio built in General Electric plants for military aircraft contains a number of condensers made up of layers of metal foil. The thickness of this foil must be controlled by measurements as fine as one one-hundred thousandth of an inch—so fragile you can hardly touch it with ordinary kinds of measuring instruments.

Together with Pratt and Whitney, G.E. engineers helped solve this problem by developing an electronic gauge using electronic tubes. As the metal foil is rolled out, it passes between two metal discs. Without their touching the foil, the exact thickness of the foil is measured and the pressure of the rollers is regulated automatically to produce a foil of absolute uniformity. This gauge eliminates the costly practice of cutting out a section from the sheet of moving foil and measuring this section with a hand micrometer. In everyday language, this means that it costs fewer War Bonds to equip an American air-fighter or bomber with radio equipment.

If you have ever seen a fighter streak across the sky, diving, twisting, and turning with the seeming speed of lightning, you may have wondered how it is possible to build planes that can withstand such terrific strains as those in power dives at speeds greater than 500 miles an hour.

Those gleaming American "wings of victory" must have tremendous strength.  
(Continued on page 750)



An interior view of another new G.E. factory, somewhere in the United States, where General Electric employees are now working day and night turning out radio and similar equipment for our armed forces and their allies.



# MOBILIZED CONDENSERS

## HOW THEY HELP WIN THE WAR

By THE ENGINEERING DEPARTMENT, Aerovox Corporation

If this be construed as giving discomfort to the enemy, make the most of it. However, with the sanction of the various censoring agencies now guarding vital details of our growing military might, it may be said that *more* condensers and *better* condensers are being turned out in ever-increasing quantities by *infinitely improved* production methods now mobilized in sealing the doom of the Axis powers. Furthermore, these strenuous efforts have a secondary, long-range aspect of establishing a far better, brighter, more interesting world of tomorrow, following the sounding of the "Cease firing" call on various battle fronts.

For years past the condenser industry considered itself full grown. It provided an outstanding case of mass production. Likewise a shining example of astonishingly low prices. It had to be geared that way to meet the mounting demands of radio set production, which demands in turn were necessarily based on popular prices that brought radio entertainment well within reach of the most modest home in the land. Thus the condenser industry reflected a production efficiency seldom matched by any other industry. And when the all-out war suddenly burst upon our nation, it seemed that the condenser industry for one was fully ready to meet all emergency demands—military as well as civilian.

We were soon disillusioned, however. The condenser requirements of modern warfare exceeded all expectations. Even for an industry accustomed to large figures—production schedules running into the millions and tens of millions of units at times—the war demands promptly proved staggering. We had to revamp our entire thinking. Our production setups had to be multiplied many times. Overnight, we now turned from the former problem of getting enough sales for what we could make, to trying, if not definitely struggling, to make enough units to meet the imperative demands of our armed forces, let alone the replacement needs of America's thirty-odd million re-

ceivers which are the very ears of our well informed people.

### WHY THE COLOSSAL DEMAND?

The condenser requirements today are truly staggering. Exact figures can not be given, for obvious military reasons. However, the requirements can be said to be many times those of pre-war days, while leading condenser plants have been greatly expanded for the new production schedules.

Why this colossal condenser demand? Well, for one thing this is a *radio* war. The *blitz* feature of modern warfare is based on marvelous coordination of all armed activities, and such perfect teamwork can be achieved only through marvelous communication facilities, which in turn come right down to radio, for the fluid state of today's warfare largely rules out wire communications, at least on the actual front where things are happening fast and furious.

Every combat plane and bomber has a radio transmitter and receiver. Every tank has a short-wave communication setup. Every brigade out in the field has its radio station. Even the doughboy, the parachutist, the spy, may have a walkie-talkie or some other form of diminutive set with which to maintain instantaneous and unbreakable contact with the military machine.

All such radio equipment calls for condensers of various types. The fact that much of the equipment operates at ultra-high-frequencies, with critically established channels, means a heavy demand for precision-type condensers. Heretofore the bulk of the mica capacitors produced might call for tolerances of plus or minus 20%, or perhaps 10% for the more critical customers. Now much of the demand is for condensers coming within closer tolerances, so that those critical high frequencies can be established and maintained for satisfactory inter-communications on the battlefield.

This war, too, is an electronic as well as a radio war. There are intricate aircraft

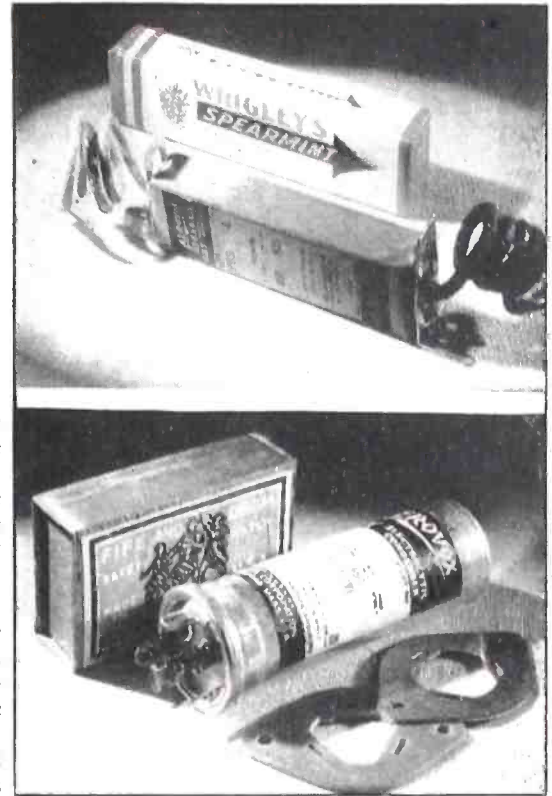

Two of the many types of condensers which have undergone wartime changes.

detection devices utilizing electronic tubes and their accompanying capacitors. The detection of U-boats is rapidly swinging over from the former audible means which served adequately in World War I, to certain electronic methods whereby the steel fish can be accurately spotted even while playing possum on the ocean floor. These detection devices call for accurate capacitors in ever-increasing quantities. Also, some of the applications call for elevated working voltages—of the order of 25,000 to 50,000 volts. Heretofore we thought that 7500 volts D.C. working was ultra-high-voltage stuff. Today we are several times higher than that on regular production units.

### HIGH-VOLTAGE OIL-FILLED CAPACITORS

A most obvious result of the wartime demand, therefore, is high-voltage heavy duty oil capacitors. These capacitors cover voltage ratings from 6000 to 50,000 D.C.W., including dual-section units for voltage  
(Continued on page 746)

## Farnsworth Research Aids War Program

FARNSWORTH TELEVISION & RADIO CORPORATION now is engaged in a one hundred per cent war effort. Orders of the War Production Board have prohibited the production of radio receivers and phonographs, including television sets, for civilian use since April 22, 1942, except for work then in process. Every facility of its plants, all the efforts of its employees, and all the energy of its research department are being directed toward the one end of supplying the United States Armed Forces with the electronic devices vital to modern warfare.

Contracts for electronic equipment for use by all branches of the United States Armed Services have been awarded to Farnsworth and Farnsworth instruments are today serving American soldiers, sailors and aviators around the world.

Prior to the war conversion referred to above, the company had consistently followed the objective established at the time of its organization:—to operate effectively

on all fronts of electronics, including television. It is gratifying to report that the soundness of this policy was demonstrated during the last year. Moreover, it was due largely to the consistent pursuit of this objective that the company was fully prepared when war struck to convert its facilities in a minimum of time and without change of personnel to all-out war production.

Research and patent activities were carried forward last year with emphasis on the further development of television and electric phonographs. In addition to obtaining new patents on improvements in these fields, this work has resulted in the filing of additional patent applications covering new inventions. Despite the fact that a substantial number of the pending applications matured into patents during the past year, the company had pending on April 30, 1942, more patent applications than in the year before. The number of United States patents now held by this firm relating to

radio and television is more than double the number it owned when the company was organized in 1938.

The improvement and re-designing of record-changing mechanisms of the types used in the Capehart and Farnsworth phonograph-radio combinations were continued. This work has resulted in further inventions and a consequent increase in the strength of the patent position in this field.

Increasing difficulties in production for civilian use were encountered throughout the year as the result of material shortages and restrictions incident to the war program. By anticipating changing conditions and increasing operating efficiency, the unfavorable results of these difficulties were minimized and the volume of civilian business was substantially increased.

Unfilled orders, which, because of war conditions cannot be disclosed, are sufficient to cause its plants to operate at capacity during the major part of the balance of the current fiscal year.

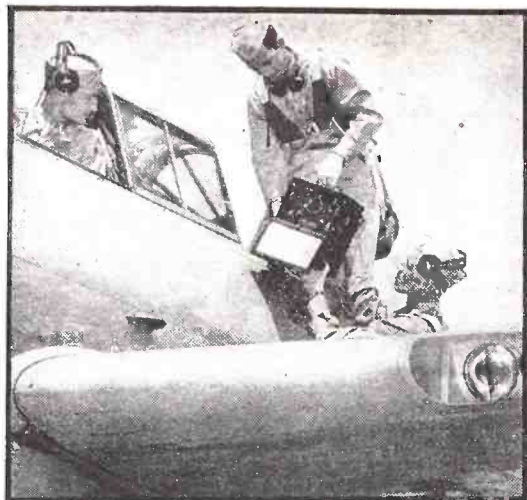

Students are shown loading a frequency meter into their ship preparatory to a flight check of the guiding beam signals of their area, putting into practice the theories learned earlier in their course.

# AIR CORPS RADIO UNIVERSITY

By MAJOR J. R. JOHNSTON, *Air Corps*

**L**OCATED far in the interior of the nation as it is, Scott Field—"Radio University of the Air Corps"—may never know the blasting impact of enemy bombs or the crunch of an Axis soldier's heel. But, nevertheless, Scott Field is playing an ever increasing part in the national war effort.

From air corps posts scattered all over the United States and its possessions come

bright-eyed, eager young men seeking the intricate knowledge that will fit them for duty as ground and plane radio operators and mechanics. Here are found college graduates, engineers, chemists, budding attorneys and writers and many young radio enthusiasts of pre-war "Ham" days.

All of them—just how many is a military secret—are obsessed with but one idea—to qualify themselves as quickly as possible for combat service against the Japanese on the west or the two other Axis rattlesnakes in Europe.

The story of Scott Field, located in Southern Illinois, is the story of American defense itself, since the post's establishment in 1917. Then it was a training ground for aviators in World War I, but after making important contributions in that role, it was practically abandoned shortly after the Armistice, when a force of less than 65 men comprised the entire personnel.

In 1920, however, activities were revived to a considerable degree by the designation of the field as the nation's headquarters for the training of airship pilots and balloon observers. That was the day when blimps, dirigibles and other lighter-than-air craft were expected to play an important part in future aerial warfare.

This second chapter in Scott Field's history, during which large expenditures brought about great improvement, was concluded in 1937 when the War Department discontinued its policy on lighter-than-air craft.

For a brief period, the status of future Scott Field operations was in doubt. Soon, however, it was recognized for the advantages of its central location, and was designated as the future home of the General Headquarters Air Force—the principal striking unit of the Army Air Corps. With an appropriation of \$7,500,000, outmoded facilities were eliminated and a new hangar, barracks, officers and non-commissioned officers' quarters, general headquarters building, and in all, 73 major buildings were constructed.

This was a far cry from the two old fashioned wooden hangars which had been built prior to the expansion program. However, before the proposed establishment of the GHQ Air Force materialized, changes in the War Department's plan added still another chapter to Scott Field's history. Under this plan, announced at the beginning of the national emergency in 1939, Scott Field became the Radio Communications Center of the entire Air Corps. The expansion program begun two years previously, was a great stride, but now even greater steps have been taken. By the end of this year, thousands of qualified radio men will have been graduated from its many schools.

To meet the demands of war, the courses too have been stepped up remarkably in tempo. Classes in code, radio repair, mathematics, transmitters, receivers, radio compass, circuit analysis, radio telegraph procedure, flight operation and many other subjects are taught in the school's extensive

(Continued on page 749)

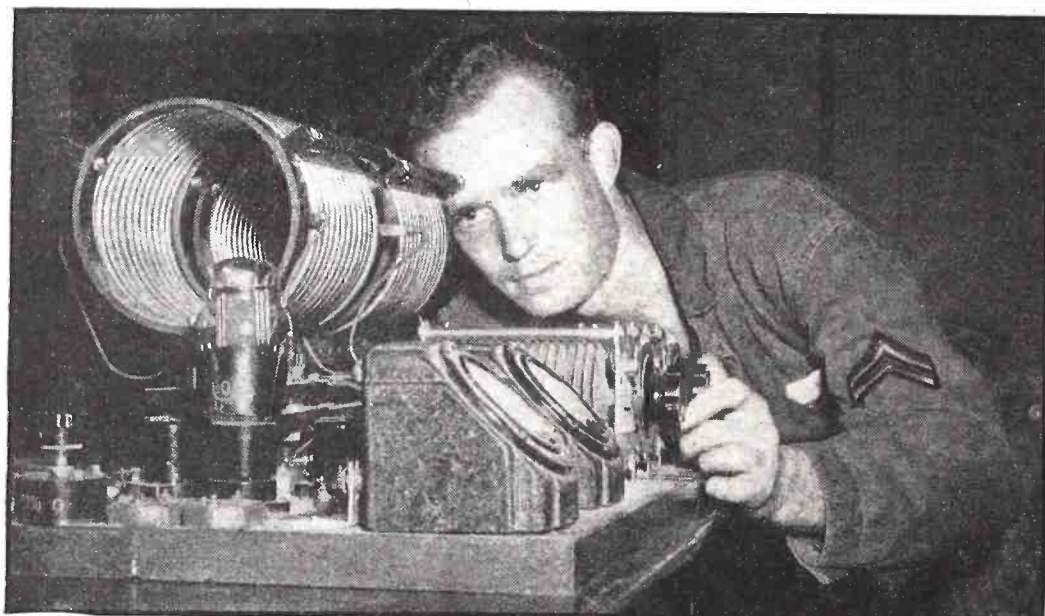

A student at work on a breadboard layout. Corp. John F. Pearson, Oklahoma City, Okla., is adjusting the oscillator circuit of a basic Colpitts low-power transmitter.

Below: Instructor Henry C. Royal, Jr., of Farwell, Texas, is helping William R. Skaggs, of Clinton, Mo., analyze the circuit of a low-power aircraft transmitter. In this class the sets are deliberately thrown out of balance and the students "trouble shoot" them.

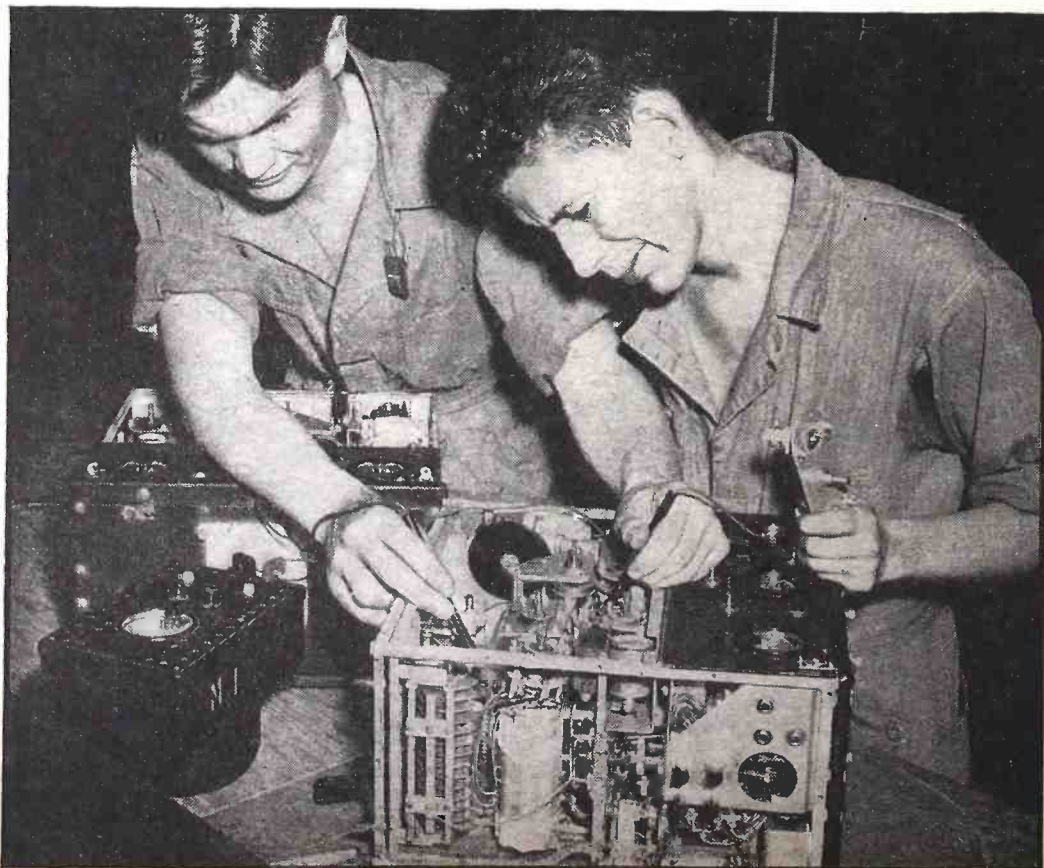

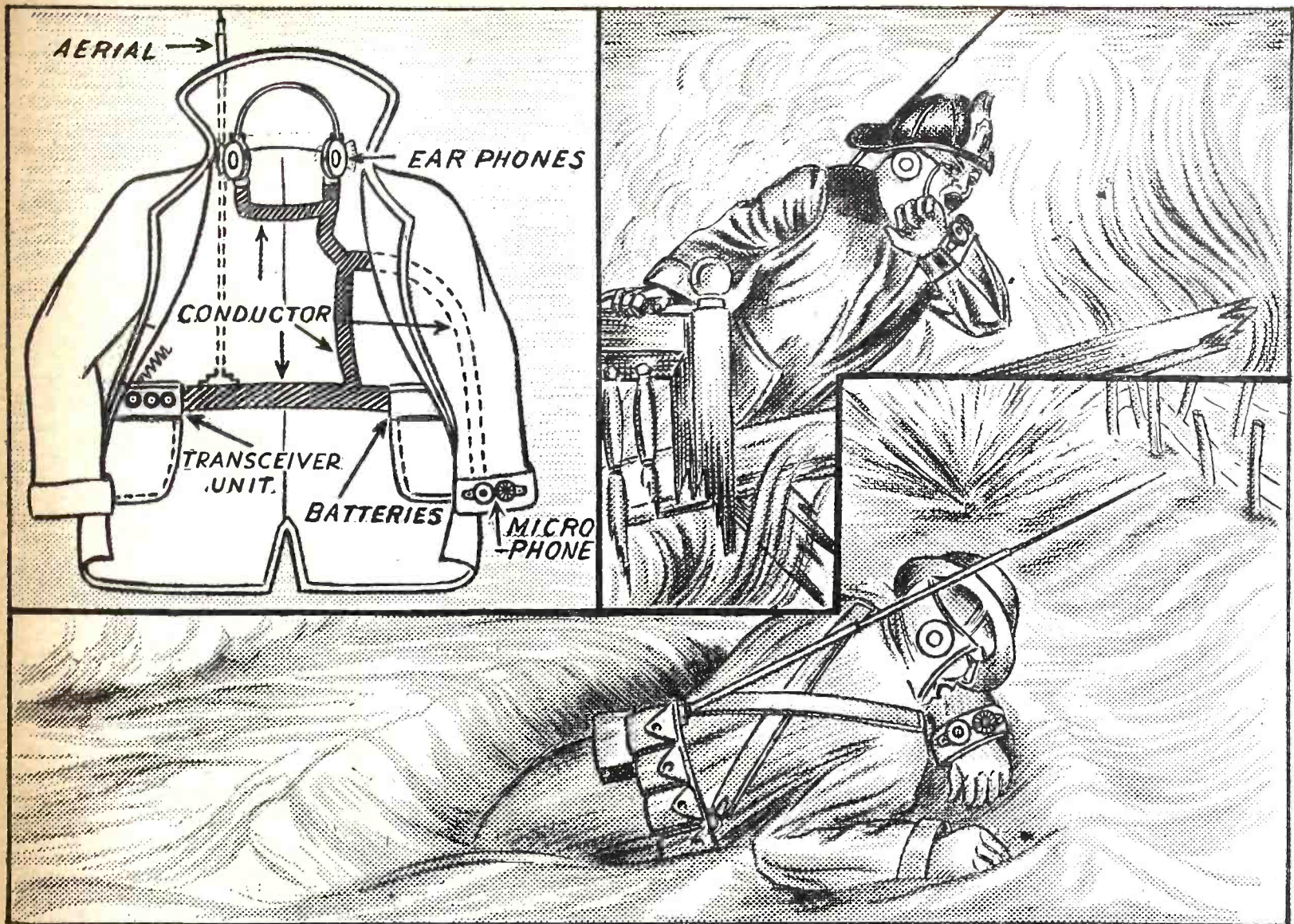

## THE RADIO COAT

**A** NEW transceiver garment which enables its wearer to carry on two-way radio conversation while having freedom of movement is disclosed in a patent granted recently to Berkey E. Cover, Sr., of Chicago.

Designed primarily for peace-time applications requiring such an outfit, this device is expected to find numerous military uses brought about by the communications needs of modern warfare.

For instance, paratroops wearing such two-way radio coats may receive orders on how to progress from a superior officer flying in a plane overhead, where ground operations can more readily be observed. Individual parachutists may report their separate findings to the superior, who may then co-ordinate the information for organized ground operations. Such a communications system would be especially useful for night operations, when the superior officer would be wholly dependent for his information on reports from the parachutists.

At a recent realistic demonstration of paratroops in action witnessed by Winston Churchill at the Army's largest infantry training post, "Walkie-talkie" equipment was used by jump commanders in the planes. Britain's Prime Minister, according to newspaper reports, "heard the battlecry for the parachute battalion — 'Geronimo!' — shriek from the throat of each man leaping into space." (See front cover and page 713.)

The para-ski troops, whose exacting duties require them to land in the snow and

When the big radio boom started in 1921 thousands of business men and would-be entrepreneurs rushed to the new radio bonanza.

The trade poked fun at the newcomers and predicted good-humoredly that soon radio would be converted into a huge cloak-and-suit business!

The jest is about to come true—partially at least. For the *Radio Garment*, just patented, is here.

use skis for swift travel to their objectives, are another group who could benefit from the use of the transceiver garment. The radio equipment could easily be a part of the heavily padded weather-resistant clothes they wear.

Commandos landing in enemy country could communicate with officers stationed at the point where they deployed for action. The specially trained regiments of Pioneers in the United States military service would increase the effectiveness of their combat operations in many cases similar to those of the Commandos.

In infantry maneuvers these transceiver garments, which may be part of the soldier's uniform, could be put to numerous uses, such as in reconnaissance work, by patrols detached from the main body of troops. With communications the life-line of fast

warfare many other applications may be found where such a garment would be useful.

On the home front this equipment could serve in air-raid rescue work. The inventor had similar uses in mind when he suggested that firemen and policemen could advantageously wear this device "for giving comprehensive orders rapidly during widespread fires to those working in or around the building on fire and for sending and receiving messages in both directions."

The garment is also intended for miners or for persons working in tunnels or in other underground work where the possibility of communicating with other workers is essential to safety. Accordingly the garment has the appearance of an ordinary coat, preferably made of water-repellent and fire-proof fabric which may be suitably insulated with asbestos or other non-conductor against heat to provide for the various types of conditions likely to be encountered. Relatively light in weight it nevertheless provides for carrying all the necessary equipment. It is constructed so that separate parts might be easily replaced when this is required.

As will be seen from the drawings the microphone is mounted on the cuff of the left sleeve and has a flap to protect the instrument when it is not in use. It may be permanently stitched in position or detachably mounted in an opening in the sleeve.

(Continued on page 746.)

# SERVICING—SECOND FRONT FOR RADIO IN WAR

ONE valuable lesson learned from war production is going to be passed along to the Serviceman, according to Stanley H. Manson, service manager of the Stromberg-Carlson Telephone Manufacturing Company, which is all-out in the production of communications instruments for the armed forces. The lesson will be passed along as part of the company's Wartime Radio Service program, which is currently passing other vital information along to Servicemen, pointing out profit opportunities and streamlining peacetime service procedure to help busy servicemen. It is believed to be the first instance of a radio manufacturer converting his war experience to consumer use to aid hard-pressed dealers.

Recently, "the three E's", engineering, education and efficiency, are being stepped up in the Rochester plants of the company to save quantities of vital tin, copper and lead, to speed production and to make more certain that communications instruments for the armed forces do not break down in battle through faulty connections.

Through this program, for example, more than 500 feet of soldering wire—40% of which is pure tin and 60% lead—will be saved a day through the development of a new type of soldering iron rest, which not only keeps the iron warm and saves current but acts also as a salvage instrument for end pieces of soldering wire. Through intensive study of the entire soldering operation, Stromberg engineers have standardized procedure to the point where the number of tinned copper tips supplying heat on the soldering iron have been reduced from a peacetime average of 65 varieties to three. Further savings of time and improving of work quality have been made by handing over to a special operative the job of replacing or reshaping soldering tips in

each iron every two days, thus relieving women workers of an irksome, time-consuming job away from the assembly line.

## ATTEND REFRESHER SCHOOLS

In addition, veterans of the assembly line, aggregating hundreds of years of experience, and many of them women who built field telephones in World War I, are going to refresher schools to help save the lives of America's fighting men. In explaining the refresher schools, Mr. Manson pointed out that good tight connections, which will stand up through shipping, handling, and battle usage, are the heart of communications instruments. Good soldering assures such connections.

The women go to school each morning in small groups and are paid by the company to relearn the fine points of their craft. Dramatic illustrations of the results of the failure of communications instruments on the battlefield are being shown to workers. In addition, women war workers are encouraged to do their own inspections, thus making it a 40 to 1 chance that the entire assembly unit on which a group may be working will pass a highly critical government inspection. The expected cut in rejections will save the loss of vital time and materials.

Soldering is the heart of radio repair and service. With this in mind, Stromberg-Carlson is preparing a study of its soldering methods and practices for use by radio dealers. It is believed that it will aid greatly in aiding dealers in teaching sound practices to newcomers to service staffs, many of which have been depleted by the draft and war industries.

## SERVICE "BY APPOINTMENT ONLY"

Mr. Manson believes that America's radio Servicemen may soon be seen only by

appointment. Priorities, price ceilings and the lure of Signal Corps appointments, are rapidly thinning the lines of the country's radio repair men.

"Pick-ups and deliveries of radios may soon disappear entirely," said Mr. Manson, "because of gas rationing and tire shortages. The Serviceman will find himself increasingly flooded with business and unable to handle it all as an increasing number of radios develop trouble. Without his assistants, now in the Army, the Serviceman will be king. He will be able to pick and choose his jobs. Customers will have to make appointments as much as a week or two in advance. Already, the average radio repair job takes from three to four days."

The new condition will work to the customer's advantage however, because repair jobs are now being done more expertly than ever before. He pointed out that with few radios left to sell, most repair jobs were being done by the proprietor of the average radio store, who has had long experience in radio. With large manufacturers devoting more emphasis than ever to radio repair work, and with more care lavished by the proprietor on a repair job, he saw no reason to expect a great drop in the number of radios now functioning.

## WARTIME RADIO SERVICE

Curtailed of radio sales and the increasing demand by customers for full efficiency in their receiver at all times is rapidly building up the service and repair business into a very profitable operation.

Reports from many parts of the country indicate that the majority of dealers have recognized this unique condition and are beginning to promote service on the same basis as sales. The Serviceman who may have felt, in the past, that his position was one of "all work and little glory," and has observed salesmen receiving full credit for performance and profitable results, now finds himself an important part of his organization.

The radio repair man has assumed an important role in his community, for he links the listeners with the entertainment and important programs of the broadcasting stations. All must accept the increased demand for services with a determination to do each job better and with as little loss of time as possible.

As a result of first-hand observations in the field, Mr. Manson offers the following ideas for placing your "house in order" individually and as an organization.

## TO THE SERVICE DEPARTMENT MANAGERS:

1. Your Repair Shop should immediately take on the appearance of a modern business establishment. Neat arrangement of equipment, good lighting, plenty of space for faster work, and modern testing facilities are essential.
2. Build up your stock of radio parts and tubes. Do not hoard these items but carry in your inventory at all times enough tubes and replacement parts to take care of the increased demand predicted in the future.
3. Your library of technical data and service information should be complete at all

(Continued on page 753)

Soldering—heart of both consumer radio and communications instruments for the armed forces—gets special attention from Stromberg-Carlson, whose soldering schools have produced improved techniques, important savings of vital war materials and an additional safety factor in military instruments. The results of this school's work are being passed along to aid the hard-pressed Serviceman.



*A warning by I.R.E. president against "compartmentalization" of knowledge and discovery. Van Dyck urges that means be found for coordination of research while preserving needed wartime secrecy. From an address to I.R.E. Cleveland convention.*

## New Ideas in Radio Must Be Interchanged

By ARTHUR VAN DYCK

**T**HE radio industry is doing a tremendous job in the war effort. It has converted from peace-time production to war production rapidly. In doing so it has changed from designs involving tolerances so crude that dials were arranged particularly to prevent the discovery thereof, to designs of high precision, both mechanically and electrically. From apparatus required to meet only the variable conditions between parlor and kitchen, it has turned to making apparatus to work reliably from the stratosphere to the equatorial desert.

The burden of this accomplishment has fallen most heavily upon the radio engineers. Perhaps the training received by radio men during the past decade, in turning out a new line of forty-nine models every three months, has stood them in good stead. Even a war has perhaps been not as bad as some of the past convulsions at new-model season.

We have done a good job so far. To continue that performance, and to better it, we should remember how basically vital is radio in this war. The new mobility of attack, on land, sea and in the air, is possible only by use of radio communication. The companion mobility of successful defense is dependent likewise upon radio communication. In addition to these, we have the applications of radio techniques to new instruments and weapons, thereby broadening the field of radio to limits not yet clearly seen. The world is in an age of miracles, and we in radio are among the favored few who are bringing them about. We should appreciate our responsibilities, but we can also take pride in what we are doing.

In connection with this matter of interchange of information, I might tell you at this time that the board of directors views

with some concern the present situation in distribution of new technical information. While recognizing fully the need for the right kind and degree of secrecy, it is recognized also that under today's conditions of rapid advance in numerous new fields, too much secrecy is readily possible.

Too close segregation of workers, and too-confined compartmentalization of knowledge, in radio science today, means duplication of work, and loss of contribution to work in each compartment from work in the others. Each and every laboratory thinks of itself as self-sufficient and wholly competent, and while they may be so for short periods of time, they cannot be so for longer periods. Mere co-ordination through executive heads or committees is not importantly beneficial. Ideas come from the technical workers themselves, and each worker is fertilized only by technical detail from other workers. And ideas in one field are more often sparked by work in other fields than by work in the same field. It seems quite certain that if this war continues much longer, as it gives every promise of doing, ways must be found of obtaining dissemination of information to loyal workers, with security from the enemy, or our performance will be dangerously handicapped. Our enemies are excellent organizers in bringing all their abilities into effective use. We must learn to do the same. The board of directors is making an effort to find a way to assist.

I would like to report to you at this time on another war activity in which the Institute is participating. This is the standardization of radio material for the armed services. As you all know, radio designs for the Army and the Navy have been developed independently under different specifications

and requirements, over past years in which their service conditions were quite different. Now, however, radio technique and communication practices are so similar in the two armed services that a high degree of standardization between the two is possible. Such standardization is of course highly desirable from every standpoint, and the government agencies concerned have initiated the co-ordination and simplification work involved. The work has been in progress for several months, under the guidance of the American Standards Association and the sponsorship of the Institute of Radio Engineers. The work of the American Standards Association is of greater importance than is recognized generally in peacetime. In wartime, when advantage to production is urgently needed, such work comes into more prominent relief and is more readily accepted. The Institute of Radio Engineers is very glad to be able to assist. This is obviously a work of great value to the war effort, and one which can be executed only by a competent professional association, impartial and willing to do much hard work without reward except that to the common good. It is being accomplished without fanfare and publicity, and will be reported through appropriate channels in due course.

This convention of the Institute may be the last for the duration. The Federal Office of Defense Transportation recommended to all associations that conventions and similar gatherings requiring travel by large numbers of people be deferred during the war. We consulted the office for opinion as to this convention, and were advised to proceed. However, it will be necessary to review carefully the holding of the annual convention next January.

## New Radio Developments Described to I.R.E.

**T**ECHNICAL papers presented at the Cleveland I.R.E. convention included a demonstration of what is believed to be the smallest broadcast receiver ever made. This pocket radio receiver, described by W. J. Brown, of Brush Development Co., Cleveland, consisted of four tubes, three of which were about the size of an inch section of the average glass medicine dropper. The over-all dimensions were 6 inches long, 2 inches wide and 1 inch thick, including the batteries. The complete unit weighs ten ounces and is relatively small for the average coat pocket.

Listening was accomplished by means of novel plugs designed to fit snugly into the ear channels. Wires that connected the ear plugs to the receivers also serve as an aerial. The set could be tuned without removing it from the pocket.

J. E. Keister, of General Electric Company, read a paper on a television relay system. The application of the "repeater" type of station is unique in that the station is 130 miles distant and more than a mile below line of sight from WNBT, from which station the programs originated. The visual signal was received on a 400-foot by 150-foot rhombic antenna and was amplified, converted and further amplified to be

re-transmitted to the main station, WRGB, at 163.25 megacycles. The novel system of output-frequency control accurately maintained the output frequency regardless of error in the received signal. This system is capable also of handling the frequency-modulation type of synchronizing pulse should the occasion arise. The aural signal has been modulated in the conventional manner and carried to the main station over telephone lines.

In a paper called "A New Approach to the Problem of Phonograph Reproduction" G. L. Beers and C. M. Sinnett, of RCA Manufacturing Co., Camden, N. J., described the experimental record reproducing system employing the principles of frequency modulation and gave data on the measured and calculated performance characteristics of the system. Mr. Sinnett, who read the paper, said the new method "will make it possible some day for music lovers to get substantially the same results in the home from 'shellac' phonograph discs as the big broadcasters get from their musical transcriptions." The musical range, he said, is extended to tones as high as the human ear can hear, "with surprising freedom from needle scratch." The method resembles a small radio transmitter linked with a

diminutive "microphone," which in turn is operated by a permanent sapphire needle. Curves were given showing vertical force required for satisfactory tracking with the experimental frequency-modulation pickup as compared with other pickups of conventional design. The paper covered development work which was done several years back.

A new type of practical distortion meter was described by J. E. Hayes, of the Canadian Broadcasting Corporation, of Montreal, which embodied circuits differing somewhat from those previously employed for this type of instrument. This meter consists essentially of a bridged-T audio frequency bridge circuit, in which the inductance element is replaced by a reactance-tube circuit. Because of the flexibility obtainable in vacuum-tube circuits, it is relatively simple to vary the effective inductance continuously over a fairly wide range and thus allowing the distortion meter to be used at any frequency in the audio range. The author outlined precautions which must be taken in a circuit of this type in order to avoid difficulties due to nonlinear action of the reactance tube circuit. Application of negative feedback to the reactance-tube circuit

(Continued on page 750)

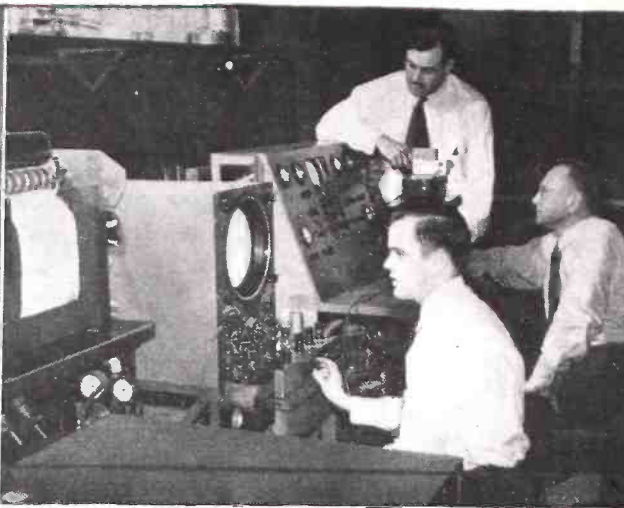
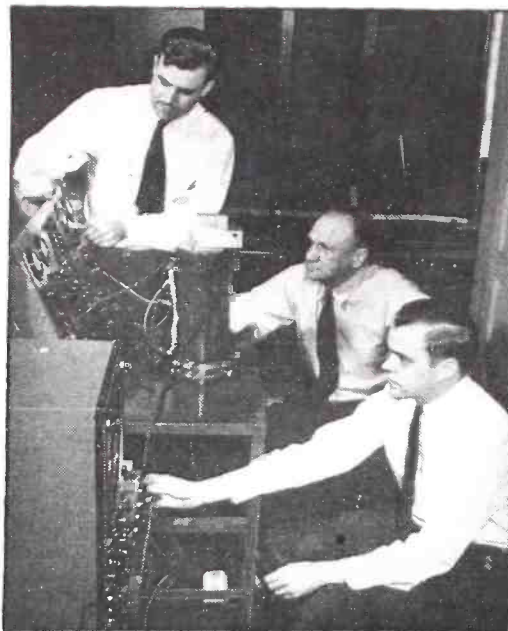

Dr. James Hillier (foreground), Dr. V. K. Zworykin (seated) and Richard L. Snyder demonstrating the recently perfected electron microscope. The picture from the facsimile printer of the instrument shows etched nickel.



# New Scanning Electron Microscope Revealed to Radio Engineers

*Dr. V. K. Zworykin describes perfection of new instrument at Convention of Institute of Radio Engineers at Cleveland, Ohio.*

**P**ERFECTION by a group of scientists of a scanning electron microscope which enables the study of surfaces of opaque objects, including metal, in far greater detail than heretofore possible, was revealed recently by Dr. V. K. Zworykin, associate director of RCA Laboratories, in a scientific paper read at the Institute of Radio Engineers' convention in Cleveland, Ohio. The paper was jointly prepared by Dr. Zworykin, Dr. James Hillier and Richard L. Snyder, all of RCA Laboratories, who contributed to development of the instrument.

While Dr. Zworykin cautioned that, as with any new instrument, it is not possible to judge the full range of utility of the scanning electron microscope at the present time, it was pointed out by associates that the new device has important, and possibly far-reaching significance to the field of metallurgy. Investigation of grain structure in metals on an order of minute detail never before realized becomes possible.

The scanning electron microscope, Dr. Zworykin said, is the result of utilizing principles and devices taken from three outstanding developments in radio and electronics—television, the electron microscope and radio facsimile.

"Think how stupendous the undertaking would be," said Dr. Zworykin, "if someone were to conceive an electron scanning microscope and then set out to research for it without having the knowledge at his fingertips which we have of television and electron microscopes, as well as the art of radiophoto or facsimile. It would be an endless task.

"But, as often happens in science, the discovery of one good thing leads to another. In addition to the developments mentioned, the electron multiplier tube is another vital factor in this latest scanning achievement. After passing through an intricate process of magnetic scanning, the electron beam containing the picture information is converted to light at a fluorescent screen. The light is concentrated by

a wide-aperture lens on the photo-cathode of the multiplier, which in turn operates a printing device."

Explaining how the new instrument works, Dr. Zworykin said that the formation of an image may result from one of two methods. One is the simultaneous imaging of all the elements, as in the projection by optical lenses of a picture on a screen, on a photographic plate, or on the retina of the human eye. The second method is by the successive recording of individual image elements, the process used in television.

"Modern high-power electron microscopes may utilize either of these procedures," Dr. Zworykin said. "The conventional electron microscope—also perfected by RCA Laboratories—like any ordinary optical instrument, records the entire array of elements simultaneously in the form of an electron-optical image. The scanning microscope, however, adopts the methods of television, that is, records one picture element at a time . . ."

Each type of electron microscope has its own particular sphere of usefulness, Dr. Zworykin pointed out. The conventional electron microscope, he said, is primarily suited for the study of "transparent" objects, specimens less than a micron in thickness; while the scanning microscope has as its special province the investigation of the surface of objects, which are opaque to electrons. Roughly, the two types of electron microscopes correspond in application to the light microscopes used in biological and metallurgical work, but the electron instruments "see" much greater detail.

"As simple as the basic principle of the scanning electron microscope may appear," continued Dr. Zworykin, "the realization of an instrument with a resolving power comparable with that of the electron microscope was confronted with very great difficulties. These obstacles arose from the

necessity of making the scanning spot no larger than the least separation which is to be resolved, that is, no larger than one two-millionth of an inch (100 Angstrom Units) in diameter. It was no easy job to form a spot of this size, but we have succeeded."

In fact, so accurate and delicate is the control of the electrons in passing through the instrument to help "see" the surface of the metal, or object being observed and photographed, that the tiny electrons pass through the scanning tube about one yard apart. The mastery achieved is indicated further by the fact that, theoretically, it would require 30 billion, billion, billion of electrons to weigh an ounce.

The scanning electron microscope was brought to perfection by research and development work which extended over a period of years, and was participated in by a large number of scientists in RCA Laboratories. The authors of the paper, Zworykin, Hillier and Snyder, called particular attention to the early work of Arthur W. Vance and L. E. Flory, and to the mathematical contributions of Dr. E. G. Ramberg, all of RCA Laboratories.

A summary of the technical paper prepared by the authors follows:

In order to examine the surface of bulk material with the high resolving power afforded by the use of an electron beam a new electron microscope of the scanning type has been developed in which an extremely fine and stationary electron probe is produced by a two-stage reducing electrostatic-lens system. The specimen is moved mechanically in such a way that each point of its surface is scanned in a systematic fashion by the electron probe. The secondary electrons which are emitted from the point of the specimen bombarded by the electrons of the probe are accelerated and projected on a fluorescent screen. The intensity of the light emitted by the fluorescent screen varies in accordance with the

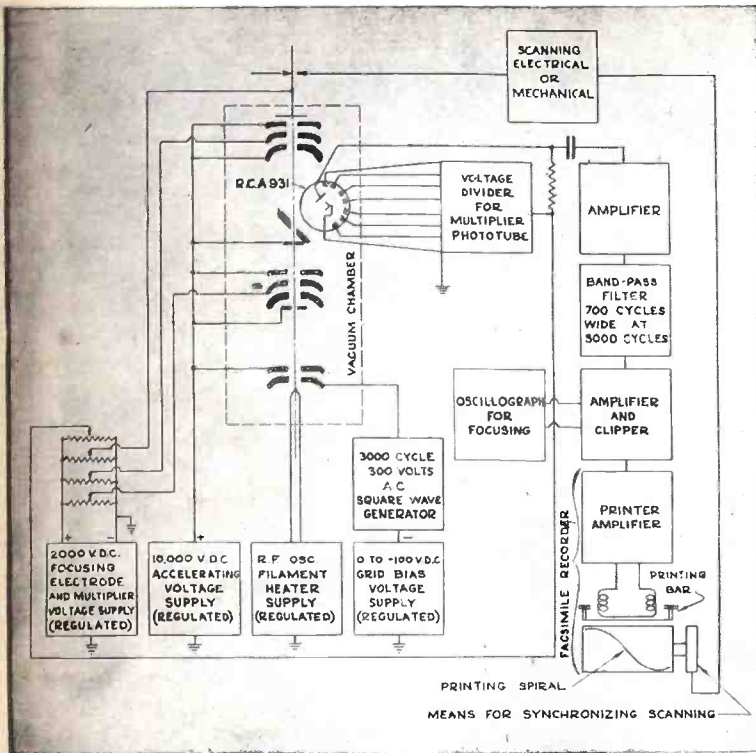

Above—Schematic arrangement of the scanning electron microscope.

Right—Skeleton of the new electron microscope, showing the placement of lenses in relation to the electron beams.

The principles of television, electron microscopy and facsimile are joined to make this new instrument.

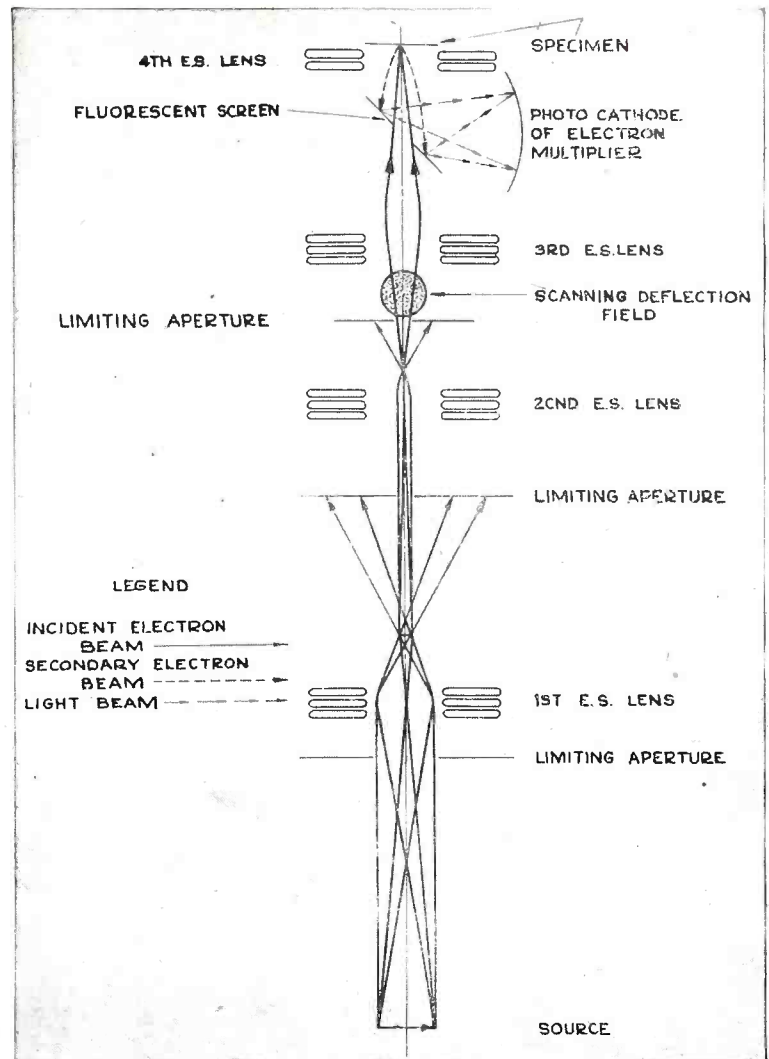

secondary-emission properties of successive points of the specimen. This modulated light signal is converted into an electrical signal by means of a multiplier phototube and then synthesized in a printed picture by an amplifier and facsimile printer system. The use of the electronic-light-electronic transfor-

mation of the image signal improves the signal-to-noise ratio by at least an order of magnitude over that found in conventional methods of collection and voltage amplification. An experimental model has been constructed and has been successful in producing images of etched metal surfaces at

magnifications as high as 10,000 diameters and with a resolving power considerably better than 50 millimicrons. The blackening of the image points has been found to be a function of the three-dimensional contour of the specimen as well as of its secondary-emission properties.

# WARTIME SOLDER

By E. M. KOLMAN

**R**OSIN-CORE solder as used by radio men is an alloy of tin and lead. No one ever bothered to think about the sources of supply on tin as long as it was possible to purchase a roll of solder with little effort. Now that tin is a strategic metal, Americans are asking, "Don't we have our own tin mines?" The answer is "No." Over ninety per cent of our tin came from Malaya, Burma, Thailand and the Dutch East Indies and, as everyone knows, the Japs are now in full possession there.

"What about the fabulous Patino Tin Mines in Bolivia and the new tin smelting plant at Texas City, Texas?"

Bolivian tin ores are second rate and they must be mixed with a first-grade ore before they can be smelted economically. The Texas City tin-smelting plant has just begun operations and it is questionable if it will ever be in a position to furnish us with tin for civilian consumption. As it is, it will produce just a small portion of our war requirements. In fact, how well it can do that will depend upon our ability to allocate ships to transport the ore from the Bolivian tin mines to our new smelting plant.

"Is it possible to solder with lead alone?" The answer is no. Tin in itself is a solder that will "wet" or alloy with other metals.

Lead when added to tin triples the strength of the solder, lowers its melting point, makes it easier to handle and lowers the cost of the solder; yet lead by itself will not wet other metals and so lead by itself is not a solder.

"What about substitutions for tin?" Cadmium, bismuth, indium and silver have been suggested.

Cadmium may be alloyed with lead for soldering purposes but at the moment cadmium is a "critical" metal and very much in demand for plating implements of war.

Bismuth like lead is no solder. It is used to lower the melting point of solders; but the more bismuth used the more brittle and porous the joint becomes.

Indium may be used for soldering but just now the price of \$12.50 an ounce is a rather steep price.

Silver-lead solders, especially an alloy of 2½% silver and 97½% lead is being recommended as a substitute for tin-lead solders. This alloy compares favorably in price with tin-lead solders but unfortunately for the radio man it is difficult to use with a soldering iron.

The radio man with his 50-, 60-, or 100-watt iron will find this solder sluggish be-

cause of its higher melting point, 580°F. It will require a 150- or 200-watt iron and even then the continued use of the iron is difficult because the faces of the iron oxidize readily with so much lead in a solder.

The Tin-Lead branch of the WPB has ordered all solders for civilian consumption to be reduced to 16/84, that is, 16% tin and 84% lead. This solder can be used successfully by the radio man with a 150- or 200-watt iron.

A resourceful radio man may not have to be without solder because it is possible to make his own. Prior to the outbreak of war all shaving-cream toothpaste and salve tubes were made of almost pure tin. Tinfoil used as food wrappers, tinfoil from old radio condensers (beware aluminum foil), tin bearings from connecting rods and pewter ware may be alloyed with lead to make solder.

To make strip solder melt your scrap in a ladle and pour it on either an iron or marble surface. If you plan to add tin to your lead, melt the lead first and add the tin.

A solder containing as little as 5% tin and the balance lead is preferable to any silver-lead alloy for radio use.

# Wartime Transformer Rewinding

Readers of *Radio-Craft* will recall the two articles by Mr. Shunaman on radio servicing in China, where all burned-out transformers had to be rewound because replacements were not obtainable. In view of the increasing scarcity of transformers, Mr. Shunaman has been asked to write an article on transformer rewinding demonstrating how good use may be made of abandoned equipment to make repairs which might otherwise—in scarcity periods—be impossible.

By FRED SHUNAMAN

**“REPAIR OR REPLACE”**—that oft-debated question—is one that the Serviceman must now face in a new frame of mind, born of vastly changed circumstances.

War and priorities stare him in the face, and many parts are difficult or impossible to obtain. I believe—speaking from experience in an area where no replacements were to be had and practically everything had to be repaired—that in almost all cases where replacements are obtainable, replacement is the quickest, cheapest and most profitable method. Where they are not—or in the case of certain high-cost components—repair is quite feasible, and parts often can be turned out as good as the day they left the factory.

Many junked parts can be put back into condition, or made to yield materials for reconstructing other apparatus. The repairman may work over old stuff during slack periods, thus gainfully employing time that otherwise might be passed waiting for customers.

This article will be devoted to power transformer rewinding, a subject especially important because these items are among the first to feel the pinch of priorities; and because the average Serviceman may know

less about transformer work than about any other branch of radio repair. Later we will deal with the repair of other components, with special attention to methods and stunts not generally known in America.

## MAKING A WINDING MACHINE

The essential thing in winding transformers is the transformer winder! This would seem obvious, but many a man has tried to work without one, inevitably coming to the conclusion that transformer winding is impractical. The winder can be made up in a number of ways. It consists fundamentally of a shaft  $\frac{1}{4}$  to  $\frac{1}{2}$  inch diameter, supported in one or two bearings, fitted with nuts (or collars and set screws), for securely holding a block of wood, slotted at one end for a revolution counter—a necessity for the work—and fitted with some kind of crank at the other. (See Fig. 1.)

An efficient emergency winder has been made with a 12-inch bolt, a piece of 2 x 4 screwed to the bench and bored for a bearing, a few nuts and washers and a spring. A discarded emery wheel can be fitted with a shaft and used for higher-speed work, and the hand- or breast-drill clamped in a vise has been widely used for small jobs. Elec-

tric power can be used if starting and stopping can be controlled and a lathe is easily adapted to the job.

A number of other things are required: Transformer tape, insulating papers, varnish, cambric tubing (spaghetti), etc. Transformer tape is cotton, about  $\frac{1}{2}$  inch wide, and is used for ends of windings. Insulating paper comes in a wide range from the thin glassine used between layers of the same winding to the heavy fiber used for making core pieces.

## INSULATING VARNISH PUT ON EACH LAYER

The best type of insulating varnish for the small user is a clear air-drying type. The commercial winder soaks his transformers in the varnish after winding. The hand winder will find it better to keep a small ink or mucilage bottle of varnish under his winder, and to put on a thin coat of varnish as he finishes each layer. A small water-color brush is used. This helps to keep the wire in place, and holds the next layer of paper. Nor is there any doubt as to whether the varnish has reached the center of the windings! Insulating varnish can be used to make small quantities of insulating paper, by saturating wrapping paper or card of the desired thickness and hanging it up to dry.

These items are obtainable from electrical supply houses, some of which deal in insulating materials only, but as prices go up steeply and as quantities diminish, you would be well advised to get a few yards of transformer tape, a stock of glassine paper, and a few pieces of thin fiber from your local armature winder. As these items become unobtainable, it may be necessary to use Duco varnishes and even linseed oil to make insulating materials, and possibly to impregnate with pitch, as in some transformers now used. Wire and iron will be salvaged from old transformers.

Select a big transformer to start on, preferably one which has a little additional space in the window, so if your job is slightly larger than the original, you will still be able to make it fit. Avoid small, cheap transformers. They are put together with the absolute minimum of iron, copper and insulation, and are often impossible to rewind. Tear down two or three old transformers and study their construction before starting to rewind one.

The first step is to take down the old transformer. First make a drawing of the way the leads come out (Fig. 2), as your

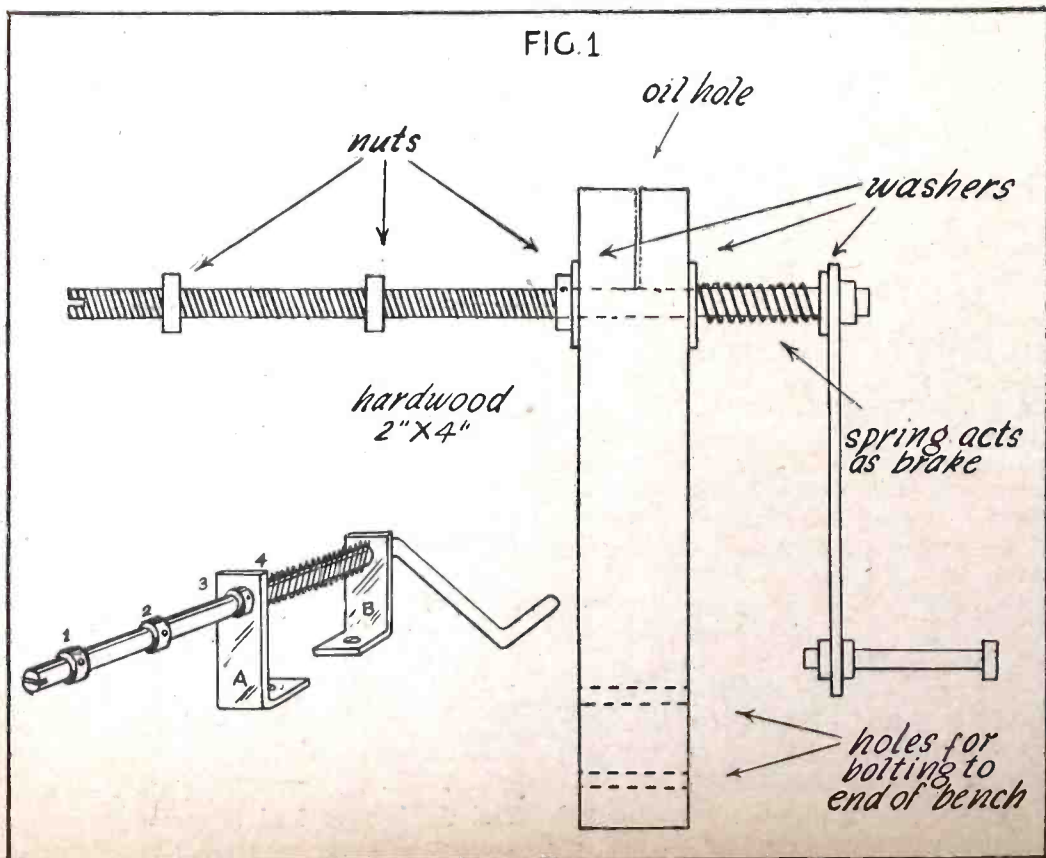



leads must come from the same sides and ends if you are to clear core material and casing when you re-install. Then take out the laminations. This may be difficult. Knock out the short butt pieces with a screwdriver. Then, if one of the end "E" pieces cannot be worked out, place the transformer on a vise with the jaws slightly opened, and drive down the center leg of one of the "E" pieces near the middle of the pack, using a thin, flat piece of iron and a hammer. As soon as you have a piece backed out to where it can be grasped with a heavy pair of pliers the rest is easy.

When the old core is removed, a block of wood exactly the size of the opening is made, bored through the center and inserted into the old winding, which is then put on the winder and secured with the nuts or collars. The old windings are then pulled off. Good wire can be wound onto spools and used again. If the secondary has burned out, probably the insulation on the primary has been somewhat damaged and should not be used. Use the counter and note down the number of turns on each winding. If some windings are so badly burned as to necessitate cutting off, an exact count of the unburned windings will make it possible to calculate the burned ones to the approximate voltage required.

Note how the various windings are insulated from each other, and how the ends are fastened. It is easier to learn this from the transformer than from a magazine article. Save some pieces from each bad winding—you will need wire of the same size, and comparison with the eye is as accurate as a wire gauge.

#### HOW TO CONSTRUCT THE COIL FORM

Now that you are down to the cardboard core-piece, use it for a pattern and cut a core-piece from good fiber. Wrap several layers of paper around the wood block and make the new core piece big enough to cover it, or you may have trouble putting back the laminations. If the old core piece is in good condition, impregnate it with insulating varnish and let it dry thoroughly. Cut a number of pieces of insulating paper, long enough to overlap each layer little more than half an inch and you are ready to go ahead.

Wrap a few layers of glassine around the core-piece and begin the first winding—almost invariably the primary. Let enough lead extend to make a good connection (wrap it around the winder shaft to keep it out of the way). Follow the old transformer in the method of bringing out leads. In some cases pieces of spaghetti are slipped over the wire—which then forms its own lead—in others a length of insulated hook-up wire is soldered to the winding, the joint covered with a piece of insulating paper, and secured at the start of the winding.

You will have noted that the winding begins about 3/8 inch from the end of the core piece and that the end is fastened by looping a piece of transformer tape around it, winding several turns on top of the tape, then pulling the tape until the end turn lies snugly against the others. See Fig. 3.

These first few turns are made by holding the wire in one hand and turning the form with the other. As soon as the wire

is fastened proceed with the crank, holding the wire in the other hand as thread is held when winding a bobbin on a sewing machine. The wire should be mounted on a shaft parallel with the winder shaft, preferably on the front of the bench just below the top, where it will be out of the way and in the best position to wind.

A little practice will make it easy to wind turns evenly and close together. Wind snugly, but not so tight as to cause the wire to bind on the wood block. As each layer is finished, brush on a thin coat of insulating varnish. The beginner's usual trouble is that the end turn slips down. This can be avoided by relaxing the tension slightly on the last several turns, so that the paper between layers holds up the wire. If a turn escapes, the next layer can be built out to full width by letting the paper project beyond the end of the core, winding out the proper distance, then turning the paper back over the winding and continuing to wind back on top of it. This holds the outside turn firmly and makes a base for further layers. Doing this too often makes a winding bulky, and care must be exercised. Your windings must go back into that window!

#### FASTENING THE FINAL TURN

When the counter tells you there are only a half-dozen turns to go, cut a piece of transformer tape, double it and lay it on the form with the loop out and the two ends on top of the winding, and wind on top of it to the last turn. Cut the wire, slip the end turn through the loop, and pull on the ends of the tape. The loop will tighten up and hold the end turn securely.

The secondary will be much the same as the primary—a little easier on account of the finer wire. Use insulating material of about the same thickness and quality as in the old transformer between all windings. If wire breaks, make a neat soldered joint, cover it with a bit of glassine paper, and continue. The filaments are often a tougher proposition, especially on old sets using low-voltage tubes. Fasten the first turn with four or more loops of tape to prevent spreading. Do not try to use the crank, but turn the form with one hand and bend the wire in with the other. Filament windings are usually—but not always—brought out bare, with no leads or insulation, and spaghetti coverings are slipped on when installing in the set.

Your winding finished, put on the outside insulating covering and put it away to dry. Putting the laminations back should present few difficulties. Note that two pieces are usually inserted from one side, then two from the other, etc. If, after winding, the form is bulged in the middle so that the outside parts of the "E" pieces scrape, the shape can be improved by putting it in a vise between two boards, and applying gentle pressure. Too much will cause internal shorts. Do not take out the wooden core during this process, and leave the form in the clamp for some hours.

#### FLEXIBLE LEADS REQUIRED FOR FINE WIRES

While bringing out leads for terminals from heavy wire presents no particular problem, providing leads where relatively

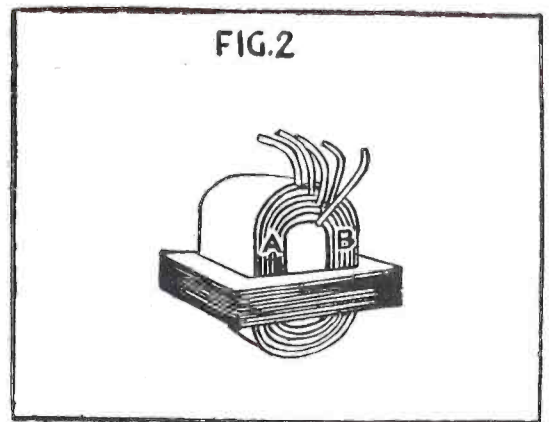

fine wire is used for windings requires special precautions.

At the start of such a winding, wrap several inches of the wire around the form, sticking it down with a piece of adhesive tape. This wire will be brought to the insulating cover of the whole winding, where it will be soldered to a flexible lead.

When the winding is finished carefully bend the wire over the insulating cover and, after allowing sufficient wire for soldering a lead, cut off the remainder of the wire.

Proceed with both fine wires as follows: Hold down one wire with your finger and use a small piece of fine sandpaper (*do not use emery cloth*) to scrape away the enamel. Do the same to the other wire.

Remove about three-eighths of an inch of insulation from the flexible lead wire, loop the fine wire from the coil around it and solder together. After this is done with both wires, make a U-shaped loop of the flexible lead and bring it out to the side, sticking down the soldered joint with adhesive or Duco cement. Another layer of insulation will be required to protect these soldered wires. This method permits enough slack so that an accidental pull on the flexible leads will not break the fine wire.

#### TESTING FOR SHORTS

Once the case or frame is on and tightened up, test all windings for shorts to each other or to the core. If none appears, connect the primary across the 110-volt line and run it an hour. Any heating is an indication of internal shorts. Devices for testing under load can be rigged up with a few lamp sockets and small lamps, but it is easier for the beginner to install the transformer and test it on the job.

Once you have mastered the technique, the same apparatus and experience can be used to rewind other types of transformers and coils, especially output and Class-B transformers and filter chokes. It is possible to rewind all copper-and-iron coils in a set, although some, such as swinging chokes and audio primaries, may be more difficult. A future article will deal with repairing such components, as well as loudspeakers, R-F and I-F coils and other parts.

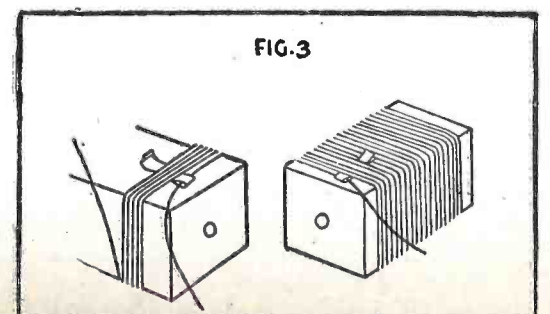

# HOW TO CONSTRUCT A SIGNAL GENERATOR

By WILLIAM MORELAND, JR.

I HAVE found that it is becoming more difficult to buy new equipment, and as I have been wanting a signal generator, I decided to build one out of old radio parts.

Looking through the junk box I found that I had nearly enough material to build the signal generator. For the radio-frequency portion of the unit I used a Hartley circuit, modulating it with an audio signal of about 400 cycles.

I found that the most difficult thing to get was a cabinet to hold the signal generator. I finally got an old cash box which had been put out of commission by a faulty lock; it not only solved the problem, but made a compact and neat appearing unit. To make a finished appearance, the box

was painted with black crackle varnish. A panel was from three-ply bristol board. Scales and the controls' uses were lettered on. I found that I had a chassis of an old midget radio which, when sawed in half, made a good fit in the box. I decided to use type 27 tubes because I had a pair of 27s and a Thordarson 2.5-volt filament transformer.

As the filament transformer had only the 2.5-volt winding it became necessary to use a 117Z6 tube. It has a 117-volt filament and gives well over 110-volts of rectified voltage.

In wiring the 117Z6, it is necessary to connect one side of the A.-C. line to the B return or you will have no voltage in the signal generator. I first grounded one side

*The increasing difficulty of obtaining test equipment is making it necessary for Servicemen to reclaim abandoned parts and revise standard plans according to available materials. Mr. Moreland's design may be modified to meet individual cases.*

of the A.-C. line to the chassis of the unit but found that it was unsatisfactory. The best method is to fasten a piece of bus wire to tie-points and to by-pass it to the chassis through an .01 mf. condenser. The 500-ohm resistor leaving the cathodes of the 117Z6 is a 1-watt carbon type.

The D.C. voltage is about 100 volts at the plate of the modulator tube, but at the plate of the oscillator and on both the stator and rotor plates of the tuning condenser it is about 37 volts. It is necessary to insulate the tuning condenser from the chassis.

An old (Pilot) audio input transformer was used to give modulation and an audio signal of about 400 cycles. In connecting the audio transformer into the circuit, I found it necessary to use the connections in the following manner:

The B+ lead of the transformer goes to the grid of the modulator tube, the plate lead goes to the B return; the grid lead goes to B+ and the F— or ground lead goes to the plate of the modulator tube. I found this to be the only way I could get a pleasing audio tone; all other connections gave a deep tone which sounded very much the same as a 60-cycle hum.

I wound the coils for the oscillator with enamel-covered magnet wire, except for the 75 to 220 kilocycle intermediate frequency band; that was wound with double cotton covered wire. The coils were wound on a wooden dowell 1/2" in diameter and the windings were jumble or scatter wound. In the coil table please note that the coils are not to be over 1/2" to 3/4" long and that all coils are center-tapped. When the coils are finished (I wound all three of my coils on a half-inch dowell five inches long) paint them with coil dope or acetone cement. Such doping not only causes the coils to hold their form, but also helps to keep moisture out of them.

Range	COIL TABLE		
	Turns	Wire	Coil Length Form
L1 75- 220 Kc.	1100	No. 34 D. C. C.	3/4" 1/2" dia.
L2 200- 500 Kc.	450	No. 28 Enamel	1/2" 1/2" dia.
L3 500-1500 Kc.	175	No. 22 Enamel	1/2" 1/2" dia.

When the coils are wound, solder the center-taps to a lead and check the coils for continuity with an ohmmeter. A two-gang three-position switch is needed to switch the coils in or out of the circuit as required. An old single-gang .00035-mf. broadcast-type condenser is used for tuning the signal wanted.

This unit gives the intermediate and standard broadcast frequencies. I did not add any short-wave bands as they are hardly ever needed. Fairly accurate aligning of short-wave bands can be done by using harmonics of the standard broadcast range.

I calibrated my instrument by beating its frequency against standard broadcast stations on a T.R.F. receiver. I aligned the I.F. bands by beating their harmonics with known frequencies. If you can obtain a signal generator for several hours, it will simplify matters quite a bit.

Modulation is obtained by leaving the switch S2 in the open or off position; when

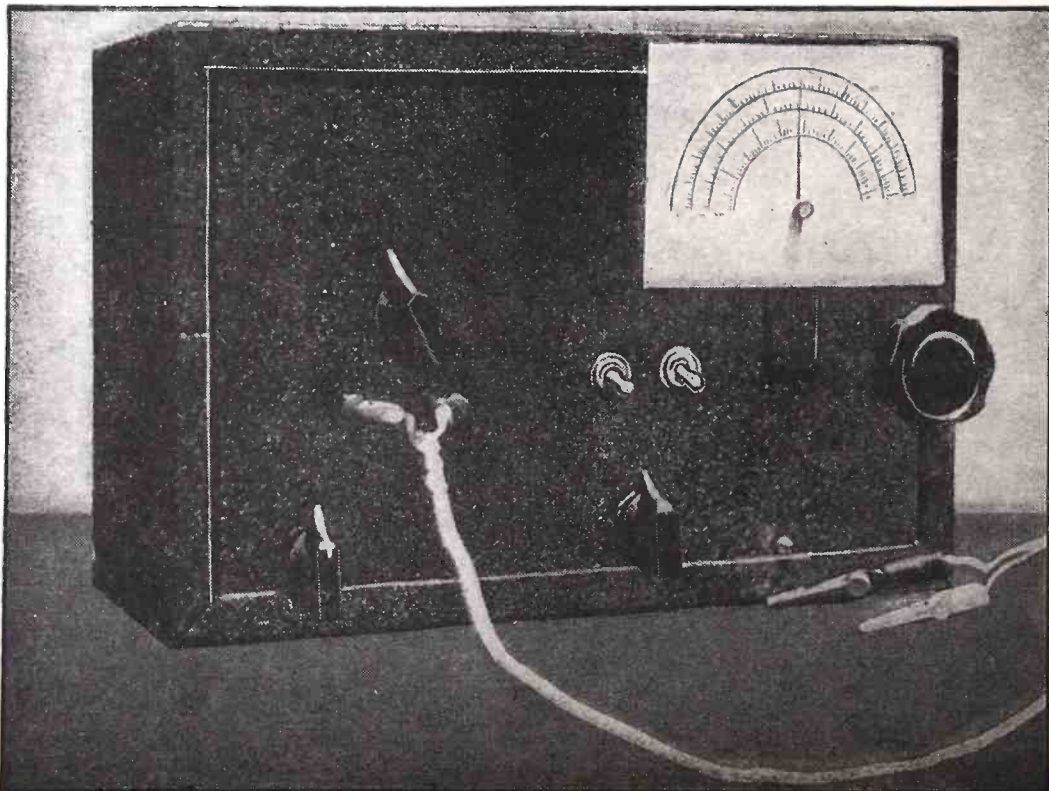
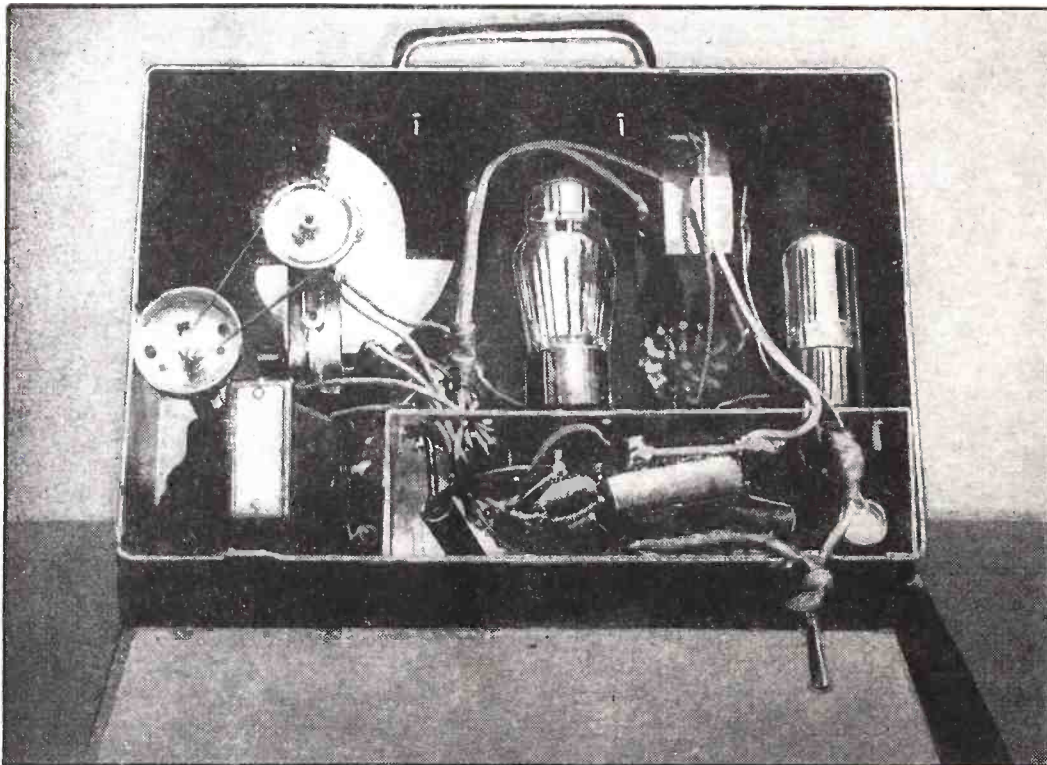

the switch is closed, you will receive an unmodulated signal.

This unit must be built in a metal can or it will not only cause much interference on the radios in the neighborhood, but will make it impossible to regulate the intensity of the signal coming from the signal generator. Since metal is so hard to get, if you place the unit in a wooden or Masonite box which has been lined with window screening, you will find it does the job nicely.

List of Parts

CONDENSERS

- C1—.002 mfd. mica CD
- C2—.00035 mfd. CD
- C3—.05 400 volt CD
- C4—3-30 mmfd. trimmer Mallory
- C5—.0005 mfd. mica Aerovox
- C6—.01 mfd. 400 volts CD
- C7—.01 mfd. 400 volts CD
- C8—.04 mfd. 400 volts CD
- C9—20 mfd. 150 volt electrolytic
- C10—.05 mfd. 400 volt CD

RESISTORS

- R1—50,000 ohms 1/2 watt IRC
- R2—200,000 ohms 1/2 watt IRC
- R3—1 meg. pot. Centralab
- R4—25,000 ohm 1/2 watt IRC
- R5—3 meg. pot. Centralab
- R6—500 ohm 1 watt IRC

MISCELLANEOUS

- T1—Thordarson 2.5 filament transformer
- T2—Input audio transformer
- SW1, SW2—2 SPST switches
- SW3, SW4—D.P. 3P switch Mallory
- 2—27 Sylvania tubes
- 1—117Z6 Sylvania

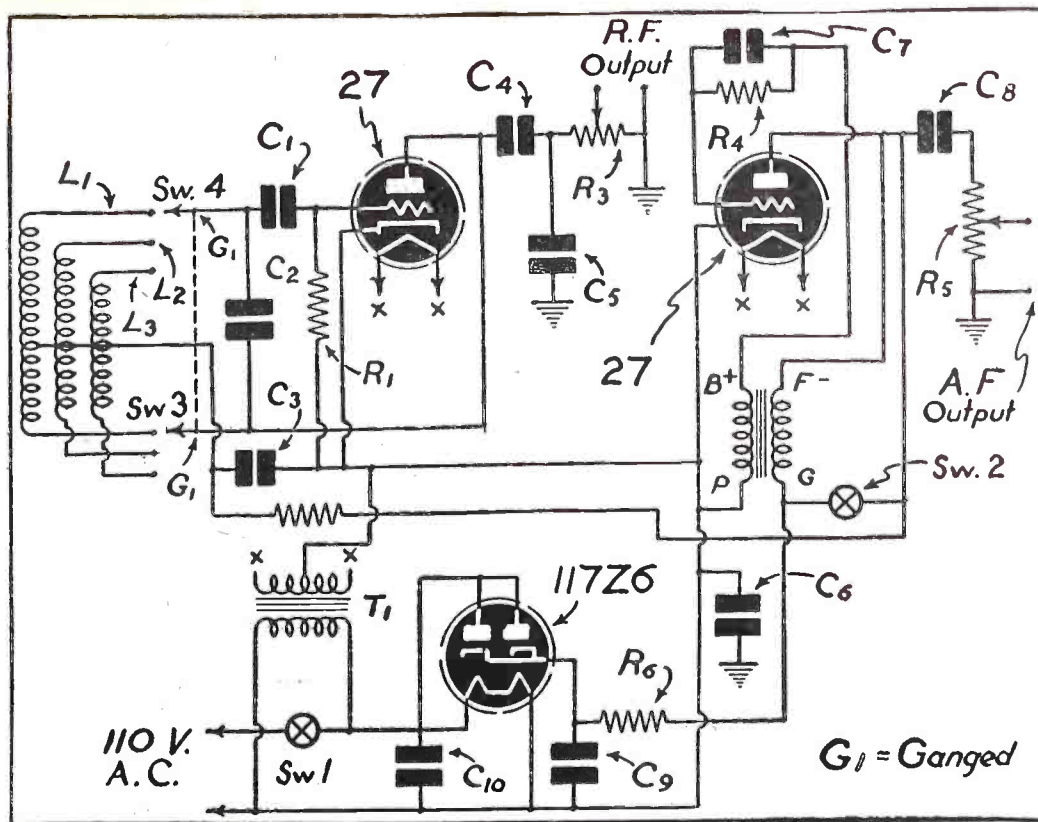

Wiring diagram for signal generator.

# Military Needs Bring Changes in Radio Processing

By H. A. WILLIAMS\*

IN order properly to understand the changes which have been made in the Stackpole Carbon Company's radio products due to the change in type of market, it is necessary to understand the basis on which the designs and choice of materials were made for civilian requirements.

In designing products for civilian requirements, cost was of primary importance and in all cases, the lowest cost material consistent with good average quality has been used. This meant, of course, that for metallic parts, steel was used almost exclusively and this steel was given a light cadmium plating or other light plating as a protection against rusting. Of course, steel was not used in all parts, notably, wires for fixed resistors were made from copper, bushings for volume controls were made from brass, and the rotating contacts for our variable resistors were made from nickel.

In addition to the above, it must be understood that when products were made for civilian requirements, it was understood that the climatic conditions under which they would be used were controlled to quite some extent. In other words, they would not be used under any greater variation of climatic conditions than those encountered within the boundaries of the United States.

Military requirements have been such that the factors given above as determining designs have had to be completely revised. In the first place, while cost is still a very important factor, we should not and cannot use the cheaper materials where other materials will be more satisfactory for the product and make it more universal in its use. We now find that the climatic conditions under which units will be used for military requirements are extremely varied. In fact, if we were to place an imaginary shell 30,000 feet away from the earth and

surrounding the entire earth, any climatic conditions within this imaginary shell may be encountered. Typical variations of climatic conditions are as follows:

1. High altitude, very dry atmosphere, very cold. Such as would be encountered with high altitude bombing planes.
2. Low altitude, very dry, very hot. Such as might be encountered in a tank fighting in the desert.
3. Low altitude, very moist, very hot. Such as might be encountered in tropical climate.
4. Very low altitude, very moist, salt atmosphere, very hot temperature. Such as might be encountered near the ocean in any warm climate. Incidentally, the last mentioned condition has usually proven to be the most severe as far as radio parts is concerned.

We might now outline various changes which have been made in some products in order to make them operate satisfactorily under all the various conditions mentioned above.

On variable resistors, all steel parts have been replaced with non-ferrous metals, usually brass and the brass has been nickel plated. It has been found by test in our own laboratories as well as in various governmental laboratories, that the copper base alloys when nickel-plated, will satisfactorily operate under all of the climatic conditions encountered. The punched laminated parts used in our variable resistors are now made from a linen base material using a higher grade resin, whereas civilian units were made from paper base and lower grade resin. The advantage to be gained here, of course, is lower moisture absorption. In addition to this, the edges of all punched laminated material should be sealed against entrance of moisture. The extreme variations of temperature which may be encountered have made it necessary that a new lubricant be developed. Our controls

now sold for military requirements are lubricated with a lubricant which is satisfactory between the temperature ranges of  $-40^{\circ}\text{F}$  to  $+125^{\circ}\text{F}$ .

On fixed resistors, the changes have been comparatively small in order to make a unit which would perform satisfactorily under the conditions mentioned above. It has been necessary to immerse our resistors after they are finished in a high grade wax, leaving a heavy film of this wax on the resistor body. This serves not only as a moisture repellent under humidity conditions but also avoids the possibility of surface moisture on the resistor unit when dew-point conditions are encountered.

On iron cores, likewise, it has not been necessary to make any very great changes to meet the requirements listed above. On some grades of material, additional rust proofing is required. Another result of the conversion to military requirements has been that very little of the cheaper and less efficient grades of iron have been used. There is a very decided tendency toward the better grades of iron. In addition to this, many of the military uses for iron cores are in the ultra-high-frequency band. This has made it necessary to develop new types of materials and new types of processing in order to make cores which will operate satisfactorily at these higher frequencies.

The policy of the company in producing radio parts for military uses has been to make each and every unit which we send out as nearly perfect as is humanly possible. In modern warfare, the very lives of our soldiers are dependent upon their communication equipment and we must send out every unit with the knowledge that it will perform satisfactorily and that it will not fail at some crucial moment when many human lives may be depending upon the proper functioning of their communication equipment.

\*Sales Manager of Radio Products, Stackpole Carbon Company.

G. E. Musaphonic Radio-Phonograph Combination Model 30

GENERAL INFORMATION

The Model 30 Musaphonic Instrument is a seven-tube, three-band superheterodyne receiver of conventional design using in combination an Automatic Record Changer.

The cabinet is an armchair model with hand-rubbed mahogany finish. The radio is in the upper deck and the controls become accessible by opening the two small sliding doors at the front. The automatic phonograph is located in the lower deck and becomes accessible by sliding the top back under the radio deck.

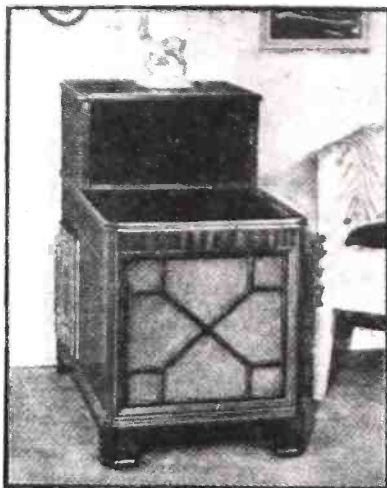

The General Electric Musaphonic three-band superheterodyne radio and automatic record changer combination.

SERVICE NOTES

The following data is taken with a vacuum-tube voltmeter or similar measuring device.

- (1) Stage Gains  
 Antenna post to RF Grid... .65 at 1000 KC  
 RF Grid to Converter Grid... .10 at 1000 KC  
 Converter Grid to IF Grid... .45 at 1000 KC  
 Converter Grid to IF Grid... .60 at 455 KC  
 IF Grid to 6SF7 diode plate... .110 at 455 KC
- (2) Audio Gains  
 .09 volts, 400-cycle signal across volume control with control set to maximum will give approximately 1/2-watt output to speaker.
- (3) D-C voltage developed across oscillator-grid resistor R6 averages 7 volts at 1000 KC, 9 volts at 4000 KC, or 6 volts at 10,000 KC.

Variations of ± 20% permissible. All readings taken with minus 1/2-volt fixed bias on AVC bus.

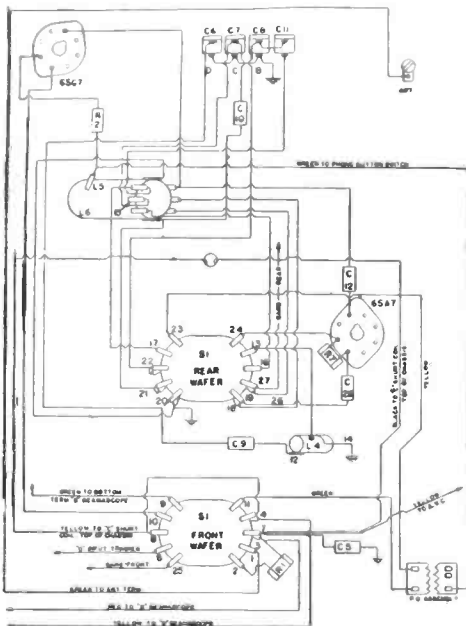

Switch Wiring

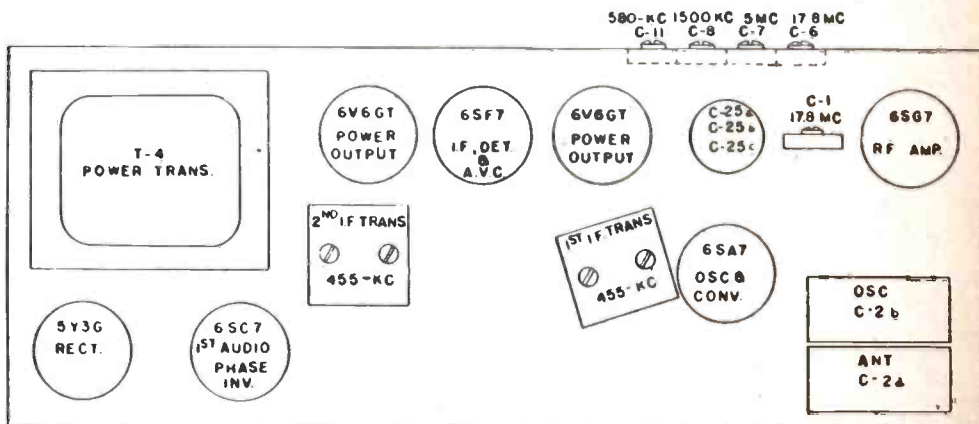

Trimmer Location

ALIGNMENT PROCEDURE

The location of trimmers is shown in the drawing. All oscillator and RF trimmers are accessible from the rear of the cabinet.

The alignment procedure is given in table form. All IF adjustments may be made with the chassis removed from the cabinet. However, the RF adjustments should be made with the chassis and loop antennas securely fastened in the cabinet, as the relative position of the loop antenna with respect to the chassis materially affects alignment. The RF signal should be capacity-coupled to the receiver loop by connecting a two-foot wire, for an antenna, on the test-oscillator output post (high side). Keeping this antenna two feet or more away from the receiver loop will generally insure freedom from too much coupling. Metal objects such as meters, tools, etc., should not be placed on top of the receiver cabinet.

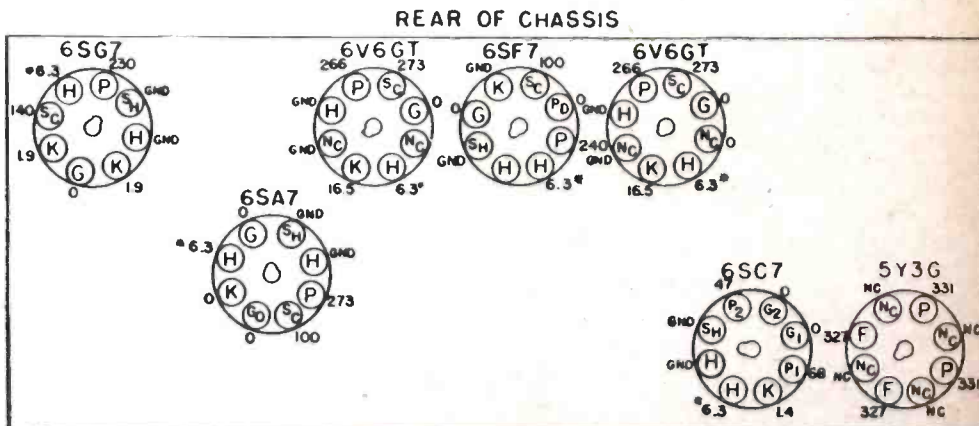

VOLTAGES MEASURED BETWEEN TERMINALS AND CHASSIS AT 117V. LINE USING 1000 OHMS PER VOLT METER. \* INDICATES VOLTS A.C.

BOTTOM VIEW OF CHASSIS

Socket Voltages

ALIGNMENT CHART

Step	Test Osc. Connection	Test Osc. Setting	Pointer Setting	Adjust Trimmers	Step	Test Osc. Connection	Test Osc. Setting	Pointer Setting	Adjust Trimmers
1	6SF7 IF Grid in series with .05 mfd.	455 KC	"BC" Band 550 KC	C17 and C16 for Maximum.	5	Capacity Coupled	580 KC	"BC" Band 580 KC	C11** for Maximum
2	6SA7 Conv. Grid in series with .05 mfd.	455 KC	"BC" Band 550 KC	C14 and C13 for Maximum	6	Capacity Coupled	5 MC	"SW1" Band 5 MC	C7** (Osc.) for Maximum
3	Capacity Coupled	580 KC	"BC" Band 580 KC	C11** for Maximum	7	Capacity Coupled	17.8 MC	"SW2" Band 17.8 MC	C6* (Osc.) to signal
4	Capacity Coupled	1500 KC	"BC" Band 1500 KC	C8** (Osc.) for Maximum	8	Capacity Coupled	17.8 MC	"SW2" Band 17.8 MC	C1** (Ant.) for maximum

\* Correct peak is at low capacity. \*\* Back gang condenser when making alignment.

# Radio Service Data Sheet

325

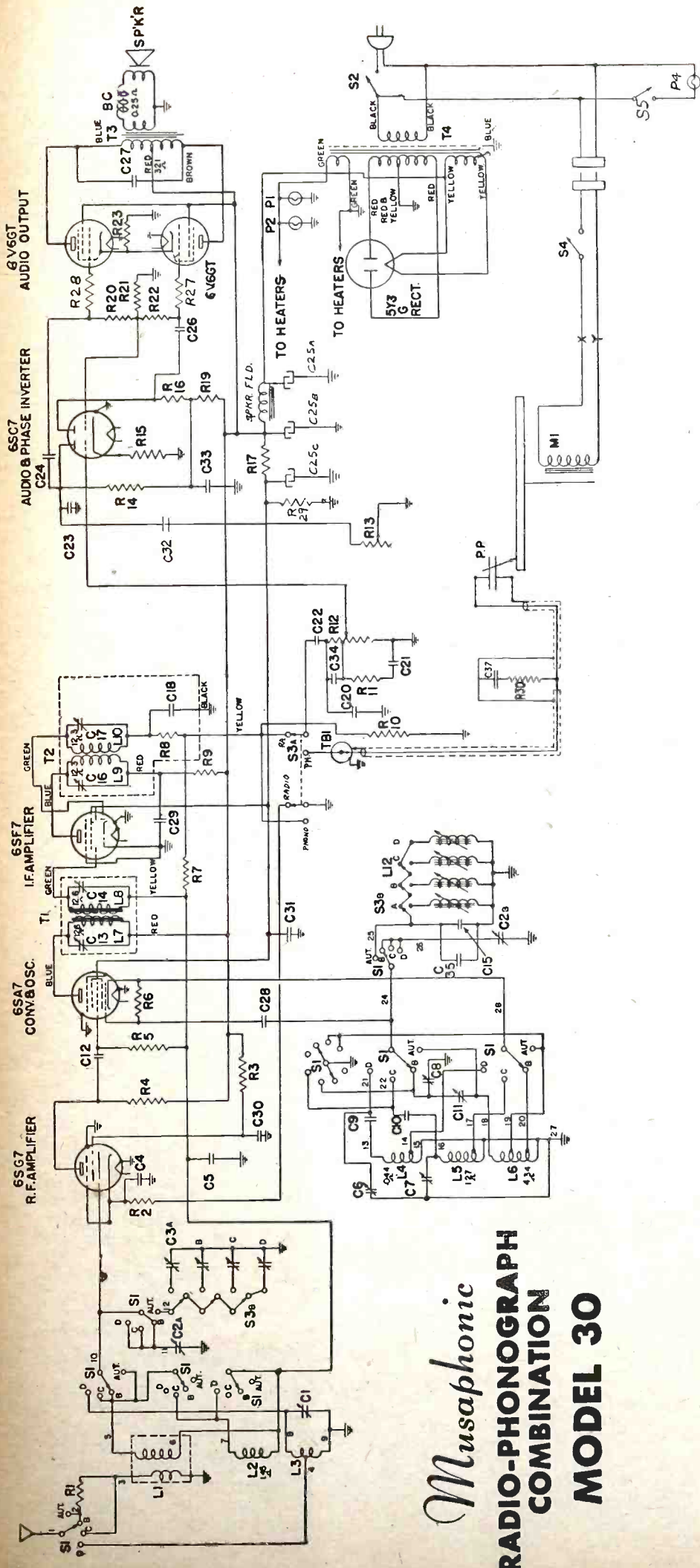

## Musaphonic RADIO-PHONOGRAPH COMBINATION MODEL 30

### PARTS LIST

Symbol	Description	Symbol	Description	Symbol	Description	Symbol	Description
C1	"D" Band trimmer	L12a	.02 mfd. 600-V paper	R19	100,000 ohms, 1/2-watt carbon	T1	1st I.F. transformer
C2a	Tuning condenser	L12b	.15 mfd. 450-V	R20	330,000 ohms, 1/2-watt carbon	T2	2nd I.F. transformer
C2b		L12c	.15 mfd. 400-V	R21	100,000 ohms, 1/2-watt carbon	T3	Output transformer
C2c		L12d	.10 mfd. 350-V	R22	330,000 ohms, 1/2-watt carbon	T4	50-60-cycle power transformer
C26	Push-button trimmer strip	R1	.02 mfd. 600-V paper	R23	220 ohms, 2-watt carbon	TB1	Phono-jack
C27		R2	.02 mfd. 600-V paper	R26	470,000 ohms, 1/2-watt carbon	SPKR	12-inch electrodynamic 400-ohm field
C28		R3	.02 mfd. 600-V paper	R27	1000 ohms, 1/2-watt carbon		
C29		R4	.02 mfd. 600-V paper	R28	1000 ohms, 1/2-watt carbon		
C30		R5	.01 mfd. 600-V paper	R29	47,000 ohms, 1/2-watt carbon		
C31		R6	.01 mfd. 600-V paper	R30	47,000 ohms, 1-watt carbon		
C32		R7	.005 mfd. 600-V paper	S1	Band-change switch		
C33		R8	.005 mfd. 600-V paper	S2	Push-button switch assembly		
C34		R9	1 mfd. 600-V paper	S3a	1st I.F. transformer		
C35		R10	100 mmf. mica	S3b	2nd I.F. transformer		
C37		R11	150 mmf. temp. compensating	T1	1st I.F. transformer		
L1	"B" padder	R12	.001 mfd. 600-V paper	T2	2nd I.F. transformer		
L2	100 mmf. mica	R13	"B" band loop	T3	Output transformer		
L3	600 mmf. silvered mica	R14	"C" RF coil	T4	50-60-cycle power transformer		
L4	200 mmf. mica	R15	"D" Band loop				
L5	100 mmf. mica	R16	"D" Band osc. coil				
L6	.0042 mfd. 600-V paper	R17	"C" Band osc. coil				
C21	.005 mfd. 600-V paper		"B" Band osc. coil				
C22	220 mmf. mica						
C23							

# Measuring Resistance with a Voltmeter

By JOHN L. BELFI

**M**OST experimenters associate resistance measurements with an ohmmeter, a bridge, or an ammeter and voltmeter. Very often, in the middle of some experiment, it is required to know the value of some resistance and none of the above is available. This occurs rather fre-

quently when one is working in the field. The two methods described below require only a voltmeter and a source of voltage.

quently when one is working in the field. The two methods described below require only a voltmeter and a source of voltage.

quently when one is working in the field. The two methods described below require only a voltmeter and a source of voltage.

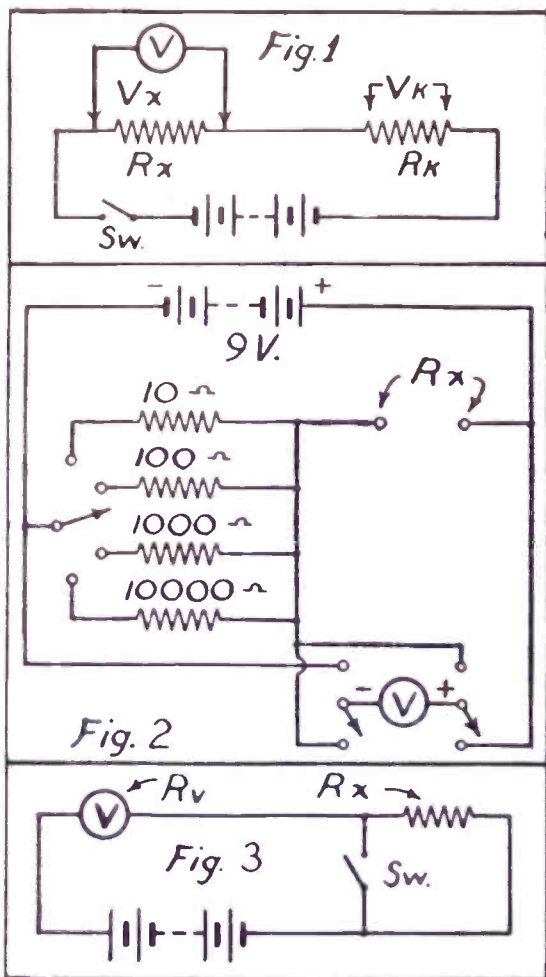

The diagrams illustrate methods of connecting a voltmeter to measure resistance when an ohmmeter is not at hand.

quently when one is working in the field. The two methods described below require only a voltmeter and a source of voltage.

The first method requires also the use of a resistor of known value, while for the second method the resistance of the voltmeter must be known. The latter method is especially suitable for measuring high resistances.

It is a fundamental law of electricity that the voltage drops across resistances in series are directly proportional to the resistances. Upon this principle depends our first method of measuring resistance. If we have a resistor,  $R_x$ , whose resistance we wish to measure, we connect it in series with a resistor of known value,  $R_k$ , and a source of voltage, as shown in Fig. 1.

The voltage should be of a value which will produce approximately a full-scale deflection on the available voltmeter. A higher voltage may injure the instrument, while a lower value will not give as accurate results. Now, with the switch,  $S_w$ , closed the voltage drop across the unknown resistance is read by connecting the voltmeter directly across the resistor,  $R_x$ , as shown in Fig. 1. Let us call this voltage  $V_x$ . The voltage drop across the known, or standard, resistance is read and designated  $V_k$ . (Of course the voltage across the known re-

Or, when solved for the unknown resistance,  $R_x$ :

$$R_x = \frac{R_k \times V_x}{V_k} \quad (1b)$$

Let us take a practical example. Assume that we have on hand a voltmeter with an 0-50 volt scale. With such a scale it will be best to use a 45 volt "B" battery. We also have a resistor (or a choke, speaker, etc.) whose resistance we wish to find. We will call this  $R_x$ . We have now to choose a standard resistance of known value. Best results will be obtained when the known resistance is close in value to the unknown. That is, if we are measuring the resistance of a speaker field, we know that its resistance will probably be in the order of several hundred ohms. Therefore we choose a resistance of 500 ohms for  $R_k$ . These are now connected as shown in Fig. 1. We place the voltmeter across the 500 ohm resistor and get a reading of 24.3 volts, which we shall call  $V_k$ . Placing the voltmeter across the unknown resistance,  $R_x$ , we get a reading of 20.7 volts, which we designate  $V_x$ . Substituting into equation (1b) we have:

$$R_x = \frac{(500) \times (20.7)}{(24.3)} = 425 \text{ ohms.}$$

Just one word of caution: When measuring very low resistances be sure to use a low voltage, since placing too high a voltage across a small tuning coil will most likely burn it out.

If desired a permanent affair can be arranged in a box and connected as shown in Fig. 2. This consists of a 9-volt "C" battery, a voltmeter with an 0-10 volt scale, and four standard resistors which can be

selected at will by means of a rotary selector switch. A D.P.D.T. toggle switch connects the voltmeter first to the known resistor and then to the unknown resistance connected to external terminals.  $R_x$  is then calculated as illustrated by the example given above.

The second method does not require the use of a standard resistance, but the resistance of the voltmeter must be known. The unknown resistance,  $R_x$ , the source of voltage and the voltmeter are connected up as shown in Fig. 3.  $R_v$  is the resistance of the voltmeter. To measure the resistance,  $S_w$  is closed and the voltmeter reading is taken, which is really the voltage of the voltage source. This reading is called  $V_1$ . Now open the switch, thereby placing the unknown resistance,  $R_x$ , in series with the voltmeter, and take another reading. Call the second reading  $V_2$ . The difference in the two readings will, of course, be proportional to the value of the unknown resistance. By substituting into the following equation,  $R_x$  can be calculated.

$$R_x = R_v \left( \frac{V_1}{V_2} - 1 \right) \quad (2)$$

If a voltmeter is available whose resistance is not known it can be found by using a resistance of known value for  $R_x$ , and letting the resistance of the voltmeter,  $R_v$ , be the unknown. The procedure outlined above is gone through, only the equation (2) is solved for  $R_v$ , instead of  $R_x$ , as follows:

$$R_v = \frac{V_2 \times R_x}{V_1 - V_2} \quad (3)$$

The second method of measuring resistance is really nothing more than an ohmmeter. If the reader wants a permanent instrument he can, by using a permanent source of constant voltage and a suitable voltmeter, build a direct reading instrument. Further details can be found in any radio *(Continued on page 751)*

## Crosley Scraps '43 Line For Military Radios

**W**HEN the Crosley Corporation was compelled by the necessity for all-out war production to discontinue its manufacture of household radio receivers as well as all its other peace-time industrial products, it became necessary to make a clean sweep of its peace-time industrial equipment.

Crosley is still building radio receivers and transmitters, but the radio equipment which it is now making for the U. S. Signal Corps, the U. S. Coast Guard, the U. S. Army Air Forces, and other branches of the armed services differs so greatly from any of the peace-time radio equipment it had been making previously that they might as well be an entirely different type of product.

Crosley had been producing the most modern type of household radio receivers, including radio-phonograph combinations, portables, frequency-modulation sets, as well as the cabinet consoles and table receivers.

Unlike some other manufacturers, Crosley introduced its 1943 line of household receivers on which development and reception work had been on the way since last

fall only a few weeks before the order to discontinue manufactures and home receivers became effective. This provided Crosley distributors with the most up-to-date types of household receivers and was largely responsible for the fact that Crosley radio sales for the first several months of 1942 far exceeded those of the industry as a whole for the same period. Production is now well advanced at the various Crosley plants in Ohio and Indiana on the most modern type of military radio transmitters and receivers. These incorporate a number of new features not previously utilized in sets of this kind.

Secrecy necessarily surrounds the nature and details of the receivers and transmitters now being built for the armed services, but into them have been incorporated all of the most modern discoveries and developments that have been made in radio.

Whole floors in the Crosley plants have been turned over to the exclusive production of military radio transmitters and receivers. Production is now on in full tilt, and the completed sets are pouring out of the factory at a rapid rate.



## TO KEEP 'EM LISTENING... HOME SETS MUST BE SERVICED

Second in importance only to direct war work is your job and ours of keeping the family radio sets of the country in good repair for the quick and widespread dissemination of information.

To furnish the resistors and controls so vitally needed for all the equipment required for speeding up the war effort is now our No. 1 job and will continue to be until Victory is won. Actually, our greatly increased manufacturing facilities are 100% utilized three shifts per day on this all-important war work.

However, we have devised means for furnishing a supply of the resistors and controls needed for servicing home sets and it will not be necessary for servicemen to use substitutes of unknown or doubtful quality for replacements.



**TYPE BT METALLIZED RESISTORS**—These famous resistors will be furnished from our stock from which we formerly supplied leading radio set manufacturers. These resistors will be of exactly the same quality, ranges, and tolerance used by the large manufacturers before they discontinued making home sets.

**VOLUME AND TONE CONTROLS**—Plans have been completed to simplify the IRC service replacement line, eliminate special units that can be replaced with universal types, and assemble new stocks from materials and parts on hand which can be done without interference with production for war needs. As in the past, you can count on the well-known IRC construction and noise-eliminating features to assure long, quiet performance on any service replacement job. IRC quality standards will be rigidly maintained.

**INTERNATIONAL RESISTANCE COMPANY** 401 N. BROAD STREET  
PHILADELPHIA, PENNA.

# Improved FM Speaker System

By BENJAMIN OLNEY\*

**L**OUDSPEAKERS having an extended high frequency range have been available for several years, but their use in radio receivers has been retarded by factors inherent in the established AM broadcast structure. Except for occasional opportunities to reproduce locally originated programs carried to high-fidelity transmitters over suitable studio lines, the full possibilities of the wide-range speaker could not be realized generally. Frequency modulation, however, has now removed the audio band-width limitation and, in addition, offers two other advantages which further make feasible the employment of a wide range loudspeaker; low noise level and low distortion. It is the purpose of this article to describe a loudspeaker system capable of doing justice to FM transmissions.

## TWO-WAY OR DUAL SYSTEM

It is an unfortunate fact that the requirements of a loudspeaker for most efficiently reproducing the high frequency range are opposed to those of an efficient low-frequency speaker. The low-frequency unit requires a comparatively large diaphragm or else one of moderate size coupled to some auxiliary device for increasing its effectiveness at low frequencies, and the entire moving system must be sufficiently sturdy to withstand the large forces and amplitudes associated with the reproduction of low-frequency sounds. The result is a comparatively massive diaphragm and driving coil system. On the other hand, a light coil and cone system is essential for efficient high-frequency reproduction, while the amplitudes and forces encountered are comparatively small. It follows that single wide-range speakers embody design compromises varying in severity with the width of the frequency band it is attempted to cover. The system described here employs separate high- and low-frequency speakers, each specially designed for the range it is to cover. The electrical input is fed through a network which divides the energy at 1,500 cycles.

\*Stromberg-Carlson Tel. Mfg. Co.

## LOW-FREQUENCY SPEAKER

The low-frequency unit has a molded fiber cone, 8 inches in diameter, which is relatively shallow and whose periphery is supported by soft, carpinchoe leather. This construction provides a relatively uniform acoustic response up to 1,500 cycles, beyond which it falls off. It is difficult to obtain uniform response much above this frequency from a single cone which meets the low-frequency requirements.

The provision of adequate low-frequency response without objectionable resonances in a radio cabinet of moderate size is a difficult matter. The open-backed cabinet of usual dimensions fails as a baffle for very low frequencies because of the relatively short circulation path between the two sides of the cone, and has the further disadvantage of a pronounced air resonance in the box-like cavity behind the loudspeaker. This results in "boomy" reproduction. The speaker under discussion employs an acoustical labyrinth to overcome these difficulties. As the labyrinth has been described several times already in acoustical literature, its action will be but briefly touched upon here.

It consists of a folded, sound-absorbent duct, coupled to the back of the speaker diaphragm and discharging usually through the floor of the cabinet. It eliminates the troublesome cavity resonance by abolishing the cavity from the acoustical system, while the low-frequency response is extended by sound radiated from the open end of the duct in phase with that from the front of the cone.

In addition, a high acoustic resistance is presented to the cone near the low-frequency cut-off, which reduces overshooting and "hang-over" vibrations.

## HIGH-FREQUENCY SPEAKER

The high-frequency speaker has a molded fiber cone only 2½ inches in diameter, terminated in a carpinchoe leather edge support and driven by a small, light coil. The small size of the cone was dictated by two considerations. First, smoother response at high frequencies can be obtained with a

small cone, particularly when a vibration-absorbing edge support is used. Second, more uniform special distribution of the high frequencies is obtained, as wide angular coverage is secured when the diameter of the cone becomes small compared with the wave length of the sound being radiated.

A disadvantage of such a small cone is that its radiation resistance falls off rapidly below about 2,500 cycles per second, even in an infinite baffle. This phenomenon also is connected with the ratio of the diaphragm diameter to the wave length of sound. As the acoustic power generated is equal to the radiation resistance times the diaphragm velocity squared, it is evident that compensation for the decreasing radiation efficiency may be obtained by suitably increasing the diaphragm velocity as the frequency becomes lower. This is done in the present instance by employing the air con-

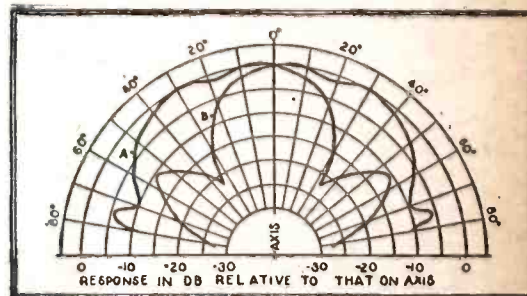

Fig. 2. Directional effects compared between (A) 2½-in. high-frequency unit of concentric speaker, (B) 8 in. cone speaker. Measurements were made at 6,000 cycles.

finned between the back of the high-frequency cone and a closed housing as the principal elastic element of a resonant system whose mass element is the diaphragm and driving coil combination. The resonance is broad, due to mechanical and acoustic resistance in the system, and results in the maintenance of essentially uniform response down to 1,500 cycles. A further advantage of the closed back construction lies in the distributed stiffness of the confined air which serves to protect the high-frequency cone from possible damage due to acoustic driving at low frequencies by the large diaphragm, closely adjacent.

## COAXIAL MOUNTING OF SPEAKERS

A feature of this system is the mounting of the high-frequency unit and partially within the hollow of its cone. This arrangement was adopted after much experimenting with speakers arranged in the usual side by side relation, and was found to be essential for most natural reproduction, especially of speech, percussion instruments and other sounds rich in transients. The inferior results obtained with the side-by-side speakers appear to be connected with the ability of hearing sense to distinguish between laterally spaced sound sources, even when they are closely adjacent. In the case of speech, one is accustomed to the sound coming from a single, small source, and is disconcerted by a division of the high- and low-frequency components between two sources, perceptibly separated in space. The ear also can perceive changes in transient sounds due to phase differences among their components. It appears possible for phase shift to arise from the side-by-side speaker relationship, and to be

(Continued on page 759)

Fig. 1. Response Curve of the Concentric Speaker, Mounted in a Radio Cabinet.

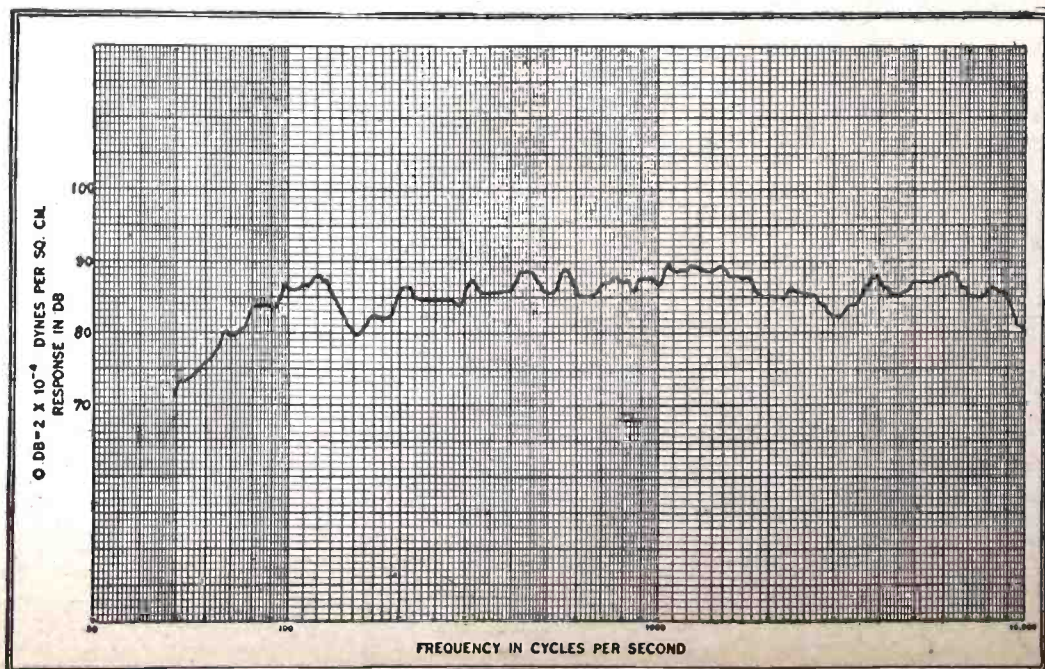



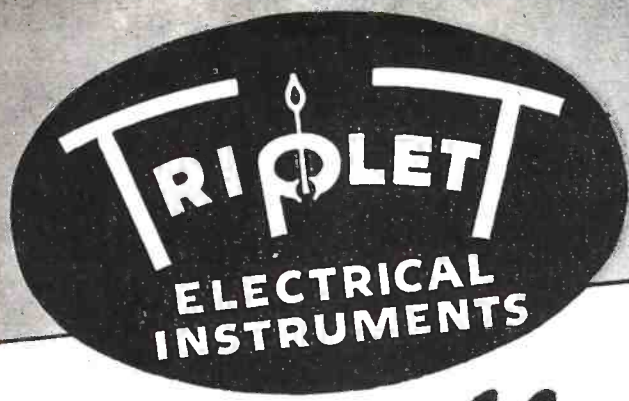

# "Portables" Speed-Up War Production Testing

Triplet Portables speed up electrical testing with the dependable accuracy that is a vital part of war production.

And whether your particular interest lies in laboratory service, production line testing, experimental work, field service, or plant maintenance, you will find your need provided for, with exacting and lasting accuracy in the expanded line of Triplet Portables.

In the drive of production-line testing, Triplet Portables supply the full-scale accuracy, the consistent performance, the hair-trigger answers that result from the Triplet method of safe-guarding quality, by making every essential part in the Triplet plant.

If you, like the writer of the letter quoted below, want to back up our armed forces with time-saving production practices, write for complete details on other Triplet Portables, panel electrical measuring and test equipment.

"With the Ohm Meter we have on order we can do in . . . seconds, what now takes a couple of hours."

Excerpt from letter of a prominent manufacturer (original in our files):

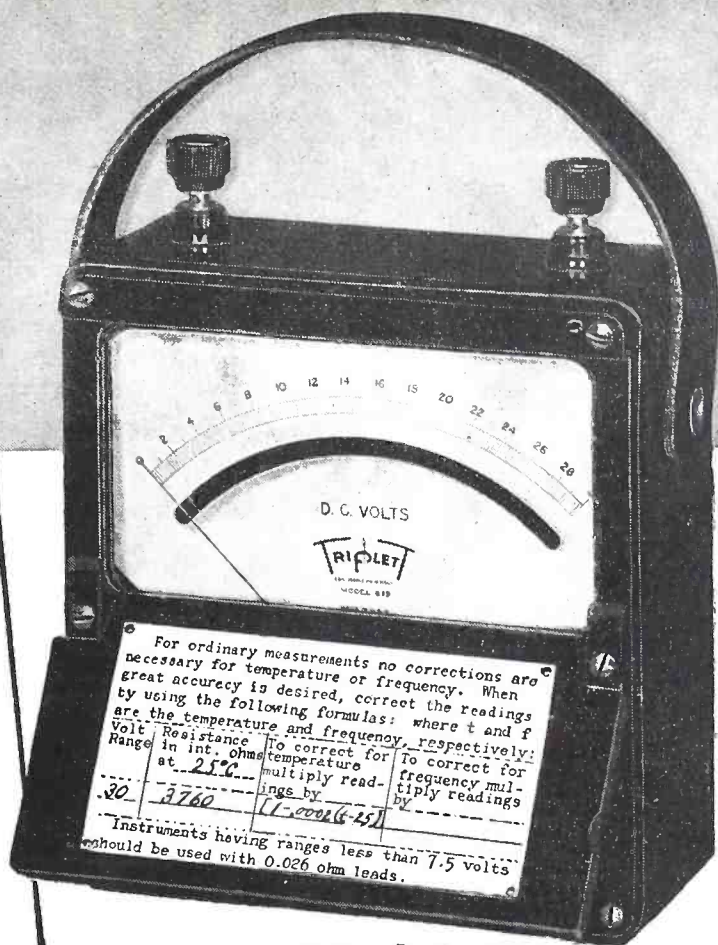

Model 625

Models 625 D.C. and 635 A.C. Portables are unequalled for today's rush in production testing or the rigid requirements of laboratory checking. These highly attractive molded case instruments have long 4.58" hand calibrated mirror scales. The hinged cover closes when instrument is not in use, for added protection. Black molded case for D.C. instruments; A.C. is red. Size is 6" x 5 1/2" x 2 1/2". Has detachable leather strap handle.

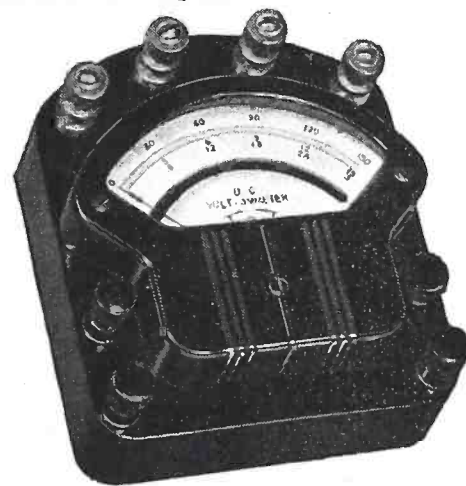

Model 425

Another new Portable combining attractive symmetrical case proportions, a long readable scale, and requiring a minimum of bench space when in use. A real beauty in design for those preferring something different. Case and base are molded; base size 5" x 4 3/8". Model 425 D.C. (3.12" hand calibrated mirror scale); Model 435 A.C. (2.88" hand calibrated mirror scale.)

THE TRIPLETT ELECTRICAL INSTRUMENT CO.  
BLUFFTON, OHIO

# BOOST Service Profits

LOWEST PRICES...  
FASTER DELIVERY at  
**RADOLEK**

LARGEST STOCK OF  
EVERYTHING IN RADIO

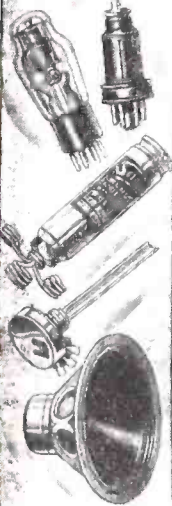

Thousands of progressive servicemen rely on Radolek for their complete requirements of repair materials. Radolek has in stock for prompt delivery replacement parts to repair any radio—every type of tube, transformer, speaker, condenser, volume control, resistor, auto radio accessory, etc. Everything you need at lowest prices. You get what you want when you want it—Radolek understands service problems—gets your order to you in double-quick time. Buying from Radolek means **Greater Values, Better Service and More Profits.** The big new Radolek Radio Service Guide is yours **FREE** for the asking. Send for your copy today!

## RADOLEK P. A. SYSTEMS FOR EVERY REQUIREMENT

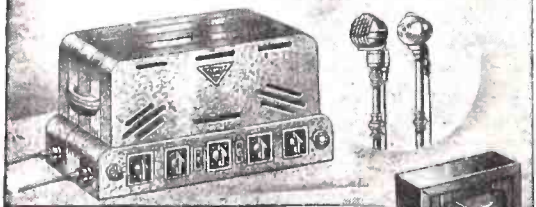

Thousands of successful Radolek P.A. installations are proof of quality, superior design and top performance. Complete systems for permanent, portable or mobile use—wide choice of microphones, speakers and related equipment. Radolek P.A. Systems give you more for your money in Performance, Styling, Dependability and Reserve Power. Select the P.A. apparatus you need from Radolek's big new **FREE** catalog.

### RADOLEK REPAIR SERVICE

Let Radolek repair your damaged or burned out transformers, coils, speakers, test equipment, etc. Many items cannot now be replaced and therefore repairing is the only alternative. Trained craftsmen, using precision tools and factory methods, assure perfect jobs equal to new. Write for prices or better still, send in any article to be repaired. It will be handled promptly.

**FREE!**

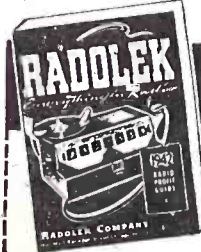

SEND FOR NEW FREE  
RADIO SERVICE GUIDE

RADOLEK CO., Dept. C-69  
601 W. Randolph St., Chicago, Ill.

Please send the Big **FREE** Radio Service Guide.

Name .....

Address .....

DEALER  SERVICEMAN  SOUND ENG

**SAVE AT RADOLEK**

# A Simple Bass and Treble Tone-Control Unit

By E. J. CONNOR

HERE is just the tone control circuit for your radio, amplifier, or record player. It is easy and inexpensive to build, uses but a single volume control and two condensers, and yet gives bass compensation at one end of the control and treble boost at the other. Thus, almost any desired frequency response may be obtained as the knob is turned from left to right. A half hour's work will add it to your radio or amplifier for a cost less than a dollar.

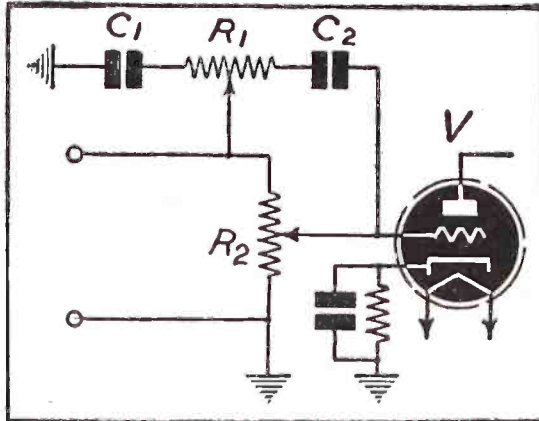

As will be seen from the diagram, the circuit is added to the regular volume control of the amplifier or radio, provided, of course, the volume is controlled from the audio side, which is true of most present-day receivers. R1, C1 and C2 make up the added tone-control circuit. The constants shown were worked out for sets having 500,000-ohm volume controls. However, for sets having controls of lower resistance C2 may be increased a little to allow for the difference. If the receiver control has a higher resistance C2 may be decreased in proportion. In general, however, the circuit works out well on the audio controls found in radios today because it is self-adjusting—at one end we increase the highs, at the other end we decrease them—so some point in between these extremes will give just the tone we want. Also at some point the highs and lows will balance so that the circuit will not affect the response. By turning R1 we may control the response

of the receiver or amplifier to suit.

Radios today need such a control. AM stations are deficient in highs. This circuit allows us to compensate for this attenuation, and, in addition, to make up for the loss of highs due to side-band cutting in the IF stages. If the radio is of the high-fidelity type, moreover, with wide band-pass IFs, on some stations distortion (which is more noticeable on the highs) may be reduced by turning the tone control toward the left. Speakers over the air do not all have pleasant voices. Some are high and raspy, others deep and hard to understand. A tone circuit of this type can give almost any voice natural quality. Thus it might be called a "personality" control!

In recording, some treble boost is usually necessary because the highs do not cut as well as the lows on a record. This is especially true near the center of the record. As we approach the center in recording, we can improve quality by turning the control slowly to the right, thus giving the whole record a more natural response.

If this circuit does not give sufficient treble boost or bass compensation, or if it gives too much, a little experimenting with the capacities of C1 and C2 will suit the circuit to any requirements. The author found the values given just about right for his high-fidelity radio and amplifier. In this case it was placed across the input volume control of the phase inverter circuit. It worked out fine for Amplitude Modulation stations, Frequency Modulation and for recording and play back. Since the tone control circuit uses no inductances it has no natural response frequency of its own. The change in tone has been found to be smooth and gradual along the entire length of the control.

### Parts List

- R1—1 meg linear tone control—Yaxley Type Y 1000 MP
- R2—500,000 volume control on set. Builders may use Yaxley Type "N" audio control. (See text.)
- C1—.005 mfd. 600 V condenser—Sprague
- C2—.0005 mfd. mica condenser—Sprague
- V—First audio input tube of radio or input to phase inverter tube, such as 6SC7 or 6N7

# Phonograph Needles in Wartime

By V. DANIELS\*

ALTHOUGH phonograph needles do not seem to occupy a very important position in these hectic days, nevertheless, there are many major war aides that cannot operate without them.

We believe a primary example is the use of the needle in conjunction with foreign radio broadcasts and short-wave broadcasts. These are recorded and later transcribed for further study or decoding. In this manner, many a hidden message has been brought to light which would otherwise have not been noticed in the normal speed of the broadcast.

A second use is their alliance with detecting devices. In the case of suspected persons, the microphone is installed secretly in rooms and the conversation is recorded on a disc with special cutting needles. This disc is then filed away for case history and can

be played back for reference at any time.

Another use for phonograph needles, and one that is becoming very popular, is their use in the USO and army camps. A small cardboard disc is used on which a soldier records his message and sends it to his family or sweetheart. In this instance, it is especially important to have a good playback needle. Transcription needles are recommended for playing these back as they will not tear the groove and they will prolong the life of the disc, enabling the hearer to play a record many times instead of just once or twice as is the case when ordinary needles are used.

Still another example of their usefulness, is their application as compass points. While this application requires certain deviation from the standardized shape and size of ordinary phonograph needles, the principle

(Continued on page 761)

\*Duo-tone Company

# THE CATHODE FOLLOWER

By J. H. HARGREAVES

CONSIDER a simple resistance loaded amplifier employing cathode biasing in the usual way (Fig. 1A). The input can be taken to be a sine wave. The current flowing through the cathode resistance will have a D.C. and an A.C. component. The condenser will offer a low impedance path to the A.C. component and so the voltage developed across the resistance will be D.C. and will be equal to the product of plate current and bias resistance. This makes the cathode positive, and as the grid is assumed to be at ground potential; it is negative with respect to the cathode.

Consider next the effect of removing the condenser (Fig. 1B). The voltage developed across the resistance will now have a signal frequency component, and instead of the grid possessing a steady bias, it will be varied at signal frequency. This will reduce the effective signal input, for when the input is such that the grid is being driven towards positive, the plate current will increase, as will the bias, thus making the grid more negative. The effect of the signal will thereby be reduced and the circuit is now a negative feedback or degenerative amplifier.

If the plate load is removed (Fig. 1C) a cathode follower results.

A cathode-follower circuit is one in which the load is common to both plate and grid circuits. The problem of the cathode follower is complicated by the fact that the change in grid volts is not caused by the signal alone but is due partly to the signal and partly to the signal-frequency component developed across the bias resistance.

Building up the cathode follower: (A) Resistance loaded and (B) negative feedback amplifiers. (C) Cathode follower.

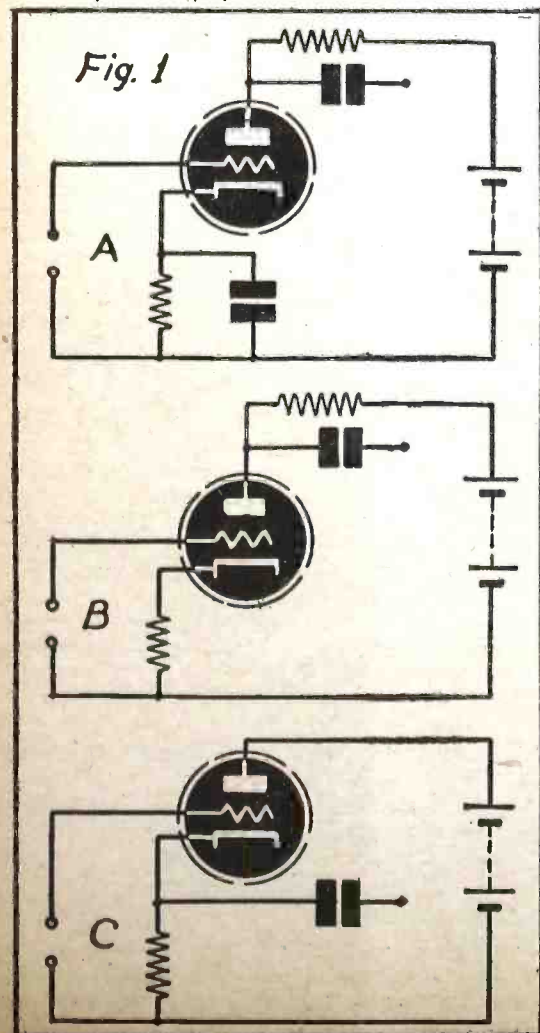

If this resistance is selected to give the correct output voltage and is made to agree with other signal-frequency requirements, a D.-C. component will generally be developed across the bias resistance of a value different from that which is required for correct bias conditions. Hence a battery or other suitable system will be needed to correct this voltage. This additional bias may be either positive or negative.

From the above reasoning it can be seen we have effectively two signal-frequency sources, one in the input circuit and the other in the voltage developed across the resistance. For convenience, these two sources can be regarded as generators. To envisage the operation of the "cathode generator," the other "generator" will be omitted for the time being, remembering that variation of the plate current can still be obtained by varying the plate voltage. (See Fig. 2.)

Consider changes only in this simplified circuit. Let the plate current  $I_a$  change by  $dI_a$ . This will result in the cathode generator producing a voltage of  $dV_k$ . The cathode will, as a consequence, rise in potential and, because the grid is at ground potential in so far as A.-C. is concerned, the cathode will be moving away from the grid in potential and the grid-cathode potential difference will be increased by  $dV_k$ ,  $dV_g = dV_k$ .

The plate is also at ground potential to A.-C. and so  $dV_a = dV_k$ . When the grid-cathode potential changes by  $dV_k$ , the resultant changes in  $I_a$  and  $V_a$  are related to  $V_g$  as follows:

$dI_a = gm dV_g + ga dV_a = (gm + ga) dV_k$  where  $gm$  is the mutual conductance and  $ga$  the plate conductance, or the reciprocal of the plate resistance.

Since  $dI_a$  is the A.-C. component of the current in the cathode load, the effective impedance of the "cathode generator" is

$$\frac{dV_k}{dI_a} = \frac{1}{gm + ga} \text{ or } Z_k = \frac{1}{\frac{\mu}{R_a} + \frac{1}{R_a}} = \frac{R_a}{\mu + 1}$$

where  $\mu$  is the amplification factor and  $R_a$  the plate impedance.

$Z_k$  is generally small, but the actual output impedance of the cathode follower is  $Z_k$  in parallel with the resistance. However, the resistance is usually so high compared with  $Z_k$  that for most practical purposes  $Z_k$  can be taken to be the output impedance.

The input impedance is very high and it can be shown that where  $C_{ga}$  is the grid to plate capacity and  $C_{ge}$  is the input capacity:

$$Z_{\text{input}} = C_{ga} + \frac{C_{ge}}{\mu}$$

To obtain mathematically the voltage amplification factor would entail delving into simple equivalent circuits and to avoid this it is proposed to give the equation:

$$\text{Voltage Amplification Factor} = \frac{\mu R}{R_a + R} \quad (1)$$

This will obviously be less than unity and although the cathode follower can not amplify, it is very useful having the following advantages:

(1) Low output impedance resulting in less susceptibility to changes in plate poten-

tial, self-impedance and the effects of capacity shunted across the load.

(2) High input impedance—a great advantage at U.H.F.

(3) A reduction in distortion. The output is in phase with the input and since the voltage amplification factor is nearly unity, the cathode and grid potentials are nearly the same, hence the name Cathode Follower.

Assume the following problem requires solution. Having been given the static characteristic curve of the tube by the makers

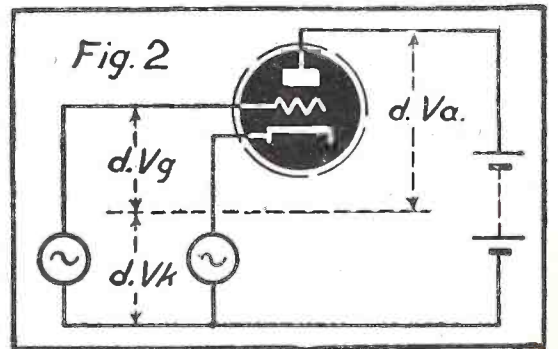

Input sources visualized as "generators."

and using a cathode load resistance of 2,000-ohms and a plate supply of 300 volts, find:—

- (1) The maximum permissible input signal amplitude, assuming the tube may swing from 0 volts bias to cut-off.
- (2) The value of additional bias required to give correct working.
- (3) The output voltage.
- (4) The voltage amplification factor.
- (5) The distortion.

Referring to Fig. 3  $V_g$  is the grid-cathode potential, which consists of the input signal  $V$ , less the voltage produced by the "cathode generator"  $V_k$ . Therefore,  $V_g = V - V_k$ , but  $V_k = R_k I_a$  where  $R_k$  is the cathode load resistance.

Now let  $I_a$  increase to  $I_a + dI_a$  and  $V_g$  increases to  $V_g + dV_g$ .

$$\begin{aligned} V_g + dV_g &= V - R_k (I_a + dI_a) \\ \text{subtract } V_g &= V - R_k I_a \\ \text{then } dV_g &= -R_k dI_a \\ dI_a &= \frac{-dV_g}{R_k} \end{aligned}$$

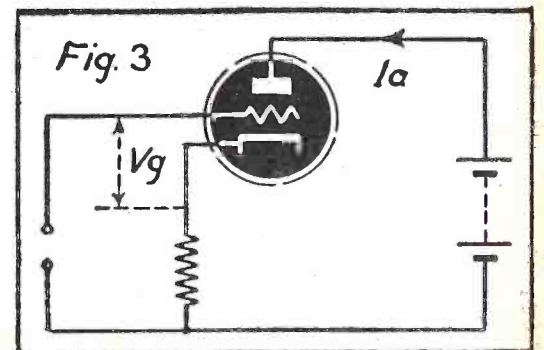

Circuit discussed in the text.

Consider now the typical  $I_a/V_a$  curves shown in Fig. 4. Suppose  $V$  remains fixed and  $R_k$  is shorted. Changing  $V_a$  would simply result in the tube working up and down the relevant static curve. That is to say, if the plate is increased, a point selected at A would move to B. With  $R_k$  in circuit any change in  $I_a$  would produce a change in the effective bias. Thus an increase in  $I_a$ , instead of moving the point from A to B, (Continued on page 752)

# STANDARDS OF MEASUREMENT

By WILLARD MOODY

If you go back and try to find out what an ampere, volt or ohm really is, you will find that electrical and mechanical units of energy, or *work*, are defined in terms of the fundamental quantities, distance, mass and time. Work will be done by the moving of a mass in a unit of time. A gram moved a distance of one centimeter in one second is a definite amount of work done, equal to the basic unit of work, the erg. This represents the centimeter-gram-second system of measurement, abbreviated c.g.s.

Time is determined by astronomical observations. The sidereal day is reckoned by the interval of time between successive meridian passages of the same star. This is the time required for earth rotation of one cycle. The *solar day* is reckoned by the motion of the sun. When the sun is on the meridian, it is said to be solar or apparent noon. The interval of time between two successive noons represents the solar day. The average length of the solar day over a period of one year is the mean solar day. The second will be 1/86,400th part of this day.

The centimeter is 1/100th part of the meter. In 1799 a platinum bar was constructed by Borda for the French Government which had a length of 1 meter, the meter being taken as 1/10,000,000th part of the meridian line from equator to the pole. It is now known that this distance is 10,000,856 meters, but the original bar serves as the standard.

The gram, unit of mass, is 1/1,000th part

of the kilogram. The gram is equal to the mass of a cubic centimeter of pure water at 4 degrees Centigrade. The standard kilogram is a bar of platinum kept at Paris and is the real standard on which all metric weights are based. The unit of mass in engineering is the pound, which is equal to 453.59 grams.

The gram has been defined in terms of the centimeter, gram and second. The centimeter and second have been explained in detail. The remaining factor is the 4 degrees Centigrade specification. Melting ice will represent 0 degrees on the Centigrade scale, and the temperature at which water boils under standard atmospheric pressure will be 100 degrees on the Centigrade scale. Now, what is standard atmospheric pressure? It is the pressure of *one atmosphere*, derived from a column of mercury 76 centimeters high at zero degrees Centigrade. In sound measurements, of radio engineering, the *bar* is occasionally used. A bar is 1/1,000,000th part of the pressure corresponding to 75 cm. of mercury at zero degrees Centigrade.

Now we come to the unit of *force*. The Greek word for force is *dyne*. A force of one dyne acting on a mass of one gram will change the mass velocity by one centimeter per second. In other words, the force required to move 1 gram a distance of 1 cm. in 1 second is 1 dyne. The work that is done and the energy used up or expended is 1 erg.

In magnetism, a unit pole is one which if placed 1 cm. from an equal pole in vacuum will repel it with a force of 1 dyne. The relation, stated mathematically, is

$$F = \frac{m m'}{r^2}$$

where  $m$  is the magnetic strength of the first pole and  $m'$  is the magnetic strength of the second pole. The factor  $r_p$  is the distance between poles in centimeters. The strength of the magnetic field at any point is the force in dynes on a unit magnetic pole placed at that point. When a pole of strength  $m$  is placed at a point where the field intensity is  $H$ , the pole is acted on by a force  $Hm$  dynes. In any field of force, the two poles of a magnetic needle are urged in opposite directions. The direction in which the north pole tends to move is known as the positive direction of the line of force at that point.

In electrostatics, *unit charge* or unit quantity of electricity is defined as that quantity which when placed 1 cm. from an equal charge in vacuum repels it with a force of 1 dyne. Stated mathematically,

$$F = \frac{q q'}{r^2}$$

where  $q$  is the first electrostatic unit and  $q'$  is the second electrostatic unit. The factor  $r$  is the distance between the charges, measured in centimeters.

In electromagnetics, unit current is that current flowing in a circular coil of 1 centimeter (cm.) radius which will act on a magnetic pole at its center with a force of 1 dyne for every centimeter of wire in the coil.

The practical unit of electricity is the Ampere, named in honor of the French physicist who investigated current. The quantity of charge transmitted by 1 ampere in 1 second is called a coulomb. One coulomb is equal to 3,000,000,000 units of electrostatic charge, as defined previous to the definition of electromagnetic charge.

In electromagnetics, 1 volt potential difference exists between two points when unit current is moved between the two points by

energy equal to 1 erg. The volt is 100,000,000 electromagnetic units of potential. The practical unit of resistance is equal to 1 volt divided by 1 ampere.

Electromagnetic field strength is measured by force per unit pole and is a vector quantity having both magnitude and direction. The magnetic field is indicated by drawing as many lines of force per sq. cm. as the field has units of intensity. The magnetic flux is equal to the magnetomotive force divided by the reluctance. If in a magnetic circuit there are 1,000 lines of flux, there are 1,000 maxwells. The Maxwell was named in honor of Clerk Maxwell, English physicist. In a moving conductor which has induced in it 1 electromagnetic unit of potential, the flux cut per second is 1 maxwell. The unit of induction is the Gauss and is equal to Maxwells/cm.<sup>2</sup> In other words, in a magnetic field having 1 line per square centimeter, or 1 maxwell per cm.<sup>2</sup>, there is 1 gauss or unit induction.

Magnetic intensity induction or flux density  $B$  is measured in lines of magnetic induction per square centimeter (gauss). If the substance in which the field exists is non-magnetic,  $B$  is the equal of  $H$  and the ratio  $B/H$  or permeability is  $\mu = 1$ . When the substance through which the field passes is magnetic (say iron core placed inside of an air core solenoid)  $B$  becomes much greater than  $H$ , in a relationship which seldom is linear and must be determined experimentally for a given material. The number of flux lines of force will be equal to magnetomotive force  $F$

$$\text{flux } \phi = \frac{\text{magnetomotive force } F}{\text{reluctance of core } R}$$

The reluctance of an iron ring may be calculated:

$$R = \frac{l}{\mu A}$$

where  $l$  is the length of the ring  $A$  the cross sectional area and  $\mu$  the permeability constant of the iron.

The French physicist Arago, in 1820, demonstrated electromagnetism. The attraction of the armature to the magnet poles, expressed in dynes, is:

$$\frac{B^2 A}{8\pi} \text{ (pull per sq. cm. of pole area)}$$

The energy of a magnetic field is

$$w = \frac{B^2}{8\pi} \text{ ergs}$$

The intensity of a magnetic field  $H$  at a point is equal to the magnetic potential gradient at that point. The *average* intensity of field between two points may be considered the average fall of magnetic potential all along the path and is expressed in oersteds or gilberts/cm.<sup>2</sup>. In a long straight solenoid with length 25 times the diameter.

$$H = \frac{4\pi N I}{10 l} \text{ or } \frac{1.257 N I}{l}$$

where  $H$  = oersteds, field intensity (vicinity of center)

$l$  = centimeters, coil winding length

$N$  = number of turns in coil

$I$  = current, amperes

A Helmholtz coil may be used for determining field intensity in a certain plane, as illustrated in Fig. 1.

The magnetic *force* of the solenoid, at any point inside of it, is for Fig. 1 expressed by the relation:

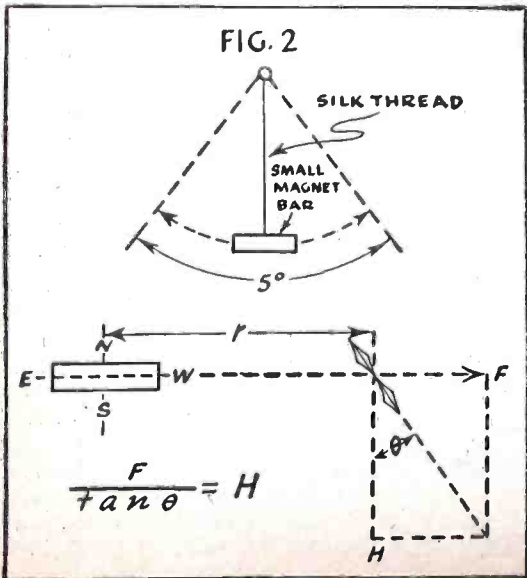
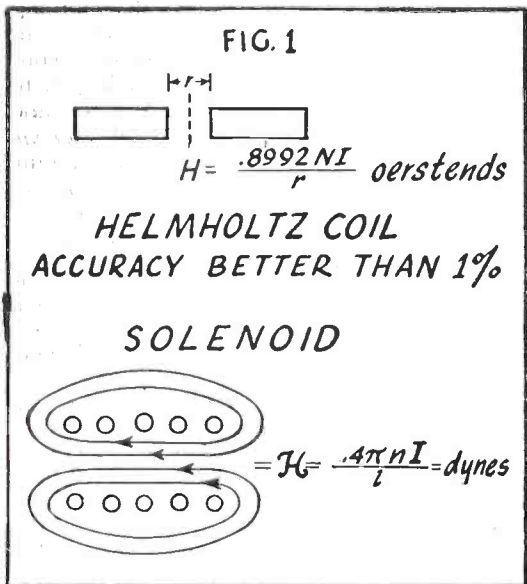

$$H = \frac{0.4 \pi N I}{l} \text{ dynes}$$

The intensity of the horizontal component of the earth's magnetic force may be measured by the following method due to Gauss. A small steel bar magnet is suspended horizontally by a fine silk thread in a closed box which protects it from air currents. It is then set to oscillate through a 5 degree arc or swing and the period of oscillation is carefully determined by using a stop watch. This period depends on  $M$ , the magnetic moment of the magnet and on  $H$  the horizontal component of the earth's magnetic force. This is expressed by the relation,

$$H M = \frac{4 \pi^2 k}{T^2}$$

where  $k$  = is the moment of inertia of the magnet, which depends upon the size, mass and shape.

To determine the relation of  $H$  and  $M$ , a second procedure is necessary. Suppose that (in Fig. 2)  $P$  is the point where the magnetic intensity  $H$  is to be determined. A short magnetic needle is placed at  $P$ , while the magnet bar is placed exactly east or west of  $P$ , and with its axis on the east-west line. If  $r$  is the distance from the center of the bar to  $P$ , the force at  $P$  due to the bar is,

$$F = \frac{2 M}{r^3} \text{ dynes}$$

Then at  $P$  the force due to earth and the force due to the magnet bar are represented vectorially. The tangent of the angle will be  $F/H$  or  $2M/r^3H$  and  $H/M$  then equals  $2/r^3 \tan \theta$ .  $M$  may also be determined by the Helmholtz coil. But, since  $F/\tan \theta = H$ , knowing the product of  $H$  and  $M$ , the quantity  $H$  can be divided into that product to get  $M$ . The Helmholtz coil or the magnetic needle and bar methods are used for determining  $H$ . The moment of inertia  $k$  is given by:

$$\frac{M l^2}{3}$$

where  $M$  is the mass in grams and  $l$  the length in centimeters of the magnet bar.

The tangent galvanometer shown in Fig. 3 can be used for determining absolute electromagnetic unit current. The coil is large compared with the magnet needle, so that the poles of the needle are considered as being at the center of the coil. The cross section of the coil must be of large enough mean radius so that all turns bear essentially the same relation to the needle.

The pendulum may be used for the estab-

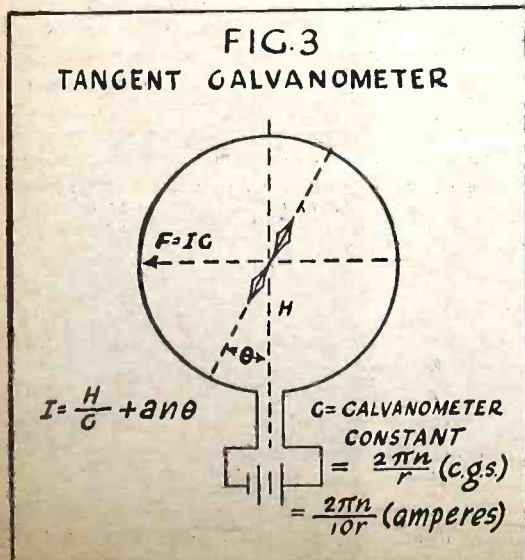

lishment of frequency. The action is shown in Fig. 4. We may assume the whole mass of the pendulum to be concentrated at  $B$ , the mass of the silk cord being so small as to be negligible. The forces acting on the mass  $m$  are its weight  $mg$  and the tension  $P$  of the suspending cord. The weight  $mg$  may be resolved into two components, one in line with the cord and opposing its tension and one at right angles to the cord and in the direction in which the mass  $m$  moves. The latter component  $F$ , gives the mass a motion through the arc. The force diagram is then  $BCO$ , and

$$F/mg = BC/BO$$

As  $BO = l$ , the length of the cord, and the angle through which the pendulum swings is quite small,  $BC$  is practically equal to arc  $BA$ . The arc length of  $BA$  may be represented as  $x$ . Approximately,

$$F/mg = x/l \text{ and } F = mgx/l$$

Therefore the force  $F$  persuading  $m$  along the arc toward  $A$  is proportional to the displacement  $x$  measured along the arc. This is a simple, harmonic vibration expressed by the relation of force to period of vibration in the equation,

$$F = \frac{m 4 \pi^2 x}{T^2}$$

substituting, we have:

$$g/l = \frac{4 \pi^2}{T^2}$$

$$\text{and } T = 2\pi \sqrt{\frac{l}{g}}$$

( $g$  = acceleration due to gravity)

The period of vibration is dependent only on length of the pendulum and acceleration due to gravity at the place the pendulum is swung, and is independent of its mass and length of arc if the length of arc is small (say 5 degrees). A more exact formula is:

$$T = 2\pi \sqrt{\frac{l}{g} \left( 1 + \frac{\theta^2}{16} \right)}$$

Where the arc is measured in radians, between points  $A$  and  $B$ .

The values of gravitational constant for various locations are given in the following table. The height is assumed as being at sea level.

	Pole	983.1 cm./sec. <sup>2</sup>	32.25 ft./sec. <sup>2</sup>
London	981.2	32.19	
Paris	980.9	32.18	
New York	980.2	32.16	
Washington	980.0	32.15	
Equator	978.1	32.09	

An approximate formula due to Clairaut gives the gravitational constant at  $n$  latitude and  $h$  height above sea level.

$$g = 980.6056 - 2.5028 \cos 2n - 0.000003h$$

The force urging downward a freely falling  $m$  is shown by the equation,

$$F = m g$$

where  $F$  is force in dynes,  $m$  mass in grams and  $g$  the gravitational constant in centimeters/sec.<sup>2</sup>. The force unit in poundals, weight of 1 pound falling, is 32.16 poundals at New York latitude. The standard force of a pound may be stated as the weight of a pound mass at New York, where the acceleration due to gravity happens to be 32.16 ft./sec.<sup>2</sup>. The acceleration due to a constant force acting on a mass moving in a single direction is constant and is related as in the equation,

$$a = \frac{F}{m}$$

It should be realized that mass and weight are not identical. The unit of mass is a physical quantity of arbitrary size, chosen

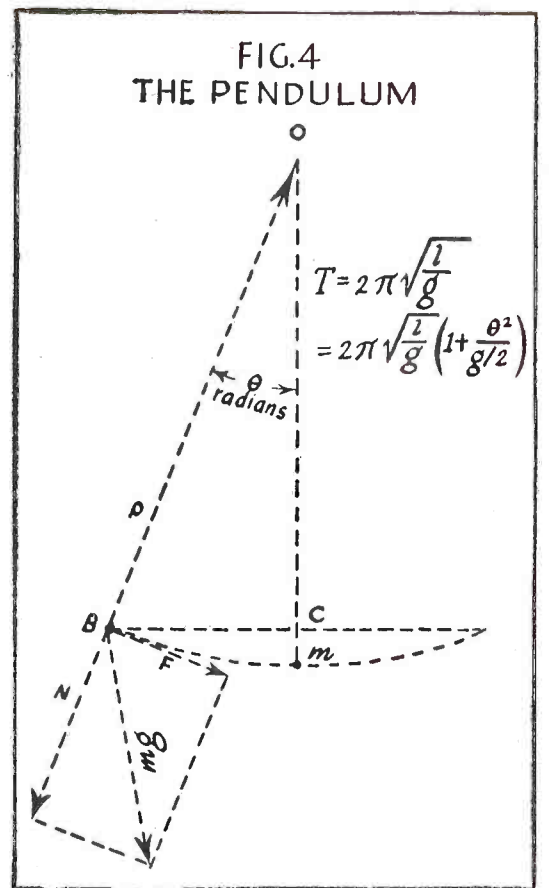

as a constant. One c.c. of water at 4 degrees Centigrade represents one gram of mass. The engineering pound is 453.59 grams. If we take a mass of one gram, raise it to a height of  $n$  centimeters above ground level, and then allow the mass to fall freely, taking the time with a stop watch for the fall to be completed, we have a means of determining the velocity constant of gravity at the point on the earth where the experiment is conducted. Speed is the ratio of unit length to time. We have miles/hour, ft./sec. and cm./sec., etc., so that if  $S = \frac{1}{2} gt^2$  and we know the speed and time, we can compute readily the gravitational constant. Conversely, knowing the gravitational constant, we may figure the speed of a falling object.

If we have a standard of mass and time, and know the height above sea level, we can determine the latitude. If we have an accurate standard of height above ground, such as a fine rule or scale graduated in inches, we can measure the time required for an object to fall a certain distance and the gravitational constant will then be,  $2s/t^2$ , where  $s$  is the speed.

LENGTH OF PENDULUM WHICH BEATS SECONDS

Latitude	Centimeters	Inches
0	99.0961	39.0141
5	99.1	39.0157
10	99.119	39.0204
15	99.1310	39.0279
20	99.1571	39.0382
25	99.1894	39.0509
30	99.2268	39.0656
35	99.2681	39.0819
40	99.3121	39.0992
45	99.3577	39.1171
50	99.4033	39.1351
55	99.4475	39.1525
60	99.4891	39.1689
65	99.5266	39.1836
70	99.5590	39.1964
75	99.5854	39.2068
80	99.6047	39.2144
85	99.6168	39.2191
90	99.6207	39.2207

# • LATEST RADIO APPARATUS •

## RADIO CHEMICALS

General Cement Mfg. Co.  
Rockford, Ill.



**A** COMPLETE "chemical laboratory" of radio cements and radio chemicals is contained in this display rack.

Twenty 2-ounce bottles are put up in a permanent stand that can be placed on your bench or hung up on the wall. The manufacturer claims that every needed chemical and cement is included in this "laboratory" for all kinds of radio repairs, speakers, coils, contacts, dials, controls, etc.

Every radio man, radio laboratory, radio engineer and radio manufacturer should find use for this arrangement of chemicals.—*Radio-Craft*

## COIL TESTING EQUIPMENT

Photobell Corporation  
116 Nassau Street, New York, N. Y.

**A** NEW line of coil testing machines is announced, for quickly checking all of the electrical properties of a coil in one handling. Tests are provided for checking the limits of insulation resistance, coil resistance, effective A-C resistance, inductance and shorted turns. Additional tests are for checking effective turns, direction of windings, and other properties. There are two types of machine, the automatic and semi-automatic. Each machine has a holder adapted to the special shapes of coils to be tested.

The photograph shows a machine of the semi-automatic type, capable of making eleven tests in quick succession on each coil, and checking up to 250 coils an hour. In using this machine, the operator attaches the coil to holder at center of panel, pushes terminal wires into spring clips and turns the large knob one step at a time. The design is such that at each step the pointer of the illuminated galvanometer must cross the center of its dial by moving from left to

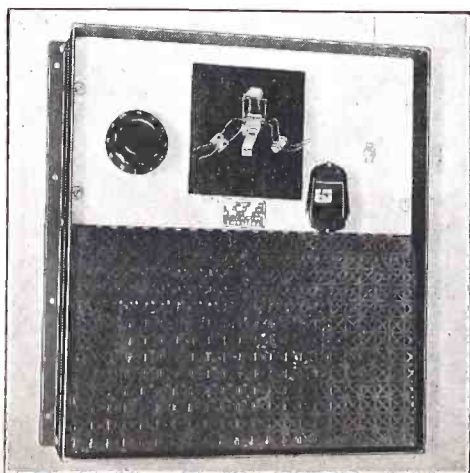

right, or from right to left. The operator watches for this movement, and if it occurs he knows that the coil has passed that test. If the pointer does not cross the center of the dial for any single test, then the nature of the defect in that coil is read directly from the lettering on the knob.

This machine is designed to check a special coil with three windings, and the holder at center of panel is designed to fit this particular coil shape. The machine checks the resistance of each winding by the "high-low bridge" method; checks the effective A-C resistance at 900 cycles; checks the direction of each winding; and finally checks the high and low limits of inductance. All of these tests are performed in a few seconds without strain or fatigue to the operator.

An automatic machine for the same purpose is in continuous use and more information on it will be available soon. This machine uses relays to supervise itself and to pass from one test to the next without attention from the operator. Up to 300 complicated coils an hour may be tested automatically for 21 possible defects. The operator merely inserts and removes coils, and notes the presence of any defect from a bank of lamps.—*Radio-Craft*

## NEW PORTABLE A-C AND D-C INSTRUMENTS

Westinghouse Electric and Manufacturing Co.  
East Pittsburgh, Pa.



**N**EW P-14 portable A-C and D-C instruments for general field-service use where an inexpensive unit is required, are announced by Westinghouse.

Modern design, accuracy, sturdiness and reliability are features of these new units. The molded cases are fully insulated and magnetically shielded from stray field influence. These instruments are available either with or without covers. The scale length is 3.2 inches A-C and 2.8 inches D-C and the units have an accuracy of plus or minus 1 per cent of full scale. The instruments are equipped with a mirrored dial and a knife-edge pointer which aid in making accurate readings.

The P-14 embodies a variety of single and multiple ranges providing for the measurement of A-C volts, amperes and milliamperes; D-C volts, amperes, milliamperes and microamperes. Ranges and combinations of ranges have been carefully chosen to meet every need of test men, laboratory

technicians and research engineers. Combinations such as four current and three voltage ranges make this a complete and flexible instrument.—*Radio-Craft*

## NEW THIN SLOT INSULATIONS

Irvington Varnish & Insulator Co.  
Irvington, N. J.

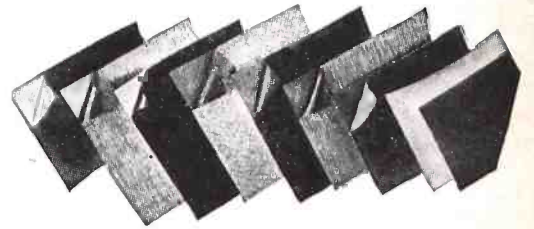

**N**EW thin types of IRV-O-SLOT provide non-bulking slot insulation for use in confined or limited space.

These materials plus straight-cut and bias-cut Varnished Cambric in heavier combinations provide for every slot requirement.

IRV-O-SLOT insulation consists of Fish or Spauldo papers coated with resin, or bonded by means of a plastic insulator, to cambric, silk or Fiberglas. These insulations possess ample strength and toughness as protection against mechanical stresses. They have high dielectric strength. The duplexed IRV-O-SLOT and Spauldo paper have exceptional heat resistance. The bonded insulations have high moisture resistance. All IRV-O-SLOT insulation is flexible and easy to form. This simplifies and speeds application. It is available in sheets and also tape form ready to be cut into slot strips.—*Radio-Craft*

## INSULATION AND BREAK-DOWN TESTER

Superior Instruments Co.  
227 Fulton St., New York, N. Y.

**T**HE new Model 520 Insulator and Break-down Tester is a sensitive danger-indicator which automatically glows to indicate leakages up to 1,000 megohms (1,000,000,000 ohms). The instrument supplies four voltages: 250 volts, 500 volts, 1,000 volts and 2,500 volts. It also shows up "shorts" and "opens".

The device requires no handcranking, no batteries to replace, no computations to make and no adjustments. To use, simply connect the two test leads to the circuit, appliance or motor to be tested, then throw the switch. The Danger Indicator will instantly glow to indicate defective insulation, or insulation which, because of excessive leakage, indicates a potential or imminent breakdown.—*Radio-Craft*



**NEW DUNCO A-C RELAY**

Struthers Dunn, Inc.  
Juniper and Cherry Sts., Philadelphia, Pa.

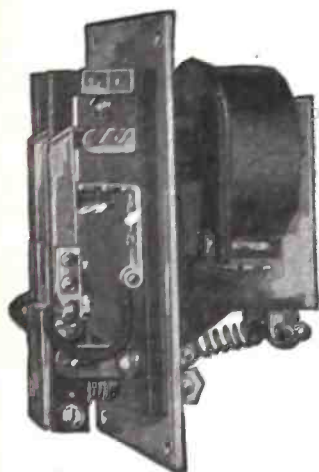

**D**ESIGNED to handle circuits carrying milliamperes at microvolts in radio applications, the new laminated-frame Dunco Relay, type CX3318, has double pole, double throw contacts, located on one side of a shielding member, and an A-C operating coil, located on the other side. It is intended for installation in a window opening in a shielded compartment so that the contacts are within the shield, and the operating coil outside of the shield.

The resistance of the contact circuit is extremely low and absolutely uniform, even under conditions of extreme shock and vibration. The contacts are not intended to handle any appreciable amount of power;

they are intended primarily for handling Class A grid circuits, and AVC circuits, and they have been found useful in handling the output of thermocouples. Tests indicate it is the only relay whose contacts may successfully be inserted between a low-level microphone and its pre-amplifier without introducing microphonics.

Each moving contact consists of 6 silver springs that wipe over silver fixed contacts. Three different lengths of springs are assembled together to avoid the critical vibration frequency that any one length of spring might have. A group of 3 springs bears on each side of the fixed contacts, so that any shock tending to reduce contact pressure on one side will tend to increase it on the other. The device is designed to give a useful life of many millions of operations.

—Radio-Craft

**AIR-RAID ALARM**

National Union Radio Corp.  
57 State St., Newark, N. J.

**N**ATIONAL UNION announces its new AR-101 Air-Raid Alarm available through its distributors. Designed to work on any A.V.C. type of radio set, table model or console, AC-DC or battery operated, the Alarm is set off by your local "alert" broadcasting station which is on the air 24 hours a day. When the radio station goes off the air at the first indication of an air-raid, the National Union Alarm automatically goes on, creating a loud, penetrating signal in your radio which will automatically warn you that an air-raid "alert" alarm has been ordered.

This unit is complete in a compact metal case, ready for immediate installation and operation.

—Radio-Craft

**NEW R.C.P. INSTRUMENTS FOR WARTIME NEEDS**

Radio City Products Co., Inc.  
127 West 26th St., N. Y. C.

**N**EW RCP instruments for laboratory and production use are described in the latest Radio City Products bulletin No. 126, prepared for America's wartime industry.

One of the new RCP models is the Electronic Limit Bridge (shown here) for precision resistance testing; another is a versatile multitester for quick and accurate production line tests.

It is believed that research, development and production engineers will recognize features they have long been seeking. The new industrial line, designed for speed, accuracy and long service, achieves economies through the elimination of useless frills and gadgets. Each instrument is equipped to do its specific job faster and better.

A copy of catalogue will be sent on request. Inquiries should be addressed to the Engineering Department of Radio City Products Co., Inc.—Radio-Craft



**NOW WESTON  
MODEL 785  
INDUSTRIAL CIRCUIT TESTER**

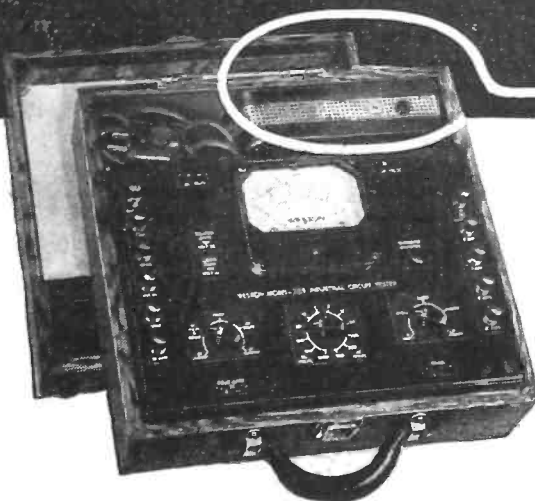

**Also tests**

**Insulation Resistance Values!**

**A**LREADY recognized throughout industry as the most complete tool for maintenance test needs, the utility of the Model 785 is now further increased to include insulation and cable covering resistance testing.

Thus this one instrument now serves for checking motor and control circuits . . . lighting circuits . . . sensitive relay circuits . . . communications and electronic circuits . . . and insulation resistance as well. The broad range coverage of Model 785 is as follows:

**DC VOLTAGE . . .** 0-1/10/50/200/500/1000 volts—20,000 ohms per volt. (\*5000 volt range with external multiplier).

**AC VOLTAGE . . .** 0-5/15/30/150/300/750 volts—1000 ohms per volt.

**DC CURRENT . . .** 0-50 microamperes, 1/10/100 milliamperes, 1 ampere and 10 amperes (\*ranges above 10 amperes with external shunts).

**AC CURRENT . . .** self-contained ranges 0-.5/1/5/10 amperes (\*higher ranges with an external current transformer).

**RESISTANCE . . .** 0-3000, 0-30,000, 0-300,000 ohms, 0-3 megohms, 0 to 30 megohms (self-contained batteries). 0-900 megohms (\*with compact Model 792 Resistance Tester).

\*Extra equipment on special order.

In addition to *wide adaptability* which enables today's busy plants to cut corners and costs in maintenance and other test work, Model 785 also provides the *years of measurement dependability* so typically WESTON. Weston Electrical Instrument Corporation, 599 Frelinghuysen Avenue, Newark, N. J.

**WESTON**  
*Instruments*

# A JUNK-BOX C-BIAS SUPPLY

By C. W. McCOMAS

IN perusing a rather old copy of RADIO-CRAFT I noticed an article that interested me very much. The article appeared in the March, 1941, issue, page 555, entitled "Independent Power Supplies," by Joel Julie.

His diagrams of a fixed "C" bias supply were interesting. The one in figure 3 showed a C bias supply without extra winding or tap on the power transformer, which might be a welcome addition to any P.A. amplifier not being thus equipped.

However, if I am not mistaken he makes one omission there that might and probably would interfere with the operation of the C bias supply. In his article he puts an arbitrary value of 240 ohms on one resistor (R2 in diagram) and it appears to me

of the amplifier tubes, excluding the power tubes—in place of his resistor No. 1. The extra rectifier tube could then well be any triode tube having a heater type cathode—there being no appreciable amount of current drawn from same. An old audio transformer winding could be used as a filter choke in the usual manner with suitable condensers. This might then be followed by potentiometer of say 25,000 ohms resistance—the other end hooked to the negative tap on the regular rectifier transformer. The middle tap of the Pot. could then be utilized as a variable bias tap for the grid return of the power tubes. In addition to the adjustable bias feature there would be the possibility of using any heater type tube of the right filament requirements

exists here also. This C bias supply can be found in any junk box and put together in an hour's time. The one I used incorporated half-wave rectification. But in these days of phase inversion any junk box probably contains several Input Push-Pull audio transformers that are not working. If the full-wave rectification type is used it will be necessary to use either a twin diode or twin triode type of tube—but who among us doesn't have several that will still "light up"? Resistor No. 1 may not be necessary. If the ratio of step-up in your transformer isn't too high it won't be. In some of the older transformers, however, a step-up ratio of five to one was not unusual. If such a transformer was used and the C bias tap advanced the whole way at once, either the condenser or tube would blow and other dire calamities ensue. However, once the C bias is adjusted it is left alone. This should be done with either the V.T.V.M. or with the milliammeter in series with one of the power tube cathodes.

No particular skill is required in making this C bias supply. Almost any audio transformer winding, either primary or secondary, will suffice for the filter choke. The condensers should be at least 2 Mfd. each—and let your conscience be your guide as to how they are rated. If resistor No. 1 has enough resistance then a low rated condenser—say 100 volts could be used.

One source of danger in using this or Mr. Julie's C bias supply might arise if filament type power tubes were used such as the 2A3, etc. Heating up faster than the heater of the Bias Rectifier would leave such power tubes almost unbiased for a few seconds. Any power amplifier of respectable size should have a means of heating the filaments before the plate supply is applied. A separate switch on the master-volume control for the Plate supply (negative leg) will save its cost in condensers many times.

If there is anything of worth in this circuit you are at liberty to use it. No charges at all and, unlike Mr. Julie, I reserve no rights to commercial application.

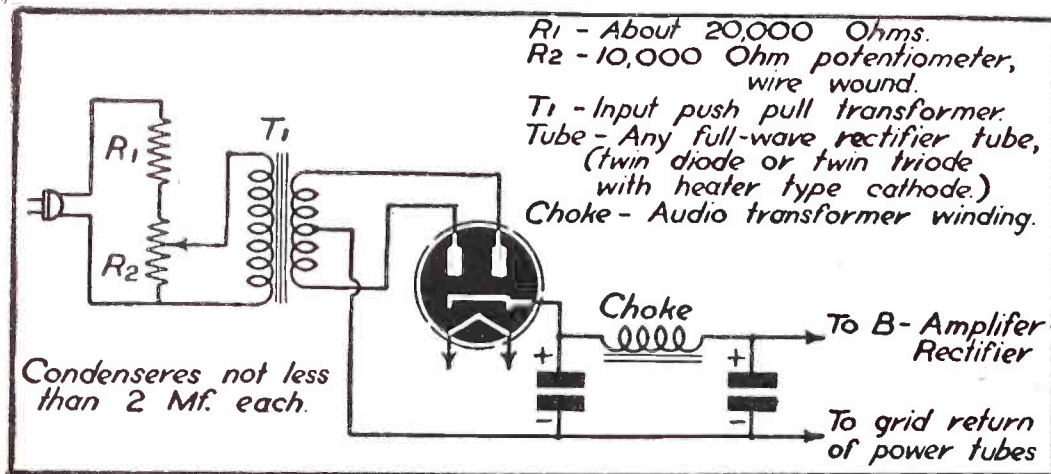

that value might be all right if the resistor was not used as it is—in a voltage divider circuit of which it is one part and the field coil of the speaker is the other part. In other words it depends on the resistance of the field coil, as no part of the plate supply from the power tubes flows through this resistor.

In my opinion a better idea would be for the field coil if you must use one (P.M. speakers being the most popular) should be used to help filter the regular plate supply

for the C bias rectifier.

All of which brings to mind a similar C bias circuit which I used some years ago. I don't claim any credit for it. It has been published before in one form or another and I am sure that it will work. In my opinion it has an attractive feature that Mr. Julie's hookup doesn't contain—the entire circuit is isolated from the A.C. line. Am sending a sketch of circuit—as I remember it.

You will notice that the variable feature

## INTERMEDIATE-FREQUENCY COMMUNICATION

By FRANKLIN WILLIAMS, W6LUE

MANY weird radio tricks can be performed by means of *intermediate-frequency communication*. The I.F. frequency of one receiver is run through the power lines into the first I.F. amplifier of another receiver so that when the first receiver is tuned, the different stations come out of the second receiver. The receivers

may be as far apart as several blocks.

Put a .01-mf. 600 volt condenser from the plate of the last I.F. amplifier to one side of the line. In the other receiver put a .01-mf. 600 volt condenser from one side of the line to the grid of the first I.F. amplifier. All tubes after the last I.F. amplifier are removed in the first receiver and all

before the first I.F. amplifier in the second receiver. The A.V.C. must be disconnected in the second receiver or there will be a loud hum from the line. If this arrangement does not work right away, try reversing the wall plugs.

By means of a phono-oscillator operating on a broadcast frequency, voice communication over distances of up to three blocks can be carried on. Be careful that the line does not actually radiate the I.F. frequency, since this would be illegal.

For a signal at 465 Kc. (a typical I.F. frequency) there should not be a signal of greater than 15 microvolts at a distance of about 100 yards from the transmitter. A signal of 15 microvolts is just about enough to put a broadcast-like signal into the average receiver.

A stunt with a "self-tuning" radio can be done by concealing a confederate with the first receiver in a room and then having the second receiver in another room. You command the radio to tune to different stations, your confederate tunes his, and it appears as if the second radio tunes itself.

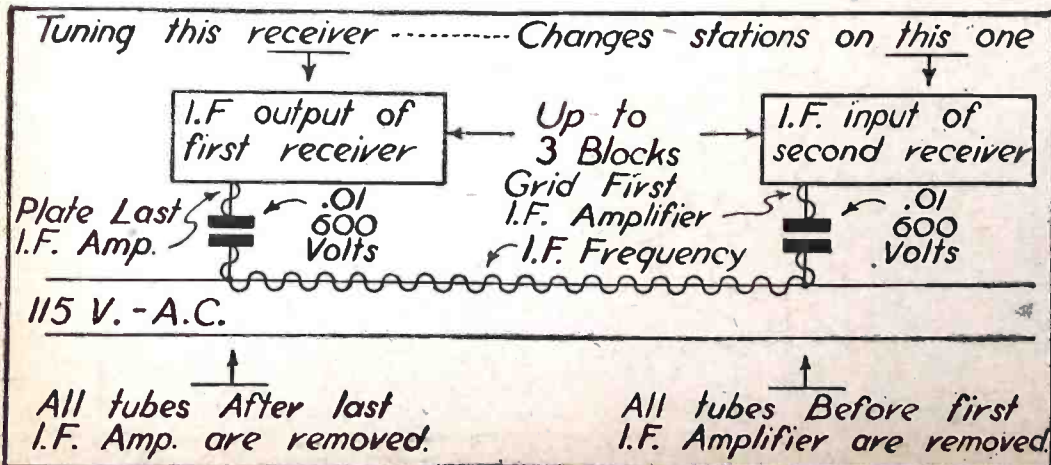



# TECHNICAL BULLETINS

Technical bulletins give reliable information in easy-to-follow form, and save valuable time otherwise spent in laborious reading of numerous books. Every subject is treated briefly and concisely, yet completely. No complicated mathematics, chemistry, electricity, or theory. Each bulletin is written in simple language.

PRICE \$1.00 EACH POSTPAID  
ORDER BY NUMBER

## ELECTRICAL DESIGN & CONSTRUCTION

**D-111—DESIGNING AND BUILDING TRANSFORMERS.**—Simple, non-mathematical methods for designing transformers of all kinds. Also special transformers such as are used for ultra-violet lamps, Neon tubes, etc.

**D-112—DESIGNING ELECTRO-MAGNETS.**—The subject of electro-magnet design is so clearly explained that anyone can design and build magnets for practically every purpose. Complete, practical data covering both A.C. and D.C. magnets.

**D-113—HOW TO DESIGN SOLENOIDS AND PLUNGER MAGNETS.**—Anyone who is interested in solenoids or plunger magnets cannot afford to be without this non-mathematical, simple and practical information.

**D-101—USING NICHROME RESISTANCE WIRE.**—Explains how to repair electric flat irons, toasters, rheostats, resistors and other electric heating devices. Simplified methods of figuring lengths and sizes of wire for any job.

**D-106—REWINDING ELECTRIC MOTORS.**—Complete information, diagrams, sketches, tables, etc., to enable any shop man, mechanic, electrician, experimenter, etc., to rewind A.C. and D.C. motors and generators of all types.

**D-144—A. C. CURRENT CONTROLLED WITH EASILY MADE CHOKE COILS.**—How to design and construct choke coils. How to determine size and amount of wire required, how to find the core size. Full details on assembly and coil winding.

**D-148—DESIGNING AND USING ELECTRIC RELAYS.**—Simple practical instructions for designing, building, and using A.C. and D.C. relays; also thermo-electric relays. Includes practical relay control systems for motors and machinery.

**D-127—SMALL ELECTRIC LIGHT PLANTS, DESIGN AND CONSTRUCTION.**—Tells how to design and build small electric light plants for cottages, camps or country homes at small cost. Covers construction of a 110-volt system to light six 30-watt lamps, how to build a 6-volt system using an auto-generator, with or without a battery, and how to convert a Ford model "T" generator to a 110-volt, A.C. generator.

**D-134—ELECTRICAL EXPERIMENTS WITH SIMPLE MATERIALS.**—How anyone without previous knowledge of electricity can perform harmless, interesting, and educational experiments with simple, inexpensive materials.

**D-131—MODEL MAKERS & INVENTORS GUIDE TO REMOTE-CONTROL SWITCHING.**—Controlling electrical devices, train models, equipment of all types at a distance by means of a telephone dial.

**D-137—ELECTRICAL METERS EASILY BUILT.**—Information that will enable students to build experimental electrical meters to measure alternating or direct currents. Including ammeters, voltmeters and wattmeters sufficiently accurate for experimental purposes.

Each Bulletin consists of a set of large sheets, assembled in one packet, size 9 x 14 1/2"; weight 1/4 lb. Numerous illustrations, diagrams, charts to supplement text.

## TECHNIFAX

1917 S. STATE ST. (DEPT. 842) CHICAGO, ILL.

DEPT. 842  
TECHNIFAX 1917 So. State, Chicago, Ill.  
Enclosed find \$..... for which please send me postpaid the following Technical Bulletins:  
Nos. ....  
Name .....  
Street and Number .....  
City and State .....

# Direction Finders in Automobiles

By WILLARD MOODY

It is essential, when a direction-finding loop is installed in an automobile, to have the loop electrostatically shielded and balanced to ground. The shielding may be obtained by using an arrangement such as the one in Fig. 1, and balancing to ground may be affected by the scheme in Fig. 2.

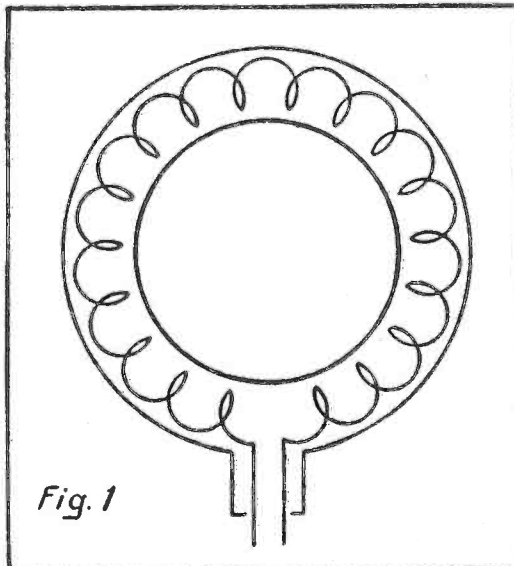

Fig. 1

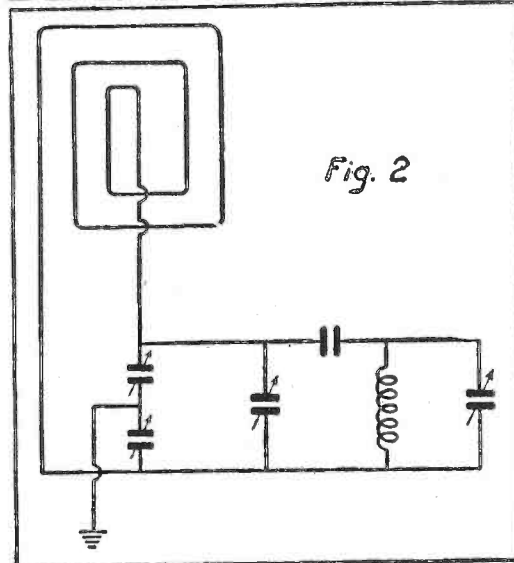

Fig. 2

An ordinary loop picks up in both directions, so that a "sense" antenna or other system permitting pick-up from a single direction is required for best results. A convenient arrangement is that of Fig. 3. The

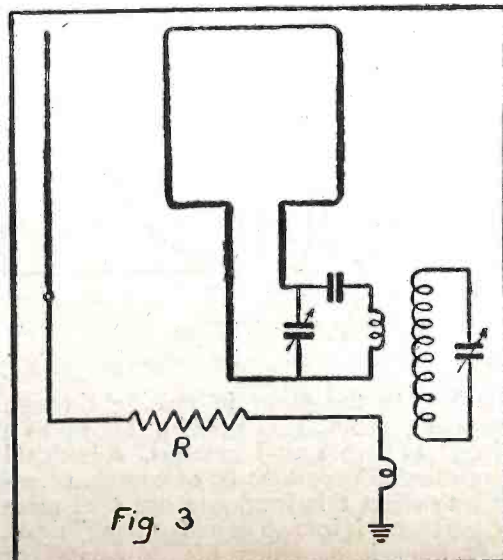

Fig. 3

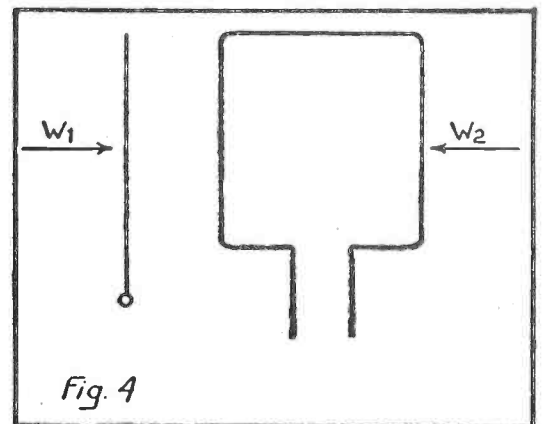

Fig. 4

resistor R is used to reduce phase angle between vertical antenna voltage and current. The pick-up of this antenna should be about equal to the loop pick-up.

With the sense antenna connected, a signal wave  $W_1$ , arriving as shown in Fig. 4, will produce a louder sound in the receiver than if the loop alone were used. A signal wave  $W_2$ , coming in the opposite direction, will produce a smaller response in the receiver than is obtained when the vertical antenna is out of the circuit.

This means  $W_1$  is made stronger and  $W_2$  weaker, giving a uni-directional effect favoring  $W_1$ .

The bearing is first taken without the vertical antenna, to get a sharp minimum. Then the vertical (sense) antenna is connected to identify the direction.

A magnetic compass is of little value in

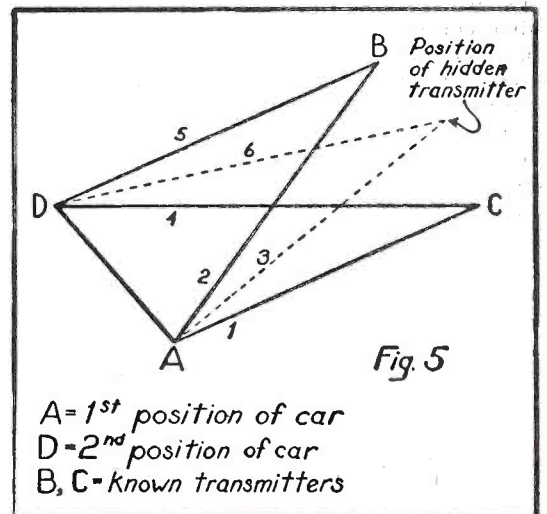

Fig. 5

A = 1<sup>st</sup> position of car  
D = 2<sup>nd</sup> position of car  
B, C = Known transmitters

a car, due to the distortion of the magnetic field produced by the steel of the car. Similar errors are also produced by magnetic ear-phones in the field of the loop, and as much separation as practical should be used between the two. Whether in country or city, buried iron pipes may cause magnetic compasses to read incorrectly.

By taking a loop bearing on one or more stations of known position, two reference lines can be drawn on a map. This map is one of the area in which a hidden transmitter is situated. If loop bearings of 10° and 30° for two known stations are obtained, and a bearing on a third UNKNOWN station of 15° is obtained, a line can be drawn on a map at the 15° mark. The car can then be moved a convenient distance to obtain another series of bearings, and the process is repeated. The new line then, at some point,

(Continued on page 757)

# FILTER TALK

By M. D. BRILL

WHENEVER an American makes or does something new, he tries to invent a new expression to describe it. And as Yankee ingenuity is proverbial our language is constantly being enriched by a stream of freshly coined words. The larger part of them are soon forgotten; but others—the better ones—survive because they carry a meaning that cannot otherwise be expressed so easily or so well.

An especially good environment for growing words is any profession that involves tools or operations peculiar to itself. Expressions come into use which are particularly apt for the pursuit at hand, and yet are bewildering to the uninitiated, until at length an industry has not only its "tools of the trade" but also its "talk of the trade."

The communications art has its share of expressions almost meaningless to the layman, but entirely clear to those working in that field. Many of them have been compiled in a "Glossary for Telephone Transmission" by K. S. Johnson, but as time goes on new ones are coined and take their places in the language. In the rather restricted field of carrier-transmission networks some of the recent expressions which enjoy considerable usage are "roof" filter, "cellar" filter, "frogging" filter, "comb" filter, and "pimple" filter. The transmission networks referred to are not new types, but the new descriptive phrases indicate the function of the networks in a transmission system in a pointed manner that the older generic classifications such as "low-pass" or "high-pass" filter could not equal. Definitions of these filters in the thumbnail sketch style of the "Glossary" may prove useful to those interested in the communications art.

A "roof" filter is a low-pass filter used in

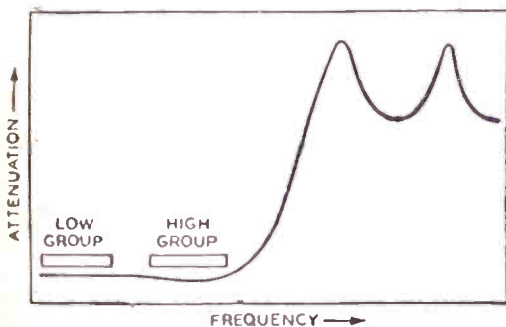

A "roof" filter

a carrier telephone repeater to limit the upper frequency end of the transmitted band to its prescribed useful range. It eliminates high-frequency disturbances which might cause noise or crosstalk in adjacent systems.

A "cellar" filter is a high-pass filter used in a carrier telephone repeater to limit the lower-frequency end of the transmitted band. Except for the difference in the fre-

A "cellar" filter

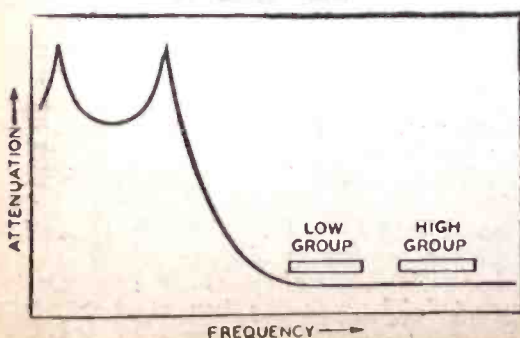

## "MONKEY CHATTER"

If you had a bliffy-sniffer  
That was full of crosstalk chatter,  
Could you add a cellar filter—  
Or a roofer, for that matter?  
Would you use a pimple filter,  
Or a combing type, perchance, sir?  
Would it need a frogging unit?  
Read the story for the answer!

quency end which it limits, its function is the same as that of a roof filter.

"Frogging" filter: The term "frogging" derives from the expression "frog" in railway engineering which refers to the mechanical device permitting wheels on one rail of a track to cross an intersecting rail. In telephone transmission terminology, "frogging" means the transfer of the intelligence-bearing frequencies of an open-wire carrier system from a particular line entering a repeater to a different line leaving the repeater. The geographical arrangement of the carrier telephone facilities occasionally makes this necessary, and the basic situation is illustrated below. Suppose that cities A and B are the terminals of a type-C carrier telephone system operating over line ARB, and R is a repeater point. Similarly,

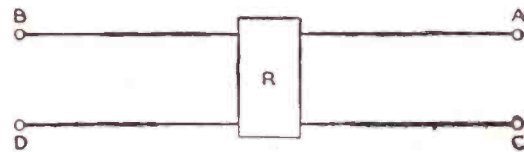

A "frogging" filter

suppose C and D to be terminals of another type-C system operating over line CRD, and R to be a repeater point for this system likewise. If it is desired to add a type-J carrier telephone system between cities A and D, and a type-J system between cities C and B without constructing additional open-wire lines, then such systems must switch from

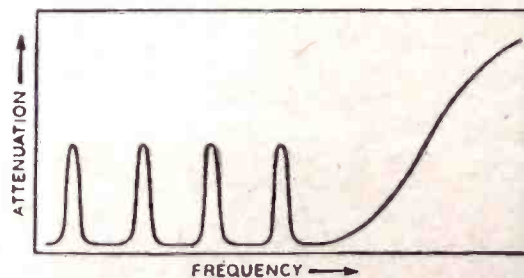

A "comb" filter

one line to the other in passing through repeater point R. This would be known as a "frog" of two type-J systems. Additional transmission apparatus is, of course, necessary to effect this frog, and one such piece of apparatus is known as a "frogging" filter. This filter is of either the "low-pass" or

"high-pass" type and serves to eliminate the increased crosstalk at the repeater resulting from the frogging process. Frogging filters may be, but are not necessarily, roof or cellar filters.

A "comb" filter is used at the terminals of a carrier telephone system to prevent a leak of the unmodulated carriers to the line. These filters assist the balanced modulators in this function, and make frequent checks of modulator balance unnecessary. In one type of carrier telephone system they consist of a parallel connection of quartz crystals, each crystal cut for a particular carrier frequency. The crystals introduce extremely sharp attenuation peaks at their respective resonant frequencies, hence the descriptive name "comb."

A "pimple" filter augments the loop loss of a directional filter set over small frequency bands where deficiencies in loss exist for some unusual service conditions. Such filters possess high discrimination over small frequency ranges and derive their name from the resemblance of their attenuation characteristic to what Webster calls "a small, pointed elevation of the skin"—in short, a pimple. In their simplest form, they consist merely of one-mesh resonant circuits; in more complicated forms they may be conventional band-elimination filters.

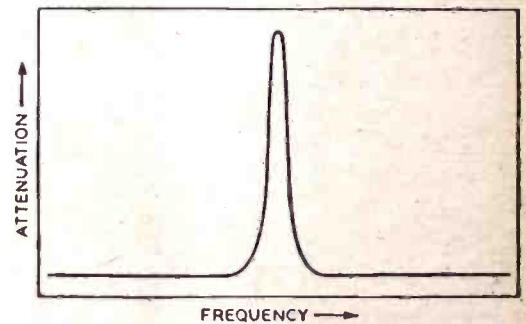

A "pimple" filter

The word "filter" is itself an excellent example of an expression whose meaning has been extended by new usage. Derived from the Latin *feltrum*, meaning "felt," or "fulled wool," which was used to strain liquors, it originally referred to any material or device employed to separate a liquid from particles of solid held in suspension. Chosen by transmission engineers to describe a circuit that suppresses certain frequencies and passes others, it has served its purpose with complete satisfaction to all concerned.

Many of the best "new" words, like "filter," are not new at all except in meaning. "Frog," referred to above, is another good example. The railroad device so called was given the name because it looked like a frog. This is a pure Americanism; in England a railroad frog is a "crossing." Other neologisms are newly meaningful combinations of old words, many of them extremely vivid, like "cloud-burst," "roughneck," "blowout," "stuffed-shirt" and "brass hat." Genuinely new words are comparatively rare, and many of them are likely to remain synthetic. To take familiar examples, "vodas," "compandor" and "codan" all still seem to creak at the joints. "Musa" is better; and although it still lingers below the salt, the best of the Bell System product to date is undoubtedly the cableman's name for the 108A amplifier: "bliffy-shiffer."

—Bell Laboratories Record

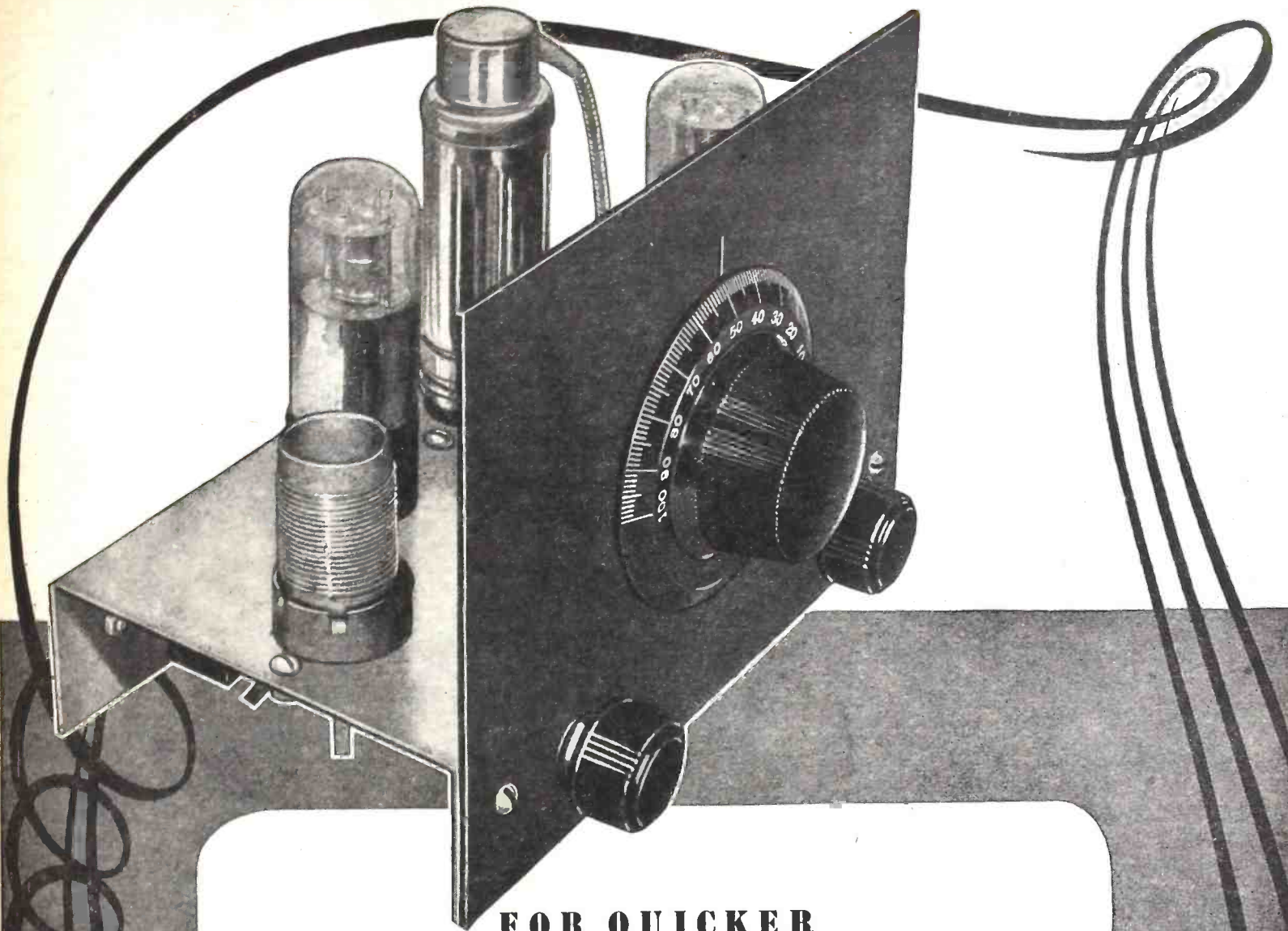

FOR QUICKER  
*Radio Defense Training*  
USE **MEISSNER KITS**

One, two and three tube Student "Midget" kits will solve the problem of quicker radio training. They are especially designed for classroom use. The "add-on" feature permits the conversion of the one tube to a two tube and the two tube to a three tube receiver. Meissner Student "Midget" Kits are being widely used in schools for defense radio training.

**EASY TO BUILD!** . . . with the Meissner Pictorial Wiring Diagram furnished with each kit, construction is simplified so that even a beginner can quickly and easily assemble the kits.

The one, two and three tube kits are available for battery operation. The two and three tube can be obtained for AC-DC operation.

Write for complete catalog. Address Dept. CT-8.

*Meissner*

MT. CARMEL, ILLINOIS

**"PRECISION BUILT PRODUCTS"**

# SPECIAL TRAINING

with a Personal Service is offered to you by the  
**INTERNATIONAL CORRESPONDENCE SCHOOLS** OF SCRANTON, PENNSYLVANIA

## TECHNICAL COURSES

<u>Air Conditioning Schools</u>	Surveying and Mapping	Metal Pattern Drafting
Air Conditioning Heating	<u>Electrical Schools</u>	Mold Loft Work
Plumbing	Electrical Engineering	Reading Shop
Refrigeration	Electric Wiring	Blueprints
Steam Fitter	Gas and Electric	Sheet Metal Worker
<u>Chemistry Schools</u>	Welding	Ship Drafting
Chemistry, Analytical	Industrial Electrician	Ship Fitting
Chemical Engineering	Lighting Technician	Shop Practice
Chemistry, Mfg. Iron and Steel	Power House Practical	Steel Mill Workers
Mfg. of Pulp and Paper	Telephony	Tool Designing
Pharmacy	Radio, General	Wood Pattern Making
<u>Civil, Architectural and Structural Engineering Schools</u>	Radio Operating	<u>Railroad Courses</u>
Architecture	Radio Servicing	Air Brake
Architectural Drafting	Telegraph Engineering	Car Inspector
Bridge and Building Foreman	<u>Internal Combustion Schools</u>	Locomotive Engineer
Bridge Engineering	Air Pilot	Locomotive Fireman
Building	Automobile Technician	Railroad Car Repairer
Estimating	Aviation	Railroad Section Foreman
Civil Engineering	Diesel—Electric	<u>Steam Engineering Schools</u>
Concrete	Diesel Engines	Boiler Making
Engineering	Gas Engines	Combustion Engineering
Contracting and Building	<u>Mechanical Schools</u>	Engine Running
Highway Engineering	Airplane Drafting	Marine Engines
Retail	Foundry Work	Petroleum Refining Plant
Lumberman	Heat Treatment of Metals	Steam Electric
Structural Drafting	Inventing and Patenting	Steam Engines
Structural Engineering	Machine Shop Practice	<u>Textile Schools</u>
	Mechanical Drafting	Cotton Manufacturing
	Mechanical Engineering	Textile Designing
		Woolen Manufacturing

## BUSINESS AND ACADEMIC COURSES

<u>Academic Schools</u>	Bookkeeping	<u>Civil Service Schools</u>
Arithmetic	Business Correspondence	City Letter Carrier
College	Business Management	Post Office Clerk
Preparatory	Certified Public Accounting	Railway Postal Clerk
First Year College	Commercial Cost Accounting	<u>Language Schools</u>
High School	Foremanship	French
Higher Mathematics	Salesmanship	Good English
Illustrating	Secretarial	Spanish
<u>Business Schools</u>	Stenography	
Accounting	Traffic Management	
Advertising		

• The successful man DOES today what the failure INTENDS to do tomorrow. Mail this coupon NOW!



### INTERNATIONAL CORRESPONDENCE SCHOOLS

Box 2880-G, Scranton, Penna.

Please send me complete information on the following subject:

(Write above Technical, Business or General Educational Subject in which you are interested.)

Name \_\_\_\_\_ Age \_\_\_\_\_

Address \_\_\_\_\_

City \_\_\_\_\_ State \_\_\_\_\_

Employed by \_\_\_\_\_

# MOBILIZED CONDENSERS

(Continued from page 719)

doubling circuits of 12,000-12,500 volts or 25,000 volts output.

These giant capacitors make virtual pigmies out of our previous oil-filled capacitors. We have had to revise our production thinking. The multi-laminated kraft tissue and hi-purity aluminum foil sections for these capacitors are uniformly and accurately wound under critically-controlled tension to avoid mechanical strains. Giant winding machines permit handling several dozen "papers" foil sections used singly or paralleled in attaining proven voltage ratings. The sections are thoroughly dried, vacuum-treated, oil-impregnated and oil filled under continuous vacuum in specially designed and built tanks. A battery of these giant tanks permits a full pumping cycle for the thorough vacuum treatment of sections.

Hermetically sealed in sturdy welded steel containers, finished in rust-proof dark gray lacquer, and provided with cork-gasketed pressure-sealed glazed high tension pillar terminals, these capacitors are immune to humidity, temperature and climatic conditions generally.

A year ago such giant capacitors would have been a special job. The cost would have been well nigh prohibitive. But today we have a regular production setup for such units. They are in regular production. Costs have been greatly reduced. The same units, with minor alterations if any, will serve after the war in power factor correction applications for public utilities and large power consumers. Likewise, these capacitors will serve in X-ray work, cathode-ray work, and various other electronic fields. They will, indeed, be a most vital contribution to the electronic age.

Recently our chemists have made important discoveries in the refining of our dielectric oils, resulting in performance records for oil-filled capacitors heretofore believed unattainable.

## YESTERDAY SPECIAL, STANDARD TODAY

The impact of the all-out war is best reflected perhaps, in the mass-production of many types of transmitting capacitors heretofore considered special and made to order only in single or at least small lots. Take the stack-mounting mica capacitors, for example. Heretofore these units were relatively costly, because the demands for radio and carrier-current applications were very limited. Today our plant has an entire department devoted exclusively to making stack-mounting capacitors as well as the large bakelite-case micas. This standardization of high-quality mica capacitors, together with the economies attained by mass-production methods, will play a large part in the rapid development of the electronic art following this war.

Another interesting angle to this wartime condenser business is the demand for fine quality capacitors. The elaborate assemblies used by our armed forces, quite as well as the growing instrumentation of industry, call for capacitors possessing not only a high degree of accuracy, but the longest dependable life as well. Thus there is an unexpectedly large demand for oil-filled paper capacitors, where plain wax-filled condensers were used before. So much so that oil-filled capacitors are subject to priorities and, for the time being, are virtually unobtainable by anyone not actively engaged in war work. This demand for finest quality capacitors is slowly but surely formulating an *electronic grade* of capacitors for the future—extra-heavy-duty capacitors intended especially for instruments, industrial, and requirements far more critical than those of regular radio

work, and necessarily commanding premium prices. We shall come out of this war effort with a firmly established line of high quality or electronic condensers in time for the electronic age.

## UNAVOIDABLE SUBSTITUTIONS

Obviously, Uncle Sam's requirements come first, closely followed by those of our United Nation associates in the war. The priority system makes sure of that. Whatever metals and other essential materials are available must go into condensers required by our combat forces and the industries backing them. If anything is left over, it may possibly be available for civilian condenser needs, but there is little chance of that.

Necessarily, therefore, we have had to resort to more and more substitutions in the case of condensers for radio replacement and other essential civilian needs. The outstanding example is aluminum cans. Due to the shortage of aluminum, condenser manufacturers have had to discontinue production of wet electrolytics for the radio trade. At first this was considered quite a blow by servicemen, because this type seems essential for high capacity values. However, the high filtering efficiency of dry electrolytics, justifying considerably lower capacity values, has been rediscovered by many a Serviceman, as he has turned to cardboard-case and tubular electrolytics. Servicemen are now finding out they can get along quite nicely without canned electrolytics.

Somehow or other, using whatever substitute condensers are made available, the Servicemen will keep our home sets going and our people will be kept informed of the progress of the war and sustained in their morale by the spoken words of their leaders. In our plant we are making every effort, and frequently that means the most strenuous effort, to keep up production on essential replacement condensers so that the war may be won on the home front as well as on the battle front.

## RADIO COAT

(Continued from page 721)

Flexible wires embedded in the sleeve carry the signal of the input to the transmitting part of the transceiver, which is located in the right-hand pocket, by way of the conduit which is lined with metallic fiber (or metallic cloth) and other insulating material. The conduit is of flat tubular construction in the form of a belt, and it carries all the essential wiring, which is insulated.

The coat collar is relatively wide and is made to project over the ears when in raised position. The earphones may be a permanent part of the collar or may be arranged to be plugged into position. An elastic band fits over the head of the wearer to hold the earphones in place. The back of the coat is provided with a mounting flange or bushing of insulated material to support a spring socket which receives the aerial. This socket has a contact in the bottom connected to one of the conductors and is adapted to support an upright aerial or antenna rod. This rod may be of telescopic or extensible type comprising several sections. It is made so that it can be easily removed. The antenna can be adjusted to any desired height and projects upward at the back of the wearer and at one side of the head, so as not to interfere with the free movements of the person wearing the garment.

# OFF THE PRESS!

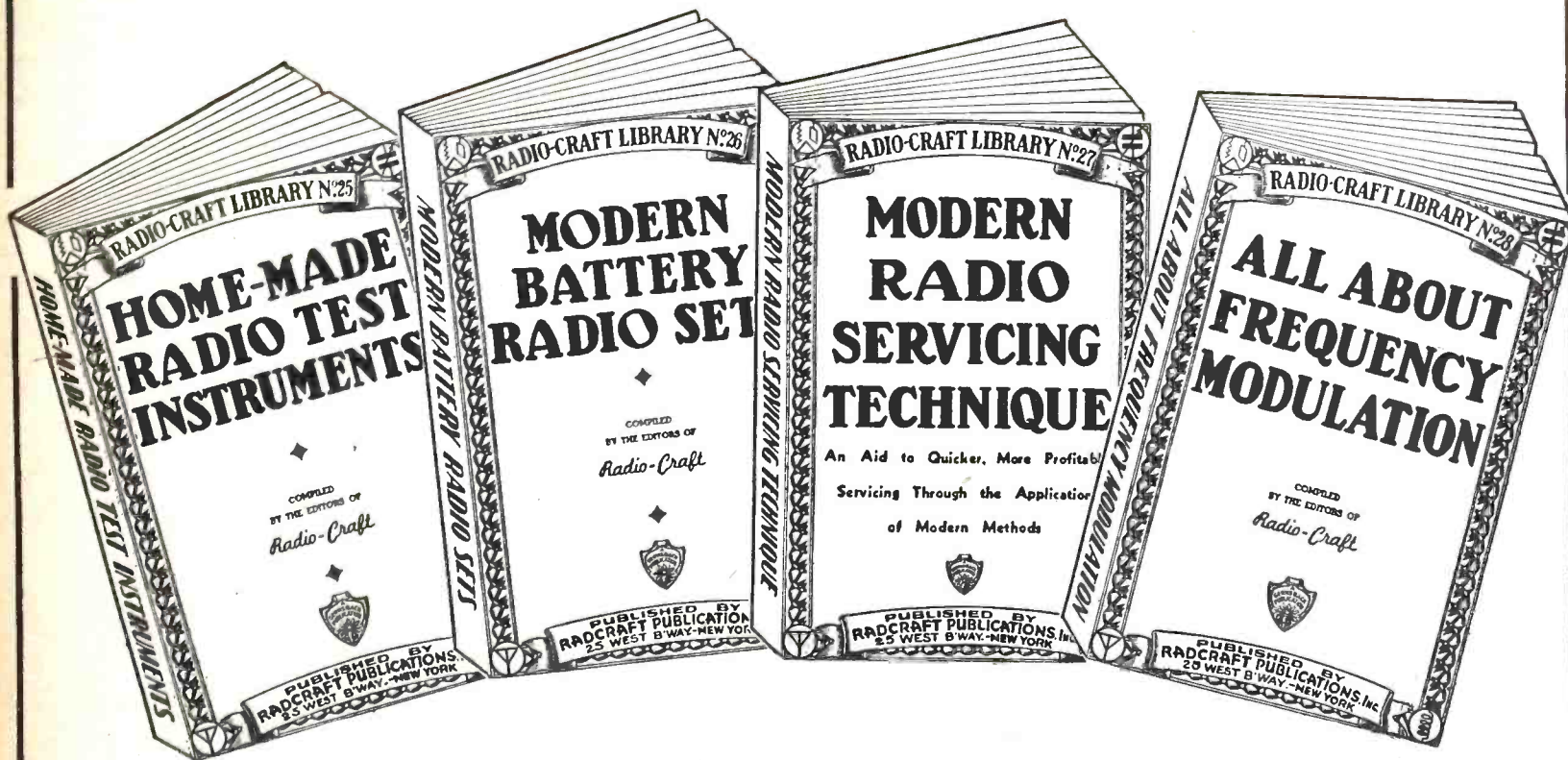

## New RADIO-CRAFT Library Books

**T**HE four latest books of our well-known RADIO-CRAFT Red Books—Nos. 25, 26, 27 and 28—have just come off the press. These four books are all on timely subjects and we recommend every one of them to you strongly.

Now, more than ever, radio education has become a burning question. If you are to be in the National Service, in the Army, Navy or Air Force—practical radio knowledge is of paramount importance. **YOU CAN GET BETTER RATINGS AND ADVANCE QUICKER IF YOU HAVE A GOOD RADIO BACKGROUND.**

Conversely, if you are not with the armed forces, there is a whale of a job to be done at home. With more and more men going into the service, the demand for practical servicemen becomes greater each day. Therefore we say: **PROFIT BY THESE UNIQUE BOOKS, WHICH ARE PRICED SO LOW THAT THEY ARE WITHIN THE REACH OF EVERYONE'S PURSE.**

### No. 25—HOME-MADE RADIO TEST INSTRUMENTS

This book includes articles covering a wide range of test apparatus of live interest to every radio man. Servicemen will find many circuits in this book to make their work more profitable. New ideas in test equipment make it possible to service radio receivers more quickly.

Laboratory workers and experimenters will find many articles which describe in detail construction and use of all essential radio test units—multi-meters, oscillators, stage-analysis testers, oscilloscope equipment, V.-T. voltmeters, etc. Even advanced technicians will be interested in the circuit arrangements showing the new and improved variations of well-known, basic test equipment. A MUST for every serviceman. This book contains 86 illustrations.

**Outline of Contents:** A Low-Cost Signal Chaser—Signal Tracer Test Unit—Simplified Practical Signal Tracer—A Home-Made Infinite-Resistance Tube Checker—Build This Direct-Reading V.-T. Voltmeter—How to Make a Modern V.-T. Voltmeter—Measuring High Values of A.C. Voltage and Current With a Low-Range Meter—How to Make a Meter-Range Extender—How to Build a Practical Tube Tester and Set-Analyzer Adapter—The Beginners' Simple Volt-Milliammeter—Build This Simplified Neon-Type Test Unit—Midget Oscilloscope—How to Make and Use a Frequency Wobbler—Double Tracing Your Oscilloscope—Home-Made Frequency Modulator.

### No. 26—MODERN BATTERY RADIO SETS

Whether you are a radio man or a beginner, the articles in this book give you basic circuit arrangements or elementary radio receivers which serve the dual role of teaching the elements of radio reception, as well as making perfectly operating 1- and 2-tube radio receivers. Picture diagrams and bread-board layouts galore.

Advanced radio set builders are offered more complicated arrangements. Laboratory workers and engineers will find in many of the articles circuit and constructional features which have become commercial practice. Many entirely new ideas are given in this book. One of the most important volumes we recently issued. This book contains 76 illustrations.

**Outline of Contents:** Beginner's 1-Tube High-Gain All-Wave Receiver—Beginners-Build This 1-Tube Loop Receiver—A "3-in-1" Battery Portable—An Easily-Built "Fluwellling Superregenerative" 2-in-1 "Card File" Battery Set—A 2-Tube Superhet. With Pentagrid Regenerative 2nd-Detector—The 4-Tube Superhet. Vacation Portable—The "Lunchbox 5" Battery Portable—The "Seafarer" Loop-Type Boat Radio Set—4-Tube Portability Portable—An All-Purpose Portable—A Typical Commercial 3-Way Portable (Pilot Models X-1452 and X-1453)—Switch for Varying "C" Bias on Battery Radio Sets—Making a Simple Portable Aerial—Making a Pilot-Light Fuse—Old Auto Sets for New Cars—Using a Loop Portable in Cars—Quasi-Electric Soldering Iron—Lamp Bulbs as Resistors.

### No. 27—MODERN RADIO SERVICING TECHNIQUE

Here is a book of great importance to every radio man, every radio engineer, and particularly all radio servicemen. A list of the contents which follows shows the importance of this book, literally jam-packed to overflowing with radio-meat. Whether you are a servicing beginner or whether you are an experienced serviceman—you will find many important helps in this volume.

Book is eminently practical and will solve many problems for you. More important: It will show you many short-cuts, all calculated to save your time and patience. Practical everyday data on standard receivers appears throughout the book. A whale of a book compressed into a minimum of space. Contains 98 important illustrations.

**Outline of Contents:** Elementary Servicing Technique—Correct Procedure for the Servicing Beginner—Elementary Procedure for Servicing Radio Sets—A.F.C. Alignment Made Easy—Dynamic Servicing—Dynamic Testing Simplified Servicing—Modern Receiver Test Requirements—Servicing Universal A.C.-D.C. Receivers—Servicing "Orphans" and Private-Brand Sets—Emergency Servicing Without Test Meters—Servicing Coils—Servicing R.F. Coils—Servicing Oscillator Coils—General Information—RMA Transformer Color Code—What Causes Echo, Fading?—Radio Service Puzzlers.

### No. 28—ALL ABOUT FREQUENCY MODULATION

Here is a complete compilation of pertinent data on the entire subject of the new coming art of Frequency Modulation.

There is no question but that Frequency Modulation is already revolutionizing radio broadcasting in this country. Were it not for the war, there would now be a tremendous boom in this new art—yet, even with war restrictions imposed upon it, Frequency Modulation is still jumping ahead by leaps and bounds.

With Frequency Modulation no longer a theory—with hundreds of stations already dotting the land and with countless hundreds of others to come when peace is achieved once more—every radio man should read up and know all there is to know on this most important subject.

This particular handbook is chuck-full with a tremendous amount of information which you probably will not find in any similar book in print.

**Outline of Contents:** The ABC of F.M.—Frequency vs. Amplitude Modulation—Basic Facts About F.M. Broadcasting—Construction—Build This Practical F.M. Adapter—Audio Amplification—F.M. Audio Amplifier, Part 1—F.M. Audio Amplifier, Part 2—F.M. Audio Amplifier, Part 3—F.M. Service—Part 1, Antenna Installation and Service—Part 2, Receiver Alignment and Diagnosis—Part 3, Test Equipment for F.M. Servicing, Engineering—Part 1, The How and Why of F.M.—Part 2, The How and Why of F.M.—Theory and Design Considerations of R.F. and I.F. Coils in F.M. Receivers.

### SPECIAL SEND-NO-MONEY OFFER

It is not necessary that you send money with order. If you wish to take advantage of our C.O.D. plan, simply cut out the coupon, paste it on a post card and send it to us. Books will be sent to you immediately.

All four books are listed uniformly at 50c each. No discount on less than three books.

If you wish to take advantage of our special offer, ordering three books or more, we make an unusual low price to you as follows:

3 books—\$1.25  
4 books—\$1.50

Do not fail to send coupon today!

RADCRAFT PUBLICATIONS, INC.  
25 West Broadway, New York, N. Y.

Radcrafft Publications, Inc., 25 West Broadway, New York, N. Y.		942
Gentlemen: Rush to me by return mail, as per your special offer, the following books: (Check books selected.)		
<input type="checkbox"/>	No. 25—HOME-MADE RADIO TEST INSTRUMENTS.	
<input type="checkbox"/>	No. 26—MODERN BATTERY RADIO SETS.	
<input type="checkbox"/>	No. 27—MODERN RADIO SERVICING TECHNIQUE.	
<input type="checkbox"/>	No. 28—ALL ABOUT FREQUENCY MODULATION.	
I will pay postman \$1.00 (if two books are ordered) plus a few cents postage and charges, \$1.25 for three books, plus a few cents postage and charges, \$1.50 for four books, plus a few cents postage and charges. WE CANNOT SEND A SINGLE 50c BOOK C.O.D.		
NAME .....		
ADDRESS .....		
CITY .....		STATE .....
<input type="checkbox"/> Save shipping and C.O.D. charges! Check here if you send cash with order. (Cash, U.S. new postage stamps, money order, check.) Foreign countries no C.O.D. Add 20% to all prices quoted.		

**To-day REFLEX SPEAKERS** are the standard for **UNCLE SAM** remember. The government requires for our **WAR NEEDS** the identical features that have made the name **UNIVERSITY** famous in the industry. These features include: Maximum possible acoustic efficiency. Super Power output. Long Life Break-down Proof diaphragm. Absolutely waterproof sealed. send your special war problem to our engineering dept. for immediate action. **UNIVERSITY LABORATORIES** 225 Varick St., N. Y. C.

**READ SEND LIKE AN EXPERT**

**CODE** Learn Quickly at Home—Get Real Speed  
It's easy, fascinating, to become a good op. with the NEW ALL ELECTRIC MASTER TELEPLEX CODE TEACHER to help you. Only instrument ever produced which records your sending in visible dots and dashes—then sends back to you at any speed you desire. That is why so many schools teaching code prefer Master Teleplex, why thousands agree this method is surest and quickest—has taught more ops in the past few years than all other methods.

There are NO PERFORATIONS—NO INK. Far superior to anything ever developed... a marvel of simplicity.



**FREE BOOK**  
We furnish Complete Course. lend you Master Teleplex, give you personal instruction with a MONEY-BACK GUARANTEE. Low cost. Send today for booklet \$8. No obligation.

**TELEPLEX CO.,** 107 HUDSON ST. JERSEY CITY, N. J.

**Do you need BINDING POSTS?**



The XL PUSH POST with its Spring Action assures Constant Contact and quick connection. Manufactured in All Aluminum Type M at 12c each. Aluminum Body, Bakelite Top Type B1 at 15c each. Types CP or NP. ALL BRASS—STAINLESS STEEL SPRING & PIN. PROVEN by 240 HR SALT SPRAY TEST as NON-CORROSIVE at 28c each. Manufacturers and Dealers Liberal Discounts

**X. L. RADIO LABORATORIES** 420 West Chicago Ave., Chicago, Ill.

**RADIO COURSES**  
Start Sept., Day and Evening Classes  
• RADIO OPERATING • RADIO AMATEUR CODE • RADIO SERVICING • RADIO TECHNICIANS  
**New York Y.M.C.A. Schools**  
4 W. 64th Street New York City

**MAKE OLD RADIOS NEW**

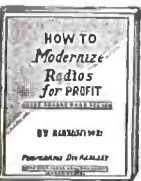

You can learn quickly to modernize all sets. No more new radios. Cash-in by improving audio circuits, modernizing cabinets, adding features usually found on late model sets. Practical job-sheets with schematics and photographs make the work easy. Complete, 8 1/2 x 11 inches, manual only \$1.00, post-paid. Money back guaranteed.

**SUPREME PUBLICATIONS** 3727 W. 13th Street, Chicago, Ill.



**CHECK HERE!**  
—If you want a BETTER radio job! Your radio experience backed by CREI modern technical training will equip you to share in the better, good-paying jobs that await trained men. Technical ability is the only thing that stands between you and a better job NOW and a secure radio career in the future. Write for FREE BOOKLET and details. **CAPITOL RADIO ENGINEERING INSTITUTE**, Dept. RC8, 3224 16th St., N.W., Washington, D. C.

**WARTIME ENGINEERING**

(Continued from page 715)

enced engineers can easily enough forget very pertinent facts. I cannot too strongly stress the thought that it is no disgrace to have to seek information. Quite the contrary; for the search for information betokens the open and inquiring mind and the resolution to accomplish the desired results. As a matter of fact, it is sheer folly to insulate ourselves from sources of valuable data. Conversely, when anyone approaches us for information, let us try to help him patiently, remembering that we shall probably be in the same boat, and for the same good reason, before much time has passed.

There are a number of ways of finding out what is known which may prove useful to us. The simplest and most obvious one is first to go to the best available textbooks. We may get some general or specific data that way. The more nearly routine the problem, the more likely we are to find help in available texts. It is advisable to make notes at each stage of our study so that, when we have completed our investigation, our notes can be digested, summarized, and used as a guide. Great care and some patience is necessary in making notes. It does little harm to make notes too complete or elaborate, but it does a great deal of damage to have them so incomplete or brief that we have difficulty in interpreting them at a later date.

Let us see if the engineering handbooks have any available information on the devices or methods in which we are interested. If so, we shall make notes of them, entering a specific reference with each note so that we can relocate the full information in the handbook or textbook if we so desire. In fact, it is a good idea to give definite information as to where we located any data, in the form of a specific reference in our notes.

To get more reference material than is obtainable by the above methods, we should resort to the published papers in the major engineering journals. It is sometimes difficult to locate the desired references in an engineering journal. However, the annual or other indexes of these journals will be of some help. The card-index system of an engineering library may also assist us. If we know the names of the engineers who have worked in a given field, we should look them up in the index or file so as to locate their papers which may bear on the subject at hand.

It is usually possible to accumulate a fairly full list of references on a given subject by a process of aggregation. One good reference article may give us a number of other references dealing with the same subject, which latter articles, in turn, will provide additional references. Thus we may soon accumulate a good bibliography of the subject and, in the process, a detailed knowledge of the particular field. Now and then issued patents or accessible patent applications will also be instructive. But we should keep in mind that patents and patent applications are not necessarily completely scientific presentations in some cases nor will they always furnish the most useful forms of technical data. They should, therefore, be taken as interesting and suggestive but not necessarily final in every instance.

Occasionally it is a good plan (if conditions permit) to lay aside work on a particular problem for awhile, and instead work for a spell on some other job. A return to the original problem in due course will sometimes show that considerable progress toward its solution has somehow been made in the intervening period.

And now, suppose that we have found what looks like a plausible or probable solution, method, or design. We shall then be ready to start putting our ideas into equipment, such as an experimental, functional, or "breadboard" model, or even what we hope will be the final manufacturing form. If we wish to make only a functional and experimental model we need consider only the requirement that it shall produce the desired result regardless of its adaptability to manufacture. But, if we are tackling the even more difficult job of making a manufacturing design—and this, it must be stressed, is an entirely different matter—we shall have to consider many additional problems of design as well as factory methods and limitations and economic controls. But in either case, this is the time to plan the model, of whatever type, very carefully. Consider in detail just what the model must accomplish. How can it be made most simply, and from the least possible number of parts? What parts are already available? Be sure to utilize these as a matter of economy of time and money. Even in building a purely experimental model, let us try to imagine as far as we can what the final and manufactured form will be like ultimately and then make our model as much like that as possible (unless we are in so early a stage of a development that it is not practical to visualize the final commercial form of the device). Keep our setup as simple, complete, and reliable as possible; but let us not waste time on unimportant details. Cultivated good judgment along these lines is an important asset to the development and design engineers.

In making tests and observations on our setup, we must watch not only for the desired results but also for any odd, or unexpected, or undesirable effects or performances. Very close observation is important at this stage. A great many new things can be learned in that way and many future "headaches," or "bugs" in the apparatus, can be avoided. Your general slogan should be "watch closely and think hard." Avoid distractions and try not to hear or see what is going on around you unless it directly concerns your work. Develop, if you can, "ear-lids"—they are as useful in shutting out undesired sounds as are eyelids in keeping out intrusive scenes. Stop, look, and think!

There is another thought which may be particularly important to us in wartime development and design. It may sometimes seem to the engineer that the requirements of the Army, Navy, or Air Force are unnecessarily stringent or detailed. But it is well to remember that, while the customer may not be invariably right, it is an excellent idea to give him every benefit of the doubt. This is particularly the case in connection with military divisions of the government in wartime. They are closest to the actual use of the equipment under the stringent and grueling field conditions. They have had experience in the difficulties which arise in its use; they must live with it; and they generally will have a more complete and clear conception of service conditions which must be met than designers who have not been active in the field for a long time. Accordingly it is wise to keep an open mind on specifications even if they look too stiff. However, it is in order to ask questions as to the reasons for them. And if we have unusual difficulty in meeting them, perhaps the specifying group may be able to suggest a solution or even to provide for us a model of something fairly similar to what we are supposed to produce and thus help us to "make the grade." Don't hesitate to ask

for help in such directions, particularly under the present emergency conditions. It is readily possible to be too "dignified" in such matters. You will often find that the customer can be a helpful friend.

**CONDITIONS OF USE**

Obviously it makes a great difference under what conditions equipment is to be used since these conditions will vitally affect its design and required performance.

We should try to accumulate as complete a list as we can of such working conditions, and then to give them major consideration in design and construction, as well as subsequent test. These requirements are of interest even in experimental models but are of course vital in the manufacturing model and design.

Every piece of equipment may develop some trouble sooner or later, and often enough at an entirely inopportune or dangerous time. Hence it is generally necessary that servicing problems shall be reduced to a minimum. Breakdown might occur at a tragically wrong time and place. Accordingly parts should be as far as possible conveniently accessible, easily removed, and readily replaceable (if there is any likelihood of their failure). Appearance is generally less important in wartime equipment than great convenience of use and reliability. The training and methods of the personnel who will probably do this servicing must be considered in each instance. Let us not hesitate to ask questions in these regards if we do not have the facts. A question is less embarrassing than an apparatus breakdown.

And we should always remember that our work is being increasingly appreciated and judged to be of paramount national importance. In its leading editorial on December 26, 1941, *The New York Times* said:

"As this war develops we can be increasingly thankful that we need no 'propaganda' to convince ourselves of the necessity and justice of what we are doing. All argument was silenced at Pearl Harbor. More and more this nation will value the gifts of certainty and of unity which our enemies bestowed upon us by their very act of aggression. Few causes and few wars are as simple as this one has become. The defeat of the Axis Powers has become as well-defined and essential an objective as was, a generation ago, the completion of the Panama Canal.

"We suspect that it arouses a not wholly dissimilar emotion. We have grown up since 1898, when we looked for 'glory' in our brief and one-sided war with Spain; and even since 1917, when an exalted and Utopian mood seemed necessary. *Today's war requires the industrial and engineering type of heroism and fortitude. It requires planning, patience and exactness.*"

We are in the first line of defense and offense. Let us then *think straight, plan well and work hard* to bring for all of us a brighter tomorrow.

**AIR CORPS RADIO UNIVERSITY**

(Continued from page 720)

curriculum. These classes operate long into the night, for here, as in the rest of the nation, the Army's war effort knows no recess.

In addition, a separate course for communications officers is provided and graduates are immediately commissioned as second lieutenants of the Army Air Corps

# NATIONAL UNION AIR RAID ALARM

**Works on Any Radio Set**



**\$5.00** UNIT COMPLETE  
INSTALLATION EXTRA

**1** An advance alert signal tied up with your local radio station.

**2** Radio stations going off the air are usually the first indications of attack.

**3** National Union alarm automatically goes on when radio station goes off the air.

**YOUR HOME ALERT SIGNAL**

**What It Is . . .**

The National Union Air Raid Alarm is an inexpensive device designed to work with any type of radio set, table model or console, AC or AC-DC or battery operated. It will not affect the operation of a radio. It doesn't harm it in any way. In fact, the device can be detached at any time without affecting the operation of the radio set. It consumes no current. It is sturdily constructed of the finest quality materials, and under normal conditions should last as long as the radio set and require no attention. In fact, the unit is sealed to prevent tampering, moisture, dust or other deteriorating factors.

**What It Does . . .**

Because a radio signal can be used as a direction guide, your key radio broadcasting station will go off the air promptly at the very first warning of attack. During normal day or evening hours when you are listening to your radio, you would immediately know this; but during the hours that you are asleep or not listening to your radio set, your radio would be off. National Union Air Raid Alarm hooked into your radio set and left on in accordance with the operating instructions will set up a loud and intensive howl whenever the station to which it is tuned goes off the air.

During one of the early air raid alarms in Los Angeles, owners of radio sets equipped

with this device had notice from six to ten minutes before the alarm sirens sounded in the city.

This device used on your radio set will insure hearing in your home where, because of weather or other local conditions, noise of sirens might not be noticeable.

**Easily Installed by Your Service Dealer . . .**

Your radio service dealer connects four wires. These wires are in each case joined to easily accessible circuit terminal points in your radio set. No change is made in the circuit of your radio set.

Full operating instructions are furnished with each unit and should be placed by customer where they can be readily observed and followed.

After installation it is extremely simple to check. Simply tune in a station, throw the switch to alarm at which time it should remain silent. Then tune the station out so no station is being received and the device should sound a loud siren-like tone. To stop this alarm, throw the air raid alarm switch to the silent position.

**Low Cost . . .**

The primary object of the National Union Air Raid Alarm has been to give an automatic alarm of utmost dependability at a cost within the reach of all.

See Your N. U. Distributor or Write

**NATIONAL UNION RADIO Corp.** 57 STATE STREET  
NEWARK, N. J.

Reserve upon completion. Then, like the enlisted men, they are sent to all parts of the country for assignment to tactical units of the Air Corps, or to more advanced schools. Not only do Scott Field students obtain instruction on the ground, but are taken aloft in the huge "Flying Classroom" to give them actual experience in plane-to-ground radio operation. The "Flying Classroom" has a capacity of 12 students and a crew of 5 and makes extensive flights throughout the middle west as an integral part of the radio training.

Like most Army posts today, Scott Field is truly a city in itself. It has its own utilities and traffic system, a well-regulated hospital system, its own churches, theaters, gymnasiums and athletic fields. It is named for Corporal Frank W. Scott, who met his

death in an experimental flight at the first Army aviation school at College Park, Maryland, in 1912. Its laboratories, training radio operators for the Army Air Forces, are among the best-equipped in the world.

The present commanding officer at Scott Field is Col. Wolcott P. Hayes, who arrived at the post in July, 1940. Col. Hayes joined the Army in 1917, taking an examination for a commission in the cavalry. In December, he was promoted to first lieutenant, and in July, 1918, transferred to the Philippine Islands with the rank of captain. While there he was transferred to the Air Corps, later to be advanced to his present rank in that branch. Col. Hayes holds ratings as command pilot, combat observer and technical observer.

"The new edition is first-rate..."

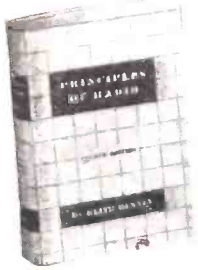

With or without the aid of a teacher, with or without technical training, "Henney" is on hand in a new edition ready to guide you in easy stages to a working knowledge of radio. Gives fundamentals in easy-to-understand language, and applies them to modern problems.

Fourth Edition  
**Principles of RADIO**

By KEITH HENNEY  
Editor, ELECTRONICS

What's new: The fourth edition of "Henney" contains the latest on detection, ultra-high frequencies, television, radio-frequency amplifiers, vacuum tube detectors, frequency modulation antennas, etc. It's all there—from principles of electricity to their application to radio practice.

"Principles of Radio" has been chosen as the textbook for the course sponsored by the U. S. Office of Education and the U. S. Signal Corps.

549 Pages      316 Illustrations  
6 by 9—\$3.50

ON APPROVAL COUPON

JOHN WILEY & SONS, INC.  
440 Fourth Avenue, New York, N. Y.

Kindly send me a copy of Henney's "Principles of Radio" on ten days' approval. If I decide to keep the book I will remit \$3.50; otherwise, I will return the book postpaid.

Name .....

Address .....

City and State .....

Employed By .....

RC-8-42

**THIS IS YOUR CHANCE!**

★ You may never have another chance to step into a real paying position where opportunity is unlimited... RADIO CODE OPERATORS are wanted right now!... The Army, Navy and our Merchant Marine needs trained operators—you can train for one of these positions now!—right in your own home by the Candler System. Thousands of code operators have been trained by the Candler System during the past quarter of a century. Today you, too, can learn by using this easy, practical system. Courses for beginners and operators wishing maximum code proficiency. It's up to you—if you want a real future send a post card or letter today—no salesman will call.

**GET A FREE BOOK**

Write today and get the free BOOK OF FACTS. Tells you all the facts about being a Radio Code Operator—your copy is waiting for you, send for it today! There's no obligation.

**CANDLER SYSTEM CO.**

BOX 928  
Dept., S-8 Denver, Colorado

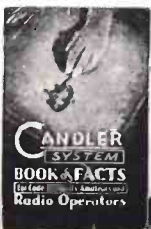

**RCA'S ALL-OUT FOR VICTORY**

(Continued from page 714)

Service also has been expanded, and is geared to receive pictures from Cairo and Moscow, in addition from London, Buenos Aires, Honolulu and Melbourne.

In wartime, ships go to sea as silent "phantoms" lest the enemy detect their whereabouts. But to every vessel radio is of double importance in times such as this. Radio is an invisible guard of the convoy, and through its contributions to the development of marine radio equipment, RCA is safeguarding life and property at sea, not only with radiotelegraph equipment, but with automatic radio alarms, radio direction finders and lifeboat radio apparatus as well.

To operate the mighty radio communication systems of this nation there must be man-power as well as kilowatts. RCA Institutes, with an experience in teaching radio subjects that dates from 1910, is training men in all phases of radio. Today, more than 1,100 students are receiving technical instruction at the Institutes—instruction that will make them valuable as operators and technicians in the various radio activities of wartime.

**RESEARCH MEETS WAR DEMANDS**

In RCA Laboratories, research and development are constantly being expanded to aid in the war effort. Research fortifies the nation's communications, and under the impetus and demands of war, achievements of scientists are multiplied. Research engineers are soldiers of science in modern war. Details of their wartime victories cannot be disclosed until the war is won. But the radio scientists are continually pioneering and inventing.

When peace comes, the radio swords which are now being forged on the anvil of science will be beaten into ploughshares useful in normal life. Then there will be a new era in the radio transmission of sound and sight, and in the industrial uses of radio and electronic devices. The new products and services growing out of radio's wartime efforts will be of great public benefit in themselves. Broadcasting, with its tremendous contribution to national entertainment, information and education, followed World War I. Today, radio, television and the science of electronics hold equal promise of providing new employment for men, money and machines, thereby contributing to the stabilization of the post-war economy.

**NEW RADIO DEVELOPMENTS DESCRIBED TO I.R.E.**

(Continued from page 723)

cuit effectively reduces nonlinearity, increases stability and at the same time keeps tube noise and hum at a minimum level. An analysis of the reactance part of this circuit and formulas for calculating the effective Q and the optimum operating conditions were given.

A paper entitled "Frequency-Modulation Distorted in Loudspeakers," by Mr. Beers and H. Belar, pointed out that as the frequency response range of a sound reproducing system is extended, the necessity for minimizing all forms of distortion is correspondingly increased. The part which the loudspeaker can contribute in the over-all distortion of a reproducing system has been frequently considered. A type of loudspeaker distortion which has not received general consideration was described. This distortion is a result of the Doppler effect and produces frequency modulation in loudspeakers

reproducing complex tones. Measurements which confirm the calculated distortion in several loudspeakers were shown.

One of the important aspects of turntable design, that of constancy of speed, or freedom from "wows," was outlined in a paper by H. E. Roys, of RCA Manufacturing Company, Indianapolis, Ind. Previous methods of "wow" measurement and improvements in apparatus and method were described, and factors involved in measurement of turntable-speed variations together with means of minimizing error caused by different rates of variation were given.

Other papers were:

"Recording Standards," by I. P. Rodman, Columbia Recording Corporation, New York, N. Y.

"Radio-Frequency Oscillator Apparatus and Its Application to Industrial Process-Control Equipment," by T. A. Cohen, Wheelco Instruments Company, Chicago, Ill.

"Half-Wave Voltage-Doubling Rectifier Circuit," by W. D. Waidelich and C. H. Gleason, University of Missouri, Columbia, Mo.

"High-Power Television Transmitter," by H. B. Fancher, General Electric Company, Schenectady, N. Y.

"Effect of Solar Activity on Radio Communications," by H. W. Wells, Carnegie Institution of Washington, Washington, D. C.

"Circular Antenna," by M. W. Scheldorf, General Electric Company, Schenectady, N. Y.

"The Focusing-View-Finder Problem in Television Cameras," by G. L. Beers, RCA Manufacturing Company, Camden, N. J.

"Automatic Frequency and Phase Control of Synchronization in Television Receivers," by K. R. Wendt and G. L. Fredendall, RCA Manufacturing Company, Camden, N. J.

**G.E.'S WAR WORK TO YIELD POST-WAR BENEFITS**

(Continued from page 718)

And the U.S. Army Air Forces must be dead sure they have that strength. Electronic tubes and strain gauges give that assurance. By attaching strain gauges to the proper parts of a wing, and by putting recording instruments in the plane, a few little electronic tubes will write a complete record of the strains during a test flight. From these records, the designer knows whether he can reduce weight and thus give more speed to bombers and fighters. But most important, he knows that American boys can fly American planes with greater safety. And he knows that the science of electronics can provide him with the facts to build planes that really can take it.

**TUBES CHECK PLANE STRUCTURE**

Stresses in the plane structure are detected by the strain gauges, which are mounted on various parts of the plane. These stresses are converted into tiny electrical impulses which are amplified sufficiently by electronic tubes to drive highly sensitive oscillograph galvanometers. By deflecting light beams of an optical system, the galvanometers record the strain gauge impulses on a photographic film. Having calibrated this equipment before flight tests, the trace on the film can be converted to either pounds per square inch of load on the plane structure, or by thousands of an inch deflection.

To the men in laboratories, and to the men in the factories and the offices of the electrical industry, it seems natural to speak of electronics as a science of the future



because it gives such promise of great things to come. Yet that promise is based solidly on the present, as the electronic tasks and achievements sketched so hastily here will indicate. Of electronics' part in the war little has been said, but much will one day be written. While war with one hand withholds and obstructs our peaceful progress, commanding the energies of science for its own purposes, with the other it actually pushes forward research and application. Under the lash of necessity, developments which might have taken years are compressed into months.

**SILVER REPLACES SCARCE METALS**

Just as Pizarro, conqueror of Peru, once shod his horses with silver in an emergency, General Electric engineers are now using the precious metal in place of tin, copper and other scarce materials in radio and electrical apparatus.

There is at least a little silver now, according to Vice-President Harry A. Winne, in almost every motor, generator, transformer or other piece of apparatus made by the company for the war.

"In many cases the use of silver adds to the cost, a consideration secondary to production at the moment," said Mr. Winne, who is in charge of G.E. apparatus design engineering. "In such instances, its use is probably temporary.

"On the other hand, the use of silver in current-carrying contacts and in brazing alloys frequently results in an improvement in quality sufficient to justify the greater cost, and so for these purposes its use will not only continue after the war but probably will increase."

The use of silver is saving huge quantities of tin at General Electric. In 1940, the company used approximately one million pounds of tin. This year, in spite of the fact that production has more than doubled, it is estimated that the amount of tin consumed will remain the same. Thus savings of more than 50 per cent in normal requirements of tin are being effected, in no small measure, by use of increased silver content in alloys.

Silver is replacing tin in soft solders, alloys which require comparatively low temperatures in joining metals. In the past, these alloys have had a relatively high tin content, ranging from almost pure tin to a very common composition of 40 per cent tin and 60 per cent lead. Today, however, solders in wide use range from 20 per cent tin, one per cent silver and 79 per cent lead, to 97.50 per cent lead and 2.50 per cent silver.

Substitutions of silver for copper are being made in brazing alloys, which require high temperatures for joining metals. One type of brazing alloy, widely used before the war, was composed mainly of copper, the remainder being silver and phosphorus. Now alloys with copper content as low as 16 per cent are in general use. A typical alloy consists of 50 per cent silver, 16 per cent zinc, 18 per cent cadmium and only 16 per cent copper.

Aside from saving tin by reducing the tin content of solders, brazing technique is now widely replacing soft soldering to conserve tin and copper. Brazing also, chiefly because of the silver present, is often quicker, more reliable and economical. Soft soldering requires a separate operation—pre-tinning of points of contact—not necessary in brazing. Some types of soft soldering also utilize a clip, or over-all metal band, in binding two bars together, which can be eliminated in brazing. In general a soft-soldered bond is less strong than a brazed connection.

A fourth advantage of brazing has been developed from experiments in adapting



**WHAT NOW?**

**No one can predict what changes may have to be made in condensers, or what additional types may yet have to be eliminated to conserve vital materials for War needs—BUT . . .**

**The fact remains that Sprague jobbers can still supply Sprague Atom Midgets and EL prong-base dry electrolytics plus TC Paper Tubulars—and these three famous condenser types will handle practically any radio set replacement job, including replacement of most wet electrolytics. The size may be different, mounting might occasionally require some ingenuity—but you can count on Sprague quality, and that's the all important thing.**

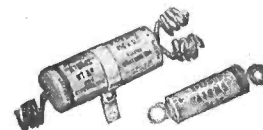
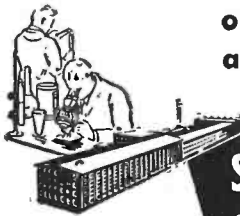

Atoms are smaller, more dependable, cost less. Available in all ranges and in many combinations.



Sprague EL prong-base electrolytics are ideal for replacing can dries and can wet electrolytics.

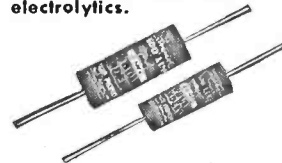

TC's meet every tubular-type by-pass condenser need—efficiently and economically.

**SPRAGUE PRODUCTS CO., North Adams, Mass.**

*Quality Components—Expertly Engineered—Competently Produced*

joint to the process; such redesigning of joints has resulted in simplification and hence in further savings in the amount of copper used. Such economies as these in materials, costs and engineering, almost certainly will be carried over into post-war manufacturing practice.

Although silver is not under priority regulation, some suppliers are finding it necessary to ration the quantities they are able to deliver to their customers. The United States Treasury has much silver and the War Production Board is understood to be studying the possibility of obtaining supplies from this source.

It has been reported that the WPB already has effected a deal whereby silver has been loaned "for the duration" to an aluminum concern for busbars essential to production. The situation is complicated by

legislation which requires the government to buy domestic silver at 71.11 cents an ounce, more than double the usual world price of approximately 35 cents. Also, the sale of Treasury stocks is forbidden.

**MEASURING RESISTANCE WITH A VOLTMETER**

*(Continued from page 732)*

handbook. The big advantage of these methods is, however, that they can be used to measure a resistance at a moment's notice when other equipment may not be available. The accuracy of the measurements depends, of course, upon the accuracy of the voltmeter and of the standard resistors.

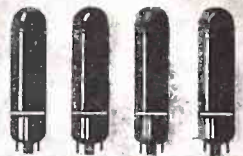

**4 STANDARD TYPES**  
of Amperite Regulators replace over 400 types of AC-DC Ballast Tubes now in use. Amperites are real REGULATORS... have patented Automatic Starting Resistor which prevents initial surge and saves pilot lights... Ask Your Jobber.

**AMPERITE**

THE *Simplest* WAY TO REPLACE **BALLASTS**

WRITE FOR REPLACEMENT CHART  
AMPERITE CO. 541 BROADWAY, NEW YORK, N. Y.

**Big in VALUE**



**Readrite**  
RANGER  
MODEL 432-A

The Outstanding Tube Tester Value . . . . Checks all type tubes including Loctals, Bantam Jr., 1.4 volt Miniatures, Gaseous Rectifier, Ballast, High Voltage Series, etc. Filament Voltages from 1.1 to 110 volts. Direct Reading GOOD-BAD Meter Scale. Professional-appearing case with accessory compartment large enough for carrying Model 739 AC-DC Pocket Volt-Ohm-Milliammeter, thereby giving the serviceman complete testing facilities for calls in the field. . . . Model 432-A with compartment, Dealer Net Price . . . . \$20.73. Model 432-A in case less compartment . . . . \$19.65. Model 739, Dealer Net Price . . . . \$10.89.

WRITE FOR CATALOG—Section 1116 College Drive

READRITE METER WORKS, Bluffton, Ohio

**THE CATHODE FOLLOWER**

(Continued from page 737)

might move it to *C* on the adjacent static curve. A further similar increase in  $I_a$  will move the point to *D*. Line *ACD* now gives a working characteristic curve for the cathode follower.

Consider now the curves given by the makers of the tube as shown by the accompanying graph—Fig. 5. The load  $R_k$  is 2,000-ohms, so first draw the load line for 2,000-ohms in the usual way. The plate supply is 300 volts. As the  $V_g$  curves are given in steps of -10 volts, it will be found convenient to use this figure for drawing working lines and each calculated point will fall on a  $V_g$  curve.

$$dI_a = \frac{-dV_g}{R_k}$$

So when  $dV_g = -10$ ,  $I_a = \frac{-(-10) \times 1000}{2,000} = 5\text{mA}$ .

When  $dV_g = -20$ ,  $I_a = 10\text{mA}$ .

These figures on the curve will give a working line for  $V = 0$ , the slope of this line being 0.5 mA/volts.

Since  $V = (I_a \times R_k) + V_g$ , then when  $I_a = 8\text{mA}$  and  $V_g = 0$ ,  $V = (0.080 \times 2,000) + 0 = 160$  volts and when  $I_a = 90\text{mA}$  and  $V_g = 20$ ,  $V = (0.090 \times 2,000) + (-20) = 160$  volts.

These figures give a working line for  $V = 160$ , the slope also being 0.5 mA/V. Where the static curves are straight, these working lines are parallel but where the static curves are very much bent, the working lines are slightly curved.

Thus the graph can be filled with working lines, but knowing the signal will only swing from  $V_g = 0$  to cut-off point at  $V_a = 300$  volts. Also draw a few working lines about the physical center of the load line for convenience in fixing later the electrical center.

Having drawing these working lines, it can be seen that a signal swinging the grid from  $V_g = 0$  to cut off can be accommodated between points *A* and *B*, or from  $V = 171$  to  $V = -54$ , which gives a peak to peak value of 112.5 volts. Now this signal swings about the electrical center of the load line which is  $171 - 112.5 = 58.5$  volts

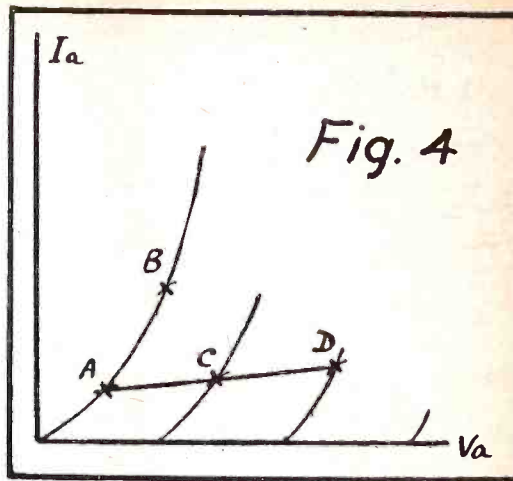

Drawing typical  $I_a/V_a$  curves.

(point *C* on graph—Fig. 5). This also indicates that for correct working of the valve a positive bias of 58.5 volts must be applied to the grid. Under "no signal" conditions the tube will have 58.5 volts positive bias, less the voltage developed across  $R_k$  which is 80.5 volts leaving -22 volts bias. Thus whatever the input signal, the grid is always swung about the point *C*.

The output voltage is read off the  $V_a$  axis and is  $300 - 127 = 173$  volts peak to peak, thus the output voltage is 86.5 peak or 60.5 volts R.M.S.

The voltage amplification factor is:

$$\frac{\text{Output Voltage}}{\text{Input Voltage}} = \frac{86.5}{112.5} = 0.76$$

The length of line *AB* = 140 mm, so the length to its center is 70 mm. (point *D*). The length of the line *DC* is 4 mm. The percentage of second-harmonic distortion is:

$$\frac{DC}{AB} \times 100 \quad \text{or} \quad \frac{400}{140} = 2.8\%$$

The problem is now solved and the answers are:—

- (1) Maximum permissible input signal = 112.5 volts peak or 78.75 volts R.M.S.
- (2) Value of additional bias to give correct working = + 58 volts.
- (3) Output voltage = 86.5 volts peak or 60.5 volts R.M.S.

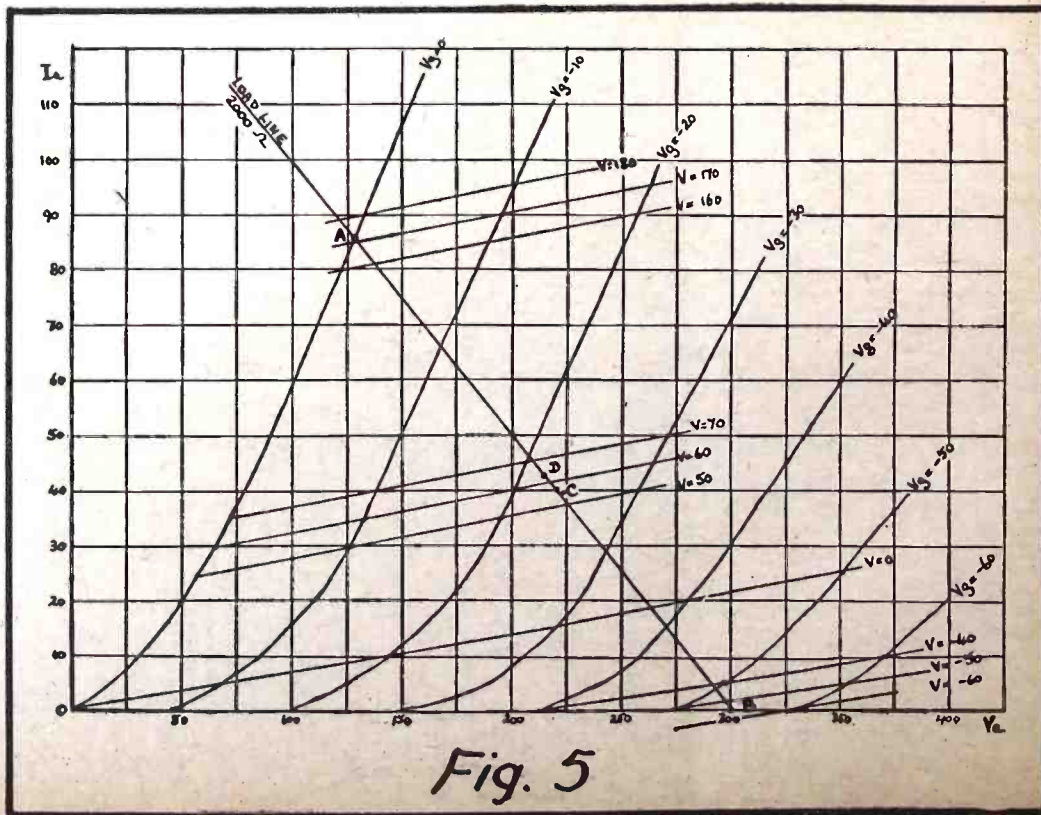

Fig. 5

(4) The voltage amplification factor = 0.76.

(5) Percentage of second-harmonic distortion = 2.8%.

Perhaps it is worth while noting that although this valve is not a particularly good one as a cathode follower—the voltage amplification factor should be nearly 0.9—as an ordinary amplifier it would only handle an input signal of 22 volts without giving more distortion.

—The T. & R. Bulletin, London.

### SERVICING—SECOND FRONT FOR RADIO IN WAR

(Continued from page 722)

times. In fairness to new and old employees and as a time and expense saver, the men in your shop need all available data which has been prepared by factory engineers.

- Investigate the procedures now being followed in your Service Department and attempt to improve them by establishing a speed-up and streamlined system of operation. This should cover incoming and outgoing deliveries and the exact status of each repair job at any given time, parts inventory records, and re-order files plus accurate bookkeeping.
- Establish standard charges for inside and outside service on a labor plus material method. Overhead and local conditions govern hourly labor rates and, therefore, we recommend that each dealer set up his own charges on a fair but profitable basis.
- Competition still exists in the service business. Therefore, the dealer who actively promotes his Repair Department attracts the attention of his own customers and many who may have purchased their radio from a competitor. Display cards in the window and in the window and in the store, newspaper advertising, listing in the Classified Section of the Telephone Directory, "spot" announcements over broadcasting stations, and truck signs are approved methods of placing your names before the public. Sell service—it will pay dividends.
- By outstanding service and fair business practices make each and every customer a booster for your company and your Repair Department.

#### TO THE SERVICEMAN:

- First and foremost have a thorough knowledge of the merchandise which you are called upon to service. Study, as never before, all available data on circuits, automatic record shifter units, and the component parts of all receivers.
- Always remember that you represent your company which prides itself on a high rating in the community. You should bear this in mind on each consumer contact and present a clean and neat appearance, talk diplomatically and instill in the consumer the utmost confidence in your ability. As in any profession your character and capabilities can build up or tear down the reputation of your employer and yourself.
- Do the job right the first time, thus saving expense, time, rubber, gas and very often the customer's faith in you. Many Servicemen today pride themselves on their ability to locate and remedy minor troubles in the radio at the customer's home. This relieves the shop of congestion and meets wholeheartedly the recommendations of the government regarding transportation problems.
- Tackle your work each day confident

that you are playing an important part in the war effort. The American public is relying on you to "Keep 'em listening!" and our Government has endorsed your important job of "keeping all radios working at all times during this emergency period!"

### WESTINGHOUSE WAR WEAPONS

(Continued from page 717)

four and a half million tons of this important metal can be "rescued" from a cubic mile of sea water, metallurgists say. Ignitrons have been adapted to the spot welding of stainless steel and aluminum, processes that require precisely measured amounts of electric power.

#### X-RAYS SEE THROUGH INCH OF STEEL

The familiar X-Ray, long used for dental examinations, studying bone fractures, and for disclosure of hidden flaws in industrial castings and forgings, is now also helping ballistics experts to study the behavior of bullets in flight. A new high-speed X-ray tube has been developed that can penetrate an inch of steel in a millionth of a second, and thus take pictures of actual bullets in flight through gun barrels or when crashing in to armor plate.

Using a battery of high-powered condensers to build up an enormous electrical charge, this new electronic tube takes a jolt of 300,000 volts at 2,000 amperes, and converts it into a stream of X-radiations.

Although now used only in the study of ballistics, the new tube promises to be an important tool in the hands of the nation's industrial engineers after the war. With it, they will be able to study the inner workings of machines in motion, and thus improve the efficiency and durability of automobiles, electric power generating equipment, motors, and other mechanical and electrical devices.

Medicine and surgery will benefit, too, from this electronic advance, engineers believe, because physicians can study bones and organs of the body in motion.

Even the nation's dinner table may be better loaded in the future because of advances in the study of X-radiations; it has been found that entirely new mutations of plants can be produced by exposing seed to these electronic rays. Engineers believe this may lead to entirely new food-plant forms, or greater productivity of farm lands.

#### ULTRA-VIOLET FIGHTS DISEASE

Engineers have already developed electronic ultra-violet-ray tubes that can kill the bacteria of a host of diseases, and are on the threshold of pitting these ultra-short-wave rays against the disease viruses, which no man has ever seen.

This germ-killing ultra-violet lamp, whose invisible rays have the power to sterilize air in a matter of seconds, is called the Sterilamp. It is a slender glass rod filled with a mixture of inert gases and mercury vapor. When the tube's electrodes release a stream of electrons into this mixture, the tube emits ultra-violet radiations of a wave length that is lethal to 99 per cent of all bacteria which come within their range.

Special applications of these ultraviolet lamps in combination with floodlighting over hospital operating tables materially reduce post-operative infections by sterilizing the air and the open surfaces of the wound. Barriers of ultraviolet radiations thrown across doors and corridors in hospital contagious wards check the spread of air-borne infectious diseases.

## SPRAYBERRY RADIO TRAINING FULL EQUIPMENT

Experience Easily Acquired at Home



You Do Practice-Giving Experiments. Many Special Features. ALL Designed to Help You Make Fast Progress

SPRAYBERRY Training starts right at the beginning of Radio. You easily learn Television, Frequency Modulation, Signal Tracing, Mobile Radio (Auto-Tank), Aviation Radio, Electronics, Facsimile Radio, Radio Set Repair and Installation work.

Training Prepares You for a Business of Your Own or Good Radio Jobs

at Excellent Pay  
The great fascinating and progressive field of Radio offers many opportunities to the man who wants to get ahead. My Training is designed to give you quick access to these opportunities. SPRAYBERRY Methods are thorough and practical. Your training will not interfere with your present work. No previous experience is needed.

You Get Complete 5 Tube Radio Set With the Radio Parts given (everything needed to build a Complete Receiver) you conduct interesting informative experiments with your own hands. You quickly learn how Radio breakdowns occur how to repair them.

Earn While You Learn  
My BUSINESS BUILDERS show you how to secure and handle money-making Radio Service Jobs shortly after you begin Training.

THE SPRAYBERRY COURSE IS SOLD UNDER MONEY-BACK AGREEMENT

RUSH COUPON for BIG FREE BOOK

SPRAYBERRY ACADEMY OF RADIO  
F. L. Sprayberry, President  
520-H University Place, N. W.  
Washington, D. C.

Please rush my FREE copy of "HOW TO MAKE MONEY IN RADIO."

Name .....  
Address .....  
City ..... State .....  
(Mail in envelope or paste on penny postcard)

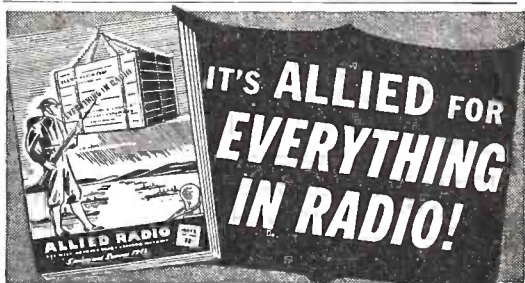

Equipment for  
War Industry  
Armed Forces  
Home Front

RADIO plays a big part in our march to Victory—and ALLIED plays a big part in Radio.

American War Industry counts on ALLIED for its Radio and Electronic equipment used in research and production operations.

ALLIED is at the service of our Armed Forces, supplying thousands of radio items for active use and instruction applications.

And on the Home Front, ALLIED helps keep American radios at top efficiency.

Your ALLIED Catalog is the key to Everything in Radio—Radio Receivers; Test Equipment; Tools; PA Systems; Tubes; Books; over 15,000 Radio and Electronic Parts for service replacement work, for Industrial application, for war use. And all this is backed by Radio's most complete stocks and speediest service. It will pay you to keep your ALLIED Catalog handy for Everything in Radio!

### ALLIED RADIO CORP.

833 W. Jackson Blvd., Dept. 2-H-42  
Chicago, Illinois  
Send me your FREE 1942 Radio Supply Catalog.

Name .....  
Address .....  
City ..... State .....



**TO Replace DISCONTINUED WETS . . .**

Despite shortages of this, that and the other material, Aerovox continues to meet the essential requirements of servicing. Through engineering ingenuity closely geared to field conditions, plus exceptional production foresight and facilities, Aerovox still has a suitable replacement condenser for almost every need. In dry electrolytics to replace discontinued "wets," for instance:

- Type GL, the always popular metal-can dry electrolytic. High filtering efficiency. Necessary choice of capacities, voltages and combinations.
- Type F prong-base dry electrolytic in compact metal can, packing a lot of dependable capacity into mini-mized bulk. Already a popular replacement item in sets initially equipped with this type, it is now being used for general servicing as well.
- Type PRU, the handy AC-DC universal replacement dry electrolytic in tubular cardboard casing, with spade lugs. Wide choice of popular capacities, voltages, combinations.
- Also the popular PRS Dandees, PBS cardboard tube electrolytics, PR tubulars, etc.

**Ask Our Jobber . . .**

He'll gladly check over your condenser replacement problems and recommend suitable Aerovox types. Ask for latest catalog—or write us direct.

**AEROVOX CORPORATION**  
 NEW BEDFORD, MASS., U. S. A.  
 In Canada: AEROVOX CANADA LTD., Hamilton, Ont.  
 EXPORT: 100 Varick St., N. Y., Cable 'ARLAB'

Diagrams for

**The Radio Experimenter**

This is a new department. If you have a new Hook-Up, send it along; a pencil diagram will do. Be sure to include a brief description.

All diagrams and descriptions accepted and published will be awarded a year's subscription. Diagrams may be for receivers, adapters, amplifiers, etc. Send them to Hook-Up Editor, RADIO-CRAFT, 25 W. Broadway, New York City.

**A HOME-MADE STROBOSCOPE**

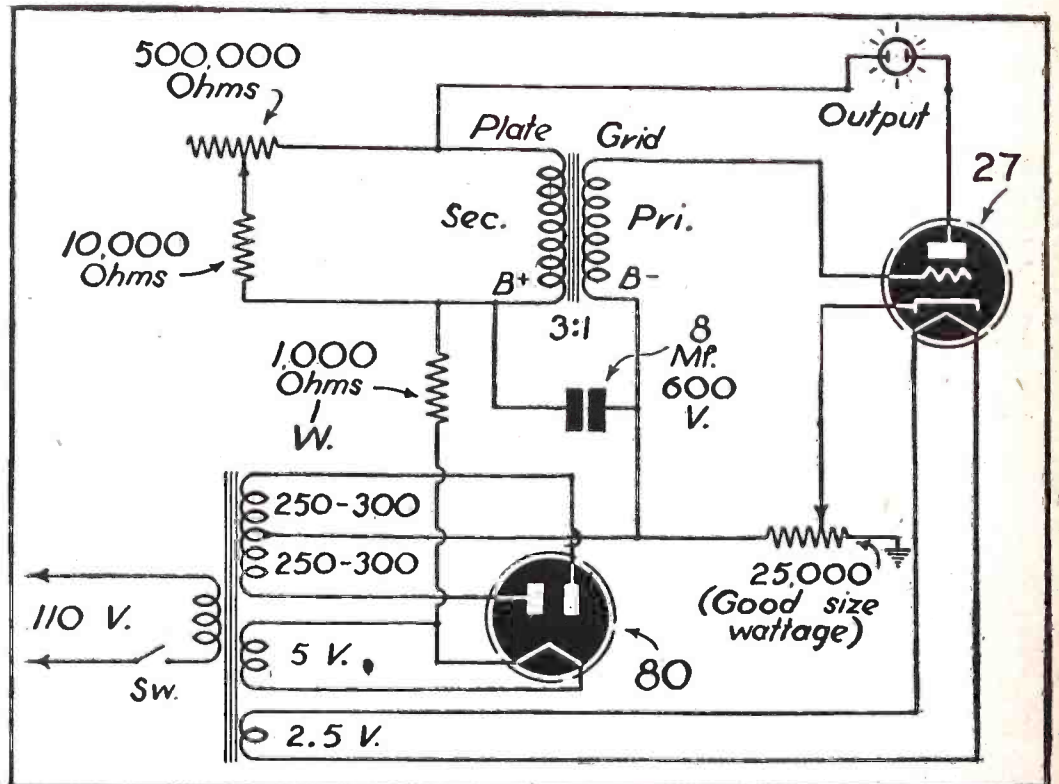

Here is a diagram of a simple home-made Stroboscope that works by simply attaching one or two medium-sized neon bulbs in series with the output of the circuit or by connecting an ordinary small fluorescent bulb in series with the output.

The two variable resistors can be adjusted to decrease or increase the frequency of the output so that when a fan or other rotating or moving object is placed in the vicinity of the oscillating neon bulb the object will appear to stand still.

No chokes are needed for the power supply, which may be between 250 and 300 volts, but the 8 mf. condenser is a necessity if the circuit is to work. The output transformer (audio) does not necessarily have to be a 1.3 (primary to secondary) ratio but may be some other closely related ratio. I might also add that when using a fluorescent bulb instead of neon bulbs in the output, an interesting rainbow color effect will be achieved by the rotating object.—Roy A. Hempel, W8VWS, Cleveland Heights, Ohio.

**A SIMPLE 2½-METER TRANSCEIVER**

This transceiver can be built with a very minimum of expense and time. One feature of this circuit is the use of a single 1,000-ohm headphone as both receiver and "mike." Although it might appear that the one stage of audio would not be enough with a headphone used as a mike, in actual operation it has proved sufficient.

JAMES ALEXANDER,  
 Terre Haute, Ind.

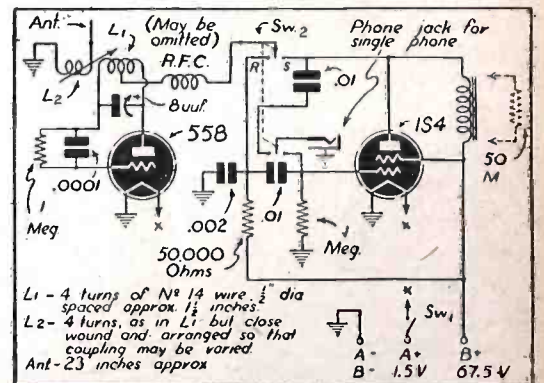

**NEW SHURE BOOKLET**

"Long Live Your Microphone" is the title of an interesting new 4-color 16-page booklet prepared and published by Shure Brothers, designers and manufacturers of microphones and acoustic devices.

This booklet tells in story and picture "how to get the best service from your microphone." There are helpful hints on the use and care of crystal, dynamic and carbon microphones, and practical pointers

on feedback, cable, plugs, output, response and other valuable information.

It is the first such booklet that Shure has published and the material and data are based on actual statistics from the Shure Service Department. It is a practical guide for microphone users. A copy may be obtained free of charge by writing for Bulletin 173G to Shure Brothers, 215 West Huron Street, Chicago, Illinois.

## The Boys Who Listen

By STEFAN JEAN RUNDT\*

SHORT-WAVE listening posts are as integral composites of total warfare as are panzer divisions, paratroops and stukas. They are simultaneously reconnaissance units collecting vital information and munitions plants manufacturing the missiles of psychological offensive. These radio receiving centers are maintained by press services, individual publications, radio networks, the Federal Communications Commission, the Office of War Information and the Intelligence Divisions of our Army and Navy. Distributed from Puerto Rico to California, they are part of our war effort; they are links of foremost importance within the framework of United Nations strategy.

"Cans" glued to their ears, bent toward blasting loud speakers and reeling off dictaphone cylinder recordings, hundreds of "monitors" patrol the ether. In "shacks," farm houses, far from man-made disturbances, and in editorial offices to which special lines are piped, these listeners are the soldiers of the "fourth front"—propaganda and morale. They are flooded by lies, allegations, acceptable truths and factual data.

Expert engineers "cruise the spectrum," hunting for new emanations and still unheard broadcasts. The most powerful sets, fed from mathematically calculated antennas, "pull in" voice transmissions and wireless Morse code dispatches, either in open languages or in ciphered messages. Until he gets "tin ears," the monitor hears headline scoops, hidden admissions, official releases, claims, denials, discrepancies, confirmations and counter-assertions. Military essentials, foreign press reactions, vital economic data, revealing trends, background details and government communiqués are extracted from broadcasts. Spot news, flashes and "victory fanfares" are relayed.

Our own transmissions to Europe and Asia depend upon material "picked out of the air" from enemy and Allied wave lengths. From feature and propaganda presentations, listening posts skim data indicative of prevailing conditions. Quantitative and qualitative analyses, digests, excerpts and trend reports from broadcasts render composite pictures which at a glance afford insight into preparations for actions to come.

Virtually all countries operate short-wave transmitters. Over each transmitter many frequencies may be broadcast. Directly or indirectly, Germany alone controls over 110 wave lengths from Oslo to Algiers and from Paris to Smolensk. One single talk from Berlin may be picked up on nine different dial positions. A single receiving center can log as many as one hundred points of origin, can record as many as 450 frequencies and listen in to over 600 newscasts, all in one day. In twenty-four hours one monitor can hear what forty countries have to say.

At times twenty news summaries are on the air simultaneously from such distant capitals as Hsinking and Bratislava. Over seventy distinct languages fill the international ether. Glib voices try to convince the world and eminent speakers to inform it. One may hear Rhaeto-Romanic from Switzerland, Gaelic from Eire, Tamil from London, Fukienese from Nanking and Hindustani from New Delhi. The Japs talk in Arabic to the Near East, the Nazis incite the Persians, the Italians misinform the Ruthenians.

In turn, Melbourne broadcasts Tagalog to the Philippines, San Francisco short-waves in Japanese, Boston in Serbo-Croat, London in Polish and Moscow in Italian.

\*In NEW YORK TIMES.

## Erwood SOUND SYSTEMS

### Typical Applications

Factories  
Auditoriums  
Chapels  
Hospitals  
Cantonments  
Shipyards  
Ships  
Mobile P.A.  
Music for workers  
Morale meetings  
War Bond rallies  
Announcements  
Group orders  
Air raid warnings  
Fire alarms  
Paging  
and hundreds of other uses

### Serving on Many Fronts!

● From the humming war plants in our home defense areas to the far-flung outposts of our armed forces, Erwood products are the soldiers of sound and communications—amplified, multiplied. Erwood's contribution to Victory is just as we, AND YOU, would want it—all-out!—in the fullest meaning of the term. Yet Erwood systems of the proper types can still be furnished to priority-rated concerns. Systems of 8 to 75 watts, with unusual flexibility meeting most needs. Faithfully made; conservatively rated.

Our catalog, sent on request, will help you determine your requirements.

ERWOOD SOUND EQUIPMENT CO., 222 W. ERIE ST., CHICAGO, ILLINOIS

Sverdlovsk in the Ural addresses Nazi soldiers in Kharkov; Daventry, England, talks to Italian sailors; German-run Belgrade sings the Czarist anthem for Ukrainians; Lahti, Finland, thanks Rome for a shipment of macaroni. Ankara reports famine in Greece. Vichy relays the Slovak Army bulletin. Radio Saigon parrots Tokyo. Rome tries to humor Italian prisoners in Egypt. Lisbon informs the world on Angola. The Vatican releases church news.

Khabarovsk in Far Eastern Siberia talks for Soviet peasants. A station in Japan-controlled Shanghai opens with "Heil Hitler." Thousands of regular commentators, newscasters and guest speakers step to the "mike" in all parts of the globe. Rear Admiral Luetzow dissects Nazi naval strategy from Berlin; expatriate Ezra Pound delivers his smutty talks in the pay of Radio Rome. Pat O'Brien speaks to Ireland for Dr. Goebbels; Vernon Bartlett, M.P. and foreign editor of *The London News Chronicle*, J. B. Priestley, Wickham Steed speak over BBC facilities.

Monitors are carefully selected. They are generally American citizens, invariably linguists commanding from three to twelve languages, in all dialects. All of them have spent years abroad, are thoroughly acquainted with foreign mentality, customs, geography, history and the biographies of personages overseas. They are usually experienced newspaper men, and their work demands keen news sense, meticulous analysis, thorough psychological evaluation. In close contact with monitors work cryptographers, code experts, propaganda specialists, analysts and statisticians.

They all demand verbatim translations, as do editors and government departments. The finest shading must be considered in English renditions. Therefore shorthand notes must be taken rapidly and with care, condensations must be reliable. Excerpts must be chosen for their characteristic value. Transcripts from wax recordings must be textual to the letter. Technical phraseology, figures, even puns, must be taken into consideration. Notes must be rechecked against recordings. "All American consular officers shot in Korea" should have said "... consular offices shut in

# THANKS

# TO YOU, MISTER SERVICEMAN

Many Jobbers still have SUPREME Instruments in Stock. Tell us the instrument you want. We'll do our best to get it for you.

From the first SUPREME instrument, and through the fourteen years since, the acceptance, loyalty and co-operation of servicemen everywhere are largely responsible for the excellence of SUPREME instruments today—and our ability to produce them in quantity for our armed forces. If you could not get the new equipment you wanted this year, just remember that it is now doing duty for us in some spot on the globe and represents part of your contribution to Victory.

# SUPREME

INSTRUMENTS CORP.

GREENWOOD, MISSISSIPPI, U. S. A.

## WORLD-TIME CLOCK

The Only Clock for Universal Use Throughout the Entire World!

A REGULAR CLOCK  
with A.M. and P.M. divided dial

A WORLD-TIME CLOCK  
instantly indicating time in all 24 zones

INTERNATIONAL CLOCK  
with A.M. and P.M. 24 hour dial

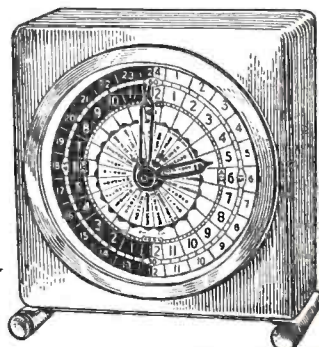

Here is really the first new clock advancement in 200 years—three clocks in one, a world-time clock. It is revolutionary! It is years ahead! The Sky Pilot WORLD-TIME CLOCK is the only clock designed for use anywhere in the world. For short-wave fans this clock offers great convenience—it is educational and at the same time indicates world time differences. In a few seconds you can determine the correct time in London, Moscow, Hawaii, Tokyo, Buenos Aires, Halifax—anywhere. American made—it is exceptionally easy to operate. It carries a guarantee of ninety days against defects in material or workmanship. In modernistic design, it is made of brushed brass—measures 5 1/4" high by 4 3/4" wide—and has convex crystal.

Electric (for A.C. 110-120 volts, 60 cycles) \$9.95

Spring Model ..... \$8.95

P.P. prepaid in U.S.A.  
Remit by check or money order; register letter if you send cash or unused U.S. postage stamps.

**GOLD SHIELD PRODUCTS**

350 Greenwich St. Dept. RC-8 New York City



## Amazing New "WALSCO" STAPLE DRIVER

for radio men, electricians, or anyone doing stapling. Makes wire and cable installations twice as easy—much neater—saves half the time. Wires can be stapled in corners, behind pipes, into moldings—places never accessible with a hammer and ordinary staples. Drives staples even into walls, brick, mortar, etc. Magazine works automatically and holds strips of staples which come in several colors. Ask your jobber for demonstration and catalogue 41-C of all WALSCO PRODUCTS

or write **WALTER L. SCHOTT CO.**  
5264 W. Pico Boulevard, Los Angeles, California

# Lowest Priced Publications for Experimenters

10 FOR 50c

Here is a large number of radio, short-wave, and mechanical "how-to-make-it" designs. Each is a special publication originated by masters in their respective fields. For the low price of 50 CENTS, you buy TEN complete pamphlets with photographic reproductions, complete mechanical layout, and full description to make it possible for anyone to build the project in question.

PLEASE ORDER EACH PROJECT BY ITS PUBLICATION NUMBER, and use the special coupon below. We accept money-orders, cash, checks or new U. S. stamps. (No foreign stamps.) If you send cash or stamps, register your letter. Money refunded if you are not satisfied. ANY TWENTY-FOUR PUBLICATIONS FOR ONE DOLLAR.

## SHORT-WAVE RECEIVER PUBLICATIONS

- HOW TO MAKE THE "OSCILLODYNE" 1-TUBE WONDER SET. No. 101
- HOW TO MAKE THE "19" TWINPLEX (ONE TUBE PERFORMS AS TWO) RECEIVER. No. 102
- HOW TO MAKE THE WIZARD-1-TUBE 50-WATT TRANSMITTER. No. 103
- HOW TO MAKE THE IMPROVED 3-TUBE DOERLE SET FOR BATTERY OPERATION. No. 104
- HOW TO MAKE THE "GO-GET-EM 2" RECEIVER FOR THE BEGGINNER. No. 105

- HOW TO MAKE THE 1-TUBE-ALL-ELECTRIC OSCILLODYNE. No. 106
- HOW TO MAKE THE 2 TO 5 METER TWO-TUBE LOUDSPEAKER SET. No. 107
- HOW TO MAKE THE 3-TUBE BATTERY SHORT-WAVE RECEIVER. No. 108
- THE BRIEF-CASE SHORT-WAVE RECEIVER AND HOW TO BUILD IT. No. 109
- HOW TO BUILD THE POCKET SHORT-WAVE RECEIVER. No. 110
- HOW TO BUILD THE CIGAR-BOX 1-TUBE "CATCH ALL" RECEIVER. No. 111

- HOW TO BUILD THE "DUAL-WAVE" SHORT-WAVE BATTERY RECEIVER. No. 112
- HOW TO BUILD THE 1-TUBE "53" TWINPLEX" RECEIVER. No. 113
- HOW TO BUILD THE PORTABLE MINIDYNE SHORT-WAVE BATTERY SET. No. 114
- HOW TO BUILD THE HAM-BAND "PEE-WEE" 2-TUBER. No. 115
- HOW TO BUILD THE DUO-AMPLIDYNE. No. 116
- HOW TO BUILD THE "MONO-COIL 2." No. 117

## RADIO BROADCAST RECEIVER AND SPECIAL RADIO PUBLICATIONS

- HOW TO MAKE THE A.C.-D.C. "CASH BOX" RECEIVER. No. 118
- HOW TO MAKE BEGINNER'S 2-TUBE ALL-WAVE SET. No. 119
- HOW TO BUILD THE "RADIO-LAMP" 4-TUBE TABLE RECEIVER. No. 120
- HOW TO BUILD A SUPER-SENSITIVE ALL-WAVE CRYSTAL SET. No. 121

- HOW TO BUILD THE 2-TUBE "PENTODE PORTABLE" BROADCAST SET. No. 122
- HOW TO BUILD THE RADIO "TREASURE" FINDER. No. 123
- HOW TO BUILD THE GERNSBACK ONE-TUBE PENTODE LOUDSPEAKER SET. No. 124
- HOW TO BUILD THE WORLD'S SMALLEST ONE TUBE BATTERY RADIO. No. 125

- HOW TO BUILD A 6-TUBE BATTERY ALL-WAVE "FARM PORTABLE" SET. No. 126
- HOW TO MAKE AN A.C.-D.C. ONE-TUBE "DEAF AID." No. 127
- HOW TO BUILD A PIANOTRON. No. 128
- HOW TO BUILD THE ONE-DOLLAR RADIO. No. 129
- HOW TO MAKE A VARIABLE-TONE CODE PRACTICE SET. No. 130

## MECHANICAL PROJECTS PUBLICATIONS

- HOW TO MAKE A SOUTH SEA OUTRIGGER CANOE. No. 131
- HOW TO BUILD A PEE-WEE AUTOMOBILE. No. 132
- HOW TO BUILD A DUAL-CONTROL GLIDER. No. 133
- HOW TO BUILD A HOUSEBOAT ON PONTOONS. No. 134
- HOW TO MAKE A BAND SAW FROM OLD AUTO PARTS. No. 135
- HOW TO BUILD A REAL LATHE FOR \$5.00. No. 136
- HOW TO BUILD A SAIL CAT-BOAT. No. 137

- HOW TO BUILD A SIMPLE PORTABLE REFRIGERATOR. No. 138
- HOW TO BUILD A XYLOPHONE. No. 139
- HOW TO BUILD THE ROWMOBILE. No. 140
- HOW TO BUILD LARGE TESLA AND OUDIN COILS GIVING 18-INCH SPARKS. No. 141
- HOW TO MAKE AN ARC WELDER. No. 142
- HOW TO USE AN A.C. ARC WELDER. No. 143

- HOW TO MAKE YOUR OWN MICROSCOPE. No. 144
- HOW TO MAKE A WIMSHURST ELECTROSTATIC MACHINE. No. 145
- HOW TO MAKE A POWER DRILL PRESS FROM SCRAP PARTS. No. 146
- HOW TO BUILD A GOOD LATHE FOR \$1.00. No. 147
- HOW TO MAKE AND EXPERIMENT WITH AN ELECTROPHOROUS. No. 148
- HOW TO MAKE AN ELECTRIC ARC WELDER FROM AN AUTOMOBILE GENERATOR. No. 149

## RADIO PUBLICATIONS, 25 West Broadway, NEW YORK, N. Y. RC 8

I enclose \$.....for the publications listed by number, at right, at the rate of 50c FOR ANY TEN PUBLICATIONS, NO ORDER FOR LESS THAN 50c ACCEPTED. \$1.00 for 24 publications. These publications are to be sent to me postpaid. I have placed a circle around each number which I want.

101	102	103	104	105	106
107	108	109	110	111	112
113	114	115	116	117	118
119	120	121	122	123	124
125	126	127	128	129	130
131	132	133	134	135	136
137	138	139	140	141	142
143	144	145	146	147	148
					149

Name ..... Address .....

City ..... State .....

# SPECIAL

The books listed below have never been sold by us before. The value of each book is 50c. They are exactly the same as RADIO & TELEVISION'S 50c blue books which have been on the market for years.

For a short time only we are selling these at a special reduced price of only 75c for the 3 books. All of the books contain numerous photographic illustrations and diagrams and have stiff flexible cover.

### ABC OF TELEVISION



Contains latest material on television developments. It covers theory of scanning; simple television receiver; how the eye sees; the photoelectric cell; neon lamps; need for broad channel width in transmission signals; cathode ray tube and television receivers; Farnsworth system of television transmission; and other important features.

### SHORT WAVE GUIDE



Covers hundreds of short-wave questions and answers; illustrates popular short-wave kinks; gives explicit instructions for building simple short-wave receivers; instruction on the best type of antenna installation; diagram and construction details for building transmitters.

### S. W. RADIO QUIZ BOOK

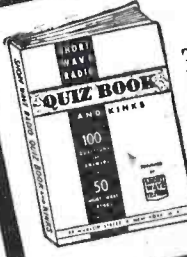

This book covers questions and answers on transmitters, short-wave receivers, ultra short-wave receivers; practical kinks, wrinkles and coil winding data; novel hook-ups for experimenters; how to "hook-up" converters, noise silencers, beat suppliers, modulators, pre-oscillators, antennas, pre-selector, 5-meter receivers.

**RADIO & TELEVISION**  
25 W. Broadway,  
New York, N. Y.

Gentlemen:  
Enclosed you will find remittance for 75c (cash, new U. S. stamps or money order accepted) for which please send me at once your 3 books  
ABC OF TELEVISION SHORT WAVE GUIDE  
SHORT WAVE RADIO QUIZ BOOK

Name .....

Address .....

City ..... State ..... RC-8-42

Korea." The slightest momentary fade-out or drop of signal strength may obliterate an important passage or cause a mutilation of consequence. The careless translation of one word may have major political results. Listening posts, often hidden from public view, contribute greatly to victory. They will also play an important part in achieving maintenance of lasting peace.

## RADIOTELEPHONE SAVES FIVE LIVES

An overseas radiotelephone call to South America some time ago was instrumental in saving five lives, according to Gustave Simons, a New York lawyer. He described the situation as follows in a letter to the A.T. and T. Company:

"Some time ago it became necessary for me to arrange for the emigration from Europe of several persons whose immediate departure from that unhappy land was a matter of life and death. Obtaining a visa for this country would have involved a delay of several weeks.

"We decided, therefore, to arrange immigration into a Latin American country. The local consulate was interviewed and the matter was referred to the capital of that country both by cable and airmail letter without results.

"I picked up my telephone and in a few minutes time, through the agency of your marvelous international system, I was speaking to an important representative of the country's government. The personal conversation made it possible for me to bring home to him the urgency of the situation in a fashion that neither cable nor airmail letter could do.

"Before the end of that day, the consul of this Latin American country, who was stationed in the area where the refugees were located, had delivered to them their visas and within twenty-four hours they had made good their departure to Lisbon and to the New World.—Long Lines.

## SEVENTH FM TRANSMITTER ADDED TO NEW YORK AREA

An FM broadcast transmitter and associated equipment have been shipped to New York City's newest FM station, W75NY, to be operated by Metropolitan Television, Inc. The station, seventh in the New York area, is owned jointly by Bloomingdale's and Abraham & Straus department stores. Construction of the station, atop Hotel Pierre, was begun last spring under the direction of Louis Thompson, who has been placed in charge of the station. The F.C.C. assigned a Class B FM permit for the use of 47.5 mcs. to Metropolitan Television, Inc., last year.

## SPECIAL PERMITS GRANTED FOR STATION OPERATORS

Responding to wartime shortages of technical personnel for broadcast stations, especially critical in cases of small stations, the Federal Communications Commission agreed to grant operation permits to persons certified by station licensees as familiar with their respective broadcasting equipment. Holders of these restricted radiotelephone operator permits would be limited to operations at a specified station and would be required to shut down the station in technical emergencies until some first-class operator repaired the trouble. An added requirement provides that persons obtaining the restricted permit would have to pass within six months an FCC examination on radio theory entitling them to endorsement of their permits by the Commission for similar work at any station.

**DIRECTION FINDERS IN AUTOMOBILES**

(Continued from page 743)

will cross the 15° line and a "fix" will be obtained. (See Fig. 5.)

For best results, the loop should be "resonant" and not merely a coiled antenna. To change over from one band to another, a tapped loop may be used or different sizes of tuning condensers may be cut in and out of the circuit. Keeping leads short minimizes tuning losses due to high minimum capacities.

Another alternative is to use series L or C for modifying the tuning range of the loop. This is shown in Fig. 6.

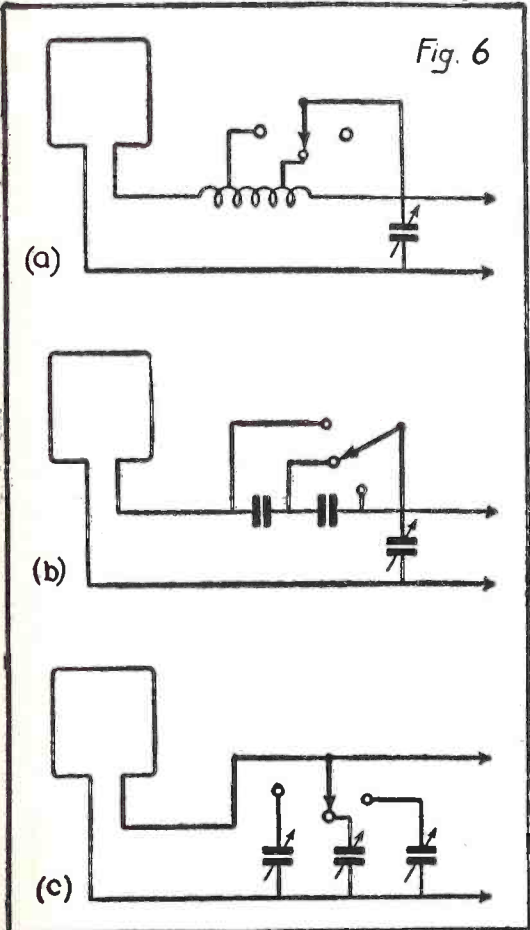

An important and required aid for accurate direction finding in an automobile is a good map of the area to be surveyed.

Field strength meters generally are unreliable and tricky, as far as getting indications of direction are concerned.

**STIMSON 'DETECTS' PLANE 'SIXTY MILES AWAY'**

Aircraft-locating apparatus, installed along the coast lines, was demonstrated to Secretary of War Henry L. Stimson recently, according to newspaper reports.

Mr. Stimson looked through one of the new warning instruments on a visit of inspection and "saw the electrical indication of a plane which I believe was sixty miles away."

Aircraft or ships at sea more than 100 miles away could be picked up, it was said.

**AUSTRALIAN RADIO PATROL AIDED BY U. S. FORCES**

United States and Australian military cars in Melbourne and other cities have been equipped with short-wave radio sets to enable them to cooperate with the regular police while on patrol, according to an Australian radio report heard by the United Press listening post.

An American authority was quoted as saying that the police radio system in the state of Victoria compared favorably with that in the United States.

**FREE!**

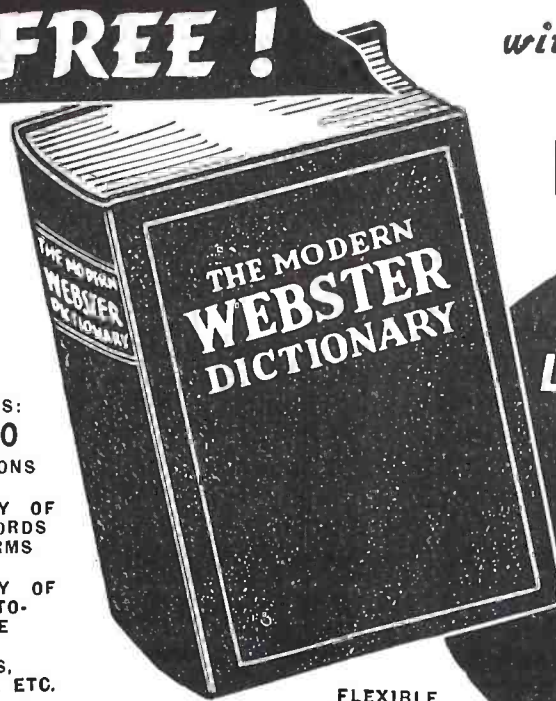

CONTAINS:  
**22,000**  
DEFINITIONS  
•  
DICTIONARY OF  
RADIO WORDS  
AND TERMS  
•  
DICTIONARY OF  
THE AUTO-  
MOBILE  
•  
TABLES,  
TREATISES, ETC.

FLEXIBLE  
IMITATION  
LEATHERETTE  
COVER, SIZE 5 1/2"x8"

with \$1.00 subscription

to

**RADIO-CRAFT**

FULL  
LIBRARY SIZE

**MODERN  
WEBSTER  
DICTIONARY**

**416  
PAGES**

**FILL OUT-MAIL THIS COUPON TODAY!**

RADIO-CRAFT, 25 West Broadway, New York, N. Y.

This is a New Order  Extend my present subscription

Gentlemen: Enclosed you will find One Dollar for which enter my subscription to RADIO-CRAFT Magazine for Eight Months. Send me, ABSOLUTELY FREE and POST-PAID, my copy of the MODERN WEBSTER DICTIONARY.

Name .....

Address .....

City ..... State .....

(Remit by check or money order; register letter if you send cash or unused U.S. Postage Stamps)

RC-8-42

**RADIO-CRAFT**  
25 WEST BROADWAY NEW YORK CITY

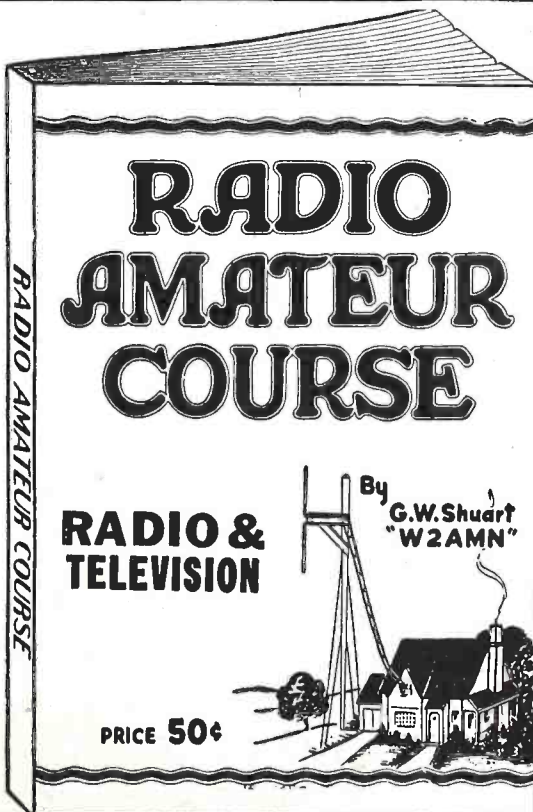

**RADIO  
AMATEUR  
COURSE**

**RADIO &  
TELEVISION**

By  
**G.W. Shuart  
"W2AMN"**

PRICE 50¢

**148 PAGES**

6 x 9 INCHES

**OVER 150 RADIO DIAGRAMS  
and TECHNICAL PHOTOGRAPHS**

**RADIO AND TELEVISION**

25 West Broadway New York, N. Y.

**Your Money Back—**

If the **RADIO AMATEUR COURSE** does not represent the greatest book value ever offered to the radio "fans" for ..... **50c**

To convince you that there isn't a better book buy today, the publishers of the **RADIO AMATEUR COURSE** make the sensational offer of a money-back guarantee on such a low-priced book. Stop in at any of the many dealers handling this book and examine it. See for yourself if the **RADIO AMATEUR COURSE** isn't just the book you've always wanted.

Printed on the finest coated paper—well illustrated attractive 4-color cover—complete with radio information you must have. It contains a step-by-step program for obtaining a short-wave radio education.

Written by **George W. Shuart, W2AMN**  
foremost short-wave authority

**RADIO AND TELEVISION**  
25 West Broadway, New York, N. Y.

Gentlemen: I enclose herewith my remittance of Fifty Cents (50c) for which please send me POST-PAID, my copy of the **RADIO AMATEUR COURSE**. (Remit by check or money order; register letter if you send cash or unused U. S. Postage stamps.)

Name .....

Address .....

City ..... State ..... RC-8-42

**The Book that takes Drudgery out of Mathematics**

Only **50c** postpaid

**SOLVES EVERYDAY PROBLEMS — HELPS YOU GET AHEAD IN LIFE**

How many times have you lost money because of a mistake in figuring? Do you know how to figure quickly and correctly? Can you figure discounts, interest rates, taxes and all the other calculations you meet up with in your daily life?

Are you having trouble qualifying for Army or Navy promotion because you're not up on mathematics?

Here is the book that gives you a good background in mathematics; that takes all the irritation and drudgery out of it. You don't need to be scared of mathematics, because here's the subject explained without frills, without useless computations.

Here's the book for men in the armed forces; for business men; technicians and craftsmen, explaining and answering everyday mathematic problems in easy-to-understand words and illustrations.

Yes, it's the key to a simple understanding of mathematics. It's a real home-study course in mathematics for the man who's alert to the importance of mathematics in the world today.

**ELEMENTARY MATHEMATICS**

● EASY — SIMPLIFIED — PRACTICAL ●

- CONTENTS OF BOOK**
- CHAPTER I. Arithmetic—Addition—Subtraction—Multiplication—Division.
  - CHAPTER II. Factoring and Cancellation—Fractions—Decimals—Percentage—Ratio—and Proportion.
  - CHAPTER III. The Metric System.
  - CHAPTER IV. How to Measure Surfaces and Capacity (Geometry).
  - CHAPTER V. Powers and Involution—Roots and Evolution.
  - CHAPTER VI. Mathematics for the Manual and Technical Craftsman—Thermometer conversions—Graphs or Curve Plotting—Logarithms—Use of the Slide Rule.
  - CHAPTER VII. Special Mathematics for the Radio Technician.
  - CHAPTER VIII. Commercial Calculations—Interest—Discounts—Short Cut Arithmetic.
  - CHAPTER IX. Weights and Measures—Useful Tables.

ONLY **50c** POSTPAID

Send Stamps, Cash or Money Order.

Send today for your copy of this indispensable book. It can be carried readily in your pocket. (Size 6 x 9 in.)

**TECHNIFAX**

1917 S. State St., RC-842, Chicago, Ill.

**"THE INDUCTANCE AUTHORITY"**

By **EDWARD M. SHIEPE, B.S., M.E.E.**  
[A NEW BOOK]

THE ONLY BOOK OF ITS KIND IN THE WORLD, "The Inductance Authority" entirely dispenses with any and all computation for the construction of solenoid coils for tuning with variable or fixed condensers of any capacity, covering from ultra frequencies to the borderline of audio frequencies. All one has to do is to read the charts. Accuracy to 1 per cent may be attained. It is the first time that any system dispensing with calculations and correction factors has been presented.

There are thirty-eight charts, of which thirty-six cover the numbers of turns and inductive results for the various wire sizes used in commercial practice (Nos. 14 to 32), as well as the different types of covering (single silk, cotton-double silk, double cotton and enamel) and diameters of  $\frac{3}{8}$ ,  $\frac{7}{8}$ , 1,  $1\frac{1}{8}$ ,  $1\frac{1}{4}$ ,  $1\frac{3}{8}$ ,  $1\frac{1}{2}$ ,  $1\frac{3}{4}$ , 2,  $2\frac{1}{4}$ ,  $2\frac{1}{2}$ ,  $2\frac{3}{4}$  and 3 inches.

Each turns chart for a given wire has a separate curve for each of the thirteen form diameters. The book contains all the necessary information to give the final word on coil construction to service men engaged in replacement work, home experimenters, short-wave enthusiasts, amateurs, engineers, teachers, students, etc.

There are ten pages of textual discussion by Mr. Shiepe, graduate of the Massachusetts Institute of Technology and of the Polytechnic Institute of Brooklyn, in which the considerations for accuracy in attaining inductive values are set forth.

The book has a flexible fiber black cover, the page size is 9 x 12 inches and the legibility of all curves (black lines on white field) is excellent.

Price at your dealer or direct—\$2.50

**GOLD SHIELD PRODUCTS**

350 Greenwich St. (Dept. RC8)  
New York City

**FLASHLIGHT BATTERY COVERS FOR COIL FORMS**

In these times of stringent war economy, here's a method of utilizing the cardboard cylinders covering "Eveready" flashlight batteries.

I have frequently wound small R.F. chokes and Short-Wave Coils on Nos. 950 and 935 "Eveready" cylinders. To minimize the losses—after all, cardboard is not quite as good as ceramic—the cylinders should be suspended above the chassis on ebonite supports. (See sketch).

The results achieved with these cylinders have been excellent.

W. E. RIGG,  
Roan Antelope Copper Mines,  
Luanshya,  
Northern Rhodesia,  
British South-Central Africa.

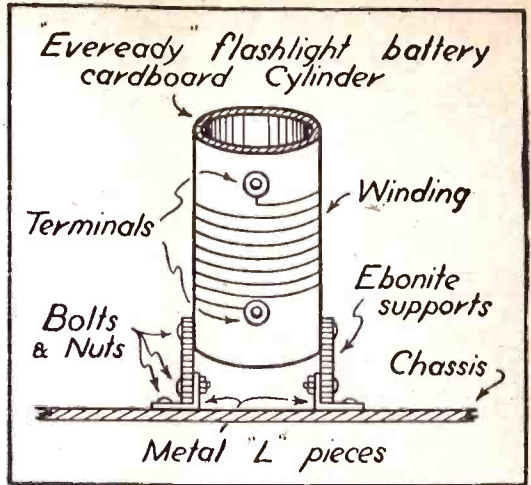

The drawing illustrates how flashlight battery covers can be converted into coil forms for R.F. chokes and short-wave coils.

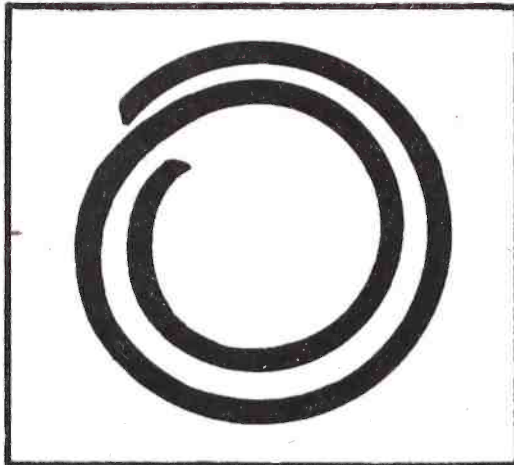

**ANTENNA SPACERS**

A complete set of antenna spacers is usually pretty expensive. Very satisfactory ones can be made from old high-wattage resistors for almost no cost. Collect from your friends their burned out resistors of the 50 or 75 watt type. The resistance element must be removed by dipping in gasoline or melting off with a gasoline blow-torch, leaving the ceramic tubing. Do not remove the soldering lugs from the ends. Wooden plugs saturated with wax are inserted in the ends of the tube. To affix the spacer to your antenna wires, run a short piece of copper wire through each soldering lug and tie to the antenna wires.

FRANKLIN WILLIAMS, W6ULE,  
Glendale, Calif.

**PAPER CLIPS CURE NOISY CONTROL**

With repair of the old part a necessity because of the scarcity of materials, a very fine washer can be made by cutting a small section from one of the newer flat paper clips. By careful manipulation on the pliers, this section can be formed around the shaft of a volume control to take the play out of it and make an otherwise noisy or bad control as good as ever. This metal bends easily, and makes washers that are useable in many other places.

JAMES H. BELL,  
St. Paul, Minn.

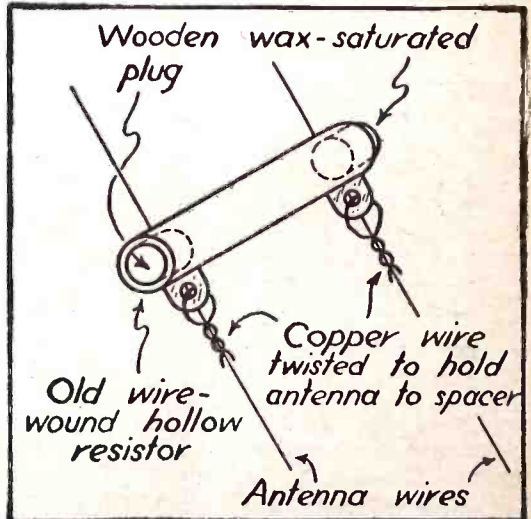

Burned-out high-wattage resistors can be transformed into suitable antenna spacers, as this sketch shows.

**10 BEST RADIO BOOKS 10 CENTS EACH**

**RADIO FANS EVERYWHERE**—these fine ten cent text books give you an excellent foundation for the study of RADIO. They are clearly written, profusely illustrated and contain over 15,000 words in each book. You'll be

amazed at the wealth of information contained in these handy books. Excellent for reference—ideal for every technical library. **YOUR MONEY BACK** if you are not satisfied. **PROMPT SHIPMENTS**

- No. 1—HOW TO BUILD FOUR DOERLE SHORT WAVE SETS
- No. 2—HOW TO MAKE THE MOST POPULAR ALL-WAVE 1- AND 2-TUBE RECEIVERS
- No. 3—ALTERNATING CURRENT FOR BEGINNERS
- No. 4—ALL ABOUT AERIALS

- No. 5—BEGINNERS' RADIO DICTIONARY
- No. 6—HOW TO HAVE FUN WITH RADIO
- No. 7—HOW TO READ RADIO DIAGRAMS
- No. 8—RADIO FOR BEGINNERS
- No. 9—SIMPLE ELECTRICAL EXPERIMENTS
- No. 10—TELEVISION

**BOOKS ARE ALL UNIFORM**

Every book in the **GERNSBACK EDUCATIONAL LIBRARY** has 32 pages—with illustrations varying from 30 to 66 in number. Each title volume contains over 15,000 words. Positively radio's greatest book buys! If you do not think these books worth the price asked, return them in 24 hours and your money will be instantly refunded.

**RADIO PUBLICATIONS • 25 WEST BROADWAY • NEW YORK, N. Y.**

RADIO PUBLICATIONS, Dept. RC-8-42  
25 WEST BROADWAY, NEW YORK, N. Y.

Gentlemen: Please send immediately, POSTPAID, the book numbers circled below, I am enclosing ..... cents —each book being 10c.

1	2	3	4	5	6	7	8	9	10
								NEW	NEW

Send FREE listing of 48 new 10c publications.

Name ..... Address .....

City ..... State .....

Remit by check or money order—register letter if you send cash or unused U. S. postage stamps.

**MAIL COUPON TODAY!**



### METHOD OF MOUNTING SPEAKER CONES

One of the greatest difficulties many service men experience when re-assembling a speaker is in holding the outside rim of a cone in place on the speaker frame while the cement is drying. The method employed at our shop never fails to line up the cone perfectly.

After shims are placed on pole pieces of the speaker, the cone is lined up around the outer rim of the cone and cement applied on the speaker frame. The rim of the cone is then pressed in place carefully and held with several spring-type wood clothes pins. For small cones six or eight pins are required, but for larger cones ten or twelve are required to do a good job.—Tony Zaccane, Stoneham, Mass. in *C-D Capacitor*.

### WARTIME SERVICING HINT

Some circuits using direct-coupled or Class-B audio systems call for a power supply furnishing a higher-than-normal voltage to the tube plates. When the power transformer on such a job fails, and a replacement can not be found, two standard universal power transformers may be hooked in series to supply the needed voltage.

If the resultant voltage is too high, it may be reduced by increasing the size of  $R_1$ , which is shown in the diagram as a 10-watt resistor of 150 ohms to supply approximately 550 volts D.C. (this however varies

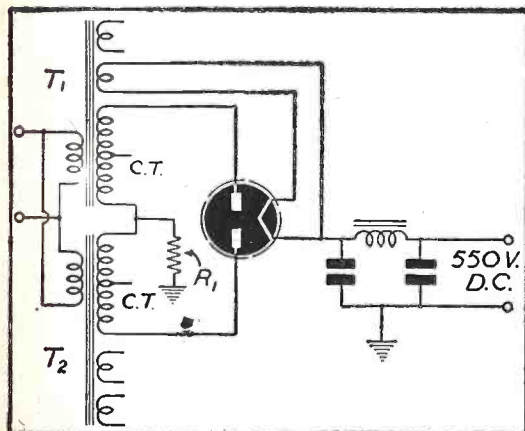

greatly with the load current and can be best determined by experiment).

In paralleling the two primaries, care must be taken to observe polarity. Otherwise, the secondaries of the two transformers  $T_1$  and  $T_2$  will actually be in parallel, resulting in half-wave rectification.

PAUL B. FALK,  
New Castle, Penna.

### FM SPEAKER SYSTEM

(Continued from page 734)

variable with the position of the listener. The location of the high-frequency unit directly in front of the low-frequency cone raises the question of possible obstructive effects upon the radiation from the latter. Acoustic theory predicts that an 8-inch cone should begin to exhibit appreciable beam radiation effects around 1,000 cycles, and that a spherical object roughly equivalent to the high frequency speaker volume should begin to act effectively as an obstacle at about the same frequency. As the dividing network attenuates the electrical input to the low-frequency speaker above 1,500 cycles, it follows that any resulting modification of the low-frequency speaker's radiation must occur in the approximate range 1,000 to 1,500 cycles. As a matter of fact, measurements have shown that the high-frequency unit actually serves as a

spreader for the radiation from the low-frequency cone in the 1,000 to 1,500-cycle region, and offsets the slight axial concentration that otherwise might occur. It is doubtful if the above phenomenon has much practical significance, even in the absence of the obstruction, on account of the limited frequency range over which it can operate. The question is here discussed because it has been raised by many upon first seeing the system.

**Performance**—A response curve of the complete loudspeaker system mounted in a radio cabinet is shown in Fig. 1. The measurement was made in a damped room with a rotating microphone, and the curve was drawn by an automatic recorder arranged to register the average response as the microphone swept around its 8 ft. diameter circular path. In spite of the averaging, a certain amount of the irregularity at the lower frequencies remains chargeable to room effects, as has been determined by past comparisons with outdoor measurements. Supplementary measurements beyond 10,000 cycles indicate that the response recovers at about 13,000 cycles and then cuts off sharply at 17,000 cycles.

Fig. 2 shows a comparison between the measured directional radiation characteristics of an 8-inch cone speaker and the 2½-inch high-frequency speaker described in this article. The frequency was 6,000 cycles in both cases and the conditions of measurement were alike. The difference shown is similar for other high frequencies. It will be seen that the radiation pattern of the smaller speaker is essentially uniform over 50 degrees either side of the axis.

This wide angle response over an extended frequency range is unusual in a loudspeaker for home use, and is a very desirable characteristic which has had much less attention than it deserves. It is believed to be an important factor in lending the property of "presence" to the reproduction from the speaker here described. Not only is

(Continued on page 761)

†Loud speaker response curves are released for publication with a certain amount of reluctance because of the considerable difficulty in interpreting them without long familiarity with the attendant measuring conditions. With the exception of those taken out of doors under certain conditions, almost all such measurements either include effects due to peculiarities of the measuring room and apparatus, or else the artifices employed to reduce the room effects, introduce other, and often as serious, inaccuracies. To the experienced engineer familiar with the conditions, acoustic response measurements serve as useful tools, not only to gauge the progress of development work, but always in conjunction with listening tests, to appraise the final result. The dangers attending their too rigorous interpretation by others deserve more appreciation than has generally been exhibited.

## A SCOOP! Webster De Luxe Mixer Changer

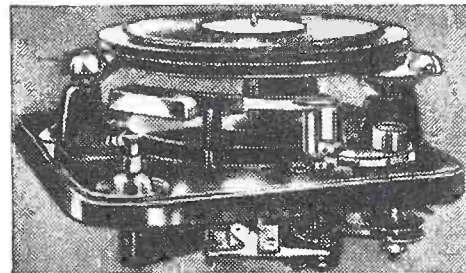

Plays from 14 to 18 Records. Lightweight lifetime needle. Crystal Pick-up. Automatic Shutoff on last Record. 13½" x 17"—5¾" above plate, 4¾" below plate. For 110 volts A.C. 60 cycles. Shipping weight 30 lbs.

**\$45.95**

### OTHER BARGAINS

- General Industries GIR 90, Two Speed Home Recording Unit .... \$24.50
- Alliance Rim Drive Motor, A.C. 9 inch Turntable ..... \$2.45
- Erwood (New Products) Automatic Changer (Double Record Shelf) ..... \$17.95

## ARROW RADIO, INC.

82 CORTLANDT ST., N. Y. C.

**RADIO**  
CATALOG NO. 58  
164 PAGES  
SETS-PARTS  
SUPPLIES  
FLUORESCENT  
*Burstein Applebee Co.*

**BIG FREE CATALOG**  
EVERYTHING IN RADIO

Sets, parts, supplies, public address systems, amateur equipment, testers, kits and fluorescent lighting at lowest prices. Huge stocks, bought months ago ... ready for shipment the same day your order is received. The Defense Program is making big demands on our industry but because of our advance buying we are able to fill your orders promptly and efficiently.

**BURSTEIN-APPLEBEE COMPANY**  
1012-14 MCGEE STREET, KANSAS CITY, MISSOURI

## LAST CHANCE

that you will have to buy

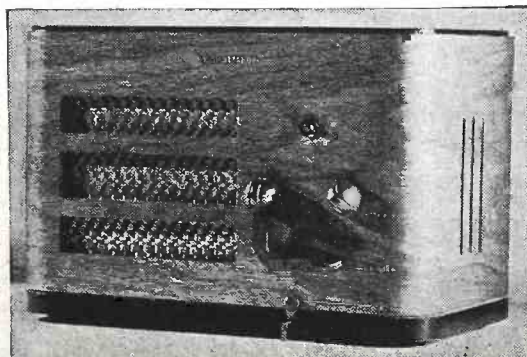

**Crosley CHATTBOX**  
INTERCOMMUNICATION SYSTEM OF TWO UNITS FOR **\$24.75**  
LIST PRICE—\$59.50 A PAIR

Complete two-way wireless loud speaking system. Perfect performance. Plug into any 110 volt house socket A.C. or D.C. Equipped with Call-Listen-Talk switch and volume control.

No installation charges. Modulated carrier signal travels over the electric light lines. **IDEAL FOR OFFICES, STORES, FACTORIES, SCHOOLS, LIBRARIES, HOMES AND WHEREVER INTERCOMMUNICATION IS DESIRED. EXCELLENT SPEECH CHARACTERISTICS.**

Each unit is housed in beautiful 2 tone veneered cabinet with grilled speaker front.

This Coupon is worth \$2.00 if mailed to us with order BEFORE Oct. 15/42.

Name .....  
Address .....  
City .....

**KORROL MFG. CO.**  
350 GREENWICH ST. (DEPT. RC8)  
NEW YORK CITY

# A New Type of Service Manual!

## RADIO CIRCUIT MANUAL - 1941

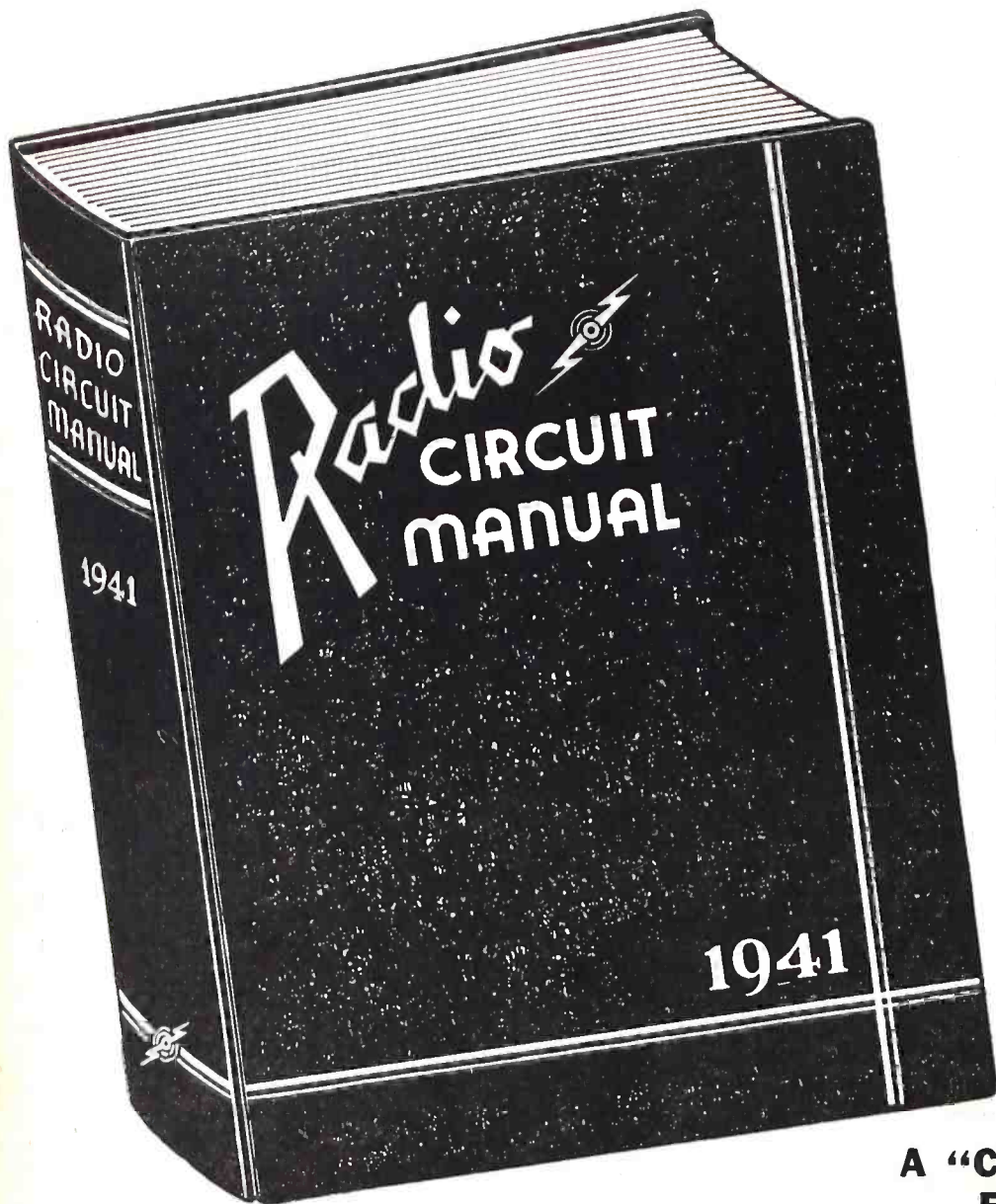

**The Only EDITED Manual  
Ever Published!**

**DIRECTORY OF RECEIVERS MANUFACTURED IN 1940 AND UP TO JUNE, 1941**

**MORE INFORMATION IN HALF THE  
NUMBER OF PAGES**

The value of a service manual is measured not by the number of pages but by the amount of useful information. Thus, in only 736 pages this Radio Circuit Manual covers over 200 receiver models MORE than does any other competitive manual in twice the number of pages.

**HOW DID WE DO IT? . . .**

. . . . By increasing the size of our page; by discarding non-essential data and editing the balance; by listing only those receivers which the Service Engineer will definitely have to repair (no communications or export receivers, no shortwave sets or amplifiers, no electronic devices, etc.); by many months of hard work based on a definite plan of procedure and a clear understanding of the actual requirements of the Service Engineer. There is no "dead weight" information to add bulk to this Manual. Every word counts. Every minute of reading time is well spent.

### OUTSTANDING FEATURES

- Contains data on more than 1800 receiver models!—more than any other radio service manual.
- Only 736 pages!—less than half the bulk of any other manual and more than 1/3 lighter.
- All information is EDITED!—all non-essential data deleted and the balance checked and correlated with the schematics and sketches.
- 40% larger page permits listing of all information on one page. (A few unavoidable cases excepted.)
- I.F. peaks for all superhet circuits are boldly displayed in black boxes;—none missing, all accurate.
- No space wasted on communications and export receivers, amplifiers, electronic musical instruments, etc.—a 100% Service Engineer's Manual.

### A "CUSTOM-TAILORED" MANUAL FOR SERVICE ENGINEERS

Here, at last, is a Service Manual deliberately PLANNED for the Service Engineer. Instead of a mere hodge-podge collection of service data, as manuals have been in the past, this RADIO CIRCUIT MANUAL is an orderly compilation of essential radio diagrams and service information, carefully edited and uniformly presented for the maximum convenience of the busy Service Engineer. All time-consuming, non-essential data have been weeded out, and the remaining information, vitally important to the rapid and efficient servicing of modern radio receivers, has been laid out in a logical, easy-reading style which cuts time from the day's work. Because of this and other features which are self-evident upon first observation, it has been possible to list all information pertaining to a given model on a single page.

In 736 pages this Manual presents essential service data on over 1800 receiver models;—more than any other existing service manual on the market!

### ONLY ONE MANUAL PER YEAR!

The new technique used in compiling this RADIO CIRCUIT MANUAL—1941 makes it possible to include in a single book all the new receiver models which the radio industry can produce in a single year. This factor alone represents an important saving to all Service Engineers.



← THE OLD TYPE MANUALS—Bulky, heavy, hard to handle, space consuming, less USEFUL data despite greater number of pages.



→ OUR NEW MANUAL—Lighter, compact, easy to handle, takes half as much room on the shelf, more USEFUL information despite fewer number of pages.

### MANUALS NOW READY!

### ORDER YOUR MANUAL IMMEDIATELY—NOW!

Get your copy directly from us by filling out and mailing the convenient coupon shown at left, or get it directly from your favorite distributor.

736 pages; size 13 3/8 x 10 1/4 x 2 in. thick; loose leaf, leatheroid-covered stiff binder; net weight 6 1/2 lbs.

ONLY  
**1000**

### A PERMANENT INSTITUTION

This Radio Circuit Manual—1941 is NOT a one-time proposition. Next year there will be a Radio Circuit Manual—1942, the following year, 1943 and so on indefinitely—each Manual better than the other as new methods are worked out for expediting and simplifying the work of the practicing Service Engineer.

RADCRAFT PUBLICATIONS, INC.,  
25 West Broadway, New York, N. Y.

Gentlemen: Enclosed find my remittance of \$10.00, for which send me, POSTPAID, my copy of the RADIO CIRCUIT MANUAL—1941.

Name .....

Address .....

City ..... State ..... RC-8-42

(Send remittance in form of check or money order; register your letter if you send cash.)

**RADCRAFT PUBLICATIONS, INC.**  
**25 WEST BROADWAY NEW YORK, N. Y.**

**FM SPEAKER SYSTEM**

(Continued from page 759)

anyone in a reasonable listening position able to hear the high frequencies unattenuated, but the wide-angle distribution causes more of these waves to strike the walls and ceiling and, by virtue of repeated reflection, produce a beneficial amount of high-frequency reverberation. It is interesting to note that this desirable property is obtained merely by the very simple expedient of making the diaphragm small. It is difficult to produce as uniform a directional pattern by the use of deflectors or diffusing vanes. These also, in any commercial applications that have come to our attention, affect only the radiation in the horizontal plane, whereas the distribution by the small cone is the same in all planes passing through the axis.

**ALL-WAVE SET FOR BEGINNERS**

Editor:

I am submitting a diagram of a small all-wave receiver which is rather common but happened to be a favorite of mine when I was doing lots of experimenting. It may prove useful to you in your experimenters' section as it is very simple and uses a minimum of parts, which is important at this time.

L. W. PLEASANT, W9UDZ  
Mattoon, Illinois

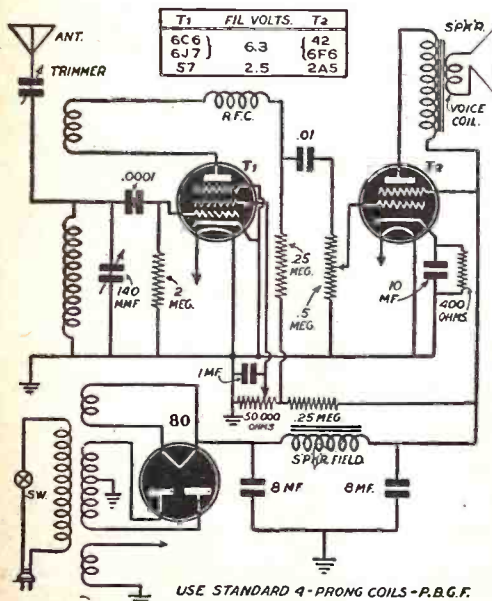

Connect a small condenser (100 to 250 mmf.) between ground and junction point of the feedback coil with the R.F. choke.

**PHONOGRAPH NEEDLES**

(Continued from page 736)

is still the same. These compass point needles are being widely used for government work.

As a morale booster, the usefulness of the needle cannot be denied both in the home and for the soldier. Many broadcast stations are now making recordings of their key broadcasts and then sending these transcriptions to the camps, and in some cases even across the seas, so that the soldier may hear his favorite program no matter how far away from home he is. This is made possible through the fact that some concerns are now manufacturing recording sets especially for army use.

Another factor that cannot be overlooked, is the home morale, to which the phonograph needle gives immeasurable support. In these trying days, everybody seeks relief or escape of some kind, and what can give more treasured comfort than your favorite records? Thus the phonograph needle is an essential material in the building of home morale.

**WHILE THEY LAST**

All of the attractive items listed here are brand new. ALL are in PERFECT WORKING ORDER. In many cases, the parts alone total more than the price we are asking. 100% satisfaction guaranteed or your money refunded. ORDER FROM THIS PAGE. Use the convenient coupon below. Include sufficient extra remittance for parcel post charges, else order shipped express, collect. Any excess will be refunded. C.O.D. shipments require 20% deposit. If full remittance accompanies order, deduct 2% discount. Send money order, certified check, new U. S. stamps. No C.O.D. to foreign countries.

**ORDER TODAY LIMITED QUANTITIES PROMPT SHIPMENTS ASSURED**

**HANDY WORKSHOP OUTFIT**

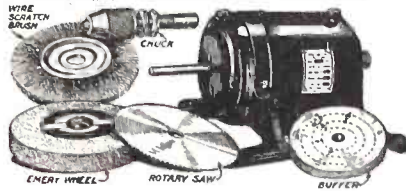

Here is a marvelous article that to the best of our knowledge has never sold at such a low price. This outfit must be seen to be appreciated. It delivers the goods! It comprises a variable speed universal motor for 110 volts A.C. or D.C. Made originally for dictaphone machines by American Gramophone Co. Motor is reconditioned and in excellent condition; all other parts are brand new. Special lever control permits various speeds up to 3000 r.p.m. Measures 7 1/2" x 3 1/4" diam. overall.

Included in the outfit are the following items, as illustrated: 1 excellent chuck which takes drills and other tools—chuck is easily screwed to motor shaft; standard emery wheel, 4" diameter; fine steel rotary saw, 4" diameter; wire scratch brush, 4" diameter; standard cloth buffer, 3" diameter. Total Wt. 9 lbs.

ITEM NO. 149  
Complete outfit, including motor. **\$5.45**  
YOUR PRICE

**VARIABLE SPEED UNIVERSAL MOTOR**

FOR 110 VOLTS, A.C. OR D.C.

Made for Dictaphone machines by American Gramophone Co. Used, but in excellent condition. Special lever control permits variable speeds up to 3000 r.p.m. 1/4" shaft extends from both sides of motor. Measures 7 1/2" x 3 1/4" diam. overall. Shp. Wt. 6 3/4 lbs.

ITEM NO. 11  
Your Price **\$2.45**

**WESTON MODEL 562 A.C.-D.C. AMMETER**

Designed by Weston for the Eastman Kodak Co. It is a precision-built magnetic-vane type ammeter which, with suitable shunts, can be used as a milliammeter, too. It is 2" in diameter and designed for panel mounting. Bakelite base and black-enameled cover. Shp. Wt. 2 lbs.

ITEM NO. 35  
YOUR PRICE **\$1.25**

**POWERFUL ALL-PURPOSE INDUCTION MOTOR**  
IDEAL FOR EXPERIMENTERS—101 USES

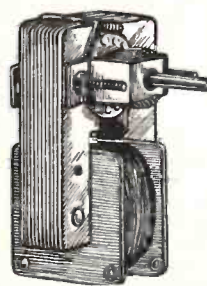

Sturdily constructed to precision standards, this self-starting shaded pole A.C. induction motor is powerful enough for a large variety of uses. Some of these are: Automatic Timing Devices, Current Interrupters, Electric Fans, Electric Chimes, Window Displays, Photocell Control Devices, Electric Vibrators, Small Grinders, Buffers and Polishers, Miniature Pumps, Mechanical Models, Sirens, and other applications.

Consumes about 15 watts of power and has a speed of 3,000 r.p.m. When geared down, this sturdy unit will constantly operate an 18-inch turntable loaded with 200 lbs. dead weight—THAT'S POWER!

Dimensions, 3" high by 2" wide by 1 1/4" deep; has 4 convenient mounting studs; shaft is 3/8" long by 3/16" diameter, and runs in self-aligning oil-retaining bearings. Designed for 110-20 volts, 50-60 cycles, A.C. only.  
ITEM NO. 147  
YOUR PRICE **\$1.45**

**100 POWER TELESCOPE LENS KIT**

Make your own high powered 8 ft. telescope! Now you can thrill to a closeup view of the worlds out in space. See the rings around Saturn, the mountains of the moon! Kit contains 3" diam., 75" focal length, ground and polished objective lens and 2 astronomical eye-pieces, magnification 50x and 100x. Complete kit with full instructions.  
ITEM NO. 123  
YOUR PRICE **\$1.95**

**HUDSON SPECIALTIES CO., 40 West Broadway, N. Y. C.**

IT'S EASY TO ORDER—CLIP COUPON—MAIL NOW ORDER FROM THIS PAGE.

HUDSON SPECIALTIES CO., 40 West Broadway, Dept. RC-942, New York, N. Y.  
I have circled below the numbers of the items I'm ordering. My full remittance of \$..... (include shipping charges) is enclosed.  
OR my deposit of \$..... is enclosed (20% required), ship order C.O.D. (for balance. No C.O.D. order for less than \$2.00. (New U. S. stamps, check or money order accepted.)  
Circle Item No. wanted: 11, 33, 35, 87, 123, 147, 149, 151, 152, 153  
Name ..... Address .....  
City ..... State .....  
Send remittance by check, stamps or money order; register letter if you send cash or stamps.

**WESTERN ELECTRIC BREAST MIKE**

This is a fine light-weight aircraft carbon microphone. It weighs only 1 lb. Mike comes with breast-plate mounting and has 2-way swiveling adjustment so that it can be adjusted to any desired position. There are 2 woven straps; one goes around neck, the other around chest. Straps can be snapped on and off quickly by an ingenious arrangement.

This excellent mike can be adapted for home broadcasting or private communication systems. By dismounting breastplate, it can be used as desk mike. Comes complete with 8-foot cord and hard rubber plug. Finished in sherrardized plate, non-rustable.

THIS IS A BRAND NEW MIKE, IT HAS NEVER BEEN SOLD AT SUCH A LOW PRICE BEFORE. ORIGINAL LIST PRICE \$15.00. Shipping weight, 2 lbs.  
ITEM NO. 152  
YOUR PRICE **\$1.00**

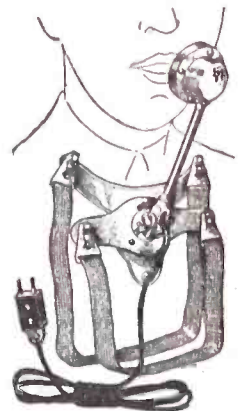

**METAL CUTTING SAW**



Here is an ideal metal-cutting saw made of fine tool steel specially designed to cut metal. Teeth are set at a special double angle for metal-cutting work. Saw is specially hardened for long and extended use; measures 3 1/4" diameter; center hole is 1/2" square; thickness 42/1000 (42 mils.) 3/64".

ITEM NO. 151  
YOUR PRICE **50c**

**POWER ADJUSTABLE RHEOSTAT**

Here is an excellent rheostat used especially to regulate speeds of small motors, such as our Handy Workshop Outfit. This rheostat can be used in connection with motors up to 1/20 h.p.

This fine rheostat is wire-wound on porcelain insulation. The black enamel steel casing is perforated for ventilation. Adjustable handle regulates speed of motor easily and smoothly. Size 5"x2 3/4" overall. Shp. Wt. 2 lbs.

ITEM NO. 153  
YOUR PRICE **\$1.20**



**AMAZING BLACK LIGHT!!**

Powerful 250-Watt Ultra-Violet Source

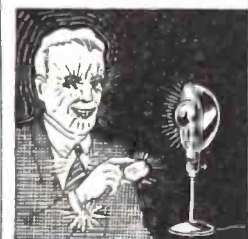

The best and most practical source of ultra-violet light for general experimental and entertainment use. Makes all fluorescent substances brilliantly luminous. No transformers of any kind needed. Fits any standard lamp socket. Made with special filter glass permitting only ultra-violet rays to come through. Brings out beautiful opalescent hues in various types of materials. Swell for amateur parties, plays, etc., to obtain unique lighting effects. Bulb only. Shp. Wt. 1 lb.

ITEM NO. 87  
YOUR PRICE **\$2.00**

**WATTHOUR METER**

Completely overhauled and ready for immediate service. Designed for regular 110-volt, 60 cycle 2-wire A.C. circuit. Servicemen use it in their shops to check current consumption of sets, soldering irons, etc. Keeps costs down. If dismantled, the parts alone would bring the price. The elaborate gear train could be used as a counter on machines of various kinds. Simple to install; 2 wires from the line and 2 wires to the load. Sturdily constructed in heavy metal case. Size: 8 1/2" high, 6 1/2" wide, 5" deep. Westinghouse or General Electric. Shp. Wt. 14 lbs.



ITEM NO. 33  
YOUR PRICE **\$4.95**

# RADIO TECHNOLOGY



RCA Institutes offer an intensive course of high standard embracing all phases of Radio and Television. Practical training with modern equipment at New York and Chicago schools. Also specialized courses in Aviation Communications, Radio Servicing and Commercial Operating. For Free Catalog write Dept. RC-42.

**RCA INSTITUTES, Inc.**

A Radio Corporation of America Service  
75 VARICK STREET NEW YORK

# LEARN RADIO

## TELEVISION

600 LICENSED graduates placed in past 7 years in shipping, broadcasting, aviation, police, etc.; we also teach radio servicing and repairing; new beginners' class forming Sept. 8th; 60-page catalog free; oldest, largest and best equipped.

## MASS. RADIO SCHOOL

18 BOYLSTON ST., BOSTON, MASS., Est. 1899

# RADIO ENGINEERING

DEGREE IN 2 1/4 YEARS

• Complete Radio Engineering Course in 27 months. Bachelor of Science Degree. Radio (television, talking pictures and the vast electronic field) offers unusual opportunities. War needs call for the engineer. Demand exceeds the supply. Courses also in Civil, Electrical, Mechanical, Chemical, Aeronautical Engineering; Business Administration, Accounting, Secretarial Science. Tuition, living costs low. World famous for technical 2 1/4 year courses. Special preparatory department for those who lack required high school work. Enter September, January, March, June, 59th Year. Write for catalog. 2482 COLLEGE AVE. ANGOLA, IND.



# TRI-STATE COLLEGE

# RADIO PATENTS REVIEW AND DIGEST

## Rectifier

No. 2,287,607 issued to Philo T. Farnsworth, Fort Wayne, Ind.

This invention relates to rectifier tubes for rectifying alternating voltages or currents of relatively high frequencies.

In conventional systems for rectifying alternating voltages of relatively high frequencies, a transformer secondary winding is usually coupled to the transformer primary winding across which the alternating voltage is produced, and an increase in alternating voltage across the secondary winding is obtained by proper choice of the transformer ratio. The transformed alternating voltage developed across the secondary winding is then applied to a vacuum tube rectifier to develop a unidirectional voltage.

Since the alternating voltage produced across the transformer primary winding may be of considerable magnitude, of the order of 10,000 volts or more, and the transformed alternating voltage across the secondary winding is still higher, proper insulation of the secondary winding with respect to the primary winding and the iron core is a difficult problem.

In conventional rectifier systems of this type it is also customary to derive the heating power for the cathode of the vacuum-tube rectifier from the primary transformer winding. For this purpose another secondary winding is usually inductively coupled to the primary winding for inducing alternating currents of high frequency in a heater element or in the filament of the vacuum tube rectifier. Since the cathode of the vacuum-tube rectifier represents the positive terminal of the unidirectional voltage source represented by the rectifier, the insulation of the winding connected to the heater or filament with respect to the primary winding and its iron core also represents a serious problem.

The object of the invention therefore is to provide a new and improved rectifier system in which satisfactory insulation is obtained by relatively simple means.

The inventor provides a rectifier structure

comprising an envelope having a hollow reentrant stem, a cathode and an anode. A secondary winding is wound on the reentrant stem within the envelope and supported thereby. This winding is connected to the anode and adapted to be coupled to a primary winding disposed within the reentrant stem outside of the envelope.

The accompanying drawing shows schematically a rectifier system including a rectifier embodying the invention, with certain elements shown in displaced positions.

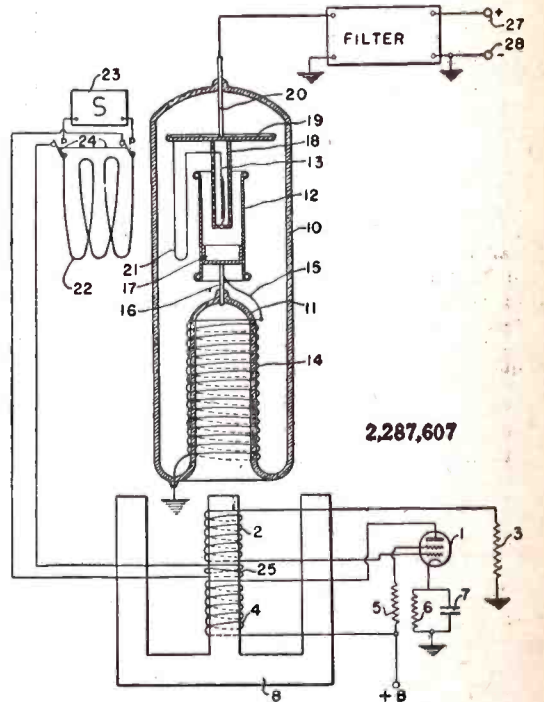

Referring to the operation of the system, the oscillator, comprising oscillator tube 1, windings 2 and 4 and transformer core 8, operates in the conventional manner and generates oscillations of a frequency in the order of 10,000 cycles or more. As is well known, the oscillating current developed by this type of oscillator is of an asymmetrical saw-tooth wave form. During the shorter portion of the saw-tooth cycle a voltage impulse of considerable magnitude is produced across the anode winding 4. This voltage is induced into the winding 14 and applies an alternating voltage of considerable magnitude between the anode 12 and the cathode 13 of the rectifier tube.

An oscillating current which may be of any suitable wave form is developed by the source 23 and supplied to the winding 22. Since the winding 22 is inductively coupled to the wire loop 21, a high-frequency current is induced therein which flows through the cathode 13 and raises its temperature to the point of thermionic emission of electrons.

Alternately, the winding 25, which is coupled to the anode winding 4 and grid winding 2 of the oscillator tube 1, may be connected to the winding 22, by means of switch 24, so that the oscillating current for the coil 22 is derived from the oscillator circuit including tube 1.

The unidirectional voltage developed between the cathode 13 and the anode 10 when these elements are energized by the high-frequency alternating voltage derived from the oscillator, is applied to the filter 26, wherein fluctuations of the unidirectional voltage so developed are filtered out. A filtered unidirectional voltage is thus provided across the output terminals 27 and 28.

The windings 14 and 21, being disposed within the evacuated envelope, are satisfactorily insulated without the requirement of substantial insulating materials as would otherwise be the case.

## Photoelectric Signaling System

No. 2,284,289 issued to Maxwell H. A. Lindsay, Summit, N. J.

In a light barrier system, a light source for creating an intangible light barrier, said barrier being subject to variation by the atmosphere, a photo-electric cell responsive to said barrier, said

# HEADQUARTERS FOR h a l l i c r a f t e r s

**W**E HAVE the World's Largest Stock of HALLICRAFTERS, HAMMARLUND, NATIONAL, RME, HOWARD communications receivers at lowest wholesale prices. Order from us for immediate delivery. We specialize in government and other priority orders and solicit such buyers. We will give you better service and lower prices.

Our stock of receivers is so large that we can sell to civilians. Anyone can buy a communications receiver while our large stock lasts. You can buy on our 6% terms financed by us. You can trade in your radio. You get ten day free trial.

We have a large stock of transmitters, Triplett meters, radio parts and supplies of all sorts. Send to us for any radio parts. No priority required.

★ Write, telephone, telegraph us anytime about any receiver, transmitter or parts. We are on the job 24 hours a day, 365 days a year. We also have a store at 2335 Westwood Blvd., West Los Angeles, Calif. Bob Henry, W9ARA, runs the Butler, Missouri, store; Ted Henry, W6UOU, the California store. Your inquiries invited.

Bob Henry

W9ARA

**HENRY RADIO SHOP**

Butler, Missouri

"WORLD'S LARGEST DISTRIBUTOR OF COMMUNICATIONS RECEIVERS"



**RADIO PATENTS REVIEW AND DIGEST**

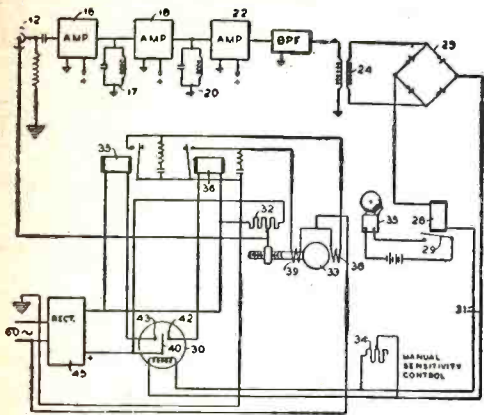

2.284,289

cell being exposed to ambient light, a light chopper between said light source and said cell for chopping said light barrier at a certain frequency, an amplifier comprising a plurality of stages of amplification connected to the output of said photo-electric cell, tuned circuits offering high impedance to the chopping frequency of said barrier and low impedance to all other frequencies and connected between stages in said amplifier for limiting the response of said amplifier to the chopping frequency of said barrier, a rectifier for rectifying the entire output of said amplifier and an alarm relay connected to said rectifier and responsive only to interception of said light barrier.

**Electric Signal Transmission System**

No. 2,284,085 issued to John Collard, Hammer-smith, London, England.

In a television system having video signals combined with interspersed synchronizing impulses and in which direct current and low frequency components of the video signals are sup-

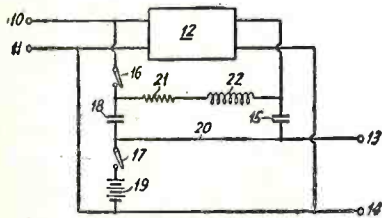

2.284,085

pressed which combined signals and impulses are subjected to distortion in transmission, the method of correcting signals representative of the suppressed components derived from the synchronizing signals at a receiving point which includes the steps of receiving the combined signals and impulses, comparing the received synchronizing impulses with each other, deriving energy representative of the difference of the compared impulses, and adding progressively varying energy to the received signals during the time interval between the synchronizing impulses, the variation of the energy being between the limits of zero and a maximum value proportional to the difference between the compared impulses.

**Record Changing Mechanism for Phonographs**

2.284,305

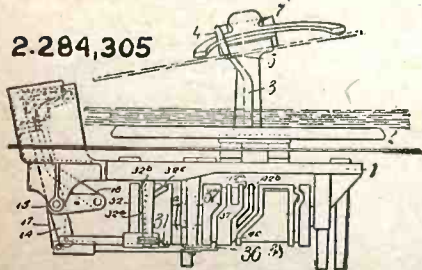

No. 2,284,305 issued to Hector Vaughan Slade, Swindon, England.

A record changing mechanism for phonographs comprising a magazine carrying a pile of disc records of different diameters disposed one above the other a member mounted for lateral movement between a position beneath the pile of

\$ \$ \$ \$ \$ \$ \$ \$ \$ \$ \$ \$ \$ \$ \$

# HARRISON

*I will pay*  
**immediate cash for your...**

**COMMUNICATIONS RECEIVER  
TRANSMITTER TEST EQUIPMENT  
METERS · PARTS, ETC.**

Send us a complete description of your equipment. Mention make, model, age, condition, "improvements," etc. If you have an approximate price in mind, state it. We will make a fair cash offer by return mail.

☆ ☆ ☆

**Hit 'em TWO ways —**

1—Put your idle apparatus to work, for Victory!  
2—Buy Victory Bonds with the cash we give you!

Send in your list today!

**We are headquarters for hallicrafters  
and ECHOPHONE receivers**

**HARRISON** RADIO CO.  
12 WEST BROADWAY - NEW YORK CITY

\$ \$ \$ \$ \$ \$ \$ \$ \$ \$ \$ \$ \$ \$ \$

**Give 'em a  
place to go—  
give to the USO**

## RADIO-TELEVISION INSTITUTE

●

Not just another radio school, but a TRAINING ORGANIZATION well equipped with LATEST and MOST EXPENSIVE APPARATUS and staffed by PRACTICAL RADIO ENGINEERS who understand the various branches of RADIO, TELEVISION and the manifold uses of ELECTRONICS.

●

*Our students quickly find profitable positions.*

●

*Resident course only.  
Inquiries invited.*

**Radio-Television Institute**  
480 Lexington Ave.  
New York City  
*Licensed by the State of New York*

# AMPLIFIERS AND PARTS

GUARANTEED IN ABSOLUTE PERFECT MECHANICAL AND ELECTRICAL CONDITION, ALTHOUGH SLIGHTLY USED.

Photo shows 30 watt ampl. # 104A



All ampl. shipped Ready to operate

# 102A—12 WATT PUSH-PULL 2A3 AMPLIFIER  
Frequency response plus or minus 2DB. from 30 to 15,000 CPS. bass and treble boost. Inputs for phono pick-up or radio tuner. Output impedance 8 or 16 ohms to P.M. or Electro-Dynamic speakers, supplies field current for one or two 2500 ohm speaker fields. An excellent amplifier for FM or recording.

\$18.45

# 102—12 WATT PUSH-PULL 2A3 AMPLIFIER  
Same as above, but without stages of crystal pick-up. Schematic furnished free to change unit over to these stages. To be used with one or two 2500 ohm dynamic speakers 16 ohm voice coil. May be changed over to use P.M. speakers. Input for magnetic pickup. Variable tone control.

\$8.75

Shipping Weight 25 lbs. for either of above

# 103A—20 WATT PUSH-PULL 6L6 AMPLIFIER  
Input for one crystal or dynamic microphone. Input for one crystal or magnetic phono pick-up. Full range tone control. Frequency response 30 to 10,000 CPS. Output impedance 8 or 16 ohms to PM or Electric-Dynamic speakers, supplies field current for one or two 2500 ohms speaker fields.

\$15.95

# 103—20 WATT PUSH-PULL 6L6 AMPLIFIER  
Same as above, but without stages of crystal pick-up and crystal microphone. Schematic furnished free to change unit over to these stages. To be used with one or two 2500 ohm dynamic speakers 16 ohm voice coil. May be changed over to use P.M. speakers. Input for magnetic pickup. Variable tone control.

\$9.85

Shipping Weight 24 lbs. for either of above

# 104A—30 WATT PUSH-PULL 6L6 AMPLIFIER  
Input for two crystal, dynamic or velocity microphones individually controlled. Input for crystal or high impedance phono pick-up. Full range tone control. Frequency response 30 to 10,000 CPS. Output impedance 2.6, 3.2, 4, 5.3, 8 and 16 ohms to P.M. or Electro-Dynamic speakers, supplies field current for one or two 2500 ohm speaker fields.

\$21.45

# 104—30 WATT PUSH-PULL 6L6 AMPLIFIER  
Same as above, but without stages of crystal pick-up and crystal, dynamic or Velocity Microphone. Schematic furnished free to change unit over to these stages. Has input for magnetic pickup, volume control, variable tone control. Supplies field current to one or two 2500 ohm dynamic speakers, output impedance 2.6, 3.2, 4, 5.3, 8, and 16 ohms. Full 30 watts output.

\$12.05

Shipping Weight 26 lbs. for either of above  
All Amplifiers Less Tubes & Speakers.



JENSEN 10 INCH ELECTRO-DYNAMIC SPEAKER

2500 OHM FIELD  
16 OHM VOICE-COIL

EACH \$2.95

Shipping Weight 7 lbs.

ORDERS SHIPPED SAME DAY AS RECEIVED. All goods are sent Express collect if no money for Parcel Post is included in remittance. Customers in Foreign countries are requested to remit in U. S. Currency or International Money Orders and include enough money to ship goods prepaid. Order from this ad. 25% deposit required on all C.O.D. orders.

PEERLESS RADIO AND SOUND CORP.

11 So. Desplaines St., Dept. 842 CHICAGO, ILL.

## RADIO PATENTS REVIEW AND DIGEST

(Continued from preceding page)

records and a position outward of the pile, a pawl on said member normally urged upwardly to project thereabove and depressible by surface contact with the lowermost record of the pile when said member is beneath the pile, a plurality of driving means of different travel, and driven means operatively connected with said member and selectively engageable with one or the other of said driving means for reciprocating said member, whereby in the outward movement of said member the depressed pawl is urged upwardly as it passes the periphery of the lowermost record of the pile and in the inward movement of said member said projecting pawl laterally displaces the lowermost record from the pile, selector means normally urging the driven means into engagement with one of said driving means for providing a lateral movement of the member to its furthest outward position, and stop means positioned to selectively engage the pawl when said pawl in the outward movement of the member has passed the periphery of a lowermost record of smaller diameter, thereby to limit the lateral movement of the member to a position intermediate the furthest outward position, said stop means upon engagement with the pawl rendering the selector means inoperative and selectively engaging the driven means with the other of said driving means.

### Reproduction of Sound

No. 2,284,039 issued to William A. Bruno, Astoria, N. Y.

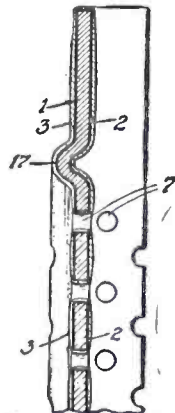

2,284,039

In a translator of sound energy into electrical energy and electrical energy into sound energy, an electro-statically charged system adapted to translate sound energy into electrical energy without the simultaneous supply of electrical energy to said system by outside sources, said system comprising a metallic back plate having transverse perforations extending from side to side, and consisting of aluminum having an electrolytically oxidized surface, a thin coating of carnauba wax composition on said electrolytically oxidized surface, and a diaphragm consisting of a thin aluminum foil.

### Signal Wave Form Indicating System

No. 2,284,219 issued to Arthur V. Loughren, Great Neck, N. Y.

A system for visually indicating at least a portion of the wave form of a television signal comprising, a cathode-ray tube having an input circuit adapted to have applied thereto a television signal to modulate the ray of said tube, said applied signal including synchronizing-signal components, means for periodically deflecting the

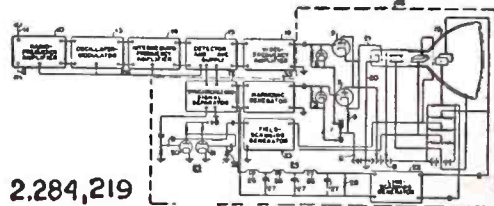

2,284,219

ray of said tube in each of two directions normal to each other, means for controlling said deflecting means to maintain said deflections in synchronism with the synchronizing-signal components of said applied signal, and means for maintaining a predetermined phase displacement between one of said deflections and a corresponding one of said synchronizing-signal components.

### Impulse Generator

No. 2,284,101 issued to Ben White Robins, Philadelphia, Pa.

A wave converter comprising an input circuit for connection to a source of alternating voltage, a capacitor, means coupled to said input circuit for applying a unidirectional charging current of constant amplitude to said capacitor once for each cycle of said alternating voltage, means also coupled to said input circuit and controlled by said alternating voltage for discharging said capacitor through an impedance once for each

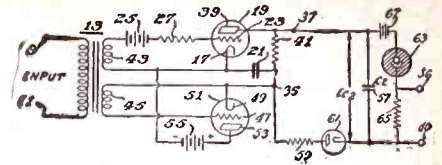

2,284,101

cycle of said alternating voltage, a unidirectional conductor and a second capacitor serially connected across said impedance for applying a unipotential charging impulse to said second capacitor for each cycle of said alternating voltage, and means for discharging said second capacitor after a predetermined number of charging impulses have been applied to said second capacitor.

### Antenna System for Modulated-Carrier Signal Receivers

No. 2,284,131 issued to Nelson P. Case, Great Neck, N. Y.

An antenna system for a modulated-carrier signal receiver including a plurality of aligned tunable circuits adapted to operate from a loop

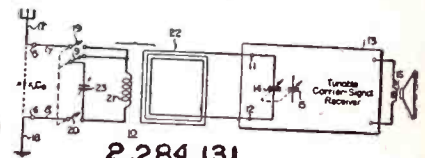

2,284,131

antenna or from an antenna-ground system comprising, a loop antenna adapted to be tuned over a frequency band, means for coupling said loop antenna to said receiver, an input circuit adapted to be connected to an antenna-ground system having capacitance, impedance means coupled to said loop and tunable by said antenna capacitance to resonance at a frequency near the lower end of said band, means for selectively connecting said last-named means to said input circuit to couple said antenna-ground system through said loop antenna to said receiver, and means for minimizing the effect on the alignment of said tunable circuits of the selective connection of said impedance means to said antenna-ground system.

### Parasitic Filter

No. 2,284,181 issued to George L. Usselman, Port Jefferson, N. Y.

In combination a pair of tubes each having an anode, a cathode and a grid, a tuned circuit

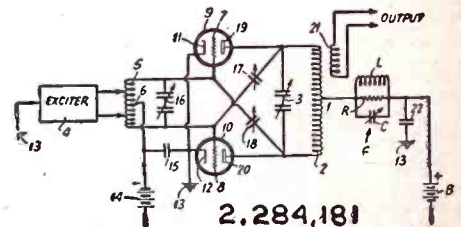

2,284,181

connected across the grids, a tuned circuit consisting of inductance and capacity connected across the anodes, and means for preventing parasitics and permitting high efficiency operation at fundamental frequency consisting of a circuit connected from the midpoint of said inductance across the anodes to ground, said circuit including a resistor, an inductance and a capacity connected in parallel.

### Inverse Feedback Amplifier

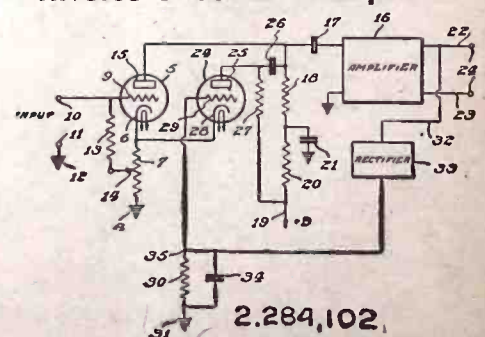

2,284,102

No. 2,284,102 issued to Charles A. Rosencrans, Sewell, N. J.

In an audio frequency amplifier, the combination of an amplifier tube having a signal input

(Continued on page 766)

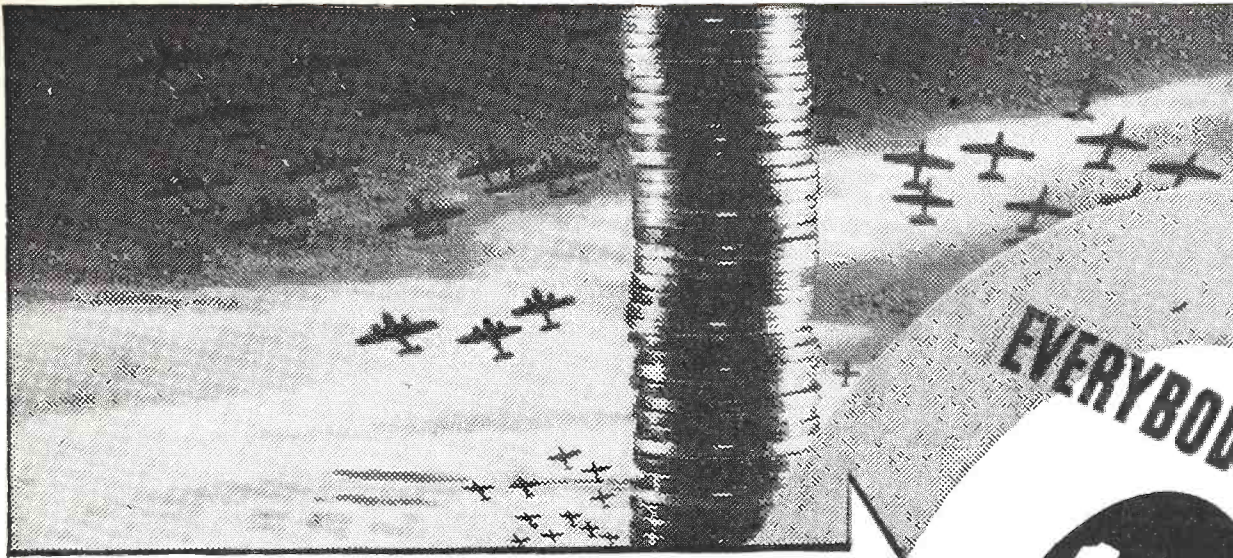

*New Target for Industry:*  
**More Dollars Per Man Per Month in the  
 PAY-ROLL WAR SAVINGS PLAN**



**TO WIN THIS WAR**, more and more billions are needed and needed fast—**AT LEAST A BILLION DOLLARS A MONTH IN WAR BOND SALES ALONE!**

This means a *minimum* of 10 percent of the gross pay roll invested in War Bonds in every plant, office, firm, and factory in the land.

Best and quickest way to raise this money—and at the same time to “brake” inflation—is by stepping up the Pay-Roll War Savings Plan, having every company offer every worker the chance to buy **MORE BONDS**.

Truly, in this War of Survival, **VICTORY BEGINS AT THE PAY WINDOW.**

If your firm has already installed the

Pay-Roll War Savings Plan, *now is the time—*

1. To secure wider employee participation.
2. To encourage employees to increase the amount of their allotments for Bonds, to an average of at least 10 percent of earnings—because “token” payments will not win this war any more than “token” resistance will keep the enemy from our shores, our homes.

If your firm has not already installed the Pay-Roll War Savings Plan, *now is the time to do so.* For full details, plus samples of result-getting literature and promotional helps, write, wire, or phone: War Savings Staff, Section E, Treasury Department, 709 Twelfth Street NW., Washington, D. C.



# U. S. War Savings Bonds

This space is a contribution to America's all-out war program by

**RADIO—CRAFT**

# AERONAUTIC RADIO

for OPERATORS, PILOTS, MECHANICS



**PRINCIPLES, SELECTION, INSTALLATION, OPERATION, MAINTENANCE**  
 By **MYRON F. EDDY**,  
 Lieut., U. S. Navy Ret.,  
 Member Institute of Radio  
 Engineers; Chief Instruc-  
 tor in Aircraft Radio,  
 Stewart Tech. School



This author writes from a back-  
 ground of more than 20 years'  
 experience as Naval Radio Oper-  
 ator, Pilot and as Instructor in  
 Aeronautic Radio in U. S. Navy  
 Ground Schools and leading Com-  
 mercial Schools. Every Student, Pilot,  
 Mechanic, Operator & Air Transport  
 Executive needs this important 502  
 Page Manual. It covers the require-  
 ments of Federal Communications  
 Commission & regulations of the  
 C.A.B., also the actual approved  
 usage of the latest equipment for  
 both communications and special  
 purposes. It contains over 198 Illus-  
 trations with Clear Explanations which  
 are Easily Understood even by Be-  
 gimmers. The 200 Questions will enable you to test your  
 grasp of the information provided in the text.

**PREPARES FOR AVIATION RADIO LICENSE EXAMS**

The interesting & informative chapters cover: Aviation  
 Radio Communications; Fundamentals of Electricity; Radio  
 Electricity; Radio Circuits; Radio Tubes; Batteries; Power  
 Supplies; Radio Telegraphy; Transmitters; Radio Range  
 Transmitters; Receivers; Direction Finders; Radio Range  
 Instrument Landing Systems; Radio Traffic  
 Control; Installation of Equipment; Mainte-  
 nance; Trouble Shooting and Servicing.

**\$4.50**  
 Postpaid

502 PAGES  
 SENT ON 5 DAYS EXAMINATION

Now is the time to speed up your knowledge of this  
 important branch of Radio. Mail Coupon Today.

**THE RONALD PRESS COMPANY, Dept. M649**  
 15 East 26th St., New York, N. Y. (Est. 1900)

Send copy of AERONAUTIC RADIO by Myron F.  
 Eddy. I agree to inspect the book and either pay  
 \$4.50 (plus few cents postage) within 5 days or return  
 it. (We pay postage when cash is sent with order.  
 Same return privilege.)

Name .....  
 Address .....  
 Reference .....  
 (Must be Complete with Address)  
 CHECK HERE FOR CATALOG OF PUBLICATIONS  
 ON AERONAUTICS.

## Headset Headquarters

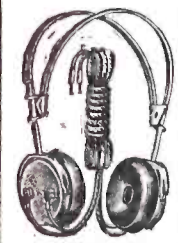

Our Headphones are used  
 by the United States,  
 Canadian, New Zealand  
 and South African Gov-  
 ernments as well as other  
 Governments not directly  
 in the war. Folder C-8 il-  
 lustrates rugged, unusu-  
 ally sensitive, dependable  
 Cannon-Ball Headsets.

Scientifically  
 Built  
 Heavy bar mag-  
 nets greatly in-  
 crease their effi-  
 ciency.

Write .....

**C. F. CANNON COMPANY**  
 SPRINGWATER, N. Y.

## Inventions Wanted

Patented or Unpatented

We have been successfully selling inventions,  
 patented and unpatented, since 1924. Write us.  
 If you have a practical, useful idea for sale.  
**CHARTERED INSTITUTE**  
**of AMERICAN INVENTORS**  
 Dept. 109 Barrister Building, Washington, D. C.

## PATENTS — TRADE MARKS

Booklet concerning Inventions & Patents  
 Form "Evidence of Conception" with  
 instructions for use and "Schedule of  
 Government and Attorneys Fees"—Free  
**LANCASTER, ALLWINE & ROMMEL**  
 Registered Patent Attorneys  
 436 Bowen Bldg. Washington, D. C.

**New Handy UNIVERSAL REPLACEMENT Capacitors**

Write for Catalog  
**SOLAR MFG. CORP., Bayonne, N. J.**

## RADIO PATENTS REVIEW AND DIGEST

(Continued from page 764)

grid, an anode and a cathode, means providing a feedback impedance in circuit with the cathode, means providing a connection with said last-named impedance for the signal input grid for applying a biasing potential thereto, an output coupling impedance in circuit with the anode, a second amplifier tube having an anode coupled to the anode end of said coupling impedance and having a cathode connected with the cathode of said first-named amplifier tube, a control grid for said second amplifier tube.

### Saw-Tooth Current Generator

No. 2,284,337 issued to Theodor Mulert and Frithjof Rudert, Berlin-Zehlendorf, Germany.

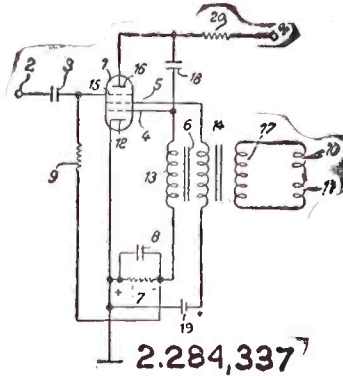

A saw-tooth current generator comprising a vacuum tube having a cathode and a plurality of control electrodes, a transformer having a plurality of windings, a resistance-capacitance parallel network connected in series with a first of said windings between said cathode and the first of said control electrodes, a source of potential connected in series with a second of said windings between said cathode and the second of said control electrodes, and a connection from the junction of said network with said first winding to the third of said control electrodes.

### Oscillation Generator

No. 2,284,372 issued to Howard M. Crosby, Schenectady, N. Y.

The combination, in an oscillation generator, of an electron discharge device having an anode, a cathode, and a plurality of control electrodes,

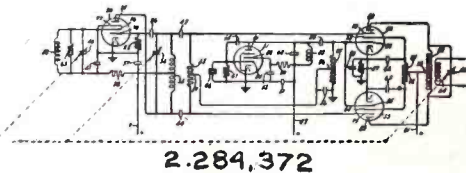

a source of operating potential connected between said anode and said cathode, an oscillatory frequency determining circuit coupled to said anode and to one of said control electrodes having oscillations excited therein by action of said discharge device, the frequency of said oscillations being dependent upon the potential of said source, and means to control the extent to which said frequency is dependent upon said potential, said means including a circuit connected between another of said control electrodes and said cathode resonant at a frequency different from harmonics of, and higher than, the frequency of said oscillations and at which the coefficient of variation of frequency of said oscillations with respect to variation in said potential is of a desired predetermined value.

### Deflecting Circuit

No. 2,284,378 issued to Robert B. Dome, Bridgeport, Conn.

In a ray deflecting circuit for a cathode ray discharge device, the combination of a current responsive ray deflecting means, a thermionic discharge device having input and output circuits, a transformer having a primary winding

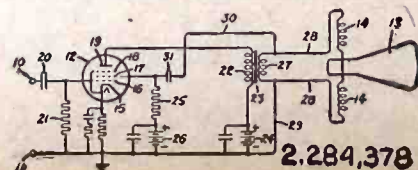

in said output circuit and a secondary winding in circuit with said current responsive means, means to impress sawtooth voltage waves on said input circuit having a relatively gradual rate of change in one direction during intervals of trace and a relatively high rate of change in the opposite direction during intervals of retrace, whereby current waves are caused to flow in said ray deflecting means which produce a relatively low positive potential across said secondary winding during intervals of trace and a relatively high negative potential thereacross during intervals of retrace, and feedback means for supplying said potentials to said discharge device in proper phase to increase the plate resistance of said device substantially during intervals of retrace.

### Continuous Electrical Outlet

No. 2,284,097 issued to Nicholas La Jone, Sr., Chicago, Ill.

An electrical outlet comprising, in combination, a body in the form of an elongated rubber strip having parallel slots opening in one face thereof, electrical conductors in-said slots, and complementary interfitting ribs and grooves on opposite sides of the slots adjoining the open faces of the slots arranged yieldingly to close said slots.

### Electrical Control Apparatus

No. 2,284,649 issued to William Christian Grabau, Brighton, Mass.

Means for maintaining frequency and voltage of a motor generator having field windings, constant under varying operating conditions, comprising a pair of gaseous conducting tubes connected in shunt with said windings and means comprising tuned circuits tuned to frequencies off

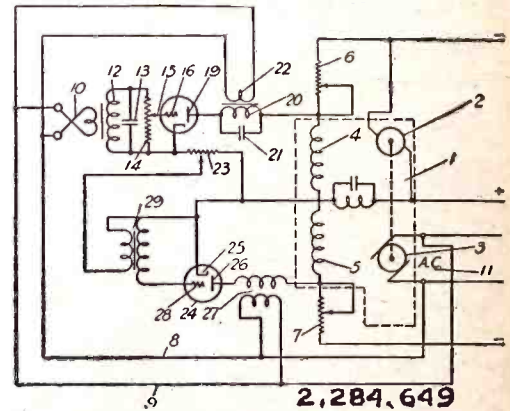

the operating frequency of the generator for controlling operation of said tubes and means for impressing said generator frequency and voltage upon said tuned circuits.

### System for the Recording of Sound

No. 2,284,731 issued to Irl R. Goshaw, Beverly Hills, Calif.

A sound recording system comprising means for obtaining a plurality of light beams, and means for varying the light values of said beams in accordance with a signal, said light beams having a certain intensity and varying in dimensions as a class A recording for amplitudes of said signal within a certain amplitude range of said signal, and varying similarly in dimensions as a combination class A and class B recording for another amplitude range of said signal, said

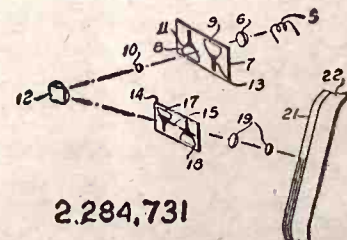

beams having a different intensity when varying as a combination class A and class B recording, the variations in said light beams corresponding to the amplitudes of said signal at all amplitudes thereof.

### Musical Instrument

No. 2,284,911 issued to Louis A. Maas, Glendale, Calif.

A chime, comprising a chime member forming one part of a condenser, a plate insulated from said chime member, and insulated spring members supporting said plate on the chime member, the said plate having a different contour from the chime.



# ● Book Reviews ●

**THE ELECTRON MICROSCOPE**, by E. F. Burton and W. H. Kohl, Published by Reinhold Publishing Corporation, New York, N. Y. Stiff cloth covers, size 9 x 6 ins., 224 pages, illustrated. Price \$3.85.

This is the story of the electron microscope—its history, development and application—told in an easily readable and readily understandable form.

Dr. E. F. Burton, head of the Department of Physics at the University of Toronto, and Dr. W. H. Kohl, now Development Engineer of Rogers Radio Tubes Co., Ltd., of Toronto, but formerly associated with Dr. Burton at the university, together have for eight years guided the work of students of electron microscopy. In 1935 C. E. Hall constructed an electrostatic electron microscope there. Two years later, Mr. Hall joined the Eastman Kodak Company research laboratory, where he has been carrying on his work in this field.

In 1937 James Hillier, a post-graduate student, began construction of a high-voltage magnetic compound microscope. In 1940 Dr. Hillier went to RCA, where, with A. W. Vance and under the direction of Dr. V. K. Zworykin, he designed the electron microscopes for industrial research (a description of the most recent of these developments appears in this issue of *Radio-Craft*).

But as each student moved on to industrial fields, others came to fill their places, and the work at the University of Toronto continued. Despite limited funds two complete instruments were entirely produced at the university, which has one of the largest and best-equipped laboratories in North America.

Drs. Burton and Kohl have enjoyed their work immensely. Their book gives every indication of this. They take their reader on a whimsical voyage in the realm of fact and fancy and point out the essential incidents that contributed to man's better understanding of the Universe.

The drawings, by Dorothy Stone, carry out the spirit and intent of the authors in such unique fashion it becomes immediately apparent that *The Electron Microscope* is neither a weighty textbook nor a light popularization. It falls somewhere between these categories into a class of its own as a factual "Through The Looking-Glass" in which the reader becomes Lewis Carroll's favorite character.

*Radio-Craft* readers may not attempt to construct electron microscopes, but they should find considerable interest in the simple experiments described and the theoretical considerations discussed, all of which led to the development of taking magnified pictures *without light*.

**FUNDAMENTALS OF RADIO**, by Edward C. Jordan, Paul H. Nelson, William Carl Osterbrock, Fred H. Pumphrey and Lynne C. Smeby. Edited by W. L. Everitt. Published by Prentice-Hall, Inc., New York, N. Y. Flexible cloth covers, 6 x 9 ins., 400 pages. Price \$5.00.

The combined efforts of six men—five writers and an editor—went into the preparation of *Fundamentals of Radio*. Three professors and an instructor of electrical engineering and the director of engineering of the National Association of Broadcasters did the preliminary work. The editor, William L. Everitt, is professor of electrical engineering at Ohio State University and is widely known as an author, editor and consultant on radio.

These men were charged with the task of providing a simple, authoritative and com-

prehensive textbook for classroom or home study to train men—from beginners to technicians—for radio industry, broadcasting and the Armed Forces. The publishers claim that this is the only book of its kind which follows exactly the specifications on training given by the United States Signal Corps and that it also answers all the requirements of the course outline given by the National Association of Broadcasters, thus meeting America's needs in peace and war.

The authenticity of the material can not, of course be questioned. There remains, therefore, only to evaluate its presentation—to see whether these men, accustomed to teaching advanced engineering students, actually are able to speak in the language of the beginner; whether thoroughness has not been sacrificed for simplicity, and, curiously, what six men could do that one man could not do.

The wording is amazingly simple—too simple, we thought, until we realized the special benefits to be derived by the youngest possible radio beginner from this type of textbook, a privilege otherwise denied to him. The authors have a way of introducing significant terminology (generally in *Italic type*) which is highly commendable. If the student is to learn radio he might as well learn it correctly in the same terminology used by radio engineers. Mathematics is introduced in the beginning of the book, with the suggestion that the student need not study all of it at once, but may return to it as his progress in radio requires.

There does not seem to be, anywhere in the book, an attempt to impress the reader with the engineering ability of its authors, a fault frequently encountered in supposedly simple textbooks. Rather, we had the feeling, in numerous parts of the book, that these men of learning had doffed their professorial garb and put on knee-pants and sat with us on a bench and explained to us in a convincing way how easy were the *how's* and *whys* of radio.

What could these six men do that one man couldn't do? They could write a book—one book rather than six—that would spare the student the time and effort required to study six books to learn the fundamentals of radio.

**THE METER AT WORK** by John F. Rider. Published by John F. Rider Publisher, Inc., New York, N. Y. Stiff cloth covers, size 5 x 8 1/4 ins., 152 pages. Price \$1.25.

John Rider is the Serviceman's serviceman. Accordingly, he solders together bits of informative material into a cascade circuit (very much as you would do with parts of a radio receiver) to yield a finished article of fairly reliable performance. But just as the Serviceman sometimes becomes an Experimenter and, finding fault with some recurring annoyance, decides to change things around to benefit his set-owner customer, so Mr. Rider changes the old order of things for the pleasure of his book-reader customer.

In *The Meter At Work* he has done the equivalent of separating his *power supply* from his *amplifier*! But he keeps them both close together for greater flexibility.

Maybe this is an old trick, but it's new to us:

The pages are cut horizontally into two sections. The upper half, which is the smaller of the two, contains the table of contents and the illustrations, while the lower—and larger—half page is devoted exclusively to text matter.

To those of us who lack photographic minds capable of carrying over an illustration to its complementary text, or vice versa, this idea is, to say the least, a blessing. We have found frequent references and cross-references to earlier pages to have a tiring and almost discouraging effect on our reading.

With this split-page arrangement the upper portion can be left open (it is numbered separately) to the page containing a diagram while the lower pages are turned in reading the book.

The inside of the cover jacket contains two charts, suitable for framing, showing family-tree descriptions of repulsion-iron and D'Arsonval movements and their uses.

The illustrations of *The Meter At Work* show principles, parts, meters and how meters are connected in circuits. The text supplies the details and occasional formulas. Generally informative, the book is written in a somewhat personal style and there is frequent use of "we." But who are *we* to complain.

**ACOUSTIC DESIGN CHARTS**, by Frank Massa, Published by The Blakiston Company, Philadelphia. Size 6 x 9 inches, washable cloth covers, 228 pages including index. Price \$4.

This book is a compilation of 107 charts relating to acoustics and electro-acoustical devices by Frank Massa, who was responsible for a large amount of the acoustical development work of R.C.A. and now is in charge of the Acoustic Division of The Brush Development Company. An opportunity to look at these charts, therefore, is like getting a glimpse of the private files or personal notebook of special short-cut methods of a leading engineer. Except that in this case it is more than just a momentary look—it is a chance to study and absorb information not otherwise available in as clear and understandable a form.

The graphical method of presenting data serves a two-fold purpose: (1) It avoids formulas and long explanations, and (2) it gives the reader an enlarged picture containing answers to problems without a great deal of computation. The only complaint one can have regarding graphs of this kind is that they do not allow for great accuracy. However, especially in the field of acoustics, approximations are permissible except in relatively few cases. In only one chart have we found that greater accuracy would be necessary to make use of it in computations to which it refers. This is the chart (No. 101) showing musical frequency ratios versus intervals in the so-called equally tempered scale. The experimenter in electronic musical instruments would require these ratios to at least five decimal places for any reasonable degree of accuracy.

Each of the charts has an accompanying short explanation, a sample problem and the solution, all of which are worked out by simple reference to the chart. Those charts involving frequency and wave length contain parallel "curves" giving wave length in feet, inches and centimeters.

The charts are grouped in nine separate sections, each giving related data. These are: Fundamental relations in plane and spherical sound waves; attenuation of sound and vibrations; mechanical vibrating systems; acoustical elements and vibrating systems; radiation of sound from pistons (direct radiator loud speakers); directional

(Continued on following page)

# NOW—A REALLY HIGH-POWERED— Radio Engineering Library

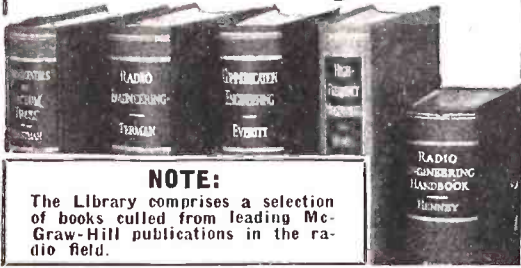

**NOTE:**

The Library comprises a selection of books culled from leading McGraw-Hill publications in the radio field.

- especially selected by radio specialists of McGraw-Hill publications
- to give most complete, dependable coverage of facts needed by all whose fields are grounded on radio fundamentals
- available at a special price and terms

THESE books cover circuit phenomena, tube theory, networks, measurements, and other subjects—give specialized treatments of all fields of practical design and application. They are books of recognized position in the literature—books you will refer to and be referred to often. If you are a practical designer, researcher or engineer in any field based on radio, you want these books for the help they give in hundreds of problems throughout the whole field of radio engineering.

**5 VOLUMES, 3319 PAGES, 2289 ILLUSTRATIONS**

1. Eastman's FUNDAMENTALS OF VACUUM TUBES
2. Terman's RADIO ENGINEERING
3. Everitt's COMMUNICATION ENGINEERING
4. Hund's HIGH FREQUENCY MEASUREMENTS
5. Henney's RADIO ENGINEERING HANDBOOK

10 days' examination. Easy terms. Special price under this offer less than books bought separately. Add these standard works to your library now; pay small monthly installments, while you use the books.

**10 DAYS' FREE EXAMINATION—SEND COUPON**

McGraw-Hill Book Co., 330 W. 42nd Street, N. Y. C.

Send me Radio Engineering Library, 5 vols., for 10 days' examination on approval. In 10 days I will send \$3.00 plus few cents postage, and \$3.00 monthly till \$24.00 is paid, or return books postpaid. (We pay postage on orders accompanied by remittance or first installment.)

Name .....

Address .....

City and State .....

Position .....

Company .....

**NEW CATALOG**  
OF SOUND AMPLIFYING SYSTEMS

AUDIOGRAPH Sound Systems represent the latest in Public Address equipment—a complete line plus pre-tested accessories.

**NEW LOWER PRICES**  
Outstanding quality and performance at prices that help you meet any competition.

WRITE FOR YOUR FREE COPY

**AUDIOGRAPH**  
THE FIRST NAME IN SOUND

John Meck Industries—Liberty at Pennsylvania Ave., Plymouth, Ind.

## COMMERCIAL RADIO INSTITUTE

A radio training center for over twenty years. Well equipped. Excellent faculty. Practical resident courses in Defense, Radio Telegraphy, Broadcast, Servicing, Industrial, Television, Aeronautical, Drafting, Mathematics and Studio Technique. Placement bureau. Fall Class now forming for October 5th. Catalog upon request.

Dept. D, 38 West Biddle Street, Baltimore, Md.

**WHO WILL BE FIRST?**

Now is the time to construct simple radio sets using from one to four tubes and made entirely from old radio parts or substitute materials.

RADIO-CRAFT wishes to publish photographs and descriptions of such sets. Regular space rates will be paid. LET'S GET BUSY.  
EDITOR.

## Book Reviews

(Continued from preceding page)

radiation characteristics; reverberation and sound reproduction, exponential horn loudspeakers and electro-mechanical design data. Section 10 contains miscellaneous data which gives, besides the frequency ratio chart mentioned, another octave ratio chart, decibel conversion charts, a graph showing the total db. level obtained from the use of an additional speaker, charts on power loss from impedance mismatching and power loss due to phase differences and a chart showing the acoustic power needed to produce a given sound pressure at a desired distance in a certain angle of coverage.

Although the book was "intended to serve as a quick, handy reference for the convenient use of any one interested in the design or construction of electro-acoustic apparatus," it appears to have a wider appeal than the author apparently had intended for it. There is a large amount of data of interest to the student and experimenter, to whom a "picture-story" presentation devoid of lengthy mathematical computations is even better suited than to the design engineer, who has the source references and is better able to perform the cumbersome operations. Perhaps a lesser use of specialized terminology and more generalized explanations would cause this book to be more widely circulated and the revisions might not be offensive to the designers for whom the book was intended. The amount of unused white space in the book under the sample problems and most of the charts could be utilized for this. There is a need for such an authoritative compilation of useful data for the worker in radio who wants the information but doesn't know where to find it.

### 5-TUBE SHORT-WAVE SUPERHET. RECEIVER

IN the article on the 5-Tube Short-Wave Superhet. Receiver, by Howard H. Arnold, which appeared in *Radio-Craft* for June, pages 626-628, the following parts list was inadvertently omitted:

**CONDENSERS**

- One Illini 8 mf., 450-V. tubular condenser, C1
- Two Aerovox dual 8 mf., 450-V. upright can elect. condenser, C2, C3
- Two Illini, 10 mf., 35-V. elect. condenser, C4, C8
- One Aerovox .01 mf., 600-V. condenser C5
- Two Aerovox .00025 mica condenser, C6, C7
- One Aerovox .0001 mica condenser, C10
- One Aerovox .1 mf., 200-V. condenser, C11
- One 30 mmf., variable condenser, C12
- One 150 mmf. variable condenser, C13
- One 140 mmf. variable condenser, C14.

**RESISTORS**

- One Ohmite 300 ohm, 1-W. resistor, R1
- Two Ohmite 70,000 ohm, 1/2-W. resistors, R2, R10
- One Ohmite 250,000 ohm, 1/2-W. resistor, R3
- Two Ohmite 50,000 ohm, 1/2-W. resistors, R4, R7
- One Ohmite 100,000 ohm, 1/2-W. resistor, R5
- One Ohmite 10,000 ohm, 10-W. resistor, R6
- One Ohmite 300 ohm, 1/2-W. resistor, R8
- One Centralab 10,000 variable resistance resistor, R9.

**TRANSFORMERS**

- One Stancor power transformer, T1 6.3 V. @ 1.2A, 5-V. @2A., 600-V. C.T.
- One Stancor Output transformer, T2
- One Meissner BFO transformer, T3
- One Allied 1500 Kc. iron core I.F. transformer, T4
- One Allied 1500 Kc. iron core I.F. transformer, T5.

**MISCELLANEOUS**

- One 450-ohm speaker field, L1.
- One UTC 30 hy. choke, L2
- One osc. plug-in coil, L3
- One R.F. plug-in coil, L4
- One S.P.S.T. on volume control, Sw1
- One S.P.S.T. toggle, Sw2
- One S.P.S.T. toggle, Sw3
- One 4 1/2-inch dynamic speaker
- One Bud circuit-opening jack, J1.

# RADIO ENGINEERING,

broadcasting, aviation and police radio, servicing, marine radio telegraphy and telephony, Morse telegraphy and railway accounting taught thoroughly. 48 weeks' Engineering course equivalent to 3 years of college radio work. All expenses low. Catalog free. School established 1874.

The Dodge Institute, Monroe St., Valparaiso, Ind.

**LES** Correspondence Courses in  
**RADIO and ELECTRICAL ENGINEERING**

**ELECTRICAL ENGINEERING** Get good grasp of wide electrical field. Prepare yourself, at Low Cost, for secure future. Modern, simplified, you can understand quickly.

**RADIO ENGINEERING** Extra fine course in radio, public address, photo-electric work. He address, photo-electric work. Trains you to be super-service man, real vacuum tube technician. Exper. kits furnished. Diploma on completion. Tuition, \$25. either course. Deferred payment plan.

**FREE** Get copies of school catalogs, student magazines, complete details. SEND NOW!

LINCOLN ENGINEERING SCHOOL Box 931-C44, LINCOLN, NEBR.

## Index to advertisers

Aerovox .....	754
Allied Radio Corp.....	753
Amperite Corp.....	752
Arrow Radio, Inc.....	759
Audel & Co., Theo.....	710
Audiograph .....	768
Burstein-Applebee Co.....	759
Candler System Co.....	750
Cannon Co., C. H.....	766
Capitol Radio Engineering, Inc.....	748
Chartered Institute of America.....	766
Commercial Radio Institute.....	768
Dodge's Institute.....	768
Erwood Sound Co.....	755
Gold Shield Products.....	755-758
Hallicrafters, Inc....	Inside Front Cover
Harrison Radio.....	763
Henry Radio.....	762
Hudson Specialties Company.....	761
Hygrade Sylvania Corp.....	708
International Correspondence Schools .....	746
International Resistance Co.....	733
Korrol Mfg. Co.....	759
Lancaster, Allwine & Rommel.....	766
Lincoln Engineering School.....	768
Mass. Radio School.....	762
McGraw-Hill Book Co.....	768
Meissner Manufacturing Co.....	745
National Radio Institute.....	705
National Union Corp.....	749
N.Y.-YMCA Schools.....	748
Peerless Sound & Radio Co.....	764
Prentice-Hall.....	Back Cover
Radcraft Publications, Inc.....	747, 760
Radio Corp. of America.....	707
RCA Institutes.....	762
RCA Mfg. Co.....	3rd Inside Cover
RCA Institutes.....	762
Radio-Television Institute.....	763
Radolek Co.....	736
Readrite Meter Works.....	752
Ronald Press.....	766
Schott Co., Walter L.....	755
Solar Manufacturing Co.....	766
Sprague Products Co.....	751
Sprayberry Academy of Radio.....	753
Supreme Instruments Corp.....	755
Supreme Publications.....	748
Technifax.....	743, 758
Teleplex Company.....	748
Treasury Department.....	765
Triplett Electric Instruments Co.....	735
Tri-State College.....	762
University Laboratories.....	748
Weston Elec. Instrument Co.....	741
John Wiley & Sons.....	750
X. L. Laboratories .....	748

(While every precaution is taken to insure accuracy, we cannot guarantee against the possibility of an occasional change or omission in the preparation of this index.)



## They'll have to keep 'em going... "Over There!"

Designing military radio equipment—? Who isn't, these days! Then pause a moment, and give thought to a very practical problem—the problem of maintenance of your equipment in the field.

This is a global war. Your equipment will probably be used in far-flung outposts, thousands of miles away. In Australia. In Africa. In Russia.

Wherever military radio equipment is used, repair posts must be set up. Such posts must be stocked with every type of tube and part your equipment uses for replacement purposes.

**DONT "OVER-DESIGN"**  
Be practical. Try to standardize on

readily-available tube types—a few types of transformers, condensers and other circuit components. Avoid "special" tubes and parts whenever possible. Remember that a good radio in working order is worth more than a "perfect" radio that's out of action!

RCA and other manufacturers are continuing to make available new and

special tube types—in keeping with our policy of offering every possible help to designers of military equipment. But remember that the more types used the more difficult becomes the problem of providing for replacements in the field.

Do not specify special types where a standard tube—or even two standard tubes—can be made to perform the same function. Remember that practical problems of supply, thousands of miles from home, may count for more than any slight theoretical improvements in performance.

**BUY U. S. WAR BONDS REGULARLY**



## RADIO TUBES

RECEIVING TUBES • POWER TUBES • SPECIAL PURPOSE TUBES

## Advice worth repeating... to YOUR customers, too!

The advertisement reproduced above is part of RCA's contribution to America's war effort. It is running in publications directed primarily to designers and engineers—advising them to keep their equipment *simple... to standardize* on parts.

That kind of advice is worth passing along. For American military radio equipment, in this global war, may have to be maintained thousands of miles from home—in remote outposts and repair depots far from normal supply-centers.

Many of *your* customers are probably at work on military radio equipment—tell *them* the story, too! Full-size reprints of this advertisement are available on request.

★ BUY U. S. WAR BONDS REGULARLY ★



## RADIO TUBES

RECEIVING TUBES • POWER TUBES • CATHODE RAY TUBES • SPECIAL PURPOSE TUBES

# QUALIFY—AT HOME—QUICKLY

for your pick of the 200,000 RADIO JOBS in the Armed Forces, Commercial Broadcasting & Industry.

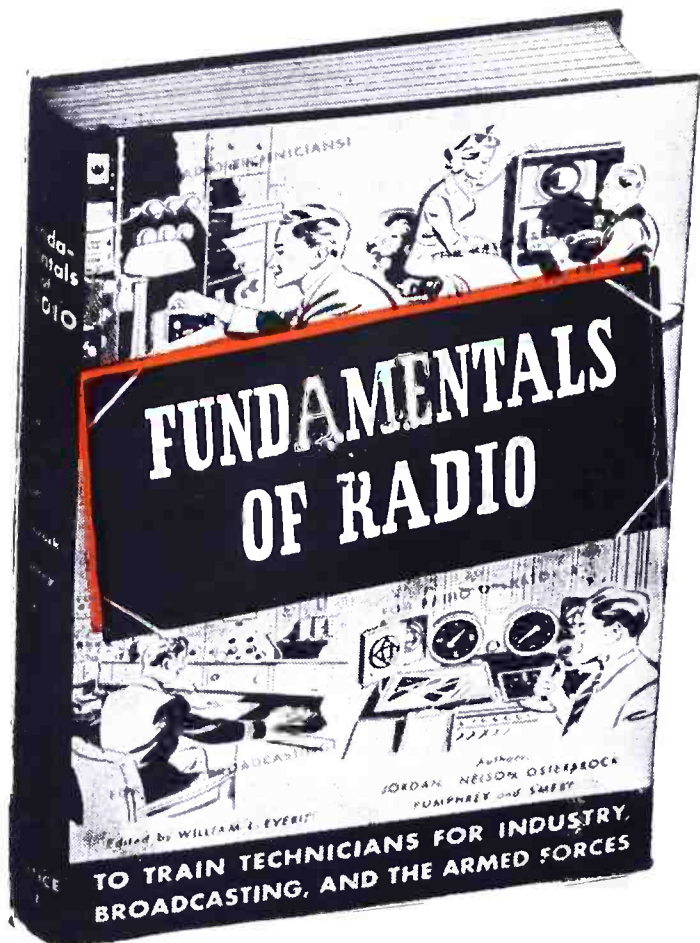

**Use this Standard New Home Course in BASIC RADIO COMMUNICATIONS to brush up and meet today's requirements**

**I**F you want to prepare yourself for a radio post in advance of induction or enlistment in the military services—if you want to get into radio broadcasting or into the radio industry—here is the book that will give you the basic training you need. FUNDAMENTALS OF RADIO trains you in the entire field of basic radio communications, from the simplest circuits right through FM transmission. No previous experience is necessary. This easy-to-grasp home course is written not for engineers, but for student technicians who must know how to maintain and operate all types of radio apparatus, and have only a limited time in which to master the required essentials.

**"The One Book Unique In The Radio Field"**

"With this one volume alone, men with no previous radio experience or knowledge can . . . obtain a thorough grounding in radio principles. In thoroughness, this book is outstanding . . . in the authors' appreciation of the reader's outlook and problems . . . the one book unique in the radio field."

—Scientific American.

"For many years, I've sought an adequate answer to the oft-repeated question, 'Where can I find a book which, in one volume, will teach me the fundamentals of radio?' This book is the answer I've waited years to have."

—E. K. Cohan, Director of Engineering, C.B.S.

"Anyone mastering the contents of FUNDAMENTALS OF RADIO should possess all the preliminary requirements of radio men and technicians for military and naval service."

—E. E. Tierney, Chief Instructor, Eastern Radio Institute, Boston, Mass.

**COMPLETE TRAINING FOR TODAY'S IMMEDIATE NEEDS . . .**

*Here is a glimpse of your instruction in basic radio communications*

Concise Review of Radio Mathematics—A. C. and D. C. Circuits—Power, Energy, Fuses, Batteries, Electromagnetism, Generators, Meters, Transformers, Rectifiers, Resonance Testing, Voice and Music Waves—Electronic Principles—Rectified Power Supplies—Sound and Electrical Transmission—Sound, Distortion, Microphones—Reproducers—Telephone—Loudspeakers—Audio Amplifiers—Public Address Systems—Vacuum-Tube Instruments—Oscillators—Electromagnetic Waves—Radiation and Reception—Antenna Structures—Transmission—Radio Frequency Amplifiers and Detectors—Input and Output Circuits—Amplitude Modulation Radio Transmitters—Radio, Audio Frequency Section—Crystal Oscillators—Buffer Amplifiers—Modula-

tors—Transmitter Circuit—Radio Frequency Section—Amplitude Modulation Radio Receivers—Frequency Modulation, General Principles, Wide-Band FM and Static Eliminators—FM Systems for Communication Services—FM Transmitters and Receivers—Radio Wave Propagation—Polarization—Static and Man-Made Noise—Ultra-High-Frequency Propagation—Diffraction—Refraction—Functions of Radio Antennas—Types—Directional Antenna Systems—Radio Beacons—Direction Finders and Radio Compasses.

**OVER 300 WORKING DIAGRAMS**  
from the simplest circuit to FM transmission

With any sort of past interest in radio as a background, your chances of landing a big-pay, big-opportunity job were never so bright. In the land and naval forces, in aviation, commercial broadcasting, police airways and the manufacturing industry, the shortage of radio technicians is acute, the rewards exceptional. Now is the time to give yourself the rapid basic training in radio communications which qualifies you without delay. FUNDAMENTALS OF RADIO provides exactly that training—at home—in your spare time—without wasting effort on non-essentials—without omitting any of the essentials required in actual practice. In one handy, easy-to-master volume, written by six high-ranking instructors, FUNDAMENTALS OF RADIO covers everything you need to know about basic radio communications.

## MONEY-BACK GUARANTEE

PRENTICE-HALL, Inc.  
Dept. FR-6, 70 Fifth Ave., N.Y.C.

Please rush copy of FUNDAMENTALS OF RADIO. I enclose \$5, plus 10¢ postage. If, within 5 days, I decide not to keep this book, I am free to return it for refund of the purchase price.

NAME .....

ADDRESS .....

CITY & STATE .....

SEND C.O.D., plus few cents postage charges. (Same refund guarantee.)

Clip this coupon or order by letter, addressing Dept. FR-6, as above.

## FREE 5-DAY OFFER

Every minute counts! Don't postpone your opportunity for a good job now and the foundation for a highly successful future in radio. Get started by mailing the coupon at once on our 5-DAY-MONEY-BACK-OFFER. Read, study, examine FUNDAMENTALS OF RADIO for five days—free. Return the book for refund if you do not find it the easiest way to qualify, at home, quickly, for one of the 200,000 radio jobs now waiting for men to fill them.



• William L. Everitt, Ph.D., Editor, Senior Consultant on Air Communication and Director of Operational Research Section in Signal Corps, U.S. Army; Professor of Electrical Engineering, Ohio State University; Fellow of AIEE and IRE; member of Board of Directors and Board of Editors of the Institute of Radio Engineers.

• Lynne C. Smeby, Consultant on Air Communication, Signal Corps; U.S. Army; formerly Director of Engineering for National Association of Broadcasting; member of Board of Editors of Institute of Radio Engineers.

• William Carl Osterbrock, Professor of Electrical Engineering, University of Cincinnati.

• Fred H. Pumphrey, Curriculum Adviser, Signal Corps, U.S. Army, Professor and Head of Electrical Engineering, Rutgers University.

• Paul H. Nelson, Ohio State University; formerly radio engineer for Westinghouse Electric, RCA Victor and other firms.

• Edward C. Jordan, Ohio State University; research work in antennas and impedance matching systems; consultant on transmitters and radiating systems.

**Let these experts fit you rapidly for big pay now—and for a post war future in radio.**