

RADIO'S GREATEST MAGAZINE

K

RADIO-CRAFT

Incorporating

RADIO & TELEVISION

HUGO BERNBACK, Editor

**BUILD YOUR OWN
AIRPLANE DETECTOR**

See Page 458



APRIL



CANADA 30¢
1942

OVER 125 ILLUSTRATIONS



The Navy says:

"WELL DONE!"

...and Radio Research Contributed

The Navy "E" pennant, symbol of achievement in war production, is the highest praise the United States Navy can bestow on an industry.

▶ Recently awarded to RCA Manufacturing Company, this emblem of excellence is a tribute to the loyalty and cooperation of the men and women who are working night and day to "Beat the Promise" to the Government on delivery dates of vital war equipment.

▶ It is a tribute, also, to RCA radio research which has helped in large measure to make America's naval

and military radio equipment the finest in the world.

▶ When the war is won, many of these wartime applications will serve industry, and the public, by helping to create new services and products. Today, at Princeton, N. J., the new RCA Laboratories building is taking shape—destined to be the world's foremost center of radio research. Surrounded by every modern tool of research, workers in the new Laboratories will continue to seek new knowledge of radio and electronics... new discoveries for America at war and America at peace.

RCA LABORATORIES

A Service of the Radio Corporation of America

Other RCA Services:

RCA Manufacturing Company, Inc. • R.C.A. Communications, Inc. • Blue Network Company, Inc.
National Broadcasting Company, Inc. • Radiomarine Corporation of America • RCA Institutes, Inc.

J. E. SMITH
President
National Radio
Institute
Established
27 Years

I WILL TRAIN YOU TO START A SPARE TIME OR FULL TIME RADIO SERVICE BUSINESS WITHOUT CAPITAL

I Trained
These
Men

I Trained
These
Men

YOU Build These and Other Radio Circuits with Standard Radio Parts. I Send You With My Course

I send you SIX BIG KITS of Standard Radio Parts as part of my Course. With them you conduct SIXTY sets of experiments, build, test and align Radio circuits, and get the experience needed to make extra money while learning.



Super-heterodyne Receiver

with preselector, oscillator-mixer-first detector, intermediate frequency stage, diode detector-a.v.c. stage and audio stage, which you build from parts I send you in my SIX Big Kits.

Measuring Instrument

you build early in the Course. This instrument, known as the N.R.I. Tester, is a vacuum tube voltmeter and multimeter with a sensitivity better than 20,000 ohms-per-volt. You will be able to make the following measurements: a.c. volts up to 550 in 4 ranges; d.c. volts up to 450 in 4 ranges; d.c. currents up to 45 ma. in 2 ranges; resistance values up to 100 meg. in 4 ranges; output measurements of receivers in 4 ranges.

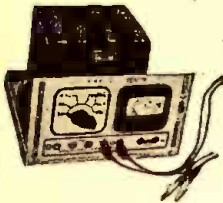

F. M. Signal Generator

really a miniature frequency-modulated transmitter. With it you study frequency modulation, the newest method of Radio communication.



A. M. Signal Generator

The circuit is exactly like the signal generator the serviceman uses. It provides an amplitude-modulated radio signal for experimental purposes.



\$600 BEFORE GRADUATING, KITS HELPED

"From your Experimental Units I learned how electricity worked, how to connect the three stages of a Radio together, also the practical basis for the operation of different parts of a set. I made about \$600 or \$700 before I graduated." S. G. PIERSON, Box 71, Dry Creek, W. Va.



FREE LESSON

Get my Sample Lesson, "Radio Receiver Troubles—Their Cause and Remedy," now. See how completely this ONE TEXT covers a long list of troubles in all types of receivers. A special section is devoted to receiver check-up, alignment, balancing, neutralizing, testing. See for yourself how complete, how practical, my Lesson Texts are. MAIL THE COUPON.

These Men Have SPARE TIME BUSINESSES



"I repaired many Radio sets when I was on my tenth lesson so much for such a small amount of money. I made \$600 in a year and a half, and I have made an average of \$10 a week—just spare time." JOHN JERRY, 1729 Penn St., Denver, Colo.

"I do Radio Service work in my spare time only, operating from my home, and I net about \$40 a month. I was able to start servicing Radios 3 months after enrolling with N.R.I."

WM. J. CHERMAK
R. Box 287
Hopkins, Minn.



"I am doing spare time Radio work, and I am averaging around \$500 a year. Those extra dollars just barely getting by difference between just barely getting by and living comfortably." JOHN WASHKO
New Cranberry
Hazleton, Penna.



"For several years I have been in business for myself making around \$200 a month. My income has steadily increased. I have N.R.I. to thank for my start in this field." ARLIE J. FROEHLER
300 W. Texas Ave.
Goose Creek, Texas



"I went into business for myself 6 months after enrolling. In my Radio repair shop I do about \$300 worth of business a month. I can't tell you how valuable your Course has been to me."

A. J. RATÉN
Box 116
Gladewater, Texas



"I started Radio in the Marines in 1917. I also built sets in the early days of Radio. Later I started studying Radio for a living. I recommend N. R. I. Training to any man no matter how long he has worked in Radio. I now have my own business." CHARLES F. HELMUTH, 18 Hobart Ave., Absecon, N. J.



The men above are just a few of many I have trained at home in spare time to be Radio Technicians. Today they are operating their own successful spare time or full time Radio businesses. Hundreds more of my men are holding good jobs in practically every branch of Radio. As Radio Technicians or Operators. Aren't these men PROOF that my 60-50 method of training gives you, in your spare time at home, BOTH a thorough knowledge of Radio principles and the practical experience you need to help you make more money in the fast-growing Radio industry?

Train This Practical N. R. I. Way

"Learn It, Do It, Prove It!"

My Course is NOT just "book-work" training! No indeed! You get practical experience with Radio parts and test equipment almost from the start. First, you LEARN the fundamental facts about Radio parts and circuits by reading my Lesson Texts, prepared especially for home study training. Next, you DO what you have learned, by working with these parts and circuits. Doing with your own hands and seeing with your own eyes makes you remember what you learn. Finally, you PROVE what you learn by making measurements with your test equipment before and after you check your Radio circuits or adjust your Radio parts.

You Get SIX Large Kits of Standard Radio Parts

In all, I send you Six Large Practical Kits which contain more than 100 standard Radio parts, including tubes, condensers, resistors, punched chassis bases, a meter, a soldering iron, solder, hook-up wire, hardware and a host of other Radio parts. With all these, you perform 60 different sets of experiments—you make hundreds of tests and measurements and acquire a wealth of practical experience. You build the N. R. I. Tester (see column at left), and learn how to use it to measure voltage, current, and resistance. You build dozens of different Radio receiver and transmitter circuits one after another, and secure practical experience with each. You learn how to recognize, locate and repair troubles in Radio circuits.

Beginners Quickly Learn to Earn \$5, \$10, A Week Extra in Spare Time
I show you, too, how to get practical servicing experience at home. Many begin doing real Radio work in their neighborhood only a few months after en-

rolling. Furthermore, right from the start I begin sending you Practical Job Sheets—over three dozen in all—which give plans and directions for doing increasingly more profitable Radio servicing jobs. This is why so many of my students start building their own spare time Radio businesses while still learning, and make \$5 to \$10 a week extra.

It's Smart to Train for Radio Now— for Good Jobs Like These

Radio is one of the country's busiest industries. The 882 U. S. broadcasting stations employ Radio Technicians with average pay among the country's best-paid industries. Radio manufacturers are getting millions of dollars worth of Government orders. The Radio repair business is booming due to shortage of new home and auto radio sets (there are 57,400,000 in use), giving good full-time and spare-time jobs to thousands; offering many opportunities for Radio Technicians to open their own Radio businesses without capital—on spare time earnings. The U. S. Government needs Operators and Technicians for civilian Radio Jobs, Aviation, Police, Marine, Commercial Radio and Loud-Speaker Systems offer good-pay jobs for trained men. Television promises good future opportunities. My Course can lead you to a good job in any of these profitable fields.



Extra Pay in Army, Navy, Too

Men likely to go into military service—soldiers, sailors, marines—should mail the Coupon Now! Learning Radio helps men get extra pay, extra prestige, more interesting duty at pay up to several times a private's base pay! Also prepares for good Radio jobs after service ends. IT'S SMART TO TRAIN FOR RADIO NOW!



MAIL THE COUPON NOW—for a Sample Lesson and 64-page book FREE. Get the details of how I can give you practical training to be a Radio Technician at home in your spare time. Find out about my Course, my 6 Big Kits of Radio Parts. Read letters from more than 100 men I trained, so you can see what they are doing and earning. MAIL THE COUPON in an envelope, or paste it on a penny postcard.

J. E. SMITH, President
Dept. 2DX
National Radio Institute
Washington, D. C.

GOOD FOR BOTH 64 PAGE BOOK FREE SAMPLE LESSON



J. E. SMITH, President, Dept. 2DX
National Radio Institute, Washington, D. C.

Without obligating me, mail your Sample Lesson and 64-page book FREE. I am particularly interested in the branch of Radio checked below. (No salesman will call. Write plainly.)

- Radio Service Business of My Own
- Service Technician for Radio Stores and Factories
- Spare Time Radio Servicing
- Auto Radio Technician
- Aviation Radio
- Operating Broadcasting Stations
- Army, Navy Radio Technician
- Operating Police Radio Stations
- Operating Ship and Harbor Radio

(If you have not decided which branch you prefer—mail coupon for facts to help you decide.)

Name Age

Address

City State 14X-1

RADIO-CRAFT

Incorporating

RADIO & TELEVISION

HUGO GERNSBACK
Editor-in-Chief

H. W. SECOR
Managing Editor

CARLOS FROWEIN
Art Director



Contents APRIL, 1942 Issue

VOLUME XIII -- NUMBER 8

Mailbag	451
Editorial: Young America and Radio	Hugo Gernsback 455
The Radio Month in Review	456
WHN's New 50-K.W. Station	461

RADIO DEFENSE

How to Build an Airplane Detector	458
Training Aircraft Radiomen	Lt. Myron Eddy 460

SERVICING

Servicing Radio in Small Institutions	James Doyle 462
How to Use Diagrams in Radio Servicing	M. N. Beitman 466
"Dark-Light" Foils Saboteurs	470
Gyps and Tips for Servicemen	E. M. Pace 473
"Auto Radio" Sales and Service Booster	Martin Francis 475
Auto Radio Interference	Alfred A. Ghirardi, B.S., E.E. 476
Watch Out Mr. Serviceman	E. H. Leftwich 477
RADIO SERVICE DATA SHEET: No. 321. Meissner 8-tube A.C. Receptor for FM	478

SOUND

The Robot Sings	H. W. Secor 480
A Simple Home Recorder	L. LeKashman, W2IOP and T. Polhemus, Jr., W2HNS 482
Sound Recorded on Steel Tape	484
How to Choose a P.A. System	L. M. Feiler 486

ENGINEERING

200 Mile "Coaxial" Put into Operation	488
---	-----

F. M.

Non-Radio Uses for FM	Frederic D. Merrill, Jr. 491
FM Antenna Coupling	H. F. Shoemaker 493

EXPERIMENTS

Four-Tube T.R.F. Receiver	L. M. Dezettel, W9SFW 494
---------------------------------	---------------------------

TEST INSTRUMENTS

Variable Frequency Audio Oscillator	Herman Yellin, W2AJL 496
Midget Volt-Ohm Meter	W. F. Davis 498
"Magic-Eye" Tube Voltmeter	499

DEPARTMENTS, ETC.

Mailbag	452
The Radio Month in Review	456
Servicing Notes	464
RADIO SERVICE DATA SHEETS (See Servicing)	478
Latest Radio Apparatus	500
Book Reviews	487

RADIO & TELEVISION

Defense 112 MC. U. H. F. Super-Regenerative Transceptor Ricardo Muniz, E.E., and George Shaler, W2MGP	502
Oscillplex—Automatic Speed Key and Code Practice Unit R. H. Utz, W8NIY	504
Electrical Kinks—Making a Shocking Coil	506
Radio Patents Review	508
Better Microphone Results	510
Radio Kinks	511



Published by Radcraft Publications, Inc. Publication office: 29 Worthington Street, Springfield, Mass. Editorial and Advertising Offices: 25 West Broadway, New York City. Chicago Advertising Office: RADIO-CRAFT, 520 North Michigan Avenue, Chicago, Ill.

RADIO-CRAFT is published monthly, on the first of the month preceding that of date; subscription price is \$2.50 per year in U. S. (In foreign countries, 75c additional per year to cover postage; Canada, 50c additional.) Entered at the post office at Springfield as second-class matter under the act of March 3, 1879. All communications about subscriptions should be addressed to: 29 Worthington Street, Springfield, Mass., or Director of Circulation, 25 West Broadway, New York, N. Y.



Foreign Agents:

London—Goringe's American News Agency, 9A Green St., Leicester Square, W, C. 2, England.

Paris—Messageries Dawson, 4 Rue Faubourg, Poissonniere, France.

Melbourne—McGill's Agency, 179 Elizabeth St., Australia.

Dunedin—James Johnston, Ltd., New Zealand.



Text and illustrations of this magazine are copyright and must not be reproduced without permission of the copyright owners.



Copyright 1942 Radcraft Publications, Inc.

STUDY HARD TO SUCCEED!

Dear Editor:

No doubt, National Defense is creating greater opportunities in the Radio industry.

Due to the demand for trained radiomen and technicians, many of our Servicemen and amateurs have already enlisted. This most naturally reduces the amount of Servicemen available for the public.

This will then mean that other men have to fill in their places.

To the people who are just getting their training in radio I say—if you want to become an expert it won't be an easy road, but after you have succeeded you will find that it pays plentifully.

Nobody can remember everything about radio, therefore we have to select some branch or phase of radio which is most promising and try to become an expert in that particular branch, not overlooking of course all other radio phases.

If you are going in for one specific phase of radio, you must try to get the most knowledge from it; that is getting everything from it that includes theory, practice, solution of problems, etc.

As we know the more training and knowledge you obtain from your branch of radio, the greater are your chances of securing a better position. Those men who are "top-rankers," I'm sure, had a hard time and made many sacrifices to reach such a point.

Today any man with some sort of radio training can easily get a job, but after this war is over you will find that only the top-ranking men will hold their jobs, and the men with less knowledge than others will surely be dropped or lowered.

So, get down to brass tacks, keep punching, and most of all—don't get discouraged.

JOSEPH LA MONDA,
Brooklyn, N. Y.

BUCK'S IN AGAIN!

Dear Editor:

This is sort of a postscript to my last letter. Don't get the idea that I am against the use of an oscillator. I have just pointed out a few factors one must contend with if one is to be as critical as some of my "boosters" would like us to think they are. Imagine a Serviceman on production service trying to determine tube capacities, impedances, etc., to get absolute alignment.

It is true, manufacturer's specify the value of impedances to work the oscillator into when aligning small sets, but how many Servicemen use schematics and manufacturer's data, especially alignment data? All the Servicemen I know use that "stuff" only when they are stuck. Then there are those that were born that way!

I feel that after servicing a number of receivers a man ought to be able to tell an I-F can from an oscillator trimmer. And after all, if one knows the peculiarities of receivers of various I-F's in his own locality and understands the superheterodyne principle, then isn't one's knowledge sufficient to eliminate the oscillator for the majority of receivers serviced in the day? I have yet to see the serviceman who would hesitate to touch up the trimmers of a set delivered to a home some distance from the shop, where it had been aligned with the latest instruments. These fellows must have a reason; they must know something of what they do. What are certain fellows trying to hand me? If they must service with a book, I recommend Ryder's *Serviceing Superheterodynes*. It is rather an old book, but there is quite a lot on beats, images, etc., that might help them a lot.

HOMER C. BUCK,
Detroit, Mich.

CRYSTAL DETECTOR TO THE FORE!

Dear Editor:

I am writing to you in the hope that you may be able to help me in my present predicament.

At the present time I am engaged in experimentation with the so-called lowly crystal detector and have had remarkable results so far.

Now I would like to know where I may purchase material on the construction and application of all the known crystal detectors; and failing that, I would like to communicate with other "fans" and swap data with them. I guarantee to answer all letters of any experimental value and in return guarantee to swap valuable crystal set information.

In closing let me state that for an experimental magazine, I find that yours is the best.

EUGENE R. GUTCHMAN,
(no address given).

HAS RADIO A FUTURE?

Dear Editor:

The GREAT FIELD of radio has only been scratched. The best part lies beneath the surface. Radio is only in its infancy, being used mostly for communication in forms of telegraphy, telephony, and television. Little do we realize how important IT is or how important IT will be in the "not so distant" future.

Radio principles could be applied to hundreds of everyday uses, such as: putting thoughts on a screen or on paper, tiny phone transceivers that could be strapped on the wrist for use by department stores or from house to house chats, broadcasting on such a frequency that the waves could be detected by the mind at will, and many other interesting and helpful machines could be invented for science, medicine, and other every-day uses.

The present day radio should be more standardized for the public. I, as one of the public, want a radio with good performance, not a hundred-dollar cabinet. Cabinets could be made of cheap plastics rather than expensive woods and the saving put into a good chassis.

This is only the beginning of what we call RADIO. After peace comes about, more time will be devoted to developing this field. I firmly believe, with all my thoughts, that radio will make itself more and more useful through the will of the human mind.

WILLIAM DRIBUENKI,
Circle, Montana.

HOW NOT TO SERVICE SETS

Dear Editor:

After reading some of the letters Servicemen write about each other I have decided that it is safe for me to do a little "fault-finding" of my own. First I'll find fault with you, Mr. Editor. I have been reading your magazine for many years and often I read articles that seem to have been published just to fill space.

For instance, the article by Mr. Harold Davis in the November-December issue. First he tells us about checking tubes in AC/DC set with an ohmmeter. I'll admit it's faster than a tube tester, but it is a good way *not* to sell tubes. There are such things as weak tubes as well as open filaments.

Then he tells us to check leakage and capacity of the good section where a dual filter condenser shorts or opens one section. Most good Servicemen know that in an AC/DC set when one section goes the other

**MODERNIZE
YOUR PRESENT
PHONOGRAPH OR
AUTOMATIC RADIO
COMBINATION
BY
INSTALLING THE NEW
DETROLA**

Automatic
Record Changer
REPLACEMENT UNIT



\$27.50 —COMPLETE WITH
MOUNTING BOARD & SCREWS

**Low Priced . . .
Easy to Install!**

FEATURES: • Plays home recordings. • Gearless. • Noiseless. • Oilite bearings. • Permanently lubricated. • Free floating light weight tone arm. • Manual or automatic record selector. • Center post with exclusive features.

DETROLA CORPORATION
1500 Beard Ave., Detroit, Mich.

Gentlemen—
Send me details—Today

Name.....
Address.....
City.....

**PRACTICAL
RADIO
INFORMATION**

Including Frequency Modulation—Television, etc.
Inside Radio Information for all Servicemen—Aircraft Pilots, Students. AUDELS RADIO-MANS GUIDE contains 772 Pages, 400 Diagrams & Photos is complete—gives Authentic Principles & Practices in Construction, Operation, Service & Repairs. Covers clearly and concisely Radio fundamentals —Ohm's Law—Physics of sound as related to radio science—Measuring Instruments —Power supply—Resistors—Inductors—Condensers—Transformers and examples—Broadcasting stations—Radio Telephony—Receivers—Diagrams—Construction—Control Systems—Loud speakers—Antenna systems —Auto Radio—Phonograph pickups—Public Address Systems—Aircraft & Marine Radio—Radio Compass—Beacons—Automatic Radio Alarms—Short Wave—Coil Calculations—Testing—Cathode ray oscillographs—Static Elimination—Trouble Pointers—Underwriter's standards—Units and tables—Frequency Modulation—REVIEW QUESTIONS & ANSWERS. Ready Reference Index.



\$4 COMPLETE • PAY ONLY \$1 A MO.
Get this practical information in handy form for yourself—Fill in and

MAIL COUPON TODAY—
AUDEL Publishers, 49 W. 23rd St., N.Y.
Mail AUDELS NEW RADIO-MANS GUIDE for free examination. If O.K., I will send you \$1 in 7 days; then remit \$1 monthly until \$4 is paid. Otherwise I will return it.

Name.....
Address.....
Occupation.....
Reference..... RCF

• MAILBAG •

follows, in a reasonably short length of time, such as to warrant replacing the whole unit. Besides, as a matter of speed, the whole unit can be replaced in the same or even less time than it takes to properly check the good section.

Also no conscientious Serviceman will align even the lowly nidget without either an output meter or scope.

As far as *intermittents* go they can be found without such drastic means as a flash voltage of 800-1000 volts. You will agree that 800-1000 volts across a coil or I-F transformer, even if it is just a flash, *won't do it a bit of good!* Most Servicemen also

know that poor contact on either the rotor or stator plates of the tuning gang will cause oscillator drift, without using a flash voltage. Other types of intermittents can be found easily with a signal generator and home-made signal tracer.

I hope Mr. Davis and you, Mr. Editor, do not take my criticism too much to heart and become peeved at me, but I have found out that speed and efficiency only work up to a certain point and then either one or the other is lost, and in the case of this article efficiency is certainly lost.

JEROME KAUFFMAN,
Reading, Pa.

trained, not by books alone but by good old lady *experience* and by experience alone can he become a Serviceman.

I have read the complete courses of N. R. L., Coyne, Cook, I. C. S., and several more, and I say it can't be done.

Secondly: I'd like to meet some of the fellows interested in *alignment*. In the shop I'm in, I get sets where the customer "*tightens up all the screws!*" I couldn't even get a signal out of the set but the set was alive from the audio drives out. One of the ways I got an image signal was to get a piece of metal, screwdriver or anything and grab the metal and touch the 6A7-6A8 grid cap while trimming the I.F.'s. After the scratching comes in fairly loud, then you can put a generated signal on a set and proceed from there on. Maybe this will help some of the boys.

I would like to shake the hand of Sam Stern of New York. I would like to see all of the radiomen have a license. Perhaps, after the war, jobs will be fewer and only the "real" Serviceman can get a job.

In 1929 I had a heck of a time to get a job. The city of Seattle was full of "so-called" radiomen. A local institution was "manufacturing" Servicemen so fast that the local radio stores had men working for \$12.00 a week—and they called themselves radio Servicemen.

The article "*64% of the Radio Men Will Gyp You*" is true! I know it is true because I just quit one fellow who was that way. (No names to be mentioned.) A good radioman can make a good living here.

Well—that's off my chest, now I feel good. Outside of that you have a good magazine. Keep it up.

JOHN S. KLINGMAN, JR.
Stockton, Calif.

SERVICING A REAL "PROFESSION"!

Dear Editor:

There has been much discussion concerning the low status of the Radio Servicing field as a whole, but I think there is one means of raising this status that has not been discussed in the many pros and cons published thus far. I refer mainly to the writing field, not technically but more or less fiction novels and short stories. It is a well known fact that for many years novelists and short story writers have glorified men in such professional fields as *law* and *medicine* and in doing so they have naturally educated the public as to the difficulties, extensive training, and may I add *capital* that confronts one who desires or is already pursuing such a vocation. The result has been that the public—confronted and armed with this knowledge—actually idolize, respect, and admire these men. Likewise they are willing to pay comparatively large sums for the services rendered by these men.

On the other hand men in the Electronic field, as far as this angle is concerned, are an unknown and sad mystery. How many stories or novels have you read wherein the hero was engaged in building up an extensive and profitable practice in the difficult but "lowly" *radio service* field? Or a budding young Service Engineer, or student in the making. The difficulties confronting him are as great (if not greater) than those in many other professions. At least (for a really good serviceman) 3 years schooling which includes practical work and specialization, and 1 to 3 years of "hard knocks"—all this, after having acquired the capital to set up a small business, and last—after having attained some measure of success, *constant* and *deliberate* study to keep abreast with the

HOME-MADE P. A. TRUMPETS

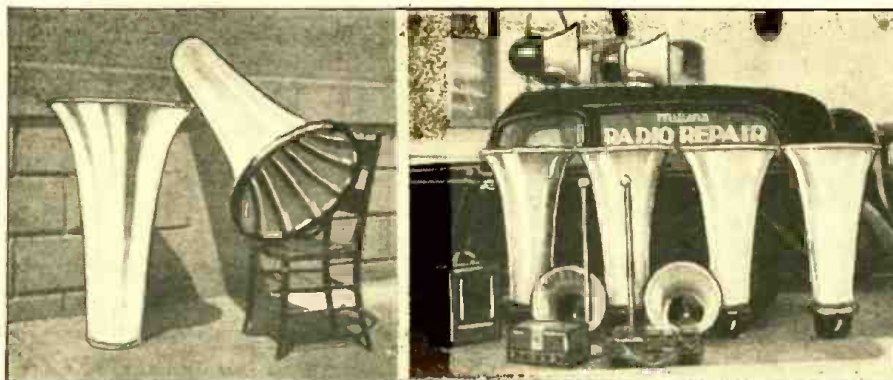

Dear Editor:

Here are snapshots of a 4 ft. round-type trumpet which I designed and built at a cost of \$2.50 each.

These are made entirely of wood; in fact, common laths. I just built a form using a 28 inch bicycle rim at the bell and an 8 inch diameter by 3/4 inch plug at the unit end, flared ribs of 1 by 1 inch material, over which was tied fly-screen, and plaster-of-Paris used to smooth up, which made a smooth, round, hard form.

Common soft pine lath was used for the trumpets. The lath was sawed in 1 1/2 inch squares, and newspaper laid around the form the height of about two rows of the lath, to keep from sticking, which were laid up like brick on edge, with thick waterproof casein glue. The squares were used for the first eleven rows, then straight beveled lath was used lengthwise to complete the unit, as more clearly shown in the pictures. The trumpet was then removed from the form when dry, and a filler rubbed in, made up of sander or fine sawdust and casein glue, which filled all cracks and further smoothed up the trumpet. When thoroughly dry they can be sanded inside and out. I then applied several coats of shellac, using about 1 qt.

inside and 1 qt. outside to waterproof, on which was applied a coat of good outside paint and then two coats of aluminum paint.

The bell edge was bound back about 2 inches with heavy canvas before shellacking and painting to protect edge from splitting. The fitting for the speaker unit was made of a strip of 18 gauge iron, 2 1/2 inches wide, bolted to each lath, leaving about 1 inch projecting, which was notched and bent at right-angles, to which was bolted a round laminated 3/4 inch wood baffle to take the speaker unit. I used ten quart buckets with about 3 inches of rim cut off, the edges turned over, set in gasket cement and screwed to the wood baffle for unit covers. Holes were drilled in underside for relief of back pressure, the buckets were lined with felt.

I used Utah 8-inch, 60 oz. P.M. units. The tone is very good. I have used these trumpets about one year up to date. They were outside 21 days playing Christmas music in several blizzards and rains which had no effect on trumpets, and withstand normal handling.

HARRY A. MILLER,
Hastings, Nebraska.

"EXPERIENCE" BEST SERVICE-TRAINING

Dear Editor:

Do you mind if I "horn in" and get my 2c worth out of your magazine? I have been reading your *Mailbag* section for a long time and often wanted to write. This section is a good place for some of us Servicemen to get a "load off our chest." I am just full of "squawks" and want to get rid of them.

Firstly: In your magazine you have schools advertising that they make a Serviceman out of you in 8 or 10 weeks. That is falsely stated; I don't care who you are or who they teach—you, or they, can't make a *good* or even a *half-good* man out of a green-horn. Look on page 168 of September "*R.-C.*"; a fellow who calls himself a

Serviceman wants to know about transformers. *Any Serviceman* doesn't have to know about an input or output, power or choke in a circuit, he puts it into the circuit when he builds it, because *he knows*. This fellow used the wrong word; he isn't a Serviceman yet, he's an *experimenter*. Today the radio man is at a premium and hard to get. I have been fooling around with radio for 20 years and have been doing service work for 11 years, and I still don't know it all yet. I get stuck on a lot of them—the best Serviceman will get stuck.

If you figure it all out, the radio—home, auto, marine, communication, or any radio—is crankier than the human anatomy. More complicated—therefore a man has to be

world's most progressive occupation.

It is my opinion, that if some of our better writers in the Electronic field could apply their abilities in this direction, that is to a degree of crashing some of our strictly literary publications, and keep pounding away to this end, that the public will soon awaken to the merits of the hard-working Electronic or Radio Engineer, whose status has been so badly abused.

I am not writing this as a "know it all", but only as one of many who would like to see the Radio Serviceman receive his just dues. In this behalf I remain an aspiring serviceman and ever an advocate of your splendid publication *Radio-Craft*.

Sincerely,

Wm. Terrell.

P.S. Let's quit quarrelling among ourselves, boys, and let the public in on a few things, that they might understand us better.

TO MR. W. MOODY!

Dear Editor:

In reference to Moody's rather interesting replies, I would like to have you know, Mr. Moody, there are a few of us who have learned most of what we know, the hard way. Night school, midnight oil and supers till day-break. The instruments we have are either home-built or purchased with hard-earned dollars. Nothing is handed to us on silver platters, nor do we have plush-covered stools on which to sit and meditate upon the evils of our competitors.

I, being one of the above variety, work for a large organization as an outside Serviceman and service 15 to 22 radio sets a day. It is the policy of this company to give customers satisfaction. The income from service is quite immaterial, the sale of merchandise being the object. If a customer were to object to my methods and the final state of affairs in their "pet" radio, I am afraid I would not be working at this time.

Since it is quite beyond my income to employ a train of porters to carry my analyzer, box of tools, box of parts, oscilloscope, audio generator, vacuum-tube voltmeter, etc., etc., through 5 eight-hour days a week, over approximately 250 miles, to approximately 100 homes. I must leave such methods to the "upper-crust", and devise ways and means to travel that far and service that many radios each week *all by my lonesome!*

Have someone turn you around from your inlaid silver bench, and I'll give you another shot.

You couldn't possibly know, among a few things, that to alter a grid circuit affects the plate resistance of a tube and—in turn, affects the load, and that under critical conditions, sometimes found in cheap supers, where high-gain stages are employed, there will occur squeaks and squawks much to the discomfort of the customer, which will have to be remedied by ear, a slight turn of a trimmer here and there, etc. Knowing full well that to align the set over again with the oscillator, would only result in a repeat of the same condition, unless the gain of the stage were altered first, which, if done, would probably eliminate some little outside station that the customer thinks he likes to hear.

From your lofty perch, I would ask you to come down and read an article by Joel Julie of your fair city, in the May issue of *Radio-Craft*.

Mr. Julie wanted to argue with me in his article, but instead he only proved my point. That a radio can be detuned as much as I said before, and still be quite capable of operating. A very nice plug, Mr. Julie! I, as a Serviceman (like that Mr. Moody?)

realize the necessity of an oscillator, to be used in such cases.

The average number of radios (or I should say, the majority) have not been tampered with before entering a service shop, and therefore alignment is easy. That is, *easy* if one has a knowledge of fundamental radio. I have a peach of an analyzer in the trunk of my car. I am going to take it out some day and brush the dust off of it, Mr. Moody.

But then, I shouldn't be saying things like that. I haven't transferred my hair to my manuals and textbooks over pipe dreams. There is quite a lot I do not know—I learn something every day. I feel so small in your lofty presence. It must be wonderful up there, Mr. Moody.

If you and others of your ilk were to form the organization mentioned in your last article, to freeze out the incompetent Servicemen (*competitors*, in my world), don't you think these magazine companies would suffer? There would be so few of you!

I have always enjoyed your articles and considered them informative. I am beginning to wonder if the mistakes I have made weren't the result of reading them. You haven't been misinforming us little fellers, have ye?

In closing: I am sure you have a lot to learn, Mr. Moody. A tempestuous outburst is sometimes so informative.

And to those who mailed so many letters, I enjoyed every one and as there were none like Mr. Moody's, I must say with regret that I cannot find time to answer them.

HOMER C. BUCK,

929 Manahoe,
Detroit, Mich.

Value of HAMS to Uncle Sam

Editor:

This letter is intended as a reply to that guy who signs himself Harry C. Reed of Steelton, Penna., who seems to think that all Hams are good for is bellowing "Hello C Q." as he so ungraciously puts it. For his information and to inform those other servicemen who think that a Ham is just some "junk-box experimenter," I wonder if they have ever heard of the U. S. Navy or the U. S. Army. Several times the local papers have published articles calling for Radio Amateurs to join our armed forces as *officers* in the various signal corps and other divisions to help Uncle Sam.

Another thing, some of the best servicemen in this locality got their starts as "Hams," branching out to help the PEOPLE as Mr. Reed puts it. If he thinks that helping to keep our great country out of the hands of Adolf and the rest of the rats over in Europe and Asia isn't helping the PEOPLE, he had better go back to the first grade.

When I read his letter in the January-February issue of *Radio-Craft* it made me so mad that I almost boiled over. As to putting more F.M. articles in *Radio-Craft*, that seems to be a good idea. But why not tell of some good uses for old parts and help to make better use of the parts now on hand, instead of using new parts which soon may become rather scarce. Several friends of mine used to read the articles in the old *Modern Mechanics* magazine telling how to get some good out of old parts "rescued" from the many old battery sets stored in attics. This idea may meet with some criticism, but I am sure that some Hams and lots of other "R-C" readers would appreciate this sort of article.

CARL FISHBACK.

HIGH SIGN OF
**SYLVANIA
SERVICEMAN
SERVICE**
by
FRANK FAX



WHEN this column bowed in last month, I promised, as a Sylvania engineer, to aid you all I can with your problems and your selling—and to supply you with whatever promotion helps your business needs.

Well, here's a good example of the kind of promotional help I had in mind—the "Complete Radio Service" sign pictured below.



Size: 11" high • 19" long • 3/4" thick • weight 4 pounds

This handsome electric sign should prove mighty useful to you radio experts in cultivating the sort of all-round trade that brings in the big profits.

For it puts passersby on notice that you're a fellow who knows his way around any type of radio—home, portable or auto. It says, whatever your problem, you'll find the answer here.

These signs are being offered to all Sylvania dealers at a below-cost price—\$1.50. To get one just drop a note to me, Frank Fax, Dept. C4, Hygrade Sylvania Corporation, Emporium, Pa., and enclose your check or money order. Or if you prefer, you can order direct from your Sylvania jobber.

And keep shooting your puzzlers to me. My staff and I will be glad to answer any and all queries, no matter how intricate or technical. So far the questions have been extremely interesting and later on we hope to discuss a few of them right here.

SYLVANIA
RADIO TUBE DIVISION
HYGRADE SYLVANIA CORPORATION

For Better Servicing - For Bigger Profits -

FOR A WIDER KNOWLEDGE OF TECHNICAL SUBJECTS, READ THE

BOOKS IN THE RADIO-CRAFT LIBRARY SERIES

GET into the swing of reading instructive, authoritative books on technical subjects—Radio, Air Conditioning and Refrigeration. The RADIO-CRAFT LIBRARY SERIES is the most complete set of volumes individually treating all important divisions in these fields. Each book has been written for the purpose of giving you the opportunity to specialize in one or more of the popular branches of the various subjects and we know of no easier, quicker or less expensive way to improve your knowledge. The material in each book is very helpful—you'll find them valuable in your work. The authors are all well known and are authorities on the subjects on which they have written. This is the first time that you are enabled to build a library of technical books by such popular writers.

ALL BOOKS ARE UNIFORM

The books in the RADIO-CRAFT LIBRARY SERIES are all uniform. The size is 6 x 9 inches. Each volume contains 64 pages and an average of 50 to 150 photographic illustrations and diagrams. The books are printed on an excellent grade of book paper and have stiff flexible covers. PRICE 50c PER BOOK. All books are sent postpaid.

 <p>Book No. 13 ABC OF AIR CONDITIONING An accurate simplified technical review of the fundamentals of this latest branch of engineering, including servicing data on present-day units. By Paul D. Harrigan. 50c</p>	 <p>Book No. 17 SERVICING WITH SET ANALYZERS A Study of the Theory and Proper Application of Modern Set Analyzers and Associated Apparatus. By H. G. McEntee. 50c</p>	 <p>Book No. 21 BREAKING INTO RADIO SERVICING Simple Instructions and Procedure for Starting a Profitable Radio Servicing Business of Your Own. By Robert Eishberg. 50c</p>
 <p>Book No. 14 POCKET RADIO GUIDE Edited by N. H. Lessem. Handy Reference Book for Radio Men—Set Construction Articles—Audio Amplifier Circuits—Useful Radio Formulas and Data—Handy Short-Cuts. 50c</p>	 <p>Book No. 15 ABC OF REFRIGERATION A carefully written volume, starting with the basic principles of refrigeration by mechanical means, and leading up to a complete analysis of the servicing of commercially available units. By Trafton Mason. 50c</p>	 <p>Book No. 18 POINT-TO-POINT RESISTANCE ANALYSIS For Service Men Theory—and Application of this Modern Test Procedure to Everyday Radio Service Problems. By Bertram M. Freed. 50c</p>
 <p>Book No. 16 PRACTICAL RADIO CIRCUITS A Comprehensive Guide to All Types of Radio Circuits for the Service man, Constructor and Experimenter. By David Bellare. 50c</p>	 <p>Book No. 19 PRACTICAL RADIO KINKS AND SHORT CUTS The contents of this book have been planned with the view to help Radio Dealers, Servicemen, Experimenters and Set Builders. By B. Baker Bryant. 50c</p>	 <p>Book No. 22 NEW RADIO QUESTIONS AND ANSWERS Answers to Questions Most Frequently Asked by Both Novices and Experts. By Robert Eishberg. 50c</p>
 <p>Book No. 20 THE CATHODE-RAY OSCILLOSCOPE Theory and Function, Power Supplies and Associated Circuits, Sweep Circuits, Operation of Typical Unit, Methods of Measurement, Practical Applications of C-R Oscilloscopes. By Charles Sicuranza. 50c</p>	 <p>Book No. 23 PRACTICAL PUBLIC ADDRESS Modern Methods of Servicing and Installing Public Address Equipment. By B. Baker Bryant. 50c</p>	 <p>Book No. 24 AUTOMOBILE RADIO PRINCIPLES AND PRACTICE A Complete Treatise on the Subject Covering All Phases from Installing to Servicing and Maintenance. By B. Baker Bryant. 50c</p>

New titles are constantly being added to the RADIO-CRAFT LIBRARY SERIES. But, on the other hand, stocks of certain titles are running low, and they may not be reprinted for some time. We would therefore suggest that at this time you order as many different titles as you are interested in. Remember, that if you delay, some of the books may later be out of print.

RADCRAFT PUBLICATIONS, Inc., 25 West Broadway, NEW YORK, N. Y.

Gentlemen: Enclosed find my remittance of \$..... for which send me, POSTPAID, the books indicated below.

RADIO-CRAFT LIBRARY SERIES @ 50c EACH

Circle book numbers wanted: 13 14 15 16 17 18 19 20 21 22 23 24

Name Address

City State

(Send remittance in form of check or money order; register your letter if you send cash or unused U. S. Postage Stamps.)

RC-442

**USE THIS
HANDY
COUPON
WHEN
ORDERING**

RADCRAFT PUBLICATIONS, Inc.
25 WEST BROADWAY NEW YORK, N. Y.

RADIO-CRAFT for APRIL, 1942

RADIO-CRAFT

Incorporating
RADIO & TELEVISION

"RADIO'S GREATEST MAGAZINE"

*... American Youths' Great
Radio Opportunity ...*

YOUNG AMERICA AND RADIO

By the Editor — HUGO GERNSBACK

THIS month—the month of April—marks the end of the manufacture of radio receiving sets for civilian consumption.

The entire radio industry has been drafted for war work and from now on the civilian population must get along on what radios there are in use at present, plus others not built by the radio industry.

It is a curious thing but true, that in practically everything history has a tendency of repeating itself. When radio was young and when broadcasting first started in 1921, there was no radio industry to speak of; just a handful of manufacturers who manufactured a few crude parts. Suddenly broadcasting started and the entire nation went wild and began to build radio sets overnight. The larger proportion of the millions of sets which were built from 1921 to 1928 were made by young men, mostly of school age, between the ages of 12 and 20.

It seems likely that we are to witness a similar activity immediately and for the duration of the war. The facts which prompt this reasoning are simple.

To begin with, there is a tremendous demand for radio sets at the present time. The country for many years has absorbed an average of thirteen million radio sets a year. This was during peace times. The instant the U.S. entered the war, the demand for receivers stepped up tremendously and it was often impossible to satisfy this demand. As time goes on, it is certain that the civilian population will require more and more radio sets, particularly for offices, factories, etc. Who then will supply this demand? The radio industry is forbidden to do so, and besides that, they cannot get the materials. Logically, the young and rising generation of American boys will be able to step into the breach and fill this demand, just as the demand was filled in the early 20's.

How is this to be accomplished? There are various means of doing it, plus the good old-fashioned American ingenuity and American enthusiasm that has always risen to the occasion, and which certainly will not fail this time, either.

(1) There are millions of obsolete radio sets cluttering up store-rooms and closets all over the country now. These can be reconditioned, modernized and brought up-to-date. It is still possible to buy tubes and certain radio parts, and various substitutions can always be made whenever necessary. This is where ingenuity comes in.

(2) New sets can be created by the salvaging method. Auto-

mobile graveyards and junk shops are loaded with a goldmine of parts that can be utilized extremely well for radio sets. Metal chassis can be made from car parts and various other essential parts can be resurrected for the building of sets. Of course you cannot get a variable condenser out of a junked automobile, but there are gears, meters, knobs, and many other useful parts which can be pressed into service. Even discarded tin cans can be used to shield coils—but why lengthen the list? American ingenuity will know what to do. Believe it or not, the country today has enough substitute parts, in one way or another, to supply the nation with millions of radio sets during the war. Moreover, there is no law against anyone doing so—indeed, *you will perform a patriotic service to conserve whatever substitute materials we have and turn such materials into radio sets.*

Furthermore, the young men between the ages of 12 and 17 who are not subject to the draft have time on their hands, which they now can turn into cash by building sets not only for their friends and relatives—yes, but even sell them to radio stores. It is certain that if a number of boys gang together and manufacture a few sets every week in their spare time, and providing the sets are made right, they can be sold to the trade.

Naturally, all this will not be done immediately and it should be understood that no dealer will buy a set thrown together with a bunch of junk,—but there will be exceptional cases where young Americans who have ingenuity and who have the right guidance will, no doubt, be able to produce a marketable article once they have gone through their trial periods.

Many radio manufacturers themselves started in some such manner and it should be noted that most of them began in a small way. There is no good reason to believe that our young and rising generation cannot do as well when put upon their mettle.

Of great importance is the fact that there will not be any cut-throat competition, because only a comparatively small amount of radio sets can be built anyway, and if they are built right, there is no question that all that are made can be sold at a profit.

More important than all this is the fact that radio talent today is extremely scarce. Those young men who know radio are continuously in demand. Here then is an excellent chance for our American youth to get a practical radio education which will help all of them to better themselves during the crucial years ahead.

•THE RADIO MONTH IN REVIEW•

The "radio news" paper for busy radio men. An illustrated digest of the important happenings of the month in every branch of the radio field.

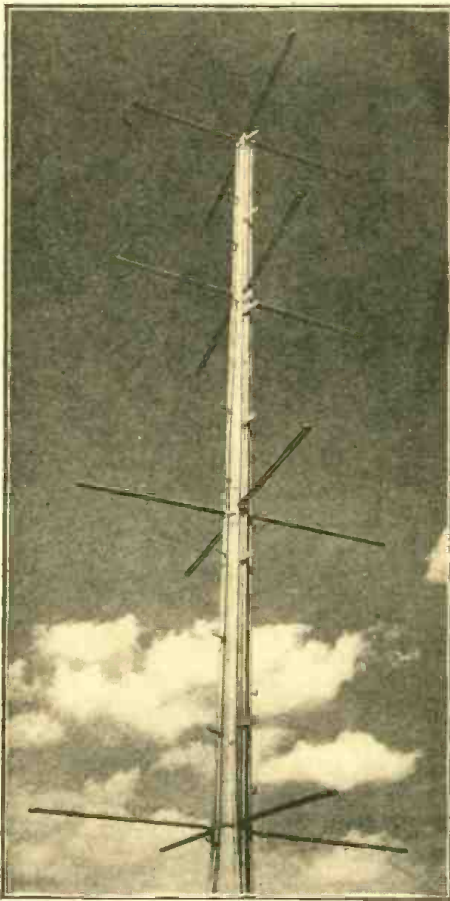

This specially-designed FM antenna erected by the Zenith Radio Corp., at Chicago, Ill., juts 60 feet above the Field Building. Their engineer claims a power gain of nearly three from this antenna.

FM GOES TO COLLEGE

ACCORDING to a recent release from Intercollegiate Broadcasting System, radio's infant prodigy, *frequency modulation*, has graduated from the realm of things you've heard about from friends with special receivers to things you can actually hear on your own regular set—that is, if you go to college.

The campus broadcasting systems of Yale, Wesleyan, University of Connecticut and Columbia are carrying regular FM broadcasts daily. The Columbia University station has been rebroadcasting programs of WOR's New York frequency modulation station, W71NY, since last November. Recently Hartford's WDRC FM unit announced that permission to carry all Station W65H's programs has been granted to the Husky Network of the University of Connecticut, the Cardinal Network of Wesleyan University and the Yale Broadcasting System.

All these college radio stations, operating as members of the Intercollegiate Broadcasting System, use extremely low-power transmitters sending signals over their "wired wireless" systems. This method of broadcasting has two significant results—no receiver outside the prescribed area of the wires can pick up the college station's programs; and, although long-wave and working on amplitude modulation, they are in effect, *staticless*.—*FREC Service Bulletin*.

BBC TO BROADCAST ANSWERS TO LETTERS

The British Broadcasting Corporation inaugurated a new service for its United States listeners on Sunday, March 1st when a portion of the "London Calling" period, at 8:15 P.M. EWT, was set aside for answers to letters sent in by listeners to the North American Transmission. Listeners who submit comments on programs or questions concerning the British war effort may expect them to be answered at this time Sunday through Friday. For listeners in the Western United States a portion of the "London Calling" period at 10:30 P.M. (7:30 P.M. PWT) has been similarly set aside, Mondays through Fridays. Letters may be submitted directly to the BBC, Broadcasting House, London W.1., England or to its New York office, 630 Fifth Avenue, New York, N. Y.

WIRED RADIO

THE USO "wired radio" station at Sacketts Harbor, N. Y., created as part of a national chain was recently pressed into service at Madison Barracks in the Army's new "current events" educational program.

Broadcasting equipment was moved from the USO Club to the Post theater. There the speaker addressed an audience of 400 officers and men, the talk being broadcast at the same time to battery day rooms in all parts of the post, thus reaching the entire garrison with the one lecture. The wired radio system also was connected with the homes of all soldiers occupying quarters on the post.

The novel radio system was installed in the Sacketts Harbor USO Club by National Catholic Community Service, one of the six USO agencies, as part of a national chain known as the Star Spangled Network. It operates on five watts, feeding the programs by direct line to the wiring system of the post, which acts as an antenna. All radios on the post then are tuned to a designated frequency and receive the program. This does not interfere with regular broadcasts of commercial stations near this frequency and radios off post cannot intercept the program.

FM CURRENTS FOR TELEGRAPHY

Frequency modulation has been adopted for telegraph circuits. This system of communication has become popular in the broadcasting industry because it is immune to static. It has been adopted for wire communication, according to F. E. d'Humy, Western Union Telegraph Co. vice-president in charge of engineering, because it also is immune to ground static. Ordinary carrier-wave systems can be thrown out of adjustment by ground currents that accompany magnetic storms while frequency-modulation currents are not affected. In carrier-wave telegraphy, musical tones are superimposed on the carrier wave. At present twenty-two different tones are imposed on the carrier wave traversing a single pair of wires. At the receiving end, tuners adjusted to particular tones are able to select the messages intended for them.—*N. Y. Herald-Tribune*.

FM USED IN ARMY TANKS

SIMPLIFIED control of tanks by frequency-modulation radio with microphones that receive sound impulses through the skin of the operator's throat—requiring little more technical knowledge than the ability to push buttons—was demonstrated recently by the 2d Armored Division in maneuvers after development by the Army Signal Corps at Fort Monmouth, N. J.

The new radio sets, tuned by the "push-button" method, allow communication between a tank-platoon commander and his various units rivaling that of telephone quality because of the absence of static in FM. Nearly 100 sets have been installed for two tank battalions in two separate regiments.

Code-trained operators are not required to man the sets, as they operate with voice only. Occupying considerably less space than earlier-type units, the radios may be placed out of the way of the tank crew.

At low power the sets will transmit and receive over a distance of one mile, and this may be increased to fifteen or twenty miles by increasing the power. Operators may block out all low-power signals on a particular frequency and use the channel for emergency transmission.

Enemy interception of messages is almost impossible, as distance over which signals will travel may be controlled directly with the amount of power used.

The microphone consists of two disks slightly larger than a nickel, held against the operator's throat by elastic and sound is picked up directly through the skin. This arrangement frees both hands of the operator and eliminates noises produced by the tank itself. Headphones are built into a specially designed helmet.

Noise, difficulty in vision and internal confusion in tank control have been reduced greatly by the new form of communication.—*N. Y. Herald-Tribune*.

ACADEMY OF MOTION PICTURE ARTS AND SCIENCES AWARDS

DARRYL F. ZANUCK, Chairman of the Research Council of the Academy of Motion Picture Arts and Sciences, recently announced the granting of two plaques for Scientific or Technical Achievement and five Honorable Mention Awards for Scientific or Technical Achievement bestowed by the Research Council with the approval of the Academy Awards Committee, to the following:

Award in Class II (Plaque)

To: Electrical Research Products Division of Western Electric Company, Inc., for the development of the precision integrating sphere densitometer.

This densitometer has been adopted by the motion picture laboratories as a primary standard for measuring the light transmission of photographic emulsions. Its use fills a long felt, widespread need for such a precise direct-reading instrument and will result in both better and more uniform quality of motion pictures.

Award in Class II (Plaque)

To: The RCA Manufacturing Company for the design and development of the MI-3043 uni-directional microphone.

The uni-directional microphone, as its name implies, has directional characteristics which suppress unwanted noise and sound reflections from behind the microphone, yet provide a uniform quality over a large frontal area resulting in greater flexibility in microphone placement and greater freedom of motion to actors. The introduction and application of this microphone to motion picture production is of technical, artistic, and economical value.

MAJOR ARMSTRONG RECEIVES JOHN SCOTT MEDAL

John Scott medals and premiums were awarded recently by the Philadelphia Board of City Trusts to Major Edwin H. Armstrong, who developed frequency modulation in radio, and Dr. Robert R. Williams, who succeeded in synthesizing thiamin, or vitamin B1. The presentation was part of the midwinter meeting of the American Philosophical Society.

Checks for \$1,000 accompanied the medals and citations awarded to Major Armstrong, who is Professor Electrical Engineering at Columbia University, and Dr. Williams, chemical director of the Bell Telephone Laboratories in New York.

FCC RESUMES ISSUANCE OF NEW "HAM" LICENSES

The FCC has resumed issuance of new amateur radio operator licenses at the request of the War and Navy Departments. The Office of Civilian Defense and the DCB also have submitted requests for re-issuance of amateurs' licenses. The War and Navy Departments advised the FCC that classification of men for the services would be greatly facilitated if qualified radio operator applicants could verify their claims by showing a license.

After the declaration of war when amateurs were no longer permitted to be on the air, the FCC followed a policy of not issuing new amateur operator licenses or amateur station licenses. Examinations for the former were continued, however. As a result about 1,500 applicants who have passed the examination for operators' licenses are now qualified to come under the new ruling.—Broadcasting-Broadcast Advertising.

WAR BOOSTS "PORTABLE" SALES

Sales of battery-operated radios skyrocketed on the first weekday of the war between Japan and the United States. A check-up by Columbia Broadcasting system showed portables selling like hot-cakes, with a probable 800% gain for the day in one large department store.



The photo herewith shows two tiny tubes developed for use in the amplifier of the Audiphone, a device for aiding those who are hard of hearing. These tubes operate from a small "A" and "B" battery carried in the case of the portable apparatus. These tubes were developed by the Bell Telephone Laboratories for the Western Electric Co., and are said to be particularly efficient.

At the beginning of the war in England, the sale of battery sets went up about 20,000 the first day. People wanted them for bomb shelters, for the country, for emergency use. New ones finally became very difficult to get, and many dealers were frantically seeking for radio servicemen to repair and service old sets.

This development is important to radio servicemen. Many people already own portables, and sets that were in use last fall will undoubtedly need battery renewals and tube replacements to put them into first class condition for possible emergency use.

Direct mail advertising and newspaper advertising along this line should bring good returns, though no "scare-head" announcements should be used. Customers should be advised that there might be emergency periods when battery radios would be very useful.—Sylvania News.

CBS COLOR TELEVISION PROGRESS

A report of the past year's progress in color television developed by the Columbia Broadcasting System was revealed at an Institute of Radio Engineers' meeting, recently, when Dr. Peter C. Goldmark, chief television engineer of the Columbia Broadcasting System, and members of his staff, disclosed new data on the subject. The CBS transmitter broadcast signals picked up by newly designed color television receivers specially installed for the meeting. The new equipment included a color camera, color film channel, color slide projector, and color mixer.

A feature of the demonstration is the fact that the equipment used is based on commercially practical designs. Previous color television demonstrations have been made with laboratory equipment.

BBC PROGRAMS FOR U. S. ON NEW FREQUENCIES

The British Broadcasting Corporation announced today the following changes in the frequencies used for programs beamed to the United States. GSL at 6.11 megacycles, previously heard throughout the whole transmission time, will carry programs only from 10:00 PM EWT to the closing of the North American Transmission at 12:45 AM EWT. A new transmitter, GSD at 11.75 megacycles is to replace this beam from 5:15 PM EWT until 9:45 PM EWT. The transmitter, GSC heard at 9.58 megacycles with increasingly good quality at this time of year, is to continue in the North American Service for the full broadcasting period, 5:15 PM EWT until 12:45 AM EWT.

(Recapitulation Including Overall Timing of North American Transmission)

Meters	M/cs	Call sign	Times
31.32	9.58	GSC	5:15-12:45
25.53	11.75	GSD	5:15- 9:45
49.10	6.11	GSL	10:00-12:45

WMCA INSTALLS AIR RAID ALARM

A device which will automatically inform a radio station of an air raid "alert" has been installed in WMCA's master control to supplant manual listening for alert alarms. The device was developed by Frank Marx, WMCA Chief Engineer, and can also signal any transmission or receiver failure.

Described as an electronic control system, the device acts on a tone signal transmitted on a fixed frequency. It can be attached to any standard radio receiver and can be applied to other control uses. Details of its construction are secret and were developed in WMCA's engineering laboratory.



WOMEN RADIO OPERATORS

MRS. ABBY MORRISON RICKER who was a licensed wireless operator in the first World War and was attached to the United States Navy as first-class radio electrician, is the instructor at the Ballard School of the Young Women's Christian Association, 610 Lexington Avenue, New York, N. Y. Mrs. Ricker, a very competent instructor, teaches the women the Morse code and how to build simple receiving sets, in order to train them as amateur operators. These courses which are held twice a week both day and evening will cease about the middle of March. The study was designed to prepare women for the Federal Communications Commission examinations. Mrs. Ricker has recently prepared a book on elementary radio instruction.

"ELECTRIC EYE" GUARDS STORES

The "electric eye," used for years to count traffic, open doors for busy waitresses, sort coffee beans according to color and do a dozen or more other jobs which previously had to be done by hand, has just come into a real wartime occupation, that of standing by as all-night guard for "alert" warnings of possible air raids. Focused on the street lights, which will be turned off the instant a warning is received in any city, the "electric eye" sounds an immediate warning and likewise turns off the lights in the home, store, display signs or wherever lights are to be extinguished to perfect a city blackout.

The idea originated with Andrew Tessier, who with his brother conducts a small machine shop in Schenectady, N. Y. and is engaged in wartime defense orders.

Mr. Tessier hit on the idea of using a photo tube, or "electric eye" as it is more popularly known. He installed this at the window on the second floor of his shop, with the eye pointed toward the street light on the corner, and adjusted it so that whenever the street light went out, all lights in his place would go out. When the street lights came back on again, on would go his all-night lights.

The setup which Mr. Tessier has installed could be used by merchants who cannot afford an all-night watchman. Since the war these merchants have been turning out their lights when they close their places of business at 6 o'clock at night, and thus have sacrificed whatever advertising might come from window shoppers during the evenings.



Left—Dr. Donald A. Wilbur of Rensselaer Polytechnic Institute of Troy, New York, tests the airplane sound detector. Above—Interior of the portable amplifier cabinet. Right—Bottom view of amplifier chassis. This airplane detector, made up from an old phonograph horn, mike and battery-operated amplifier, cost about \$50 to make.

How to Build an AIRPLANE DETECTOR

Suitable for Use by Home Defense Corps. A Device which can be built from Standard Parts at a Cost of about \$50.00. This instrument was actually built and successfully picked up the sound of a bomber 10 miles away.

THE accompanying plans and pictures showing how to build a home-made airplane detector, have been supplied through the courtesy of Floyd Tift, Publicity Director of Rensselaer Polytechnic Institute of Troy, New York. This airplane detector is easily built by any radio Serviceman, experimenter, or radio amateur from standard parts. The cost of the particular instrument illustrated is about \$50.00. The device picked up the conversation of persons three blocks away and the sound of a bomber as far distant as ten miles. This detector should be of particular interest and value to civilian defense units all over the country.

Dr. Robert A. Patterson, head of the

Department of Physics, in which the detector was produced and tested by Dr. Donald A. Wilbur and Rodney F. Simons had the following to say: "Our problem was to select and adapt existing low-priced materials which would be relatively easy to procure anywhere, under existing priorities, and which could be easily assembled by practical radio repair men and operated by laymen volunteers."

The device consists merely of a few boards for a base and standard, an old phonograph horn for a big "ear," a microphone, and a battery-operated amplifier.

Its operator, wearing earphones, could pick up the sound of a bomber five to ten miles distant. More elaborate, precise and

costlier detectors, such as those used by the military, have far longer ranges. This one is solely for civilian observation and warnings.

The horn, slanted skyward, revolves on the standard so that the "big ear" can be turned to the four corners of the skies and thus detect a bomber approaching from any direction. The microphone, attached to the smaller end of the horn, picks up the sound before it would be audible to the human ear, and the sound is increased by the amplifier connected to the microphone. Thus amplified, the sound is carried to the earphones of the operator.

Best locations for using the device would be tops of buildings, hilltops or the outskirts

Wiring diagram of the amplifier is shown below. Output stage is a special low-impedance matching unit.

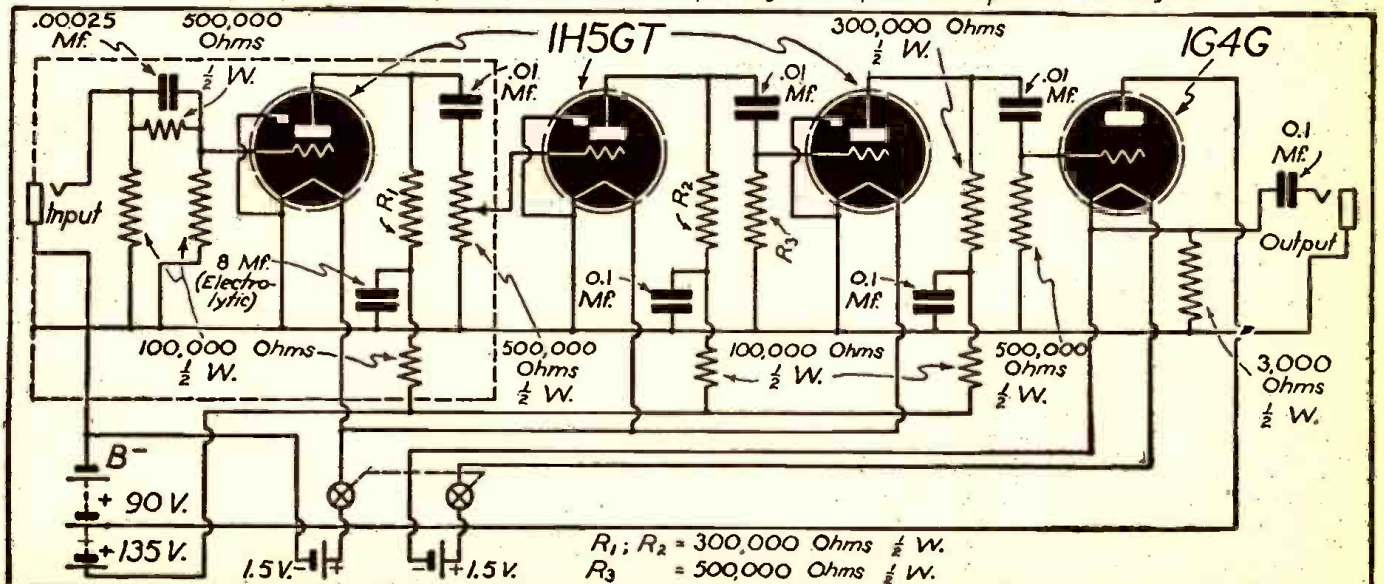

of cities. Since it is portable and operates from its own battery, it can be used anywhere without benefit of electric line supply. While civilian "spotters" can scan the skies with their eyes by day only, this "mechanical ear" can be used at night as well.

During its initial tests the "big ear" was pointed out of a window in the physics laboratory toward two men walking along the street three blocks away. *It brought their conversation into the room!*

The microphone container includes a six-inch length of $\frac{1}{4}$ inch to $\frac{3}{8}$ inch tubing terminated in a rock wool plug as shown. Its purpose is to suppress resonant effects. Its use is desirable but not necessary.

The mouth of the horn (large end) should be covered with a single thickness of some lightweight cloth. The horn should be mounted so that it may be pointed in any direction. The motion on the bearings should be smooth in order to avoid jarring the microphone when it is in use. A pair of

good quality high impedance head-phones is recommended for use with the amplifier.

As the wiring diagram for the amplifier shows, this comprises four stages of amplification, utilizing battery-type tubes. The "B" batteries required should supply up to 125-volts and 1.5-volt "A" batteries are necessary. Input and output jacks are wired into the circuit as shown. All of the resistors and condensers are standard units readily available.

Note that an unusual output stage is used in connection with the amplifier, no appreciable gain being obtained from this stage, whose principal function is to provide a low impedance matching device. This circuit was rechecked with the inventors of the Airplane Locator here described. Radio students may possibly remember this type of circuit, which is similar to that used in the DuMont Oscillograph. As no particular gain is expected in this impedance matching stage T4, only 90 volts is supplied to the plate of the tube.

Sectional view of the Microphone housing.

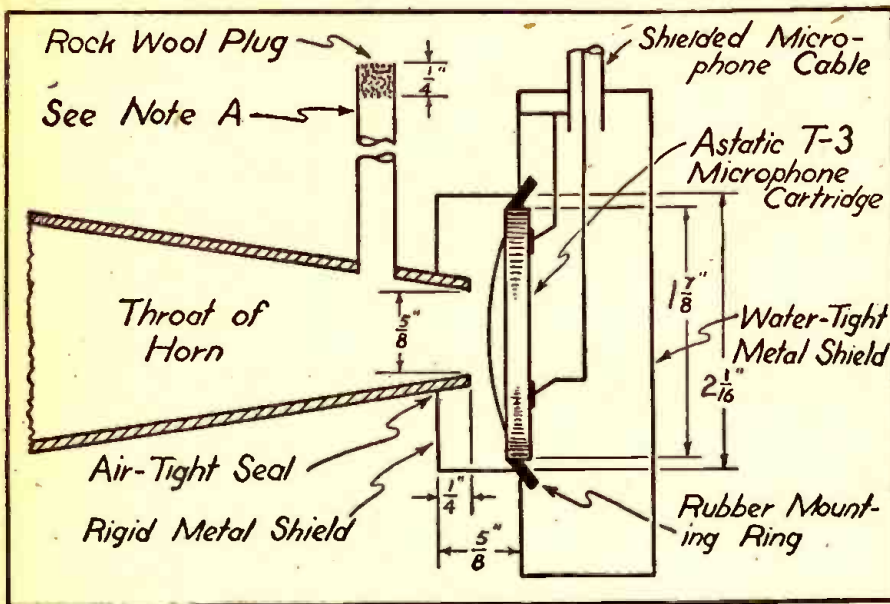

RADIO IN THE WAR

Since the start of the war Britain has made remarkable progress in applying radio to war purposes.

Radio-location is, of course, the outstanding innovation. It can be briefly described as a system for detecting and plotting the position and course of aircraft by multiple radio beams which, when they encounter any object, inform the operator of its presence.

In radio-location the intersection of the beam by aircraft is recorded in each transmitting station and the position of the intersecting machine is worked out trigonometrically. Ultimately, success depends on covering the entire country with locator stations, thus forming an interconnected network of waves through which no enemy aircraft can pass without betraying its approach.

Experiments in the radio control of aircraft are also being made in Britain and America. Eventually, we are promised, both pilot and navigator will be superfluous. The bomber will take off, fly at an enormous height to its objective, do its work and return without direct human control. The United States Army Air Corps began experiments of this type six years ago.

Tank Control: Modern mechanized warfare has brought another use for radio: the control of advancing tank formations

from a central base or from one particular machine. The problems of radio transmission and reception within a noisy, heavy steel shell, packed with machinery were formidable but they have been solved with complete satisfaction and the units of a mechanized army can now maintain radio contact. New midget tubes have made the really portable transreceiver a fact.—Robert Williamson, London.

Movie on Television:—The movies, drawing on the National Broadcasting Company's television plant and knowledge, are going to explain the mystery of the art of electronic pictures through the air to the American public.

Moving their cameras into NBC's sight-sound studios at Radio City the Jan Handy Organization shot the sequences for "Magic in the Air," a new Chevrolet film short.

In the first film explanation to give a simple visual explanation of the intricate processes of television, the production will employ diagrams and animations. It will show how the televised subject, a bathing beauty on a swimming pool set, is scanned, the light image converted to countless separate electrical impulses broadcast through the air and, finally, how the receiver reconstructs a moving image of the bathing beauty in the televiewer's screen.

RADIO DEFENSE



SERVICE MEN • DEALERS
AMATEURS • BUILDERS
ENGINEERS • SOUND
MEN • LABS
SCHOOLS
INDUSTRY

FOR EVERYTHING
IN RADIO NOW—
Depend on
ALLIED!

Free!
RADIO'S
NEWEST
CATALOG



These are unusual times, but you'll find ALLIED now—as always—the same dependable source of supply for Everything in Radio. Stocks are the most complete in the field. Quality is more carefully guarded than ever. Service is speedy. Depend on your ALLIED Catalog to bring you everything you need at lowest prices. Send for your FREE Spring and Summer 1942 copy today!



1942 Radio Receivers—better models than ever—a complete line of plastic and wood table models, consoles, phono-radios, FM combinations, phonograph players, recorders, portables, auto sets, farm radios, etc. More than 42 new models that set the pace for value in today's market. They're ready for prompt delivery.

Service Equipment—now, more than ever, radio-service plays a vital role in the maintenance of many millions of American radios. Count on ALLIED for Test Equipment, tools, manuals—and for more than 18,000 quality parts for servicing every type of radio equipment. You can always obtain the part you want when you want it, from ALLIED.

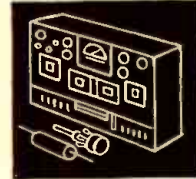

Sound Systems—built to give you more for your PA dollar. Full selection of systems from 7 to 60 watts, designed to meet every sound application need. You'll get the best of the 1942 features, better tone quality, greater usable output. Full listing of PA accessories, too. And you can buy safely on our liberal 15-Day Trial terms.

Specialized Equipment—Latest Communication Receivers, special radio and electronic parts, accessories, and equipment for industrial applications, for defense instruction, for research labs. Consult our Industrial Division for your requirements. Today, when speed and service count most, it will pay you to keep your ALLIED Radio Catalog handy!



ALLIED RADIO

833 W. Jackson Blvd.
Dept. 2-E-2, Chicago, Illinois

Send me your FREE Spring and Summer 1942 Catalog.

Name

Address

City..... State.....

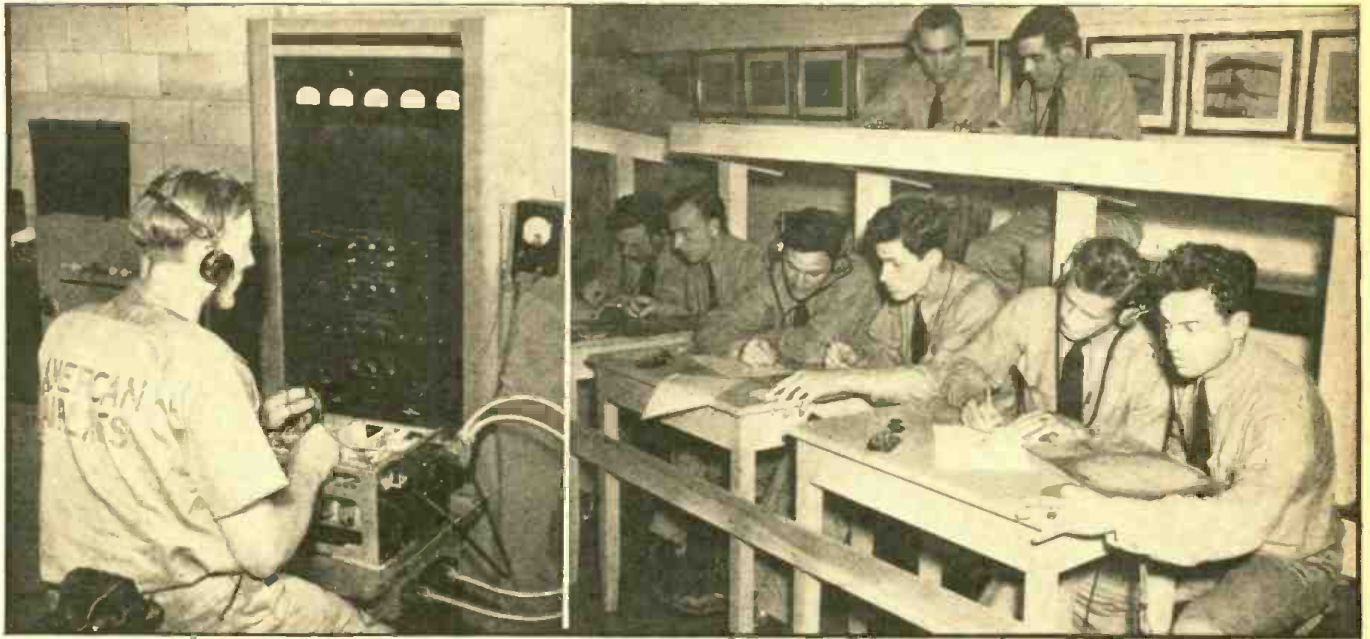

Left—American Airlines radio mechanic checks a "flag-ship" receiver in the Lines' maintenance shop. Right—Aviation Cadets of the Naval Air Station, Pensacola, Florida receiving code instruction.

Training AIRCRAFT RADIO MEN

LIEUT. MYRON EDDY, U.S.N. Ret.*

● SOMETHING new has been added to the radio picture:—*Jobs, New Jobs.*

You do not have to know code to get these jobs.

You *do* have to qualify in other ways. From my survey, I believe that some of you are already qualified. And I feel certain a great many amateurs and unlicensed radio experimenters have what it takes to go after these jobs and *get them*. But—you'll have to be told about the requirements—and that's my job.

Here's the setup. War came along and the Service grabbed radio men right and left—*had to*. Most of these men held commercial licenses. All of them were deemed capable of doing certain maintenance work. It isn't possible to replace all of these operators; there just aren't enough men with "tickets" to go around. This means that from now on operators will operate their radio sets and other men—new men—will service these sets.

The problem of securing new radio maintenance personnel brings up this question: can you service a receiver? If you understand the basic principles of radio, if you can handle pliers and screw-drivers and soldering iron and get results you can get started as a junior radio mechanic-technician.

"Radio Mechanic-technician" is the title used by the Civil Service to indicate the radio man who is not an operator but who can work on radio sets.

A Civil Service Radio Mechanic-Technician will "perform varied duties in connection with the construction, assembly, maintenance, overhaul, repair or operation of a variety of radio equipment, including all types of modern radio communication equipment. The duties and responsibilities of the work will vary and be commensurate with the grade of the position."

SALARIES TO \$2300

There are five grades as follows: Principal Radio Mechanic-Technician, \$2,300 a

*Author of *How to Become an Amateur Radio Operator and Aeronautic Radio.*

year; Senior Radio Mechanic-Technician, \$2,000 a year; Radio Mechanic-Technician, \$1,800 a year; Assistant Radio Mechanic-Technician, \$1,620 a year; Junior Radio Mechanic-Technician, \$1,440 a year.

Experience is the chief requirement for the more senior grades but one requirement that can be met by those willing to go to school is this: "The successful completion of a 6-months' technical radio course of study in residence at a radio school."

It is to meet this requirement that the New York School of Aircraft Instruments has added radio to its curriculum. Questionnaires returned by radio amateurs and experimenters clearly indicate that these radio-minded men want to qualify for defense work, for military service and for civil jobs. Some of these men come to us so well qualified that a three months day course or a six months night course is all they need.

I've mentioned Civil Service appointments merely as one example of jobs that are now open and I have mentioned this school merely as one example of where training can be obtained. The Civil Service also recognizes as qualifying experience "*The successful completion of a Defense Training Course U. S. sponsored in any branch of radio work, properly attested by documentary evidence of completion of the training course.*"

THE "RADIO MECH"

A more important example of the work now suddenly opened up to radio men everywhere is found in every air transport line in the country. Many of their radio men were *reservists*. Many who were not in the *reserve* have enlisted; some have been drafted. Airplane radio equipment has to be constantly checked on the flight line; certain component parts have to be periodically removed from aircraft, serviced, tested, calibrated. This condition has built up a demand for the "*radio Mech*," a junior man in the communications gang—a man who has a chance to learn readily and to advance rapidly.

As to airline radio operator's jobs, I wonder how many amateurs now copying 10 and 15 words per minute and thinking nothing of it, know that 16 code groups per minute is all the speed needed to make 3rd class?

Another license, even easier to get, is a *restricted radio-telephone*.

If you can answer the questions on Basic Law (regulations) required by the Federal Communications Commission, you can secure this form of commercial license at once. If you feel a little shaky on "regs," you may purchase from the U. S. Government printing office for fifteen cents a little booklet put out by the FCC called "Study Guide and Reference Material for Commercial Radio Operation examinations."

Any restricted license now-a-days means increased earning power in aviation, if it is coupled with a little "savvy" as an electrician or mechanic.

FUTURE AIRPLANE RADIO JOBS

Another thing: what about all the planes that are going to be built in the next couple of years. The quantity of aircraft to be produced under the president's all-out war program is breathtaking in its hugeness. ALL of these many planes must carry radio—*lots of radio!* No wonder there are jobs for radio men at airplane factories installing radio sets, wiring planes, assembling and testing power-packs.

I've been in *aviation radio* for the past twenty years. It looks very much to me as if there will always be jobs in that line of work, interesting, well-paid work for the man who is willing to go ahead—*thinking, studying and experimenting with radio!* After radio in airplanes will come *television* and after that—who knows!

Rest assured "something new" will be added to the radio picture every so often. So—you radio amateurs and experimenters: keep coming along, keep stepping; qualify for a radio job and work at radio. YOU'LL find it as much fun as playing.

Right—These are the 50 kilowatt rectifying tubes with an output of 18,000 volts. For the sake of safety, they are located in the transmitter house behind electrically locked doors and are automatically shut off when the doors are opened.

Catwalk leading from the WHN transmitter house to the antennae is 725 feet long. Underneath the walk are five coaxial cables which feed the programs to the towers.

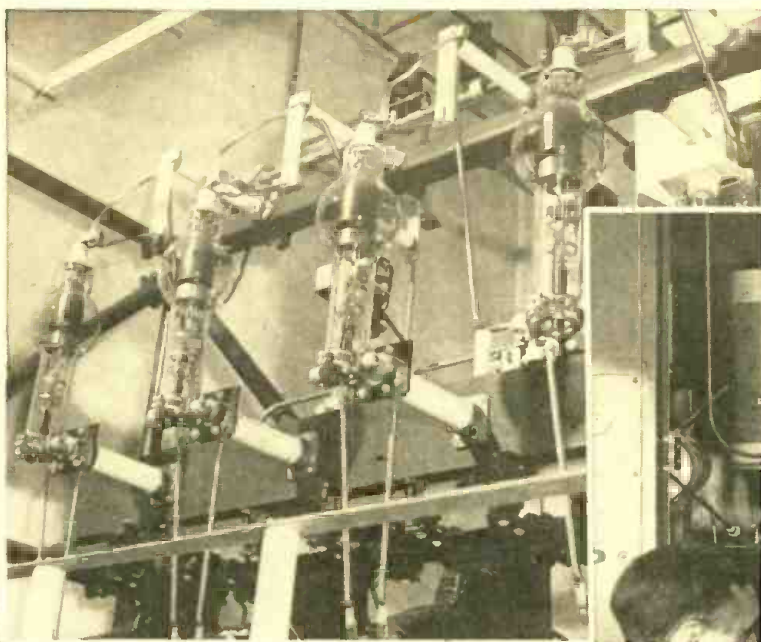

WHN engineer shown making adjustments on 50 kw. tube during test operation. Photo shows tube lighted. Each tube costs \$1650 and is kept cool by a constant flow of 150 gallons of distilled water.

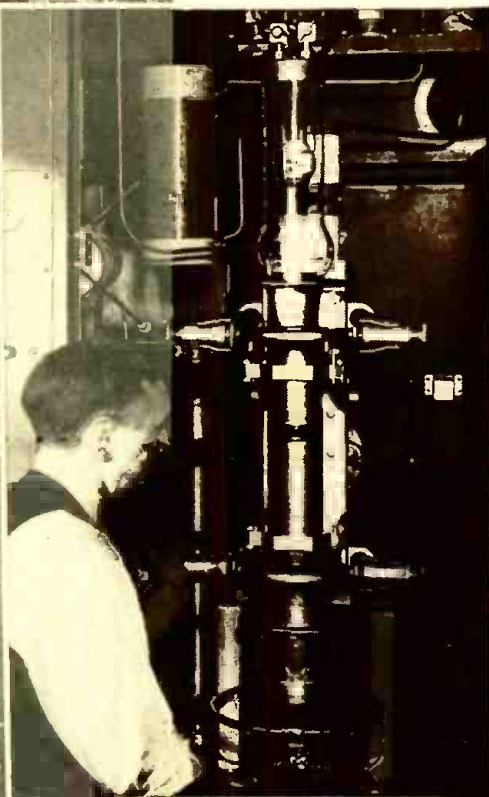

WHN - NEW YORK HAS 50 K.W.

Now Most Powerful Independent AM Station in Nation

SIX miles west of 42nd Street and Broadway, out in Rutherford, N. J., stands WHN's third AM transmitter, a 50 kw. (50,000 watt) unit which steps up the station's signal power ten-fold. Frequency used is 1050 kc.

The technical staff of WHN, New York's second oldest station, have long been familiar with Western Electric technique and performance, for both the 1 kw. and 5 kw. transmitters which preceded the new unit were of W. E. manufacture. Nevertheless, the new transmitter was selected only after exhaustive study and investigation of the various designs available.

Representing the last word in design, manufacture, and installation, the new transmitter is the product of years of research and development at Bell Telephone Laboratories.

One of the most outstanding features incorporated in the new WHN transmitter is the Doherty high-efficiency circuit, named after its youthful Bell Laboratories inventor. This circuit utilizes two giant 100-kilowatt power tubes, but unlike other circuits, its tubes do not both continually draw full power from the supply source.

Instead, one of these tubes serves as a part time assistant to the other. Normally in a stand-by condition, it is ready at all times to help out the other tube. For instance, the sudden flare of a bank of trumpets, a symphony orchestra in fortissimo,

may briefly provide a great volume of sound. At such times the stand-by tube contributes its share of energy toward the total fed into the transmitter's antenna, thus relieving the first tube of the extra burden and guarding it against overload.

The moment such a "peak load" has passed, the second tube lapses again into a temporary state of inactivity. Thus, one tube "rests" most of the time, with the obvious result that the life of the tube is materially extended, and the station's power bill is substantially reduced. Incidentally, guarding against any possible emergency, WHN has purchased five of these tubes, three to be stored and used only as and if needed.

WHN has installed its two previous transmitters, the 5 kw. and the 1 kw., one on each side of the new unit. In the event of service breaks, each could be switched into service at the touch of a button, thereby maintaining continuity of the station's signal.

Another interesting feature of the WHN installation is the automatic program amplifier. Located at the input of the transmitter, where feeble impulses picked up by the microphones are fed into the giant system, this device maintains those impulses below a safe maximum. Strong surges caused by loud bursts of volume in the program are sufficiently reduced in level to prevent overloading or distortion, and thus weaker impulses resulting from soft music or low tones

may be safely built up to keep the transmitter's output up in the high level range. The automatic program amplifier not only improves the quality of the station's signal by minimizing distortion, but also makes it practical to keep the station's signal continually strong enough to deliver the entire program with more satisfactory volume than would otherwise be possible. This extends the effectiveness of the transmitter without increasing its maximum power output above the 50-kilowatt figure for which it is licensed.

The two giant water-cooled tubes in the output stage of the new transmitter are each rated at 100 kilowatts, and are of unusual design. These tubes are double-ended, having a glass envelope at each end, with the metallic plate in the mid-section, around which water is circulated to dissipate the intense heat generated within. Instead of an outdoor cooling pond, an entirely enclosed water circulating system is employed. Thus the same water may be used over and over. The use of distilled water, furthermore, avoids the corrosive effects on metal parts of the impurities in ordinary water supply systems.

Apparatus for the new transmitter, as well as for the two former units, is locked in rooms behind each. The locks are automatic, and will not open until buttons are pressed which cut off power and ground the high-voltage units.

SERVICING RADIO IN

SMALL INSTITUTIONS

JAMES DOYLE

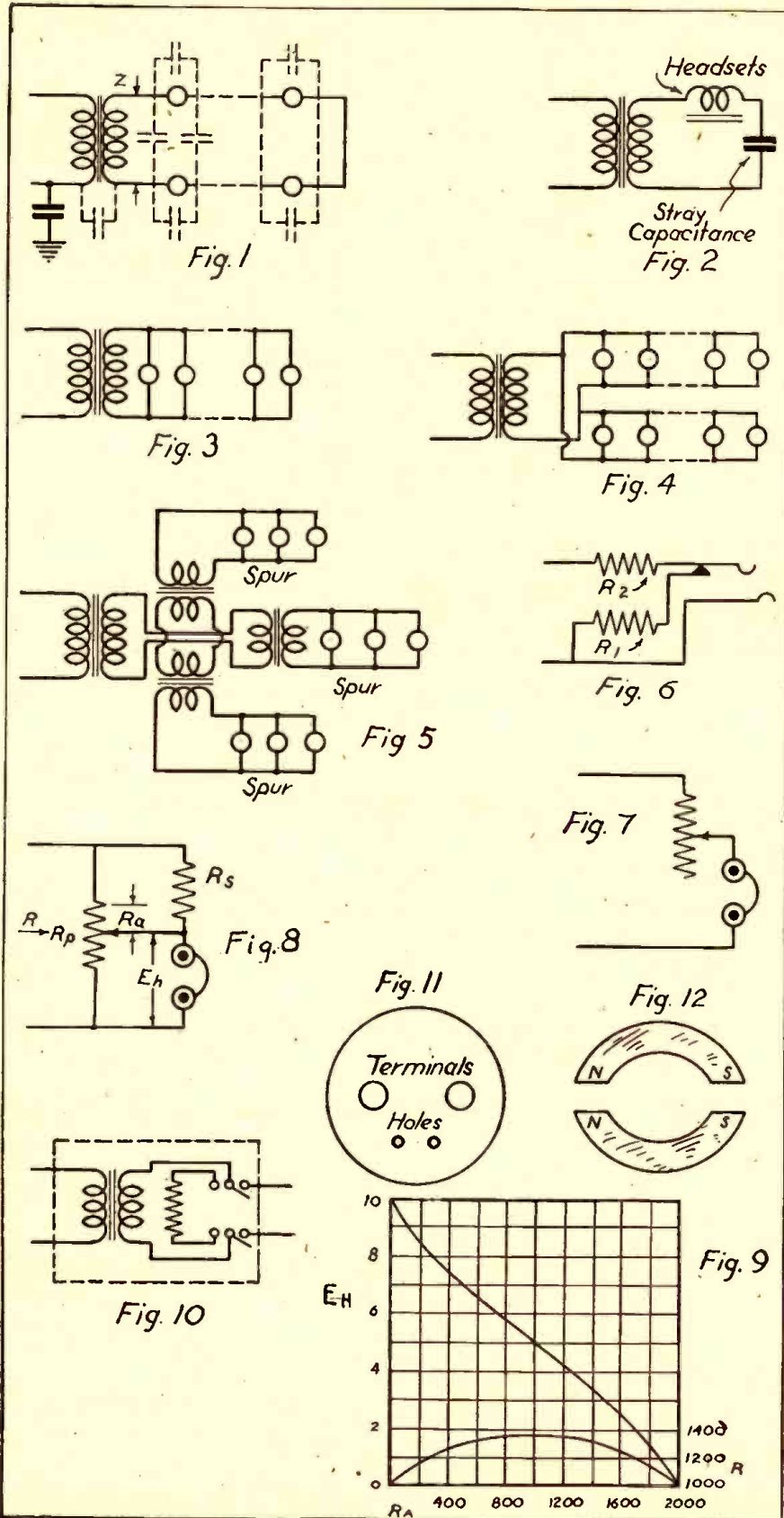

The diagrams above show various methods of connecting headphones for radio program reception in small institutions, such as hospitals, etc. Fig. 9 shows the excellent results obtained by the use of the compensated circuit Fig. 8.

LARGE institutions that are equipped with centralized systems usually employ technicians who are capable of maintaining the equipment and making minor changes in the networks, but many small institutions call in a serviceman or technician at intervals to do similar work. Sufficient information is given here to enable any serviceman to keep a small system functioning satisfactorily.

Although the installation may include loudspeakers in single rooms, or even in wards, most of them consist of headsets throughout the entire institution. The receiving and amplifying apparatus may be just standard equipment, or it may be a special arrangement built for the purpose. The simplest of all installations consists of a table-model receiver working into a transmission-line to which the headsets are connected. In more elaborate systems several lines are used to provide a choice of entertainment. Usually, at least one microphone is installed to permit local talks or concerts to be heard, and there may be equipment for playing recordings. Receivers, amplifiers, pick-ups and microphones are tested and repaired by methods that are discussed periodically in *Radio-Craft*, so that such treatment here would be unnecessary repetition. A fault in any one of these usually may be detected immediately by monitoring the input to the network.

The electrical power delivered to the network is only a few watts in a small institution, and an ordinary receiver having the proper output-transformer is satisfactory. A table-model receiver will drive 50 to 100 headsets easily. The amount of power necessary for each headset depends upon the type of institution involved, because the noise field in which the listener is immersed may vary between the equivalent of that existing in a quiet home of a residential district and that of a noisy office. This noise may change between wide limits in an institution where regular rest-periods are observed. The output of a headset must be sufficient to mask, at all times, the noise around the listener. Because of noise it is not advisable to use pillow-phones. In a quiet building each headset requires about .005-watt of electrical power, but in a noisy location the power may be .01 watt. If the noise changes considerably during the day, the power must be changed between these two limits. A master-control at the amplifier or receiver is adjusted to permit a fixed maximum output from each headset, but individual controls may be used also to permit variation between zero and the maximum available.

The headsets may be connected in *series* or in *parallel*, although the latter method is best. A wiring-diagram of each building should be available, to aid in tracing certain types of faults.

Series-Network

When numerous high-impedance headsets, of 1000 ohms or more each, are connected in series, as shown in fig. 1, the stray capacitance along the line may be the cause of serious defects. The total impedance at low frequencies, as measured at the points indicated, is nearly equal to the D.C. resistance, but is much greater at high frequencies (about 4000 c.p.s.) because of the greater inductive reactance of the coils in

PROFESSOR SQUEEGEE SMASHES THE ATOM

the headsets. The transformer that couples the line to the output-stage must have a large secondary winding, because a step-up ratio to the line is necessary; this means high voltage across the line. In a carelessly designed system resonance may occur at the medium frequencies, and results in blasting because the diaphragms are most lively in this range. Several lines may be connected in parallel to the secondary winding in some buildings.

The stray capacitance is a variable because of the different positions to which the headsets are subjected. The capacitance to ground is increased by hanging a headset on a metal bed to which may be clamped a metal bedlamp. This change of capacitance is serious if one of the leads touches the inside of the case, or if one of the terminals is grounded to the case. The increase of capacitance results in decreased output from some, or all, headsets and increased distortion.

Annoying shocks may occur through the heads of listeners connected to that part of the line near the output-transformer, and this is worse if one of the leads or terminals is grounded to the headset. The cause of this is usually a "worn" headband. Obviously aluminum caps on such headsets may be undesirable. Listeners at, and near, the remote end of the line may not be subjected to shocks because of the lower voltage. The capacitance along the line bypasses a considerable amount of current, and this causes the progressive reduction of voltage.

Line Voltage Drop

Because of the reducing voltage along the line the headsets at the remote end may not produce sufficient output, while those near the amplifier-end are too loud. This condition can be modified by connecting small by-pass condensers across the jacks of the loud headsets; the capacitance required should be determined by experiment. The result is a partial loss of the higher frequencies, but is the best of two evils, because the low frequencies are not heard well when a headset is so loud that it cannot be clamped right over the ears of the listener.

If numerous headsets are in series there will be little change in the rest of them if one is *shorted*, but if one becomes *open* the output of the rest will be low and distorted. Part of the equivalent circuit of an "open" line is shown in fig. 2. The stray capacitance permits some current to flow, but its reactance is so high that the low frequencies are not reproduced by the headsets. Unfortunately, an *open* headset may reproduce weakly, because *capacitance* permits some current to flow, and the listener who uses the offending headset may be unaware of the true source of the trouble. A *shorted* headset, of course, is detected immediately because it does *not* reproduce.

Parallel-Network

There are numerous possible arrangements for headsets in *parallel*, but the three typical systems given here are sufficient for the purpose of this paper. The simplest network is a single line connected directly to the output-transformer; the circuit is shown in fig. 3. Figure 4 is a variation of fig. 3 and may be used in a multiple-floor building. In both of these circuits low-impedance lines are used and the efficiency may be low. If 20 headsets of 1000 ohms each are in parallel their net impedance at low frequencies is approximately $\frac{1000}{20} = 50$ ohms.

The line may be about 100 feet long and have a resistance of about 2 ohms. Such an installation is highly efficient. If 100

After walking to his desk, Professor Oswald Z. Squeegge, P.D.Q., COD, carefully wound his watch, dropped it into the cuspidor and tucked his chew into his vest pocket. Then he faced the eager, upturned faces of his class.

"Listen to me, you intolerable numbskulls," he shouted. "Today we're going to study the Atom. What's more, we're going to smash the Atom right here in this room. S'help me!"

The Professor paused, reached for a coughdrop, got an eraser by mistake and chewed it vigorously. Then he cleared his throat and continued:

"The Atom, as you ought to know but probably don't, is the unit of all matter. It is the alpha of everything—the smallest, theoretically indivisible portion into which anything can be divided and still maintain its identity. In that respect, it is a good bit like the salaries most of you will earn when you graduate—if you ever do.

"How to smash the Atom has long puzzled scientists, including myself. However, we won't go into that today. Instead, we'll deal with an entirely different type of Atom—the Sprague Atom Dry Electrolytic Condenser, appropriately named for its small size and great durability. This, however, is a type of Atom that *can* be smashed. What's more I'm gonna smash it!"

After ten minutes search, the Professor finally found an 8 mfd. 450 volt Sprague Atom in his cigar case—also a similar midget dry electrolytic of another make. These he connected into a weird electrical circuit on his desk. Then he slowly turned on the juice.



"Now," he gloated, "both condensers are rated at 450 volts and that's exactly what they're getting. As you see, nothing happens. We'll step the voltage up to 500. Now up to 525. Note that the other condenser is beginning to sizzle, although the Atom is still in good shape. Here we go to 550 volts—now to 575—now to—goodness me!"

There came an explosion not unlike that of a giant firecracker and the heads of the class suddenly disappeared beneath their desks.

"You're all wrong," shouted the Professor gleefully after order had been restored. "You thought I smashed the Atom—but I didn't. It was the other condenser that blew up—not the Atom."

Sure enough, the Atom on the desk was still connected—now hissing a bit under the strain of over 600 volts but functioning perfectly.

"The Atom," continued the professor, "is especially protected against blow-outs—against moisture, heat and whatnot. The way to smash the Atom is not merely a matter of overloading it. The way to smash the Atom is this."

The professor grasped an axe hung over a sign "Use only in case of fire." Swinging this with the skill of a woodchopper and shouting wildly all the while he brought the blunt end down on the Atom—again and again and again.

"There!" he screeched, gleefully looking at the shattered remains. "We've done it. We've succeeded where others have failed. That, gentlemen, is how to smash the Atom. Class dismissed."

A TYPE FOR EVERY DRY ELECTROLYTIC REPLACEMENT NEED

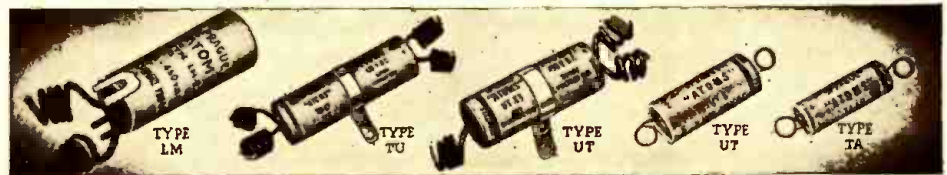

SPRAGUE PRODUCTS CO.

North Adams, Mass.

GOOD CONDENSERS—EXPERTLY ENGINEERED—COMPETENTLY PRODUCED

low-impedance headsets are used in parallel their combined impedance is less than the resistance of the wire used for the line, and the efficiency of the system is low. Low efficiency is permissible in some small institutions, because the output-stage can deliver enough power to drive the headsets, despite the high transmission loss.

Figure 5 shows the basic arrangement of an installation that has a relatively high efficiency. The spurs are like fig. 3 but they are across a high-impedance line that acts as a feeder, which may be quite long. The impedance of the feeder may be 500 ohms, and the output-transformer matches this impedance to that required by the output-tubes. The transformers between the spurs and the feeder must act so as to make the spurs reflect a net impedance equal to that of the feeder. In figure 5 each spur is reflected as 1500 ohms at low frequen-

cies and the net impedance across the feeder is approximately $\frac{1500}{3} = 500$ ohms. The

feeder must be well insulated because the voltage across it is much greater than that across a spur. The feeder is built to have low capacitance because of the high voltage, but by-passing is negligible along a spur.

The voltage across any headset, or from it to ground, is so low that shocks do not occur, and a change of the stray capacitance does not produce any noticeable effect. An *open* headset is detected immediately and does not cause any change in the output of the rest of them. A *shorted* headset may upset an entire installation if open-circuit jacks are used, but this can be prevented by including a suitable resistor at each jack.

"Jack" Problems

On a series-line a jack must close when a plug is withdrawn, but it should remain open on a parallel-line. Weakening of the springs occurs gradually and may result in choppy reproduction because movement of the headsets reacts upon the jacks. Special jacks and resistors may be used for the headsets, to prevent shorts and opens from disturbing the line. In fig. 6 the resistor R_1 acts as a "load" if the headset is disconnected; it is not required in systems that can function satisfactorily if several headsets are disconnected simultaneously. The resistor R_2 prevents the line from being shorted if the headset is shorted. Some systems use special coils whose impedance-versus-frequency curve is similar to that of a headset, but it is questionable if the extra expense is justifiable. The values of R_1 and R_2 depend upon the headset used, and usually they are equal to several-times the D.C. resistance of the headset. The springs of the jack used in fig. 6 may weaken and cause intermittent effects, just the same as any jack. There is a loss of power in R_1 and in R_2 , so that a system that uses them is inefficient.

Volume-Control

The control at the receiver or amplifier is a standard device and need not be considered here. When a control is used for each headset, the impedance faced by the output-stage may vary considerably, and this may cause a serious change of output and distortion. The output-transformer is designed to provide a correct match for the average value of impedance connected to the secondary winding, and this value may result when, say, 75% of the controls are adjusted to permit 75% of the maximum available output from each headset; this will then include the effect of some controls being turned off and others turned on full.

If circuits such as fig. 7 are used, there will not be a zero-setting unless the resistance of the rheostat is much greater than that of the headset. Increasing the size of the rheostat causes an increase in the variation of the net impedance of the network. This circuit may be used with low-impedance headsets, but even then is not satisfactory. The maximum power required at each outlet is consumed when the rheostat is cut out, so that the circuit is efficient from this point of view.

Figure 8 shows a circuit that minimizes the variation of impedance faced by the output-stage, but the maximum power consumed by the circuit is greater than that required for the headset. The voltage across the headset is maximum when the moving contact of the potentiometer is at the top, and is zero when it is at the bottom. The value of the stabilizing resistance, R_s , and that of the potentiometer, R_p , should equal, at least, the D.C. resistance of the headset. Increasing R_s raises the efficiency of the circuit, but causes the net impedance of the circuit to vary between wider limits. The curves of fig. 9 indicate the excellent results obtained by using the circuit.

Maintenance

Any intelligent serviceman can trace faults in the receiving and amplifying apparatus, but if special equipment is involved, it may be best to secure any available information from the manufacturer. The wiring-diagram of the entire system should have marked on it pertinent information, such as resistance and voltage values at key-points, minor changes that have been made and any repairs that have been made other than to the headsets.

About 85% of all faults occur some-

where along the network, and in a multiple-line installation it usually is possible to cut out the offending spur if necessary. At key-points there may be transformers and switching arrangements for substituting a resistor for the spur; figure 10 shows one of these. The spur that is cut out may be tested for shorts between the wires or to ground, and the normal resistance with all outlets in good order should be known. Headsets may be tested for opens or shorts by using an ohmmeter, but a reliable method is to make a dynamic test. A portable A.F. oscillator equipped with a jack makes an excellent dynamic tester.

The headsets develop faults easily but they can be made almost foolproof. A common complaint is broken lugs when the terminals are outside the case. A remedy for this is to anchor the cord as shown in fig. 11. Two holes are drilled through the case, and a loop of No. 16 wire prevents strain on the lugs. The cord should be taped underneath the anchor to prevent wearing. To eliminate twisting and wearing of the V of the cord, it is best to run one side of it over the headband, but be sure to make a series connection, as before, or the impedance of the network will be changed. It is a good idea to use light, parallel rubber-covered cords to replace worn fabric-covered cords.

The fine leads inside the case may break as the result of jars or corrosion. In institutions such as sanatoria the open-air construction causes condensation of moisture which aids electrolysis. Acid should not be used when soldering because it corrodes fine wires. Always make a "pigtail" whose spring-effect can absorb jars. If one of the coils cannot be repaired, it may be shorted without causing a serious change in the network or the output of the headset involved.

Magnets must be replaced in parallel, as shown in fig. 12, or the flux-density of the field in which the diaphragm is immersed may be insufficient to develop adequate reproduction.

One who is maintaining a system in an institution will be expected to connect headsets to receivers. In most instances the headset has been obtained before the serviceman has been consulted, and this may mean that the best must be made out of a bad start.

Mr. A. C. Shaney discussed the general methods of connecting the headset to the output-stage in the Sound-Engineering department of the July, 1941 issue of RADIO-CRAFT.

Best results usually are obtained from a low-impedance headset because the impedance faced by the tube for all frequencies, is more constant than it is when a headset of high-impedance is used. Some claims are made for crystal-type headsets, but they are usually used in devices that have a voltage-amplifier tube, instead of a power-amplifier tube in the output-stage.

References: Because of the limited space available for this paper the principles of "impedance-matching" have been omitted. Past issues of RADIO-CRAFT contained excellent discussions of the subject, and the interested reader should refer to those listed here before offering to service the networks of any institution. Anyone interested in the design of transformers will find full information in advanced textbooks and handbooks.

A.F. Amplifier Load-Matching Technique: A. C. Shaney; RADIO-CRAFT, March 1940.

Speaker-Matching Technique: H. S. Manney; RADIO-CRAFT, June 1940.

Servicing Notes

.... PHILCO RADIO—270 OR 270A

If all the voltages and tubes test OK and the set brings in about two stations very weakly, the trouble can be traced to a shorted cathode condenser in the second detector circuit. The radio will not operate without the condenser.

SPARKY'S RADIO & ELEC. SERVICE,
Hanover, Kansas

.... FARNSWORTH AKLS9

In cases where a loud hum is heard, sometimes tunable or inoperative on both radio and record, the trouble will usually be found by replacing the green insulated wire that runs from the variable tap of the volume control through the coiled wire shield to the terminal near the rear of the chassis. A spot will be found on the insulation that apparently causes a short-circuit.

MARSHALL J. WAGNER,
Baltimore, Md.

.... PHILCO 41-608

If, while recording, a loud rasping intermittent noise should develop in the cutter crystal, replace the 785 oscillator tube.

LEONARD CHIOMA,
Waterbury, Conn.

.... PHILCO 41-250

Complaint: pushbuttons go dead. Replace the dual 370 mmf. condenser No. 21 on diagram.

LEONARD CHIOMA,
Waterbury, Conn.

.... RCA VICTOR 19K, 110K, 111K

Intermittent audio output; look for leaky by-pass filter on plate of audio 6SF5 tube. Replace condenser (330 mmf.) and resistor with units of higher working voltage rating.

ANTONIO FRAU,
Ponce, Puerto Rico.

.... RCA VICTOR BP-10 "PERSONAL RADIO"

Complaint: Dead "A" battery, even if the set was not used in twenty-four hours. Unusually short life of the "A" battery was traced to a high leakage on the negative side of the insulated battery holder. Install a bakelite insulator, using a brass screw as the contact, and recommend sealed batteries for satisfactory upkeep.

ANTONIO FRAU,
Ponce, Puerto Rico.

1941 SERIES

.... STEWART WARNER 12-4D1, 02-4C1, 02-5T1, 02-428, 205CA AND 205CK

Each of the above models utilizes an "on-off" indicator located in the dial face. The on-off indicator is operated mechanically by an arm attached to the volume control shaft. Since this arrangement is of necessity a friction drive, you may encounter isolated cases where a small burr or rough surface will make the volume control knob exceedingly hard to turn. This action is noted particularly when an attempt is made to turn the set off.

The remedy for the above condition is to first examine the arm and slider (arm attached to volume control shaft and slider located under dial scale) to determine if these parts are smooth and free of burrs. Any burrs or roughness can be corrected by filing. Then place a small amount of grease or vaseline on the portions of both parts which make a sliding contact. This lubricant will make the parts operate much easier.

INDUSTRY ANSWERS THE CALL!

A WAR MESSAGE
to
ALL EMPLOYERS
From the United States Treasury Department

Writes you that as is going to take the mightiest effort America has ever made to win this war, it is necessary to produce the planes, tanks, ships, and guns our Army and Navy need most. Only by regular pay-day investment of the money that you and your employees have saved can this be done.

Facing these facts, your Government needs, urgently, your cooperation with your employees in immediately installing a **PAY-ROLL SAVINGS PLAN**.

The voluntary Pay-Roll Savings Plan (approved by Congress) provides for regular purchases by your employees of Defense Bonds through voluntary pay-roll allotments. All you do is hold the small funds authorized from pay-roll allotments in a separate account and deliver a Defense Bond to the employee.

To get full facts on installing the Pay-Roll Savings Plan, write TODAY for literature, Section B, Treasury Department, 709 Twelfth Street, N.W., Washington, D. C.

U. S. Defense BONDS * STAMPS
This space contributed to National Defense by
YOUR NAME HERE

32,145 Firms With Over 17,700,000 Employees Have Installed the . . .
PAY-ROLL SAVINGS PLAN



Have YOU Started the Pay-Roll Savings Plan in YOUR Company?

Like a strong, healthy wind, the Pay-Roll Savings Plan is sweeping America! Already more than 32,000 firms, large and small, have adopted the Plan, with a total of over seventeen million employees—and the number is swelling hourly.

But time is short! . . . More and more billions are needed, and needed fast, to help buy the guns, tanks, planes, and ships America's fighting forces must have. The best and quickest way to raise this money is by giving every American wage earner a chance to participate in the regular, systematic purchase of Defense Bonds. The Plan provides the one perfect means of sluicing a part of ALL America's income into the Defense Bond channel regularly every pay-day in an ever-rising flood.

Do your part by installing the Pay-Roll Savings Plan now. For truly, in this war, this people's war, **VICTORY BEGINS AT THE PAY WINDOW.**

Plan Easy to Install

Like all efficient systems, the Pay-Roll Savings Plan is amazingly easy to install, whether your employees number three or ten thousand.

For full facts and samples of free literature, send the coupon below—today! Or write, Treasury Department, Section C, 709 Twelfth Street NW., Washington, D. C.

MAIL THIS COUPON NOW

Treasury Department, Section C
709-12th St., NW.
Washington, D. C.

We want to do our part. Please rush full information regarding the Pay-Roll Savings Plan.

NAME

POSITION

COMPANY NAME

ADDRESS

NUMBER OF EMPLOYEES

MAKE EVERY PAY-DAY . . . BOND DAY! U. S. Defense BONDS * STAMPS

This space is a Contribution to NATIONAL DEFENSE by Radio-Craft
RADIO-CRAFT for APRIL, 1942



How To Use

Diagrams In Radio Servicing

M. N. BEITMAN

RELATIVELY few radio servicemen know how to get every bit of information from a schematic diagram. This article is prepared to help you learn how to use effectively radio diagrams for quicker and better repairs. Give this material a fair chance and, even if you are an old timer, you will agree with us that

Author of many technical books and articles. This article prepared from data supplied through the courtesy of Supreme Publications.

But the lines are not exact representation of the wires for circuit tracing purposes. If all radio sets were made on large bases,

there should be four knobs employed. A dynamic speaker is used and it is indicated as a 6" unit. The set is a superhet using one stage of I.F. Of interest is the resistance-capacity coupled R.F. coil giving superior tone quality. Also note that the I.F. transformers joining the tubes 6SA7, 6SK7 and 6SQ7 are of the permeability

AIR-CORE INDUCTANCE COIL	ELECTROLYTIC CONDENSER	PILOT LAMP
AMMETER	FIXED CONDENSER	POTENTIOMETER
(ANT.) ANTENNA	FIXED RESISTOR	SINGLE CELL
BATTERY (BAT.)	FUSE	SINGLE-POLE SINGLE-THROW SWITCH (S.P.S.T.)
BINDING POSTS	GROUND (GND)	TRANSFORMER
CONNECTED WIRES	IRON-CORE CHOKE COIL (CH.)	VARIABLE CONDENSER
COUPLED R.F. COILS	MAGNETIC SPEAKER	VARIABLE RESISTOR
CRYSTAL DETECTOR	MILLI-AMMETER (MA.)	VOLTMETER
DOUBLE BUTTON	PHONES	WIRES NOT CONNECTED
CARBON MICROPHONE	PHOTO-CELL	
DYNAMIC SPEAKER		

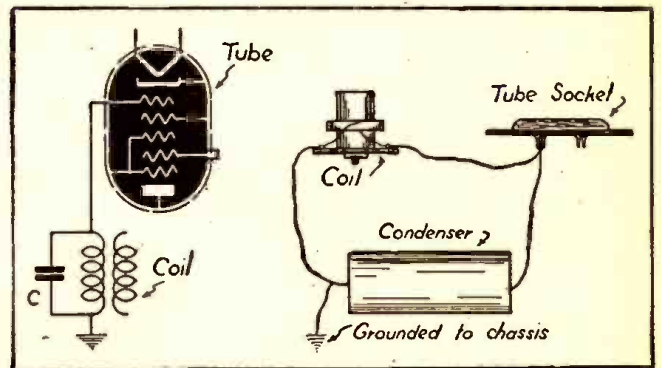

Fig. 2, above, shows the relation between a schematic diagram and the actual physical connection of a coil and a condenser to a tube socket. If you look over the diagrams in this magazine, you will soon learn the relation between the two.

Fig. 1 at the left shows the general radio symbols used in diagrams of radio sets. Once these are carefully studied and memorized, you will soon be able to read complicated diagrams with relative ease.

you learned plenty from this article about the use of diagrams and servicing methods. Let us begin with a simple question:

1. WHAT IS A RADIO DIAGRAM?

Short-hand symbolic notations are used in all branches of science. Radio diagrams show different parts used and the circuit connections in a simplified symbolic form. To save time, permit easier tracing of the connections, and allow quick comparison, radio diagrams are used. For the readers who are beginners and to serve as a reference for others, symbols of common radio parts are listed above at Fig. 1.

In complete diagrams straight lines are used to indicate the connections between parts, but these lines do not indicate the actual wires. The parts may be wired in any fashion as long as exactly the same component parts are connected with the lines and are also wired to permit the passage of current.

Figure 2 above illustrates that the actual wires and the diagrammatical lines will permit the same passage of current and are, therefore, considered the same connections.

all parts carefully laid out and clearly marked with their exact values, all wires were clearly visible, and we could see above and below the chassis at the same time, no schematic diagram would be required. Of course, this is not the case and what a job it really is to trace out even a small portion of a circuit. But a complete radio circuit diagram gives you this picture of the radio set and we will see the multitude of helpful hints and service pointers which can be found in any diagram.

2. 1000 FACTS IN EVERY DIAGRAM

Probably you cannot see how a single diagram can give 1,000 facts about the circuit, but it does. Let us consider the diagram of a seven tube Pilot set on the next page.

Here is the general information about the complete radio set:

This is a seven tube radio using a tuning eye tube and designed for A.C. operation. The set covers two bands and has a novel arrangement of pilot lights for band indication. Assuming single dial control, band switch, tone control, and volume control

tuned type. These facts are only a few of the many to be learned from this circuit.

Here is the basic information about the audio output stage:

The power output stage employs a 6F6-G pentode and is resistance coupled to the previous triode section. The tube is coupled to the voice coil of a dynamic speaker by means of an output transformer. From a tube manual it is easy to learn that the power output is about three watts. A tone control is incorporated in this circuit.

Here is the specific data about the same stage:

If we analyze this same stage with greater detail, we can obtain specific information on the value of each condenser and resistor used. Many of these parts are also listed with exact manufacturer's numbers. Circuit details also can be found. For example a .02 mfd. condenser is used as a tone compensator and the tone control consists of a series condenser and variable resistor and is also placed in the plate circuit. Of interest is the biasing method used for this 6F6-G tube. The cathode is kept at a ground potential and the .02 mfd. condenser serves as a grid return decoupling bypass. The total drop in the negative leg of the power supply (in the 250 and 50 ohm series resistors) is used for this purpose. The voltage at the tap of these two resistors is used as the minimum bias for the tubes with A.V.C. This will give you an idea what we mean by specific data and, of course, there is plenty more.

And here is the specific information about one part—the plate coupling resistor of 6SQ7 tube, part 13191:

This resistor has a resistance value of 200,000 ohms, as marked. It is used to load the triode section of the tube mentioned and carries the plate current for this tube. Without consulting tube characteristic information, you can guess that the current is in the order of a few milliamperes. Applying the wattage formula: Watts equals current in amperes multiplied by itself multiplied by the resistance, we can find the power handling requirements of this

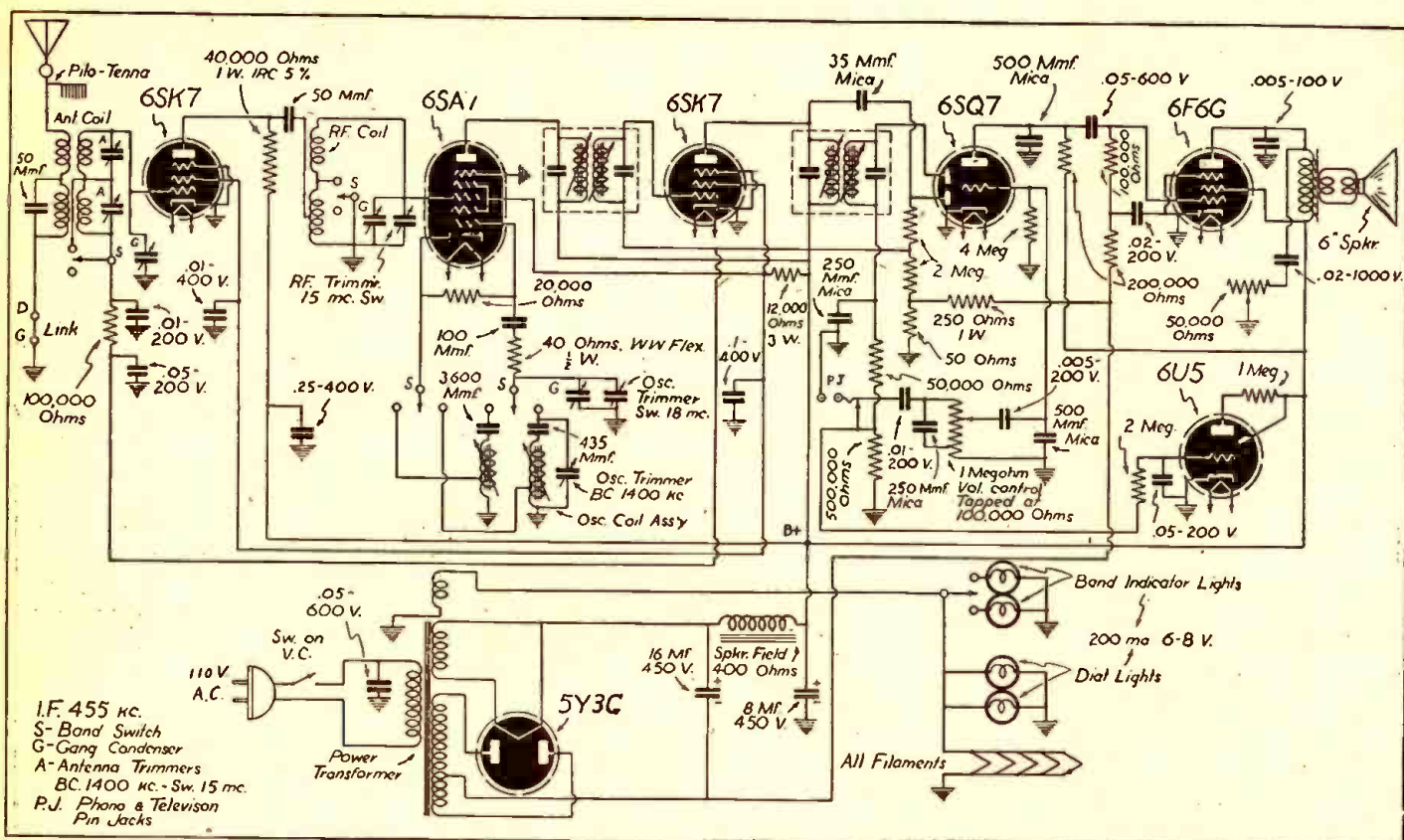

Fig. 3, above, shows the hookup of a seven-tube Pilot short and broadcast wave receiver. Beginners will find the explanatory text given in the article.

resistor. (Actual problem: about $.002 \times .002 \times 200,000$ equals 0.8 watts; probably one watt resistor used.) An important fact to notice is the possibility of this resistor to burn out if the plate R.F. by-pass 500 mmfd. condenser shorts.

Now consider the several stages used as well as the power supply, multiply this by the many different parts used in each stage, multiply this by facts known to you in general but made specific with the aid of a circuit diagram, and you have the total information needed to service the set quickly and efficiently.

3: WHAT A DIAGRAM DOES NOT TELL YOU

But a diagram does *not* tell you many things. Sometimes the non-indicated data can be found in the actual radio, or figured out by reasoning or formulae, or obtained from a parts list. Let us see how this additional information may be obtained.

In the previous chapter, we assumed that there were four control knobs from the data given in the circuit. This, of course, can be checked by examining the chassis itself. Using a formula for wattage, we have also calculated the wattage of a resistor.

Now looking back at the circuit we have been using in our discussion, we notice several switches marked "S" located in different sections of the circuit. The foot-note in the lower left hand corner of the diagram, tells us that this is the band switch and these many separate switches must be controlled by a single knob. This fact, you will notice, is not obvious from the circuit, but can be understood by an experienced radio man with the aid of a diagram.

Information on number of turns in a coil, the type of base used for pilot lights, and other such facts are not often included, but they are not needed for servicing.

4. HOW TO USE DIAGRAMS IN SERVICE WORK

Facts about radio diagrams are interesting, but you are primarily interested in

knowing how to apply this knowledge to actual servicing problems. Let us show you how a circuit diagram

- (1) Saves time in servicing,
- (2) Points directly to the fault, and
- (3) Eliminates the need for complex and expensive test equipment for many jobs.

We will study several service jobs and consider the procedure used with and without a suitable diagram for each case.

For example let us assume you are called to repair a large, rather complex radio. You suspect that the service work was first attempted by the self-styled mechanical expert of the household, and this probably resulted in several connections being changed to some wrong positions. While the more able of us in the servicing game can trace a circuit with ease, only a few are able to find a wrong connection in the 20,000 different models manufactured to date. To find actual changes made in wiring a circuit diagram is absolutely essential.

But even if the wiring has not been changed, how does one locate a shorted by-pass condenser in the grid circuit of a power output tube which receives its bias from a tap in the field coil? We will require twenty to thirty minutes to trace things to a point where we can realize that the field coil is used as a choke and is connected in semi-fixed bias arrangement.

With a diagram the symptom of this fault will be a guide which cannot fail. The continued "hum" will suggest poor filtering of the power supply at same point, and, seeing that a special biasing circuit is employed, you would immediately suspect the condenser mentioned. You must agree with us that hours can be saved almost every day by using diagrams.

5. HOW TO FIND THE PROBABLE TROUBLE USING DIAGRAMS

A radio diagram divides the set into definite sections and, thereby, permits you to find quickly the single section at fault. In

actual placement, a filter condenser may be located near the antenna coil, but even a beginner can see from a diagram that these parts belong to totally distinct sections. If the one faulty section is discovered, you need not search among all the parts for the fault, but can confine the work to a limited number of parts in this single section.

And here is the simple way to find the section at fault. Every section or stage of a receiver can be upset electrically, so that, if this one section being tested and all following stages leading to the speaker are functioning, this change in the circuit under test will alter the output volume or tone, or cause a hiss or click. See Fig. 4.

For example, in making this test in the 1st audio stage, a certain response may be expected (see table) if this stage, the following audio stage, the loud speaker, and power supply are working properly.

While test instruments may be used, these informative tests may be made with two pieces of wire and a 5c resistor. This simple test unit is explained below. See Fig. 5.

It is best to begin upsetting the circuit in the power supply. For this, as well as for almost all other tests, hold one lead of the test unit shown (Fig. 5) to the chassis—usually B minus. Touch the other prod to a B plus point, such as the positive side of a filter condenser, or the screen grid of an output pentode. If there is a noticeable spark at the point of contact assume the voltage is OK. Of course, a voltmeter can be used with greater accuracy. Please notice that the B+, and B- connections can be found immediately with a diagram.

Next test the speaker. Determine from the diagram if the speaker is of the electrodynamic type and, if so, bring an iron blade of a screw driver near the field. There should be a magnetic attraction—none will be present if set is off or field not operating.

To test voice coil operation, one prod should be held to the chassis as mentioned before, and with the other prod touch the plate prong of the output tube. There will be a spark at the contact and a loud single

SERVICING



For Triplet Customers Only

Long before the state of emergency was proclaimed, the Triplet Company was getting ready to do its part in building our national security. We knew that we must meet important new responsibilities. At the same time, we felt keenly our continuing obligations to our customers—old friends with whom we have had happy business relations through many years.

We doubled—then tripled—our output to fill the needs of our old accounts. We added to our production facilities . . . hired many more men . . . are working extra shifts at time-and-a-half.

All this has not been enough. We have been called on to produce more and more for national defense. We are proud of the job we are doing to help meet the emergency, but it is difficult not to be able to serve our old friends equally as well. In the face of these conditions, the Triplet Company has adopted these policies "for the duration."

FIRST: We will continue to serve you by our service to our mutual responsibility—the national emergency.

SECOND: We will continue to do everything we can to fill orders from our regular customers, even though some deliveries may be temporarily delayed. No business from new accounts has been nor will be accepted until after our old friends have been served, except where priorities make it impossible to do so.

THIRD: Our engineering and research departments will continue to work on the development of superior equipment and improved methods to serve you still better when we can resume normal operations.

The present emergency is incidental and as we work towards the future, we will do our best to continue to merit your confidence and loyalty.

C. L. Triplet

President
The Triplet Electrical
Instrument Company

MANUFACTURERS OF PRECISION
ELECTRICAL INSTRUMENTS

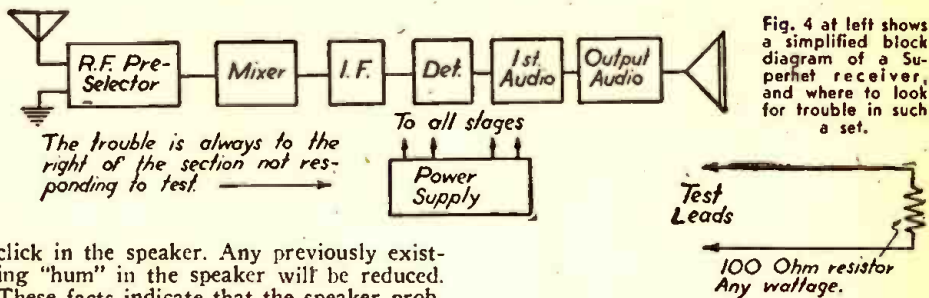

click in the speaker. Any previously existing "hum" in the speaker will be reduced. These facts indicate that the speaker probably is operating correctly. See chart for other tests.

Fig. 5 above shows a simple resistance test device explained in the text.

LOCALIZING TEST CHART, IN RECOMMENDED ORDER

First prod (momentary contact only)	Second prod	Visual observation at contact	Aural response	Where to look for faults
B+ point before filter at rectifier tube	Chassis B—	Arc made, wire will weld	Clicks, hiss	Rectifier tube, 1st filter, pwr. transformer
B+ point after filter	Chassis B—	Large spark	Dual click	Choke, or field, 2nd filter cond. short in set
Plate prong output tube	Chassis B—	Spark	Click less hum	Output transformer
Control grid output tube	Hold in hand	None	Hiss	Wrong bias on output tube
Triode, or pentode detector tube cont. grid	Antenna post	None	Click, strong hiss	Bad condenser or resistor in circuit of detector tube
Control grid of any R.F. or I.F. tube	Hold in hand, remove grid cap	None	Strong oscillations, hum, change in tone	Parts of the associated circuit

You can see that a diagram will help you find the places for these suggested tests. A diagram is like a "floor-plan" of the radio hook-up and permits immediate location of all parts and circuit connections for quick tests by any method.

By using instruments, the different parts of the circuit can be actually measured (resistors with an ohmmeter, condensers with a condenser tester) and compared to the values indicated in the diagram. At times, the voltages at important points are marked in the diagram. In such cases, using a voltmeter, you may measure voltages between these individual points and chassis. Incorrect reading suggests that the trouble lies in the associated circuit.

You can see that with diagrams the fault in a radio can be found faster. And since any service job is primarily a task of finding what is wrong—only a few minutes being needed for the actual repair or part replacement—you will earn the same service charge for less time spent on the job.

6. HOW TO MAKE SURE OF YOUR SUSPICION

The simple localizing test will suggest, or perhaps your own favorite point-to-point test with a voltmeter or ohmmeter will point to the section of the radio receiver at fault. Now to find the actual source of trouble.

The recommended procedure can be best described with a few examples. If the trouble seems to lie in the section between the I.F. tube and the detector, your localizing test will give expected response at the detector but not at the I.F. tube.

If the tubes have not been tested initially, first test the tube used in the I.F. stage. This I.F. tube is part of the section at fault. Next the circuit of this suspected section should be examined and a diagram is essential for this purpose.

Our test-unit, described before, or a voltmeter may be used to determine if the

expected voltages are at the plate of the I.F. tube, screen grid, and the B connection of the I.F. transformer (usually the red lead). If the home-made test-unit is used, connect one lead to the chassis, and touch the other to the points mentioned watching for a small spark which will indicate voltage present. A voltmeter is used the same way, but will indicate exact voltage.

In a AC-DC type of radio about 100 volts may be expected at the points mentioned, in AC sets with transformers about 200 to 250 volts. An I.F. stage from a AC-DC set is illustrated at Fig. 6 below.

Lack of voltage at a point where it is required and expected indicates that either it cannot get to this point because of a part being open or wire broken, or because an associated by-pass condenser is shorted and passes the voltage to the chassis. This means we will look for broken wire in wiring or coil, or shorted wire, or try disconnecting condensers one at a time.

This is but a single test procedure applicable to a section; however, it does suggest a simplified servicing method made possible with a circuit diagram of the radio under repair.

7. MAKING THE ACTUAL REPAIR

When you finally locate the actual source of trouble—a shorted condenser, two wires touching, or an open winding in a trans-

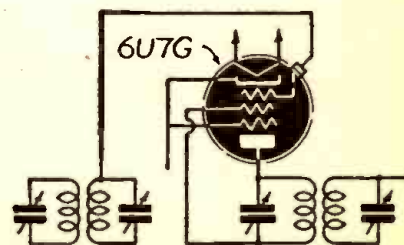

Fig. 6—Typical I.F. stage in a receiving set is here illustrated and referred to in the text.

former—you are ready to do the mechanical work of actual repair. And here again a wiring diagram is an indispensable aid.

The diagram also serves as a catalog of parts employed and will permit you to obtain the proper replacement. But more than just this—the diagram will tell you how far off in value a replacement condenser or resistor may be without noticeable ill effects.

For example, a .01 mfd., 400 volt condenser needs to be replaced. It is used to by-pass the biasing resistor of a R.F. amplifier tube. This data about the use of this condenser obtained from a diagram will

1. Eliminate the need for complex equipment.
2. Help you localize the trouble.
3. Help you to find the actual fault.
4. Permit you to select a replacement part.

This really means that you can,

1. Save time on every job.
2. Do the job better.
3. Earn more money.

By doing any radio repair better, you can charge more and will eliminate the expense of the call-backs. But not only will you be getting more money per job, but the job will take less time when using dia-

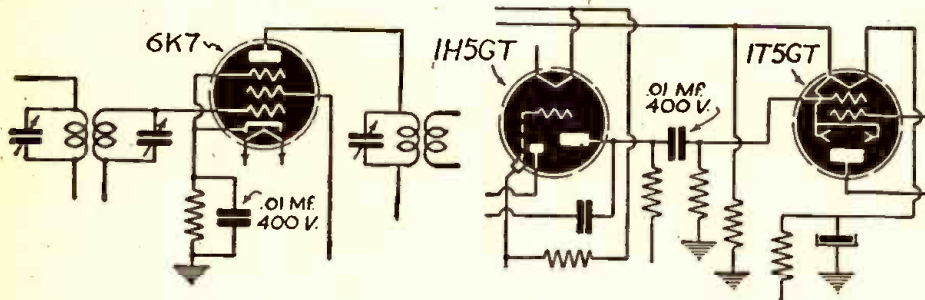

In Fig. 7 above the condenser used for cathode by-pass is not critical, but in Fig. 8 at right for an audio coupling system, an exact replacement value is recommended.

tell you that the capacity really is not critical. A somewhat smaller capacity will serve and, of course, .05 .1, or even .5 mfd. will do. The diagram also will let you know that the voltage in this cathode circuit is small and a 200 volt condenser may be used. Besides you also know that higher voltage condensers are always permissible in any circuit.

A condenser used for cathode by-pass is not critical, but for audio coupling exact replacement is recommended. See Figs. 7 and 8 above.

If this same size condenser was used in a resistance coupled stage, the value of the condenser would be much more critical. In this application, as is evident from the diagram, any other size condenser will sacrifice audio response. A larger unit will permit greater "hum" amplification; while a smaller capacity will reduce the response of the "highs."

8. HOW ANY SERVICEMAN CAN MAKE MORE MONEY

A radio circuit diagram of the set you are servicing will:

grams. And so your earning per hour will increase. As you will see in the next section, diagrams are very inexpensive and always more than repay for themselves.

9. HOW TO OBTAIN AND FILE DIAGRAMS

An active radio serviceman is interested in commercial diagrams of sets he repairs or in circuits of recently developed radios for the purpose of keeping up with the times. Several technical magazines publish a limited number of circuits of lately released sets. These should be filed by you in a suitable binder which will form a manual.

Very few radio manufacturers have diagrams for distribution to servicemen. If the diagram you want is available, a week or more will be required by the manufacturer to answer your letter. We do not recommend trying to obtain diagrams from a set manufacturer.

The diagrams should be kept in a suitable note book or filing case. A complete index with cross references should be made for a quick location of the diagram you need or as a check to see if a certain diagram is available.

An Emergency Fuse

While running short of the ordinary fuses, I was able to make one that suited

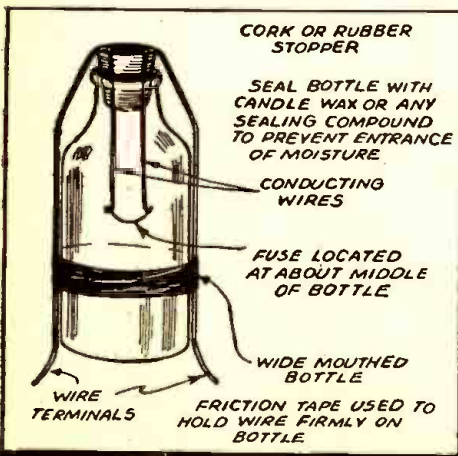

my purpose well. I procured a small, wide-mouthed bottle (diameter of mouth about 3/4") with its proper cork stopper. Using an ordinary size needle, I made two holes as far apart as possible. I inserted soft enameled wires through each of those holes. The wires must fit tightly through the holes. I used small wire-fuses. However, small-sized copper wires will do. To avoid the lead wires from touching each other, I strapped them to the sides of the bottle as shown.—Jose Ramas.

A neon tube makes a very handy tester for blown fuses. Some electricians use a 110 volt lamp as a tester, placing the lamp in a socket provided with a couple of insulated wires. By bridging the test lamp first across one fuse and then the other, diagonally, the two fuses in the block are quickly tested.

MR. W. E. COWAN
Cowan Radio Service
14 North Water St.
Sapulpa, Oklahoma

"My shop is equipped from tube tester to chandlyst thru N. U. Equipment Deals.
"I can't find adequate words to tell how much I appreciate National Union."

WHERE YOU FIND
NATIONAL UNION
YOU FIND BETTER
RADIO SERVICE

PREMIUM
Quality
TUBES



BATTERIES



CONDENSERS

also Transmitting tubes, panel lamps, cathode ray tubes, exciter lamps, sound equipment, photo electric cells, sound accessories, dry batteries, flash light bulbs.

NATIONAL UNION invites . . .

All radio service dealers to enjoy the benefits of the N. U. Shop Equipment Plan. The latest in tube testers and test equipment are available to you . . . prompt delivery. More than 60,000 completed deals prove the success of this plan. Investigate now.

Ask Your N. U. Distributor or Write



NATIONAL UNION
RADIO Corp.
57 STATE ST., NEWARK, N. J.

"DARK-LIGHT" FOILS SABOTEURS

Here's a new source of revenue for Servicemen . . . selling and installing invisible light-beam protective equipment. It is being rapidly adopted for the protection of factories, banks, offices, etc. "Surprise" flood-lighting is one of the devices actuated by the photo-cell when the prowler intercepts an invisible light-beam . . . making him a fine target for armed guards.

The photos herewith show the apparatus involved and also how it is applied for the protection of War production plants by invisible light means.

Photo at right shows typical outdoor application for guarding the property of a gas company.

Below—light source at right and Robot at left. The weatherproof case shown in the center is that used on both Robot and light source units.



NEVER before have the fortunes of war been so dependent upon materials as they are today. And never have the industries serving the prosecution of war been so dependent on each other.

Food supplies depend on canning factories which depend on can manufacturers who in turn depend on steel mills, tin smelters, etc. Munitions makers have various parts supplied to them by other factories. Makers of trucks, tanks, ships, etc., depend on dozens of suppliers for raw materials, semi-finished goods and parts. Thousands of factories are links in this chain and breaking any one link shuts off the output.

Manufacturers who think they are free from the dangers of sabotage, simply because no finished products leave their plants to go to the war zones, are inviting trouble because of their complacency. Those who take steps now to guard against Sabotage are wise. We should not wait for any "industrial" Pearl Harbor to teach us that our enemies are looking for a chance to stab us in the back while shaking hands.

Factories are not the only objectives of saboteurs. They are equally anxious to "get a crack at" municipal water plants, electric power companies, railroads, landing fields, docks, gas companies, coal companies, coal mines, refineries, etc.

All such vulnerable points are, one after another, turning to photo-electric equipment for protection. Even plants using guards are adding photo-electric protection to safeguard the lives of the men on property patrol duty.

HOW LIGHT-BEAM PROTECTS PROPERTY

Basically, the photo-electric sets consist of a *light source* to project a beam of invisible (infra-red) light and a receiver, containing a photo-electric cell, into which the beam is projected. As long as the beam

continues to strike the photo-electric cell a current flows in the cell circuit and keeps the alarm device from operating. Interruption of the beam causes relays to turn on the alarm equipment. Amplifiers in the photo-electric sets build up the current in the photo-cell circuit to the point where it will operate any type of signal and alarm system, either at the point of trespass or at a central station or both. (See Fig. 1.)

On these basic principles are built special anti-sabotage sets which project and receive the beams at long range (up to 500 feet). In effect these anti-sabotage sets represent posts in an invisible fence. The signal system is usually connected so that it not only indicates trespass but also locates the point of trespass. If the photo-electric sets have a 500 foot range the point of trespass is located within 500 feet; if they have a 250 foot range the point of trespass is located within 250 feet, etc.

The actual layout for the location of the photo-electric sets is different for each installation. One company, that has designed and built special sets for anti-sabotage, plans the layout whenever requested to do so. Information on that subject, though furnished to actual buyers of the equipment, cannot be published in a magazine without danger of giving information to the enemy.

Once the layout has been planned, the installation is easy and can be handled by any average maintenance man in the employ of the company which purchases the anti-sabotage equipment. Mechanical adjustment, electrical adjustment and maintenance are very simple.

An important use of photo-electric anti-sabotage equipment is for operating "surprise flood-lighting." (Fig. 3.) In the first World War property to be guarded was kept continually flooded with light. Nowadays when enemy airplanes scout through

the sky to plot the location of important targets, such a system is worse than useless—it is a *positive menace to safety!* The modern method is to leave the floodlights off and tie them in with a Photo-electric Anti-Sabotage System, so that when a trespasser interrupts the beam that action turns on the "surprise floodlights" and puts him "on the spot," making him a sharp target for armed guards.

INDOOR LIGHT BEAM DETECTORS

Anti-Sabotage equipment is also made for installation indoors. It may be used to guard against espionage as well as sabotage. For example, one room may contain blueprints, another laboratory experiments, another new production equipment, etc. The enemy's purpose may not be to destroy these, but rather to investigate them closely and copy down detailed information.

For the prevention of both sabotage and espionage on indoor locations, Photo-electric equipment is provided with operating ranges to suit the various indoor needs. One manufacturer has a whole series of models for the purpose, which he calls "Trespass Traps." These guard entrance-ways to the rooms or by means of mirrors reflect the invisible beams criss-cross in the room to make a "web" of invisible light. (See Fig. 2.)

Such an installation may either be used independently or in connection with a closed circuit "foil" system. The foil system consists of a closed circuit made of fragile foil tape fastened around the border of all windows and door glass. Contacts between doors and door-jamb complete the circuit, which is connected to alarm or signal lights (or both), in such a way that opening the circuit at any point gives notice of trespass. This system is quite effective in preventing forced entrance through doors and windows. However, it has its limitations, which are now generally recognized and acknowledged by the leading burglar-alarm companies. Several of these companies, who formerly regarded photo-electric equipment as a rival, are now recommending the use of Trespass Traps to supplement their own closed-circuit foil systems. There are two main reasons for this.

First—criminals can see the foil on the windows. Then, knowing the kind of system they have to deal with, they gain entrance to an adjoining building and chop their way through a wall. Sometimes a floor in the same building, above or below the one they wish to enter in the same building, is unprotected. In that case they chop their way through the floor or ceiling.

Second—saboteurs and espionage agents do not always gain their objectives by forced entry. In fact they often prefer to "pull an inside job." They become trusted employees and conceal themselves within the portion of the building that is protected by the foil system. Being already inside the circuit, they do not have to break it and no alarm is given. When they are alone they perform their acts of sabotage or espionage. Before leaving the room they put a shunt or "jumper" across the portion of the original circuit which they wish to

break in making their escape. They break the original circuit and the current goes through the shunt, without operating the alarm or signals.

The two means of "beating" the foil system can both be prevented by the use of the photo-electric units called Trespass Traps. When they are used it is not a question of how the trespasser gets into the room—whether by concealment or forced entry—the fact is that as soon as he starts moving about the room he intercepts an invisible light beam and sets off the alarm. Whatever audible or visible alarm is used may be located in the building or at some guard houses or law enforcement agency. Light signals may be used in connection with the audible alarm to show in which room trespass is taking place.

Trespass Traps are so designed that no engineering knowledge is required for their installation or operation. Sometimes, however, the engineer may be called upon to decide what type or make of equipment is to be used. In making his decision there are some important factors which it would be well for him to keep in mind.

APPARATUS MUST BE WEATHER-PROOF

Anti-Sabotage Sets should have the following qualifications:

Qualifications for Outdoor Use:

Sets should be in weatherproof housings.

They should be provided with visors for keeping rain and snow away from the projector of the light source and the beam-hole of the receiver.

They should be equipped for mounting on rigid supports, such as stanchions of pipe imbedded in blocks of concrete.

They should be made so that ground vibrations of passing trucks and trains will not throw the beam off and give a false alarm.

Qualifications for All Uses:

Provision should be made for visible beams to be used in setting up and "aiming" the apparatus.

Visible beams should easily be convertible into invisible (infra-red) light by means of a filter, which cuts off the light rays at 7200 Angstroms.

Should be designed to make mechanical adjustment, electrical adjustment and maintenance simple.

Models should be provided in various ranges from those designed to operate at 100 feet, to those designed to operate at 500 feet.

Receivers should be made to exclude, as far as possible, all light except that projected from the Light Source.

A Master Control Cabinet should be provided, where a number of sets are to be used and no control board is already installed.

Such a Master Control Cabinet should be designed to prevent false alarms and tampering.

Receivers should be responsive only to light very accurately "aimed," so that they cannot be operated by the beam from a flashlight.

Sets should be made with coaxial cable to avoid capacity effect.

All models should be available for either 110 volt or 12 volt input.

Lamp in Light Source should be long-burning (with a life of not less than 1,000 hours).

This article has been prepared from data supplied by courtesy of Warner Products.

In some cases mirrors are used to reflect the invisible light ray back and forth and this method has been used for the protection of banks, etc. With a great many of these reflected rays in criss-cross formation, it is practically impossible for an intruder or saboteur to gain access to a building or grounds. The moment the body of the intruder interrupts the invisible light ray, the photo-cell is no longer affected by the ray and the relay connected with it closes an alarm or floodlight circuit, depending upon the particular requirements of the plant where it is installed.

Keep 'em Going with
OHMITE
*Resistors * * **

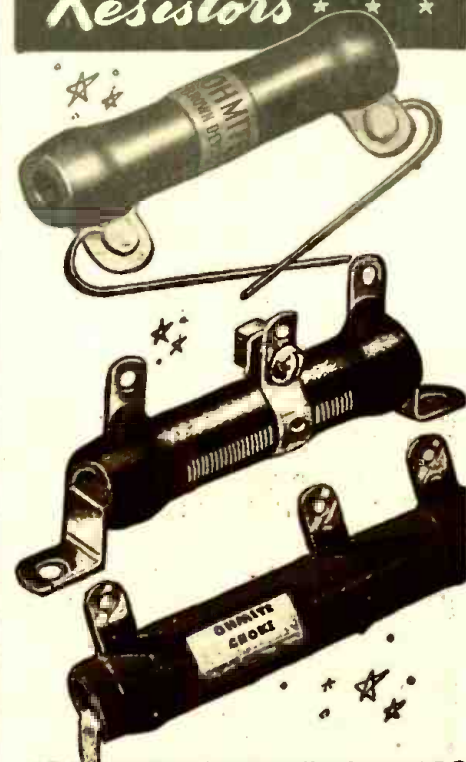

HERE is how you can insure the long trouble-free performance so necessary in replacements today. Install time-proved dependable Ohmite parts—10 and 20 watt wire-wound vitreous enameled Brown Devil Resistors, 10 watt adjustable Dividohm Resistors, R.F. Power Line Chokes and other units available in many stock types and sizes at your Jobber. They give you the same high quality used in defense industries and in the armed forces on land, at sea and in the air. Write for free Catalog 18.

Send for Handy
**Ohm's Law
Calculator**



Solves any Ohm's Law problem with one setting of the slide. Requires no slide rule knowledge. Size 4 1/4" x 9". Yours for only 10c to cover handling cost.
At Your Jobber or Send Coupon

OHMITE MANUFACTURING COMPANY
4894 Flournoy St., Chicago, U. S. A.
 Send Free Catalog 18.
 10c enclosed — Send Ohm's Law Calculator.

Name

Address

City State

R.C. April '42

Be Right with **OHMITE**
RHEOSTATS · RESISTORS · TAP SWITCHES

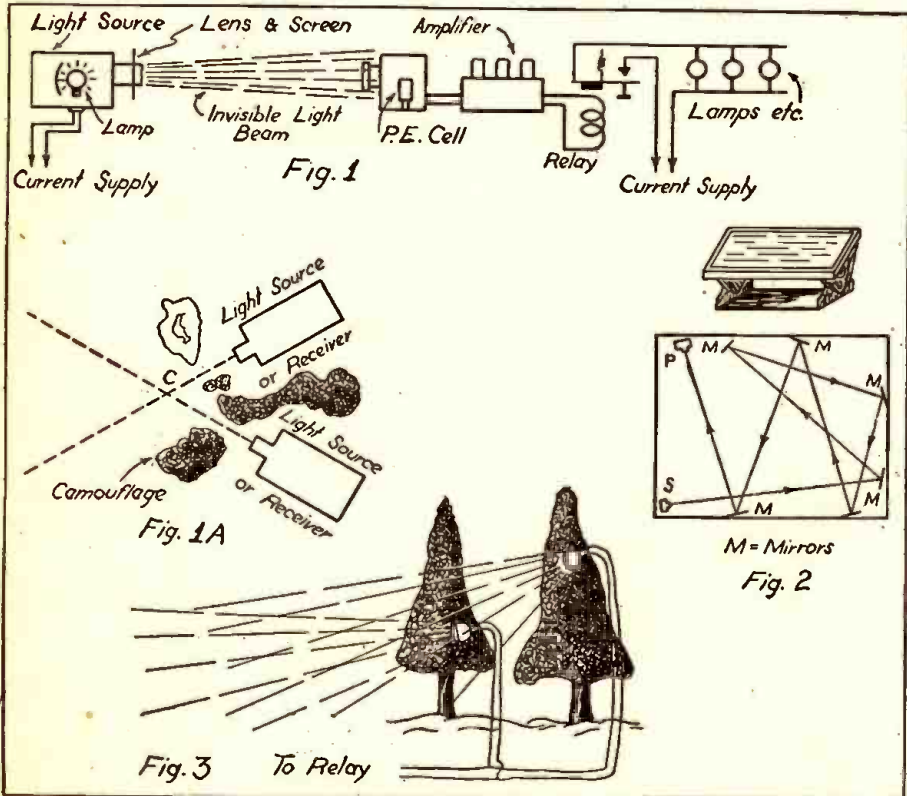

The diagrams above show how the "invisible" light beam is put to work for the protection of War-time plants. The visible light is filtered out and the non-visible rays continue on to the photo-cell unit.

Build Your Own 12 Tube "Super"

You can easily build this 12-tube "Custom" Super and have a receiver that will give peak performance. Compare these features! 5 bands, covers 132 kc. to 42 mc., exceptional sensitivity on all bands, 2 stages I.F. 15 watts undistorted power output. Kit includes Meissner Pictorial Wiring Diagram, which greatly simplifies the assembly. Complete kit less tubes and speaker—without panel and cabinet, \$114.75 list. Kit, including panel and cabinet less tubes and speaker \$127.50 list.

7-Tube "UTILITY" Super Kits

Designed for exceptional 7-tube performance. 4 models, including standard broadcast, broadcast and short-wave, broadcast Police and short-wave and broadcast, long-wave and short-wave. List prices \$41.00 to \$51.00—See your Meissner distributor.

Send for new 1942 Catalog listing a complete line of Kits from 1 tube to 14 tubes.

DEPT. RC-4

Meissner
MT. CARMEL, ILL.

PRECISION-BUILT PRODUCTS

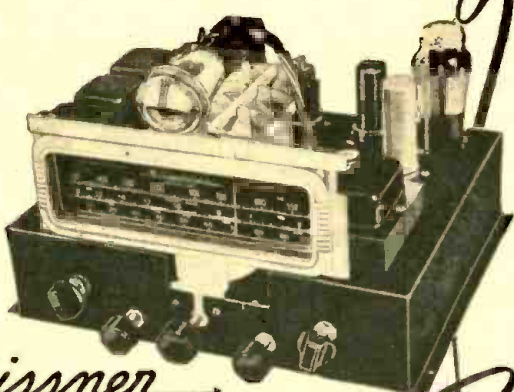
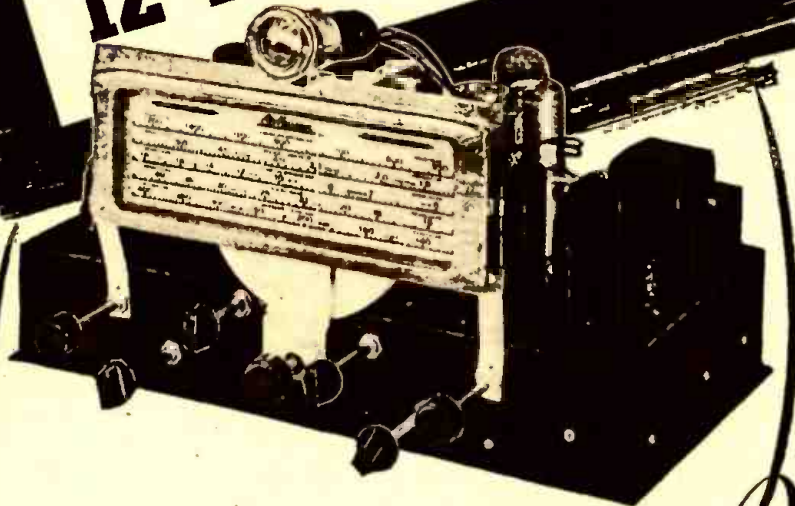

Big FM vs. AM Fight

Blow by Blow

by ELIZABETH KELSEY

Technical Advisor
Zenith Radio Distributing Corp.

● ALREADY in the ring awaiting the big battle is the present champion, for years title-holder, A.M. (standard broadcasting). Amplitude Modulation is the name given this present type broadcasting system. The intelligence is superimposed on the high-frequency

carrier wave of, say, 720 KC by varying its height or amplitude.

Now entering the ring is our contender for the championship, F.M. Frequency Modulation differs from A.M. in that the height of the carrier wave remains constant while intelligence becomes part of the signal by varying the carrier frequency.

The bell rings and the big battle of radio is on. We bring it to you round by round, blow by blow.

ROUND ONE

Fighting is hard and fast. There goes a heavy blow for F.M. to A.M.'s jaw. It's a terrific punch called DYNAMIC RANGE that wins this round for F.M. By DYNAMIC RANGE we mean the variation in sound intensity from very soft notes to the great loud climaxes. In A.M. this range is compressed but in F.M. the ratio of soft to loud pas-

sages heard at the loudspeaker is relatively the same as the original program. Here we find another important factor in the realism of F.M. reception.

ROUND TWO

Both fighters are in there hitting hard. Bang! Looks like another one for F.M., as A.M. weakens, unable to stand a right to the body. The referee calls this one HIGH FIDELITY, since F.M. gives us an over-all frequency response ranging from 20 to 15,000 cycles as compared to A.M. from about 100 to 5,000 cycles. We therefore will get with F.M. all the fundamental tones as well as at least their third harmonics, which are so necessary for true reproduction of musical instruments. The character of every sound is maintained and heard as never before in radio.

ROUND THREE

A.M. is still putting up a good fight, but F.M. is gaining. Here they come, right, left, right, with F.M. going strong. A.M. lands on the ropes as F.M. lets him have a heavy body blow—ELIMINATION OF CROSS TALK between stations. In A.M. interference is caused if the unwanted signal is one per cent of the desired signal, then one powerful broadcasting station mixes with another and can't be separated.

F.M. is another story. A ratio of 2 to 1 between the desired and undesired signal is enough to eliminate trouble. If two stations of equal power are located in neighboring cities, 100 miles apart, and operate on the same channel, interference might occur in a small territory about half way between the two stations. Directional antenna should solve this difficulty. A national network of F.M. stations is consequently possible without "cross talk" between them.

ROUND FOUR

Never before have we watched a fight such as this. Every minute brings a new surprise and A.M. may win this round if he keeps his present pace. Each is meeting the other blow for blow. Now F.M. gets in a terrible punch. Looks as if A.M. can't take it, as F.M. delivers reception with NO FADING. F.M. has been assigned to the short wave band from 43 to 50 megacycles and is quasi-optical in character. That is, the radio wave behaves like light, which restricts service area to about 100 miles radius, approximately the distance seen from atop the antenna. This gives a constant strong field strength, so the signal just can't fade.

ROUND FIVE

F.M. doesn't seem to be a bit worn but is almost as fresh as when he stepped into the ring. Joe Louis has nothing on this fellow. Look at those fists fly! A.M. can't seem to get in a single good punch. Here they come—Oh, what a beating A.M. is taking! Zowie! It's a knockout! A.M. takes the count, as F.M. lets him have MICROSTATIC RECEPTION. No more static in your radio. Only the nature of F.M. transmission and receiver circuit design can reduce static. At the radio receiver noise is kept from becoming part of the audio signal. Noise-free reception can be obtained when the signal strength is sufficient to operate the limiter circuit of the receiver.

This ends a blow-by-blow description of the most sensational fight in radio history. Here are five strong arguments for F.M. that can be understood by any radio buyer and used by every radio salesman. Remember then—(1) *Dynamic Range*, (2) *High Fidelity*, (3) *No "Cross Talk,"* (4) *No Fading*, (5) *"The Knockout Blow,"—Absence of Static.*

Gyps and Tips for Servicemen

E. M. PACE

WILL no doubt be classed as an obstinate old cuss who always wants to be different, but I think the article in *Readers Digest* for August, entitled "The Radio Repairman Will Gyp You if You Don't Watch Out," is just the dose of medicine the Radio Service Business needed. I agree that it is a nasty dose, but usually the worse the medicine tastes, the more good it does the patient.

While I do not approve of such methods as used by the *Readers Digest*, the article will, I think, prove a blessing to the Radio Servicing Business as I will try to show. My opinion is that the percentage of shops visited was far too low, as 304 shops out of approximately 30,000 is just about 1%, and for this type of survey the percentage of calls made should not have been less than 5% of the estimated 30,000 radio repair shops in this country.

MR. GERNSBACK'S EDITORIAL

How will the *Readers Digest* article help the Radio Service Business? Well, let's see: Mr. Gernsback in his editorial in the September issue of *RADIO-CRAFT* said in part: "Let the buyer **BEWARE** will now be the watchword of every radio set owner, with few exceptions." If this proves to be true, and it will to a great extent, then we of the 36% who are trying to conduct our business on an honest basis and give the customers an honest job at a price which will enable us to earn a fair profit on our parts and for our labor, will benefit materially as well as financially from the article. Customers are few that won't be agreeable to such a price, as they realize that the Serviceman expects and must receive fair compensation for his work, or he will soon be out of business. Of course we have now and always will have the "Chiseler," who objects to paying the list prices for parts, when he happens to be in a position to buy them as cheap as we can. Our answer to these fellows is: "All right—you buy the parts you need, **IF YOU KNOW WHAT IS NEEDED**, and we will install them for you at our regular rates for such work."

Let us suppose that the radio set owner does **BEWARE**, then what happens? If his set does go dead, he will (if he has read the article in *Readers Digest*) promptly go into a quandary as to which Serviceman to call in for the repairs. Let us assume that Mr. John Customer has always heretofore called in the Gyppo Radio Service, and since he has read the article he does remember now that they have repaired his set three times. He does not know what was done, as they always carried the set to the shop and when it was returned, he paid the "bill" (without asking what was done, nor did he pay any particular attention to the bill, to see whether or not it showed what was done). He does remember that at the time he paid each bill he had thought that there must have been something *terribly wrong* with the set, *judging from the amount of the bill*. Anyway, the set was playing, so Gyppo Radio Service must be good. They have a large place down town with a big front, so they must be doing a good busi-

ness. He picks up the 'phone to call Gyppo Radio Service. No, wait—he is calling a friend of his, Joe Blank. He heard Joe say just last week that he had missed an important speech because his radio had gone out just a few minutes before the speech was put on the air, but he had gotten it repaired the next day in time for the news by his favorite news commentator. Joe tells Mr. Customer that he had called the *Square Deal Radio Service* and that they had sent a serviceman over promptly and that he found a tube burned out. A new tube was installed and the set performed perfectly again. The price? Oh, yes; the bill was \$2.05. The serviceman said the tube was \$1.05 and that there was a \$1.00 *service charge*, but he checked all the tubes and gave me some pointers on how to tune in those *foreign* stations on the *short wave* bands—never did understand how to tune that *short wave* stuff anyway, but now I can get *London* just as easy as I can the "locals."

HOW A COMPETENT SERVICEMAN ACTS

Mr. Customer calls the *Square Deal Radio Service* and a competent serviceman is soon checking the set. Mr. Customer is smart, though, he is not going to tell this serviceman that he has been calling in the Gyppo Radio serviceman, he is going to see what this fellow will find. The serviceman is testing the tubes now and has been putting some of them back in the set, but he has left two of them out; now he puts another one aside, Gosh—he must be a GYP, that article in "R. D." said they would take out your good tubes and put in old ones that have been taken from some other radio. Oh, oh, he is looking for something else now. Wish I knew what he is looking for—should have called Gyppo Radio Service anyway. Now the serviceman has finished his analysis, let's see: Well, Mr. Customer, you have one tube burned out, that is what stopped the set completely, but you also have two more tubes that are too weak to give you the reception you have a right to expect from your radio. These three tubes are cheap, *off-brand* tubes and the only good ones in your set are the original tubes—they are a high quality tube. I will replace the burned out tube, this will make your set play, and then I will replace the two weak tubes with two good ones and let you be the judge as to whether you want to buy them or not. The serviceman pulls a tube out of a sealed carton (it is bound to be new for he had to break the seal) and places it in the set. It does play, but not like it did when it was new, but just about as good as it has since Gyppo Radio Service repaired it the first time. The serviceman installs the other two tubes and the difference is certainly noticeable. The set plays like it used to—why, there is that station up around 600—been a long time since I heard that one. The tone is much better, too—used to have such a good tone when it was new. Gosh, the dial is full of stations now—guess I'll buy all three tubes anyway. The serviceman thanks Mr. Customer for his business and solicits any future business he may have and departs, but pauses at the door to remind Mr. Customer that he had removed the pack-

SPRAYBERRY RADIO TRAINING

includes
FULL EQUIPMENT

Experience Easily Acquired at Home



You Do Practice-Giving Experiments. Many Special Features . . . ALL Designed to Help You Make Fast Progress

SPRAYBERRY Training starts right at the beginning of Radio . . . unfolds each subject in a simplified, logical, understandable style. You easily learn Television, Frequency Modulation, Signal Training, Mobile Radio (Auto-Tank), Aviation Radio, Electronics, Facsimile Radio, Radio Set Repair and Installation work.

Training Prepares You for a Business of Your Own . . . or Good Radio Jobs at Excellent Pay

The great fascinating and progressive field of Radio offers many opportunities to the man who wants to get ahead. My Training is designed to give you quick access to these opportunities. SPRAYBERRY Methods are thorough and practical. Your Training will not interfere with your present work. No previous experience is needed.

You Get Professional Test Equipment Plus Complete Radio Set

With the Radio Parts Given (everything needed to build a Complete Receiver) . . . you conduct interesting, informative experiments with your own hands. Also you are supplied a modern **TESTER-ANALYZER**

Earn While You Learn

My **BUSINESS BUILDERS** show you how to put your equipment to actual use in handling money-making Radio Service jobs shortly after you begin Training.

THE SPRAYBERRY COURSE IS SOLD UNDER MONEY-BACK AGREEMENT



FULL RADIO SET



TESTER-ANALYZER

RUSH COUPON for BIG FREE BOOK

SPRAYBERRY ACADEMY OF RADIO
 F. L. Sprayberry, President
 520-D University Place, N. W.
 Washington, D. C.

Please rush my FREE copy of "HOW TO MAKE MONEY IN RADIO."

Name

Address

City State

(Mail in envelope or paste on penny postcard)

BIG BOY

MODEL 860

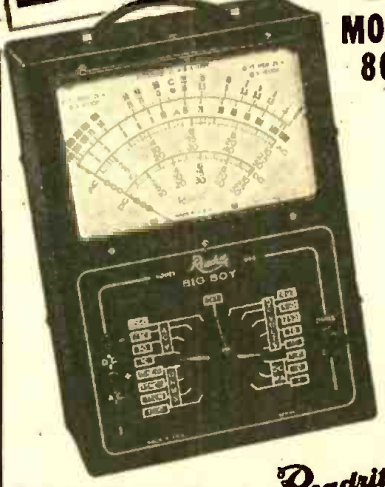

Readrite
RANGER

Performance . . . Eye Appeal . . . Value . . . Sensationally Priced at \$19.65, Dealer Net Price

Here is an AC-DC Volt-Ohm-Milliammeter with all the ranges you want . . . easily readable on the large 7" instrument with extra-long 6" scale. In a new up-to-the-minute three-tone case. DC Volts 0-10-50-250-500-1000 at 5000 Ohms per volt DC; 1000 ohms per volt AC. AC Volts 0-10-50-250-1000 at 400 ohms per volt; DC Ma. 0-1-10-100; Resistance ranges: 0-1500 Low Ohms; 0-150,000 Ohms and 0-7.5 and 0-15 Megohms. Maroon case with red and silver panel, attached handle.

Dealer Net Price, \$19.65

For Catalog Write—Section 316 College Drive

READRITE METER WORKS, Bluffton, Ohio

•SERVICING•

BOOST Service Profits

LOWEST PRICES...
FASTER DELIVERY at
RADOLEK

LARGEST STOCK OF
EVERYTHING IN RADIO



Thousands of progressive servicemen rely on Radolek for their complete requirements of repair materials. Radolek has in stock for prompt delivery replacement parts to repair any radio—every type of tube, transformer, speaker, condenser, volume control, resistor, auto radio accessory, etc. Everything you need at lowest prices. You get what you want when you want it—Radolek understands service problems—gets your order to you in double-quick time. Buying from Radolek means Greater Values, Better Service and More Profits. The big new Radolek Radio Service Guide is yours FREE for the asking. Send for your copy today!

**RADOLEK P. A. SYSTEMS
FOR EVERY REQUIREMENT**

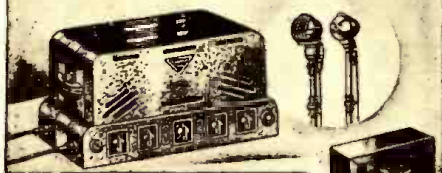

Thousands of successful Radolek P.A. installations are proof of quality, superior design and top performance. Complete systems for permanent, portable or mobile use—wide choice of microphones, speakers and related equipment. Radolek P.A. Systems give you more for your money in Performance, Styling, Dependability and Reserve Power. Select the P.A. apparatus you need from Radolek's big new FREE catalog.

RADOLEK REPAIR SERVICE

Let Radolek repair your damaged or burned out transformers, coils, speakers, test equipment, etc. Many items cannot now be replaced and therefore repairing is the only alternative. Trained craftsmen, using precision tools and factory methods, assure perfect jobs equal to new. Write for prices or better still, send in any article to be repaired. It will be handled promptly.

FREE!



SEND FOR NEW FREE
RADIO SERVICE GUIDE

RADOLEK CO., Dept. C-65
601 W. Randolph St., Chicago, Ill.

Please send the Big FREE Radio Service Guide.

Name

Address

DEALER SERVICEMAN SOUND ENG.

SAVE AT RADOLEK

ing and shipping bolts from the radio, so that the chassis could float freely on the rubber cushions—they should have been removed when the set was sold and installed.

Mr. Customer goes back to his radio and while enjoying a fine orchestra from a station he hasn't heard in a long time, his thoughts run something like this: REPAIRED THREE TIMES BY GYPPO RADIO SERVICE, THREE BAD TUBES IN THE SET AND THESE AN "OFF-BRAND" TYPE, AND THE SHIPPING BOLTS AND PACKING HAD NOT BEEN REMOVED FROM THE SET. SURELY TWELVE OR FOURTEEN DOLLARS IS A BIG PRICE TO PAY FOR THREE GYP TUBES.

Mr. Customer gets the 'phone directory and puts a heavy ink line through the listing of the Gyppo Radio Service, but he underscores the listing of the Square Deal Radio Service.

"WORD-OF-MOUTH" ADVERTISING

I have a friend who works for a concern that operates "juke boxes" in this territory (yes, we do their amplifier work), and recently this friend mentioned a radio belonging to a man that had one of their juke boxes in his establishment, located some 67 miles from my shop. This man had a Silver-tone Model 4786, which had stopped playing, and he had asked a serviceman in his home town to check the radio and see how much it would cost to repair the set. The home town serviceman made a check of the set and made a price of \$8.75 for repairs. Due to the fact that this set was located 67 miles from our shop, I didn't even suggest that the set be sent to us for repairs—just passed it off with a shrug of the shoulders and a mumbled Uh, uh! For \$8.75 we could rebuild the radio (don't think I meant that, however). My friend makes weekly trips to this town so what happens the next week, but here he comes lugging the set in to our shop for repair. A complete check of the set and tubes was made, and now get this! One, just one, of the two .003 mfd. condensers used as bypass condensers from the output stages (this set has two output tubes) was broken down. We replaced this condenser with one of the same capacity but with a working voltage of 1000 volts and the set performed perfectly. Then as a precaution we replaced the other condenser with one of 1000 W.V., instead of the 600 volt as originally used. A couple of dial lights were replaced and a charge of \$3.00 was made. You may say that this was too small a charge to make, but consider that I did not have the expense of pickup and delivery; here is the real ace-in-the-hole. This set was brought to us three weeks ago, and since then our friend has brought in three more sets for repairs from this same town. The net profit on the job was \$8.15 or just 60c less than the price the home-town serviceman wanted to repair the first set. I will leave it to you, readers, whether or not the first serviceman (the home-town man) who wanted \$8.75 for a \$3.00 job and lost that one and three others, is the winner or we, who made a reasonable charge for parts and labor, is on top. We feel that we will have many more such jobs literally "dumped in our lap" from this town, and all because we satisfied our first customer and he has been telling his friends about us. Also, you can—without any stretch of the imagination—see what will happen to the home-town serviceman.

My advice to the servicemen who are in the 36% class is to keep on giving honest service! Build up a lot of CUSTOMER CONFIDENCE and you will soon find that the GYP has gyped himself right out of

the business and has gone hunting for greener pastures

DON'TS FOR SERVICEMEN

DON'T take in an old, obsolete receiver and expect to "show your stuff" by modernizing it. It just can't be done and bring you anything except a headache and a loss of time and money, in spite of the many articles that have been written to the contrary.

DON'T be afraid to tell your customer that his set is not worth the cost of repairs (if this is the case). He will thank you if you take the time to explain to him that even though you could make the set work fairly well for a while, it would still be a source of much trouble and dissatisfaction to him. He knows that the darn thing will wear out some time!

DON'T—except in rare cases—try to improve the operation of the set by making changes in it. The manufacturer knows more about designing and building his sets than you do. This does not mean that you should not use a condenser of 600 volts where a 400 volt type was originally used, but stay pretty close to the original capacity. Follow resistance and condenser values and capacities closely when making replacements. Don't use a 250,000 ohm volume control, if the original was one of 500,000 ohms—and watch the taper curves. If you don't have the part on hand, then explain this to the customer, and suggest to him that in making the replacement the original must be followed closely or the operation of the set will be affected. You will get the job for all owners want their sets repaired so the performance will be as good as when new, and it is easy to show them why you want to make the correct replacement.

DON'T waste your time and customer's money on the ultra midgets. Perhaps a tube replacement will be in line, but don't go any further. Did you ever try to get a so-called dollar watch repaired at a reputable jeweler's? Try it some time.

DON'T move console cabinets from the customer's home. They will get scratched no matter how careful you are, and you have to remove the "innards" anyway to make the repairs. Remove all units necessary for the operation of the set, and take this opportunity to show your customer what is underneath the chassis and explain the different parts to him, and that a failure of any one of the parts will either stop the set completely or affect the performance. He will not see anything but a conglomerated mess anyway, but he will think you are a wizard if you can fix the darn thing. Educate your customer—help him to understand his radio as well as he does his car, and you will win his respect and confidence.

DON'T make repairs in the customer's home except in cases of burned out or defective tubes, loose socket or aerial and ground connections, etc., as it gives the customer a chance to ask you what the heck the \$2.00 service charge is for; and that should be your minimum if any parts have to be replaced, and the parts should be billed extra and at the regular list price. This is not gyping your customer. It is just plain common sense as you can soon find out if you stop long enough to figure what it costs you to make the repairs.

Last—but not least—ALWAYS RETURN THE OLD PARTS TAKEN FROM THE CUSTOMER'S RADIO, including tubes. Insist that he take them and dispose of them in any way that he sees fit as they are no good to you, not even as "junk"! At this time it is a good idea to salvage all aluminum and give it to the customer, so he can do his bit to help OUR National Defense Program.



The photos show the busy radio repair shop operated by Charles Deason, San Antonio, Texas. The novel idea conceived by the operator of this service station to boost Auto Radio Sales and Service was to erect the sign shown in one of the photos. People automatically feel an urge to drive in and have their auto set checked or serviced.

"AUTO RADIO" SALES AND SERVICE BOOSTER

MARTIN FRANCIS

A COMBINATION of "auto" radio repair service, plus "home" set repair work, has brought a fine volume of business and profit to Charles Deason, owner of Deason Radio Service of San Antonio, Texas.

Deason handles the automobile radio installations and repairs of twenty-seven car dealers in San Antonio, and this arrangement works out very well. "Used car" dealers especially send a lot of work to Deason.

If an automobile customer wants a radio in his car, the dealer sends him to Deason to pick out the set he wants in his car, and have it installed. Deason bills the dealer for the entire job, giving him a discount on the radio and charging the customer \$3.50 for the installation. Most other dealers charge less than this, so at \$3.50 Deason makes a good profit.

Deason also guarantees his installations for 90 days, and eventually gets a lot of service work from auto radio customers after the 90 day "free" period. He has two servicemen who can handle both auto radio and home set work.

"We handle about 400 auto service calls a month," states Deason. "This, of course,

includes factory installed jobs and service, on which the minimum is usually \$1.75 where we remove the set. On other auto sets our minimum charge is \$3.25."

This dealer has his shop so arranged that customers can drive their cars either into the shop, or onto a special canopied space behind the shop. This feature brings in many auto radio customers whenever they have set trouble.

In addition, this dealer also has a special waiting room for auto set owners in his service department. This waiting room is well arranged, with both new and used home radio sets placed about, a few chairs, a settee, magazines, newspapers, etc. The car owner who wants to wait while his set is being repaired can sit here and read, smoke, or listen to the radio.

"This feature has helped me a great deal," says Deason, "for naturally a car owner doesn't want to sit in his car while the set is being repaired. The special waiting room appeals to him. He often tells his friends about our service shop arrangement, etc., and thus we get more business."

Deason visits all car dealers in the city regularly to maintain contacts with them, and add new names to his "service list".

Originally he did not have such a difficult time to convince them that it would pay them to co-operate with him on the auto radio sales and service setup, for the arrangement gave them a profit on the sale of new sets and relieved the dealers of the service problem.

"The thing I like about it is, that not only do we obtain a good volume of business at a profit from this setup," states Deason, "but we have also developed the reputation of being leaders in auto radio sales and service. All these auto dealers plug for our shop on service, and this means a great deal, especially when you have a service department with more than one man."

Deason also points out that once he satisfied an automobile radio set customer on sales and service, the chances are that the man will give him an order eventually to repair a radio set at his home, and he will sometimes be able to sell new sets to such customers.

"We can trace many new console set sales to our automobile radio service customers," says Deason. "The man who owns a car with a radio in it, can usually afford to buy a new set for his home."

Can YOU Answer these Radio Questions?

1. Name two advantages of FM for military use. (See page 456)
2. How many stages of amplification should an airplane detector have and what type of amplifier circuit would you use? (See page 458)
3. What five grades of radio technicians are open for Government service and what are the salaries? (See page 460)
4. What are some of the problems met with in servicing radio in small institutions? (See page 462)
5. How is "Dark-Light" used to guard war plants? (See page 470)
6. Name two reasons for interference in proper reception on Auto Radio receivers. (See page 476)
7. For FM reception what are some of the factors to watch out for when installing the doublet antenna? (See page 478)
8. What is the "Vocoder"? (See page 480)
9. In Home Recording how is a "crystal cutter" coupled to the output circuit? (See page 482)
10. What is the "Mirrophone" and how does it work? (See page 484)
11. What are two important things to watch out for in choosing a "P.A." system? (See page 486)
12. How would you attempt to calibrate an audio frequency oscillator? (See page 496)
13. How can a "Magic Eye" tube be used as a voltmeter? (See page 499)
14. Why is it important to keep the coils in a Transceiver well away from the metal cabinet walls? (See page 502)

Eliminating Ignition-System Interference with AUTO RADIO RECEPTION

ALFRED A. GHIRARDI, B.S., E.E.

THE routine installation practices described elsewhere in this handbook are usually sufficient in most cars (especially the newer models of the past few years)—but many are encountered in which additional steps must be taken before ignition interference and other disturbances are eliminated entirely. This is especially true among the older models of cars. Such "persistent" interference is due to conditions peculiar to the particular model of car, or even to the particular individual car—quite often making each job of this kind an individual problem.

Since the causes which may be responsible for these conditions are so varied, a great many hours of fruitless trouble-shooting may often be spent before the exact cause of the trouble, and its remedy, are found. For this reason, the information gained by a considerable amount of experience in auto-radio installation work has been assembled here to assist service men—to save their time when attempting to remedy such stubborn cases of ignition system interference. The remedies are tabulated under the headings of the various commercial car names. These names are arranged in alphabetical order.

In each case it is assumed, of course, that the noise persists after the standard suppressor equipment, "grounding," etc., as directed in the chart in Section 10 of this handbook, has already been installed on the car and the receiver is securely bolted in place and connected properly. In those cases in which the use of spark-plug and distributor suppressors actually *increases* the noise level, the fact is stated; otherwise it is understood that the standard spark-plug and distributor suppressors are recommended to be installed.

INTERMITTENT INTERFERENCE IN CARS OF COMPOSITE BODY CONSTRUCTION

Intermittent interference may often be encountered in the older model cars of composite body construction (wood and metal), and is seldom in perfect timing with the firing of the spark plugs. It may easily be recognized by its erratic "popping" and "crackling."

If this interference is due to an r-f voltage produced by the interference building up in poorly-grounded sections of the metal car body, and then discharging at irregular intervals, it will be necessary to secure better grounds on the particular body sections affected. The particular parts to ground will be specified here for each car model. In some extreme cases, it is even well to secure better grounding of the car body to the chassis by flexible bonds.

IMPORTANCE OF GOOD "GROUNDS"

Too much cannot be said about the importance of good "grounds" if ignition interference is to be eliminated. Experience shows that many cases of "persistent" ignition interference can be cleared up effectively and permanently by doing nothing more than improving the ground connections at the following points:

- (1) Receiver mounting bolts.
- (2) Dome-light filter grounded to the cowl—not to the instrument panel.
- (3) Grounding rear edges of the hood when using roof aerial.
- (4) Ground the steering column, if necessary, especially in Chrysler cars and in cars where the distributor suppressor is omitted.

When "grounding" bonds are installed, all paint should be removed thoroughly, and the connections should be clean and tight. Otherwise the bond will be ineffective, and may even result in a source of noise itself if it should happen to make poor or intermittent contact.

OBTAINING MORE EFFECTIVE BY-PASSING

It is also exceedingly important that all by-passing condensers make good connections. When they are mounted on a bracket or under bolts which are covered with paint or grease, the bracket or bolt should first be carefully cleaned so that the condenser will have a bright, clean contact with the metal. All leads should be kept as short and straight as possible to reduce their inductance. If these precautions are not observed, the condenser may not be effective in by-passing undesirable r-f disturbances.

Reprinted from new 2nd revised edition of the *RADIO Trouble Shooters Handbook*. Copyright, 1941, Radio & Technical Publishing Co. Copyright in Canada and Great Britain, and all countries subscribing to the Berne Convention, by Radio & Technical Publishing Co. All rights reserved.

If generator interference is not eliminated when the usual by-pass condenser is installed, it may be cleared up by cleaning the commutator and reseating the brushes.

When extra electrical accessories are installed on a car, additional by-pass condensers may be required to eliminate interference they produce. Thus, if an electric clock has been installed, a condenser connected to the battery lead at the clock, and grounded to the instrument board will clear up the trouble, etc.

WHEEL STATIC, AND WHEEL-STATIC COLLECTORS

Wheel static sounds somewhat like continuous heavy atmosphere static. When the car gets rolling its intensity does not vary appreciably with car speed, but it dies down noticeably when car is allowed to coast and gradually reduce its speed to a stop. Wheel static is usually strong on a cold day, and practically disappears in wet or damp weather. It is also strongest on dry concrete or asphalt pavements and hardly noticeable on gravel or dirt roads. Wheel static may be eliminated by installing wheel-static collectors in the front wheels. They serve to maintain continuous electrical contact between the wheel and the axel.

There are various types of wheel-static collectors, and the manufacturer's recommendations for the type to be used should be followed. However, regardless of the type being used, all dirt, scale and grease should be cleaned from the contact surfaces to assure a good ground connection.

BRAKE STATIC

Worn or uneven brake linings having high spots which come into contact periodically with the brake drum while the car wheels are rotating cause a form of static which is heard as a series of clicks. The frequency of these clicks depends upon the speed of the car. Brake static can often be eliminated by proper adjustment of the brake bands, but in most cases, installation of new brake lining is the only effective remedy.

INDIVIDUAL CARS PRESENT SPECIAL PROBLEMS:

It must not be supposed that every car of the same make and model will require the same treatment in every case. For example, poor bonding between certain of the metal parts of one particular car (because of paint between the bolted or riveted surfaces, loose bolts or rivets, etc.) may cause excessive noise interference in that car. Since this may be an exceptional case, it cannot be expected that all cars of that particular make and model will have the same resistance between different parts of the body and chassis, and be troubled by the same interference. For this and other similar reasons, it is sometimes found that the treatment that succeeded in minimizing the noise in one car cannot always be relied upon to produce exactly the same results in another similar car. However, in most cases, the troubles and their remedies are similar, so the information which follows should prove of great value.

ALL DATA COMPILED AS RESULT OF EXPERIENCE

All of the remedies specified here have actually been employed on hundreds of cars, and represent the findings of both the author and many auto-radio specialists. In the cases of those cars which are not listed, the reader is to assume that no special characteristic troubles will arise, and that the standard interference elimination procedure outlined in the Chart in Section 10 of this book will suffice to minimize all interference.

It is wise to try one of the suggested remedies at a time, and note the effect in each case, as often a single change is all that is necessary to minimize the noise, even though there is more than one suggestion for each make of car.

AUBURN

General: On almost all Auburn cars it may be necessary to shield the high-tension lead from the ignition coil to the distributor, bonding the shield to the lock cable. It is also necessary to bond and ground all control rods entering the car from the engine compartment, and to ground all metal floor plates.

(Continued on page 501)



Ever hear of the FREE tube-test shark!

Watch Out! Mr. Serviceman! Or Set-Owner Will GYP You!

E. H. LEFTWICH

"CONFIDENTIALLY Radio repair men are saps!"

Cushman P. Jones dusted the ash from his cigar with a stubby forefinger and motioned our Investigator to a seat. "When you ask me if I've ever gypped a Radio serviceman, I have to laugh . . . because I'll admit that I've gypped them plenty, and it's just about the easiest thing I ever did!"

Chuckling gleefully, Jones nodded toward the ancient *Flajestic* in the corner of the living room.

It was Monday noon in Bush Creek, Texas, and although she'd been working overtime, Hettie Snyder, one of the 50 Investigators turned loose by our organization, "*Suffering Servicemen of Skoboshi*," was still going strong.

We had given her her orders. "Contact 50 Radio set owners per day. Ask them if they've ever gypped a Radio serviceman, and note their replies. Contact 50 per day . . . or else, back you go . . . to the psychopathic ward!"

We counted ourselves fortunate in securing the services of Miss Snyder. She came highly recommended by the resident alienist at the Neurotic Infirmary. "At times," he told us, "she actually evinces a spark of intelligence. Momentarily, one might say, she gives the illusion of being almost normal."

Certain literary periodicals had recently conducted an investigation tending to show that the Radio serviceman gypped the Radio set owner. Being somewhat dubious of these results, we decided to get to the bottom of the matter. There are two sides to every question.

"GYP" NO. 1

Still chuckling, Jones continued. "I've had that old squawk-box in the corner for 14 years, come next June . . . but precious little I've spent on it. Why? Because Radio servicemen are such saps. Whenever 'old iron-sides' quit, I'd jerk the tubes outta her and take 'em to a Radio Shop.

"They tested 'em free. I'd find out which tubes were bad and either buy 'em wholesale through my brother who runs a meat shop, or order 'em from an out-of-town gyp house. If something serious was wrong, I got a "free estimate" from a serviceman, found out what parts were bad and got 'em wholesale. I got the kid around the corner to put 'em in for an ice-cream soda. . . ."

"But," interrupted our Miss Snyder, "suppose something really difficult was wrong . . . something that the new parts the kid put in didn't fix. . . ?"

"Right!" Jones nodded his head. "I had a way around that, too. I'd scar up the cabinet and knock a couple of dents in the chassis. Then I'd send it to a Radio Shop and tell 'em to give it the works. When they'd deliver it back, I'd raise merry hell about the scars and the dents.

"I'd threaten to sue the serviceman for

damaging my cabinet and chassis. In every case he'd compromise by tearing up his bill and calling it square. . . ."

"But didn't they finally get onto you?"

"Nope. I'd call different ones each time. The town is full of 'em. A sucker may be born every minute, but there are three Radio servicemen born to every other sucker!"

With few exceptions, Radio owners everywhere, told our Investigators the same story. Were there no Radio set owners who didn't gyp the serviceman? We wondered.

Our 50 competent Investigators, scattered throughout the country, contacted 15,000 Radio owners during a week's survey.

The results were amazing, even to us!

Exactly 92.77% of the Radio owners had gypped the Radio serviceman at least five times during the past three years. 61.47% of Radio owners made a practice of gypping some of the servicemen some of the time, while 54.49% gypped all the servicemen all of the time.

The different "lines" these Radio owners used on unsuspecting Radio servicemen were unique.



The set never worked since you fixed it . . . ?★!

Without question, the favorite "line" was, "*You fixed this radio — years ago, and it never has worked right, since.*"

WATCH OUT FOR THE LADY "GYPPER"

A little old lady, contacted by our Mr. Horace J. Mutz of Petersburg Psychopathic Palladium, was truly representative of this group. Finally convincing her that he was not a Gas Company collector, Mr. Mutz routed the old girl out of her hall-bedroom and stated his business. She owned a *Blasta Midget*.

"I allus takes it to a diff'runt place when it quits," she confessed. "I say, 'Lissen you . . . many years ago, you fixed this radio and you done a bum job. It ain't never played right, since!' An' if they ast me why I never complained sooner, I jist tells 'em I been sick. . . . see? I allus gets the work done free."

Not only did the majority of Radio owners readily admit that they gypped the Radio serviceman, but actually seemed proud of the fact!

One of our crew went into a Radio shop to get a "free estimate" on repairing his Auto radio. (Confidentially . . . he had an uncle who ran a grocery store and could get the parts wholesale.) In this shop out in Ishbini, Iowa, the proprietor was a revelation and if we may say so, an exception to the rule. He was a jump ahead of his chiseling customers.

On his wall, there was a large sign reading, "*Don't tell me . . . let me guess. I fixed your Radio a long time ago . . . and it hasn't been right since!*"

EVEN THE SHERIFF LIKES TO "GYP"

Then there was the retired Deputy Sheriff out in La Conchita, South Dakota, who deplored the passing of "free home demonstrations."

"Back in 1929," he told our Mr. Michael O'Levy (of South Platt Home for Morons) "Dealers would send Radios out on trial 'demonstrations.' Why, I had 16 different radios sent out. I got free music for nearly five years. . . ."

Mr. O'Levy's leering grin had vanished. Here, he figured was the prize dead-beat of our Investigation. He ought to get a bonus out of this. (He didn't.) His eyes popped in their sockets. The cigarette-butt he had found on the lawn burned his lower lip. He was all ears.

"And then," he muttered, "*then . . . what did you do?*"

"What could I do?" asked the Sheriff. "There was nothing left for me to do but to make a five dollar down payment on one of the darn things." He laid a heavy hand on an antique arm-chair model Radio. "This is it . . . and would you believe it, that five bucks and one or two payments of three bucks each every year has kept me in music?"

"No?"

"Yeah. You see, every time they sent out to collect, I'd complain about the *static* or something and tell the man I wouldn't make a payment until they got the set right. Every time a payment came due I'd kick again, and nearly drove the servicemen crazy when they came out to see about the set. I hope to get it paid for by 1950."

Our survey, then, brings to light the other side of the question and shows that most Radio set owners *gyp* the serviceman. There are those Radio set owners who sincerely mean to do right by the serviceman, but sadly the temptation is great, even for these to do a bit of gypping. If these people will think back, the majority will undoubtedly recall instances where they have complained, "it hasn't been right since you fixed it — years ago." To these, we say, "if it wasn't right . . . you know darn well you'd have made a legitimate kick *right away*. Further, you wouldn't have brought the set *back* to us again after so long a time, if the job *wasn't* right, unless you planned to get something for nothing, or speaking frankly to 'gyp the serviceman.'"

(And now, please excuse your writer. I see "Doc" coming to take me back to my ward.)

321

Radio Service Data Sheet

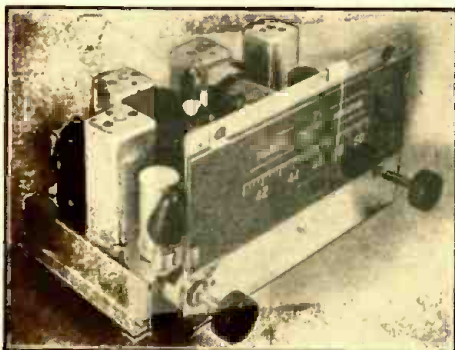

Meissner Frequency Modulation Receptor

MODEL 9-1047A 8 TUBE AC - 50 to 60 Cycles - 41.2 TO 50.4 MC

INSTALLING THE RECEPTOR

receptacle in either one of two ways, but a reversal should be tried for any possible hum reduction during reception.

CONNECTIONS TO AN A.C. RECEIVER

Although the Receptor will operate with any radio receiver, large or small, that has terminals for a phonograph pick-up, the audio quality inherent in the Frequency Modulation System will be more apparent when it is used with a regular type radio receiver having a large speaker and baffle as well as a good audio amplifier. The shielded, cloth-covered lead from the Receptor carries the audio output of the unit and is to be connected to the phonograph input terminals of the receiver.

Various input arrangements to the audio amplifier will be encountered in radios of different manufacture, such as jacks of various types, terminal strips and binding posts. The dealer will be able to supply an appropriate plug to make connections with the jack on your set. For instance, if the radio with which it is to be used is provided with a phonograph "jack" the corresponding type "plug" should be connected to the shielded lead, the outside metal shielding being connected to the frame of the plug and the inside insulated wire being connected to the high-potential (tip) side of the plug. With the Receptor placed conveniently close to the receiver, the phonograph plug may be inserted and the Receptor is ready for use. When terminal strips or binding posts are used the shielded lead from the Receptor connects directly to these points without additional parts. In all cases, the outside shielding connects to the terminal which connects directly (or through a coupling condenser) to the chassis.

If the receiver has no "Phono" or "Television Sound" terminals the additional switch and terminals can easily be installed.

CONNECTIONS TO AN AC-DC RECEIVER

This Receptor is not recommended for use with any AC-DC receiver, because of the hazards to safety involved in connecting this unit to an AC-DC set having its chassis connected to the power line, and because of almost insurmountable hum troubles on sets having the chassis insulated from the power line.

ALIGNMENT

Alignment of the Receptor may be accomplished by use of the equipment usually used in alignment of All-Wave receivers. Neither a Frequency Modulated oscillator nor a Cathode Ray oscilloscope is necessary.

DISCRIMINATOR ALIGNMENT

Connect the audio output leads of the Receptor to any convenient audio amplifier or "Phono" plug of any receiver, and connect on output meter (having a low range of 1 to 5 Volts) across the voice coil of the speaker. Temporarily increase the gain of the 6SJ7 limiter tube by shunting a 2,000-ohm resistor across the resistor through which "B" voltage is supplied to the red wire of the discriminator transformer, No. 01860. Apply a 4.3-mc. signal to the grid of

the limiter tube through a .05-mfd coupling condenser.

When a Frequency Modulated signal is used for aligning the Discriminator, the adjustment is made for maximum output in much the same manner as the conventional alignment of a 466-KC. (AM) I-F transformer on an AM signal, but if only an AM generator is available for alignment the Discriminator, the primary is aligned for maximum output and the secondary for balance or zero output, since one of the functions of the Discriminator is to eliminate amplitude modulated signals.

In tuning the secondary of the discriminator there are three places of minimum response; (1) out of resonance with the condenser too tight, (2) CORRECT, and (3) out of resonance, with the condenser too loose. The proper minimum has the characteristic that the signal rises very rapidly as the trimmer is turned IN EITHER DIRECTION. The other two minima mentioned above DO NOT have this characteristic and are incorrect. The trimmer farthest from the 6SJ7 tube tunes the secondary of the discriminator and by slowly rotating this trimmer the point of minimum audio response will be found and will indicate correct alignment of this trimmer. Now MISTUNE this trimmer as little as possible but enough to hear a signal and to obtain an output meter indication with which to align the primary trimmer for MAXIMUM response. Leaving the secondary trimmer mistuned, to assist in the I-F alignment, move the signal input to the grid of the second 6SK7 I-F amplifier tube, and align this stage, always reducing input as sensitivity increases so as to remain below the level at which the "Limiter" works. Unless this precaution is observed, the resonance indication is broadened. In the same way align the remaining I-F transformers finishing with the signal applied to the 6SA7 grid. The SECONDARY of the discriminator may now be returned to minimum response and the 2000-ohm shunt resistor removed, completing the I-F alignment.

R.F. ALIGNMENT

For reasons of stability, the oscillator in the Receptor operates on the low side of the R-F signal. Because of the high intermediate frequency (4.3 mc) there is no possibility of aligning the oscillator on the image. If there is reason to believe that the trimmers are badly out of alignment, a very practical initial adjustment would be to adjust ALL THREE TRIMMERS to a position about one-fourth turn from maximum capacity. Then apply a 48 mc. signal (or equivalent harmonic of some lower frequency) to the antenna terminals of the Receptor through a dummy antenna of 200 to 400 ohms, set the pointer to 48 MC. and adjust the trimmer on the center (oscillator) section of the gang condenser to give the maximum response OF THE TUNING EYE. Align the antenna (front) and R-F (rear) trimmers for maximum response and check the sensitivity at various points within the band. When properly aligned the antenna and oscillator trimmers are about one-fourth turn from maximum capacity with the R-F trimmer about two turns from minimum.

SERVICE DATA (for Professional Service Men)

Power Consumption...45 Watts & 117 Volts A.C.
Intermediate Frequency.....4.3 Megacycles
Tuning Range.....40.5—50.5 Mc.

VOLTAGES AT SOCKETS

The voltages that should be considered normal at each tube-socket terminal are indicated in the table below. All voltages indicated are measured between the socket terminal and ground (chassis). Readings shown are positive on the

socket terminal with the chassis as the negative terminal except where a negative voltage reading is given in which case the chassis is positive. Readings marked "AC" indicate normal AC heater voltage and should not be read with a DC meter.

These voltages are read with a Line Voltage of 117 Volts and no signal being received.

Readings are taken with a 1000-ohm-per-volt meter. Plate and screen voltages are read on the 250-volt scale. All readings under 50 volts are read on the 50-volt scale.

VOLTAGE CHART

FUNCTION	TYPE	1	2	3	4	5	6	7	8
R. F. Amp.	6SK7	0	0	36	0	3.6	110	6.3AC	105
Mixer	6SA7	0	0	100	100	—	0	6.3AC	0
1st IF	6SK7	0	0	3.6	0	3.6	110	6.3AC	110
2nd IF	6SK7	0	0	3.0	0	3.0	105	6.3AC	105
Limiter	6SJ7	0	0	0	0	0	38	6.3AC	26
Discr.	6H6	0	0	0	0	0	0	6.3AC	0
Tuning Eye	6U6	0	15	0	163	0	6.3AC	—	—
Rectifier	6x5GT	0	0	170AC	NC	170AC	NC	6.3AC	170

ANTENNA AND GROUND

FOR reception of nearby or local stations, a length of wire five to ten feet long will generally be found to provide a satisfactory antenna. This wire is to be connected to either terminal marked "D" on the antenna-ground terminal strip (D-G-D) on the back of the chassis. When this antenna arrangement is used, the OTHER "D" terminal must be connected by a short piece of bare wire to the terminal marked "G". An ordinary broadcast type of antenna may also be used with good results if connected as just described for the short antenna.

For more distant reception or where the signal strength is low, as in buildings of steel construction, a "doublet" or "dipole" antenna will give much better results. This is particularly true in locations where difficulty is experienced with automobile ignition interference. Such a doublet may consist of two lengths of wire, placed end to end, in a straight line. Each wire should be five feet long and the two wires held together at their near ends by a short insulator. The outer ends of the two wires must be supported by insulators which may be fastened to poles suspended between convenient supporting points. A twisted pair (lamp-cord or equivalent) lead-in is used with this antenna. One wire of the lead-in is soldered to each of the doublet wires at the inner ends. This lead-in should be carried as directly as possible to the receptor and EACH wire connected to its own "D" terminal. When a dipole is used "D" and "G" are NOT to be connected together as previously described.

The "doublet" antenna should be placed as high and as far from surrounding objects as possible. In order to facilitate placing it high and in the clear, it may be made of metal rods instead of wire. The assembly may then be mounted on a high wooden pole.

On the very high frequencies employed in Frequency Modulation transmission, directional effects are frequently noticed in the installation of antenna systems. The best reception is usually obtained when the "doublet" antenna is parallel to the transmitting antenna. Thus, if the transmitting antenna is vertical, a vertical "doublet" will provide the best reception, while a horizontal receiving antenna will give the best results when the transmitting antenna is horizontal. For this reason, since it is obviously impossible for the set owner to check the antenna arrangement of the transmitters he may desire to receive, a receiving antenna with a 45-degree slope should provide fairly satisfactory results under all conditions.

Although this receptor will operate well without a ground connection, the use of such a connection is desirable since it will often help to reduce noise pick-up, even though the Frequency Modulation system is much less susceptible to noise than the Amplitude Modulated system in general broadcast use. A good ground connection may be obtained by connecting a wire to a convenient water pipe, radiator or a rod driven into the ground, using a suitable clamp to make a good electrical connection to the rod or pipe. This "ground" wire is then to be connected to the terminal marked "G" at the back of the chassis.

Very weak signals do not operate the "Limiter" in the Receptor and consequently may be accompanied by considerable hiss.

TUBES

The type and position of each tube is given on the license label in the back of the receptor.

POWER SUPPLY

CAUTION—This receptor must be operated on a 105-125 volt, 50 or 60 cycle AC supply only. Do not insert the power cord into the receptacle unless all the tubes are in their proper sockets and the chassis housed in the cabinet.

The power cord may be inserted in the line

8 TUBE AC RECEPTOR FOR FM

41.2 TO 50.4 MC
INTERMEDIATE FREQUENCY 4.3 MC

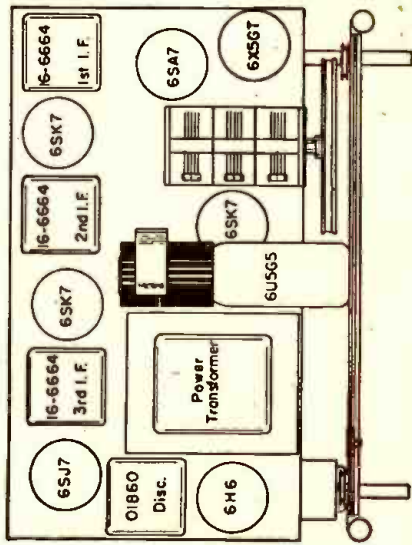
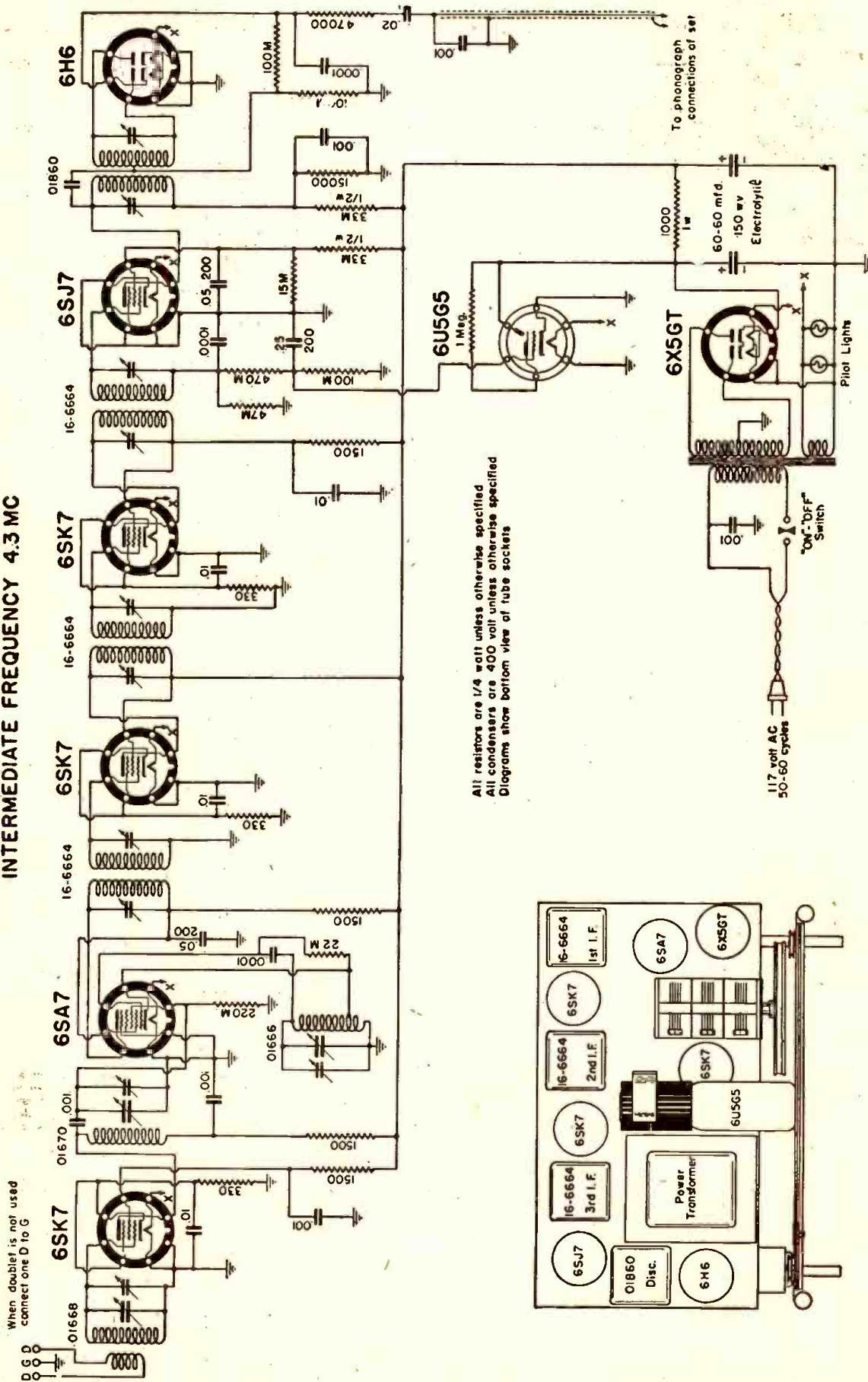

The diagram of the FM tuner or adapter shown herewith will be of interest to radio students as well as to Servicemen. It tunes in the FM programs, amplifies and detects them and passes the final audio signal out through the shielded connection (at extreme right) to the phonograph jack or terminals on your regular A.M. "Broadcast" receiver. This FM signal may also be fed into any high-fidelity audio amplifier.

When doublet is not used connect one D to G

All resistors are 1/4 watt unless otherwise specified
All condensers are 400 volt unless otherwise specified
Diagrams show bottom view of tube sockets

To phonograph connections of set

117 volt AC 50-60 cycles

Pilot Lights

"DM" "OFF" Switch

60-60 mfd. 150 wv Electrolytic

1000 1w

6U5G5 1 Meg.

6X5GT

6SK7

6SA7

6SK7

6SK7

6SJ7

6H6

01860

01668

01670

16-6664

16-6664

16-6664

01860

THE ROBOT SINGS

H. W. SECOR

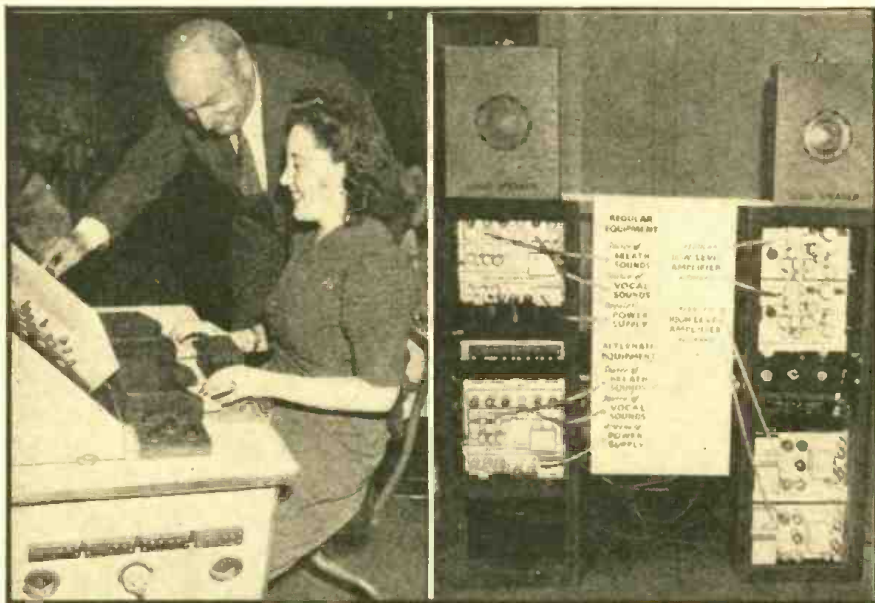

Photo at left shows Voder or synthetic speech control keyboard being operated by Miss Anna Mae Swenson, while Dr. Perrine looks on. Right-hand photo shows close-up of amplifiers and loudspeakers used in Voder demonstrations.

Dr. J. O. Perrine of the American Telephone and Telegraph Company recently presented before the New York Section of the A.I.E.E. a remarkable new demonstration of the "Voder", a synthetic voice apparatus which thousands of people heard at the recent World's Fairs at New York and San Francisco. In the new demonstration violin music was modulated by the Voder keyboard, so as to create the words of the song being played.

A STARTLING demonstration of music modulated by the synthetic voice device known as the *Voder* was conducted recently before a large audience of the New York Section of the American Institute of Electrical Engineers. The apparatus was demonstrated by Dr. J. O. Perrine, Assistant Vice President of the American Telephone and Telegraph Company, ably assisted by Miss Anna Mae Swenson, who operated the keyboard of the *Voder*, and Mr. Joseph L. Richey, who looks after the efficient performance of the *Voder* equipment.

First the audience heard a well-known tune, "Love's Old Sweet Song," being played by four violins over the high fidelity loudspeaker on the platform. The electrical currents from the "pick-up" of the electrical transcription were sent to the filters and console of the *Voder*. Then Miss Swenson pressed the proper keys on the *Voder* and "mirabile dictu" the words of the song created out of violin vibrations were heard through the loudspeaker. When the *Voder* creates speech, it uses as sources of energy, vacuum tube generators producing vocal and breath sounds. In the recent demonstration of the *Voder* the source of energy for creating the sounds of the spoken word was the violin music picked up from a phonograph record by means of an electro-magnetic "pick-up."

In addition to the music modulation demonstration, discussed at length in a recent interview with the writer, Dr. Perrine re-emphasized the idea that in the usual functioning of the *Voder*, speech is analyzed by the young woman operator into signals which act as *control signals* along the interconnecting circuit between console and synthesizer. These signals bear no actual relation to the speech sounds and, generally speaking, they could be called therefore *telegraph signals*. They need interpretation by the synthesizer before they become speech. In other words the wide band of frequencies required to transmit actual sounds (or rather sound

currents) over a circuit such as the ordinary telephone lines, are here absent, and only the control signals for "shaping" the speech currents as it were may be transmitted over the line to the receiving end from the *Voder* keyboard. Dr. Perrine cited a good parallel by comparing the action taking place to that of the console on a pipe organ. The organist does not create or transmit directly the musical sounds, but whenever he presses a certain key, he merely sends out control signals to the organ pipe unit, which may be situated several hundred feet distant from the console keyboard.

It is an interesting speculation as to whether or not at some time in the future the telephone or radio speech may be thus transmitted on a much narrower band than at present, the voice being telegraphed, as it were, on a narrow frequency band of probably 500 cycles. On the latest improved telephone circuits a frequency band from 250 to 3,000 cycles is generally used. In the new "coaxial" cable 480 telephone conversations can be transmitted by the use of radio frequency carriers extending from 60 kc. to 2,060 kc. each telephone channel using about 2800 cycles. However, by using this new system of transmitting speech over narrower bands, the sending of telegraphic specifications for telephone conversations by this means, would make possible the multiplication of many more speech channels over telephone lines. Of course much additional accessory terminal and amplifying equipment would have to be designed. In other words it has now become thinkable, thanks to the research work performed in the Bell Telephone Laboratories and as demonstrated by Dr. Perrine, to break down speech into its "manufacturing specifications," and transmit these specifications over a multiplex system (wire or radio), using narrow-band signals to a receiving station, and then have these signals synthesize speech, using a local source of energy, thereby recreating the spoken words.

The accompanying pictures show the *Voder* apparatus as recently demonstrated, when violin music was transformed (modulated) into the spoken word corresponding to those of the song being played. For the more technically-inclined a diagram of the *Voder* is shown herewith; also a brief description of the operation of the device taken from a recent lecture by Dr. Perrine entitled "Artificial Creation of Speech."

Figure 1 shows in block diagram form the interconnections of a device called the "*Vocoder*" from which the *Voder* was derived. In the case of the *Voder* the young lady operator mentally analyzes the sounds she hears and proceeds by skillful manipulation to reconstruct synthetically these same sounds which the facilities of the *Voder* provides. Her brain plays the role of an analyzer. Her manual controls then play the role of a synthesizer. This figure shows a system that can analyze and synthesize electrically and automatically. In telegraph operation, an operator at one end analyzes letters which he put into a telegraph code on the line. At the distant end a similarly trained operator, recognizing these sounds of the Morse code, translates or synthesizes them back into letters of the message. The telegraph system is relatively very simple. The processes of analysis and synthesis were an embodiment of the intelligence of the telegraph operators. When one sends a message over a long distance on the teletype, the simple act of pressing the proper keys causes an electrical device to send out telegraph signals, and at the distant end these telegraph pulses operate the receiving electro-mechanical system to reconstruct the letter.

It is possible to transmit as many as 20 teletype messages on one good long-distance telephone circuit. This is because of the relative simplicity of the telegraph system which requires a smaller frequency band of perhaps 200 cycles. The telephone, on the other hand, is relatively complex requiring for the inflection and quality of the human voice 3000 cycles. The *Vocoder* is a system that electrically analyzes the voice into what may be termed code or control signals, and when these control signals arrive at the terminal

where the synthesizer is located, they direct the synthesizer to reconstruct the original speech. All of these operations are done electrically and automatically. In this system are the possibilities of transmitting the speech over the line by a system similar to the telegraph. As mentioned before, it is possible to send 20 teletype messages on one telephone circuit. It is conceivable that some day, with the Vocoder equipment at each terminal, we can increase the load-carrying capabilities of a telephone circuit by perhaps two or three times.

The Voder and the Vocoder represent splendid research along a wide front of communication. Carrier systems typified in the recent K system of twelve simultaneous telephone messages, and the coaxial cable of 480 simultaneous telephone messages, greatly increase the efficiency—the coefficient of performance of a pair of wires. Perhaps by applying the Vocoder principle and philosophy—that efficiency and the coefficient of performance can be pushed still further.

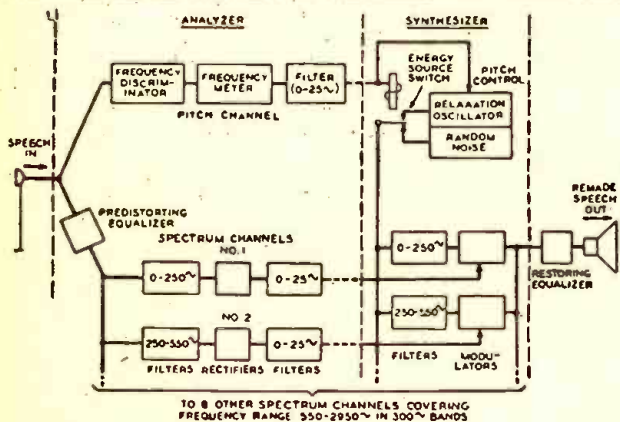
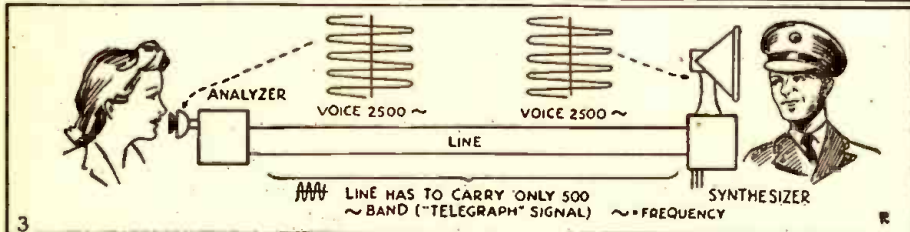
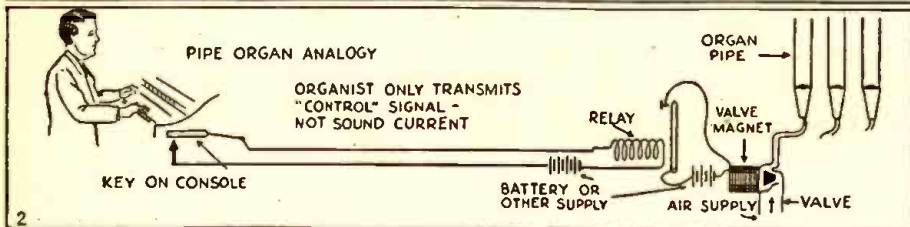
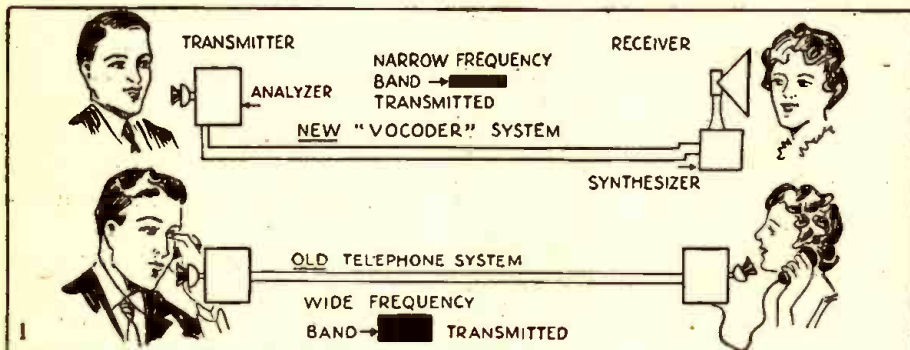

The drawings above show the action of the Voder and the Vocoder which analyzes and reproduces speech. Fig. 1—"Vocoder"—appears at left.

A Call To Service Men!

The Editors would like to hear from radio men in the service as to what kind of articles they would like to see in RADIO-CRAFT.

Do you want more articles on "how and why"—including the mathematics, of frequency modulation?

Or do you want more *Elementary Electricity* articles with electrical hints, circuits and constructional data?

Or do you want more articles on *Antennas, Ultra Short Waves*, etc.?

Let's hear from you and we will endeavor to publish what you most need. A post-card will do. Write to the Editor, RADIO-CRAFT, 25 W. Broadway, New York City.

New Direct-Coupled FM - AM AMPLIFIER MANUAL

By A. C. SHANEY

Chief Engineer, Amplifier Co. of America

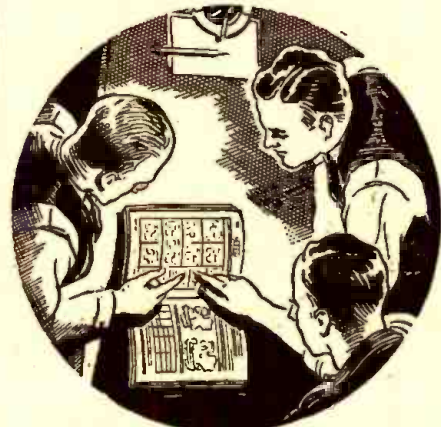

For the Layman, Serviceman, Recordist and Engineer

Regardless of whether you are interested in the finest type of phonograph reproduction, high fidelity recording, sound-on-film applications, FM or AM programs, you will find invaluable information in this practical handbook. Written by the leading exponent of direct-coupled amplifiers who has spent more than 10 years improving and perfecting the famous Loftin-White circuit.

Explains the theory and practical application of:

- Variable Speed Non-Overloading Push-Pull Expansion
- Non-Frequency Discriminating Scratch Suppression
- Push-Pull Balanced Direct-Coupled Amplification
- Push-Pull High-Frequency Equalization
- Push-Pull Low-Frequency Equalization
- Push-Pull Volume Compression
- Automatic Volume Limitation
- Automatic Volume Control
- Calibrated V.U. Indicator
- Audio Spectrum Control
- Remote Control

If you are interested in the latest audio developments, you can't afford to be without this complete compilation of authentic articles on Direct-Coupled Amplifiers. 82 pages 8 1/2" x 11". Over 100 diagrams and illustrations.

Priced to Cover Cost of 20c

Printing and Mailing

Send Stamps or Coins

AMPLIFIER CO. of AMERICA

17 WEST 20TH STREET, NEW YORK, N. Y.



HIGH EFFICIENCY results in *Sound National Defense* that is why **NATIONAL DEFENSE SOUND SYSTEMS** are equipped with *University Reflex HIGH POWER LOUDSPEAKERS* UNIVERSITY LABS. 195 CHRISTIE ST. N. Y. C.

Inventions Wanted Patented or Unpatented

We have been successfully selling inventions, patented and unpatented, since 1924. Write us, if you have a Practical, useful idea for sale.

CHARTERED INSTITUTE OF AMERICAN INVENTORS

Dept. 109 Barrister Building, Washington, D.C.

PATENTS—TRADE MARKS

Booklet concerning Inventions & Patents Form "Evidence of Conception" with instructions for use and "Schedule of Government and Attorneys Fees"—Free
LANCASTER, ALLWINE & ROMMEL
Registered Patent Attorneys
436 Bowen Bldg. Washington, D. C.

USED Correspondence Courses

COMPLETE HOME-STUDY COURSES and educational books, slightly used. Sold, rented, exchanged. All subjects. Money-back guarantee. Cash paid for used courses. Full details and illustrated 72-page bargain catalog FREE. Write today!
NELSON COMPANY, 500 Sherman, Dept. D-210, Chicago

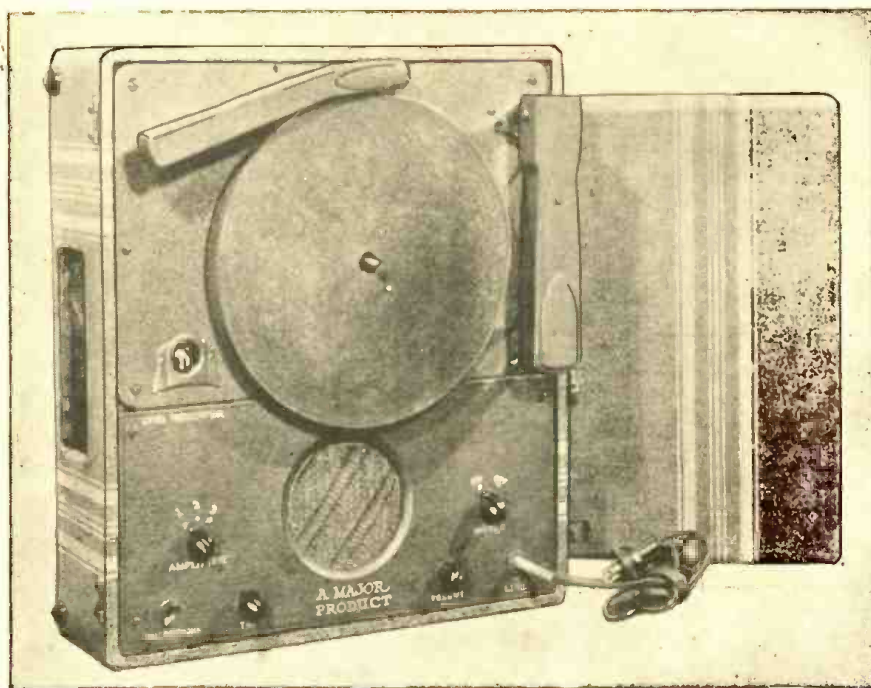

Home Recorder used by the authors.

The authors provide some practical hints on Home Recording—a branch of experimental radio that is rapidly expanding. A suitable amplifier is described, also how to connect crystal and magnetic “cutters.”

A DB. meter may be incorporated in the output circuit; or more commonly used for home recording outfits, a magic eye or neon bulb. The simpler methods of indicating level are illustrated. The calibration of the indicator is different in every case, since it is dependent upon the type equipment used. The indicator should be adjusted by a few test cuts. In the case of the meter a red line should be drawn where the cutter overloads. In the case of the neon bulb, resistor R2 should be adjusted so that the neon bulb lights when the recorder reaches the overload point. In both cases the recorder should be operated just below the point of overload. This should provide enough level to overcome surface noise.

A Simple HOME-RECORDER

L. LeKashman, W2IOP

T. Polhemus, Jr., W2HNS

● CONSIDERABLE interest developed in the art of recording with the introduction, about eighteen months ago, of low priced cutting mechanism. While it is true, recordings of commercial quality are not obtainable with this caliber equipment, perfectly acceptable recordings of voice and certain types of music can be made. The General Industries Company and the Meissner Manufacturing Company both make complete recording units suitable to the experimenter.

The standard recording mechanism for the home recorder is usually a metal pan upon which is mounted a crystal playback arm, a 10" rim drive turntable and a crystal or magnetic cutter. The motor is a specially designed 78 r.p.m. unit, since an ordinary phonograph motor would not have sufficient torque to carry the load of a cutter. The feed is driven from the center of the table by means of a worm and gear. The cutting arm engages the lead screw with a phosphor bronze blade that is raised or lowered by raising or lowering the cutting arm. That is, when the cutting arm is up it is disengaged.

Probably the most perplexing problem in the use of the home recording assemblies is their installation from a mechanical standpoint. Electrically it is a simple matter, since the pick-up arm follows the conventional rules. The crystal cutter, which is slightly more expensive, is superior to the magnetic cutter in most respects. It is far easier to get operating without compensation than a magnetic cutter, which has a tendency to be extremely bassy. Excessive

bass might cause overloading. The crystal cutter is capacity coupled to the output circuit of the amplifier, as illustrated in the diagram. The low impedance magnetic cutter is connected to the voice coil winding of the output transformer.

The amplifier presents no difficulty with the possible exception of a level indicator.

The recording panel must be mounted on a firm base. The Par-Metal phono tables make an excellent method of rack mounting the recorders. A carrying case similar to the one illustrated can be made to order for three or four dollars. Serious motor “wow” and turntable rumble in experimental models was largely cleared up by a firm foundation. Poor needles and improper insertion into the cutter, as well as improper depth of cut are a constant source of trouble in home recorders. Home recording aspirants would do well to consult the numerous magazine articles dealing with the mechanics of recording. It is suggested that prospective builders acquaint themselves fully with the whys and wherefores before proceeding with any actual construction. Suitable are Shure Bros. hand-mike No. 750-B and Xtal pick-up No. 99-C.

Diagram for a Recording Amplifier.

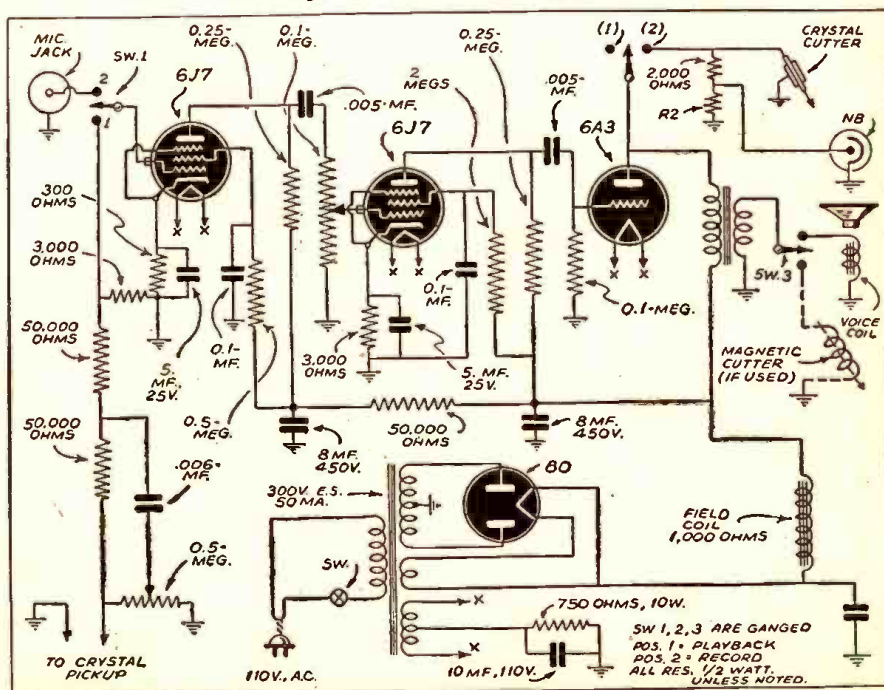

A New Type of Service Manual!

RADIO CIRCUIT MANUAL - 1941

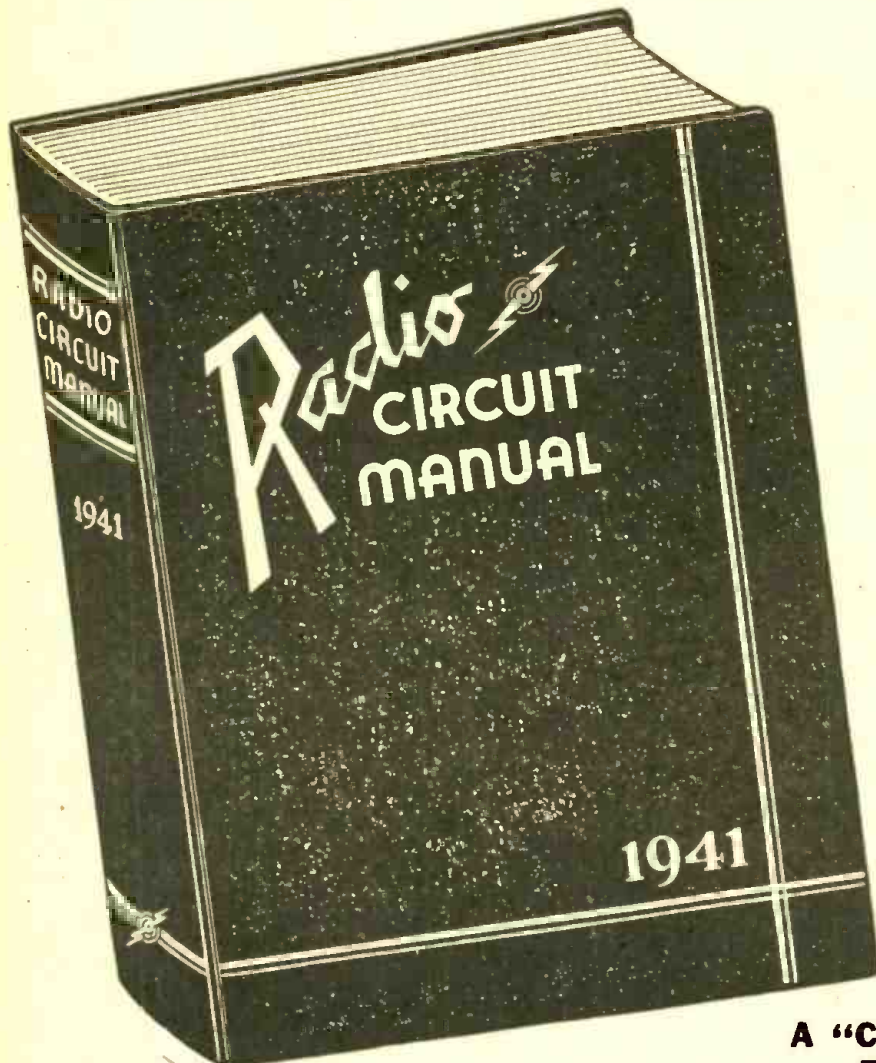

**The Only EDITED Manual
Ever Published!**

DIRECTORY OF RECEIVERS MANUFACTURED IN 1940 AND UP TO JUNE, 1941

MORE INFORMATION IN HALF THE NUMBER OF PAGES

The value of a service manual is measured not by the number of pages but by the amount of useful information. Thus, in only 736 pages this Radio Circuit Manual covers over 200 receiver models MORE than does any other competitive manual in twice the number of pages.

HOW DID WE DO IT? . . .

. . . By increasing the size of our page; by discarding non-essential data and editing the balance; by listing only those receivers which the Service Engineer will definitely have to repair (no communications or export receivers, no shortwave sets or amplifiers, no electronic devices, etc.); by many months of hard work based on a definite plan of procedure and a clear understanding of the actual requirements of the Service Engineer. There is no "dead weight" information to add bulk to this Manual. Every word counts. Every minute of reading time is well spent.

OUTSTANDING FEATURES

- Contains data on more than 1800 receiver models!—more than any other radio service manual.
- Only 736 pages!—less than half the bulk of any other manual and more than 1/3 lighter.
- All information is EDITED!—all non-essential data deleted and the balance checked and correlated with the schematics and sketches.
- 40% larger page permits listing of all information on one page. (A few unavoidable cases excepted.)
- I.F. peaks for all superhet circuits are boldly displayed in black boxes;—none missing, all accurate.
- No space wasted on communications and export receivers, amplifiers, electronic musical instruments, etc.—a 100% Service Engineer's Manual.

A "CUSTOM-TAILORED" MANUAL FOR SERVICE ENGINEERS

Here, at last, is a Service Manual deliberately PLANNED for the Service Engineer. Instead of a mere hodge-podge collection of service data, as manuals have been in the past, this RADIO CIRCUIT MANUAL is an orderly compilation of essential radio diagrams and service information, carefully edited and uniformly presented for the maximum convenience of the busy Service Engineer. All time-consuming, non-essential data have been weeded out, and the remaining information, vitally important to the rapid and efficient servicing of modern radio receivers, has been laid out in a logical, easy-reading style which cuts time from the day's work. Because of this and other features which are self-evident upon first observation, it has been possible to list all information pertaining to a given model on a single page.

In 736 pages this Manual presents essential service data on over 1800 receiver models;—more than any other existing service manual on the market!

ONLY ONE MANUAL PER YEAR!

The new technique used in compiling this RADIO CIRCUIT MANUAL—1941 makes it possible to include in a single book all the new receiver models which the radio industry can produce in a single year. This factor alone represents an important saving to all Service Engineers.



← THE OLD TYPE MANUALS—Bulky, heavy, hard to handle, space consuming, less USEFUL data despite greater number of pages.



→ OUR NEW MANUAL—Lighter, compact, easy to handle, takes half as much room on the shelf, more USEFUL information despite fewer number of pages.

MANUALS NOW READY!

RADCRAFT PUBLICATIONS, INC.,
25 West Broadway, New York, N. Y.

Gentlemen: Enclosed find my remittance of \$10.00, for which send me, POSTPAID, my copy of the RADIO CIRCUIT MANUAL—1941.

Name

Address

City State

RC-4-42

(Send remittance in form of check or money order; register your letter if you send cash.)

ORDER YOUR MANUAL IMMEDIATELY—NOW!

Get your copy directly from us by filling out and mailing the convenient coupon shown at left, or get it directly from your favorite distributor.

736 pages; size 13 3/4 x 10 1/4 x 2 in. thick; loose leaf; leatheroid-covered stiff binder; net weight 6 1/2 lbs.

ONLY
1000

A PERMANENT INSTITUTION

This Radio Circuit Manual—1941 is NOT a one-time proposition. Next year there will be a Radio Circuit Manual—1942, the following year, 1943 and so on indefinitely—each Manual better than the other as new methods are worked out for expediting and simplifying the work of the practicing Service Engineer.

RADCRAFT PUBLICATIONS, INC.
25 WEST BROADWAY NEW YORK, N. Y.

SOUND RECORDED ON STEEL TAPE

The Mirrophone—a new magnetic sound recorder and reproducer perfected by the engineers of the Bell Telephone Labs. will find many uses in the training of public speakers, singers, school students, etc. It records the voice on a steel tape and the sound may be reproduced at any desired time.

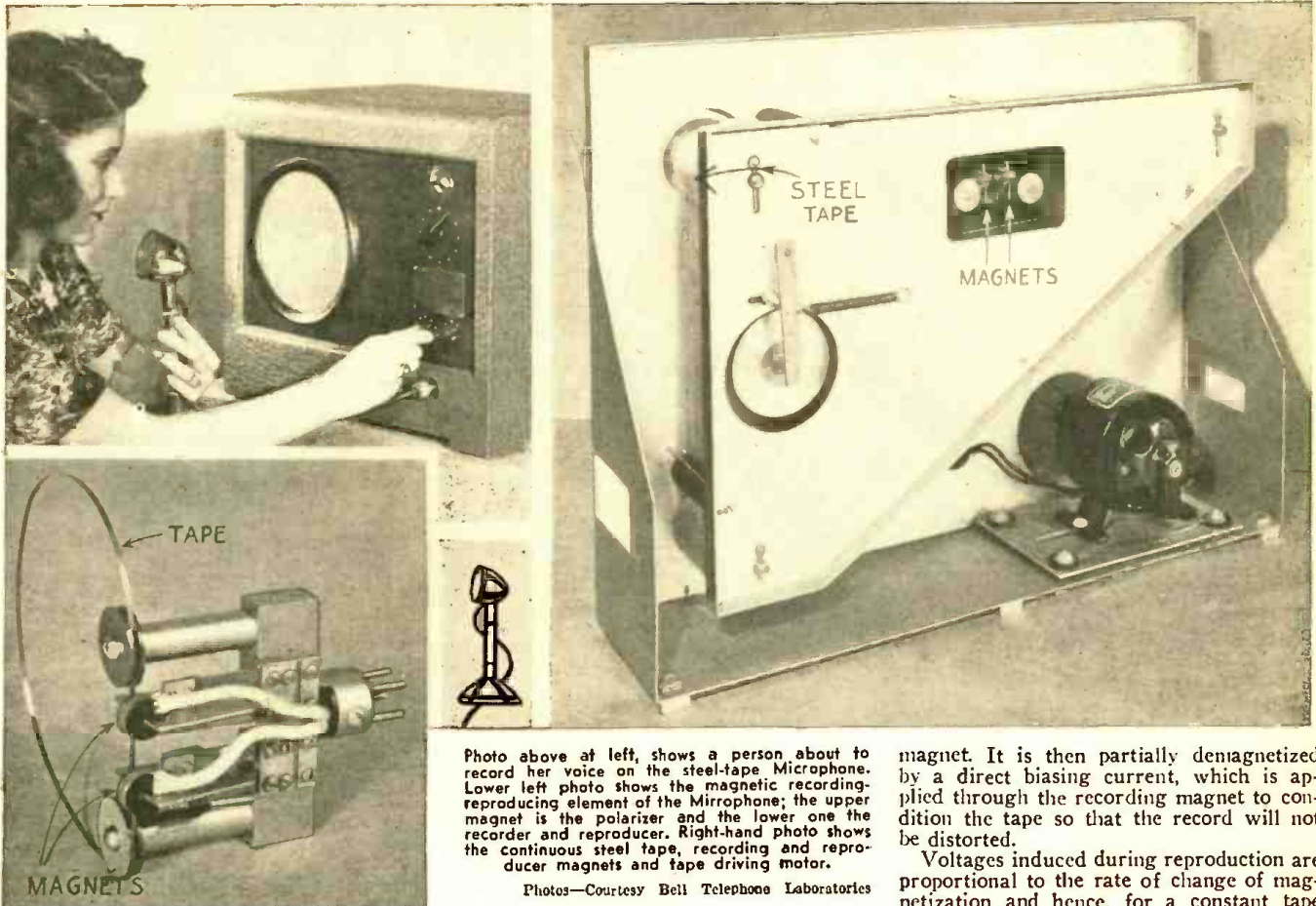

Photo above at left, shows a person about to record her voice on the steel-tape Microphone. Lower left photo shows the magnetic recording-reproducing element of the Mirrophone; the upper magnet is the polarizer and the lower one the recorder and reproducer. Right-hand photo shows the continuous steel tape, recording and reproducer magnets and tape driving motor.

Photos—Courtesy Bell Telephone Laboratories

FOR many years telephone engineers have been experimenting with sound recording, because it is a most useful tool in studying the characteristics of speech. Reproducibility of a recorded sound, and its permanency, make possible detailed analysis of a particular word or phrase. There are three methods of recording sound: mechanically on wax, photographically on film, and magnetically on a steel wire or tape. The first method has found wide commercial application in phonographs and the second in sound pictures; but the third has until recently been used only in experimental apparatus. Recent developments, however, have made it a practical means of high-quality sound recording and reproducing. These new developments have been incorporated in the Western Electric "Mirrophone." It handles higher frequencies than previous magnetic sound recorders and is freer from distortions. These improvements largely account for its faithful reproduction of speech and music.

That sound could be recorded on a steel wire drawn at a uniform rate past the poles of an electromagnet, which carried voice currents from a microphone, was discovered by Poulsen, a Danish physicist, about forty years ago. This method has the advantage that the records are ready for immediate reproduction, since no processing is required as with sound recordings on wax or film. Moreover, recordings can be retained practically indefinitely without ap-

preciable deterioration; but if wanted only temporarily they can be erased and used immediately for other records.

Attempts to commercialize the magnetic method of sound recording met with little success, however, until the improvements of recent years in which Bell Telephone Laboratories have been largely concerned. These improvements include the use of better magnetic materials and thin, narrow tape instead of round wire. Round wire twists and the magnetic elements have to be recorded along it instead of transversely across so as to maintain in reproduction the same direction of polarity. This result was achieved by offsetting the pole pieces of the recording magnets along the wire. The highest frequency that could be reproduced depended on the length of the longitudinal magnetic elements and high wire speeds were necessary to obtain faithful reproduction by this method. These high speeds not only required long recording wires but they wore the pole pieces excessively.

Flat tape does not twist and this permits magnetizing the recording medium transversely instead of length-wise. The magnetic elements can then be shorter and this allows the speed of the tape to be reduced without losing the higher frequencies in the recorded sounds.

Before a magnetic record is made, the tape is strongly magnetized in a direction opposite to that produced by the recording

magnet. It is then partially demagnetized by a direct biasing current, which is applied through the recording magnet to condition the tape so that the record will not be distorted.

Voltages induced during reproduction are proportional to the rate of change of magnetization and hence, for a constant tape speed proportional to the frequency of the recorded sound. The response, in other words, increases directly with the frequency. This holds true, however, only at low frequencies. At higher frequencies the response diminishes because of the finite width of the pole pieces and because of hysteresis and eddy current effects. The frequency at which this decrease begins is higher in proportion to the speed of the tape. The response of a magnetic recorder thus rises steadily with the frequency to a maximum determined largely by the design of the pole pieces and the speed of the tape. Beyond that the response decreases progressively. In practice an equalizer is inserted in the circuit to make the response essentially constant for all frequencies.

These principles of magnetic recording are incorporated in compact practical form in the Mirrophone, shown in the photographs above. Housed in a small cabinet is the recording-reproducing unit, an amplifier and a loud speaker. Associated with this unit there is a high-fidelity crystal microphone. The thin narrow tape on which the recordings are made is mounted on drums as shown, which rotate to draw the tape between the poles of the recording magnet. To allow the tape to repeat without rewinding, its ends are welded together to form an endless belt. The material of the tape is a special magnetic alloy recently developed by the Laboratories which is superior to other materials for magnetic recording.

In reproduction the recording magnet serves as the pickup device. A photo shows the recording and the polarizing magnets; a short loop of tape illustrates the method of threading. These magnets are a removable unit with plug connections. The dynamic loud speaker is supplied by a two-stage amplifier which develops exceptionally high gain. An acoustic chamber encloses the back of the speaker. Its field coil also serves as a filter in the amplifier plate-circuit.

Alternating current from any 110- to 120-volt lighting circuit operates the Mirrophone. A volume control regulates the intensity of the recording or the reproducing currents; and an electronic volume indicator shows when the level is correct for recording. To indicate the length of the recording there is a moving pointer which makes one complete revolution per minute and can be reset at any time.

"Record" Can be Reproduced Many Times

A record once made can be reproduced as often as desired and kept indefinitely or until the switch is again thrown to the recording position. Doing so automatically clears the tape as it passes the polarizing magnet and prepares it for a new record. The switch also has a stand-by position which leaves the tape running but disconnects the erasing, recording and reproducing units. An output jack permits connection to an external loud speaker or another recording machine when permanent records are wanted.

Best quality recordings are obtained when the speaker is close to the microphone, but the results are entirely satisfactory from greater distances. Group conversation can be picked up when the speakers are several feet away. Intelligible recordings have been made in large auditoriums with the sound source many feet from the microphone. On the other hand whispered words can be reproduced loud enough to be heard by all present in a large audience.

A person who hears a recording of his own voice for the first time usually insists that it does not sound natural. His friends on the other hand assure him that the reproduction of the Mirrophone is faithful. This is because one's own voice is ordinarily heard not only through the air but also internally by conduction through the bones of the head. Thus its true quality is unfamiliar.

Excellent for Voice Training

In the Mirrophone, therefore, instructors in voice training have an effective new tool. Public-speaking classes and music schools find it helpful in developing good diction and correcting faulty technique in the rendition of vocal and instrumental music, for it has the great advantage of permitting a student to hear his own efforts as others hear them and to listen critically to the faults which his teacher wishes to correct. An experimental model has been in use at the Juilliard School of Music in New York City.

As a lecture demonstration for talks and at expositions and conferences, it has the advantage of being able to reproduce recorded speech immediately and of preparing itself automatically for a new record. The Mirrophone is also an effective aid in teaching the correct pronunciation of foreign languages. Large commercial organizations and retail establishments can use it to train their personnel in correct diction for contacts with their customers both face to face and over the telephone. For the first time those interested in cultivating the voice and studying instrumental music have in the Mirrophone the opportunity of immediately reviewing their renditions—a privilege long enjoyed by devotees of the literary and graphic arts.

New SELF-BALANCING
DRIFT-CORRECTING
DIRECT-COUPLED AMPLIFIERS
FOR DISCRIMINATING MUSIC LOVERS
Designed by A. C. Shoney



These new amplifiers bridge the gap between the laboratory and the home, and make available for the first time, extraordinary equipment at less than ordinary prices. Built in a new way, without interstage coupling condensers or transformers. Although specifically designed to meet the strictest requirements of professional sound engineers, these direct-coupled amplifiers embody all desirable features sought by the most discriminating music lovers. Send for Literature.

AMPLIFIER CO. of AMERICA
17 W. 20TH STREET, NEW YORK, N. Y.

HAM SERVES CHINA AS U.S. LISTENING POST

MR. CHARLES E. STUART, of Ventura, Calif., who received his first amateur license from the Department of Commerce when he was thirteen years old, has been assigned by the Central Chinese government in Chungking to act as the American listening post to short-wave broadcasts from China.

Dr. Stuart's work is to receive and translate daily English voice broadcasts emanating from XGOY and XGOX, Chinese International Broadcasting stations in Chungking. These broadcasts consist of military and general news and talks by distinguished Chinese and foreigners, and are made primarily for use by the Chinese News Agency in New York City and by United China Relief.

At present the broadcasts are made on 11.9 and 15.2 megacycles on acetate instantaneous disks and then are translated. Dr. Stuart is aided in his job by Mrs. Alicia Held, who probably is the only secretary in the world who takes dictation from a source 7,000 miles distant, through static and heterodynes, through "fading" and "hash."

Dr. Stuart uses uni-direction antennae (rhombic) which are also reversible. One of the antennae used for the Chungking receptions is a highly directive diamond rhombic with a full mile of wire in the system. This gives great signal strength from Chungking, according to Dr. Stuart, plus consistent reception when poor general conditions are confronted. The location of this vital station is ideal, according to Dr. Stuart, being on a flat stretch of beach land underlaid with salt water, which gives maximum reflection and ground conductivity. The low horizon, plus the absence of interfering hills or mountains shields the incoming signals.—*N. Y. Herald-Tribune*

Did YOU Buy that DEFENSE BOND Yet?

SERVICE MEN HAVE BOUGHT OVER 100,000 SUPREME TESTERS

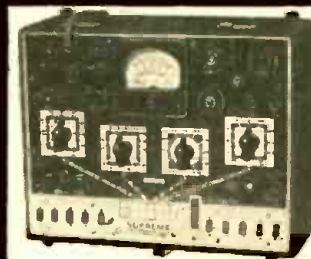

Be sure you see the complete **SUPREME** line before you purchase new test equipment. See your Jobber or write for new catalog.

WRITE FOR NEW CATALOG AND PRICES

SUPREME
TESTING INSTRUMENTS

GREENWOOD, MISSISSIPPI U. S. A.

NEW CATALOG

OF SOUND AMPLIFYING SYSTEMS
AUDIOGRAPH Sound Systems represent the latest in Public Address equipment—a complete line plus pre-tested accessories.

NEW LOWER PRICES
Outstanding quality and performance at prices that help you meet any competition.

WRITE FOR YOUR FREE COPY

AUDIOGRAPH
THE FIRST NAME IN SOUND

John Mack Industries—1313 W. Randolph Street, Chicago, U. S. A.

Amazing New "WALSCO" STAPLE DRIVER

for radio men, electricians or anyone doing stapling. Makes wire and cable installations twice as easy—much neater—saves half the time. Wires can be stapled in corners, behind pipes, into moldings—places never accessible with a hammer and ordinary staples. Drives staples even into walls, brick, mortar, etc. Magazine works automatically and holds strips of staples which come in several colors. Ask your jobber for demonstration and catalogue 41-C of all WALSCO PRODUCTS

or write **WALTER L. SCHOTT CO.**
5264 W. Pico Boulevard, Los Angeles, California

New Handy **UNIVERSAL REPLACEMENT Capacitors**



Write for Catalog
SOLAR MFG. CORP., Bayonne, N. J.

How to Choose

THE PROPER P. A. SYSTEM

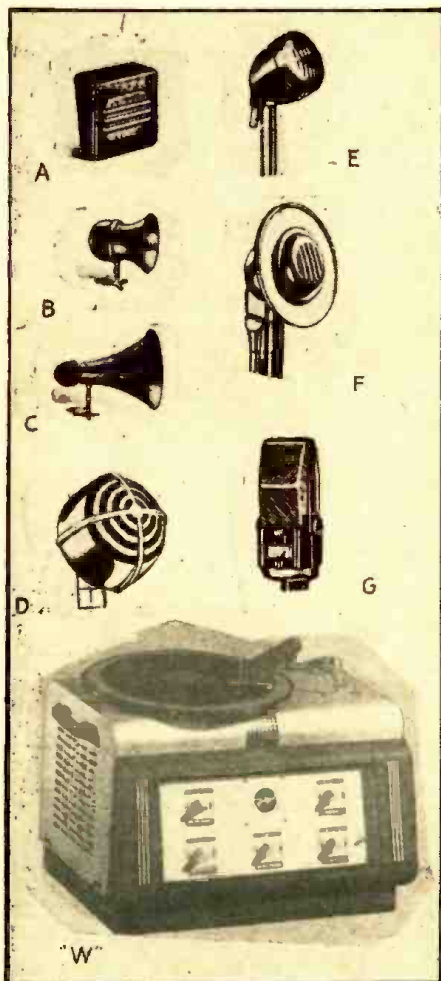

A—Flat type of speaker baffle. B—Projector type for directing sound further out along a narrow channel. C—Trumpet type for focusing sound. Lower picture shows modern P.A. amplifier. D—Uni-direct mike; E—Crystal; F—Dynamic; G—Velocity.

EVERY progressive radio man is aware of the money-making possibilities in the sale and installation of public address equipment. However, the average serviceman has felt that, because of its specialized nature, the selection of the proper equipment and its correct installation was a complicated job best left to the P.A. specialist. This has been a very wise decision as most radiomen who have tried their hand at P.A. sales and installation have had the sad experience of learning that "it wasn't worth the grief" involved. Because of this condition, the author set out to find a new technique which would be simple to apply and which would enable any radioman to select and install P.A. equipment. After a careful analysis of all the factors involved, a reliable procedure was finally worked out. By following this procedure, which will be explained here, you can be certain that your selection of P.A. equipment will be as accurate as that made by the best engineers in the field.

Mr. Feiler presents in simple form the principal considerations to be watched in choosing a "P.A." system. The table provided makes it easy for any Serviceman to select the proper wattage amplifier and style of loud-speakers for any installation—interior or outside. Keep this article for future reference—place the table in your pocket data-book.

L. M. FEILER

First of all, let's see what we really need to know to select the correct equipment for any public address need. Since almost every public address system consists of an amplifier, a system of reproducers, (speakers and baffles), and an input device (microphone, phono, etc.), we have only to learn how to correctly choose each of these in turn. Study the data which follows carefully, and you'll be able to solve any P.A. problem.

HOW TO SELECT YOUR AMPLIFIER

The amplifier is the heart of any sound system. However, you need know only three things about its selection: (1) The usable power output available, (2) Frequency response—the ability to reproduce the tonal range, (3) The degree of accommodation for mikes, phonos, and speakers, and the type of control facilities.

To determine how much power you need, refer to the chart (Fig. D). Every well-designed amplifier delivers a certain amount of usable power, comparatively free from distortion. It will also deliver a larger (peak) output, but this is only useful on occasional passages. Make sure the amplifier you use has the right amount of usable power.

With regard to frequency response, for average requirements, a tonal range of 70 to 7000 cycles per second is acceptable. Anything wider will give you better than average results. Your requirements will determine how many mikes, phonos, speakers, etc., you will need. Make sure the amplifier you select provides adequately for your requirements.

HOW TO SELECT YOUR SPEAKERS AND Baffles

Having selected the correct amplifier, we are now ready to select the proper speakers and baffles. As in the case of the amplifier, here again, it is only necessary to refer to the chart (Fig. D). The chart gives you the proper size and number of speakers. Generally it is better to use more than the minimum number of speakers specified to do the job because you get better spread and adequate sound coverage.

The Chart also indicates proper baffles choice. Three types are generally used: (Fig. A) Flat type for widest sound spread; cases, inclined wall baffles and boards are in this group; (Fig. B) projector type, for directing sound farther out along a narrower channel; (Fig. C) trumpet type for focusing sound in a narrow far-reaching beam. For maximum results choose the type of baffle that best answers your need.

HOW TO SELECT MICROPHONES

All modern microphones are satisfactory for average use, and you don't have to worry too much about the type you pick. But there are some particular advantages in different types of mikes that you ought to know about. Consider these advantages as outlined below, and select the microphone best suited to your requirements.

At the present time there are four general types of microphones that are widely used. They are the new Uni-Directional types which incorporate the one-direction pickup principle, and the Crystal, Dynamic, and Velocity types. (Complete descriptions of leading makes of each of these microphone types can be found in the catalog of your local jobber or any mail order house.)

Uni-Directional Microphones: These are the finest new-type mikes for P.A. use. Because they pick up sound from one direction only, they give excellent results where excessive feedback (howling) or poor acoustics are encountered. Uni-Directionals are available in Crystal, Dynamic, and Dynamic-Velocity types.

Standard Crystal and Dynamic Mikes: These types pick up sound from all directions and give good results where feedback and room acoustics are not critical problems. The Dynamic type is considered somewhat more rugged and is well-adapted for outdoor and portable work. Crystal mikes are, however, widely used with satisfaction for most general P.A. work.

Velocity Mikes: This type is bi-directional, picking up sound from front and back only (they are dead at sides). They give better results than standard Crystal and Dynamic types where excessive feedback and poor room acoustics are encountered. However, the Velocity mike is not as effective as the Uni-Directional type in reducing feedback.

HOW TO USE THE CHART

It's easy to use the chart above. To quickly determine the Sound System best suited for your needs. (1) Measure the length and the width of the area you desire to cover. (2) Multiply these two figures to determine the total number of square feet to be covered. (3) Locate on the chart in the column headed "Applications" the use for which your system is intended. (4) Run your finger across until you reach the column including the square foot area obtained in Step 2. (5) The system you need is that indicated at the top of the appropriate column.

Example: Suppose you want a Sound

Applications	7 Watts			14-18 Watts			20-30 Watts			60 Watts		
	Area sq. ft.	Spkr.	Baffle	Area sq. ft.	Spkr.	Baffle	Area sq. ft.	Spkr.	Baffle	Area sq. ft.	Spkr.	Baffle
Armories and Barracks.....	1000 to 2900	1-8"	Wall	2900 to 7200	2-12"	Wall	7200 to 14,000	2-12"	Proj.	14,000 to 39,000	2-4 Trumpets	
Auditoriums & Banquet Halls.....	1000 to 4000	1-8"	Wall	4000 to 7800	2-12"	Wall	7800 to 20,000	2-12"	Wall	20,000 to 66,000	4-12"	Proj.
Ballrooms & Dance Halls.....	1000 to 2900	1-8"	Wall	2900 to 6600	2-12"	Wall	6600 to 14,000	2-12"	Proj.	14,000 to 39,000	4-12"	Proj.
Carnivals & Fairs.....				1000 to 3600	2-12"	Proj.	3600 to 8000	2-12"	Proj.	8000 to 50,000	2-4 Trumpets	
Churches.....	1000 to 2900	1-8"	Wall	2900 to 7800	4-8"	Wall	7800 to 20,000	8-8"	Wall			
Factory Paging (Noisy).....	500 to 1150	1-8"	Proj.	1150 to 2400	2-12"	Proj.	2400 to 6500	2-4 12"	Proj.	6500 to 12,500	2-4 Trumpets	
Funeral Parlors.....	500 to 1150	1-12"	Bass Reflex	1150 to 3000	1-12"	Bass Reflex	3000 to 6500	2-12"	Bass Reflex	6500 to 12,500	4-12"	Bass Reflex
Night Clubs & Taverns.....	1000 to 2900	1-8"	Wall	2900 to 7200	2-12"	Wall	7200 to 14,000	2-12"	Wall			
Outdoor Adv. & Meetings.....				1500 to 4800	2-12"	Proj.	4800 to 10,000	2-12"	Proj.	10,000 to 66,000	2-4 Trumpets	
Roller Skating Rinks.....							2000 to 6000	2-4 12"	Proj.	6000 to 39,000	2-4 Trumpets	
Stadiums, Athletic Fields, Race Tracks.....	Areas given are those of Grandstand or Bleachers.						3000 to 8000	2-12"	Proj.	8000 to 50,000	4-6 Trumpets	
Store & Office Paging, Classrooms.....	1000 to 4000	1-8"	Wall	4000 to 7800	2-12"	Wall	7800 to 20,000	2-12"	Proj.	20,000 to 50,000	4-12"	Proj.

THIS CHART SHOWS YOU HOW TO CHOOSE THE RIGHT SYSTEM:

System for a ballroom measuring 100 feet long and 50 feet wide. This is a total of 5,000 square feet (100 × 50 = 5,000). Reference to the chart shows that you require a 14- or 15-watt system with two 12-inch speakers in wall baffles. If the location happens to be unusually noisy, order the next larger system—the 20-watt unit shown in the next column.

Note A. If you know how many persons will be present and do not wish to measure the area, allow about 6 square feet per person.

Note B. If your location includes a balcony, or if you wish to place extension speakers in adjacent rooms, add these areas to the main area for the total.

Note C. If your system is to cover a number of applications, choose the system required for the largest area. A larger system will easily cover smaller areas, but the reverse is not true.

Note D. If you wish to cover two applications simultaneously—e.g., school auditorium and the athletic field—first find the size of the system required to handle the auditorium alone; then find the size required for the field. Be sure to choose a system having a power output equivalent to the sum of both (or use two separate amplifiers).

This article has been prepared from data supplied by courtesy of Allied Radio Corp. Mr. Feiler is an engineer with this company.

BOOK REVIEW

TELEVISION—TODAY AND TOMORROW, by Dr. Lee de Forest. Published by the Dial Press, New York. Size 6½ x 9½ ins., cloth covers, 362 pages, illustrated. Price \$3.75.

The "Father of Radio" has filled the gap between the mathematical treatises on the subject and the frequently "half-baked" historic treatises we have been deluged with. "Doc" tells 'em how television works, so that anyone can understand it. He writes with a certain charm which makes the text interesting as well as instructive.

Let's have a look at "Doc's" roster of subjects: What Is Television? History of Television; Coaxial Cable Network Costs vs. Television by Films; Projection Television Tubes; Cathode Beam Systems; Synchronization; Use of Film in Television; Networks by Short-Wave Relay Systems, etc.

Television for amateurs is covered in detail with diagrams of receiving sets. Next the author takes up Television Transmitter and Studio Pick-up; Film Projectors for Television Pick-up; a fine chapter (with diagrams) on Television Receiving Aerials; Sweep Circuits; The DuMont System; Priest System; Magnetic Focusing and Deflection; Television and Frequency Modulation; The Television Profession; If Television Is Your Job; Television's Future and Its Influence Upon Society.

The general reader will find the treatment clear and complete, while the technical student will find it refreshing to peruse the author's masterly review of all the steps leading up to television as we know it today.

An interesting analysis is given by Dr. de Forest of the value of films vs. relays and coaxial cables (network connecting links) for television. The author shows by actual cost figures that we shall probably use film plays, as well as "news" films, etc., to a very great extent at the start, and that television "relays" will come along as a secondary method in their own good time.

DICTIONARY OF RADIO AND TELEVISION TERMS, by Ralph Stranger. Cloth covers. Published by Chemical Publishing Co., Inc., Brooklyn, N. Y. Price \$2.50.

Following is the contents of the book: Dictionary; Morse Code; Conventional Signs Used in Theoretical Circuit Diagrams; Conventional Signs for Cathode Ray Oscillograph Tubes; Table of Chemical Elements in Alphabetical Order; Table of Chemical Elements in the Order of Atomic Numbers; Table of Wavelengths and Corresponding Frequencies; Table of Squares; Table of Cubes; Table of Reciprocals; Average Relative Numbers of Sun-Spots as Given by the Zurich Observatory, etc.

(Continued on page 505)

SQUARE FACE FOR A ROUND METER

TO modernize that old round-faced meter is a simple job. First obtain a piece of Black Masonite 3/16" thick (brown will do if filled and painted several coats of black paint). To make the masonite fit flush against the panel it is necessary to cut a groove 3/32" deep in the back side of the block. This is done with a circle cutter before the front opening is cut.

Set the cutter to 1 3/16" dia. (for 2" meter flange) and run the guide drill through the exact center of the block. Cross marked as shown will show the center (Fig. 1).

Chip out the masonite to the depth of 3/32" with a sharp chisel. Now turn the block face up and by using the center hole as a guide, draw a 7/8" dia. circle with a pencil type compass. Draw a line horizontally across the block just below the hole in the center. Cut this portion out with a coping saw. File smooth.

Drill two 1/8" holes at the sides of the block to mount it to the panel.

If the meter has a zero adjustment screw, drill a 3/16" hole in the block at the proper place.

If the meter is a 3" or larger type it is necessary to cut two blocks the same size. The first one has a circular hole cut all the way through it, the diameter of the

mounting flange of the meter. The other has the semi-circular hole cut like the smaller one shown.

It is advisable to allow at least 1/2" from flange edge to edge of block on the sides of the meter, and about 3/8" at top and bottom for clearance of the mounting screws.—Earle C. Draese, W9CGN.

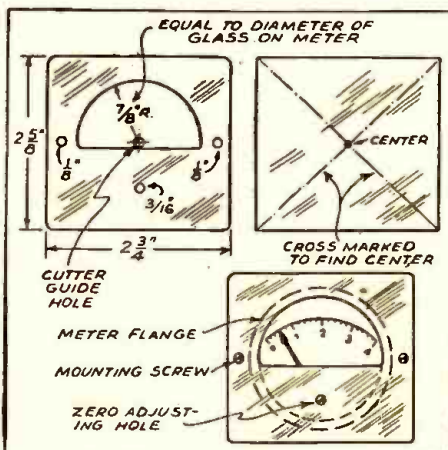

The illustration above shows how to make a "round" type meter into a "square" design, and thus make your instrument board or panel more up to date.

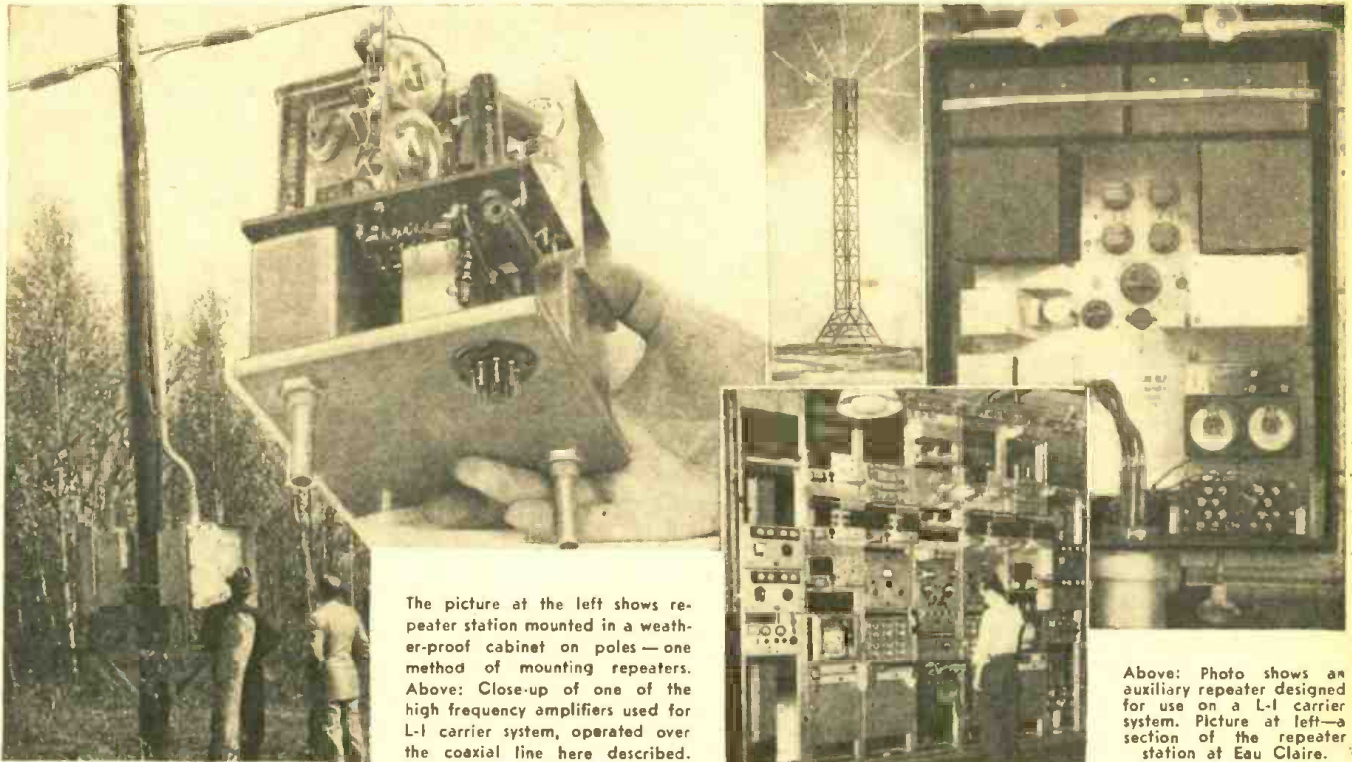

The picture at the left shows repeater station mounted in a weather-proof cabinet on poles — one method of mounting repeaters. Above: Close-up of one of the high frequency amplifiers used for L-1 carrier system, operated over the coaxial line here described.

Above: Photo shows an auxiliary repeater designed for use on a L-1 carrier system. Picture at left—a section of the repeater station at Eau Claire.

200 Mile "Coaxial" Put Into Operation

A COAXIAL cable telephone system, known as the type L-1 carrier system, was put in regular commercial service between Stevens Point, Wisconsin, and Minneapolis in June 1941. This installation took advantage of knowledge gained from the experimental coaxial cable between New York and Philadelphia.

In an L-1 carrier system, each coaxial unit carries signals in one direction only, and hence two units are required for a two-way system. The cable laid between Stevens Point and Minneapolis has four coaxial units in its sheath and thus provides for two complete lines, one of which is a complete spare and is cut into service automatically when trouble occurs on the regular line.

The cable route, which is slightly under 200 miles in length, divides into four sections of about fifty miles each. At both Stevens Point and Minneapolis are terminal stations, where the modulators are located that transform from voice-frequency circuits to carrier circuits and vice versa. These terminals also include amplifiers, complete regulating and power-supply equipment, and a full complement of testing apparatus and alarms. At the junction points between fifty-mile sections are main repeater stations, also equipped with amplifiers, regulating equipment, and power supply. These main repeater stations may or may not serve as branching stations as well, slightly more repeater equipment being required for branching service. At branching points some of the circuit groups may be tapped off, either as a branch coaxial system, or—more likely—as J or K carrier or voice-frequency systems, and under the latter conditions frequency conversion apparatus is required. Between the main repeater stations are a number of

auxiliary repeater stations spaced at about five-mile intervals. These intermediate repeaters may be mounted on poles, placed underground, or enclosed in small surface structures, but they are operated on an unattended basis, and any serious deviation from normal transmission occurring at them is signaled to the nearest main station that is attended continuously. Although the main repeater stations are approximately fifty miles apart on the circuit between Stevens Point and Minneapolis, this distance is not a requirement of the system, and somewhat wider spacing could be used, if circumstances made it desirable.

Over one of the four main divisions—the one immediately west of Stevens Point—the cable is aerial. Over the other sections it is underground. The same cable is used throughout, but for the underground sections "gopher tape" and jute protection cover the lead sheath. The underground

cable was laid by a new cable-laying plov at an average depth of thirty inches.

The main repeater stations for the L-1 system are normally attended, at least partially, and have power-supply apparatus as well as amplifiers, regulators, and perhaps even frequency-conversion equipment. Some of the equipment at the Eau Claire repeater station is shown above. In general, the three bays at the left include the apparatus for the regular two-way coaxial system, and the three at the right, that for the alternate system. The middle bay is chiefly testing equipment. Some of the power equipment is in the power room and is not shown in this photograph. This particular station is designed to serve as a branching point. No branch circuits are taken off at the present time, however, and the equipment arrangement is very similar to that at the other main repeater stations.

For the auxiliary repeaters, the equip-

Below: Coaxial cable route, nearly 200 miles in length, between Stevens Point and Minneapolis.

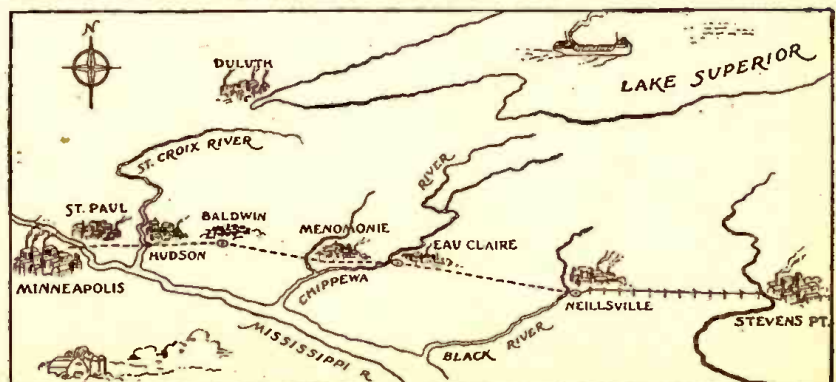

ment is much less extensive, and all of it is mounted on a single panel about nineteen inches wide and two feet high. This panel is arranged for mounting either on a relay rack or in a weatherproof steel housing, shown with the cover open in photo. Each such repeater handles two-way traffic on one pair of coaxial units, and a repeater is provided for both the regular and alternate systems at each point. A number of methods have been designed for mounting these repeaters, partly to take care of the different methods of running the cable—either overhead or underground—partly to meet the different conditions of the terrain, and partly to secure experience with different types of construction. The simplest arrangement is to mount the weatherproof housings directly on a pole. For underground cable a short stub pole is used, while for overhead construction one of the poles of the line is used. Several types of small huts are also used. One is of steel, one of pre-cast concrete, and one of cement block, and any of them may be used with either overhead or underground construction. For use only with underground construction, a manhole or a semi-underground vault may be used.

The repeater includes two amplifiers, each compact assembly as shown in photo. One amplifier is used for each direction of transmission; and besides the two amplifiers, the repeater includes equalizing networks, regulators, alarms, and certain miscellaneous equipment. Each automatically adjusts its gain, under control of a pilot frequency of 2064 kc. to compensate for variations in line loss with temperature. This adjustment is secured through thermistors in the feedback circuit of the amplifiers, the thermistors being heated from the output of the regulators, which are in turn controlled by the amplitude of the pilot frequency. The line loss varies with change in length of line very nearly as the square root of the frequency; and the change in loss due to change in temperature also varies approximately in the same manner. This makes it possible for a single adjustment to take care of either a change in length of the repeater section or a change in temperature to a very good degree of approximation.

At the main stations, in addition to the 2064-kc. regulator, regulation is provided under control of a 3069-kc. pilot to compensate for temperature effects in the equipment. Provision has also been made at the main stations for a regulator under control of a 556-kc. pilot to correct for inaccuracies in the regulation of the auxiliary repeaters. A 64-kc. pilot is used for supervisory purposes and some manual adjustments, and in longer systems it might be used to operate another type of regulator.

Power for the repeaters is transmitted at sixty cycles over a balanced circuit consisting of the central conductors of two coaxial units. It is derived from the commercial supply and fed to the cable at the main stations. To insure continuity of supply, electronic inverters are provided at each main station to convert direct current from the station battery to sixty cycles in case of a failure of the commercial supply.

The coaxial cable itself does not have any very definite upper frequency limit for practical communication purposes. The frequency band transmitted over it is determined primarily by the repeater equipment. Repeaters designed for the L-1 carrier system will transmit frequencies up to a little above three million cycles, which enables the coaxial cable to be used for a single television channel if desired.

800 MILE TEST

To show the effectiveness of these cables for television transmission, a demonstration was given in May of 1941 using an 800-mile circuit formed by connecting the four coaxial units between Stevens Point and Minneapolis in series. There is no immediate prospect of requiring a television channel between Stevens Point and Minneapolis, but the availability of the circuits provided an opportunity to study television transmission over a longer cable circuit than had ever been tried for this purpose before.

Although the system provides for a possible 480 telephone channels, only forty-eight are equipped at the present time. Besides the four coaxial units, however, the cable includes eighteen 19-gauge quads, four 19-gauge pairs, and six 22-gauge pairs. A few of these conductors are used for alarm and maintenance work, but most of the quads provide voice channels, and thus there are more than forty-eight message channels in the cable as now operated.

Experience in two lightning seasons has shown the coaxial units to be less subject to lightning damage than the paper-insulated conductors of the same cable. A severe electrical storm in October, 1940, badly damaged a number of the paper-insulated conductors, but although the coaxial system was operating at the time, the lightning surges had no effect on it. Storms in April, 1941, also damaged the paper-insulated pairs without causing a failure of the coaxial system. In May, 1941, lightning damaged one coaxial unit and a number of paper-insulated conductors but did not interfere with service over the coaxial system itself.

The coaxial system was placed in service on a permanent basis on June 7, 1941.

Courtesy Bell Laboratories Record

New Electron Microscope Technique

With important results for defense and civilian industry indicated by preliminary studies of heavy armor plate and various carbon steels, RCA Laboratories recently announced development of a new technique that permits heretofore impossible microscopic examination of the grain structure of metals.

Using the new process in connection with the RCA Electron Microscope, designed to accommodate only very thin transparent objects, laboratory technicians obtain detail in metal surfaces that is at least 15 times finer than results with the best metallographic microscope.

It is possible, using peak magnification, to identify particles of only 50 atoms or six 10-millionths of an inch apart.

Looking deeply into the insect world, the RCA electron microscope is revealing new gossamer-like wonders. It magnifies the windpipe of a mosquito to the size of a tree trunk, and in so doing brings out details never before seen.

So sharp is the view or micrograph, as the pictures taken directly in the electron microscope are called, that spiral thickenings or tiny hoops lining and reinforcing the sheer walls of the mosquito's windpipe are shown to be covered with tiny submicroscopic spines. The hoops are only one fifty-thousandth of an inch broad, and the small spines in the tube are less than one quarter-millionth of an inch in length. The micrograph pictures the hoops as heavy spiny wire ribs. The smallest structural parts of the mosquito's windpipe are less than one half-millionth of an inch in size, yet the electron microscope sees them as "large as an elephant."

SPECIAL TRAINING

with a Personal Service is offered to you by the INTERNATIONAL CORRESPONDENCE SCHOOLS OF SCRANTON, PENNSYLVANIA

TECHNICAL COURSES

<u>Air Conditioning Schools</u>	Surveying and Mapping	Metal Pattern Drafting
Air Conditioning Heating	Electrical Schools	Mold Loft Work
Plumbing	Electrical Engineering	Reading Shop
Refrigeration	Electric Wiring	Blueprints
Steam Fitter	Gas and Electric Welding	Sheet Metal Worker
<u>Chemistry Schools</u>	Industrial Electrician	Ship Drafting
Chemistry, Analytical	Lighting Technician	Ship Fitting
Chemical Engineering	Power House Practical	Shop Practice
Chemistry, Mfg. Iron and Steel	Telephony	Steel Mill Workers
Mfg. of Pulp and Paper	Radio, General	Tool Designing
Pharmacy	Radio Operating	Wood Pattern Making
<u>Civil, Architectural and Structural Engineering Schools</u>	Radio Servicing	<u>Railroad Courses</u>
Architecture	Telegraph Engineering	Air Brake
Architectural Drafting	<u>Internal Combustion Engines Schools</u>	Car Inspector
Bridge and Building Foreman	Air Pilot	Locomotive Engineer
Bridge Engineering	Automobile Technician	Locomotive Fireman
Building Estimating	Aviation	Railroad Car Repairer
Civil Engineering	Diesel—Electric	Railroad Section Foreman
Concrete Engineering	Diesel Engines	<u>Steam Engineering Schools</u>
Contracting and Building	Gas Engines	Boiler Making
Highway Engineering	<u>Mechanical Schools</u>	Combustion Engineering
Retail Lumberman	Airplane	Engine Running
Structural Drafting	Drafting	Marine Engines
Structural Engineering	Foundry Work	Petroleum Refining Plant
	Heat Treatment of Metals	Steam Electric
	Inventing and Patenting	Steam Engines
	Machine Shop Practice	<u>Textile Schools</u>
	Mechanical Drafting	Cotton Manufacturing
	Mechanical Engineering	Textile Designing
		Woolen Manufacturing

BUSINESS AND ACADEMIC COURSES

<u>Academic Schools</u>	Bookkeeping	<u>Civil Service Schools</u>
Arithmetic	Business Correspondence	City Letter Carrier
College Preparatory	Business Management	Post Office Clerk
First Year College	Certified Public Accounting	Railway Postal Clerk
High School Higher Mathematics	Cost Accounting	<u>Language Schools</u>
Illustrating	Foremanship	French
<u>Business Schools</u>	Salesmanship	Good English
Accounting	Secretarial	Spanish
Advertising	Stenography	
	Traffic Management	

• The successful man DOES today what the failure INTENDS to do tomorrow. Mail this coupon NOW!



INTERNATIONAL CORRESPONDENCE SCHOOLS

Box 2879-G, Scranton, Penna. Please send me complete information on the following subject:

(Write above Technical, Business or General Educational Subject in which you are interested.)

Name _____ Age _____
 Address _____
 City _____ State _____
 Employed by _____

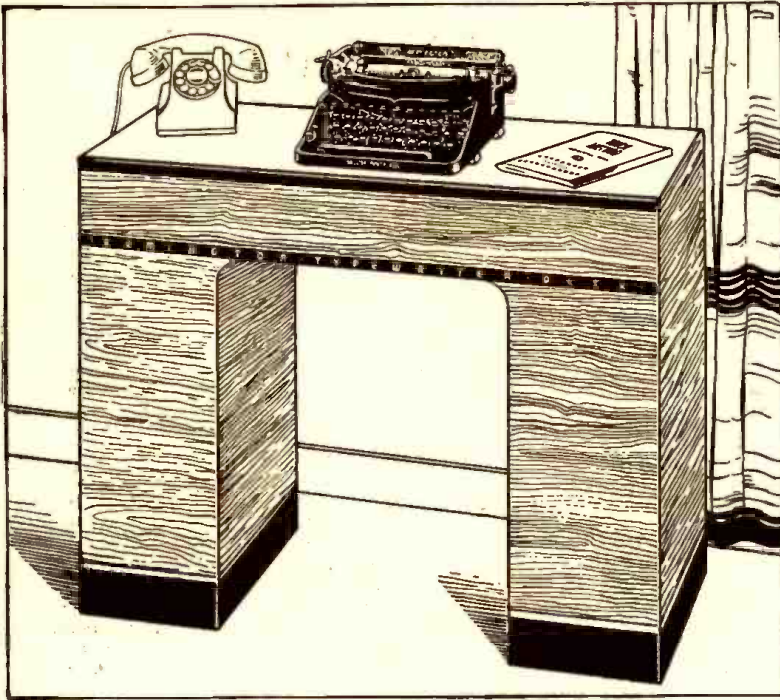

**THIS
BEAUTIFUL DESK
for only \$1.00 EXTRA**

**WITH ANY
REMINGTON
PORTABLE TYPEWRITER**

A beautiful desk of handsome Walnut grain, finished with rich Burgundy top which will fit into the decorations of any home, and made of sturdy fiber board, is now available for only one dollar (\$1.00) extra to purchasers of a Remington Portable Typewriter. The desk is so light a child can move it, so strong it will hold six hundred (600) pounds! What a combination this desk and a Remington Portable Typewriter make—a miniature office in your home! Learn complete details of this offer. Mail the coupon today!

Remington's Amazing Combination Offer

How easy it is to get this combination of a desk and Remington Deluxe Noiseless Portable Typewriter. Just imagine, a small deposit and the balance on Remington's easy 10 pay plan. This will actually make you immediately the possessor of this amazing office-at-home combination. You assume no obligations by sending the coupon.



THESE TWO EXTRAS FOR YOU

LEARN TYPING FREE

To help you even further, you get free with this special offer a 44-page booklet, prepared by experts, to teach you quickly how to typewrite by the touch method. When you buy a Noiseless you get this free Remington Rand gift that increases the pleasure of using your Remington Deluxe Noiseless Portable. Remember, the touch typing book is sent free while this offer holds.

SPECIAL CARRYING CASE

The Remington Deluxe Noiseless Portable is light in weight, easily carried about. With this offer Remington supplies a sturdy, beautiful carrying case which rivals in beauty and utility the most attractive luggage you can buy.



SPECIFICATIONS

ALL ESSENTIAL FEATURES of large standard office machines appear in the Noiseless Portable—standard 4-row keyboard; back spacer; margin stops and margin release; double shift key and shift lock; two color ribbon and automatic ribbon reverse; tabulator; variable line spacer; paper fingers; makes as many as seven carbons; takes paper 9.5" wide; writes lines 8.2" wide. There are also extra features like the card writing attachment, black key cards and white letters, touch regulator, rubber cushioned feet. These make typing on a Remington Deluxe Noiseless Portable a distinct pleasure. Thousands of families now using the Remington Deluxe Noiseless Portable know from experience how wonderful it is!

**MAIL
COUPON
NOW!**

Remington Rand Inc., Dept. 189-4
Buffalo, N. Y.

Tell me, without obligation, how to get a free Trial of a new Remington Deluxe Noiseless Portable, including Carrying Case and Free 44-page Touch Method Instruction Book. Also about your 10 pay plan. Send Catalog.

Name.....
Address.....
City..... State.....

Non-Radio Uses for FM

FREDERIC D. MERRILL, JR.

FREQUENCY modulation may be considered merely as another method for translating energy from one form into another. For this reason it may be added to the well established list of mechanico-electric methods such as photoelectric magnetic, electrostatic, and resistive. Either of these primary methods could be combined with FM and the electrostatic method is the simplest and cheapest of all these. Variation of the capacity across the grid coil of an oscillator tube provides the most elementary case.

Electrostatic systems for translating the vibrations of membranes, reeds, and strings into electric oscillations by direct current polarization have long been known. Principal among these historically is the condenser microphone which is now largely superseded by other types, such as the velocity and ribbon. Present day successful commercial applications of the polarized electrostatic system are the electronic reed organ and electronic pianos.

WEAKNESSES OF DIRECT CURRENT POLARIZED ELECTROSTATIC PICK-UP SYSTEM

Every electronic musical tone generator system, regardless of whether it is magnetic, electrostatic, photoelectric, or vacuum

tube oscillator, possesses its own peculiar advantages and disadvantages. There is no perfect translating system. The weakness of the direct current polarized electrostatic system will now be discussed since the conversion of that system to FM is easiest and has decided advantages.

Referring to Fig. 1, the impedance from point A to Point B should be large compared with the value of $1/C_w$. The resistance viewed between these two points ought to be at least five megohms to prevent appreciable dropping off of the low frequencies. This is not obtainable in practice for the reasons to be described.

In electronic music applications the vibrator 1 usually has a complex waveform to be translated into electric form so that additional pick-up area to bring up the fundamental alone alters the timbre to overemphasize the harmonics. Selective filtration employing a separate channel adds another problem of a smooth joining of the two neighboring channels.

The actual design and construction of the polarized amplifier input involves three main problems: (1) the use of as large a charging and amplifier input resistance as possible to increase pick-up efficiency and improve low frequency response; (2) high

insulation resistance under all conditions of humidity; (3) circuit elements free from mechanical vibration (even though the elements are usually located within a vibrating instrument). The divergent requirements of (2) and (3) compared with (1) necessitate a compromise towards reducing the input resistance.

Painstaking care must be exercised in the physical construction of the high impedance polarized input circuit. Slight motions of wires introduce howls or spurious resonant tones. In addition, and what is perhaps the most critical factor, the insulation resistance must be maintained at many megohms and not allowed to vary. This is a difficult problem to meet on days when the relative humidity exceeds about 95%. After a prolonged dry period the insulation resistance on open circuit between 88 pick-up screws and the associated strings of an electronic piano may be of the order of 750 megohms but following several days of 98% humidity this may drop as low as 35 megohms. This surface leakage is of course brought about by moisture condensation, and the effect is minimized by maintaining long leakage paths of at least an inch between low and high D.C. potential points which are stationary. The input parts

Fig. 1, electronic music application. Fig. 2, FM capacitor pickup system. Fig. 3, Frequency response curve. Fig. 4, FM piano pick-up system. Fig. 5, FM electrostatic pickup. Fig. 6, mechanical volume expansion.

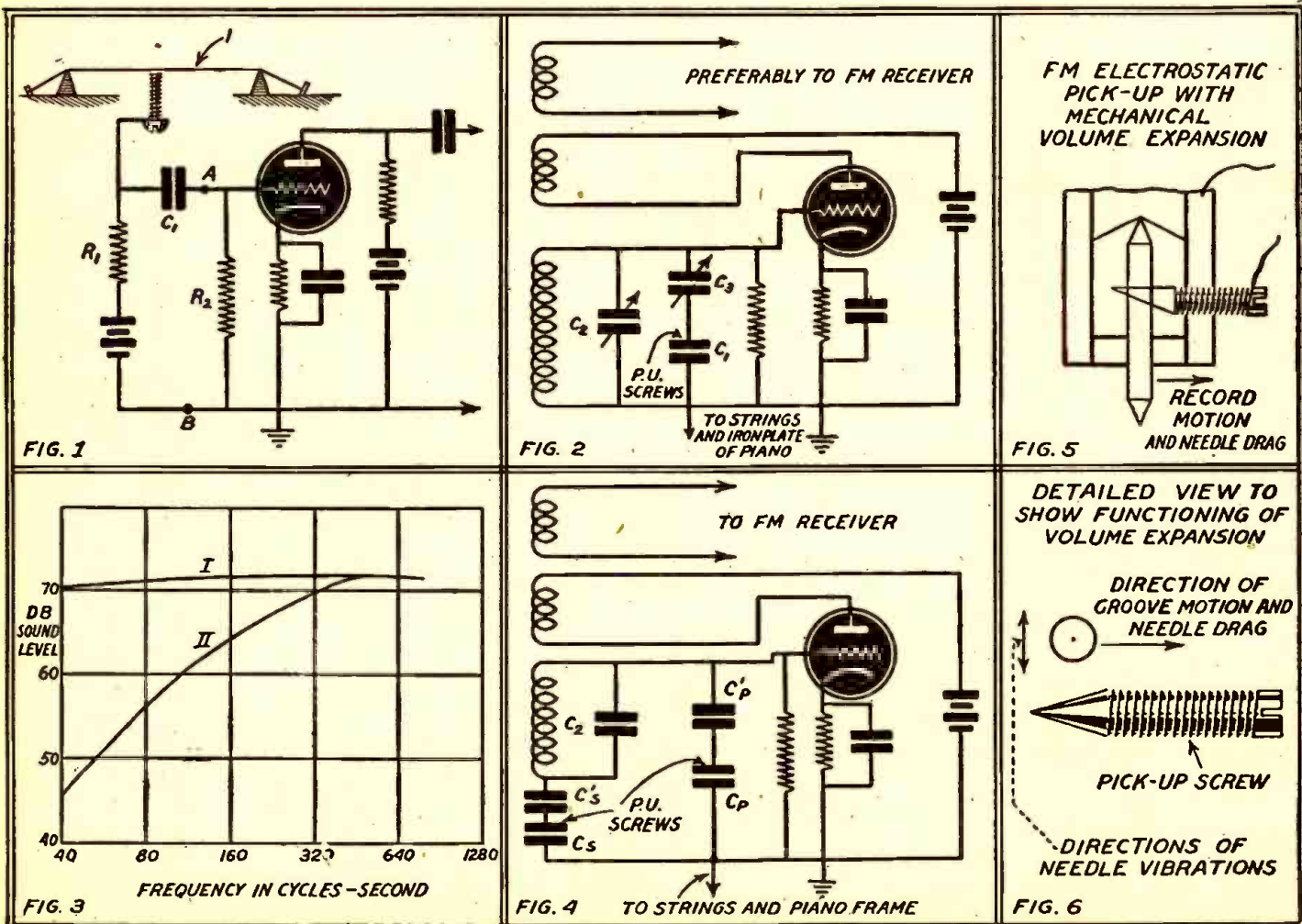

K45LA

the West's
ONLY
FM station

DON LEE

BROADCASTING SYSTEM

5515 MELROSE AVENUE
HOLLYWOOD, CALIFORNIA

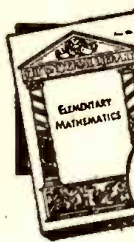

**The Book that takes
Drudgery out of
Mathematics**

Only **50¢**
postpaid

SOLVES EVERYDAY
PROBLEMS — HELPS
YOU GET AHEAD IN
LIFE

How many times have you lost money because of a mistake in figuring? Do you know how to figure quickly and correctly? Can you figure discounts, interest rates, taxes and all the other calculations you meet up with in your daily life?

Are you having trouble qualifying for Army or Navy promotion because you're not up on mathematics?

Here is the book that gives you a good background in mathematics; that takes all the irritation and drudgery out of it. You don't need to be scared of mathematics, because here's the subject explained without frills, without useless computations.

Here's the book for men in the armed forces; for business men, technicians and craftsmen, explaining and answering everyday mathematical problems in easy-to-understand words and illustrations.

Yes, it's the key to a simple understanding of mathematics. It's a real home-study course in mathematics for the man who's alert to the importance of mathematics in the world today.

ELEMENTARY MATHEMATICS

● EASY — SIMPLIFIED — PRACTICAL ●

- CONTENTS OF BOOK:
- CHAPTER I. Arithmetic—Addition—Subtraction—Multiplication—Division.
 - CHAPTER II. Factoring and Cancellation—Fractions—Decimals—Percentage—Ratio—and Proportion.
 - CHAPTER III. The Metric System.
 - CHAPTER IV. How to Measure Surfaces and Capacity (Geometry).
 - CHAPTER V. Powers and Involutions—Roots and Evolution.
 - CHAPTER VI. Mathematics for the Manual and Technical Craftsman—Thermometer conversions—Graphs or Curve Plotting—Logarithms—Use of the Slide Rule.
 - CHAPTER VII. Special Mathematics for the Radio Technician.
 - CHAPTER VIII. Commercial Calculations—Interest—Discounts—Short Cut Arithmetic.
 - CHAPTER IX. Weights and Measures—Useful Tables.

ONLY
50¢
POSTPAID

Send Stamps, Cash or Money Order.

Send today for your copy of this indispensable book. It can be carried readily in your pocket. (Size 6 1/2 x 9 in.)

TECHNIFAX

1917 S. State St., RC-442, Chicago, Ill.

Tell the Editors
What Kind of Articles
YOU Like—
We'll Try to Please

are usually encased in sealing wax for these reasons.

However, should lint or hair lodge between the fixed pick-up electrode and the temporarily motionless vibrator, unavoidable spurious noises may be generated due to the variations in potential resulting from the partial shorting of the pick-up capacity or the agitation of a dielectric in the electrostatic field. The first effect is minimized by a coating of insulating lacquer over the pick-up screw face. As a matter of fact, the lowering of signal strength due to leakage paths would not by itself be serious were it not for the irregularity of the leakage process. Several cases of regular clicks have been traced to a small piece of felt dropping from piano string hammers and then moving towards and away from the pick-up screw owing to attraction, discharge, removal of force temporarily, and re-attraction. Surface moisture is in a continual state of change from evaporation to condensation according to the air currents and this irregularity in resistance produces the undesired noise. Weather conditions tending to produce this effect are rare in the temperate zone but more frequent in the tropics.

This article represents a report on the development work carried out by Benjamin F. Miessner of Miessner Inventions, Inc., to find an alternative system to the polarized electrostatic pick-up which would retain the original advantages of cheapness and simplicity and at the same time overcome some of the disadvantages. The object is to retain capacity pick-ups but (1) reduce the direct current resistance so that humidity and leakage effects are minimized and (2) to improve the bass response.

AMPLITUDE MODULATION OF A HIGH FREQUENCY VOLTAGE BY CAPACITY MEANS

The first method attempted was to amplitude modulate a high frequency current with the capacity translation system previously direct current polarized. Owing to the small variations in capacity resulting from a string vibrating near its pick-up screw, the amplitude modulation is extremely small and the system inefficient. The steady capacity from 88 motionless strings is about 300 mmf, leaving a variation of about 3 mmf. pick-up screw possible, and this is not large enough to work with by standard methods.

FREQUENCY MODULATION CAPACITOR PICK-UP SYSTEM

A trial of placing the pick-up capacity across the grid tuning condenser of an 800 kc. oscillator immediately gave very promising results provided the usual AM receiver was tuned to approximately the mid-resonance point of one side of the resonance curve. Fig. 2 shows the final arrangement of the circuit. C_1 is the pick-up capacity and C_2 adjusts the oscillator to the approximate mid-frequency desired, while C_3 determines the width of modulation. If the modulation is too wide, then the frequency excursions pass beyond the range of the receiver resonance curve, and non-linear distortion (which may under some conditions be desirable for an electronic musical instrument) appears.

The frequency response curve of Fig. 3 for a portion of the range of an electronic reed organ show unmistakably that the attenuation of the bass is eliminated. The bass response of an organ must, of course, be good down as low as 32 cycles. Experiments showed that a resistor of as low a value as 30,000 ohms may shunt the string to pick-up capacity before the volume level at loudspeaker is appreciably affected.

In the translation of string vibrations, a large variation in timbre is desired and a

plurality of pick-ups for each string is useful if they can be connected in both aiding and opposing relationship. This is done electrically in an easy method by arranging the parallel pick-ups of one system either in series or in parallel with the inductance coil of the oscillator grid circuit. This is shown in Fig. 4 where C_s represents series connected systems and C_p parallel connected systems. Again C_1 and C_2 are to prevent over-modulation.

Completely portable small electronic musical instruments are practical with the FM system by transmission of the R.F. energy to a central receiving station through the air. This also eliminates the problem of the connections to the amplifier input that is found in the D.C. polarized system. Cable noises in themselves are a source of trouble. The advantages of amplification at radio and intermediate frequencies compared with simple audio amplification are too well known to require enumerating.

Originally the polarized D.C. electrostatic system had been adopted so that envelope control of the output tone was available. This would result in time-amplitude curves of organ and plucked string tones even though the excitation method of the string by the customary piano hammer remained unchanged. In that respect the FM system does not appear to possess any easy solution.

PHONOGRAPH PICK-UPS EMPLOYING FREQUENCY MODULATION

Inasmuch as FM radio receivers are soon to be found in many homes, Mr. Miessner has carried out development work on a suitable FM phonograph pick-up and his description is as follows: Fig. 5 shows one of these forms and it is to be noted that provision is made for volume expansion directly at the pick-up point. The unit has only one moving part and this is the needle, close to which is an electrostatic pick-up screw. The needle is pointed at its upper end also and this end bears into a conical socket which makes a connection to ground for one terminal of the pick-up capacity. The other electrode of this capacity is an adjustable screw. The needle vibrations modulate this capacity. The needle passes through an easily yieldable rubber bushing near its bottom end and this establishes its normal position about which it vibrates. Obviously this pick-up is extremely light in weight. A permanent needle is used and the record wear is extremely low.

Volume expansion is accomplished mechanically by so arranging the pick-up electrode that the needle drag along the record groove for strong passages biases the needle closer to the pick-up screw and thus increases its translation efficiency. The amount of volume expansion can be controlled by the cone angle of the pick-up screw. Fig. 6 shows in greater detail the volume expansion operation.

REFERENCES

- 1—An analysis is given in the textbook "Acoustical Engineering" by West on page 170.
- 2—"The Application of Electronics to the Piano," Benjamin F. Miessner; Proceedings of the Radio Club of America, January, 1934. Also: "The Electone—An Electronic Piano," Gordon S. Taylor, Electronics, January, 1939.
- 3—U. S. Patents No. 785,803 and No. 785,804 of C. D. Ehret, issued in 1905.
- 4—"Evolution of Frequency Modulation," E. H. Armstrong, Electrical Engineering (New York), Dec., 1940, pp. 485.

CORRECTION NOTICE

There was an error in the initials and call letters of the plaque award winner of the January-February issue. His correct name is D. Reginald Tibbetts, W6TH and not R. R. Tibbetts, W6LIH.

F-M ANTENNA COUPLING

H. F. SHOEMAKER

Member of the Faculty, Radio College of Canada

Many useful hints on the construction of FM Receiving Antennas were given in the last number of Radio-Craft. Herewith are some more very practical and valuable suggestions on methods of coupling FM antennas to the receiver, including some worth-while advice on what type of transmission lines to use between antenna and receiver.

In a recent article we discussed the use of the dipole in FM reception and came to the conclusion that it was the only satisfactory receptor except where signal strength was particularly good. However, it was found that the dipole, designed to operate at or near FM frequencies, was not always suitable for AM reception on the standard broadcast frequencies. We were therefore faced with the problem of providing both FM and AM reception without the use of separate aerials and some switching arrangement.

No doubt FM-AM antenna kits will be made available and will provide a profitable field for servicemen specializing in that work, just as doublet antenna kits for standard broadcast reception always have, particularly in the north where reception is often poor. However we are going to find that, as in the past, the average customer is going to be loath to part with about \$15.00 or \$20.00 for an antenna kit but will expect the retailer or the serviceman to erect a suitable antenna at a minimum cost.

THE SIMPLEST SOLUTION

The simplest answer to this problem is shown in Fig. 1. It consists of a dipole antenna resonant to FM frequencies as previously described but having an extra length of wire, as long as may be required, connected to one leg. Interposed between the dipole leg and the extra wire length is a wave trap designed to have a high impedance to FM frequencies and therefore isolate the dipole for FM reception. For standard broadcast frequencies such a wavetraps would have negligible impedance and so for practical purposes the long wire length is directly connected.

This wave trap adds practically nothing to the cost of the antenna installation. If a glass or porcelain insulator having a diameter of 1 inch is inserted between the dipole leg and the extra length of wire it may be wound with 16 turns of closely spaced number 18 enamelled copper wire. One end of this coil is connected to the dipole and the other to the long wire and used as a connecting link between the two as shown in Fig. 2. Its inductance and distributed capacity make it roughly resonant to the FM frequencies and it will offer an impedance of somewhere around 50,000 ohms at 46 mc.

ANTENNA COUPLERS

A somewhat more elaborate, and therefore more costly, system that permits the elevated wire to operate as a dipole for FM and as a Marconi antenna for AM is shown

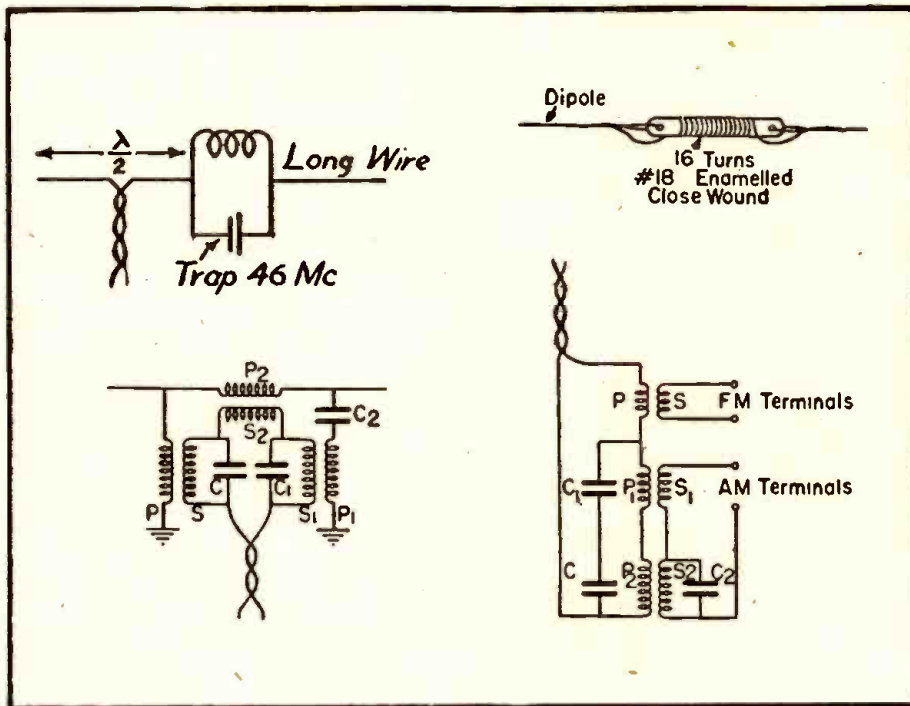

Several methods of coupling FM aeriels. Figures 1 & 2 at top; 3 & 4 below.

in Fig. 3. For the ultra-high FM frequencies the broadcast and short wave primaries P and P₁ offer a very high reactance and the elevated wire operates as a dipole with FM coupling transformer P₂S₂ in its centre. The ultra-high frequencies delivered to the secondary S₂ are by-passed around the broadcast and short wave secondaries S and S₁ by the condensers C and C₁.

For standard broadcast reception the elevated wire acts as a capacity connected to ground through the primary of the broadcast coupling transformer PS. The same provision is made for short wave frequencies by the coupling transformer P₁S₁ and the series condenser C₁.

All coupling transformer secondaries are connected in series and to the transmission line as shown. Such coupling units may be provided in kit form.

COUPLING AT THE RECEIVER

Of course another coupling unit will be required for impedance matching at the receiver itself and a suitable unit for use with receivers having separate FM and AM terminals is shown in Fig. 4. The coupling transformers PS, P₁S₁ and P₂S₂ are for FM, short wave and standard broadcast reception respectively. The condenser C and C₁ in the primary circuit by-pass the FM around the standard and short wave primaries and the condenser C₂ in the secondary circuit by-passes the short wave frequencies around the standard broadcast secondary S₂.

All these transformers must have of course the proper impedance ratios and are therefore to be purchased in kit form.

TRANSMISSION LINES

It was previously stated that the impedance at the centre of a half wave dipole was about 73 ohms and that it was desirable that the transmission line impedance be approximately equal to this. Four types of cable suitable for the purpose are avail-

able and are as follows:

(a) Coaxial cable consisting of a wire enclosed in spun glass insulation and surrounded by a tinned-copper braid that is used as one conductor. This cable has a characteristic impedance of 71 ohms and has the lowest attenuation in db per 100 feet. It is therefore the most desirable but also the most expensive.

(b) Coaxial cable similar to (a) but with low-loss rubber insulation. Has a characteristic impedance of 63 ohms and losses considerably greater than (a) especially at the ultra-high frequencies.

(c) Twisted pair, consisting of two conductors of 16 strands No. 30 wire, rubber insulation. Loss only slightly higher than (b) but has a characteristic impedance of 110 ohms. This may be a favorite line for the cheaper installations.

(d) Standard telephone wire of No. 14 twisted pair. The least desirable of all. Losses considerably greater than all others and has a characteristic impedance of 150 ohms—more than twice the dipole impedance.—Radio Trade-Builder, Canada.

FM Sets Will Be Available

FM radio sets will be available beyond April 22nd, and may be obtained by the public even after Labor Day, it was revealed by Lee McCanne in a recent talk on FM receiver production prospects for 1942.

Mr. McCanne estimated, on the basis of reports from leading manufacturers of radios, that fully one-third and possibly more than one-half as many FM sets would be made available in 1942 as were put in operation in 1941.

In explaining the Labor Day availability, Mr. McCanne said that the WPB order L-44 cancelling work on chassis put into production on April 23rd would be observed to the letter by the industry.

"Nevertheless deliveries will not cease automatically on April 22nd," he stated. "In the first place, some chassis put into production on April 22nd will not be set into cabinets with record changers for possibly two or three months beyond that date."

Mr. McCanne asserted that Stromberg-Carlson, who delivered 10% of all the FM sets sold by the industry up to the end of 1941, will produce even more FM receivers in 1942 than they did in 1941.

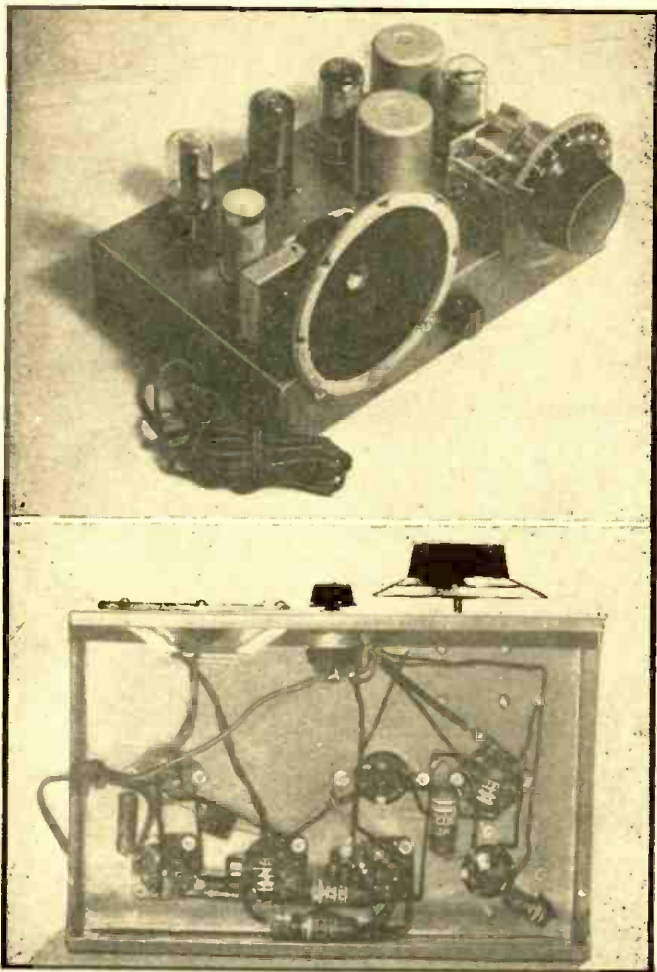

4-TUBE T. R. F. RECEIVER

Works on A. C. or D. C.

L. M. DEZETTEL, W9SFW

This set will appeal to the average constructor as it can be easily built and no delicate aligning of intermediate frequency transformers is required. Once the set is assembled and properly wired according to the diagram, it should operate perfectly. It covers the "broadcast" band and gives loud-speaker reception.

Left—Front and bottom views of the four-tube T.R.F. receiver. The assembly shown is simple and effective.

a selection of tubes that would give us the best possible results, as well as wiring convenience for this type of circuit. A study of the circuit diagram will reveal other features that makes this an ideal circuit. In fact, some of these features would be worthwhile incorporating into receivers you may now already have. For instance, the 45Z5GT rectifier tubes have a tapped filament. Connecting the plate of the rectifier tube to this tap has the same effect as adding a small amount of resistance in the plate circuit, such as is generally recommended for increasing the life of rectifier tubes. This is especially true where high values of filter condensers are used.

Another feature of this rectifier tube is that a panel lamp may be conveniently connected to it without altering the circuit. A No. 40 panel lamp is connected to the No. 2 and No. 3 terminals of the 45Z5GT tubes. Notice that the 150 ohm resistor in the cathode of the 50L6GT output tube is not by-passed. Instead, we connect a .01 mf. tubular condenser from plate to cathode.

WHEN you go over the list of tubes now available to the radio builder, you find that you have a very wide selection from which to choose. Not only have the tube types been improved, but it is possible to choose a combination that fits into almost any scheme of design that you may have in mind. One of the greatest advances in tube design is the "single ended" type of tubes. Placing the grid terminal at the bottom of the tubes, and re-locating nearly all of the other pins, has resulted in a line of tubes that is not only easier to wire into a circuit, but have higher amplification

than their counterparts with the grid caps on top. In addition to this, we have the choice of filament voltages. In the case of the AC-DC set we are about to describe, for instance, we have selected tubes so that when their filament voltages are added and used in series, it totals approximately the line voltage available. This eliminates the necessity of a line cord resistor, or any other voltage dropping resistor for the filaments.

IDEAL 4-TUBE T.R.F. CIRCUIT

This 4-tube TRF receiver was based on

The first two tubes should be 65K7GT's, but the 12.6 Vt. tubes (12S type) may be used if they are handy, especially if the circuit supply is nearer 120 volts than 110 volts.

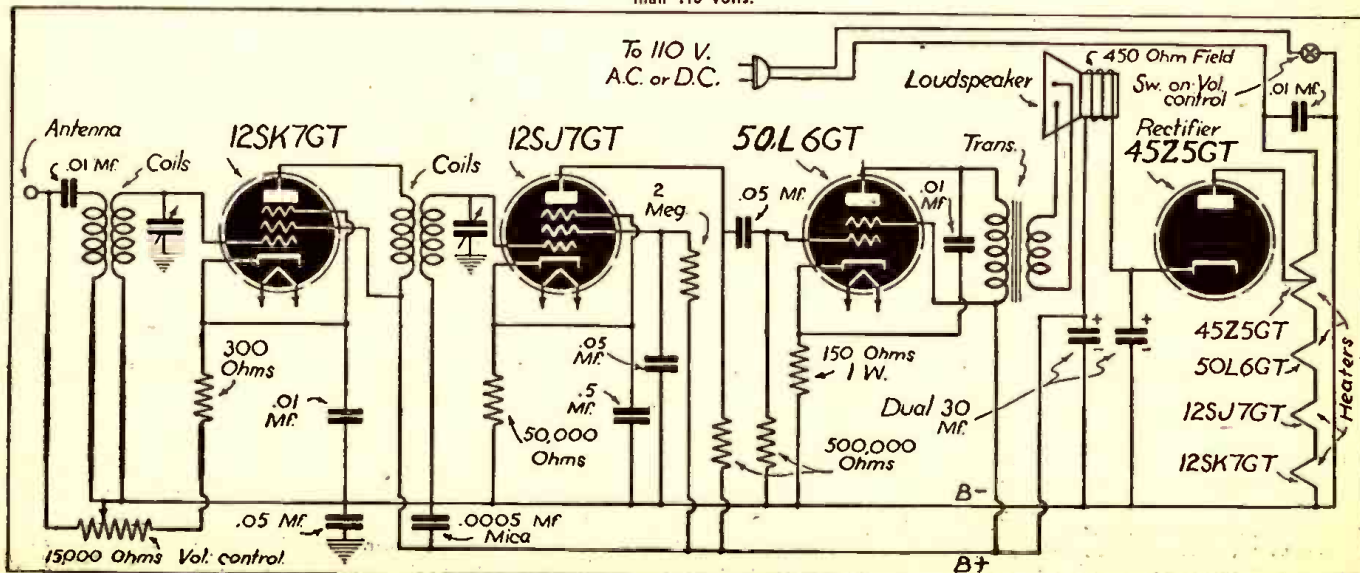

This condenser feeds back a little out-of-phase voltage from the plate to the cathode. Thus, we have *inverse-feedback* incorporated into our circuit without additional cost. Inverse-feedback is a great thing for beam power tubes, such as the 50L6GT, as it *reduces distortion and increases fidelity* in this stage.

Only two controls are used on the set—a 4 inch bakelite dial for tuning and a small knob for volume. If you plan on using this set in a cabinet, we suggest that you use an airplane-type dial with translucent scale and pilot lamp.

We don't claim much for the appearance of this set as shown in the photograph. A large chassis was purposely used in this model, so that there would be plenty of space under the chassis, permitting the parts to show up in the photo. If you are a good mechanic and neat in your wiring, a much smaller chassis could be used.

LAYOUT OF PARTS

The photograph of the top view will give you a general indication of the layout of parts. The important thing to keep in mind when locating your parts is to maintain *short* connections from one part to another. Notice that the two shielded coils are placed in such a way that they isolate the first two tubes of the circuit. This method eliminates the necessity of shields on the tubes. The rotation of the tube sockets is important. Place them in such a way that the grid and plate contacts are adjacent to the part to which they are to be connected. Mount the speaker last to reduce the possibility of damage to the cone while handling it.

Wiring of the set is the most important part of the entire job. Make connections short and direct. Long, loose, straggling wires will cause excessive regeneration, resulting in poor quality. Use wiring tie-points freely. Two were used in the original model of this set. Push all the wires down, close to the chassis. *Never let grid and plate connections run close to each other.* Be sure that the terminal marked "outside foil" on the by-pass condensers is connected to the ground side of the circuit.

Each connection should be properly soldered as you make it. Use a good grade of rosin-core solder and apply it sparingly. One of the greatest causes of noise in a receiver is what is called a "rosin joint." This is due to the fact that rosin has flowed into the connections, but the connection was not hot enough to properly flow the solder. The best method of soldering it to apply a hot iron to the connection itself, allowing it to get hot enough to flow the solder.

Let me emphasize this. The solder is not applied to the soldering iron, but to the heated connection.

Work slowly. Check against the circuit diagram frequently as you go along. When you have completed the wiring, *check again.*

TWISTED WIRE EASILY MADE AT HOME

● TWISTED wires for long link lines or antenna feeders can be made in excellent shape right at home, from good insulated single strands as shown.

Pivot a large wheel such as an old carriage wheel to a post or the side of a building. Tie two strands to the wheel, at opposite sides of the rim. Stretch out the wires and bring them together at the outer ends, tying them to a bag of sand or other equally heavy weight.

Then turn the wheel over, keeping it revolving slowly. This will twist the wires together. The weight will exert sufficient drag to keep them taut and in a short time

READY FOR TEST!

Plug the line cord into any 105-125 volt A.C. or D.C. outlet. If you are operating from a D.C. source, it may be necessary for you to reverse the plug in the socket. Turn the set on and allow the tubes a few seconds to warm up. You should hear stations at once. If the set begins to oscillate as you turn the volume control up, it is probably due to improper wiring. If this is the case, look over the wiring again. Push aside any grid and plate connections that seem to be close to each other. It is possible that even with all wiring precautions observed, the set will continue to oscillate. This is an extremely sensitive circuit and sometimes oscillation is hard to avoid. *Here is a sure cure:* Reverse the "B Plus" and "Plate" connections on the R.F. Coil. This reduces the sensitivity of the set a little, but there is still plenty of amplification and the overall results are sometimes better.

Very little *alignment* is necessary on this receiver. Tune the variable condenser to a station at the highest frequency end of the band. Adjust one of the trimmers on the side of the condenser until the station comes in loudest. If the condenser specified in the parts list is used, there will be four such trimmers on it. The only purpose of four trimmers is to allow wide latitude in adjustment, although they are seldom used. Generally, it is only necessary to adjust one or two to get peak performance.

If you are handy with tools, you should build a neat cabinet to house the receiver. You can make it a worthwhile addition to your home, and it will perform every bit as well as any commercial receiver you may buy.

This article has been prepared from data supplied by courtesy of Allied Radio Corp.

Parts List -

RESISTORS

- 1—15,000 ohm potentiometer with switch
- 1—300 ohm 1/2 watt carbon
- 1—50,000 ohm 1/2 watt carbon
- 1—2 megohm 1/2 watt carbon
- 2—500,000 ohm 1/2 watt carbons
- 1—150 ohm 1 watt carbon

CONDENSERS

- 4—.01 mf. 400 volt paper tubulars
- 3—.05 mf. 400 volt paper tubulars
- 1—.5 mf. 200 volt paper tubular
- 1—.0005 mf. mica
- 1—Dual 30-30 mf. 150 volt electrolytic
- 1—Two gang 370 mmf. tuning (Knight 61-070)

TUBES

- 1—6SK7GT
- 1—6SJ7GT
- 1—50L6GT
- 1—4Z5GT

MISCELLANEOUS

- 1—11" x 7" x 2" electrical alloy chassis
- 4—Octal wafer sockets
- 1—Set shielded antenna and R.F. coils (Knight 60-561)
- 1—5" dynamic speaker 450 ohm field (Utah Q545)
- 1—Speaker matching transformer
- 1—Line cord and plug
- 1—4" round dial
- 1—Small knob
- 2—Single terminal wiring tie-points

WANT A BETTER RECEIVER?

Receivers are scarce. But we have a large stock of Hallicrafters, National, Hammarlund, Howard, RME short wave receivers at lowest wholesale prices. We help you get the best receiver for your use. We cooperate with you to see that you are 100% satisfied.

YOU get 10 day trial of receivers.
YOU get best trade-in for your receiver.
Tell us what you have to trade.
YOU get best 6% terms financed by us with less cost, no red tape, quicker delivery.

Write, wire, fone us anytime about any receiver, transmitter, radio supplies of any sort. It will pay you to buy from us. Your inquiries invited.

For the Western U.S.A. we have a new store at 2335 Westwood Blvd., West Los Angeles, Calif.

HENRY RADIO SHOP

BUTLER MISSOURI

"World's Largest Distributor of Short Wave Radios"

READ AND SEND CODE

Learn Easily at Home This Quicker Way

No experience needed. Beginners read code quickly, copy accurately. If already an op, speed up your wpm with this approved amazing all Electric Master Teleplex Code Teacher. Only instrument which records your sending in visible dots and dashes on specially prepared paper tape—then sends back your own key work at any speed you wish. There are NO PERFORATIONS—NO INK. Far superior to anything ever developed... A marvel of simplicity. Fascinating, foolproof—gets results because you learn by HEARING as well as SEEING. That is why thousands agree this method is surest and quickest. While not designated standard equipment, Teleplex is used at many U. S. Army Posts, Naval Training Stations. We furnish Complete Course, lend you the New All Electric Master Teleplex, and personal instruction with a MONEY-BACK GUARANTEE. Low cost, easy terms. Write today for folder S4, no obligation.



TELEPLEX CO. 107 HUDSON ST. JERSEY CITY, N. J.

Headset Headquarters



Scientifically Built Heavy bar magnets greatly increase their efficiency.

Our Headphones are used by the United States, Canadian, New Zealand and South African Governments as well as other Governments not directly in the war. Folder C-4 illustrates rugged, unusually sensitive, dependable Cannon-Ball Headsets. Write ..

C. F. CANNON COMPANY SPRINGWATER, N. Y.

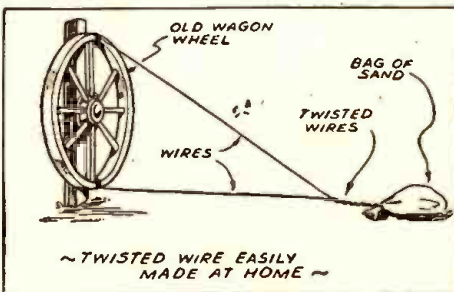

you will have as nicely a twisted pair as you can buy.—L. B. Robbins.

SUPER SPECIALS

frequency held constant, the audio oscillator is varied until two sine waves appear on the screen of the scope, indicating an oscillator frequency of 120 cycles. The oscillator frequency is then again varied to obtain successively 3, 4 and 5 sine waves on the screen, giving us oscillator calibration points of 180, 240 and 300 cycles. With the oscillator at 300 cycles, the sweep frequency is then changed so that a single sine wave again appears on the screen, giving us a sweep frequency of 300 cycles, and again the audio oscillator is varied to obtain 2, 3, 4 and 5 sine waves on the screen. The entire process is repeated a sufficient number of times to completely calibrate the oscillator throughout its range.

Parts List

- Meissner Mfg. Co.
 1—4-gang 365 mmf. condenser, No. 21-5223
 2—Bakelite octal sockets, No. 25-8209
 P. R. Mallory & Co.
 1—2-circuit, 3-position rotary switch, No. 3123-J
 1—16 x 16 mf. 250 volt condenser block, No. CM164
 4—½ mf. 200 volt paper condensers, No. TP-441
 1—Phone jack, No. A-1
 I.R.C.
 1—5000 ohm wire-wound potentiometer, No. W-5000
 3—100,000 ohm, ½ watt resistors, type BT-½
 2—800,000 ohm, ½ watt resistors, type BT-½
 2—5 megohm ½ watt resistors, type BT-½
 2—500,000 ohm ½ watt resistors type BT-½
 1—3500 ohm ½ watt resistors, type BT-½
 1—10,000 ohm 1 watt resistors, type BT-1
 1—1000 ohm 1 watt resistors, type BT-1
 1—500 ohm 1 watt resistors, type BT-1
 1—250 ohm, 10 watt type, AB
 Bud Radio
 1—5" x 6" x 9" cabinet, No. 1099
 1—¾" to ¼" insulated shaft coupling, No. 1210
 Sylvania
 1—12J7GT tube
 1—70L7GT tube
 NE Radiocrafters
 1—Four-inch vernier dial, No. 400V (with 1-½" knob, No. 158F)
 1—Gain-control dial plate, No. 150B

U. S. Wants Radio Inspectors

The position of radio inspector in the Federal Communications Commission has been added to those jobs in the field of radio for which the U. S. Civil Service Commission is seeking qualified persons. Salaries range from \$2,000 to \$2,600 a year. The maximum age is 45 years. Applications for the written test on radio and electrical engineering must be filed with the Commission's Washington, D. C., office not later than April 21, 1942.

For assistant positions (\$2,000 a year), completion of a 4-year college course in electrical or communication engineering or physics is prescribed. Provision is made for the substitution of radio engineering experience for this requirement. To qualify for the \$2,600 positions, applicants must have had in addition at least 1 year of appropriate radio engineering or teaching experience, or 1 year of graduate study in communication engineering. All applicants must be able to transmit and receive messages in the International Morse Code.

The duties of these positions involve radio inspection work of all kinds, including inspecting radio equipment on ships, aircraft, and at various land stations to determine compliance with Government specifications. The announcements of this opportunity for Government employment and the forms for applying may be obtained at first- and second-class post offices or from the U. S. Civil Service Commission, Washington, D. C.

All of the attractive items listed here are brand new. ALL are in PERFECT WORKING ORDER. In many cases, the parts alone total more than the price we are asking. 100% satisfaction guaranteed or your money refunded.
ORDER FROM THIS PAGE. Use the convenient coupon below. Include sufficient extra remittance for parcel post charges, else order shipped express, collect. Any excess will be refunded. C.O.D. shipments require 20% deposit. If full remittance accompanies order, deduct 2% discount. Send money order, certified check, new U. S. stamps. No C.O.D. to foreign countries.

ORDER TODAY LIMITED QUANTITIES PROMPT SHIPMENTS ASSURED

HANDY WORKSHOP OUTFIT



Here is a marvelous article that to the best of our knowledge has never sold at such a low price. This outfit must be seen to be appreciated. It covers the goods! It comprises a variable speed universal motor for 110 volts A.C. or D.C. Made originally for dictaphone machines by American Gramophone Co. Motor is reconditioned and in excellent condition; all other parts are brand new. Special lever control permits various speeds up to 3000 r.p.m. Measures 7½" x 3¼" diam. overall.
 Included in the outfit are the following items, as illustrated: 1 excellent chuck which takes drills and other tools—chuck is easily screwed to motor shaft; standard emery wheel, 4" diameter; fine steel rotary saw, 4" diameter; wire scratch brush, ¼" diameter; standard cloth buffer, 3" diameter. Total Wt. 9 lbs.

ITEM NO. 149
 Complete outfit, including motor. **\$4.95**
 Your Price

WESTON MODEL 562 A.C.-D.C. AMMETER

Designed by Weston for the Eastman Kodak Co. It is a precision-built magnetic-vane type ammeter which, with suitable shunts, can be used as a milliammeter too. It is 2" in diameter and designed for panel mounting. Bakelite base and black-enamelled cover. Shp. Wt. 2 lbs.
 ITEM NO. 35
 Your Price **\$1.25**



POWERFUL ALL-PURPOSE INDUCTION MOTOR IDEAL FOR EXPERIMENTERS—101 USES

Sturdily constructed to precision standards, this self-starting shaded pole A.C. induction motor is powerful enough for a large variety of uses. Some of these are: Automatic Timing Devices, Current Interrupters, Electric Fans, Electric Chimes, Window Displays, Photocell Control Devices, Electric Vibrators, Small Grinders, Buffers and Polishers, Miniature Pumps, Mechanical Models, Sewing Machines, Phonograph Motors, Coffee Grinders, Motion Picture Projectors, Motorized Valves, Sirens, and other applications. Consumes about 15 watts of power and has a speed of 3,000 r.p.m. When geared down, this sturdy unit will constantly operate an 18-inch turntable loaded with 200 lbs. dead weight—THAT'S POWER!
 The motor is of midget dimensions, 3 inches high by 2 inches wide by 1½ inches deep; has 4 convenient mounting studs; shaft is ¼" long by 3/16" diameter, and runs in self-aligning, oil-retaining bearings; the best materials, perfect precision assembly and rigid inspection certify to its high quality, and assure long life. Designed for 110-20 volts, 50-60 cycles, A.C. only.
 ITEM NO. 147
 YOUR PRICE **\$1.29**

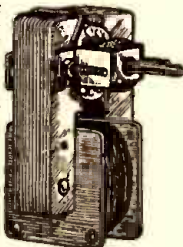

100 POWER TELESCOPE LENS KIT

Make your own high powered 6 ft. telescope! Now you can thrill to a closeup view of the worlds out in space. See the rings around Saturn, the mountains of the moon! Kit contains 3" diam., 75" focal length, ground and polished objective lens and 2 astronomical eye-pieces, magnification 50x and 100x. Complete kit with full instructions.
 ITEM NO. 123
 YOUR PRICE **\$1.95**

NEW—EXTRA LARGE LENS KIT—contains completely finished 4" diameter 100" focal length ground and polished objective lens, three 1¼" diameter eye-pieces giving 66x, 133x, and 200x, an aluminumized insertion in lens eye-piece, and a color filter for overheat viewing, and a color filter for insertion in lens eye-piece.
 ITEM NO. 123L
 YOUR PRICE **\$3.95**

HUDSON SPECIALTIES CO., 40 West Broadway, N. Y. C.

IT'S EASY TO ORDER—CLIP COUPON—MAIL NOW ORDER FROM THIS PAGE.

HUDSON SPECIALTIES CO., 40 West Broadway, Dept. RC-4/42, New York, N. Y.
 I have checked below the numbers of the items I'm ordering. My full remittance of \$..... (include shipping charges) is enclosed.
 OR my deposit of \$..... is enclosed (20% required), ship order C.O.D. for balance. No C.O.D. order for less than \$2.00. (New U. S. stamps, check or money order accepted.)
 Circle item No. wanted: 11, 33, 35, 87, 123, 123L, 147, 149, 150, 151
 Name Address
 City State

Send remittance by check, stamps or money order; register letter if you send cash or stamps.

DISPLAY MOTOR AND TURNTABLE

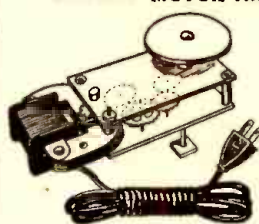

Here is an article ideal for use with a Pulley for sliding displays, such as skilling, etc. For horizontal use, it can be used for any type of moving display. Can carry a weight of 20 to 30 lbs.; while with extra ball bearings it will operate under a weight of 50 lbs. Sturdily built motor with five brass gear train, top and bottom pulleys. Complete with 6-foot cord. Gears are housed between 2 heavy brass plates. Motor operates on A.C. only. Display motor can be used for many other purposes. Self-oiling bearings. Size, overall, 5½" long x 2½" wide x 3" thick.
 ITEM NO. 150
 Your Price **\$2.90**

METAL CUTTING SAW

Here is an ideal metal-cutting saw made of fine tool steel specially designed to cut metal. Teeth are set at a special double angle for metal-cutting work. Saw is specially hardened for long and extended use; measures 3¼" diameter; center hole is ½" square; thickness 42/1000 (42 mils.) 3/64". Due to the impossibility of securing a new supply, we can sell only those we have on hand. Once these are gone, none are to be had for the duration. Better stock up now with a quantity of these fine saws.
 ITEM NO. 151
 Your Price **50c**



VARIABLE SPEED UNIVERSAL MOTOR

FOR 110 VOLTS, A.C. OR D.C.
 Made for Dictaphone machines by American Gramophone Co. Used, but in excellent condition. Special lever control permits variable speeds up to 3000 r.p.m., ¼" shaft extends from both sides of motor. Measures 7½" x 3¼" diam. overall. Shp. Wt. 8¼ lbs.
 ITEM NO. 11
 Your Price **\$1.55**



AMAZING BLACK LIGHT!!

Powerful 250-Watt Ultra-Violet Bulb



The best and most practical source of ultra-violet light for general experimental and entertainment use. Makes all fluorescent substances brilliantly luminescent. No transformers of any kind needed. Fits any standard lamp socket. Made with special filter glass permitting only ultra-violet rays to come through. Brings out beautiful opalescent hues in various types of materials. Swell for amateur parties, plays, etc., to obtain unique lighting effects. Bulb only. Size of bulb.
 Shp. Wt. 1 lb.
 ITEM NO. 87
 YOUR PRICE **\$2.00**

WESTINGHOUSE WATTHOUR METER

Completely overhauled and ready for immediate service. Designed for regular 110-volt, 60 cycle 2-wire A.C. circuit. Servicemen use it in their shops to check current consumption of sets, soldering irons, etc. Keeps costs down. If dismantled, the parts alone would bring the price. The elaborate gear train could be used as a counter on machines of various kinds. Simple to install; 2 wires from the line and 2 wires to the load. Sturdily constructed in heavy metal case. Size, 8½" high, 6¼" wide, 5" deep, overall. Shp. Wt. 14 lbs.
 ITEM NO. 33
 Your Price **\$4.50**



Midget Volt-Ohm Meter

W. F. DAVIS, W5GHU

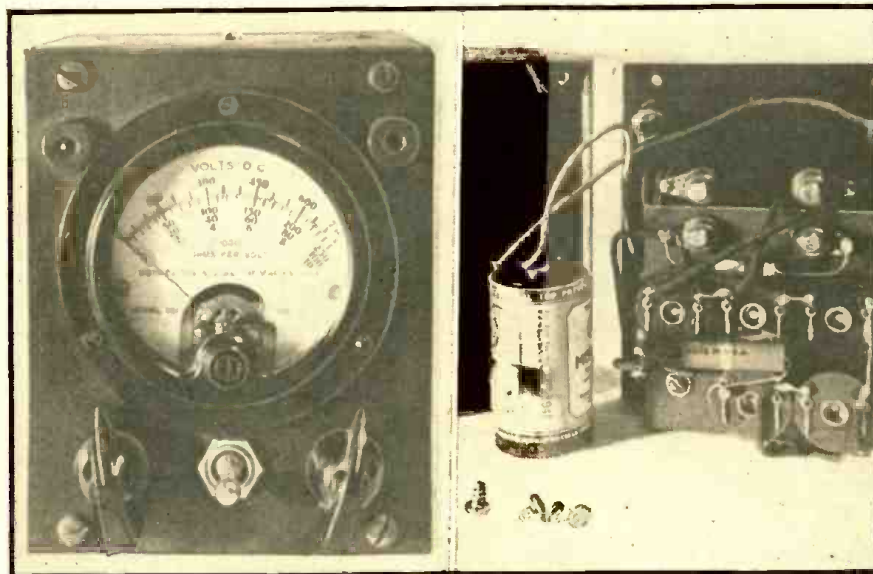

Front and rear views of the Volt-Ohm Meter as built by Mr. Davis.

● NO unusual features are claimed for this little volt-ohm meter except the inclusion of a full size three and a half inch meter in about as small a case as the parts will fit into. To be of much use a good volt-ohm meter should have a meter movement of precision construction, and sufficient scale length to be read easily. In spite of its small size, the unit illustrated is capable of quite a range of measurements at good accuracy.

The construction of the complete unit was finally inspired by a near calamity! I had been in the habit of keeping the 0 to 1 ma. meter on the shelf, along with the multiplier resistors. When it became necessary to make any measurement, I reached over and got the meter, whatever resistors were needed, tied them together, and proceeded to make the measurement. One fine day, when I just managed to catch the meter by one stud and the flange, about six inches before the floor caught it, I decided to put it together as a permanent piece of equipment. Zero to one mil. A. C. and D. C. meters have rarely been observed to grow on trees!

METER COVERS WIDE FIELD

Setting of the selector switch allows the meters' use as a 0 to 1 ma. meter, 0 to 10, 100, 250, 500, 750, and 1000 volt meter, at 1000 ohms per volt, or as a 1400 ohm center-scale ohm meter. This selector switch is controlled by the pointer knob at the lower left of the panel. The pointer at the lower right is the ohm meter full scale adjuster. The toggle switch in the center is used to change over from A.C. to D.C. measurements.

The meter, as supplied, requires about 400 microamperes for full scale deflection. This makes it necessary to use a shunt for one ma. full scale operation. If a toggle switch were available that had three poles instead of two, the A.C. and D.C. shunts could be of different values, and allow the use of the same scales for reading both A.C. and D.C. Using the double pole switch, and a common shunt, a separate scale must be used for A.C., or a little mental arithmetic resorted to in interpreting the readings. Since the meter will read average voltage, and the r.m.s. voltage is the reading

usually wanted, the indicated voltage on the D.C. scale will have to be multiplied by 1.1 to arrive at the r. m. s. voltage. The calibration for the ohms scale can be applied as shown in the drawing, or a special scale can be purchased for the meter. If the meter is bought new, it can be obtained with the desired scales already on it, but one of the sad facts of life is that traded meters seldom are equipped with the scales that you want when you get them!

If the volt-ohm meter is to be exactly duplicated, it would be best to follow the parts layout shown, as it will be a rather close fit in spots to get them all in. The 3" x 4" x 5" crackle finished cabinet does not leave any too much spare space.

PARTS MOUNTED ON BAKELITE PANEL

A panel of 1/8" bakelite is used to avoid trouble in insulating the pin-jacks used for terminals. The lips of the cabinet are bent down on the long sides to allow clearance

Are you in the habit of connecting a meter and a few scattered resistors together whenever you have to make a test? Take a tip from the author and assemble them in a small cabinet. You will then have a handy, reliable piece of apparatus always ready when you need it.

for the parts, and are cut out on the short sides for the same reason. This should allow the panel to be easily slipped on after all the parts have been mounted on it. A dull finish is put on the panel with a small piece of steel wool and some elbow grease.

The meter, selector switch, ohms adjusting potentiometer, and tip jacks are mounted on the panel. The multiplier resistors are mounted on a small bakelite panel, which is in turn mounted on the two bottom studs of the meter. Before mounting this strip to the meter, wires should be soldered on the switches to as many of the connections as possible, and wires long enough to reach the multiplier resistors put on the switch. With the multipliers mounted the wiring can be finished. This is all simple and straightforward, and if the diagram is followed, no trouble should be experienced. Two extra wires are soldered on about six inches long, which are then soldered to the terminals of the single flashlight cell which furnishes current for the ohm meter. This battery is mounted in the top of the case by a small bracket of strip brass to keep it from rattling around when the meter is moved. A small handle can be put on the top of the case to make it easier to carry around.

Except for the 0 to 1 position, milliamperes ranges were not included, but could easily be added by the use of another switch section.

RESISTORS

- One Meter shunt (for this meter, 165 ohms), R1;
- One I.R.C. 1200 ohm, 1 watt, R2;
- One I.R.C. 400 ohm, wire-wound potentiometer, R3;
- One .25 megohm wire-wound precision, R4;
- One .25 megohm wire-wound precision, R5;
- One .25 megohm wire-wound precision, R6;
- One .15 megohm wire-wound precision, R7;
- One 90,000 ohm wire-wound precision, R8;
- One 9,970 ohm wire-wound precision, R9.

MISCELLANEOUS

- One single flashlight Cell, B;
- One Double-pole, double-throw toggle switch, SW1;
- One Centralab Single-pole, eleven-position rotary switch SW2;
- One Weston Model 301, A.C., D.C. 400 micro-ampere meter.

Wiring diagram for the Volt-Ohm Meter is given below.

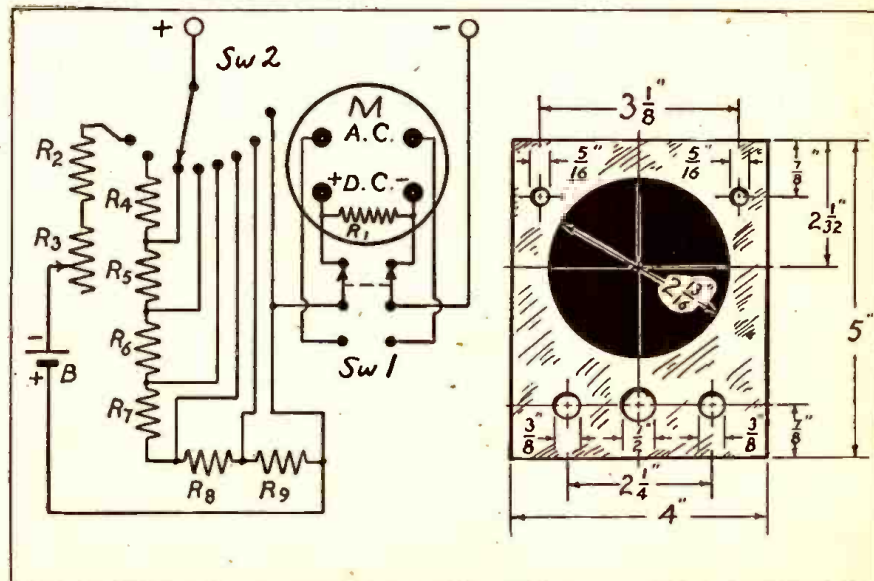

"Magic-Eye" Tube Voltmeter

● IN Britain, priorities have made it difficult for amateurs and experimenters to secure the usual types of moving coil meters. Therefore these classes have been turning to the use of the *magic-eye* tube and a calibrated dial in order to make measurements, as reported by J. C. G. Gilbert in *Electronics and Television & Short-Wave World*.

The author states that a "magic-eye" indicator consists of a high- μ triode tube directly coupled to a small cathode-ray or "magic-eye" tube.

The circuit is basically as shown in Fig. 1. When the grid bias of the triode section is zero, the target shadow is at its greatest width and as the triode grid becomes more

employed, the infinite impedance detector is recommended.

As Fig. 1 shows, a triode of minimum impedance is used and the external load consists of a resistance in the cathode circuit, thus much negative feedback is obtained and the tube operates as a "plate curve" detector.

The input resistance is therefore negative if gRC/Cgc is greater than $(1 \text{ plus } R/Ra)$ where g and Ra are the mutual conductance and A.C. resistance of the tube. At radio frequencies the value of the bypass condenser can be about C equal 10μ mmf. and the cathode resistance R equal 50,000

and will resonate at some frequency it is desirable to use a small mica dielectric condenser in parallel having a capacity of about 0.001 mf.

The plate circuit is at ground potential from a signal viewpoint, and is bypassed to ground by the 16 mf. electrolytic condenser; and, for the same reason as given above, with a small mica condenser of about 0.002 mf. The cathode load is actually a 50,000 ohm potentiometer and the whole or a portion of the rectified signal is passed to the control grid of the magic-eye indicator.

If a signal is applied across the input terminals, either A.C. or D.C., of a suitable value—0.2 to 200 volts—the plate current flowing through the cathode resistance will increase by an amount that is substantially proportional to the D.C. or peak A.C. voltage applied. The action is similar to that of the diode-condenser rectifier, except that practically no power is drawn by the negative-grid input circuit.

In the case of D.C. voltages being applied, it is necessary that the positive side of the potential be applied to the grid input terminal, while in the case of A.C. voltages, the rectification occurs on the positive half-cycle and the cathode condenser is charged up to the peak value of the signal.

The 1-megohm resistor in series with the grid of the magic-eye indicator is necessary to prevent any damage to the tube due to excessive grid current. Immediately the tube runs into grid current, the IR drop across the resistor automatically biases the tube so that the grid current cannot rise to a high value.

The rise in the positive polarity at the cathode end of the potentiometer causes the shadow angle of the indicator to increase, and by adjustment of the bias potentiometer in the cathode circuit of the indicator, the increase can be cancelled out. Thus if the bias potentiometer is calibrated in volts, both A.C. and D.C., and the shadow is always brought back to the same point, the potentiometer is measuring the value of the applied signal. The necessary plate potentials for V1 and V2 are obtained from a conventional full-wave rectifier circuit, except that due to the small currents that are required to operate the tubes, *resistance-capacity* smoothing is used.

The degree of accuracy that can be obtained from an instrument of this nature is dependent on the accuracy of cancellation of the pattern on the fluorescent screen. D.C. voltages between 0.2 and 10 can be read to a figure better than 0.1 volt, and between 10 and 100 with an accuracy of plus or minus 1 volt. The meter requires separate calibration for A.C. voltages, but the degree of accuracy is comparable to that of the D.C. range.

The construction of the meter is quite simple and the chief precaution to be taken is the mounting of the input tube and keeping the input lead as short as possible. In the meter shown, the grid prong of the socket is within an inch of the mount. The 10,000 ohm potentiometer in the cathode circuit of the indicator is mounted on the chassis, and usually it will be found that once it is accurately set, it requires little further adjustment.

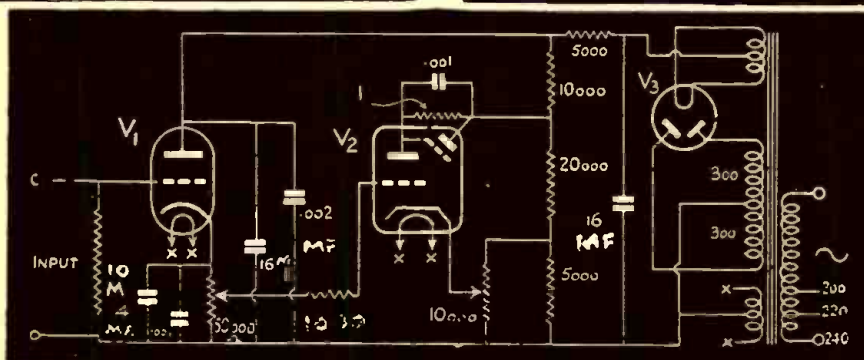
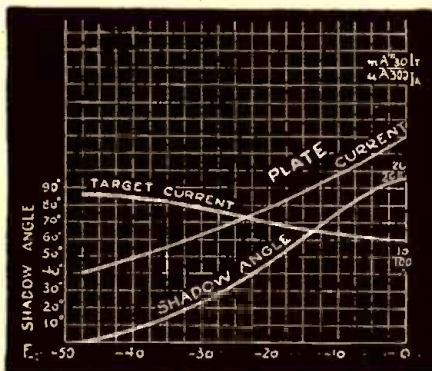
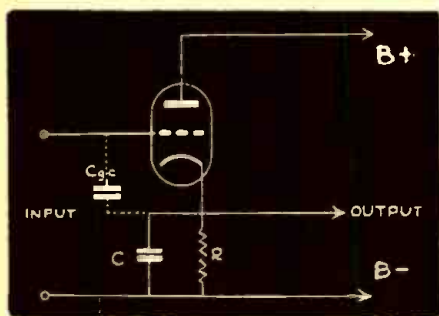

Fig. 1. Top left—fundamental circuit. Fig. 2. Top right—relation between shadow angle plate current and target current. Fig. 3. Lower diagram—complete "Magic-Eye" tube voltmeter.

negative (reducing the plate current and increasing the plate voltage and therefore the deflector plate voltage) the shadow becomes smaller. The 1 megohm resistor between the triode plate and target maintains the triode plate always negative in respect to the target, and the changes of potential create changes of shadow angle. Usually a negative voltage of 6 to 8 volts on the triode grid will completely close the shadow angle, while greater voltages may cause the edges of the shadow to overlap and produce a bright line.

Therefore, if the shadow angle be controlled by changes in the value of the applied D.C. voltage, the device can be calibrated directly in terms of voltage, having practically infinite input resistance and drawing no power from the circuit being measured. The actual variation of the shadow angle plate current and target current in respect to the triode grid potential are shown in Fig 2. It will be seen that a change of 4.8 volts will open the shadow by 90 degrees and the plate current is practically proportional to the shadow angle. Of the various types of rectifier that can be

resistance of some 10,000 ohms and a "g" of about 3.5. At audio frequencies, however, it is necessary to increase the value of the condenser C considerably, so that it is charged up to the peak value of the rectified signal.

By the use of suitable values of components in the circuit of the complete instrument shown at Fig. 3, a V.T. voltmeter covering a range of A.C. or D.C. potentials from 0.2 to 200 volts can be designed. Its frequency range is from zero to about three megacycles, although the attenuation at high frequencies may require special calibration. The input circuit of the triode is completed to ground by a 10-meg. resistance so that the grid is always at ground potential when no input is applied to the tube.

Across the cathode resistor of 50,000 ohms are two condensers in parallel. The value of the large condenser is dependent on the lowest frequency that one wishes to deal with, and 50 cycles can be regarded as the most usual figure. This condenser will then require a value of 4 mf., and a high insulation resistance; therefore a good paper dielectric will be necessary. As all types of condensers offer some inductive component,

TRANSCASTER

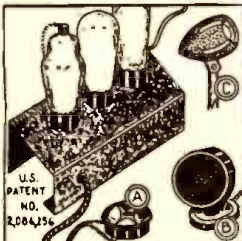

WIRELESS! Hundreds of practical applications. Will broadcast voice or music from any room or floor in home, office or store in a m.c. building **WITHOUT CONNECTING WIRES!** Operate from any lighting socket. Transmit your favorite recordings thru any radio without connections between radio and phonograph. Your radio becomes a public address or inter-communication system with a Transcaster.

Home broadcasting without wires. Great fun for parties, auditions. Use as a detective device to listen to secret conversations. A few other uses include wireless nursemaid, pipe line tracer, mind reader, trick ventriloquist, bingo announcer, talking dog, etc. Impossible to enumerate many other uses in this limited space. Transcasters are completely wired, laboratory tested and ready to use. All fully guaranteed as to materials and workmanship and also against damage in transit.

DE LUXE MODEL TRANSCASTER-TRANSMITTER Powerful, high-gain device engineered so that it will transmit high-fidelity music without connection wires to remote radio set. No sacrifice of quality or power. Operates from a.c. or d.c. Frequency range 1500 to 1750 **\$4.95** (Set of 4 Matched Tubes for Deluxe Model) **\$1.95**

SPECIAL 5-TUBE TRANSCASTER This ultra-efficient device has been engineered especially for advanced experimental and professional uses. Employs two extremely high-gain pre-amplifier stages ahead of the audio modulated oscillator. When used with crystal microphone it will pick up and transmit a whisper, with mike concealed anywhere in room. Suitable for special police work, for use with recorders, etc. Price, complete with 5 tubes, ready to plug into any a.c. or d.c. outlet (less **\$15.00** mike)

TRANSCASTER ACCESSORIES Dynamic Microphone, 50 db. (Fig. B) **\$2.95**, 525 List Wide Range Response Crystal Mike (Fig. C) **\$5.95** High Impedance Crystal Pickup **\$3.45**; Earphone Mike (Fig. A) **\$1.25**.

TELEJECTOR

RADIO'S MOST AMAZING ACCESSORY Picks up telephone conversations without tapping wires. Merely place device near telephone instrument or wire and listen to both parties to any telephone conversation through the loud speaker of your radio. Works from any a.c. or d.c. outlet. Complete with tubes, ready to use **\$7.50**

H. G. CISIN, Chief Engineer
ALLIED ENGINEERING INSTITUTE
91 Warren St., Dept. 82, New York, N. Y.

WAR-TIME REPLACEMENT CONDENSERS

Cornell-Dubilier Elec. Corp.
South Plainfield, N. J.

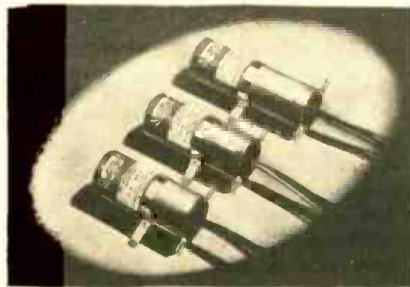

• IF only one type of filter capacitor is to be carried in stock, it should be a type having wide adaptability so far as the method of mounting is concerned in order that it can serve as a suitable replacement for box, tubular or can types. The accompanying illustration shows such a universal unit, the Cornell-Dubilier Type EZ. This is equipped with both mounting feet for vertical mounting and with a strap for under-chassis mounting. Yet in spite of this complete flexibility in application it is as inexpensive as any available good quality capacitor of like ratings. In addition to the two values of capacity, it will probably be desirable to stock units of two voltage ratings, although the difference in cost between the 250-volt and 450-volt-units is a matter of only a few cents and many service men deem it worth while to stock only the higher value.

In addition to its other advantages, such a universal capacitor is easy to add to a chassis, where its purpose is to replace a single burned-out section of a multiple capacitor unit.

It is the application of such ideas as these that helps the practical serviceman to economically maintain a supply of parts on hand adequate to meet the present emergency market conditions, thus insuring him the ability to render prompt good-will-building service to his customers and saving him many "procurement" headaches.—*Radio-Craft*

HIGH-FREQUENCY IRON CORE DATA

Henry L. Crowley & Co., Inc.
1 Central Avenue, West Orange, N. J.

• **FACTS, figures and curves** dealing with the electrical and mechanical characteristics of various "high-frequency" powdered iron materials and cores has just been released by Henry L. Crowley & Co., Inc., 1 Central Ave., West Orange, N. J. The information is in loose-leaf form so that it may be added to from time to time as new powdered iron materials and new core shapes are made available. Due to the highly technical and specialized nature of the data, it is being made available only to engineers engaged in professional radio or allied work, writing in on their business stationery.—*Radio-Craft*

DESIGN PRECAUTION FOR OSCILLATORS

RCA Manufacturing Co., Inc.
Harrison, N. J.

• **EXPERIENCE** with filament-type acorn tubes as oscillators in transmitting equipment has shown that, under some conditions of operation, oscillation may continue after the filament voltage has been removed unless the plate voltage is also removed. When the filament voltage is removed from an oscillator tube having particularly low filament power consumption, continued oscillation frequently takes place because of continued heating of the filament by the plate current.

Continued oscillation has been found most likely to occur (1) with a tube having high emission capability, (2) with an exceptionally well-designed circuit, and (3) with a high value of oscillator plate current; it has been observed with oscillator tubes operated at moderate values of plate voltage and current.

Because of these results in the laboratory and

in the field, it is recommended that both the filament voltage and the plate voltage of filament-type miniature, GT, and acorn oscillator tubes used for transmitter purposes be removed when equipment employing these types is "shut down." Usually, a convenient method is to break the minus filament and the minus plate supplies with a single, double-pole switch.

The recommended procedure insures that the oscillator will always stop functioning in the "off" position, saves B power, and avoids interference with reception in combined transmit-receive equipment.—*Radio-Craft*

TAPE SOUND RECORDER

Jefferson-Travis Radio Mfg. Co.
380 Second Ave., New York, N. Y.

• **THE Jefferson-Travis Radio Mfg. Corp.** of New York has taken over the manufacture and is conducting the sales activities of the Fonda AV Tape Recorder, a new type of portable equipment which makes use of non-inflammable acetate film as a means of permanent high fidelity reference recording and automatic play-back.

This equipment is particularly suitable for use in broadcasting studios, Army and Navy offices, business offices, police departments, court houses, and in many other cases where a continuous recorder operating for periods of up to four hours without supervision is desired.

Consisting of a recording and play-back mechanism, an amplifier, and a microphone, contained in a sturdily constructed lightweight carrying case, this Recorder may be put into operation by merely plugging in the power line to a convenient electric outlet and connecting the recorder to a radio or telephone line, or else to a microphone.

The recorder play-back mechanism is constructed to the close tolerances of precision standards and is therefore capable of continuous and exacting service without frequent maintenance attention. Once put into operation it will record through a normal eight hour day without supervision, save for the changing of the tape

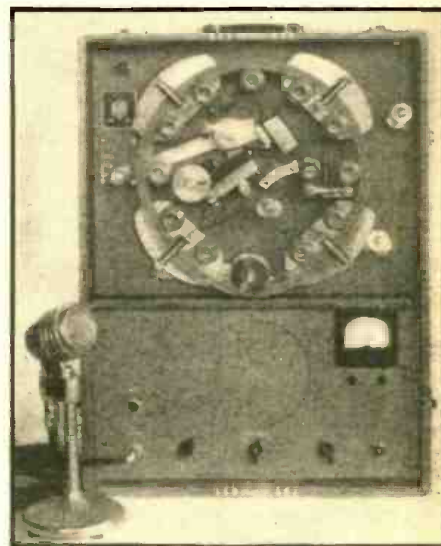

at the end of four hours. Since the title of all reference material can be marked directly on the tape and its filing carton, an easy access may be had to any recording through the use of a file index.

Both shavings and the necessity of changing needles are eliminated; reproduction is exceptionally quiet, distinct, and free from surface noise.—*Radio-Craft*

NEW 4,000 PLAY NEEDLE

The Duotone Company, Inc.
799 Broadway, New York, N. Y.

• **A NEW 4,000 play needle** has just been developed by the Duotone Company. The new "Lifetone" needle adds to the widely varied Duotone line a super playback needle that is guaranteed to give at least 4,000 perfect playings. Quality has not been sacrificed to longevity here for the "Lifetone" needle maintains brilliant highs, while holding surface noise to a new low.—*Radio-Craft*

QUICK, EASY WAY TO TRAIN FOR RADIO in 8 WEEKS

H. C. Lewis
I'LL FINANCE YOUR TRAINING
Mail the Coupon TODAY and I'll not only tell you about my quick, easy way to train for a good pay job in Radio, Television and Sound, BUT, I'll also tell you how you can get it and pay for it, in Easy monthly payments starting 60 days after 8 weeks' training period.

LEARN BY DOING
On Real Equipment in Coyne Shops
Simple, easy method of Practical Training. You don't need previous experience or a lot of book learning. You work on real equipment in the Coyne Shops at Chicago. This 8 weeks training prepares you for a job in service and repair work—we also offer radio operating training. Full details of this training will also be sent you when you send coupon.

EARN WHILE LEARNING, Job Help After Graduation
We help you get part time work to help with living expenses and then give you employment service after graduation.

H. C. LEWIS, President,
Radio Division, Coyne Electrical School,
500 S. Paulina St., Dept. 32-8H, Chicago, Ill.
Dear Mr. Lewis:
Please send me your Big FREE Book, and details of your PAY-AFTER-GRADUATION-PLAN.

NAME.....
ADDRESS.....
CITY..... STATE.....

SEND COUPON TODAY

Many FM and Television Articles Valuable to Students Appeared in back numbers. See List in recent issues or write for list.

AUTO RADIO-RECEPTION

(Continued from page 476)

On antenna-equipped cars, it may be necessary to install a length of shielded braid over the antenna lead-in up into the roof structure; the shield should be grounded to the frame with the same screw that holds the glove box in place.

Auburn 1930, 1931: Thoroughly ground (on both top and bottom) the aluminum plate which houses the distributor. Use a length of braided shield fastened to one of the motor-block bolts.

By-pass condensers are required on the ignition coil, ammeter and generator. If interference still persists, connect by-pass condensers between each of the battery terminals and the instrument panel.

Auburn 1934: The ignition coil by-pass condenser should be connected to the terminal of the coil to which the yellow lead is attached. It is also necessary to connect a by-pass condenser at the generator. The antenna lead-in wire should be shielded as completely as possible, so that none of the lead-in wire will be exposed behind the instrument panel. It is advisable to even cover the point where the aerial wire from the receiver is spliced to the lead-in, using a piece of shielding sleeve which fits over the regular shield and which can be slid over the splice after it is made. The ends of this shielding sleeve should be tightly taped so that it makes good contact with the rest of the shielding braid from both the lead-in and the lead from the receiver. The shield should be grounded at the point where it enters the corner post.

Also ground the windshield wiper pipe at the point where it passes through the dashboard, and insert a dome-light filter at the point where the dome-light lead enters the right front corner post. The filter may consist of a choke coil (about 12 to 20 turns of No. 18 wire wound on a 1/2" or 3/4" form) connected in series with the dome-light lead and by-passed to ground with a 0.5-mfd. condenser.

In some cases, it may be necessary to eliminate the spark-plug suppressors and to include an additional by-pass condenser from one side of the ammeter to ground.

Auburn 1935: Suppressors are necessary at the spark plugs and the distributor. By-pass condensers are required at the ignition coil, ammeter and generator. The lead-in should also be carefully shielded, as outlined above for the 1934 models.

Auburn 1936: Install suppressors at the distributor and spark plugs, and by-pass condensers at the generator, ignition coil and ammeter. Install a dome-light filter as explained above for the 1934 models, grounding the filter to the bulkhead. The hood should be bonded with flexible bonding braid and grounded to the bulkhead. Connect dome-light filters in all 3 tail-light leads (which run across the top of the car and come down the left-hand front corner post). In some cases, removal of the distributor suppressor may actually improve reception.

BUICK

General: Ground the spark-plug cover with flexible braid to the water pump nut and to the oil lines at the rear of the motor. In some cases, it may be necessary to install a copper screen enclosure from the spark-plug cover over to the distributor, enclosing all the high-tension leads in between. Both ends of this enclosure should be bonded to the motor block.

Install a dome-light switch between the ammeter and the dome-light at the left-hand side of the dash. It may sometimes be necessary to shield the dome-light wire, grounding the shield at both ends. If this does not help, use a choke coil (consisting of 12 to 20 turns of No. 18 wire wound on a 1/2" or 3/4" form) in series with the dome-light lead, and by-pass the choke to ground with a 0.5-mfd. condenser. Install a strip of copper screening under the toe boards and floor boards, and ground the screen to the car frame.

By-pass condensers are required on the ammeter and generator. Spark-plug suppressors may not be required in this car; they may actually increase the noise level.

Buick 1933: Ground the dome-light filter shield wiper tubing, as well as the small metal braces on both sides of the windshield, should be grounded. The lead-in wire should be grounded to the nut on the upper instrument panel bolt, and again at the top of the door post. Check for loose body at conventional points.

Buick 1933: Ground the dome-light filter on right corner post. Install by-pass condenser on dome-light switch. Ground lead-in shield at point where it enters the car post. Add a 0.5-mfd. by-pass condenser from starter relay switch located on left side of dash. Ground windshield wiper tubing at each end.

Allied's New 1942 Spring and Summer Catalog

● ALLIED RADIO CORPORATION, Chicago, announces the release of a new 1942 Spring and Summer catalog.

The new edition is a complete catalog in itself, offering "Everything in Radio and Electronics" from a single source of supply. It is excellently planned and organized for quick reference.

Of outstanding interest is the radio set section covering forty-two KNIGHT 1942 models, setting new high standards in design and improved features. Included are plastic and wood models, consoles, FM combinations, auto sets, farm radios, phono-players and radios, recorders, and a complete section of recording and phono accessories.

A varied line of P.A. sound systems and inter-communication units for all requirements is illustrated. There is a range from 7 to 60 watts with all the new features, improved tonal quality, and greater usable output.

10 BEST RADIO BOOKS 10 CENTS EACH

RADIO FANS EVERYWHERE—these fine ten cent text books give you an excellent foundation for the study of RADIO. They are clearly written, profusely illustrated and contain over 15,000 words in each book. You'll be

- No. 1—HOW TO BUILD FOUR DOERLE SHORT WAVE SETS
- No. 2—HOW TO MAKE THE MOST POPULAR ALL-WAVE 1- AND 2-TUBE RECEIVERS
- No. 3—ALTERNATING CURRENT FOR BEGINNERS
- No. 4—ALL ABOUT AERIALS
- No. 5—BEGINNERS' RADIO DICTIONARY
- No. 6—HOW TO HAVE FUN WITH RADIO
- No. 7—HOW TO READ RADIO DIAGRAMS
- No. 8—RADIO FOR BEGINNERS
- No. 9—SIMPLE ELECTRICAL EXPERIMENTS
- No. 10—TELEVISION

BOOKS ARE ALL UNIFORM

Every book in the GERNSBACH EDUCATIONAL LIBRARY has 32 pages—with illustrations varying from 30 to 66 in number. Each title volume contains over 15,000 words. Positively radio's greatest book buy! If you do not think these books worth the price asked, return them in 24 hours and your money will be instantly refunded.

RADIO PUBLICATIONS • 25 WEST BROADWAY • NEW YORK, N. Y.

RADIO PUBLICATIONS, Dept. RC-4-42
25 WEST BROADWAY, NEW YORK, N. Y.

Gentlemen: Please send immediately, POSTPAID, the book numbers circled below. I am enclosing cents —each book being 10c.

1 2 3 4 5 6 7 8 9 10
NEW NEW NEW NEW NEW NEW NEW NEW NEW NEW

Send FREE listing of 48 new 10c publications.

Name Address

City State

Remit by check or money order—register letter if you send cash or unused U. S. postage stamps.

MAIL COUPON TODAY!

DO YOU NEED
RADIO/ELECTRONIC ?
PARTS IN A HURRY ?

Save time—

Call **HARRISON** First
Worth 2-6276

HARRISON RADIO CO.
12 WEST BROADWAY - NEW YORK CITY

DATAPRINTS



TESLA-LOUDIN COILS

- 20c Ea. in order for 10 (Data and Drawings only.)
- 36" Sp'k Tesla-Oudin Coil 40c (1 K.W. Exc. Trf. Data incl.)
- 8" Sp'k Tesla-Oudin Coil 40c (1/4 K.W. Exc. Trf. Data incl.)
- 8" Sp'k Oudin; 110 Vt.
- "Kick Coil" type 40c
- 3" Tesla Works on Ford Coil 40c
- 1" Sp'k Vibrator Hi-Freq. Coil 40c

NEW! 5 ft. Sp'k. Oudin Coil & Exciter
Data 75c



Induction PIPE & ORE LOCATOR

Induction Type, Data 40c
Radio Type 40c

More DATAPRINTS 40c each!

- 5 Meter Superhet.
- 1/2 Meter Tr. & Rec.
- 20 A.C. Probs. & Ans.
- 20 Telephone Hook-ups
- 100 Mech. Movements
- 20 Motor Hook-ups
- Television Hook-up
- 20 Elec. Party Tricks
- Solenoids and Magnets —get list.
- Fry Eggs on Ice!
- Experimental Photophone
- Radio Control for Models
- Diathermy Apparatus
- Inductor Organ
- Electric Refrigerator
- Wheatstone Bridge
- Weld. Transf. 2 K.W.
- Rewinding Armatures
- String Galvanometer
- 20 Simple Bell Circuits
- Steel Wire Recorder!
- Water Wheels
- Water Turbines
- Photo Cell and Relay
- Ring 4 bells: 2 Wires
- 20 Tesla Tricks
- Polarized Relay
- Induction Balance
- Electric Pipe Thawer

Special Prices: 4 prints \$1.00; 10 for \$2.00; Single, 40c each. Get New Catalog 100 A.

The DATAPRINT Co.
Lock Box 322D, Ramsey, N. J.

DEFENSE 112 Mc.

U. H. F.

Super-Regenerative
TransceptorRICARDO MUNIZ, E.E., and GEORGE SHALER,
W2MGP.

This low-power combination transmitter and receiver will be found very useful for local defense work. It must be operated only under the supervision of a licensed amateur radio operator with special permit to operate it under war-time F.C.C. rules.

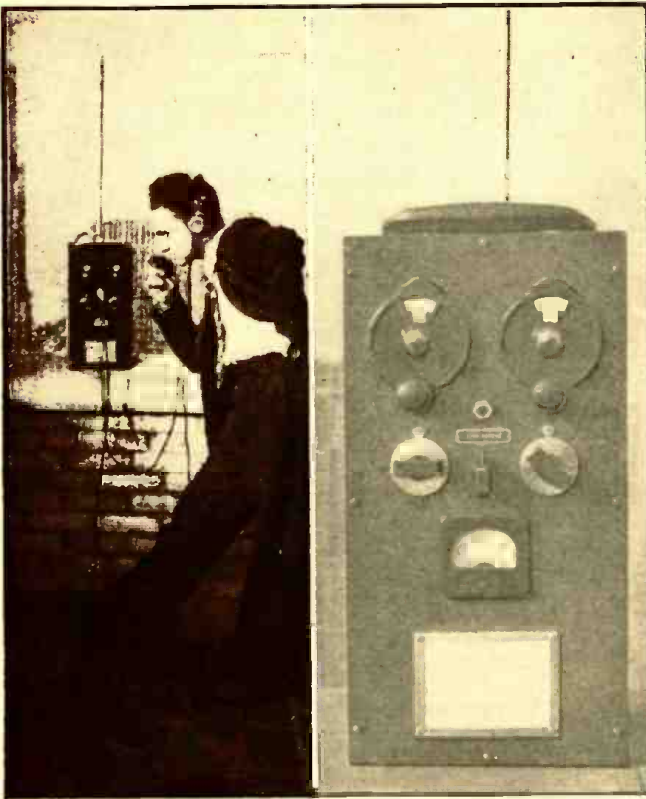

Two views of the 112 mc. Transceptor.

INSPIRED by the frequent use of the "Walkie-Talkie" in modern army maneuvers the authors developed this Transceptor which they felt would outperform the average Ham transceiver. Using the newly developed Hytron 114-B tubes it has proven equal to their fondest hopes.

During preliminary tests (before War was declared) the first CQ was answered and subsequent CQ's were usually effective. Amateurs over a goodly area around the operating location were QSOed and Q5 R9 reports were the rule.

Choice of Circuit: The "Minute Man" type of circuit was chosen after exhaustive tests of various others including the so-called "Electron-Coupled" variety. It was found that better output, as well as higher sensitivity and stability were obtained with the circuit chosen. The "Minute Man" is a variation of the old dependable Hartley and is used in both the transmitter and receiver sections. Positive operation and ease of adjustment further recommend it. It was decided to use a separate detector and transmitting oscillator. This arrangement permits operation of receiver and transmitter on different frequencies, allowing rapid switch-over from transmit to receive regardless of the frequency of the station being communicated with. This arrangement also permits the adjustment of the transmitter for maximum output and the receiver to maximum sensitivity, instead of striking a compromise as in the average transceiver.

The transmitter speech input system has high "gain," permitting the operator to speak much farther from the mike with full modulation of output than is usually possible. The extra gain of the audio system, of course, does no harm when used in conjunction with the receiver, since it makes the received signals louder.

ANTENNA

An end-fed Marconi type antenna was employed, which gives the desirable feature of low angle radiation. Amphenol flex-

ible co-axial cable was used to feed the antenna, thus making for very high efficiency.

The circuit constants were so chosen as to give a wide band-spread (approximately 80°) on both the transmitter and receiver sections. The coils were so proportioned as to give identical tuning dial calibrations on both xmtr and receiver sections when adjusting to the same frequency.

Construction Hints: As is the general rule in all construction involving ultra high frequency equipment, great care is necessary in choosing the placement of parts and the routing of leads, if stability of operation and efficiency are to be achieved.

KEEP LEADS SHORT

It is very important that the coils should all be mounted in positions well removed from the walls of the cabinet, so as to maintain High Q and retain efficiency. Leads carrying R.F. should be kept just as short as possible. The grounds for both the transmitter and receiver section should be brought to a common terminal. That is to say there should be a ground for each, but all parts requiring grounding, such as bypass condensers, should be brought directly to this common ground and not grounded to the chassis at the nearest point. With a little study it will be found possible to accomplish this without breaking the other cardinal rule of short leads. Proper placement of parts is of paramount importance. Before drilling the chassis it is desirable to place all the parts on it and to shift them around until the optimum adjustment is found.

Shielded-leads are to be used to the controls for audio gain control and super-regen. control. In the case of the audio control this prevents introducing audio frequency feed-back and therefore oscillation into this circuit. Shielding the regeneration control keeps the quench voltage out of the audio system, which would give rise to howling and erratic operation.

All but two plates must be removed from the National UM-15 condensers in order to obtain the proper band-spread. The remain-

ing plates are adjusted by bending to give the 80° band-spread and to get the two tuning dials to "track" on the nose.

Mallory bias cells were used and are recommended for bias source in the audio system. Improved output is obtained since the usual drop caused by cathode bias has been eliminated. Improved audio quality is obtained because of the unvarying bias.

It is important that all the parts be mounted absolutely solidly, as any vibration will cause shifts in frequency! The importance of this point cannot be overemphasized.

OPERATION HINTS

Once you have bent the condenser plates properly, having made the coils according to the specifications given, you will have the two tuning dials (one for receiver and one for xmtr) tracking. There should be no trouble in getting the transmitter oscillator to function if the parts specified are used. In operating the receiver section it is necessary to advance the regeneration control until the normal "rushing" sound is heard. Turning the dial should then bring in various stations, providing the antenna has been extended the proper distance to approximate one-quarter wave-length. Since this transceptor is designed for 112 mc. operation this will be approximately 2 ft.

The transmitter section normally draws about 4.9 ma. When properly modulated the meter reading will change π or -0.2 ma. If you talk too close to the mike or have the gain up too high, more violent changes in plate ma. will be noted. It is desirable to avoid over-modulation as this will decrease intelligibility.

One of the superior features of this transceptor is the ease of switching. The switch has three positions: Receive — Off — Send. It switches A power, B power, antenna, illuminators, detector and oscillator filaments, also audio from receiver to transmitter.

A three-way jack is provided for the phones and mike. A French type (hand-mike) unit is convenient to use.

COIL DATA: Both coils are for use on two and a half meters (112 mc.). They

consist of 5 turns of No. 14 tinned copper wire on a 1/2" diameter form (form is later removed). They are spaced to occupy 3/4".

Parts List

CORNELL DUBILIER:

- 6 1/2—.01 Mf. cond's—DT 4S1
- 1 .5 Mf. cond's—DT 4P5
- 2 50 Mmf. cond's—5W 50S
- 1 .002 Mf. cond's—1W 5D2
- 1 .006 Mf. cond's—1W 3D6

AMPHENOL

- 5 feet of small co-axial cable—76-225
- 4 shield clamps—72-25
- 1 jar coil dope-liquid 912—53-2

HYTRON

- 2 type HY-114 D tubes
- 1 type 1H4G tube
- 1 type 1E7G tube

AMERICAN RADIO HARDWARE

- 1 microphonic: Shure Bro. Xtal "Hand-mike" type—750-B

1 pair head-phones (about 2000 ohms); or 1-1000 ohm phone, if built into a French hand-mike set

MALLORY

- 1 8-circuit 5-position switch—1345L
- 1 package of 1 1/4 volt bias cells
- 1 grid-bias cell holder—4-cell—GB4
- 1 grid-bias cell holder—2-cell—GB1B

I.R.C.

- 1 15,000 ohm 1W res.—F-1
- 1 5 meg ohm 1/2W res.—F-1/2
- 1 6 ohm WW pot.—W-6
- 1 100,000 ohm pot.—CS 11-128
- 1 500,000 ohm pot.—CS 13-133

THORDARSON

- 1 Push-pull interstage transformer—T-13A36
- 1 Plate impedance coupling choke—T-37C36
- 1 Plate impedance coupling choke—T-13C26
- 1 Transceiver transformer—T72A59

NATIONAL

- 2 Dials with No. 1 clockwise scales—BM Dial
- 2 Dials—HRO Dial

- 2 Padding condensers—M30
- 2 Illuminators for Bm dial
- 2 15 Mmf. variable condensers—UM-15
- 2 plug-in sockets—XB-16
- 4 plug-in bases—PB-16
- 2 tube shields—T78
- 4 octal sockets—CIR-8
- 1 chart frame—Size "B"

PAR-METAL

- 1 standard steel cabinet—PC-1576
- 1 chassis for above—PC-15760

BUD

- 2 U.H.F. chokes—CH-925
- 1 "send-receive" name-plate—N-1150
- 1 3 circuit microphone jack—J-1058
- 1 phone plug—FP-284
- 1 box of insulated shafts—SE-1055

TRIPLETT

- 1 2" square 0.5 ma. meter—227A
- EVEREADY
- 3 45 volt "B" Mini-max batteries—482
- 2 1 1/2 volt "A" batteries—741

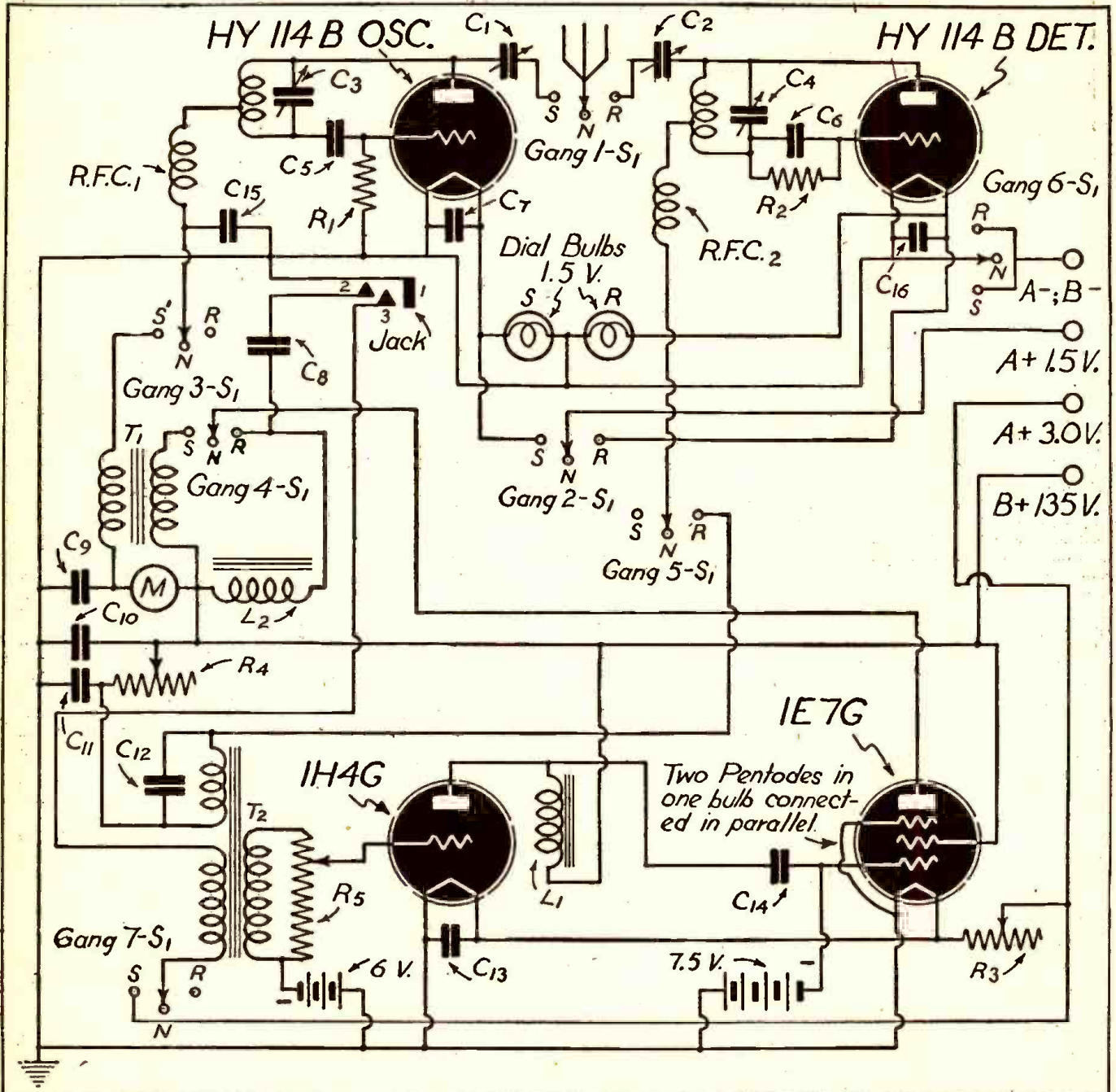

RESISTORS

- 1—15,000 ohm, 1 watt, R1
- 1—5 megohm, 1/2 watt, R2
- 1—6 ohm, wire-wound rheostat, R3
- 1—100,000 ohm potentiometer, R4
- 1—500,000 ohm potentiometer, R5.

CONDENSERS

- 2—3-30 mmf. trimmers, C1 and C2

- 2—15 mmf. variables, C3 and C4

- 2—.0005 mf. Micas, C5 and C6
- 4—.01 mf. papers, C7, C8, C9 and C10
- 1—.5 mf. paper, C11
- 1—.002 mf. mica, C12
- 2—.01 mf. paper, C13 and C14
- 1—.006 mf. mica, C15
- 1—.01 mf. paper, C16

TRANSFORMERS

- 1—Modulation transformer, T1, (see text)
- 1—Transceiver transformer, T2.

MISCELLANEOUS

- 2—Plate impedance coupling chokes, L1 and L2 (see text)
- 1—Triplet, M (0.5 Ma.)
- 1—Switch, 8 P.S.T., S1, (see text)
- R.F.C.1, R.F.C.2 (see text).

are basic time-controlled units, that can be translated into the formation of perfect characters, so vitally necessary to perfect sending. The user of the "bug key" will find no handicap in mastering this control, and the beginner will be forced to make good characters, or else not make them at all, for remember *control* is the thing! A further check of the unit can be had by connecting an ohmmeter across the key-jack, and if the needle of the ohmmeter flips in exact accordance with the relay in the unit it is okay. Better yet connect it to a transmitter which is connected to a dummy antennae, and check the keying on the receiver. If it is desired to use a straight hand key, merely plug one into the three-circuit jack and go ahead after having turned the cathode controls to zero. Microphone cable was used throughout for the key lines, with all outside conductors connected to the grounded side of the unit.

The author feels that this unit is well worth the cost and effort, when you get so many associated units rolled into one. Any communications concerning this article will be answered in a stamped self-addressed envelope, although it is contemplated none will be necessary.

Parts List

- 1—Loudspeaker, Utah 3P
- 1—Relay, 5,000 ohm coil, SPDT, Staco MR-5 or Staco T-63-F
- T1, Power transformer, Stancor, P-6011
- T2, Audio, interstage, 3-1 ratio, Stancor, A-4774
- T3, Universal output trans., Stancor, A-3870
- Ch, A.C.-D.C. filter choke, Stancor, C-1080
- C1, 16 mfd. midjet electrolytic, 450 volt rating, Cornell-Dubilier, BR-1645
- R7, 10,000 ohms, I.R.C. type BT
- C2, 16 mfd. midjet elec., 450 V, Cornell-Dubilier, BR-1645
- C3, 10 mfd. midjet elec., 25 V, Cornell-Dubilier, BR-102A
- C4, and C5, .01 mf. paper tubular, 400 V, Cornell-Dubilier, MD-851
- C6, .25 mfd. paper tubular, 450 V, Cornell-Dubilier, DT-4P25
- R1, 3,000 ohm wire wound pot., Centralab, VF-133
- R2, 2,000 ohm wire wound pot., Centralab, VF-131
- R3, 100 ohm wire wound pot., and SW, Centralab, VF-121 plus switch
- R4, 40,000 ohm 1 watt, I.R.C. type BT
- R5, 3,000 ohm, 50 watt, I.R.C. type EP
- R6, 750 ohm 2 watt, I.R.C. type BT
- P1, Pilot light assembly, Mallory, type 310-G
- J1, Three-way jack, Mallory, type 3B
- J2, Ordinary open-circuit jack, Mallory, type 701
- Misc., 2 five-prong Amphenol sockets, 1 four-prong Amphenol socket, 2 male 110 plugs and metal caps, 1 female 110 socket, (both of Amphenol make). A 3-way plug with metal shell for the key connection to the unit., Mallory 76-A. wire, screws, etc. One Par-Metal amplifier foundation unit No. DF-510. Four felt mounting feet. One handle on the foundation unit may be placed on the top of the cover to make it more readily portable, the other left off.

Hams Are Asked to Sell Sets

RADIO hams are being asked to sell their transmitters and receivers for use by the armed forces of the United Nations, according to an announcement by the American Radio Relay League, which is centralizing information on available apparatus on behalf of the government agencies concerned.

Only commercially-manufactured communications-type receivers and transmitters for which standard instruction manuals are available are required at present. Such equipment is more readily used and understood by military operators than homemade units, even though the latter may be of comparable quality, it was explained.

Urgent shortages of communications equipment required for defense needs led to this call.

Amateurs willing to turn over their apparatus to their country are requested to advise the ARRL at West Hartford, Conn., giving model number, condition, and the price for which it can be delivered crated to a local transportation company. Only standard manufactured equipment should be offered, it was reiterated; homemade or "composite" equipment not being required at present.

The greatest need is for transmitters.

This notice deals with a vital need, rapidly growing more critical with the developing crisis in the Pacific. This appeal is being made on behalf of U. S. Army and Navy procurement agencies, the Netherlands Indies purchasing commission and other government departments.

Send the information on your gear to the ARRL at West Hartford, Conn. Do It Now!

RADIO-CRAFT for APRIL, 1942

BOOK REVIEW

(Continued from page 487)

POWER RECTIFIERS (The Electrical Engineering Series—Volume 13), by J. Rosslyn. Published by the Chemical Publishing Company, Inc., Brooklyn, N. Y. Cloth covers, size 5½ x 8¾ ins., 200 pages, 83 diagrams and photos. Price \$2.50.

Rectifying equipment is being used to an ever-increasing extent throughout industry. Therefore this book should be included in the library of every electrical engineer.

This book deals with the theory and operation of the various types of rectifiers used in connection with railways, electro-plating plants, cinema projectors and welding and battery-charging equipment.

Details are included of mercury arc, copper oxide, selenium, and hot cathode rectifiers, while separate chapters are devoted to rotary and motor converters, frequency changers and boosters.

MATHEMATICS FOR ELECTRICIANS AND RADIOMEN (1942), by Nelson M. Cooke. Published by the McGraw-Hill Book Company, Inc., New York, N. Y. Cloth covers, size 6 x 9 ins., 604 pages. Price \$4.00.

Radio engineering students will welcome this book most strongly as it is exactly what they need to increase their mathematical knowledge and give them a sound background in this subject. This course in mathematics is directly concerned with application to electrical and radio circuits. This book will enable the students to further their understanding of the basic principles of electricity.

This textbook is intended to provide a mathematical background adequate for the solving of practically all everyday electrical and radio problems. If a student wishes to enter into the realm of higher mathematics in the study of radio and electrical design problems, he will find that this subject matter will give him a firm foundation on which to build. A student who wishes to study by himself will find this book very valuable, as the lessons are so arranged that the problems that are most difficult appear at the end of each group.

Answers are given at the back of the book; thereby making it more convenient for the home-study student.

RADIOTRON DESIGNER'S HANDBOOK, Third Edition, Edited by F. Lanford Smith. Published by the Wireless Press for Amalgamated Wireless Valve Company Pty. Ltd., Sidney Australia. Distributed by RCA Manufacturing Co., Inc. Cloth covers, size 6 x 9 ins., 352 pages. Price \$1.00.

Though this book was especially prepared for the radio set designer, it is of value to all radio engineers, amateurs, experimenters, service men and others interested in the fundamental principles of practical circuit design.

The eight chapters contained in this book cover Audio Frequencies, Radio Frequencies, Rectification, Receiver Components, Tests and Measurements, Tube Characteristics, General Theory, and Sundry Data. It is copiously illustrated and has numerous reference charts and tables. The Logarithm Table and Resistance Wire Tables are very useful.

The information contained in this book is so arranged that all those interested may derive some knowledge with the minimum of effort in searching.

THE RADIO AMATEUR'S HANDBOOK, Nineteenth (1942) Edition, by the Headquarters staff of the A.R.R.L. Published by the American Radio Relay League, Inc., West Hartford, Conn. Paper covers, 552 pages. Price \$1.00.

Due to the defense needs the general plan of this book has been revised to meet the growing need for a simple and non-mathematical, but thorough, text on the theory, design and operation of radio communication equipment, as well as to provide the constructional information on tested and proved amateur gear which has always been an outstanding feature of the book. To this end the *Handbook* is divided into two main parts.

The first section, consisting of nine chapters, starts the reader with the essential electrical fundamentals, takes him through the principles of vacuum tubes and their operation, methods

of generating radio-frequency power, transmitter keying, methods of modulation and adjustment of modulated transmitters, radio reception, means of obtaining power supply, principles of wave propagation, and finishes with a chapter on antenna systems. This part of the book is sectionalized by subjects.

The second part, dealing with the construction of equipment, has eight main chapters on the subjects of receivers, transmitters, modulation equipment, u.h.f. receivers and transmitters, portable and emergency equipment, antennas, and measuring gear.

In addition to the two main parts of the book described above, there are four additional chapters: on workshop practice, tube characteristics and miscellaneous data, operating a station, and radio regulations.

Always an especially valuable feature of the *ARRL Handbook* is the catalog section at the rear of the volume, wherein data and specifications concerning the products of approved suppliers of amateur gear are conveniently available. Constructors and designers have found it advantageous to have both the constructional guidance they seek and the needed data on available equipment between the same two covers.

HOW TO MODERNIZE RADIOS FOR PROFIT, by M. N. Beitman. Published by Supreme Publications. Soft paper cover, 32 pages, size 8¼ x 10½ inches. Price \$1.00.

This book will be very valuable to radio Servicemen during the next year or two, as not many new sets will be manufactured due to the Defense situation. It explains how to improve the appearance of any set by refinishing the cabinets, building new cabinets, or adding improvements to the old cabinets housing the radios. Hints on paints, finishes, removal of scratches are also given.

This booklet also contains suggestions for adding late improvements such as tuning eye tubes, new style tubes, S.W. adapters, push-button tuning and also recording equipment. Also instructions are given on how to eliminate hum and improve selectivity.

Every Serviceman will benefit by having this book in his possession during the next few years, when the public will have to have their old sets repaired or modernized rather than buy new ones.

PRINCIPLES OF ELECTRON TUBES, by Herbert J. Reich, Ph.D., Professor of Electrical Engineering, University of Illinois. Published by McGraw-Hill Book Company, Inc., New York. Stiff covers, size 6½ x 9¾ ins., 398 pages. Price \$3.50.

As the author points out in the preface, this book treats on radio tubes and the theory of their operation in an introductory manner, so that it is suitable as a "home study" course. The author has been careful to present the fundamental principles of operation of each type of tube. A glance at the various chapters show that the ground has been thoroughly covered by the author.

Opening chapters cover physical concepts, and basic thermionic emission. The book is illustrated with diagrams and pictures throughout. Next, the author takes up the action occurring in grid-controlled high-vacuum tubes, with characteristic curves and simplified diagrams showing the plate current relations, etc. Later sections deal with the methods of analyses of vacuum tubes; amplifier classifications; modulation and detection. We then come to some very interesting and practical subjects, treated in a comprehensive manner, including the action of vacuum-tube oscillators, glow and arc-discharge tubes, light-sensitive tubes and cells. A very complete chapter with special diagrams and descriptions appears on rectifiers and filters, followed by a section on electron tube instruments—the V. T. Voltmeter, the Cathode-Ray Oscillograph, etc.

Technical Review of Catalogs, Etc.

What to Know and How to Select the Proper Antenna—These suggestions are released by the Vertron Manufacturing Co. This catalog also describes the new series of "V" Antennae, recommended for noiseless reception of Frequency Modulation, Short Waves and Broadcast. The new 1942 catalog is available at no charge upon request. (Vertron Manufacturing Co., New York, N. Y.)

DISPOSAL SALE OF RECONDITIONED AMPLIFIERS & PARTS IN GUARANTEED PERFECT MECHANICAL AND ELECTRICAL CONDITION

Photo shows 30 watt
ampl. # 104A



All ampl. shipped
Ready to operate

#102—12 WATT PUSH-PULL 2A3 AMPLIFIER
To be used with one or two 2500 ohm dynamic speakers 16 ohm voice coil. May be changed over to use P.M. speakers. Input for magnetic pickup. Variable tone control. Schematic furnished to change unit over to use crystal pickup, crystal microphone and P.M. speakers. **\$8.75**

#102A—12 WATT PUSH-PULL 2A3 AMPLIFIER
Frequency response plus or minus 2DB. from 30 to 15,000 CPS. bass and treble boost. Inputs for phono pick-up or radio tuner. Output impedance 8 or 16 ohms to P.M. or Electro-Dynamic speakers. supplies field current for one or two 2500 ohm speaker fields. An excellent amplifier for FM or recording. **\$18.45**

Set of Matched Tubes for either #102 or #102A. 1—57, 1—56, 2—2A3, 1—5Z3 **\$1.73**
Shipping Weight 25 lbs. for either of above

#103—20 WATT PUSH-PULL 6L6 AMPLIFIER
To be used with one or two 2500 ohm dynamic speakers 16 ohm voice coil. May be changed over to use P.M. speakers. Input for magnetic pickup. Variable tone control. Schematic furnished to change unit over to use crystal pickup, crystal microphone and P.M. speakers. **\$9.85**

Set of Matched Tubes: 2—6L6, 1—6A6, 1—76, 1—5Z3 **\$1.78**

#103A—20 WATT PUSH-PULL 6L6 AMPLIFIER
Input for one crystal or dynamic microphone. Input for one crystal or magnetic phone pick-up. Full range tone control. Frequency response 30 to 10,000 CPS. Output impedance 8 or 16 ohms to PM or Electric-Dynamic speakers. supplies field current for one or two 2500 ohm speaker fields. **\$15.95**

Set of Matched Tubes: 1—6SF5, 1—76, 1—6A6, 2—6L6 **\$2.29**
Shipping Weight 24 lbs. for either of above

#104—30 WATT PUSH-PULL 6L6 AMPLIFIER
Has input for magnetic pickup, volume control, variable tone control. Supplies field current to one or two 2500 ohm dynamic speakers, output impedance 2.6, 3.2, 4, 5.3, 8, and 16 ohms. Full 30 watts output. Schematic furnished to change unit over to use crystal pickup and crystal, dynamic or velocity microphone and change over to use P.M. speakers. **\$12.05**

Set of Matched Tubes: 1—6C6, 1—6A6, 2—6L6, 1—5Z3. **\$1.78**

#104A—30 WATT PUSH-PULL 6L6 AMPLIFIER
Input for two crystal, dynamic or velocity microphones individually controlled. Input for crystal or high impedance phono pick-up. Full range tone control. Frequency response 30 to 10,000 CPS. Output impedance 2.6, 3.2, 4, 5.3, 8 and 16 ohms to P.M. or Electro-Dynamic speakers. supplies field current for one or two 2500 ohm speaker fields. **\$21.45**

Set of Matched Tubes: 2—6SF5, 1—6C6, 1—6A6, 2—6L6, 1—5Z3. **\$2.80**

Shipping Weight 26 lbs. for either of above
All Amplifiers Less Tubes & Speakers.



**JENSEN 10 INCH
ELECTRO-DYNAMIC
SPEAKER**
2500 OHM
FIELD
16 OHM
VOICE-COIL

EACH **\$2.95**

Shipping Weight 7 lbs.

ORDERS SHIPPED SAME DAY AS RECEIVED.
All goods are sent Express collect if no money for Parcel Post is included in remittance. Customers in Foreign countries are requested to remit in U. S. Currency or International Money Orders and include enough money to ship goods prepaid. Order from this ad.

25% deposit required on all C.O.D. orders.

**PEERLESS RADIO
AND SOUND CORP.**

25 S. JEFFERSON ST., Dept. 442 CHICAGO, ILL.

MAKING A SHOCKING COIL

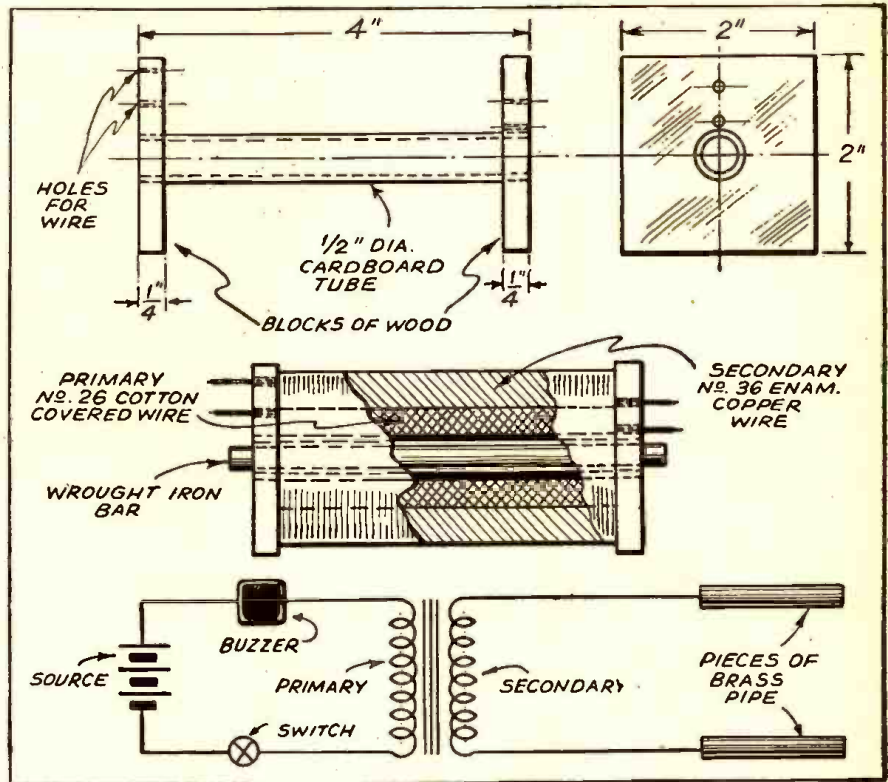

One of the simplest methods of making a "shocking" coil is shown.

● THIS shocking coil will bring enjoyment and entertainment to both young and old electricians. Simple and inexpensive, it can be built in spare time or in an evening. The shocking coil is operated on two flashlight batteries and can be made compact enough to be carried anywhere.

The coil is wound on a cardboard roller. The roller is four inches long and one-half inch in diameter. The roller must be hollow inside because a metal bar must be passed through it. If a suitable roller cannot be found one can be made by rolling up pieces of paper and gluing them together. Two blocks of wood, one and a quarter inches square and a quarter of an inch thick are glued at each end of the roller to prevent the wire from slipping off the roller. When the roller is completed it can be shellacked to make it stronger.

The primary is wound with number twenty-six double cotton covered wire. Three layers of this wire are required. If the layers of wire do not become even, a piece of heavy paper can be glued between each layer of wire. A piece of heavy paper should be placed between the primary and secondary coils. Seven layers of about number thirty-six enameled wire, are needed for the secondary. If these sizes of wire are not available, sizes close to them can be used. No smaller size wire is recommended for the secondary because of the difficulty in winding the coil. Each end of the wire should be passed through its proper hole. Before passing the wire through its hole in the secondary, twist some of the wire around the end, so that some of the danger of breaking the wire is eliminated. If in winding the coil the wire should break it should be thoroughly scraped and soldered.

When the coil is completed a piece of heavy paper should be glued over the coil. The primary, the current source, a buzzer, and a switch are connected in series. (The source is two flashlight batteries connected in series.) The secondary is connected to two pieces of brass pipe, about four inches long. The pieces of pipe are tapped and a screw placed in them, to connect the wire.

A bar of soft wrought iron either square or circular, is passed through the hole in the center of the coil. As the bar is passed through the coil the shock increases. Moving the iron core in and out will vary the degree of shock obtained. Best results are obtained by using a bundle of soft annealed iron wires for the core. To obtain a stronger shock wind on more layers of fine wire on the secondary (or use more batteries).
—Carlo Fugazzi.

COMPASS TELLS POLES OF MAGNET

● THE experimenter as well as the electrician often has to determine the polarity of magnetic poles, such as those on the field magnet of a motor, etc. A small pocket compass is very useful for the purpose, and the drawing herewith shows how it's used to determine that the magnet coils are properly connected to give poles of opposite polarity. Usually the electrician does not care which pole is north and which is south, so long as the two poles are of opposite polarity. The compass in any case should be moved away from one pole, out through a wide circle back to the opposite pole, in order to avoid false readings. If the two poles of an electro-magnet as shown attract opposite ends of the compass needle, then

the coils are properly connected, and the magnet will exert its full power.

Note in Fig. B that if the coils are incorrectly connected and two like poles result, that you will find the same end of the compass needle attracted by each pole. The remedy here is to reverse the connections to one of the coils. Fig. C shows the action of the compass needle near the poles of a permanent steel magnet, opposite ends of the needle being attracted in the usual way. It is very interesting to experiment a little with the compass and explore the magnetic field around a steel bar magnet; Fig. D shows how the needle reverses as you pass the compass along the bar, from the north to the south poles.

The electrician may sometimes have to determine whether the coils of a magnet are connected properly, without the aid of a compass. Fig. E shows one method of doing this; if the coils are properly connected, every time current is passed through the coils, a piece of iron will be strongly attracted to the magnet poles. If the magnetic pull is very weak, it is usually an indication that the connections to one of the coils should be reversed.

When checking odd shaped electromagnets, including the field poles of small motors, it is often difficult or impossible to get the compass near the individual poles and check them properly, so that alternate poles are north and south as they should be. A very good trick in this case is to use a soft iron bar and place it on each pole as you get ready to test it, and bring the compass needle near the end of this iron bar. The current of course is connected to the field coils when motor fields are being tested. By moving the iron bar from pole to pole and watching the compass needle, you will quickly be able to determine the correct polarity of each field pole. If you find two south or two north poles adjacent to each other, the terminals to one of the coils must be reversed.—H. W. S.

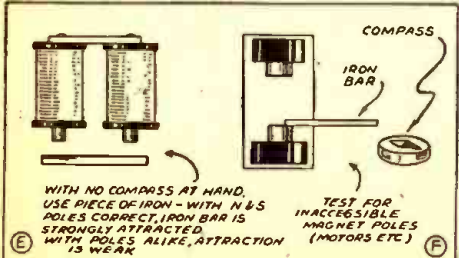
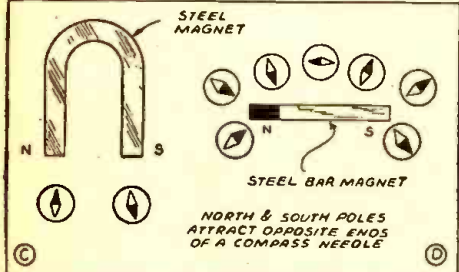
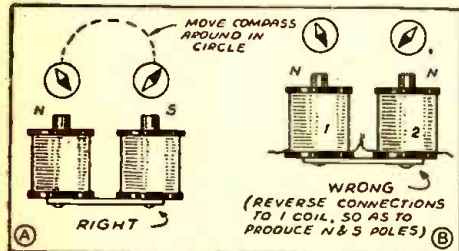

FREE!

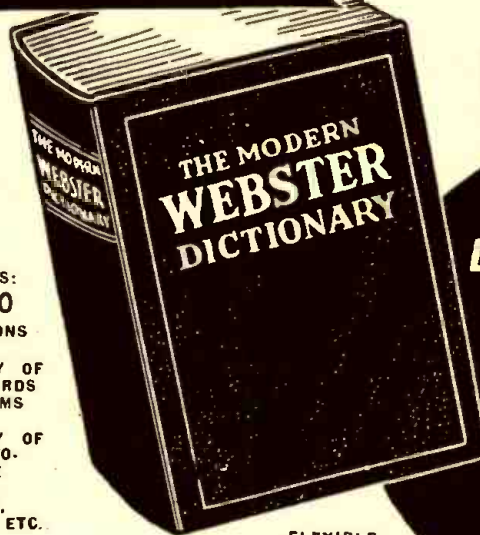

CONTAINS:
22,000
DEFINITIONS
•
DICTIONARY OF
RADIO WORDS
AND TERMS
•
DICTIONARY OF
THE AUTO-
MOBILE
•
TABLES,
TREATISES, ETC.

FLEXIBLE
IMITATION
LEATHERETTE
COVER, SIZE 5 1/2" x 8"

with \$1.00 subscription
to
RADIO-CRAFT

FULL
LIBRARY SIZE
**MODERN
WEBSTER
DICTIONARY**
416
PAGES

If you will take advantage NOW of our special subscription offer of eight months for \$1.00, we will send you ABSOLUTELY FREE and POSTPAID this 416 page full library size MODERN WEBSTER DICTIONARY—useful and instructive to everyone. This self-pronouncing authoritative dictionary—a new work throughout—contains the most up-to-date words now in common use, 22,000 definitions in all. It also features a Glossary of Radio Words and Terms, Dictionary of the Automobile, Treatises on Practical Syntax, Etymology, Punctuation and Standard English by well known authorities, Metric Tables, Time, State Flowers, National Parks of the U. S., etc.

This is a time limited offer, so don't delay in returning the Coupon.

RADIO-CRAFT
25 WEST BROADWAY NEW YORK CITY

FILL OUT—MAIL THIS COUPON TODAY!

RADIO-CRAFT, 25 West Broadway, New York, N. Y.

This is a New Order Extend my present subscription

Gentlemen: Enclosed you will find One Dollar for which enter my subscription to RADIO & TELEVISION Magazine for Eight Months. Send me ABSOLUTELY FREE and POSTPAID, my copy of the MODERN WEBSTER DICTIONARY.

Name

Address

City State

(Remit by check or money order; register letter if you send cash or unused U.S. Postage Stamps) RC 4-42

SPECIAL

ABC OF TELEVISION
Contains latest material on television developments. It covers theory of scanning; simple television receiver; how the eye sees; the photo-electric cell; neon lamps; need for broad channel width in transmission signals; cathode ray tube and television receivers; Farnsworth system of television transmission, and other important features.

SHORT WAVE GUIDE
Covers hundreds of short-wave questions and answers; illustrates popular short-wave kinks; gives explicit instructions for building simple short-wave receivers; instruction on the best type of antenna installation; diagram and construction details for building transmitters.

The books listed below have never been sold by us before. The value of each book is 50c. They are exactly the same as RADIO & TELEVISION'S 50c blue books which have been on the market for years. For a short time only we are selling these at a special reduced price of only 75c for the 3 books. All of the books contain numerous Photographic Illustrations and diagrams and have stiff flexible cover.

S. W. RADIO QUIZ BOOK
This book covers questions and answers on transmitters, short-wave receivers, ultra short-wave receivers, practical kinks, wrinkles and technical winding data; novel coil winding for experimenters; how to "hook-up" converters, noise silencers, beat suppressors, modulators, power oscillators, antennas, proselctors, 5-meter receivers.

Popular Book Corp., 25 W. Broadway, New York, N. Y.

Gentlemen: Enclosed you will find remittance for 75c (cash, new U. S. stamps or money order accepted) for which please send me at once your 3 books: ABC OF TELEVISION, SHORT WAVE GUIDE, SHORT WAVE RADIO QUIZ BOOK

Name

Address

City State RC-4-42

THE EDITORS WANT

good **constructional** articles (with clear photos and diagrams), Radio Receivers and other sets, especially "FM" Tuners and Adapters. We also are anxious to see constructional articles on Short Wave Receivers; also general articles on Antennas, etc.

MODULATION SYSTEM

2,248,462 issued to Dale Pollack, Cambridge, Mass.

● THIS invention relates to modulation systems and particularly to a device for modulating radio frequency currents, in which a pair of radio frequency amplifiers are connected in parallel across an antenna, and in which the phase of one of the radio frequency amplifiers is controlled by a modulating voltage. The current in the antenna of such a transmitter is varied by the modulating voltage so that the resultant antenna current is the sum of two radio frequency currents during positive peaks of modulation, and is equal to the difference of the two radio frequency currents during negative peaks of the modulating voltage.

An auxiliary tube is called into play to supply an in-phase current which increases

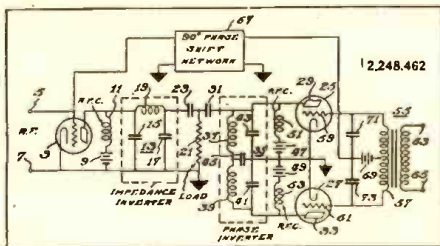

The circuit of an improved modulation system.

the effective power output during upward peaks of modulation. Downward modulation is accomplished by reversing the phase of the radio frequency current supplied by the auxiliary tube. The auxiliary out of phase current cancels some, or all, of the output from the first output tube and thereby reduces the net power which is supplied to the antenna.

The present invention is an improvement over the method described by Vance, in that a simplified system of providing the out of phase radio frequency current is shown herein. Instead of utilizing a balanced

modulator and an additional power amplifier to provide the in and out of phase auxiliary currents, a pair of auxiliary power tubes are directly coupled to the antenna, and means are provided for reversing the phase of the radio frequency output of one of the auxiliary tubes. The auxiliary tubes are driven by the modulating voltage in such a manner that one tube responds to positive peaks of modulating voltage while the other tube responds only to negative peaks of the modulating voltage.

PHOTO-TRANSMISSION

2,250,476 issued to Earl R. Evans, Jackson Heights, N. Y.

● ACCORDING to one feature of the invention, apparatus is provided for quickly forming an electron image or electrical charge image to be transmitted and then for transmitting and reproducing the picture at a relatively slow rate, for example, during an interval of several seconds, in this manner successive snapshots of news events and the like may be transmitted at frequent intervals and reproduced for an observer for a suitable period with comparatively simple transmission and receiving apparatus. Since the speed of transmission may be only about one one-hundredth as great as that employed in television, an ordinary radio channel of a width of ten kilocycles or less may be employed for the transmitting channel or ordinary wire lines may be used whereby the space or distance limitations of the high-frequency television channels are overcome and the radio transmitting and receiving apparatus is greatly simplified.

In accordance with this invention, suitable storage mechanism for the picture at the transmitting station is employed whereby the picture may be transmitted at a desired rate after it has been formed upon a picture sensitive element, such as the mosaic screen of an "iconoscope." Likewise at the receiving station a transitory or evanescent image is formed and retained for a short

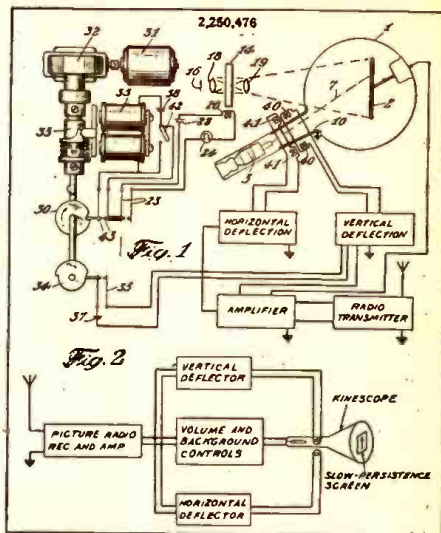

Improved method of photo transmission.

time. The received picture is stored for a sufficient time to be viewed by the observer, as for example, by forming the picture on an electro-luminescent screen of the retentive or slow-persistence type utilizing a phosphorescent material which remains luminescent for, say, several seconds.

Another object of the invention is to provide automatic or manually operated means for selecting and spacing the pictures to be transmitted. Thus in transmitting a news event, the individual snapshots or transmitted scenes may be selected in accordance with the desired progress of the game or other event being transmitted.

The kinescope tube used in reproducing the pictures in the present system should preferably employ a slow persistence screen such as the type developed by DuMont, and with such a system (as the editor sees it) it will be possible to transmit a number of photographs rapidly, photographing each one by placing a magazine camera in front of the image reproducing tube screen.

Interference Suppressor

2,250,550 issued to Harold Olaf Peterson and R. Lee Hollingsworth, Riverhead, N. Y.

● THIS invention relates to an interference suppressor for a radio receiver. More particularly the invention is intended for use in radio telegraphic reception for the purpose of limiting the voltage of the signalling energy as applied to the receiving devices, applying tone modulations to the interrupted carrier wave signals, and filtering out the product of the tone modulator mixer through a suitable band-pass filter having the desired characteristics for reducing certain types of atmospheric static and man-made static.

Further, to provide a circuit arrangement which renders a radio receiver relatively free from interference such as atmospheric and man-made static.

Another feature is to provide a system including a voltage limiter, a balanced modulator, and a narrow band filter which are so co-ordinated as to obtain satisfactory signal reception while greatly attenuating the effects of noise-clicks and other short impulses.

A still further object is to improve the conditions for radio telegraph signal reception so that mutilation of the signals shall be reduced to a minimum.

In the operation of the circuit arrangement of Fig. 1 it will be seen that whenever signal or noise energy is collected by the antenna 1 a rectified current is caused to flow through the resistor 5, which current blocks the tube 7. The consequent reduction of the plate current of this tube to zero places a normal bias on the control grids

of the tubes 11 and 12. The tone frequency modulations are, therefore, impressed upon the push-pull output circuit of these tubes and the resultant operation of the transformer 29 is such as to apply the modulations to the filter 14. When, however, a no-signal condition exists the current conducted through resistor 9 and the tube 7 is such as to bias the grids of the tubes 11 and 12 sufficiently to block these tubes. Hence no tone modulations are applied to the filter 14.

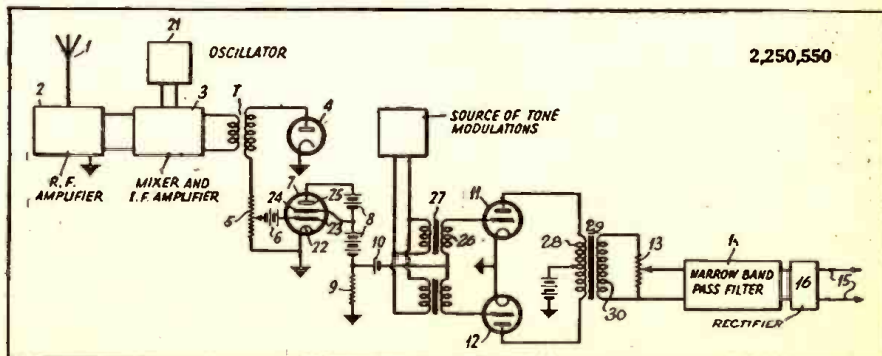

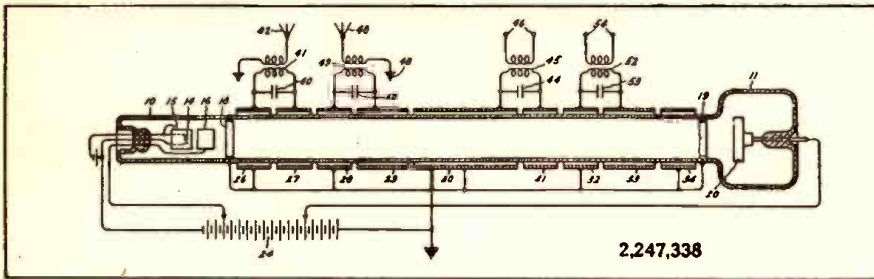

2,247,338

HIGH FREQUENCY APPARATUS

2,247,338 issued to Simon Ramo, Schenectady, N. Y.

● THE inventor's idea here is to decrease the amount of apparatus required at a station, at which it is desired to receive *simultaneously* two or more independent signals of differing frequency. In the attainment of this object, an important feature of the invention consists in the provision of means by which a single electronic device may be used for the simultaneous amplification of two or more concurrently applied signals.

The apparatus shown in the drawing comprises an electron beam tube, which includes an evacuated envelope having an elongated tubular portion 10. This portion, which is of uniform diameter along its length, connects at one end with an enlarged electrode containing portion 11. The envelope is preferably made of a low-loss insulating material such as glass or quartz.

In the operation of the apparatus the electrodes 18 and 19 are ordinarily held at

a potential on the order of several thousand volts above the cathode. The anode 20 may appropriately be maintained at a somewhat lower potential for efficient collection of the beam. These potential relationships may be established by means of a suitable voltage source which is conventionally illustrated as a battery 24. In order to maintain the beam in focus during its passage along the axis of the envelope, one may employ a series of magnetic focusing coils (not shown) or other known focusing means.

VARIABLE PHASE SHIFTER

2,247,941 issued to Murray G. Crosby, Riverhead, N. Y.

● IN this scheme the artificial line, consisting of inductance elements 1 and capacitive elements 2, is mounted so that the coils are disposed substantially along a closed path or circle. The coupling coil 5 is mounted on an arm for movement relative to the line 1, 2 so that it may be coupled to any one of the coils 2 of the line by rotating shaft 8 by means of a dial. The output leads

7 to the coupling coil 5 may be run out the hollow shaft 8 as shown or may utilize slip rings to allow continuous rotation of the shaft 8. The input voltage is supplied to the phase shifting line by leads 6 and the phase shifted energy is taken from leads 7. Resistor 3 damps the line to prevent reflections. This damping means may be replaced by a combination of a resistor and inductance or capacity to effect a more complete damping.

In order to make the phase shift of the line continuous for all positions of the rotatable coupling coil, it will be necessary to make the artificial line, consisting of elements 1, 2, of an electrical length of

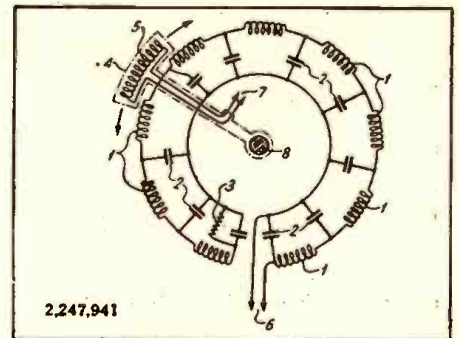

2,247,941

360 degrees. With this length, the coupling coil may be rotated continuously and the change of phase will be proportional to the angle of rotation.

Remote Control System

2,250,371 issued to David Grimes, Meadowbrook, Pa.

● THIS patent covers a "wireless" remote control system for radio-phonograph receivers and provides methods whereby these may be controlled from a distance, by operating a simple portable transmitter unit, permitting one to operate the radio receiver and the phonograph *selectively* at will. Further, this method of control will permit the operator to select any desired

one of a group of predetermined broadcast stations, to start or stop the phonograph, to play successively a number of recordings and to reject any recording at any time during the playing thereof. Similar to the "mystery" control featured on one of the radio receivers now on the market, this system employs a portable control device as shown in the diagram, which may take the form of a radio frequency oscillator. This "miniature transmitter" may be

operated by a dial type switch, which will send out a pre-determined number of impulses or radio waves. The system also provides for control of the volume of the reproduction on the receiver; all in all, this is a very good patent for radio students to make a close study of, as variations of this system should find wide application in the control of radio models, miniature planes, and other similar mechanisms.

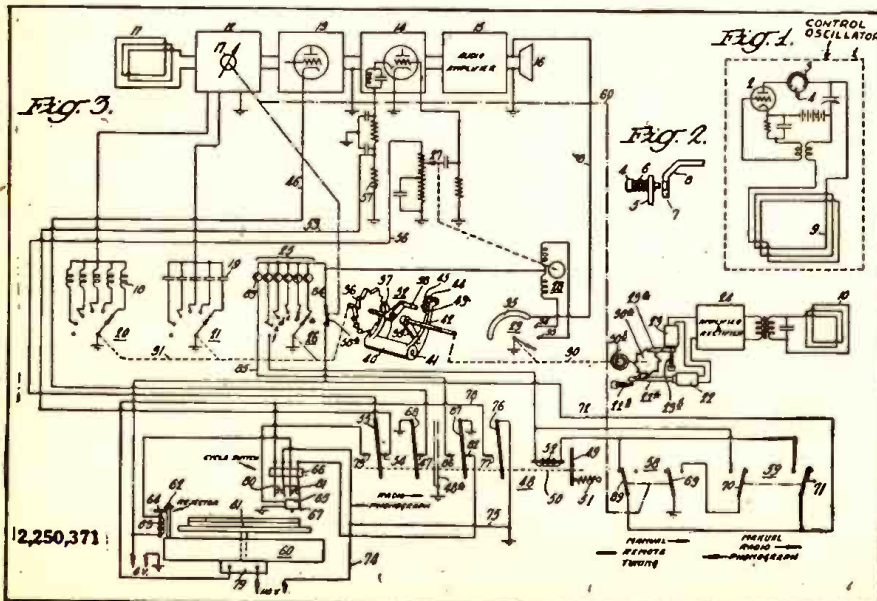

2,250,371

ANTENNA FOR UNIDIRECTIONAL RADIATION

2,247,757 issued to Walter Jacknow, Berlin, Germany.

● THIS invention consists of a wave antenna comprising a pair of long wires arranged closely adjacent to one another, said wires being axially displaced with respect to one another a distance equal to a quarter of the length of the operating wave, a transmission line connected to each of said wires at points intermediate their ends, each of said transmission lines having means for separately adjusting the phase of energy supplied to said wires to a mutual phase quadrature relationship, these wires being so closely spaced as to radiate as a single wire.

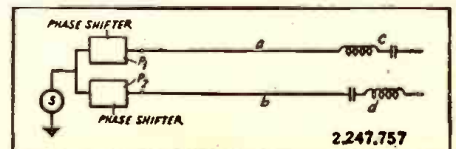

2,247,757

THE SHORT CUT TO CODE SPEED!

Don't be discouraged if you are "stuck" or have failed! The Candler System can teach you to receive and send code at high speed. The Candler System teaches you code the right way—by sound. Candler teaches you to coordinate mind and hand properly, to read code as easily as you do print.

FREE!

Send today for Candler's big book of code facts—it costs you nothing—you owe it to your future to read this book. There's no obligation—write today!

CANDLER SYSTEM CO.
DENVER, COLORADO
BOX 928, DEPT. D4



RADIO ENGINEERING DEGREE IN 2 1/2 YEARS

• Complete Radio Engineering Course in 27 months. Bachelor of Science Degree. Radio (television, talking pictures and the vast electronic field) offers unusual opportunities. Defense needs call for the engineer. Demand exceeds the supply. Courses also in Civil, Electrical, Mechanical, Chemical, Aeronautical Engineering; Business Administration, Accounting, Secretarial Science. Tuition, living costs low. World famous for technical 2 1/2 year courses. Special preparatory department for those who lack required high school work. Enter June, September, January, March, 59th year. Write for catalog, 2442 COLLEGE AVE. ANGOLA, IND.

TRI-STATE COLLEGE

LEARN RADIO

TELEVISION

600 LICENSED graduates placed in past 7 years in shipping, broadcasting, aviation, police, etc.; we also teach radio servicing and repairing; new beginners' class forming Sept. 8th; 60-page catalog free; oldest, largest and best equipped.

MASS. RADIO SCHOOL
18 BOYLSTON ST., BOSTON, MASS., Est. 1899

Do you need BINDING POSTS?



The XL PUSH POST with its Spring Action assures Constant Contact and quick connection. Manufactured in All Aluminum Type M at 12c each. Aluminum Body, Bakelite Top Type B1 at 15c each. Types CP or MP. ALL BRASS—STAIN-LESS STEEL SPRING & PIN. PROVEN BY 240 HR SALT SPRAY TEST as NON-CORROSIVE at 25c each. Manufacturers and Dealers Liberal Discounts

X. L. RADIO LABORATORIES
420 West Chicago Ave., Chicago, Ill.

TIME-SAVING OPERATOR LIC. COURSE

This New Course will get you a License to Operate Television, Facsimile, Radiotelephone and Broadcasting Stations. Latest, Inexpensive, Short-Cut Course by A. Binneweg, Jr., B. Sc. Includes 150-Page Book for self-study, showing diagrams necessary. Answers over 700 Necessary Questions. We answer any other Questions by Mail. NO CODE NECESSARY. Send \$1.00 now for Self-Study Book. Pay another \$2.00 when book is received, and \$1.00 later when you complete the Course.

RADIO-TELIO INSTITUTE
524 Fairbanks Ave., Oakland, California

COMMERCIAL RADIO INSTITUTE

A radio training center for over twenty years. Well equipped. Excellent faculty. Practical resident courses in Radio Telegraphy, Broadcast Servicing, Industrial, Television, Aeronautical, Drafting, Mathematics and Studio Technique. Placement bureau. Classes now forming. Catalog upon request.

Dept. D, 38 West Biddle Street, Baltimore, Md.

510

Better Microphone Results

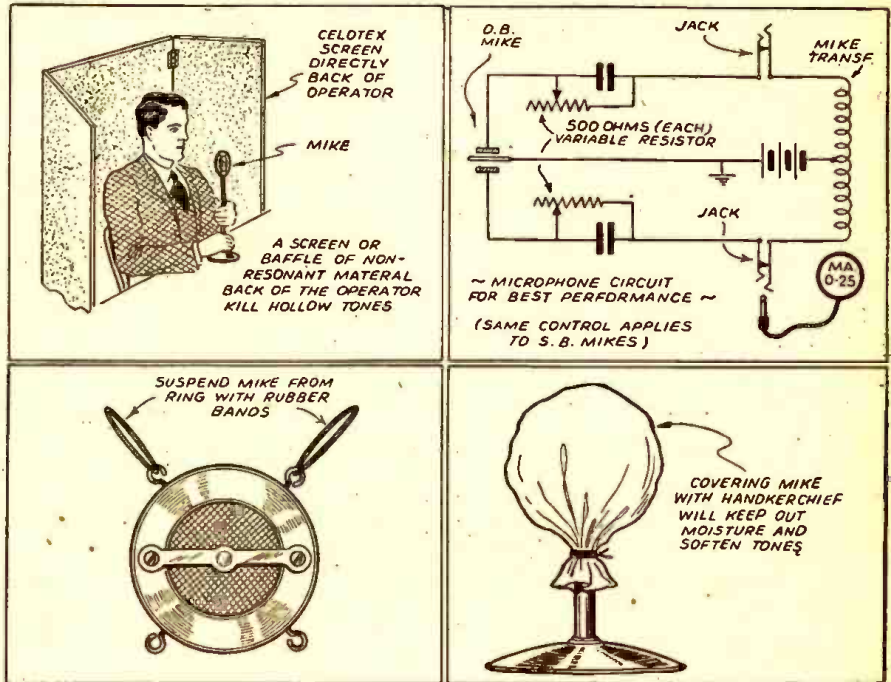

Several practical hints showing how to get better results from microphones.

• INSTEAD of plugging a microphone straight into a 6 volt supply and "letting it go at that," why not study the situation a bit more and improve speech quality as well as save the mike.

A single-button mike will work on 100 mils current, but it also will work and work better and with longer life with much less current. The same applies to a double-button mike, but to a greater degree. The diagram illustrates a glorified mike circuit (carbon mike) that takes care of all the failings of the usual published diagram. Note that a closed circuit jack is inserted in each side. This is for reading the current and keeping both sides in balance. Current should be the same for each side. Any 0-25 milliammeter with a cord and plug will be sufficient. Next, to maintain this balance, insert a 500 ohm variable resistor in each side as shown, shunting the resistors with a small fixed condenser—.0001 to .002 mf. is O.K. Then cut down the voltage to 4 1/2 volts or less. By these little additions speech input can be controlled and your quality will improve and the mike have a good long life. A good mike will not need over 20 mils per button; sometimes 10 mils will be found sufficient.

Are you troubled with microphone ring;

no matter how much you try to stifle it? One of the best ways to strangle the noise produced by the suspension springs in the holding ring is to substitute rubber bands. Four heavy bands in place of the springs will usually cure any tendency to produce metallic sounds in the background.

One more little trick that will not only smooth down the voice quality but will prevent dampness from the breath eventually corroding the innards of the mike, is shown in the sketch.

Tie a silk handkerchief over the mike as indicated. Silk holds out moisture better than linen or cotton. A third point is that it also keeps dust from piling up on the diaphragm and buttons.

Then again there is the "barrel effect" so often heard behind the voice. The effect is that of echo and hollowness prevalent in a bare room. This can be effectively reduced by erecting a baffle in back of the operator. Hanging a blanket or heavy curtain will often effect a cure. Better yet and more slightly is a three-fold screen made of heavy Celotex or other deadening material. Stand this directly back of the one at the mike and most of the echo will be killed.—L. B. Robbins.

Bottle-Neck Insulators

Choose a bottle of good glass. Carefully cut a line around the bottle where the neck starts to flare in and use a good cutter for the purpose. Then carefully tap along the scratch with the cutter and the neck will come off. Then heat the cut edge with a blow-torch or even an alcohol flame until it softens enough to flow around.

The halyard wire can be fastened through the neck while the antenna wire can be twisted around the neck as shown.—L. B. Robbins.

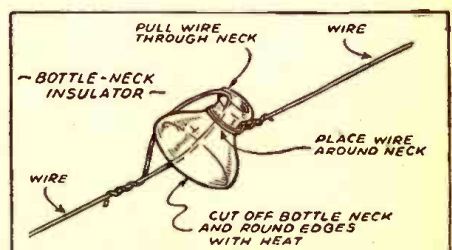

A Simply-Made Insulator

Doubling Transformer Power

● MANY requests have been made as to just how we get away with using a small power transformer (plate) and get so much high voltage.

We have used almost every kind of transformer and have doubled the manufacturer's rating. This circuit, I think, will prove very useful.

Those who build this unit will find the cost low and the construction easy. Also, it will prove trouble-free.

Yes, you can double your present transformer rating, and get up to five hundred watts output, depending on the tubes you use as rectifiers. And the rectifiers are receiving tubes!

I have run anywhere from six hundred to twelve hundred volts input this way, and from two hundred to seven hundred milliamperes. This is doubling the manufacturer's rating on tubes.

This can easily be seen as the plates of each rectifier are connected in parallel.

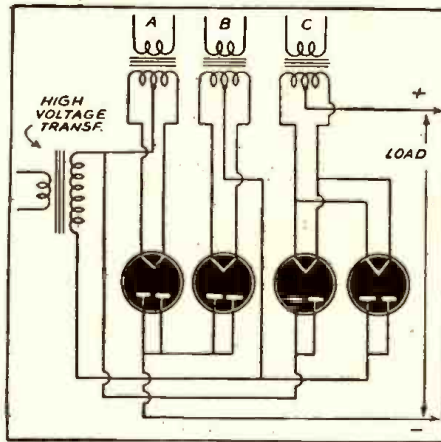

Three 5-volt or 2.5-volt filament transformers with good insulation should be used.

The input of the plate transformer will be double, since the use of the center tap is done away with.—Wilfred Neil, W8TTY.

EXPLANATION OF SUPER T.R.F. CIRCUIT

Editor:

Here's my explanation of the technical operation of the Super T.R.F. 4 described in the July issue of Radio and Television.

The Super T.R.F. 4 is a "straight" tuned radio-frequency circuit with a few quirks which make it unusual. Coil A is a typical antenna transformer with both primary and secondary tuning. The 6K7 operates as a pentode R.F. amplifier. The amplified R.F. signals pass through coil B which is tightly coupled to provide broad tuning in the secondary, and thus eliminate the use of another condenser in this spot.

The signal is then passed on to the control grid of the 6J8. The 6J8 is a heptode triode designed for converter operation. In this particular application, the heptode section works as a pentode R.F. amplifier while the triode section is employed as a voltage or power detector. Thus the R.F. signal amplified by the heptode section is fed through transformer C, which also has a tuned secondary and supplied to the grid of the triode section. Electron coupling be-

tween the two sections of the tube further helps stabilize the circuit.

Volume is controlled in this tube, through the use of the 10,000 ohm volume control. The arm of the control is grounded, one end is connected to the cathode of the 6J8 and the other end to the antenna end of the antenna transformer. When the volume control arm is near the cathode end, the bias voltage on the 6J8 is low and the resistance between the antenna and ground is maximum. Thus the volume is greatest. When the arm is nearer the antenna end, the reverse action takes place and the volume is minimum.

After the signals are detected in the triode section of the 6J8, they are sent through an ordinary audio transformer and supplied to the 6B5, which operates as an ordinary triode. This tube is designed to be used as a direct-coupled power amplifier; greater amplification can be secured by using one section as driver and the other as power output.

GERALD J. CASSENS,
Engineer, WSOY (W9SQY)

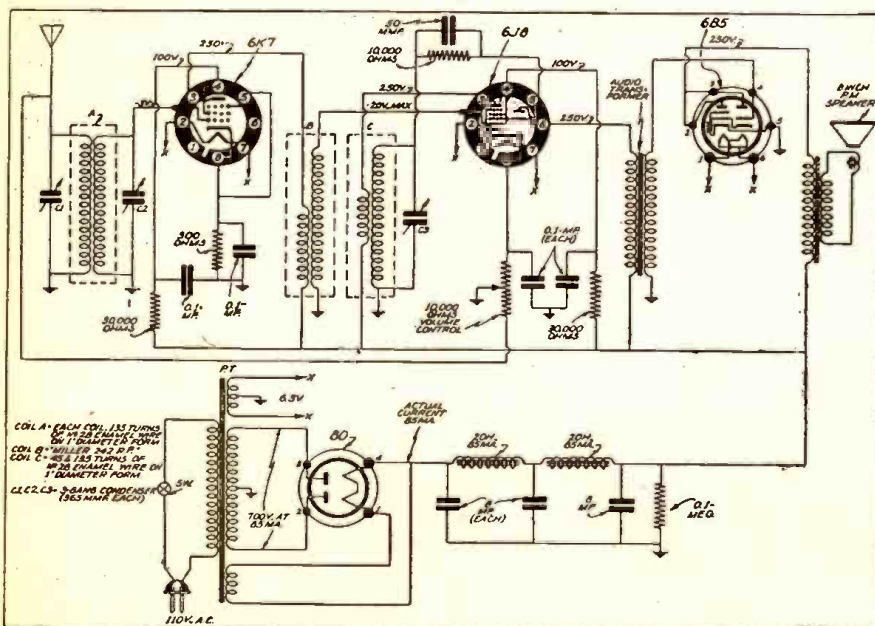

TECHNICAL BULLETINS

Technical bulletins give reliable information in easy-to-follow form, and save valuable time otherwise spent in laborious reading of numerous books. Every subject is treated briefly and concisely, yet completely. No complicated mathematics, chemistry, electricity, or theory. Each bulletin is written in simple language.

PRICE \$1.00 EACH POSTPAID
ORDER BY NUMBER

D-103—LATEST GAS-WELDING PRACTICE.—Simplified instructions for using the modern oxyacetylene torch for welding and cutting. Instructions for welding steel, cast iron, aluminum and aluminum alloys, lead and lead alloys, nickel and nickel alloys, monel metal, etc. Data on lead burning, gas pressure for all jobs, formulas for fluxes.

D-117—THE ABC OF AIR-CONDITIONING.—Enables anyone to acquire quickly a general practical working knowledge of air-conditioning. Tells what complete air-conditioning is and how it works.

D-125—BUFFING AND POLISHING METALS.—Explains methods of producing high quality polished work. Tells what abrasive to use on steel, stainless steel, monel metal, aluminum, brass, copper, zinc, and nickel. How to apply glue and grit to wheels and how to prepare stick abrasives.

D-135—ELECTRIC ARC TORCH.—A small carbon-electrode arc torch that operates on 110-volt A.C. current. Of value to metal-working shops and home work shops for soldering and brazing, and even light welding on sheet metal. Can also be used to melt small quantities of metals and alloys. Also used by Dentists to melt gold.

D-143—THERMOCOUPLE PYROMETERS.—Concise, detailed instructions enable anyone to make thermocouple pyrometers for reading temperatures as high as 2500° F., as used in heat-treating metals, melting metals, etc.

D-109—ELECTROPLATING WITH ZINC, LEAD AND CADMIUM.—The use of these metals is becoming popular for the protection of other metals against corrosion, rust, oxidation, etc.

D-114—DESIGNING THERMOSTATS FOR AIR-CONDITIONING AND HEAT-CONTROL PURPOSES.—Complete information on how to design and build thermostats of many types for controlling temperature, automatic furnace regulators, air-conditioning regulators, humidity-control units, electric flat irons, safety switches to turn off power when motors overheat, etc.

D-120—GAS FIRED BLAST FURNACE FOR MELTING METALS, ALLOYS AND HEAT TREATING.—Of interest to Practical shop men, home workers, amateur metallurgists and experimenters requiring a furnace to melt 10 to 15 pound charges. Excellent for making alloys, heat treating, case hardening, enameling, etc.

D-130—GLASS WORKING TECHNIQUE.—Correct technique for cutting, drilling, grinding and mounting glass. Includes cutting of disc, rounds, squares and irregular shaped holes, fastening glass to wood, hanging glass shelving, etc.

D-140—ETCHING METALS AND GLASS.—Etching names, monograms or designs. Gives formulas and procedures.

D-116—PRINTING PHOTOS ON CLOTH, PAPER, ETC.—Formulas enable anyone to print photos on scarfs, pillows, handkerchiefs, etc.

Each Bulletin consists of a set of large sheets, assembled in one packet, size 9 x 14 1/2"; weight 1/4 lb. Numerous illustrations, diagrams, charts to supplement text.

TECHNIFAX

1917 S. STATE ST. (DEPT. 442) CHICAGO, ILL.

DEPT. 442
TECHNIFAX 1917 So. State, Chicago, Ill.
Enclosed find \$..... for which please send me postpaid the following Technical Bulletins:

No.

Name

Street and Number

City and State

BIG FREE CATALOG

EVERYTHING IN RADIO

Sets, parts, supplies, public address systems, amateur equipment, testers, kits and fluorescent lighting at lowest prices. Huge stocks, bought months ago—ready for shipment the same day your order is received. The Defense Program is making big demands on our industry but because of our advance buying we are able to fill your orders promptly and efficiently.

BURSTEIN-APPLEBEE COMPANY
1012-14 McGEE, KANSAS CITY, MO.

RADIO CATALOG NO. 58
164 PAGES SETS-PARTS SUPPLIES FLUORESCENT
Burstein-Applebee Co.

PREPARE YOURSELF

for a commercial radio position through a home study course written for the man who has forgotten higher mathematics and who has had a non-technical education. This course qualifies you to pass the Federal Radio Telegraph and Telephone examinations. An easily read, and easily understood course. Moderate tuition fee. Write for particulars.

AMERICAN RADIO INSTITUTE

1123 Broadway New York City

RADIO TECHNOLOGY



RCA Institutes offer an intensive course of high standard embracing all phases of Radio and Television. Practical training with modern equipment at New York and Chicago schools. Also specialized courses in Aviation Communications, Radio Servicing and Commercial Operating. For Free Catalog write Dept. RC-42.

RCA INSTITUTES, Inc.

A Radio Corporation of America Service
75 Varick St., New York. 1154 Merchandise Mart, Chicago

Are YOU The Man For The JOB?

Every radioman has the opportunity today to advance himself to a better radio job. Men with advanced technical training are in demand. CREI home study training is the proven way to more money and a secure future in the years to come—“5,000 other radiomen can't be wrong”! WRITE FOR FREE BOOKLET, CAPITOL RADIO ENGINEERING INSTITUTE, Dept. RC-4, 3224 16th St., N.W., Washington, D. C.

FLUORESCENT LIGHTING

BUY DIRECT - from Factory at Distributors Prices. COMPLETE LINE—for Industrial and Home Use. 100%—G.E. Parts and Lamps. Descriptive, illustrated circular—FREE.

McGEE RADIO COMPANY

F-2056 Kansas City, Mo.

Correspondence Courses in RADIO and ELECTRICAL ENGINEERING

ELECTRICAL ENGINEERING Get good grasp of wide electrical field. Prepare yourself, at low cost, for secure future. Modern, simplified, you can understand quickly.
RADIO ENGINEERING Extra fine course in radio, public address, photo-electric work. Trains you to be super-service man, real vacuum tube technician. Excer. kits furnished. Diploma on completion. Tuition, \$25. either course. Deferred payment plan. Get copies of school catalogs, student magazines, complete details. SEND NOW!

LINCOLN ENGINEERING SCHOOL, Box 931-C39, LINCOLN, NEBR.

RADIO ENGINEERING,

broadcasting, aviation and police radio, servicing, marine radio telegraphy and telephony, Morse telegraphy, and railway accounting, taught thoroughly—48 weeks' Engineering course equivalent to 3 years of college radio work. All expenses low. Catalog free. School established 1874. The Dodge Institute, Monroe St., Valparaiso, Ind.

MAKE OLD RADIOS NEW



You can learn quickly to modernize all sets. No more new radios. Cash-in by improving audio circuits, modernizing cabinets, adding features usually found on late model sets. Practical job-sheets with schematics and photographs make the work easy. Complete, 8 1/2 x 11 inches, manual only \$1.00, post-paid. Money back guaranteed.

SUPREME PUBLICATIONS
328 S. Jefferson St., Chicago, Ill.

Low Resistance—Hi-Wattage Resistor

Needing a high wattage bleeder for a C bias supply I took an ordinary 50 watt bleeder with slider taps and arranged the taps at 5M, 10M, 15M ohms with an ohmmeter. Then I connected No. 14 wire to the taps as shown. The original bleeder was 20M ohms. (M-thousand) The two connecting wires were then taken off as shown. This arrangement makes a resistance of 1250 ohms at 200 watts.—Earle C. Draese, W9CGN.

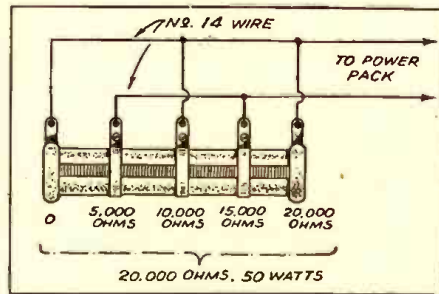

SOLDERING IRON SUPPORT FOR FINE WORK

I FOUND it difficult to do fine soldering with an iron without my hand shaking. As a result I designed the support shown in the sketch. It can be adjusted to any reasonable height and supports the weight of the soldering iron so any shakiness of the hand will not destroy the efficiency of the job. A pointed end prevents it slipping on wood surfaces while a small cork acts as a non-scarring foot on glass or finely finished surfaces.

A yoke of stiff metal was fashioned as a cradle for the copper itself. A small hole was drilled in the center of the bottom. Then a short length of brass tubing was threaded in one end for a screw. The screw passed down through the hole in the yoke and thus secured the tube solidly to it below. A threaded hole and set screw were fastened in the side of the tube near the bottom. Then a steel rod, pointed at one end, was slid into the bottom of the tube as shown.

It is only necessary to adjust the height of the supporting column by adjustment of the sliding rod. Then stand the support on the working base and rest the copper in the yoke.—L. B. Robbins.

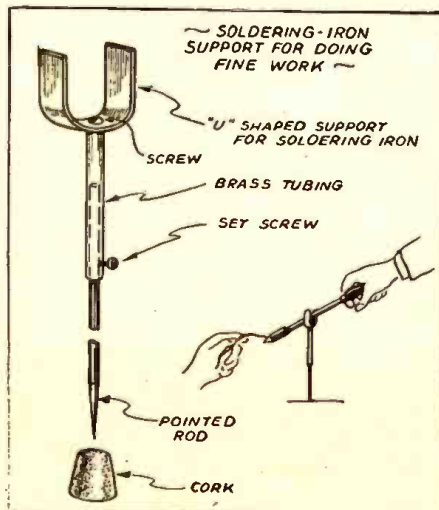

Notice—HAMS!

“Hams”—Please tell the Editors what type of articles you would like to see in the Amateur Section of this magazine, now that War has been declared and a general ban placed on Amateur Station operation. Let us hear from you, Pronto!—Editors



“Lum and Abner”

BIG PRIZE CONTEST

54 wonderful prizes—\$100 U.S. Defense Bond, 7-Tube All-Wave Radio, Set of Aviation Books, Woodworking Lathe, Model Gas Engine, Power Scroll Saw, Daisy Air Rifle, and many other prizes valued at \$400.00 given away FREE.

CONTEST OPEN TO ALL
Costs nothing to enter. Win a valuable prize. Get Science and Mechanics at your newsdealer today for full details. Or send 15¢ direct to Science and Mechanics, Dept. A-5, 800 North Clark St., Chicago, for a copy.

SCIENCE AND MECHANICS
On Sale at All Newsdealers

Index to advertisers

Allied Engineering Institute.....	500
Allied Radio Corporation.....	459
American Radio Institute.....	512
Amperite Corporation.....	Inside Back Cover
Amplifier Co. of America.....	481, 485
Audel & Co., Theo.....	461
Burstein-Appleby Co.....	512
Candler System Co.....	510
Cannon Co., C. F.....	495
Capitol Radio Engineering Institute.....	512
Chartered Institute of American Inventors	481
Commercial Radio Institute.....	510
Coyne Electrical School.....	500
Data Print Co.....	501
Detrola Corp.....	461
Dodge's Institute.....	512
Don Lee Network.....	492
Harrison Radio Co.....	501
Henry Radio Shop.....	495
Hudson Specialties Co.....	497
Hygrade Sylvania.....	463
International Correspondence Schools.....	489
Lancaster, Allwine & Rommel.....	481
Lincoln Engineering School.....	512
Mass. Radio School.....	510
McGee Radio Co.....	512
Meek Industries, John.....	495
Meissner Mfg. Co.....	472
National Radio Institute.....	449
National Schools.....	499
National Union Radio Corp.....	469
Nelson Co.....	481
Ohmite Mfg.....	471
Peerless Sound & Radio Corp.....	506
Radio-Telio Institute.....	510
Radolek Company.....	474
RCA Institutes.....	512
RCA Laboratories.....	Inside Front Cover
RCA Manufacturing Co.....	Back Cover
Readrite Meter Works.....	473
Remington Rand, Inc.....	490
Solar Mfg. Corp.....	485
Schott Co., Walter L.....	485
Science & Mechanics.....	512
Sprague Products Co.....	463
Sprayberry Academy of Radio.....	473
Supreme Instruments Corp.....	485
Supreme Publications.....	512
Technifax.....	492, 511
Telex Co.....	495
Treasury Department.....	465
Triplett Elec. Instrument Co.....	468
Tri-State College.....	510
University Laboratories.....	481
X.L. Radio Laboratories.....	510

(While every precaution is taken to insure accuracy, we cannot guarantee against the possibility of an occasional change or omission in the preparation of this index.)

"Finest Dynamic I ever used"
 SAYS EVAN R. RUSHING, SOUND ENGINEER, HOTEL NEW YORKER

**AMPERITE
 P. G. DYNAMIC**
 BRINGS STUDIO QUALITY
 TO ORDINARY P. A. JOBS

- **UNI-DIRECTIONAL.** NEW SUPERIOR ELIPSOID PICKUP PATTERN
- **ELIMINATES FEEDBACK** TROUBLE BECAUSE IT HAS LOWEST FEEDBACK POINT OF ALL DIAPHRAGM TYPE MICROPHONES
- **FLAT RESPONSE.** FREE FROM ANNOYING PEAKS, GIVING STUDIO-QUALITY REPRODUCTION.



The P.G. diaphragm follows air particle velocity where amplitude is a GRADIENT of the PRESSURE. In ordinary dynamics amplitude is restricted from following air particle velocity.

The P.G. DYNAMIC, is a radical improvement in this type of microphone. You can actually hear the difference. Case is designed according to modern acoustic principles. Rugged, not affected by temperature, altitude or humidity. **HAS UNUSUALLY HIGH OUTPUT. -55 DB.**

MODEL PGH (PGL, 200 ohms). Excellent for high fidelity P.A. installations, broadcast studio, and professional recording. With switch, cable connector, 25' cable. Chrome finish. LIST \$32.00 (40-10000 C.P.S.)

MODEL PGAL (PGAL, 200 ohms). For speech and music, 70-8000 C.P.S. Switch, cable connector, 12' cable. Chrome. LIST \$25.00

**COMBINATION VELOCITY-DYNAMIC
 ACHIEVED WITH
 ACOUSTIC COMPENSATOR**



An exclusive Amperite feature: By moving up the Acoustic Compensator you change the AMPERITE VELOCITY to a DYNAMIC microphone without peaks. At the same time you reduce the back pick-up, making the microphone practically UNI-DIRECTIONAL.

WITH ACOUSTIC COMPENSATOR:
MODEL RBHk: RBMk (200 ohms) with switch, cable connector.
 Chrome. LIST \$42.00

RSHk: RBSk (200 ohms). Switch, cable connector, Acoustic Compensator.
 Chrome or Gunmetal. LIST \$32.00

WRITE FOR FREE SALES AIDS

AMPERITE ©

AMPERITE KONTAK MIKE
 Puts Musical Instruments Across



So beautiful is the tone produced with the Kontak Mike, that it was used in the Philadelphia Symphony to amplify a mandolin solo. Gives excellent results with any amplifier, radio sets, and record players.

MODEL SKH (hi-imp) LIST \$12.00

MODEL KKH, with hand volume control. LIST 18.00

Plug extra List 1.50

FOOT PEDAL, for making beautiful crescendos LIST 12.00

561 BROADWAY, N. Y. U. S. A.

Specify **AMPERITE**



Today, It's More Vital Than Ever—

TO STOCK THE TUBES THAT MOVE!



★ TANKS NEED TUBES!



★ PLANES NEED TUBES!



★ SHIPS NEED TUBES!



and
★ AMERICA NEEDS TUBES!



PREFERRED TYPE RENEWAL TUBES PROGRAM

TUBES that “gather dust” on your shelves for months on end can no longer be tolerated. Such tubes not only eat up your profits in overhead . . . *they tie up vital defense materials!*

Of more than 500-odd tube types, just 66 account for 71% of *all* American renewal tube demand . . . and up to 84% by “interchanging” types. With tube availabilities limited by America’s wartime needs—and with radio today more important than ever—tubes belong in radio sockets. The

RCA Preferred Type Renewal Tubes Guide helps you to put them there quickly—with minimum time between factory and user.

For, at a glance, your Guide tells you not only *which* tubes to stock, but *how many of each*, as well. It enables you to set up a “model stock” that is matched to normal demand . . . based on facts, not theory.

Ask your RCA Tube and Equipment Distributor for *your* copy, today!

Remember Pearl Harbor!
BUY U.S. DEFENSE BONDS



Radio Tubes