

RADIO-CRAFT

HUGO GERNSBACK, Editor

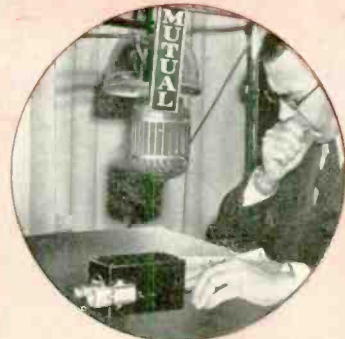

BOMBCASTING!
See Page 714



"COUGH BUTTON"

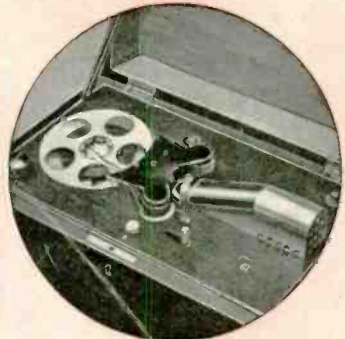

FILM PHONOGRAPH



AIRPLANE MIKE



"VIDEONEWS"

RADIO'S GREATEST MAGAZINE
HOW TO MAKE A LEAK DETECTOR • R.F. AND I.F. COILS IN F.M. RECEIVERS
EXPERIMENTAL SLANT ON RADIO • MINIATURE PORTABLE TRANSMITTER • NEW TUBES

THERE'S MORE DRAMA and excitement packed into amateur reception when your communications receiver is a Hallicrafters. Back of Hallicrafters precision engineering is long experience, and it is this that accounts for the finer, broader, more accurate and dependable reception amateur owners enjoy. Lafayette Radio offers a complete line of latest Hallicrafters models. Time payments make owning one easy. Send for **FREE** catalog today, or visit branch nearest you.

Hallicrafters

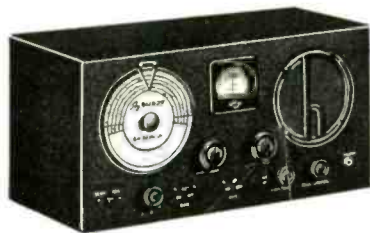

MODEL S-19R

Efficient superheterodyne circuit employs 6 tubes, of which two are double-purpose types, providing 8 tube performance. Complete tuning range of the receiver from 545 kc. to 44 mc. in 4 tuning bands. Electrical band spread on each band. Broadcast band coverage, beat frequency oscillator, automatic volume control switch, built-in speaker and a separate band spread dial. Designed for operation from any 110-120 volt 50-60 cycles a.c. line. Antenna connections provided for both doublet and Marconi type antennas. Cabinet beautifully finished - 17 1/2" x 8" x 8 1/2".

\$29⁵⁰



MODEL S-20R

New improved 9 tube model. Covers the complete range from 545 kc. to 44 mc. in four bands. Employs a stage of pre-selection on each band for added sensitivity and selectivity. Controls: r.f. gain, audio gain, tone control, a.v.c. switch, BFO switch, band switch, main tuning control, separate band spread control, and "stand-by" switch. Built-in speaker. Circuit features electrical band spread, automatic noise limiter, r.f. amplifier. Designed for 110 volts 50/60 cycles a.c. operation. (plug and jack provided for batteries or vibrapack operation). Steel cabinet measures 18 1/4" x 9 3/8" x 8 1/2".

\$49⁵⁰

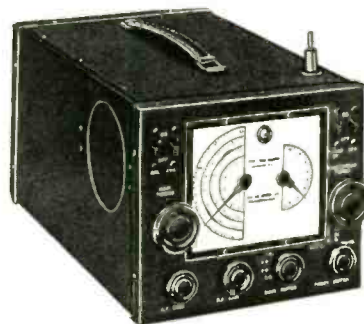

MODEL S-29

Precision-built communications receiver in portable form. Operates on either 110 volts AC or DC or from self-contained batteries. Self-contained telescopic antenna. Receiver covers four complete bands: 11.26 mc. to 1490 kc. Employs an r.f. stage on all bands, incorporates an automatic noise limiter; electrical band spread. Built-in speaker. Controls include: main tuning—band spread—r.f. gain—A.f. gain—band switch—power switch—a.v.c. "off-on" switch—BFO "off-on" switch—ANL "off-on" switch—send-receive—standby switch. Dimensions: 7" high, 8 1/2" wide, 13 1/4" deep.

\$59⁵⁰

Lafayette

100 SIXTH AVE., NEW YORK

901 W. JACKSON BLVD., CHICAGO

265 PEACHTREE ST., ATLANTA

boston • newark, n.j. • bronx, n.y. • jamaica, l.i.

THE WORLD'S LARGEST RADIO SUPPLY HOUSE

**Men NOW in Radio
who Don't Think
they know it All
Read This**

You don't want to see younger, better-trained men push ahead of you, I know. You don't want Radio's new technical developments to baffle you either, I am sure. You want to get ready to "cash in" on Television, Frequency Modulation, too. I have helped many already in Radio to win promotions, to make more money. Read my message below.

J. E. SMITH, President
NATIONAL RADIO INSTITUTE
Established 25 years

He has directed the training of more men for Radio than anyone else—has helped men already in Radio to get ahead, and men not in Radio to get into Radio and win success.



**If You're NOT
Working in Radio Now
Read This**

Do you want to make more money? Do you want to cash in on your present interest in Radio, Television, Frequency Modulation? Do you want a full-time job with good pay in one of Radio's many fascinating branches? Or do you want to make extra money in your spare time to boost your present income? If you want to do either of these things—you owe it to yourself to find out how I have trained hundreds of men for jobs in Radio. MAIL THE COUPON BELOW—TODAY.

Make Me Prove I Can Train You at Home for RADIO and TELEVISION

Clip the coupon and mail it. I'm certain I can train you at home in your spare time to be a Radio Technician. I want to send you a sample lesson free; to examine, read. See how clear and easy it is to understand. See how my Course is planned to help you get a good job in Radio, a young, growing field with a future. You don't have to give up your present job, or spend a lot of money to become a Radio Technician. I train you at home nights in your spare time.

**Many Radio Technicians Make
\$30, \$40, \$50 a week**

Radio broadcasting stations employ operators, technicians, and pay well for trained men. Radio manufacturers employ fitters, inspectors, servicemen in good-pay jobs with opportunities for advancement. Radio jobbers and dealers employ installation and servicemen. Many Radio Technicians open their own Radio sales and repair businesses and make \$30, \$40, \$50 a week. Others hold their regular jobs and make \$5 to \$10 a week fixing Radios in spare time. Automobile, police, aviation, commercial Radio; loudspeaker systems, electronic devices, are newer fields offering opportunities to qualified men. My Course includes Television and Frequency Modulation which promise to open good jobs soon.
Charles F. Helmuth, 419 N. Mass. Ave., Atlantic City, N. J., writes: "I started Radio in the Marines. Later I took the N. R. I. Course. Now I am my own boss, and get jobs over others who were sure they had them. I owe plenty to N. R. I. Training." James E. Ryan, 119 Pebbles St., Fall River, Mass., writes: "I was working in a garage when I enrolled with N. R. I. I am now

Radio service manager for the M— Furniture Co. for their four stores."

**Beginners Quickly Learn to Earn \$5 to \$10
Extra a Week in Spare Time**

The day you enroll, in addition to my regular Course, I start sending you Extra Money Job Sheets—start showing you how to do actual Radio repair jobs. Throughout your Course I send plans and directions which have helped many make \$5 to \$10 a week extra in spare time while learning. I send special Radio equipment; show you how to conduct experiments, build circuits. My 50-50 training method makes learning at home interesting, fascinating, practical. I devote more than 10 Lesson Texts exclusively to Television, and in addition Television fundamentals are covered by my regular Course.

You Get This Professional Servicing Instrument

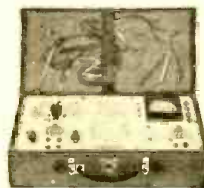

This instrument makes practically any test you will be called upon to make in Radio service work on both spare time and full time jobs. It can be used on the test bench, or carried along when out on calls. It measures A.C. and D.C. voltages and currents; tests resistances; has a multi-band oscillator for aligning any set, old or new. You get this instrument to keep as part of your N. R. I. Course.

Draft Registrants, Attention!

Hundreds of men who know Radio when they enter military service are going to win specialist ratings in the Army, Navy and Marine Corps. These ratings pay up to 6 times a private's or seaman's base pay, in addition to carrying extra rank and prestige! If you ARE NOT called, you are getting into Radio when the Government is pouring millions into the Radio industry to buy Defense equipment, on top of boom civilian Radio business. Whether you enlist or wait for conscription—IT'S SMART TO LEARN RADIO—NOW!

Get Sample Lesson and 64-Page Book Free

Act today. Mail coupon now for Sample Lesson and 64-page Book. They're FREE. They point out Radio's spare-time and full-time opportunities and those coming in Television; tell about my Course in Radio and Television; show more than 100 letters from men I trained, telling what they are doing and earning. Read my money back agreement. Find out what Radio offers you. Mail the coupon in envelope or paste on penny postcard—NOW!

J. E. SMITH, President
Dept. IFX, National Radio Institute
Washington, D. C.

SAMPLE LESSON FREE

I want to prove that my Course gives practical, money-making information; is easy to understand—is what you need to master Radio. My sample lesson text, "Radio Receiver Troubles—Their Cause and Remedy," covers a long list of Radio receiver troubles in A.C., D.C., battery, universal, auto, T.R.F., super-heterodyne, all-wave, and other system of sets. And a cross reference and a heterodyne, and a probable cause and a quick way to locate and remedy these set troubles. A special section is devoted to receiver checkup, alignment, balancing, neutralizing and testing. Get this lesson FREE. No obligation. Just mail coupon.

**GOOD FOR BOTH 64 PAGE BOOK FREE
SAMPLE LESSON FREE**

J. E. SMITH, President, Dept. IFX
National Radio Institute
Washington, D. C.

Dear Mr. Smith: Mail me FREE, without obligation, your Sample Lesson and 64-page book, "Rich Rewards in Radio," which tells about Radio's spare-time and full-time opportunities and explains your 50-50 method of training men at home to be Radio Technicians. (No salesman will call. Write plainly.)

(Please Check)
 I AM doing Radio work. I am NOT doing Radio work.

Name Age

Address

City State 14X1

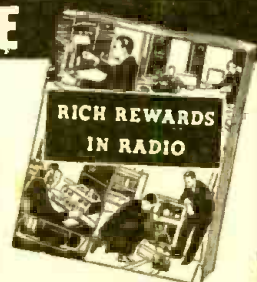

RADIO-CRAFT

HUGO GERNSBACK, *Editor-in-Chief*

N. H. LESSEM
Associate Editor

THOS. D. PENTZ
Art Director

R. D. WASHBURNE, *Managing Editor*



Contents JUNE, 1941 Issue

VOLUME XII -- NUMBER 12

Mailbag	707
Editorial: Radio Famine	Hugo Gernsback 713
The Radio Month in Review	714

SERVICING

New Circuits in Modern Radio Receivers—No. 45 F. L. Sprayberry	716
Operating Notes	717
An Open Letter—To the Radio Industry.....James H. Hanly	718
From the F.C.C. Mailbag	718
Selling Radio Service	Willard Moody 720
Advice to Set Owners—How NOT to Get Good Radio Service Fred Shunaman	721

RADIO SERVICE DATA SHEETS:

No. 308—Montgomery Ward Airline Model 04BR-1105A...	722
No. 309—Ditto	723
Oriental Slant on Radio	Fred Shunaman 724

SOUND

New Parallel-Feed Audio Circuit	Ted Powell 726
Utility Radio Receiver	H. Gernsback 730
Sound Engineering—No. 18.....Conducted by A. C. Shaney	731
A Radio Ol' Timer Thinks Back Aways	733
Latest Acoustic Speaker Housings	734
A Manufacturer Comments on "Modern Microphone Technique"	A. L. W. Williams 736
Sound Is the Spur	Leo Fenway 738

TEST INSTRUMENTS

Buying Test Equipment	Bob Stang 740
-----------------------------	---------------

EXPERIMENTERS

How to Build a Simple Miniature Portable Transmitter H. G. Cisin, M.E.	743
How to Build and Use a Leak Detector	G. M. Bettis 746

F. M.

Theory and Design Considerations of R.F. and I.F. Coils in F.M. Receivers	C. S. Linell 750
(Including List of Articles in Past Issues of RADIO-CRAFT on Frequency Modulation)	

Distinctive Calls for F.M.	753
Classified Radio Directory—Section III (Revised)	757

DEPARTMENTS, ETC.

Mailbag	707
Listing: "Treasure"-Finding and "Geo."-Prospecting Articles in <i>Radio-Craft</i>	711
The Radio Month in Review	714
New Circuits in Modern Radio Receivers—No. 45 F. L. Sprayberry	716
Operating Notes	717
From the F.C.C. Mailbag	718
RADIO SERVICE DATA SHEETS (See Servicing)	722, 723
Sound Engineering—No. 18.....Conducted by A. C. Shaney	731
Latest Radio Apparatus	754
Classified Radio Directory—Section III (Revised)	757
Shop Notes—Kinks—Circuits	764
Book Reviews	763, 764
F.C.C.	766



Published by Radcraft Publications, Inc. Publication office: 29 Worthington Street, Springfield, Mass. Editorial and Advertising Offices: 20 Vesey Street, New York City. Chicago Advertising Office: RADIO-CRAFT, 520 North Michigan Avenue, Chicago, Ill.

RADIO-CRAFT is published monthly, on the first of the month preceding that of date; subscription price is \$2.50 per year in U. S. (In foreign countries, 75c additional per year to cover postage; Canada, 50c additional.) Entered at the post office of Springfield as second-class matter under the act of March 3, 1879.



Foreign Agents:

- London—Gorringe's American News Agency, 9A Green St., Leicester Square, W. C. 2, England.
- Paris—Messageries Dawson, 4 Rue Faubourg, Poissonniere, France.
- Melbourne—McGill's Agency, 179 Elizabeth St., Australia.
- Dunedin—James Johnston, Ltd., New Zealand.



Text and illustrations of this magazine are copyright and must not be reproduced without permission of the copyright owners.



Copyright 1941 Radcraft Publications, Inc.

AN ORIGINAL PHASE INVERTER

Dear Editor:

I am submitting to you a description of a phase inverter I developed and, surprised with its optimum result, I would like it to become known to other fellow amateurs and public address designers.

One of the most important problems met by amplifier designers is certainly the phase inversion for push-pull operation.

The phase inverter presented here is the result of a careful study, conducted by logical considerations and electrical calculations.

Looking for simplicity (best policy in all design), the author considered the circuit of Fig. 1 used in D.C. direct-coupled amplifiers for cardiograph purposes, employing high-amplification pentodes with low plate voltage.

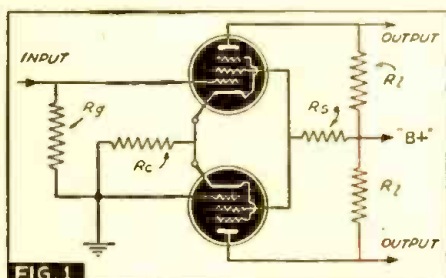

FIG 1

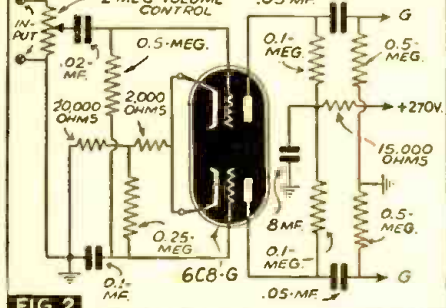

FIG 2

It is known that, if the cathode resistor R_c is a few times greater than the ratio: plate plus plate load resistor, to amplification factor,

$$\frac{R_p + R}{\mu} \quad (A)$$

the signal will appear at the cathode end of the cathode resistor. Connecting the cathode of tube No. 2 to the cathode of tube No. 1 and grounding the grid of tube No. 2 phase inversion is accomplished. In actual practice the cathode resistor R_c is made 3 to 10 times greater than the value given by the second member of formula (A).

This circuit, simplicity itself, is unfortunately impracticable for triodes with low μ on account of the high bias developed across R_c . To enjoy triode quality using the above principle a solution was logically imposed: reduce bias to rated value. A tap on R_c at the proper bias voltage, and a filter circuit preventing the cathode signal from reaching the grids, is the originality developed by the author.

This circuit is shown in Fig. 2 where values given are from the experimental model using a double-triode 6C8-G with plate load of 100,000 ohms and 250 volts plate supply. Other types of triodes and pentodes will work equally well, values of parts being easily calculated considering load and plate resistances, amplification factor, rated bias voltage and plate or plate- and screen-grid currents. Equality of plate potential makes this phase inverter surprisingly suited to direct-coupled amplifiers. The filter network

on the grids bypasses very high frequencies, improving the signal from a crystal pickup and reducing needle scratch noise.

WALDEMAR DE OLIVEIRA,
Civil Engineer,
Sao Paulo, Brazil.

CENTRAL AMERICA CALLING

Dear Editor:

We have great pleasure to inform you that one of our transmitters, namely TGW, operating on the frequency of 1,520 kc. p. s., will have its power increased to 10 kw. in the near future, the necessary apparatus having been already acquired.

The "Voice of Guatemala" will then operate with the following transmitters:

TGW: 10 kw. on 1,520 kc.; TGWA: 10 kw. on 15.170 during the day, on 9,685 during the night, with optional frequencies of 11,760 and 17,800; TGWB: 1 kw. on 6,480 kc.; and TGWC: 1 kw. on 2,320 kc.

TGW, TGWB and TGWC are on the air during week-days from 7:00 to 8:00 and from 11:45 to 14:45, also from 17:15 to 23:15, C.S.T. And on Sundays from 9:30 to 16:15 and from 18:00 to 23:00.

TGWA is on the air during week-days from 11:45 to 13:00 and from 21 to 22:45; on Sundays from 11:45 to 16:15 and from 18 to 23:00.

Having recently installed rhombic antennas directed towards the U.S.A., we would appreciate very much if your readers can check up our signal strength. All reports will be promptly answered, there being no need to send stamps, coins or international reply coupons.

Thanking you in advance for the publicity you may give to this information, I remain

LUIS SCHLESINGER CARRERA, Director,
Radiodifusora Nacional de Guatemala,
"La Voce Guatemala,"
Guatemala, Central America.

CONCURRING IN "WHY THE SUPERHETERODYNE?" BY MR. MOODY

Dear Editor:

Three cheers for Mr. Moody, the man who dared defy the laboratory geniuses, technicians and experts who foist supers. on an innocent public.

The writer concurs completely with Mr. Moody's assertions. How often have we heard the purchaser of one of the late models lament that, although his set is more sensitive and selective and can do more than his old set, including receiving overseas broadcasts on one of the shortwave bands, it is sadly lacking in a very important requirement—*tone quality*? When asked what the "old set" was, the inevitable reply was: "Philco (Majestic, Atwater Kent, Crosley, Brunswick, etc.), model such and such," which all persons, who have made radio a hobby or means of livelihood for the past decade or two know, were T.R.F.'s.

Even though these "old sets" were inferior when we consider the detector, audio section and speaker, the tone more nearly approached realism than present-day models, even expensive ones. With present-day audio development such as inverse feedback, beam power tubes and high-quality audio transformers and loudspeakers, a well-designed T.R.F. tuner is capable of reproduction with breath-taking realism.

The average listener is strictly a layman so far as the intricacies of radio are concerned, and cares not what is on the label of his radio set or what kind of circuit it employs, just so it sounds good. The word "superheterodyne" is pretty high-sounding

New Direct-Coupled FM - AM

AMPLIFIER MANUAL

By **A. C. SHANEY**

Chief Engineer, Amplifier Co. of America

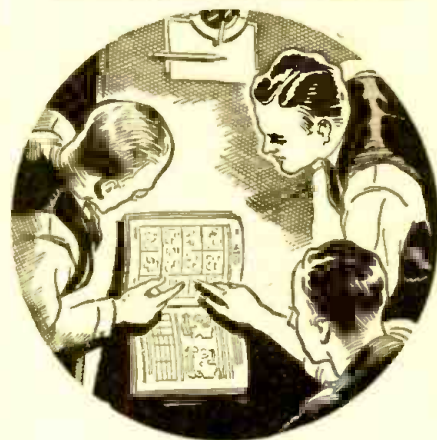

For the Layman, Serviceman, Recordist and Engineer

Regardless of whether you are interested in the finest type of phonograph reproduction, high fidelity recording, sound-on-film applications, FM or AM programs, you will find invaluable information in this practical handbook. Written by the leading exponent of direct-coupled amplifiers who has spent more than 10 years improving and perfecting the famous Loftin-White circuit.

Explains the theory and practical application of:

- Variable Speed Non-Overloading Push-Pull Expansion
- Non-Frequency Discriminating Scratch Suppression
- Push-Pull Balanced Direct-Coupled Amplification
- Push-Pull High-Frequency Equalization
- Push-Pull Low-Frequency Equalization
- Push-Pull Volume Compression
- Automatic Volume Limitation
- Automatic Volume Control
- Calibrated V.U. Indicator
- Audio Spectrum Control
- Remote Control

If you are interested in the latest audio developments, you can't afford to be without this complete compendium of authentic articles on Direct-Coupled Amplifiers, 32 pages 8 1/2" x 11". Over 100 diagrams and illustrations.

Priced to Cover Cost of 20c
Printing and Mailing

Send Stamps or Coin

AMPLIFIER CO. OF AMERICA

17 WEST 20TH STREET, NEW YORK, N. Y.

EVERYTHING IN RADIO

This big book serves your entire needs. It includes sets, parts and supplies, public address amateur equipment, testers, kits, fluorescent lighting. Nationally known favorites at lowest possible prices. Write today for your copy of this **BIG FREE CATALOG**

BURSTEIN-APPLEBEE COMPANY

1012-14 MCGEE STREET, KANSAS CITY, MISSOURI

RADIO TECHNOLOGY

RCA Institutes offer an intensive course of high standard embracing all phases of Radio and Television. Practical training with modern equipment at New York and Chicago schools. Also specialized courses in Aviation Communications, Radio Servicing and Commercial Operating. For Free Catalog Write Dept. RC-41.

RCA INSTITUTES, Inc.
A Radio Corporation of America Service
75 Varick St., New York, 1154 Merchandise Mart, Chicago

New Fountain Pen Size! RF. IF. AF Signal Generator

Self powered oscillator for:
• All alignment
• Trouble shooting
• PA systems • Checking sensitivity • AVC • Antennas • 10 second locating of auto set ignition pickup
• Host of other tests. Utterly simpler, faster, more accurate. Used by U.S. Army Signal Corps, hundreds of servicemen and organizations. Write now for leaflet.

GENERAL TEST EQUIPMENT CO.
213 S. CROSBY AVE. KENMORE, N. Y.

➔ How to Get the
➔ BETTER Job in Radio!

• **Technical Training Backed by Your Own Radio Experience Should Prepare You for a BETTER Job in Radio!**

Did you ever realize how much money the lack of modern advanced training is costing you? It's worth taking time right now to find out how CREI offers you a planned program for advancing yourself in radio. CREI courses in Practical Radio and Television Engineering equip you with the ability to go after and get the better engineering jobs.

THINK THIS OVER:

Actual Records Show—
• CREI graduates, as a group, are among the highest paid in radio! • CREI men are in more than 350 broadcasting stations! • More than 5,000 radiomen have taken this course of training! • Employers are increasingly calling upon CREI for personnel replacements and additions.

WRITE TODAY! If you are a professional radioman and want to make more money, send for free booklet and factual information. To help us intelligently answer your inquiry—please state briefly your education, radio experience and present position.



CAPITOL RADIO ENGINEERING INSTITUTE

Dept. RC-6 3224 16th St., N. W. Wash., D. C.



ELEMENTARY MATHEMATICS

• EASY — SIMPLIFIED — PRACTICAL •

HERE is a book for the business man, the technician and craftsman explaining and answering every operation and meaning with interpreting illustrations and examples.

It is the key to a simple understanding of many perplexing problems in daily life.

In clear, positive and definite language, the author popularizes and clarifies every subject and helps the reader to overcome any apparent difficulty in the study of mathematics.

A real home study-course in mathematics for the student or the man who wants to achieve proficiency or desires to brush-up on his knowledge.

Entire Chapter on Special Mathematics for the Radio Technician

CONTENTS OF BOOK

- CHAPTER I. Arithmetic—Addition—Subtraction—Multiplication—Division.
- CHAPTER II. Factoring and Cancellation—Fractions—Decimals—Percentage—Ratio and Proportion.
- CHAPTER III. The Metric System.
- CHAPTER IV. How to Measure Surfaces and Capacity (Geometry).
- CHAPTER V. Powers and Involutions—Roots and Evolution.
- CHAPTER VI. Mathematics for the Manual and Technical Craftsman—Thermometer conversions—Graphs or Curve Plotting—Logarithms—Use of the Slide Rule.
- CHAPTER VII. Special Mathematics for the Radio Technician.
- CHAPTER VIII. Commercial Calculations—Interests—Discounts—Short Cut Arithmetic.
- CHAPTER IX. Weights and Measures—Useful Tables.

ONLY
50c
POSTPAID

TECHNIFAX
1017 S. State St. RC-641 Chicago, Ill.

RADIO COURSES
Start September
RADIO OPERATING—BROADCASTING
RADIO SERVICING—a practical course
RADIO AMATEUR CODE TELEVISION
ELECTRONICS—1 yr. day course 2 yrs. eve.
Day and Evening Classes. Booklet Upon Request.
New York Y.M.C.A. Schools
4 W. 64th Street New York City

RADIO-TELEVISION

Oldest, largest Radio-Television school in West trains you for good pay job. Complete instruction including Radio Construction and Service, Broadcast Operating, Sound, Talking Pictures, Television, Public Address, etc. Flexible plan to meet specific needs of those with or without jobs. Transportation allowed to L.A. Earn room and board while learning. Request Free Catalog.

NATIONAL SCHOOLS, Dept. 6-RC
Los Angeles

and, like 2 or 3 shortwave bands, is used advantageously by salespeople when promoting sales.

After all is said and done, the average listener—who might be a housewife listening to her favorite morning program while busying with her chores, or a tired businessman, settled comfortably in his easy chair relaxing to the strains of some pretty melody—does not care a hoot for shortwave programs, nor does he strain his receiver on domestic DX reception. He is content with receiving stations within his “easy-to-get” range; a job that can be done with a T.R.F.—with superior tonal results.

The writer is aware that supers. are very important in filling a need for the amateur, as communications receivers, etc. But what could be more flagrantly misused than a multi-tube super. with a stage of R.F., 2 stages of I.F. and very good sensitivity and selectivity, used entirely for reception of strong locals whose signal strength is so strong that the diode detector develops a high A.V.C. voltage which practically overbiases the R.F. and I.F. tubes resulting in distortion at the output? Don't say it isn't done—just look around for yourself.

EMILE J. ROME,
New Orleans, La.

ELECTRIC CLOCK REPAIRS AS A SERVICE SIDELINE FOR THE RADIO MAN

Dear Editor:

In New York City, at least, the majority of the electric clocks sold to the public are either Telechron or General Electric, and, in one case I know of, G.E. uses a Telechron Timer in a special set designed to switch the radio receiver on and off at a predetermined time setting.

It would be worthwhile for the Serviceman to investigate the advantages of the electric clock repair business, since for the investment required and the return on that investment, there is a decidedly more favorable ratio than in the case of radio servicing itself. In addition, the profit is not only easy to obtain, but it is there practically for the asking. In outlying districts, the suburbs of metropolitan New York and Jersey, there are many people who would rather bring their clock to a repair man in their neighborhood than to cart the thing all the way to the big city. If, then, you go after the business, you will have a profitable sideline, something that will help to pay the minor expenses of your organization.

Further, in servicing sets using the clock type of timer, it would be valuable experience to have had the opportunity of working on cheap, relatively simple clocks before tackling the complicated mechanism of such a radio switching system.

The parts are obtainable from the Electric Time Co., 915 Broadway, or from G.E. Supply, 585 Hudson St., both in New York City.

The G.E. people, although the motors used in their clocks are the same, identical, charge more than Telechron. This is because Telechron owns the patent rights and licenses G.E. Most kitchen clocks sell for around \$4. The motors required for servicing cost the repairman 80c if he buys from Telechron and returns the old motor; G.E. sells the same thing for \$1.50.

If the Serviceman charges, for a simple kitchen clock repair involving but 10 minutes' time and the replacement of this motor, bought at 80c, he can collect \$1.50 for the work, a good profit. Given enough of such repairs, over a period of a week, he will be able to expand his allowance for test equipment.

There is nothing mechanically or elec-

trically complicated about the work above outlined, and it is really worthwhile. Later, after having acquired some skill, the repairman may try his hand at repairing the more complicated clocks, the alarms and the chimes.

If it is considered that the clock repair business does not pay, or is below the dignity of the highly trained service specialist, just remember that it is a good policy to get people into the habit of coming into your shop. That point is very important and the key to wider business and increased prestige. More likely than not, the patrons of your establishment may come to look upon you, a Serviceman, as a mechanical or electrical genius. And that kind of attitude on the part of your customers will not hurt business, you can be very certain.

WILLARD MOODY,
New York, N. Y.

RADIO-CRAFT BOOSTER

Dear Editor:

I am a steady reader and booster of Radio-Craft.

Have read Willard Moody's letter as published in the February, 1941, issue of "R.-C." As for Willard Moody, I have read many of his letters published in "R.-C." and have found them very interesting, and would like him to continue writing for "R.-C.", but I sharply disagree with him on his views regarding Hugo Gernsback.

I have followed Hugo Gernsback's editorials since the days when he wrote for Science & Invention (a good many years back).

Just because Hugo Gernsback can see further than his nose doesn't mean he should be condemned. His editorials are farsighted and constructive. I sincerely hope you continue his writing editorials for "R.-C."

If you drop "Shop Notes, Hints and Kinks" from your magazine you would be omitting a department which I believe is referred-to by every reader of this magazine.

I will close with three cheers for Radio Craft.

I. L. FRIEDMAN,
Brooklyn, N. Y.

Thank you, Sir, thank you!

RADIO-CRAFT EASES SORE EYES

Dear Editor:

What a sight for sore eyes! Was looking over the magazines at a stand for something interesting to read and like money from home, I saw the words HUGO GERNSBACK, Editor. You should have used larger type for those words I've looked for but missed for years. I used to read Radio News when you were editor, then when some other bohunk became editor, I lost interest. My work (and of course study) took me away from radio, but all the while I've been wondering just what you were doing. I've never missed anything so much as your magazine. The editorials, articles, and the mental prods are just the kind of meat I like. Can't say how thankful I am to find a magazine—HUGO GERNSBACK, Editor. Just a stroke of luck that I needed some dope on an amplifier I'm making as a hearing-aid for a person that is darn near deaf.

And listen Bud, DON'T stop those editorials. Just the thing a fellow needs to wake up all of us. We really are too lazy to think. Also I'd like to see a Serviceman who is too intelligent to read the articles you select or too "intelligent" to benefit from the "Hints and Kinks." Anyone so intelligent as the fellow who uses a whole column of a department he wants discontinued, as in

Feb. *Radio-Craft*, should find out how much he doesn't know. But I do agree with him to continue the experimental (articles—*Ed.*). I don't know if there is much profit in a magazine for the experimenter, but you have done a lot more to make this a better world to live in, than any 10 of us realize. Ours is the sin for not following your suggestions; yours is the glory of pointing the way.

The letter of Earl Russel on hearing-aids took my eye. Three months ago I undertook to make a hearing-aid, for a person who hasn't been able to find a satisfactory 'aid in the last 30 years—money no object. I used to be a radio Serviceman in the days of 3-element battery tubes, but since then I have forsaken radio for electricity in the power field. It's a bigger job than I bargained for but thanks to 3 years of laboratory work I don't mind the slow progress. I don't know much about "1941" amplifiers but the last 'aid I've made works.

The person it was intended for can use a telephone and talk with anyone in the same room. (Without mirrors, Mr. Russel.) This in spite of the fact the person cannot hear you shout if your lips are an inch from her ear. Mr. Russel is a bit wrong about crystal nikes and phones. But I believe his prayer for a battery-operated 'aid is a bit hopeless.

I've a few experiments to complete before I can call this 'aid finished, but after that I feel I'll have exhausted the possibilities of present-day equipment and parts. I'm thankful for my laboratory training, as I don't believe the work would have been successful without it. As it is I almost can consider myself an authority on hearing-aids. I've made them from "1-tubers" to "10 watters," and have the good fortune to have a wide variety of people with various hearing troubles to work with. I believe the cause of confusion in the hearing-aid field is that certain people can hear well with certain 'aids but it takes an unusual 'aid for anyone to use. It could be made, but in one way or another, each person requires a custom-built job. Do not attempt to make one for Mr. A that is just like the one Mr. B likes so well.

HERBERT SASS,
Port Clinton, Ohio

THE BETTIS METAL LOCATOR

Dear Mr. Bettis:

We built one of the Metal Locators which was described, or outlined, in the September, 1939, issue. But it was not any too satisfactory. We did some changing, but still we realized there was plenty of room for further improvements. This you outline in the December, 1940, issue, and as it seems to be a great improvement, we are planning to build it! But we thought it best to write you directly, first, to be sure that the details as to the circuit outline might not be a little off from those which you submitted to the publishers.

One thing in particular we had in question, was whether the value of 500 mmf. for the condenser which appears in the transmitting loop, is correct?

Another question: Is the item calling for a "Meissner I.F. interstate transformer," instead of an input type, No. 16-5728? Is there too much gain in the input, or is this a mistake in the printing of the article? There being a gain of 80 in the input and only 19 in the interstage. If there is no mistake in the printing of the article of course it is correct, but we were just not sure ourselves, and as we want this one correct, the only way was to write you.

Too: Wouldn't a Simpson 0-200 micro-ampere, which we already have, work in the

other rig, or must we get an 0-100 as the article calls for before it would work satisfactorily? No doubt our 0-200 would not be as sensitive as the 0-100, but we just wondered if it would not do?

And if there are any other changes that should be made from the line-up as given in the *Radio-Craft* article would you please tell us! We certainly would appreciate it. And we thank you very much indeed!

B. B. BARTHOLOMEW,
Puyallup, Wash.

Mr. Bettis replied as follows:

Dear Sir:

Your letter just reached me this morning from *Radio-Craft* and hope that I may be of help.

There is an error, in the article in the December issue, in that the depth of the 1/2-in. water line should be 1 ft. instead of 21 ft. The dual condenser unit in transmitter Fig. 12 is condenser 5 as in the List of Parts. In the receiver, the dual condenser is 4A as in the List of Parts. Figure 15 has a slight error, and a correction is here supplied. Otherwise everything is correct.

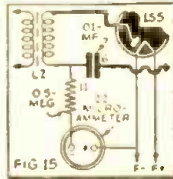

The circuit shown at left is in correction of a portion of the diagram shown on pg. 365 of the December '40 issue of "R-C." ("Building a Modern Miniature-Tube Metal-Treasure Locator").

The 500 mmf. unit in the transmitting loop is correctly rated as to capacity.

The Meissner interstage I.F. transformer was used but the No. 16-5728 will probably be OK but may take a different setting of the gain control to prevent oscillation.

The 0-200 microA. meter you have will probably be satisfactory and will be just as sensitive if you can obtain full-scale reading on the meter.

The aluminum foil should extend to within 2 ins. of the inside edge of the receiver case and only on the front panel of the receiver.

Extension hand grips are very necessary for sensitive operation. Mine are fastened to handles, 27 ins. from each end, with small bolts; and are made of stiff wire with a wooden spool for the hand grip similar to the handle of a heavy 5-gallon oil bucket.

It will be noted that this locator is not very sensitive to metal above ground but really goes to town on buried lines or metal that has been in the ground some time.

I hope this will help, and would appreciate hearing how you come out and just what luck you have.

G. M. BETTIS

SAYVILLE AGAIN

(A Letter to Hugo Gernsback)

WITH regard to the correspondence you quote on page 687 of your May, 1941, issue of *Radio-Craft*, the following may be of interest to your readers, and you may therefore want to quote me in this connection. You certainly have my permission to do so, as a matter of general information.

Early in the days of World War I, while I was editor of *Modern Electrics*, I received a 'phone call from Richard Pfund, who had only recently divorced himself from the Telefunken Wireless Telegraph Company of America. This company, although carrying the German name, was jointly owned by some American gentlemen and by the German parent organization. However, it was very much in the hands of Dr. Albert, who in turn headed the activities of the Atlantic Communication Company. Because of the German intrigue and definitely un-neu-

Learn RADIO SERVICE WORK with these 2 BIG Ghirardi BOOKS

MODERN Radio SERVICING

Learn How with this!

Here's the world's most highly praised course in practical radio service work—all for you in this handsome 1300-page home-study book. First, a big 420-page section explains all types of servicing test instruments—how they work, how to use them—so, how to build your own. Then, 900 more pages give you a thorough, step-by-step procedure course in trouble-shooting, testing, aligning and repairing all makes of radio sets and other electronic devices by latest scientific "factory methods." Learn radio servicing this quick, easy, economical way. Learn WHAT to do and HOW to do it. Send for your copy today. Use the coupon below! \$4



RADIO Trouble-Shooter's HANDBOOK

Save Time with this!

Here's real help for servicemen—518 big manual-size pages of valuable, time-saving, factory-checked servicing data right at your finger tips to help you do every servicing job quickly and accurately. Its 52 BIG SECTIONS contain 275 large pages of time-saving "Case Histories" on over 3,300 receivers. Alignment data for over 15,000 superhets. Servicing and installation data for all Auto Radios. Trouble-Shooting Charts. Tube, Resistor and Condenser Charts. EVERYTHING! Speed up your service work with all the vital servicing data NOW in this one big book. \$3



CLIP OUT! MAIL NOW!

Radio & Tech. Publ. Co., Dept. RC-61
45 Astor Pl., New York

Enclosed find payment for:
 MODERN RADIO SERVICING
 RADIO TROUBLE-SHOOTER'S HANDBOOK

Check here for FREE circulars.
 BOTH books at \$8.50 Money-Saving Combination Price

NAME _____ ADDRESS _____ CITY _____ STATE _____

---MONEY-BACK IF NOT SATISFIED---

FREE!

HAMMARLUND NEW "41" RADIO CATALOG

The latest Hammarlund catalog with complete data, illustrations, drawings and curves on the entire Hammarlund line. Address Department RC-6-1 for your free copy.

HAMMARLUND MFG. CO., INC.
424-438 West 33rd Street, New York City

Be a RADIO SERVICE EXPERT LEARN AT HOME IN SPARE TIME

The demand for radio experts grows every day. Learn this paying profession under personal guidance of qualified engineer and educator. Clear, fascinating instruction and experimental kits make learning easy. Leaders in the radio industry endorse R.T.A. methods. Spare time profits soon pay for training.

NOW IS A FINE TIME TO START

New National Defense program requires radio trained men in radio factories and every branch of U. S. Service. Opportunities for advancement almost limitless.

FREE Write today for complete information and radio book telling what R.T.A. training can do for you.

RADIO TRAINING ASS'N. OF AMERICA
1559 Devon Ave. Dept. RC-61 Chicago, Ill.

SOLAR RED-CAPS
Smaller Diameter Dry Electrolytics

SPEED Servicing

Write for Catalog

SOLAR MFG. CORP. Bayonne, New Jersey



LEARN RADIO
SERVICING COURSE—8 WEEKS
OPERATING COURSE—5 MONTHS

H. C. Lewis

I'LL FINANCE YOUR TRAINING

Mail coupon today for free book showing how you can learn Radio Operating, Servicing, Sound and Television in a few short weeks in Coyne Shops and also how you can pay tuition in easy monthly payments after graduation.

LEARN BY DOING

On real Radio receiving and transmitting equipment at Coyne. Simple, easy method of practical shop training. You don't need previous experience. Prepare for Radio Operators' Government license Exam, and for good jobs in Broadcast, Police Radio, Aircraft Radio, Ships, Commercial Radio stations, or in service shops and radio factories. "Learn by doing", the quick, modern way, at Coyne Shops in Chicago.

EARN WHILE LEARNING

Job Help After Graduation

We assist you in getting part-time work to help pay living expenses and give you real employment service after you graduate.

H. C. LEWIS, Pres., COYNE RADIO SCHOOL, 500 So. Paulina St., Dept. A1-84, Chicago, Ill. Please send me your free book and details of easy Pay-After-Graduation Plan.

NAME _____
ADDRESS _____
CITY _____ STATE _____



SEND COUPON TODAY

BRAND NEW! INVALUABLE!

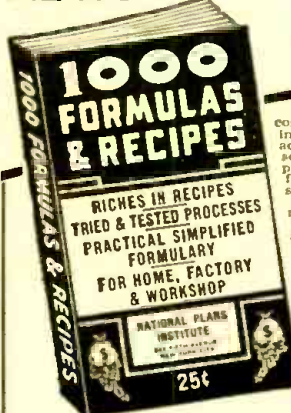

ONLY **25¢** a copy

The greatest, most compact formula book in print. Contains actually 1000 trade secrets, recipes and processes for home, factory and workshop. Check full of money-making ideas. Has newest tried and tested formulas for making Glues, Cements and Adhesives; Cleaning Compounds; Paint and Pigments; Wood Stains; Varnishes, Disinfectants and Deodorants; Fire Proofing and Extinguishers; Glass working; Inks; Insecticides; Laundry Processes; Metal Work; Etching Fluids; Solders; Preserving Essences; Extracts and Flavors; Plastics; Plating Solutions; Polishes; Preservatives; Fireworks; Soaps; Creams; Dyes; Toilet Preparations, Dentifrices and Cosmetics; Hair Preparations; Manicure Preparations; Sun Burn Creams and Lotions; Waterproofing; Waxes and countless others.

Paper Making; Photographic Processes; Preserving Essences; Extracts and Flavors; Plastics; Plating Solutions; Polishes; Preservatives; Fireworks; Soaps; Creams; Dyes; Toilet Preparations, Dentifrices and Cosmetics; Hair Preparations; Manicure Preparations; Sun Burn Creams and Lotions; Waterproofing; Waxes and countless others.

A Wonder Book of Useful Knowledge! Worth its weight in gold.

Book is up-to-date. Newest methods—latest discoveries. Remember—1000 clearly described SIMPLIFIED formulas, processes and recipes—MANY NEVER BEFORE DISCLOSED.

66 pages, printed on good paper.

Send for your copy TODAY. Remember, great fortunes are made from formulas.

25¢ a copy, sent postpaid anywhere

Send money order, check, unused U.S. stamps or coin.

NATIONAL PLANS INSTITUTE
246-R Fifth Avenue New York, N. Y.

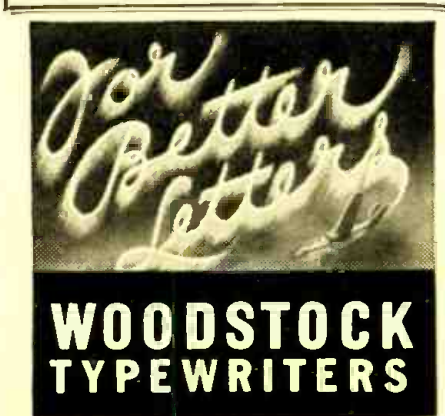

WOODSTOCK TYPEWRITERS

tral activities in this country, Mr. Pfund decided to resign from the company, and set himself up in his own radio business in the Trinity Building on lower Broadway, New York City. I had worked for him several years before, when he was still with the Telefunken Wireless Telegraph Company of America.

He 'phoned me the first week of August 1914. He told me to come right down to see him, regardless of what I might be doing. I did so. Arriving at his office, I found him in a great state of excitement. He showed me half a dozen messages which he told me were from the Sayville wireless station, intended for some German ships out in the Atlantic. I recall that one of them was the German commerce raider *Dresden*, which was somewhere off our territorial waters. These messages told the German ships the latest news concerning the British cruiser *Birmingham* and the French cruiser *Descartes*, as gathered from our own American knowledge of their whereabouts. Also, these messages told of the clearings of Allied shipping from such ports as Boston, New York, Philadelphia, Baltimore and others along the Atlantic seaboard. Naturally, such messages were un-neutral, and were infringing upon our American hospitality to German interests.

Mr. Pfund explained to me that he had picked up these messages at his home, where he had an amateur receiving station. He had decoded the messages, thanks to the absolute stupidity of the German authorities. It seems that the Telefunken Company used the German Imperial Navy code for its secret messages, and when Pfund left the company, he had a copy of that particular code. The messages were being sent in code, but Pfund had the code book, whereby he was able to decipher the messages.

He urged me to go to the French Consul General in New York City, which I did. I brought the messages along with me. Needless to state, I had quite a difficult time getting by the clerks who were busy handling hundreds of French reservists who were anxious to return to their faterland for military service. I finally made myself noisy enough to get attention, speaking French as well as English, and was introduced to the Consul's right-hand man. I showed him the messages, explained the circumstances, and gave him my name and address.

Two days later, I read in the newspaper that French Ambassador Jusserand and British Ambassador Cecil Spring-Rice had called on Secretary Bryan, then Secretary of State, and had registered a joint protest regarding the un-neutral activities of the Sayville wireless station. As a result, a Navy guard was sent to Sayville, for the purpose of checking the communication activities of the station.

Despite the Navy personnel guarding the Sayville station, four months later a radio amateur by the name of Apgar, living in Jersey, I believe, succeeded in detecting further duplicity of the Germans operating the Sayville station. He took the high-pitched continuous notes being transmitted by the Sayville station, on a dictating phonograph record. By playing the record slowly, he deciphered dots and dashes which at the normal speed of operation were run in together as a continuous note. He exposed the situation to the Government, whereupon the Sayville station was taken over definitely by Navy operators, and the trickery stopped, fully enforcing our American neutrality.

Years later the French Government rewarded me for my efforts, with a decoration, in 1919.

I mention these facts to show that you were quite right in your attitude regarding

the Sayville station, as my story proves. Please note that my story preceded your editorial, having taken place in the early days of the War, in August 1914.

Perhaps this episode may be of interest to your readers, particularly at this time, when once again we have to watch for this very same sort of trickery. I have no doubt that we shall have secret transmitters or known transmitters operating with all sorts of trickery, whereby much un-neutral information and even information definitely undermining our national defense, may be transmitted to the Axis powers. I think radio amateurs should be on guard every moment, first to detect and report any suspicious transmissions, and secondly, to be sure that they do not fall into any sort of trap, whereby they might be used as tools, unknowingly, for such activities.

AUSTIN C. LESCARBOURA

Editor's Note—Austin C. Lescarboura is a radio old-timer who, as an editor and as a free-lance technical writer, has authored many interesting articles. More lately Publicity Director for a number of radio companies, he is perhaps best known as the guiding genius of "The Word Shop," his offices at Croton-on-Hudson.

Mr. Lescarboura holds memberships in a number of organizations including The Institute of Radio Engineers and the Radio Club of America (Fellow). He was decorated an Officier d'Académie by the French Government in 1919 for World War I services.

Many *Radio-Craft* readers will recall his book, "Radio for Everybody."

MEASURING RESISTANCE BY THE SUBSTITUTION METHOD

Dear Editor:

Enclosed is a brief description of a test box by which resistances may be measured by the substitution method.

In looking back through my files of radio magazines I do not find any description of this simple and rapid method.

There are hundreds of shops and "shacks" where the meters are not calibrated for resistance reading.

This method has the added advantage that higher voltages may be applied where needed, thus obtaining higher readings than on a standard calibrated meter, resulting in better accuracy on high values of resistors.

By using low voltage it is possible to measure low resistances also with good accuracy.

Those who have built test boxes such as here described tell me they "wouldn't know how to get along without it."

Don't you think your readers would be interested?

C. S. CARNEY,
Evanston, Ill.

(Editor—We'll put it up to the readers directly by printing it below.)

Measuring Resistance by the Substitution Method

There are several advantages in the substitution method of measuring resistances.

Any meter may be used without special calibration.

No calculations are required.

No special battery is needed.

It permits more accurate readings by using the high end of the meter scale.

The test set is simple to build from parts found in almost any "junk box."

Best of all it is rapid and accurate. The wiring diagram is shown on page 711.

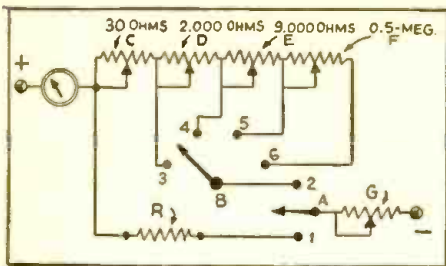

How it works.—Switch A alternately shorts out of the circuit the unknown resistor R or a selected portion of the resistance in the test box.

This latter resistance is adjusted until the meter readings are equal. Then the selected resistance is equal to the unknown resistance, and is read on the test box scales.

The voltage is adjusted by resistor G to give approximately full-scale readings on the meter.

Since the two readings are equal, the meter need not be calibrated, nor is it neces-

sary to know the exact voltage applied.

Any convenient source of "B" power may be used. Resistors may be measured without removing them from the radio set, merely by disconnecting the "B" power leads and transferring them to the test box (or an outside source of power may be used).

Operating Notes.—Start with A on 1 and B on 6.

Warning! If B is not on 6 at the start the meter may be damaged.

Adjust G until the maximum possible is obtained.

Now throw A to 2 and gradually short-out part of the resistance in the circuit until the meter reading is the same as on A1.

Swing A back and forth several times to check this setting. Then read the calibrated scales of the remaining resistance. This is equal to the unknown resistance "R".

Construction Notes.—Any convenient values of rheostats may be used.

Switch A is an S.P.D.T. knife or rotary. Switch B may be a rotary selector type or 4 S.P.S.T. knife switches.

REAL "TREASURE" FINDING!

Dear Editor:

Having been a subscriber to your magazine, *Radio-Craft*, for a number of years while in the radio business, I thought that some articles on "treasure hunting" and *radio balances* might have appeared in your magazine recently. I have not read it since March, 1938.

In the latter part of 1937 I built a unit based on the Chilson circuit and other circuits given in *Radio-Craft* prior to that time. With this unit I was able to locate some buried placer gold in western Arizona. As a result of the findings of the radio balance, I was able to mine successfully according to its indications and I was able to recover a total of about \$2,000 in gold at a depth of 20 to 30 feet.

I would like to know if any articles on "treasure hunting" units have appeared in *Radio-Craft* since January, 1938, and if so, have you the back numbers? I wish to redesign this equipment in order to make it more effective and efficient. Do you know of

any articles appearing in other magazines on this subject which might be of help to me?

Any information you can give me will be greatly appreciated.

W. HALL WAGENER,
St. Louis, Mo.

A number of articles on metal locators (so-called "treasure" finders) have appeared in past issues of *Radio-Craft*. Unfortunately, we have no index to most articles in this magazine; however, the record of previously-published articles on this subject is an exception (see list below). These copies are available at 25c for current issues; 50c for issues a year old; and \$1.00 for copies older than that.

Radio-Craft will be glad to consider for publication, construction articles on metal locators of the so-called "treasure"-finding type, particularly if these articles include information and illustrations concerning the use of the completed equipment in actually finding buried metals.

"TREASURE"-FINDING AND "GEO."-PROSPECTING ARTICLES IN RADIO-CRAFT

Title	Author	Issue	Page
Prospecting by Radio at 1.6 Meters	Joseph I. Heller	June 1931	728
*How to Build the Radio "Treasure" Finder	Clyde J. Fitch	June 1932	716
**How to Build the New "Treasure" Finder	E. Franklin Sarver	July 1933	8
An Improved "Treasure" Locator	C. W. Palmer	Aug. 1934	76
Newest in "Treasure" Locators	Gerhard R. Fisher	Dec. 1936	339
How to Make a Modern Radio "Treasure" Locator	Allan Stuart	Sept. 1939	146
***Building a Modern Miniature-Tube Metal-Treasure Locator	G. M. Bettis	Dec. 1940	364

*Also see "The Radio 'Treasure' Finder," Oct. 1932, pg. 229; and, "The Radio 'Treasure' Finder," May 1933, pg. 677, for additional data on this instrument.

**Also see "The New 'Treasure' Finder (corrections)," Nov. '33, pg. 294; and, "Treasure Locator," April 1934, pg. 610, for additional information.

***See letter from Mr. Bettis on pg. 709 (June, 1941).

REMINISCENCES

Old-Timers Tell of Broadcasting Prior to Its 20th Anniversary

Thinking back over the old days of broadcasting, Robert A. Simon, WOR continuity director who's been a radio writer for over 17 years, remembers:

... When announcers identified themselves on the air with code letters instead of their names. Tommy Cowan was WCN and Milton J. Cross was AJN.

... When the announcer had a switch to click himself and his studio on and off the air. Sometimes he forgot to make the switchover at the proper time, and there was trouble.

... When some writers used to use the finest bond paper for their scripts and the crackle often drowned out the announcer.

... When every announcement after the first one in a program began with "You have just heard..."

... When engineers bounced the mike up and down to clear its throat before a program—that was the old carbon mike.

... When "Hank Simmon's Showboat" and "Main Street Sketches" were two of the most popular dramatic programs on the air.

... When he wrote a sample hour dramatic program in 1929 for a prospective sponsor who liked the script, but said it wouldn't do because listeners wouldn't accept a full hour drama. That same manufacturer in 1940 sponsors a full hour network dramatic program.

RADIO TRAINING



PORT ARTHUR COLLEGE—not privately owned, not operated for profit, a college built and endowed by the late capitalist-philanthropist, John W. Gates—offers the most thorough practical Radio training in America. P. A. C. owns Radio Station KPAC, which is equipped with the very latest type 1000-Watt high fidelity RCA transmitter, operating on 1220 kc. with directional antenna system. The college is authorized to teach RCA texts.

The Radio training covers thoroughly Airways, Press, Announcing, Teletype, Typewriting, Laboratory and practical experience at KPAC transmitter, control room and studios. Announcing is an optional part of this training; nevertheless a number of students annually make successful announcers. Port Arthur College pioneered the teaching of radio with its first classes in 1909, and for thirty-one years has maintained an active Employment Bureau that is successful in placing graduates in airways, broadcast and marine radio industries.

If interested in details about the Radio Course, write for Bulletin R-41

PORT ARTHUR COLLEGE
PORT ARTHUR (World-Known Port)
TEXAS

FIX ANY RADIO

Amazing New Invention

Simplified Radio Servicing by Comparison Method

Repair radios in minutes instead of hours. Revolutionary different Comparison technique. Permits you to do expert work immediately. Most repairs can be made without test equipment. Simple, point-to-point, cross-reference, circuit suggestions locate the fault instantly. Plan copyrighted. Covers every radio set—new and old.

Complete \$1 Training

In Manual form, 8 1/2 x 11 in., 112 pages. Over 1,000 practical service hints, 18 large trouble-shooting blue-prints, 114 different tests using a 5c resistor, invented by M. N. Bestman, noted engineer and radio teacher. Results and Satisfaction Guaranteed. The complete simplified training is yours for only \$1.00, postpaid. Will pay for itself with time saved on the first job. Limited quantity. Money-back guarantee. Write today. SUPREME PUBLICATIONS, Room 957, 3727 West 13th Street, Chicago, Illinois

Simplest WAY TO REPLACE BALLASTS

4 STANDARD TYPES of Amperite Regulators replace over 200 types of AC-DC Ballast Tubes now in use... Has patented automatic starting resistor. List \$1.00

WRITE FOR REPLACEMENT CHART "S" Amperite Co. 561 Broadway, N. Y. C.

AMPERITE

Correspondence Courses in RADIO and ELECTRICAL ENGINEERING

ELECTRICAL ENGINEERING Get Road Map of wide electrical field. Prepare yourself, at Low Cost, for secure future. Modern, simplified, you can understand quickly.

RADIO ENGINEERING Extra fine course in radio, public address, photo-electric work. Trains you to be super-service man, real vacuum tube technician. Excer. kits furnished. Diploma on completion. Tuition, \$25, either course. Deferred payment plan.

FREE Get copies of school catalog, student magazines, complete details. SEND NOW!

LINCOLN ENGINEERING SCHOOL, Box 931-C30, LINCOLN, NEBR. 711

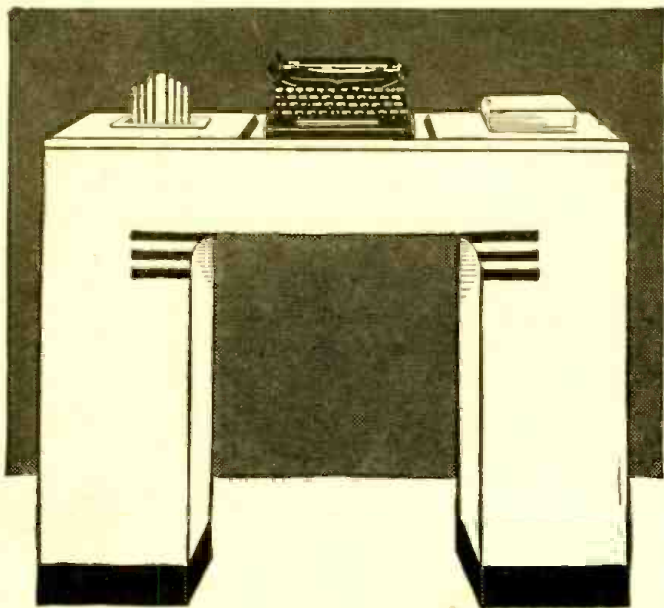

**THIS
BEAUTIFUL DESK
for only \$1.00
EXTRA**

**WITH ANY
REMINGTON
PORTABLE TYPEWRITER**

The
COMBINATION
FOR AS LITTLE AS
10¢ A DAY

How easy it is to pay for this combination of desk and Remington Deluxe Noiseless Portable Typewriter! Just imagine, a small good will deposit with terms as low as 10c a day to get this combination at once! You will never miss 10c a day. Yet this small sum can actually make you immediately the possessor of this amazing office at home combination. You assume no obligations by sending the coupon.

A beautiful desk in a neutral blue-green which will fit into the decorations of any home—trimmed in black and silver—and made of sturdy fibre board—is now available for only one dollar (\$1.00 extra) to purchasers of a Remington Noiseless Portable Typewriter. The desk is so light that it can be moved anywhere without trouble—it is so strong that it will hold six hundred (600) pounds. With this combination of desk and Noiseless Deluxe Portable Typewriter, you will have a miniature office at home. Learn the complete details of this offer. Mail the coupon today.

THESE TWO EXTRA FOR YOU

LEARN TYPING FREE

To help you even further, you get free with this special offer a 32-page booklet, prepared by experts, to teach you quickly how to typewrite by the touch method. When you buy a Noiseless you get this free Remington Rand gift that increases the pleasure of using your Remington Noiseless Deluxe Portable. Remember, the touch typing book is sent free while this offer holds.



SPECIAL CARRYING CASE

The Remington Deluxe Noiseless Portable is light in weight, easily carried about. With this offer Remington supplies a sturdy, beautiful carrying case which rivals in beauty and utility the most attractive luggage you can buy.



SPECIFICATIONS

ALL ESSENTIAL FEATURES of large standard office machines appear in the Noiseless Portable—standard 4-row keyboard; back spacer; margin stops and margin release; double shift key and shift lock; two color ribbon and automatic ribbon reverse; variable line spacer; paper fingers; makes as many as seven carbons; takes paper 9.5" wide; writes lines 8.2" wide. There are also extra features like the card writing attachment, black key cards and white letters, touch regulator, rubber cushioned feet. These make typing on a Remington Deluxe Noiseless Portable a distinct pleasure. Thousands of families now using the Remington Deluxe Noiseless Portable know from experience how wonderful it is!



**MAIL
COUPON
NOW!**

Remington Rand Inc., Dept. 189-6
465 Washington St., Buffalo, N. Y.

Tell me, without obligation, how to get a Free Trial of a new Remington Deluxe Noiseless Portable, including Carrying Case and Free 32-page Typing Instruction Booklet on terms as low as 10c a day. Send Catalogue.

Name.....
Address.....
City..... State.....

RADIO-CRAFT

"RADIO'S GREATEST MAGAZINE"

RADIO FAMINE

By the Editor — HUGO GERNSBACK

. . . . Defense priorities,
especially in metals, portends
important radio developments

UP to very recently the radio industry did not fully appreciate the tremendous Defense effort through which this country is now going. The shortage of certain materials which has taken place recently has caused a near-panic in radio manufacturing circles, because it is being realized that it will be difficult to produce as many radio sets in 1941-1942 as was the case in the preceding year.

The Raw Materials division in Washington which controls all priorities of materials, has set a figure of 30% of last year's requirements of certain important materials that established manufacturers of radio sets can use. This is particularly true of the key metal, aluminum. Thus, if a manufacturer used 100,000 lbs. of aluminum in the year preceding, he would only be allowed 30,000 lbs. for the coming year. A similar condition exists in the metal nickel which is almost unobtainable at the present time; that means that permanent magnets—in which nickel is used—for loudspeaker purposes are at the present time hardly obtainable. It appears that radio manufacturers will not be able to obtain high-grade permanent magnets for loudspeaker purposes for a long time to come.

There are two schools of manufacturers at the present time, one which feels that if everybody would cut down his production to 30%, all of the set manufacturers no doubt would be able to make money because they would have to get more money for their product and due to the fact that less sets will be sold during the coming year, all manufacturers would have to charge more for their sets. That would mean more profit for the manufacturers. The public would get better sets for the money and everybody would be satisfied—in theory. The other school, mass-production minded, will have nothing to do with a smaller production. Their arguments run somewhat as follows:

"This is America, the land that makes the impossible possible, the land where Yankee ingenuity was born. We will not allow our production to lag just for the sake of a little aluminum or nickel. We will substitute other materials for these metals and go the German *Ersatz* artists one better. We are not going to let these two metals stop our production one iota."

It remains to be seen which class will have the better of the argument. There is much to be said for both sides and only the future can tell exactly what will happen.

The "*Ersatz*"—substitution—craftsmen, will tell you that variable condensers now made exclusively with aluminum can just as well be made with steel stators and rotors. Indeed, there is nothing new about this either. One of the oldest radio parts manufacturers in the business blanked-out steel condenser blades in the early '20's. The trouble with steel plates is that they are magnetic and in the course of time, will accumulate (on account of wear and tear) small iron filings which adhere to the edges of the plates like whiskers. These are held in place due to the magnetism of the plates and after awhile such condensers tend to short-circuit. But we can still use brass, copper or phosphor-bronze. Zinc is a good material and could be used but unfortunately zinc is also on the priorities list and cannot be obtained. As far as the copper materials are concerned they seem to have the best chance.

The trouble here may be expressed in one word—weight. All of these materials are considerably heavier than aluminum. For this reason new designs must be evolved because

due to the greater weight; the rotor will tend to fall back by its own weight, unless some friction method is used. On the other hand if friction is used to keep the rotor from tumbling back due to its weight, tuning becomes more difficult and will not compare with the smooth tuning methods to which we have been accustomed.

Fortunately the difficulties in the variable condenser problem cited here, are not unsurmountable. It is certain that American ingenuity will overcome the trouble and perhaps emerge with something that might even conceivably replace aluminum completely, even when it can be had again. Tendency of invention and progress is, that often when an industry is put to the task, something better is evolved which replaces old methods and old materials. If an illustration is desired, we can point to plastics, now on a tremendous upswing. It is certain for instance that in due time wood in radio sets will be completely obsolete. Even today a large proportion of radio sets already are made with plastic cases and this tendency is on the increase.

Of course aluminum is used elsewhere in radio sets aside from variable condensers. There are quite a few other small parts termed "radio findings." These, however, can easily be replaced. There are also the so-called shield-cans which heretofore, on account of the desirability of achieving light weight, were made of aluminum. These will now be made of copper or brass and there is no difficulty about this.

There remains the electrolytic condenser used in many sets. Here the substitution problem is far more difficult for the reason that in an electrolytic condenser, aluminum is practically the only metal that can be used effectively. What the electrolytic manufacturers are going to do about this problem is not immediately apparent. If no substitution can be found then it means we will have to do with only 30% of electrolytics for the coming years, till the aluminum shortage has passed.

As for the permanent magnets in our loudspeakers, this is not such a very serious thing except that we may have to go back to the permanent-type magnets which were used before the nickel-iron magnets had been invented. That means larger and heavier magnets and is one thing the radio manufacturers do not cherish. Yes, we can go back to the electromagnetic type of loudspeaker which makes a permanent magnet unnecessary, but this again means using something that was discarded years ago and incidentally such loudspeakers not only cost more, but they also have been, as a rule, larger in size.

There is however, a possibility that a substitute of nickel may be found in the future. The metal tungsten has been used in permanent magnets for many years but tungsten is one of the metals difficult to obtain and it is also rather expensive; whereas nickel is much less expensive but right now unobtainable on account of Defense priority.

From all this it will be seen that a great deal of inventive ability will of necessity be required during the coming months to find substitutes for the present radio bottleneck. Personally I have no doubt that the problems can be solved and will be solved in due time, if it becomes a vital necessity to solve them.

We will probably be in for a good many radio surprises on account of all of this and it will be interesting to watch American radio receiver progress during the near future.

The "radio news" paper for busy radio men. An illustrated digest of the important happenings of the month in every branch of the radio field.



BOMBCASTING—THUMBS UP FOR THE BRITISH! (Cover Feature)

Robin Duff, B.B.C. War Observer, is shown broadcasting an eye-witness account of the result of a fire "blitz" on London while fires are still burning. Radio broadcasting is a valuable communications link between the government and the people. It is a powerful instrument of both propaganda and counter-propaganda, and as such, plays a tremendous role in the defense of the British Isles.



KOVAR

Westinghouse's "tube maker," B. Condret, inspects the vacuum-tight Kovar-and-glass joint of a high-voltage vacuum tube. An alloy of nickel, iron, cobalt and manganese, Kovar expands and contracts at the same rate as glass as the temperature changes.



VIDEO NEWS

Frazier Hunt, noted radio commentator and foreign correspondent, is shown telecasting a news program over Philco station W3XE, Phila., Pa. Hunt's new technique for enlivening his news broadcasts consists of effective use of both audio and video channels, augmenting his voice with motion pictures, maps and charts.

DEFENSE

HOW long does it take to train a person to handle radio duties in Uncle Sam's armed services? Only 4 months, these days, according to *Assoc. Press* reports last month, which tell how the U. S. Navy has clipped a 9-months' course down to 4, and of sending out of the Naval Radio School at Norton Heights, Conn., 500 youths all set to take over radio duties anywhere in the U. S. or its possessions.

According to an issue of *Radio Daily*, the 1st *Radio Intelligence Co.*, U. S. A. *Signal Corps*, at Ft. Monmouth, N. J., is "seeking amateur radio engineers and others interested in shortwave radio operation." Enlistment period: 3 years. Opportunities for officer ratings and advancement are exceptional.

IN PRINT

FORTUNE magazine last month ran a characteristically informative article entitled "Radio Turns South," in which author William S. Paley (C.B.S.'s young prexy) told how he had spent 7 weeks signing-up broadcast stations in key cities serving the 15,000,000 radio listeners south of the Panama Canal. The new network is designed to solve the problem of supplying good North American programs to South American listeners, and vice-versa.

In "RCA Laboratories—A New Center for Research," a compendium of addresses by David Sarnoff and Otto S. Schairer (company President and vice-President, respectively), the objectives and directing personnel of this new "world's largest" laboratory, at Princeton, N. J., are outlined. "By the application of electronic devices to industrial processes, the Radio Age promises to electrify modern industry, just as the application of electrical devices to industry at the beginning of this century created the Electrical Age," said Mr. Sarnoff, and it is with the idea of fostering this development, and of meeting the expanding demands of national defense, that this huge Radio

Laboratory, with an initial staff of 435 persons and a floor space of 200,000 sq. ft., was created.

Did you see "The Klystron Boys—Radio's Miracle Makers," by Frank J. Taylor, in an issue of the *Saturday Evening Post*? Worth looking up, if you didn't.

Tide magazine last month, in "Latin America—a Progress Report on U. S. International Radio," analyzed the pros and cons of the "beam" and "network" systems of N.B.C. and C.B.S., respectively, which are competing for the South American broadcast listener market.

The Export-Market (Possneck, Germany) describes the general design and applications of the latest-type Siemens & Halske electron microscope in an article entitled "Supermicroscopy—a Source of Technical Progress." The article is useful as showing the potentialities of this new tool.

F.M.

REPORTED *Radio Daily*, station WIP (Phila., Pa.) plans to give 24-hour service on its Frequency Modulation wavelength. It is due to go on the air before this issue of *Radio-Craft* is in distribution.

FM Broadcasters, Inc., considers it an "interesting sidelight on F.M. reception," that many persons suffering from poor hearing, and therefore unable to enjoy the full benefits of ordinary radio reception, find that the wider frequency range encompassed by F.M. programs affords greater listening ease and pleasure. This is particularly true where the hearing deficiency is in loss of sensitivity to high frequencies.

At the 4th Annual Broadcast Engineering Conference at Ohio State U., Columbus, O., more than 250 radio engineers absorbed oodles of information on F.M. Harvey Fletcher of Bell Telephone Labs. thrilled far-sighted technicians with his discourse on experimental tests of both binaural and diotic transmissions over F.M. channels. Here's virgin territory for experimenters.

Add new title: Major Armstrong, "Father of F.M." (according to FM Broadcasters, Inc.)

A news item of last month states that experts are of the opinion that when Nazi Panzer divisions moved into France last Summer they used F.M. as a radio link between tanks. "Later reports from Britain indicate conclusively that German aircraft recently shot down near London were equipped with F.M. transmitters," the report concluded.

The Federal Communications Commission last month gave us a new term: STL, meaning "studio-transmitter link." A total of 23 frequencies above 330 mc. are allocated for these link stations, for the use of F.M. broadcasters, only 1 link station per single broadcaster being permitted.

How far can Frequency Modulation signals be heard? Well, "it all depends." For example, the range of the giant 50-kw. F.M.

station which is going up atop 6,600-ft.-high *Clingman's Peak*, No. Carolina, will be 500 miles in all directions! Yep, we said 500 miles. Some 4 1/3 million people will be serviced by this ultra-H.F. station. It is one of the characteristics of Frequency Modulation that the range of this 44.1-mc.-channel station will be the same during the day as at night. It wouldn't take many such stations to make a transcontinental F.M. relay network, would it?

Station W2XAH is the new station which the F.C.C. last month authorized Finch Telecommunications, Inc., to operate at Bendix, N. J., for transmitting facsimile programs on F.M. channels between 30 and 40 mc., with 1 kw. Finch also has an Armstrong license to manufacture F.M. equipment.

Major Edwin H. Armstrong is rolling right along with his self-made tide. The F.C.C. last month gave him the high-sign to utilize his present station W2XMN at Alpine, N. J., for a 35-kw. station on 43.1 mc. to serve more than 12,200,000 people in portions of N. J., N. Y., Conn. and Pa. (an area of about 15,000 sq. miles).

Gotham's pioneer school station WNYE has been given an OK to install a 1-kw. Frequency Modulation transmitter on 42.1 mc. New York City's Board of Education is missing no bets.

"Never before in a broadcast have I been able to pick out each instrument individually." Dr. Serge Koussevitsky speaking, after this eminent conductor heard his own Boston Symphony Orchestra as broadcast over Westinghouse F.M. station W1XK, at Hull, Mass.

The current issue of *FM* magazine contains an article analyzing 2-way F.M. police-radio operation in Douglas County, Nebraska. A 25-watt car-radio transmitter installed atop an 18-story building several blocks from Headquarters served excellently to boost the field strength of the 250-watt Headquarters transmitter. This simultaneous operation perfectly solved problems presented by several low-intensity areas. Both the Headquarters transmitters and the car transmitters are "voice actuated"; that is, speaking into the microphone automatically turns on the transmitter, in this new G.E. F.M. installation!

SOUND

ENGINEERS pricked-up their ears, and so would you, if you had been there, last month, when H. F. Olson of RCA told the attendees at the 4th Annual Broadcast Engineering Conference, at Columbus, O., that 60% of the radio receivers sold in America retail for less than \$20, that they are table-model sets incapable of high-fidelity reproduction, and that less than 1% of the total number of radio sets sold are high-fidelity consoles, according to *Radio Daily*. Judging by these figures, "the surface hasn't been scratched," so far as the sale of high-fidelity radio sets is concerned. Radio's No. 1 problem: how to make Mr. Radio Listener high-fidelity conscious?

In connection with its plans to operate a staff of 350 technicians, translators, etc., in a 24-hour watch on overseas broadcasts,

FILMGRAMAPHONE

This film phonograph plays 90 mins., non-stop. Recordings are 4 parallel sound-tracks on a single endless film. Photo legend: A—Film; B—Locating pins; C—Light intensity control; D—Track aligning screw; E, F—Automatic track changer and pushbutton control; G—Film-threading gate lever; H—Automatic track number indicator; J—Lamp housing; K—Line switch. Four barrier-layer photocells are used, 1 per track.

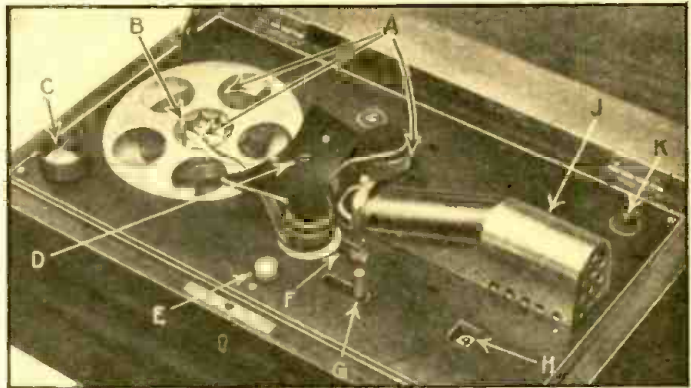

the F.C.C. last month commented that 7 hours of translation and transcription are required to fully process an hour of recorded material.

Steel-alloy sound recording blank discs with a "super glossy finish in silver blue" and which can be processed and pressed like aluminum recordings, are now available, according to Record Sales Co., Los Angeles, Calif.

WOR-Mutual's 2 recent "Defense in Action" broadcasts, dramatically portraying the construction and test of a bomber and a tank, have been recorded for distribution among 300-odd schools. Classed as transcriptions, the discs are being released by official sanction of the National Defense Advisory Commission and the Federal Radio Education Committee.

A business-getter released last month by Presto Recording Corp. was designed to help Servicemen cash-in on the reallocation business by leaving one of the items with each customer. It was an order card, listing prices of home-recording needles and blank discs and imprinted with the Service organization's name, address and phone number, which also could be mailed to the service company (postage prepaid).

Plans are to market 18,000 Panorams (Mills Novelty Co.'s slot-machine sound motion picture apparatus for restaurants, railroad stations, etc.) in 1941, thus giving employment to an estimated 5,000 people. The RCA Indianapolis plant is building these 16 mm. picture - sound machines (or did you read "Introducing 'Soundies,'" in Feb. *Radio-Craft*?).



CH-CH-CH-COUGH!—PARDON ME!

If cough drops can't do it, perhaps this "cough button" will. Nimble-minded WOR technical wizards devised this microphone cut-off button to momentarily cut the announcer off the air for the duration of his cough. Saves frantic waving to control room.



TELEVISION "COOLIGHT"—750 FOOT-CANDLE!

G.E. engineers have announced a floodlight, which produces daylight-intensity illumination without extreme heat, for indoor television work. The young lady is comparing with an "ordinary" 1,000-W. lamp, one of the three 1,000-watt cigarette-size mercury lamps which are used in a single reflector. The tubes, cooled with a gal. of water a minute, develop 195,000 lumens of light over approx. 100 sq. ft.



AIRCRAFT MICROPHONE

This newly-developed, press-to-talk microphone was designed especially for use in private airplanes and on yachts. It is a Universal microphone, Model CU-1, of molded bakelite. The mike is a single-button carbon type, designed to be unaffected by motor noise.

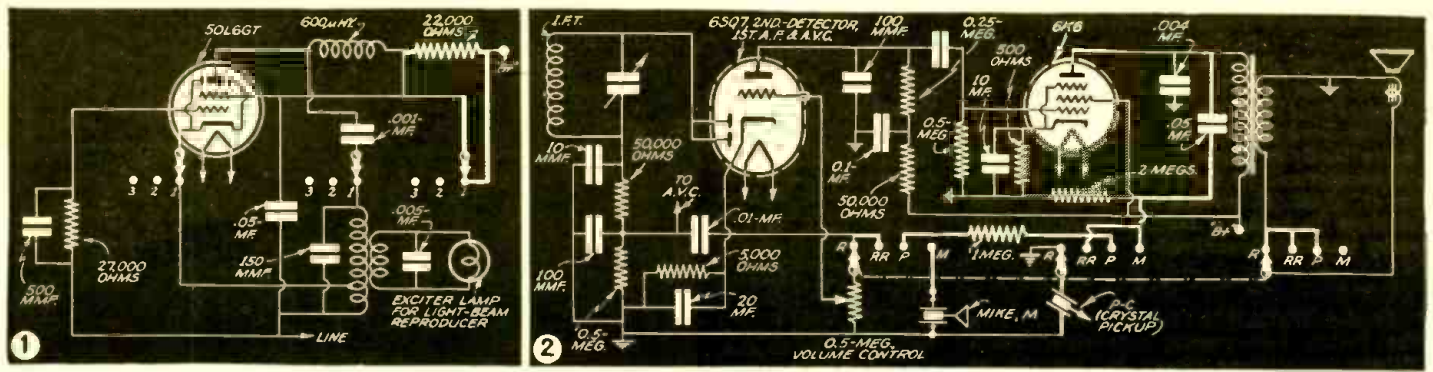

NEW CIRCUITS IN MODERN RADIO RECEIVERS

In this series, a well-known technician analyzes each new improvement in radio receiver circuits. A veritable compendium of modern radio engineering developments.

F. L. SPRAYBERRY

No. 45



(FIG. 1.) OSCILLATOR POWER INCREASED FOR LIGHT-BEAM EXCITER OPERATION

PHILCO MODEL 41-623, 41-624 AND 41-625.—A power tube is used as an oscillator and when phonograph operation is desired the plate voltage of the oscillator is increased as it is switched into the special circuit for supplying the exciter lamp of the light-beam pickup.

According to the circuit of Fig. 1 it will be observed that as the oscillator is switched in position 1, the plate and screen-grid voltages are increased by shorting-out the 22,000-ohm series resistor. Moreover, the coupling of the oscillator to the 1st detector, as for reception, is broken by the cathode switching circuit, and a fixed condenser replaces the usual tuning condenser in the oscillator resonant circuit. The increased plate and screen-grid voltage increases the power output of the oscillator so that it will have no difficulty in supplying the exciter lamp. Note that the oscillator is a power output beam type of tube.

(FIG. 2.) CRYSTAL PICKUP AND CUTTER COMBINED

WILCON-GAY MODEL A-100.—Through the appropriate circuit connections a single crystal unit is made to perform the functions of picking-up a signal from a record or of cutting a record.

As observed in Fig. 2, arrangements are made to switch the entire audio circuit for radio reception (R) in which the microphone is open and the pickup is grounded; for recording radio programs (RR) in which the pickup - cutter is switched to the output plate signal circuit with the speaker in usual operation; for phonograph operation (P) where the pickup is fed into the volume control; and, for microphone recording (M) where the microphone is fed into the volume control, the pickup - cutter is connected to the output as before, and the speaker voice coil circuit is open.

An additional output winding for the cutter is avoided simply by using the relatively high impedance of the output transformer primary for the cutter connection. Mechanical facilities are of course required to guide the pickup - cutter while operating as a pickup and a cutter.

(FIG. 3.) AUDIO GAIN CONTROL FOR RECORDING

RCA MODEL VHR-307.—Under conditions of recording where the variations of microphone input are extreme, an audio gain control maintains a good average cutting signal level preventing over-cutting and yet not losing any instantaneous low input signal.

Any manual volume setting means is of

course only good to set the average signal level, and together with a signal level indicator such as a meter or "eye" tube can serve only as a crude reference level basis. In Fig. 3 a bridge network using 2 diode elements furnishes a bias for the 12K7-GT microphone amplifier which is related to the output signal. Diode element D1 is a voltage regulation limiter while diode D2 rectifies the output signal for bias purposes.

An increasing signal at the output transformer tap causes the plate of D2 to become relatively negative by nearly the value of the signal peak at this tap coupled to the cathode, while the resistance bypass network filters and divides this voltage before application to the 12K7-GT grid-return. Provisions are made for a delay bias on the D2 plate, for no delay, and for cut-off bias of the 12K7-GT when not in use. The delay permits normal volume "inflection" but the circuit establishes an upper limit of output to the cutter to prevent over-cutting and distortion.

(FIG. 4.) A.F. AMPLIFIER USES CATHODE LOAD

PILOT MODEL T-133.—The intermediate A.F. amplifier between the 1st A.F. stage and the output makes use of a triode-operated pentode with a coupling transformer primary in its cathode circuit.

The circuit is illustrated in Fig. 4. The

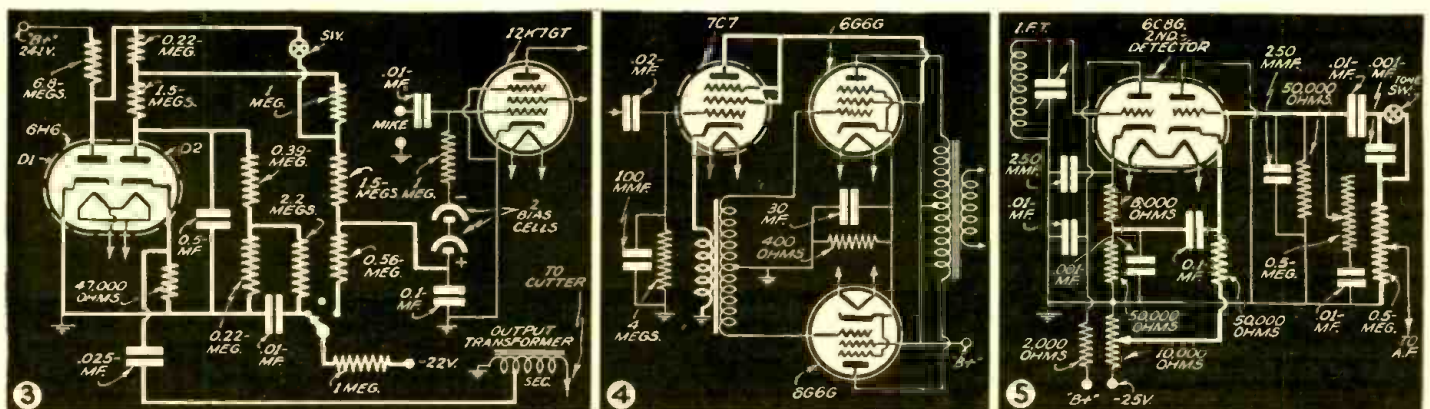

7C7 tube provides no gain because the cathode signal voltage cannot exceed the grid signal voltage. The primary of the coupling transformer is designed so that its D.C. resistance provides the proper bias for the tube when triode-operated as shown. Regulation is very good due to no plate load and the tube when connected with a cathode load automatically adjusts itself to the impedance which it feeds. Moreover there is no high D.C. voltage between windings as for the usual transformer connection.

The tube acts as an effective impedance transforming device without contributing any gain to the stage. Roughly the same signal voltage may be delivered between the 6G6G grids from the 1000-ohm secondary impedance as that entering the 7C7 grid

circuit at approximately 100,000 ohms impedance. The power gain is therefore about 100 times and is equivalent to a voltage gain of 10 although the actual voltage is not increased.

(FIG. 5.) DETECTOR-LIMITER CIRCUIT USES CONTROL-GRID OUTPUT

NATIONAL MODEL NC-200 COMMUNICATIONS RECEIVER.—By means of a double-triode, the cathode of the 1st section is loaded while the cathode of the other section is driven with the plate grounded and the control grid serving as the rectifier output element.

In the circuit, Fig. 5, the 1st triode element functions as the usual power detector except that the audio signal is taken from

the cathode circuit instead of the plate circuit. The cathode-to-ground circuit is filtered only for the I.F. The A.F. signal is then coupled into the cathode of the 2nd section and the output signal voltage is taken from the control-grid which has a 50,000-ohm load resistor. By manual control of the 10,000-ohm potentiometer the D.C. cathode-grid current can be varied from zero to saturation value.

For the usual signal the cathode-grid circuit acts simply as a series resistor of nearly constant value but for an excessive signal the grid current reaches saturation, thus forcing an excessive voltage drop to form across the cathode-grid instead of across the load resistor. The point of saturation (limiter action) may be set for any signal between zero and 25 volts peak.

OPERATING NOTES

Trouble in . . .

. . . PHILCO 71-91-14

Oscillator failure (radio set fails to tune at either high- or low-frequency end of dial).

(Notes have been seen before, but this is a complete summary.)

- Reduce cathode resistor on the type 36 tube to 10,000 or 8,000 ohms. Never use less than 8,000 ohms.
- Replace mica in 3 compensating condensers mounted on condenser-gang. Moisture in mica will stop oscillation.
- Reduce the I.F. 10 kc. and re-align. In some cases it has been found necessary to replace I.F. compensating condensers, but this should not be done unless other suggestions fail to restore operation.
- Remove cotton-covered wire used in oscillator coil circuit, and replace with rubber-covered only to prevent moisture absorption.
- Replace the type 36 tube with one of known value; do not rely on tube tester solely.
- Remove oscillator coil. Dry out, dip in paraffin, and replace. If coil is damaged, obtain replacement from the manufacturer; checking part number carefully, as there are early and late models of these sets, each using a different coil.

(Note: The first 3 are suggested as routine adjustments; they work fine for us. The last 3 are to be used in "stubborn" cases.)

. . . STEWART-WARNER NO. 91-711 (Chassis No. 91-711)

Symptom: smoking power transformer.

Leads grounded to shell at point of emergence, due probably to chafing action resulting from failure to allow for expansion and contraction in cutting leads.

Removal of the shell clears the short and the transformer is still serviceable. Simply enlarge the hole in the bottom shell and re-insulate the chafed leads.

JOHN E. HUSSEY,
Salem, Mass.

. . . ATWATER KENT 61 D.C.

This set is D.C. operated and there are 2 line chokes in series with the incoming line. There is also a filter condenser across the chokes. If this condenser shorts, one or both of the chokes may burn out if the house fuse does not burn out first. When this happens the set goes dead. The chokes

mentioned are numbers 1 and 2 on the factory circuit diagram. The condenser mentioned is number 1 with the U encircled on the circuit diagram.

. . . MAJESTIC 90B

When this set was turned on sparks shot out of the type 80 tube socket. Also when the 80 tube was removed the sparks still shot out of the socket.

This set has the lead from the volume control running right across the 80 tube socket and constant rubbing of this wire to the tube socket connections pierces the insulation and causes it to short and over-heat the transformer and eventually burn it out. Whenever repairing this receiver always re-route this wire and save the expense of buying a power transformer in the future.

HAROLD R. KUNTZ,
Brooklyn, N. Y.

. . . RCA U44

Under certain conditions the line voltage in a suburb may reach a high value, putting too much voltage on the tubes of the receiver, temporarily. In the case of the RCA U44, this may cause breakdown of units not conservatively rated. The 0.005-mf. plate by-pass condensers in both of the 6F6 tubes seem particularly susceptible to this sort of trouble. Replacement with 600-volt units is recommended.

WILLIARD MOODY,
New York, N. Y.

. . . G.E. K-107

Complaint: intermittent. Check the soldered connections on the tuning meter, directly inside the case, for a corroded condition. Retouching with a hot soldering iron is all that's needed for a repair job.

. . . RCA 4-T

Complaint: loss of volume after approximately 5 minutes' operation. Check resistor R10, the 330-ohm 1-watt carbon resistor connecting from the 10-mf. condenser to the cathode of the 6A7. Check the 470,000-ohm ¼-watt resistor, R8, from the 10-mf. condenser to the 1st I.F. transformer. These resistors must be checked while still hot for they show no defect when cold. These resistors if found defective, can be replaced satisfactorily with a 500-ohm and a 500,000-ohm unit, respectively. The circuit under discussion is on page 91 of Gernsback Manual No. 7.

. . . RCA CAR RADIO MODEL 67-M-1

Complaint: distortion. Replace the volume control with a Mallory-Yaxley No. TM-242

unit having an S.S. 11-shaft. This set checked OK when out on the bench but as soon as it was placed in the car it acted-up again. Replacing the original control with a new one, then tearing the old one down showed a burned condition probably caused by loose roller contacts when the car was in motion.

EDWARD J. WELLS,
Wells Radio Service,
Pennsgrove, N. J.

. . . RCA 97KG

If the set is dead, and has no A.V.C. action, first check the red and white wire from the tubular condenser container. You'll probably find the 10 mf. section dead-short. If defective, cut loose and replace with a new one. If not defective check the 8 mf. section for dead short.

If use of the pushbuttons results in distortion at low volume, on this model, replace the 470 mmf. mica condenser that goes to the grid of the 1st-detector.

JAMES WILSON, JR.,
% D. K. Chapman,
Florence, Ala.

Radio & Television JUNE, 1941

Facsimile Made Easy with New Dry Recording Paper, by H. W. Secor

A 600-Watt Transmitter, by Larry LeKashman, W2IOP

How to Get "Response Expansion" in Your Audio Amplifier, by Winton P. Walter

W8KPX Modulator—How to Build It, by Harry D. Hooton, W8KPX

A Booster Amplifier for Weak "Television Signals," by Thornton Chew

Ultra-Small Transmitter-Receiver, by Robert Joseph Stahl

The "Pushbutton 5" Receiver, by L. M. Dezettel, W9SFW

59 mc. Amplifier for Amateur "F.M." Transmitter, by Ricardo Muniz, E.E.

Radio Hook-ups Department

An Open Letter—

To the Radio Industry

JAMES H. HANLY
Radio Engineer

IT is not the intention of the writer to crab, but, here are a few things that the Radio Industry should straighten out very soon.

Let us first take the set manufacturer to task. Present-day production facilities have made it possible to produce reasonably-priced receivers. However, the manufacturers are prone to ruin what could be a perfectly good receiver.

Take the oscillator for instance, this is a very important part of the set. Why doesn't some one build a really shielded oscillator?

The writer is responsible for the clearing of radio interference for over 53,000 customers covering an area of over 130 square miles.

In riding around, all day, hundreds of radio sets can be heard that are radiating waves caused by the oscillators. In our area the BCL (broadcast listener—Ed.) frequencies are (pre-reallocation—Ed.) 630 kc., 780 kc., 890 kc., and 1,430 kc. Quite frequently a complaint is received stating that a noise is heard on one particular frequency. Investigation will reveal something like this: Mr. A likes to listen to a station on 1,230 kc. but cannot do so when Mr. B is listening on 780 kc. This adds up to one thing, 1,230 less 780 equals 450. We find that Mr. B's receiver has 450-kc. intermediates in it. This is a deplorable condition to have exist anywhere. And there is no need of it.

Then again the manufacturer takes what could be a perfectly good receiver and doesn't put in any R.F. stages ahead of the 1st-detector. Now the set is subject to images of every description. Local stations are heard in 4 or more places on the dial, or the other 2 stations can be heard in the background of the one you are listening to. Radio amateurs are cursed and reported to official Washington just because the set cannot tune them out. All it takes to clean up a condition of this sort is shielding, and 1 or more stages of R.F. in the set.

Mr. and Mrs. Average Radio Purchaser are not afraid to spend an extra \$5 to produce reception. They only buy cheap when it is put in front of them.

Now because some Servicemen have refused to take an interest in the installing of a good aerial the manufacturers have now built in loops. That is like going back to the "dark ages."

When the set is installed in the house, 90% of the time, it is placed as near the electric outlet as is possible. What happens? All that the manufacturers have taught us, about the lead-in coupling with the light wires in the wall, goes out of the window.

The loop picks up noise and even has actual A.C. voltages induced in it to produce an A.C. hum. You turn the loop to turn out the noise and that nearly always turns out some popular station you might like to listen to.

What is the matter with the manufacturers anyway?

Well! Even if the manufacturer turned out the ideal receiver some Serviceman would hook the antenna post of the set to a water pipe or steam radiator and let it go at that.

The antenna situation is a disgrace to the radio industry. Joints are not soldered, and no thought is put into the installation.

The writer has found perfectly good antennas hung in partial dead spots when a little effort, and a different location, would bring in excellent reception. Also there are hundreds of sets installed without grounds.

It has always been my belief that the antenna and ground posts on a set were put there to use, not for a decoration. They are meant to be used, they are necessary for the proper operation of the set.

Throughout the country there are a great many Servicemen who really know their stuff and do a mighty fine job on radio installations. But the whole industry gets a black eye because of the careless ones.

Radio Servicemen should be licensed by the State or Federal Government so that the industry could be cleaned up.

Recently a nice new F.M.-A.M. combination was installed in our area. Your writer was called in to see why the Frequency Modulation station 20 miles away was noisy. First of all the Servicemen had thrown a piece of wire on the floor for an

aerial. Right off the bat the Servicemen who installed the set gave F.M. a "black eye." Anyone hearing it operate in the condition it was would never buy an F.M. receiver.

I hate to think what they will do to the television receivers when we get television out our way.

Well, this has been sort of a blasting against the radio manufacturers and Servicemen, but somehow they need it.

You may notice that no reference has been made to the A.C.-D.C. receivers. It would take too many pages to cover this scourge of the radio industry.

Now the amateur comes in for his share. It costs about \$1 to make up a good key-click filter, but some of the boys go merrily on clicking the neighbors' receivers to pieces. On the whole they will cooperate 100%.

By this time you will think that your writer is a crab of the first water, but honestly, aren't the things enumerated true?

All of the important professions have been cleaned up, why not the Radio Industry, one of our most important, too?

The Federal Communications Commission keeps the weather eye out for infringements made by the amateur and the Commercial Stations. It is about time that they or some one else reached out a little farther and did something to control the conditions of Receivers and Servicing.

Radio Amateurs have so policed their bands that very few deliberate infringements are prevalent.

The commercial stations work under very strict regulation but a good many of them radiate a 2nd-harmonic that can be heard many miles away. One station locally puts an R9 2nd-harmonic in the 1.75 mc. band used by the amateurs! The amateur is severely criticized and put on the carpet when he has a 2nd-harmonic, so why should a BCL station be allowed to radiate on a frequency not assigned to it!

Well, your writer's neck has been stuck out far enough now, however it may bring out some discussions that will do the Radio Industry some good.

FROM THE F.C.C. MAILBAG

Individually disgruntled radio fans still deluge the Federal Communications Commission with their particular complaint about this or that radio program. Few well-known programs—or artists—escape mention at one time or another in such letters. As constantly reiterated, the Commission has no authority to censor individual programs or performers. Some idea of the type of squawks in which the Commission lacks jurisdiction may be gleaned from recent "pan" mail:

Various letters object to the air utterances by Col. Charles A. Lindbergh, Hanford McNider, Frank Gannett, Judge John A. Matthews, Earl Browder, and others.

A New Yorker wants the radio team of Burns and Allen barred from the air because he doesn't find some of their jokes funny.

A Connecticut man feels that he has been personally stung by "The Green Hornet" series.

A Pennsylvania man would like to have "Confidentially Yours" publicly censured.

The numerous contest programs invite numerous letters to the Commission from listeners who think they are also entitled to prizes.

A letter from California complains of American stations rebroadcasting Hitler's speeches; a New Yorker objects to pro-British utterances on American stations.

A New Yorker wants the Commission to require a certain official to retract a statement he made on the air. This is beyond the power of the Commission.

Another New Yorker is advised that there is no statute or regulation making the playing of "America" or the "Star Spangled

Banner" obligatory on radio programs.

To a Detroit man who registers complaint about an express company the Commission points out that authority is confined to communication by means of electrical energy, hence it can take no action.

By the same token, it cannot help a wife get her husband reinstated as an announcer at a particular radio station. Or make a radio station award a prize to a woman who claims to be entitled to one by reason of a program offer. Or require a radio station to supply an advance copy of a scheduled address to anyone who might ask for it.

Nor can the Commission adopt suggestions that fees be collected for issuing radio licenses, or for the use of radio receivers. To do either would require Congressional enactment of an amendment to the present Communications Act.

THERE IS A DIFFERENCE

Insist on
SOUND X/TRA
for **HEAVY DUTY**

TUBES
AUDIO WORK



*Individually
Packed in
Special
Containers*

PEAK PERFORMANCE in
AMPLIFIERS • PUBLIC ADDRESS SYSTEMS •
SOUND PROJECTORS • INTER-OFFICE COMMUNI-
CATING SYSTEMS • COIN OPERATED REPRODUCERS

*We regard every letter from the Radio Service Industry as our personal mail.

Can Be Used to Replace Ordinary Tube of Same Type Number for Better Reproduction

A very complete line of special heavy duty audio tubes. Just ask for National Union SOUND X/TRA and the type you want. Characteristics are the same as ordinary tubes and therefore no change whatever is required in the amplifier or installation. Just put the same type number of SOUND X/TRA TUBES in the tube sockets. You will notice the difference in lowered hum level and you will get improved performance and longer life without trouble-some tube call-backs.

The chief requirement for National Union's new SOUND X/TRA tube types is that they must be **DEMONSTRABLY BETTER**. In order to accomplish this outstanding performance in SOUND X/TRA types, modifications in construction and details of engineering were incorporated. Emission limits are very high to insure exceptional uniformity, long life and adequate power-handling capacity. Cus and grid current are held to exceptionally low limits to insure minimum distortion, uniformity and stability. Every tube is carefully tested for hum and microphonics and, where necessary, changes have been made in construction such as the use of special micas, extra rugged supports, double helix heaters and special insulation.

Demonstrably Better

- ★ NON-MICROPHONIC
- ★ LOW-HUM LEVEL
- ★ UNIFORM CHARAC-TERISTICS
- ★ NO MATCHING NECESSARY
- ★ LONG LIFE AT FULL OUTPUT

*Ask Your N. U. Jobber or Write**

© 1940, N. U. R. CORP.

NATIONAL UNION RADIO

57 STATE STREET, NEWARK, N. J.

Corporation

SELLING RADIO SERVICE

At the suggestion of RADIO-CRAFT, author Moody has selected some of the questions most frequently asked of Servicemen by the owners of radio sets in need of repair. The experienced radio Serviceman, is not stumped by such questions, his answers frequently following somewhat the patterns of the answers presented here.

WILLARD MOODY

BECAUSE the newcomer to the radio servicing field may avoid certain preventable difficulties, through advice given by some one who has been "through the mill," this article attempts to impart such information as may be deemed useful and essential. To this end, questions that are typical of those likely to be asked, and the answers to those questions are here presented. The first Q. and A. follows the average pattern of a telephone conversation.

Q. What do you charge to look at a radio?

A. If the set is brought to the shop, there is no charge for inspection and an estimate. If we go to your home there is a charge for inspection, not necessarily repair of \$1.00. We would advise you, however, in order to save yourself the cost of an inspection, that you bring the chassis and speaker in to us, which will cost you nothing for our estimate. In addition, we can give it a better check in the shop, since we have all of the necessary test equipment here.

The above answer may not agree with the policies or ideas of some Servicemen who proceed on the notion that "hooking" the customer good is a worthwhile idea. Some have fancy ideas of reaping rich rewards in radio by overcharging, while others, it is equally true, do not charge enough. However that may be, the above method of operation has several points in its favor.

First, the idea of no charge for inspection and estimate. This is an inducement to bring the set into your shop. If it once gets there, it is likely that you will get the job, if for no other reason than that the customer is not going to lug it around unless absolutely necessary.

Secondly, the charge of \$1.00 for inspection in the home will, in most cases, at least cover the cost of your making the call. This charge is a further incentive to bringing the set back to the shop, and the customer is quite likely to want to save that hard earned dollar since the dollar outside service charge is credit on the shop bill. At any rate, if the set is not repaired, due to too high an estimate or other reasons, you at least have the right to collect that dollar—but be sure to make a fuss over the radio receiver, while you are checking it, and repair any minor defects, such as a loose plug, loose antenna wire or similar receiver troubles.

Q. Is that my price? (Tube, or receiver sale.)

A. That is the list price, but we will give you a discount (10%, 20% or whatever you can afford to do regarding the price).

It is wise to give some reduction off the list, in some communities, since customers may see the same tube that you are selling for 90c being sold by a large radio outfit for 45c. Usually, you will be more conveniently located, and the customer will save at least on carfare or postage that would be required to buy the tube from a more or less distant cut-price house. Price protection exists in some tube brands sold to the Serviceman, and in that case, you can say your tube is a better tube that cannot be bought anywhere else for less money. It is very

Maybe the customer talks to you over your counter or maybe he questions you face to face at home. In either case, do you know the answer? Experienced radio men do.

Photo — Courtesy John J. Harnett, Proprietor, Edison Electric Shop, New York City.

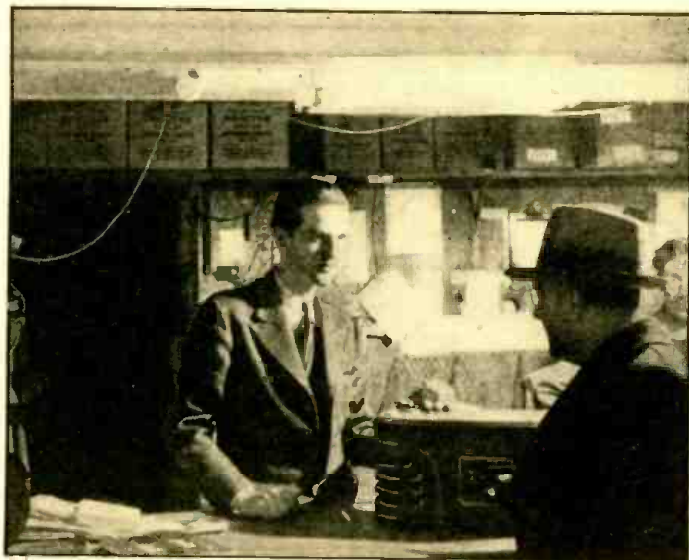

hard though, in many cases, to convince a customer that he should not buy the nationally-advertised brand at a cut price. But you still have a trump card, one which goes over big—give a 6 months' guarantee with your brand of tube. The nationally-advertised make is only guaranteed for 90 days, and you, therefore, are going them one better—so that you can either get more money, or at least sell your brand.

Concerning receivers, the Serviceman or small dealer is at a distinct disadvantage, due to limited purchasing power and low margin of profit. It is necessary for him to charge full price, especially on table models under \$30. Your argument there is one of service—give a year's guarantee, exclusive of parts or tubes.

Q. What is the matter with this set? I had it repaired by you, only a short time ago, and now it's worse than it ever was.

A. I see. (Politely) Have you a receipt showing when the set was repaired? No? Well, we'll check it over and let you know when it's ready.

The customer leaves, and you have said that you will send him a card, letting him know when to call for the set. You look up your repair tag or other record and find out what was done and what is wrong now. If it is a matter of a tube, or some part, that you did not repair previously, and the set was repaired a month or two ago, see whether you made enough on the previous job to allow you a little leeway in the matter of satisfying the customer. If possible, repair the set no charge. You may be able to get it back either through future sales or future repair work and recommendation to the friends of the customer.

Q. My radio is very noisy. What would you recommend?

A. What kind of a radio do you have?

Customer: A—

Q. (By serviceman) How old is it?

Customer: Oh, it's about 2 years old.

Serviceman: Do you notice that the noise is on one station, or is it on all of the stations? What kind of an aerial have you got connected to the set? Have you had your tubes tested lately? Does the noise seem worse as you turn the volume control? Is it a steady humming sound or a hiss? Do you notice it particularly at night, or just in the daytime? Do you live near an El, a trolley line or a subway? Where do you live? (General location.) Have you an elevator in the house, a refrigerator? Is it a series of heavy clicks or thumps that bother you when listening to the radio? Is there a doctor or a dentist in your house? What current do you have (D.C. or A.C.)?

After securing a clue to the interference problem—the solution to which may consist of re-alignment of the chassis, a noise-reducing antenna installation or an installation of a line filter either on the radio set or the offending device, whether refrigerator, motor or other interference source—a definite course of action may be charted. Typical questions which then follow:

Q. What will an antenna cost?

A. (If in your section.) A noise-reducing antenna installation will cost you \$6.50: antenna \$3.50, labor \$3.

This figure may be varied to suit the circumstances and will be changed according to the amount of time that it will be necessary to spend in getting to the customer's home and doing the necessary work.

If a private home, where you have to drill through the floor of the living room and route wires through the cellar and generally work hard, then charge \$10. If in a hotel, with a drop of 15 or 20 stories, with the hazard of falling off the darn roof 200 feet above the ground, a little more. When the set is more than 10 stories above ground, in a metropolitan community where signal strength is high, usually a short wire dropped out of the window will suffice—provided a good line noise filter is used on the

radio receiver, or when the set is equipped with an electrostatically-shielded loop. The plain loops will pick up too much noise.

Q. Will you guarantee to take out the noise, and will I get my money back if it is still there?

A. We guarantee that the set will play better, with less noise, but we cannot refund your money. We guarantee to do a good, workmanlike job, and say that in many cases a big improvement results.

Q. What do you charge for getting the noise out of my radio when the refrigerator is running?

A. Is the refrigerator working satisfactorily otherwise?

Customer: No, it doesn't seem to start quickly, nor work right.

Serviceman: My advice to you is to have it repaired. Then you will probably have no radio interference. When the refrigerator is working properly, no brushes sparking on the motor, then you don't get radio interference.

Q. There is a funny-looking antenna on my roof and sometimes I get a series of thumping sounds in my radio, so that I have to turn it off. What can that be?

A. It would seem that you have a radio amateur in your apartment house. My suggestion is that you inquire of the superintendent of the building. If there is a "ham" operating his transmitter, and you have a modern set with adequate selectivity, yours is a legitimate complaint. Report the interference to the amateur operator who probably will be glad to cooperate. If not, write a letter to the F.C.C. which will take care of the matter.

Q. This set needs a new condenser. I've checked it myself and know that is the trouble. What will you charge to fix it? I used to build radio sets, you know (Or, I am an electrical engineer, or mechanical engineer—anything but a Serviceman.) and, although I know what is the matter with it I am bringing it to you to fix.

A. (The same as for any other customer.) Well, we'll look it over and send you a card with the estimate on it, and you can let us know if it is satisfactory to proceed with the work. Or, we will call you on the telephone.

If they insist on waiting for the estimate, and it is a tough job, tell them it simply can't be helped, but the set must be left for a thorough check—in fairness to them and yourself.

The representative questions which have been enumerated may have many variations. About the only rule one needs to follow is:

Be fair not only to the customer but to yourself as well. If you do that you will make out all right.

ADVICE TO SET OWNERS How NOT to Get Good Radio Service

By Serviceman FRED SHUNAMAN

1.—Never bring your set to the shop, even if it is a pee-wee midget. You will provide extra employment for the Serviceman by letting him run to and from your home. Besides, they might damage the radio set if they could bring all their instruments to bear on it.

2.—Stand over the Serviceman while he is working and give him what advice and encouragement you can. You know more about the set than he does—you've had it longer! If in spite of your help (!) he seems nervous, soothe him as much as possible. A radio receiver is a delicate piece of apparatus and needs care, precision and concentration. See that his attention doesn't wander!

1942 ? FACTS About Next Year's Models!

FACT 1. It takes a long time to build a really GOOD test instrument—to get the "bugs" out—to prove, and improve, its performance and reliability. Then—when it's REALLY good—why change?

FACT 2. Today's SUPREME Instruments are as modern, as accurate, as dependable as test equipment can be built.

FACT 3. That is because SUPREME believes in, and practices, a policy of continuous improvement instead of just "putting a new coat of paint on an old chassis."

FACT 4. A new SUPREME model is never announced until progress in radio has developed a definite need for such an instrument.

FACT 5. Therefore, SUPREME will announce NO "new" models at the June radio show. Which proves that SUPREME Engineers know their business—that they know, and are guided by, YOUR requirements.

FACT 6. SUPREME Test Equipment for 1942 will be as it is now, your best buy, and "SUPREME BY COMPARISON!"

Write for SUPREME'S current catalog. It pictures and describes the instruments your Jobber has in stock NOW—for 1942. Due to present conditions, prices and prompt delivery guaranteed only until June 1st.



Still time to get your new SUPREME Book explaining a new servicing procedure that makes an ailing radio talk to you like a patient talks to his doctor. Only 35c to cover cost of printing and mailing.

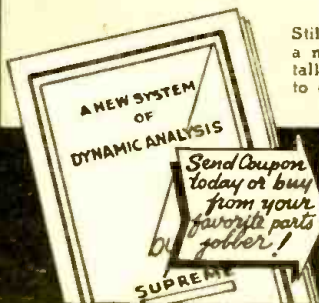

SUPREME Instruments Corp., Dept. RC2, Greenwood, Miss. Gentlemen: I enclose 35c. Please send me your new book referred to above.

NAME _____
ADDRESS _____
CITY _____ STATE _____

3.—If he tells you the set must be repaired in the shop, refuse to let it out of your sight. It is easier to bring the shop to the set than to take it to the shop! If it must go, make him estimate the price of the job before he takes the receiver out of the house. There may be some defective part which he hasn't found with his portable test apparatus. If he finds it with the shop instruments after having estimated the job he will probably replace it free, to save a kick-back in case your set breaks down a week after he has repaired it.

4.—Whatever estimate he gives you, squawk like Donald Duck! Don't let him have the job till he gives you a cut of at least 25%. Ten to one he was planning to use unnecessarily high-priced repair parts anyway—so he wouldn't be troubled by a kick-back on his guarantee. He can do it

cheaper, and believe you me, if he does, it will be cheaper!

5.—Get your radio back from the shop the same day! The radioman will probably want to play it for several hours after it is repaired, ostensibly to test it, but really for his own amusement and to wear out your tubes so he can sell you new ones.

6.—Never pay on delivery. Tell the man to come back on Saturday, and pay in two installments if at all possible. Probably he overcharged you on the job anyway, and this is your chance to make him earn his money.

And if you have faithfully followed all the above rules—and I know how many of you do!

Rule 7.—NEVER CALL THE SAME SERVICEMAN A SECOND TIME!! He might take revenge for the first job!

Radio Service Data Sheet

MONTGOMERY WARD AIRLINE MODEL 04BR-1105A

11-Tube Superhet.; A.C. Operation; 5 Bands (540-1,600 kc., 5.9-6.1 mc., 9.1-10 mc., 11.4-12.1 mc., and 14.9-15.4 mc.); Pushbutton Tuning; Bass and Treble Tone Controls; Phono Jack; Automatic Volume Control; Permeability Tuning; Power Output 10 watts undistorted; Power Consumption 120 watts; Push-pull Output; Phase Inversion.
(See Data Sheet 309 for additional information.)

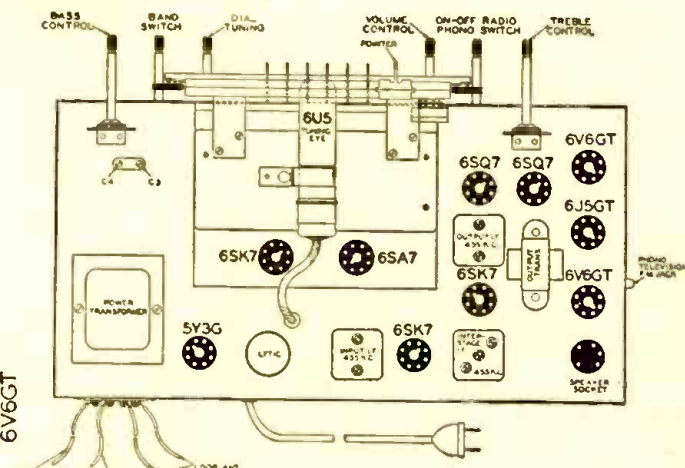
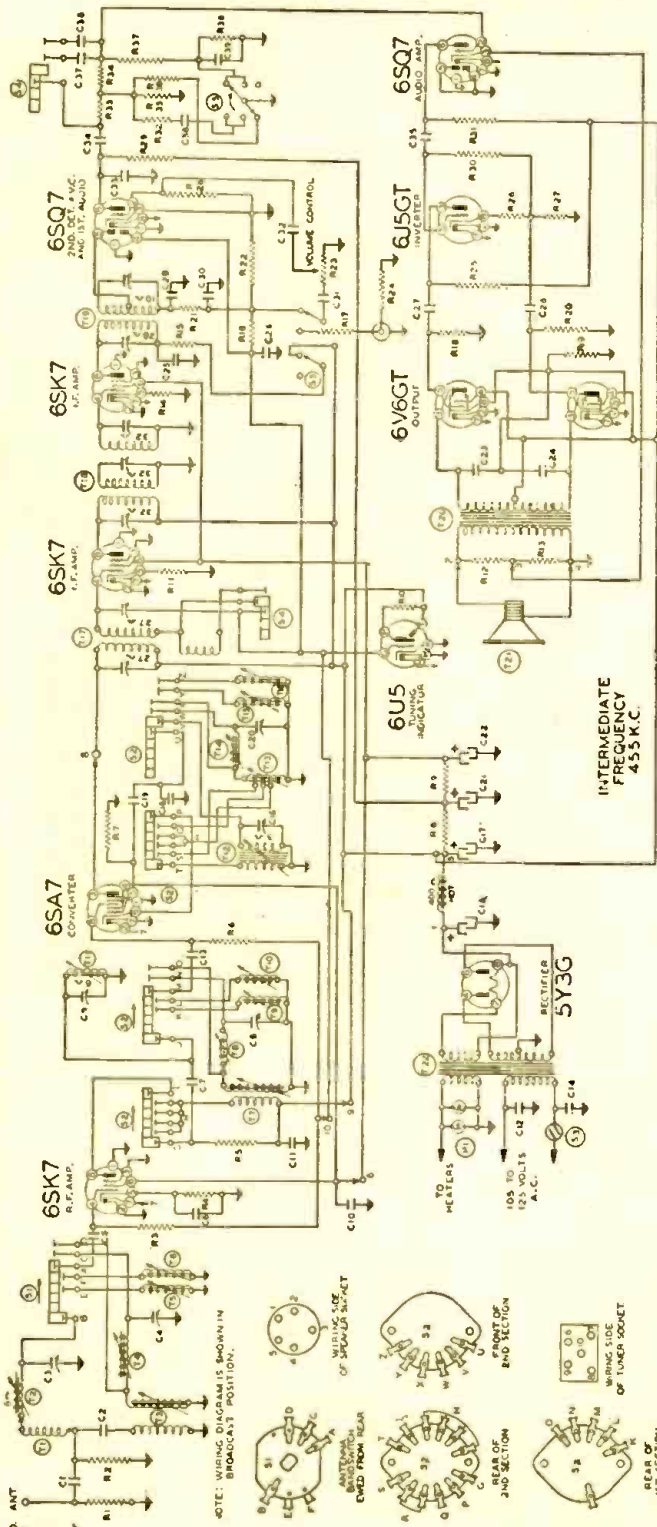

TOP VIEW

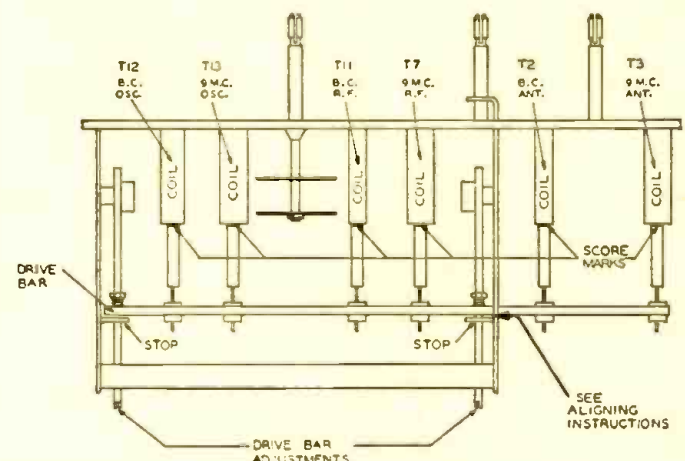

IRON CORE ADJUSTMENT VIEW

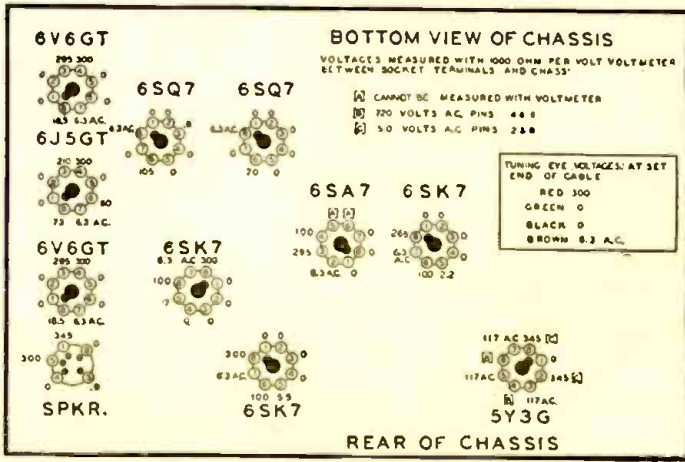

BOTTOM VIEW OF CHASSIS

VOLTAGES MEASURED WITH 1000 OHM PER VOLT VOLTMETER BETWEEN SOCKET TERMINALS AND CHASSIS:
 (A) CANNOT BE MEASURED WITH VOLTMETER
 (B) 220 VOLTS AC PINS 4 & 8
 (C) 50 VOLTS AC PINS 2 & 6

TUNING EYE VOLTAGES: AT SET END OF CABLE
 RED 300
 GREEN 0
 BLACK 0
 BROWN 6.3 A.C.

- RESISTORS**
- R1, 25,000 ohms, 1/3-W.
 - R2, 25,000 ohms, 1/3-W.
 - R3, 1 meg., 1/3-W.
 - R4, 250 ohms, 1/3-W.
 - R5, 5,000 ohms, 1/3-W.
 - R6, 1 meg., 1/3-W.
 - R7, 25,000 ohms, 1/3-W.
 - R8, 6,000 ohms, 2 watts
 - R9, 10,000 ohms, 2 watts
 - R10, 1 megohm
 - R11, 1,100 ohms, 1/3-W.
 - R12, 10,000 ohms, 1/3-W.
 - R13, 1,500 ohms, 1/3-W.
 - R14, 2,000 ohms, 1/3-W.
 - R15, 2,000 ohms, 1/3-W.
 - R16, 1 megohm, 1/3-W.
 - R17, 0.5 meg., 1/3-W.
 - R18, 0.5 meg., 1/3-W.
 - R19, 0.5 meg., 2 watts
 - R20, 0.5 meg., 1/3-W.
 - R21, 50,000 ohms, 1/3-W.
 - R22, 0.5 meg., 1/3-W.
 - R23, 0.5 meg.
 - R24, 0.5 meg., 1/3-W.
 - R25, 50,000 ohms, 1/3-W.
 - R26, 5,000 ohms, 1/3-W.
 - R27, 50,000 ohms, 1/3-W.
 - R28, 5 meg., 1/3-W.
 - R29, 0.5 meg., 1/3-W.
 - R30, 0.5 meg., 1/3-W.
 - R31, 0.5 meg., 1/3-W.
 - R32, 0.5 meg., 1/3-W.
 - R33, 0.5 meg., 1/3-W.
 - R34, 0.5 meg., 1/3-W.
 - R35, 0.5 meg., 1/3-W.
 - R36, 75,000 ohms, 1/3-W.
 - R37, 0.5 meg., 1/3-W.
 - R38, 2 meg., 1/3-W.

- CONDENSERS**
- C1, 0.005-mf., mica
 - C2, 0.002-mf., 600 V.
 - C3, B.C. trimmer
 - C4, 9 mc. trimmer
 - C5, 500 mmf., mica
 - C6, 0.1-mf., 200 V., tubular
 - C7, 10 mmf., mica
 - C8, 9 mc. R.F. trimmer
 - C9, B.C. R.F. trimmer
 - C10, 0.1-mf., 400 V.
 - C11, 0.1-mf., 400 V.
 - C12, 0.02-mf., 600 V.
 - C13, 500 mmf., mica
 - C14, 0.02-mf., 600 V.
 - C15, 30 mf. electrolytic
 - C16, B.C. Osc. trimmer
 - C17, 30 mf. electrolytic
 - C18, .0002 silver mica
 - C19, .00005 mica
 - C20, 9 mc. trimmer
 - C21, 10 mf. electrolytic
 - C22, 16 mf. x 530 w.v.
 - C23, .015 x 600 V.
 - C24, .015 x 600 V.
 - C25, .1 x 400 V.
 - C26, .1 x 200 V.
 - C27, .05 x 400 V.
 - C28, .05 x 200 V.
 - C29, .0001 mica
 - C30, .0001 mica
 - C31, .1 x 200 V.
 - C32, .006 x 600 V.
 - C33, .00025 mica
 - C34, .1 x 400 V.
 - C35, .05 x 400 V.
 - C36, .008 x 600 V.
 - C37, .00005 mica
 - C38, .000125 mica
 - C39, .003 x 600 V.

- REAR OF CHASSIS**
- SPKR.
 - 6SK7
 - 6SK7
 - 5Y3G

- CONDENSERS**
- C1, 0.005-mf., mica
 - C2, 0.002-mf., 600 V.
 - C3, B.C. trimmer
 - C4, 9 mc. trimmer
 - C5, 500 mmf., mica
 - C6, 0.1-mf., 200 V., tubular
 - C7, 10 mmf., mica
 - C8, 9 mc. R.F. trimmer
 - C9, B.C. R.F. trimmer
 - C10, 0.1-mf., 400 V.
 - C11, 0.1-mf., 400 V.
 - C12, 0.02-mf., 600 V.
 - C13, 500 mmf., mica
 - C14, 0.02-mf., 600 V.
 - C15, 30 mf. electrolytic
 - C16, B.C. Osc. trimmer
 - C17, 30 mf. electrolytic
 - C18, .0002 silver mica
 - C19, .00005 mica
 - C20, 9 mc. trimmer
 - C21, 10 mf. electrolytic
 - C22, 16 mf. x 530 w.v.
 - C23, .015 x 600 V.
 - C24, .015 x 600 V.
 - C25, .1 x 400 V.
 - C26, .1 x 200 V.
 - C27, .05 x 400 V.
 - C28, .05 x 200 V.
 - C29, .0001 mica
 - C30, .0001 mica
 - C31, .1 x 200 V.
 - C32, .006 x 600 V.
 - C33, .00025 mica
 - C34, .1 x 400 V.
 - C35, .05 x 400 V.
 - C36, .008 x 600 V.
 - C37, .00005 mica
 - C38, .000125 mica
 - C39, .003 x 600 V.

- REAR OF CHASSIS**
- 6V6GT
 - 6SQ7
 - 6SQ7
 - 6J5GT
 - 6SA7
 - 6SK7
 - 6SK7
 - 5Y3G

- REAR OF CHASSIS**
- 6V6GT
 - 6SQ7
 - 6SQ7
 - 6J5GT
 - 6SA7
 - 6SK7
 - 6SK7
 - 5Y3G

Radio Service Data Sheet

MONTGOMERY WARD AIRLINE MODEL 04BR-1105A

11-Tube Superhet.; A.C. Operation; 5 Bands (540-1,600 kc., 5.9-6.1 mc., 9.1-10 mc., 11.4-12.1 mc., and 14.9-15.4 mc.); Pushbutton Tuning; Bass and Treble Tone Controls; Phono Jack; Automatic Volume Control; Permeability Tuning; Power Output 10 watts undistorted; Power Consumption 120 watts; Push-pull Output; Phase Inversion.
(See Data Sheet 308 for schematic diagram.)

SETTING PUSHBUTTONS

Make a list of your 6 favorite stations. Push out the call letters of these stations from the call letter sheets supplied. Insert a call letter in the slot on top of each pushbutton.

Next pull one of the pushbuttons all the way out as far as it will come (pull, with fingers on top and bottom of button). Now tune-in the station you want with the tuning knob—tune back and forth until the station is clear and distinct. Now push the button hard all the way in to lock the station in place (push directly on front of button). Continue setting each pushbutton in the same way. Pressing the proper button will now tune the station you want. If it does not do so you did not push the button hard enough to lock in place when setting-up the station.

To change stations simply repeat the procedure above.

SERVICE NOTES

Voltages taken from different points of circuit to chassis are measured with volume control at minimum, all tubes in their sockets and speaker connected, with a volt-meter having a resistance of 1,000 ohms/volt.

Resistances of coil windings are indicated in ohms on the schematic circuit diagram.

To check for open bypass condensers shunt each condenser with another condenser of the same capacity and voltage rating, which is known to be good, until the defective unit is located.

Excessive hum, stuttering, low volume and a reduction in all D.C. voltages is usually caused by a shorted electrolytic condenser; open bypass condensers frequently cause oscillation and distorted tone.

ALIGNING INSTRUCTIONS

CAUTION: No aligning adjustments should be attempted without first thoroughly checking over all other possible causes of trouble, such as poor installations, open or grounded antenna systems, low line voltage, defective tubes, condensers and resistors. In order to properly align this radio set, the chassis should be removed from the cabinet. Although the shortwave bands on this

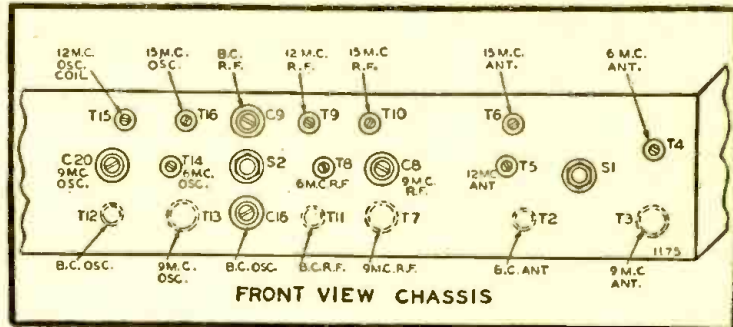

FRONT VIEW CHASSIS TRIMMER VIEW

radio receiver are of the band-spread type the alignment procedure is not difficult. However because each shortwave scale covers only a small portion of the shortwave spectrum you must do the work carefully and your oscillator must be accurate.

Do not realign the band-spread scales unless you are positive they are out of adjustment. When adjustment is necessary proceed as follows.

First refer to the "Iron-Core Adjustment View." Now turn the tuning knob until the drive bar comes within 1/64- to 1/32-in. from the stops. (A piece of blotting paper is about the right thickness and will serve as a gauge.) The clearance of the bar must be the same at both stops. If far off you can raise one drive screw gently and equalize them. Minor adjustments may be made with the drive bar adjustments.

Next rotate each iron core until the fine score marks are even with the edge of the coil forms.

You are now ready to continue with the trimmer adjustments as shown on the alignment chart.

The following equipment is required for aligning: An allwave signal generator which will provide an accurately calibrated signal at the test frequencies as listed. Output indicating meter. Non-metallic screwdriver. Dummy antennas —0.1-mf., 200 mmf., and 40 ohms.

ALIGNMENT CONDITIONS

Tone control—treble. Volume control—maximum all adjustments. Connect ra-



Ward's "Airline" model 04BR-1105A 5-band console receiver.

dio chassis to ground post of signal generator with a short, heavy lead. Connect dummy antenna value in series with generator output lead. Connect output meter across primary of output transformer. Allow chassis and signal generator to "heat up" for several minutes.

BAND	SIGNAL GENERATOR Frequency Setting	Dummy Antenna	Connection to Radio Set	Position of Band Switch	Dial Pointer Setting	Trimmers Adjusted in Order Shown	Trimmer Function	Adjustment
I. F.	455 kc.	0.1-mf.	Grid of 6SK7 (2nd I.F.)	Broadcast	Set Dial at 1,600 kc.	2 Trimmers on Top	Output I.F.	Adjust to maximum output
	455 kc.	0.1-mf.	Grid of 6SK7 (1st I.F.)	Broadcast	Set Dial at 1,600 kc.	3 Trimmers on Top	Interstage I.F.	Adjust to maximum output
	455 kc.	0.1-mf.	Grid of 6SA7	Broadcast	Set Dial at 1,600 kc.	2 Trimmers on Top	Input I.F.	Adjust to maximum output
31-METER BAND	9.6 mc.	400 ohms	Antenna lead	31M.	Set Dial at 9.6 mc.	(See Trimmer View) C20 (See Trimmer View) C4	Osc. R.F. Ant.	Adjust to maximum output
49-METER BAND	6.1 mc.	400 ohms	Antenna lead	49M.	Set Dial at 6.1 mc.	(See Trimmer View) T14 (See Trimmer View) T8 (See Trimmer View) T1	Osc. R.F. Ant.	Adjust to maximum output
25-METER BAND	11.8 mc.	400 ohms	Antenna lead	25M.	Set Dial at 11.8 mc.	(See Trimmer View) T15 (See Trimmer View) T9 (See Trimmer View) T5	Osc. R.F. Ant.	Adjust to maximum output
19-METER BAND	15.2 mc.	400 ohms	Antenna lead	19M.	Set Dial at 15.2 mc.	(See Trimmer View) T16 (See Trimmer View) T10 (See Trimmer View) T6	Osc. R.F. Ant.	Adjust to maximum output
BROADCAST BAND	1,600 kc.	200 mmf.	Antenna lead	Broadcast	Set Dial at 1,600 kc.	(See Trimmer View) C16 (See Trimmer View) C9 (See Trimmer View) C3	Osc. R.F. Ant.	Adjust to maximum output
	1,400 kc.	200 mmf.	Antenna lead	Broadcast	Set Dial at 1,400 kc.	Rotate Core T11 Rotate Core T2 (See Iron-Core Adjustment View)	R.F. Ant.	Adjust to maximum output

ORIENTAL SLANT ON RADIO

The problems of the radio Serviceman in China are perhaps best illustrated in this article which considers the problems confronting the radio man whose job it is to keep the radio receiver of the Shanghailanders in good operating condition. Many of the puzzling situations stem from broadcast conditions peculiar to the Orient.

FRED SHUNAMAN

Serviceman from Shanghai, China

SHANGHAI, the Baghdad on the murky Whangpoo river, is the strangest and most interesting city in the world. The strangest—if not the most interesting—things about it have to do with radio.

To begin with, we have more broadcast stations in this city of less than 5 million people than do most countries. There are roughly 40 stations in Shanghai. Every Shanghailanders has one. Two of the best, XMHA and XMHC, are American-owned and -operated. XMHA has a shortwave outlet on 25 meters. The Japanese run 2 stations and the English and Germans have 1 each, happily located at opposite ends of the dial. The French operate a powerful station, and even the local Russians and Portuguese are represented on the air. With the exception of 2 or 3 doubtful "foreign" stations which spend their time broadcasting in English or Chinese, with a smattering of propaganda for one or the other of the European belligerents, the rest of the broadcasters are Chinese. The broadcast band runs from 600 to 1,400 kilocycles, and from 1,200 up it is an inextricable muddle. The Serviceman spends a large part of his time explaining to customers why they cannot hear their favorite Peiping dramas from a 30-watt station the

This illustration shows the author (left); C. C. Chay, head Serviceman (center); and, benchman David Savage.



other side of town while a local newspaper's 500-watt is working 5 kilocycles to one side of him.

This confusion had its roots in the beginning of broadcasting here in 1930-'31, when a few discarded stations were brought in from America and put on the air. There was "no law for radio in Shanghai." Both the Chinese government and the foreign powers claimed authority over radio in the area, and no nation would curb its own nationals for fear of giving the others an advantage. The number of stations continued to increase, with power, calls and quality depending only on the owners' whims, means and technical ability. The climax came when a popular American cabaret owner went on the air with the call (or query) RUOK. After this stroke the foreign governments agreed to Chinese control of radio in the area. Foreigners operating stations at the date of agreement were permitted to continue on the air. "X" calls were allotted to all stations, and "RUOK" went off the air forever!

The word "program" is synonymous with phonograph records here. Some of the Chinese stations use living artists (notably our "glass broadcasting station" where the performers are the chief attraction of a restaurant seating more than a thousand people), but excepting some ballroom broadcasts, practically all the foreign entertainment is recorded. The American and most of the Chinese stations depend entirely on advertising for their living. Some of the foreign stations are partly or wholly subsidized and are able to put on better programs, i.e., buy better records! None of the stations spend as large a percentage of their time in actual advertising as do the American broadcasters.

The problem of revenue is not the only one worrying the Chinese station owner. Jap and Chinese forces are in a struggle for control of all means of propaganda in this international settlement, and he is approached by the opposing sides, asked to cooperate—or else! If he falls in with one party, agents of the other will shoot him

on the way to the studio. If he resists and remains neutral, both sides are likely to go gunning after him. Some of our most prominent owners and station managers have already been killed.

Even the life of a foreign radio announcer is not too dull. The one man to whom everyone in Shanghai listens—to curse or applaud—is said to go about his work in a bullet-proof vest and has 5 bodyguards. He is Carrol Alcott, the Dakota-born newscaster who 3 times daily comments on the political situation and the excellence of Maxwell House. His outspoken adherence to democracy in general and the Chinese cause in particular has earned him the combined hatred of the Japanese, Germans, Italians and the Chinese "puppets." His name is on Wang-Ching-Wei's "honor list" of more than 80 undesirables, a number of whom have been assassinated since its publication. Carrol is bearing up well under the honor, and gets considerable comfort out of the fact that he is no longer pestered by life insurance agents.

The warring factions go in for malicious interference, or "jamming" of displeasing programs. The Alcott broadcasts were interrupted for several weeks last spring. A strong ICW note came on the air when he did and stopped when his broadcast was over. About the same time a small missionary-owned station, XHMD, was jammed continuously, nobody seemed to know why. The jamming on the Alcott news broadcast has started again, and station authorities believe the interference comes from a Japanese warship in the river. Retaliation by jamming the 2 local Jap stations is threatened, and a quiet statement was made to the effect that the local station has enough power to interfere seriously with shortwave broadcasters in Japan itself.

Probably 80 per cent of the receivers in use here are American. The others are mostly English, German and Dutch (Philips). There is also a Jap regenerative-detector 2-stage audio on the low-price market. This set, an A.C. version of the old supersqualodyne we used in 1923, is capable of receiv-



Exterior view of Mr. Shunaman's radio shop located on Bubbling Well Road in Shanghai. Divided into 3 parts, Shanghai comprises (1) the French Concession, under direct control of the French Consul, (2) the International Settlement, nominally controlled by a Court of the Consuls of the various nationalities making up its population (but usually referred to as "English Town"), and (3) the "Chinese area", now largely a mass of ruins. There are subdivisions: Hongkew, nominally part of the International Settlement but now called "little Tokyo", and run by the Japanese army; and the famous "badlands", a district formerly in dispute by the Settlement and Chinese government but now "controlled" chiefly by organized gangsters, toughs and the gendarmerie, and devoted to gambling and opium-smoking, with murder and other equally innocent amusements on the side.

ing most of the Shanghai stations simultaneously, but is not now available. War conditions in Japan have apparently stopped manufacture of most radio parts, and Japanese stores here are forced to sell mostly Chinese and American stuff.

The ancient trade-guild methods of European companies explain the great success of American radios. I once sent to the local branches of the leading British and American radio firms—Marconi and RCA—for information on transmitting tubes. The American concern loaded a chit-boy with a copy of every piece of literature they had and sent him over the next afternoon. The British firm hasn't answered my letter—yet. Thousands of Chinese studying radio went for information where they could get it—to the American publications and American companies. They became familiar with American apparatus, then took positions in firms throughout China and naturally pushed the stuff they understood. The well-known electron bottle is a "tube" here, not a valve, though the elevator is a lift and the streetcar a tram.

Another factor favoring American receivers is their somewhat greater sensitivity. Geographical considerations have made it necessary to build highly-sensitive short-wave receivers for America, while the shorter distances in Europe made it possible for the manufacturer to concentrate on the audio end of his receivers, as demanded by the more critical musical tastes of European audiences. Many of the older European sets are useless at the great distances we have to receive, though some of their latest jobs are second to none.

P.A. is important here. Shanghai has more dance-halls and night-clubs per square foot than any other city in the world, and almost all of them have some kind of public address system. Most singers will not work without a mike. All amplifiers are constructed locally, the high exchange making it impractical to import them ready-made. Many of the microphones are also made here. The transverse-current—a type of carbon mike—is the most popular, but American velocity mikes are widely used, and I have seen a crystal at one of our best places.

Since the value of the Chinese dollar has dropped to less than 1/16th that of the American, a number of locally-built Chinese sets have appeared. The circuit is invariably that of a 5-tube super. Made in small shops, the quality varies from excellent down to solderless jobs with the under-chassis wiring done with fuse-wire. Loudspeakers, condensers of all kinds, a mediocre volume control and other parts are being made locally, and new items are appearing daily.

So far, business conditions have been remarkably good, considering that the city is now an "isolated island" cut off from that interior on which it once depended for its very life. The influx of 2 million people (including most of China's wealthy), the war boom and the demand for news, which makes radio a necessity, has offset the loss of the hinterland to some extent. The situation, however, is growing more and more insecure. Pressure from the outside makes life in the foreign settlements daily less worth living, and residents are leaving in a stream. But Shanghai has lived through too many "fatal" situations for us to consider the present one as more than an incident.

WHAT'S NEW IN AUTO-RADIO?

What are the new circuit features of this year's models which distinguish them from last year's? For complete circuit analyses see

JULY RADIO-CRAFT

RADIO-CRAFT for JUNE, 1941

FISHING'S GOOD AT NORTH ADAMS

... but we're not doing much of it this year

Sure, we like to fish—but these are times when fishing must take a back seat. With one big Sprague plant working exclusively on national defense orders and with the other turning out more Sprague Condensers, Koolohm Resistors and Test Equipment for the radio trade than ever before, we've got a man's size job to do—and we're doing it. Meanwhile, we take this means of assuring our radio friends that, while putting national defense wholeheartedly first, we are neither forgetting nor neglecting them.

SPRAGUE
PRODUCTS COMPANY
North Adams, Mass.

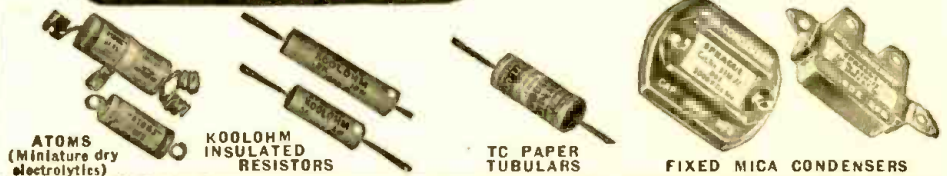

SHOW TIME IS HERE AGAIN

The July 1941 issue of *Radio-Craft* will carry a complete review of the Radio Parts National Trade Show which opens this year at the Stevens Hotel in Chicago on June 10th and runs for 4 days. In your own interest, make sure you attend this all-important event. If you miss it, however, don't fret; just refer to July *Radio-Craft*, on the newsstands early June. Reserve your July issue of *Radio-Craft* now.

"Every afternoon we get Uncle Charlie's Kiddie Hour from the Television Studio next door!"—Reprint from *The Merk Report*, April 1941, by permission of Merk & Co., Inc.



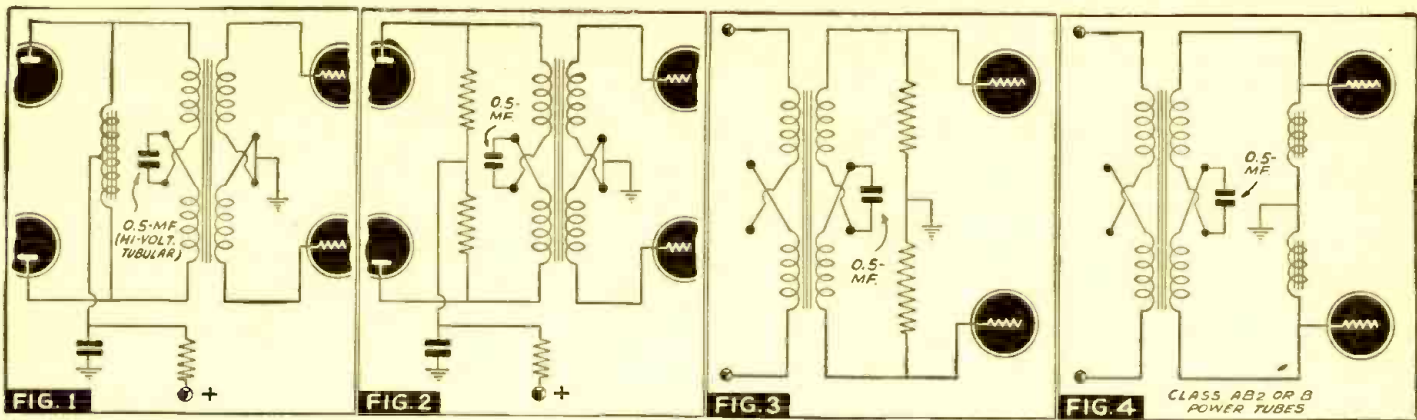

NEW PARALLEL-FEED AUDIO CIRCUIT

The following article will speak for itself and requires no comment from us. It suggests a new idea, in audio amplifier circuits, designed to achieve increased fidelity. Readers are invited to submit to Radio-Craft the result of their analyses of this "C.-T.-Coupled" circuit.

TED POWELL

A VARIATION of the parallel-feed circuit which seems to be something new is presented here for whatever it may be worth and is hereby christened the "C.-T.-Coupled Circuit" or "C.-T. Coupling." It is rather difficult to believe that something so obvious should escape the notice of radio and sound men but like Orville La France's voltage-doubler diode, that seems to be the case. Only a listening test has been made of it and it seems to give slightly better results than the standard circuit. If any of *Radio-Craft's* readers happen to possess cathode-ray and sine-wave audio oscillator equipment perhaps they might make comparison tests of it and send in their findings.

CENTER-TAPPED COUPLING

While transformer coupling is more or less passe today, it still has its uses (single-side to push-pull coupling, modulation, driver to class AB2 or B power grid coupling, matching such as mike to line or grid, power tube to line or speaker, various other matching duties, isolation of circuits, etc.).

The center-tapped or "C.-T." circuit shown here in various forms may be useful in AB2 or B power circuits, some sort of modulation circuits or any situation where a parallel-feed circuit has its advantages.

This circuit was sent in to Mr. Shaney for comment. He stated that though it was something new technically speaking, it was

only a simple variation of the standard parallel-feed circuit (quite true) and that he failed to see any really practical use for it. He gave the following criticism of it:

- (1) Considerable increase of costs of parts over ordinary circuiting.
- (2) The inductance of the plate chokes would have to be too high to maintain good low-frequency response.
- (3) The capacity value of the C.-T. condenser would have to be prohibitively high to obtain adequate low-frequency response.
- (4) Chokes and transformers will pick up hum.
- (5) Uncontrollable resonance effects might become evident in a circuit involving series arranged condensers and inductances.
- (6) Any form of direct-coupling between drivers and power tubes would produce far less distortion.
- (7) For good low-frequency response excessive costs would be involved (a generalization of 1, 2, and 3).

In a telephone conversation with one of the Kenyon Transformer Co. engineers (after a letter was sent to them), the writer was assured that the general assumptions made by the writer (which follow later) were correct and that in the engineer's opinion the circuit would perform somewhat better than the standard circuit. He

added that the uses of the circuit would be limited and it would be rather impractical from a commercial standpoint because of the cost factor (as in the case of any parallel-feed circuit). His technicians did not run any "lab" tests on it because the electronics industries are swamped with rearmament orders and they have much more pressing work to get done.

Therefore from these two experts' statements we can deduce the following: While Mr. Shaney's criticisms are sound of course, they hold good for any parallel-feed circuit and to some extent to all impedance and transformer circuits. Perhaps the writer's original letter was not very clear, but the point in question is not the merits of this circuit vs. direct coupling (Loftin-White), but rather the merits of this circuit vs. the standard parallel-feed circuit.

There are times when transformer coupling must be used. We most certainly would not direct- or even resistance-couple drivers to class AB2 or B power grids. The relatively high grid currents flowing in these grid circuits would cause excessive voltage drops in the loading resistors and cause poor grid circuit "regulation" and consequent high distortion. Therefore, we can safely say that while this circuit may be commercially impractical, more or less, it is slightly superior to the standard parallel-feed circuit and will have its uses in P.A. work, custom-built amplifiers, experimental work, modula-

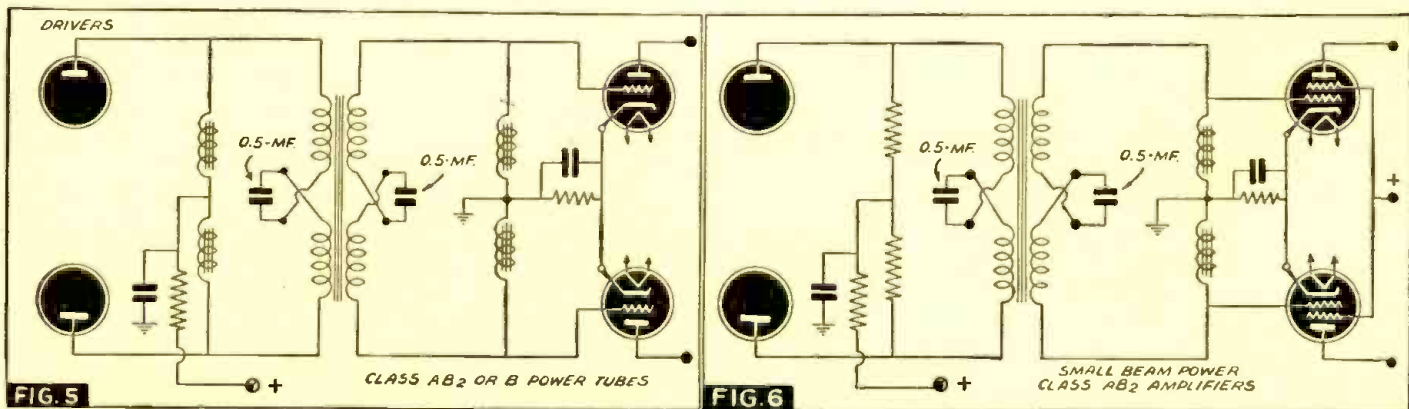

Looking for Values?

HERE'S THE RADIO BOOK YOU NEED!

Yes—if you want more for your money—you'll do your buying from ALLIED'S complete 180-Page Catalog—the only full-sized Radio Book for 1941! It's crammed with smashing values from cover to cover—big values—on Everything in Radio! You'll see what we mean when you check some of the typical ALLIED "Buys" described below. If you haven't got this latest ALLIED Catalog—it's smart to send for it now! If you've got it—reach for it every time you need anything in radio—it will save you money—get what you need quicker and easier! And right now—send in your order for the ALLIED Specials you can use, featured in the listing below. Use the coupon for quick service.



ONLY
\$5.95



STATION LOCATOR

For Servicemen. Just in time for re-setting radio set pushbuttons. A high stability battery-operated signal generator covering the standard Broadcast band. Self-contained in 3 x 4 x 5" metal case. 3 1/4" 0-100° dial with extra large knob. Produces either strong, steady modulated or straight CW signal. No external antenna or direct connection to set required. Complete with tube, batteries, and instructions. Wt., 3 lbs. **\$5.95**
B10060. NET



ONLY
\$1.79

RIM-DRIVE PHONO MOTOR

A bargain in a self-starting phono-graph motor. Friction rim-drive through idler gives steady 78 RPM. Absence of gears provides quiet, smooth-running operation. Motor is shock-mounted; forced ventilation assures cool operation. 8" felt-covered turntable. Ideal for building your own phono unit, replacement of obsolete motors, portable record players, etc. Size: 3" long, 3 1/2" wide; depth below mounting plate, 3". For 110 volts, 60 cycles AC, at 15 watts input. **\$1.79**
Wt., 6 lbs. B10095. NET

WIRE SPECIAL

NO. 14 RUBBER-COVERED STRANDED LEAD-IN

Here's a big value in finest-quality general-purpose lead-in wire. Consists of No. 14 gauge 7-stranded-conductor, covered with live rubber insulation that strips easily. Two leads can be twisted together for double antenna. This same quality wire is sold elsewhere at substantially higher prices. An outstanding "buy." Shpg. wts.: 100 feet, 3 lbs.; 250 feet, 6 lbs.
N1099. 100 ft. Coil **24¢**
SPECIAL AT

N1099A. 250 ft. Coil. NET **55¢**

5 FOR
89¢

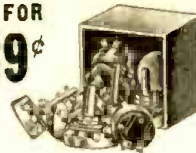

VOLUME CONTROL KIT

These assortments contain brand new, standard type volume controls in popular resistances. Several types with switches are included. Ideal for serviceman and experimenter. All assortments contain random but popular values. (Not available in selected values.) Pays for itself on first job.

Assortment of 5 Controls (3 lbs.) **89¢**
B5917. PER KIT
Assortment of 10 Controls (6 lbs.) **\$1.69**
B5918. PER KIT

ONLY
\$1.96

POCKETRACER SIGNAL GENERATOR

Compact instrument designed for quick analysis of circuit difficulties. Works on multivibrator principle. Generates highly directional HF and AF signals. Determines what stage of a receiver is defective. Excellent for aligning HF and IF circuits. Quickly finds point where ignition noise enters auto set. With self-contained battery. Size, 5" long, 1 1/2" diameter. Wt., 1 lb. **\$1.96**
B9899. NET

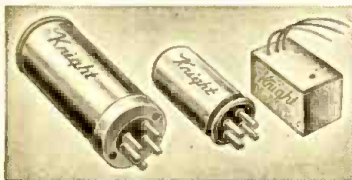

VIBRATOR BARGAINS

Exceptional values in exact duplicate vibrators. Highest quality. Wt., 2 lbs. each.

FOR MOTOROLA SETS

B4711. 6-Volt, 4-Prong. Size: 3 1/4" x 1 1/2". Replaces Mallory 901 M, 902 M; Radiart 5340 M, 5341; Motorola 48A333, 48A3333B, 2404.

FOR DELCO SETS

B4695. 6-Volt, 4-Prong. Size: 3 1/4" x 1 1/2". Replaces Mallory 294; Delco 50-40000; Chevrolet 1212966.

FOR PHILCO SETS

B4713. 6-V., 4-Prong. Size: 3 1/4" x 2". Replaces Mallory 505P; Philco 41-370, etc.

NET EACH **92¢**
Lots of 6, EACH **90¢**

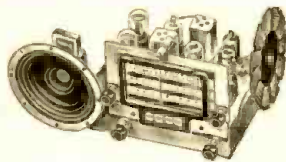

6 TUBE 2-BAND KIT

Our biggest Kit Value! 6 Tube Superhet—with built-in loop. Push-Button tuning. 2-Band Range! Has AVC, Tone Control, Slide-Rule Dial. 2 1/2 Watts output, phono connection, etc. Tunes 535-1720 KC; 5.65-18.3 MC. Kit is ready for easy assembly. Chassis is punched and drilled—all you need is soldering iron, pliers and screwdriver to build. 6 1/2" PM Speaker. For 110 volts. AC-DC. Wt., 10 lbs.

B9820. Complete, less tubes and cabinet. NET **\$5.95**
B9822. Tube Kit. NET **\$2.30**
B9821. Walnut Cabinet. NET **\$2.25**



SPECIAL VALUE FLUORESCENT ADAPTER

Now—the benefits of modern fluorescent lighting are available for every lighting requirement at unbelievably low cost! This amazing new fluorescent lamp fixture screws into any 105-125 volt, 60 cycle AC socket. As easy to install as a light bulb. You will want one for every light socket in your shop, garage, etc. Inside of reflector finished in white enamel, outside in durable brown wrinkle. Has patented swivel feature. Ideal for service shops, work benches, homes, offices, assembly lines, etc. Uses one standard 18" 15-watt fluorescent lamp bulb. Less lamp. Shpg. wt., 4 lbs.

B15012. EACH, **\$2.56** **\$2.37**
LOTS OF 3, EACH **2**
B15261. 15 watt lamp **72¢**

ADJUSTABLE ANGLE COWL AERIAL

A wonderful "buy" in the very latest and finest type of auto aerial! New universal 3-section swing-angle auto antenna is designed to fit any car contour. Stainless steel barrel locks to position by slight adjustment of one-piece eye-bolt. Rust-proof aerial is 66" long and collapses to 29". Single-insulator mount. Shock-proof bakelite insulator has molded rubber gasket and shielded lead-in cup. With waterproof 48" low-loss loom cable. Shipped complete with adapters for Motorola and Philco sets. One of the best auto aerial values we've ever been able to offer! Shpg. wt., 2 lbs.

B16119. EACH, **\$1.39**
LOTS OF 6, EACH **\$1.25**



ALLIED RADIO CORPORATION. Dept. 2-F-1 833 W. JACKSON BLVD., CHICAGO, ILL.

Send me your FREE 180-Page 1941 Catalog.
Enclosed you will find \$..... covering my order for the Special Values checked below. Postage is enclosed. Ship C.O.D. for postage charges.

Stock No.	Description	Quantity
<input type="checkbox"/> B10060.	Station Locator
<input type="checkbox"/> B10095.	Phono Motor
<input type="checkbox"/> N1099.	Lead-in Wire
<input type="checkbox"/> B5917.	Volume Control Kit
<input type="checkbox"/> B9899.	Pocketracer
<input type="checkbox"/> B4711.	Motorola Vibrator
<input type="checkbox"/> B4695.	Delco Vibrator
<input type="checkbox"/> B4713.	Philco Vibrator
<input type="checkbox"/> B9820.	6 Tube Kit
<input type="checkbox"/> B15012.	Fluorescent Adapter
<input type="checkbox"/> B15261.	15 W. Fluorescent Lamp
<input type="checkbox"/> B16119.	Auto Aerial

Name

Address

Free!

ALLIED'S 180 PAGE RADIO CATALOG

THE ONLY COMPLETE BOOK FOR 1941

ALLIED RADIO CORP.
833 W. JACKSON BLVD. CHICAGO, ILL.





Oil-filled MIDGETS . . .

• Originally made special to meet the rigid specs. of Government and commercial-communication buyers, this midget oil-filled condenser now becomes a standard item at a mighty low price. Ideal for vibrator applications, coupling, low-power transmitters and transceivers, high-power amplifiers, and for severe-service test equipment. Hermetically sealed against moisture and oil leakage. Cadmium-plated brass can. Varnished-paper jacket. Center mounting strap for added connection. .006-.5 mfd., 400 and 600 v. D.C.W. .006-1 mfd. 1000; to .25 in 2000 v. D.C.W. • Ask jobber for them. Ask for latest catalog—write direct.

AEROVOX
CORPORATION
NEW BEDFORD, MASS.
IN CANADA: AEROVOX CANADA Limited Hamilton, Ont.

SENSATIONAL SOUND OFFER

To acquaint Sound Men Everywhere with the unbeatable qualities of LIFETIME P.M. Speaker Units and Trumpets we make this STARTLING OFFER - One 4 Trumpet - List \$40.00 One No. 40 P.M. Unit List \$40.00 One Trumpet Mounting List \$15.00 - A total List of \$95.00 - the complete Unit for only \$30.00

CASH WITH ORDER

Send for this IMMEDIATELY and get information on our complete line of Trumpets, Baffles, Speakers and Microphones - at AMERICA'S LOWEST PRICES!

THE LIFETIME CORPORATION
1021 ADAMS ST., TOLEDO, OHIO

MAKE BIG MONEY at HOME!
NEW INVENTION
Electroplates by Brush

New, patented invention makes possible big earnings AT HOME. Replate auto-parts—worn articles in homes, stores, hotels, restaurants, etc., with durable, sparkling, new coat of metal—with stroke of brush. Easy, simple, quick. Genuine Gold, Silver, Nickel, Cadmium, etc. Everything furnished. Outfit complete, ready for use. No shop required. Clear from \$2 to \$5 an hour in lifetime business. Small investment starts you in business. Steady repeat. Machine can pay for itself in week. Send TODAY for FREE SAMPLE and illustrated BOOKLET how you can have a life income from a business of YOUR OWN built upon satisfied customers. Act at once!

FREE SAMPLE and BOOKLET
REPLAINS ALL

WARNER ELECTRIC COMPANY
225 N. Wabash Ave., Chicago, Ill., Dnt. 6-A

FREE! RADOLEK'S 1941 RADIO PROFIT GUIDE

Everything New in Radio at Bargain Prices! Radio Parts—Sets—Accessories—Ham Gear—Electric appliances and supplies—Public Address Systems. Don't Wait—Send for the Big FREE Radolek Profit Guide Now! Save Money at Radolek.

RADOLEK CO., Dept. C-55
601 W. Randolph St., Chicago, Ill.

tion circuits, as a basis for other "trick" p.-p. circuits, and so on.

In laboratory- and broadcast-type amplifiers, parallel-feed is sometimes used in a p.-p. transformer-coupled circuit to improve frequency response. Of course, where p.-p. circuiting is involved, the adverse core-saturation effects of the D.C. (direct current) components of the driver plates do not exist to anywhere near the extent that they do in a single-sided circuit because of the self-neutralizing action of the oppositely-flowing D.C. components. However, the frequency response is improved slightly for several minor reasons—exact balance between the p.-p. driver plates does not usually exist at all times and some core saturation effects with their adverse effect upon low-frequency response (mostly 3rd-harmonic distortion) are present; leakage reactance effects between transformer windings are decreased with decreased currents in the windings, with consequent improvement in high-frequency response; etc.

Where transformer coupling is necessary and parallel-feed circuiting is used to improve response slightly in a p.-p. transformer-coupled circuit, this C.-T.-Coupled Circuit will eliminate one condenser, save chassis space, lower circuit costs, lower intra-circuit coupling, will eliminate any slight unbalance effects due to inequality of condenser reactances and leakage conductances, and finally, will theoretically halve the slight distortion effects introduced by coupling condensers due to slight inductive reactance effects at the highest frequencies, capacitive reactance at the lowest frequencies and adverse leakage conductance effects.

THEORY

To accurately explain the action of this circuit either mathematically or physically is admittedly a bit beyond the writer. However, we can reason this way. The power factor of a transformer runs at about .7 or .8 lagging. That is, the cosine of the time angle lag (cosine theta) between the current and voltage waves is .7 to .8 or so. This makes the time angle lag somewhere about 40 deg. In the case of a 1,000-cycle note, this would amount to a lag of about 0.005-sec.

Thus, at the transformer center-tap ("c.-t.") which we vaguely call the "zero point" of the E.M.F., we actually have a "mid-point" E.M.F. spot which puts out half the total E.M.F. to either side of the whole winding and is at any instant just as positive with respect to one side as it is negative to the other.

Therefore, we have a zero point of polarity, not voltage, since potentials exist between points and not at any single point. Then if we have unity power factor (as in the case of resistance networks or tuned circuits), we would also have a coincident zero point of current polarity (and not amperes). Quite obviously, if current is flowing in a circuit, we would not have a zero point of current amperes, strictly speaking, but of current polarity at a c.-t., and this current "mid-point" would coincide with the E.M.F. mid-point since the voltage and current waves are in-phase in a unity power factor circuit.

In the case of the c.-t. coupling circuit involving chokes and transformers, we would also have the two zero polarity points at the c.-t., but now they would not be coincident because of the 40° lag of the current wave. Therefore, the c.-t. condenser, while blocking off the D.C. components from the transformer primary, "carries over" the plate-current-modulating A.C. signal currents (which lag their driving signal modulating E.M.F.s by about 40°) by the electrostatic-

field-storage action typical of any condenser in any other A.C. circuit.

This explanation is not technically correct or "rigid" as a mathematician would say, but it should give a rough idea of this circuit's behavior. Ordinarily, even relatively simple A.C. circuits cannot be fully explained away with word pictures and vector analyses, and mathematics must be resorted to, especially where electronic circuits are involved. When more complicated circuits are involved, even vectors are inadequate and several types of higher math using various approximation methods (setting up "equivalent" circuits) are necessary.

CIRCUITS

In diagrams 1 to 6 we have 6 out of 8 possible combinations of this c.-t. circuit as applied to both plate and grid sides of a transformer.

Figs. 1, 2.—In diagrams 1 and 2 are shown the simple improvements over the standard parallel-feed networks as applied to the plates of drivers or plate-to-line coupling circuits.

Impedance loading will result in a better bass, more gain and greater driving power. The greater the impedance of the chokes, the better the low-frequency response, but the higher frequencies will begin to suffer because of the greater shunting (distributed) capacity effects of the more cumbersome windings. Therefore a compromise value must be arrived at to obtain the best overall frequency response over the whole audio spectrum for any given audio amplifier system and its local acoustic conditions.

Roughly speaking, at the lower frequencies, if the impedance load drops to within 3 times the plate impedance of the driver, the frequency response will fall off about 1 db., and if it drops to about 3 times the plate impedance, the response will fall off only ½-db. Thus it becomes pretty obvious that the higher the plate-load impedance the flatter and more extended will be the low-frequency response. However, increasing capacity effects in larger chokes (and leakage reactance, mutual capacity and inductance vs. capacity resonance effects in the case of transformers in addition to these factors) begin to have noticeable effects upon the higher frequencies. Generalizing briefly, the higher the mu (and the plate resistance or impedance) of an amplifier tube, the higher must be the compromise value of load impedance to get satisfactory low-frequency response.

Resistance coupling will result in superior all-round frequency response, especially at the higher frequencies since a far more "linear" load is placed upon the driver plates. There are no capacity effects (windings distributed capacities, winding to core capacities and also mutual capacities between windings in the case of transformers), no capacity vs. inductance resonance effects, no non-linear constants such as the non-linear permeability vs. induction characteristics of core alloys, etc., to worry about.

The higher the values of the plate load resistors, the further will the low-frequency response be extended, but the "tinnier" the tone quality will become because of the decreasing plate currents, and if the values of the plate resistors are made excessively high, a high-frequency cut-off effect will become evident. Again, as in the case of impedance loading, the higher the plate resistance (and the mu) of the drivers, the higher must be the compromise value of the plate loading resistors to get satisfactory low-frequency response with good over-all response.

It might be added here that the higher the values of either plate loading chokes or resistors, the less harmful might be

their shunting effects upon the transformer primary as far as the low frequencies are concerned.

Fig. 3.—In diagram 3 we have what is probably a circuit of theoretical interest only. Since the principal reason for parallel-feeding at the grid side of the transformer would be the elimination of grid currents from the transformer secondary to reduce leakage reactance effects, we would only be jumping from the frying pan into the fire in the case of class AB2 or B circuits. The relatively high grid currents that flow in these circuits would cause excessively high variable drops in the grid resistors with resulting poor grid circuit "regulation" and consequent high distortion.

In the case of class A or AB1 circuits there are no "grid currents" (actually there are minute grid currents of several microamperes) and this particular circuit could be used under such conditions. However, the elimination of such minute currents from the transformer secondary should cause no noticeably beneficial results; and the presence of the series condenser across the c.t. with its slight reactance and leakage-conductance effects should result in slightly inferior results as compared to the standard direct coupling to the secondary.

Fig. 4.—In diagram 4 we have what may be a potentially useful commercial application of the c.-t. coupled circuit. As in the case of 3, class A or AB1 application would probably be futile. It is AB2 or B work where it may have possibilities. In these efficient power circuits we have a distortion problem arising from the fact that grid current flows.

One of the principal sources of distortion in a transformer is the leakage reactance between the sets of windings (primary, secondary, tertiary, etc.) which behaves as series inductances and causes mostly amplitude distortion in the form of a high-frequency "cut-off." This adverse effect is greatly increased when grid currents flow in the secondary windings.

In practice, this problem in AB2 and B work is met by the use of suitable step-down transformers with low-impedance secondaries, and consequently lower leakage reactance effects, with the primaries and lower shunt capacities in the secondaries. In the case of high-class units, balanced, interleaved, sectional windings are used which further reduce the leakage and to some extent the capacity effects.

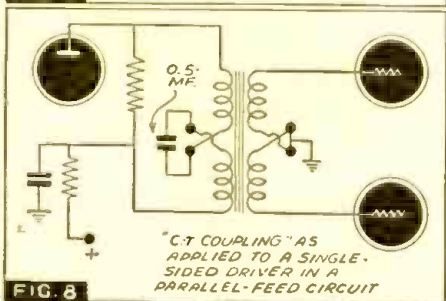
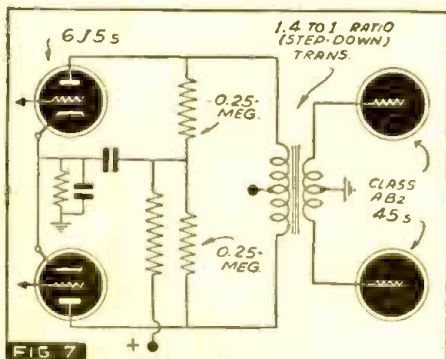

It's Got to be Right to be **TRIPLET**

Nobody "bosses" Cliff Elliott, chief of the Triplet inspection line. Production is up—'way up, but nobody puts the heat on "Inspection" for the slightest variation from the most hardboiled inspection scrutiny in the Industry. For it is an axiom in the whole Triplet plant—regardless of position or the pressure of orders—"It's got to be right to be Triplet."

Under expanded Industrial demand there continues to be no compromise in those rigid Triplet standards which have become the International Hallmark of Precision and Quality. For more information write Section 166, Harmon Avenue.

THE TRIPLET ELECTRICAL INSTRUMENT COMPANY Bluffton, Ohio

All this helps to reduce all 3 types of audio distortion at the higher frequencies, namely, waveform (harmonic), phase-displacement (phase-shift) and mostly amplitude (non-linear amplification) distortion. Here we have another possible solution to the problem.

By using a parallel-feed circuit such as this, we eliminate the grid currents from the secondary windings without sacrificing transformer gain or low-frequency response by eliminating the need for a low-impedance secondary that would otherwise be necessary. In the case of the grid chokes, there is no leakage reactance problem involved since there is only one winding on the core. Since grid currents are relatively small, the core is comparatively light and the choke winding can be of high inductance without having too cumbersome a winding, and too-high shunt capacity effects, especially if the core is made of one of the super-permeability alloys such as special treated mu-metal or one of the permalloys prepared from chemically pure "hydrogenized" iron.

This means that at a good compromise value of grid impedance we can have both good low- and high-frequency response with no sacrifice in gain; and generally superior results to those obtained from the step-down input transformer commonly used here. However, the writer is no sound engineer and his assumptions may be incorrect. Perhaps some of our technician-readers can enlighten us on these points.

Fig. 5.—In diagram 5 we have what would be more of a theoretical circuit than any practical set-up because of the excessive costs involved—unless, of course, the circuit constructor has a plentiful supply of chokes on hand.

Fig. 6.—In the circuit in diagram 6 we



A new HOTEL
AWAITS YOU
in New York

This world famous establishment, formerly the American Woman's Club, is now one of New York's newest and finest hotels. Its unique facilities include six lounges, five sun-decks, music studios, library, art gallery and three popular priced restaurants. Many floors are reserved exclusively for women.

1200 Rooms with Bath
DAILY—Single, from \$2.50;
Double, from \$4
WEEKLY—Single, from \$12;
Double, from \$16
Special Floors and Rates for Students

John Paul Stack
General Manager

Henry Hudson
HOTEL
353 WEST 57th STREET * NEW YORK

SERVICE ENGINEERS
Here's the meter
you've been waiting for!

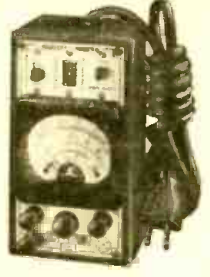

**APPLIANCE
TESTER**
Model 417
for
AC and DC

Measures Volts—Amperes—Watts
quickly and accurately

Now you can test every household electrical appliance, electric signs, and industrial equipment up to 6000 watts.

LOOK AT THESE USEFUL RANGES!
All measurements of AC and DC
on 4 easily read scales

VOLTS—0-250
AMPERES—0-1 5 25
WATTS—0-30 120 600 3000, at 120 V
0-60 240 1200 6000, at 240V

MODEL 417 NET **\$10.75**

In portable, hinged cover carrying case... \$11.95
Furnished with power-factor classification chart and correction curves for power-factor and line voltage.

Order from your distributor
TODAY



**RADIO CITY
PRODUCTS CO., INC.**
88 PARK PLACE • NEW YORK, N.Y.

LEOTONE

The House of a Million Parts and a million bargains. 5 Floors and Warehouse of Hard-To-Get Parts. We invite inquiries; send all details, or samples. Also write for better prices in quantities.

A FEW OUTSTANDING BUYS

- DeJure Molded Bakelite Bases; 11c ea.
- 8 Prong Auto Vibrators; perfect condition; used in Arvin, Lafayette, Philco, Zenith, etc. 49c ea.
- Dielectric Slate Bases—7" x 3" x 3/8"; for mounting Keys, Rufs, Sounders, etc. 5c ea.
- 110-216-5V Filament Transformers; 3 1/2" x 2 1/2" x 3 1/2" 39c ea.
- RCA Shielded Double Trim 175 KC. I.F. Coils; 1st. or 2nd. 19c ea.
- W.E. 2000 Ohm Earphones; incl. headband and cord \$2.49 ea.
- Super-sensitive Galena Crystals; mounted or unmounted. 5c ea.
- Earphone Cores; tip-tip, or tip-lug 19c ea.
- Fixed Crystal Detectors, mntd. in attractive Bakelite cases; dia. 1 3/8" 35c ea.
- Light Power AC Motor; 1750 RPM with gear reduction arrangement for 78 RPM; includes mounting bracket; ideal for winding or polishing rig-up, display stands, etc. 89c ea.

Minimum order \$1.00. 20% deposit required

LEOTONE RADIO CO.
Leading for 20 Years as Mfrs. of Cones and Field Coils.
63 Dey St., Dept. RC-1, New York, N.Y.

**NEW AUDIOGRAPH
Sound Catalog**

AUDIOGRAPH Sound Systems represent the latest in Sound Engineering and Design—a complete line plus pre-tested accessories.

NEW LOWER PRICES

Outstanding quality and performance at prices that help you meet any competition.

WRITE FOR FREE COPY
JOHN MECK INDUSTRIES
1313 W. Randolph St., Chicago, Ill.

have a limited use in the case of small class AB2 beam-power tubes where not much driving power would be required. In such a case, better fidelity would be obtained than that possible with plate chokes.

We still have the possibility of resistor-resistor, and choke-resistor combinations. These would probably be impractical for reasons explained for circuit 3.

In all of these circuits, a value of 0.5-mf. is shown as the recommended capacity value for the c.-t. coupler. This is a compromise value and it can vary over a fairly wide range without greatly affecting frequency response. If we use too-low a value, the increased capacitive reactance of the smaller condenser will cause a slight bass cut-off. If we use too large a value, the increased value of the slight inductive reactance of the cumbersome condenser will cause a slight amount of distortion and cut-off effects at the highest audio frequencies, and harmful leakage conductance effects will be present, although the low-frequency range will be extended slightly. Some capacity from 0.1- to 1.0-mf. should be chosen, preferably near to 0.25-mf., depending to some extent upon the impedances and frequency characteristics of the circuits being coupled. Whatever value is finally chosen after careful tests, a high-voltage "non-inductive" tubular condenser is recommended in order to keep harmful leakage and high-frequency inductive effects down to a minimum.

A factor entering into consideration here is the mild series-resonance effects occurring between the c.-t. condenser and the transformer primary halves. This resonance effect is not very serious since the relatively high ohmic resistance of the primary dampens-out circuit resonance to such an extent that only slight signal E.M.F. rises occur about the resonant frequency at the lower end of the audio spectrum. The choice of an optimum value of capacity, usually about 0.5-mf., will tend to flatten-out and extend the low-frequency end of the circuit's frequency response curve.

Fig. 7—In diagram 7, we have a further extension of the c.-t. idea; it is a theoretical circuit which might be called a direct-shunt-feed or a "d.s.f." circuit.

While a D.C. potential will exist in the primary, no D.C. can flow in it since it

would have no place to go. There is no D.C. potential gradient across the primary or any part of it, and it exists only between it and the "ground" or the chassis. Since there is no circuit between these points, no D.C. can flow in the primary. The A.C. signal modulation components of the tubes' outputs will flow back and forth through the primary since it is shunted across the tube plates. Thus we eliminate the 3 detrimental effects of the condenser. However, we have leakage, dielectric stress and the presence of relatively high D.C. potentials in the transformer windings to consider now. Though only minor factors, we might conclude that the c.-t. condenser represents the lesser set of evils. This d.s.f. circuit can be used by Servicemen in the makeshift, temporary or emergency repair of class AB2 or B driver circuits.

Fig. 8—In Fig. 8 we see the C.-T.-Coupled Circuit as applied to a single-sided driver. Thus we now have 3 possible locations for the blocking condenser as well as for the primary "return" lead. In the case of the condenser—at the P side of the primary, at the "B+" side or across the c.-t.; and, in the case of the primary return lead—to ground, direct to the cathode or to the same "B+" spot as the plate load resistor or choke.

Generally speaking, the preferable circuit is the one where the blocking condenser is on the "B+" side of the primary and the return lead is run direct to the cathode. In the case of the c.-t. circuit, the return lead is run to the same spot as the plate load in order to improve circuit balance. If the return is run to ground or the cathode, only one-half of the primary will carry a D.C. potential and we will have some electrostatic and leakage unbalancing effects. As the circuit stands, there is still a D.C. potential difference between the 2 primary halves equal to the plate load drop, but now both halves carry D.C. potential. No special advantages are claimed for this circuit and it is presented here as a thought provoker.

These circuits may be rather impractical from a commercial standpoint and perhaps may not even be anything new. However, they are presented here in the hope that they may find some application in special circuits or serve as the bases for other circuits.

UTILITY RADIO RECEIVER

In my Editorial for March, entitled, "Utility Radios," I listed a number of ideas by which radio sets can be made more useful than they are today. I also mentioned the fact that while there had been many lamp-radio combinations, we had not come across any midget lamp-radio utility receivers so far.

Just to show that it can be done, I took a *Detrola* midget set and combined it with a low-priced lamp, as shown in the illustration. This particular lamp, which in quantity costs less than 50c apiece, was chosen, first because of its small size, and second, because it has a swivel arrangement whereby the lamp can be moved forward and backward to throw the light wherever wanted. As the illustration shows, the combination makes a rather pleasing design, and it looks much better in reality than the photograph would lead you to believe. The lamp, of course, works independently of the radio set and you need not turn on the radio set for the lamp, or vice-versa.

I am convinced that there is an excellent market for sets of this type and if some enterprising manufacturer will get behind it, I am sure thousands of them can be sold.

H. GERNSBACK



SOUND ENGINEERING

Free Design and Advisory Service
For Radio-Craft Subscribers

Conducted by A. C. SHANEY

This department is being conducted for the benefit of RADIO-CRAFT subscribers. All design, engineering, or theoretical questions relative to P.A. installations, sound equipment, audio amplifier design, etc., will be answered in this section. (Note: when questions refer to circuit diagrams published in past issues of technical literature, the original, or a copy of the circuit should be supplied in order to facilitate reply.)

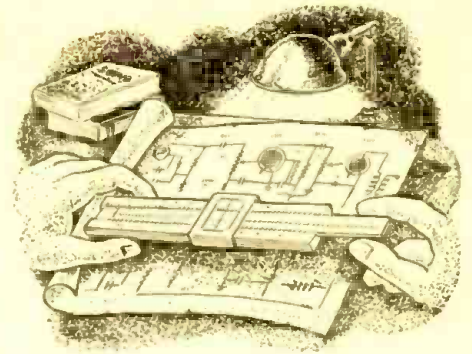

No. 18

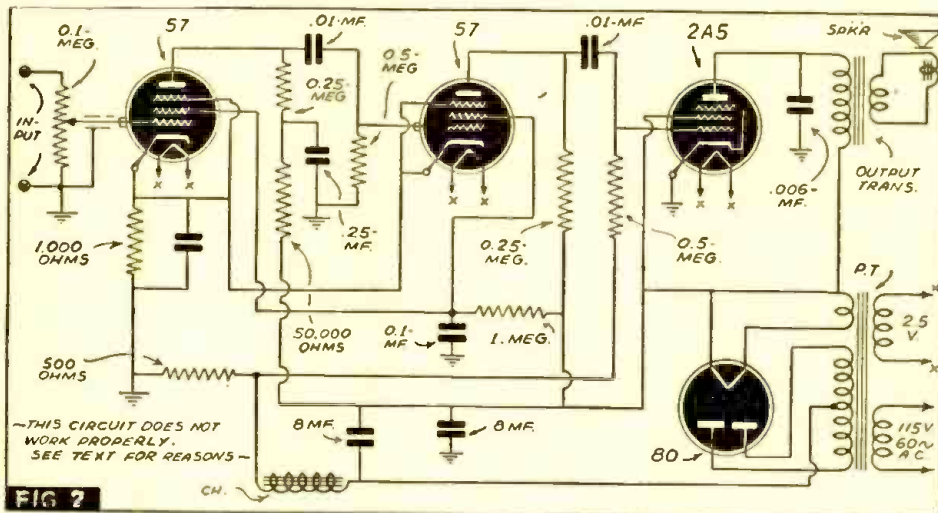

FIG 2

FIXED-BIAS 6L6 AMPLIFIER

The Question . . .

In regard to the amplifier shown as Fig. 1 in *Radio-Craft* for March, 1940, page 531 (shown below, Fig. 1—Editor), could I use the same diagram but in place of 25-W. output, get 34 watts by using 25 volts fixed-bias on the 6L6s?

I understand that I would have to use appropriate transformers, etc., but would I have to change the rest of the schematic?

Although no bias resistors or condensers are used on the input stage of the amplifier, wouldn't these resistors increase the gain? Please advise. What size resistors? What tube can I use to replace one of the 6SC7s so that I will have only two microphone inputs and one phono input? What plate current would two 6L6s draw at the 34-watt output level with -25 V. cathode fixed-

bias? What screen-grid voltage and current would have to be applied?

Can a 500-ohm line be of any length? Is the kind of wire important?

LEROY W. JOHNE,
Ideal Radio Service,
Sheboygan, Wis.

The Answer . . .

In order to obtain 34 watts with minimum distortion, the driver circuit of the amplifier would have to be changed so that it could deliver at least 140 milliwatts of power to the control-grids of the fixed-bias push-pull output stage.

For your convenience, I am giving complete data on the latest published rating for 6L6s operating in either the 31- or 47-watt condition (values are for 2 tubes):

	Fixed-Bias	
Plate V.	360	360
Screen-grid V.	225	270
Control-Grid	-18	-22.5
Peak A.F. grid-to-grid V.	52	72
Zero-sig. plate ma.	78	88
Max-sig. plate ma.	142	205
Zero-sig. screen-grid ma.	3.5	5
Max-sig. screen-grid ma.	11	16
Effective load resistance, plate to plate, ohms	6,000	3,800
Peak grid-input power, milliw.*	140	270
Total harmonic distortion, %**	2	2
Max-sig. power output, watts	31	47

Inserting bias resistors in the cathodes of the 6SJ7s will not increase the gain of the input stages. In fact, it will probably reduce the gain between 1 db. and 3 db., depending upon the cathode resistor used. If bias for the input stages is desired (and it may be necessary if the input signal voltage is high), use a 3,000-ohm resistor in each cathode circuit, bypassed with a 10-mf. or 20-mf. condenser.

You may replace the lower 6SC7 tube with a single 6SF5. The common 2,000-ohm cathode resistor should be increased in value to 2,700 ohms, and the common 6SC7 10,000-ohm plate-load resistor should be increased to 15,000 ohms.

A 500-ohm line can be of any reasonable length, provided its D.C. resistance is not too high and its shunt capacity is not too great.

For a complete discussion of this phase of the subject, refer to "A.F. Amplifier Load-Matching Technique," which appeared in the March, 1940 issue of *Radio-Craft* (see page 539).

*Driver stage should be capable of supplying the grids of the class AB2 stage with the specified peak values at low distortion. The effective resistance, per grid circuit, of the class AB2 stage should be kept below 500 ohms and the effective impedance at the highest desired response frequency should not exceed 700 ohms.

**With zero-impedance driver and perfect regulation, plate-circuit distortion does not exceed 2%. In practice, plate-voltage regulation, screen-grid voltage regulation, and control-grid-bias regulation should be not greater than 5%, 5% and 3%, respectively.

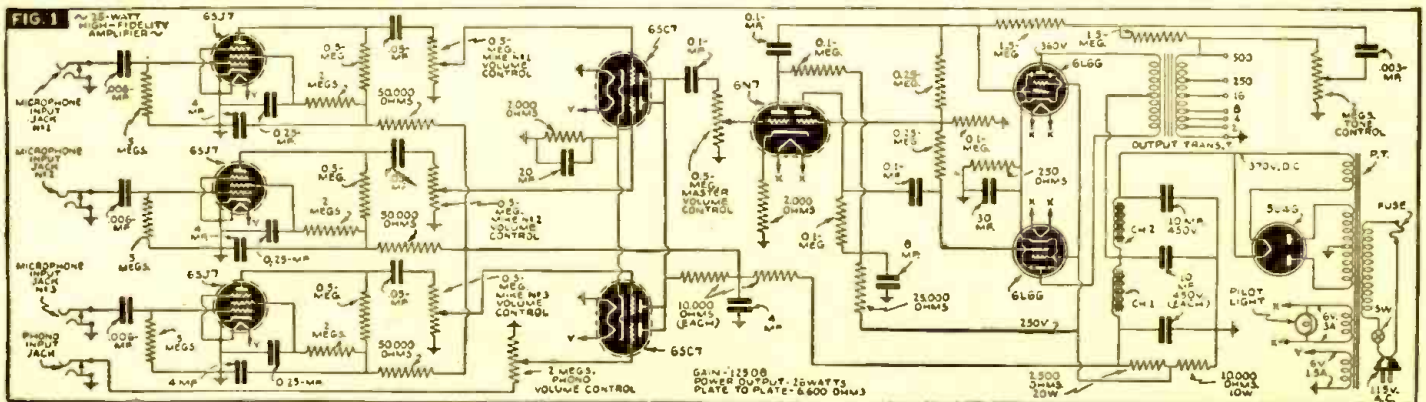

Order your copy NOW—the only
P. A. HANDBOOK



**MOST COMPLETE
 AND AUTHENTIC
 P. A. BOOK PUBLISHED**

THAT no book has yet been published which covers amplifiers and sound systems (also kindred systems), in one complete, authentic volume is almost unbelievable. Yet, it is a fact, there is no book in print which covers Public Address from A to Z. To bridge this wide-spread gap, RADIO-CRAFT will publish a complete, magnificent volume on Public Address of such magnitude—so complete and authoritative—that every man engaged in radio can have both a theoretical and practical knowledge of the function and operation of sound systems. The editorial pages are so filled with instruction and replete with illustrations that the volume fully justifies its title of 1940 AMPLIFIER HANDBOOK AND PUBLIC ADDRESS GUIDE. This great HANDBOOK on Public Address should be read and studied by those who consistently build, service and sell sound equipment.

A MATCHLESS VOLUME

As complete as you would expect to find any engineering handbook—this is how the radio or P. A. man finds the AMPLIFIER HANDBOOK AND PUBLIC ADDRESS GUIDE. With essential technical data compiled from an exceptionally large number of sources, the volume covers nearly a hundred different subjects coordinating every conceivable branch or sub-division of Public Address.

THE CONTENTS

To actually show the scope and magnitude of the AMPLIFIER HANDBOOK AND PUBLIC ADDRESS GUIDE, an analysis of the contents is found at the right, showing the breakdown of the material featured within each particular section. A thorough reading of the contents shows the completeness of this book.

**A Resume of the Contents of the
 AMPLIFIER HANDBOOK
 AND PUBLIC ADDRESS GUIDE**

FOREWORD

INTRODUCTION

Definitions—decibels, frequency, input, output, impedance, etc.

SECTION I—SOURCE

- Carbon microphones (single-button and double-button)
- Condenser microphones
- Velocity (ribbon) microphones
- Dynamic microphones
- Crystal microphones (sound-cell types, crystal diaphragm types)
- Cardioid microphones
- Contact microphones
- Phonograph pickups (magnetic types, crystal types)

SECTION II—AMPLIFIERS

- Voltage Amplification**
 - Design of resistance-coupled voltage amplifiers
 - Commercial voltage amplifier
- The Power Stage**
 - Class A amplifiers
 - Class AB amplifiers
 - Class AB₁ amplifiers
 - Class AB₂ amplifiers
 - Class B amplifiers
 - When to apply class A, AB, and B amplification

Power Supplies

- Half-wave rectification
- Full-wave rectification
- Voltage doublers

Filter Circuits

- Power supply regulation, etc.

Practical Hints on Amplifier Construction

- Microphonism
- Placement of components
- Tone compensation
- Inverse feedback
- Remote control methods

SECTION III—DISTRIBUTION

The Loudspeaker

- Dynamic speakers
- Speaker performance (frequency response, efficiency)
- High-fidelity speakers
- Speaker Baffles and Housings**
 - Outdoor speaker installations
 - Power cone speakers
 - Radial (360° distribution) speaker baffles

SECTION IV—COORDINATION

- Input impedance matching
- Matching speakers to P.A. installations
- Phasing speakers
- Effect of mismatching speakers to amplifier output
- A typical P.A. installation (in a skating rink)

SECTION V—USEFUL PUBLIC ADDRESS DATA AND INFORMATION

- Speaker matching technique
- The ABC of Db., VU, Mu, Gm and Sm
- Charts and formulas useful to the practical P.A. sound man
- Handy index to important articles on public address and sound

RAD-CRAFT PUBLICATIONS ■ 20 VESEY STREET ■ NEW YORK, N. Y.

RAD-CRAFT PUBLICATIONS, INC. ★ 20 VESEY STREET ★ NEW YORK, N. Y. RC-641
 Gentlemen: Enclosed find my remittance of 25c for which send me POSTPAID, one copy of your NEW—1940 AMPLIFIER HANDBOOK AND PUBLIC ADDRESS GUIDE.

Send me others, for friends, also POSTPAID @ 25c each.

Name Address

City State

Remit by check or money order; register letter if you send cash or unused U.S. Postage Stamps.

Order Your Copy NOW—

*Clip Coupon and
 Mail Today!*

MOTORBOATING CURE

The Question . . .

I recently built the 3-stage amplifier, diagrammed on the enclosed sheet (Fig. 2) for a steel guitar with a magnetic pickup. I am having difficulty with it.

When the pickup is hooked into the input terminals, all I get is motorboating while with the input lead to the 2nd tube, the tone is good and it amplifies, but does not give sufficient volume. Also, there is some hum which disappears when the finger is touched to any part of chassis or shielding.

I think the trouble is feedback, but I do not know where. The physical arrangement is exactly as diagrammed; the first 57 is shielded, as are all pickup and grid leads.

I would greatly appreciate a solution to this puzzler, either direct or through the "Sound Engineering" column of *Radio-Craft*.

C. W. KUNKELMAN,
Pendleton, Oregon

The Answer . . .

I don't know where you got the circuit diagram from which you built your amplifier. It is obvious that the designer was primarily interested in using the smallest number of parts and at the least expense. You must surely be aware of an axiom in engineering that whenever a circuit is stripped to its bare essentials, some sacrifice in dependability, performance, or stability must be made.

In your amplifier, stability has evidently been completely overlooked. There are at least 3 possible causes for the motorboating condition that you complain of.

(1) The use of a common cathode resistor in a high gain 2-stage cascaded amplifier is highly unsatisfactory, particularly when the cathode resistor is inadequately bypassed. I would suggest that a separate cathode resistor and bypass condenser be employed for the second 57 tube.

(2) If this does not fully correct the trouble, then the condenser which bypasses the isolating resistor connected to the plate load of the first tube should be increased to at least 4 mf.

(3) If some trouble still persists, the 2nd-stage screen-grid circuit should be altered so that a separate resistor and condenser network is employed to isolate it from the screen-grid of the first stage.

The reason the amplifier does not give sufficient volume when your pickup is connected to the input of the 2nd stage, is that under this condition, you have insufficient amplification to drive the output stage to full power.

You will not experience this difficulty when you utilize the gain of the 1st stage.

The hum trouble can be eliminated by shielding the pickup coil as much as possible from external body effects.

The 2½ volt winding should be center-tapped and grounded. If a center-tap is not

Acratone HI-FIDELITY AMPLIFIERS



6-8 WATT BEAM POWER AMPLIFIER
(Not Illustrated)

This amplifier has been designed as a complete utility amplifier for all low power applications. It is ideal for use as a high quality phono-amplifier.
Specifications: 6 Watts normal, 8 Watts peak. Mike input channel (100 db. gain). Phono input channel (60 db. gain).
Tubes used: 1-6V6GT, 1-6SC7, 1-5W4GT.
Output Impedance: 5000 ohms to speaker, 1000 to 2000 ohm field.

LESS TUBES AND COVER

\$1.22 Kit of matched tubes.
\$1.50 Protective cover.

\$7.95

COMPLETE PORTABLE SYSTEM consisting of 6-8 high fidelity speaker Watt Amplifier complete mounted in a scientific

base reflex portable microphone and desk leatherette case including stand. a high quality crystal Price **\$25.49**

14-18 WATT AMPLIFIER

FINISHED IN ATTRACTIVE BROWN WRINKLE WITH BRILLIANT CHROME TRIM. BEAM POWER OUTPUT. INVERSE FEEDBACK. UNIVERSAL OUTPUT. DESIGNED FOR CONTINUOUS SERVICE.

This amplifier will operate as many as ten 12" PM Speakers. It is ideal for use in average size auditoriums, churches and theatres. It will operate with any modern high impedance microphone.

Specifications: 14 Watts normal, 18 Watts peak. Mike input channel (115 db. gain). Phono input channel (70 db. gain).

Tubes used: 1-6SC7, 1-6SJ7, 2-6V6GT, 1-5W4GT.

Output Impedances: 2, 4, 8, 500 ohms.

Model 2160 less tubes and cover \$11.95

Kit of Matched Tubes 3.00

Streamlined Decorative Cover 1.50

COMPLETE PORTABLE SYSTEM consisting of 14-18 Watt Amplifier complete with tubes and cover, 2 Heavy Duty High Fidelity 12" PM Speakers with 50 feet of speaker cable. Also included is a streamlined high quality crystal mike and desk stand. Price **\$38.95**

25-30 WATT AMPLIFIER

FINISHED IN BROWN WRINKLE WITH BRILLIANT CHROME TRIM. INCLINED CONTROL PANEL. INVERSE FEEDBACK. UNIVERSAL OUTPUT. BALANCED PHASE INVERSION. DESIGNED FOR CONTINUOUS OPERATION.

This amplifier has been designed to meet the most exacting needs of the PA industry. It has ample power to cover larger outdoor areas as well as practically all indoor auditoriums. This amplifier is extremely flexible as it is equipped with four input channels which are individually controlled.

Specifications: 25 Watts normal, 30 Watts peak. 2 Microphone input channels (122 db. gain). 2 Phono input channels (81 db. gain).
Tubes used: 3-6SF5, 1-6N7, 2-6L6G, 1-5U4G.
Output Impedance: 2, 4, 8, 16, 500 ohms.

COMPLETE WITH TUBES PRICE

\$32.95

COMPLETE PORTABLE SYSTEM consisting of 25-30 Watt Amplifier complete with tubes, 2 Heavy Duty High Fidelity 12" PM Speakers, 1 chrome friction clutch floor-stand and high grade crystal microphone. Price **\$67.95**

FEDERATED PURCHASER INC.

80 PARK PLACE

DEPT. R-61

NEW YORK CITY

available, a 100-ohm potentiometer should be placed across the winding and the moving arm grounded. The arm should be adjusted for some optimum setting which produces minimum hum. You might also try connecting the chassis of the amplifier to some external ground.

Now Ready: Sylvania's Tube Complement Book, 1941 Edition. Improved, revised, enlarged . . . more valuable than ever. Has tube replacement information for 100,380 tubes or sockets and The First and Only Compilation of Panel Lamp Numbers! The patented, Hold-Tite, WIRE-O binding keeps book together, allows you to open it flat without cracking or tearing. Send 35c to Hygrade-Sylvania Corp., Dept. RC50, Emporium, Pa.

A RADIO OL' TIMER THINKS BACK AWAYS

J. R. Poppele, chief engineer of WOR, who has been with the Newark station since it first went on the air in February, 1922, remembers the early days of radio . . .

. . . When the first transmitter was a 250-watt outfit that had been used by deForest himself in some of his experiments. This pioneer transmitter was bought and rebuilt. . . . When all of WOR was in one small, crowded room in the furniture and radio department at the Bamberger store. The room was not only the studio, it also contained a piano and the transmitter.

. . . When Poppele borrowed some oriental rugs from the rug department, which was on the same floor as the station, and used this carpeting as acoustical treatment for that one and only studio.

. . . When its first microphone was a converted telephone transmitter with a phonograph horn at one end.

. . . When the news that the station had been heard in Staten Island, Asbury Park and Brooklyn was big news, and the station took a newspaper advertisement to tell the world about it.



HIGH EFFICIENCY!
University Reflex Speakers will project sound clearly for two miles with less than 25 watts input. Write for catalogue.
UNIVERSITY LABORATORIES
195 Chrystie St.
New York City

. . . When WOR, on October 1, 1922, broadcast the first international program to Europe. Sir Thomas Lipton delivered an impressive message, the orchestra played, and the broadcast was heard in London.

LATEST ACOUSTIC SPEAKER HOUSINGS

Illustrated and described are new "Triangular" and "Bass-Reflex" Loudspeaker Housings designed to afford increased fidelity of sound-response and to affect improved sound distribution.

RADIO-CRAFT is indebted to Messrs H. C. Reinhardt and H. W. Stewart for the following descriptions of, respectively, a 3-cornered loudspeaker housing, and a new design of acoustic baffle. The descriptions include useful information on the practical applications of these housings.

PERI-CONIC SPEAKER ENCLOSURE

The triangular shape and styling of the new "Peri-Conic" Speaker Enclosure, Fig. A, offers a number of advantages over the conventional wall speaker housing or square cabinet type of enclosure. The new Atlas Sound speaker baffle, as shown in Fig. 1A, has physical dimensions and construction permitting:

- (A) Corner speaker mounting;
- (B) Side-wall mounting for oblique sound projection;
- (C) Central cluster arrangements in groups of 4 for 360° coverage.

Many other applications and methods of mounting can be easily determined to suit the sound coverage requirements of the particular locations.

The baffle design of the "Peri-Conic" is such that it prevents the back pressure wave of the cone speaker diaphragm from striking a flat surface, as it would inside a square cabinet. It might be mentioned at this point that many broadcasting and recording studios are now being constructed in a triangular shape, or other than a perfect square or rectangle. The internal dimensions of the "Peri-Conic" Enclosure are triangular in area, thus reducing the cabinet resonance to a minimum.

The back-pressure release cut-out, directly under the cone opening, provides a release for the back pressure normally built up inside the enclosure. This opening, being on the front panel, directs the back pressure of the cone diaphragm in the same general direction as the pressure wave generated by the front side of the cone diaphragm. This factor increases the overall efficiency to some extent, and results in an extension of the frequency response.

The same principles used in designing an acoustically perfect studio can be applied to a speaker enclosure in order to lessen frequency discrimination due to reverberation, standing-wave cancellation, etc.

New, commercially-available loudspeaker housings. A.—The triangular "Peri-Conic" speaker enclosure developed by Atlas Sound Corporation. B.—the Bass-Reflex Acoustic Chamber of Ray-Lab, Inc.

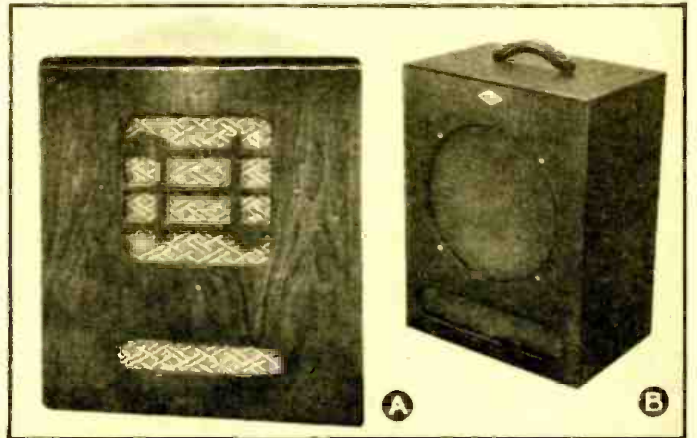

The "Peri-Conic" Enclosure is designed for use with all 12-in. cone speakers, usually those that are sold for general Public Address application. The enclosure is recommended for all speakers which do not exceed 6 ins. in depth.

No damping material or sound absorbent padding is used internally, although the experimenter may find that a particular speaker may be aided slightly if a layer of acoustic hair-felt or other material is attached internally.

TYPICAL APPLICATIONS

Figure 2A illustrates a typical bandstand or platform installation when the microphone is located at one end of a rectangular room. The "Peri-Conic" enclosures are mounted on both side walls, some distance forward from the microphone position.

The sound waves, originating from each speaker, cross at a point somewhere ahead of the microphone. This speaker set-up offers smooth and uniform coverage, also reducing feedback to a minimum. The small area directly in front of the platform is normally covered by the orchestra or vocalist without the necessity of sound amplification.

Another similar set-up is described in Fig. 2B. In this application it will be noted that the bandstand and microphone are located at a center point along one of the long walls of a rectangular room.

Figure 2C describes a more difficult installation in a long hall where undesirable conditions of reverberation are present, due to a vaulted roof or long and hard wall reflecting surfaces. The speaker placements suggested in Figs. A and B would not be entirely suitable because the necessarily higher output level of the speakers would result in reflections of sound that would impair the quality or intelligibility of the reproduction.

If a number of lower-powered speaker units are used at a low level, the sound will be diffused simultaneously over the whole audience and eliminate the reverberant effect.

Cafés and places of entertainment having a circular bar or stage, with the microphone located in the dead-center of the room present another kind of coverage problem illustrated in Fig. 2D. The fact that the speakers are pointed directly at the microphone may cause some concern, but if a number of speakers are used as illustrated, each one operating at a low level, the sound is uniformly distributed. The uniformity of sound distribution eliminates the "beam effect" or wall reflections that often kick back into the microphone with resultant feedback or acoustic howl.

FOR LARGEST LOCATIONS

Figure 2E describes an installation that may be employed in a skating rink or indoor stadium. The noise level is very high and considerable sound output is necessary to overcome the normal background noises. Four of the "Peri-Conic" triangular baffles can be easily grouped in a cluster and suspended in the direct center of the location. If additional sound level is required, the corners can be utilized for mounting individual speakers directing sound to the center of the room.

It is often difficult to hit upon the most perfect arrangement without some preliminary tests and investigations. Don't depend on coverage formulas—the time spent in a careful survey of the acoustical conditions will always be worthwhile.

The correct phasing of speakers in multiple installations is extremely important. Whenever 2 or more speakers are used, they must be connected so that all cones or diaphragms move in the same direction at the same time. A good method to utilize to assure phasing is to mark the terminals

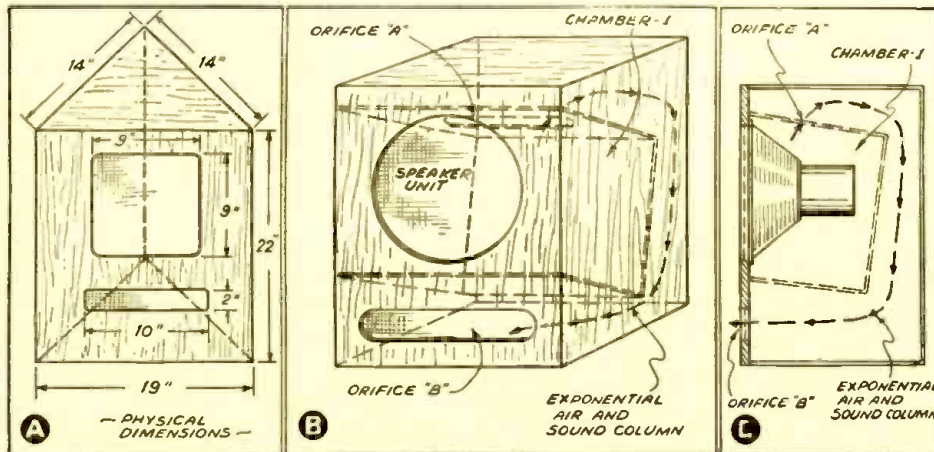

Fig. 1. Details of the new baffles. A.—Phantom view of the corner-of-room, triangular "Peri-Conic" loudspeaker. B.—Front phantom view of Bass-Reflex Acoustic Chamber. C.—Side view.

of identical speakers in an identical manner. If the speakers are connected so that all the terminals connected to one line are identical, the speakers will be in-phase. An aural method can also be used for determining phase relationship. If 2 speakers are operating, and the sound appears to be coming from 2 distinct locations or from each speaker individually, you can be reasonably assured that they are out-of-phase. Changing-over the input connections on either speaker will rectify this condition and the sound will then appear to be coming from one source.

It might be well for the sound engineer to conduct a phasing experiment in order to become acquainted with the aural test described.

BASS-REFLEX ACOUSTIC CHAMBER

The second design of loudspeaker housing, the Bass-Reflex Acoustic Chamber, is pictured in Fig. B; the details of its construction are shown in Figs. 1B and 1C. The theory and basic principles developed in this speaker chamber are entirely new and different. This new design it is claimed, affords the following desirable results:

- (1) Bass-reflex response.
- (2) Desired bass cut-off.
- (3) Resonant tuning to give hall and auditorium acoustical conditions.
- (4) Perfect phasing of tones, from back and front of speaker, from zero to the highest audible frequency.
- (5) Ability to obtain the maximum efficiency of the speaker unit.
- (6) Elimination of distorting vibrations of the speaker cone at ultra-high and -low frequencies.

The first facts brought out, by an analysis designed to secure the above results, were that the basic formula depended upon obtaining a zero medium, for maintaining the air pressure mechanically developed inside chamber 1, Fig. 1B, in perfect balance with the outside atmospheric pressure.

Using this as a basic medium, it was possible to regulate our bass-reflex response by the size of the opening in chamber 1, which acts as an air valve.

Further research disclosed the necessity of finding the principle upon which to compute the proper cubic inch size of chamber 1. It was found that this depended on the size of the cone, and the flux efficiency of the permanent magnet or field coil.

Differing Only in Size and Price!

WESTON
Packet Size
TEST INSTRUMENTS



No need to sacrifice dependability when seeking the convenience which pocket-size instruments afford. For this series of WESTONS... while truly compact in size and low in initial cost... provide the dependability and long life which are typically WESTON. In addition, they are versatile instruments; Model 697, for example, providing the necessary voltage, current and resistance ranges for efficient trouble-shooting. Let us send you full particulars on these convenient, low-cost instruments. Write today.

WESTON ELECTRICAL INSTRUMENT CORPORATION
 599 FRELINGHUYSEN AVENUE, NEWARK, NEW JERSEY

It was found by experiment that the efficiency of the speaker could be varied over a wide range by changing the size of chamber 1. Although it was then possible to control bass-reflex response, only a very limited range of bass cut-off could be obtained to meet all conditions. The basic principle that controlled this feature of the acoustic chamber, it was found, was the degree of taper of the exponential air column, Fig. 1C. between orifice A and orifice B; and, the proper sizing of orifice B, Fig. 1B. Resonant

tuning of the acoustic chamber, which is necessary in order to maintain a 180° out-of-phase relationship between front and back of the motor unit, was also controlled by proper design of the air column.

Up to this point, experimental verification of the calculated results had progressed satisfactorily, but then a new problem arose. Distorting vibrations developed due to the power of the speaker being so increased within so compact an acoustic chamber. This was corrected, in part, by gluing the acoustic chamber in its construction; and, by properly placing an acoustic material inside of chamber 1. Fig. 1B.

USEFULNESS

Use of the above-described construction of an acoustic chamber, in combination with a loudspeaker-unit of proper type, results in a loudspeaker combination capable of reproduction over a frequency range of 24 to 19,000 cycles, without resonance peaks.

These acoustic chambers, being very compact, can be used for portable use as well as permanent installations. Three sizes have been perfected, namely, for 10-in. speakers handling up to 15-watts power; 12-in. speakers, handling up to 25-watts power; and, 15- to 18-in. speakers rated at up to 50-watts power-handling capacity. These are all in the box type as shown. Two more types will soon be perfected, one corner type and one wall type.

These Bass-Reflex Acoustic Chambers have been proven by test to be capable of solving many problems in "acoustically difficult" halls, gymnasiums, and auditoriums.

Messrs. Reinhardt and Stewart are connected with, respectively, Atlas Sound Corporation, and Ray-Lab, Inc., manufacturers of the new speaker housings described in the foregoing article.

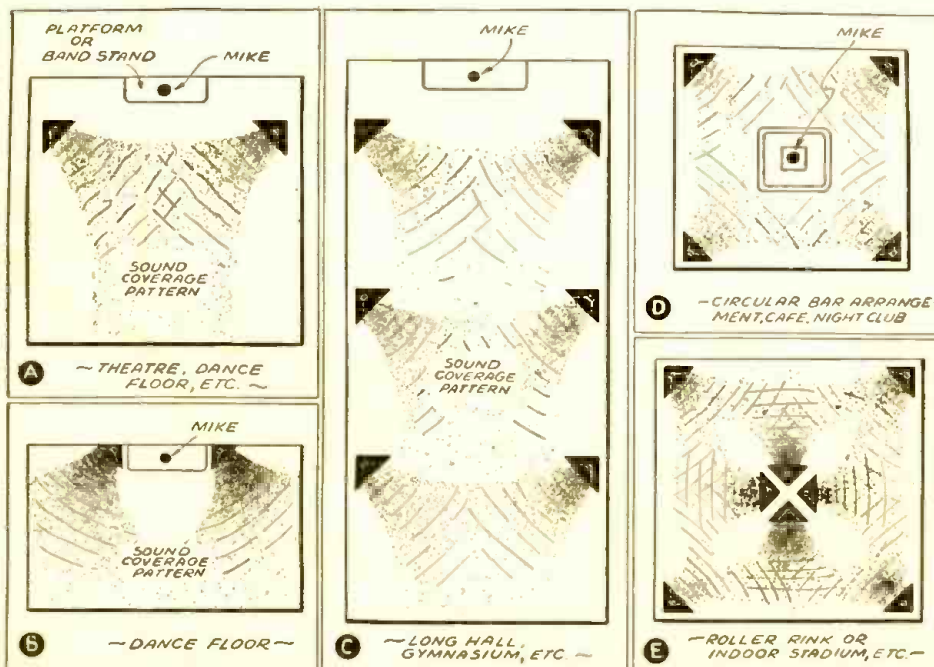

A Manufacturer Comments on

"MODERN MICROPHONE TECHNIQUE"

The following letter discusses statements, concerning directional, semi-directional and non-directional sound cell and diaphragm types of crystal microphones, published in a 3-part article in Radio-Craft.

A. L. W. WILLIAMS

President, The Brush Development Co.

WE have before us the article entitled "Modern Microphone Technique" in the February issue of *Radio-Craft* and are taking the liberty of writing you in regard to certain statements contained therein. Our company, The Brush Development Company, is the only commercial source of Rochelle salt crystals in this country, as far as we know. In addition to manufacturing piezoelectric devices ourselves, we license others to make such devices using our crystals. We enclose (appended.—*Editor*) herewith for your attention a list of our licensees.

We maintain an engineering laboratory which specializes in piezoelectric problems, and in making the following comments we are relying on the experience which we ourselves have gained in dealing with crystal devices. We believe there are a number of errors and omissions in the article that are likely to give the reader a false conception of the qualities and limitations of crystal microphones.

The paragraph headed "Crystal" begins by stating that "There are 2 general types of crystal microphones on the market: (1) the sound cell type, and (2) the dual-diaphragm type." Crystal microphones should be divided into the sound cell type and the diaphragm type, the latter including both single and dual diaphragm. The single-diaphragm type greatly outnumbers the dual-diaphragm and sound cell types combined. In this connection, note that all the 6 crystal microphones illustrated at the bottom of page 489 are of the single-diaphragm type.

The "Crystal" paragraph compares frequency response, impedance, output, etc., of the sound cell and dual-diaphragm types and much of this information is incorrect, or is misleading in that it is applicable to particular microphones but not to the whole class of microphones. Since the comparison is between the sound cell type and only one small part of the large class of diaphragm types, we shall not attempt to take up point by point the incorrect statements but rather we shall present what we believe to be a correct summary of the properties of crystal microphones.

It is difficult and often misleading to compare different types of microphones since microphones in the same general class may vary even more in their properties than representative microphones in different classes. This requires that direct comparisons between individual models of different classes be avoided, or be made with great caution, as otherwise the comparisons may lead to false conceptions of the classes as entireties. On the other hand, general comparisons by classes may hide outstanding qualities of certain specific models. Having these limitations in mind we believe that a correct summary of the properties of the

The 3-part article "Modern Microphone Technique," which appeared serially in the February, March and April, 1941, issues of *Radio-Craft*, has aroused comments pro and con in many quarters.

As authors L. Fletcher and H. S. Manney pointed out, "Microphone Technique," as such, is a big subject to cover in a single series of articles . . . and this series . . . has been merely an attempt to sum up some of the ideas which . . . are in current belief and use today." The difficulty of presenting an article that would be approved by all the opposing groups in the microphone field was recognized during the early stages of the preparation of this article, and it was only by using the approach to the subject embodied in this series, that some measure of equity between these divergent views could be found.

Diametrically opposed information concerning the use of microphones was obtained not only from technicians—practitioners in the field—but manufacturers as well.

"Modern Microphone Technique" was intended, and to this extent has served its purpose, as a background against which differing opinions on the subject could be projected.

We are happy to present the accompanying letter which expands one class of microphones in operation; if and when equivalent material is submitted to *Radio-Craft* on allied classes, we will be glad, too, to give this material display.

Sound and Radio technicians long have lacked practical, applicational information which attempted to coordinate all the differing opinions, and associated information and characteristics data, etc., currently available. It is hoped that "Microphone Technique" has altered this situation and that *Radio-Craft* readers now will feel more "at home" with microphones.

crystal types now available is as follows:

Response.—Sound cell microphones as a class have flatter, wider response than diaphragm crystal microphones as a class. The dual-diaphragm is an outstanding example of a high-quality diaphragm type and has better response than some sound cell models, but is excelled by other sound cell models. For example, we make a Laboratory Standard sound cell microphone which has such flat response through the audible range and beyond that it is used for calibrating other microphones, but for the ordinary range one can achieve flatness with high output more cheaply by using a diaphragm construction.

Impedance.—With the exception of a few models equipped with step-down transformers (for use on 500-, 200- or 50-ohm lines), all crystal microphones are of the "high-impedance" variety and are intended to work into the grid circuits of amplifiers through shielded cables. The impedance is similar to the impedance of a condenser and the length of cable that can be used without serious loss of output depends on the capacity of the microphone, higher capacities (lower impedances) permitting longer cables. The loss due to cable capacity is, in practically all cases, the same at all frequencies; in other words, cable capacity does not cause a relative loss of "highs." Microphones employing a plurality of parallel-connected diaphragm units or parallel-connected sound cells have much higher capacity (lower impedance) and can be used on much longer cables than most single-unit microphones.

Output.—As a class, sound cell microphones have lower voltage output than diaphragm microphones.

Directivity.—With at least 2 exceptions (Shure "Tri-Polar" and Shure "Uniplex") crystal microphones are pressure-operated and therefore non-directional or semi-directional. Sound cell and small-diaphragm microphones (including double-diaphragm types) are small enough in relation to high-frequency wavelengths so that they are substantially non-directional. The average diaphragm microphone, however, is larger and somewhat more directional at the higher frequencies. In this respect it is similar to the average dynamic microphone and in some cases this directivity is deliberately accentuated by suitable case design. On the other hand, some of the large-diaphragm microphones are used with their diaphragms horizontal and the cases symmetrical about a vertical axis so that they are non-directional in a horizontal plane. A few crystal microphones of special design are highly directional. They include a Cardioid type ("Tri-Polar") which is equipped with a switch to change directivity; and a single unit uni-directional microphone ("Uniplex").

In addition to the misleading comparison of the 2 types of crystal microphones, there are several statements in the "crystal" paragraph that require comment as they are also apt to add confusion:

"Being more efficient in the higher frequencies, it (sound cell) tends to overload the amplifier sooner, causing feedback."

In any microphone - loudspeaker system, feedback is accentuated by the presence of more-than-average efficiency at one part of the frequency range. This is true regardless of the type of microphone, although directional microphones offer an opportunity to reduce the effect. However, amplifier overloading seldom, if ever, is the cause of

feedback as implied in the above statement but may result from feedback.

"The diaphragms (of dual-diaphragm units) are smaller in diameter than the wavelength of the highest frequency waves encountered in high-fidelity application, and thus the microphone cannot be acoustically overloaded."

This statement leaves the impression that large microphones may be overloaded acoustically because they are larger than a wavelength. Actually, size has little to do directly with acoustical overloading and to the best of our knowledge all commercially-available microphones operate well below the acoustical overload point even for very loud sounds. The size is important, however, in its effect on directivity, small size usually being required for non-directional performance and this is the reason for the small size of dual-diaphragm and sound cell microphone units.

"Like the sound cell type, they (dual-diaphragm microphones) are also non-directional. In other words, they behave very much like the human ear, picking up sound sometimes within a radius of 20 or 30 feet."

The only practical limitation to the range of pick-up of the human ear is the weakness of the sound to be "picked up" and the loudness of interfering sounds. If the sound is loud enough at the source, it can be heard for many miles provided that local sounds near the listener are sufficiently weak so that they do not mask the distant sounds. The same thing holds for most all practical microphones with the additional important limitation that the noise level of the microphone and amplifier combination masks weak sounds that are picked up. The reference to the 20- or 30-foot pick-up range has, in our opinion, no foundation and is most misleading.

In other paragraphs of the article there are still more statements upon which we wish to comment as they place crystal microphones in a most unfavorable light which we think is entirely unwarranted. In the paragraph headed "Velocity," we find the following:

"The velocity has the flattest frequency response of any microphone on the market, as far as the higher and middle frequencies are concerned."

Of course, high-quality velocity microphones do have very flat response but there are also on the market poor-quality velocity microphones which certainly do not meet this specification. On the other hand, although some sound cell microphones tend to have a rising characteristic at the higher frequencies, others are at least as flat as the best ribbon microphone.

Near the end of the second column on page 492 is a statement which is shocking to us as a manufacturer of crystals and therefore as one who knows the extent of this application.

"A crystal microphone with a flat frequency response, might even be used successfully for music."

Although the implication of this statement is modified somewhat by other statements in the article, taken by itself or in combination with the rest of the matter under the sub-heading "Semi-Professional," it is, to say the least, most unfair to crystal microphones which have been and are used extensively where the very highest quality is desired for recording and for broadcast purposes. There are, of course, low-priced crystal microphones which are not satisfactory for high-quality recording but they are engineered deliberately as low-cost units. One might as well condemn all dynamic speakers because the speaker used in a

New SELF-BALANCING
DRIFT-CORRECTING
DIRECT-COUPLED AMPLIFIERS
FOR DISCRIMINATING MUSIC LOVERS
Designed by A. C. Shaney



These new amplifiers bridge the gap between the laboratory and the home, and make available for the first time, extraordinary equipment at less than ordinary prices. Built in a new way, without interstage coupling condensers or transformers. Although specifically designed to meet the strictest requirements of professional sound engineers, these direct-coupled amplifiers embody all desirable features sought by the most discriminating music lovers. Send for Literature.

AMPLIFIER CO. of AMERICA
17 W. 20TH STREET, NEW YORK, N. Y.

\$7.95 midget radio set does not reproduce the full audio range and has a bad peak.

Licensees of The Brush Development Company.

American Microphone Co., Los Angeles, Calif.

Astatic Microphone Laboratory, Youngstown, Ohio

L. D. Cahoon & Company, Limited, Toronto, Canada

Dictograph Products Company, Inc., New York City

Thomas A. Edison, Incorporated, Orange, New Jersey

Fairchild Aviation Corporation, Jamaica, New York

The Gray Manufacturing Company, Hartford, Conn.

Herz-Lasker Corporation, New York City

B. A. Proctor, Inc., New York City

RCA Manufacturing Company, Inc., Camden, New Jersey

Shure Brothers, Chicago, Ill.

Sonotone Corporation, Elmsford, New York

The Turner Company, Cedar Rapids, Iowa

Webster Electric Company, Racine, Wis.

American Telephone and Telegraph Company

We regret that it has been found necessary to hold over for July *Radio-Craft*, the articles "Recent Radio Tubes" and "Developments in Personal Portables," originally scheduled to appear in the June issue. Also, don't forget that July *Radio-Craft* will contain the "Review of the Radio Parts National Trade Show."

J. D. R. Freed, Dead

Joseph D. R. Freed, 43, one of the highly-regarded old-timers of radio, died recently at his home in Riverdale, New York. He will be well remembered for his many contributions to the radio art, notably improvements designed for the U. S. Navy during World War I.

He was best known for his highly-successful Freed-Eisemann Radio Corporation, pioneer radio set manufacturers in 1921. His loss is a great shock to the radio industry.

GEOPHYSICAL PROSPECTING PRINTS

50¢ EACH
7 FOR \$3.—



With any one of the modern geophysical methods described, instruments can be constructed to locate metal and ore veins, subterranean water and oil deposits, buried pipes, tools, or other metallic objects sunken in water, etc. Folder contains blueprints and detailed data covering each instrument.

Folder No. 1. Radioflector Pilot. Construction and use of 2 tube transmitter and 3 tube receiver. Reflected wave principle. Visual and aural signals.

Folder No. 2. Harmonic Frequency Locator. Radiates low frequency wave to receiver. Aural signals.

Folder No. 3. Beat Note Indicator. 2 oscillators. Visual and aural signals.

Folder No. 4. Radio Balance Surveyor. Balanced loop principle. Modulated transmitter. Visual and aural signals.

Folder No. 5. Variable Inductance Monitor. Inductance principle. Aural signals.

Folder No. 6. Hughes Inductance Balance Explorer. Bridge principle. Aural signals.

Folder No. 7. Radiodyne Prospector. Balanced loop principle. Very large field of penetration. Aural signals.

Each set of blueprints and instructions enclosed in heavy envelope (9 1/2" x 12 1/2"). Blueprints 22" x 34"; eight-page illustrated 8 1/2" x 11" folder of instructions and construction data 50¢
Add 5¢ for postage

The complete set of seven folders \$3.00
Shipping weight 2 lbs. (add 25¢ for shipping anywhere in U.S.A.)

TECHNIFAX

RC-641

1917 S. STATE ST.

CHICAGO, ILL.

★ ★ ★ SPEAKER HIT! NEW! "Peri-Conic" riangular Cabinet

- ◆ 101 Sound Applications
- ◆ Bass Reflex Design
- ◆ Improves Any 12" Speaker
- ◆ Distinctive Walnut Finish

ATLAS SOUND CORP.

1446 39th St., Brooklyn, N. Y.

FREE: CATALOG F-41

Describes 125 Sound Products



TR-12 CABINET \$7.64
Dealer Net

The story of how two typical Radio Servicemen, discouraged and disgruntled because of bad business conditions, found themselves in the Sound field. It might well have been your story or the story of so many hundreds of other Servicemen who complain of how bad the servicing business is.

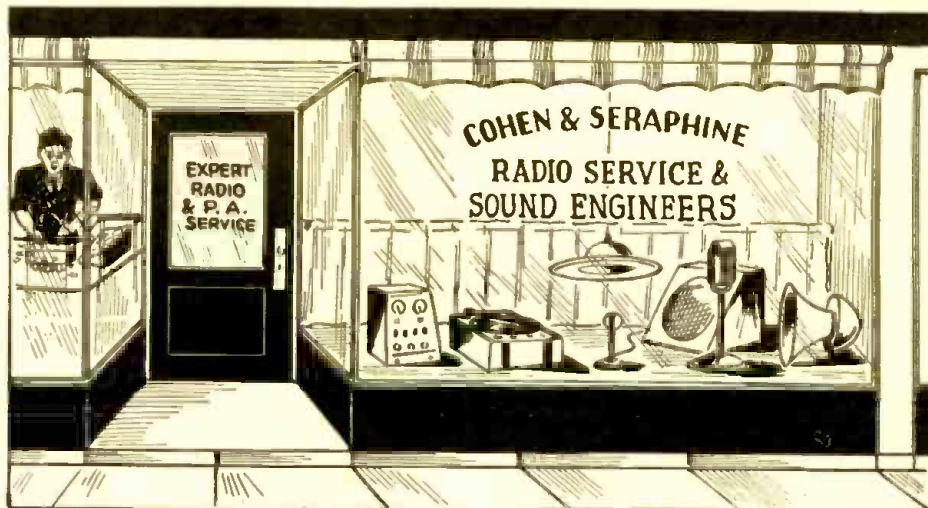

SOUND *Is the* SPUR

LEO FENWAY

IF YOU have been one of the millions of visitors to the New York World's Fair you, of course, know the all-important part radio played in its success.

If you went there in the morning, before the gates opened, doubtless you were greeted with a sudden blast of sound as a spieler tested his microphone.

"H-E-E-R-R Y-A-A-R-R, FOLKS. It's Fascinating—" And far across the field another barker shouts, "Step Right Up. Step Right Up—"

Later, if you joined the countless thousands who stood spellbound at the spectacular "Railroads on Parade" pageant, surely you must have marveled at the near-perfection of the sound system.

The evolution of sound amplification from the single Baldwin headphone placed in a tea cup (the earliest form of loudspeaker), to the giant 350-watt amplifiers used at the Fair is a factor of overwhelming significance to every Serviceman with imagination and understanding.

To Emil Cohen and Tony Seraphine, East Side Servicemen, it was adventure walking suddenly into their lives. It was more than that. Much more. It was the beginning of an idea that two radio men, geared in different branches of the craft, could do business as cheaply as one, provided they put all their eggs in one basket.

Tony conducted a small radio business in the basement of an apartment-hotel in the East Seventies. Many a time Emil had passed Tony's place and wondered how much he owed a month for "that dump."

Emil's store, located downtown on 2nd Avenue, reminded Tony of a thrift shop. Even with its conspicuous "Expert Radio Service" sign, Tony was all for calling it a blind for a bookmaker.

As a matter of fact, both men were honest, upright citizens trying to support their families . . . struggling against a decline that neither entirely understood. Deep down, each in his own way, often looked at his microscopic business, with its competitive death grapple for trade, and wondered if the radio business would ever again equal its former glory.

And then one day both men went to the World's Fair—independently. It was Emil who became imbued with the come-on technique of radio. He discovered that people were not only conscious of what the Fair looked like, but also what the Fair sounded like.

Sound! That was the thing. Take that P.A. equipment at the Railroads on Pa-

rade exhibit. Some one, Emil thought, made a nice few dollars. And those amplifiers in the amusement area—why, the idea of a Serviceman doing a real sound selling job was so logical, so matter-of-course—

Then he met Tony.

"Servicemen tackle sound?" Tony said. "Why, only a month ago I rented an amplifier for two bucks. And y'know what? When I got it back the speaker was busted. Yeah. I tried my luck with sound. I got two or three P.A. chassis under my bench right now. All naked and rusty skeletons, gentle reminders of—"

"All the same," Emil cut in, "if a couple of real radio guys got together, like you and me, we could clean-up on the East Side, selling sound. I'd take over the sound end of the business. You could handle the usual repairs. Every lodgeroom, club, restaurant and other joint where groups gather would get to know me like they know their own landlord. Believe me, pal, with the worries of repairing sets off my mind, I'd give the sound business all I got—attention, charm, personality, imagination, stick-to-it-iveness—the works."

"Y'mean," Tony said, "instead of being my competitor, you'd be my partner?"

"Competitor hell!" Emil grunted. "You ain't got a competitor any more than I have. We're only a drop in the bucket. How much stock you got on hand? Don't tell me—mine's lousy, too! How many calls you made this month? See what I mean?"

Tony grinned. "I've been wanting a 1st-class service bench all my life."

Emil laughed. "I've been wanting," he said, "to get away from one all mine."

"Well," Tony said. "I've a little stock. And about a hundred bucks in cash. I may be a sucker. Especially when most Servicemen know less about selling sound than almost any other branch of radio. Still, if you're game to try it, so am I—provided you can tell me how to stall off my creditors, until we get things going."

Emil assured him that it could be done. He had angles.

So, with cash assets of \$274.25, they got started. Tony's store was closed, and the contents moved to Emil's place of business. A new sign reading, "Cohen & Seraphine—Radio Service & Sound Engineers" was proudly hung over the door. Working like Trojans until the wee small hours of the morning, both men took turns with (a), a paint brush; (b), a hammer; (c), saw, plane, nails. They put the repair department right in the window. Emil said: "We're

going to turn our back on yesterday's methods of servicing radios. We'll not use any ruse of false advertising, sales talk, or hocus-pocus to hide from the customer what he is getting for so much money." Tony agreed that was swell, knowing full well that many of the fly-by-night Servicemen paid the full penalty for sharp dealing and buccaneering tactics.

After all, there is no substitute for knowledge and experience. Neither can be faked.

The partners' next move was to send a letter to all of their creditors, pointing out their new position, and assuring them that they were anxious to honor their obligations. They suggested that they could set aside so much a month which could be divided pro rata among their creditors. Their suggestion was received with pleasure. Unknown to them, their credit rating was being established at the Credit Bureau.

Weeks passed. Tony had to admit that for a little guy—Emil was only 4 foot 10—with a receding chin, he had a lot of moxie. Sales and Service were climbing. In one restaurant, Emil sold a 5-position, selective intercommunicating system, allowing them a few dollars for their 8-year-old talk-phone set.

A club in Harlem, where they run nightly Bingo parties, bought a high-quality 12-watt system. Previously, this club had been using a popular broadcast receiver, with a carbon mike. Emil made it a point to hang around the first two or three evenings in order to meet people. The second night he ran face to face with a Mrs. B. He had tried many times to get past the ornate doorman at the Swish-Arms, where Mrs. B lived, but had not been successful. He had been tipped off. She was in the market for a phonograph with automatic record changer. Meeting her at the club was the most logical thing in the world, because she, like hundreds of other women was "nuts about the good old bingo game!"

Two months went by. The partners were very optimistic. The only break in their friendly relationship was quickly patched up. It came about because Tony wanted to start building their own sound systems. Emil was against it from the start. "If we," Emil said, "use standard equipment, we'll have no apologies to make. The day for apologies, if it ever existed with factory-made units, is past. We want our work and our accomplishments to be measured by the same standards as are the best in the sound business."

And Emil didn't mean any reflection upon

SUPER SPECIALS

Tony's ability. Tony was an excellent mechanic. But the early sound shoemakers built most of their equipment, and left most of their work unfinished. Emil meant to carry on that work, not so much to preserve the heritage of radio, but because there was money to be made doing so.

He canvassed the most out-of-the-way places. That's how he happened to hear about the auction of household furniture in the warehouse down by the river. Most warehouse auctions are noisy, what with furniture being moved about, etc., so, why not help the auctioneer with sound?

Emil approached him the day before the sale. He was a big surly fellow with a pugnacious jaw.

"Nothin' doin'," he said in his gruffest voice. "I wouldn't spend a cent for—"

"But you don't have to spend anything!" Emil said. "I'll install the equipment. You give me 1% of the total sales."

The following day, that auctioneer sold \$2,791.75, in less than 4 hours. It was something of an achievement, and netted the partners a nice tidy sum for the day's work.

Moreover, the auctioneer engaged Emil's services for a second auction to be held in Jamaica. Emil says, "After the job is repeated several times, it will take little selling to convince the auctioneer that outright purchase of the P.A. equipment is more practical than repeated rental."

That's taking a long view of it. Still, a sound amplifier is a long-time item.

Besides, Emil and Tony take a long view of everything these days. They've gotten over the idea that Servicemen are by long odds the most ill-paid, under-nourished tradespeople in the country. They've forgotten about the radio men who live only for today, cannot think of yesterday without regrets, nor of tomorrow without fear. Emil and Tony have their feet on the ground. They know that selling Sound is like placing an ad in a paper with a large circulation. It reaches the most people. The more people, the better the prospects are for business. Emil and Tony would like to open many a Serviceman's brain and pour into it a mass of facts, rules-of-thumb, opinions and notions about improving business in their community. And boiled down the words of the success-makers are: "Sound is the Spur."

MORE F.C.C. MAILBAG

All radio transmission is interstate commerce, notwithstanding its scope or territorial limits, the Commission reiterates to an inquiring Texan. As such, it is subject to the regulatory powers of Congress or of a delegated authority. Various court decisions are quoted.

A New York State resident wants authority to record certain radio programs as they are broadcast to the public. The Commission replies that this does not come within its jurisdiction, being a matter involving the private rights of the radio station, the artists, and the sponsor of the program.

"What procedure should be followed in the event of the death of a station licensee?" inquires a Chattanooga. In such cases the administrator of the estate should make application to the Commission for an assignment of license to be exercised pending settlement of the estate. When the estate is settled, the administrator should make application for assignment of license to the party who is to carry on station operation.

An Ohio letter-writer objects to certain Berlin broadcasts. The programs in question are not rebroadcast, but are received from Berlin direct. The Commission does not, of course, have jurisdiction over alien stations.

All of the attractive items listed here are brand new. ALL are in PERFECT WORKING ORDER. In many cases, the parts alone total more than the price we are asking. 100% satisfaction guaranteed or your money refunded.
ORDER FROM THIS PAGE. Use the convenient coupon below. Include sufficient extra remittance for parcel post charges, else order shipped express, collect. Any excess will be refunded. C.O.D. shipments require 20% deposit. If full remittance accompanies order, deduct 2% discount. Send money order, certified check, new U. S. stamps. No C.O.D. to foreign countries.

ORDER TODAY LIMITED QUANTITIES PROMPT SHIPMENTS ASSURED

VARIABLE SPEED UNIVERSAL MOTOR

FOR 110 VOLTS. A.C. OR D.C.

Made for Dictaphone machines by American Gramophone Co. Used, but in excellent condition. Special lever control permits variable speeds up to 3000 r.p.m. 1/2" shaft extends from both sides of motor. Measures 7 1/2" x 3 1/4" diam. overall. Shp. Wt. 6 3/4 lbs.

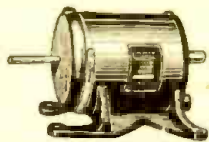

ITEM NO. 11
Your Price \$1.55

POWERFUL ALL-PURPOSE INDUCTION MOTOR

IDEAL FOR EXPERIMENTERS—101 USES

Sturdily constructed to precision standards, this self-starting shaded pole A.C. induction motor is powerful enough for a large variety of uses. Some of these are: Automatic Timing Devices, Current Interrupters, Electric Fans, Electric Chimes, Window Displays, Photoelectric Control Devices, Electric Vibrators, Small Grinders, Buffers and Polishers, Miniature Pumps, Mechanical Models, Sewing Machines, Phonograph Motors, Coffee Grinders, Motion Picture Projectors, Motorized Valves, Sirens, and other applications. Consumes about 15 watts of power and has a speed of 3,000 r.p.m. When geared down, this sturdy unit will constantly operate an 18-inch turntable loaded with 200 lbs. dead weight—THAT'S POWER!

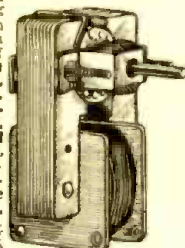

The motor is of midsize dimensions, 3 inches high by 2 inches wide by 1 1/2 inches deep; has 4 convenient mounting studs; shaft is 7/8" long by 3/16" diameter, and runs in self-aligning, oil-retaining bearings; the best materials, perfect precision assembly and rigid inspection certify to its high quality, and assure long life. Designed for 110-220 volts, 50-60 cycles, A.C. only.
 ITEM NO. 147
YOUR PRICE \$1.29

BENNETT LABORATORY BALANCE

A compact laboratory balance made of finest quality tested materials. Extreme sensitivity (to 2-100ths gram or 2-thus grain). Weighs to one decimal pt. further.

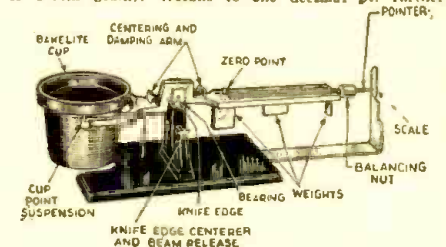

than usual low priced counter scale. Will handle up to 100 grams (about 4 oz.). Bakelite pan; tool steel knife edge; sate bearing for long life and accuracy. Ideal for photographic work and lab use. Handsome streamline design. Graduated either in metric or apothecary system. Shipping wt. 2 lbs.
 ITEM NO. 122
YOUR PRICE \$7.20

100 POWER TELESCOPE LENS KIT

Make your own high powered 6 ft. telescope! Now you can thrill to a closeup view of the worlds out in space. See the rings around Saturn, the mountains of the moon! Kit contains 3" diam., 75" focal length, ground and polished objective lens and 2 astronomical eye-pieces, magnification 50x and 100x. Complete kit with full instructions.
 ITEM NO. 123
YOUR PRICE \$1.95

NEW—EXTRA LARGE LENS KIT—contains completely finished 4" diameter 100" focal length ground and polished objective lens, three 1 1/4" diameter eye-pieces giving 66x, 133x, and 200x, an aluminumized diagonal for overhead viewing, and a color filter for insertion in any eyepiece.
 ITEM NO. 123L
YOUR PRICE \$3.95

HUDSON SPECIALTIES CO., 40 West Broadway, N. Y. C.

IT'S EASY TO ORDER—CLIP COUPON—MAIL NOW ORDER FROM THIS PAGE.

HUDSON SPECIALTIES CO., 40 West Broadway, Dept. RC-641, New York, N. Y.
 I have circled below the numbers of the items I'm ordering. My full remittance of \$..... (include shipping charges) is enclosed.
 OR my deposit of \$..... is enclosed (20% required), ship order C.O.D. for balance. No C.O.D. order for less than \$2.00. (New U. S. stamps, check or money order accepted.)
 Circle Item No. wanted: 11, 86, 87, 97, 122, 123, 123L, 125, 147
 Name Address
 City State

Send remittance by check, stamps or money order; register letter if you send cash or stamps.

AMAZING BLACK LIGHT!!

Powerful 300-Watt Ultra-Violet Bulb



The best and most practical source of ultra-violet light for general experimental and entertainment use. Makes all fluorescent substances brilliantly luminescent. No transformers of any kind needed. Fits any standard lamp socket. Made with special filter glass permitting only ultra-violet rays to come through. Brings out beautiful opalescent hues in various types of materials. Swell for amateur parties, plays, etc. to obtain unique lighting effects. Bulb only. Size of bulb. Shp. Wt. 1 lb.
 ITEM NO. 87
YOUR PRICE \$2.00

ULTRA MAGNET

LIFTS MORE THAN 20 TIMES ITS OWN WEIGHT

LITTLE GIANT MAGNET. Lifts 5 lbs. easily. Weighs 4 oz. Made of ALNICO new high-magnetic steel. Complete with keeper. World's most powerful magnet ever made. The experimenter and hobbyist will find hundreds of excellent uses for this high quality permanent magnet. Measures 1 1/2" x 1 1/2". Shp. Wt. 1/2 lbs.



ITEM NO. 86
YOUR PRICE \$1.00

NEW ELECTRIC MOTOR-SAW

Now you can have all the fun of fine, fast jigsaw work without any of its difficulty. Simply steer the lightning-fast blade and see it seemingly melt its marble way through wood, plastics and building board. 7200 STROKES per MINUTE! Average cutting speed 1 foot per minute through 3/4" medium hard wood. Works 3 times faster than any free-hand saw. Operates on 50-60 cycle 110 v. Alternating Current. Screw adjusts blade stroke from 1/4" to 5/16". On-On Switch built in handle. Complete with 6 ft. power cord and 3 saw blades.

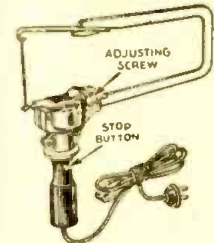

ITEM NO. 97
YOUR PRICE \$4.85

ELECTRIC HUMIDIFIER FOUNTAIN

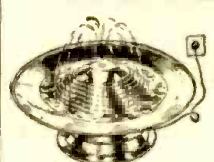

Adds healthful moisture to the air in winter. Evaporates as much as a pint of water in 24 hours. Fountain is 14" in diam. Sprays 8 streams of water 5" above fountain head. Made of spun aluminum. Comes in five colors: Bronze, chrome, copper, red, green. No water connections required. Just plug into 110 volt, 60 cycle A.C. outlet. Current consumption few cents a month. Complete with base switch and 8 ft. power cord. Shipping wt. 9 lbs. List price \$14.95. Only a limited supply on hand.

ITEM NO. 125
YOUR PRICE \$4.95

1941 Catalog

A POSTAL CARD BRINGS IT TO YOU
 SEND FOR IT TODAY

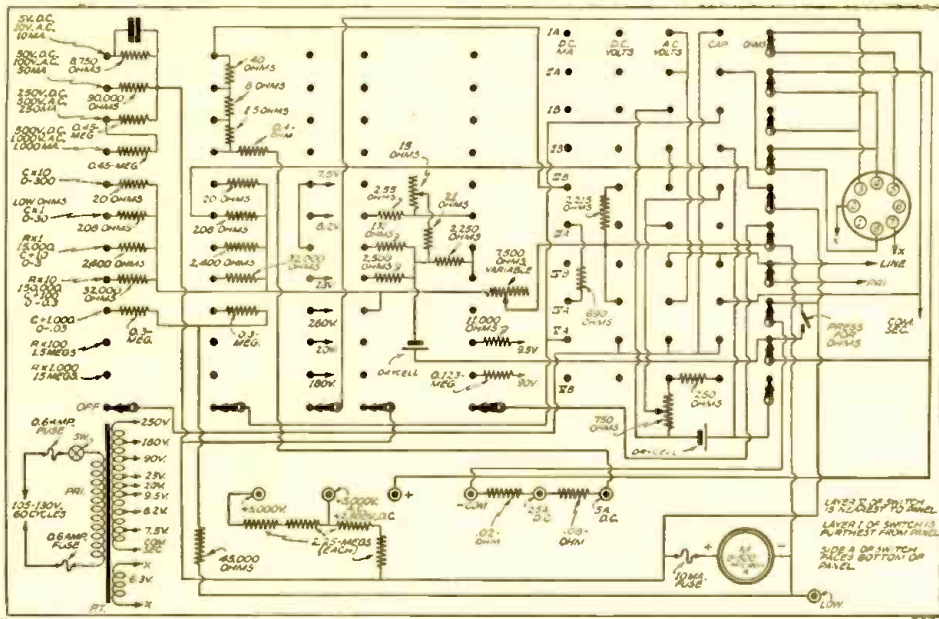

"Always bear in mind that your service instruments are the tools with which you earn your living. Good equipment is expensive, but it's far better to have several good, basic pieces of equipment than a laboratory full of junk," concludes the author, after analyzing the general pros and cons of fundamental test apparatus for Servicemen. Representative circuits of actual instruments are given, and breakdown diagrams of certain circuit details are shown.

◀ Fig. 1.—The Radio City Model 414 instrument is a simple versatile multimeter that includes capacity ranges.

BUYING TEST EQUIPMENT

BOB STANG

THE writer feels that there has been a lack of unbiased, comparative data on the various types of test equipment available to the Serviceman at the present time. In his position as the seller of test equipment to the Serviceman-consumer in one of the largest distributors in the world, it has been his observation that the average purchaser either is not clear in his mind about the different kinds of similar equipment that will do the job for him, or else has a glorified notion of what some particular gadget will accomplish. The latter misconception is due largely to high-pressure advertising.

Since it is true that one usually gets what one pays for (assuming a reputable brand is chosen), it is the writer's intention to review the various types of equipment available, mentioning the duplicating features and the feasible application of each to its proper type of job.

MULTITESTER

In the actual repairing of radio receivers, probably the most frequently used instrument is the *multitester*. Fundamentally this is a d'Arsonval meter conveniently arranged with appropriate shunts, multipliers, rectifier and battery so that it can be used for the measurement of voltage, current and resistance in a number of ranges of each, the actual range limitation being determined by the meter movement sensitivity; and the number of ranges dependent upon the particular manufacturer in mention.

It is not practical to attempt to apply a meter of less sensitivity than 1,000 ohms-per-volt to radio service. Standard sensitivities now supplied are either 1,000, 5,000 or 25,000 ohms/volt. The latter although the most versatile, is not practical for incorporation into portable instruments as the movement sensitivity forbids rough handling.

Most multimeters measure A.C. by rectifying it through either a cuprous-oxide or a thermionic rectifier. The tube rectifier makes a better output meter, as its scale is linear in respect to frequency change, but it is impractical in a portable instrument as it requires the instrument to be

plugged into a line for filament voltage for the tube.

Naturally the sensitivity of the instrument on A.C. will be less than on D.C. A 5,000 ohms/volt movement is usually 1,000 ohms/volt on A.C. and this must be taken into consideration in choosing the movement sensitivity. Further, the greater the movement sensitivity the higher it will measure in resistance with the usual 4½-volt battery used. A 1,000 ohms/volt meter is usually scaled to read up to ½-megohm on its highest scale, whereas the 25,000 ohms/volt meter will read as high as 20 megohms.

ELECTRONIC VOLTMETER

Recently, several *Electronic Voltmeters* have been made available to the Serviceman. These make themselves very valuable in that their input impedance is practically infinite being usually as high as 15 meg-

ohms. Of course, such a meter will draw virtually no current from the circuit being tested, and so will not disturb the normal operation of the set. The best application here is in the testing of A.V.C. voltage, although not electronically but through the conventional cuprous-oxide rectifier. An electronic voltmeter, however, is definitely not a portable piece of equipment.

FREE-POINT TESTER

In the application of the multitester to the actual fixing of radio sets, a very handy piece of equipment is the *Free-Point Tester*, otherwise known as the "Point-to-Point Analyzer." This convenient arrangement of sockets and switches is frequently available incorporated into the multitester or can be used as an auxiliary piece of equipment.

It permits the analysis of the trouble, or at least the measurement of voltages and currents, while the set is playing and with-

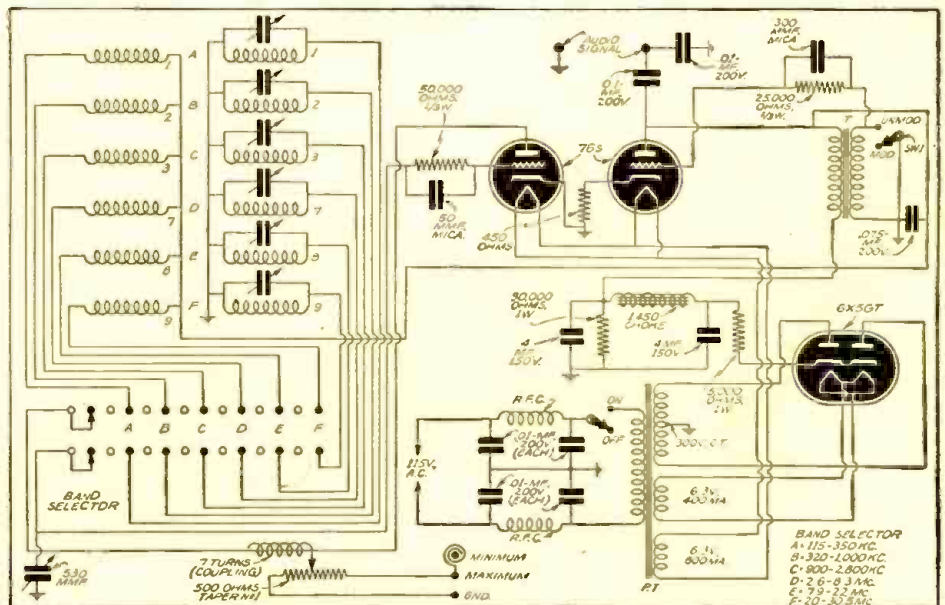

Fig. 3.—A satisfactory, simple signal generator is the Triplett Model 1232A.

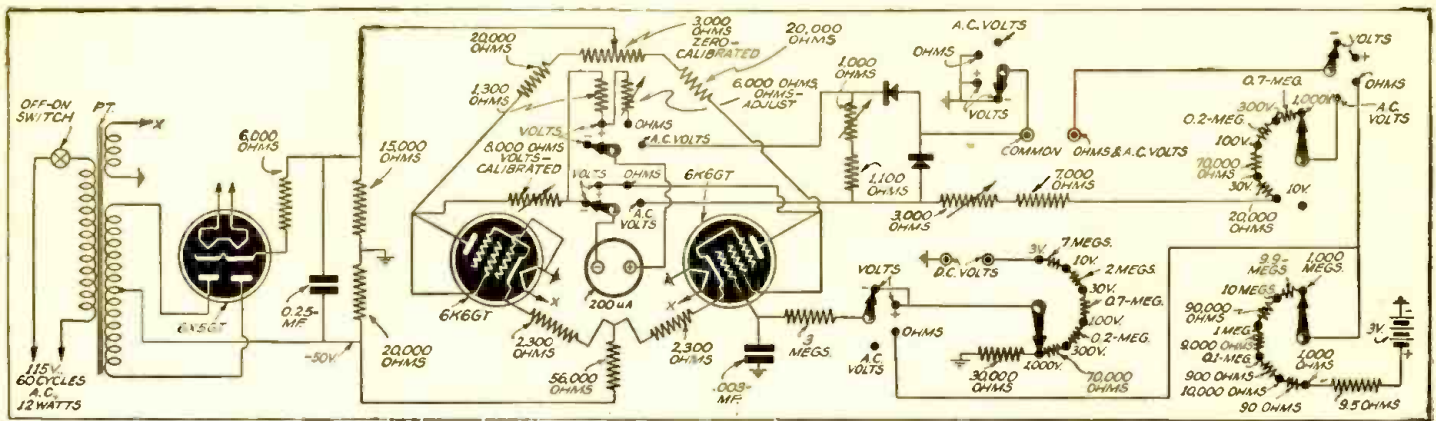

Fig. 2.—Bridge type of electronic voltmeter as exemplified in the RCA Junior VoltOhmyst. Ranges: 0/1,000 V. D.C. at high input impedance; 0/1,000 V. A.C. at 1,000 ohms/volt; 0/1,000 megs. This piece of apparatus well illustrates the great advance which has been made in test equipment over the period of the last few years.

out removing the set chassis from its cabinet. In this way it is very useful in saving time for the Serviceman in giving an estimate.

TUBE TESTER

Another indispensable piece of equipment around the service shop is the *Tube Tester*. Immediately in any discussion of tube testers we run into the old argument of the emission versus the dynamic tester. It is the author's well-based opinion that either of these types of tester is fully satisfactory for routine tube testing.

It is an accepted fact that the dynamic tester is more accurate in its results than the emission type, the comparative figures in percentage of bad tubes detected being in the neighborhood of 95% as compared to about 98%. In quickness of operation and cheapness of price the average emission tester about compensates for this difference in efficiency. It becomes a matter of individual taste and particular requirements.

There are available several combination tube and multi-testers, and even a few that also include free-point testers. These are good, convenient instruments to take on a job but are usually limited in range and not over 1,000 ohms/volt in sensitivity.

Where possible, it is always best to have equipment of this sort for the outside job and the better, less limited equipment in the shop where it is free from damage, the best arrangement being some kind of a rack or panel set-up.

SIGNAL GENERATOR

It is impossible to properly align a modern radio receiver without the use of a *Signal Generator*. For normal purposes this instrument should have a range from 100 kc. or so, to at least 30 mc. It should be mentioned that all bands should be fundamental although calibration on the dial of harmonics beyond 30 mc. is convenient. Tuning should be done with a vernier dial arrangement with a good rugged pointer that is either covered or not easily bent; and accuracy should be within 2%. Straight A.C. generators are considerably better in frequency stability, than the A.C.-D.C. variety. Where the generator is to be used largely in the field, a battery-operated model is probably preferable.

It should be modulated or unmodulated, at will, and should have provision for external modulation. This will prove valuable later for connecting an external sweep modulator for use in aligning F.M. receivers. Audio modulation at 400 cycles is standard. It is convenient to have provision for using the audio signal alone externally for test purposes.

At least 2 models are at present available that incorporate wide-band sweep modulation. Although this feature is not

necessary for the alignment of conventional or Amplitude-Modulated sets, it will be necessary for the alignment of Frequency-Modulated receivers in which case best results will be obtained when the instrument is used in conjunction with an Oscilloscope.

AUDIO OSCILLATOR

For some applications, particularly in sound work, an *Audio Oscillator* is a very convenient piece of equipment. If one is procured, its range for practical application should be at least from 30 to 15,000 cycles. Some Signal Generators at present on the market incorporate a variable-note audio oscillator. Others have provision for only a fixed 400-cycle note in addition to their normal function.

A variable audio range is convenient in that it permits the location of otherwise hard-to-find rattles in speakers and cabinets but is otherwise not essential in ordinary service. To a sound man it is an indispensable piece of equipment.

OSCILLOSCOPE

The *Oscilloscope* could not fairly be termed an indispensable piece of equipment. It will usually be found only in the possession of the more advanced Serviceman. Its application is that of a dynamic piece of equipment versus the static voltage and current testers that tell only the basic facts and leave the interpretation of these facts to the Serviceman. On the 'scope one actually sees the "picture" or image.

To determine the actual flat-top bandwidth of an I.F. channel, or the hum level at various points in the set, or the percentage of modulation of a carrier; or any of hundreds of other facts not readily determined with measuring equipment the 'scope is a great source of enlightenment to the advanced Serviceman. It is not a beginner's piece of equipment but definitely the sign of the well-equipped Service Laboratory.

CONDENSER TESTER

The *Condenser Tester* is a handy bit of incidental equipment. Usually a Wien Bridge circuit, it is remarkably accurate for its small cost. Some will test a condenser without removing it from its circuit. This is an obvious convenience. All will measure capacity, usually in ranges from about 10 mmf. to about 50 or 60 mf.

The bridge is usually used in conjunction with a visual indicator or "eye" tube, resonance and the opening of the eye indicating capacity, which is read directly on a calibrated scale. One end of the scale is marked OPEN and the other end is marked SHORTED. Resonance at one of these points on all scales indicates an open or shorted condenser. The amount that the eye opens, in indicating resonance, can be in-

terpreted as an approximate power factor indication. Some testers have a separate control to measure power factor. Condenser testers can be obtained incorporating a slide-back type of vacuum-tube voltmeter and one is available that includes an oscillator for alignment purposes.

SIGNAL TRACER

The *Signal Tracer* being the newest and most versatile piece of equipment yet to appear on the service equipment market is naturally the most talked about and at the same time the least understood of all service equipment. There is nothing fundamentally new about the signal tracer. Its application is what is different. Basically, the signal tracer is a T.R.F. set, through the detector stage, and with or without an audio section and speaker.

The rectified output of the detector usually is fed into an indicating "eye" tube. This eye by its deflection will indicate the presence and amplitude of a signal; and by the calibration of its resonant R.F. cir-

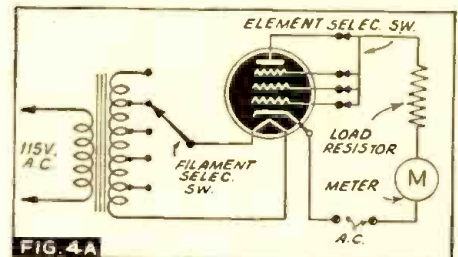

FIG. 4A

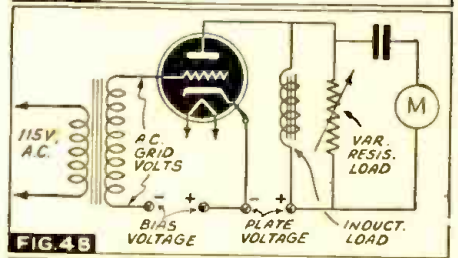

FIG. 4B

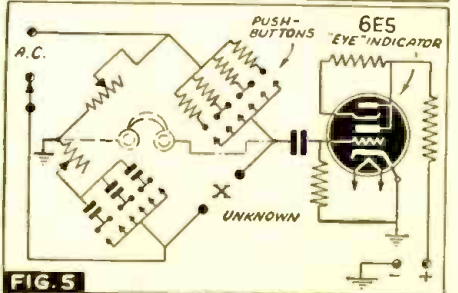
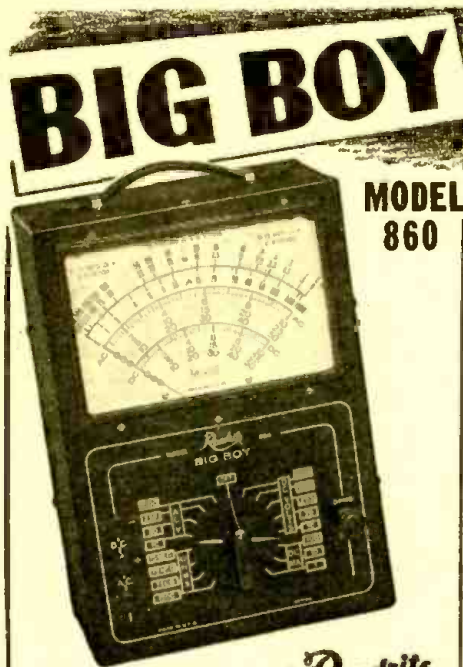

FIG. 5

Breakdown circuits. Fig. 4A.—Basic circuit of emission-type tube tester; Fig. 4B.—Basic conductance or dynamic tube tester showing A.C. applied to grid. The elements are independently connected to the voltage supply; Fig. 5.—Wien Bridge circuit for checking condensers. As indicated by the dotted lines, phones can be substituted for the "eye" tube.



MODEL 860

Readrite
RANGER

Performance Eye Appeal Value
Sensationally Priced at \$17.85, Dealer Net Price.

Here is an AC-DC Volt-Ohm-Milliammeter with all the ranges you want... easily readable on the large 7" instrument with extra-long 6" scale, in a new up-to-the-minute three-tone case. AC Volts 0-10-50-250-500-1000 at 5000 Ohms per volt DC; 1000 ohms per volt AC. AC Volts 0-10-50-250-1000 at 400 ohms per volt; DC Ma. 0-1-10-100; Resistance ranges: 0-1500 Low Ohms; 0-150,000 Ohms and 0-7.5 and 0-15 Megohms. Maroon case with red and silver panel, attached handle.

Dealer Net Price, \$17.85

For Catalog Write—Section 616, Collego Drive

READRITE METER WORKS, Bluffton, Ohio

cuit will indicate the frequency of the signal being measured. Signal tracing devices have either one channel as described above, or several channels, one for R.F., one for the Oscillator or I.F. output of the set, a channel and eye for measuring audio, an electronic voltmeter circuit and a channel that will measure the watts (power) consumption of the set. The advantage of having all these channels in one instrument is primarily in the detection of fading and intermittent trouble, the bugaboo of radio service.

The single-channel type of instrument can be considered to be a "tuned electronic meter." It will do anything the multi-channel job will, with the exception that it cannot be hooked up to several portions of an intermittent-condition set. Where the multi-channel job is used, when the set fades or cuts out, the eye associated with that portion of the set that is causing the trouble will open, indicating where the trouble lies.

Several signal tracers on the market have meters in place of the eyes. These are slightly more expensive but some Servicemen find a meter easier to read.

The signal tracing type of instrument cannot become obsolete since it measures that which is the essence of radio transmission itself, namely, the signal; signal tracing is a great time saver, and when you become familiar with it, really a much easier way to fix radio receivers. These instruments are expensive, however, but if your time is worth money they are a good investment.

Stress should be placed at this point on the necessity of avoiding duplication of function in the equipment purchased. For example, if you already possess a good multimeter which can be used as an output meter, it would be foolhardy when purchasing a signal generator, to obtain one that includes an output meter. Do not be tempted by the convenience of compactness if efficiency and versatility are sacrificed.

Always bear in mind that your service instruments are the tools with which you earn your living. Good equipment is expensive, but it's far better to have several good, basic pieces of equipment than a laboratory full of junk.

OPPORTUNITY AD-LETS

Advertisements in this section cost 15 cents a word for each insertion. Name, address and initials must be included at the above rate. Cash should accompany all classified advertisements unless placed by an accredited advertising agency. No advertisement for less than ten words accepted. Ten percent discount six issues, twenty percent for twelve issues. Objectionable or misleading advertisements not accepted. Advertisements for July, 1941 issue must reach us not later than May 7th.

Radio-Craft • 20 Vesey St. • New York, N. Y.

BOOKS AND MAGAZINES

ASSURE YOURSELF OF GREATER PROFITS BY doing radio service jobs more quickly. Authentic service guides show you the way to locate and correct troubles in any radio receiver. Gernsback's Official Radio Service Manuals show you how to complete more repair jobs in less time—how to earn more money by faster servicing. Radecraft Publications, 20 Vesey St., New York City.

WE HAVE A FEW HUNDRED RADIO ENCYCLOPEDIAS, by S. Gernsback, second edition, originally sold at \$3.98. Book has 352 pages, weight 3 lbs., size 9 x 12 inches. Red morocco—keratol flexible binding. Send \$2.49 in stamps, cash or money order and book will be forwarded express collect. Technifax, 1915 So. State Street, Chicago, Illinois.

WHAT DO YOU KNOW ABOUT AMPLIFIERS AND Sound Systems? The Amplifier Handbook and Public Address Guide covers P.A. from A to Z. Most complete and authentic book published on the subject. Contains 80 pages of vital information on Amplifiers, P.A. Systems, Speakers, Accessories, Pickups, Microphones, etc. Printed on fine coated stock, with numerous photographic illustrations and explanatory diagrams, and only 29c. See page 732.

EDUCATIONAL COURSES

CORRESPONDENCE COURSES AND EDUCATIONAL books, slightly used. Sold, Rented, Exchanged. All subjects. Satisfaction guaranteed. Cash paid for used courses. Complete details and bargain catalog FREE. Write Nelson Company, 500 Sherman, Dept. P-242, Chicago.

FLOUORESCENT LIGHTING

24" FLOUORESCENT BENCH LIGHT \$1.49. LESS TUBE. Harold Davis, Jackson, Mississippi.

PHOTOGRAPHY

1/100,000 OF A SECOND SPEED FLASH UNIT FOR Stroboscopic Photography, \$200.00. Apt. 63, 782 West End Ave., New York City.

POWER PLANTS, GENERATORS, ETC.

SOME BARGAINS ON USED LIGHT PLANTS, AC generators, and converters, 80 to 10,000 watts. Write Katolight, Mankato, Minn.

RADIO

SACRIFICE! 12-TUBE LINCOLN SUPER-DELUXE All-Wave Receiver, complete with 12-inch electrodynamic speaker and separate power pack. Cost originally \$145. Will sacrifice for \$25.00. Set is 1933 model, rarely used and in good working condition. Excellent sensitivity and selectivity. A resonance tuning meter, wave-band switch, phonograph input terminals, an ideal set for the DX fan. Excellent tonal fidelity. All components mounted on a beautiful chromium-finished chassis. Hush! First come, first served! D. Kreissman, 1430 Ocean Ave., Brooklyn, N. Y.

AT LAST! SUCCESSFUL SYSTEM RADIO TUBE REjuvenation. One dollar. Warranted. Vance Lind, St. Paul, Neb.

WANTED—ADAMS-MORGAN WOODEN-CASE, BRASS-plate variable condenser; electrolytic detector, Tuska "Superdync"; Bunnell 1" sparkcoil. Have radio sets, meters, etc.—or what do you want? R. Bernard, 40 Manning Ave., No. Plainfield, N. J.

RADIO KITS

RADIO KITS—\$3.95 UP, SINGLE BAND; ALL WAVE, 5-10 tubes. Fluorescent lighting. Save 50%. McGee Radio, P-2055, K.C., Mo.

TECHNICAL ART SERVICE

DRAFTING AND ART SERVICE—A COMPLETE Service for the Industrial and Commercial Marketers. If your business or plant can't afford a designing or drafting staff, don't let this stop you from going ahead with that new product you intend marketing, or that catalog of mechanical or electrical items which needs fine detailed drawings and highly retouched photographs. Any mechanical, electrical or radio problem can be solved for you by our associated staff of designers, draftsmen and artists, and technical copywriters. Write for any additional information as to methods and price for this service. Tec-Art Drafting Service, 228 Charlotte Terrace, Roselle Park, N. J.

DRAFTING SCHEMATIC DIAGRAMS SEND US A rough sketch of your circuit. Estimates by return mail. Our prices are moderate; our work guaranteed. No jobs too big or small. Wm. Kadlecik, Jr., 440 East 85th St., New York, N. Y.

PATENTS—TRADE MARKS

Booklet concerning Inventions & Patents Form "Evidence of Conception" with instructions for use and "Schedule of Government and Attorneys Fees"—Free LANCASTER, ALLWINE & ROMMEL Registered Patent Attorneys. 436 Bowen Bldg. Washington, D. C.

DATAPRINTS

TESLA-LOUDIN COILS



- 20c Ea. in order for 10 (Data and Drawings only.)
- 36" Sp'k Tesla-Oudin Coil 40c (1 K.W. Exc. Trf. Data incl.)
- 8" Sp'k Tesla-Oudin Coil 40c (1/4 K.W. Exc. Trf. Data incl.)
- 3" Sp'k Oudin; 110 Vt. "Kick Coil" type.....40c
- 3" Tesla Works on Ford Coil.....40c
- 1" Sp'k Vibrator Hi-Freq. Coil 40c

NEW! 5 ft. Sp'k. Oudin Coil & Exciter Data75c



Induction PIPE & ORE LOCATOR

- Induction Type, Data40c
- Radio Type40c

More DATAPRINTS 40c each!

- 5 Meter Superhet.
- 1/2 Meter Tr. & Rec.
- 20 A.C. Probs. & Ans.
- 20 Telephone Hook-ups
- 100 Mech. Movements
- 20 Motor Hook-ups
- Television Hook-up
- 20 Elec. Party Tricks
- Solenoids and Magnets—get list.
- Fry Eggs on Ice!
- Experimental Photo-phone
- Radio Control for Models
- Dianthermy Apparatus
- Inductor Organ
- Electric Refrigerator
- Wheatstone Bridge
- Weld. Transf. 2 K.W.
- Rewinding Armatures
- String Galvanometer
- 20 Simple Bell Circuits
- Steel Wire Recorder!
- Water Wheels
- Water Turbines
- Photo Cell and Relay
- Ring 4 bells: 2 Wires
- 20 Tesla Tricks
- Polarized Relay
- Induction Balance
- Electric Pipe Thawer

Special Prices: 4 prints \$1.00; 10 for \$2.00; Single, 40c each. Get New Catalog 100 A.

The DATAPRINT Co.

Lock Box 322D, Ramsey, N. J.

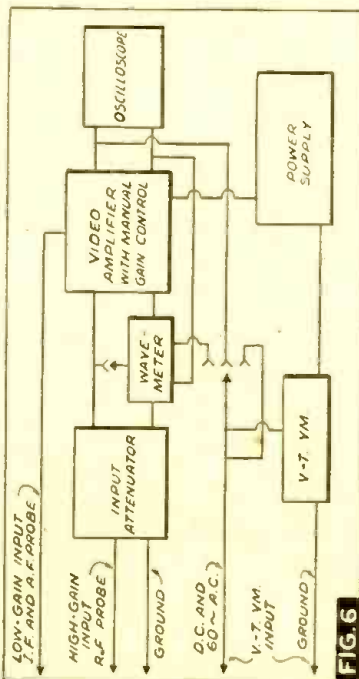

Fig. 6—Block diagram, Supreme Veedolyzer.

How to Build a Simple

MINIATURE PORTABLE TRANSMITTER

The miniature tubes recently announced are getting into their stride. First introduced (to any considerable extent) in the now well-known "Portable" radio receiver, they are here utilized as the basic components for a "Personal" radio transmitter that has many uses. This "walk-about", veritable radio station may be used without a license only if operated for very short distances, and under certain other restrictions, as the author points out. Complete construction details are given.

H. G. CISIN, M.E.

ALTHOUGH the Miniature-tube Portable Transmitter described in this article was designed especially for police and detective work it has many other practical uses. Some of these applications will be mentioned later. The instrument is a low-powered battery-operated portable instrument, extremely compact and very light.

The Transmitter is mounted in a leatherette-covered wood case measuring only 5 x 3 3/4 x 1 1/4 ins. thick. It weighs approximately 10 1/2 ounces. It is powered by an Eveready 67 1/2 volt Mini-Max "B" battery weighing 12 ounces and a 1 1/3 volt radio "A" cell of about the same weight as the "B" battery. The battery dimensions are: "B" battery, 3 1/2 x 2 3/8 x 1 1/4 ins.; "A" cell, 4 1/4 x 2 1/2 x 1 1/4 ins.

CIRCUIT

As the circuit diagram discloses, this device consists of 2 microphone preamplifier stages ahead of a modulated oscillator. The first preamplifier stage employs the 1T4 super-control R.F. miniature amplifier pentode tube. The 1T4 tube was chosen after experimentation with other available types and found to be most suitable. This is resistance-capacity coupled to the next preamplifier stage which employs a 1S4 power amplifier pentode. This in turn is resistance-capacity coupled into the 1R5 pentagrid converter, used in this circuit as a modulated oscillator. Resistance coupling was used in both stages chiefly because it is difficult to obtain a miniature-type transformer of the proper (and light-weight and compact) type whereas resistances and condensers are available everywhere.

The 1R5 is the only miniature tube available for oscillator purposes. The modulated

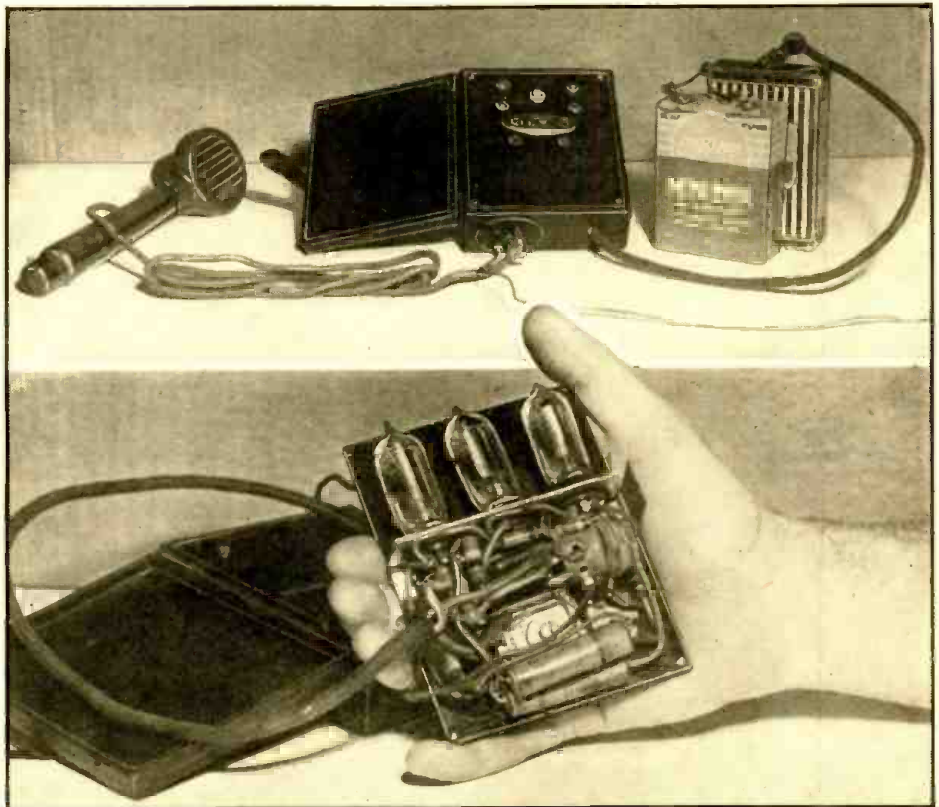

Exterior, and underneath interior view, of the completed Miniature Portable Transmitter. The top photograph shows a crystal-type hand microphone which the author made up simply by mounting a stand-type crystal microphone on the end of a conveniently-available wooden handle. The transmitter may be carried in one pocket and the batteries in another. The compactness of this instrument is evident from the photo.

signal is impressed on control-grid G1. This varies the electron stream between the

cathode and the anode in the oscillator portion of the circuit.

The oscillator circuit includes a tuned grid winding, with gridleak and grid-condenser connected to G3. The combined grids G2, G4, shield G3. The internally-connected element G5 serves as the suppressor-grid because of its internal construction of the tube. Its purpose is as usual to prevent secondary emission from the anode. The energy from the plate circuit is fed back to the grid circuit by means of a secondary winding, rather closely coupled to the tuned grid winding. The carrier frequency or oscillation is determined by the inductance of the grid winding and by the capacity of the trimmer condenser, C7.

Using a 30-175 mmf. trimmer with coil L1 (see sketch of coil) the device tunes between 1,500 and 1,750 kilocycles. By using a trimmer having an increased number of plates, the frequency of the oscillator may be reduced so that it may be varied between 500 and 750 kc. or between any other desired frequencies.

While the electrical connections involved in constructing this ultra-midget transmitter are comparatively simple, the lack of

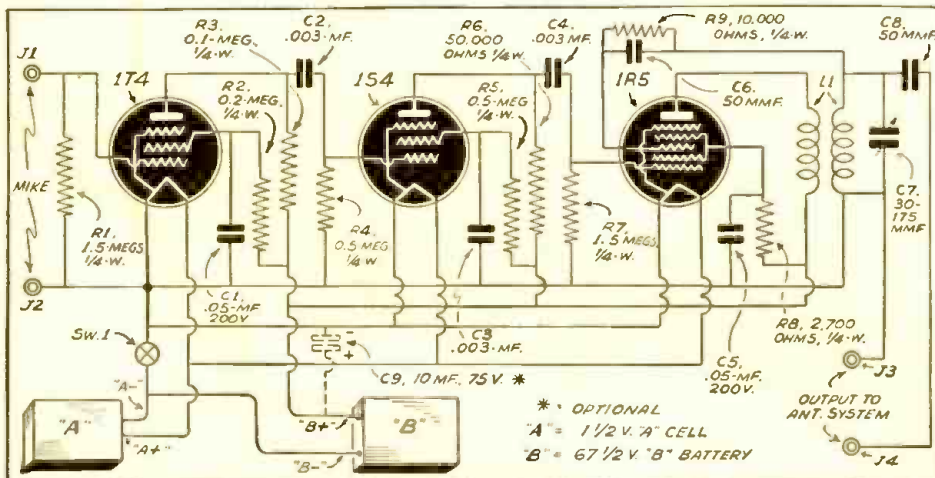

Complete schematic diagram of the Miniature Portable Transmitter. The values shown in this diagram have been double-checked as being correct for use with the particular miniature tubes used by the author. In practice, slight variations from these values may be necessary, if maximum results are to be secured, in order to compensate variations in individual tubes.

ELECTRIC LANTERNS

\$3.19



← No. 400. Price \$3.19. 1500 foot Power Beam. Two reflectors. Steel construction. Finished ebonized enamel. Takes standard 6 v. Battery.

\$1.48



→ No. 500. Price \$1.48. 1000 foot Power Beam. Size: Height 7". Steel construction. Finished baked lacquer. Takes standard 6 v. Railroad type Battery.

\$2.69

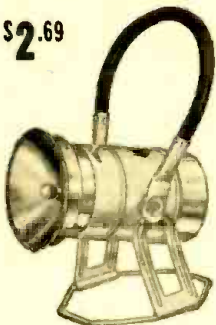

← No. 600. Price \$2.69. 1500 foot Power Beam. Steel drawn construction. Unbreakable plastic lens. Takes standard 6 v. Battery.

Shipping weight for any of the above Models 3 lbs. Furnished without Batteries.

All merchandise in original packages—never used. Money-back guarantee.

All Shipments will be forwarded by Express Collect if not sufficient postage included.

WELLWORTH TRADING CO.

1915 So. State St. Dept. RC-641 Chicago, Ill.



FLIGHT THE PICTORIAL FLYING REVIEW

Bring you all the phases of world aviation and aeronautics in a non-technical yet educational manner—exciting articles which catch your breath, yet give you the fundamentals of flying and ALL related subjects.

FLIGHT keeps you abreast of all the major developments as fast as they appear anywhere. Now, when planes and flying are of vital importance to all, you just can't do without this highly absorbing yet instructive publication. You must be "in the know."

Partial Contents of the June Issue:
 Navy's New Dive-Bomber—The Sting in the Whitley Tail—Learn Flying in a Swivel Chair—Gustav Wright 21-B Interceptor—Bomber Over Berlin—How Anti-Aircraft Guns Work—Bombing Unseen Targets—How Planes Dip and Turn—Hot and Cold Weather Flying—Details of German Fighter Planes—Book Review

Attractive three-color cover, numerous illustrations. **15¢** a copy. Send 10¢ for a Sample Copy.

Subscription price \$1.50 a year, Canada and foreign \$2.00.

FLIGHT MAGAZINE, 20-R Vesey St., New York, N.Y.

space will undoubtedly present a real problem to those who are not accustomed to workmanship of this nature. To save space, all resistors should be of 1/4-watt rating.

CONSTRUCTION

The bakelite panel should be prepared first. Holes must be drilled for the 4 pin-jacks, for the single-hole mounting trimmer condenser, for the switch and for fastening the subpanel. The aluminum subpanel is next prepared as per the accompanying sketch. The compact oscillator coil may be fastened to the back of the panel by one of the switch mounting screws or a separate mounting screw may be used. After the 3 miniature tube sockets have been mounted, the subpanel is fastened to the bakelite panel by 2 small mounting screws. The jacks, switch and trimmer are mounted and the instrument is ready for wiring.

After the wiring has been completed, test the circuit carefully, preferably using a continuity meter, and try to locate opens or shorts before the battery power is applied. Next, connect the batteries and test the tube terminals for rated voltages, with a voltmeter. Make certain that the filament terminals show no more than 1 1/2 volts. Finally, turn the "on-off" switch to "off" and insert the 3 miniature tubes. It should hardly be necessary to warn anyone that these tubes must be handled with considerable care. Do not twist the tubes, but after the correct socket holes have been located, press the tubes gently but firmly into place.

The Transmitter is now ready for test operation.

TEST

Tune a nearby radio receiver to a point between 1,500 and 1,700 kilocycles. Connect a few feet of wire to output jack J4 of the Transmitter. Leave the antenna connected to the radio set, if the set employs an antenna. Insert a crystal microphone into jacks J1 and J2. Be sure to connect the ground terminal of the jack to J2 and the control-grid terminal to J1. Turn switch Sw.1 to the "ON" position and slowly tune trimmer C7. A whistle will be heard on the loudspeaker of the radio set as the trimmer reaches the correct tuning point. When the trimmer is exactly tuned, a feedback howl will be set up, if the microphone is too near the radio receiver. The Transmitter should then be moved away from the set until the feedback howl is eliminated. The Transmitter may then be tested by talking into the microphone. To increase the range of the Transmitter, lengthen the antenna wire connected to J4. Another way to increase the range is to connect this wire to a radiator, water pipe or other ground. In general it is advisable not to employ an outside antenna, as this may increase the range to a point where there may be interference with other radio sets.

LICENSE

It is assumed that the users of this device are familiar with F.C.C. regulations regarding the operation of oscillators. Those who are not acquainted with these rules would do well to send to Washington for a copy before attempting to experiment with any type of transmitter, even a low-powered device such as this one.

Due to the fact that the Miniature Transmitter employs 2 preamplifier stages, it is extremely sensitive to low-volume sounds, provided that the proper-model crystal microphone is used. This feature makes the instrument especially well adapted for detective work. (The proper model mike for detective work is one which will pick up sound from all directions rather than one

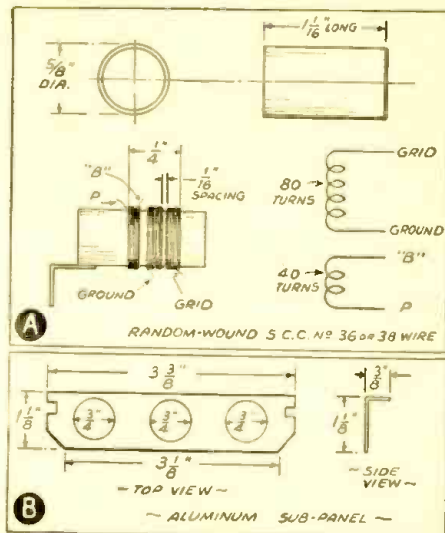

Details in building the Miniature Portable Transmitter. A.—Coil winding details; B.—Sketch of aluminum sub-panel.

which requires a person to talk directly into the mike.)

Using a different (less sensitive but more directional and rugged) type of crystal microphone, the Transmitter may be used for police work, permitting an officer to make reports to a central point while patrolling his beat, or for similar purposes. Other uses of this device include mind-reading acts, the making of bingo and similar announcements, mobile or portable announcing systems and many other applications requiring a concealed or small-space Xmitter.

LIST OF PARTS

CONDENSERS

- Three Aerovox tubular paper, type 284, 0.05-mf., 200 V., C1, C3, C5;
- Two Aerovox mica, type 1464, 0.003-mf., C2, C4;
- Two Aerovox mica, type 1469, 50 mmf., C6, C8;
- One Aerovox miniature electrolytic (optional), type PRS, 10-mf., 75 V., C9;
- One Hammarlund isolantite trimmer, type DTS-115, 30-175 mmf., C7.

RESISTORS

- Two I.R.C. insulated carbon, 1 1/2 megs., 1/4 W., R1, R7;
- Two I.R.C. insulated carbon, 1/2-meg., 1/4 W., R4, R5;
- One I.R.C. insulated carbon, 0.2-meg., 1/4 W., R2;
- One I.R.C. insulated carbon, 0.1-meg., 1/4 W., R3;
- One I.R.C. insulated carbon, 50,000 ohms, 1/4 W., R6;
- One I.R.C. insulated carbon, 10,000 ohms, 1/4 W., R9;
- One I.R.C. insulated carbon, 2,700 ohms, 1/4 W., R8.

TUBES

- One Hygrade Sylvania miniature, 1T4;
- One Hygrade Sylvania miniature, 1S4;
- One Hygrade Sylvania miniature, 1R5.

Misc.

- One Eveready (Mini-Max) "B" battery, 67 1/2 V. (or Burgess equivalent);
- One Burgess "A" cell, 1 1/2 V., type 2F (or Eveready equivalent);
- One bakelite panel, size 4 3/4 x 3 1/2 ins.;
- One aluminum subpanel (home-made, see sketch);
- Four pin-jacks, J1, J2, J3, J4;
- One 4-connector battery cable;
- One oscillator coil (see sketch giving specifications), L1;
- One leatherette-covered wood case;
- One crystal microphone (hand-type);
- One crystal microphone (hearing-aid type).

THE FINEST RADIO BOOK FREE

WE EVER OFFERED :-
the 1940-41 Radio-Television Reference Annual
With \$1.00 subscription to
RADIO - CRAFT

WITH our compliments, we want to send a copy of the 1940 RADIO-TELEVISION REFERENCE ANNUAL to you FREE, if you will simply take advantage of RADIO-CRAFT magazine's special subscription offer NOW. This offer is being made for a limited time only.

The 1940 RADIO-TELEVISION REFERENCE ANNUAL has 68 pages, large size 8½ x 11½, with over 170 illustrations. The contents of this book has never appeared before in handy book form. Its pages cover practically every branch of radio sound, public address, servicing, television, construction articles for advanced radio men and technicians, time and money-saving kinks, wrinkles, useful circuit information, "ham" transmitters and receivers, and a host of other data.

The Annuals have always been regarded as a standard reference work for every practical branch of radio operation and service. This 1940 edition ably sustains this reputation. Every radio man wants a copy of this valuable book. Just as this book will be of unquestionable value to you, so, too, will every monthly issue of RADIO-CRAFT. This magazine brings you big value every month. It keeps you intelligently informed about new developments in radio and television. You want the news, want it fully but concisely, want it first—that is why you should read RADIO-CRAFT regularly.

This very special offer is made for just one purpose—we want you as a regular subscriber. The Annual, whose contents appears at the right, is not sold, but a copy is FREE to you if you subscribe now.

**SAME SIZE AS
RADIO-CRAFT**

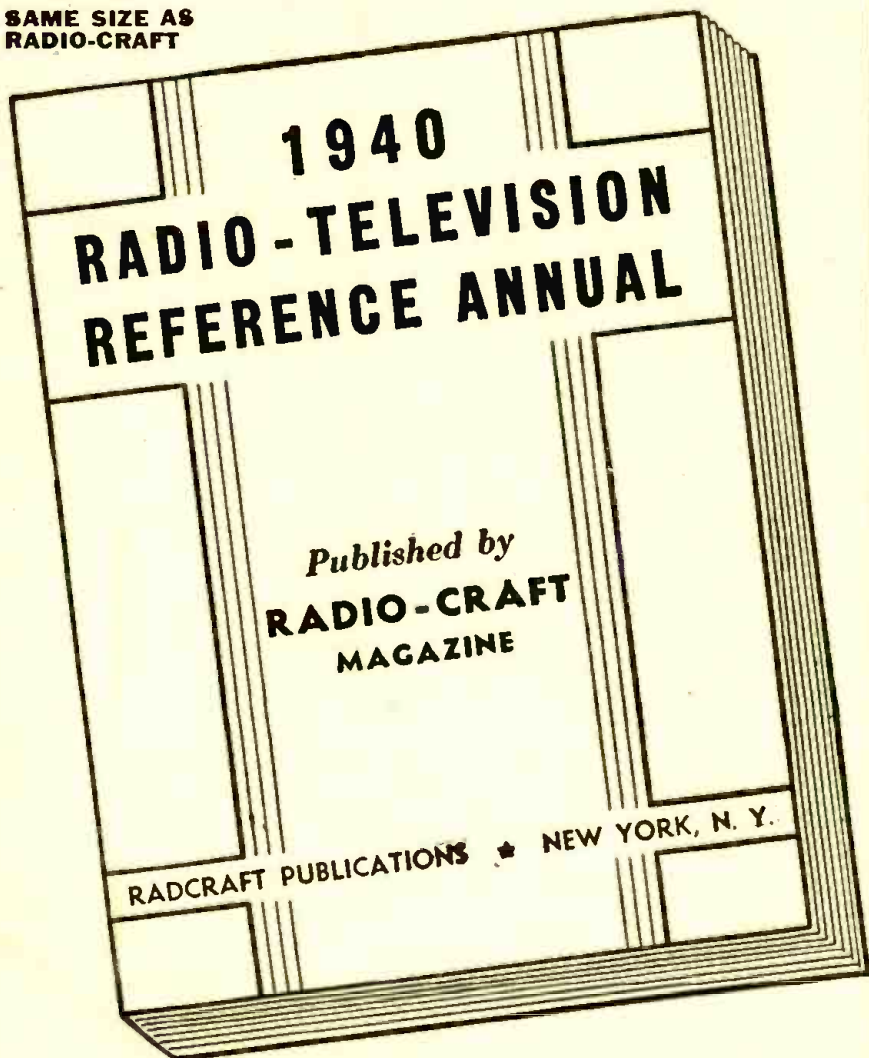

THIS COUPON BRINGS YOU THE ANNUAL

RADIO-CRAFT • 20 VESEY STREET • NEW YORK, N. Y.

Gentlemen: Enclosed you will find One Dollar for which enter my subscription to RADIO-CRAFT Magazine for Eight Months. Send me ABSOLUTELY FREE and POSTPAID, my copy of 1940 RADIO-TELEVISION REFERENCE ANNUAL.

This is a new order Extend My Present Subscription

NAME ADDRESS

CITY STATE

DON'T DELAY — MAIL TODAY! RC-641

**Read the summary of contents
in this FREE BOOK!**

THE 1940 RADIO-TELEVISION REFERENCE ANNUAL contains a collection of the best and most important articles. Covering as they do nearly every branch of radio, they form a handy reference works. In addition, many time and labor-saving kinks, circuits and wrinkles, tried and tested by practicing Servicemen, experimenters and radio fans have been included. This book cannot be bought anywhere at any price. Yet it is yours by merely subscribing. Use the convenient coupon below.

**BEGINNER'S SIMPLE INEXPENSIVE
CONSTRUCTION ARTICLES**

Beginner's Breadboard Special - a 1-Tube High-Gain All-Wave Receiver—Wiring Pointers for Radio Beginners—A Watch Charm Size 1-Tube Set—Beginner's Simple Volt-Milliammeter—Making a 1-Tube Broadcast Loop Receiver—A.C.-D.C. Power Supply for Battery Portables—A 1-Tube Short-Waver with Band Coil Switching.

MORE ADVANCED SET CONSTRUCTION

The "High-Seas 4" Broadcast Lamp Radio—How to Build a 6-Tube 1.4-Volt Short-Wave Superhet for the "Ham" or Short-Wave Fan—Build the "Lunch Box 5" Super Set - a Broadcast Battery Portable—How to Build a Plug-Together 8 Tube Broadcast Set—The "5-in-4" All-Wave Radio for A.C. Operation—An Easily-Built 3-Tube Midget Broadcast Superheterodyne Receiver.

THE SERVICEMEN'S SECTION

Bass Tone Control—Simplified Variable Selectivity—Practical Servicing Pointers—Servicing Universal A.C.-D.C. Receivers—Killing the "Intermittent" Bug—A Service Shop A.C. to D.C. Power Supply—Sideline Money for Servicemen—Adding A.V.C. to any Screen-Grid T.R.F. Receiver—Iron Particles in Speaker Air Gap.

TEST INSTRUMENTS

A Useful Neon Lamp Tester—An Inexpensive Output Meter—Making Milliammeter Multipliers—Home-Made Frequency Modulator—The Busy Servicemen's V.T. Volt-Meter.

PUBLIC ADDRESS AND AMPLIFIERS

Build this Combination A.C.-D.C. Radio and Inter-Communicator—Speaker Placement in P.A. Work—The Design and Construction of an Inexpensive All-Push-Pull 10-Watt Amplifier—Obscure Sources of Hum in High-Gain Amplifiers—How to Build a High-Fidelity 5-Watt Versatile Amplifier.

"HAM" SECTION

Ultra-High Frequency Antennas—The Beginner's Low-Cost Xmitter—Modulator Meter—Phone Monitor—The Beginner's "Ham" Receiver—2½ Meter Acorn Transceiver.

TELEVISION

How to Build a 441 Line T.R.F. Television Receiver—Useful Notes on Television Antennas.

MISCELLANEOUS

Simple Photo-Cell Relay Set Up—Making a Burglar Alarm—How to Build A.C.-D.C. Capacity Relay—How to Make a Modern Radio Treasure Locator.

USEFUL KINKS, CIRCUITS AND WRINKLES

Making a Flexible Coupler—Two-Timing Chime—A Simple Portable Aerial—An Improvised Non-Slip Screw-Driver. NOTE: The book contains numerous other useful Kinks, Circuits and Wrinkles, not listed here.

(approximately)

45 ARTICLES

(approximately)

170 ILLUSTRATIONS

68 BIG PAGES

**RADIO-CRAFT
20 VESEY STREET
NEW YORK, N. Y.**

How to Build and Use a

LEAK DETECTOR

Details are here given for building a Leak Detector, and using it in conjunction with a Metal Locator (the latter for tracing the course of pipes), for locating leakages of water, gasoline, oil, etc.

G. M. BETTIS



The completed Leak Detector (right) is used only after the Metal Locator has traced the underground path of the pipe. The latter is here shown during the process of completing this important initial step. The second and final step, next to repairing the actual leak, is to probe through the ground, until contact is made with the pipe, at 50-foot distances until the sound of the leak is heard. The vibration pickup (crystal microphone) is on top of the probe.

THE feature of this Leak Detector is the use of the new Miniature tubes in an amplifier operating from a single 45-volt "B" battery and a single 1.5-volt "A" cell; this gives the inertia-type crystal

pick-up ample gain to detect very weak sound waves or vibrations that are truly reproduced in the crystal phones.

Note that the writer has placed a certain amount of stress on the *quality* of the re-

A Leak Detector, used in conjunction with a Metal Locator to plot the underground path of a pipe line suspected to be leaking, may save huge sums of money by identifying and localizing the rushing sound of the leaking fluid. Leak-detecting crews operating in one major city estimate that water leaks cost the city about \$500 per day; companies maintaining oil and gasoline lines have equivalent leakage expenses. It is therefore evident that construction and use of the efficient Leak Detector here described presents money-making possibilities for the radio Serviceman.

production, since this factor enables the operator to make important determinations concerning the various amplified sounds.

PIPE LINE LEAK LOCATOR

This high-gain miniature-tube portable amplifier has been designed with the main idea that it would be used as a Leak Detector for locating leaks in pipe lines underground. This Leak Detector was planned as a companion machine to the Metal Locator that was described in the December issue of *Radio-Craft*, as the Metal Locator proved to be unusually good for exact location of buried pipe lines.

One of the advantages of the basic amplifier used in this Locator is that the self-contained power supply is in a completely-shielded metal cabinet. This eliminates any power-line noise and makes it practical to use the device anywhere. The excellent fidelity obtained through use of the crystal pickup, crystal headphones, and resistance-capacity coupled amplifier, is well worth while.

PRACTICAL LEAK-LOCATING

Job No. 1.—There was for example a known water leak, on a water line carrying 80 pounds pressure, that was showing-up in a low place on a small creek. The water was coming down alongside a line on a hill.

The exact course of the line was not known as it had been laid and covered about 3 feet deep some 20 years ago. The exact location of this line was spotted by use of the Metal Locator described in the issue of *Radio-Craft* previously mentioned. (See photo, upper-left.)

The leak was spotted by using the amplifier with the inertia-type or vibration pick-up attached, and listening with the headphones every few feet, with the probe of the pickup jabbed into the ground. As the leak was approached the sound became louder; and as it was passed the sound became weaker. On digging down, this leak was found almost directly under the spot of loudest sound. *This saved the time, bother and expense of starting from the small creek and having the line uncovered for 85 feet to the spot where the line was found to be leaking.*

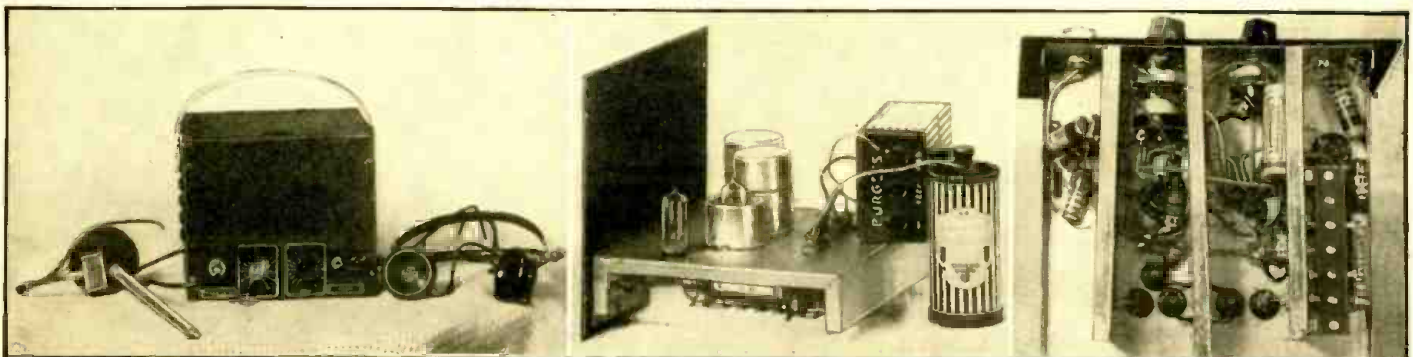

The completed Leak Detector (above) is frequently worth more than its weight in gold. Its accessories are the vibration pickup (left) and crystal headphones (right). A rear view of the Leak Detector shows the use of the new miniature vacuum tubes. The underside view of this instrument shows how channel-aluminum both shields and divides the high-gain stages.

This leak was about 1/2-in. in diameter and was roughly estimated to be wasting 30 gallons of water per minute which would be 1,296,000 gallons per month and if distributed through water meters at the city rate of \$2.25 for 4,000 gallons minimum would supply 324 customers at the price of \$729. As furnished to manufacturers or large users of water the rate is about 10c per thousand which would bring in the city \$129.60.

The price of this one job more than paid for the equipment. There were many other leaks in this small city which the same equipment was used to detect.

Job No. 2.—A local bottling company was having to pay an excessive water bill due to a leak somewhere under their concrete floor. Due to exceptional noise and vibration of their equipment and machinery it was impossible to detect this leak during working hours. At 3 A.M. when all was quiet the Leak Detector was used to carefully examine every water outlet for the loudest signal of escaping water. After one was identified as "it," the floor was tested for several feet along the probable course of the line, and about 25 feet from the water outlet the spot to dig was marked. There was a leak in a pipe thread where it had broken in connection to a "Tee" in the water line.

This saved a large bill as this bottling company could only get a bid from pipe repairmen by the hour. How many hours? How much concrete flooring would they have to destroy before finding a leak in a building 60 by 125 ft.? What would be the amount of the bill? The actual cost of fixing this leak was \$5 after it was located with the Leak Detector. The excess on the water bill alone was about \$15 per month. Quite a lot of water and well worth saving.

There are many cases similar to this—not on water lines alone but on oil carrier lines and other types of lines—where a considerable amount of time and work can be saved.

OIL & GASOLINE LEAKS

The probe as shown in the detail drawing was used with a crystal-type vibration pickup and amplifier in testing an oil carrier line for leaks. There was not a leak on the line but a small 1/4-in. valve was open slightly with a small stream of oil coming from the line that carried 300 pounds pressure. This was our leak to test.

The line was exactly located with the Metal Locator and the probe was pushed

By courtesy of the *Sunday Call* (Newark, N. J.), *Radio-Craft* here presents a well-posed photograph, taken during a series of tests in an effort to track-down some portion of the loss in about 3,000,000 gallons of water which escape daily in Newark's underground pipes. It is in work of this nature Servicemen will find, that a Leak Detector such as here described will frequently pay for itself on a single job. Gaetano W. Sepe, head of one of Newark's squads of "water-leak detectives," is here shown listening for the sound of water leaks, 4,126 of which were located in Newark during 1940. Figures in this connection are interesting: a leak at 40 lbs. pressure through a 1/8-in. hole would cost a private user (in New Jersey) roughly \$100 per year.



into the ground just as shown in connection with locating the water leak.

The further from the leak, the fainter was the sound; and as the leak was approached, the louder. The leak could be easily detected 100 feet away with the probe pushed into the ground, and contacting the line, which incidentally was easily located. As the frequency of an oil leak is rather low, the use of the tone control incorporated in the instrument was of considerable help. It was used to cut down the high-frequency noises, and to the average person the result is very much better; however I could easily distinguish the leak, but probably my ears are more accustomed to this and similar noises that may be amplified with so sensitive an instrument.

This line was buried from 1 1/2 to 2 feet in the ground as are most of the oil carrier and gas lines that are used in this part of the country to carry the various oil products.

Frequently these oil lines spring leaks, and if in a sandy or gravelly soil, which is quite common, they may leak for several days before saturating the ground and

showing on top of the soil. The pipe line companies check the oil each hour between pump stations and know just when a shortage occurs, and can start looking immediately; testing with pickup and amplifier then will enable a lot of oil to be saved by quickly locating the leak.

Pressures of 800 pounds are quite often used on oil carrier lines to move large quantities of oil as rapidly as possible. This pressure enhances the probability of leaks; the pipe line companies recognize this probability. Contraction and expansion caused by climatic temperature changes, as well as erosion caused by the elements, are also contributors to leaks as are defects in material and workmanship even when every precaution known is taken to prevent leaks.

The usual procedure to detect a leak in a buried pipe line is to first determine the exact location of the line with the Metal Locator. The Leak Detector, as shown in the heading illustration and diagram, is then used approximately every 50 feet with the probe pushed into the ground and in contact with the line. If there is a leak in the

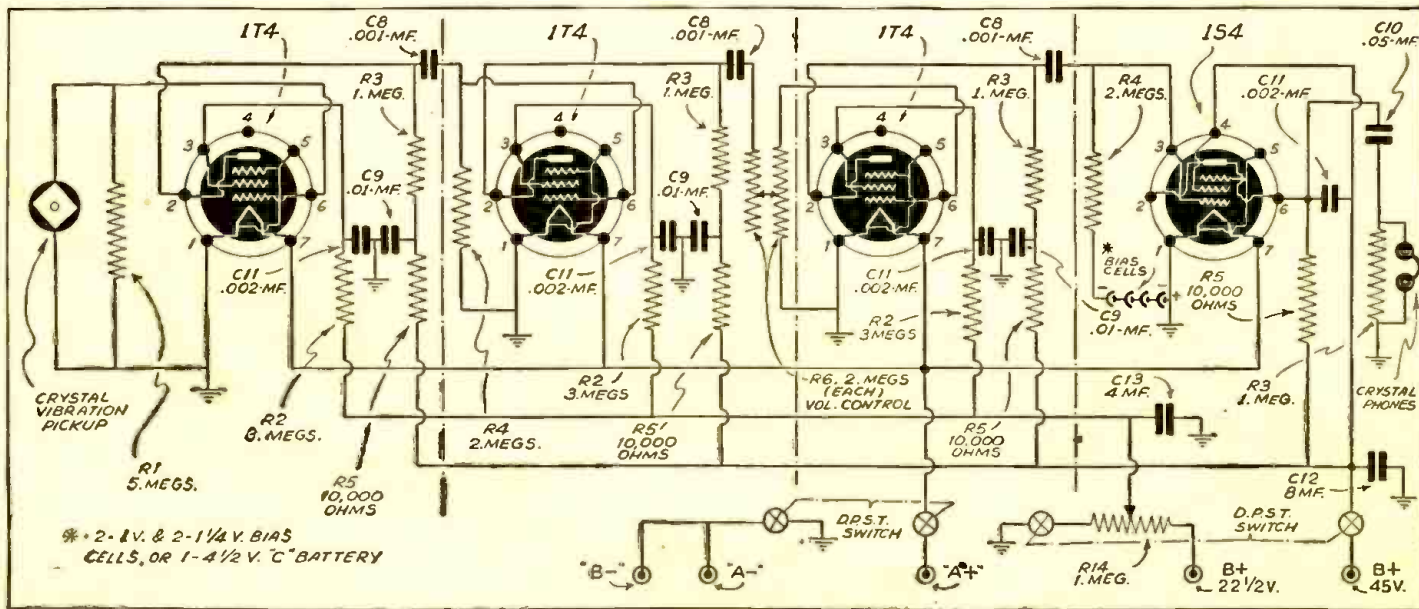

pipe line the sound of this leak will be reproduced in the phones.

The distance between the points of test with the probe will depend upon the size of the expected leak; the smaller the leak, or the lower the line pressure, the closer are the test points; the converse procedure is followed when searching for larger leaks on lines at greater pressure.

The use of this Leak Detector is practical on lines carrying pressures of a few pounds to several hundred pounds as the sound of the leak is amplified so that it is easily detected.

A leak the size of a pencil lead in an oil carrier line with 300 pounds pressure will amount to about 10 barrels per hour! Oil in West Texas at most of the wells is worth about \$1 per barrel and as it is carried toward the Coast, a distance of some 700 miles from a number of oil fields, it is worth quite a bit more as the price at the Coast is around \$2 per barrel. This price is determined by the gravity and quality of the oil. A 10-barrel leak would waste \$10 worth of oil or more per hour, and if this leak is not located for a day, \$240 worth, or in a week \$1,680 worth, or more depending upon the distance the oil must travel before reaching, let us say, the Coast. Various-size leaks, and the time it takes to locate them, determine the worth of the oil wasted.

The price of proper equipment to trace-down these leaks is very small compared to the price of the oil wasted. The time the carrier line is out of service amounts to a lot when the carrier is transferring 50,000 barrels per day which many of them do.

OTHER APPLICATIONS

Some of the applications of this amplifier with the inertia-type pickup are testing of all kinds of bearings (electric motor bearings for example), crankshafts, gears, generators, compressors, refrigerators, fans,

washing machines, vacuum cleaners, air conditioning units, and their component parts.

The location of the source of noise in any rotating machine, the vibration of pipe lines, and many other test-applications, have not been mentioned.

WATCH DETECTOR

There are other applications of this amplifier that are possible with various types of pickups and microphones. One was the use by a local watch repairman in listening to watches to tell what was wrong with them by the tremendous noises or vibrations as they sounded when amplified. He could spot in watches, various things needing attention that radio Servicemen would term equivalent to *intermittents*.

For example, the amplifier and vibration pickup was used in the detection of noises, loose jewels, bad hair-springs, and many other things easily recognized by the trained ear of a competent watch repairman.

One of the crystal headphones was built into a small metal box with a metal cover that was lined with sponge-rubber. Room was left over the headphone for the watch to be placed. This proved very satisfactory and much cheaper than use of the inertia-type pickup but was not as efficient because of pickup of other noises.

The headphone type of microphone or pickup was connected to a piece of shielded microphone cable, the other end of which had a microphone connector for attaching to input of amplifier.

USE BY DOCTOR

A crystal headphone was built into a small metal can, sponge-rubber lined and with an electrostatic shield of copper screen across face of the headphone, that then was connected to the horn-shaped part of a doctor's stethoscope (as the diagram shows).

This was tested by a doctor in his office in listening to patients' breathing, bronchial-tubes and lungs action, and other things that are far more familiar to a doctor than to the writer. This comparatively makeshift arrangement proved very satisfactory.

CONSTRUCTION

The chassis was laid out and drilled as shown in Fig. 2. The folded-under front edge of the chassis was straightened out and drilled, as shown in Fig. 3, with the front panel of the cabinet matching holes as shown. The aluminum channels were placed after the holes were drilled to permit passage of wires for the connecting stages and batteries, and for mounting the bias-cell holder.

The front panel was made secure to the chassis by mounting the pickup connector, control 6 with attached switch 7, control 14 with attached switch 15, and headphone jacks. The dial plates were also mounted with the front panel controls.

A common ground of a heavy piece of copper was soldered to the chassis and extended across all the stages.

The tube sockets and battery connector sockets 18 were then mounted, and the amplifier assembled and wired as Fig. 1 shows, with all grid leads shielded as well as the component parts of each stage with the aluminum channels. It is essential to mount the lower part of the tube shielded and cut down the middle section of the tube shield to a height of 1 1/4-ins.

After the amplifier wiring has been checked and the batteries connected, the switches are turned on and each tube connection checked with a voltmeter; then the tubes, headphones, and pickup are hooked to the amplifier, preparatory to trying out the setup.

Disconnect the batteries and place them in the cabinet, with the chain of the microphone making connection under the panel screw. The batteries are then held in place on top of the chassis, in back of cabinet, with an aluminum strap 1/2-in. wide (cut from panel No. 984) and clamped to the back of the cabinet with 2 small bolts and nuts. The 45-volt battery lies horizontally and the 1.5-volt cell stands vertically. The brass nuts furnished with the 1.5-volt cell were replaced with insulated ones, similar to those on the 45-volt battery, to avoid accidental shorts to the cabinet.

The picture, Fig. B, shows how the handle was connected (or one can do this to suit).

The Leak Detector is now complete and ready for actual use. As we know, the ground carries sound waves well, and with the tremendous gain, which is adjusted by controls 14 and 7, the Leak Locator can be set to pick up minute sounds in the ground.

A meter for checking the different vibrations can be made to connect to the Detector externally, or it may be built into this unit according to the diagram of Fig. 4.

The use of this instrument as a Leak Detector has been tested with very good results but no wild claims are made. In the final analysis, this device is essentially a high-gain vibrations amplifier. However it performs perfectly in the services for which it was designed.

LIST OF PARTS

- CONDENSERS**
 Three P. R. Mallory TP404, 0.001-mf., 8C;
 Three P. R. Mallory TP421, 0.01-mf. 9C;
 One P. R. Mallory TP436, 0.05-mf., 10C;
 Four P. R. Mallory TP405, 0.002-mf., 11C;
 One P. R. Mallory BB21, 8 mf., 12C;
 One P. R. Mallory BB20, 4 mf., 13C.
- RESISTORS**
 One International Resistance BT 1/2, 5 megs., 1R;

A NEW BOOK TO ADD TO YOUR TECHNICAL LIBRARY

AUTOMOBILE RADIO — Principles & Practice

by B. Baker Bryant



A COMPLETE compilation of pertinent data on how to install and service the modern automobile radio receiver. All of the non-essential details which have crept into the profession have been weeded out. Each topic is treated so as to contain a precise statement of the fundamental principle involved, to assure the reader's clear understanding of this principle, without distracting his attention by the discussion of a multitude of details and mathematical expressions, which are primarily for the engineer, and tend to confuse rather than clarify a statement for the auto-radio-technician. A practical treatise based on practical experience by practical radio people for the practical radio-technician.

Brief Outline of Contents—
 Introduction—The Auto-Radio Art.
 Features of the Modern Automobile Receiver.
 Installations of Automobile Radios and Antenna.
 The Automobile High and Low Tension Electrical Systems.
 Automobile Electrical Disturbances.
 Vibrator Converters and Motor Generators.
 Service Hints, Classified Automobile Installation Notes, and Conclusion.

Send 50c check, money order, unused U. S. stamps, or coin for your copy of "Automobile Radio—Principles & Practice"—It will be sent to you postpaid upon receipt of your remittance.

RAD-CRAFT PUBLICATIONS, Inc.
 20 Vesey Street, New York, N. Y.

50c

POSTPAID

Size—6 x 9 Inches
 64 Pages
 Stiff, flexible covers
 Numerous illustrations and diagrams

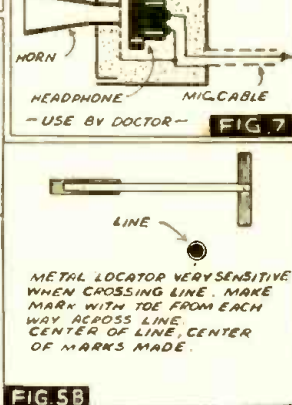
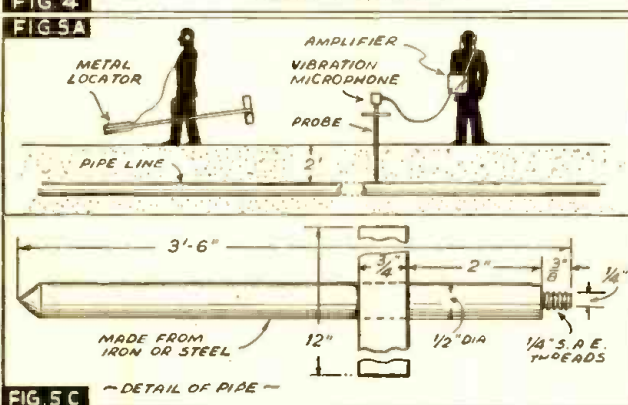
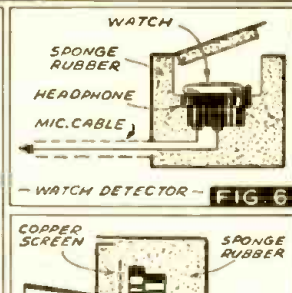
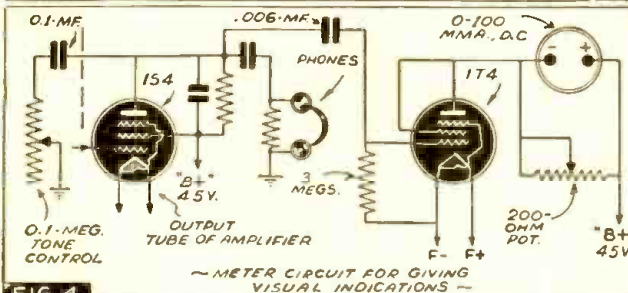
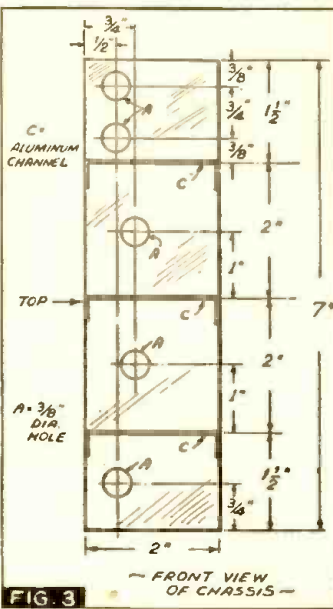
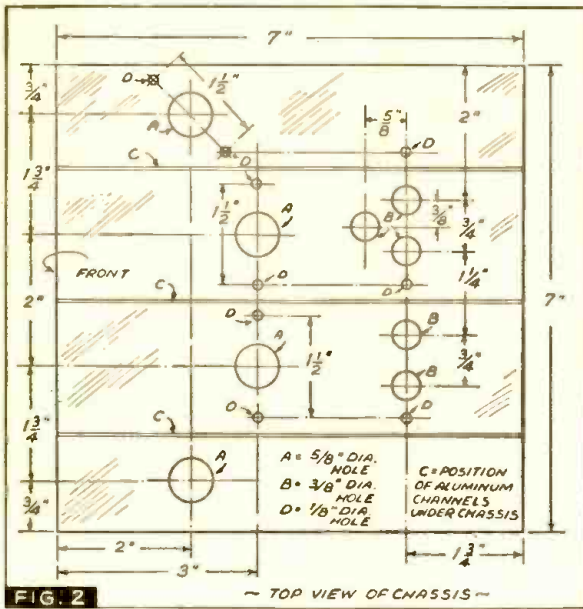

- Three International Resistance BT 1/2, 3 megs., 2R;
- Four International Resistance BT 1/2, 3 megs., 3R;
- Two International Resistance BT 1/2, 2 megs., 4R;
- Four International Resistance BT 1/2, 10,000 ohms, 5R;
- One International Resistance 2-meg. dual control, 6R;
- One International Resistance No. 22, with D.P.S.T. switch, 7R;
- TUBES**
- Three RCA type 1T4;
- One RCA type 1S4.
- MISCELLANEOUS**
- One Brush model A crystal headphones, 19;
- One Brush No. 310 VP-5, vibration pickup, 20;
- Five Amphenol 78-1M 1/8-in. sockets (Red, Black, Green, Blue, Yellow), 17;
- Five Amphenol 71-M 1/8-in. sockets (Red, Black, Green, Blue, Yellow), 18;

- Four Amphenol 78-7P tube sockets;
- One Amphenol CCC-1 cap and chain;
- One Amphenol MC-1F pickup connector;
- One Amphenol PC-1M pickup connector;
- One Burgess Z30NX 45-V. battery;
- One Burgess No. 44 1.5-V. cell;
- One Burgess No. 5360 4 1/2 V. battery;
- One Bud 973 cabinet;
- One Bud 41 chassis;
- One Bud 984 panel;
- Two Bud 261 channels;
- Three Bud 391 shields;
- One (each) Bud 980, 982, 1719, 1720 dial plates;
- One P. R. Mallory MR53 1-meg. control, 14;
- One P. R. Mallory M27 D.P.S.T. switch, 15;
- One P. R. Mallory GB-14 bias-cell holder, 16;
- Two P. R. Mallory 1 V. bias cells;
- Two P. R. Mallory 1 1/4 V. bias cells;
- One P. R. Mallory 420 jack;
- One P. R. Mallory 421 jack;
- Two P. R. Mallory 366R knobs.

"FACSIMILE FREDDY"
 "Facsimile Freddy," WOR's facsimile cartoon, last month went to school. The work of students of a cartooning class, held by Milt Hammer who draws "Freddy," was

put on a transmitter set up for the purpose in the classroom, at the Newark, N. J., Y.M.C.A., sent from there to WOR, and from there broadcast on the regular facsimile program.

Social Security name plate

SOCIAL SECURITY ACT
 NUMBER 000-000-000
 NAME JOHN DOE

Only **35¢**

Bronze Plate with your Name & Number on it and This **GENUINE LEATHER BILLFOLD** without Extra Charge.

ACT NOW! Mail the coupon below and enclose 35c in coins. The bronze name plate and the Leather Billfold will be forwarded to you at once.

PREMIUM DISTRIBUTING SERVICE
 Wrigley Bldg., Chicago, Dept. RC-6-41
 Enclosed find 35c for which mail to the address below, my Social Security Bronze Plate and the Genuine Leather Billfold without extra cost, as per your offer.

My Social Security Number is

NAME

ADDRESS

CITY

STATE

Sensational New!

"WALSCO UNIBELT"

ADJUSTABLE DIAL BELT
 THE GREATEST TIME SAVER FOR RADIO MEN IN YEARS!

Belts are adjustable and come apart. They can be installed without taking the dial mechanism apart. Patented slipper-like fastener gives instant connection. The WALSCO UNIBELT cannot slip or stretch and one can do a replacement job in two minutes that before took an hour or more.

Ask your jobber for FREE WALSCO CATALOG No. 42-A
 O. W. WALTER J. SCHOTT CO.
 5266 Pico Blvd., Los Angeles, Calif.

FACTORY-TO-YOU SAVE UP TO 50%

PUT THIS NEW 1941
15-TUBE RADIO-PHONO
 COMBINATION CHASSIS IN YOUR PRESENT CABINET

COMPLETE RADIO-PHONO CHASSIS WITH TUBES AND SPEAKER

30 DAYS TRIAL EASY TERMS up to \$25 TRADE-IN (on Many Models)

Write for FREE catalog today.
 Dept. 12-NR MIDWEST RADIO CORPORATION, Cincinnati, Ohio

HOME RECORDER FREE

POWER AND LIGHT

ONAN A.C. ELECTRIC PLANTS supply current for Radios, Transmitters and Receivers, P. A. Systems, Movie Projectors, Sound Truck Apparatus, Tools, Lights, All Appliances, Used as Stand-by Equipment in Schools, Hospitals, Theatres and Public Buildings in case of Power Line Failure due to Storms, Floods, etc. Available in 110 or 220 Volt A.C.—12, 32 and 110 Volt D.C.—Also Dual Voltage AC-DC Types, Manual, Full-Automatic & Self-Starting. \$99 and up. Shipped, Ready to Run.

D. W. ONAN & SONS
 722 Royalston Avenue, Minneapolis, Minn.

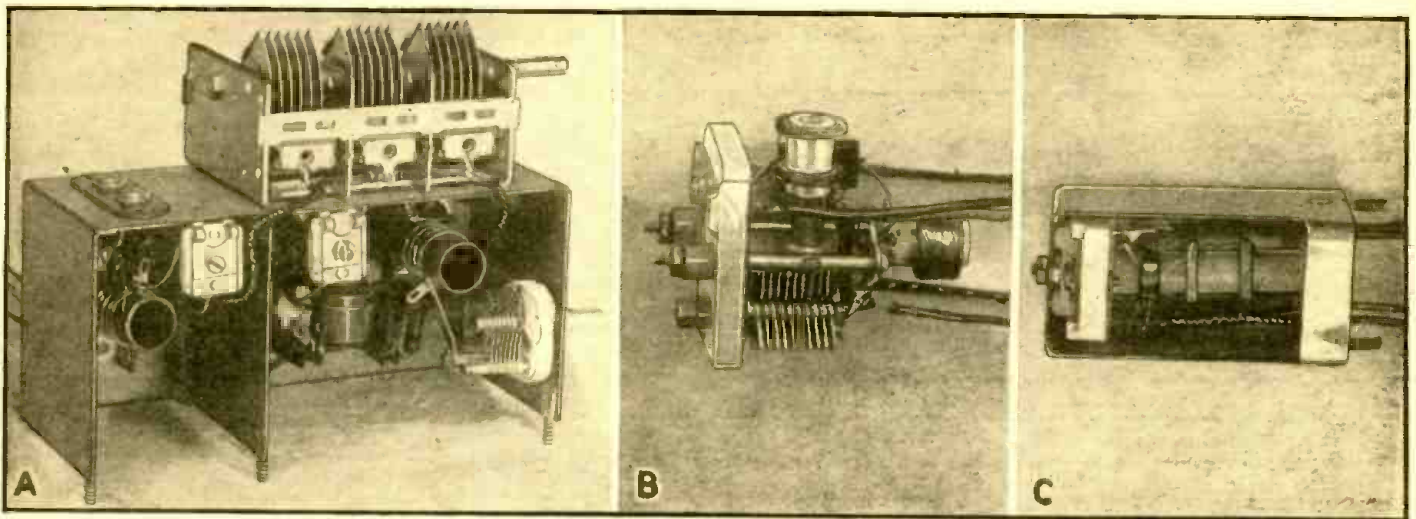

Practical coil arrangements. A—Wired and tested R.F. and oscillator tuning assembly; B—F.M. discriminator transformer, with combined "air and mica tuning", removed to show ceramic winding forms; C—F.M.-I.F. transformer for 4.3 mc. (can is 2½ ins. long). Carron coils are illustrated.

Theory and Design Considerations of R.F. AND I.F. COILS IN F.M. RECEIVERS

It is believed that the following article, prepared by a coil specialist and presenting material almost entirely new, should prove of exceptional value to Radio-Craft readers. The article concerns the design and design practices in various coils used in Frequency Modulation reception, and no reference is made to the operation of an F.M. receiver other than that necessary to describe the operation of the coils.

C. S. LINELL

DURING the last 12 months radio literature has contained a number of articles dealing with the various phases of Frequency Modulation from receiver design to antennas and service. (*) Today the average reader of *Radio-Craft* is on speaking terms with F.M. even though situated in localities not yet having the benefits of F.M. service.

It is our plan not to describe any particular F.M. receiver or the operation of the various circuits in an F.M. receiver since this has been so well covered in the past. The art is new and rapidly progressing; the information which has been printed requires no summary and we shall therefore devote this article to the design and theory of the various coils and I.F. Transformers used in a representative F.M. receiver.

The ability of an F.M. receiver to receive and demodulate commercial wide-band F.M. transmissions depends on the band-width

which the amplifier is able to accept, and since this band-width is determined chiefly by the I.F. characteristics, we shall discuss the I.F. amplifier before turning to the R.F. and Oscillator stages.

THE I.F. STAGE—4.3 MC.

The Radio Manufacturers Association, after considerable deliberation, selected a frequency of 4.3 megacycles as a recommended intermediate frequency for use in F.M. receivers since a frequency above 4 mc. precludes the possibility of image frequency interference within the band of 42-50 mc. An I.F. of 4.3 mc. provides a *guard band* between the amateur 3.5-4 mc. band and the 75 kc. transmitter frequency excursion. Thus the first design factor, the frequency, is already established.

The *ideal overall response* of a perfect I.F. amplifier for use with present transmission standards is shown in Fig. 1, at *a*.

Fortunately, this curve does not have to be duplicated since the action of the limiter tends to remove all increments in amplitude beyond a certain level as determined in the design of the receiver. The dotted line represents a suitable level of about 4 volts at the limiter grid.

Band-pass.—If then, we design an amplifier having a curve such as *b* in the same figure and depend on the limiter to operate as before, we may retain the ability to align the tuned circuits with an ordinary unmodulated signal at 4.3 mc. and still have essentially the same band-width characteristics as the ideal band-width curve shown at *a*. By using a curve of this shape, maximum band-width is not obtained at full receiver sensitivity, but this sensitivity would not be usable in any case, since the ability of the limiter to remove all traces of amplitude modulation, static, etc., requires a signal of about 4V. as already stated. In addition, the ability of the limiter to discrimi-

*See listing at end of article.

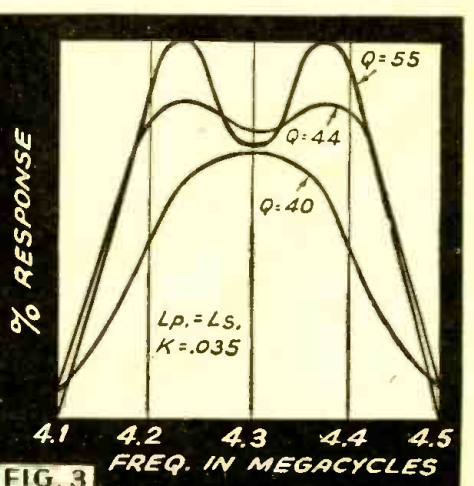
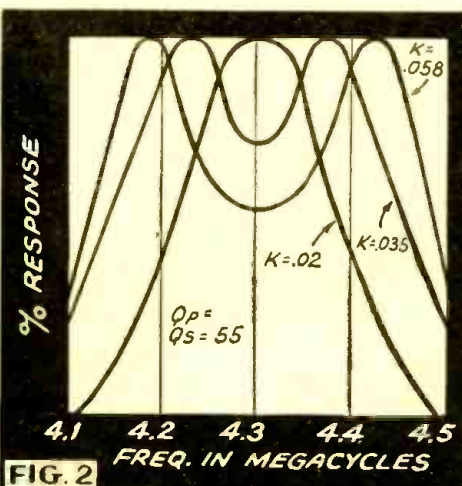
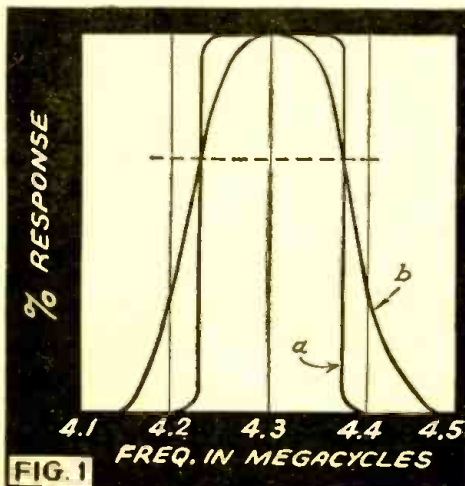

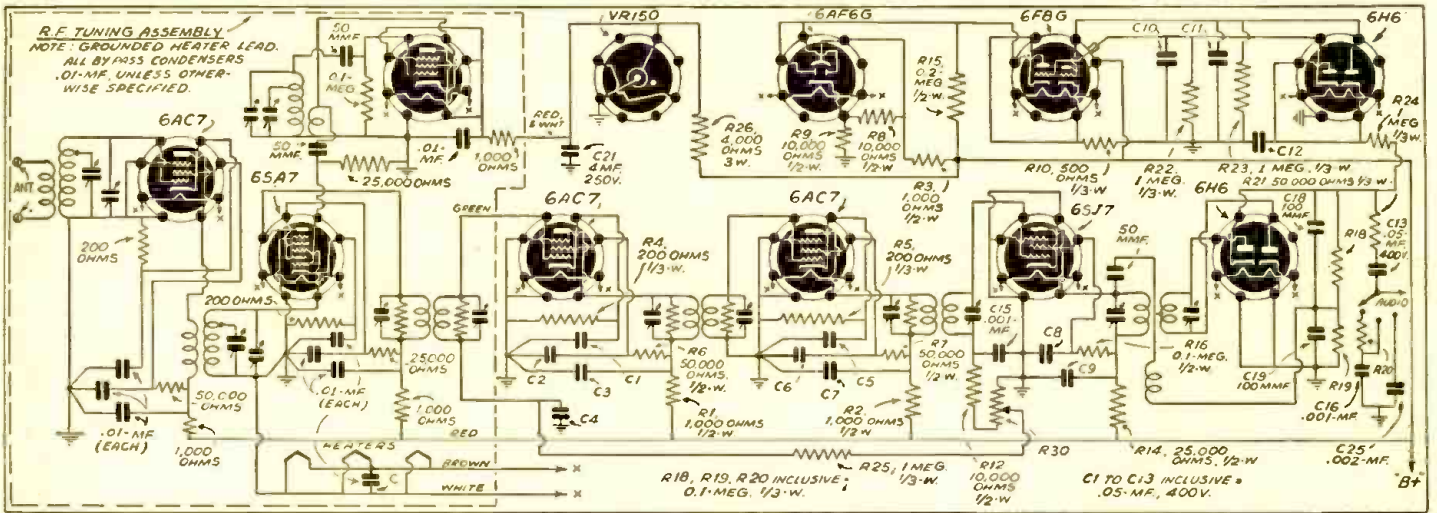

R.F. and I.F. operation of a typical F.M. receiver. Note unit-built R.F. section enclosed within dotted lines. (See NOTE at end of article.)

nate against amplitude changes increases in proportion to the I.F. signal available at its grid.

Band-pass characteristics such as we require may be obtained by the use of tuned circuits, coupled by a mutual coupling, the value of which determines the pass band. Consulting Fig. 2 and disregarding for the moment the fact that several of the curves have pronounced "double humps," we see that 2 circuits of constant "Q" and having various degrees of coupling designated as *k*, exhibit various band-widths from which we may make our selection. The value of *k* may be predicted with sufficient accuracy from the formula:

$$(1) \frac{\text{Width of Pass Band}}{\text{Mean Intermediate Frequency}} = k$$

after which the mutual inductance, *M*, may be set to the proper value from:

$$(2) M = k \sqrt{L_p \cdot L_s}$$

In practice this value is set approximately. Final adjustment is made in the actual amplifier, since unknowns in the form of unpredictable capacitative and inductive coupling occur. These may increase or decrease the effective coupling.

Although a satisfactory curve could be selected from Fig. 2 curve *k* .035, we find that it has 2 distinct peaks with an area of reduced response between them, a condition entirely unsuitable for F.M. reception. Consult now, curve *Q* = 55 in Fig. 3 which represents 2 tuned circuits having a value of *k* = .035 suitable for our purpose but having the same "double hump" response. If we vary the *Q* of the coupled circuits, maintaining the coefficient of coupling constant, we may alter the "double humped" response to any intermediate value. Bearing in mind the action of the limiter, and the band-width selected, we find that by employing tuned circuits having a *Q* of 40 a satisfactory response is secured. This value of *Q* may be calculated from the formula:

$$(3) \sqrt{Q_p \cdot Q_s} = \frac{1.4}{k} \text{ or } Q_p = Q_s = 40$$

If we desire the curve to be essentially "flat topped" the formula would read:

$$(4) \sqrt{Q_p \cdot Q_s} = \frac{1.5}{k} \text{ or } Q_p = Q_s = 42.9$$

Q.—There are several methods of obtaining the required value of *Q*. The coils may be wound on high-loss cores, wound with high-resistance fine wire, or shunted with a value of resistance to lower the *Q* from a higher value. In actual practice,

either the 1st or 3rd method is preferable, since fine wire usually results in finer insulation and increased distributed capacity, resulting in a lower L/C ratio with consequent reduction of resonant impedance. The author prefers the 3rd method in which the coils may be designed for the most satisfactory winding from a mechanical standpoint. This results in coils of consistent characteristics, which are symmetrically loaded with shunt resistors across the primary and secondary. These resistors have the two-fold purpose of providing (a) the proper *Q* and (b) a dissipative circuit which prevents the rapidly changing frequency from setting up transients. The latter may be heard as a "fuzz," particularly on loud, high-frequency passages.

L/C Ratio.—Although treated last in this discussion, the *L/C* ratio of the tuned circuit inductance to its shunt capacity must be borne in mind all during the design of the I.F. transformers. To provide a reasonable amount of gain at the relatively high frequency of 4.3 mc., we must employ as much inductance as possible compatible with stability. We know that the sum of wiring, tube input and output, and coil distributed capacity will be approximately 15 mmf. We have available a midget trimmer having a mid range or most stable capacity

of approximately 50 mmf. This results in a total shunt capacity of 65 mmf. Calculating, we find from substitution in the formula:

$$(5) f = \frac{1}{2\pi \sqrt{LC}}$$

that the required inductance is 21 μH. We then may calculate the approximate mutual inductance between primary and secondary as already mentioned (formula 2). A mica trimmer mounted on a ceramic base is chosen, since no electrical improvement could be obtained from the use of either permeability or air tuning in conjunction with the relatively low *Q* necessary. Their use would result in unnecessarily increased cost.

So far, we have discussed the I.F. Transformers as a group. Actually we have 3 types: (1) Input/Interstage which are identical, (2) Limiter input, and (3) Discriminator.

The *Limiter* transformer differs from the *Input and Interstage* only in that no loading resistor is necessary for the secondary, because it is loaded to a somewhat greater degree by the grid current drawn by the limiter tube. It is permissible to increase the coefficient of coupling in the limiter transformer to maintain the symmetry of response. The difference in coupling is so

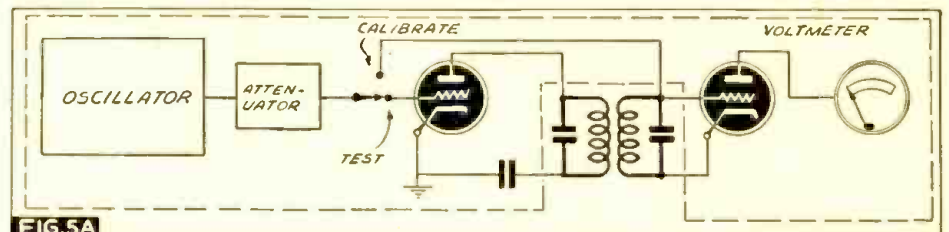

FIG. 5A

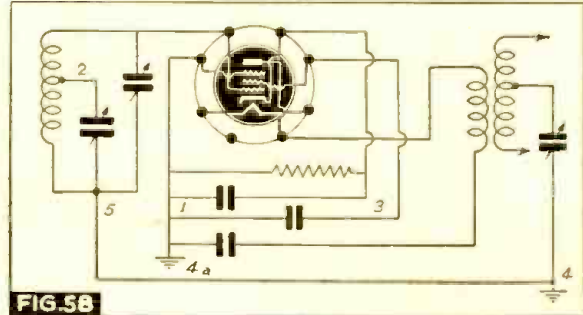

FIG. 5B

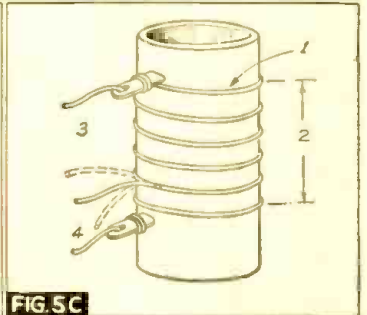

FIG. 5C

Fig. 5—Testing and applicational circuits. A—Block diagrams of coil-testing setup with which final adjustments are made. Band-width and gain-per-stage may be measured by means of the instrument represented here. B—Diagram showing the introduction of undesired inductance at (1) due to bypassing through a long lead to ground; (2) long lead to tuning condenser; (3) long lead to screen-grid, with regeneration introduced due to the common inductance of the ground path between the gang and ground (4) and bypass ground (4a). Long lead (5) contributes inductances to the tuned circuit but introduces a loss of gain. C—Detail showing how overall inductance may be increased by moving turns as shown by 1, or decreased, 2; or the effective tap position raised, 3, or lowered, 4. Larger changes in tap (tracking) position may be made by moving the position of the turns above and below the tap.

small that it is not practical in production to maintain and is seldom taken into account.

Discriminator-Transformer Design.—Unlike the Limiter, the Discriminator differs considerably from the I.F.s both in mechanical construction and in electrical characteristics. The voltage input to the primary of the Discriminator transformer is practically constant at about 20 volts under usual operation. The voltage delivered to the diode rectifier is not constant, however, and varies with the frequency of the applied signal at any instant. The primary and secondary windings of the discriminator transformer are identical to those of the I.F. transformers. The coupling between the 2 coils is made by means of 2 independent methods. The coefficient of coupling is selected to give a peak separation of 250 kc. for reasons which will be discussed later. In addition, a capacity is placed between the plate end of the primary and a center-tap on the secondary.

Let us consider the relationship between the voltages in this transformer and their effect on the design. It is necessary for proper discriminator operation that the voltages developed in the 2 halves of the secondary be EXACTLY equal and 180° out-of-phase with each other. This requires an exact electrical center-tap. Even capacities to ground must be equal and a small compensating condenser (a few mmf.) is often placed externally from the ungrounded diode to ground to compensate for the smaller diode capacity of this circuit.

In the operation of the discriminator the secondary is tuned to exact resonance with the mean I.F. Any mis-tuning of this circuit results in phase shift and consequent non-linear operation. Therefore, best design practice dictates that we employ a coil wound on a ceramic form and tuned by means of an air trimmer. The primary winding need not be so exacting since phase shift occurring in this resonant circuit will not affect the operation. For this reason we may use the more economical mica trimmer. The primary must pass the full bandwidth of frequencies from 4,225 to 4,375 kc. with but little frequency discrimination. We will show how this is accomplished. For proper demodulator operation the recovered voltage versus frequency curve should be linear within the frequency deviation encountered.

The response curve of the discriminator, is a combination of the voltages developed across the secondary due to the inductive coupling with the primary, and the primary voltage introduced into the center-tap. In form, it resembles a "double hump" I.F. response curve with one hump reversed to complement the other. This resembles a letter "S" laid on its side. Our object is to make the center of the curve as straight as possible over the range of the frequencies included in the maximum deviation of the transmitter.

Inspection of curve $k = .058$, Fig. 2 will show that the sides of the curve between the mean frequency and 75 kc. are fairly straight. The peak separation in this curve is 250 kc. Using this as a design factor we may construct our discriminator transformer. Although the sides of this curve are not absolutely straight their differences are such that they cancel each other and a linear response vs. frequency results. One other factor, the primary response, affects the shape of the curve. In operation the resistance reflected by the closely-coupled secondary tends to broaden the primary acceptance band to the full band-width which satisfies the condition mentioned in the beginning of the discussion of the discriminator. No resistance loading is necessary on

the secondary as this is provided by the resistance of the diodes and their associated circuits.

R.F. AND OSCILLATOR STAGES

Frequency Modulation transmissions occupy the band between 42 and 50 megacycles. Any experimenter who has built amateur 5-meter receivers is familiar with the small size of the coils and condensers necessary to tune to these frequencies. Several facts, however, are usually overlooked. The length of leads from the coil, size of the variable condenser (length of electrical path), bypass condenser leads, etc., all contribute to the inductance in the circuit. For

extent of stating: "If it becomes necessary to replace any part be sure to put the replacement part in the exact position occupied by the defective part and use exactly the same lead length originally employed." Bearing these remarks in mind we will proceed with the actual coil design.

Condenser Tuning-Ratio.—As stated, we wish to cover a range of 42-50 mc. If we use a condenser to tune to these frequencies we may employ the formula for inductance, capacity and frequency to determine the tuning ratio of the variable condenser (ratio of total minimum capacity to maximum capacity). To permit a slight space at each end of the dial we assume a range greater than actually required and in the case of F.M. our total range will be 39-51 mc. If the inductance L is held constant we will require a condenser ratio which is equal to the square of the frequency ratio. We will therefore have:

$$(6) \left(\frac{51 \text{ mc.}}{39 \text{ mc.}} \right)^2 = \text{Condenser ratio} = 1.71$$

This value 1.71 is very small and is not ordinarily obtained with any available variable condenser. There are, however, several solutions to this problem:

(1) We may place a large shunt capacity across the coils and use a small variable capacity for actual tuning. This method has the disadvantage that unless the coils are very small, an extremely small variable condenser is required for tuning. If the inductance is reduced the L/C ratio becomes unfavorable, the parallel resonant impedance is lowered and the available gain is small.

(2) A small series condenser (semi-fixed) may be used between the coil and the tuning condenser. From the loss of gain standpoint this method is superior to Method 1. It has several disadvantages such as critical adjustment (stray capacities), and difficulty in obtaining proper tracking between the oscillator and R.F. stages.

(3) A combination of both these systems may be used which will result in retaining the better features of both. This consists of placing a small semi-fixed trimmer directly across the coils to provide alignment at the high-frequency end of the band. A standard small variable tuning condenser may be tapped down on the coils. This tap has the same effect in limiting the tuning range as the series condenser in Method 2. It has the additional advantage that adjustment of the inductance above and below the tap allows us to vary the tuning ratio and accomplish tracking over the narrow band required.

Its disadvantages lie in a somewhat higher distributed capacity and a tendency to resonate at 2 distinct frequencies. This latter fault is not important in a superheterodyne, since the effect is such that it is impossible for the oscillator to beat with the undesired frequency to produce the I.F. No padding condenser is necessary with this circuit (general high-frequency practice usually eliminates the padding condenser) as this adjustment may be made by as simple a procedure as bending the tap lead where it leaves the coil. By this means its mutual inductance may be added or subtracted from the effective inductance tuned.

Design Example.—For the sake of design let us use Method 3. Connect a small "high-lift low-capacity trimmer" across each coil, assuming a wiring and input capacity, plus trimmer capacity, of 22 mmf. for R.F. and Oscillator circuits. For the time, ignoring the maximum tuning capacity, we can calculate the inductance necessary to resonate at the highest frequency (51 mc). Employing formula (5).

We find the required value to be approxi-

List of Articles in Past Issues of Radio-Craft on Frequency Modulation

- New Circuits in Modern Radio Receivers (Dept.): "New Circuit Using 'Electric Eye' as F.M. Tuning Indicator" (Pilot); "Direct-Coupled Limiter Tubes Used in F.M. Receiver" (Zenith), April 1941. "Frequency Modulation Receiver uses 2 Limiters in Cascade" (Scott), Dec. '40. "Supplementary Shadows Indicate F.M. Resonance" (Meissner), Nov. '40. "Pushbutton Amplitude—Frequency Modulation Changeover" (Stromberg-Carlson), Aug. '40. "Same Tuning Indicator Used Both for Amplitude and Frequency Modulation Receiver" (Stromberg-Carlson). "Tuning Indicator for Frequency-Modulation Receiver" (Stromberg-Carlson), March '40.
- Recent Improvements in F.M.-Receiver Design, March 1941.
- A New A.F.-Drift Correcting, Signal-Balancing, Direct-Coupled F.M. 24-Watt Audio Amplifier, Part I, Dec. '40; Part II, Jan. '41; Part III, Feb. '41.
- Circuit Features of the Latest Ultra-H.F. "DX" F.M.-A.M. Receiver, Feb. '41.
- F.M. Servicing Pointers, Jan. '41.
- The ABC of Frequency Modulation, Dec. '40.
- Station WOR Gets F.M. Voice, Dec. '40.
- Present Status of F.M. Broadcasting, Dec. '40.
- F.M. Servicing Procedure, Nov. '40.
- Servicing F.M. Receivers, Oct. '40.
- Servicing F.M. Receivers, Sept. '40.
- Latest 28-Tube DeLuxe High-Fidelity F.M. and A.M. Broadcast Receiver, Sept. '40.
- Build This Practical F.M. Adapter, Aug. '40.
- Choosing an F.M. Antenna, July '40.
- Data Sheets (Dept.): "Stromberg-Carlson, No. 425 Frequency Modulation Receiver and 'Converter'," Feb. '40.
- Frequency-Modulated Programs on Your Present Receiver!—with This Easily-Built F.M.-A.M. Ultra-Shortwave Adapter, Part I, Dec. '39; Part II, Jan. '40.

this reason trouble is usually encountered when gang condenser operation is attempted.

Coil Design in Theory and Practice.—At these frequencies it is ABSOLUTELY IMPOSSIBLE to design a set of coils on paper and expect them to work perfectly. The only method by which perfect results may be obtained is to follow the preliminary design with actual application.

Here the exact circuit and proposed layout are constructed and final inductance adjustment is made. Coils so designed will give the maximum performance in THIS LAYOUT ONLY and any attempt to install them in a similar circuit with a different physical arrangement will give unsatisfactory results. For this reason manufacturers who supply F.M. components in kit form generally furnish the complete R.F. and Oscillator sub-assembly completely wired and tested. Commercial receiver manufacturers are specific in their service notes to the

In a Hurry for F-M?



Use the Meissner

F-M RECEPTOR

for immediate satisfaction!

The Meissner F-M Receptor is a complete, self-powered, 8-tube converter, designed to add F-M reception to any regular receiver—feeds directly into the input of the audio system! With this inexpensive unit you can have all the advantages of F-M—hi-fidelity, staticless, noise-free and interference-free reproduction—right on your own radio set! Power output and tone quality are limited only by your present audio system.

RF stage provides maximum reception range and noise rejection—tuning indicator for accurate adjustment—only two controls. Extremely compact—only 13" wide, 7" high and 6 3/4" deep—beautiful, hand-rubbed walnut cabinet. For 110-volt AC operation only; also available without cabinet if desired. List price, ready to operate, only \$39.95!

See Your Jobber Today!

1941 INSTRUCTION MANUAL

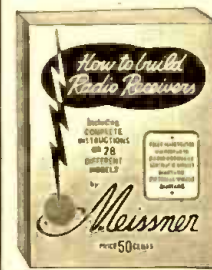

Now Ready!

Contains complete instructions for all Meissner Kits
Circuit Diagrams
Parts Lists
Pictorial Diagrams
Charts and other useful data

ONLY 50c NET!

WRITE TODAY FOR FREE 48-PAGE COMPLETE CATALOG

Address Dept. C-6



mately .44 μ H. This value may be obtained by winding 5 turns of No. 18 bare wire, spaced twice its diameter, on a 3/8-in. O.D. bakelite tube. Using this value of inductance we find by again substituting in formula (5) that approximately 37.7 mmf. will be required to tune to 39 mc. Rather than use a small condenser (37.7 mmf. - 22 mmf. = 15.7 mmf.) as a tuning condenser we may choose a condenser several times as large and tap down on the inductance to give the same result. If we select a condenser having a range of about 90 to 100 mmf. we may tap down to about 1/6th of the total inductance. This method of design neglects the minimum capacity of the tuning condenser but due to the impossibility of designing these coils without actual application, this discrepancy may be corrected in the final adjustment. This method permits us to utilize approximately 80% of the condenser rotation to cover the required band, resulting in an easily read dial.

R.F. and Antenna Primaries.—The design of the R.F. and Antenna primaries also represent a compromise, since extreme care must be taken to keep the capacity between the primary and secondary low. One of the most satisfactory methods is to space-wind the primary between the spaced turns of the secondary. Care must also be taken to prevent the R.F. primary from resonating with the tube output and wiring capacity, within the band employed. Since at best, the impedance of the primary as presented to the plate of the preceding tube is far too low to permit a reasonable amount of gain, it is necessary to use as much inductance in the primary as possible, without conflicting with the conditions mentioned. A ratio of 2 primary turns to 3 secondary turns represents a workable value.

The antenna primary is a less critical matter. The impedance reflected into a transmission line from a doublet antenna should be approximately 70 to 100 ohms. The impedance of the primary may be considered as the sum of the impedances of the primary alone plus that coupled into it by the secondary. This coupled impedance is equal to:

$$(7) \quad Z_c = \frac{(2\pi M)^2}{Z_s}$$

where M is the mutual inductance between primary and secondary and Z_s is the parallel resonant impedance of the secondary.

The condition for maximum transfer of energy is such that the coupled impedance is equal to the primary impedance and the coupled reactance is equal but opposite in

sign to the primary reactance. Formulas have been developed for the calculation of the ideal conditions, but due to their complexity they are seldom used and the same variables as we encountered with the design of the I.F. transformers affect the coupling and alter it from the calculated value.

For our purpose we may calculate the primary impedance based on about 1/2 the desired impedance and from formula (7) and a knowledge of the effective circuit Q determine the approximate required mutual inductance. We may assume that the coupled reactance will approach the required value and from this starting point the primary may be constructed. On the R.F. coils mentioned above this results in 2 turns interwound with the primary starting 1/2-turn outside of the end secondary turn.

Oscillator Coils.—The exact construction of the oscillator coil will depend on the type of circuit employed. Electron-coupled oscillators may be used with the 6SA7 or with a separate electron-coupled oscillator. These circuits require a tapped coil.

The position of the tap should be determined experimentally to give the most suitable amount of feedback. Coupling should be close in any case (interwound if a 6A8 converter is used). The oscillator inductance should be adjusted to a slightly lower value than that used in the R.F. stages and a ceramic-insulated air trimmer should be employed to assure permanence of dial calibration and freedom from drift.

By this time the reader has probably come to the conclusion that the design of tuned circuits for frequencies such as employed in F.M. is a rather haphazard business. This is true to a certain extent. We should remember that the principles involved, are a starting point in the design, and their use at lower frequencies may be made with greater accuracy. At these lower frequencies stray capacity and lead lengths do not represent so large a proportion of the total circuit constants.

This article has been prepared from material supplied by courtesy of Carron Manufacturing Company.

Note.—In the bank of 3 condensers which are bypasses for the input 6A7 tube, the unit which bypasses the 1,000-ohm filter resistor to ground should be instead a 0.001-mf. mica condenser.

It may be of interest to note that condenser C which shunts the heaters serves only to reduce the impedance of the heater circuit close to the sockets of the assembly. This is necessary because of the relatively long heater wires which have considerable inductance and which therefore may, under certain conditions, allow a certain amount of feedback between these tubes.

DISTINCTIVE CALLS FOR F.M.

TO provide distinctive calls for F.M. (Frequency Modulation) broadcast stations, the Federal Communications Commission has adopted a new system of call letters with interposed numbers for this now commercially recognized broadcast service.

The new call letters will combine letters and figures in a system designed to show the radio listener not only whether the station is East or West of the Mississippi, but also where to look for it on the tuning dial.

In accordance with the international prefixes of "K" and "W" assigned to U.S. stations (also "N" for Navy and Coast Guard), the new F.M. call letters will start with "K" if West of the Mississippi, "W" if East. This has been standard broadcast procedure for many years.

The 2nd and 3rd characters, however, will be numerals, indicating on which of the 40 channels in the F.M. broadcast band the

station operates. At the end of the call sign is another letter or letters which may be either arbitrarily assigned, or indicate in some abbreviated form the city or area in which the station is located.

Simplifying this description somewhat are the following examples given by the F.C.C.:

W41B might indicate a station operating on a channel of 44.1 megacycles in Boston, whereas K43SF could be another station on 44.3 megacycles in San Francisco. (The numerals are obtained by taking the last 2 numbers of the assigned frequency. All educational, non-commercial stations will use the letter "E" on the end.)

The system is adapted from the method used by Chile to designate standard broadcast transmitters, at the same time itemizing vital data about the station. Calls will not exceed 5 characters.

• LATEST RADIO APPARATUS •

12-WATT BOOSTER SPEAKER

University Laboratories
195 Chrystie St., New York, N. Y.



MODEL 1B8 is an intercommunicator booster speaker especially designed for paging and intercommunicating use. In this connection, it is claimed due to the extremely high efficiency of this 12-W. speaker, it gives the effect of an added booster amplifier. This high efficiency, combined with the uniform frequency response of the speaker, enables it to cut through background noise and give clear speech reproduction, even in airplane factories.—*Radio-Craft*

FLOCK REPAIR KIT

General Cement Co.
919 Taylor Ave., Rockford, Ill.



A COMPLETE kit, everything necessary for repairing the flock finish used on phonograph turntables, metal cabinets, testers, tool chests, displays, etc.

Kit consists of "Felt-Koat" flock, "Felt-Koat" undercoat, "Felt-Koat" undercoat thinner, and a specially-developed sifter-top can for sifting flock over the undercoat. Complete directions are included.—*Radio-Craft*

TRANSPARENT ACETATE TUBING

Precision Paper Tube Co.
2033 Charleston St., Chicago, Ill.

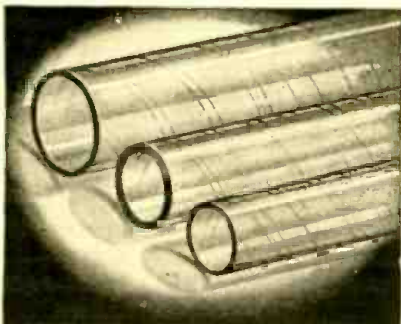

A NEW self-supporting, spirally-wound, transparent acetate tubing is shown. Due to its superior dielectric properties, this tubing is recommended for many high-frequency and electronic uses. It is pre-formed, and unlike extruded acetate tubes, will not

shrink. This new product can be supplied in continuous lengths of any wall thickness with any inside and outside diameters.—*Radio-Craft*

3-WAY AVIATION PORTABLE

RCA Mfg. Corp.
Camden, N. J.

IN addition to standard broadcast programs, this 3-way portable, designed especially for use in private airplanes, is capable of receiving such important aviation information as CAA weather reports, radio range courses, and airport control tower signals. Operates on self-contained batteries (life, average use, about 200 hrs.) or from an A.C./D.C. line. Known as Model AVR-102, this portable receiver incorporates a 6-tube, 2-band superhet. circuit which includes a stage of R.F. and has a built-in loop antenna and a P.M. dynamic speaker. Chassis is mounted to withstand vibration. Circuit incorporates "static-limiter" switch to improve signal/noise ratio.—*Radio-Craft*

COMMUNICATIONS RECEIVER

Radio Mfg. Engineers, Inc.
111 Harrison St., Peoria, Ill.

THE new RME-99 is a modern communications receiver which boasts the following features: 6 bands (550 to 33,000 kc.); large, calibrated, bandspread dial; automatic voltage regulation; illuminated R-DB. meter; 6-position crystal filters; relay and break-in control; automatic noise limiter; combination antenna input. It is a well-designed, custom-built instrument made primarily for reliable amateur and commercial reception. Utilizes external loudspeaker to match.

Circuit employs Loktal-type tubes. The receiver is housed in a metal case, with inclined front panel, measuring 19 x 10½ x 9 ins.—*Radio-Craft*

DIRECT-READING WAVEMETER

General Radio Company
30 State St., Cambridge, Mass.



TYPE 758-A wavemeter is a convenient instrument for measuring high frequencies in the laboratory, where quite frequently ease of operation is more important than high accuracy. The direct-reading dial in a single rotation continuously tunes to frequencies from 55 to 400 megacycles. Variation in inductance is automatic, by a silver spring, attached to the rotor of the variable condenser, which slides along a silver strip connected to the stator.—*Radio-Craft*

DISTRIBUTOR NOISE-SUPPRESSOR

Continental Carbon, Inc.
13900 Lorain Avenue, Cleveland, Ohio

THIS new unit does away with the heavy metal cap on the usual automobile distributor suppressor into which the ignition

cable fits. The top of this unit, known as the T-22 Suppressor, is all bakelite and therefore insulated against high voltage. Another feature is the 4-pronged metal spring contact which is pushed out by a rubber "slug" against the metal cylindrical wall of the distributor housing in order to assure rigid contact in the face of continuous vibration.—*Radio-Craft*

TRANSMITTING CONDENSERS

Aerovox Corporation
New Bedford, Mass.



THE feature of this new transmitting condenser is not the condenser itself but rather its slip-through method of mounting. Instead of cutting a hole large enough to slip through the entire condenser, it is merely necessary to drill 2 small holes large enough to pass its pillar terminals; 2 smaller holes take the mounting bolts.—*Radio-Craft*

ADJUSTABLE DIAL BELTS

Walter L. Schott Co.
Los Angeles, Calif.

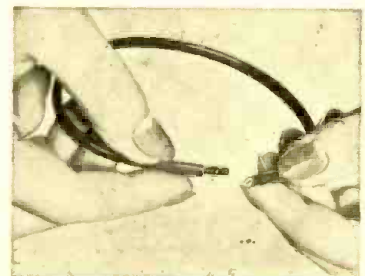

IT is claimed that this ingenious belt speeds up dial repairs and increases profits to Servicemen by enabling an ordinary hour's job to be done in a few minutes.

The belt is adjustable to fit any dial and comes in open form, which means that the belt can be put on without taking apart the dial mechanism. A patented zipper-like fastening gives instant, lasting connection. The core of the belt is made of a highly-flexible steel which does not stretch with use.—*Radio-Craft*

VARIABLE-SPEED MOTOR PULLEY

Ideal Commutator Dresser Co.
Sycamore, Ill.

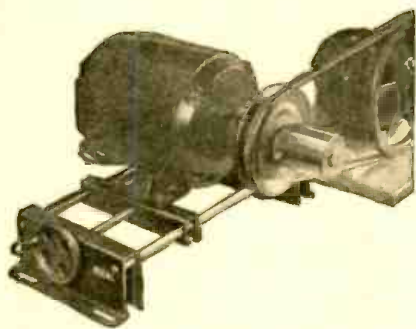

THIS variable-speed motor pulley is designed for light, inexpensive machines. It mounts directly on the motor shaft and requires only a standard V-belt. Speed ratios up to 2 $\frac{3}{4}$ to 1 available; speed changes may be made while running. Sizes up to $\frac{3}{4}$ h.p.

Complete unit includes variable pitch pulley and adjustable sliding motor base.—Radio-Craft

NEW RECORDING BLANKS

Record Sales Company
Los Angeles, Calif.

IN view of the shortage of aluminum, these blanks are expected to be widely accepted wherever acetate discs have previously been used. These discs are being manufactured in coated forms on a steel alloy base having a super-glossy silver-blue finish. They are said to be unbreakable and not affected by

abrupt climatic changes. They may be played-back immediately, and can be processed and pressed just as the usual aluminum recording blanks. The blanks are known as "Alco Recording Discs."—Radio-Craft

UNIVERSAL-USE DIPOLE ANTENNA

Technical Appliance Co.
17 E. 16th St., New York, N. Y.

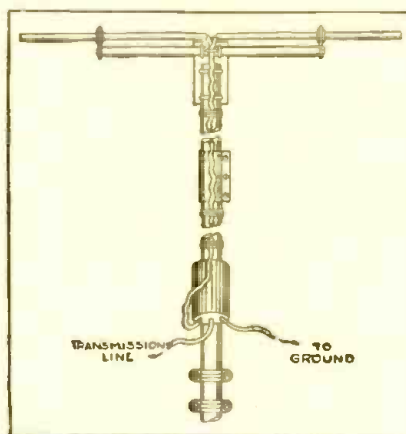

THROUGH the use of newly-developed selector transformers utilizing ultra-H.F.-iron cores for maximum transfer of radio energy, this complete dipole-rod antenna system may be used for the reception of F.M.-A.M. shortwave and television signals. The transmission line may be up to and even exceeding 100 feet long, if necessary. This makes it possible to place the dipole at an extremely high position, away from inter-

fering noises. A polarization bracket holding the dipole to the mast permits tilting the antenna at any angle from horizontal to vertical, thus permitting correct polarization.—Radio-Craft

ELECTRONIC VOLT-OHM-MF. METER

Radio City Products Co.
88 Park Place, New York, N. Y.

MODEL 661, because of its unusual flexibility, will find wide and important applications in the radio, electronic and electrical service fields as well as in the laboratory.

It is an electronic tube voltmeter, ohm-meter, and capacity meter. Its input resistance is 16 megohms (low) to 160 megohms. The A.C.-D.C. voltage range is from 0.1- to 6,000 volts. Its resistance range is from 0.1-ohm to 1,000 megohms. Its capacity range is from 50 mmf. to 600 mf. The instrument employs a 4 $\frac{1}{2}$ inch rectangular meter mounted in an all-metal case with etched front panel. All necessary accessories are supplied with it.—Radio-Craft

NEW HEARING-AID

Western Electric Company, Inc.
195 Broadway, New York, N. Y.

THIS instrument is a tone-compensated vacuum-tube hearing-aid which should prove a boon to all hard-of-hearing persons. Tones heard very poorly may be greatly re-enforced and those heard fairly well may be amplified only a small amount. Thus the "Ortho-tronic Audiophone" can compensate for individual types of hearing deficiency. Also, at the throw of a switch, annoying extraneous noises fade out while essential

**MR. SERVICEMAN:
Your Dollar Buys a Lot When
You Use It to Join the RSA!**



It entitles you to membership in the only national organization of servicemen that has the sponsorship of the RMA, the NAB, the Sales Managers Clubs, and the trade journals.

It entitles you to receive the house organ, the RSA membership certificate, and the RSA pocket membership card.

It gives access to the RSA Technical Helps Bureau, and enables you to participate in all functions and

benefits the RSA offers.

It enables you to exchange ideas with thousands of good servicemen who are already members of the RSA.

Protected territories will be established as rapidly as local chapters are formed. Applicants in present chapter areas will be referred to the local chapter. Fill out the coupon, attach a \$1.00 bill and mail it in today.

Don't Be the Last Man in Your Neighborhood to Join the RSA

RADIO SERVICEMEN OF AMERICA, INC.

"Reliable Service Assured"

**JOE MARTY, JR., EXECUTIVE SECRETARY
304 S. DEARBORN ST., CHICAGO, ILLINOIS**

**RADIO SERVICEMEN OF AMERICA, INC.
304 S. Dearborn Street, Chicago, Illinois**

\$1.00 enclosed for 1941 National Dues in RSA.

Name

Address

City State

Radio-Craft—June

• LATEST RADIO APPARATUS •

speech sounds pass unhampered. An audio A.V.C. circuit builds up weak sounds and acts less on strong ones, thus reducing the "shock effect" of loud sounds.

There are 2 outstanding circuit features; namely, the miniature pentode vacuum tube and the "stabilized feedback" circuit. The sensitive crystal microphone is sealed in the amplifier case which is slightly larger than a cigarette case. The receiver is of the magnetic type and may be had in either air conduction or bone conduction models. It is easily concealed underneath wearing apparel; its batteries are contained in a separate case.—*Radio-Craft*

3 IN 1 "PERSONAL" PORTABLE

Lafayette Radio Corp.
100 Sixth Ave.
New York, N. Y.



THIS ultra-midget "personal" portable can be used with its self-contained batteries or on the 110 V. A.C. and/or D.C. line. Including the rectifier tube, it employs 5 tubes and operates on the standard broadcast band. The set is highly attractive in its genuine leather-covered case. Overall dimensions are 9 ins. high, 6 ins. wide and 3 3/4 ins. deep. Uses 3 standard flashlight cells and one 67 1/2 V. "B" battery. Its weight is approximately 6 lbs.—*Radio-Craft*

LOOP-ANTENNA ATTACHMENT

RCA Mfg. Company
Camden, N. J.

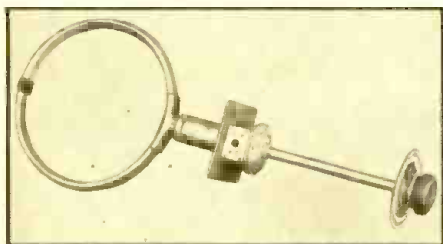

A NEW loop antenna designed as an aural-null direction finding attachment for RCA models AVR-7D, -E, -F, -G, and -H Aircraft Receivers. The loop is available in either remote or local control forms and will operate as a direction finder on the Beacon band (195-420 kc.), or on the Beacon and Broadcast bands (195-420, and 459-1,400 kc.). Designed for civilian aircraft.

The antenna makes possible accurate direction finding for the civilian pilot. The electrostatic shielding and balanced windings of the loop materially reduce precipitation static and allow clearer reception of weak signals.

Double-ended pointers are used on the indicators. One end shows the bearing to which the loop is rotated while the other indicates the calibration correction for the bearing being taken. These corrections may be inscribed directly in a blank space pro-

vided on the azimuth scale. The entire loop is weatherproofed. Its neoprene insulation is oil- and gasoline-proof.—*Radio-Craft*

RADIAL LOUDSPEAKER

University Laboratories
195 Chrystie St., New York, N. Y.



THE model 2RYR is a new "bull" type radial 360° loudspeaker, having a very high power handling capacity. It is of the long exponential reflex driver unit design for high efficiency.

A multiple acoustic throat is used to adapt the high-power driver units to the horn. The driver units are housed in a weatherproof cover as illustrated. The speaker can handle 50 watts efficiently. Of especial use for high-power chime systems, and paging and announcing systems, circuses, etc. Bell diameter is 26 ins., height 32 ins.—*Radio-Craft*

"CIN-AXIAL" DUAL SPEAKER SYSTEM

Cinaudagraph Speaker, Inc.
2 Selleck St., Stamford, Conn.

THIS system comprises a 12-inch "woofer," a 5-inch "tweeter," and a complete crossover network. It is designed for use in high-fidelity phonograph equipment for commercial, professional and home use as well as for F.M. receivers. Its frequency response is said to be "flat" from 30 to 12,000 c.p.s. Its useful range is reported as being in excess of 12,000 c.p.s.—*Radio-Craft*

3-WAY PORTABLE

Allied Radio Corp.
833 W. Jackson Blvd., Chicago, Ill.



MODEL B17115 is a 6-tube superhet. 3-way portable measuring 12 3/4 x 9 3/4 x 6 1/2 ins. It uses the latest 1.4 volt low-drain tubes which assures long life to battery operation. In addition to operation on self-contained batteries, it may be used on any 110-120 V., A.C./D.C. line.

Has built-in loop antenna, P.M. dynamic speaker, and a stage of R.F. (for added sensitivity). Tuning range: 540 to 1,650 kc. Average battery service: 200 to 250 hours.—*Radio-Craft*

REFLEX PROJECTOR

Atlas Sound Corporation
1449 39th St., Brooklyn, N. Y.



MODEL DR-54 is an intermediate size (4 1/2 ft.) "Morning Glory" reflex projector with a bell opening of 25 ins. Its effective air column is 54 ins. The "dynamic reflex design" reduces the overall length of the double re-entrant trumpet to 23 1/2 ins. This new size is excellent for general P.A. applications.—*Radio-Craft*

LIGHTWEIGHT MOBILE AMPLIFIER

Thordarson Electric Mfg. Co.
500 W. Huron St., Chicago, Ill.

BECAUSE this 6-volt mobile amplifier weighs only 20 lbs., it is conveniently portable and may be used for a variety of P.A. applications. It is a compact unit measuring only 13 1/2 x 7 1/2 x 7 1/4 ins. Some of its suggested uses are for military drilling fields, athletic fields, parade grounds and outdoor relays. It is also well suited for use in police cars, fire-fighting trucks, etc. The amplifier, known as Model T-30W12, has several output impedances available at the turn of a simple rotary selector switch. A standby switch permits immediate operation without the necessity of waiting until the filaments are heated.—*Radio-Craft*

SIGNAL GENERATOR

Radex Corporation
1733 Milwaukee Avenue, Chicago, Ill.

AN inexpensive Signal Generator and Station Finder, which can be conveniently used for resetting pushbuttons, is the model B2. It is a compact unit measuring 6 1/2 x 4 1/2 ins. square, and is light in weight (4 1/4 lbs. with self-contained battery). The instrument is designed to cover the broadcast band (500 to 1,750 kc.) and puts out either a modulated or unmodulated signal at the throw of a switch. The dial is calibrated and requires no reference charts. The circuit of the instrument is here shown; a grid-blocking electron-coupled type of oscillator circuit is employed.—*Radio-Craft*

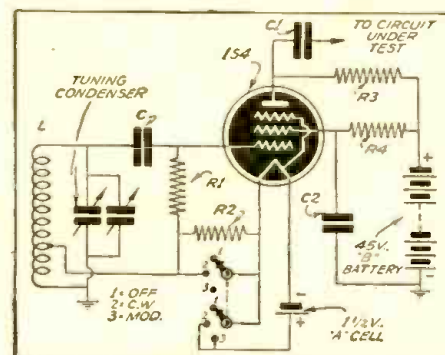

Where to Buy It! —

CLASSIFIED RADIO DIRECTORY

Handy Buying Guide, by Products and Manufacturers' Names and Addresses, for the Entire Radio Industry

There is no charge for regular light-face listings in the Classified Radio Directory. However, if dominant bold-face listings are desired, we make a charge of \$2 for concern names and \$1 for trade names for each bold-face listing. Please write to the Advertising Dept., Radio-Craft, 20 Vesey St., New York, N. Y., for details.

This DIRECTORY is published in sections—1 section per month. This method of publication permits the DIRECTORY to be constantly up-to-date since necessary revisions and corrections can be made monthly. All names preceded by an asterisk (*) indicate that they are trade names.

If you cannot find any item or manufacturer in this section or in previously-published sections, just drop us a line for the information. Canadian radio manufacturers are unable to purchase any merchandise from the States, Radio-Craft is advised. Our readers, however, may wish to make Canadian purchases, and hence, current listings are being continued.

Presented here is Section III of the completely revised Second Edition of the CLASSIFIED RADIO DIRECTORY.

While every precaution is taken to insure accuracy, Radio-Craft cannot guarantee against the possibility of occasional errors and omissions in the preparation of this Classified Directory. Manufacturers and readers are urged to report all errors and omissions at the earliest moment to insure corrections in the very next issue.

INSULATION



Ceramics	CE
Fibre	FB
Fiber-glass	FL
Insulation cases	IC
Mica	MI
Mycalex	MX
Paper	PA
Plastics	PI
Polystyrene	PO
Rubber (hard and/or soft)	RU
Rubber (liquid)	RL
Rubber (synthetic)	RS
Sleeving (saturated)	SS
Sleeving (untreated)	SU
Stand-off insulators	ST
Tape (cloth friction)	T
Tape (rubber)	R
Tubing "spaghetti" (varnished)	TV
Varnished cambric	V
Waxes	W

*AC—National Company, Inc.
 THE ACME WIRE CO., 1255 Dixwell Ave., New Haven, Conn.—V
 *AIRLINE—Montgomery Ward & Co., Inc.
 AKRON PORCELAIN CO., Akron, Ohio—CE, ST
 ALDEN PRODUCTS CO., 715 Center St., Brockton, Mass.—FB, PI, ST
 ALLIED RADIO CORP., 833 W. Jackson Blvd., Chicago, Ill.—*Knight—FL, R, ST, T
 *ALLIGATOR—Porcelain Products, Inc.
 ALPHA WIRE CORP., 50 Howard St., New York, N. Y.—TV
 *AISIMAG—American Lava Corp.
 AMERICAN LAVA CORP., Cherokee Blvd. & Manufacturers Rd., Chattanooga, Tenn.—*AISIMAG, "Lava"—CE, ST
 AMERICAN PHENOLIC CORP., 1250 W. Van Buren St., Chicago, Ill.—CE, PI, PO, ST
 AMERICAN RADIO HARDWARE CO., INC., 476 Broadway, New York, N. Y.—CE, PI, RU, ST
 *ANTENNEX—M. M. Fleron & Son, Inc.
 ANCHOR WEBBING CO., P.O. Box 555, Pawtucket, R. I.—SS, SU, T, TV, V
 AUBURN BUTTON WORKS, INC., Auburn, N. Y.—PI
 BAKELITE CORPORATION, 30 E. 42nd St., New York, N. Y.—PI
 BARKER & WILLIAMSON, Ardmore, Pa.—CE, PI, ST
 BENTLEY HARRIS MFG. CO., Conshohocken, Pa.—*B.H.—TV
 *B.H.—Bentley, Harris Mfg. Co.
 BIRNBACH RADIO CO., Inc., 145 Hudson St., New York, N. Y.—*Birnbach—CE, FL, ST
 *BIRNBACH—Birnbach Radio Co., Inc.
 CARBIDE & CARBON CHEMICALS CORP., 30 E. 42nd St., New York, N. Y.—PI
 BOND PRODUCTS CO., 13139 Hamilton Ave., Detroit, Mich.—TV
 BOONTON MOLDING CO., 326 Myrtle Ave., Boonton, N. J.—PI
 L. S. BRACH MFG. CORP., 55 Dickerson St., Newark, N. J.—ST
 BUD RADIO, INC., 5205 Cedar Ave., Cleveland, Ohio—PI, ST
 CELLULOID CORP., 180 Madison Ave., New York,

N. Y.—*Lumarith, "Lumarith Protectoid", "Celluloid"—PI
 *CELLULOID—Celluloid Corp.
 CONTINENTAL-DIAMOND FIBRE CO., Newark, Del.—FB, MI, PI
 CORNING GLASS WORKS, Corning, N. Y.—ST
 CORNISH WIRE CO., INC., 15 Park Row, New York, N. Y.—FB, FL, PA
 HENRY L. CROWLEY & CO., INC., 1 Central Ave., W. Orange, N. J.—CE
 CRUMPACKER DISTRIB. CORP., 1801 Fannin St., Houston, Tex.—R, T
 HAROLD DAVIS, INC., 428 W. Capitol St., Jackson, Miss.—ST, T
 DOW RADIO SUPPLY CO., 1759 E. Colorado St., Pasadena, Calif.—CE, FB, FL, MI, PA, R, ST, T, TV, V
 E. I. DU PONT DE NEMOURS & CO., INC., 626 Schuyler Ave., Arlington, N. J.—PI
 *ELECTRAMIC INSULATORS—Stupakoff Ceramic & Mfg. Co.
 EMPIRE NOTION CO., 105 E. 29th St., New York, N. Y.—T, TV, V
 ERIE RESISTOR CORP., 644 W. 12th St., Erie, Pa.—PI
 FEDERAL SCREW PRODUCTS CO., 24 S. Jefferson St., Chicago, Ill.—R, T, TV
 FEDERATED PURCHASER, INC., 80 Park Pl., New York, N. Y.—CE, FB, FL, MI, R, ST, T, TV
 FISCHER DISTRIB. CORP., 222 Fulton St., New York, N. Y.—CE, FB, FL, MI, PA, PI, R, ST, T, TV, V
 *FLERON—M. M. Fleron & Son, Inc.
 M. M. FLERON & SON, INC., 113 N. Broad St., Trenton, N. J.—*Antennex, "Fleron", "Safest", "Signaler"—ST
 FONDA CORPORATION, 29 W. 57th St., New York, N. Y.—FB
 THE FORMICA INSULATION CO., 4614 Spring Grove Ave., Cincinnati, Ohio—PI
 GENERAL CEMENT MFG. CO., 919 Taylor Ave., Rockford, Ill.—FB, PI, R, T, TV, V
 GENERAL CERAMICS CO., PLANT NO. 3, Keasbey, N. J.—CE, ST
 GENERAL ELECTRIC CO., 1 River Rd., Schenectady, N. Y.—CE, MY, PA, PI, TV, V
 B. F. GOODRICH CO., 500 S. Main St., Akron, Ohio—PI, R, RS
 CARL GORR PRINTING CO., 1801 W. Byron St., Chicago, Ill.—PA
 HAMMARLUND MFG. CO., INC., 424 E. 33rd St., New York, N. Y.—ST
 HARRISON RADIO CO., 12 W. Broadway, New York, N. Y.—CE, FL, R, ST, T, TV, V
 HOPE WEBBING CO., P.O. Box 1495, Providence, R. I.—FL
 IMPERIAL MOLDED PRODUCTS CORP., 2925 W. Harrison St., Chicago, Ill.—PI
 INSULATION MANUFACTURERS CORP., 565 W. Washington Blvd., Chicago, Ill.—FB, FL, MI, PA, R, T, TV, V
 INSULATION PRODUCTS CO., 504 N. Richland St., Pittsburgh, Pa.—PI
 INSULINE CORP. OF AMERICA, 30-30 Northern Blvd., Long Island City, N. Y.—CE, FB, PI, ST, TV, V
 E. F. JOHNSON CO., Waseca, Minn.—CE, ST
 KELLOGG SWITCHBOARD & SUPPLY CO., 6650 S. Cicero Ave., Chicago, Ill.—T
 *KNIGHT—Allied Radio Corp.
 LAFAYETTE RADIO CORP., 100 6th Ave., New York, N. Y.—CE, FB, MI, PA, PI, R, ST, T, TV, V
 *LAVA, American Lava Corp.
 *LUMARITH, Celluloid Corp.
 *LUMARITH PROTECTOID, Celluloid Corp.
 MICA INSULATOR CO., 200 Varick St., New York, N. Y.—FB, FL, MI, MP, PA, PI, TV, V
 JAMES MILLEN MFG. CO., INC., 150 Exchange St., Malden, Mass.—CE, PI, ST
 MITCHELL-RAND INSULATION CO., INC., 51 Murray St., New York, N. Y.—FL, TV

MONTGOMERY WARD & CO., INC., 619 W. Chicago Ave., Chicago, Ill.—*Airline—CE, R, ST, T, TV
 NATIONAL COMPANY, INC., 61 Sherman St., Malden, Mass.—*National, "AC"—CE, FB, PI, ST
 *NATIONAL, National Company, Inc.
 NATIONAL VULCANIZED FIBRE CO., P. O. Box 311, Wilmington, Del.—FB, PI
 NORTHERN ELECTRIC CO., LTD., 1261 Shearer St., Montreal, Que., Canada—R, ST, T, V
 OFFENBACH ELECTRIC CO., 1452 Market St., San Francisco, Calif.—CE, FB, MI, PA, PI, R, ST, T, TV, V
 PARISIAN NOVELTY CO., 3510 S. Western Ave., Chicago, Ill.—PI
 GEORGE F. PETTINOS, INC., 1206 Locust St., Phila., Pa.—FB
 POINSSETIA, INC., 97 Cedar Ave., Pitman, N. J.—PI
 PORCELAIN PRODUCTS, INC., P. O. Box 300, Findlay, Ohio—*Alligator—ST
 PREMAX PRODUCTS DIV., CHISHOLM-RYDER CO., INC., Drawer F, Bridge Sta., Niagara Falls, N. Y.—ST
 RADIO ELECTRIC SERVICE CO., INC., N.W. Cor. 7th & Arch Sts., Phila., Pa.—CE, FL, MI, PI, R, ST, T, V
 RADIO EQUIPMENT CO., 326 Elm St., Buffalo, N. Y.—CE, FB, R, ST, T, TV, V
 RADOLEK COMPANY, 601 W. Randolph St., Chicago, Ill.—R, ST, T, TV, V
 THE RICHARDSON CO., Melrose Park, Chicago, Ill.—MI, PI, RU
 *SAFTEST, M. M. Fleron & Son, Inc.
 MAURICE SCHWARTZ & SON, 710 Broadway, Schenectady, N. Y.—CE, FB, FL, MI, PA, PI, R, ST, T, TV, V
 SEATTLE RADIO SUPPLY CO., INC., 2117 2nd Ave., Seattle, Wash.—CE, PA, PI, R, ST, T, TV, V
 SELF-VULCANIZING RUBBER CO., INC., 605 W. Washington, Chicago, Ill.—PI, RL
 SHELLEY RADIO CO., 1841 S. Flower St., Los Angeles, Calif.—FL, R, ST, T, TV
 *SIGNALER, M. M. Fleron & Son, Inc.
 STUPAKOFF LABORATORIES, INC., 6627 Hamilton Ave., Pittsburgh, Pa.—*Electramic Insulators—CE
 SUN RADIO CO., 212 Fulton St., New York, N. Y.—CE, FB, FL, PA, PI, R, ST, T, TV, V
 TAYLOR FIBRE CO., Norristown, Pa.—FB, PI
 TELERADIO ENGINEERING CORP., 484 Broome St., New York, N. Y.—CE, FB, MI, PI, TV
 UNION ELECTRICAL PORCELAIN WORKS, INC., P. O. Box 762, Trenton, N. J.—CE
 THE WATERBURY BUTTON CO., Waterbury, Conn.—PI
 WESTINGHOUSE ELEC. & MFG. CO., E. Pittsburgh, Pa.—FL, MI, PA, PI, T, TV, V
 ZOPHAR MILLS, INC., 112 26th St., Brooklyn, N. Y.—PI, W

INTERCOMMUNICATING SYSTEMS



Aircraft	A
Wired	I
Wireless	IL

*AIRLINE—Montgomery Ward & Co., Inc.
 ALLIED RADIO CORP., 833 W. Jackson Ave., Chicago, Ill.—*Knight—PI
 AMERICAN TELEVISION CORP., 130 W. 56th St., New York, N. Y.—I, IL

Please say you saw it in the Radio-Craft "Classified Radio Directory"

CLASSIFIED RADIO DIRECTORY

ATLAS SOUND CORP., 1451 39th St., Brooklyn, N. Y.—I
 AUTOCRAT RADIO CO., 3855 N. Hamilton Ave., Chicago, Ill.—I, "Autocrat"—I
 *AUTOCRAT—Autocrat Radio Co.
BANK'S MANUFACTURING CO., 5019 N. Winthrop Ave., Chicago, Ill.—I, IL
 BARKER & WILLIAMSON, Ardmore, Pa.—I, IL
 BELL SOUND SYSTEMS, INC., 1183 Essex Ave., Columbus, Ohio—I
 BIRNBACH RADIO CO., INC., 145 Hudson St., New York, N. Y.—I, "Birnbach"—I
 *BIRNBACH—Birnbach Radio Co., Inc.
 DAVID BOGEN CO., 663 Broadway, New York, N. Y.—I, IL
 *CLARION—Transformer Corp. of America
 COMMUNICATIONS INC., 3215 Western Ave., Seattle, Wash.—I, "Commun-O-Phone," "Incriminator," "Electro-Phone"—I
 *COMMUN-O-PHONE—Communications, Inc.
 *CO-RECHT—Electronic Sound & Music Co.
 CRUMPACKER DISTRIB. CORP., 1801 Fannin St., Houston, Tex.—I
 HAROLD DAVIS, INC., 428 W. Capitol St., Jackson, Miss.—I, IL
 DEVRY CORPORATION, 1111 Armitage Ave., Chicago, Ill.—I
 *DICTAFILM—Miles Reproducer Co., Inc.
 ELECTRONIC CONTROL CORP., 2667 E. Grand Blvd., Detroit, Mich.—I
 ELECTRONIC SOUND & MUSIC CO., 10 Stuyvesant St., New York, N. Y.—I, "Co-Recht"—I
 *ELECTRO-PHONE—Communications, Inc.
 ELKAY MFG. CORP., 200 5th Ave., New York, N. Y.—I
 EXECUTONE, INC., 415 Lexington Ave., New York, N. Y.—I
 FEDERATED PURCHASER, INC., 80 Park Pl., New York, N. Y.—I, IL
 *FILMGRAPH—Miles Reproducer Co., Inc.
 FISHER RESEARCH LABORATORY, 1961 University Ave., Palo Alto, Calif.—IL
 HARRISON RADIO CO., 12 W. Broadway, New York, N. Y.—I, IL
 FISCHER DISTRIB. CORP., 222 Fulton St., New York, N. Y.—IL
 GUIDED RADIO CORP., 118 E. 25th St., New York, N. Y.—I, IL
 *INCRIMINATOR—Communications, Inc.
 INTERCALL SYSTEMS, INC., 5th & Norwood, Dayton, Ohio—I
 KELLOGG SWITCHBOARD & SUPPLY CO., 6650 S. Cicero Ave., Chicago, Ill.—I
 *KNIGHT—Allied Radio Corp.
 LAKE MFG. CO., INC., 2323 Chestnut St., Oakland, Calif.—I, "Voycall," "Lake"—I
 *LAKE—Lake Mfg. Co., Inc.
 LAFAYETTE RADIO CORP., 100 6th Ave., New York, N. Y.—I
 LEKTRA LABORATORIES, INC., 30 E. 10th St., New York, N. Y.—I
 MAJESTIC RADIO & TELEVISION CORP., 2600 W. 50th St., Chicago, Ill.—I, IL
 JOHN MECK INDUSTRIES, 1313 Randolph St., Chicago, Ill.—I
 MILES REPRODUCER CO., INC., 812 Broadway, New York, N. Y.—I, "Filmgraph," "Dictafilm"—I, IL
 MISSION BELL RADIO MFG. CO., INC., 831 Venice Blvd., Los Angeles, Calif.—I
 MONTGOMERY WARD & CO., INC., 619 W. Chicago Ave., Chicago, Ill.—I, "Airline"—I
 MUSIC MASTER MFG. CO., 508 S. Dearborn St., Chicago, Ill.—I
 NORTHERN ELECTRIC CO. LTD., 1261 Shearer St., Montreal, Que., Canada—I, IL
 OFFENBACH ELECTRIC CO., 1452 Market St., San Francisco, Calif.—I, IL
 OPERADIO MFG. CO., St. Charles, Ill.—I
 PACENT ENGINEERING CORP., 79 Madison Ave., New York, N. Y.—I
 PHILCO RADIO & TELEVISION CORP., Tioga & "C" Sts., Phila., Pa.—I
 PHONOTONE LABORATORIES, INC., S. E. 15th & State Sts., Washington, Ind.—I
RADIO ELECTRIC SERVICE CO., INC., N.W. Cor. 7th & Arch Sts., Phila., Pa.—I, IL
 RADIO EQUIPMENT CO., 326 Elm St., Buffalo, N. Y.—I, IL
 RADIO RECEPTOR, INC., 251 W. 19th St., New York, N. Y.—I
 RADOLEK COMPANY, 601 W. Randolph St., Chicago, Ill.—I
 RAY-LAB COMPANY, Grand Central & 11th Sts., Elmira Hts., N. Y.—I, "Ray-Lab"—I
 *RAY-LAB—Ray-Lab Company
 RCA MANUFACTURING CO., INC., Camden, N. J.—I, IL
 REGAL AMPLIFIER MFG. CORP., 14 W. 17th St., New York, N. Y.—I, IL
 REMLER CO. LTD., 2101 Bryant St., San Francisco, Calif.—I
 ROGERS-MAJESTIC CORP. LTD., 622 Fleet St., Toronto, Ont., Canada—I
 SEATTLE RADIO SUPPLY CO., INC., 2117 2nd Ave., Seattle, Wash.—I, IL
 SETCHELL CARLSON, INC., 2233 University Ave., St. Paul, Minn.—I

S.O.S. CINEMA SUPPLY CORP., 636 11th Ave., New York, N. Y.—I
 SUN RADIO CO., 212 Fulton St., New York, N. Y.—I, IL
 TALK-A-PHONE MFG. CO., 1219 W. Van Buren St., Chicago, Ill.—I
 TAYLOR AIRPHONE PROD., INC., Long Beach Municipal Airport, Long Beach, Calif.—A
 TELEMOTOR CORP., 260 5th Ave., New York, N. Y.—I
 TELERADIO ENG. CORP., 484 Broome St., New York, N. Y.—IL
 TELEX PRODUCTS CO., 1645 Hennepin Ave., Minneapolis, Minn.—I
 TELEFAIR TELEPHONE CORP., 62 Standish Ave., W. Orange, N. J.—I
 TRANSFORMER CORP. OF AMERICA, 69 Wooster St., New York, N. Y.—I, "Clarion"—I
 TRANSMARINE RADIO, INC., 1184 Broadway, Hewlett, L. I., N. Y.—I, IL
 UNITED SCIENTIFIC LAB., INC., 440 Lafayette St., New York, N. Y.—I
 VICTOR ANIMATOGRAPH CORP., Davenport, Iowa—I
 *VOYCALL—Lake Mfg. Co., Inc.
 WEBSTER-CHICAGO CORP., 5622 W. Bloomingdale Ave., Chicago, Ill.—I
WEBSTER ELECTRIC CO., Clark & DeKanen Ave., Racine, Wis.—I
 WESTERN SOUND & ELECTRIC LABS., INC., 311 W. Kilbourn Ave., Milwaukee, Wis.—I, IL

*BROWN DEVILS—Ohmite Manufacturing Co.
 BUD RADIO, INC., 5205 Cedar Ave., Cleveland, Ohio—RF
 CANADIAN MARCONI CO., 211 St. Sacramento St., Montreal, Can.—PF, RF
 CONSOLIDATED WIRE & ASSOCIATED CORP., 512 S. Peoria St., Chicago, Ill.—RF
 CONTINENTAL CARBON, INC., 13900 Lorain Ave., Cleveland, Ohio—PF, RF
 CORNELL-DUBILIER ELECTRIC CORP., S. Plainfield, N. J.—PF, RF
 CRUMPACKER DISTRIB. CORP., 1801 Fannin St., Houston, Tex.—PF, RF
 *DETERMÖHM—Ohmite Manufacturing Co.
 TOBE DEUTSCHMANN CO., Canton, Mass.—PF, RF
 DOW RADIO SUPPLY CO., 1759 E. Colorado St., Pasadena, Calif.—PF, RF
ELECTRO PRODUCTS LABS., 549 W. Randolph St., Chicago, Ill.—PF, RF
 FEDERATED PURCHASER, INC., 80 Park Pl., New York, N. Y.—PF, RF
 FERGUSON RADIO, INC., 14553 Madison Ave., Lakewood, Ohio—RF
 FISCHER DISTRIB. CORP., 222 Fulton St., New York, N. Y.—PF, RF
 *FLERON—M. M. Fleron & Son, Inc.
 M. M. FLERON & SON, INC., 113 N. Broad St., Trenton, N. J.—I, "Antennex," "Fleron," "Safest," "Signaler"—RF
 GIRARD-HOPKINS, 1000 40th Ave., Oakland, Calif.—RF
 GUIDED RADIO CORP., 118 E. 25th St., New York, N. Y.—PF
 HARRISON RADIO CO., 12 W. Broadway, New York, N. Y.—PF, RF
 HERBERT H. HORN, 1201 S. Olive St., Los Angeles, Calif.—PF
 INSULINE CORP. OF AMERICA, 30-30 Northern Blvd., Long Island City, N. Y.—PF, RF
 KELLOGG SWITCHBOARD & SUPPLY CO., 6650 S. Cicero Ave., Chicago, Ill.—PF
 KENYON TRANSFORMER CO., INC., 840 Barry St., New York, N. Y.—PF
 *KNIGHT—Allied Radio Corp.
 *KOOLOHMS—Sprague Products Co.
 LAFAYETTE RADIO CORP., 100 6th Ave., New York, N. Y.—PF, RF
 M & H SPORTING GOODS CO., 512 Market St., Phila., Pa.—PF, RF
 P. R. MALLORY & CO., INC., 3029 E. Washington St., Indianapolis, Ind.—PF, RF
 MEISSNER MANUFACTURING CO., Mt. Carmel, Ill.—RF
 *MILLER—J. W. Miller Co.
 J. W. MILLER COMPANY, 5917 S. Main St., Los Angeles, Calif.—I, "Miller Quality Products," "Miller"—PF, RF
 *MILLER QUALITY PRODUCTS—J. W. Miller Co.
 MONTGOMERY WARD & CO., INC., 619 W. Chicago Ave., Chicago, Ill.—I, "Airline"—PF, RF
 *MULTIVOLTS—Ohmite Manufacturing Co.
 MUSIC MASTER MFG. CO., 508 S. Dearborn St., Chicago, Ill.—PF, RF
 NORTHERN ELECTRIC CO. LTD., 1261 Shearer St., Montreal, Que., Can.—PF, RF
 OFFENBACH ELECTRIC CO., 1452 Market St., San Francisco, Calif.—PF, RF
 OHMITE MANUFACTURING CO., 4835 W. Flournoy St., Chicago, Ill.—I, "Ohmite," "Brown Devils," "Multivolts," "Determinohm," "Riteohm"—PF, RF
 *OHMITE—Ohmite Manufacturing Co.
 PACENT ENGINEERING CORP., 79 Madison Ave., New York, N. Y.—PF, RF
 PHILCO RADIO & TELEVISION CORP., Tioga & "C" Sts., Phila., Pa.—PF, RF
 PHILMORE MFG. CO., INC., 113 University Pl., New York, N. Y.—RF
RADIO ELECTRIC SERVICE CO., INC., N.W. Cor. 7th & Arch Sts., Phila., Pa.—PF, RF
 RADIO EQUIPMENT CORP., 326 Elm St., Buffalo, N. Y.—PF, RF
 RADOLEK COMPANY, 601 W. Randolph St., Chicago, Ill.—PF, RF
 *RITEOHM—Ohmite Manufacturing Co.
 *SAFTEST—M. M. Fleron & Son, Inc.
 MAURICE SCHWARTZ & SON, 710-712 Broadway, Schenectady, N. Y.—PF, RF
 SEATTLE RADIO SUPPLY CO., INC., 2117 2nd Ave., Seattle, Wash.—PF, RF
 *SIGNALER—M. M. Fleron & Son, Inc.
 *600 LINE—Sprague Products Co.
 SOLAR MANUFACTURING CORP., 25th St. & Ave. "A", Bayonne, N. J.—PF, RF
 SPRAGUE PRODUCTS CO., No. Adams, Mass.—I, "600 Line," "Atoms," "Koolohms," "Telohmike"—PF, RF
 STROMBERG-CARLSON TELEPHONE MFG. CO., 100 Carlson Rd., Rochester, N. Y.—RF
 SUN RADIO CO., 212 Fulton St., New York, N. Y.—PF, RF
 TAYLOR AIRPHONE PRODUCTS, INC., Long Beach Municipal Airport, Long Beach, Calif.
 TECHNICAL APPLIANCE CORP., 17 E. 16th St., New York, N. Y.—RF
 *TELOHMIKE—Sprague Products Co.
 UNITED TRANSFORMER CORP., 150 Varick St., New York, N. Y.—PF
 VOGUE PRODUCTS CO., 8420 S. Ashland Ave., Chicago, Ill.—RF

KITS



Amplifier	A
Electronic	EL
Experimental	E
Facsimile	F
Flocking	FL
Receiving	R
Sound effects	S
Television	T
Test equipment	TE

AMERICAN RADIO HARDWARE CO., INC., 476 Broadway, New York, N. Y.—F
 AMPLIFIER CO. OF AMERICA, 17 W. 20th St., New York, N. Y.—A
 AUDIO DEVICES, INC., 1600 Broadway, New York, N. Y.—S
 CARRON MANUFACTURING CO., 415 S. Aberdeen St., Chicago, Ill.—R
 THE CROSLLEY CORPORATION, Cincinnati, Ohio—F
 FLOCK PROCESS CORP., 17 W. 31st St., New York, N. Y.—FL
 MIDLAND RADIO & TELEVISION SCHOOLS, INC., Power & Light Bldg., Kansas City, Mo.—E, T
 RADIO CITY PRODUCTS CO., INC., 88 Park Pl., New York, N. Y.—TE
 RADOLEK COMPANY, 601 W. Randolph St., Chicago, Ill.—F
 RCA MANUFACTURING CO., INC., Camden, N. J.—S
 WILCOX ELECTRIC CO., INC., 40th & State Line, Kansas City, Mo.—F
 WORNER PRODUCTS CORP., 1019 W. Lake St., Chicago, Ill.—EL

KNOBS (see Dials & Parts) LINE FILTERS

(Also see Noise Elimination Equipment)



Power filters (industrial)	PF
Radio set (for the home)	RF

AEROVOX CORPORATION, New Bedford, Mass.—RF
 *AIRLINE—Montgomery Ward & Co., Inc.
 ALLIED RADIO CORP., 833 W. Jackson Blvd., Chicago, Ill.—I, "Knight"—PF, RF
AMERICAN CONDENSER CORP., 2508 S. Michigan, Chicago, Ill.—PF, RF
 AMERICAN COMMUNICATIONS CORP., 123 Liberty St., New York, N. Y.—PF, RF
 AMPLIFIER CO. OF AMERICA, 17 W. 20th St., New York, N. Y.—PF
 *ANTENNEX—M. M. Fleron & Son, Inc.
 *ATOMS—Sprague Products Co.
 BARKER & WILLIAMSON, Ardmore, Pa.—PF
BELDEN MANUFACTURING CO., 4647 W. Van Buren St., Chicago, Ill.—RF

Please say you saw it in the Radio-Craft "Classified Radio Directory"

For Better Servicing - For Bigger Profits—

FOR A WIDER KNOWLEDGE OF TECHNICAL SUBJECTS, READ THE

BOOKS IN THE RADIO-CRAFT LIBRARY SERIES

GET into the swing of reading instructive, authoritative books on technical subjects—Radio, Air Conditioning and Refrigeration. The RADIO-CRAFT LIBRARY SERIES is the most complete set of volumes individually treating all important divisions in these fields. Each book has been written for the purpose of giving you the opportunity to specialize in one or more of the popular branches of the various subjects and we know of no easier, quicker or less expensive way to improve your knowledge. The material in each book is very helpful—you'll find them valuable in your work. The authors are all well known and are authorities on the subjects on which they have written. This is the first time that you are enabled to build a library of technical books by such popular writers.

ALL BOOKS ARE UNIFORM

The books in the RADIO-CRAFT LIBRARY SERIES are all uniform. The size is 6 x 9 inches. Each volume contains 64 pages and an average of 50 to 150 photographic illustrations and diagrams. The books are printed on an excellent grade of book paper and have stiff flexible covers. PRICE 50c PER BOOK. All books are sent postpaid.

 <p>Book No. 13 ABC OF AIR CONDITIONING An accurate simplified technical review of the fundamentals of this latest branch of engineering, including servicing data on present-day units. By Paul D. Harrigan. 50c</p>	 <p>Book No. 17 SERVICING WITH SET ANALYZERS A Study of the Theory and Proper Application of Modern Set Analyzers and Associated Apparatus. By H. G. McEntee. 50c</p>	 <p>Book No. 21 BREAKING INTO RADIO SERVICING Simple Instructions and Procedure for Starting a Profitable Radio Servicing Business of Your Own. By Robert Eichberg. 50c</p>
 <p>Book No. 14 POCKET RADIO GUIDE Edited by N. H. Lessem. Handy Reference Book for Radio Men—Set Construction Articles—Audio Amplifier Circuits—Useful Radio Formulas and Data—Handy Short-Cuts. 50c</p>	 <p>Book No. 18 POINT-TO-POINT RESISTANCE ANALYSIS For Service Men Theory—and Application of this Modern Test Procedure to Everyday Radio Service Problems. By Bertram M. Freed. 50c</p>	 <p>Book No. 22 NEW RADIO QUESTIONS AND ANSWERS Answers to Questions Most Frequently Asked by Both Novices and Experts. By Robert Eichberg. 50c</p>
 <p>Book No. 15 ABC OF REFRIGERATION A carefully written volume, starting with the basic principles of refrigeration by mechanical means, and leading up to a complete analysis of the servicing of commercially available units. By Trafton Mason. 50c</p>	 <p>Book No. 19 PRACTICAL RADIO KINKS AND SHORT CUTS The contents of this book have been planned with the view to help Radio Dealers, Servicemen, Experimenters and Set Builders. By B. Baker Bryant. 50c</p>	 <p>Book No. 23 PRACTICAL PUBLIC ADDRESS Modern Methods of Servicing and Installing Public Address Equipment. By B. Baker Bryant. 50c</p>
 <p>Book No. 16 PRACTICAL RADIO CIRCUITS A Comprehensive Guide to All Types of Radio Circuits For the Serviceman, Constructor and Experimenter. By David Bellare. 50c</p>	 <p>Book No. 20 THE CATHODE-RAY OSCILLOSCOPE Theory and Function, Power Supplies and Associated Circuits, Sweep Circuits, Operation of Typical Unit, Methods of Measurement, Practical Applications of C-R Oscillographs. By Charles Sicuranza. 50c</p>	 <p>Book No. 24 AUTOMOBILE RADIO PRINCIPLES AND PRACTICE A Complete Treatise on the Subject Covering All Phases from Installing to Servicing and Maintenance. By B. Baker Bryant. 50c</p>

New titles are constantly being added to the RADIO-CRAFT LIBRARY SERIES. But, on the other hand, stocks of certain titles are running low, and they may not be reprinted for some time. We would therefore suggest that at this time you order as many different titles as you are interested in. Remember, that if you delay, some of the books may later be out of print.

USE THIS HANDY COUPON WHEN ORDERING

RADCRAFT PUBLICATIONS, Inc., 20 VESEY ST., NEW YORK, N. Y.
Gentlemen: Enclosed find my remittance of \$..... for which send me, POSTPAID, the Books indicated below.

RADIO-CRAFT LIBRARY SERIES @ 50c EACH
Circle book numbers wanted: 13 14 15 16 17 18 19 20 21 22 23 24

Name Address

City State

(Send remittance in form of check or money order; register your letter if you send cash or unused U. S. Postage Stamps.) RC-641

RADCRAFT PUBLICATIONS, Inc.
20 VESEY STREET NEW YORK, N. Y.

• CLASSIFIED RADIO DIRECTORY •

LOUDSPEAKERS (& PARTS)



Accessories	AC
Acoustic chambers	AC
Baffles	BA
Cones	CO
Cone speakers	CS
Electrodynamic speakers	ES
Field coils	FC
Field exciters	F
Grille cloths	G
Grilles (molded)	GM
Horns	H
Horns (weatherproof)	HW
Horn units	HU
Magnetic speakers	MS
Metal housings	M
Permanent-magnet dynamic speakers	PD
Pillow speakers	PS
Speaker cements	SC
Speaker shims	SS
Stands	S
Volume controls	VC

THE ACME WIRE CO., 1255 Dixwell Ave., New Haven, Conn.—FC
ALLIED RADIO CORP., 833 W. Jackson Blvd., Chicago, Ill., *"Knight"—A, BA, CO, ES, FC, F, G, H, MS, PD, S
 *AIRLINE—Montgomery Ward & Co., Inc.
 ALLISON BAFFLE CO., 207 S. 86th St., Birmingham, Ala.—AC, BA
 AMERICAN COMMUNICATIONS CORP., 123 Liberty St., New York, N. Y.—AC, BA, F
 AMERICAN PHENOLIC CORP., 1250 W. Van Buren St., Chicago, Ill.—A
 AMPLIFIER CO. OF AMERICA, 17 W. 20th St., New York, N. Y.—BA
 ARLAVOX MANUFACTURING CO., 430 S. Green St., Chicago, Ill.—MS
 ART SPECIALTY CO., 1115 N. Franklin St., Chicago, Ill.—A, BA, H, S
 ATLAS SOUND CORP., 1451 39th St., Brooklyn, N. Y.—A, AC, BA, CO, CS, ES, F, G, H, HW, HU, PD, S
 AUDIOGRAPH SOUND SYSTEMS, 1313 W. Randolph St., Chicago, Ill.—A, AC, BA, PD
 *AUTOCRAT—Autocrat Radio Co.
 AUTOCRAT RADIO CO., 3855 N. Hamilton Ave., Chicago, Ill., *"Autocrat"—PD
 BANK'S MANUFACTURING CO., 5019 N. Winthrop Ave., Chicago, Ill.—A, BA, ES, H, PD
 THE BENWOOD-LINZE CO., 1838 Washington Ave., St. Louis, Mo.—F
 DAVID BOGEN CO., 663 Broadway, New York, N. Y.—A, AC, BA, ES, PD, S
 CANADIAN MARCONI CO., 211 St. Sacrament St., Montreal, Can.—ES, MS, PD, S
 CANADIAN RADIO CORP., LTD., 622 Fleet St. W., Toronto, Ont., Can.—F, G
 CARRON MANUFACTURING CO., 415 S. Aberdeen St., Chicago, Ill.—CO, FC, G
 CASTLEWOOD MANUFACTURING CO., 12th Ave. & Burnett Sts., Louisville, Ky.—BA
CINAUDAGRAPH SPEAKERS, INC., 921 W. Van Buren St., Chicago, Ill.—CS, ES, HW, HU, MS, PD
 *CLARION—Transformer Corp. of America
 CRESCENT TOOL & DIE CO., 4140 Belmont Ave., Chicago, Ill.—ES, PD
 CRUMPACKER DISTRIB. CORP., 1801 Fannin St., Houston, Tex.—A, BA, CO, ES, FC, G, MS, PD, S
 *DICTAFILM—Miles Reproducer Co., Inc.
 HAROLD DAVIS, INC., 428 W. Capitol St., Jackson, Miss.—A, AC, BA, CO, ES, FC, F, G, H, MS, PD, S
 DOW RADIO SUPPLY CO., 1759 E. Colorado St., Pasadena, Calif.—A, BA, CO, FC, G, MS
 HUGH H. EBY, INC., 4700 Stenton Ave., Phila., Pa.—A
ELECTRO PRODUCTS LABS., 549 W. Randolph St., Chicago, Ill.—A, VC
 ERWOOD SOUND EQUIP. CO., 224 W. Huron St., Chicago, Ill.—AC, BA, H, PD, S
 FEDERATED PURCHASER, INC., 80 Park Pl., New York, N. Y.—A, AC, BA, CO, ES, FC, F, G, H, MS, PD, S
 *FILMGRAPH—Miles Reproducer Co., Inc.
 FISCHER DISTRIB. CORP., 222 Fulton St., New York, N. Y.—A, AC, BA, CO, ES, FC, F, G, H, MS, PD, S
 FLOCK PROCESS CORP., 17 W. 31st St., New York, N. Y.—G
 FONDA CORPORATION, 29 W. 57th St., New York, N. Y.—ES, PD
 GENERAL CEMENT MFG. CO., 919 Taylor Ave., Rockford, Ill.—A, G, SC, SS
 GENERAL ELECTRIC CO., Schenectady, N. Y. & Bridgeport, Conn.—PD

GLOBE PHONE MFG. CORP., Reading, Mass.—PD
 GUIDED RADIO CORP., 118 E. 25th St., New York, N. Y.—AC, BA, CO, FC, H, PD
 HARRISON RADIO CO., 12 W. Broadway, New York, N. Y.—A, AC, BA, CO, ES, FC, F, H, MS, PD, S
 HAWLEY PRODUCTS CO., 201 N. 1st Ave., St. Charles, Ill.—BA, CO, H
 A. G. HINTZE, 300 W. Adams St., Chicago, Ill.—G
 HERBERT H. HORN, 1201 S. Olive St., Los Angeles, Calif.—CO, G, H, MS, PD
 CHARLES JACK MFG. CORP., 27 E. Phila. St., York, Pa.—H
 JENSEN RADIO MFG. CO., 6601 S. Laramie Ave., Chicago, Ill.—A, BA, ES, H, PD, S
 J. F. D. MANUFACTURING CO., 4111 Ft. Hamilton Pkwy., Brooklyn, N. Y.—FC
 *KNIGHT—ALLIED RADIO CORP.
 LAFAYETTE RADIO CORP., 100 6th Ave., New York, N. Y.—A, AC, BA, CO, ES, FC, F, G, H, MS, PD, S
 LEOTONE RADIO CO., 63 Dey St., New York, N. Y.—A, BA, CO, ES, FC, MS, PD
THE LIFETIME CORPORATION, 1825 Adams St., Toledo, Ohio—A, BA, H, PD, S
 THE LINCROPHONE CO., INC., 1661 Howard Ave., Utica, N. Y.—BA, PD
 T. R. McELROY, 100 Brookline Ave., Boston, Mass.—MS
 M & H SPORTING GOODS CO., 512 Market St., Phila., Pa.—AC, BA, CO, ES, FC, F, G, H, MS, PD, S
 THE MAGNAVOX COMPANY, INC., 2131 Bueter Rd., Ft. Wayne, Ind.—ES, PD
 JOHN MECK INDUSTRIES, 1313 Randolph St., Chicago, Ill.—AC, BA, PD
 MILES REPRODUCER CO., INC., 812 Broadway, New York, N. Y., *"Filmgraph," "Dictafilm"—ES, FC, F, H, MS, PD
 *MONOBAR—Tibbetts Laboratories
 MONTGOMERY WARD & CO., INC., 619 W. Chicago Ave., Chicago, Ill., *"Airline"—BA, H, MS, PD, S
 NASH RADIO PRODUCTS CO., 6267 Gravois Ave., St. Louis, Mo.—G
NATIONAL UNION RADIO CORP., 57 State St., Newark, N. J.—BA, ES, H, PD, S
 OFFENBACH ELECTRIC CO., 1452 Market St., San Francisco, Calif.—A, AC, BA, CO, ES, FC, F, G, H, MS, PD, S
 A. OLEK, 4759 Melrose St., Phila., Pa.—G
 OPERADIO MANUFACTURING CO., St. Charles, Ill.—A, AC, BA, CO, ES, FC, F, H, PD
OXFORD-TARTAK RADIO CORP., 915 W. Van Buren St., Chicago, Ill.—ES, MS, PD
 PACENT ENGINEERING CORP., 79 Madison Ave., New York, N. Y.—ES
 PAR-METAL PRODUCTS CORP., 32-62 49th St., Long Island City, N. Y.—M
 PHILCO RADIO & TELEVISION CORP., Tioga & "C" Sts., Phila., Pa.—A, CO, ES, FC, G, H, MS, PD
 QUAM-NICHOLS CO., 33rd Pl. & Cottage Grove, Chicago, Ill.—ES, MS, PD
 RACON ELECTRIC CO., INC., 52 E. 19th St., New York, N. Y.—A, AC, BA, CO, ES, FC, F, H, MS, PD
RADIO ELECTRIC SERVICE CO., INC., N.W. Cor. 7th & Arch Sts., Phila., Pa.—A, AC, BA, CO, ES, FC, F, G, H, MS, PD, S
 RADIO EQUIPMENT CORP., 326 Elm St., Buffalo, N. Y.—A, AC, BA, CO, ES, FC, F, G, H, MS, PD, S
 RADOLEK COMPANY, 601 W. Randolph St., Chicago, Ill.—A, AC, BA, CO, ES, FC, F, G, H, MS, PD, S
 RCA MANUFACTURING CO., INC., Camden, N. J.—A, BA, CO, ES, FC, F, H, MS, PD
 REGAL AMPLIFIER MFG. CORP., 14 W. 17th St., New York, N. Y.—BA, H, MS, PD, S
 JOHN A. ROEBLING'S SONS CO., 640 S. Broad St., Trenton, N. J.—FC
 THE ROLA COMPANY, INC., 2530 Superior Ave., Cleveland, Ohio—ES, PD
 ROWE INDUSTRIES, INC., 3120 Monroe St., Toledo, Ohio—AC, BA, ES, F, H, MS, PD, S
 WALTER L. SCHOTT CO., 5266-70 W. Pico Blvd., Los Angeles, Calif., *"Walsco"—SC
 MAURICE SCHWARTZ & SON, 710-712 Broadway, Schenectady, N. Y.—A, AC, BA, CO, ES, FC, F, G, H, MS, PD, S
 SEATTLE RADIO SUPPLY CO., INC., 2117 2nd Ave., Seattle, Wash.—A, AC, BA, CO, ES, FC, F, G, H, MS, PD, S
 SHELLEY RADIO CO., 1841 S. Flower St., Los Angeles, Calif.—A, AC, CO, FC, H, PD
 MARK SIMPSON DISTRIB. CO., INC., 16 Hudson St., New York, N. Y.—BA, S
 SOUND APPARATUS CO., 150 W. 46th St., New York, N. Y.—ES, MS, PD
 STROMBERG-CARLSON TELEPHONE MFG. CO., 100 Carlson Rd., Rochester, N. Y.—CO, ES, PD
 SYRACUSE ORNAMENTAL CO., Syracuse, N. Y.—GM
 SUN RADIO CO., 212 Fulton St., New York, N. Y.—A, AC, BA, CO, ES, FC, F, G, H, MS, PD, S
 TIBBETTS LABORATORIES, Camden, Maine, *"Monobar"—PS
 TRANSFORMER CORP. OF AMERICA, 69 Wooster St., New York, N. Y., *"Clarion"—A, BA, ES, H, PD, S

TREBOR RADIO CO., Pasadena, Calif.—FC
 UNITED TELEPHONE CORP., 150 Varick St., New York, N. Y.—AC, BA, CO, ES, FC, F, H, MS, PD, S
 UNIVERSITY LABORATORIES, 195 Christie St., New York, N. Y.—AC, BA, ES, H, PD
 UTAH RADIO PRODUCTS CO., 812 Orleans St., Chicago, Ill.—AC, BA, CO, ES, FC, PD
 THE VEGA COMPANY, 155 Columbus Ave., Boston, Mass., *"Vega," "Vitar"—H
 *VEGA—The Vega Company
 VICTOR ANIMATOGRAPH CORP., Davenport, Iowa—BA, PD
 *VITAR—The Vega Company
 *WALSCO—Walter L. Schott Co.
 WEBSTER-CHICAGO CORP., 5622 W. Bloomingdale Ave., Chicago, Ill.—BA, H, S
 WESTERN SOUND & ELECTRIC LABS., INC., 311 N. Kilbourn Ave., Milwaukee, Wis.—A, BA, G, PD, S

MACHINERY (PRODUCTION)



Braiders	B
Coil winders	CW
Drill presses	D
Flocking	F
Lathes (& equipment)	L
Tube-making, Radio	T
Wire stripper	WS

ATLAS PRESS CO., Kalamazoo, Mich.—D, L
 EISLER ENGINEERING CO., 751 S. 13th St., Newark, N. J.—T
 FLOCK PROCESS CORP., 17 W. 31st St., New York, N. Y.—F
 JAMES WIRE & CABLE CO., 1014 Madison Ave., Toledo, Ohio—B
 MORRIS REGISTER CO., 2925 W. Broadway, Council Bluffs, Iowa—CW
 SOUTH BEND LATHE WORKS, 425 E. Madison St., South Bend, Ind.—L
 THE WIRE STRIPPER CO., P. O. Box 2421 E. Cleveland, Ohio—WS

MAGNETS & SOLENOIDS



Permanent magnets	P
Solenoids	S

ARLAVOX MANUFACTURING CO., 430 S. Green St., Chicago, Ill.—P
BELDEN MANUFACTURING CO., 4647 W. Van Buren St., Chicago, Ill.—P
 FISCHER DISTRIB. CORP., 222 Fulton St., New York, N. Y.—P
 GENERAL ELECTRIC CO., Schenectady, N. Y. & Bridgeport, Conn.—P (Alnico)
 EDWIN I. GUTHMAN & CO., INC., 400 S. Peoria St., Chicago, Ill.—S
 KELLOGG SWITCHBOARD & SUPPLY CO., 6650 S. Cicero Ave., Chicago, Ill.—P
 RACON ELECTRIC CO., INC., 52 E. 19th St., New York, N. Y.—P
RADIO ELECTRIC SERVICE CO., INC., N.W. Cor. 7th & Arch Sts., Phila., Pa.—P

METAL FOR RADIO



Aluminum	AL
Brass	BR
Chassis	CH
Core materials	CO
Foils	FO
Graphite	G
Iron (and/or steel)	I
Laminations	LA
Molybdenum	MO
Nickel	NI
Panels	PA
Permanent magnets	PE
Racks	RA
R.F.-iron cores	RF
Shield-cans	S
Speaker housings (cabinets)	SP

Please say you saw it in the Radio-Craft "Classified Radio Directory"

• CLASSIFIED RADIO DIRECTORY •

Stampings	ST
Transformer housings	TR
Tube parts	TP
Tungsten	TU
Zinc	Z

*AC—National Company, Inc.
ACRO TOOL & DIE WORKS, 2815 Montrose Ave., Chicago, Ill.—AL, BR, CH, LA, RA, ST
 *AIRLINE—Montgomery Ward & Co., Inc.
ALLIED RADIO CORP., 833 W. Jackson Blvd., Chicago, Ill., *"Knight"—AL, CH, PA, RA, SP
ALTO MANUFACTURING CO., 1647 Wolfram St., Chicago, Ill.—SP, ST
AMERICAN RADIO HARDWARE CO., INC., 476 Broadway, New York, N. Y.—AL, BR, CH, LA, PA, RA, ST, TP
THE AMERICAN ROLLING MILL CO., Middletown, Ohio—L
ARLAVOX MANUFACTURING CO., 430 S. Green St., Chicago, Ill.—PA, PE, SP, ST
BAKER & CO., INC., 113 Astor St., Newark, N. J.—NI
 *BAREX—King Laboratories, Inc.
THE BALTIMORE BRASS CO., 1201 Wisconsin St., Baltimore, Md.—BR
BUD RADIO, INC., 5205 Cedar Ave., Cleveland, Ohio—AL, CH, PA, RA, SP
CINEMA ENGINEERING CO., 1508 W. Verdugo Ave., Burbank, Calif.—R
CRESCENT TOOL & DIE CO., 4140 Belmont Ave., Chicago, Ill.—CH, SP, ST, TR
HENRY L. CROWLEY & CO., INC., 1 Central Ave., W. Orange, N. J.—RF
CRUCIBLE STEEL CO. OF AMERICA, 405 Lexington Ave., New York, N. Y.—PE
DOW RADIO SUPPLY CO., 1759 E. Colorado St., Pasadena, Calif.—CH, G, PE, RA, SP, TR
DRIVER-HARRIS COMPANY, Harrison, N. J.—NI, TP
DUAL REMOTE CONTROL CO., INC., 31776 W. Warren Ave., Wayne, Mich.—ST
ELECTRO PRODUCTS LABS., 549 W. Randolph St., Chicago, Ill.—RF
EMPIRE NOTION CO., 105 E. 29th St., New York, N. Y.—ST
FAIRMONT ALUMINUM CO., Fairmont, W. Va.—AL
GENERAL CEMENT MFG. CO., 919 Taylor Ave., Rockford, Ill.—AL, FO, G
GENERAL ELECTRIC CO., Schenectady, N. Y. & Bridgeport, Conn.—PE, TP
GENERAL EXTRUSION CORP., 181 Long Ave., Hillside, N. J.—AL, S, Z
GOAT RADIO TUBE PARTS, INC., 314 Dean St., Brooklyn, N. Y.—ST, TP
L. F. GRAMMES & SONS, INC., 361 Union St., Allentown, Pa.—PA, ST
HARRISON RADIO CO., 12 W. Broadway, New York, N. Y.—CH, RA, SP
HUNTER PRESSED STEEL CO., 8th St. & Maple Ave., Lansdale, Pa.—ST
INSULINE CORP. OF AMERICA, 30-30 Northern Blvd., Long Island City, N. Y.—AL, BR, CH, CO, PA, RA, SP, ST, TR
E. F. JOHNSON COMPANY, Waseca, Minn.—AL
THE JOHNSTON TIN FOIL & METAL CO., 6106 S. Broadway, St. Louis, Mo.—FO
KARP METAL PRODUCTS CO., 129 30th St., Brooklyn, N. Y.—CH, PA, RA, SP, ST, TR
KING LABORATORIES, INC., 205 Oneida St., Syracuse, N. Y., *"Barex"—TP
 *KNIGHT—Allied Radio Corp.
LAFAYETTE RADIO CORP., 100 6th Ave., New York, N. Y.—AL, CH, PA, RA, SP
P. R. MALLORY & CO., INC., 3029 E. Washington St., Indianapolis, Ind.—MO, TU
JAMES MILLEN MFG. CO., INC., 150 Exchange St., Malden, Mass.—ST
MONTGOMERY WARD & CO., INC., 619 W. Chicago Ave., Chicago, Ill., *"Airline"—PA, RA, SP
NATIONAL COMPANY, INC., 61 Sherman St., Malden, Mass., *"National," "AC"—CH, PA, RA, SP
 *NATIONAL—National Company, Inc.
NEW ART SPECIALTIES, INC., 816 W. Erie St., Chicago, Ill.—ST
OFFENBACH ELECTRIC CO., 1452 Market St., San Francisco, Calif.—AL, BR, CH, PA, RA, SP
PAR-METAL PRODUCTS CORP., 32-62 49th St., Long Island City, N. Y.—PA, RA, SP
PAUL & BECKMAN, Div. of PHILA. LAWN MOWER & MFG. CO., 4250 Wissahickon Ave., Phila., Pa.—CH, ST, TR
GEORGE F. PETTINOS, INC., 1206 Locust St., Phila., Pa.—G
RACON ELECTRIC CO., INC., 52 E. 19th St., New York, N. Y.—PE, SP
RADIO ELECTRIC SERVICE CO., INC., N.W., Cor. 7th & Arch Sts., Phila., Pa.—AL, CH, PA, RA, SP, ST
RADIO EQUIPMENT CORP., 326 Elm St., Buffalo, N. Y.—AL, CH, PA, RA, SP
RADOLEK COMPANY, 601 W. Randolph St., Chicago, Ill.—AL, BR, CH, PA, RA, SP
R-B-M MANUFACTURING CO., Div. Essex Wire Corp., Hanna & Chestnut Sts., Logansport, Ind.—ST
ROGERS-MAJESTIC CORP., LTD., 622 Fleet St., Toronto, Can.—LA, ST, TR, TP
SCOVILL MANUFACTURING CO., 99 Mill St., Waterbury, Conn.—BR, ST
SHELLEY RADIO CO., 1841 S. Flower St., Los Angeles, Calif.—G, PA

SORENG-MANEGOLD CO., 1901 Clybourn Ave., Chicago, Ill.—ST
STANLEY WORKS, Pressed Metal Division, New Britain, Conn.—ST
STEWART STAMPING CORP., 621 E. 216th St., New York, N. Y.—ST
SUN RADIO CO., 212 Fulton St., New York, N. Y.—AL, CH, PA, RA, SP, ST
SWEDISH IRON & STEEL CORP., 17 Battery Pl., New York, N. Y.—I, TP
THORDARSON ELECTRIC MFG. CO., 500 W. Huron St., Chicago, Ill.—TR

METAL, ORE, OIL & LEAK LOCATORS



Geophysical prospecting instruments, (ore and oil) G
 Leak locators L
 Metal (treasure) locators M
 Pipe locators P

ALLIED RADIO CORP., 833 W. Jackson Blvd., Chicago, Ill., *"Knight"—G, M, P
BARKER & WILLIAMSON, Ardmore, Pa.—G
CAMBRIDGE INSTRUMENT CO., INC., 3732 Grand Central Terminal, New York, N. Y.—G
ENGINEERING RESEARCH CORP., 909 Giddens-Lane Bldg., Shreveport, La.—M, P
FISHER RESEARCH LAB., 1961 University Ave., Palo Alto, Calif.—G, L, M, P
THE GOLDAK COMPANY, 1031 S. Broadway, Los Angeles, Calif.—G, L, M, P
 *KNIGHT—Allied Radio Corp.
LUMENITE ELECTRIC CO., 407 S. Dearborn St., Chicago, Ill.—M
RCA MANUFACTURING CO., INC., Camden, N. J.—G

MICROPHONES & ACCESSORIES



Accessories A
 Aircraft AC
 Cable (see Wire) C
 Carbon-type C
 Condenser-type CD
 Connectors CN
 Contact-type CT
 Crystal-type CY
 Dynamic-type D
 Home-broadcasting H
 Laboratory-type L
 Springs SP
 Stands ST
 Velocity-type V
 Vibration-pickup (inertia) type VP

*AIRLINE—Montgomery Ward & Co., Inc.
ALLIED ENGINEERING INSTITUTE, 85 Warren St., New York, N. Y.—CT, CY
ALLIED RADIO CORP., 833 W. Jackson Blvd., Chicago, Ill., *"Knight"—A, C, CD, CN, CT, CY, D, H, SP, ST, V
AMERICAN CONDENSER CORP., 2508 S. Michigan, Chicago, Ill.—CD
AMERICAN MICROPHONE CO., INC., 1915 S. Western Ave., Los Angeles, Calif.—A, C, CN, CT, CY, D, H, SP, ST
AMERICAN PHENOLIC CORP., 1250 W. Van Buren St., Chicago, Ill.—A, CN
AMERICAN RADIO HARDWARE CO., INC., 476 Broadway, New York, N. Y.—SP
AMPERITE COMPANY, 561 Broadway, New York, N. Y.—A, CT, D, ST, V
ART SPECIALTY CO., 1115 N. Franklin St., Chicago, Ill.—A, ST
ASTATIC MICROPHONE LAB., INC., 830 Market St., Youngstown, Ohio—A, CY, D, ST
ATLAS SOUND CORP., 1451 39th St., Brooklyn, N. Y.—A, CN, ST
AUDIOGRAPH SOUND SYSTEMS, 1313 W. Randolph St., Chicago, Ill.—CN, CT, CY, D, ST
 *AUTOCRAT—Autocrat Radio Co.
AUTOCRAT RADIO CO., 3855 N. Hamilton Ave., Chicago, Ill., *"Autocrat"—CY, H
THE BRUSH DEVELOPMENT CO., 3311-3405 Perkins Ave., Cleveland, Ohio—CT, CY, ST, VP
BUD RADIO, INC., 5205 Cedar Ave., Cleveland, Ohio—ST

CANADIAN MARCONI CO., 211 St. Sacramento St., Montreal, Can.—A, C, CD, CN, CT, CY, D, SP, ST, V
 *CARDAK—Electro-Voice Mfg. Co., Inc.
CARRIER MICROPHONE CO., 439 S. La Brea Ave., Inglewood, Calif.—CD, D, V
CHICAGO SOUND SYSTEMS CO., 315 E. Grand Ave., Chicago, Ill.—A, CY, D, ST
CRUMPACKER DISTRIB. CORP., 1801 Fannin St., Houston, Tex.—A, C, CD, CN, CT, CY, D, H, SP, ST, V
HAROLD DAVIS, INC., 428 W. Capitol St., Jackson, Miss.—A, C, CN, CT, CY, D, H, SP, ST, V
 *DICTAFILM—Miles Reproducer Co., Inc.
DOOLITTLE RADIO, INC., 7421 Loomis Blvd., Chicago, Ill.—C
DOW RADIO SUPPLY CO., 1759 E. Colorado St., Pasadena, Calif.—A, C, CD, CN, CT, CY, D, H, SP, ST, V
EASTERN MIKE-STAND CO., 56 Christopher Ave., Brooklyn, N. Y.—A, ST
 *ELECTRO-VOICE—Electro Voice Mfg. Co., Inc.
ELECTRO-VOICE MFG. CO., INC., 1239 S. Bend Ave., South Bend, Ind., *"Electro-Voice," "Cardak"—A, C, CN, CT, D, SP, ST, V
EPIPHONE, INC., 142 W. 14th St., New York, N. Y.—D
ERWOOD SOUND EQUIP. CO., 224 W. Huron St., Chicago, Ill.—A, CD, CN, CY, D, ST
FEDERATED PURCHASER, INC., 80 Park Place, New York, N. Y.—A, C, CD, CN, CT, CY, D, H, SP, ST, V
 *FILMGRAPH—Miles Reproducer Co., Inc.
FISCHER DISTRIB. CORP., 222 Fulton St., New York, N. Y.—A, C, CD, CN, CT, CY, D, H, SP, ST, V
GENERAL CEMENT MFG. CO., 919 Taylor Ave., Rockford, Ill.—C, SP
GENERAL ELECTRIC CO., Schenectady, N. Y. & Bridgeport, Conn.—A, CN, ST, V
GLOBE PHONE MFG. CORP., Reading, Mass.—C, CT, CY, D, V
HARRISON RADIO CO., 12 W. Broadway, New York, N. Y.—A, C, CD, CN, CT, CY, D, H, SP, ST, V
HUNTER PRESSED STEEL CO., 8th St. & Maple Ave., Lansdale, Pa.—SP
KAAR ENGINEERING CO., 619 Emerson St., Palo Alto, Calif.—C
KELLOGG SWITCHBOARD & SUPPLY CO., 6650 S. Cicero Ave., Chicago, Ill.—C
 *KNIGHT—Allied Radio Corp.
LAFAYETTE RADIO CORP., 100 6th Ave., New York, N. Y.—A, C, CN, CT, CY, D, H, SP, ST, V
LEKTRA LABORATORIES, INC., 30 E. 10th St., New York, N. Y.—D
THE LIFETIME CORPORATION, 1825 Adams St., Toledo, Ohio—A, C, CD, CN, D, SP, ST, V
THE LINCROPHONE CO., INC., 1661 Howard Ave., Utica, N. Y.—CY, D, V
M & H SPORTING GOODS CO., 512 Market St., Phila., Pa.—A, C, CN, CT, CY, D, SP, ST, V
MILES REPRODUCER CO., INC., 812 Broadway, New York, N. Y., *"Filmgraph," "Dictafilm"—C, CD, H, SP, ST
 *MONOBAR—Tibbets Laboratories
MONTGOMERY WARD & CO., INC., 619 W. Chicago Ave., Chicago, Ill., *"Airline"—A, C, CN, CT, CY, DY, ST, V
NATIONAL DOBRO CORP., 400 S. Peoria St., Chicago, Ill.—CY, ST
NATIONAL UNION RADIO CORP., 57 State St., Newark, N. J.—CY, D, V
NORTHERN ELECTRIC CO., LTD., 1261 Shearer St., Montreal, Que., Can.—C, CD, CT, CY, D, ST
OFFENBACH ELECTRIC CO., 1452 Market St., San Francisco, Calif.—A, C, CD, CN, CT, CY, D, H, SP, ST, V
OLSON MANUFACTURING CO., 362 Wooster Ave., Akron, Ohio—C
PARAPHONE HEARING AID, INC., 4300 Euclid Ave., Cleveland, Ohio—C
PHILOCO RADIO & TELEVISION CORP., Tioga & "C" Sts., Phila., Pa.—A, CN, DY, D, ST
PHILMORE MANUFACTURING CO., INC., 113 University Pl., New York, N. Y.—C, D
RACON ELECTRIC CO., INC., 52 E. 19th St., New York, N. Y.—D
RADIO ELECTRIC SERVICE CO., INC., N.W., Cor. 7th & Arch Sts., Phila., Pa.—A, C, CD, CN, CT, CY, D, H, SP, ST, V
RADIO EQUIPMENT CORP., 326 Elm St., Buffalo, N. Y.—A, C, CN, CT, CY, D, H, SP, ST, V
RADIOTONE, INC., 7356 Melrose Ave., Hollywood, Calif.—CY, D
RADOLEK COMPANY, 601 W. Randolph St., Chicago, Ill.—A, C, CD, CN, CT, CY, D, H, SP, ST, V
RCA MANUFACTURING CO., INC., Camden, N. J.—A, CN, CY, D, H, ST, V
REGAL AMPLIFIER MFG. CORP., 14 W. 17th St., New York, N. Y.—CY, H, ST
 *ROCKET—Shure Brothers
ROWE INDUSTRIES, INC., 3120 Monroe St., Toledo, Ohio—CT
WALTER L. SCHOTT CO., 5266-70 W. Pico Blvd., Los Angeles, Calif., *"Walsco"—SP
MAURICE SCHWARTZ & SON, 710-712 Broadway, Schenectady, N. Y.—A, C, CD, CN, CT, CY, D, H, SP, ST, V
SEATTLE RADIO SUPPLY CO., INC., 2117 2nd Ave., Seattle, Wash.—A, C, CD, CT, CY, D, H, SP, ST, V
SELECTAR MANUFACTURING CORP., 30 W. 15th St., New York, N. Y.—A, CN, H, V

Please say you saw it in the Radio-Craft "Classified Radio Directory"

• CLASSIFIED RADIO DIRECTORY •

SHELLEY RADIO CO., 1841 S. Flower St., Los Angeles, Calif.—A, C, CY, D, H, ST
 SHURE BROTHERS, 225 W. Huron St., Chicago, Ill.,
 "Shure," "Unidyne," "Uniplex," "Rocket," "Stratoliner," "Super-Level," "Ultra-Wide Range," "Zephyr"—A, C, CN, CT, CY, D, H, L, SP, ST, VP
 *SHURE—Shure Brothers
 MARK SIMPSON DISTRIB. CO., INC., 16 Hudson St., New York, N. Y.—ST
 SOUND APPARATUS CO., 150 W. 46th St., New York, N. Y.—C, CD, CY, D
 *STRATOLINER—Shure Brothers
 STROMBERG-CARLSON TELEPHONE MFG. CO., 100 Carlson Rd., Rochester, N. Y.—C, H
 SUN RADIO CO., 212 Fulton St., New York, N. Y.—A, C, CD, CN, CT, CY, D, H, SP, ST, V
 *SUPER-LEVEL—Shure Brothers
 TAYLOR AIRPHONE PRODUCTS, INC., Long Beach Municipal Airport, Long Beach, Calif.—AC, C
 TIBBETTS LABORATORIES, Camden, Maine, "Monobar"—CY
 TRY-MO RADIO CO., INC., 85 Cortlandt St., New York, N. Y.—A, C, CD, CN, CT, CY, D, H, SP, ST, V
 THE TURNER COMPANY, 909 17th St., Cedar Rapids, Iowa, "Turner"—A, C, CD, CN, CT, CY, D, H, ST
 *TURNER—The Turner Company
 *ULTRA-WIDE RANGE—Shure Brothers
 *UNIDYNE—Shure Brothers
 *UNIPLX—Shure Brothers
 UNIVERSAL MICROPHONE CO. LTD., 424 Warren Lane, Inglewood, Calif.—A, C, CN, CY, D, H, SP, ST, V
 THE VEGA COMPANY, 155 Columbus Ave., Boston, Mass., "Vega," "Vitar"—CT
 *VEGA—The Vega Company
 VICTOR ANIMATOGRAPH CORP., Davenport, Iowa—D, V
 *VITAR—The Vega Company
 THE VOLU-TONE COMPANY, 252 S. Broadway, Los Angeles, Calif.—V
 *WALSCO—Walter L. Schott Co.
 WEBSTER-CHICAGO CORP., 5622 W. Bloomingdale Ave., Chicago, Ill.—AM, CY, D, ST, V
 WESTERN SOUND & ELECTRIC LABS., INC., 311 W. Kitbourn Ave., Milwaukee, Wis.—A, CN, CY, D, H, SP, ST, V
 *ZEPHYR—Shure Brothers

Flock FL
 Insulating compounds IC
 Lacquers LA
 Paint (and/or wrinkling & crystallizing) PA

Preceding Listings in RADIO-CRAFT'S CLASSIFIED RADIO DIRECTORY

Sec. I (Revised), April '41:

Amplifiers
 Antennas & Accessories
 Automatic Tuners & Parts
 Auto-Radio Controls
 Aircraft Radio (see Receiving Sets—including Adapters and Converters)
 Battery Chargers (& Parts)
 Batteries (& Cells) Dry & Wet (Storage)
 Books (see Service Manuals, Books & Magazines)
 Cabinets, Cases, Parts & Services
 Chemicals for Radio
 Coils & Transformers (R.F. & I.F.) & Accessories
 Coin Controls (see Records & Record-Playing Equipment; also, Receiving Sets)
 Condensers, Fixed
 Condensers, Variable
 Crystals (Quartz)

Sec. II (Revised), May '41:

Crystals (for detection—receiving) & Detectors
 Dials & Parts
 Electric Fence Controllers
 Electronic Equipment
 Electronic Musical Instruments & Parts
 Facsimile
 Fluorescent & Neon Lamps (& Equipment)
 Frequency Modulation Equipment
 Hardware—Connectors & Misc. Parts & Supplies
 Headphones
 Hearing-Aids
 Hearing-Aid Parts

Sec. II, Nov. '40 (in part):

Insulation
 Intercommunicating Systems
 Line Filters

Sec. III, Dec. '40:

Magnets
 Metal & Special Fittings (for Radio)
 Metal, Ore & Oil Locators
 Microphones
 Noise Elimination Equipment
 Paint, Cement & Wax Products
 Plastics
 Plastic Molders
 Radio Logs, Maps & Globes
 Receiving Sets (including Adapters & Converters)
 Records & Record-Playing Equipment

Sec. IV, Jan. '41:

Recording Equipment
 Resistors & Volume Controls (Attenuators & Networks)
 Schools
 Service Manuals, Books & Magazines
 Servicing Equipment
 Sound Systems, Amplifiers & Accessories

Sec. V, Feb. '41:

Speakers (& Parts)
 Switches & Relays
 Television
 Test Equipment—Laboratory & Production
 Tools
 Transformers & Chokes
 Transmitters (& Equipment)

Sec. VI, March '41:

Tubes (& Parts)
 Vibrators
 Wire
 Literature

The above back-issues of *Radio-Craft* are available at the regular price of 25c per copy.

Next month: Section IV of the Classified Radio Directory, revised, with new classifications, and new names and addresses added; and with obsolete listings removed. Reserve your copy, today, from your regular newsdealer.

NOISE-ELIMINATION EQUIPMENT



Acoustical materials AM
 Industrial noise analyzers IA
 Interference analyzers I
 Interference locators IL
 Power filters (see Line Filters)
 Radio-set filters (see Line Filters)
 Wave-traps W

ALLIED RADIO CORP., 833 W. Jackson Blvd., Chicago, Ill., "Knight"—IA, I, IL
 *ATOMS—Sprague Products Co.
 BAKER & WILLIAMSON, Ardmore, Pa.—IA
 CANADIAN MARCONI CO., 211 St. Sacramento St., Montreal, Can.—IA, I, IL
 THE CELOTEX CORPORATION, 919 N. Michigan Ave., Chicago, Ill.—AM
 CONTINENTAL CARBON, INC., 13900 Lorain Ave., Cleveland, Ohio—I
 TOBE DEUTSCHMANN CORP., Canton, Mass.—I, IL
 FEDERATED PURCHASER, INC., 80 Park Pl., New York, N. Y.—I, IL
 HARRISON RADIO CO., 12 W. Broadway, New York, N. Y.—IA, I, IL
 *KNIGHT—Allied Radio Corp.
 *KOOLOHMS—Sprague Products Co.
 RADOLEK COMPANY, 601 W. Randolph St., Chicago, Ill.—I
 SEATTLE RADIO SUPPLY CO., INC., 2117 2nd Ave., Seattle, Wash.—IA, I, IL
 *600 LINE—Sprague Products Co.
 SPRAGUE PRODUCTS CO., N. Adams, Mass., "Sprague," "600 Line," "Atoms," "Koolohms," "Telohmike"—IA, I, IL
 *SPRAGUE—Sprague Products Co.
 *TELOHMIKE—Sprague Products Co.
 VOGUE PRODUCTS CO., 8420 S. Ashland Ave., Chicago, Ill.—W

PAINT, CEMENT & WAX PRODUCTS



Cements CE
 Enamels EN

Self-designing paints & enamels SD
 Varnish VA
 Wax WA
 Wax, phonograph WP

*AC—National Company, Inc.
 ALDEN PRODUCTS CO., 715 Center St., Brockton, Mass.—CE, LA, PA
 ALLIED RADIO CORP., 833 W. Jackson Blvd., Chicago, Ill., "Knight"—CE, VA, WA
 AMERICAN PHENOLIC CORP., 1250 W. Van Buren St., Chicago, Ill.—CE, IC
 BAKELITE CORPORATION, 30 E. 42nd St., New York, N. Y.—IC
 BUD RADIO, INC., 5205 Cedar Ave., Cleveland, Ohio—LA
 CINEMA ENGINEERING CO., 1508 W. Verdugo Ave., Burbank, Calif.—WA
 CONSOLIDATED WIRE & ASSOCIATED CORP., 512 S. Peoria St., Chicago, Ill.—CE, EN, IC, LA, PA, VA
 CRUMPACKER DISTRIB. CORP., 1801 Fannin St., Houston, Tex.—CE, LA
 HAROLD DAVIS, INC., 428 W. Capitol St., Jackson, Miss.—CE
 DOW RADIO SUPPLY CO., 1759 E. Colorado St., Pasadena, Calif.—CE, EN, LA
 FEDERATED PURCHASER, INC., 80 Park Pl., New York, N. Y.—CE, LA
 FISCHER DISTRIB. CORP., 222 Fulton St., New York, N. Y.—CE, EN, IC, LA, PA, VA, WA
 FLOCK PROCESS CORP., 17 W. 31st St., New York, N. Y.—FL
 GENERAL CEMENT MFG. CO., 919 Taylor Ave., Rockford, Ill.—CE, EN, IC, LA, PA, VA, WA
 HARRISON RADIO CO., 12 W. Broadway, New York, N. Y.—CE
 INSULATION MANUFACTURERS CORP., 565 W. Washington Blvd., Chicago, Ill.—CE, IC, LA, VA, WA
 J. F. D. MANUFACTURING CO., 4111 Ft. Hamilton Pkwy., Brooklyn, N. Y.—CE, EN, VA, WA
 *KNIGHT—Allied Radio Corp.
 LAFAYETTE RADIO CORP., 100 6th Ave., New York, N. Y.—CE, EN, IC, LA, PA, VA, WA
 M & H SPORTING GOODS CO., 512 Market St., Phila., Pa.—CE
 MAAS & WALDSTEIN CO., 438 Riverside Ave., Newark, N. J.—CE, EN, LA, PA, VA
 MAGIC ART PAINT CO., Box 23, Hasbrouck Heights, N. J.—SD
 MEISSNER MANUFACTURING CO., Mt. Carmel, Ill.—CE, LA
 MITCHELL-RAND INSULATION CO., INC., 51 Murray St., New York, N. Y.—IC, WA
 NASH RADIO PRODUCTS CO., 6267 Gravois Ave., St. Louis, Mo.—CE, EN, IC, LA, PA, VA, WA
 NATIONAL COMPANY, INC., 61 Sherman St., Malden, Mass., "National," "AC"—CE, LA
 *NATIONAL—National Company, Inc.
 OFFENBACH ELECTRIC CO., 1452 Market St., San Francisco, Calif.—CE, IC, LA
 GEORGE F. PETTINOS, INC., 1206 Locust St., Phila., Pa.—CE
 POINSETTIA, INC., 97 Cedar Ave., Pitman, N. J.—WA
 RADIO EQUIPMENT CORP., 326 Elm St., Buffalo, N. Y.—CE, EN, LA
 RADOLEK COMPANY, 601 W. Randolph St., Chicago, Ill.—CE, EN
 SAUERISEN CEMENTS CO., 2308 Main St., Sharpsburg, Pittsburgh, Pa.—CE, IC
 WALTER L. SCHOTT CO., 5266-70 W. Pico Blvd., Los Angeles, Calif., "Walasco"—CE, EN, IC, LA, PA, VA
 MAURICE SCHWARTZ & SON, 710-712 Broadway, Schenectady, N. Y.—CE, EN, IC, LA, PA, VA, WA
 SEATTLE RADIO SUPPLY CO., INC., 2117 2nd Ave., Seattle, Wash.—CE, EN, IC, LA
 SELF-VULCANIZING RUBBER CO., INC., 605 W. Washington, Chicago, Ill.—CE, IC, PA
 SHELLEY RADIO CO., 1841 S. Flower St., Los Angeles, Calif.—CE, LA
 SMOOTH-ON MANUFACTURING CO., 572 Communipaw Ave., Jersey City, N. J.—CE
 SUN RADIO CO., 212 Fulton St., New York, N. Y.—CE, EN
 TALKING DEVICES CO., 4447-44 W. Irving Park Rd., Chicago, Ill.—WP
 TELERADIO ENGINEERING CORP., 484 Broome St., New York, N. Y.—LA, WA
 *WALSCO—Walter L. Schott Co.
 WESTINGHOUSE ELEC. & MFG. CO., E. Pittsburgh, Pa.—EN, IC
 ZOPHAR MILLS, INC., 112 26th St., Brooklyn, N. Y.—CE, IC, WA

PLASTICS



Cellulose acetate CA
 Lucite L
 Methyl-methacrylate MM
 Phenols P
 Polystyrene PO
 Rubber R
 Vinyl resins VR

*AC—National Company, Inc.
 ALDEN PRODUCTS CO., 715 Center St., Brockton, Mass.—P

BOOK REVIEWS

ALLIED RADIO CORP., 833 W. Jackson Blvd., Chicago, Ill.—*Knight*—PO
 AMERICAN PHENOLIC CORP., 1250 W. Van Buren St., Chicago, Ill.—CA, L, P, PO
 AMERICAN RADIO HARDWARE CO., INC., 476 Broadway, New York, N. Y.—CA, L, P
 BAKER & WILLIAMSON, Ardmore, Pa.—CA, L, P
 BIRNBACH RADIO CO., INC., 145 Hudson St., New York, N. Y.—*Birnbach*—L
 CARBIDE & CARBON CHEMICALS CORP., 30 E. 42nd St., New York, N. Y.—VR
 *CELLULOID—Celluloid Corporation
 CELLULOID CORPORATION, 180 Madison Ave., New York, N. Y.—*Lumarith*, *Lumarith Protectoid*, *Celluloid*—CA
 FLOCK PROCESS CORP., 17 W. 31st St., New York, N. Y.—CA, L
 GENERAL CEMENT MFG. CO., 919 Taylor Ave., Rockford, Ill.—PO
 GENERAL ELECTRIC CO., Schenectady, N. Y. & Bridgeport, Conn.—CA, MM, P, PO
 *KNIGHT—Allied Radio Corp.
 *LUMARITH—Celluloid Corporation
 *LUMARITH PROTECTOID—Celluloid Corporation
 JAMES MILLEN MFG. CO., INC., 150 Exchange St., Malden, Mass.—PO
 ELMER E. MILLS CORP., 812 W. Van Buren St., Chicago, Ill.—CA, L, P, PO
 NATIONAL COMPANY, INC., 61 Sherman St., Malden, Mass.—*National*, *AC*—CA, PO
 *NATIONAL—National Company, Inc.
 NATIONAL VULCANIZED FIBRE CO., P. O. Box 311, Wilmington, Del.—P
 PARISIAN NOVELTY CO., 3510 S. Western Ave., Chicago, Ill.—CA, L, P, PO
 THE RICHARDSON COMPANY, Melrose Park (Chicago), Ill.—CA, L, P, PO, R
 SEATTLE RADIO SUPPLY CO., INC., 2117 2nd Ave., Seattle, Wash.—L, PO
 SELF-VULCANIZING RUBBER CO., INC., 605 W. Washington, Chicago, Ill.—R
 VICTORY MANUFACTURING CO., INC., 1217 Washington Blvd., Chicago, Ill.—CA, L, P, PO
 THE WATERBURY BUTTON CO., Waterbury, Conn.—CA, L, P, PO
 WESTINGHOUSE ELEC. & MFG. Co., E. Pittsburgh, Pa.—P

PLASTIC MOLDERS



Cabinet molders CM
 Small parts molders SM

AMERICAN PHENOLIC CORP., 1250 W. Van Buren St., Chicago, Ill.—SM
 AMERICAN RADIO HARDWARE CO., INC., 476 Broadway, New York, N. Y.—SM
 AUBURN BURN WORKS, INC., Auburn, N. Y.—CM, SM
 BOONTON MOLDING CO., 326 Myrtle Ave., Boonton, N. J.—CM, SM
 CHICAGO MOLDED PRODUCTS CORP., 1020 N. Kolmar Ave., Chicago, Ill.—CM, SM
 HUGH H. EBY, INC., 4700 Stenton Ave., Phila., Pa.—SM
 EMPIRE NOTION CO., 105 E. 29th St., New York, N. Y.—SM
 ERIE RESISTOR CORP., 644 W. 12th St., Erie, Pa.—SM
 GEMLOID CORPORATION, 79-10 Albion Ave., Elmhurst, L. I.—SM
 B. F. GOODRICH COMPANY, 500 S. Main St., Akron, Ohio—SM
 IMPERIAL MOLDED PRODUCTS CORP., 2925 W. Harrison St., Chicago, Ill.—SM
 INSULATION PRODUCTS CO., 504 N. Richland St., Pittsburgh, Pa.—SM
 KELLOGG SWITCHBOARD & SUPPLY CO., 6650 S. Cicero Ave., Chicago, Ill.—CM, SM
 KURZ-KASCH, INC., 1421 S. Broadway, Dayton, Ohio—CM, SM
 MICAMOLD RADIO CORP., 1087 Flushing Ave., Brooklyn, N. Y.—SM
 ELMER E. MILLS CORP., 812 W. Van Buren St., Chicago, Ill.—CM, SM
 POINSETTIA, INC., 97 Cedar Ave., Pitman, N. J.—SM
 RADIO KNOB CO., 43 E. Ohio St., Chicago, Ill.—SM
 REMLER COMPANY, LTD., 2101 Bryant St., San Francisco, Calif.—CM, SM
 THE RICHARDSON COMPANY, Melrose Park (Chicago), Ill.—CM, SM
 SYRACUSE ORNAMENTAL CO., Syracuse, N. Y.—CM
 TELEX PRODUCTS CO., 1645 Hennepin Ave., Minneapolis, Minn.—SM
 TILTON ELECTRIC CORP., 15 E. 26th St., New York, N. Y.—SM
 THE VALPEY CRYSTALS, Box 321, Holliston, Mass.—SM
 VICTORY MANUFACTURING CO., INC., 1217 Washington Blvd., Chicago, Ill.—CM, SM
 THE WATERBURY BUTTON CO., Waterbury, Conn.—CM, SM

RADIO-CRAFT for JUNE, 1941

"GO AHEAD—GARRISON!"—A Story of News Broadcasting, by A. A. Schechter. Published by Dodd, Mead & Co. Cloth covers, size 8 x 5½ ins., 237 pages, Price \$2.00.

We start our review of this book by giving a few chapter titles selected at random: IV, Press Meets Radio; V, Storm Warnings; X, Sunshine and Disaster; XV, Radio Tour; XVI, Ballots at Breakfast; XIX, Radio Newsmen Abroad.

Probably by this time you have formed the not erroneous opinion that this book is one you might find on nearly any reading table.

After an apprenticeship with *The New York World*, Associated Press, and International News Service, the author joined N.B.C., eventually to become Director of its News and Special Events service department. The story he tells is a first-person picture of how news is garnered for the air and how it is conditioned for programming.

It's an inside story, about radio news, factual, and entertaining to the nth degree, it's a book of wide general interest and of special interest to everyone in the radio field. Carrying no obvious torch, it yet is sugar-coated dynamite that effectively sells the earnestness of purpose which motivates all great news staffs.

A NEW SYSTEM OF DYNAMIC ANALYSIS. Published by Supreme Instruments Corp. Paper covers, size 8½ x 11 ins., illustrated, 28 pages. Price, 35c.

This book is ingeniously described as being an explanation of a new, definite and direct servicing procedure that "makes an ailing radio set talk to you just as a patient talks to his doctor." It presents in a particularly convenient form the application notes for the cathode-ray type of dynamic analyzers.

Chapter I describes the Veedolyzer. Succeeding chapters develop the application of this instrument in signal tracing, checking intermittents, etc., and fault-finding in F.M. receivers. Analyzing receiver faults by checking circuits is also discussed.

VACUUM TUBE VOLTMETERS, by John F. Rider. Published by John F. Rider. Cloth covers, size 8¼ x 5½ ins., 169 pages. Price \$1.50.

This book describes the various types of vacuum-tube voltmeters—how they are made and how they are used. Calibration and testing are given consideration in chapters devoted to these topics. Has a bibliography of 145 references.

The chapters which discuss vacuum-tube voltmeter types, etc., are as follows: I, Fundamentals of voltmeters; II, Diode types; III, Triode types; IV, Slide-back types; V, Rectifier-Amplifier types; VI, Tuned vacuum-tube voltmeters; VII, A.F. and Logarithmic types; VIII, Vacuum-tube voltmeters for D.C. measurements; IX, Design and construction of various types; X, Calibration and Testing; XI, Applications.

No book on the market can come anywhere near touching "Johnny" Rider's latest contribution to "must" books for the Serviceman. In fact, anyone having any technical interest in radio will find this book big value. It apparently does not leave unanswered many questions the technician may propound on the subject of vacuum-tube voltmeters; and it answers far more than the average radio man is ever likely to ask.

SIMPLIFIED RADIO SERVICING BY COMPARISON METHOD, by M. N. Beitman. Published by Supreme Publications. Paper covers, size 8½ x 11 ins., well illustrated (including numerous complete receiver diagrams), 108 pages. Price, \$1.00.

Briefly, the idea is to compare the diagrams, etc., in the book, with equivalent circuits, etc., in the receiver under test. Tables and information for test procedure are then followed until the fault in equipment or components has been located and corrected.

The first 38 pages discourse on radio fundamentals designed to acquaint the reader with the elements necessary for complete understanding of the COMPARISON test procedure described in the remaining pages.



Get This Electric Dry Shaver
ABSOLUTELY FREE!

JUST THINK OF IT—you can get absolutely FREE, the useful DRY ELECTRIC SHAVER which is shown at the left. This ELECTRIC DRY SHAVER is sent to you by the publishers with a one-year subscription to RADIO-CRAFT.

Here Are the Features of The ELECTRIC DRY SHAVER

Constructed of metal with attractive red bronze finish. Scientifically constructed to give a perfectly clean shave. 5-foot rubber insulated cord and plug. Constructed to last for many years.

Operates from 110-volt, 60-cycle A.C. electric line. Carries a two-year manufacturer's guarantee. A fine quality, self-sharpening toilet necessity.

Send your subscription to RADIO-CRAFT for One Year (12 issues) and receive absolutely FREE one of these remarkable Electric Dry Shavers. New subscribers are accepted or you may extend your present subscription another twelve months. Mail your remittance of \$2.00 (plus 25c for shipping charges on Shaver) to the publishers. (Canada and foreign \$2.75.) You will receive your DRY ELECTRIC SHAVER immediately by return mail. Use coupon below to enter your subscription.

RADIO-CRAFT
20 Vesey Street, New York, N. Y.

RADIO-CRAFT, 20 Vesey Street, New York, N. Y.

Gentlemen: Enclosed find my remittance of \$2.00 for which enter my subscription to RADIO-CRAFT for one year (12 issues). Send me immediately FREE ELECTRIC DRY SHAVER (Canada and foreign \$2.75). In U. S. add only 25c additional to cover shipping charges on Shaver.

New Subscriber Extend Present Subscription

Name

Address

City State

(Send remittance by check, money order or unused U.S. Postage Stamps. Register letter if you send cash or stamps.) RC-641

WE SHIP ELECTRIC DRY SHAVER THE SAME DAY YOUR SUBSCRIPTION ORDER IS RECEIVED.

CLIP COUPON— AND MAIL!

Index to advertisers

PUBLISHERS

Amplifier Co. of America.....	707
Data Print Co.....	742
National Plans Inst.....	710
Radcraft Publications, Inc.....	732, 748, 759
Radio & Technical Pub. Co.....	709
Supreme Publications.....	711
Technifax.....	708, 737

RADIO PARTS

Aerovox Corporation.....	728
Amperite Co.....	711
Hammarlund Mfg. Co.....	709
Solar Mfg. Corp.....	709
Sprague Products Co.....	725

RADIO SETS

Meissner Mfg. Company.....	753
Midwest Radio Corp.....	749
RCA Manufacturing Co., Inc.....	Back Cover

RADIO SUPPLY HOUSES

Allied Radio Corp.....	727
Burstein-Applebee Co.....	707
Federated Purchaser, Inc.....	733
Hudson Specialties Co.....	739
Lafayette Radio Corp.....	Inside Front Cover
Radolek Co.....	728

SCHOOLS

Capitol Radio Eng. Inst.....	708
Coyne Radio School.....	710
Lincoln Engineering School.....	711
National Radio Institute.....	705
National Schools.....	708
New York Y.M.C.A. Schools.....	708
Port Arthur College.....	711
Radio Training Assoc.....	709
RCA Institutes.....	707
SDrabberry Academy of Radio	Inside Back Cover

SOUND & RECORDING EQUIPMENT

Amplifier Co. of America.....	737
Atlas Sound Corporation.....	737
Lifetime Corp., The.....	728
John Meek Industries.....	730
University Laboratories.....	733

TEST EQUIPMENT

General Test Equipment Co.....	707
Radio City Products Co.....	730
Readrite Meter Works.....	742
Supreme Instruments Corp.....	721
Triplett Electrical Instrument Co.....	729
Weston Elec. Instrument Corp.....	735

TUBES

Hygrade Sylvania Corp.....	733
National Union Radio Corp.....	719

MISCELLANEOUS

Classified Section.....	742
Flight Magazine.....	744
Henry Hudson Hotel.....	729
Lancaster, Allwine & Rommel.....	742
Onan, D. W., & Sons.....	749
Premium Distributing Service.....	749
Radio Servicemen of America, Inc.....	755
Remington Rand Inc.....	712
Walter L. Schott Co.....	749
Warner Electric Company.....	728
Wellworth Trading Co.....	744
Woodstock Typewriter Co.....	710

(While every precaution is taken to insure accuracy, we cannot guarantee against the possibility of an occasional change or omission in the preparation of this index.)

COMBINED OVER-MODULATION INDICATOR, MONITOR (PHONE), AND VOLUME LEVEL METER

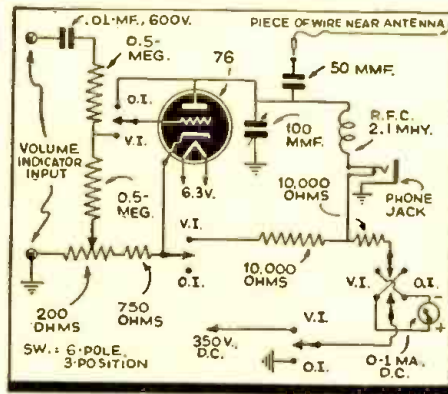

● REALIZING the cost of having separate 0-1 ma. meters for each of these instruments, I designed a simple circuit (shown here) to perform both of these functions.

To use it as an over-modulation indicator (or O.I.), throw the switch to the position marked O.I., and adjust to optimum reading with the variable condenser after attaching a piece of wire near the antenna. Any change in meter readings indicates over-modulation.

As a volume indicator (or V.I.), short the input, adjust meter to zero with the potentiometer, and connect to circuit.

To use as a phone monitor, insert phones and proceed as for the over-modulation indicator.

EUGENE SIMPSON,
Naperville, Ill.

PHONO TURNTABLE KINK

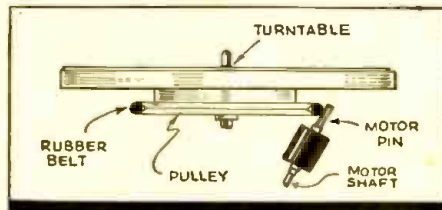

● THE rubber belt, on turntables that are driven by a motor pin against a rubber tire, sometimes wears out. You can replace it very efficiently and rapidly by using the round rubber type of vacuum cleaner belt. The cost is 10c and makes a better job than the original equipment. We use this method exclusively on RCA.

F. M. VANDERGRIFT,
Trenton, N. J.

COLORED DIAL LAMPS

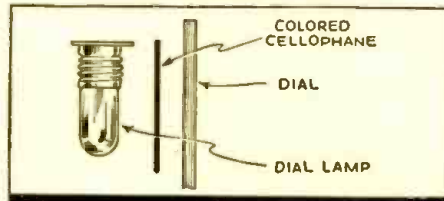

● EVERY now and then you have a call for a colored dial lamp; or, in repairing a set with a weird and wonderful collection of colored dial bulbs, you find one burned out and no dial-lamp coloring on hand.

Simply arrange a piece of colored cellophane between the bulb and the dial. You can get this colored cellophane in all colors and it pays to save the colored pieces wrapped around so many things you buy.

GEORGE E. MCALLAN,
Fernie, B.C., Canada

VOICE COIL RUBBING

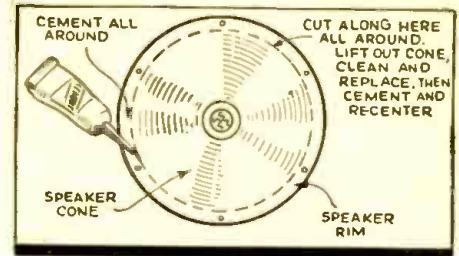

● WHEN a speaker voice coil rubs due to foreign particles on the pole piece, and no replacement of cone is available (and the cone is cemented to the iron speaker), take a sharp razor blade and cut out the whole cone very close to the metal ring. Now lift out the cone, clean the voice coil and pole piece, set back the cone, and re-cement with aeroplane glue.

F. M. VANDERGRIFT,
Trenton, N. J.

BOOK REVIEWS

RADIO AMATEUR'S HANDBOOK, by A. Fredrick Collins (1940). Published by Thomas Y. Crowell Company. Size 5½ x 8 ins., cloth covers, profusely illustrated. 342 pgs. Price, \$2.00.

The revised 8th Edition of "Radio Amateur's Handbook" will be of exceptional interest to the general radio experimenter and particularly the beginner in radio who wishes to have available in convenient form, or who wishes to learn, the bases of radio in general and its component receiver circuits.

Ten chapters have been revised and corrected and 10 entirely new chapters have been added. This includes new material on shortwave operation, frequency modulation, facsimile and television.

This review would be incomplete without calling attention to its exceptionally large number of illustrations, ranging from the most elementary, to pictorial and schematic diagrams of modern radio equipment. The book is fully indexed for you. It also includes a glossary of technical terms; tables, etc. We list a few chapter headings selected at random:

Chapter 1—Fundamentals of Radio; Chapter 4—Electricity Simply Explained; Chapter 12—Assembling Your Own Radio Receivers; Chapter 18—The Photoelectric Cell and Its Uses; Chapter 20—Frequency Modulation.

EDUCATION ON THE AIR, 11th Edition. Edited by Josephine H. MacLatchy (1940). Published by Ohio State University. Cloth covers, size 6 x 9 ins., 368 pages. Price \$3.00.

The Institute of Education by Radio annually publishes a résumé of the 12-month progress in this field as seen by Ohio State University. This University, which operates WOSU, one of 27 educational stations in the country, annually holds a conference of radio engineers and makes every effort to maintain a foremost place in the field of education by radio.

The 11th Edition of "Education by Air" contains 13 important chapters, a few of which are given below. Each of the chapter subdivisions is written by a specialist assigned to the work of compiling respective topical information. Chapters: I. International Broadcasting; II. Radio and Propaganda; IX, A Schoolroom Use of Radio; XI. Radio Techniques; XIII, Research in Educational Broadcasting.

THE ELECTRIC WORD — THE RISE OF RADIO, by Paul Schubert. Published by The Macmillan Company, New York. Cloth covers, size 8¼ x 5½ ins., 311 pages. Price \$2.50.

This book is a readable presentation of the development of radio from its infancy. The authentic treatment of its technical content merely highlights what is, in the main, a book for non-technicians. Excellent reading matter for high-school students who want to obtain at least a superficial knowledge of just where radio stands, in its development, in relation to other growing industries.

SERVICEMEN SAY:—For Bigger Profits— For Better Servicing—USE GERNSBACK MANUALS

Since 1931 more and more Servicemen have been buying GERNSBACK OFFICIAL RADIO SERVICE MANUALS year after year. The authentic material, easily accessible diagrams and complete service data make them invaluable to dealers and radio Servicemen. Without a Gernsback Manual with you on a repair job, there's time and profit lost. Your service kit or laboratory is incomplete without all the GERNSBACK OFFICIAL RADIO SERVICE MANUALS. There are GERNSBACK MANUALS also for servicing auto-radios, refrigeration and air conditioning equipment.



VOLUME 7 OFFICIAL RADIO SERVICE MANUAL

The newest and most outstanding GERNSBACK Manual published since 1931. Contains many features never previously published in any service guide. ● OVER 1,800 PAGES ● OVER 3,000 ILLUSTRATIONS ● OVER 1,600 SETS REPRESENTED ● Complete Service Data ● Includes 1938 Models Not Found in Other Manuals ● All New Material—No Reprint or Refresh ● Master Index of 74 Pages Includes Sets Listed in All Other Gernsback Manuals ● Stiff, Leatherette Looseleaf Covers ● Size 9 x 12 Inches ● Net Weight 10½ lbs.

Price \$10.00



1935 OFFICIAL AUTO-RADIO SERVICE MANUAL

If you are overlooking servicing auto radios, then you are missing a great deal of business. The great number of car radios in use require constant servicing and you can make it a profitable sideline to your regular servicing business. This complete Manual contains schematic diagrams,

chassis layouts, mounting instructions and trouble shooting hints. ● OVER 240 PAGES ● OVER 500 ILLUSTRATIONS ● Flexible, Leatherette Looseleaf Covers ● Size 9 x 12 Inches ● Net Weight 1¾ lbs.

Price \$2.50

1936 OFFICIAL RADIO SERVICE MANUAL

Just packed with service data of sets manufactured during 1935 and 1936. Schematic diagrams show speaker connections, power-transformer connections, R.F. and I.F. coil connections, phonograph connections and other information. ● OVER 1,200 PAGES ● OVER 1,500 SETS SHOWN ● OVER 2,500 ILLUSTRATIONS ● Index of Trade Names ● Complete Tube Chart ● Stiff, Leatherette, Looseleaf Covers ● Size 9 x 12 Inches ● Net Weight 8 lbs.

Price \$7.00



1934 OFFICIAL RADIO SERVICE MANUAL

This manual contains values of I.F. transformers on superheterodyne receivers, valuable tube data, complete list of American broadcast stations, free question and answer service, service material and schematic diagrams. ● OVER 400 PAGES ● OVER 2,000 ILLUSTRATIONS ● Flexible, Leatherette, Looseleaf Covers ● Size 9 x 12 Inches ● Net Weight 2¾ lbs.

Price \$3.50

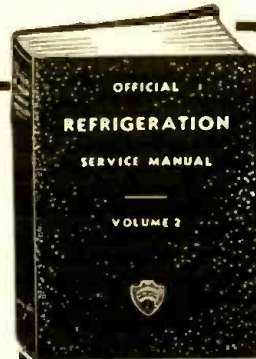

OFFICIAL REFRIGERATION SERVICE MANUAL

Volume 2

This is the only complete refrigeration service manual ever published. Contains detailed information on servicing, outlines of theory and methods of operation, instructions for the handling of refrigerants, charging systems, diagnosing troubles, charts, electrical hook-ups and a wealth of other necessary data. ● OVER 352 PAGES ● OVER 300 DIAGRAMS ● Flexible, Leatherette, Looseleaf Covers ● Size 9 x 12 Inches ● Net Weight 1¾ lbs.

Price \$5.00



1932 OFFICIAL RADIO SERVICE MANUAL

Here is the volume which shows a step-by-step analysis of how to service any receiver. It is one of the early editions and covers many old sets, thousands of which are still in use throughout the country. ● OVER 1,000 PAGES ● OVER 2,000 ILLUSTRATIONS ● Flexible, Leatherette, Looseleaf Covers ● Size 9 x 12 Inches ● Net Weight 4½ lbs.

Price \$5.00



OFFICIAL AIR CONDITIONING SERVICE MANUAL

This manual is edited by L. K. Wright, who is an expert and leading authority on air conditioning and refrigeration. Nearly every page is illustrated, every modern installation and individual part carefully explained, diagrams furnished of all known equipment, special care given to the servicing and installation end. Necessary tools are illustrated and explained, etc. ● OVER 352 PAGES ● OVER 600 ILLUSTRATIONS ● Flexible, Leatherette, Looseleaf Covers ● Size 9 x 12 Inches ● Net Weight 2¾ lbs.

Price \$5.00



To order these famous Manuals, see or write to your jobber or favorite mail order house. If more convenient, mail coupon directly to publishers.

RADCRAFT PUBLICATIONS, Inc., 20 VESEY ST., NEW YORK, N. Y.

Gentlemen: Enclosed find my remittance of \$..... for which send me, POSTPAID, the Manuals indicated below by a cross (x) in the panel.
 Volume 7 @ \$10.00 1936 Manual @ \$7.00 1934 Manual @ \$3.50
 1935 Auto-Manual @ \$2.50 1932 Manual @ \$5.00
 Refrigeration Manual (Vol. 2) @ \$5.00 Air Conditioning Manual @ \$5.00

Name

City State

(Send remittance in form of check or money order; register your letter if you send cash or unused U. S. Postage Stamps.) RC-641

RADCRAFT PUBLICATIONS, Inc.
20 VESEY STREET NEW YORK, N. Y.

F.C.C. ACHIEVEMENT DURING 1940

IN AN annual report which incorporates important developments since the close of the fiscal year, the Federal Communications Commission chronicles new milestones in the advancement of broadcasting, and cites augmented duties in supervising radio, telephone, telegraph, and cable in connection with the national defense program.

This streamlined report is almost half the size of the one last year. To summarize some of its highlights:

NATIONAL DEFENSE.—The Commission's particular role in the preparedness program is to "police" radio communications. In consequence, it has added to its monitoring and other field facilities. Also, it must keep tab on the many persons who operate electrical apparatus capable of farflung and almost instantaneous communication.

So the F.C.C. is requiring all radio operators (about 100,000 licensees—including commercial and amateur) to prove their citizenship. Common carriers are compiling similar data with respect to employees who engage in international communication. The Commission has banned amateur communication with foreign countries, and, further, prohibits the use of portable long-distance transmitters by amateurs. Such steps are precautionary rather than disciplinary. The Commission does not want to interfere with radio and wire communications any more than is necessary for the national protection. Individuals and industries concerned are collaborating in this common contribution toward the national security.

The relationship of radio, wire, and cable facilities to the Preparedness picture is being further coordinated in planning by the Defense Communications Board, created by Executive order in September.

BROADCASTING (F.M.).—Last year, which marked the 20th Anniversary of Broadcasting, was notable because of Commission recognition of a new type of public service in frequency modulation, popularly known as "F.M." The ensuing year will offer practical demonstration of F.M.'s claimed clarity and staticless qualities. Also, by utilizing the high frequencies, F.M. promises to relieve the long congested standard broadcast band.

Business will benefit by the new equipment, sets, and servicing which F.M. requires. And, by being generally limited to local coverage, this new service should have a stimulating effect on local programming. Distinctive call letters have been assigned. To date the Commission has authorized 25 F.M. stations to engage in full commercial operation.

BROADCASTING (Standard).—This older type of broadcast (which uses amplitude modulation) should experience a marked improvement in service by reason of the North American Regional Broadcasting Agreement, effective March 29th next. Mutual interference problems are expected to be eliminated or minimized as a result of this compact between Canada, Cuba, Mexico, and the United States.

To make agreement possible, the Commission is effecting an orderly shift of frequencies without disturbing the general broadcast structure. A total of 846 standard broadcast stations were operating or under construction during the fiscal year. There were 79 new authorizations and 10 deletions. Increased use of directional antennas is necessary in coping with the interference problem. During the calendar year 1939 a

total of 705 standard broadcast stations (including networks) reported total time sales approaching \$130,000,000, making a net income of nearly \$24,000,000. They also listed a payroll of nearly \$52,000,000 for nearly 25,000 employees. The report of the Commission's special committee on chain broadcasting was the subject of oral argument in December in connection with its consideration by the full Commission. Commission inquiry revealed some 200 domestic stations broadcasting in about 30 foreign languages. Commission action in 5 broadcast cases was upheld by the United States Supreme Court.

BROADCAST (International).—Broadcast service to Latin America was improved by reason of the Commission requiring power of at least 50 kilowatts for international program service. In this country 13 international broadcast stations were operative.

TELEVISION.—Television is now making substantial progress with the cooperative assistance of that industry and the Commission. More than a score of stations geographically distributed throughout the nation have been licensed to experiment with various types of transmission with a view to reaching early accord on uniform standards which will enable television to move forward on a full commercial basis. Participating stations have budgeted a total of \$8,000,000 for this practical experimental work.

In conjunction with such effort, a National Television Systems Committee, jointly sponsored by the Radio Manufacturers Association and the Commission, has made a thorough study of the engineering phases of the situation which should be helpful in arriving at a general agreement. The continued rapid evolution of television is attested by developments in color reproduction, large-screen projection, and new service demonstrations.

MISCELLANEOUS RADIO SERVICES.—Increased use of radio for miscellaneous services is noted. Police stations have increased to 6,300, aviation stations to nearly 2,000 and more than 1,000 stations are employed for forest conservation work.

The Commission clarified its rules with respect to more than 450 special emergency stations. This class of station has demonstrated its ability to establish radio communication in time of emergency. The Commission completed its final report on a special study of radio requirements for safety purposes on the Great Lakes and Inland Waters, and gathered information with respect to possible like need on the Mississippi River system. There are 56,300 amateur stations in operation. Some 40,000 commercial operator licenses were handled during the year. Inspection was made of radio installation on more than 14,000 ships and at some 8,600 land stations.

TELEGRAPH.—As a remedy for many ills in the highly competitive telegraph industry, the Commission recommended merger of the domestic telegraph companies, and, further, urged consolidation of international communication carriers domiciled in the United States in the interests of defense and other national needs.

TELEPHONE.—Savings to telephone users aggregating \$10,000,000 annually are indicated by tariff revisions filed with the Commission since its previous annual report. New construction amounting to more than \$9,000,000 was authorized.

CABLE.—Some cable, as well as radio, circuits were disrupted as a result of the war, and the Commission speeded authorizations for new or temporary replacements.

ACCOUNTING.—More than 23,000 tariff schedules were filed by common carriers. The Commission adopted a revised uniform system of accounts for telegraph and cable carriers, to become operative in 1942. The new system, which conforms to Government accounting principles, will supplant one in use since 1914.

RECOMMENDATIONS TO CONGRESS.—None, other than those contained in the Great Lakes and telegraph merger reports.

Radio Frequencies and Their Allocation

THE radio spectrum, or radio waves, is but one portion of the total electromagnetic spectrum. The electromagnetic spectrum covers 8 different classes of radiation—(1) electric waves, (2) radio waves, (3) infra-red, (4) visible light, (5) ultra-violet, (6) X-rays, (7) gamma rays, and (8) secondary cosmic rays.

The emission of this energy may be likened to the expanding ripples of water suddenly disturbed by a thrown stone. However, electromagnetic energy travels in all directions.

Since electromagnetic radiations have a common speed (that of light), their only difference is in frequency and wavelength. "Frequency" may be characterized as the number of these waves per second, and "wavelength" as the distance between successive waves.

The divisions between the various classes of electromagnetic radiations are not definite. The lines of separation are based largely upon the effects and the particular method of producing the various emissions. Under certain conditions, some of these electromagnetic impulses may be seen, felt, or heard. Of the eight classes of electromagnetic radiations, that portion classed as "radio waves" covers a relatively small part of the total electromagnetic spectrum.

Radio facilities are extremely limited. In order to provide the maximum possible service for the benefit of the public, it is necessary to control and restrict the use of the available channels. As transmission by radio waves spans great distances, it has been found necessary to have international agreement on the proportion of available channels to be allocated for particular services. To prevent interference and confusion within our own country, it is necessary to further apportion the frequencies in the best interests of users.

Besides the standard broadcast channels, our radio spectrum is shared by other primary services, such as: fixed, marine, aviation, emergency, amateur, miscellaneous, experimental, Government, and broadcast services other than standard broadcast. These general service allocations cover various classes of station, including: relay, international broadcast, high frequency broadcast, non-commercial education, facsimile, television, point-to-point telephone and telegraph, agriculture, press, coastal, telegraph and telephone, ship, aircraft, aeronautical, blind landing systems, airport, municipal and State police, marine fire, forestry, geological, mobile press, motion picture, amateur phone, telegraph and television, as well as experimental classes of stations.

The present useful radio spectrum, in

which channels are now allocated, ranges from 10 to 300,000 kilocycles, or in terms of wavelengths, from 30,000 meters to 1 meter. That portion below 100 kilocycles is popularly referred to as "long waves"; from 100 kilocycles to 550 kilocycles as "medium long waves"; from 550 to 1,600 kilocycles as "broadcast"; 1,600 to 6,000 kilocycles as "medium short wave"; 6,000 to 30,000 kilocycles as "short waves"; and above 30,000 kilocycles as "very short" or "ultra-short waves."

The band below 100 kilocycles is occupied by Government and commercial long-wave fixed service stations.

From 100 kilocycles to the beginning of the broadcast band at 550 kilocycles, we have the medium longwave stations, as follows:

100 to 200 kilocycles—Government and private ship, coastal, and fixed service stations.

200 to 400 kilocycles—primarily Government aids to navigation, such as radio navigation for aircraft, and radio beacon service to ships, interspersed with airport on 278 kilocycles, direction finding on 375 kilocycles, and miscellaneous fixed stations.

400 to 550 kilocycles—Government and commercial ship and coast stations in the maritime service centered near the international calling and distress frequency of 500 kilocycles (600 meters).

The rest of the spectrum from the end of the "broadcast" band at 1,600 kilocycles, involving the so-called "medium short", "short", and "ultra-short" wave bands, could be pictured as a many-layered sandwich, with police, amateur, aviation, Government, ship, coastal, broadcast, mobile press, special services, experimental, television, fixed, forestry, and all other classes of stations providing varying depths of filling.

Of course, this does not mean that all these bands are completely filled. Radio communication is still undergoing change, and the Federal Communications Commission, in licensing individuals and firms to use the public's radioways, is charged with preparing for the future, as well as for the present. Hence, some channels are held open for future developments, while others already allocated, are subject to shift with changing events.

A WORD TO THE WISE

The Commission has warned radio operators that transmission of superfluous communication is not only illegal but is distinctly frowned upon at the present time. Hence, in enforcing this law the Commission has asked a tugboat company to explain a superfluous ether conversation concerning family difficulties, and a baseball game, which was picked up by one of the Commission's monitoring stations.

Numerous persons requesting the 1300-page report on chain broadcasting made by a committee of the Commission are informed that only a limited number of copies were mimeographed, and the supply has long since been exhausted. The official record, however, is open to public inspection at the Commission's Washington offices.

The Commission has sent a note of appreciation to the Ohio Power Co. for its interest and cooperation in eliminating interference to radio reception in a community in that State.

A committee for the care of refugee children seeks Commission permission to solicit funds by radio. Such permission is not required under provisions of the Communica-

10 BEST RADIO BOOKS 10¢ ea.

RADIO FANS EVERYWHERE—these fine ten cent text books give you an excellent foundation for the study of RADIO. They are clearly written, profusely illustrated and contain over 15,000 words in each book. You'll be amazed at the wealth of information contained in these handy books. Excellent for reference—ideal for every technical library. **YOUR MONEY BACK** if you are not satisfied. **PROMPT SHIPMENTS**

No. 1
HOW TO BUILD FOUR DOERLE SHORT WAVE SETS
Thousands of radio fans have built the famous DOERLE Short Wave Radio Receivers. So insistent has been the demand for these receivers, as well as construction details that this book has been specially published. Contains **EVERYTHING** that has ever been printed on these famous receivers.



No. 2
HOW TO MAKE THE MOST POPULAR ALL-WAVE 1- and 2-TUBE RECEIVERS
This book contains a number of excellent sets, some of which have appeared in past issues of RADIO-CRAFT. These sets have been carefully engineered. They are not experiments. Not only are these sets described in this book, but it contains all of the illustrations, hookups, etc.



No. 3
ALTERNATING CURRENT FOR BEGINNERS
This book gives the beginner a foothold in electricity and Radio. Electric circuits are explained. Ohm's Law, one of the fundamental laws of radio, is explained; the generation of alternating current; sine waves; the units—volts, amperes, and watts are explained. Condensers, transformers, A.C. instruments, motors and generators.



No. 4
ALL ABOUT AERIALS
This book explains the theory underlying the various types of aerials: the inverted "L", the Doublet, the Double Doublet, etc. It explains noise-free reception, how low-impedance transmission lines work; why transposed lead-ins are used. It gives in detail the construction of aerials suitable for long-wave broadcast receivers, for short-wave receivers and for all-wave receivers.



No. 5
BEGINNERS' RADIO DICTIONARY
Are you puzzled by radio language? Can you define Frequency? Kilocycles? Tetraohm? Screen grid? Baffle? Anode? Triode? Pole? Ionization? Joule's Law? Harmonic? Gravy? Ohm? If you cannot define these very common radio words and dozens of other, more technical, terms used in all radio magazines and instruction books, you need this book in your library.



No. 6
HOW TO HAVE FUN WITH RADIO
Stunts for parties, practical jokes, scientific experiments and other amusements which can be done with your radio set are explained in this fascinating volume. It tells how to make a newspaper talk—how to produce silent music for dances—how to make visible music—how to make a "silent radio" unit, usable by the deafened—how to make toys which dance to radio music, etc., etc.



No. 7
HOW TO READ RADIO DIAGRAMS
All of the symbols commonly used in radio diagrams are presented in this book, together with pictures of the apparatus they represent and explanations giving an easy method to memorize them. This book by Robert Eichberg, the well-known radio writer and member of the editorial staff of RADIO-CRAFT Magazine, also contains two dozen picture-wiring diagrams of simple radio sets that you can build.

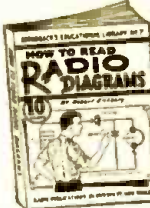

No. 8
RADIO FOR BEGINNERS
Hugo Gernsback, the internationally famous radio pioneer, author and editor, whose famous magazines, RADIO AND TELEVISION and RADIO-CRAFT are read by millions, scores another triumph with this new book. Any beginner who reads it will get a thorough ground work in radio theory, clearly explained in simple language, and through the use of many illustrations. Analogies are used to make the mysteries of radio clear.



No. 9
SIMPLE ELECTRICAL EXPERIMENTS
Over 100 interesting and practical electrical experiments are described in this book, covering every branch of electricity—from simple experiments with magnets to high frequency "stunts". All of the experiments described can be carried out with simple apparatus, most of which can be found about the home.



No. 10
TELEVISION
Every one is asking the question: How does television work? This book explains all of the different systems of television from the simplest to the most complex. It describes in A-B-C style just how the image is scanned, how the scene is picked up by the television camera and broadcast to your home, etc. Various types of television systems are described.



BOOKS ARE ALL UNIFORM

Every book in the GERNSBACK EDUCATIONAL LIBRARY has 32 pages—with illustrations varying from 30 to 66 in number. Each title volume contains over 15,000 words. Positively radio's greatest book buy! If you do not think these books worth the price asked, return them in 24 hours and your money will be instantly refunded.

RADIO PUBLICATIONS • 20 VESEY STREET • NEW YORK, N. Y.

RADIO PUBLICATIONS, Dept. RT-6-41
20 VESEY STREET, NEW YORK, N. Y.
Gentlemen: Please send immediately, POSTPAID, the book numbers circled below. I am enclosing cents—each book being 10c.

1 2 3 4 5 6 7 8 9 10
NEW NEW

Send FREE listing of 48 new 10c publications.

Name Address

City State

Remit by check or money order—register letter if you send cash or unused U. S. postage stamps.

MAIL COUPON TODAY!

tions Act of the Commission's rules. Decision rests with the individual station or the network.

It is mostly in the matter of complaints with reference to broadcasting that the Commission has to advise lack of jurisdiction. The following current cases are typical:

A Toronto, Canada, woman objects to radio commentators who "spread terror by innuendo."

A San Francisco man dislikes the "hysterical broadcasting" of war news by a particular commentator.

A Macon, Ga., man would prohibit networks from carrying news reports originating in Germany.

A Philadelphia man suggests censorship of news and comment by radio and press

during "continuation of the present unsettled world conditions."

A New Yorker asks the Commission to make radio stations broadcast a song he has written.

A Bismarck, N. Dak., man wants the Commission to require a network to carry a particular religious broadcast.

An Asheville, N. C., man would require newspapers owning radio stations to publish the programs of competing broadcast stations.

A Philadelphia man thinks he is entitled to a prize from one of the radio contest programs.

AGAIN—RADIO-CRAFT FOR SERVICEMEN

Dear Editor:

In the past I have been a regular subscriber to *Radio-Craft* and received much information and help as a Serviceman. By all means do not change your fine new method of publishing *Radio-Craft*. On second thought the Serviceman must make his living by radio service work and here is where you fit in the picture by helping him speed up with more accurate work which

in the end increases his net income and ends in a better living.

B. F. ROBINSON,
Spokane, Wash.

STOCK PHRASE—"RADIO-CRAFT FOR SERVICEMEN"

Dear Editor:

I have been reading your publications for 15 years. I have all copies of *Radio News* beginning with 1925 to 1932, and from there on *Radio-Craft*, and **Shortwave Craft*. I bind each year into one book.

I am a Serviceman and would suggest you keep one paper for Servicemen and receivers, as I for one, after 15 years of servicing, am not interested in Ham gear and transmitters. Let's have that and all shortwave in **Shortwave & Television*. I like your papers better than any others and would not want to get along without them and I feel you have given me quite an education in Radio and long may you prosper. Thanks. I remain your sincere reader,

A. J. NIEBUR,
Norfolk, Nebr.

*Now RADIO & TELEVISION magazine.

For Advertisers Index

See Page 764

USE OF RADIO IN SPECIAL EMERGENCIES

Safety of Life and Property Being Promoted in Extended Use of Special Emergency Service by Public Utilities. These uses have been illustrated and described in past issues of Radio-Craft but are again mentioned here in a coordinated article.

THERE is one class of radio station license issued by the Federal Communications Commission which, though little known, is playing an increasingly important role in the economic life of the nation. This particular type of license covers Special Emergency Stations. These stations have already demonstrated their value in time of localized stress, and now loom as a valuable adjunct to the linking of communications for widespread protection of life and property.

Special emergency stations have rendered valuable service in regional disasters, such as the New England hurricane and in time of flood when the normal means of communication are destroyed or are rendered inoperative. It would be difficult to obtain information as to casualties and extent of damage, and even more difficult to restore communication, were it not for the temporary facilities which can be rapidly established to meet such emergencies. The use of special emergency stations in this connection is probably the most spectacular use to which these stations are now put.

The Long Lines Division of the American Telephone and Telegraph Company, as well as many local telephone companies, have been issued licenses for special emergency stations. Special equipment has been designed for the purpose. This equipment can be stored in a chest. In time of emergency, it can be loaded in a truck, driven to the scene, and quickly and easily set up for operation. When so used, the design of these stations permits either communication between construction crews at the scene of the emergency or the interconnection of regular land lines in such manner that regular subscriber communication can be re-established.

Aside from service in time of disaster, these stations are in growing daily use by public utilities. For example:

The economic life of our country has become so dependent upon electricity that a sudden and complete disruption of electric service to any large metropolis would make

that city practically uninhabitable. The network of interconnecting electric power lines has greatly reduced the hazards which would be created by failure of a single plant. However, constant vigilance is required to maintain the transmission lines, which constitute this network, for the most efficient service. As these transmission lines normally carry very high voltages, and since they cannot be disconnected for any extended period, close coordination is needed between the working parties and the switching central at the power house.

UTILITIES EXTEND RADIO USE

Special emergency stations make this possible. Some utility engineers say the time is rapidly approaching when no power distribution system or gas, oil, or water distribution system operating over a large area will be considered fully equipped unless it has a radio communication system to augment the wire, telegraph, telephone, and carrier-current (wired-radio) communication systems.

There is a particular, day-to-day emergency demand for radio communication, by public utilities within the metropolitan districts. To illustrate:

Should an automobile run into a light pole and knock it down, electrical voltages of dangerous potentials are exposed and endanger passers-by. Also, there have been occasions in which a street car has run over a pedestrian and in order to remove the victim it has been necessary to jack up the street car from the rail. Without radio communication, it is necessary for a service truck to be dispatched from some far quarter to the scene even though a truck with proper equipment might be working only a block or two away.

Other emergency services of this nature include repairs of wires downed because of sleet, and restoration of power to hospitals, etc. To meet these situations, the Commission allocates appropriate frequencies and issues authorizations to public utilities interested solely in metropolitan area service.

POOLED CHANNELS

Inasmuch as the number of frequencies available for such assignment is extremely limited, it is required that those public service units eligible to receive emergency

station licenses cooperate among themselves in the choice and use of frequencies so as to avoid duplication and interference. For this and other reasons it has become common practice for various public utilities in a single area to pool their needs, one utility requesting the license and rendering the service while the other utilities receive this service and contribute to the cost of operation on a pro-rated basis.

Recent Commission authorizations illustrate this arrangement.

In the New York metropolitan area there are a number of public utilities, including the New York Telephone Company, which are eligible for, and have need of, special emergency radio communication. In order to reduce the capital investment and to receive the maximum benefits from this type of communication, the New York Telephone Company has taken the lead and is constructing a sufficient number of special emergency stations to serve all utilities in that metropolitan area. (Italics ours.—Editor)

This radio service will be made available for the handling of only such communications as meet the definition of emergency in the Commission's rules and regulations. In order that the cost of operation may be recovered, and to prevent this new system from becoming a burden on the general telephone subscriber, the telephone company is to make charges to the various utilities concerned, in much the same manner as to the telephone and teletype subscribers. In other words, a definite charge per call will be made and the company will be given a guarantee in the form of minimum service charge.

On January 1 of this year, 76 special emergency systems involving 368 individual transmitters had been authorized by the Commission.

The rules and regulations governing special emergency stations appear as Part 10 of the Rules and Regulations of the Federal Communications Commission, which are available in pamphlet form from the Superintendent of Documents, Government Printing Office, Washington, D. C., at a cost of 5c a copy. Information and application forms may be obtained either from the Washington headquarters of the Commission or from any of its field offices.

TRAIN NOW FOR TECHNICAL RADIO WORK

**I GIVE YOU FULL
RADIO EQUIPMENT
TO DO OVER 100 ACTUAL EXPERIMENTS**

You Are Pre-conditioned with
RADIO REPAIR EXPERIENCE
... In Your Own Home!

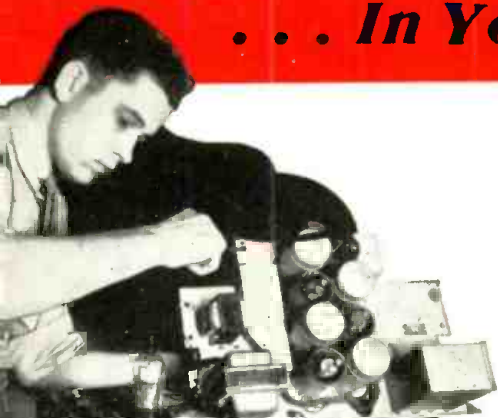

**TRAINING PREPARES YOU FOR A BUSINESS OF YOUR OWN
OR GOOD RADIO JOBS AT EXCELLENT PAY**

Specially designed to help you make fast progress, SPRAYBERRY Training starts right at the beginning of Radio . . . unfolds each subject in a simplified, logical, understandable style. You easily learn in your spare hours . . . AT HOME or AT CAMP. Course covers Television, Frequency Modulation, Signal Tracing, Mobile Radio (Auto-Tank), Aviation Radio, Electronics, Facsimile Radio, Radio Set Repair and Installation Work and other essential subjects

CASH IN ON RADIO'S RICH OPPORTUNITIES

There is good money to be made. My Training will give you quick access to excellent opportunities. Sprayberry Methods are thorough and practical. Your Training will not interfere with your present work. You get PROFESSIONAL TEST EQUIPMENT plus EXPERIMENTAL OUTFITS. Includes 146 RADIO PARTS for building a complete Receiver, RADIO TOOLS and a modern TESTER-ANALYZER. You also receive 8 BIG SHIPMENTS OF RADIO EQUIPMENT. I show you how to create Radio defects . . . how to correct them. ALL EQUIPMENT BECOMES YOUR PERSONAL PROPERTY!

**LEARN MORE ABOUT SPRAYBERRY TRAINING
AND HOW EASY IT IS TO START**

Regardless of previous education or experience, I can fit you for a good-paying Radio job. My BUSINESS BUILDERS will show you how to put your Equipment to actual use in handling money-making Radio Service Jobs shortly after you begin Training. You can EARN WHILE YOU LEARN. Get complete details AT ONCE . . . in my new, valuable 52-page FREE BOOK. Mail coupon below.

**REMEMBER THE SPRAYBERRY COURSE IS SOLD
UNDER MONEY-BACK AGREEMENT**

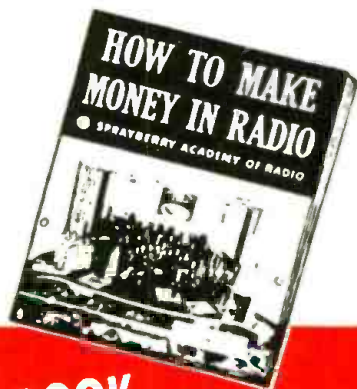

READ THESE LETTERS



"Grossed Between \$150 and \$200"
Before finishing your training I've started to do Radio repair business. I have about all the work I can take care of. I have grossed between \$150 and \$200 in the last few months in my spare time. I think your Course is "GOD". W. Francis Wessels, Fountain City, Wisconsin.

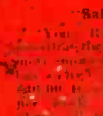

"Salary Has Increased"
You know I am a Radio Repairman. I have made it my business to do the best work in the Radio business. I have a salary of \$12.00 per month. I have made it my business to do the best work in the Radio business. I have a salary of \$12.00 per month. I have made it my business to do the best work in the Radio business. I have a salary of \$12.00 per month.

Get **FREE BOOK**

SPRAYBERRY ACADEMY OF RADIO
F. L. Sprayberry, Pres.
420-F University Place, N. W.

Washington, D. C.

Please send me FREE copy of "HOW TO MAKE MONEY IN RADIO".

Name

Age

Address

State

City

Tear off this coupon, mail in envelope or paste on penny postcard.

Boost your Summer Profits

the **RADIOLA** Way!



Radiola Model P-5 3-Way Portable

- Plays on AC, DC, Batteries
- Superhet with Tuned Loop Antenna
- Full AVC Action
- Durable, Washable Case
- Alnico P. M. Dynamic Speaker

Lend it and you'll sell it while their set is in your shop!

SUMMER'S THE SEASON for sales by *servicemen!* For in summer, service customers want an extra radio more than ever—particularly if that extra radio will play *anywhere*. . . with the superb *performance* of this RADIOLA Model P-5 three-way portable.

Salesmanship? The salesmanship is in the *set!* Just "lend" them the P-5 while you work on their regular receiver. Let them discover the convenience of "another" radio: a radio

they can carry upstairs, downstairs, all around the house . . . and right out the front door, when they wish!

Servicemen the country over are boosting their incomes the RADIOLA way . . . with the only line of radio receivers specifically designed for servicemen to sell. Try it yourself. See the great new RADIOLA line at your distributor's. Combine business with *more business*: sell sets when you sell service!



All RADIOLA Models Are Equipped Exclusively with RCA Preferred Type Tubes

THESE
RADIOLA MODELS, TOO,
are selling like hotcakes!



Radiola Model 515

Superb *foreign* reception in an "extra" radio! Plus a continental-style cabinet . . . large, easy-reading dial . . . and RF Stage for stepped-up sensitivity! Six RCA Preferred Type Tubes. Six tuned circuits. Two built-in antennas for long and short waves. No wonder it's a *super* seller.



Radiola Model 511

A RADIOLA model you can sell nearly everywhere—a set that's packed with value! Beautiful antiqued ivory plastic cabinet. Five RCA Preferred Type Tubes in a sensitive superheterodyne with full AVC action. 5" electrodynamic speaker, large, built-in tuned loop antenna.

Radiola Preferred Type Radios

Made by RCA Manufacturing Co., Inc., Camden, N. J., U.S. A.
A Service of the Radio Corporation of America
In Canada, RCA Victor Company, Ltd., Montreal