

RADIO'S LIVEST MAGAZINE

OVER 175 ILLUSTRATIONS

Radio-Craft

Special
Television
Number

August

25 Cents

in United States
and Canada

HUGO GERNSBACK EDITOR



See Page 76

Television's New "Projection Kinescope" — A 2-Tube Carrier Interphone
How to Make A 30-Tube Radio Set — The Balance Sheet of Television

OVER 50,000 RADIO MEN READ RADIO-CRAFT MONTHLY

EVEN IF NEXT YEAR'S TUBES LOOK LIKE THIS
THE NEW

SUPREME

502

WILL TEST THEM!

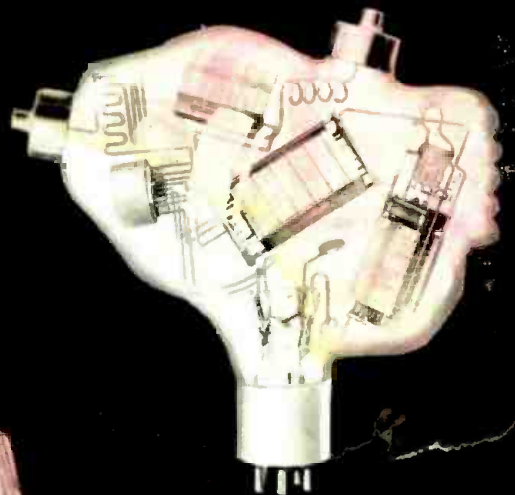

ONLY \$49.95
\$5.50 DOWN
\$4.95 FOR 10 MONTHS

FEATURING:

- 1 Tube testing circuit uses exclusive "Floating Filament" return selector circuit which deals old man "obsolescence" a knockout blow. It will test any 4, 5, 6, 7 or 8 prong tube regardless of whether the filament terminates on the regular two pin terminations or not. It could even test any future tube with one of the filament connections terminating on a "top cap"!
- 2 Supreme Square meter with large easily read scales and 1 m. a. movement (1000 ohms per volt).
- 3 New tube testing circuit which is easier to operate and more accurate than ever before. Sells more tubes. Results shown on English reading "Good Tube—Bad Tube" scale.
- 4 Tests all elements for opens; tests shorts and leakages between any two elements, all while the tube is HOT and on neon bulb.
- 5 Simple tube testing system requires minimum controls, maximum saving of time and more profit to you.
- 6 Primary Volts adjuster using tapped transformer, the most accurate line voltage adjustment method.
- 7 Extra multimeter ranges too! A combination tube checker and multimeter—just the instrument to carry on service calls.
- 8 Four A. C. Voltage ranges of 0/7/140/350/1400 volts.
- 9 Four D. C. Voltage ranges of 0/7/140/350/1400 volts.
- 10 Three Ohmmer ranges—0/200/2000/20,000 ohms.
- 11 Two Megohms ranges—0/2 megs, 0/20 megs.
- 12 Electrolytic Filter Capacitor leakage test on "Good-Bad" English reading scale.
- 13 Electrostatic Capacitor leakage test on neon bulb.
- 14 Four Output measuring ranges, 0/7/140/350/1400 A. C. volts.
- 15 Nineteen multimeter ranges and functions besides the best tube tester design ever offered the serviceman.
- 16 Only six sockets test all tubes. No question as to which is the proper socket to use.
- 17 Panel only 13 1/2 inches by 9 inches of Beautiful Antique Bronze.
- 18 Golden Oak Carrying Case.
- 19 Low ohms 0/200 ohm range has center scale reading of only 3.5 ohms! Just the unit to accurately measure voice coil and R. F. coil resistances, first division on this range is 0.1 ohms!

SOLD ON SUPREME S. I. C. TERMS—THE WORLD'S EASIEST INSTALLMENT TERMS!

SUPREME INSTRUMENTS CORP.
GREENWOOD MISSISSIPPI

READ THESE 8 True Experiences of Men I Trained at Home for RADIO



I NOW HAVE MY OWN RADIO BUSINESS AND AVERAGE \$55 TO \$70 A WEEK.
JAMES SKLAVOS
 333 THIRD ST.
 SAN FRANCISCO, CALIF.



I DO RADIO SERVICE WORK IN SPARE TIME AND AVERAGE ABOUT \$12.50 A WEEK.
J. B. MILBY
 BOX 95
 UTICA, MICH.



AFTER COMPLETING TWENTY LESSONS I JOINED STATION WMPC WHERE I AM NOW CHIEF OPERATOR.
HOLLIS F. HAYES
 85 MADISON ST.
 LAPEER, MICH.



I AM NOW FOREMAN OVER PRODUCTION OF RADIOS FOR THE W-G-CORP.
OTTO CLIFFORD
 512 W. SEMINARY ST.
 CHARLOTTE, N. C.



I AM EMPLOYED BY A RADIO STORE, AND EARNED ABOUT \$2,500 LAST YEAR.
CHARLES L. TORREY
 825 S. 12TH ST.
 SAN JOSE, CALIF.



AUTO RADIO AND N.R.I. TRAINING ARE A GOOD COMBINATION I AM BUILDING A FINE BUSINESS.
A.C. HENDRIKSEN
 125 S. MELROSE AVE.
 ELGIN, ILLINOIS



MY LOUDSPEAKER SYSTEM PAYS ME ABOUT \$35 A WEEK, BESIDES MY RADIO WORK.
MILTON L. LEIBY, JR.
 TOPTON, PENNA.



I AM NOW GROUND STATION OPERATOR FOR THE AMERICAN AIRWAYS, INC. AT CINCINNATI.
WALTER B. MURRAY
 LUMKEN AIRPORT
 CINCINNATI, OHIO

THIS FREE BOOK HAS HELPED HUNDREDS OF MEN MAKE MORE MONEY



Mail Coupon

I WILL TRAIN YOU AT HOME *in Spare Time* FOR A GOOD RADIO JOB



J. E. SMITH
 President
 National Radio Institute

Do you want to make more money? Radio offers you many opportunities for well-paying spare time and full time jobs or for starting a Radio service business of your own. And you don't have to give up your present job or leave home and spend a lot of money to become a Radio Expert.

Many Radio Experts Make \$30, \$50, \$75 a Week

Radio broadcasting stations employ engineers, operators, station managers and pay up to \$5,000 a year. Spare time Radio set servicing pays as much as \$200 to \$500 a year—full time jobs with Radio jobbers, manufacturers and dealers pay as much as \$30, \$50, \$75 a week. Many Radio Experts own and operate their own full time or part time Radio sales and service businesses. Radio manufacturers and jobbers employ testers, inspectors, foremen, engineers, servicemen, paying up to \$6,000 a year. Radio operators on ships get good pay and see the world besides. Automobile, police, aviation, commercial Radio, and loud speaker systems are newer fields offering good opportunities now and for the future. Television promises to open many good jobs soon. Men I have trained are holding good jobs in these branches of Radio. Read their statements. Mail the coupon.

There's a Real Future In Radio for Well Trained Men

Radio already gives good jobs to more than 300,000 people. And in 1936, Radio enjoyed one of its most prosperous years. More than \$500,000,000 worth of sets, tubes and parts were sold—an increase of more than 60% over 1935. Over a million Auto Radios were sold, a big increase over 1935. 24,000,000 homes now have one or more Radio sets, and more than 4,000,000 autos are Radio equipped. Every year millions of these sets go out of date and are replaced with newer models. More millions need servicing, new tubes, repairs, etc. A few hundred \$30, \$50, \$75 a week jobs have grown to thousands in 20 years. And Radio is still a new industry—growing fast!

Many Make \$5, \$10, \$15, a Week Extra in Spare Time While Learning

Practically every neighborhood needs a good spare time serviceman. The day you enroll I start sending you Extra Money Job Sheets. They show you how to do Radio repair jobs that you can cash in on quickly. Throughout your training I send you plans that made good spare time money—\$200 to \$500 a year—for hundreds of fellows. My training is famous as "the Course that pays for itself."

I Give You Practical Experience

My Course is not all book training. I send you special Radio equipment and show you how to conduct experiments and build circuits which illustrate important principles used in modern Radio receivers, broadcast stations and loud speaker installations. I show you how to build testing apparatus for use in spare time work from this equipment. You work out the things you read in the lesson books. Read about this 50-50 method of training—how it makes learning at home interesting, quick, fascinating, practical. Mail coupon.

Money Back Agreement Protects You

I am so sure that I can train you successfully that I agree in writing to refund every penny you pay me if you are not satisfied with my Lessons and Instruction Service when you finish. I'll send you a copy of this agreement with my Free Book.

Find Out What Radio Offers You

Act Today. Mail the coupon now for "Rich Rewards in Radio." It's free to any fellow over 16 years old. It describes Radio's spare time and full time opportunities; tells about my Training; shows you actual letters from men I have trained, telling what they are doing and earning. Find out what Radio offers YOU! MAIL THE COUPON in an envelope, or paste it on a penny post card—NOW!

J. E. SMITH, President, Dept. 7HX
 National Radio Institute, Washington, D. C.

MAIL NOW FOR BIG BOOK *Free*

J. E. SMITH, President, Dept. 7HX,
 National Radio Institute, Washington, D. C.

Dear Mr. Smith: Without obligating me, send "Rich Rewards in Radio," which points out the spare time and full time opportunities in Radio and exhibits your 50-50 method of training men at home in spare time to become Radio Experts. (Please Write Plainly.)

NAME AGE

ADDRESS

CITY STATE

Please Say That You Saw It in RADIO-CRAFT



HUGO GERNSBACK, Editor-in-Chief
 C. W. PALMER Technical Editor
 R. D. WASHBURNE, Managing Editor
 C. P. MASON Associate Editor

CONTENTS

AUGUST, 1937, ISSUE

Volume IX Number 2

Editorial: Television Economics.....Hugo Gernsback	69
The Radio Month in Review.....	70
How to Make the RADIO-CRAFT—1937 Television Receiver—Part V	72
A Supersonic "Fog Shaker".....Ernest E. Fairbanks	74
"Talking Paper" Uses "Electric Eye"	75
.....Georges A. Rubissow	75
A Circular-Image Cathode-Ray Tube.....A. Stager	75
A Television "Streamer" for Spot News	76
.....Robert Oakhill	76
New Special-Service Tubes.....C. W. Palmer	78
New Oscilloscopes Use 2-In. C.-R. Tube	79
.....Samuel C. Milbourne	79
Keeping Voltage Constant.....Harry F. Dart	79
The Balance Sheet of Television...Wilhelm E. Shrage	80
How to Make the RADIO-CRAFT Super-Deluxe 30-Tube Set— Part I (Introduction).....	82
The Projection Kinescope Makes Its Debut.....	83
Servicing a Students' Television Set-Up	84
.....E. J. Doyle & J. P. Kennedy	84
Build the RADIO-CRAFT 1937 Car-Radio Receiver— Part III.....	84
How to Make a 2-Tube Carrier Interphone	85
.....Arthur Blumenfeld	85
Experimental High-Fidelity Television	86
.....R. D. Washburne	86
The Future Status of Television Programs	87
.....William H. Priess	87
Radio and Television in Recent Public Addresses	87
.....David Sarnoff & Thomas F. Joyce	87

Operating Notes.....	88
The Art of Television Make-Up.....G. Barz	90
How to Add a 2-In. C.-R. Tube to the RADIO-CRAFT Midget Oscilloscope.....	90
International Radio Review.....	91
The Latest Radio Equipment.....	92
The Potentiometer Voltmeter—A New Service Tool	94
.....G. V. Morris & Bradley Thompson	94
The Delta-T Pad—Inexpensive P.A. Control	94
.....Wm. H. Fritz	94
An Excellent Coil-Testing Unit for the Service Man —Part II.....Walter L. Lyons	95

RADIO SERVICE DATA SHEETS:

No. 206—Ford-Philco Car-Radio Models F-1440 and F-1442	96
No. 207—Howard Model B-5 (Schaeffer Radio-Clock-Pen Desk Set); Remler Model 46 "Scottie" Radio Receiver	98
No. 208—General Electric Auto-Radio Models FA-60 and FA-61.....	99
RADIO-CRAFT'S Information Bureau.....	97
Voltage-Doubling Circuits.....Charles Golenpaul	100
ORSMA Members' Forum.....	100
Book Reviews	128

SEPTEMBER RADIO-CRAFT— ANNUAL SET BUILDER'S NUMBER

SCOOPS—SCOOPS—AND MORE SCOOPS!

The tuner chassis of the RADIO-CRAFT 30-tube super deluxe receiver will be described! The boat radio set with directional loop antenna originally scheduled for August RADIO-CRAFT will appear in the September issue! Another article describes a 1-tube interoffice communicator! The independent Service Man can save money by applying the important principles discussed in the new series entitled "Radio Business Problems."

Published by Radcraft Publications, Inc. Publication office: 29 Worthington Street, Springfield, Mass. Editorial and Advertising Offices: 99 Hudson Street, New York City. Chicago Advertising Office: L. F. McClure, 919 North Michigan Avenue, Chicago, Ill. Western Advertising Office: Loyd B. Chappell, 530 West Sixth St., Los Angeles, Calif.

Foreign Agents:

London—Gorrings American News Agency, 9A Green St., Leicester Square, W. C. 2, England.
 Paris—Messageries Dawson, 4 Rue Faubourg, Poissonniere, France.
 Melbourne—McGill's Agency, 179 Elizabeth St., Australia.
 Dunedin—James Johnston, Ltd., New Zealand.

RADIO-CRAFT is published monthly, on the first of the month preceding that of date; subscription price is \$2.50 per year in U. S. and Canada. (In foreign countries, \$3.00 a year to cover additional postage.) Entered at the post office at Springfield as second-class matter under the act of March 3, 1879.

Text and illustrations of this magazine are copyright and must not be reproduced without permission of the copyright owners.

Copyright 1937. Radcraft Publications, Inc.



You DON'T HAVE TO PAY ONE PENNY IN ADVANCE FOR YOUR COPY OF VOLUME SEVEN

OVER 1,800 PAGES

★ **OVER 3,000 ILLUSTRATIONS**



RADCRAFT PUBLICATIONS, INC., 99 HUDSON STREET, NEW YORK, N. Y.

SUBSCRIBERS HAVE ALREADY RECEIVED
Four Installments
OF VOLUME 7 OF THE
OFFICIAL RADIO SERVICE MANUAL

SEND for Volume 7 of the GERNSBACK Official Radio Service Manual today. You can make use of it every day in your service work—and pay for it while you're using it. Three easy ways to get this new Manual are outlined in the coupon below. Two of the plans save you money. Don't delay—clip the coupon—fill it in and mail today. Within a few days you will receive by mail the *first* four installments of radio's newest service Manual.

● **Here Are the Highlights of VOLUME SEVEN** ●

PUBLISHED SIMILARLY TO A MAGAZINE

The OFFICIAL RADIO SERVICE MANUAL (Volume 7) is being published in twelve installments—one installment being mailed every month to subscribers.

DEFERRED PAYMENT PLAN

This new Manual is sold on the deferred payment plan. Complete details of this "pay-as-you-complete-your-manual" plan appears in coupon.

150 PAGES OF SERVICE DATA

is sent to you every month. Each installment will never be less than 150 throughout the year.

MANUAL OF OVER 1,800 PAGES

The total amount of service data which you have received during the year exceeds any other service guide published.

CUMULATIVE INDEX EACH MONTH

The Index accompanying the first installment lists all sets which appear in that section; the index mailed with the second installment lists sets appearing in both the first and second installments, and so on. You discard the previous index and use the new one furnished with each installment. With the final, twelfth installment, the Master Index which you receive will cover not only the set data you received during the entire year's monthly service (which constitutes Volume 7), but, in addition, the sets listed in every GERNSBACK OFFICIAL RADIO SERVICE MANUAL since 1931.

OVER 3,000 ILLUSTRATIONS

The largest compilation of complete wiring diagrams, schematics and charts ever included in a single volume of any radio service Manual.

OVER 1,200 DIFFERENT MODELS

More wiring and schematic and other servicing diagrams will be included in Volume 7 than in any other Manual. At least 1,200 different models will be covered.

ALL FRESH MATERIALS—NO REHASH

And, most important, there will be no duplication of any material. In Volume 7 you will find material which has never appeared previously in the first six volumes.

MANY 1938 MODELS TO BE INCLUDED

At the end of a year's service (12 months), subscribers receive service data and diagrams on many advance 1938 models. This material would ordinarily appear in the 1939 Edition of the MANUAL.

NEW SERVICE DATA EACH MONTH

This new plan permits you to have in your possession service data just released. Previously, the material was a year old or more when it reached you. Service data on older receivers never before published in any other of the Gernsback Manuals, will be included in Volume 7.

COMPLETE SERVICE DATA

Data includes such valuable information as I. F. peaks, operating voltages, alignment procedure, chassis and tube socket layout, values of components, lists of parts, and other vitally important service hints.

SERVICE DATA AND DIAGRAMS NOT LISTED ELSEWHERE

A considerably large portion of the data appearing in the monthly installments will not be found in any other radio service Manual . . . at least not for some time to come. This is an outstanding advantage of this new plan.

SIMPLE TO INSERT EACH INSTALLMENT

You literally "slap" them in . . . one installment on top of the other . . . without any fuss of arranging the pages numerically, alphabetically or otherwise. You merely open the binder and, with one single motion, slip the entire group of pages over the steel binding posts. You don't remove the pages thereafter, they stay in the binder for good. We've done all the filing work for you. . . . That's all there is to it! The specially compiled cumulative index (which you receive with each installment) does the rest. This index shows at a glance where any required information can be found.

EQUIVALENT TO TWO REGULAR SERVICE MANUALS

since the sets covered are those manufactured during the latter part of 1936, all in 1937 and many in early 1938. The second year (starting April, 1938) of this monthly service will begin with sets manufactured during 1938.

RADCRAFT PUBLICATIONS, INC. • 99 Hudson Street • New York, N. Y.

RC-837

Please enroll me as a subscriber to Volume 7 of the GERNSBACK Official Radio Service Manual and start sending me immediately the installments. I have marked below the plan which I prefer.

PLAN NO. 1

I enclose \$10.00 herewith, for which send me immediately, FREE OF CHARGE, a heavy, stiff binder, and the first four installments. Send me thereafter for eight consecutive months commencing August 1, 1937, regularly once a month, an average of 150 pages of Volume 7 of the OFFICIAL RADIO SERVICE MANUAL. These pages can be immediately filed into the binder. Both the binder and the monthly pages are mailed to me POSTAGE PREPAID. Total cost: \$10.00. THIS PLAN SAVES ME \$2.00.

PLAN NO. 2

I enclose \$3.50 herewith, for which send me immediately, FREE OF CHARGE, a heavy, stiff binder, and the first three installments. Send me thereafter commencing July 1, 1937, regularly once a month for nine consecutive months, an average of 150 pages of Volume 7 of the OFFICIAL RADIO SERVICE MANUAL. After I have received the 3rd, 6th and 9th installment, you are to bill me for \$2.50 in advance for the coming quarter making the total cost for the year's service \$11.00. THIS PLAN SAVES ME \$1.00.

PLAN NO. 3

I pay nothing in advance. Each month an average of 150 pages of the OFFICIAL RADIO SERVICE MANUAL will be delivered to me. I pay postman \$1.20 plus a few cents for C.O.D. charges each month for ten months. The eleventh and twelfth installments of the subscription will be delivered to me FREE OF CHARGE. You prepay shipping charges on all installments mailed to me. With the tenth installment send me FREE OF CHARGE a heavy, stiff binder.

I want the binder sent with the first installment, and will pay postman a total of \$2.40 plus a few cents for C.O.D. charges and \$1.20 per month for eight consecutive months thereafter. Under this plan, the tenth, eleventh and twelfth installments are delivered to me FREE OF CHARGE. TOTAL COST UNDER THIS PLAN \$12.00.

NAME ADDRESS CITY STATE

Send remittance by check or money order. Register your letter if you send cash or unused U.S. Postage Stamps.

Please Say That You Saw It in RADIO-CRAFT

MEET ALL RADIO SERVICING EMERGENCIES WITH GERNSBACK RADIO MANUALS AND SERVICE HANDBOOK

JUST as we say—"Be prepared to meet all radio servicing emergencies with the Gernsback Official Radio Service Manuals and Official Radio Service Handbook.

**1,200
PAGES**

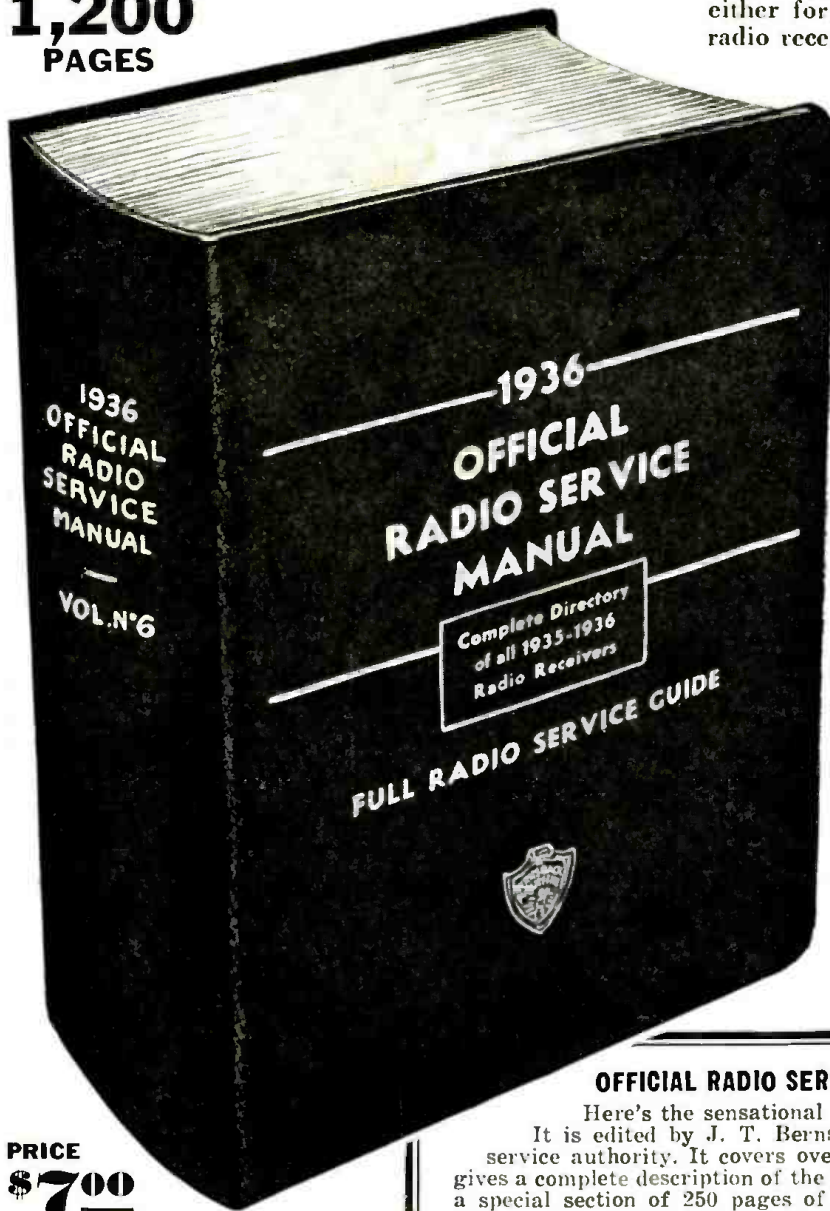

You never know when a service job requires that "extra" special attention. It might mean the difference between doing the job or losing it. You're safe if you have on hand the GERNSBACK SERVICE BOOKS—either for regular service work or for servicing auto radio receivers. Get your copy today!

1936 OFFICIAL RADIO SERVICE MANUAL

Packed with service data of sets manufactured during 1935, and 1936—SCHEMATIC DIAGRAMS of over 1,500 manufactured receivers showing speaker connections, power-transformer connectors, R.F. and I.F. coil connections, phonograph connections. On all set diagrams, with few exceptions, the I.F. peaks are indicated, also socket connections. Notes on alignment procedure are printed with diagrams. For over 80% of the sets you will find OPERATING VOLTAGES. Assembly diagrams show relationship of separate units to each other. A complete index of TRADE NAMES and their respective manufacturers. COMPLETE TUBE CHART includes information on hundreds of tubes. CUMULATIVE INDEX contains all sets printed in the 1931, 1932, 1933, 1934, 1935, and 1936 Manuals.

1,200 PAGES * OVER 2,500 ILLUSTRATIONS
Looseleaf Binder—Stiff, Hard Covers
Size 9 x 12 Inches * PRICE \$7.00

1935 OFFICIAL RADIO SERVICE MANUAL

Over 1,000 Pages, 9 x 12 Inches Over 3,000 Illustrations
Flexible, Looseleaf, Leatherette Cover
List Price \$7.00

1934 OFFICIAL RADIO SERVICE MANUAL

Over 400 Pages, 9 x 12 Inches Over 2,000 Illustrations
Flexible, Looseleaf, Leatherette Cover
List Price \$3.50

1933 OFFICIAL RADIO SERVICE MANUAL

Over 700 Pages, 9 x 12 Inches Over 2,000 Illustrations
Flexible, Looseleaf, Leatherette Cover
List Price \$5.00

1932 OFFICIAL RADIO SERVICE MANUAL

Over 1,000 Pages, 9 x 12 Inches Over 2,000 Illustrations
Flexible, Looseleaf, Leatherette Cover
List Price \$5.00

1931 OFFICIAL RADIO SERVICE MANUAL

650 Pages (Including Supplements) 9 x 12 Inches Over 1,500 Illustrations
Flexible, Looseleaf, Leatherette Cover
List Price \$4.50
(Including Supplements)

AUTO-RADIO SERVICE MANUALS

1935 MANUAL

Over 240 Pages 9 x 12 Inches
Over 500 Illustrations
Flexible, Looseleaf, Leatherette Cover
List Price \$2.50

1933 MANUAL

Over 240 Pages 9 x 12 Inches
Over 500 Illustrations
Flexible, Looseleaf, Leatherette Cover
List Price \$2.50

OFFICIAL RADIO SERVICE HANDBOOK

Here's the sensational new book on servicing. It is edited by J. T. Bernsley, well-known radio service authority. It covers over 500 radio topics and gives a complete description of the "Magic Eye." Contains a special section of 250 pages of Operating Notes. The book covers: Circuit Theory and Analysis; Modern Servicing and Test Equipment; Practical Short-cuts in Trouble Shooting and Repairs; Specialized Receiver and Installation Data; Modernization and Conversion Data; Social and Economic Problems of Service Men; and Operating Notes and Practical Data Listings.

OVER 1,000 PAGES * OVER 1,000 ILLUSTRATIONS

Beautiful Linen, Gold-Stamped Cover Size 6 x 9 Inches



**PRICE
\$7.00**

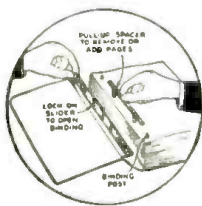

New Practical Binder

Note at the left, the details of the new binder used on this manual. It not only securely locks the 1200 pages into the stiff leatheroid covers, but facilitates removal and replacement of individual pages.

If your jobber or mail order house cannot supply you, order any of the OFFICIAL RADIO SERVICE MANUALS or the OFFICIAL RADIO SERVICE HANDBOOK from the publishers. Send your remittance in form of check or money

order—or, if you send cash or unused U. S. Postage Stamps, be sure to register your letter. ALL ORDERS ARE FILLED PROMPTLY. BOOKS ARE SENT TO YOU POSTAGE PREPAID. Address Dept. RC-337.

RADCRAFT PUBLICATIONS, INC., 99 HUDSON STREET, NEW YORK, N. Y.

GERNSBACK RADIO SERVICE MANUALS ARE AVAILABLE FROM JOBBERS AND MAIL ORDER HOUSES

Please Say That You Saw It in RADIO-CRAFT



"Takes the Resistance out of Radio"

Editorial Offices: 99 Hudson St., New York, N. Y.

HUGO GERNSBACK, Editor

Vol. IX, No. 2, Aug. 1937

TELEVISION ECONOMICS

An Editorial by HUGO GERNSBACK

THERE ARE still those people, and there are a good many of them, who believe that the "radio interests" (whoever they may be!) are deliberately "holding television back" for dark reasons of their own. It is surprising how many people, and particularly laymen, hold such silly notions, when, as a matter of fact, all of the "radio interests," big and little, are working day and night and are spending innumerable millions to perfect television with the hope that it will finally emerge from the laboratory stage. No corporation cherishes the idea of spending money on research, month after month, when the goal may be years away. Yet this is exactly what has been happening right along and will happen for some time to come.

The problems of television today are quite complex. If we were to accept television as it is today—and it has been quite well developed—then, economics would stand in the way for a very simple reason.

The present-day television receiver costs between \$400 and \$600. Set against this the average price of a radio set of about \$25, and then figure out how many television sets could be sold today. The answer is less than 100,000, even this being a high figure. Set this figure against 27,000,000 radio sets at present in use, and you immediately know why television today is not practical.

You can't sell 27,000,000 television sets at from \$400 to \$600, and even if television sets could be produced at \$100, the price would still be far above the popular level. This puts us right back to where we were many years ago, and that means that the final word in television has not as yet been spoken. If once we can discover and develop a revolutionary new principle in television, whereby we can sell sets at \$50 and later on for \$25, then we will have television in earnest, and then it will be worthwhile for the big sponsors to broadcast television, as sound radio is broadcast today.

It is one thing to produce, let us say, *THE MARCH OF TIME*, in a studio where the ear can be fooled by sound effects and where the eye cannot see perspiring actors working in shirt sleeves. It is something entirely different to present *THE MARCH OF TIME* via television, and, while certain illusions can still be manufactured the same as we manufacture them on the stage, yet even a short program of 10 minutes will require actors and necessary stage equipment, with expensive dresses, costumes, and all the other paraphernalia that goes with it. While it will be possible to build certain sets on miniature stages and thus fool the eye, we cannot have miniature human beings to complete the illusion. Thus, while we could fire a miniature gun in a battle scene, we could not have miniature soldiers doing the same thing, unless we took motion picture shots and projected them by television—and for this, the public would probably not stand any more than they do not stand for phonograph records in a first-class broadcast today.

Even a simple production which today is reasonably cheap, when translated into television terms comes to an enormous cost. There must be dress rehearsals. There must be stage properties. There must be special backgrounds and a thousand and one things that radio today does not have to bother with.

The question, therefore, arises: Who is going to pay for all of this? Suppose the television stations have finally been perfected and coaxial cables have brought the television stations together in a perfect network all over the country, at an expenditure that probably would not be less than a

half-billion dollars. Now we are getting ready to broadcast television, and naturally the first thought is the advertisers.

Let us say that in a national hookup on one of our networks, we buy a half-hour, as we do for a radio program nowadays. A half-hour's time on a coast-to-coast hookup for radio broadcast time alone costs, at this moment of writing, approximately \$6,000. To this we must add the entertainment. Suppose we engage a famous comedian like Eddie Cantor; he is reputed to get as high as \$5,000 for a performance. To this you must add other supporting members of the cast—musicians, etc., bringing the talent costs for the half-hour up to about \$6,000 for a first-class program. Added to the radio time cost, this gives a grand total of \$12,000. In the future, when television has achieved the position given to radio today, it is reasonable to suppose that the program time itself will come to at least double the present cost or \$12,000. The actors in the play, rehearsing costs, properties, etc., will probably run to \$7,000 or \$8,000 minimum, if first-class actors are used. This gives us a grand total of \$20,000 for a half-hour program. It can be seen from this that economics bulks ponderously large.

Will the advertiser be satisfied with announcements as we have them today, or, will he feel that with television he must also have eye appeal?; if the play of which we speak is sponsored, let us say, by a toothbrush manufacturer, will the toothbrush manufacturer insist on displaying the brush so we can all see it? We hope not, although we can never tell. It is possible that an entirely new sales technique will be invented in order to put over such a product. We can thus visualize a Shirley Temple or the Dionne Quintuplets being shown using toothbrushes while they go through their morning exercises—without offending the television audience too much. But such stunts, too, are costly. On the other hand, they may pay. Just what type of television technique will be developed to make the advertising of the sponsors palatable is a thing difficult to envisage today. But that it will be developed in due time is a logical outcome of present-day broadcasting technique. In this respect, of course, the United States stands unique because radio sets are not taxed and it seems pretty certain that television sets will not be taxed either. That means that the broadcast companies must look to the advertisers to foot the bill. In Europe, notably England and Germany, where radio sets are taxed, advertising over the radio is unknown, because the government collects the taxes and provides the program from the money collected from the public. In each case, the economics are roughly the same. In America, broadcasting has survived due to indirect taxation, while in Europe, it is placed on the same footing by direct taxation. It is doubtful if another form of taxation can be evolved, but, of course, in the future anything may be possible, and there may be another system of taxation undreamt of today. If there is, it is not as yet in sight, and has as yet, not been invented.

When will we have universal television? This is a question which is asked more persistently every day. And today as 10 years ago, there is no answer. All we can say is that we are making progress and that each month sees an improvement in the art. New knowledge is being gained, but up to now nothing fundamentally new has been evolved in television that was not known 5 years ago. We simply have more refinements and have kept on improving. Of course, television will become universal in the future—never doubt it! But whether that will be next year or 10 years from now is impossible to predict at this moment.

THE RADIO MONTH



Members of the MBS staff broadcasting comments by servicing members of the crew of the Hindenburg.

RADIO AND THE ZEP. CRASH

RIVAL networks claimed the honors of bringing to the radio listeners of two continents the first news of the tragic end of the Zeppelin Hindenburg which burned at the Lakehurst, N. J., hangar, last month.

The effectiveness of radio as a communicating medium was demonstrated by the speed with which the officials of the air line in Germany were notified—only a few minutes after the explosion.

The mobile units of NBC, CBS and MBS were sent speeding by airplane, car and rail to set up short-wave equipment at the hangar where news items concerning the disaster could be relayed to the sympathizing world.

ORGAN VS. ELECTRONIC ORGAN

AN amusing argument about "what is an organ" took place last month, with the Federal Trade Commission as referee.

The pipe organ makers have been smoldering under a barrage of "unfair competition" which they allege the makers of electric organs have been using. As a matter of fact, they claimed that it was unfair for these manufacturers to even call their instruments "organs" since they do not use "pipes" or "wind."

After much arguing before the F.T.C. it was decided to leave the matter to organ "experts" who were asked to differentiate between selections played on two hidden organs—one pipe and the other electric. The "experts" were all 80 to 90 per cent wrong—giving the decision to the electric organ makers!



Part of the record 1200 attendance at the IRE Convention at the Pennsylvania Hotel.

THE I.R.E. "SILVER" ANNIVERSARY

THE Institute of Radio Engineers celebrated the 25th anniversary of their founding, last month, with a convention in New York City.

Thirty technical papers, representing the outstanding developments of the year in radio and television, were read before a record audience of radio engineers. Over 1200 members of the Institute and guests registered at the convention during the 3-day program.

A few of the highlights of the Convention are given here for those who were unable to attend:— during the first morning a talk on "Ultra-High Frequency Relay Broadcasting" was read by W. A. R. Brown of the NBC. Mr. Brown described the various types of pack and mobile relay transmitters used for remote pick-ups by NBC, giving demonstrations of several new types including the "beer mug"—a tiny crystal controlled ultra-short wave, short-distance transmitter weighing less than 8 lbs. and made with two handles on the sides like a beer stein.

Mr. W. Hahnemann described some ultra-high frequency equipment developed in Germany for aircraft landing beams and some experiments in u.-h.f. flying beams working on a wavelength of 9 meters and covering consistently a distance of 250 to 275 miles.

A new type of "steerable" antenna for long-distance reception (used in the trans-Atlantic phone service) which consists of 6 or more stationary rhombic aerials coupled together by means of coaxial cables through phase-shifters, was described by Mr. H. T. Friis of Bell Tel. Labs.

A new graphic method of arriving at vacuum-tube parameters which has advantages over previous purely mathematical methods, giving solutions where no present solutions exist was described by Mr. M. A. Acheson of Hygrade-Sylvania Corp.

To wind up the Convention, Drs. Zworykin, Law, Morton and other RCA engineers presented a number of papers on television, including a descrip-

tion and demonstration of a new projection kinescope (described elsewhere in this issue), an analysis of light intensity conditions in picking up outdoor scenes in iconoscope television transmitters, and descriptions of recent laboratory work on television.

BEACON MARKERS DISCONTINUED

SINCE our comment, last month, regarding the "fan" type marker station which was installed near the towers of station WHK to warn pilots from flying too low near the radio station, the F.C.C. notified the station owners that they had changed their minds about the use of the marker.

Another "good idea" gone wrong?

WARTIME RADIO TECHNIQUE

IN the course of a demonstration, last month, dealing with the means of protecting Rome against foreign invasion, the staff of radio station EIAR donned gas masks and operated their radio transmitter under wartime conditions.

Besides the usual tasks of watching power and amplifier panels, riding the gain, etc., the technicians of the station conducted a complete inspection of the equipment from antenna to auxiliary power supply—performing some of the operations in complete darkness.

Just one more step in the preparation of Europe for war!



The staff of station EIAR in Rome with gas masks. (Radio Press Photo)

IN REVIEW

Radio is now such a vast and diversified art it becomes necessary to make a general survey of important monthly developments. RADIO-CRAFT analyzes these developments and presents a review of those items which interest all.

BLIND LANDING SYSTEM

THE Lorenz "blind landing" radio beam system, which has been received so enthusiastically in all parts of Europe, was demonstrated by the I.T.&T. Co. at the Indianapolis Municipal Airport, last month, before representatives of every large airline, the Army, Navy, Coast Guard and Air Commerce Bureau.

The Lorenz blind-landing system, also known as the "low-approach system" provides an inclined radio beam from the landing field to a point crossing the regular flying beam. Crossing the landing beam are two marker beams which tell the pilot how far he is from the run-way. Signals are received both visually and audibly, telling the pilot whether he is in the proper line of descent and guiding him to the paved landing strip.

No official comments were made about the three successful landings made through a 700 ft. ceiling, at the air field.

BLIND MEN MAKE RADIO SETS

A UNIQUE radio assembly plant under the PWA and the American Foundation for the Blind, was "discovered" last month by *Radio-Craft*. The workers in this factory are all blind, from the men who mount parts and solder connections in place, to the aligners and testers who put the units in condition for shipment. They make "talking books" (portable phono-radio units) and radio receivers.



Blind workers making and testing phono-radio sets.



WOR announcer with Merrill and Lambie and their plane the "Daily Express."

BROADCASTING AND TELEVISION

THIS was a "star" month for radio broadcasting and television.

The broadcasting in 30 languages, of the Coronation of King George VI of the British Empire, over an elaborate network of short-wave beam stations, using 23 directional arrays, some of which were set up especially for this event, set a record for the largest number of stations simultaneously sending the same program. A new monitoring system was used so that the same background sounds could be used for all the announcers (in different languages).

The two-way flight of Dick Merrill and Jack Lambie across the Atlantic, which was broadcast over the MBS net, with conversation and descriptions by the fliers most of the way across and back, sets a new precedent in keeping the public informed of the progress of a DX flight.

The new tax on radio broadcast stations proposed by G. H. Payne, F.C.C. Commissioner, was received with almost universal favor in Washington. And while this tax will bring in a large revenue, there are objections to it, for instance, it will raise the cost of broadcasting above newspaper ad. cost.

A mosque in Singapore has loudspeakers installed in its minarets to blare out the summons to devotion above the din of traffic—at a sound level that can be heard over half-a-mile.

It was estimated that 50,000 "televisioners" looked-in on the Coronation Parade, in London.

The new television transmitter which CBS is installing in the Chrysler Building, New York, has been purchased from RCA.

The Soviet Union has just purchased 3 television transmitters from RCA for use in Moscow, Leningrad and Kiev.

According to H. B. Brown of Philco, television sets will retail for about \$600.

It is rumored that the U. S. Navy's experiments in television at the Bellevue Laboratory, in Washington, are "decades ahead of commercial progress."



The facsimile scanner sending a "colorgram" for exact color matching.

FACSIMILE "COLORGRAMS"

BY means of cooperative work between the Western Union facsimile service and the laboratory workers of the International Printing Ink Corp. it was demonstrated, last month, that color samples or "colorgrams" could be sent by telegraph, between the cities of New York, Chicago and Buffalo.

By combining the recording photoelectric spectrophotometer developed by the Massachusetts Institute of Technology with the WU facsimile system, the curves recorded by the spectrophotometer can be sent over the wires and analyzed at a distant place for exact color matching required by advertisers, printers, designers, painters, cosmeticians, etc.

THE PALEY AWARD FOR 1937

THE Paley Amateur Radio Award, which we mentioned in these columns several months ago, was awarded, last month, to Walter Stiles, Jr., of Coudersport, Pa., operator of station W8DPY for his work during the March 1936 flood emergency in maintaining for 130 hours the sole communication for 4,000 beleaguered citizens of Renova, Pa., and transmitting more than 1,000 messages in behalf of the various official agencies operating in the Allegheny River area.

The Paley Amateur Radio Award, of which Stiles is the first annual recipient, is to be presented annually "to that individual who, through amateur radio, in the opinion of an impartial Board of Awards, has contributed most usefully to the American people."



Fig. 8. Mr. Sobel with his version of the RADIO-CRAFT vision receiver. The set is housed in a "table" cabinet laid on its back.

HOW TO MAKE THE TELEVISION

In this Part V, additional data for constructors of the television receiver is presented. A few errors in the circuits and parts values plus a clever synchronizing circuit developed by a builder of the set are shown to aid other builders of the set.

PART V

IN THE FOUR previous parts of this series describing an experimental television receiver, it was pointed out that, while this set is a *practical working model which may be duplicated by those experimenters who wish to follow the development of the art of television first hand*, it is by no means the final word in how a vision set should be made.

In the first place, for several reasons it was thought desirable to keep the cost of the set at a minimum consistent with the reception of satisfactory images when the receiver is not located more than a few miles from one of the experimental transmitters now in operation. The range of the set, of course, like all ultra-shortwave receivers is limited by the nature of the waves used for television transmission. But, if the receiver is to be located more than a few miles from the transmitter, or if the signal strength for some other reason is low, it is desirable to increase the number of I.F. amplifier stages used.

In the original model, which is operated about 7 miles from the Empire State transmitter, the two stages of I.F. in the video section of the set were found adequate.

Concerning the subject of definition, several builders and prospective builders of the set have questioned the use of a comparatively low frequency in the video amplifier, on the basis that full 441-line definition is not obtained with such a low frequency I.F. While theoretically this is true, it was found in the original model, which at one or another time in the development period was equipped with several different I.F. amplifiers, that while 3,100 kc. was not the

optimum frequency for best definition, considering the cost of a 13,000 kc. amplifier which would have to employ many more stages to give an equivalent gain, the loss of definition from the standpoint of an experimental receiver was negligible.

For those builders who wish to realize the best reception possible regardless of cost, we advise, by all means, that a 13,000 kc. I.F. amplifier be substituted for the specified one. The changes do not alter the constants of the tuned circuits or the frequency changer, though the sound channel I.F. will have to be changed to beat 3.5 mc. away from the video channel against the local oscillator.

Incidentally a well-known coil manufacturer has recently placed on the market a new 13,250 kc. I.F. transformer suitable for both the video and sound I.F. channels of the set.*

With regard to the receiver construction, we believe that the following letter from one of the builders of the set (whose set is shown in the photos on these pages) will be of great interest to other builders. Of especial interest is the synchronizing circuit which Mr. Sobel originated for his set to help synchronize the pictures. The original circuit uses synchronizing only on the high-frequency sweep circuit, which is the most ready to drift and which completely disrupts the image when it does drift. Drift of the low-frequency sweep, within limits, simply causes the image to move up or down on the end of the tube and this drift is easy to control. However, the set becomes much more stable by the insertion of the low-frequency stabilization.

Mr. Sobel's letter follows:

Editor, *Radio-Craft*:—

I have built the television receiver as published in *Radio-Craft Magazine*.

Inasmuch as I am convinced that many others have also followed this circuit, I am taking the liberty to suggest several changes; I have found these changes necessary for improved operation and to correct a few printing errors.

Move the video stage to the tuner chassis. Change the 0.1-meg. plate load resistor to 15,000 ohms and the 85 mhy. choke to 2½ mhy.

Change the constant-current pentode from type 57 to type 58; also, change the 5,000-ohm frequency controls to 50,000 ohms, but do not alter the circuit except by changing the high-frequency discharge condenser, which in the diagram is 0.004-mf., to a 0.0004-mf. unit and the 0.5-mf. L.F. discharge condenser from a 0.5- to 0.05-mf.; also, the 0.5-mf. condenser leading from the H.F. sweep circuit into the deflection plates from a 0.5-mf. condenser to 0.02-mf.

Place a 1 meg. isolating resistor in the grid circuit of the C.-R. tube between resistor R35 and condenser C37 as per diagram. Unless this change is made, the grid of the C.-R. tube will be completely blocked to any video signals.

I am also enclosing a synchronization diagram (see Fig. 10), slightly different from the one published, including both the horizontal and vertical sweep circuits and working perfectly.

*Name of manufacturer will be supplied upon receipt of a stamped and self-addressed envelope.

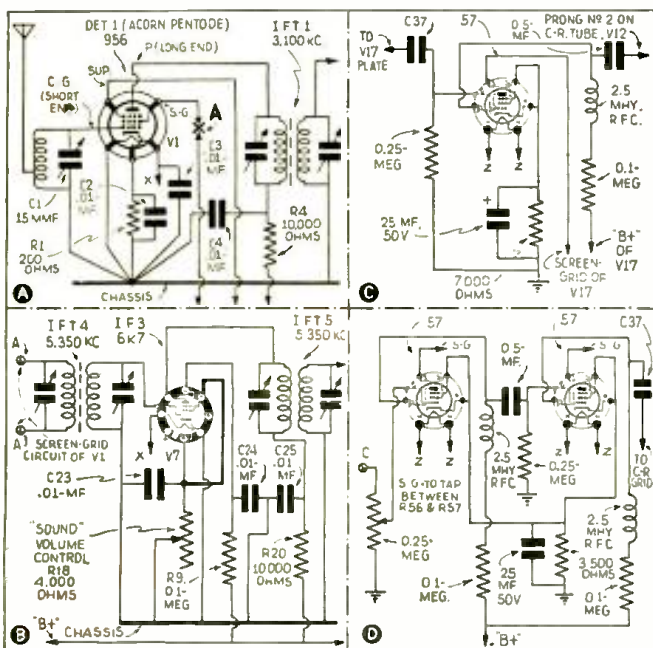

Fig. 9. Several circuit variations and two additional circuit details of video amplifiers for the experimenter.

RADIO-CRAFT—1937 RECEIVER

The transmissions of the Empire State television station of the NBC have now reached the point where almost continual operation of the station is required by the engineers in charge in their field experiments on the 441 line interlaced scanning. It is of interest, therefore, for experimentally-inclined radio technicians to build up equipment in order to familiarize themselves with the requirements of high-definition television technique. This article contains all the basic data needed to build a successful receiver.

I also want to draw your attention to the difference in frequency between the sound and the video signals. It has been standardized to 3.25 mc. and unless several turns are removed from the 5,000 kc. I.F. transformers, you cannot tune the sound channel to the required frequency.

It is essential that both chassis be interconnected by a 0.02-mf. mica condenser!

Hoping that this will help other experimenters, I remain

A. D. SOBEL.

We wish to thank Mr. Sobel for his kind letter and suggest that other builders try the changes he mentions. Several of these are due to errors in the diagrams, such as the values of condensers C40 and C43 which should have values of 400 mmf. and 0.05-mf., respectively.

However, some of the changes suggested by Mr. Sobel were due to differences in the characteristics of parts used. Such a case is the insertion of the 1-meg. resistor in the lead from the control-grid of the cathode-ray tube and the end of potentiometer R35. In the original model, this resistor was not needed since the slider arm on R35 was operated at the end near resistor R34, so that practically the entire resistance was inserted between the control-grid and the cathode, to prevent shunting of the signals to ground. This resistor can be used if needed, but should be omitted if it is not found necessary.

An interesting and desirable change in the set recommended by Mr. Sobel is the shifting of the video (A.F.) amplifier from the chassis housing the cathode-ray tube to the receiver chassis, and changing the source of plate and filament power for this tube (V17) to the power transformer of the receiver. This change ensures a constant plate voltage on the video amplifier which is particularly desirable.

Another change made by Mr. Sobel, though he does not mention the change in his letter is the use of a thick iron-pipe shield over the neck of the C.-R. tube. We did not find the use of a shield essential to getting a straight-line "raster" or field, but suggested the use of a length of stove-pipe over the tube to prevent inductive pick-up if the raster is rippled or otherwise irregular.

A word to the wise is given here—keep the cathode-ray tube away from transformers, chokes or speaker fields which have strong magnetic fields as the elements of a C.-R. tube can be easily magnetized and when this has occurred the tube must be returned to the manufacturer to be demagnetized before clear images can be seen again.

And now that Mr. Sobel's suggestions have been considered, we have a few on our own hook to make. First, corrections in the diagrams:— In Fig. 1, we show point A, where the sound channel is inserted, pointing to the suppressor-grid of the 956 tube, V1. This arrow should point to the screen-grid of V1 as injection cannot be made at the suppressor. This change is shown in Fig. 9A. In Fig. 4, the suppressor-grid connection of the tube V7 is not joined to any other circuit. This suppressor should be connected to the cathode terminal of the tube V7 socket (see Fig. 9B). In Fig. 5, the amplifier volume control should be

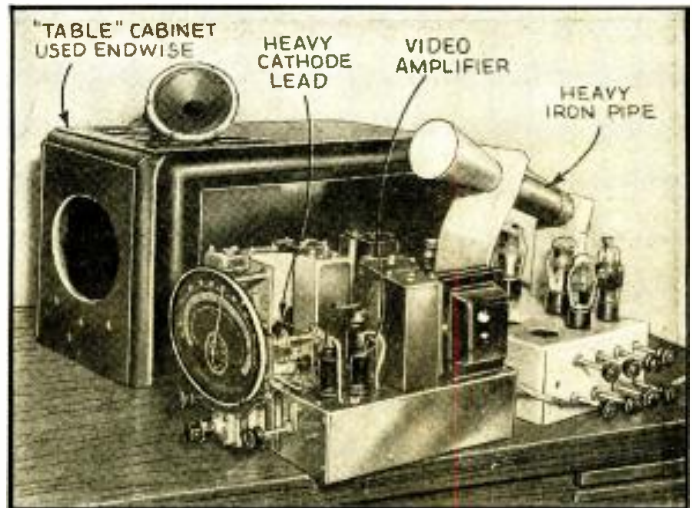

Fig. N. Mr. Sobel's set with the table-model cabinet in which it is housed. The cabinet is laid on its back.

0.25-meg. instead of 2.5 meg. as specified.

In order to obtain smooth plate power on the C.-R. tube and the sweep tubes of the video chassis, it is sometimes necessary to shunt resistor R37 with an 8 mf. 1,000 V. condenser (two electrolytic condensers of 16 mf. and 450 V. connected in series can be used if they are well made).

The value of resistor R59 can be increased to 5,000 or 6,000 ohms, with improved flatness of the frequency response of the video amplifier.

And concerning the video amplifier circuit, some experimenters may find that they see negative images. In other words, the parts of the image which should be dark are light and vice versa. If this is the case, either the type of 2nd-detector utilized must be changed, or what is more desirable, an additional video amplifier stage made according to the connections of Fig. 9C should be inserted between the present video stage and the grid of the C.-R. tube. If this is done, it is desirable to place both video amplifiers on the receiver chassis and power them from the receiver power supply.

The circuit for a 2-stage video amplifier is given in Fig. 9D.

In conclusion, we wish to say that the builders of this—or any other—television receiver must be both capable technically, and willing to do some experimental work to remove the "bugs" which invariably enter the job at some point or other. A television receiver, being a good deal more complex than even large multi-tube radio receivers, is subject to a

(Continued on page 101)

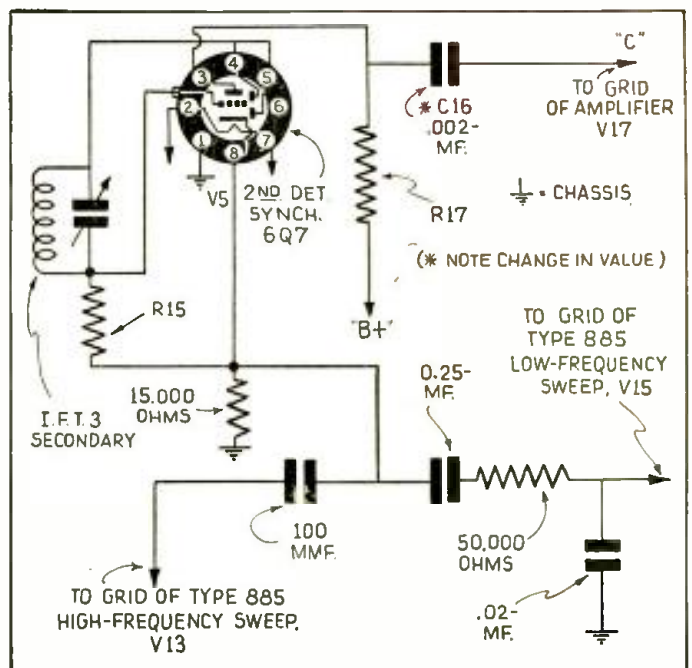

Fig. 10. The vertical and horizontal synchronizing circuit, with high and low filters, used by Mr. Sobel.

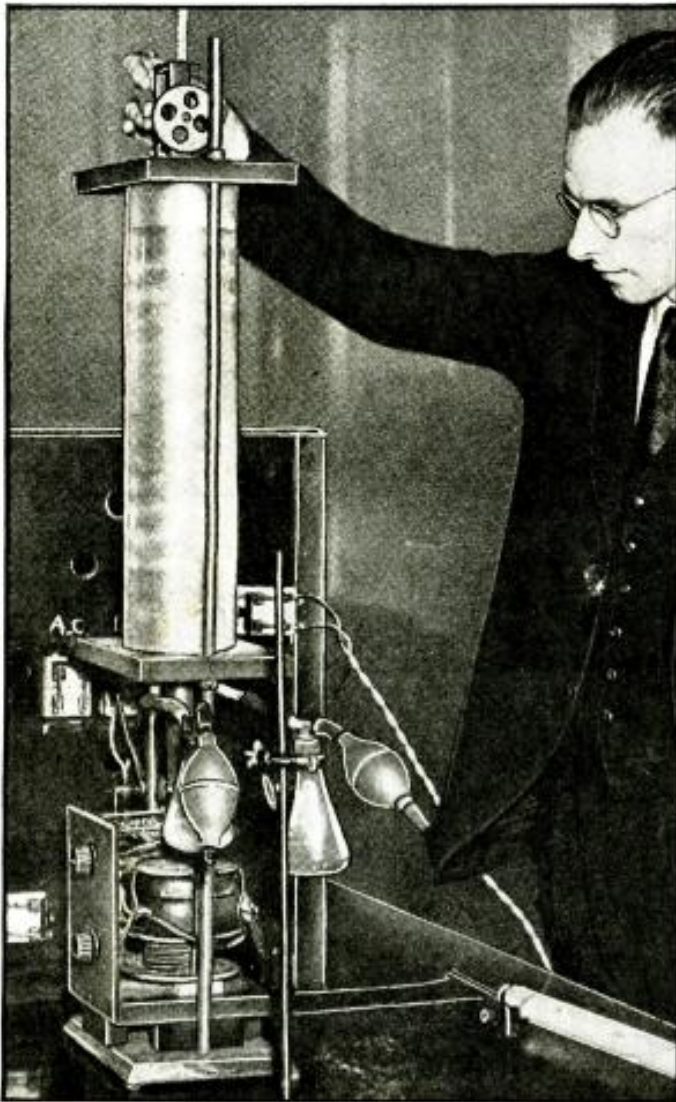

Fig. A. Sound-wave nodes and loops are visualized in ammonium chloride vapor.

A FEW gallons of water dispersed in the atmosphere as fog is the basis of the greatest menace confronting aerial and marine navigation today. Effective control of this vapory menace by means of sound waves is forecast as a result of the recent discovery made by a 27-year-old scientist working in the laboratories of the U. S. Bureau of Mines.

Success in dispersing smoke and fog particles by *floculation* (coalescence into flaky particles) produced by *supersonic* waves—sound waves above the limit of human audibility—and high-frequency *sonic* (audible) frequencies may eventually give Hillary W. St. Clair recognition as aviation's greatest benefactor since the Wright brothers.

Precious particles of gold, silver, lead, copper, zinc and other metals including poisonous arsenic, at present either entirely lost or collected at considerable cost and difficulty can now be easily precipitated as valuable by-products by means of these high-frequency sounds. As

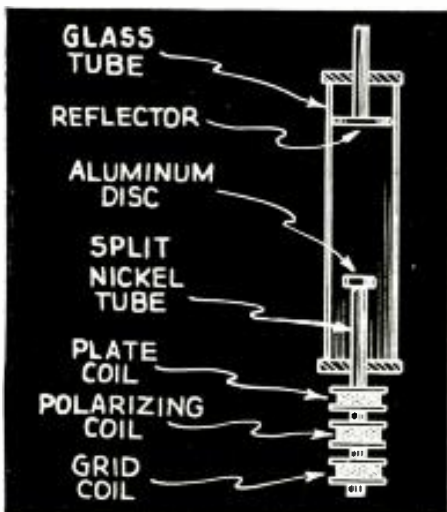

Fig. 1. Diagram of the "fog shaker" components.

A SUPERSONIC "FOG SHAKER"

Audio frequencies, from 7,000 cycles to the super-audible range, it has been found by Mr. H. W. St. Clair of the U.S. Bureau of Mines will dispel fog—and precipitate precious metals!

ERNEST E. FAIRBANKS

this new process is still further developed it is expected that chemical warfare methods will be revolutionized; in laboratory experiments it has been found possible to settle particles making up chemical warfare smoke screens!

Originally assigned to a research problem dealing with effects of high-frequency sound waves on solid particles suspended in a fluid, St. Clair applied his peculiar sound waves to similar particles as they normally occur suspended in air as smoke. To do this he made a thick, opaque smoke by burning smelter flue dust with potassium chlorate. Confining this smoke in a long glass tube with a nickel tube vibrator generating supersonic waves within its lower end, it was possible to observe any effects taking place under their influence.

THE SUPERSONIC MAGNETOSTRICTION OSCILLATOR

St. Clair uses a magnetostrictive vibrator similar to the vibrator described by Gaines 4 years ago. It consists of a nickel tube which vibrates longitudinally by virtue of its magnetostrictive properties when placed in an alternating magnetic field.

This magnetic field is set up by an alternating current in the coils shown in the diagram. The A.C. is generated by a Hartley oscillator using two type UV-203A tubes. The necessary feedback for maintaining the oscillations is provided by the grid coil. The circuit is tuned to a frequency equal to the natural frequency of the nickel tube which is split lengthwise half-way to prevent eddy currents. Even then it was necessary to blow air on the tube to prevent it from overheating.

An aluminum disc is placed on the end of the nickel tube in order to enlarge the radiating surface. The driver used in the original experiment had a frequency of about 7,000 cycles per second. This frequency lies well within the audible range. Similar results have been obtained with inaudible, supersonic waves.

EFFECT OF THE OSCILLATOR

When the vibrator was set in operation the smoke particles began to *floculate*—condense into flaky particles—immediately. As the action continued these particles became deposited in rings on the walls of the glass tube. The resonating air column within the tube deposited the flocculated particles in rings indicating the positions of nodes and loops along the tube.

Other aerosols—extremely small particles—have been used in further experiments with supersonic waves. Fog (water vapor condensed on

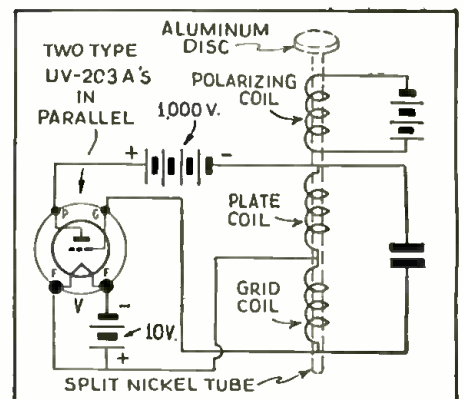

Fig. 2. Circuit of the set-up shown in Fig. 1.

"TALKING PAPER" USES "ELECTRIC EYE"

"The Fotoliptofono". Light reflected from PRINTED waveforms impinge on a PE. cell. A standard radio set reproduces the "record".

GEORGES A. RUBISSOW

INTRODUCTION. Here is a simple, inexpensive audio recording and reproducing system that may sound the death knell of the present system of making and reproducing phonograph records. The following information was obtained by Radio-Craft, via the American Consulate General in London, from the author in Paris. Mr. Rubissow, a Russian refugee, is European representative of the inventor of the Fotoliptofono, Mr. Fernando Crudo of Buenos Aires, Argentina.

—Editor.

AFTER several years' work a South American company has finally developed the most up-to-date design to create "talking paper" (talking, singing, playing, etc.), which up till now was only a dream.

The principal inventor of the system is an engineer, Fernando Crudo, who has specialized in different radio and sound reproduction experiments, since 1923, and who com-

(Continued on page 111)

A CIRCULAR-IMAGE CATHODE-RAY TUBE

Entirely new design in C.-R. tubes permits waveform analyses in terms of polar-coordinates. The backtrace, in most instances an "ugly duckling," becomes useful.

A. STAGER

A SENSATIONAL NEW cathode-ray tube makes extremely short time intervals and decimeter wave impulses measurable.

This new type of cathode-ray tube, recently developed in Europe, has an entirely new method of beam deflection. The function of the new tube stands for something entirely new in the field of cathode-ray tube design, and reminds one of a cross-breed between an electric motor and a cathode-ray tube.

ROTATING AND MODULATING THE C.-R. BEAM

The main trick of the new device is the combination of two deflection plates with a pair of coils; the latter are, as usual, installed outside the tube. The two plates mentioned are placed directly in the propagation path of the cathode-ray beam (which is produced as customarily in the neck of the tube). When the beam enters the space between the 2 plates, something strange happens; it is thrown out of its regular path of straightforward propagation, and is forced to rotate in a circular path.

But this is not the only obstacle placed in the path of the beam. After it has passed the "motor-combination" (the pair of coils) and the 2 plates (mentioned above) which forces the beam to rotate it is confronted with a cone-shaped condenser of coaxial design. The beam must penetrate this cone before reaching the fluorescent screen of the tube.

(Continued on page 105)

RADIO-CRAFT for AUGUST, 1937

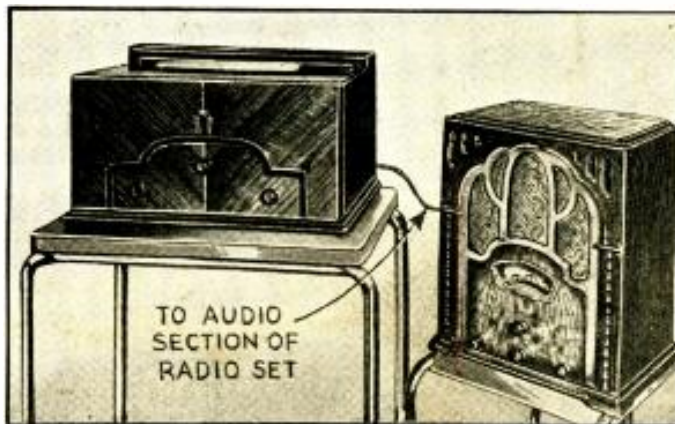

Fig. A. The radio set at right is reproducing the "record" on the Fotoliptofono at left.

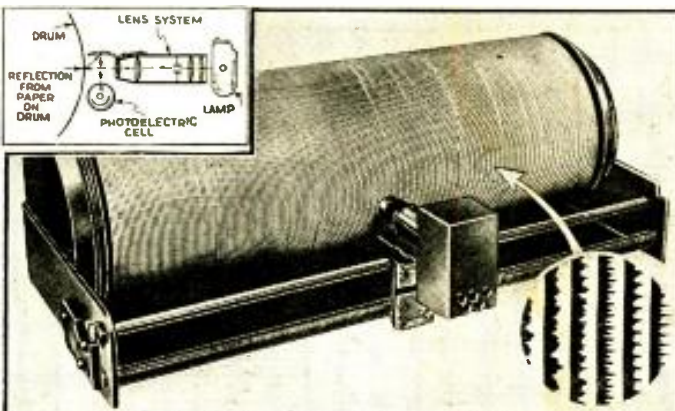

Fig. B. Reflected, not transmitted, light energizes the photocell—connected to an amplifier.



Fig. A. Manfred von Ardenne analyzing a circular waveform on the special screen.

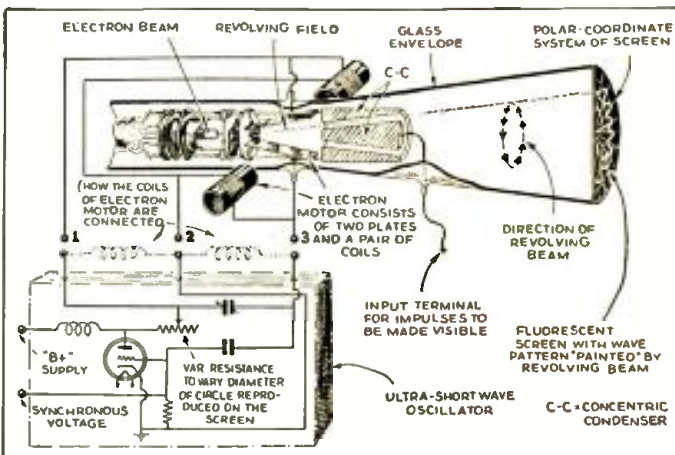

Fig. 1. A concentric coaxial condenser, C-C, revolves the electron stream.



A TELEVISION "STREAMER" FOR SPOT NEWS

A combination advertising and spot-news service to remote points, either by radio or wire, is now available which transmits typed "copy" by means of television.

ROBERT OAKHILL

A RADICALLY new idea for the distribution of news and other reports to group-audiences through the use of television devices has been perfected.

By combining spot news with advertising blurbs, a valuable service is made available for use in hotel lobbies, and in cafés, clubs and wherever else people congregate. (An idea whereby this television "streamer" may be used, for example, atop the delivery trucks of newspaper companies is illustrated, in colors, on the cover of this magazine; and above.—*Editor*)

Unlike existing group-audience news systems the images produced on a narrow, horizontal mirror by this television method are clean-cut; and sufficiently brilliant to be clearly readable in broad daylight. Another outstanding advantage of this new method of conveying typewriter information is that the requisite frequency channel may be reduced to about 8,000 cycles—a bandwidth which may easily be sent over existing telephone lines that have been corrected for ordinary broadcast program fidelity. This is accomplished by using 25-line image reproduction—which has been found to be adequate for typewritten characters—and arranging the lenses (developed by William Hoyt Peck, president, of Peck Television Corp.) in a manner to eliminate flicker.

Still another and highly important consideration to the person who plans to install a television news service such as this is the cost. Due to the simplicity of this new system the equipment cost is held to an exceptionally low figure, which makes possible an unusually low rental price for a complete installation; as to maintenance, the major expense is the expenditure for the services of a dependable typist.

In this connection it is important to note that a central bureau could be set up in each town and only one transmitter (and therefore only one typist) would be required to supply all the receiving instruments with the news and advertising programs. The receiving units except for periodical inspection require no more attention than is necessary to operate the off-on switch.

DETAILS OF EQUIPMENT

Of interest to the technical man is the manner in which the typewritten items are transmitted and received. Although

the general idea is conveyed in the drawings and photographs a more detailed analysis follows. Reference will be made only to the photographs but perhaps the relations of the components will be more evident by the occasional reference to the drawings, Figs. 1 and 2.

THE RECEIVER

Figure A shows how an actual news item appears on the mirror when viewed from almost directly in front. The letters (symbols, etc.) form at the right side of the "streamer" and travel toward the left side, where they disappear; the "8" in the "copy" here shown hasn't yet been completed and the "A" at the opposite end hasn't started to disappear. The mirror is tilted at an angle of about 45 deg. and reflects the image built-up by the flying spot of light projected from below.

This relation of the mirror and the lightbeam source is evident upon reference to Fig. B, which shows an actual installation in the lobby of a famous Canadian hotel.

The receiver and projection mechanism, shown by diagram in Fig. 1B and in close-up at Fig. C, requires only an exciter lamp of the 6-V. automobile headlight type. *This light is first polarized, then modulated (or depolarized) and analyzed (or re-polarized), and finally focused to a point from which it is reflected by means of a series of patented lenses; these lenses, which are mirrored on the back surface, are adjustably mounted on the periphery of a small, rapidly-rotating drum. The short-wave radio receiver utilized to receive experimental transmissions is shown, in the laboratory set-up pictured in Fig. C, on top of the cabinet, at the left side. Immediately below this and inside the cabinet may be seen the remainder of the receiving and amplifying equipment. The power pack appears at extreme right. The engineer is shown holding one of the special, highly-perfected light-modulator cells.

THE TRANSMITTER

The transmitter at which the news and advertising programs originate is shown by diagram in Fig. 1A and, in part, by photo in Fig. D. An electric motor is geared to a

(Continued on page 101)

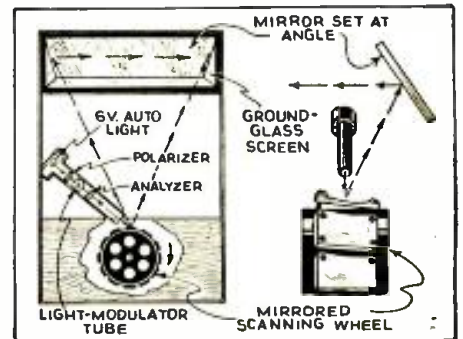
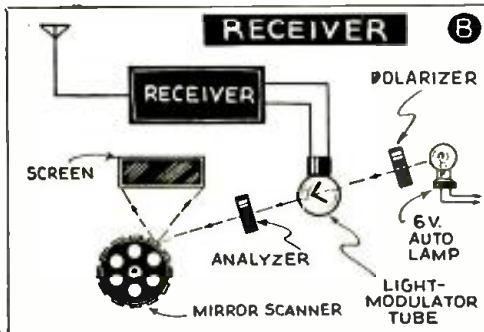
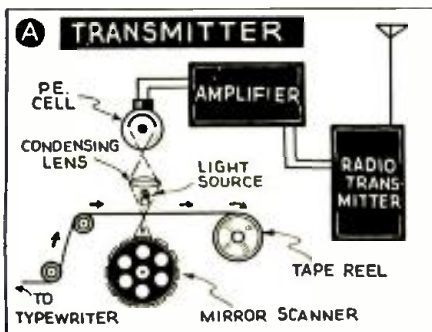

Fig. 1. Televised "copy" is transmitted via radio or wire. The receiver translates these impulses into light rays that are projected onto a mirror (screen).

Fig. 2. Details of the "streamer's" receiving set-up.

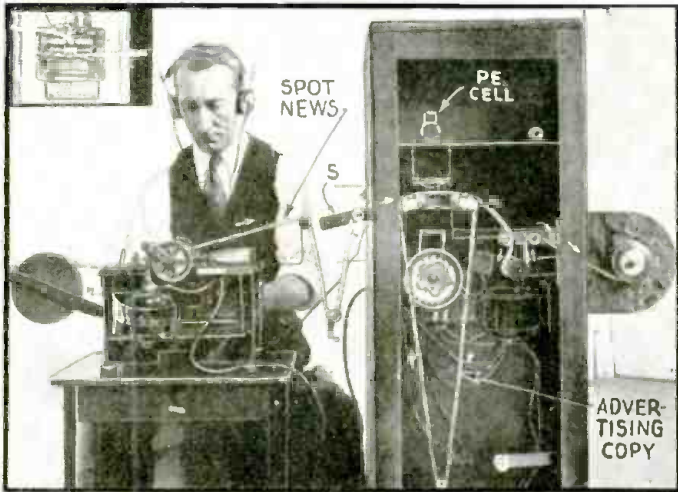

Fig. D. Harold C. Goodridge, typing. Insert—top view of the special typewriter.



Fig. A. Chief engineer Wm. Hoyt Peck watching a televised news item travel across the "streamer."

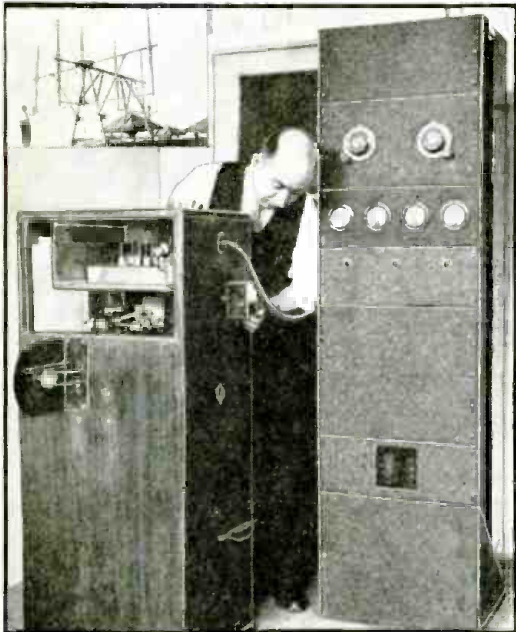

Fig. E. Checking-up the 6-V exciter lamp. Insert—experimental television news service antenna.

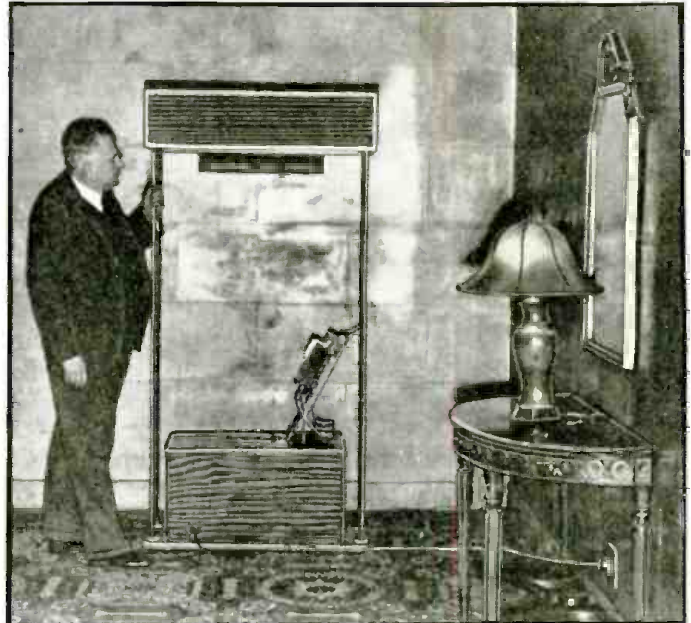

Fig. B. An installation in the lobby of the Mount Royal Hotel, Montreal, Canada.

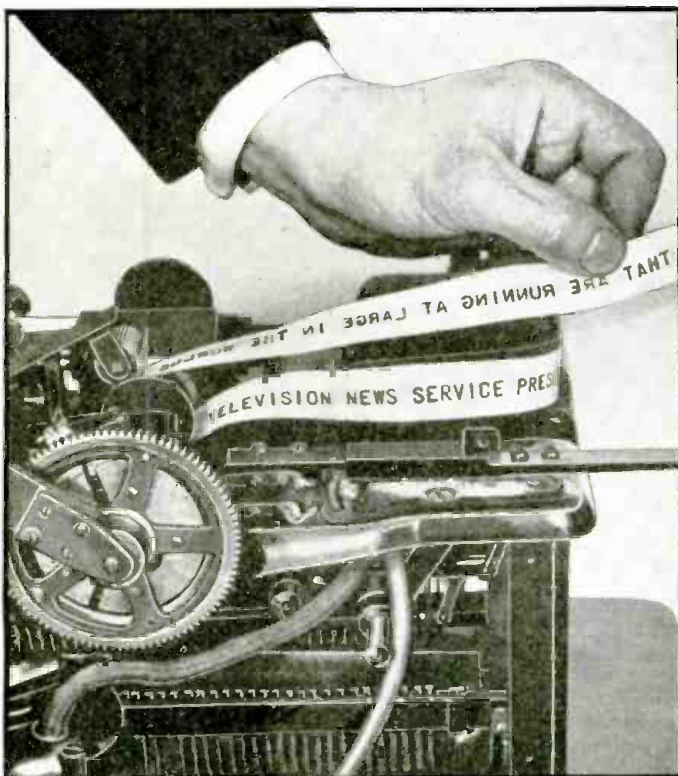

Fig. F. This close-up view of the special typewriter, and its cellophane tape, and typed "copy."

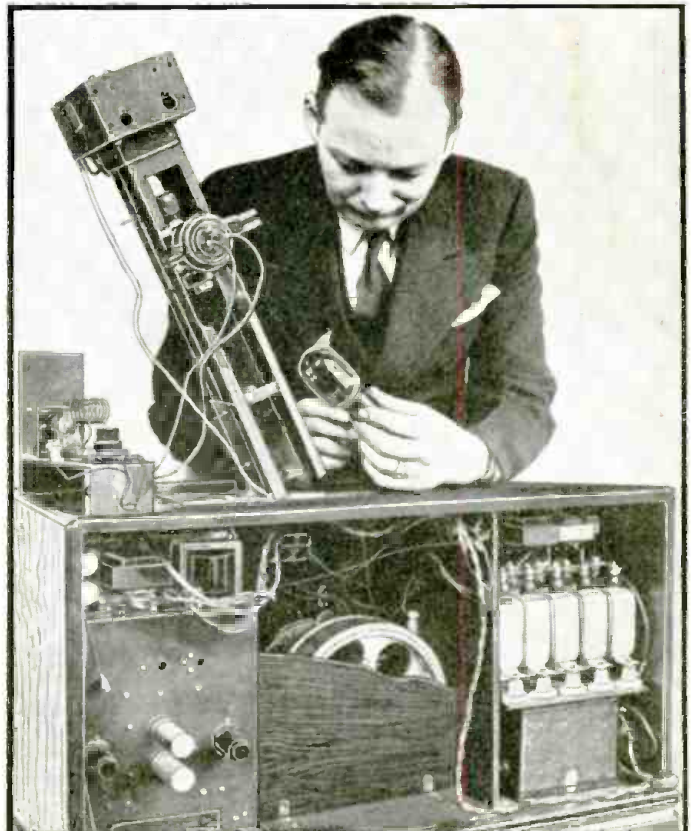

Fig. C. The multi-mirrored scanner; and Mr. J. Francis Dusek, holding one of the Peck light-modulator cells.

NEW SPECIAL-SERVICE TUBES

The backbone of the radio and electronic industries is the electron tube. A few new types are described.

C. W. PALMER

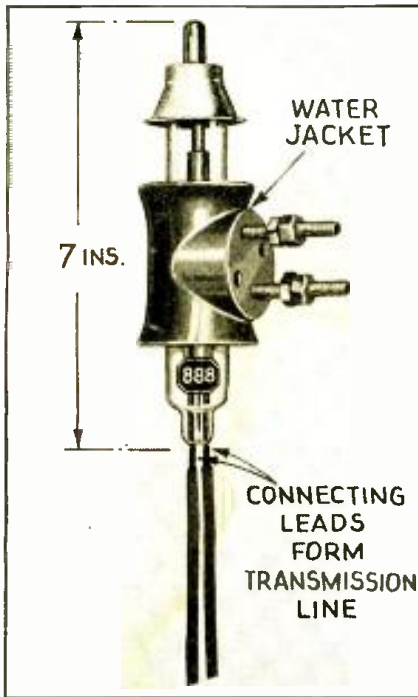

Fig. A. The unusually small size of this water-cooled, high-frequency triode tube can be realized when an ordinary 1 kw. transmitting tube is 2 to 3 ft. high. When employed as an oscillator this tube may be operated at its maximum power rating on frequencies as high as 240 mc.; while in amplifier circuits, where the input and output circuits are isolated, it may be run to full output on frequencies as high as 300 mc. (1 meter). The power output as oscillator on 100 mc. (3 meters) exceeds 700 W.

AS THE widespread fields of radio, television and electronics move rapidly forward in their path toward a final goal of stable, dependable service to mankind, it becomes more and more evident that the controlling factor in progress in all these fields is the electron tube.

As tubes are perfected, so also is the remainder of the art perfected. By this, it is not meant that the development of new and better vacuum tubes acts as the controlling genius which is followed by the remainder of the technique involved in perfecting a particular branch of the industry, but rather that as the industry advances, the call is for better and better tubes to keep abreast of the development of new and better circuits, parts and technique.

By following, closely, the evolution of the vacuum tube, therefore, the radio enthusiast, technician, engineer and Service Man can most readily keep informed of the progress in the particular part of "radio" which is of greatest interest to him.

An example of this reasoning is found in the announcement, at the recent I.R.E. convention, in New York, of 2 new triode tubes for generating R.F. currents in the high-frequency spectrum between 3 meters (100 mc.) and 1 meter (300 mc.). Both of these tubes are water cooled, having a hollow metal jacket, around the center of the glass envelope, which permits the circulation of cold water and at the same time acts as an effective shield for the elements.

Fundamentally, these 2 tubes feature: (1) no internal insulating material; (2) low inter-electrode capacity; (3) low lead inductance; (4) attached water jacket; and, (5) paralleled grid and plate leads which act as a transmission line (with the plate and grid elements as part of the tuned circuit).

887 and 888. These tubes are so small that their size belies their ability to produce the high power of which they are capable. One of the triodes has a low mu factor and is known as the 887 while the other has a high mu and is labeled 888. When used as oscillators these tubes can be operated with a maximum power input of 1,200 W. at frequencies as high as 240 mc. (1.25 meters). In R.F. amplifier circuits they can be used with

maximum input at frequencies as low as 300 mc.

The "secret" of the high output of the 887 and 888 is the small size of the elements (the plate is only as large as a thimble) and the extremely small spacing between them. The small size reduces the capacity to a minimum so that the elements may be used with greatest effectiveness (lowest shunt capacity); and the small spacing (0.06-in between grid and cathode) reduces the "transit time" or length of time for electrons to pass from cathode to plate, to a minimum. The importance of this consideration can be realized when it is understood that at 3 meters the electrons must travel between cathode and plate in one-five hundred millionth (0.00000005) of a second.

The significance of the above facts about these two new tubes is in the thousands of new channels which will be opened up for use between 3 meters and 1 meter because of the availability of efficient generators of power on these wavelengths. This may be an important factor in the growth of television, also, as these tubes will undoubtedly find
(Continued on page 112)

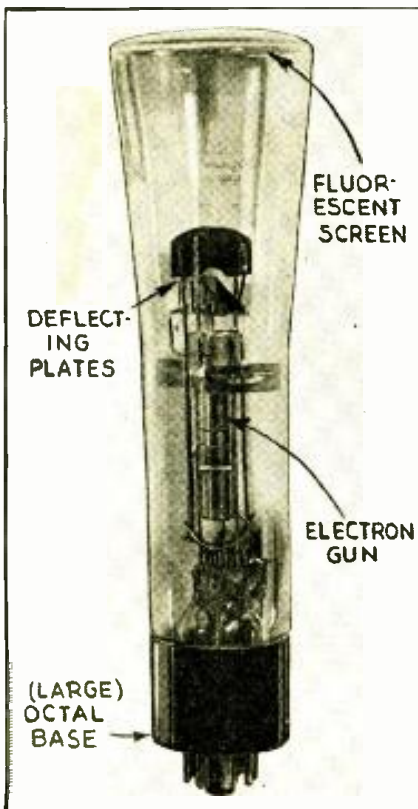

Fig. B. The 24 XH high-vacuum cathode-ray tube is very similar in construction to its larger brother the 34 XH (906), with the exception that it focuses to a screen closer to the deflecting plates. This calls for a change in the shape of the deflecting plates. The area of the screen of this tube is 4 times that of the 913 or 1-in. C.-R. tube which increases its usefulness many times over the (latter) small tube. The 2nd.-anode operates at 600 V. (max.).

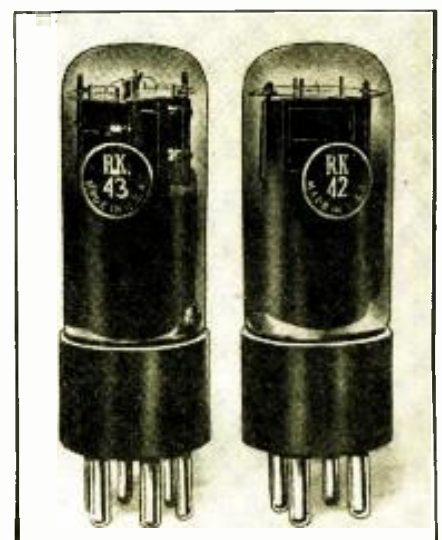

Fig. C. These two tubes, the RK42 and RK43 triodes were especially developed for the tiny lightweight transmitters used for meteorological purposes. The RK42 is a triode, enclosed in a cylindrical envelope somewhat smaller than the usual dome-shaped envelope used for receiving tubes. The RK43 is similar to the RK42, except that it contains 2 sets of elements (grids and plates) for more complex transmitter circuits.

NEW OSCILLOSCOPES USE 2-IN. C.-R. TUBE

Service Men are here informed of the economy and efficiency presented by the new 2-in. oscilloscope tubes.

SAMUEL C. MILBOURNE

THE TYPE 24XH 2-in. cathode-ray tube now enables Service Men to purchase oscillographic equipment at a cost far below that necessary for 3-in.-tube apparatus; and with the assurance that the apparatus will actually perform in a worth-while manner. The 2-in. tube does not supersede the 3-in. tube, rather, it augments it and so broadens the economic availability of oscillographic units that no Service Man can now claim "I haven't got the price." Deferred payment plans are now offered and these should be utilized to the utmost as they enable the Service Man to equip his shop with the most modern of instruments and to pay for them as he earns.

The biggest drawback to the 3-in. tube and associated apparatus is its initial cost. Three-inch tube equipment, without signal generator or wobulator usually costs in the neighborhood of \$100. This cost is necessitated by the original cost of the tube itself, and the necessity for having a power supply of

around 1,000 or more volts for supplying the tube's elements.

(Continued on page 118)



Fig. A. The modernistic panel of the oscilloscope.

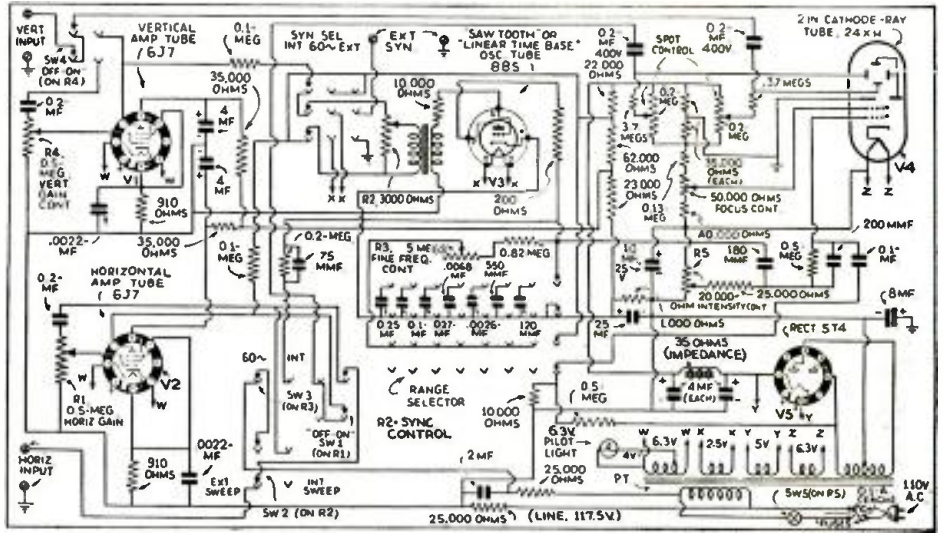
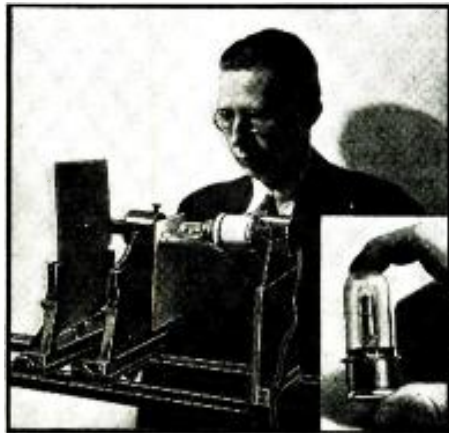

Fig. 2. The circuit, with values of parts, of the new oscilloscope. Note the 2 amplifiers.



KEEPING VOLTAGE CONSTANT

Facsimile and television demand constancy of current supply—a vital topic which the author ably discusses.

HARRY F. DART

Fig. A. left. A new Westinghouse crater lamp with scanning focus of 200 lines—double the present focus.

MOST REGULATOR TUBES fall into one or two general classes, namely, (1) filament types and (2) gaseous types. Since the principle of operation of these tubes, as well as their application, falls into two rather distinct classes, the groups are most conveniently considered separately.

As indicated by the name, the filament type of regulator tubes ordinarily use a filament mounted in a bulb containing a cooling gas. The material of the filament should have a step in its resistance characteristic so that there is a portion of the curve over which the voltage changes to a relatively large degree while the current is changed by only a relatively small extent. Iron and tungsten wire have been found very satisfactory for this service.

To reach the proper portion of the characteristic curve, the tube must be filled with a heat-conducting gas which "cools" the filament by maintaining it at proper critical temperature. Hydrogen has been found best for this purpose because it is a good conductor. It conducts the filament heat to the bulb where, by convection, the surrounding air acts as a further conductor. With hydrogen there is a minimum of risk that the filament will oxidize or that its characteristics will otherwise suffer adverse changes.

The action of the filament when mounted in an atmosphere of hydrogen is best represented by the accompanying char-

(Continued on page 104)

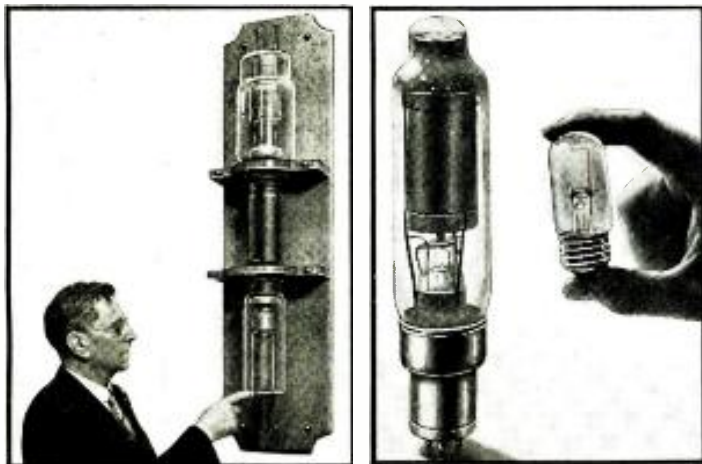

Fig. B. Type AW-200 H.F. generator. Fig. C. WL-706; WL-896 (regulators).

THE BALANCE SHEET OF TELEVISION

This careful analysis of available information concerning television here and abroad concludes with some amazing deductions.

W. E. SHRAGE

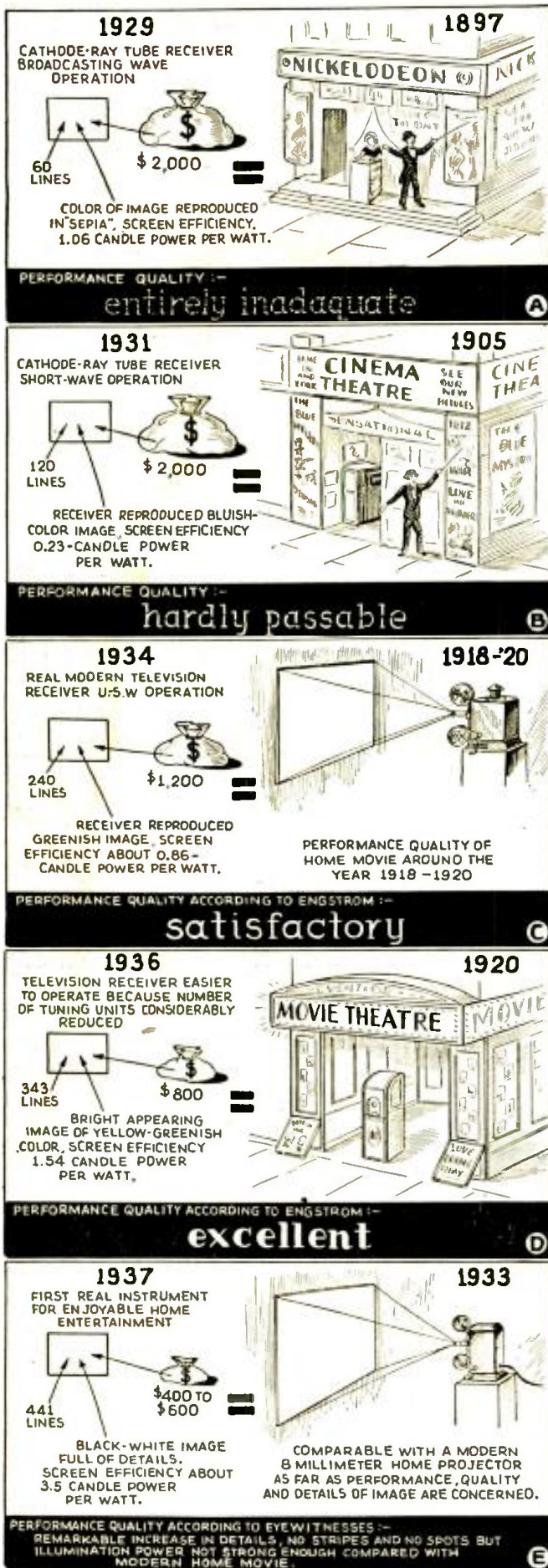

Fig. 2. Television compared to motion pictures.

THE ART of television although more than 50 years old has never before made such impressive and remarkable progress as in the past 12 months. A single fundamental achievement which justifies this statement is the recently effected increase in the number of scanning lines from 343 to 441.

This achievement when presented in the colorless language of arithmetic symbols probably does not mean much to the average amateur and Service Man. However, let's look at the same facts but from another point of view. This changed point of view is interestingly portrayed in Fig. 1. The diagram shows an electric sign reading "RADIO." Most of its letters (as shown at A) consist of approximately 10 electric bulbs. And now something which may sound surprising at first—this sign has about the same quality of form and detail as 60-line television had around 1929. A convincing proof of this comparison is given in the following test.

Let's look, from a very short distance, at a sign of the type shown in Fig. 1A. An illegible, glaring "bulb-collection" meets the eye. If seen from afar, only a weak and quite "washy" image is visible. That's exactly the way 60-line television used to appear. If seen from a distance, too-close a number of disconnected lines was presented to the eye. If looked at from far off, a weak image with a pronounced lack of details glowed somewhere in the dark.

But this type of television transmission had distinct advantages as Fig. 1A indicates. A 60-line image consists (as the table at the right side shows) of only about 4,800 picture points (or image elements)—resulting in a very low degree of detail. However the required bandwidth is also very small. A 60-line television transmission when radiated on a wavelength within the broadcast range occupied the space of about 12 broadcast transmitters (each of a bandwidth of 5 kc.).

This requirement caused the use of the short-wave band between 200 and 300 meters for television transmission. The most pronounced advantage of 60-line television reception was the "narrow" bandwidth of the amplifiers required in these receivers. The bandwidth was, of course, approximately 12 times as broad as the 5 kc. bandwidth of contemporary broadcast receivers. But, as we shall see, the design problems were not as involved as in the case of present television amplifiers of tremendously extensive bandwidth. One additional resistance-coupled stage added to a customary A.F. amplifier equalized the decrease of amplification caused by the attenuation applied to permit the amplifier to pass a band of 63 kc.

1929

It is quite amusing to read today what magazines of 1929 had to tell about this type of television. But seen from a realistic point of view this type of television when compared with present requirements is: "entirely inadequate" as the diagram of Fig. 2A readily explains. Nevertheless the audience was quite satisfied, as much as our parents were with the "nickelodeon" performance which in more than one respect resembled that of 60-line television.

The "nickelodeon's" image was of a brownish color, and approximately the same performance quality was presented

by the cathode-ray tube receivers of 1929. The screen of this receiver would glow in a fluorescent light of a "flat" sepia color, despite the fact that the screen efficiency was surprisingly high, namely 1.06 candlepower per watt.

And finally, a word about the price of a 60-line television receiver with cathode-ray tube would not be amiss. As Fig. 2A shows, it cost about \$2,000 per set! This seems extremely expensive compared with the results obtainable. But we have to consider that all of these sets were custom-built affairs, and cost the manufacturer at least three times as much as he dared to ask for it. A cathode-ray tube alone which was able to reproduce an image of 3x3 ins. (see Fig. 3A) was priced at about \$400. (Considering all these facts, and comparing them with the performance quality of modern talkie exhibition (which, after all, is the only sensible standard) we derive an efficiency factor of approximately 1 per cent for the 60-line television transmission.

1931

Considerable improvement was shown in the 120-line television transmission which was achieved around 1931. Although the screen size increased to 3x4 ins. (see Fig. 3B), and the number of picture elements to approximately 19,000 (see Fig. 1B), the efficiency factor of this type of television transmission did not increase to more than 4 per cent.

The reason becomes obvious upon observing as example the "RADIO" sign presented in Fig. 1B. The characteristic form of the letters is now much better reproduced but no one could claim that too much detail is presented. Considering this lack of detail and the decreased illumination power of the screen (0.23-candlepower per watt—because of the new type of bluish image applied) one can't be far wrong in saying: "A 120-line television transmission has about the same performance qualities as the 'CINEMA THEATRE' of 1905"—that is: "hardly passable"! (See Fig. 2B.)

"Time marches on," and after 1931 television engineering started to make strides as never before. The "RADIO" sign of Fig. 1C is a practical comparison. The number of picture elements increased to 77,000 but also the required bandwidth increased (to about 1,024 kc.). Only the ultra-short wave-band could accommodate the requirements of such a tremendous bandwidth, which, in the parlance of the broadcast range, is as broad as required by 200 broadcasting stations. As Fig 1C clearly indicates, this type of television transmission can by no means be called excellent, since the performance quality was about as mediocre as the performance of the home movie around 1918-1920, and the judgment of E. W. Engstrom who determined the performance quality of a 240-line transmission as "satisfactory" still stands as an approximately correct evaluation.

1934

The year 1934 not only brought us

	LINE'S	NUMBER OF PICTURE ELEMENTS OF TELEVISION IMAGE	BAND WIDTH REQUIRED FOR TRANSMISSION
1929 A	60	APPROX. 4,200	63 KC. SPACE OF 12 STATIONS
1931 B	120	APPROX. 19,000	256 KC. SPACE OF 51 STATIONS
1934 C	240	APPROX. 77,000	1,024 KC. SPACE OF 200 STATIONS
1936 D	343	APPROX. 150,800	2,250 KC. SPACE OF 450 B.C. STATIONS
1937 E	441	APPROX. 275,000	3,250 KC. SPACE OF 650 B.C. STATIONS

Fig. 1. Bandwidth, lines and definition of different television images.

images of larger size (increase of screen dimensions to 5x7 ins.—see Fig. 3C) but also the more efficient green fluorescent light (with a factor of 0.84-candlepower per watt—as indicated by Fig. 2C); during this year also the regular design and production of television receivers was started in Europe.

Despite all the improvements mentioned so far, and despite the increased cost in manufacturing a television receiver (because it had to pass a frequency band of 1,000 kc. without cutting the edges) the price of a 240-line television set (with an image size of 5x7 ins.) decreased to \$1,200. This price still seems exorbitantly high, but one should try to figure out how much he would have to pay if he had the desire for a hypothetical broadcast receiver with a band-pass width about 142 times as broad as a contemporary high-fidelity set of 7 kc. bandwidth, and he will then appreciate the need for the price. And besides, a television set consists not only of an image receiver but of an ultra-short wave sound receiver as well!

1936

Then came the eventful year of 1936. American television engineering perfected the 343-line television transmission. They increased the size of the image to 6x9 ins., and the number of picture elements presented per second to approximately 150,000. But this is not all. The screen efficiency increased to 1.54-candlepower per watt, and instead of the "eye-straining" greenish hue characteristic for television receiver of 1934 vintage a pleasant yellowish-green fluorescent light was used to reproduce the image.

However, there was one point that only a few of the experts failed to point out—a bandwidth of approximately 2,250 kc. was necessary to transmit the image impulses required for a 343-line television performance. They argued that this tremendous bandwidth (which is equal to the space covered

(Continued on page 102)

A	3" x 3"	60 LINES	1929	RELATIVE EFFICIENCY FACTOR OF PERFORMANCE QUALITY 1%
B	3" x 4"	120 LINES	1931	RELATIVE EFFICIENCY FACTOR OF PERFORMANCE QUALITY 4%
C	5" x 7"	240 LINES	1934	RELATIVE EFFICIENCY FACTOR OF PERFORMANCE QUALITY 10%
D	6" x 9"	343 LINES	1936	RELATIVE EFFICIENCY FACTOR OF PERFORMANCE QUALITY 14%
E	9" x 12" (EUROPE)	441 LINES	1937	RELATIVE EFFICIENCY FACTOR OF PERFORMANCE QUALITY 16%

Fig. 3. Relative efficiencies of images.

HOW TO MAKE THE RADIO-CRAFT SUPER-DELUXE 30-TUBE SET

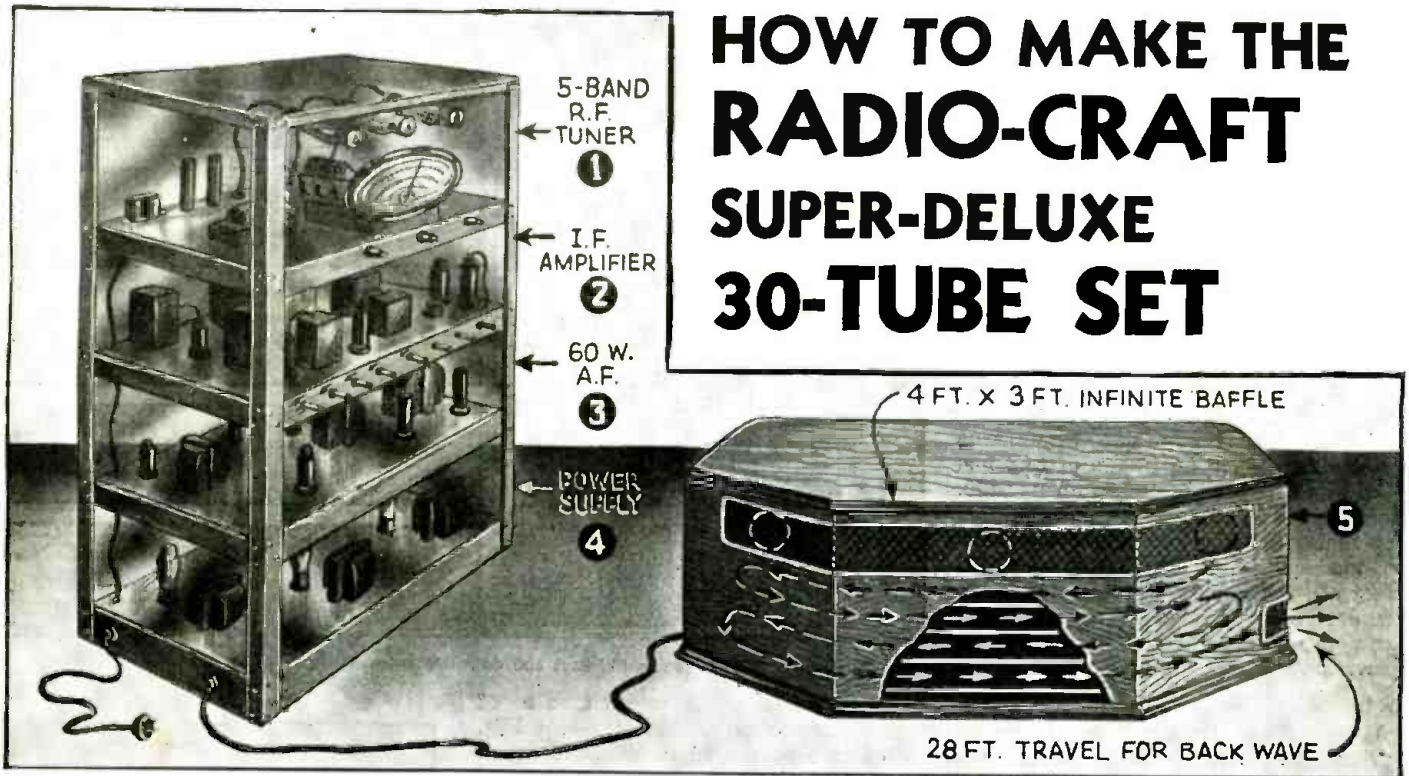

Fig. A. An artist's conception of the Radio-Craft 30-tube Super-Deluxe Radio Set, in phantom. The completed design will vary slightly from this form.

RADIO-CRAFT has made arrangements with Mr. Charles Sicuranza, who is directing the development of this superlative instrument, to have tested and repaired **WITHOUT CHARGE** any set, built in accordance with these instructions **AND USING ONLY THE SPECIFIED COMPONENTS**, which fails to function correctly. In other words—**YOU CAN'T LOSE!**

PART I INTRODUCTION

SINCE the advent of high-gain tubes a few years ago, most receiver manufacturers have tried to obtain the utmost results from the least number of tubes. Economic conditions led to the making of tiny sets using 4 or 5 tubes and with reproducers which generally were but little larger than headphones.

Tone quality, sensitivity and selectivity were sacrificed and a great number of people bought such sets *only* because they could not afford larger and better ones. As conditions gradually improved, manufacturers warily attempted making larger and larger radio receivers.

To-day, there is a definite demand for
(Continued on page 103)

TABLE I FEATURES OF THE RADIO-CRAFT 30-TUBE SUPER-DELUXE RECEIVER

- (1) SKYSCRAPER CONSTRUCTION, 5 chassis for ease of wiring and servicing. Modified rack-and-panel layout.
- (2) ALL-WAVE SUPERHETERODYNE CIRCUIT; 3.8 to 555 meters, 5 bands, R.F. stage, 1st pentagrid mixer, 1st electron-coupled oscillator (all in the Meissner multi-wave assembly).
- (3) DOUBLE-I.F. AMPLIFIER, with I.F. No. 1 at 456 kc. and I.F. No. 2 at 175 kc.; includes 2nd pentagrid mixer and 2nd oscillator; this "double-superhet." action results in extremely high gain with stability—for DX reception.
- (4) I.F. BAND EXPANSION, with 3-position panel control for (1) high-fidelity, (2) medium, and (3) DX reception.
- (5) NOISE-SILENCER CIRCUIT, with panel control, to level out static and noise surges.
- (6) AMPLIFIED DELAYED A.V.C., with panel control for selecting A.V.C. level.
- (7) BEAT-FREQUENCY OSCILLATOR (or B.F.O.), with panel control, for C.-W. reception or as a DX station finder.
- (8) B.F.O.-A.V.C. PANEL SWITCH, a 3-position switch for turning B.F.O. on and A.V.C. off or vice versa, or both A.V.C. and B.F.O. on.
- (9) THREE TUNING "EYES" used as (1) carrier tuning indicator, (2) "R" or signal-volume indicator, and (3) A.F. overload indicator.
- (10) MANUAL SENSITIVITY CONTROL, 1st I.F. cathode.
- (11) AUTOMATIC BASS AMPLIFIER, self-controlled, automatically increases low-frequency response as volume level is progressively lowered.
- (12) BASS CONTROL on panel, to select desired amount of bass response.

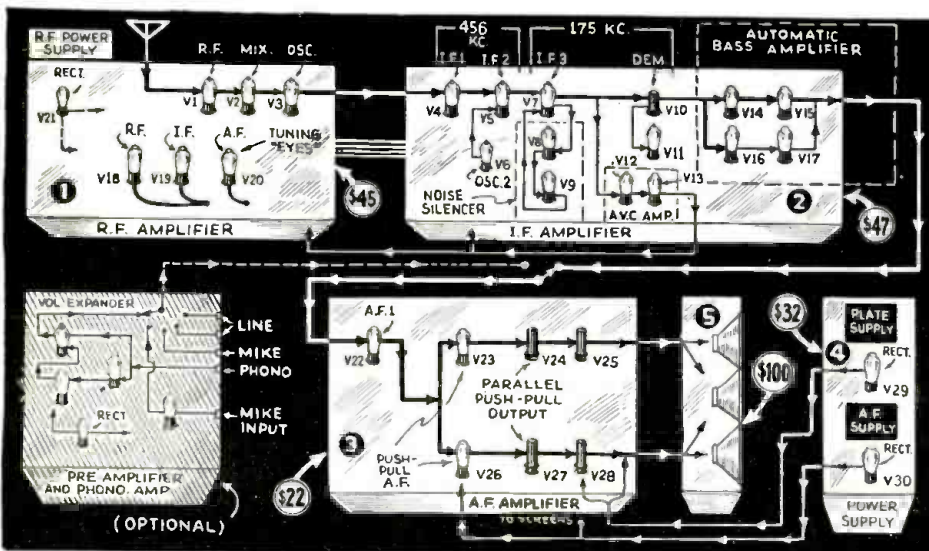

Fig. 1. Block diagram—tubes and services; and approx. chassis parts costs at mail-order-house prices.

THE PROJECTION KINESCOPE MAKES ITS DEBUT

At the recent I.R.E. Silver Convention was introduced a special demonstration-type, 441-line television set-up of American design.

INTRODUCED last May at the Silver Convention of the Institute of Radio Engineers' jubilee celebrating the 25th year of this famous radio society, was an American version of the projection-type cathode-ray tube, the general principles of which are familiar to *Radio-Craft* readers.

This "projection Kinescope," which is illustrated here, reduced an image from a picture printed on the image-

plate at one end of the Kinescope-section of the complete tube; this was more

convenient, for demonstration purposes, than reproducing an actual scene (view of a living person)—in this manner the use of much equipment was obviated. About 1,200 engineers crowded into the grand ballroom of the Hotel Pennsylvania in New York City to witness this



Fig. A. Here is a view of Dr. Law and the projection type cathode-ray television image he obtained on a 3 x 4 ft. screen.

new, convenient method of large-group demonstration of high-fidelity or 441-line television.

The tube, which is about 18 ins. in length, produces an image about 1½ x 2¼ ins. on its fluorescent screen. It is so brilliant that a simple optical system will project it on a large screen. A projected picture 18 x 24 ins. compares favorably in brightness with home motion pictures. In the demonstration, a picture 3 x 4 ft. in size was shown, which was bright enough to be seen by the gathering.

The principal feature of the demonstrated device is a new type of "electron gun," developed by Dr. Law and a group of associates in the RCA laboratories at Harrison, N. J. The gun is the structure in a television receiving tube which focuses flying electrons into an extremely slender beam. In projection, it is necessary to start with a much smaller and brighter picture than in the case of the ordinary Kinescope or television-type cathode-ray image receptor which is viewed directly. Since the brightness is dependent on the current in a smaller "spot."

The television images shown were on the 441-line standard which RCA adopted some months ago for its practical field tests. Despite the enlargement, it was difficult if not impossible for the eye to detect line-scanning or other de-

(Continued on page 110)

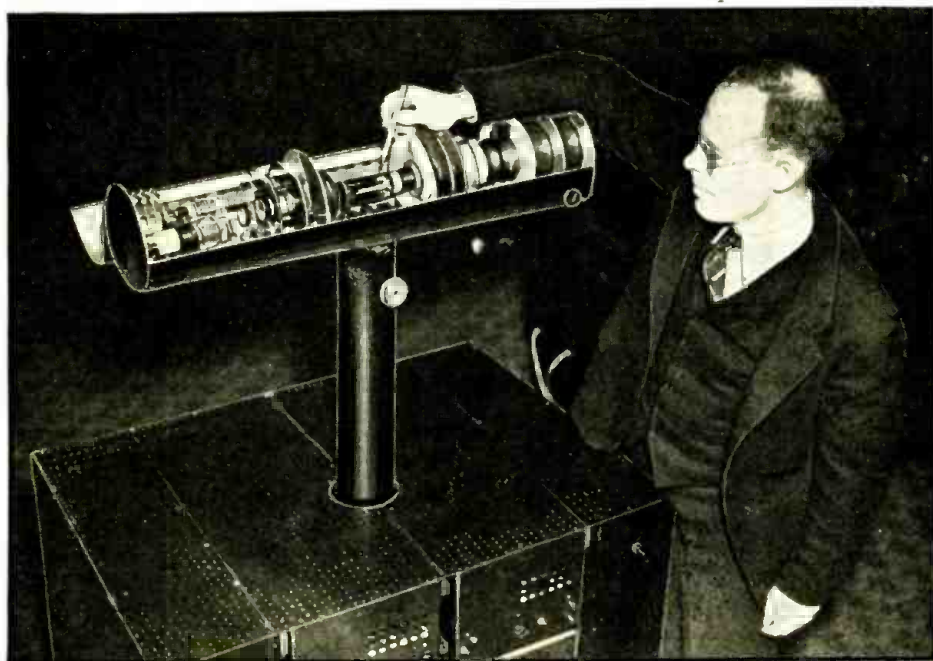

Fig. B. Immediately in back of the projection Kinescope's electron multiplier section, to which Dr. Law is pointing, is the amplifier section.

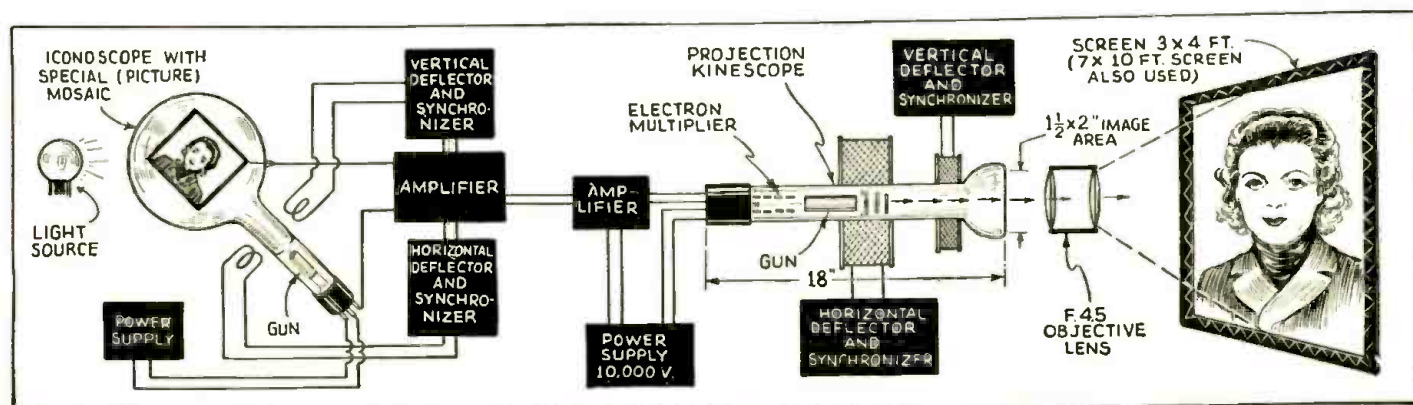

Fig. 1. Sequence of operation in the newest, American-version projection-type cathode-ray television. Set-up demonstrates high-fidelity, 441-line image transmission and reception.

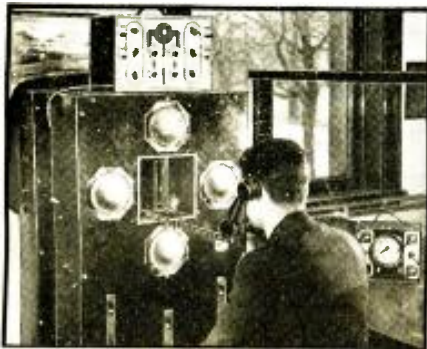

Fig. A. The Service Man working on the transmitter.

IT WAS a 2-station, 2-way television outfit, installed in De Paul University for student use by the American Television Institute, that first started us on the hunt for the trouble which serves as the basis of this article.



Fig. B. The rear view of the equipment.

SERVICING A STUDENTS' TELEVISION SET-UP

Of special significance to Service Men — a practical insight into the future business of television service.

E. J. DOYLE & J. P. KENNEDY

The complaint was a peculiar wave in the output picture which apparently was caused by 60-cycle A.C. pick-up somewhere in the system.

The circuit looked relatively simple with 4 large television "eyes" connected in parallel and feeding into a type 75 tube grid. The diode section of the 75 was not connected and apparently it was used only as an amplifier having the grid connection coming out of the top of the tube and thus as close as

possible to the group of photocells.

This tube was located in a shielded compartment, much as if it had been an R.F. amplifier. Directly below it in a smaller shielded compartment, we observed another 75 with its grid coupled through a condenser to the plate of the first tube, less than 1 in. above it.

At successive stages, each individually shielded, directly below the preceding, we located two type 85 tubes and a 48.

(Continued on page 124)

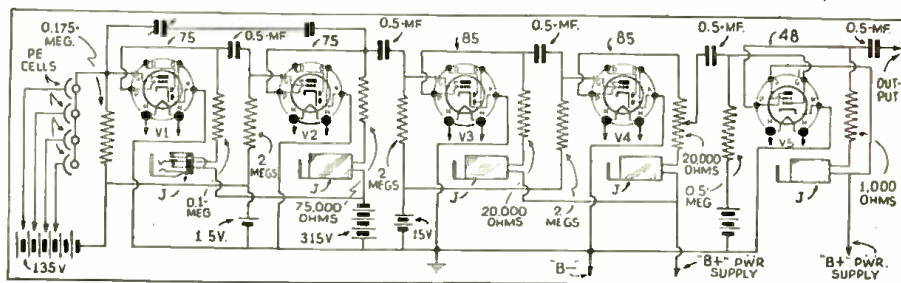

Fig. 1. The circuit of the wide-range resistance-coupled amplifier of the system.

BUILD THE RADIO-CRAFT 1937 CAR-RADIO RECEIVER

PART III

Automatic frequency control introduces an important element of safety while simultaneously driving and tuning-in.

SOME BUILDERS of the *Radio-Craft* Car Set may wish to use automatic frequency control on the broadcast band, especially if their sets are to be remote controlled and if exact peak tuning to a desired signal is required with a minimum of manual adjustment. Figure 5 gives the correct circuit details. Note that we cannot use A.V.C. on the I.F. stage with A.F.C., as the automatic volume control action will work to disturb exact peak alignment at the intermediate frequency.

The 6Q7 2nd-detector is used as before and is NOT employed as a balancer. The signal—or, rather, part of the signal, is fed through a coupling condenser from the 6K7 plate to a separate center-tapped transformer feeding a separate balanced 6H6 detector (to be installed, with the transformer, under the set chassis, perhaps on the R.F. shield partition). When we are tuned exactly "on the nose," the voltage across the two resistors in the 6H6 output circuit are exactly equal, and opposite, and in effect cancellative—and no voltage, negative or positive, appears in the A.F.C. line. The moment the R.F. circuits are out of alignment, an un-

symmetrical I.F. signal results, unbalance appears in the output of the 6H6, and a negative or positive voltage appears in the A.F.C. line to control the bias on the 6J7 oscillator control tube—which is IN EFFECT a resistance placed across a portion of the oscilla-

tor tuned circuit. The effective oscillator inductance is affected, thus causing the oscillator frequency to shift until it mixes with the signal to produce exact I.F. peak and perfect 6H6 output voltage balance. (See Mr. C. P. Mason's (Continued on page 112)

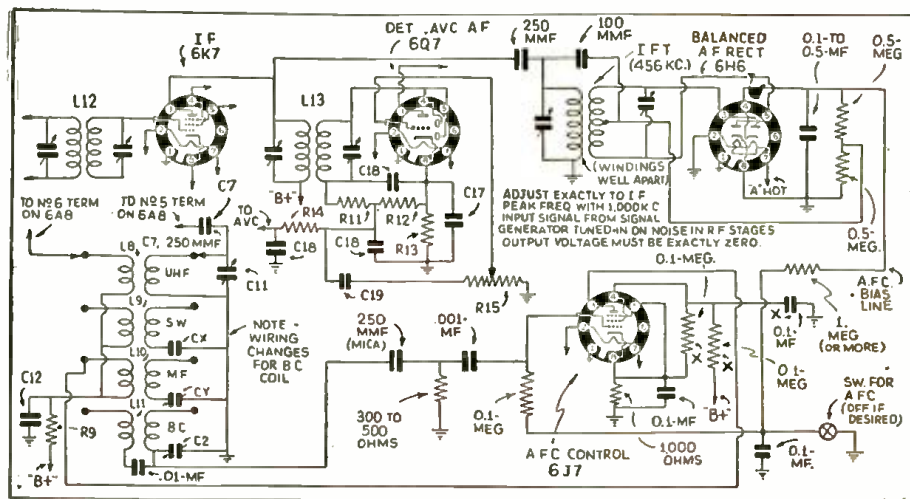

Fig. 5. This circuit gives connections of the A.F.C. unit and parts of the receiver proper.

HOW TO MAKE A 2-TUBE CARRIER INTERPHONE

This "swell," greatly-simplified "wireless" communicator is inexpensive and economical.

ARTHUR BLUMENFELD

THE SURFACE has hardly been scratched when it comes to the exploitation of the carrier-type intercommunicators. From the commercial point of view, there is hardly a manufacturing or sales organization that could not make profitable use of one or more of these devices. The number of concerns that have recently been organized to get this business is sufficient proof of this.

The average experimenter or radio enthusiast could likewise find a number of personal uses for this type of communicator. The only factor which holds back many from building one for themselves is the newness of the system and the attendant fear of failure to make the apparatus work without too much trouble—either in construction or maintenance. This is the reason for the 2-tube A.C.-D.C. unit described in this article.

First of all, it is fool-proof. There are no possibilities of undesired circuit oscillation, hum or what-not which the multi-tube type have, when imperfectly constructed. The possibilities of breakdown have been reduced to a minimum by the elimination of all parts not vitally necessary to the operation of the set. This, in turn, has reduced the size of the communicator—which is an advantage. Last but not least, the cost of construction has been reduced to a point where it is probable that the design will not be obsolete by the time sufficient funds have been saved up to build the contraption. This system is of the single-channel type—i.e., for use between 2 points. First let us look into the whys and wherefores of the design.

DESIGN CHARACTERISTICS

The elements vital to a carrier intercommunication unit are given in the following paragraph.

(1) Radio-frequency oscillator tube—this may be used as the detector when receiving. (2) Power modulator tube—for modulating the R.F. This may be used as the power tube when receiving. (3) Voltage amplifier tube—to step-up the

(Continued on page 116)

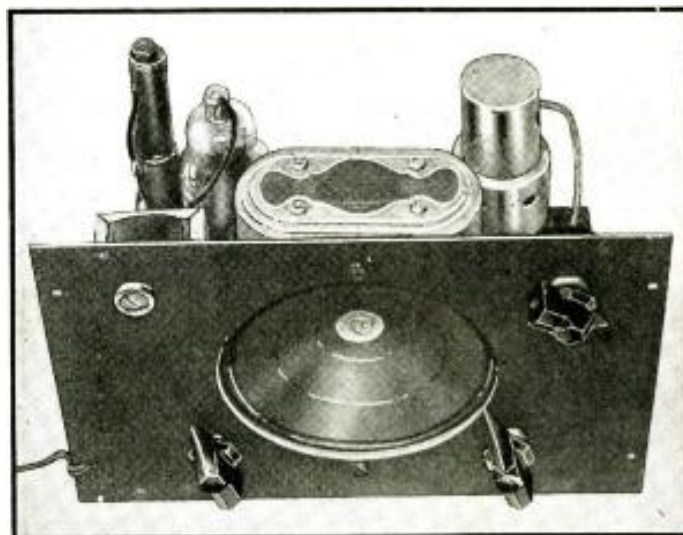

Fig. A. The front-panel appearance of the interphone.

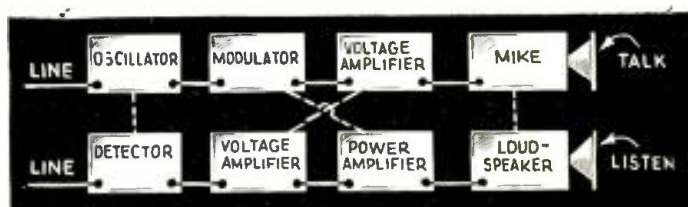

Fig. 2. Block diagram showing the dual functions of parts.



Fig. 8. The locations of the parts can be seen here.

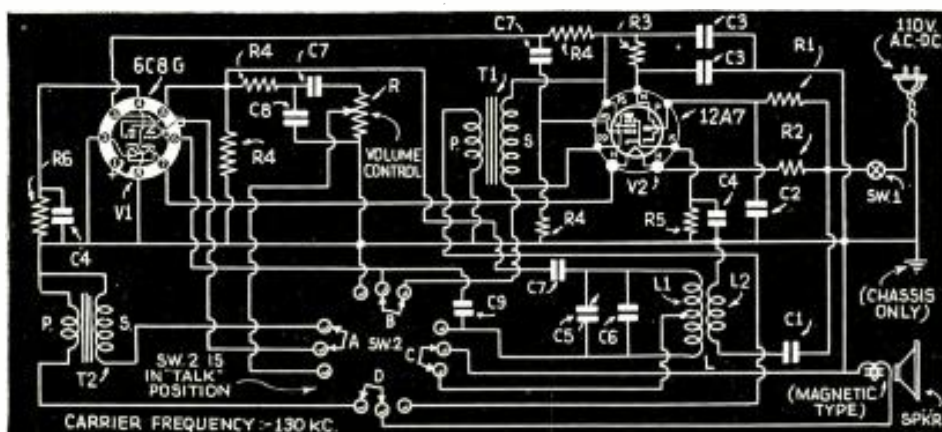

Fig. 1. Schematic circuit of the unit with Sw.2 in the "talk" position. See List of Parts for values.

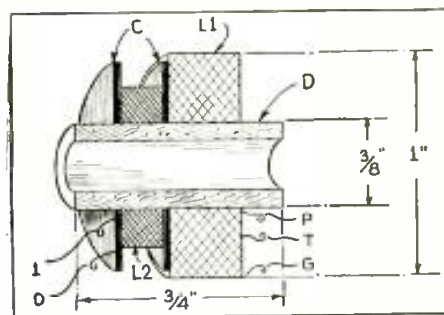

Fig. 3. Coils L1 and L2 are wound on the same coil form. Winding L1 is a honeycomb or "universal" winding with a tap as shown. Coil L2 is layer-wound between the washers, C, placed next to coil L1. The core may be either wood or impregnated paper. (This combination constitutes unit L in the schematic circuit, Fig. 1.)

EXPERIMENTAL HIGH-FIDELITY TELEVISION

High-fidelity 441-line television—indoor and outdoor transmission and reception — via Philco experimental station W2XE in Philadelphia has been given field tests.

R. D. WASHBURNE



Fig. A. Mr. A. F. Murray, left, demonstrating a Philco 26-tube, 10-control television receiver to Mr. Hayward, past-president of Franklin Institute, and Mrs. Hayward.



Fig. B. Charles Stec operating a Philco 441-line, television-transmitter "camera."

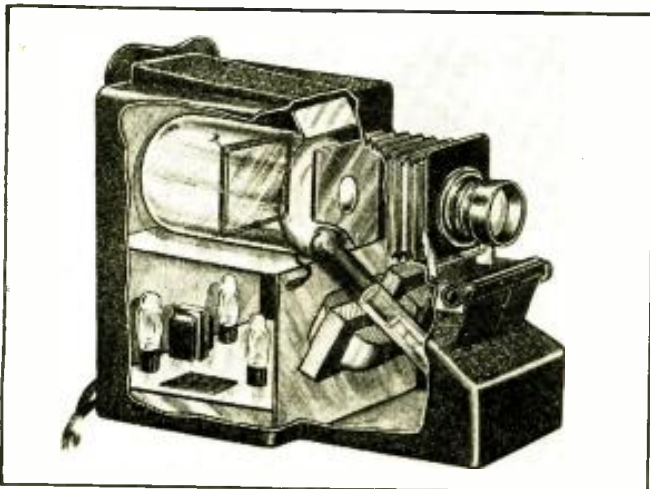

Fig. C. Phantom view, high-fidelity television "camera" shown pictorially in Fig. B.

REVIEWING various reports concerning experimental television transmission by Philco, so far this year, we find many technical, semi-technical and non-technical figures, facts and statements that have mixed interests. Many of these are included in the following paragraphs.

Franklin Institute, last January, saw and heard Nathan Hayward, retiring President of the Institute, open a meeting in the Institute auditorium in Philadelphia. At the conclusion of the meeting the crowded assembly hall "saw" and "heard" Nathan Hayward deliver a farewell address—by television, for, Mr. Hayward was at that moment in the Philco television transmitting studio, about 5 miles distant!

At that time, the following interesting information was recounted to the assemblage by A. F. Murray, a company television engineer.

While television has been making progress during the past 7 years, there are still many unsolved problems, for instance:

(1) A camera tube which will give better resolution, better sensitivity, and less extraneous signal; (2) wide-band amplifiers, in which the disturbances due to inherent tube noises are reduced or eliminated; (3) ultra-high frequency transmitters of large power, giving outputs equal to or greater than our largest sound broadcasting station, 500 kw., and capable of being modulated by frequencies up to 4 megacycles; (4) a system of single-sideband transmission which will permit increased picture detail while permitting a reduction in width of the communication band; (5) simpler radio receivers which will reproduce the very high modulating frequencies required and still have sufficient selectivity to separate television transmitters; (6) a picture tube which will give larger, brighter, clearer pictures.

While the majority of workers in the television research laboratories come from the ranks of radio engineers, it is interesting to note that *physicists*, too, are making valuable contributions to television in the electronic field; and no group is complete without researchers in the field of *chemistry* because one of the greatest problems is to obtain a more

(Continued on page 113)



Fig. D. This "camera tube" will televise even the second-hand of a watch!

THE FUTURE STATUS OF TELEVISION PROGRAMS

The President of International Television Radio Corp. has prepared for RADIO-CRAFT an analysis of modern television.

WILLIAM H. PRIESS

PUBLIC pressure and pressure from within television organizations seem to indicate that television on a small scale will be in the home by the end of this year. This art has opened certain questions which the Public itself must answer. Questions of cost and questions of a technical nature, such as the picture size, brilliancy and quality, and the type of system that will give the most satisfactory service.

Let us brush aside these factors and assume that television is of such low cost, and of such acceptable performance that it is generally in use in our homes. What can we expect from it? How will it change our habits? Since it is the television program alone that

can hold our interest, we might probe into program possibilities and develop an answer to these questions.

The plans of the television groups do not conceive of the elimination of the motion picture theatre, nor of the illustrated printed media, no more than the telephone interests contemplated the complete substitution of the telegraph and mails by the spoken word over wires. Television service is to be a new and additional channel for intelligence and entertainment. It is to be a powerful and compelling force for the broad dissemination of knowledge, culture, amusement and news. It promises a new attack on sales resistance to the pur-

(Continued on page 122)



2,000-BULB "TELEVISION" SIGN

Television moguls appear to have "missed a bet" (at least, until the advent of the Peck, full-fledged television "streamer" described in this issue of RADIO-CRAFT), by passing-up the possibilities of television in advertising "animateds" and "spectaculars." But New York's Great White Way has just had added to it the brilliance, magnified about 4 times by means of bull's-eye lenses, of 2,000 electric light bulbs in the new Leigh-Epok Control—an Austrian invention which one commentator described as "half television, half movie cartoon." The article, "Television in the Theatre," by Dr. Alfred N. Goldsmith, in December 1935 RADIO-CRAFT, contained an illustration of a German theatre-size television screen or "mosaic," consisting of 10,000 neon bulbs; and in 1927 Bell Telephone Laboratories demonstrated Dr. Ives' theatre-size 2,500-picture-element television neon grid.

(Continued on page 117)

RADIO AND TELEVISION IN RECENT PUBLIC ADDRESSES

DAVID SARNOFF

RADIO had its origin in the purely theoretical reasoning of James Clerk Maxwell, a professor at King's College, London, when in 1865 he advanced reasons for the existence of electromagnetic waves. Twenty-two years later, Professor Heinrich Hertz, at Bonn University, inspired by Maxwell's theoretical work, proved by experiment the actual existence of these waves and their ability to travel through space.

The social results of radio have been far-reaching, and the end is not yet in sight. Dr. William F. Ogburn, Professor of Sociology at the University of Chicago, not long ago compiled a list of 150 social effects directly traceable to radio. From Maxwell's theory of

(Ct. on pg. 120)

From an address before the American Physical Society, in Washington (D.C.), recently.



Left—the Television Traffic Man, watching the action in the studio, monitors the program on the Kinescope above the window. A breast microphone connects directly with . . . Right—the Iconoscope. Camera Man, who is here shown putting Miss Hildegarda "on the air" via NBC-RCA at Radio City.

Abstracts from two recent talks by RCA men include mention of television.

THOMAS F. JOYCE

INNUMERABLE engineers, technicians, producers and manufacturers have devoted many years of effort and millions of dollars to provide the best possible motion picture entertainment. It depends entirely upon each individual exhibitor and theatre owner whether he capitalizes these vast expenditures of time, effort and money to the fullest extent, or whether he gets the benefit of only a part of them.

Mr. David Sarnoff, President of the Radio Corporation of America, has frequently said that the future of any great industry rests with the research engineer; that no industry can afford to stand still—it must either go forward or slip back; and that unceasing research and de-

(Ct. on pg. 120)

From an address before the Motion Picture Theatre Owners Assoc., in Miami, Florida, recently.

NOTICE

Contributors to this department should submit only Operating Notes that discuss recurrent receiver faults; those which have occurred only once or twice cannot be considered characteristic of a particular set model. Accompany Operating Notes by sketches.

is made from the volume control to a terminal nearby, as shown in Fig. 1D.

STROMBERG-CARLSON SOLDER NUGGETS

Philco 116X, 116B. Motorboating, oscillation, fading and occasionally total inoperation are frequent complaints with these models, which are often caused by failure of the same component. A 4-section electrolytic tubular block is employed for bypassing various circuits. Due to loss in capacity or intermittent internal contact, which may be classed as an open-circuit, the symptoms mentioned above are encountered. A 1-mf. section bypasses the first A.F. screen-grid circuit, failure of which produces weak, unstable, motorboating reproduction. Oscillation and total inoperation or the condition wherein only one or two powerful local stations are received at incorrect points on the broadcast band, is the result of an open-circuited 2-mf. R.F., 1 F., or 1st-detector screen-grid bypass section, and a faulty 1-mf. oscillator plate bypass section.

Although a new bypass block may be installed when one or more sections are found defective, individual condensers may be utilized to effect a repair. Bridging the suspected section with a unit of the correct capacity is the simplest method of determining the faulty section.

Very weak, choked reproduction with normal shadowgraph action, indicating that the trouble lies with the A.F. amplifier, is due to an open-circuited 1-meg. carbon resistor in the first A.F. screen-grid circuit, which fact, of course, will be immediately manifested by lack of screen-grid voltage on that tube. It is only that the symptom is not unlike output-tube bias difficulty that it is mentioned at all, to save time.

A complaint occasionally encountered with these receivers is the condition wherein reception is obtained for only a minute or two after the set is turned on, after which operation ceases and the shadow indication widens out. When a finger is momentarily placed upon the control-grid of the 77 1st-detector, recovery is had for a few moments. This is due to an open-circuited gridleak for this stage, a 2-meg. unit mounted on a bracket in front of the 1st-detector.

Philco 16, 16B, 16X (Codes 125, 126), 500, 501. Distorted reproduction on this series of the 16 model has been traced to the grounding of the push-pull input transformer secondary return, either to the laminations or to the metal case, internally. This failure, of course, may be remedied by replacement of the unit, although a repair may be accomplished by properly insulating the push-pull input transformer assembly from the chassis with suitable fibre bushings and washers. The distortion due to the lack of grid-bias voltage on the output tubes in this case also will be accompanied by the symptom of glowing screen-grid elements of the type 42 tubes.

A slipping tuning-drive assembly may sometimes be traced to more than sufficient pressure of the dial against the 2 felt rests at the top of the dial. When slipping is prevalent at one point or section on the dial, check the drive cable for a worn or frayed condition at the large roller in the drive assembly with the dial set at this point. Seldom does moving the tension spring to the next notch to take up the slack in the drive cable correct the difficulty.

The complaint of intermittent reception, wherein the volume level cuts down abruptly to a whisper, with sudden recovery, has been traced to an open-circuited 0.05-mf. A.F. diode-coupling condenser connected between the junction of the 2 diode-load resistors and the bottom lug of the volume control. The shadowgraph will operate normally when the open-circuit occurs, the latter being due to poor internal contact of the pigtail leads of the tubular condenser.

Weak reception on these models with a wide indication on the shadowgraph and lack of plate voltage on the 2nd I.F. type 78 tube as disclosed with a set analyzer is usually caused by an open-circuited 500-ohm wire-wound pigtail type cathode-bias resistor. This unit is mounted across the cathode bypass condenser for this stage.

Philco 17. As with the model 16, codes 121 and 122, choked, distorted reproduction may often be attributed to the 1 meg. carbon resistor in the plate and screen-grid circuits of the silencing and 1st A.F. tubes, which has increased in value, thus lowering the screen-grid voltage upon the 1st A.F. tube almost to the cut-off point.

The complaint of distortion and hum, with the attendant symptom of glowing control-grids of the output, type 42 tubes is usually caused by either the grounding of the secondary return of the push-pull input transformer secondary to the metal case or laminations, internally, or to leakage between the electrolytic filter condenser cans to chassis. The latter is the result of seepage and the formation of oxides at the bases of the condensers. This leakage also effectively removes the normal grid-bias voltage from the output tubes. Should clearing the oxide formation or renewal of the paper which insulates the condensers from the chassis fail to remedy matters, replacement is the only solution. By insulating the push-pull input transformer from the chassis, the grounded secondary-return will be cleared.

Philco 118X, 507. In the event the shadowgraph does not function and the only indication is that of a narrow line, the probability of an open shadowgraph coil is evident. The receiver will operate normally despite the open-circuit of the shadowgraph, because of the carbon bleeder resistor which is shunted across the shadowgraph to obtain a finer indication.

The symptom of high-pitched reproduction even with the tone control in the bass position although the tone control does produce frequency response variation has been traced to an open-circuited 10,000-ohm carbon resistor which is connected in series with a 0.01-mf. bypass condenser across the plates of the type 42 output tubes. Distorted reproduction and hum, on the other hand, as with the model 16, and 17, is due to the similar ground of the push-pull input transformer secondary return to the laminations or transformer case, internally.

When the tuning drive is found to slip, a worn cable or insufficient tension of the spring employed to take up slack in the cable is not always

(Continued on page 127)

SERVICING QUESTIONS & ANSWERS

Service Men may write, requesting answers to specific service questions. Address inquiries to Service Editor. For questions answered by mail, a service fee of 25c per question is made. AN EFFORT IS BEING MADE TO MAINTAIN 48-HOUR SERVICE IN HANDLING THIS MAIL.

TUNING EYE OPERATING BUT NO SIGNAL

(15) Eddie Walsh, Brooklyn, N. Y.

(Q.) I have recently purchased a Grunow model 1191, and have had considerable fading trouble although the tuning eye always functioned. My set stopped operating a few days ago, but the tuning eye tube seems to function. The tubes were tested and found OK. Please advise what to do to correct this trouble.

(A.) Your inquiry indicates that your trouble lies in the audio end of the receiver.

The cause for fading can usually be traced to the 205-ohm, 6F6 bias resistor intermittently opening and is the cause for fading. It is also the reason for your set being inoperative.

To correct, replace this resistor with a 10-W. unit. See Fig. Q.15.

NO POWER

(16) John Costello, New York City

(Q.) I have owned a Zenith model 6S-152 receiver. I live in a D.C. neighborhood, therefore I had to have it converted to an A.C.-D.C. receiver. The set operated very well for 6 months, but now it seems to have lost a great deal of power. My tubes were tested and found perfect. I examined my aerial and it is OK.

What do you think is the cause for the loss of power?

(A.) In answer to your inquiry regarding the reason for loss of power, it can be traced to I.F. transformers changing in frequency and usually attributed to the heat of the chassis causing the capacity of the I.F. transformer trimmers to change. The frequency of the I.F. transformers is 456 kc. and requires re-aligning. Unless you possess a very good signal generator, it is advisable to have a competent Service Man do the job for you.

FADING IN A.K. 38

(17) Oscar Hennemslacer, Richmond, Va.

(Q.) I own an Atwater Kent model 32A receiver and have considerable trouble with fading. I notice that when I touch the frequency switch while the set is operating the station signal drops in volume. I believe the trouble lies in the switch, and would like to know how to remedy this condition.

(A.) You are undoubtedly right about the frequency switch being the cause of fading. To correct this fault means only to remove the chassis and clean all the contacts with carborundum (using a long pencil brush).

(Continued on page 113)

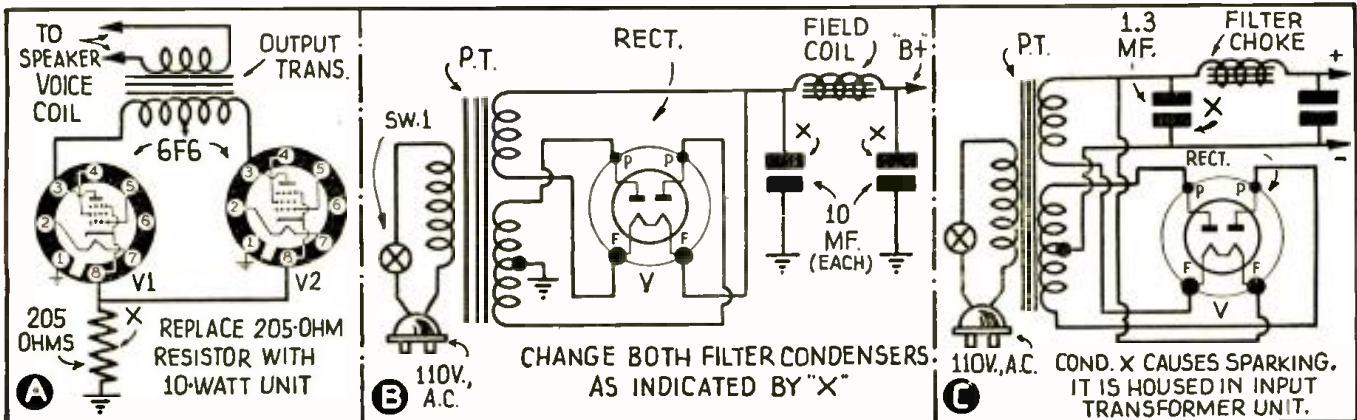

Fig. Q15. Grunow 1191 repair. Fig. Q19. Emerson model 102 condenser break-down. Fig. Q20. Stromberg-Carlson model 64 defect causing "sparking."



Compare the "cannon" in this view, with Fig. A in April *Radio-Craft*.

HOW TO ADD A 2-IN. C.-R. TUBE TO THE RADIO-CRAFT MIDGET OSCILLOSCOPE

More accurate, convenient, complete wave-forms may be set up on the new 2-in. cathode-ray tube.

SINCE the *Radio-Craft* midget oscilloscope was described ("Make the *Radio-Craft* Midget Oscilloscope," April and May 1937 issues.), there has come on the market a new cathode-ray tube, the Dumont 24XH, which has a screen double the diameter of the original tube used, the 913. Many technicians will wish to use this new tube in their oscilloscope, but because of its size it cannot be plugged into the case of the original instrument.

It was decided that the best way to accommodate the 24XH would be to build a new top-of-case "cannon," similar to that described originally but of larger size. It should be emphasized here that this new equipment is not intended to entirely supersede the 1-in. or type 913 tube. The latter still retains the great advantage of small size, and its use means

that the technician will have available a tiny portable instrument devoid of any clumsy projections, for the cannon type of mounting is just that. With the 913 inside, the apparatus is ideal for portable work. In the laboratory where convenience is of no great consequence, however, the use of the 2-in tube in a flexible mount is a distinct advantage.

The new 24XH tube is rated at from 400 to 600 V. so that with the voltage supplied by the original instrument we can obtain satisfactory patterns. In fact, *there are no circuit changes needed whatsoever since the ratings of the 24XH at 400 V. are very close to those of the 913.* Thus the ranges of all controls are adequate and no circuit changes need be made.

(Continued on page 115)

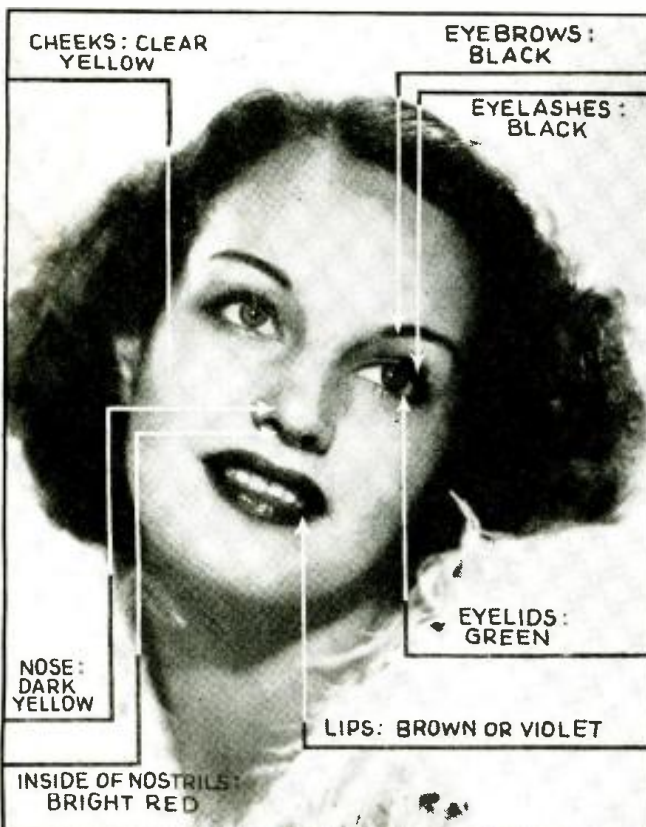

Beautiful Rochelle Hudson, 20th Century-Fox star, typifies the facial requisites—natural and otherwise—for properly affecting the television camera.

THE ART OF TELEVISION MAKE-UP

If you are "photogenic"—"take a good picture"—you stand a better chance of meeting the video requirements of television.

G. BARZ

IF THE movies require that the male and female artists—even though "photogenic" ("a natural" as to camera suitability)—must submit to strange and often times, grotesque make-up, before they are completely ready to be photographed, no less severe are the requirements for television.

The gracious little ladies that form the delight to the eyes and to the spirit, and even the masculine men who entrance the fair sex, on the television, resemble, if seen at the transmitting studio, savages painted for weird rites.

The view of Rochelle Hudson, reproduced here, offers an idea of how a person must make-up in order to be televised properly.

Eyelids are painted green, the cheeks a clear yellow, the lips should be painted brown or violet (red lips would televise as grayish). The nose should be dark yellow while the inside of the nostrils should be bright red. Eyebrows and

(Continued on page 112)

INTERNATIONAL RADIO REVIEW

RADIO-CRAFT receives hundreds of magazines from all parts of the world. Since the cost of subscribing to each of these would be prohibitive for most radio men, we have arranged with technical translators to prepare reviews for our readers.



Fig. A. The Voigt corner horn speaker installed in home surroundings.

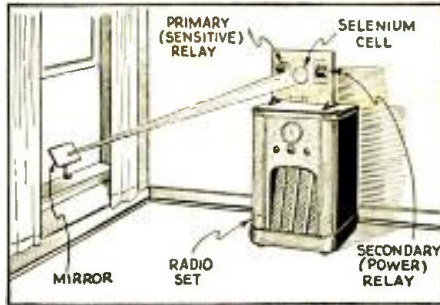

Fig. C. A selenium cell and two relays turn on the radio set in the morning.

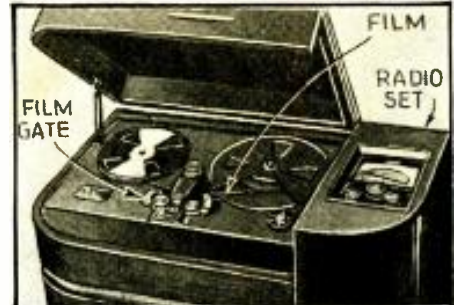

Fig. D. The appearance of the Duo-Trac sound-film reproducer which plays 40 minutes.

AN ENGLISH CORNER HORN

RADIO enthusiasts who wish to try the latest in their attempts to get the "best" quality might try constructing the latest type of "corner" horn which has just become available in England, according to a recent issue of *Wireless World* (London). See Fig. A.

According to the tests made by the staff of the above magazine, the speaker, which stands 5 ft. 1 in. in height and projects about 18½ ins. from the corner of the room, has a low-frequency cutoff at about 60 cycles. The high-frequency response (using the specified speaker unit) is more uniform than a flat baffle of equivalent proportions. The speaker unit fits into a concrete base which provides the necessary weight to keep the speaker upright.

OCTAL-BASE TUBES IN ENGLAND

MUCH to the confusion of English Service Men who will now have to add a new line of octal adapters to their already overloaded tube testers and set analyzers, Marconiphone and General Electric Co. have just released a line of "International" tubes having

Octal bases and characteristics similar to American metal-glass tubes, but using the English numbering system instead of RMA (American) standard. See Fig. B. A list of these new tubes was published in the latest issue of *Wireless Retailer and Broadcaster* (London).

AN AUSTRALIAN DIRECT-COUPLED AMPLIFIER

THE LOFTIN-WHITE amplifier has a habit of popping up seasonally and starting minor furors in the radio field. The Australian radio magazine *Wireless Weekly* (Sydney) is responsible for the latest of these, in the form of an extremely simple direct-coupled amplifier using modern tubes. The application of modern triodes, instead of tetrodes or pentodes, eliminates the need for a complicated voltage divider and many other parts formerly considered essentials of this circuit.

The circuit in Fig. 1, shows just how simple this amplifier can be when built around a high- μ triode (2A6) and power output triode (2A3). (Continued on page 124)

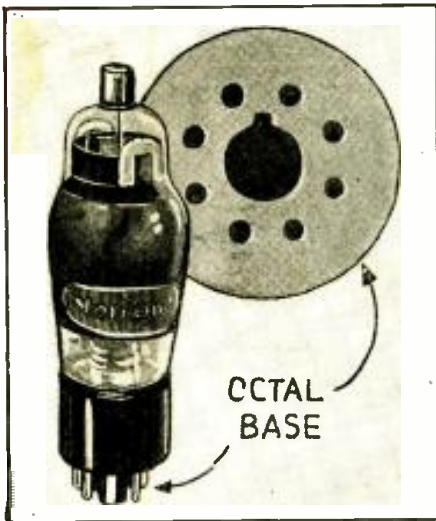

Fig. B. The appearance of the new line of English octal-glass tubes.

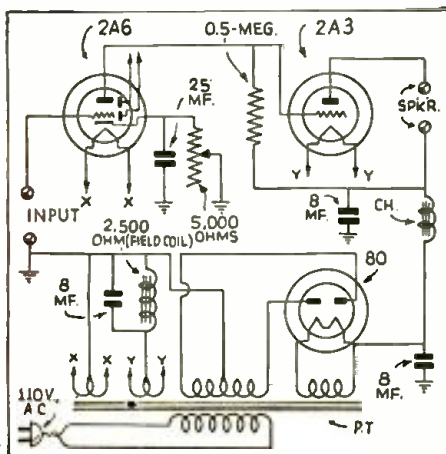

Fig. 1. The basic circuit of the D.C. amplifier.

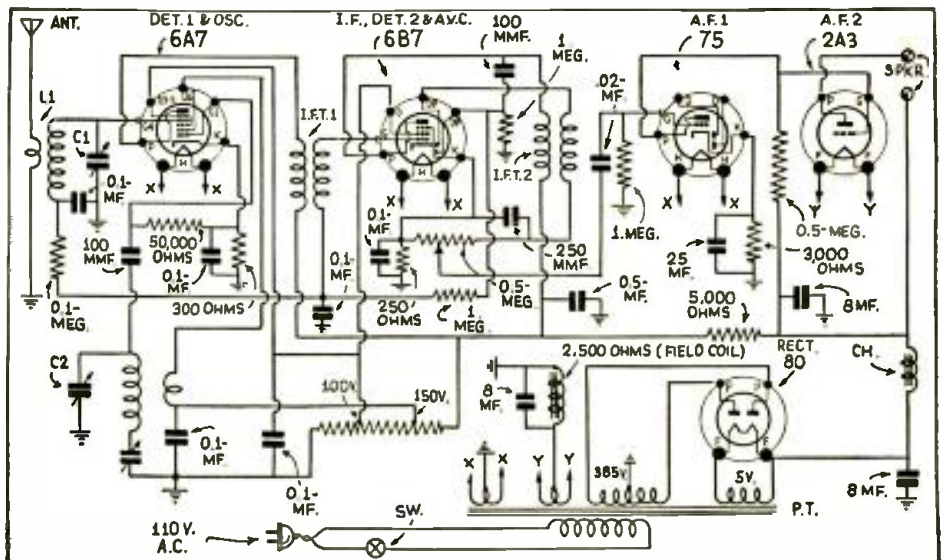

Fig. 2. This superhet. set uses the direct-coupled amplifier—it will have high gain!

THE LATEST RADIO EQUIPMENT

This department brings to you each month the newest developments in electronic, radio and public-address equipment. Aggressive technicians use this department to keep posted on the newer and better ways of doing things.



A "megger" cross-coil moving system is used in this meter (range—to 0.2-meg.). (1421)

PRECISION OHMMETER (1421)

UNLIKE previous test equipment available to the technician this new, precision midget ohmmeter is of the "megger" type; the megger cross-coil moving system eliminates the need for a battery-adjusting control—thus, states the manufacturer, it is a *true* ohmmeter. Range: 1/10-ohm to 2/10-meg. Permits reliable readings down to 1/10-ohm. Case is green molded bakelite.

PHONO-RADIO COMBINATION (1422) (Allied Radio Corp.)

A DUAL-WAVE 7-tube A.C.-D.C. radio receiver with 25L6 beam power output is utilized in the table model phono-radio combination illustrated (an 8-tube console model is also available); utilizes metal tubes and an all-wave circuit covering 17 to 500 meters. The phonograph equipment is said to be of the "newest high-fidelity" type.



Dual-wave phono radio. (1422)

A TUBE CHECKER WITH "ROTARY TUBE-INDEX" (1423)

(Weston Electrical Instrument Corp.)

A FEATURE in the counter-type model of this new tube checker is a rotary-type reference index, covering all tubes in current use, so arranged in the base that tube test data is instantly brought into view beneath a glass-covered opening. This index also utilizes a "key number" classification system. Listings may be replaced as necessary. A noise test jack is provided for checking tube noise in any electrode circuit by means of headphones. The unit includes hot-cathode leakage test and neon hot check of intermittent shorts. Direct-reading line voltage test at any time. Utilizes total emission test on a "specific load basis" for all types of tubes.

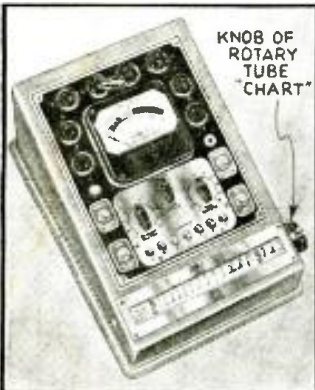

Modern tube checker includes built-in tube listing. (1423)

110-V. A.C. AND 6-V. D.C. 25-W. MOBILE P.A. SYSTEM (1424)

(Operadio Mfg. Company)

THIS combination mobile public-address system has been designed to give the sound man a unit extremely rugged, compact and "ready to go" in almost every instance where a temporary installation is

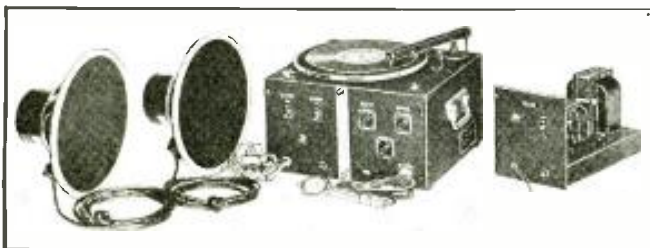

Portable 25-W., 110-V. A.C. and 6-V. D.C., P.A. system. (1424)

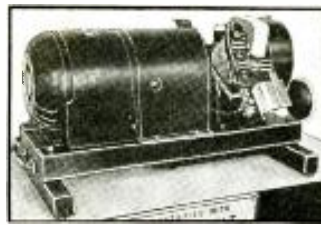

A.C.-D.C. power plant. (1425)

required. It may be used for 110-V. A.C. or 6-V. D.C. by a simple interchange of self-contained packs.

Uses beam power tubes. Electronically mixes one microphone and one phonograph. Includes latest "dual-diaphragm" crystal microphone of the hand type but also can be used with velocity, velotron, or high-impedance dynamic microphones. Includes two 12-in. permanent-magnet speakers especially designed for public-address work. Interchangeable power packs for 6-V. D.C. and 110-V. A.C. High-grade phono motor. "Economizer" control for battery supply. Fused. Heaviest-duty-type generator. Can be used in conjunction with radio set by using model A-3960 radio matching unit.

300-W. POWER PLANT DELIVERS A.C. AND D.C. (1425)

HERE is an electric power plant that provides both A.C. and D.C. in one unit. Delivers 300-W. at 110-V., 60 cycles and about 200-W. at 6-V. D.C. Recommended for sound trucks. The 5-horsepower engine is direct-connected to the generator. Fuel tank capacity, 1 gal. (12 hrs. operation under full load). Weight, 125 lbs.; size, 17 x 14 x 24 ins. long.

NEW 20,000 OHMS/VOLT SET TESTER (1426)

READINGS down to 1 microampere and up to 50 milliamps, may be made with this 20,000 ohms/volt set tester. Full-scale readings: 2 1/2/10/50/250/1,000 V. D.C. at 20,000 ohms/volt; same range on A.C. but at 1,000 ohms/volt. A 25-A. range is included for checking the current drain of auto-radio sets. Resistance range 1/2-ohm to 40 meg. The high sensitivity of this instrument permits making tests (as previously discussed in *Radio-Craft*) over a wide range of unusual conditions.

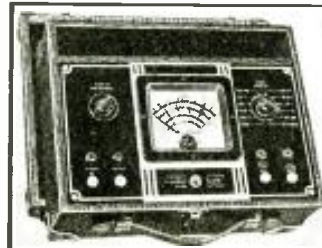

A 20,000-ohms/volt tester. (1426)

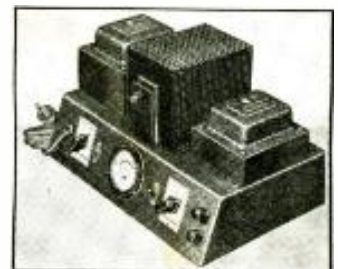

Car-radio "A" unit. (1427)

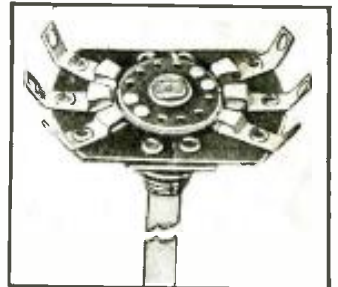

Improved switch. (1428)



Improved crystal pickup. (1429)

AUTO-RADIO CURRENT TEST-PACK (1427)

(Standard Transformer Corp.)

FOR TESTING and demonstrating auto-radio sets and accessories there is now available a source of accurately-controlled direct-current that eliminates the trouble of depleted batteries. Available in 3 models: Junior—power output 5 A. at 5 to 7 1/2 V. (drain of average-current radio set); Standard—up to 12 1/2 A. output; Deluxe—up to 15 A. output, and equipped with hi-lo switch and continuously-variable voltage control.

Each model is protected with a circuit breaker and equipped with an accurately-calibrated meter. A surge suppressor prevents damage through voltage feedback to the rectifier and protects the condenser from line surges. Electrostatically shielded to prevent line noise entering the output circuit.

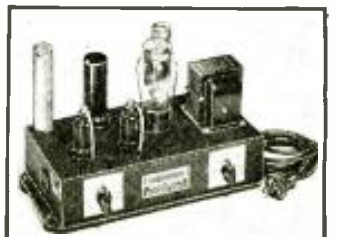

An 8-W. amplifier. (1430)

Name and address of any manufacturer will be sent on receipt of self-addressed, stamped envelope. Kindly give (number) in above description of device.

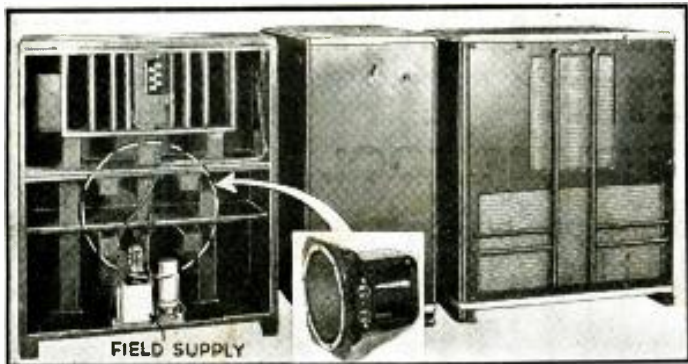

High-fidelity monitor loudspeaker with acoustical labyrinth. (1431)

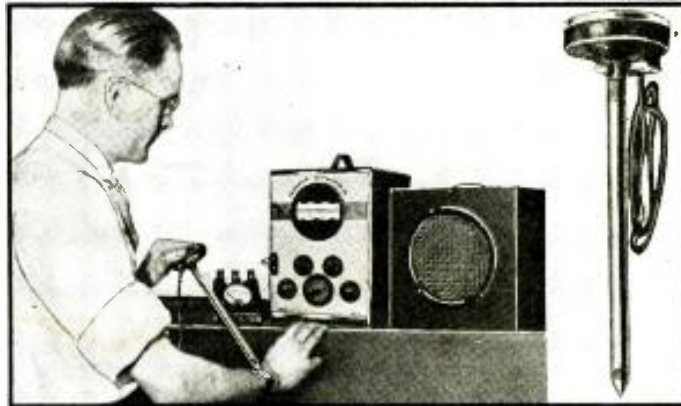

Vibration test unit in use; right, crystal test prod. (1439)



Dry-battery tester. (1432)

OFFSET-HEAD CRYSTAL PICKUP (1429)

(Astatic Microphone Laboratory, Inc.)

THIS phonograph pickup utilizes the principles of the offset head which maintains the projected vibration axis of the pickup tangent to the recorded groove throughout the entire playing surface to a degree not otherwise obtainable. This results in marked reduction of tracking error (and the consequent tendency to jump grooves). Needle loading from above. Crystal cartridge equipped with plug-in connector, and sealed against moisture; according to the manufacturer the frequency response curve of this pickup is "easily suited to present-day recording practice"; arm resonance is said to have been completely eliminated. Finish—modernistic black and chrome; arm length (needle point to center of base)—12 ins. This type B16 unit supersedes the type B10 shown in May *Radio-Craft*, as item No. 1333, page 671.

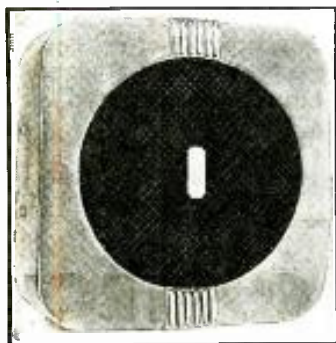

Speaker housing. (1433)

A NEW "REPLACEMENT" TONE SWITCH (1428)

(Centralab)

A TONE switch has been designed which meets the demand for a replacement unit. Available in 3 types: single-pole 2-position, single-pole 3-position (illustrated), and 2-pole 2-position. Common terminal insulated, and shaft and bushing in all types. Uses: as phono switch, sensitivity control, simple selector switch, public-address channel selector, meter-reversing switch, wave-band changing, intercommunicator talk-back, or in the new mid-gate oscilloscope circuits. Maximum current rating: 1 A. at 6 V.

HIGH- OR LOW-IMPEDANCE INPUT 8-W. AMPLIFIER (1430)

(Radolek Company)

HERE is an excellent amplifier suitable for all requirements of medium power, high quality, and economy of price. Clever engineering and design permit the use of crystal, velocity, dynamic, or single- and double-button carbon microphone. Phono input for a high-impedance pickup. Latest-type metal tubes: "beam power" 6L6 output. Frequency response is essentially flat from 50 to 9,000 cycles. Field current for one 1,000-ohm speaker. Has fader and tone control.

HI-FI MONITOR SPEAKER HAS LABYRINTH (1431)

(RCA Manufacturing Co., Inc.)

A CONSOLE cabinet loudspeaker with a frequency-response range of 60 to 10,000 cycles, ± 6 db.,

has been introduced. Recommended for use in classes for music appreciation, music rooms, hotel lobbies and wherever utmost fidelity is a factor of prime importance. The single 8-in. dynamic reproducer has a power-handling capacity of 10 W. Voice-coil impedance is 15 ohms. Cabinet, acoustically treated and coordinated with the speaker unit, is modernistically finished in black with aluminum trimming. Listing for under \$135, this reproducer unit is a fitting complement for many of the superlative power amplifiers now available.

DRY-BATTERY TESTER (1432)

(Triumph Manufacturing Co.)

A COUNTER-TYPE dry-battery tester which checks voltage under loads comparable to normal operating conditions is illustrated. Ranges are provided for 3-V. and 4½-V. "A" batteries and tests are made at ½-A. load; "C" and "B" batteries are tested at 20 ma. loads.

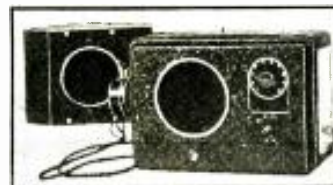

Improved inter-office system. (1435)



Test unit; wide-range scales—to 20 meg., 1,000 V. D.C., 800 V. A.C. 16 mf. and 500 ma. (1436)

SUEDE HOUSINGS FOR REPRODUCERS (1433)

(Wright-DeCoster, Inc.)

FOR VEHICULAR use the color scheme of this loudspeaker cabinet is taupe with black grille and chromium ornaments. The wall-cabinet design has a light-brown grille.

The "vehicle" cabinet is equipped with base-mounting holes and a speaker mounting strip and stud. The "wall" cabinet, recommended for hotels, schools, apartment houses, etc., instead is equipped with a back-mounting plate. Available for either 8- or 10-in. speakers.



All-purpose sound system. (1437)

INFINITE Baffles



A 20-W. portable P.A. system with infinite-baffle reproducers. (1434)

20-W. P.A. SYSTEM UTILIZES INFINITE Baffles (1434)

THE PORTABLE sound system here illustrated utilizes 2 heavy-duty "high-velocity" speakers of the infinite-baffle type which it is stated will reduce feedback by as much as 30 to 40 per cent. Octal sockets permit optional use of glass or metal tubes. Includes facilities for matching up to 6 speakers, gain is sufficient for low-level pickups of all types. Cases are finished in black Keratol. Overall gain 112 db. Frequency response 35 to 10,000 cycles, ± 2 db. Utilizes 2-6F5Gs, 2-6N7Gs, 2-6N6Gs, 1-5V4G. Operates on 110 V. A.C. Has 2 volume controls, tone control and selector switch.

(Continued on page 108)

DEFLECTORS

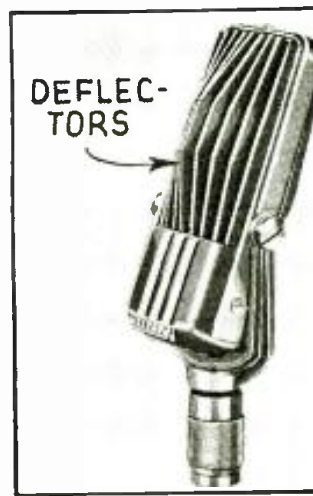

New-principle velocity mike. (1438)



Fig. A. External appearance of the test unit.

THE POTENTIOMETER VOLTMETER —A NEW SERVICE TOOL

The potentiometer-type, no-current voltmeter, available in a commercial set tester, tests high-ohm circuits.

G. V. MORRIS & BRADLEY THOMPSON

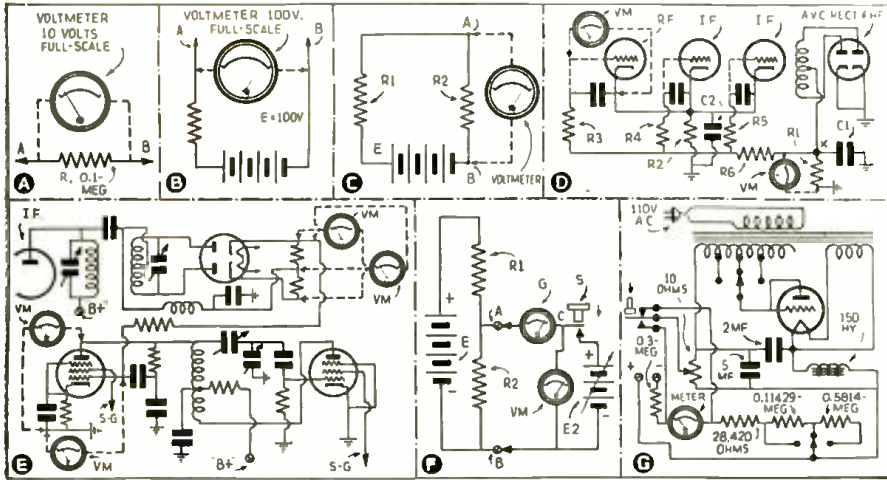

Fig. 1. Circuit details explaining the various factors discussed. Detail G is the complete voltmeter.

WITH THE ever-increasing complexity of circuits in radio receivers due to the advent of new tubes and new features, and with the ever-increasing necessity of greater precision in voltage measurement in order to insure the development of maximum efficiency in radio service work, the older types of analyzers and similar devices fall far short of the ideal in electrical measuring equipment.

As every Service Man knows, modern receivers with their high-fidelity audio circuits, effective automatic volume controls, automatic frequency control and silencing circuits, make use of numerous networks of high resistances in which, at times, currents of only a few microamperes flow. If an attempt is

(Continued on page 114)

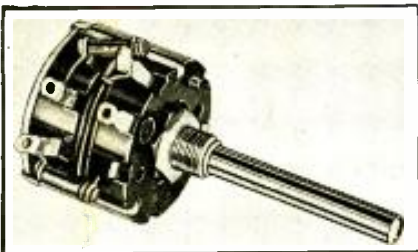

Fig. A. Appearance of the "Delta-T" pad.

THE DELTA-T PAD— INEXPENSIVE P.A. CONTROL

The new, constant-impedance Delta-T pad in mixer and gain controls, is compared with more well-known types.

WM. H. FRITZ

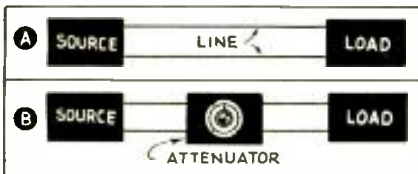

Fig. 1. Matching load to source with attenuator.

TO OBTAIN maximum power transfer from a generating source to its load, the impedance of the load should equal the impedance of the source—at all times. This is a well-known maxim among men working with public-address installations, and one that must be followed, if best results are expected.

Consider the general diagram of source and load, Fig. 1A. In this simple case, if the load impedance is selected to match the source impedance, the relation is fixed. Now insert an attenuator in the line. See Fig. 1B. This complicates matters, for unless a specially-designed attenuator is installed, the load impedance (which is now a combination of the attenuator and load impedance) will vary with attenuator knob position. The solution to the problem is obvious. Use an attenuator that is so designed that the combination of attenuator and load impedance remains constant regardless of attenuator dial setting, and equals the source impedance.

There are 3 fundamental resistance networks that can be used to attenuate a signal and still maintain load resistance at a constant value. They are (1) the "T" Pad, (2) the "π" (Delta) Pad, and (3) the "Bridged-T" Pad. These are

(Continued on page 106)

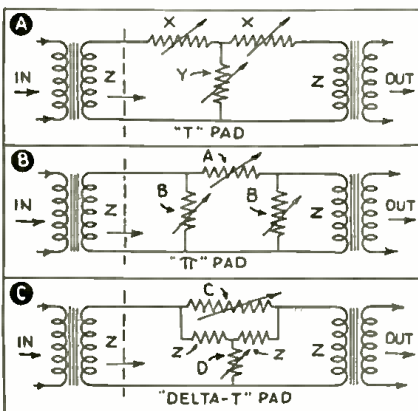

Fig. 2. Three constant-impedance pads.

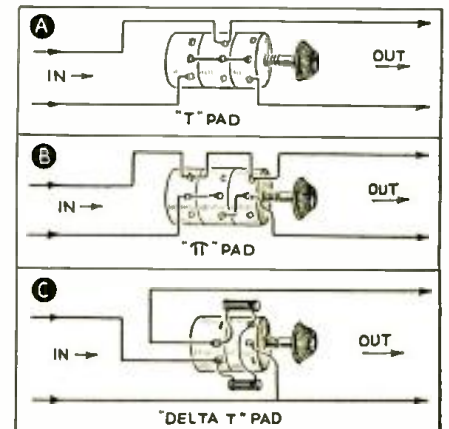

Fig. 3. Connections of the three types.

AN EXCELLENT COIL-TESTING UNIT FOR THE SERVICE MAN

Accurate alignment of home-made coils is possible if this coil-test unit is used.

WALTER L. LYONS

PART II

PART I of this article described in detail the principle upon which this coil tester is based. Certain details of construction, with photographs and a schematic circuit were also given, to permit an advanced technician to go ahead with the construction of the unit. It should be stressed that a unit such as this one is not intended to be used by the radio beginner. A working knowledge of the principles of coil design as well as a general knowledge of engineering principles are necessary to intelligently use such an instrument. The advanced Service Man and experimenter, as well as the laboratory and production engineer will find the unit of exceptional usefulness.

After the unit has been made up according to the details in Part I, the unit must be calibrated. The details of this important operation follow.

CALIBRATION OF THE A SCALE

It is apparent from Fig. 3, that the dials of C2 and C3 each bear two sets of scales designated, respectively, as A and B. Both calibrations are in mmf. Each scale has its own indicator—a sector of celluloid bearing a fine “hair

line” drawn with India ink. The calibration of all scales can be most conveniently accomplished by the use of a standard condenser, Cs, with a maximum capacity of at least .0015-mf. and capable of being read in multiples of 5 mmf. to 200 mmf.

The calibration of the C2-A scale will be more accurate if link “L” is opened (thus disconnecting C3). Switches Sw.1, Sw.2 and Sw.3 are set as in Fig. 2 (Part 1); Cs, set at minimum capacity, is connected by short leads to the banana jack terminals J1 and J2, the rotor of course, on the grounded terminal. Condenser C2 is set *accurately* at maximum capacity and the dial point under the C2-A indicator is then designated “zero.” The oscillator should be sharply resonated to the frequency determined by the cir-

cuit L2-Cs (min.)-C2 (max.), and C4 decreased to the lowest capacity that will give full-scale milliammeter deflection over the entire oscillator range. This should be determined before the calibration is started. The sharpness of indication is decreased by too-high a capacity of C4 which is normally 3 to 4 mmf.

If now, with the oscillator resonated, Cs is increased 5 mmf., the resonant condition of L2-C2-Cs may be restored by decreasing C2 from its “zero” (maximum capacity) position by the amount Cs increased—5 mmf. This gives the second calibration point on C2-A dial. Cs is again increased 5 mmf. and C2 decreased until resonance again obtains. The A hairline now indicates the 10 mmf. mark on the C2 dial. This process is continued until the entire C2-A scale is calibrated.

The C3-A scale is calibrated in like fashion. After the link L is closed, C3 is carefully set at maximum capacity to locate the “zero” point on C3-A scale. Condenser C2 is kept at minimum capacity during this calibration. The oscillator is resonated to the circuit L2-Cs (min.)-C3 (max.) and the above calibration process repeated except that Cs is increased and C3 decreased exactly 100 mmf. at a time until the C3-A scale is entirely calibrated. It should be realized that the two above calibrations of C2 and C3 represent not true capacity values but *decreases* in capacity from maximum settings.

(Continued on page 123)

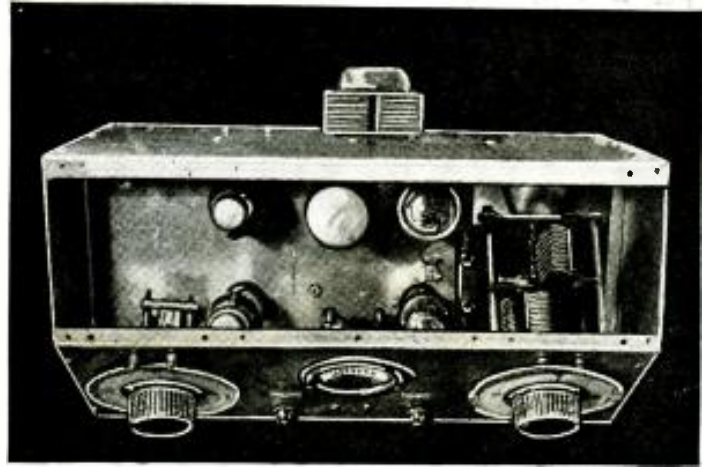

Fig. C. The top view of the instrument with cover removed.

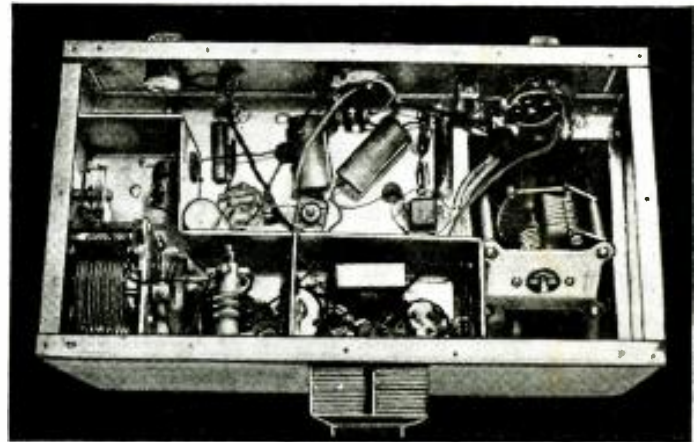

Fig. D. The under-chassis appearance. Note transformer position.

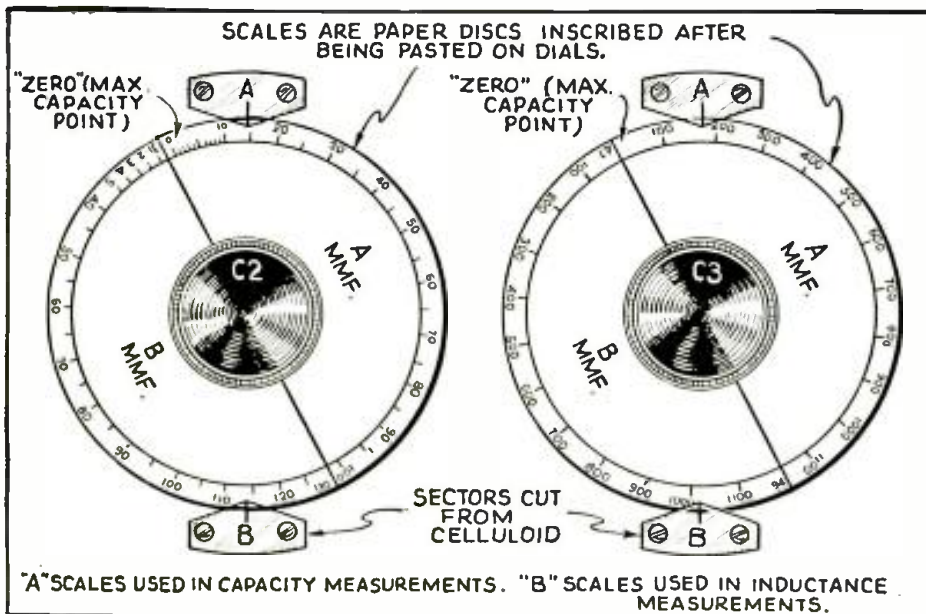
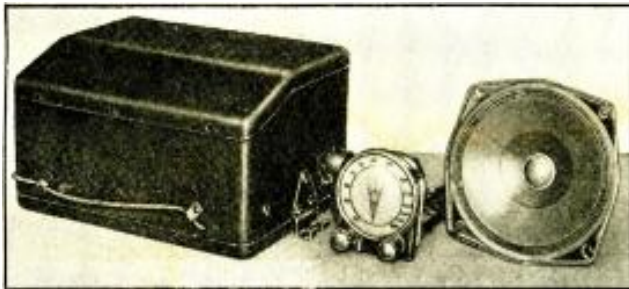

Fig. 3. Dial calibrations—A scales for capacities and B scales for inductances.

FORD-PHILCO CAR-RADIO MODELS F-1440 AND F-1442

6-tube, 6-V. battery and vibrator power, overhead full dynamic speaker, A.V.C., special antennas (including "Rotary 'Reserve Power' Aerial")



The receiver, its control unit, and the dynamic speaker. Observe the familiar V8.

These two models differ in the antenna and R.F. connections (compare Fig. 1, showing the F-1440, with Fig. 2, showing the first stage of the F-1442), and there are minor differences in the bypassing (See notes indicated on Fig. 1). In the F-1440 the antenna is connected to a transformer on the roof (the Ford Rotary "Reserve Power" Aerial), and led in to a receptacle on the receiver housing. In the F-1442, the antenna choke is on the receptacle.

The roof antenna transformer is adjusted at the factory, and warning is given against attempting to readjust it.

The I.F. amplifier is peaked at 260 kc. The signal generator is applied to the grid cap of V3 through a 0.1-mf. condenser. The secondary C28 of I.F.T.2 is then adjusted for maximum reading (see Fig. 3 for positions of trimmers) on the output meter; then C26. The connection is then changed over to the grid cap of V2. C24 (secondary of I.F.T.1) is then adjusted for maximum reading; then C22. With the generator still connected, adjustments are again made on C28, then C26.

The R.F. amplifier is then given a 1,550-kc. signal, through a 0.1-mf. condenser, to the grid of V1. Using a piece of paper approximately 0.006-in. thick (bond paper), turn the rotor plates till the paper is held between the heel of the rotor plates and the stator plates. Leaving the tuning condenser in this position, adjust high-frequency padder C16 and R.F. padder C12 (see Fig. 3) until maximum reading is obtained. This is the correct setting for 155 on the dial. Then mesh the condenser plate to approximately 600 kc. (60 on the dial) and apply a 600-kc. signal. Roll the condenser, and adjust

the low-frequency padder C20, behind the gang, to maximum reading. Turn the plates out again to 1,550 kc.; apply the 1,550-kc. signal, and readjust C16.

When adjusting the antenna stage on Model F-1440, it is important to construct and use a proper dummy antenna, and that the antenna transformer and lead be connected to the receiver. Connect a 15-nmf. condenser in series between the signal generator and the socket on the antenna transformer assembly, which is connected to the receiver. Turn the tuning condenser to 1,400 kc. and apply a 1,400-kc. signal. Then adjust C12 and C6 for the maximum reading on the output meter. If the antenna stage is adjusted, with the receiver in a car, the receiver is connected in the usual manner, and the signal generator output applied to a wire near the car antenna, but not directly connected.

With the F-1442, the generator lead is connected to an antenna lead, and this to the socket on the receiver housing.

Color codes of the I.F. transformers are illustrated in Fig. 1. The primary and secondary padders are accessible through the tops of the cans. These parts are 32-2246 for the first I.F.T., and 32-2167 for the second I.F.T.; coils and padders are not furnished separately.

Two types of vibrators are made; the choice is optional. The vibrator plugs in, as shown, behind the output tube V5. Because operating voltages, with such a supply, vary, a table of them is not furnished by the manufacturer.

The open car aerial shown in Fig. 4 rotates in a sleeve inserted in a 3/4-in. hole cut through the car's "header"; when it is turned down, there is a minimum pick-up for local broadcasts. When it is turned up perpendicularly, reception may be had at a considerable distance from the station; and, when necessary, the sliding end section of the aerial may be pulled out to its full length to increase the pick-up.

The speaker is mounted above the

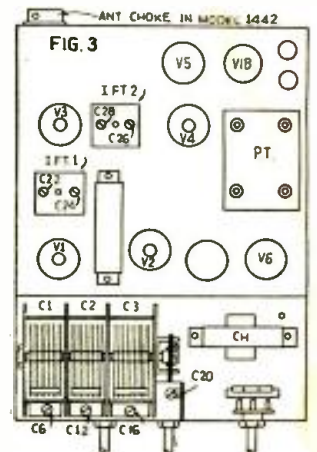

Locations of tubes and padding screws. In the F-1440.

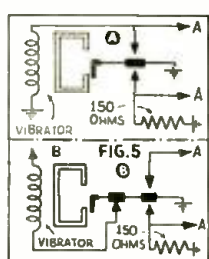
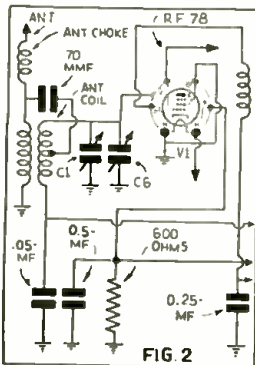
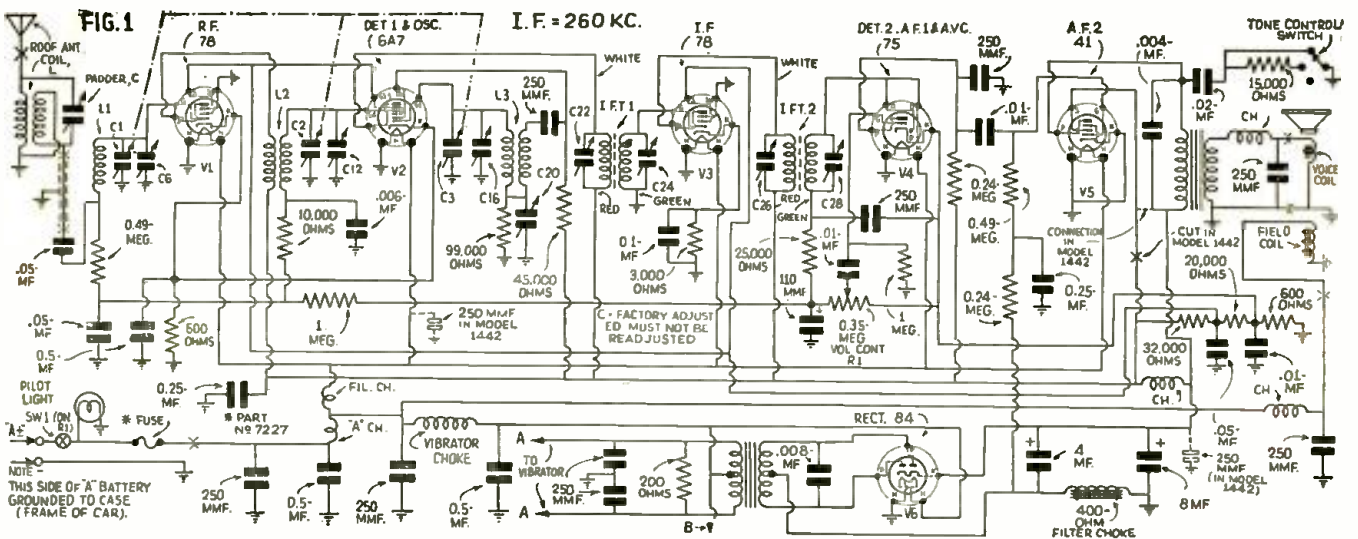

Above. Two vibrators. Left. Antenna and R.F. stage of F-1442. Extreme right. Ford aerial, Part No. 78-18813B.

rear-vision mirror. In 1937 cars, designed to receive it, there is a fish-cord tied to a roof brace; it can be seen behind the header bar, and running down the right pillar. With a tow strap, in the accessory braid, the speaker cord is pulled up from below to the position of the speaker. The "A" power is taken from the right glove compartment of the car, through a hole provided for the purpose; the operating switch here enables it to be turned off and locked. To overcome interference, 4 types of condensers are used: on the ignition switch, the generator, the oil gauge and the gas gauge.

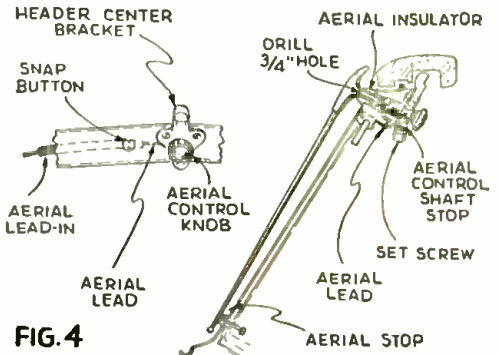

FIG. 4

SPECIAL NOTICE

Those questions which are found to represent the greatest general interest will be published here, to the extent that space permits. (At least 5 weeks must elapse between the receipt of a question and the appearance of its answer here.) Mark such inquiries, "For Publication."

Replies, magazines, etc., cannot be sent C.O.D. Back issues of *RADIO-CRAFT* ordinarily are 25c per copy but those which are more than 1 year old are available only at 50c per copy; (except the following issues: 7/29, 1, 2, 3, 4, 6, 7, 9 and 11/30; 5, 6, 8 and 9/31; 6, 7, 9 and 11/30; 5, 6, 8, 1/35 which are out of print).

Inquiries to be answered by mail MUST be accompanied by 25c (stamps) for each separate question; answers are subject to subsequent publication if considered of exceptional interest.

Furnish sufficient information (in reference to magazine articles, be sure to mention issue, page, title, author and figure numbers), and draw a careful diagram (on separate paper) when needed to explain your meaning; use only one side of the paper. List each question. Be SURE to sign your name AND address.

Enclose only a STAMPED and self-addressed envelope for names and addresses of manufacturers; or, in connection with correspondence concerning corrections to articles, as this information is gratis.

Individual designs can be furnished at an additional service charge. The fee may be secured by addressing the inquiry to the SPECIAL SERVICE department, and furnishing COMPLETE specifications of desired information and available data.

COIL DETAILS

(385) W. H. Evans, Vashon, Washington

(Q.) In the January 1936 issue of *Radio-Craft* there appeared a short-wave preselector unit which I have decided to build. However, you do not give details for making the coils for this unit. Can you help me?—I would prefer to make my own coils, for the enjoyment I derive from making all the parts in the sets I construct.

(A.) We have received the following information from the J. W. Miller Co., the manufacturers of the coils used in the original model of the preselector.

"While we do not make a practice of releasing detailed specifications on our standard products, we are quite willing to supply this data to *Radio-Craft* readers. Detailed specifications are as follows:

Coils are wound on 1/16-in. wall threaded bakelite tubing 1 in. O.D. x 3 1/2 ins. long—

Antenna Coils

(75-200 Meter Band) Secondary 39 1/2 turns No. 29 E wire wound to occupy a length of 3/4-in. Primary 6 turns No. 29 E wire wound to occupy a length of 1/4-in. Coupling primary to secondary 1/16-in.

(35-75 Meter Band) Secondary 13 turns No. 20 D.C.C. wire wound to occupy a length of 9/16-in. Primary 28 turns No. 34 E wire wound to occupy a length of 3/16-in. Coupling primary to secondary 3/32-in.

(12-35 Meter Band) Secondary 5 turns No. 20 D.C.C. wire wound to occupy a length of 3/4-in. Primary 15 turns No. 30 D.S.C. wire wound to occupy a length of 7/32-in. Primary to secondary coupling 3/32-in.

RADIO-CRAFT'S INFORMATION BUREAU

R.F. Coils

(75-200 Meter Band) Secondary 29 1/2 turns No. 29 E wire wound to occupy a length of 3/4-in. Primary 20 turns No. 36-E wire wound to occupy a length of 7/32-in. Primary to secondary coupling 1/16-in.

(35-75 Meter Band) Secondary 13 turns No. 20 D.C.C. wire wound to occupy a length of 9/16-in. Primary 13 turns No. 32 D.S.C. wire wound between secondary turns.

(12-35 Meter Band) Secondary 5 turns No. 20 D.C.C. wire wound to occupy a length of 3/4-in. Primary 5 turns No. 30 D.S.C. wound between secondary turns."

INTERCOMMUNICATOR CIRCUIT— "WIRELESS" INTERPHONE "LAW"

(386) Donald Freeman, Chicago, Ill.

(Q.1) In the June issue of *Radio-Craft*, you printed a picture of an interphone of the A.F. type made by Webster and capable of permitting 10 stations to operate at the same time. Can more than one conversation be carried on at the same time with this system? Will you give the circuit of the unit used in this system?

(A.1) The circuit of the Webster Amplicall unit, type OCM-A is given in Fig. Q.1-386. The selector system which permits operation of 10 stations either with a master station or with individual control of the lines is shown at the left of the diagram.

Two methods of operation are supplied by this unit. The first utilizes one amplifier at the central location and may be employed with 1 to 10 outlying stations. The central station in this system is the only unit supplied with a selective switch for talking to any one of the outlying stations, but the outlying stations can call the central station at will. This system permits one conversation at a time.

The second system consists of 3 or more OCM units as shown in the accompanying circuit shown below. In this system each of the stations can call each other's station and the system will accommodate as many as 5 separate conversations at the same time.

(Q.2) Also, I am wondering about the use of the R.F. type of intercommunicator where the wiring of the building is exposed. In spite of the claims of manufacturers, I believe that a certain amount of radiation will take place and I wonder if the Federal Communications Commission will give rulings on the use of such devices?

(A.2) In answer to a query from *Radio-Craft* to the Federal Communications Commission regarding your question of radiation, the following reply was received:

"You are advised that the Commission has investigated and conducted some tests with certain types of such apparatus (intercommunicators of the "wireless" type—*Editor*), for the purpose of determining whether the operation

of same would require a license under the provisions of Section 301, but no final decision has yet been reached in the matter."

VOLUME-CONTROL REPLACEMENT

(387) H. W. Faulkner, Philadelphia, Pa.

(Q.) In replacing volume controls in radio receivers, where exact replacement units are not available, I have run into the problem of getting the correct type for a particular purpose. Why are different types needed and what are the controlling factors in ordering a potentiometer for a particular circuit? In other words, how will I know what taper to specify?

(A.) The following facts concerning volume control potentiometers have been obtained from Clarostat. They should be of interest to many Service Men.

When replacing defective volume and tone controls, the Service Man should take into consideration several important factors if a satisfactory job is to result.

(1) Consider the circuit in which the control is to function and the total resistance to be included.

(2) The maximum current the control must carry.

(3) Use a control that is noiseless in operation, both mechanically and electrically.

(4) All of the foregoing is taken care of by knowing the exact make and model of the set, as well as the exact function of the unit to be replaced, and then referring to a reliable volume-control replacement guide.

(5) When replacement is for a "C-bias" circuit, use a fixed resistance at the clockwise end of rotation. Such a fixed resistance is generally between 200 and 400 ohms. The value is not so critical, so that a resistor of about 300 ohms will be satisfactory. Some controls to be used in "C-bias" circuits are equipped with a flexible resistor of 300-ohm value, intended to be attached to the right-hand terminal (looking at the shaft end of the unit) when circuit calls for fixed-bias resistance. By using this minimum resistance outside, the control increases in rotation which in turn results in better volume control. It also helps to increase the safe load capacity, because part of the load will be dissipated in the external resistor.

(6) For emergency replacements, when you simply cannot wait to order exact duplicate or close approximation, you can make good use of volume-control kits containing general-utility units (either wire-wound or composition element) taking care of the majority of all standard sets.

(7) In volume control listings it will be noted that there are exact duplicates, precisely matched both electrically and mechanically with the original unit being replaced, and standard units more or less approximating the requirements so that they can be installed with a minimum amount of change and trouble. The exact duplicate should be employed wherever possible.

(Continued on page 119)

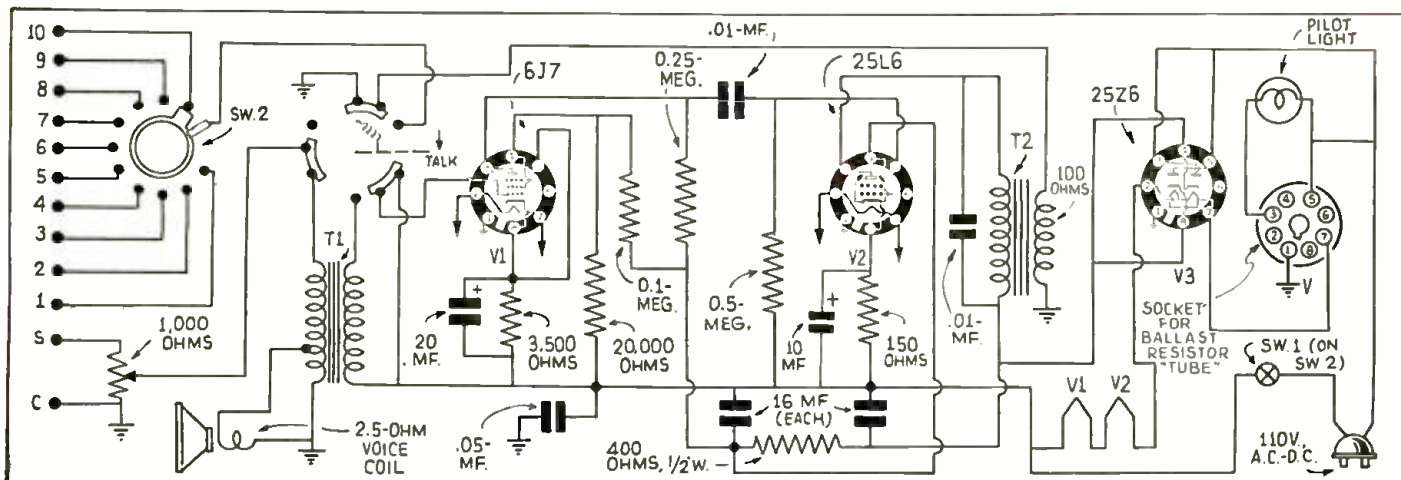

Fig. Q.1-386. Amplicall 10-station unit. Improvements: C-bias bypass 12 mf., not 20; filter: 8 and (right) 20 mf., not 16 each. Ground is chassis only.

HOWARD MODEL B-5 (715), SERIES 1 AND 2 (USED IN SHEAFFER RADIO-CLOCK-PEN DESK SET)

5-tube, 2-band (Broadcast; S.-W.—5.5-18 mc.), A.V.C., 110-V., A.C.-D.C.

This receiver is aligned at its I.F. of 465 kc., by feeding in this signal. The I.F. trimmers C1, C2, C3, and C4 are peaked carefully, as they are critical; their positions are

seen in Fig. 2A. The sensitivity of these stages is 25 microvolts for 50-milliwatt output.

The R.F. stages are adjusted first on the S.-W. band; after adjusting the dial hand, if needed, tune to 17 mc. Do not couple signal generator to set; but pick up signal with antenna wire, inductively, so that it is just heard. Peak trimmer T1-D to signal, then T1-C. Increase signal strength; tune to 16.9 mc., and note if signal is heard. If not, back trimmer T1-D off till it is; reduce signal, go back to 17 mc. and correct trimmer. (Fig. 2B.)

Then couple in 1,400 kc. signal, and tune on B.C. band to this frequency. Peak T1-B and then T1-A. Tune to 550 kc. and adjust T2-A. Recheck on 1,400 kc.; then in middle of dial. Bend plates of COsc., if necessary. Seal trimmers after adjusting.

A copy of the schematic circuit (Fig. 1)

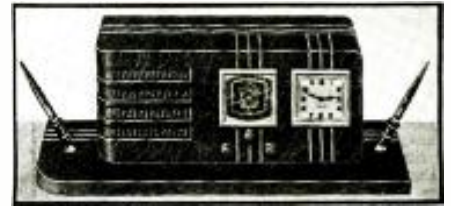

should be on back of chassis.

Socket voltages, to ground (115 V. on line) are as follows:

Tube	P	K	S.-G.
V1	92	2.5	65
V2	92	2.5	92
V3	14	—	—
V4	42	—	92
V5	—	92	—

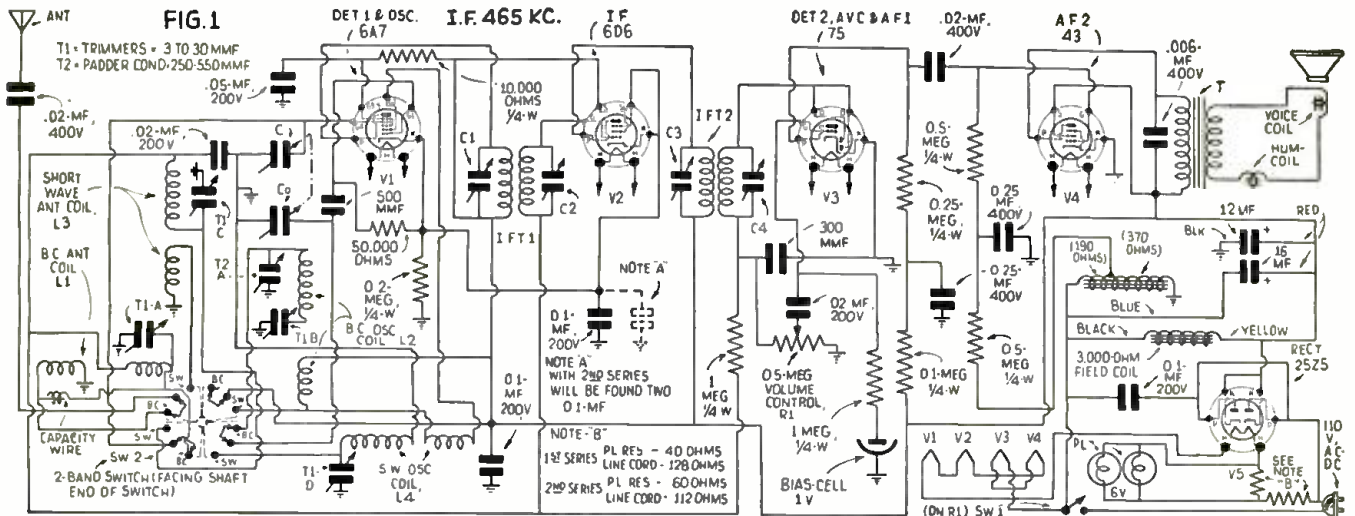
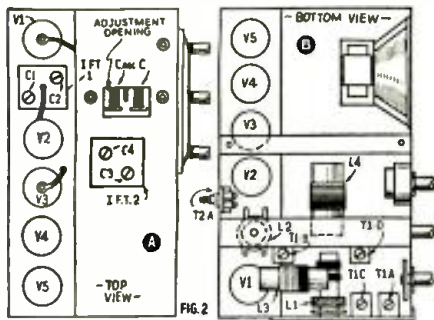

REMLER MODEL 46 ("SCOTTIE")

5 metal tube, V.C., and police ranges, A.C., compact plastic cabinet.

This set tunes up to 1,700 kc. on the broadcast band, for low-frequency police calls. Switch 2 cuts out enough turns on the antenna coil secondary to permit tuning-in a higher police band.

The antenna coil, located over the gang condenser, is trimmed by adjusting the small condenser on the rear of the gang (not shown in diagram). The oscillator coil, mounted under the chassis, is trimmed by the small condenser on the front of the gang. The two I.F. transformers, with their trimmers, are mounted under the chassis; they are peaked at 450 kc.

The high-frequency police switch is located on the back of the set. Vertical tuning dial has a moving pointer, control led by right-hand tuning knob.

Voltages (line 120 V.) are 6 V. on each filament except V5 (5 V.); on the tube elements (full volume, no signal) to ground:

Tube	Plate	S.-G.	Cath.
V1, V2	240	75	3.8
V3	65	16	2.0
V4	230	240	*18.0

*Grid bias. On oscillator plate (6) of V1, 75 V. (All read with 1,000 ohms/volt meter.)

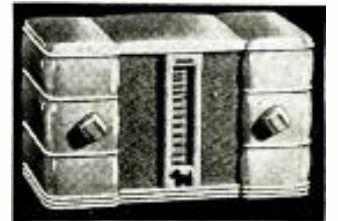

"Scottie" (black or ivory).

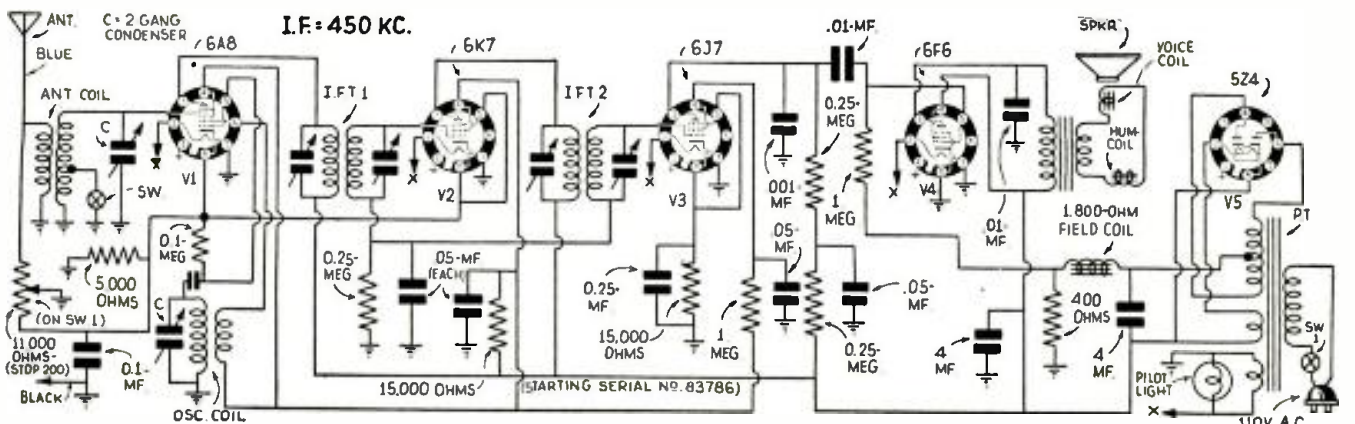

GENERAL ELECTRIC AUTO RECEIVERS MODELS FA-60 AND FA-61

6 metal tubes and vibrator, 6.3 V. battery; iron-core antenna coil and matching transformer; resistance-capacity coupling in I.F. output; "degenerative" audio feedback for improved low-note response.

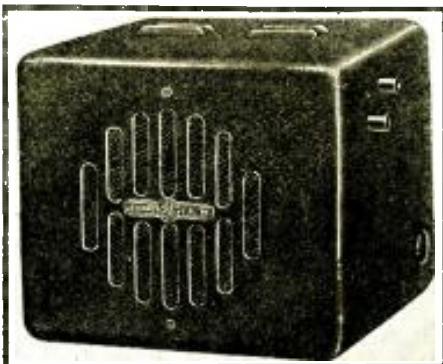
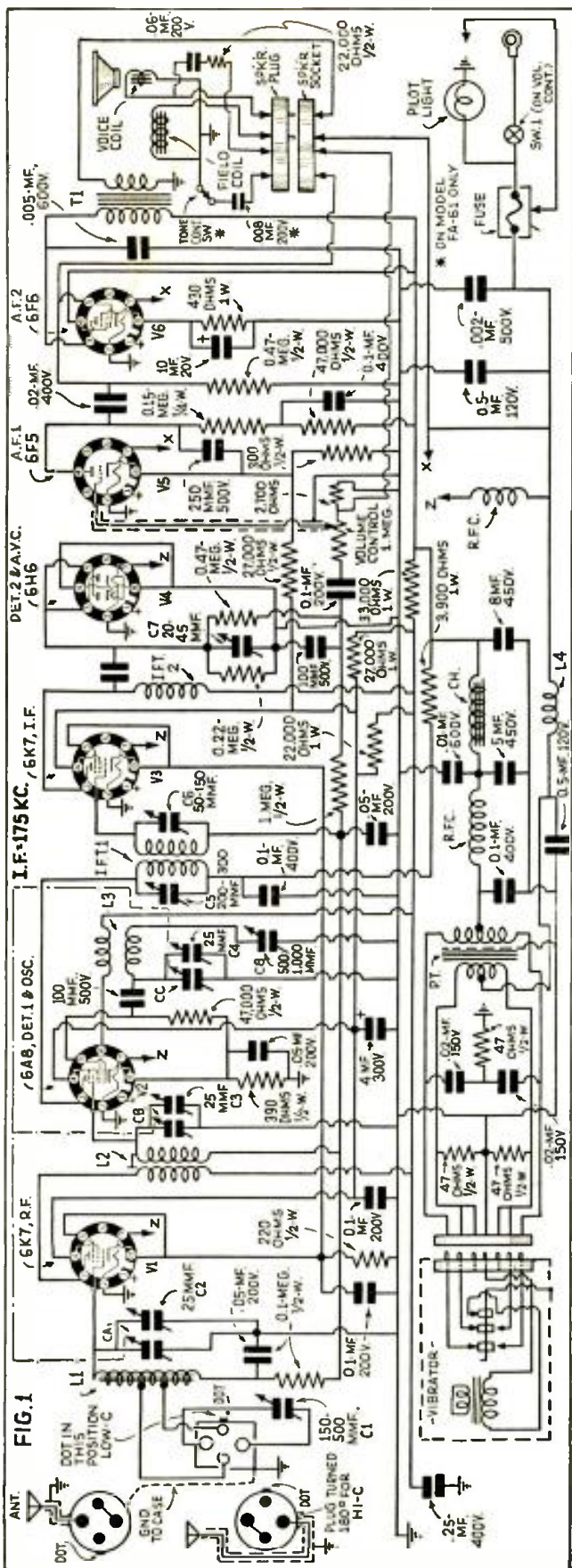

G.E. Model FA-60, in housing. The FA-61 differs in having a tone control, as shown in Fig. 1, with a knob at the lower-right of the grille, which also bears the letters "GE" in monogram. Speaker cover is held on by snap fasteners; 7 self-tapping screws secure chassis.

These two models differ in that the FA-61 has a 2-point tone-control switch as shown. The 6½ in. dynamic speaker, built into the housing, has undistorted 3-W. output. The set draws 7 A. from the storage battery. It is made for several cars, panels for which are obtainable.

The vibrator is set for cars with "+" battery terminal grounded. If "-" terminal is grounded, instead, the cover is removed and the vibrator turned half-way round in the socket, till arrow on label points to "-" on vibrator top. The receiver is connected to the terminal on the car ammeter which causes a "Dis." showing.

The antenna coil has an iron core, and matching trimmer C1 permits adjustment for maximum energy transfer. The antenna plug is turned into the socket on the set for "High-Capacity" or "Low-Capacity" antenna as shown. Trimmer C1 is adjusted on a weak signal, between 1,200 and 1,500 kc., with volume control nearly full-on. If antenna capacity is too low for peaking with C1, turn this to max. (counter-clockwise) position and peak C2, on gang condenser. (See Fig. 2 for locations.) Fishpole, under-car, built-in top and over-top antennas are usually low-capacity; insulated metal top and insulated running-board types, high-capacity. With latter, the red dots on plug and socket should be opposite, instead of together. In this position, C1 is in series with the antenna and the high tap on the cored coil.

The I.F. amplifier is peaked with a 175 kc. signal; adjusting C7, C6 and C5 (Fig. 2) in that order for maximum output, and readjusting.

R.F. alignment is made, after verifying scale calibration, at 1,500 kc., with gang condenser plates completely meshed. Connect signal generator through 250 mmf. condenser to prong nearest red dot on antenna receptacle; set dial at 150; peak C4, C3 and C2 (in that order) for max. output reading. Then apply signal at 580 kc. with receiver dial at 58; peak oscillator padder (C8) while rocking condenser through resonance; realign C4 at 1,500 kc.

To set the dial, which has a friction drive, rotate tuning knob counter-clockwise till dial reaches its stop. Continue to rotate the knob for several turns; and dial will be set.

To attach volume-control cable, rotate control with a screwdriver, fully clockwise. Turn "Vol. Con." knob fully counter-clockwise, insert cable into bushing on receiver. Rotate knob fully, clockwise, against slip-clutch. If cable tip does not engage slot during the first half of its rotation, reset control with a screwdriver, so that this will occur. Tape cables in place to prevent slipping; there will then be no snapping from tension in the cable.

If a built-in roof antenna is used, shield lead-in down to set and put R.F. filter in lead to dome light, as near as possible where lead enters. When making grounds, select quietest point; as determined by noise pick-up. Ground steering post, speedometer cable, oil line, etc. Collector springs under caps may overcome wheel pick-up.

This connection through coil and condenser, from speaker voice coil to volume control, is "degenerative"; it reduces, by bucking feedback, audio amplifier distortion, and improves frequency response.

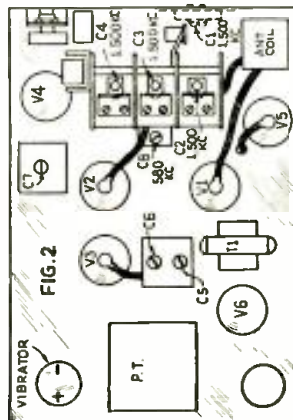

AVERAGE SOCKET VOLTAGES
(Battery 6.4 V., no signal, 540 kc., 1000 ohms/volt meter)

Tube	Prong	3	4	6	8
V1 & V3		200	97	—	3.4
V2		210	97	200	4.0
V5		—	147	—	1.5
V6		231	251	—	15.6
Filter input		265 V.	output	251.	

HEATERS 6.3 V.

RESISTANCE AND CURRENT

Tube	Cap	Prong	5	Cath.	Cur.
V1	1,790,000				5.8 ma.
V2	1,690,000	47,000			9.5 ma.
V3	1,690,000				5.8 ma.
V4		*220,000			
V5	†1,000,000				0.3 ma.
V6		470,000			37.0 ma.
Total plate current, 63 ma.					
*Also prong 3. †Vol. Con. up; down, 2,700 ohms. Voice coil, 5½ ohms.					

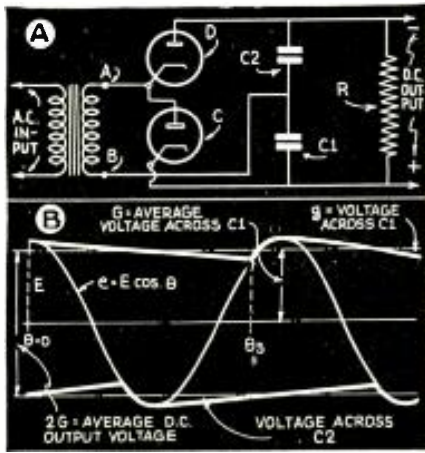

Fig. 1. Fundamental circuit of a voltage-doubling rectifier (A); and a curve showing the relation between the transformer secondary voltage and the average output voltage. Note the waveform (heavy outline) of the ripple voltage.

VOLTAGE-DOUBLING CIRCUITS

Through the use of voltage-doubling, high voltages may be obtained from inexpensive low-voltage transformers.

CHARLES GOLENPAUL

THE VOLTAGE-DOUBLING circuit has been popular among amateurs and others because it affords a means to obtain relatively high voltages from inexpensive low-voltage transformers. Although it is known that the maximum voltage available from such a circuit is nearly equal to twice the peak voltage of the transformer secondary and that it is less than this when the drain increases, very

little is known about the way the output voltage varies with the load and the input capacity. The curves presented herewith should prove helpful for designers of voltage-doubling circuits.

Figure 1A shows the circuit of a typical voltage doubler; in this circuit a transformer has been included but the doubler may of course work directly from the A.C. line. During one-half of the cycle, when A is positive with respect to point B, rectifier C is conducting and the condenser C1 is being charged. When the polarity reverses, the rectifier D conducts and the condenser C2 is charged. The 2-condensers are in series with respect to the load, resistor R, which results in double the voltage appearing across this resistor.

Comparing this rectifier circuit with others one can make the following observations. Starting with a transformer secondary delivering a peak voltage of E volts and assuming all circuits to be operated with condenser

(Continued on page 125)

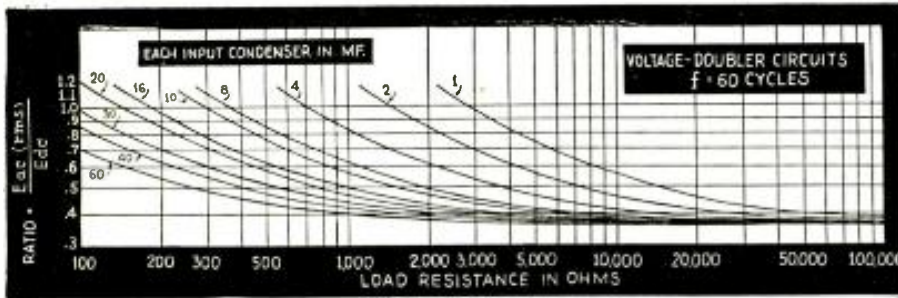
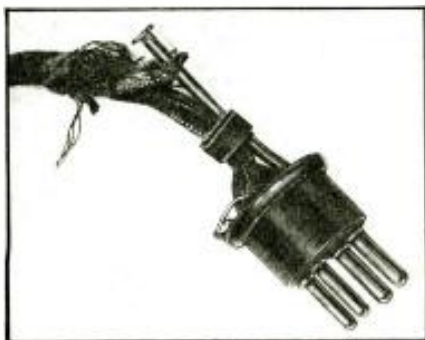

Fig. 2. Characteristic curves of a voltage-doubling circuit for different values of capacity.



A department devoted to members and those interested in the Official Radio Service Men's Association. For mutual benefit, contribute your kinks, gossip and notes of interest to Service Men, or others interested in servicing.



Here's an interesting sample (first shown in *Sylvania News*) of home-made service work. "We took this speaker plug out of a set that came in for service. The only trouble was that the wire wasn't making good contact with the nail!" says Broun D. Rinehart, Rinehart Refrigerator and Radio Sales.

(Would this suggest to Service Men that a little detective work might uncover a few "crimes" like this in YOUR neighborhood, and give you a chance to demonstrate the difference between professional and amateur service work?—EDITOR)

VOTE: NO STORIES

RADIO-CRAFT, ORSMA Dept.:

I read Edward Rosmarin's letter in the May issue of *Radio-Craft*, and I fully agree with Mr. Rosmarin's ideas.

The story in this issue is pretty good but many a good magazine has gone to the "dogs" from stories, and their titles don't even fit them any more. Why not publish another magazine for the stories and let us Service Men continue to have our magazine.

Here is a hint on Emerson sets which may help some other Service Man. If an Emerson 34C or 101 plays good for a while, then dies out (I've had 4 such cases), examine the power transformer high-voltage winding center-tap, which opens. Replace the transformer.

TRACEY PETERSON

ENGLAND QUESTIONS TELEVISION COMMENTS

RADIO-CRAFT, ORSMA Dept.:

I have recently been able to obtain your publication regularly—the March and April numbers just arrived—and I wish to say that I think your journal is excellent in every way.

As a radio engineer of 13 years' experience (part of this time being spent with B.B.C. and Marconi-E.M.I.) I do appreciate your efforts very much.

At present I am in charge of a radio dealer's service department. We are situated on the outskirts of London and a great number of American receivers pass through our hands.

In conclusion, I feel unable to let Philco's opinions—as reported in your April issue—on British television results, pass unchallenged. I have personally installed a number of well-known British-made television receivers, actually outside the "accepted" receiving radius and we are obtaining consistently excellent results. Philco's "reference to 'arms and legs look like bags of sand'" is perfectly ridiculous!

I have shown this report to several well-known engineers over here and, to us all, the statement is incomprehensible. Can it be "sour grapes", I wonder?

I am interested in the ORSMA and wish you to send me the necessary details regarding membership.

NORMAN STEELE,
Dunmow, Essex,
England.

(Continued on page 125)

A TELEVISION "STREAMER" FOR SPOT NEWS

(Continued from page 76)

friction pulley that pulls forward a transparent celluloid strip on a special typewriter. This typewriter is provided with means for imprinting opaque characters on the strip. This strip is pulled forward by means of a second motor housed in a scanning cabinet. Sufficient slack is provided in this cellophane strip to permit the making of corrections, deletions and insertions. A switchlever, S, projecting from the side of the cabinet enables the operator to transfer from this news strip to a second strip, inside the cabinet, that may carry advertising copy, time intervals, etc. This second strip is an endless loop which repeats the same copy.

A "headlight" lamp similar to the one used in the receiving unit is housed in a little box on the outside of the cabinet and projects into the cabinet. The light, from this lamp, passes through a lens system tilted downward and is focused onto a mirrored, motor-driven drum identical to the one used in the receiving units. The lightbeam is then reflected directly upward from the drum of mirrors, through a condensing lens and then into the photoelectric cell located in the top compartment.

The insert in Fig. D shows the progression of the tape through the special typewriter.

The exciter lamp housing mentioned above may be seen, in Fig. E, on the outside of the cabinet that contains the scanning equipment. The photocell amplifier in the top compartment also is visible. The tall rack-and-panel set-up at extreme right is the radio transmitter equipment.

Figure F discloses in greater detail the manner in which the cellophane tape feeds through the special typewriter; the capital letters you see on the tape are about 3/8-in. high.

Although only a single general application of this new Television "Streamer" (or "sign") is here described for *Radio-Craft* readers many other and important uses are being investigated and developed. At the present writing it seems that future developments of the Television "Streamer" may soon constitute an important, individual branch of radio that will call for the services of various classes of expert help for manufacturing and inspection work, installation, etc.

*Following is a general and greatly abbreviated explanation, that may interest some of our readers, of the manner in which the light-beam is modulated at the receiver.

The first polarizer passes light rays in only one plane, while the second polarizer passes light rays in only a plane at right-angles to the first; hence, no light passes through the second polarizer unless the rays have been first "twisted" from the first plane to the second.

Here is where the modulator functions. Interposed between the two polarizers, it serves to "twist" the light rays from one plane to the other.

The amount of light passed by the second polarizer (degree of modulation) is proportional to the voltage impressed on the modulator cell.

—Editor

HOW TO MAKE THE RADIO-CRAFT—1937 TELEVISION RECEIVER

(Continued from page 73)

myriad of varying electrical actions all of which must be controlled in order to result in satisfactory images.

Do not get discouraged by failure to receive good images, at first; just stick to the job until the causes of trouble are found, and success is sure to be attained.

We would like to hear from *Radio-Craft* readers who have built this television receiver and who are listening-in and looking-in to television programs. A 1-year subscription to *Radio-Craft* goes to the constructor who sends us a good photograph of the best-looking job. We would also like to know of any alterations of the construction you may have found desirable to compensate for differences in the characteristics of individual components.

FREE EQUIPMENT LIST

Listed below are some of the things you can have free with your purchases of National Union radio tubes. If you don't see what you want, ask for it!

Equipment You Can Have	Tubes You Buy Per Week
Carrying Case	2 For 1 Year <input type="checkbox"/>
Clough-Brengle OM-A Freq. Modulator	11 " 2 Years <input type="checkbox"/>
Clough-Brengle 81-A Freq. Modulator	6 " 2 Years <input type="checkbox"/>
Clough-Brengle Signal Generator	6 " 2 Years <input type="checkbox"/>
Clough-Brengle 85-A	5 " 2 Years <input type="checkbox"/>
Clough-Brengle CRA Oscillograph	15 " 2 Years <input type="checkbox"/>
Clover Remote Control Cable Kit	4 " 1 Year <input type="checkbox"/>
Communication Inst. Audio Oscillator	3 " 2 Years <input type="checkbox"/>
Electric Clock	4 " 1 Year <input type="checkbox"/>
Hickok OS-11 Oscillator	8 " 2 Years <input type="checkbox"/>
Hickok No. 99 Tube Tester	8 " 2 Years <input type="checkbox"/>
Hobart Cabinet (100 Drawer)	5 " 2 Years <input type="checkbox"/>
J.F.D. Remote-O-Cable Replacer	7 " 2 Years <input type="checkbox"/>
Precision No. 600 Electronometer	7 " 2 Years <input type="checkbox"/>
Ranger 640-740 Volt-Ohm-Milliammeter	4 " 2 Years <input type="checkbox"/>
Ranger 557 Signal Generator	3 " 2 Years <input type="checkbox"/>
Ranger 735 Volt-Ohm-Milliammeter	3 " 1 Year <input type="checkbox"/>
Readrite No. 430 Tube Tester	3 " 2 Years <input type="checkbox"/>
Royal Portable DeLuxe Typewriter	10 " 2 Years <input type="checkbox"/>
Service Manual (any volume except 2 & 7)	3 " 1 Year <input type="checkbox"/>
Simpson All-Wave Signal Generator	8 " 2 Years <input type="checkbox"/>
Simpson Set Tester No. 225	5 " 2 Years <input type="checkbox"/>
Simpson Set Tester No. 250	6 " 2 Years <input type="checkbox"/>
Simpson Roto-Ranger Tester No. 220	9 " 2 Years <input type="checkbox"/>
Simpson Roto-Ranger Milliammeter No. 201	5 " 2 Years <input type="checkbox"/>
Simpson Roto-Ranger Milliammeter No. 202	5 " 2 Years <input type="checkbox"/>
Shop Coat	2 " 1 Year <input type="checkbox"/>
Supreme No. 525 Soldering Tool	2 " 1 Year <input type="checkbox"/>
Supreme No. 450 Set Analyzer	6 " 2 Years <input type="checkbox"/>
Supreme No. 510 Meter Kit	3 " 2 Years <input type="checkbox"/>
Supreme No. 400 Tube Tester	7 " 2 Years <input type="checkbox"/>
Supreme No. 590 Multi-Meter	8 " 2 Years <input type="checkbox"/>
Supreme No. 580 Signal Generator	10 " 2 Years <input type="checkbox"/>
Supreme No. 550 Radio Tester	10 " 2 Years <input type="checkbox"/>
Supreme No. 500 Automatic	12 " 2 Years <input type="checkbox"/>
Supreme No. 585 Diagonometer	17 " 2 Years <input type="checkbox"/>
Supreme No. 555 Diagonoscope	26 " 2 Years <input type="checkbox"/>
Triplett 1503 Multipurpose Tester	8 " 2 Years <input type="checkbox"/>
Triplett 1250 Vacuum Tube Voltmeter	6 " 2 Years <input type="checkbox"/>
Triplett 1240 Condenser Tester	4 " 2 Years <input type="checkbox"/>

I want the items checked! How can I get them?

RC-837

Name

Address.....City.....State.....

CHECK! FILL IN! MAIL TO NATIONAL UNION RADIO CORP. 570 LEXINGTON AVE., NEW YORK CITY

To Readers of RADIOCRAFT

FREE POSTCARDS MAY BE HAD UPON WRITING TO THE PUBLISHERS

These post cards make it easy to answer advertisements which appear in RADIO-CRAFT, without cutting valuable data which you may wish to save.

Many times manufacturers request you to "clip the coupon" when answering their ads. Often this means destroying part of an article on the reverse page you may need later for reference. Save your RADIO-CRAFT issues complete. If you should ever want to sell bound volumes, or certain copies of RADIO-CRAFT, the resale value of uncut issues is very much higher than that of mutilated ones. So send for a supply of these free post cards and use them in answering all RADIO-CRAFT advertisers.



Build a Kit-Type Carrier Interphone Wireless 2-Way Communication System

As Featured in June issue RADIO-CRAFT.

Build the WIRELESS-PHONE! Fool-proof design—complete instructions—holes

drilled in chassis and cabinet. You can't go wrong! Build it in a few hours! To Dealers and Servicemen.
Kit of parts, per unit chassis WP-11 \$8.95
Kit of Sylvania tubes (1-6C6, 2-43's, 1-2525) .. 2.18
WP-12 .. 2.82
Cabinet WP-14 .. 2.18

Total \$13.95
Complete Wireless-phone kit (two units)—nothing else to buy WP-10 \$27.90
Wires and tested—extra—per unit 4.00

ARROW RADIO, INC., 82 Cortlandt St., New York, N. Y.
Enclosed please find money order Check for \$3.00. (Balance—C.O.D.) Rush Wireless-phone Kit No. at once.

Please Say That You Saw It in RADIO-CRAFT

THE BALANCE SHEET OF TELEVISION

(Continued from page 81)

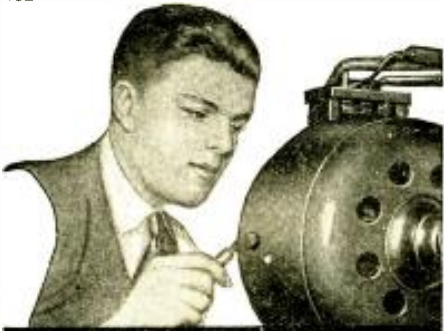

Amazingly Easy Way to Get into ELECTRICITY

Send Today for Details of

"Pay-After-Graduation" Plan

Don't spend your life never sure of a job. Let us prepare you for your start in a good paying field. Let us teach you how to prepare for positions that lead to good salaries in Electricity—NOT by correspondence, but by an amazing way we teach right here in the great Coyne Shops. You get a practical training in 90 days. Mail the coupon below. If you are short of money I'll send you all details of my "pay-after-graduation plan" where many get my training first and start paying for it 5 months after they start school and then have 18 months to complete their payments.

LEARN BY DOING—IN 90 DAYS BY ACTUAL WORK IN THE GREAT COYNE SHOPS

I don't care if you don't know an armature from an air brake—I don't expect you to! Coyne training is practical "learn-by-doing" training. Don't let lack of money hold you back from getting all details of my amazing plan.

MANY EARN WHILE LEARNING

If you need part time work to help pay your expenses, we may be able to help you as we have hundreds of others. When you graduate we'll give you lifetime employment service. And, in 12 brief weeks, in the great shops of Coyne, we train you as you never dreamed you could be trained. . . on one of the greatest outlays of electrical apparatus ever assembled. . . real dynamos, engines, power plants, autos, switchboards, housewiring, armature winding and many other branches of Electricity.

Electric Refrigeration Air Conditioning

Right now we are including additional instruction in Electric Refrigeration and Air Conditioning without extra cost so that your training will be complete and you can get into this marvelous, rapidly expanding field.

GET THE FACTS Coyne is your great chance to get into Electricity. This school is 38 years old—Coyne training is tested. You can find out everything absolutely free. Simply mail the coupon and let us send you the big, free Coyne book with photographs . . . facts . . . opportunities. Tells you how many earn expenses while training and how we assist our graduates in the field. No obligation to you. So act at once. Just mail coupon.

BIG FREE BOOK

Send for my big book containing photographs and telling the complete story—absolutely FREE.



COYNE ELECTRICAL SCHOOL 500 S. PAULINA ST., Dept. C7-78 CHICAGO, ILL.

H. C. Lewis, Pres., COYNE ELECTRICAL SCHOOL, 500 S. Paulina Street, Dept. C7-78 Chicago, Ill. Dear Mr. Lewis: Without obligation send me your big, free catalog with facts about Coyne Training and details of your "Pay-Tuition-After-Graduation" Plan.

Name Age
 Address
 City State

by more than 450 stations in the broadcast range) might be too much even for the very extensive ultra-short wave range, and predicted that any further increase eventually would overcrowd it as much as broadcasting stations do at present in their range.

But this is not all. Surprisingly extensive distances were bridged by means of ultra-short waves, and the dear old-fashioned theory that these "U.-S.W." signals reach only as far as the optical sight goes, seemed to be quite shaky. However, every one agreed that the performance quality attained was "excellent." Of course, no one dared to compare the performance quality of 343-line television with the quality by which modern talkies are presented, but it could be compared very well with the performance quality of silent pictures around 1920. In short, a final step towards the introduction of television in the home seemed to be imminent.

Nevertheless, the RMA (Radio Manufacturers Association) did not seem to think so, and recommended to the F.C.C. (Federal Communication Commission) in Washington, in May 1936, the 441-line transmission as the final standard. Wicked tongues explained this "philanthropic" step ("in the interest of the American public," as the RMA claimed) as being founded on the desire to safeguard for a few years the excellent all-wave set business against surprise attacks from the television faction. This type of comment is, of course, as much exaggerated as the "concealing" arguments of the RMA.

The truth lies probably between the two points of view, and since the F.C.C. accepted the 441-line standard, and NBC as well as CBS are experimenting with this number of scanning lines, there remains not much to discuss pro and con regarding the increase in the number of lines to 441.

1937 . . . ?

There is doubt however that this increase in the number of definition lines has brought television one step nearer its goal of final introduction into the American home. But what are the fundamental obstacles?

(1) There seemed a year or so ago to be a chance to reduce the price of a 360-line television receiver to about \$250, when mass production was taken into consideration. (Remember that the price of the television receiver is the most important factor for general introduction into the American home). However, today no one likes to commit himself as to the future price of a 441-line set.

(2) We are no longer 100 per cent sure that ultra-short waves do not "jump" once in a while far above the limit of the optical sight as theoretical determinations had previously indicated.

(3) If we consider that the tremendous bandwidth of approximately 3,250 kc. (which is required to transmit a 441-line signal) restricts the number of television stations considerably (in case every station has to be furnished with a separate channel because of the "jumping activities" of the U.-S.W.) we come to the following realization:

(4) According to RCA estimates, 80 television stations are required to cover the U.S. with television signals of sufficient strength.

(5) Let us not forget the ardent desire of the Army, Navy, civil aviation and the Department of Agriculture to secure considerable slices of the U.-S.W. range for their services. What does that mean?

(6) Something quite simple! There is not enough space in the range utilized at present (for television transmission) to allot enough channels to all interested parties.

(7) Since certain specialized services of some of the parties mentioned above are more important for the welfare and the security of the country than is television image transmission, the following probabilities occur.

(8) Television transmission will eventually be shifted to a range far below the present experimental range, namely to the one between 10 centimeters and 1 meter.

(9) In other words, all the experiments made at present may eventually be repeated in a lower wave range, with completely new transmission and reception problems.

(10) And until all these problems are eradicated, and the price for a television receiver has been reduced to a reasonable sum in respect to the buying power of the masses, much time may pass before television in the American home will become an actuality.

No doubt, these 10 points massed against an early introduction of television in the American home are by no means seen from a very optimistic point of view, and a number of them will probably be of less grave importance than indicated above. Nevertheless, those who are ardent admirers of the great art of television transmission had better be prepared for an additional delay of a few years.

TELEVISION IN EUROPE

So far, we have searched television progress of the past decade with an eye to American achievements in regard to television. Now let's see what Europe attained. From reports pouring in from the other side of the Atlantic, one can conclude that European television technique seems to be far advanced. But all these optimistic reports indicate only that the public abroad is easily satisfied, as American visitors who surveyed the situation assure us.

In Germany they transmit 180-line images, and probably this year their number will be increased to 360. In London after the extensive housecleaning for which Baird Television, Ltd., had to pay the bill, and only the Marconi outfit survived, they intend to follow the American example and install a 441-line system. In France, Holland, Italy and Australia, as well as in Japan, many interesting things are in the experimental stage, but nothing definite concerning the final, future design can be said at present. Much that is reported about the television transmission from the Olympic Games at Berlin, and the Coronation Festival in London is of hypothetical value only, and the reason is quite simple. They have daily television transmission in Berlin and London, and even regular programs are published in the dailies and in various radio publications—but, how many persons are looking-in?

The author made an ardent effort to obtain facts and figures concerning the number of television receivers installed in private homes in London as well as in Berlin. The results of this research were quite meager. There are practically none in private homes. According to carefully-executed estimates about 1,000 television receivers have been manufactured in Germany by the three or four companies interested in television, and hardly 50 per cent of them have ever left the four walls of the laboratories. The corresponding figures for England indicate that about 1,200 television receivers of modern design have been produced in the United Kingdom, but hardly more than 30 per cent have been used or sold so far.

The information obtainable indicates quite clearly that television abroad is not more advanced than in America, and if we consider the undeniable fact that most of the television cameras are either of American origin, or have been produced in Europe by utilization of American design "recipes," there remains not much to brag about concerning actual television activities—here or abroad. Television is on its way, no doubt, but when it will finally arrive is still a question of great perplexity.



Does this car have A.C. or D.C.?

Please Say That You Saw It in RADIO-CRAFT

HOW TO MAKE THE RADIO-CRAFT SUPER-DELUXE 30-TUBE SET

(Continued from col. 2, page 82)

ultra-fine receivers and almost every large manufacturer includes in his line a set having from 15 up to 37 tubes. The price range of such receivers is from \$200 up to \$1,000.

For the first time in any publication, we are going to describe the construction of a 30-tube receiver (with—optional—phonograph amplifier, 35 tubes), the performance of which is in the \$1,000 bracket, but, nevertheless, can be built as shown in Fig. 1 for under \$250! (This "top" price includes the highest-price group of reproducers—less expensive loudspeaker units and labyrinth may materially reduce the overall cost of the complete set-up.) The 20 major features are listed in Table I.

WHY 30 TUBES?

How and why 30 tubes are used and needed is shown in the block diagram, Fig. 1. The heavy line represents the path which R.F. signals traverse from antenna to loudspeakers. (The phonograph chassis is optional and therefore may be entirely omitted.)

Such a set could not advantageously be built on a single chassis and even a 2-chassis construction would be cumbersome to build and service. It was decided to use 4 chassis on the "skyscraper" method, with one chassis atop another. (An artist's conception of a single rack-and-panel arrangement of the completed chassis and the reproducer system is shown in Fig. A; the phono chassis is not included in this view.)

These chassis are listed as follows:

(1) A 5-tube (including 1 tuning "eye" used as carrier tuning indicator), 5-band R.F. Tuner, of the superhet. type, with a continuous wavelength range of 555 to 3.8 meters (this range therefore includes the high-fidelity audio channels of the ultra-short wave television transmitters).

(2) A 15-tube (including 1 tuning "eye" used as an "R" or signal-volume indicator meter) I.F. Amplifier incorporating delayed A.V.C., B.F.O., noise (static, etc.)-silencer circuit, and automatic bass compensation.

(3) An 8-tube (including 1 tuning "eye" used as A.F. overload indicator) A.F. Amplifier with type 6L6 tubes in parallel push-pull arranged to produce an output of 60 W. with an estimated total harmonic distortion of less than 2 per cent over a frequency range of approximately 20 to 15,000 cycles.

(4) A 2-tube Power Supply having individual output for the 6L6s.

This so simplifies the construction and wiring of each chassis that even a moderately experienced home builder could construct the complete receiver. In addition to the ease of construction, there is the further advantage that each and every unit can be used separately or in conjunction with existing equipment.

For instance, the A.F. Amplifier chassis and Power Supply chassis can be removed and used anywhere as a complete P.A. system. Try and do this with any commercial 30-tube set.

NO "TRICK" PARTS!

It would also be well to point out that no special parts are required. EVERY ITEM IS A STANDARD PRODUCT OF A NATIONALLY-KNOWN PARTS MANUFACTURER. Furthermore, every part specified is the finest product of each maker, and was chosen with a critical eye toward long, dependable service in each case.

Undoubtedly, many will ask, why build such a large set and where can you use it? The answer to the first question is that thousands of people are satisfied with 4-cylinder cars, because they are unable to afford something better, while others, always seeking something finer than average, drive 16-cylinder cars. As to where the set can be used, here are just a few examples: In hotels, beaches, schools, country clubs, DX clubs, airports, churches, amusement parks, fraternal lodges, broadcast and amateur stations. Custom set builders—here's your chance to interest your "pet" customers in a really worthwhile radio installation that delivers results for every single tube used.

Construction details of the various chassis will be taken up in succeeding issues of *Radio-Craft*.

Special Notice:—RADIO-CRAFT has made arrangements to have tested and repaired WITHOUT CHARGE any RADIO-CRAFT Super-Deluxe 30-Tube Radio Receiver, built in accordance with these instructions AND USING ONLY THE SPECIFIED COMPONENTS, which fails to function correctly; (the constructor however must pay shipping charges both ways). Not only that, but, custom-set builders who feel qualified to make substitutions and who then encounter trouble, too may have their sets checked-up, in the event of faulty operation; the cost to the set builder in this instance will be the cost of shipping—plus a nominal charge for making the necessary tests and repairs, and for such replacement parts as may be necessary to effect perfect results.

In other words—YOU CAN'T LOSE!

(Continued from col. 3, page 82)

(13) FIDELITY CONTROL on panel, range 5,000 to 15,000 cycles.

(14) HIGH-FIDELITY, PARALLEL PUSH-PULL BEAM AMPLIFIER, class AB1, 60-W. AUDIO output.

(15) INFINITE Baffle, logarithmic-labyrinth type, 28 ft. back-wave travel. May use either 2 or 3 large reproducers.

(16) THREE SEPARATE POWER SUPPLY UNITS, 1 for tuner, 1 for A.F. amplifier stages and 1 exclusively for the 4—6L6 plates.

(17) ALL CHASSIS ARE CONNECTED TOGETHER BY MEANS OF PLUGS AND SOCKETS. The A.F. Amplifier can be removed and used as a P.A. system.

(18) ALL PARTS USED ARE STANDARD ITEMS; no special parts are needed.

(19) MEISSNER MULTI-WAVE ASSEMBLY IS COMPLETELY ALIGNED AT FACTORY; no special apparatus required for alignment.

(20) PHONOGRAPH OPERATION (optional with Preamplifier, and Phono Volume Expander—with all types of input circuits—to be built on the 5th chassis).

COMPACT, UNIVERSAL-MOUNTING ELECTROLYTICS

Flexibility in mounting and extreme compactness in design makes the Cornell-Dubilier JR and KR series of etched-foil dry-electrolytic condensers (illustrated below) more versatile for constructional and replacement purposes. The type JR is enclosed in a square silver container, its small size and universal mounting brackets getting it into unusually tight corners. The type KR, shown mounted on top of the chassis, is less than one-half the size of a similar can-type electrolytic, and adds symmetry and neatness to the average service and set-building job.

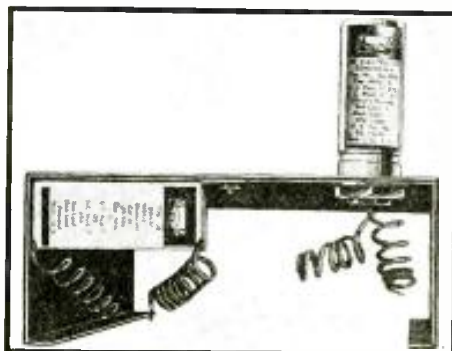

Please Say That You Saw It in RADIO-CRAFT



Here's the new Model 773 Tube Checker . . . companion to the famous Model 772 (20,000 ohms-per-volt) Analyzer,

and equally outstanding. It is a perfected emission type tester, that tests metal, glass, spray shield and "MC" tubes under standardized load resistance . . . provides neon short check while tubes are hot . . . noise test, each electrode . . . cathode leakage test . . . and many other features that make it the most modern, profitable checker available. Has a big, sensitive WESTON Meter and is furnished in handsome, polished, solid-wood case. Get the full details.

. . . and the **New!** Model 775 SERVICE SET



A complete, modern servicing combination. Handsome, solid-wood case contains the Model 772 (20,000 ohms-per-volt) Analyzer, and the new, matched Model 773 Tube Checker. Enables you to thoroughly service all receivers, television, P.A. systems, sound movies, photo-cell circuits, etc. Mail coupon for full data. All instruments can be purchased under WESTON INVESTMENT PLAN.

WESTON Instruments

Weston Electrical Instrument Corporation
599 Frelinghuysen Ave., Newark, N. J.
Send data on Models 773 and 775.

Name _____
Address _____
City _____ State _____

"LET ME TRAIN YOU at home FOR A GOOD RADIO JOB"

Get in Line for Big Money
 Radio is growing fast. Modern receivers require thoroughly trained experts for service and maintenance. You can become such an expert at home... through R.T.A. methods and begin earning money almost from the start of your course. In a very short time you will

Be the ONE Man in 1,000

who understands everything there is to know in order to give quick "sure-fire" service to all kinds of receivers. You can be the one man who can take the service business away from the old-time radio "tinker."

No Experience Needed
 Even though you know nothing about Radio now, you can quickly qualify the R.T.A. way to step right into a well-paying position—or start your own profitable business. No need to spend a lot of time and money in training. Use your spare time and

LEARN AT HOME

Most R.T.A. members start making money right from the beginning. The special servicing equipment which is supplied without extra cost makes this possible. Don't wait—get started now. Write today for our interesting Radio Book FREE.

INCLUDED WITH OUR TRAINING



This efficient time-saving, trouble-finding Circuit Analyzer and Resistance Tester helps you to make money without delay. Our Free Book tells you how.

Don't Put It Off—Send Coupon Now

RADIO TRAINING ASSOCIATION OF AMERICA
 4525 Ravenswood Ave., Dept. RC-87, Chicago, Ill.

RADIO TRAINING ASSN. OF AMERICA
 Dept. RC-87, 4525 Ravenswood Ave., Chicago, Ill.
 Gentlemen: Send me details of your Enrollment Plan and information on how to learn to make real money in radio quick.

Name

Address

City State

ELECTRIC PENCIL

AN electric tool that embosses on leather, wood, silk, paper or other material. Writes like a pencil. The writing can be embossed in any of the five following colors: Gold, Silver, Red, Green, Blue. A roll of colored foil of each of these colors is furnished with the outfit. Cord and plug is included in the box. Also 4-page instruction booklet. Plugs into any electric outlet, A.C. or D.C. 110 volts. Amount of current used is negligible. Very useful to anyone wanting to emboss books, wooden objects, leatherware, fabrics, Radio panels, hat bands, stationery goods, gifts, tools, instruments, etc. Size of writing tool 6". Size of box containing outfit 10"x8 1/4".
STOCK NUMBER: S204 ELEC-TRIC EMBOSSING SET. YOUR PRICE \$2.27
 Sent postpaid anywhere in U. S. A. Money back guarantee
WELLWORTH TRADING CO.
 Dept. RC-837
 560 W. WASHINGTON BLVD., Chicago, Ill.



On broadcast as well as shortwave frequencies, in any location, you can eliminate "man-made" static with

NOISE-MASTER
 ALL-WAVE ANTENNA

Send for complete literature.
 CORNISH WIRE CO., 30 CHURCH STREET, NEW YORK CITY

RADIO
 1938

FREE

SERVICEMEN AND RADIO SALESMEN—represent MODSELL'S in your territory and establish an independent business for yourself without a penny of investment. We carry RCA Philco G.E.—Zenith and many other makes of home electric sets, auto and boat sets, farm and camp sets of Nationally known manufacturers. Send for this new catalog TODAY.
 Write to Dept. D-3 and mail to address nearest you.

KEEPING VOLTAGE CONSTANT

(Continued from page 79)

acteristic curve of a filament type of regulator tube, the WL-896 (Fig. 1A). The curve shows only the relatively flat portion which would drop rapidly to zero if the scale were extended in that direction and which would rise rapidly if carried farther to the right. Tubes of this type are ordinarily rated for operation over the flat portion of the curve where the voltage change is greatest with a minimum of change of current. They might well be rated to operate from 4 to 8 V. because the average increase in current is approximately 8 per cent over this range.

In a circuit (Fig. 2A), the filament type of regulator tube may be used to maintain the filament current through a radio tube, A, at a fairly constant value even though the line voltage may be varying to a large extent. For instance, if the normal filament potential of the tube, A, is 6 V. at 0.25-A., the drop through the regulator tube would be 6 V. when the line potential is 12 V.

If the line voltage decreases to, say 10 V., the current through both tubes would decrease, resulting in a slight voltage decrease at tube "A" but in a much larger decrease in the potential on the regulator tube, namely to approximately 4 V. The normal operating temperature of tube A will not be appreciably reduced thereby.

Conversely, if the line voltage rises above 12, most of the increase in voltage will be absorbed by the regulator tube with A experiencing only a slight increase in filament potential. This characteristic of the regulator tube insures the operation of tube A under practically its optimum condition at all times even though the line voltage may be varying by a rather high value.

INCREASES LIFE

Maintaining a constant filament voltage on tube A gives a more stable operation with an accompanying increase in life. This is particularly important in thoriated and oxidized-coated filaments where the emission of electrons depends upon the operating temperature of the filament and where the emission is adversely affected if the operating temperature remains high or low for any appreciable length of time.

To keep the filament operating temperature at its best value, this regulator tube should be mounted in a chimney-like structure. In that way, the cooling air around the tube will circulate properly. There is an added protection against air leaking into the bulb, mixing with the hydrogen, and possibly causing an explosion. The Type WL-896 regulator tube (right, Fig. C) has a standard lamp base like that used on Mazda lamps for household and industrial lighting.

GASEOUS REGULATOR TUBES

Operation of gaseous regulator tubes depends upon proper electrode design and upon the characteristic of the gas when ionized between the anode and cathode. It should be such that slight variations in voltage will produce relatively large changes in current. Although the regulating characteristic depends upon the design of the tube for the desired operating range, most types are designed to operate with a drop of approximately 100 V.

If the voltage between the anode and cathode is increased slightly, the ionization increases very rapidly. Hence, high current may be carried by the tube with only a slight increase in applied voltage.

Similarly, if the applied voltage is decreased, the ionization drops rapidly and the current through the tube is decreased correspondingly. Thus, there is continual fluctuation in the number of positive ions present between the electrodes. The result is a continuous change in the

tube resistance and consequently in the current passing through the tube. Because the regulation characteristic depends upon the gaseous conduction phenomenon, the response of the tube is instantaneous in both the increasing and decreasing directions. Therefore, there is no thermal lag or delay caused by overshooting or undershooting the desired output voltage.

The average characteristic curve of a gaseous type of regulator tube, the WL-706 (Fig. 1B), may be considered typical of this class. Its current changes by a very large degree as the applied potential is varied by only a few volts. It should be rated to operate over that part of the curve which gives satisfactory and stable operation. Operating it at current values too low makes the regulating characteristic erratic. Too high current values may overload the tube and ultimately destroy it. It is far better to use several tubes in parallel.

In both the gaseous and the filament types of regulator tubes, regulation is obtained at the expense of using unwanted power which must be liberated as heat in the bulb. Obviously then, adequate cooling or circulation of air should be

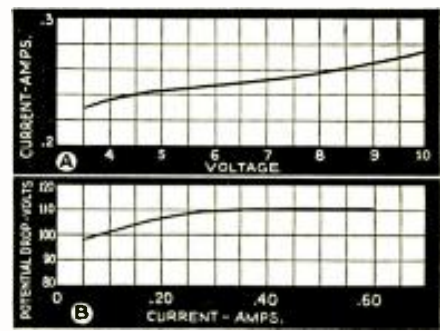

A—Average characteristic curve of the gaseous type of regulator tube. The WL-706 is considered typical of its class.

B—Characteristic curve of WL-896 filament-type regulator tube showing only the relatively flat portion which would drop rapidly to zero if the scale were extended in that direction and which would rise rapidly if carried farther to the right.

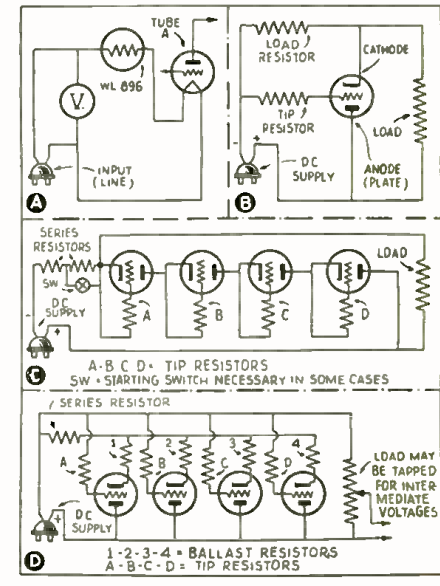

A—The filament type of regulator tube may be used to maintain the filament current through a radio tube, A, at a fairly constant value despite line-voltage variations.

B—A typical circuit in which the WL-706 gaseous-type regulator tube may be used. The load should not be more than 100 V. at 0.5-A.

C—For higher voltage regulation, two or more WL-706 tubes may be connected in series.

D—If higher currents are to be regulated or if a finer degree of regulation is desired, two or more tubes may be connected in parallel.

New 1938 Standard Brand Radio Catalog Listing more than 500 sets

Modell's - Wholesale Radio Division
 Since 1882

NEW YORK, N.Y. CHICAGO, ILL. ATLANTA, GA.
 58 Cortlandt St. 136 W. Washington St. 57 Forsyth St.

Please Say That You Saw It in RADIO-CRAFT

provided. The gaseous type of regulator tube can, therefore, absorb or reject current as needed so as to maintain at a more constant value the voltage and consequently the current to some associated piece of equipment.

The gaseous type of regulator tube, the WL-706 (left, in Fig. C), is typical of this class. It has the UX type of base which has been especially modified by a flange which provides greater protection against bulb loosening under conditions of extreme vibration. A tube of this size will absorb currents up to 0.6-A.

AUXILIARY ELECTRODE PERMITS LOWER VOLTAGE

An inherent characteristic of a gaseous discharge tube is that the gas glow, or ionization, will not start until a voltage somewhat higher than the operating voltage is applied between the electrodes. In the WL-706 regulator tube therefore, an auxiliary electrode on a special circuit connection initiates the ionization, permitting the tube to start and be used at lower voltages. The starting voltage of this tube is only a few volts higher than the normal operating value.

A typical circuit, in which the WL-706 regulator tube may be used (Fig. 2B) is suitable where a load of not more than 0.5-A. at 110 V. is to be regulated. If lower voltage and current loads are to be regulated, the load resistance may be tapped as in a potentiometer. Of course it is imperative that the D.C. supply voltage should be somewhat in excess of the voltage ratings of the regulator tube.

Where higher voltage regulation is desired, two or more of the WL-706 tubes may be connected in series (Fig. 2C). In a similar manner, if higher currents are to be regulated or if a finer degree of regulation is desired, two or more tubes may be connected in parallel (Fig. 2D).

Our Information Bureau will gladly supply manufacturers' names and addresses of any items mentioned in RADIO-CRAFT. Please enclose a stamped and self-addressed envelope.

**NONE HAVE DARED...
-to Build Sound Amplifiers
with "HUSHED POWER"
Performance!**



"HUSHED POWER"

—one of many exclusive VOCAGRAPH features

"Hushed Power"—provides more usable watts from the same rated power output—thus giving you more sound per dollar invested.

"Hushed Power"—performance is secured by new circuit design and balancing stage gain to give greater output with fewer tubes. These tubes are operated at lower ratings, thus reducing noise and overload.

"Hushed Power"—results are not guesswork. Every VOCAGRAPH amplifier must pass tests for gain, output, and wave-form on the beat-note audio oscillator, power level indicator, cathode-ray oscillograph, and General Radio's finest wave-analyzer.

Series 40 Line—offers these additional features: Built-in monitor speaker; Dual tone controls; All plug-in connectors; Illuminated control panel; and modern streamlining. Write for full description.

**New VOCAGRAPH
Sound Systems**

**Combine—Startling Performance
Lowest Cost**

Here is the answer to your sound problems! Quality performance at a new low cost.

You ask how it is done, for NONE HAVE DARED to take such a revolutionary step. Only VOCAGRAPH, with the advantages of "Hushed Power" design and modern production methods, can afford to offer so much performance per sound dollar.

The new VOCAGRAPH line was designed today—for tomorrow's needs—overcoming the usual time-worn engineering and production handicaps.

The complete line contains over twenty models in separate chassis, semi-portable and fully portable systems.

Write today for your copy of the new engineering bulletin, "NONE HAVE DARED," and the complete VOCAGRAPH catalog.

ELECTRONIC DESIGN CORPORATION

162-D N. May Street, Chicago, U.S.A.



Send at once new VOCAGRAPH engineering bulletins, complete catalog, and dealer net prices

**Clip and
Mail
Today**

Name

Address

City State

**A CIRCULAR-IMAGE
CATHODE-RAY TUBE**

(Continued from page 75)

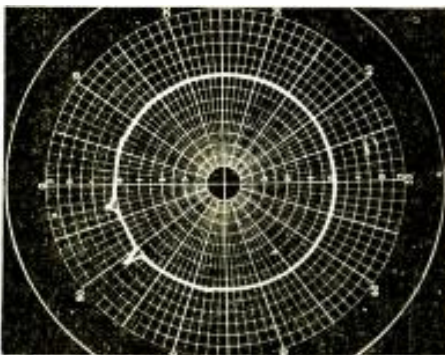

Fig. 2. A one-millionth-second impulse is here indicated at a frequency of 7.6 megacycles.

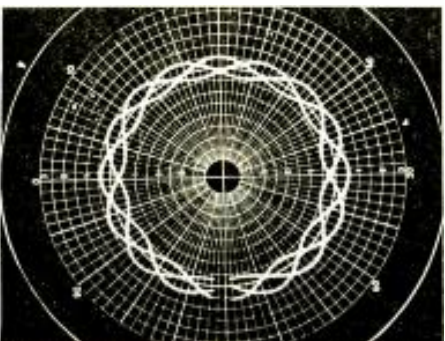

Fig. 3. A waveform is here shown extended to 3 cycles for more detailed analysis.

While passing between the plates of the coaxial condenser (see diagram), the beam is "pulled up and down"; of course in radial direction, i.e., from the center axis of the tube towards the wall of the tube, and vice versa. It is not necessary to be a scientist to realize that this "cone condenser" in its very principle is nothing but an element replacing the second pair of plates usually found in cathode-ray tubes, to force the beam into vertical motion.

It is quite logical that a rotating beam "pulled up and down" in radial direction must appear upon the fluorescent screen in the form of a circle which is "decorated" by the wave pattern. As the illustrations, Figs. A and 1, indicate, this is actually the case.

USES OF CIRCULAR OSCILLOGRAMS

1.—Continuous Patterns. The first advantage we observe by operating with a revolving beam is the fact that oscillograms without any gap may be obtained, which is of great importance in the instance of fast-changing electric fields.

In the case of present-type C.-R. tubes, important indications may be lost because they appear by accident during the "backtrace" of the beam; since there is no gap but rather constant registration in this new "polar-coordinate" C.-R. tube, an important advantage (use of the backtrace) is obtained.

2.—Long-length Pattern. The second advantage of the new cathode-ray tube is the fact that the length of the oscillogram is about 3 times as long as the beam of an ordinary tube of the same size which "paints" the curves to be registered in a horizontal direction across a fluorescent screen.

This is easy to understand because we know from our school mathematics that the circumference of a circle is 3.1416 times as long as its

(Continued on page 107)

EFFICIENT

RELIABLE

MODERN



KEN-O-DRIVE

The Modern Answer to Critical Driver Operation

KEN-O-DYNE

The Precision Method of Matching Output Tubes to Speakers

KEN-O-LINE

The Efficient Coupling Device From Universal Line

Ask Your Dealer For Our 16 Page "T" Line Catalog Which Contains A Large Selection Of Modern Audio Circuits.

KENYON

TRANSFORMER CO., Inc.
840 Barry St., New York, N. Y.

Export Dept., 25 Warren St., New York, N. Y.

Please Say That You Saw It in RADIO-CRAFT

the AMPERITE VELOCITY with NEW DESK STAND

Ideal for desk, pulpit, footlights, banquets. Leaf spring suspension acts as shock absorber. **STAND ONLY** LIST \$4.00 **NAME PLATE** with call letters . . . LIST \$2.00

MICROPHONES: Model RBHn (High Imped.) or RBMn (200 ohms) with cable connector & switch . . . LIST \$42.00 Model RBSn, RSHn, with switch only . . . LIST \$32.00



NEW "HAM MIKE"

No Peaks! No Splashing! Real Broadcast Quality! RF Choke Circuit included in microphone. Output, -68 db. Operates directly into grid. **MODEL HAM** (High Imped.) or **MODEL HAL** (200 ohms) . . . Gunmetal. LIST \$22.00. Chrome LIST \$23.00. Price includes Ham Desk Stand, Call Letters, and 6 feet of cable.

MODEL RAL \$22.00 LIST

A popular Amperite Velocity of very high excellence. Used for both speech and music. No peaks. Flat response over audible range. Output, -68 db. Triple shielded. Shock absorber, swivel bracket. **MODEL RAL** (200 ohms) or **MODEL RAH** (2000 ohms) high impedance . . .



FREE: Window Decal & Window Display

AMPERITE Co. 361 BROADWAY, N. Y.

AMPERITE Velocity MICROPHONE

Doing a world-wide job....

little giant

COMPACT Dry Electrolyte CAPACITORS

So small . . . efficient . . . completely equalling standard sizes in dependability! All usual capacities; two ratings, 450 v.w. and 200 v.w. You won't believe your eyes!

SOLAR MFG. CORP.
599-601 Broadway, New York, N. Y.

Vest Pocket Adding Machine

Sturdy Steel Construction, Lifetime Pocket Companion. Adds, Subtracts, Multiplies, Divides. Capacity, 999-999.99. A real machine—guaranteed 5 years. Send name and address. We ship immediately. On delivery, pay postman \$2.50 (plus few cents post-charge). (Foreign countries send cash.) Your money back after 10 days trial if not satisfied. Thousands of satisfied users. Total Send for Special Offer. Cost per to agents.

Free Trial \$2.50



TAVELLA SALES CO., 21 West Broadway, New York, N. Y.

HAVE YOU SOME SPARE ROOM

a basement or garage where you can do light work? We can offer you a profitable proposition lasting 5 and 10c. Norelites, Ashtrays, Toy Automobiles, etc. as manufacturer for firm of many years standing. No experience necessary as we furnish full instructions with moulds. If interested in devoting your spare or full time to profitable work and you mean strictly business write AT ONCE for full details as we are now choosing arrangements for supply of our goods.

METAL CAST PRODUCTS CO.

Dept. 26, 1696 Boston Road, New York, N. Y.

THE DELTA-T PAD — INEXPENSIVE P.A. CONTROL

(Continued from page 94)

schematically shown in Fig. 2. We have renamed the last-mentioned network the "Delta-T" Pad because it is a combination "Delta" circuit and "T" Pad. The attenuators are shown inserted in a line having Z-ohms impedance. Under these conditions the impedance is constant and equal to Z ohms looking in the arrow direction from the source regardless of control setting. This is indicated on each sketch.

Figure 3 shows the physical layout of the 3 types of control. Notice that both the "T" Pad and "x" Pad use 3 variable resistors in tandem. The "Delta-T" Pad incorporates 2 variable resistors and 2 small fixed resistors to accomplish the same results. The economy of this control is apparent from the construction.

HOW THE "DELTA-T" MAINTAINS CONSTANT IMPEDANCE

By properly tapering the 2 variable-resistance sections of the "Delta-T" Pad (shown as C and D in Fig. 2C), constant impedance is maintained in both directions through the control. Both small fixed resistors have the same resistance in ohms as the line impedance. In the extreme counter-clockwise, or "off" position, the resistance value of D is zero and C is open-circuited, thus the fixed resistor Z is directly across the line to match the source impedance. In the extreme clockwise, or "on" position, resistor C is short-circuited and D is open-circuited. Under these conditions the control is not in the circuit, since there is zero series resistance and the shunt resistance is open-circuited. The source works into the load impedance alone. This means that the control has zero insertion loss.

Figure 4 illustrates the actual impedance and attenuation characteristics of a 50-ohm pad. In this case the load impedance is also 50 ohms. A perfect control would have an impedance

curve as shown by the dotted line. The actual curve varies so little that the difference is unnoticeable. A perfect attenuation curve is also a straight line. The attenuation decreases (or the volume increases) in direct proportion to the knob rotation. The actual attenuation curve is so close to a straight line that the difference is negligible.

The "Delta-T" Pad can be used in series, in parallel, or series-parallel mixing circuits, as a gain control at the amplifier input, or in any low-impedance attenuator circuit. The power level limit at which the unit can be operated is plus 22 db. above zero level or 1 W. Cases are rare when a higher level than this will be encountered in input circuits. The "Delta-T" Pad is designed for this service.

This article has been prepared from data supplied by courtesy of Centralab.

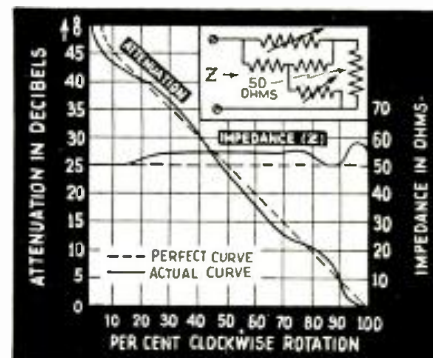

Fig. 4. Impedance and attenuation characteristics of a 50-ohm pad.

A SUPERSONIC "FOG SHAKER"

(Continued from page 74)

dust particles), chemical warfare smoke screens, and even cigarette smoke were quickly flocculated by the sound.

Although all experiments performed to date have been on a laboratory scale engineers-scientists hail the discovery as containing the answer to the fog problem chiefly because directional beams of powerful supersonic waves are capable of extreme amplification by existing methods. More accurately, a central "beam" of sound can be confined to a cone of small angle.

Recently a room filled with heavy tobacco smoke was quickly cleared of smoke particles by sound-wave flocculation. In this tobacco smoke experiment any possible effect of standing waves as produced within the glass tube of the original experiment, was avoided. Given a sufficiently powerful supersonic or high-frequency sonic generator there is every reason to believe that the same effects can be obtained on a larger (out-door) scale.

Until this or a similar discovery finds application, a few quarts or gallons of water dispersed as fog will continue to ground planes and bottle up shipping.

NATURE OF SUPERSONIC WAVES

Inaudible vibrations usually below 25 cycles per second are known as *subsonic* or *infrasonic* while those above audibility (20,000 cycles per second), fall under the heading *supersonic* or *ultrasonic*. Normal range of hearing extends roughly from 20 to 20,000 vibrations per second.

Biologists have often wondered whether animals produce sounds above the range of human audibility in the range of supersonics. They have noted that a humming bird continues to sing above the point where sound is audible. These vibrations amplified and heterodyned or combined with a vibration of a different frequency, give an audible vibration in a radio loudspeaker. By this means it has been found that the main frequency produced by crickets is 5 octaves above middle C on the piano or 8,000 vibrations per second. Other strong vibrations occur at 16,000, 24,000 and 32,000. Anyone dialking the audible sound of the cricket should consider themselves

fortunate in not being able to hear the "loudest" part.

This supersonic world is a weird one especially during a high wind. Scientists have listened-in to vibrations emitted by leaves resulting from wind action. Rubbing of clothing or hands can be heard a considerable distance away. Interesting effects are obtained by igniting a match. The ticking of a watch can be identified up to 30,000 vibrations per second.

The first use of supersonic waves was made by Prof. P. Langevin of Paris although Lewis Richardson suggested their use previously, just after the collision of the Titanic with an iceberg in 1912. The Langevin acoustic oscillator appeared in 1917. It was based on the discovery by Curie that if a disc of natural quartz was compressed its faces became oppositely electrified, the electric charges being reversed if the disc was subjected to tension instead of compression.

If a slice is cut from a crystal of quartz by first cutting perpendicular to the long axis of the crystal and then cutting a slice from this with faces parallel to the long axis and perpendicular to a pair of faces, application of an alternating difference of potential will produce a periodic change in its thickness. Placing the free face in contact with air, water, oil, or any fluid, supersonic waves may be generated in the fluid.

If optical wavelengths—ordinary light waves—are compared with their acoustical relatives, the supersonic waves, the differences will be found to be almost infinitesimal. Both exhibit the phenomena of refraction and reflection. If this resemblance is a close one as indicated, supersonic waves should affect photographic plates exactly as light rays do. Evidence has been forthcoming that this actually is the case.

Other methods for the production of supersonic waves include large sirens and similar large-volume-sound producers such as whistles and the Hartmann device. Magnetostrictive vibrators as used by St. Clair are also transmitters similar to the ordinary electromagnetic telephone. This latter device was used with considerable success for underwater signaling during the World War.

Please Say That You Saw It in RADIO-CRAFT

Recent applications include the sonic marker beacon for fog aviation (between 2,000 and 4,000 cycles).

Langevin observed in the course of his marine signaling experiments that fish entering a beam of high-frequency sound waves were, in some instances, killed as a result. Led by this observation many experimenters have studied the biological effects of such vibrations. Effects such as the arrest or retardation of beating of an exposed, isolated frog's heart and embryonic heart of a chick, and increase in agglutinating power of certain streptococci are reported examples.

If intensive sound beams are used to combat fog it will become necessary to make a thorough check of their physiological effects including a possible lethal action. Fortunately transport planes are sound proofed although it may be necessary to sound proof even more effectively.

Engineers hope to be able to shoot holes through a 5,000 foot fog so that beacon lights will be visible to a pilot flying well above the fog.

These lights from the proper altitude would serve to outline the boundaries of the air field. In addition any efficient system of fog dispersion should be capable of keeping the immediate landing area clear and free of fog.

In the meantime, metallurgical applications such as the settling of smelter dust can be very efficiently and inexpensively made of St. Clair's discovery. An annual saving amounting to millions of dollars is indicated by application of supersonic waves to this field.

EARLY ATTEMPTS TO DISPERSE FOG

Long ago an English physicist by the name of Aitken showed that a drop of moisture can form only around a tiny particle such as make up dust. Without dust there can be no clouds of fog. In spite of the fact that the presence of dust particles is vital for the formation of fog, many attempts to clear up fog have been made by adding more particles to the air. One such attempt involved the use of electrified sand scattered through fog banks from an airplane. Since electrified particles tend to repel each other, it is entirely possible that fog particles similarly charged act in a like manner. Electrified sand successfully dissipated fog, perhaps by neutralizing the charges sufficiently to cause flocculation. Obviously the cost of electrifying enough sand together with the necessity of sprinkling it from airplanes, in order to clear an area of any appreciable size, was far from practical.

Anyone of an observing nature may have noticed the clear areas along a seashore during a fog. Sea spray liberates tiny granules of salt which are very hygroscopic or in other words, readily able to absorb moisture. The rapid evaporation of sea spray releases a by no means inconsiderable amount of salt of this character.

About 3 years ago something resembling sea spray in its effect, was tried at the Round Hill, Massachusetts, estate of the late Col. E. H. R. Green where fog drifting in from Buzzards Bay is a frequent visitor. Colonel Green, son of the famous Hetty Green, activated by a great interest in science, was noted for his assistance to just such projects as this of fog dispersion. The apparatus as set up was devised by Henry G. Houghton, Jr., of Mass. Inst. of Technology. It consisted of a system of pipes and nozzles

suspended 30 ft. above-ground for a distance of 100 ft. from which chemicals could be released in a fine spray.

A disagreeable, thick fog sweeping in from the Bay was the favorable occasion for the first experiment beyond that of a laboratory scale. When Houghton turned on his chemical spray, fog disappeared leaving a clear lane about 100 ft. wide for a distance of 2,000 ft. surrounding the pipes. This was the greatest success achieved in the history of fog-clearing. Regardless of such evidence of success no one rushed forward to apply Houghton's fog-eliminating system.

Karl T. Compton, President of M.I.T., has stated that, "A method has been invented and tested during the past 2 years which is successful in dissipating fogs created artificially in the laboratory and which gives reasonable promise of being capable of development to produce clear patches or holes of a few thousand sq. ft. in area in a natural fog.

"Preliminary plans have been made for equipment to open a permanent hole through a fog through which a beam may be sent into the clear sky above the fog or which may be used as a landing lane, and other apparatus for opening the fog for a limited region ahead of a ship or below a flying plane. Although this development is still in the laboratory stage, the problem of economy and safety in transportation through fog is so great as to justify the attempt practically to develop any proposal like this one, which has successfully met theoretical and laboratory tests."

Other methods of "precipitation" or removal of particles suspended in gas are known, but are not applicable to large scale operations involving large volumes of air or gas. The Cottrell process, one such method, uses a strong electric or so-called static field. A more recently announced electrostatic precipitator, devised by G. W. Penney of the Westinghouse Laboratories, is slated to be of reduced size, voltage and power requirements also to give a reduction in the formation of ozone and nitrogen compounds.

G. R. Tatum, of the Cruft Laboratory, Harvard University, was able to clear up water vapor, titanium tetrachloride (aerial smoke screen), and cigarette smoke by means of apparatus almost identical with that used by St. Clair thus corroborating the original discovery. All 3 represent future commercial applications (1) dispersion of fog, (2) chemical warfare use, and (3) smoke-free theaters and smoking rooms.

The Chemical Warfare Service interests itself solely in substances producing powerful physiological action such as irritation of the lungs, inflammation of body tissue or a copious flow of tears, act as a screening smoke or have incendiary action. Only about 12 practical war gases, 6 screening smokes and 3 or 4 incendiaries are known.

Typical smoke screens include the black oil fuel smoke emitted from destroyer funnels, white phosphorus smoke of artillery shells and the dramatic and picturesque curtain dropped from airplanes in the form of titanium tetrachloride.

Supersonic waves will eventually be used, it seems, to clear a path through "solid" smoke screens for the purpose of locating the enemy.

(The author of this article was formerly Associate Metallurgist, U. S. Bureau of Mines. —Editor)

A CIRCULAR-IMAGE CATHODE-RAY TUBE

(Continued from page 105)

diameter. Expressed in other words, a greater number of patterns may be made visible by use of the same screen size.

Polar-Coordinate Oscillograms. The third advantage of the new oscilloscope tube is the polar-coordinate diagram printed upon the outside of the fluorescent screen.

The diagram is divided into 100 radial sections. This diagram is an important help for time measurements, etc., because the number of revolutions executed by the beam in each second divided by the number of radial sections (covered by the curve which is reproduced), indicates the time in tiny split parts of a second.

Let us take an example when the beam rotates at 200,000 revolutions per second—the curve then reproduced upon the screen covers only one segment of the radial screen division. It is easy to find that the length of time "covered" by the oscillogram in question is 1/200,000 divided by

100, which gives 1/20,000,000 second—a time as yet not measurable with such great ease on any other instrument.

This time measurement, when explained in terms of radio technique corresponds to a frequency of 20 megacycles (mcs.). If only a section of the tube screen is covered by the curve plotted we register a frequency of 40 mcs.; and when only a third of a radial section is covered by the curve, the time indicated is exactly 1/60,000,000 second. This value corresponds with a frequency of 60 mcs. or expressed in meters it equals a wavelength of 5 meters.

To make these measurements more exact, provisions are made to vary the diameter of the circle painted behind the fluorescent screen. A simple variable resistor in the plate circuit of the oscillator tube which feeds its current into the "beam-rotating-device" of the cathode-ray tube does the trick without great difficulty.

Every
RAYTHEON TUBE
is Tested Over
87 Times!

RAYTHEON
TRADE MARK

Raytheon production methods are the most scientific and accurate in the tube industry. Every Raytheon tube is checked more than 87 times during production!

To insure uniform quality of raw materials, Raytheon employs metallurgists, chemists and engineers of all kinds to check and re-check every piece of material used in a Raytheon tube. The Raytheon tubes you sell your customers are right. Used and demanded by all leading radio parts dealers and servicemen.



RAYTHEON PRODUCTION CORPORATION
 420 Lexington Ave. New York, N. Y.
 445 Lake Shore Dr. Chicago, Ill.
 55 Chapel Street Newton, Mass.
 555 Howard St. San Francisco, Cal.
 415 Peachtree Street, N. E. Atlanta, Ga.

Please Say That You Saw It in RADIO-CRAFT

DON'T!

BUY ANY AMPLIFIER OR P. A. SYSTEM

until you read our bulletin describing a new line of 1938 advanced amplifiers designed by A.C. Shaney with such revolutionary features as,

- Cathode-Drive Amplification
- Automatic Feedback Suppression
- F. V. F. B. Beam Power Amplification
- Automatic Audio Volume Control
- Floating Audio Power
- Automatic Volume Expansion
- Plus many other exclusive features.

Our Amazingly Low Prices, FREE TRIAL OFFER, and Usual FIVE YEAR GUARANTEE Make It Well Worth Your While to Write To-Day for Free Bulletin No. PA 887. Free P.A. Consulting Service.

AMPLIFIER CO. of AMERICA
37 West 20th St., New York, N.Y.

FACTORY TO YOU

NEW REMINGTON NOISELESS PORTABLE!



10¢ A DAY

Famous Remington Noiseless Portable that speaks in a whisper, only 10c a day, direct from factory. Standard keyboard. Automatic ribbon reverse. Variable line spacer and all the conveniences of the finest portable ever built. PLUS the NOISELESS feature. Act now. Send coupon TODAY for details.

You don't RISK a Penny

We send you Remington Noiseless Portable for 10 days' free trial. If not satisfied, send it back. We pay all shipping charges.

FREE Typing Course and Carrying Case

You will receive FREE a complete simplified home course in Touch Typing. Also FREE, a handsome, sturdy carrying case. No obligation. Mail coupon for full details—NOW

Remington Rand Inc., Dept. 189-8
815 Fourth Ave., New York, N.Y.
Tell me, without obligation, how to get a new Remington Noiseless Portable, plus Free Typing Course and Carrying Case, for 10c a day. Send Catalogue.

Name.....
Address.....
City..... State.....

PATENTS—TRADE MARKS

All cases submitted given personal attention by members of the firm.

Form "Evidence of Conception" and instructions

"How to Establish Your Rights"—Free

LANCASTER, ALLWINE & ROMMEL

PATENT LAW OFFICES

436 Bowen Bldg. Washington, D. C.



"HAM" SPECIAL Standard Teleplex

A highly efficient code teacher using heavy specially prepared waxed paper tape, having two rows of perforations. Write for Free folder A8.

We are the originators of this type instrument

TELEPLEX CO.

Instrument with tapes prepared by expert and complete course; all for \$11.95. Without Oscillator. 72-76 Cortlandt St., N. Y. C.

FOR TEST EQUIPMENT—BUY RCA

RCA makes all types of test equipment—including the popular Cathode Ray Oscillograph and Oscillator. RCA Test Equipment is used in the RCA instrument factories—by major set manufacturers and thousands of service engineers—proof that it's good! Available at moderate cost. For full details write to Parts Division, RCA Manufacturing Co., Inc., Camden, New Jersey. A service of the Radio Corporation of America.

THE LATEST RADIO EQUIPMENT

(Continued from page 93)

WIRED INTER-OFFICE SYSTEM (1435)

THIS 4 tube "Vocal" unit is of the selective call and selective talk type. Dial connection of remote station. The talk-listen key is used once the dial system has established connection. The unit is provided with busy signal. Inter-station conversation is strictly private at all times.

NEW ANALYZER INCLUDES WIDE-RANGE SCALES (1436)

(The Clough-Brengle Co.)

DIRECT-READING capacity scales on this new "Super-Unimeter" cover all values from 250 mmf. to 16 mf., in 3 ranges. Resistance ranges are said to allow "accurate measurement" of values from 1/2-ohm to 20 megs., in 5 ranges. Voltage range: 0/5/50/500/1,000, D.C.; 0/8/40/160/400/800, A.C. Current: 0/50/500 ma., D.C. Available in both portable and 10-in. relay rack mounting types. Built-in power supply.

30-W. ALL-PURPOSE 110-V. A.C. AND 6-V. D.C. SOUND SYSTEM (1437)

(Webster-Chicago)

THE COMPLETE sound system consists of a 30-W. amplifier with phono turntable, new-type crystal microphone, and 2 heavy-duty permanent-magnet speakers. The only change needed from 6-V. D.C. to 110-V. A.C. is to change the plug-in type power pack.

NEW VELOCITY MIKE UTILIZES "DEFLECTORS" (1438)

A NEW principle in microphone design which tends to amplify the pick-up angle in front of the microphone and reduce it at the rear, thus enabling a wider angle of pick-up and yet reducing the danger of feedback from the reverberated sound waves, has been developed. As a result, two of these microphones are said to adequately serve an area previously requiring 3 microphones of the same general type.

Modernistic design. Available with a thumb-operated switch (shown at bottom of unit) designed to prevent accidental throw. Output, -65 db.; frequency response, 50 to 12,000 cycles. This model AM unit is available with the following characteristics: type HP, high-pitched and high-impedance (from normal P.A. pick-up); HF, high-fi and high-impedance (for distant pick-up); CT, close-talking and high-impedance (for announcing); LI, high-fidelity and 200-ohms impedance (for distant pick-up, low-impedance input).

VIBRATION TEST PROD (1439)

(Sundt Engineering Co.)

SO SENSITIVE it will pick up the vibrations from the escapement of a wrist watch, yet so rugged it will withstand vibrations up to



New multi-purpose tester claimed to be equivalent to 11 separate instruments. (1440)

1/16-in. amplitude, is a feature of the new model 156 inertia-type crystal vibration pick-up (prod only—which is here shown in use, and connected to an oscilloscope).

The bimorph crystal used in this model is mounted inside of the aluminum case and has no direct mechanical connection with the prod. When the case (which weighs only 4 ozs.) vibrates, the crystal flexes of its own inertia and sets up voltage impulses of exactly the same waveform as the mechanical motion. The response is practically linear up to the resonant frequency of 2,500 cycles. The output sensitivity is relatively high—2 V. r.m.s. with 0.001-in. motion at 400 c.p.s. An 8-in. duralumin test prod is provided.

A partial list of applications on which vibration study with this set-up may be used includes: Production testing of electric motors, ball bearings, crankshafts, gear trains, fans, air-conditioning equipment, and locating source of vibration in reciprocating or rotating machinery; checking relative smoothness of surfaces, such as paper, polished metal, gauges, glass plate, etc., checking longitudinal rods for fracture, and the relative efficiency of materials for deadening sound.

MULTI-PURPOSE TESTER (1440)

(The Triplett Electrical Instrument Co.)

COMBINED in this one instrument is said to be the equivalent of 11 separate units. Checks any type tube for worth. Neon short test (for shorts and opens). Separate diode test. Metered paper condenser test. Electrolytic condenser leakage test. D.C. voltmeter; D.C. milliammeter; A.C. voltmeter; Ohmmeter; Decibel meter. Free point tester. Tube testing is by the approved power output emission method, providing complete tests for any type tube. Case measures 15 3/4 x 11 1/8 x 7 1/2 ins.

SEMI-BALLAST TUBE TESTER SEGREGATES READINGS (1441)

(L & L Electric Co.)

A NEW "semi-ballast" circuit is incorporated in this tube tester which allows both even and correct tube readings to be obtained. Weak-tube indications are driven well back into the BAD area and satisfactory tubes read at one point in the GOOD sector.

Of interest to Service Men in rural areas is the fact that this instrument may be adapted to test battery tubes where line power is not available.

Instrument has a "filament selector return switch" which permits filament to be placed on any one of 8 tube elements. Tube elements terminate at 8 toggle switches; in combination with the filament selector switch this permits free-reference-point test, hot-test for shorts and leakage on neon; high-resistance-open element test on neon. An 11-point tap switch affords line voltage regulation; meter indication. Etched metal panel; wood case.

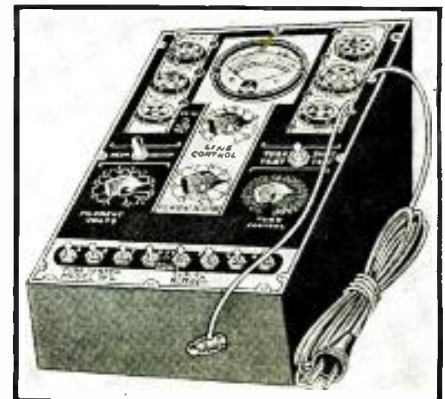

Tube tester with "semi-ballast" circuit, permitting uniform, correct readings. (1441)

Please Say That You Saw It in RADIO-CRAFT

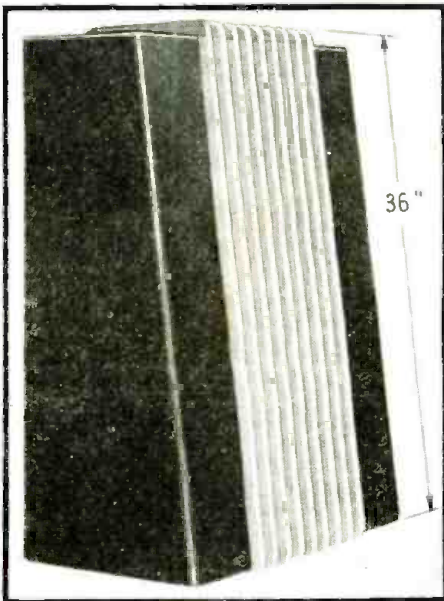

Streamlined, 50-W. reproducer uses cavity resonance to improve low-note response. (1443)

NEW TUBE TESTER HAS 5-YR. "INSURANCE"
(1442)
(Radio City Products Co.)

SERVICE MEN will be greatly interested to learn that the model 306 tube tester, here shown, is guaranteed by the manufacturer against obsolescence prior to September, 1942—for all new American receiving tubes developed that have the same bases and filament voltages as those in use in July, 1937. This 5-yr. insurance against the possibility of the test equipment becoming out-of-date is a welcome departure.

Of further interest is the fact that this new policy is also applicable at only a nominal service charge in the event that tube designs vary radically from present standards; new tube sockets as necessary will be installed and wired-in at a cost not exceeding \$5.00; and, if necessary to accommodate new plate and filament voltages, a new transformer will be installed and wired-in for \$9.00 or less.

This tube tester checks all glass and metal tubes so far designed; provision is made for all "ordinary" future types. Indications are English-reading under R.M.A. rated-load conditions. Tests all elements of all tubes including cold-cathode-type rectifiers. Both neon and meter tests of hot cathode leakage; neon indication (sensitivity, 1/4-meg.) of hot inter-element shorts and leakage. Free-reference-point element test without recourse to selector switches. Incorporates meter test of line voltage. Includes resistance, capacity, and condenser-leakage measurements; in portable-counter combination, and in kit models; and in 25-cycle and 220 V. 50-cycle operation (at slight additional cost).



New, versatile tube tester guaranteed for 5 years against obsolescence! (1442)

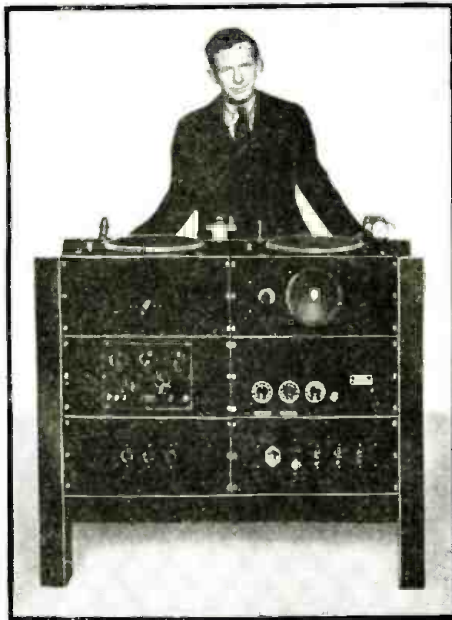

Portable 30-watt, P.A. theatre system. (1444)

STREAMLINED LOUDSPEAKER UTILIZES CAVITY RESONANCE
(1443)

(United Sound Engineering Co.)

NORMALLY, an enclosed baffled loudspeaker would raise the resonance point and destroy the low-frequency response. However, the cavity of the new streamlined cabinet here shown is so designed that it raises the frequency of resonance only 10 cycles above the resonance point of speaker diaphragm operation without a baffle and, as a consequence, this unit has actual frequency response even below 100 cycles.

Power handling capacity of the standard "302" is 15 W. Cabinet dimensions are approximately 36 x 23 x 15 ins. The cabinet is finished in "telephone black" and ivory, and can be used for either wall-mounting or portable work. (Complete sound systems designed to utilize the characteristics of this reproducer to best advantage are available from the same manufacturer.)

PORTABLE THEATRE SOUND SYSTEM (1444)

(Wholesale Radio Service Co., Inc.)

DESIGNED for the Ziegfeld Follies on tour, is this new 30-W. hi-fi sound system. The installation is completely assembled on a frame of steel channels, and incorporates a model 263-A 30-W. high-fidelity amplifier, a model 203-A triple-input electronic mixer-fader, twin turntables using 2 RCA pickups, model 402-A monitor speaker with its own gain control, individual and overall volume controls, tone controls and necessary equipment so necessary for stage flexibility.

DOUBLE PE. RECORDER AIDS IN CRIME DETECTION (1445)

(General Electric Co.)

A PHOTOELECTRIC instrument which will record simultaneously on one chart, 2 electrical quantities as low as 1 microampere, full-scale, and representing a power consumption of but 0.000000001-W. from the measured circuit, has just been marketed. It is designated the "double photoelectric recorder."

The double photoelectric recorder can be applied wherever simultaneous readings are desired. In some cases this immediately cuts testing time in half and in others it aids materially in discovering unusual relations between 2 variable electrical quantities. This recorder is the outgrowth

Handy...and for 1000 Uses

Size:
3-1/16" x
5-3/8" x
2-1/8"

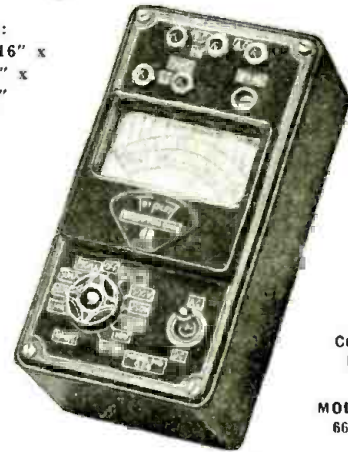

Completely Insulated
MODEL 666

Dealer Price **\$15.00**

AC - DC
Pocket Volt-Ohm-Milliammeter

For laboratory, shop or field use. Handy pocket size yet sturdy and precision built.

Uses Large 3" Sq. Triplet Instrument.

AC-DC Voltage Scales Read: 10-50-250-500-1000-volts at 1000 Ohms per volt.

DC Milliampere Scale Reads: 1-10-50-250.

Ohms Scales Read: Low 1/2-300; High 250,000.

Black Molded Case and Panel.

Low Loss Selector Switch.

Complete with Alligator Clips, Battery and Test Leads.

DEALER PRICE \$15.00

A Complete Instrument for all servicing needs. Can be used for all AC-DC voltage, current and resistance analyses.

Leather Carrying Case, Model 669, supplied extra. Of attractive black, heavy leather with finished edges and strap. Dealer Price \$3.00

SEE YOUR JOBBER WRITE FOR CATALOG



The Triplet Electrical Instrument Co.
168 Harmon Ave., Bluffton, Ohio
Without obligation please send me
More information on Model 666.
I am also interested in
Name
Address
City State

Please Say That You Saw It in RADIO-CRAFT

IT'S HERE AT LAST! A TUBE TESTER

that can't get out of date

We've studied every development in tubes since radio began—looked into every potential change in tubes in the future—and we're here to say that at last you can have a tube tester guaranteed against getting out of date. How is that possible? The new Dependable Tube Tester is the most flexible instrument of its kind ever produced. And it's not only attractively designed and sturdily constructed, but it's priced amazingly low. Get complete specifications and technical details—today. Be sure to mention Model 306.

RADIO CITY PRODUCTS CO.
88 PARK PLACE
NEW YORK CITY
"DEPEND ON
DEPENDABLE"

**CRYSTAL
HEAD PHONES**
**SOUND CELL
MICROPHONES**
Information on request
THE BRUSH DEVELOPMENT CO.
3312 PERKINS AVE • CLEVELAND, OHIO

ON THE BOARDWALK
ATLANTIC CITY
**HOTEL
KNICKERBOCKER**

IN THE HEART OF ALL
RESORT ACTIVITY

FIREPROOF CONSTRUCTION
AMERICAN & EUROPEAN PLAN
SALT WATER BATHS

ROOM AND BATH FROM \$3.50
AMERICAN PLAN FROM \$6.00

C. HENRY LANDOW, Manager

Get into
RADIO
REAL
JOBS
REAL PAY

**Earn While Learning
at Home!**

Television, Photo Electric
Cells, Public Address
Many R-T-I Trained Men
make up to \$75 a week
and more in full-time ra-
dio jobs—\$5-\$15 in spare
time alone. More trained
men needed. Learn at
home by quick, easy,
R-T-I way.

PHILCO
CROSLLEY
ZENITH
GRUNOW
and 46
other
mfrs.
endorse
R-T-I

R-T-I WAY. Endorsed by 50 big concerns. Write for
the Opportunity Book FREE. **RADIO and TELEVISION**
INSTITUTE, Inc., 2130 Lawrence Ave., Dept. 22-C, Chicago, Ill.

FREE RADIO CATALOG
1001 BARGAINS
Here's the greatest guide to radio buying in the
world. Remarkable values in receivers, parts, public
address systems, amateur equipment, etc. Don't
buy a thing in radio until you get your free copy
of this catalog.
WHOLESALE RADIO SERVICE CO., INC.
103H SIXTH AVE. NEW YORK, N. Y.

of the original photoelectric recorder which has become familiar to electrical and mechanical engineers, physicists, and others, including physicians, and scientific crime-detection specialists.

ORNAMENTAL ROOF-TOP ANTENNA (1446)

WHAT is claimed to be the first ornamental aerial for automobile roof-top installation, is here illustrated. In addition to it being modernly styled in the streamline vogue, and to enhance the beauty of a car, this new antenna affords increased efficiency as compared to antenna types which do not present as great elevation above the roof of steel-top cars. Fits all makes of cars regardless of whether the windshield opens. The manufacturer calls this the "Clipper" car-roof aerial.



This antenna is both artistic and "sensitive." (1446)

Manufacturer has not furnished frequency range.)
Black finish.

STREAMLINED MECHANICAL PICKUP (1447)

IN ADDITION to its eye appeal this new magnetic pickup incorporates the following features: (1) critically-damped armature, which completely eliminates resonance peaks and transient response; (2) bearing and arm design coordinated so as to maintain compensated bass response and smooth tracking; (3) inherently light construction which eliminates need for counterbalancing and detrimental inertia effect; (4) vibration-free bearings; (5) both vertical and lateral stops; (6) 80-deg. pivoting of vertical bearing makes needle changing easy. (Manu-



Above—new magnetic pickup is streamlined. (1447)
Right—this pocket-size A.C.-D.C. test unit is 6 1/2 ins. high. (1448)

POCKET A.C.-D.C. TEST UNIT (1448)

(Try-Mo Radio Company, Inc.)

A VERSATILE instrument for the Service Man or experimenter is the new Elgin model 801A pocket volt-ohm-milliammeter. Unit is compact—can be carried in coat pocket. Baked enamel finished case of welded steel measures 3 1/2 x 6 1/2 x 3 ins. Unit is said to utilize a "precision" 1,000 ohms/volt meter; self-contained battery; zero ohms adjustment; 2 colored scales make reading easier; instrument panel is engraved. Ranges: voltage, D.C.—0/5/50/500/1,000; A.C.—0/5 50/500/1,000. Current, D.C.—0/10/100/500. Resistance—0/500 ohms/0.5-meg.

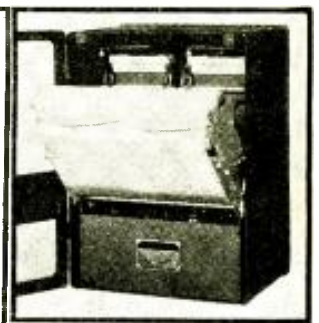

Above—scientific crime detection utilizes this double PE recorder. Normal and abnormal lie-detector recordings, for instance, may be made simultaneously. (1445)

THE PROJECTION KINESCOPE MAKES ITS DEBUT

(Continued from page 83)

tails by which the illusion of direct vision was accomplished.

The detailed construction of the newly-devised electron gun which makes this advance possible calls for specifications so rigid that the idea was nearly discarded as impracticable, when first proposed. A flood of electrons must be regimented into the solid column of a narrow beam, to "paint" the received picture more vividly on the fluorescent screen of the Kinescope. The electrons are "conditioned" for the job by being passed through 3 metal discs, each having an aperture in its center about the diameter of a pencil lead. Then, they pass through a 4th and last disc, similar to the others, but with an opening too small to pass a human hair! Electrons are made to pour through this tiny opening to the fluorescent screen at the tube's end. The bombardment is so intense that the light produced on the screen of the projection Kinescope may be spread over an area 100 to 400 times greater in a projected picture.

Although it is regarded in scientific circles as a distinct technical advance in RCA's television developments, engineering opinion is that Dr.

Law's contribution could not at this stage be incorporated in home television receivers. The achievement is possible only under special conditions employing special laboratory equipment. The intense bombardment by the electrons from this gun has required re-earch to produce a luminescent material to withstand it. This work continues.

This article has been prepared from data supplied by courtesy of RCA Mfg. Co., Inc.

RE: "VARI-VOLT TRANSFORMER" (1407)

The description of this unit last month, in the Latest in Radio department, erroneously credited this item to G.E. Co. It is manufactured, instead, by Halldarson Co.

This transformer affords many voltages, as selected by snapping various switches.

Please Say That You Saw It in RADIO-CRAFT

"TALKING PAPER" USES "ELECTRIC EYE"

(Continued from page 75)

pleted his researches in 1932. Different patents have been applied for, and granted, since this date, throughout the whole world, and more than 250 patent applications protect the interests of the company. (Principal patent, United Kingdom, 402,074 and 386,842, German patent DRP No. 614,829, etc., etc.)

PRINTING PRESS TURNS OUT "RECORDS"

The new invention, or rather the quite new industry, which is created by this invention, consists of the printing of the ordinary paper or newspaper in the form of a rectangular sheet of normal size. The printing is made in the ordinary way with ordinary printing ink, with the help of the ordinary printing plate, with only one difference:—that instead of characters you use *phonograms* which reproduce all sounds—such as voice, several voices, music choirs, etc.—in the most perfect condition.

The printing plate is very easily obtained by the well-known microphone combined with amplifier and oscilloscope, which register different sounds, voices and music, etc., on the negative, from which then is made the printing plate. The printing plate (one or several) is given to the printer (newspaper printer, or book printer), who prints from it the sound pages, or "talking paper." One hour after the voice or the music has been registered, you can get thousands and thousands of printed sheets which may be distributed like newspapers or like the so-called "talking books," etc., as the ordinary newspaper is distributed at present.

For reproduction from this printed paper of what it records, you need only put this paper in the "Fotoliptofono"—the trade name of the new apparatus—where, with the help of a photo-electric cell and ordinary radio apparatus, you obtain perfect reproduction of the voice, music, sound, etc., the quality of which is much better than can be obtained from phonograph records and even better than can be obtained from talking films. (It is probable that latest "transcription" record and sound-film technique modify this statement to a considerable extent.—*Editor*)

The sound paper record, during the reproduction, is not touched at all, because nothing but a beam of light strikes the phonogram of these printed sound records; hence, the sound record is practically indestructible.

The light beam replaces the needles of a phonograph. There are absolutely no noises, like the scratch of the needle with the phonograph. A phonograph record after having been used very little, even only 10 times, loses its quality (and the needles must be frequently replaced). The sound record never changes.

(It is claimed that the two edges of the paper match so perfectly there is no "click" at each revolution.—*Editor*)

The sound record of Fotoliptofono, which may be printed at the rate of 50,000 an hour, is condensed in one sheet of about 17 x 20 ins., contains what would be about 1/4-mile of phonograms if measured as one continuous length of wave-forms.

QUALITY OF SOUND

The quality of the printed record of Fotoliptofono is extremely high. As you know, the radio and the talking film have obtained wonderful results, and applied to Fotoliptofono these results have greatly improved the process of sound reproduction. The ordinary phonograph reproduces, generally, up to a frequency of about 3,500 to 4,000 cycles per second. A very good motion picture reproduces now up to about 5,000 to 6,000 cycles per second. The lowest frequencies that the ordinary home phonograph can take are about 200. The Fotoliptofono can easily offer with ordinary print about 7,000 cycles per second, but if they are put on the market 5,000 cycles, and even then the quality will be much higher than that of an ordinary phonograph record. The lower frequencies in Fotoliptofono may easily begin at about 16 cycles per second, instead of hundreds as with a phonograph.

APPLICATION OF THE INVENTION

The new industry which may be created by the Fotoliptofono may be applied, as far as we can judge now, in different ways.

Music Libraries. Musical programs, which have been till now served by phonograph records, will be advantageously replaced by Fotoliptofono. Instead of having a hundred phonograph records

weighing about 50 lbs., you will have 100 printed paper sound-records, which will weigh only 1 lb.

With the Fotoliptofono it may be possible to offer whole editions of music by all composers. For instance, you can have a Fotoliptofono music book for Chopin, Beethoven, etc., played by the best players, orchestras, etc., for a very low price—much cheaper than the printed music at present. In this way, the home-study of good compositions may be facilitated, etc., etc.

If you wish to have a special piece of music, it may be obtained at little cost. If you do not wish to be served by the menu offered by the broadcasting people, you may be served a la carte with Fotoliptofono.

Many people now have a good radio set, and it will be possible to obtain the inexpensive Fotoliptofono apparatus which will be connected to the radio receiver.

Sound Newspaper. The newspaper news and advertising, etc., may be made in part by sound pages. You will surely buy, in future, the so-called *Sound Edition* of a newspaper, in which the newspaper people will offer to the customer some printed sound, which will reproduce the talks of leading politicians, or eminent personalities, etc., or give pieces of music played at concerts, political gatherings, etc.

Advertising by sound pages in newspapers will become a separate and very powerful branch of commercial and also political propaganda. The procedure: just tear the sound section from the newspaper, place it on the cylinder of the reproducer, and listen-in!

Speaking Books. A quite new type of book will now be created, and even the authors will change their writing because, with the help of Fotoliptofono sound pages, there will be created a new writing technique. Imagine to yourself a Roman novel or tragedy, to which you can listen, and in which the heroes, women, children and animals speak by different voices; and the wind, rain, thunder, guns, machinery, etc., will be reproduced exactly as they are in reality. How useful it will be for plays which will be read by the Fotoliptofono apparatus with the natural voices of all the biggest artists, and it will be very easy to register this, because you can put a simple microphone on the stage of a theatre giving a play and you will obtain the printing plate as described previously, and then you can print your sound plays, etc., etc.

Sound Books for Schools and Universities. There are enormous possibilities in this branch. You can make the printed sound book of lectures in the Universities by the most eminent professors, in all languages, and send them to other towns or countries, making an exchange between the universities, and also create a real university at home, as far as the imagination may carry one. Especial attention may be paid to the study of languages, and the records will never change even in thousands and thousands of years, because the elements which are used to reproduce the sounds are unchangeable in themselves.

Policy Statements and Courts of Law. Great help will be obtained for taking (secretly, or otherwise) testimonies which will correspond perfectly to each word pronounced. It may be communicated to the press in the form of a sound page, etc.

Correspondence. You may speak directly to the Fotoliptofono and in this case obtain only one sound page which we will call a "sound letter," which will cost you only a small sum, and which you may send to the country where your friends or parents put the same paper in a Fotoliptofono apparatus, and hear exactly what you say, even your breathing.

Medical Consultations. These may be accomplished at a distance. We tried it in Buenos Aires with some very sick people. The medical sound page recording of the heart beats, and breathing, was sent to a medical man in another town who gave advice, and the remedy for the illness.

RESUME

The most remarkable thing is that Fotoliptofono bids fair to become a *world-wide* industry; one which will be served by radio apparatus existing through the whole world, and by printing on paper. Paper is the most useful, cheap and common material, and Fotoliptofono most happily employs it.



"I use it on almost every job—and it cost me just 15c!"

Every day, more and more service men write in for their copy of the new Sylvania Technical Manual. Every day, more and more service men are finding out how *really helpful* the Technical Manual is—solving their problems, saving them the expense of wasted time and needless mistakes. You need this book in your tool kit. It's a *whale* of a value—yet it costs you only 15c.

Quick! Get Your Copy Now!

This convenient, pocket-size manual contains 184 pages . . . lists 193 tube types with important circuit application information on each—tells all about glass, metal and "G" type tubes, as well as those for Majestic receivers. Gives full information on Sylvania "Ballast Tubes." Send the coupon and 15c now . . . and leave the rest to us!

Hygrade Sylvania Corporation, makers of Sylvania Radio Tubes and Hygrade Lamp Bulbs. Factories at Emporium, Pa.; Salem, Mass.; and St. Mary's, Pa.

SYLVANIA SET-TESTED RADIO TUBES

HYGRADE SYLVANIA CORPORATION, Emporium, Pa. RC-87

I enclose 15c for which please send me a copy of the new Sylvania Technical Manual. I am (check below).

Experimenter Amateur Call Serviceman
 Employed by Dealer Independent

Member Service Organization.....

Name

Address

CityState.....

Name of Jobber

Address

Please Say That You Saw It in RADIO-CRAFT

Genuine Majestic

Majestic & Grigsby-Grunow, original and genuine factory radio and refrigerator service. We have purchased all of the assets formerly belonging to Grigsby-Grunow. All parts, service replacement units will carry regular factory guarantee. Buy only through our authorized distributors, dealers or ourselves. **GENUINE MAJESTIC PARTS & TUBES. Write for Prices. G & G GENUINE MAJESTIC REFRIGERATOR & RADIO PARTS SERVICE. 3801 Dickens Avenue, Chicago, Illinois.**

6L6 TRANSFORMERS

These basic fully shielded units will enable you to construct the latest 6L6 Beam Power Amplifiers utilizing inverse feedback. Circuit diagram supplied.

- 32-Watt Power Transformer.....\$3.95
- Universal Output Transformer.....2.25
- Input Push-pull Transformer.....1.95
- First Filter Choke.....1.85
- Second Filter Choke......75

Order from this list! 24 Hour Service!

SPECIAL TRANSFORMERS PROMPTLY BUILT TO ORDER—SEND SPECIFICATIONS FOR PRICES. INTERNATIONAL TRANSFORMER COMPANY 39 West 20th Street New York City

RADIO MEN GRAFOLINE

Insures correct permanent repairs for all air exposed contacts and wherever dust and dirt affect moving parts. Ideal for all-wave switches, wire wound volume controls, etc. Easy to apply, insures longer wear for parts. Lubricates electric motors, vacuum cleaners, etc. Full sized bottle 35c from your Radio Parts Jobber. If he cannot supply—WRITE for free circular complete line. GENERAL CEMENT MFG. CO., Rockford, Illinois.



RADIO ENGINEERING

RCA Institutes offer an intensive course of high standard embracing all phases of Radio. Practical training with modern equipment at New York and Chicago schools. Also specialized courses and Home Study courses under "No obligation" plan. Catalog Dept. RT-37.

RCA INSTITUTES, Inc.
75 Varick St., New York 1154 Merchandise Mart, Chicago
Recognized Standard in Radio Instruction Since 1909.

RADIOS...SAVE UP TO 50%

DEAL DIRECT...FACTORY PRICES! Many models to select from: AC-DC-All-Wave Farm sets that operate like city radios! Your name and address on postcard brings you NEW Bargain Catalog in colors FREE. Get details of 30-DAY TRIAL plan and agent-user proposition! **GOLDENTONE RADIO CO.** Dept. 85 DEARBORN, MICHIGAN

Free Catalog

30 DAY TRIAL \$6.98 UP

CLASSIFIED ADVERTISEMENTS

Advertisements in this section are inserted at the cost of twelve cents per word for each insertion—name, initials and address each count as one word. Cash should accompany all classified advertisements unless placed by a recognized advertising agency. No less than ten words are accepted. Advertising for the Sept., 1937, issue should be received not later than Wednesday, July 7, 1937.

DOGS

TERRIERS; ALSO BULL DOGS. SHIP ANYWHERE. Bob Tonn, Dallas, Texas.

RADIO

CHASSIS, CABINETS, PORTABLE CASES, PANELS, Shielding, Backs. Send for circular. R. H. Lynch Mfg. Co., 376 Camulos, Los Angeles, Calif.

**OVER 1,500
RADIO SERVICE MEN
ARE ALREADY USING
VOLUME 7 OF THE
OFFICIAL RADIO
SERVICE MANUAL—**

See Page 67 for Details!

NEW SPECIAL-SERVICE TUBES

(Continued from page 78)

ready application in the amplifier and oscillator circuits of U.-H.F. television transmitters.

Both the 887 and the 888 are new developments by RCA Radiotron.

24XH or 2-in. cathode-ray tube. A new tube designed for visual analysis of electrical wave-forms which is expected by some technicians to replace the 1-in. C.-R. tube has just made its appearance. This tube is of the high-vacuum type having 4 electrostatic deflecting plates, two of which are common. It is housed in a glass envelope 7 1/2 ins. long and having a full 2-in. fluorescent screen. The heater voltage is 6.3 V. An octal type base is used in its construction so that it can replace the type 913 where space permits. The 2nd-anode operates at a voltage of 300 to 600 V.

(Description prepared from technical data supplied by the *manufacturer.)

24 XH Characteristics

Heater Voltage (A.C. or D.C.)6.3 V.
Heater Current0.6-A.

Maximum Ratings

High-voltage Electrode (anode No. 2) 600 max. V.
Focus Electrode (anode No. 1)300 max. V.
Grid VoltageNever Positive
Grid Voltage for Current Cut-off-600 approx. V.
Power per Sq. Cm. of Screen 10 max. Milliwatts

Typical Operating Conditions

Anode No. 2 Voltage 400 500 600 V.
Anode No. 1 Voltage 80 100 120 V.
Grid Voltage Adjusted for Suitable Spot

Deflection Sensitivity

Plates D₁ and D₂ 0.21- 0.17- 0.14-mm./V. D.C.
Plates D₃ and D₄ 0.23- 0.19- 0.16-mm./V. D.C.

RK42 battery triode. The Raytheon Production Corp. has recently introduced 2 new tubes having small-size envelopes and economical filament requirements for operation in the small meteorological balloons which have recently become the vogue in weather men's circles. These tubes have filaments which draw the usual 60 ma. but which require only 1.5 V. (as compared to the previous minimum of 2 V.), so that very small dry cells can be used for the filament supply for the required number of hours during which the transmitter in the balloon is intended to function.

The first tube is a triode enclosed in a special glass envelope, having characteristics similar to the old, type 30 tube, with the exception of the filament. This tube is a prolific generator of R.F. currents in the ultra-high frequency range.

RK43 battery twin-triode. This second tube is also housed in the cylindrical glass envelope which encloses the RK-42, but this tube contains 2 identical sets of triode elements with a single filament. This construction permits more elaborate transmitter circuits in the balloon equipment with very little additional "B" drain and the same filament requirements as the RK42.

While these tubes are not likely to become very popular in receiver design, they offer possibilities in the design of light, small-space portable receivers for vacation and camp use.

General Electric Tubes. Within the past month the General Electric Co., which sponsored the design of the metal series of tubes and subsequently manufactured a line of such tubes, has announced the introduction, on the American market, of a complete line of 103 glass tubes to supplement the 19 types of metal tubes which they previously made.

By carefully surveying the new-order and replacement-order market, before bringing out these new tubes, G. E. was able to avoid the manufacture and stocking of types for which there was no call, thus reducing their engineering, manufacturing and sales costs.

New RCA Tubes. It has been rumored that RCA Radiotron is working on a new 2-in. cathode-ray oscilloscope tube.

Another rumor concerning RCA Radiotron laboratories intimates a new type of acorn high-frequency tube having a direct filament, instead of the indirect heater cathode of the 954, 955 and 956 types, which will permit these tubes to be used for meteorological work, is in the offing. The rumor is not specific as to whether the new tube will be a triode or a pentode.

The above few sample tubes will show what is being done in the tube development laboratories of various tube manufacturers to improve the radio art and permit better radio communication on higher and higher frequencies to be carried on. They will demonstrate to the reader the truth of the assertions made in the opening paragraphs.

*Name of manufacturer will be supplied upon receipt of a stamped and self-addressed envelope.

THE ART OF TELEVISION MAKE-UP

(Continued from page 90)

eyelashes may be black.

This curious make-up provides all the essential colors which respond to the photosensitive radiations of the visual spectrum.

Because of previous lack of knowledge in this field, an out-of-the-ordinary phenomenon was observed, recently in Paris, where, upon the occasion of an experiment effected with Zworykin's kineoscope, the images of a few ballet dancers, because of the particular sensitivity of the tube to infrared radiations, appeared entirely denuded on the screens of the receivers!

This cannot happen again, because science has already provided a remedy, so that from now on, no more surprises such as this, will occur.

It is of interest to note, further, that not all persons are equally adapted to be televised. The best subjects seem to be those with marked lineaments and rounded contours.

(This article has been translated and reprinted, by special permission of Dr. L. deFeo, from *Cinema* magazine, Rome, Italy.)

It is reproduced here to give some general idea as to the make-up requirements. However, if we consider the strict letter of modern make-up for television we find that the somewhat exaggerated coloring suggested above may now be modified with improved results. Thus, ordinary *panchromatic* [or all-colors] shades of pale orange, red and brown—just as used in movie make-up—are employed.

At present, proper studio lighting for television purposes demands 50 per cent more light than is used on the Hollywood movie lots! The terrific heat that ordinarily would result, and thus cause havoc with make-up [and which in the earlier days of television often *did* produce such disconcerting effects as beads of perspiration!], has been circumvented by placing in

front of the spotlights special glass filters that check the heat intensity without detracting from the light intensity; and by using air-conditioning equipment to keep the studio cool.

In general, a No. 1 requirement is the ability to "take a good picture," according to a recent broadcaster on the "Highlights of Hollywood" program. The cameraman calls it being "photogenic." You will recall how some people whom you would term "good looking" never seem to "take a good photograph," while, other people who seem to be downright homely come through in A-1 order, when photographed. It's just one of those things—but whether you are born with it, or whether you aren't, the make-up man can do much in making you over to look "natural" to the televisor [television camera].—Editor

BUILD THE RADIO-CRAFT 1937 CAR-RADIO RECEIVER

(Continued from page 84)

article "The ABC of A.F.C." in the March, 1937, issue of *Radio-Craft* for further explanation of essential A.F.C. action). The A.F.C. is confined to the broadcast band alone, as it is neither effective nor desirable on the higher frequency bands.

This set is without any question of a doubt the most advanced and unusual design yet offered for exact reproduction to the experimental constructor and the professional custom set-builder, and any data necessary to proper building and application will be gladly given to any reader professing a sincere desire to develop one like it, either for his own use or for custom sale.

Please Say That You Saw It in RADIO-CRAFT

EXPERIMENTAL HIGH-FIDELITY TELEVISION

(Continued from page 86)

efficient light source, as the subject of fluorescence still withholds many of its secrets from mankind.

STUMBLING BLOCKS

Other things that have to be accomplished before commercial television becomes a reality are:

(1) Endorsement by the Federal Communications Commission of television standards and the issuance of commercial licenses for transmission in the ultra-high frequency band suitable for television.

(2) More complete coverage of the United States than is obtained by a few transmitters having limited ranges averaging 25 miles.

(3) Sources of programs—interesting programs will have to be developed. Television requires more in the way of costumes, rehearsals and properties than any other known form of entertainment.

(4) A reduction in the cost of television receivers. Home receivers producing pictures of a quality equal to home movies and much smaller in size will probably cost more than most of us care to pay. In England there is no rush to buy television receivers now selling from \$500 to \$600.

Engineer N. S. Bean, in charge of the television receiver laboratory, who assisted Mr. Murray with the demonstrations, mentioned that a special antenna installation on the roof of the Institute was necessary because of the extremely severe conditions of interference from automobile ignition and nearby electrical equipment. Otherwise satisfactory pictures would not have been possible.

The first public showing of Philco's television system which occurred at Franklin Institute was followed by the first large-scale demonstration of this high-fidelity system, at the Germantown (Pa.) Cricket Club, in February. Television receivers installed in the ballroom of the club reproduced 441-line, and 441-line compared to 345-line, television transmissions from the transmitter located 3 miles away. The image area was about $7\frac{1}{2} \times 10$ ins.; and was viewed by about 100 "lookers-in." The ordinary viewing distance was 5 ft.

"WHEN WILL WE HAVE TELEVISION?"

At this demonstration, Sayre M. Ramsdell, vice-president of the company, made the following remarks.

"Two questions naturally will arise in your minds, and I may as well anticipate them and give you my views upon them at the outset.

"The first is:—Will television supersede sound broadcasting? My answer to that, is, most positively not. Each has its own field and function, and sound broadcasting will continue to occupy its important place in the home.

"The second is:—When will we have television? On this point I will venture no prediction as to time. Certain things must be accomplished before it can become generally used. These things are:—

"(1) Technical standards for television transmission will have to be approved by the Federal Communications Commission so that any receiver will receive from any transmitter within range.

"(2) The present limited range of television, averaging about 25 miles, will have to be increased. Key cities, such as New York, Philadelphia, San Francisco, Boston, Washington will have television first.

"(3) Before we have commercial television, the Government will have to issue commercial licenses suitable for television, that is in the 42-90 megacycle band.

"(4) A source of programs will have to be developed. In putting on a short sketch by television more is required in the way of costumes, rehearsal and stage properties than for any known entertainment field. Actors no longer can read their scripts. Both appearance and voice are necessary for the television star. The problem of giving the American people television programs 365 days of the year assumes staggering proportions, so far as personal energy and finances are concerned.

"(5) Reduction in the cost of television receivers."

HOW TO TUNE FOR W3XE

The technician may desire to refresh his memory concerning the standards of tele-

vision operation by station W3XE. The number of lines is 441; frame frequency, 30 per second; field frequency, 60 per second, interlaced; aspect ratio, 4:3; polarity of transmission, negative; synchronizing, amplitude selection (in connection with the "narrow vertical" synchronizing impulse). Sound—54 mc.; video—49 mc.

In conclusion, we can do no better than reprint (below) a prognostication made by Mr. Murray at Franklin Institute.

A forecast of what 1937 holds for television may be made at this time. Field tests will continue. The peculiarities of ultra-high frequency waves will be further explored and service areas more definitely determined. Leading experimenters will change their transmitting equipment to conform with the RMA Television Standards. This means, among other characteristics, 441 lines. Experimental receivers will be improved, simplified; costs will be somewhat reduced, making the price nearer what the man-in-the-street can pay when commercial television arrives. Some improvement in picture size and brightness may be expected. Experiments in television relaying will be initiated, that is, images from the athletic field will be relayed to the main broadcasting station for rebroadcast. Research will continue in the various laboratories with unabated vigor. The search for new and better ways of flashing pictures into the home will be broadened and intensified. The result might be an entirely new method of producing this modern miracle.

SERVICING QUESTIONS & ANSWERS

(Continued from page 89)

DISTORTION—PHILCO 611

(18) Vincent Collari, New York City
(Q.) I have used a Philco model 611 receiver for about 7 months with very good results. Lately, after the set is on a while it sounds distorted. What would you advise me to do to correct this?

(A.) The first thing to do is to replace the power amplifier type 43 tube. This is the most common cause for distortion in your receiver, and will probably remedy your condition.

SET DEAD

(19) Frank Blanco, Peekskill, N. Y.
(Q.) My Emerson model 102 receiver stopped completely. I noticed that the type 80 tube became red hot before it quit. A few weeks prior to its going haywire a loud hum was heard and seemed to be getting louder. Please advise me how to solve this trouble.

(A.) When the plates of the rectifier 80 tube became red hot, this indicated that your trouble lies in a shorted filter condenser, and incidentally the lowering of capacity of these condensers below their rated capacity, was the chief reason for hum. When you replace these filter condensers use two 10-mf., 600-V. units. See Fig Q.19.

SPARKING IN CHASSIS

(20) Mark Ratner, Plainfield, N. J.
(Q.) I own a Stromberg-Carlson model 64 receiver and wish to ask the reason for occasional sparks that seem to emanate from a small box in the rear of the set. At times an awful odor can be detected. Please advise the remedy.

(A.) The cause of both the odor and sparks in your chassis can be traced to a 1.3-mf. condenser which is housed together with the input unit. By removing the chassis you will observe 7 leads leading out of this unit. The 2 green leads are the connections to the 1.3-mf. condenser. It is only necessary to cut these green leads and add another condenser of the same value. By doing this your trouble will be alleviated. See Fig. Q.20.

(Questions addressed to the SERVICING QUESTIONS AND ANSWERS department are answered within 48 hours. When "stuck" by a job, write to this department for post-haste information.)



Profits from Those Tough Ones

You can't give your customers their money's worth and make profits from those "hard-to-fix" radio repair jobs without good equipment and knowledge of modern methods.

Competent authorities estimate 34,000,000 radio sets will be in use during this summer.

Be prepared to get your share of the profits from servicing these receivers by using the BEST equipment available -- C-B instruments.



MODEL 88 Vacuum-Tube Voltmeter

Invaluable for automatic frequency control adjustments, gain and impedance measurements, checking oscillator stages, amplifier performance, and other difficult measuring problems. MODEL 88 Vacuum-Tube Voltmeter, complete\$45.50

Use the C-B Easy Payment Plan—only \$5.50 down and ten monthly payments of \$4.57.

Free

Write for our new technical bulletin



telling all about the Vacuum-Tube Voltmeter and what it does.

Mail Coupon Now

Please send additional information on the MODEL 88 Vacuum-Tube Voltmeter.

Name
Address
City..... State.....

The CLOUGH-BREngle CO.

2809 W. 19th St., Chicago, Ill.

Please Say That You Saw It in RADIO-CRAFT

THE POTENTIOMETER VOLTMETER— A NEW SERVICE TOOL

(Continued from page 94)

THE NEW
L&L
MODEL WL



TESTS ALL TYPE TUBES

Semi-Ballast Tube Tester

Has Filament Selector return Switch that allows filament to be placed on any one of 8 tube elements. Tube elements terminate through 8 toggle switches, which in connection with filament selector allows extreme flexibility, as any and all points are instantly available for test. NEON short and leakage test while tube is "hot." Visual test on Neon for high resistance open elements. LINE VOLTAGE regulation by 11 boost tap switch and reading on meter. New SEMI-BALLAST circuit allows even and correct tube readings. Weak tubes driven well back into bad area and good tubes read at one point in GOOD section. Sliding type wood case. Etched metal panel. CAN BE ADAPTED TO TEST BATTERY TUBES WHERE POWER IS NOT AVAILABLE. Full charts included.

TESTS TUBES WHERE THERE IS NO POWER

10 DAY TRIAL

A GUARANTEED Tryout for 10 days and if not satisfied your money promptly refunded. Shipping wt. 15 lbs. Net to service men and dealers \$21.75 F. O. B. Memphis.

L & L ELECTRIC CO., 350 MADISON AVE., MEMPHIS, TENN.

\$21.75

made to determine with a conventional voltmeter the voltages in portions of these networks, not only is the voltage observed incorrect due to the loading effect of the meter, but in too many cases the act of connecting the voltmeter so disturbs conditions within the circuit as to make all observations of voltage or current valueless.

To appreciate the extent of these disturbances it is only necessary to consider two typical examples involving two opposite sources of error.

CONSTANT-CURRENT CIRCUITS

In Fig. 1A is shown a typical case of measurement where constant current is involved. It is assumed that in a portion, A-B, of a circuit the current is limited to substantially a constant value of 20 microamperes by high impedances elsewhere in the circuit, such as the plate circuit of a vacuum tube or current limiting resistors.

From Ohm's Law it is seen that the voltage developed across the 0.1-meg. resistor R will be 2 V. However, if an attempt is made to measure this voltage with a voltmeter having a range of 10 V. full-scale and a sensitivity 1,000 ohms/volt, the meter will constitute a shunt of 10,000 ohms in parallel with R. From the formula for the equivalent resistance of parallel resistors:

$$R = \frac{r_1 \times r_2}{r_1 + r_2} = \frac{10,000 \times 100,000}{10,000 + 100,000} = 9,090 \text{ ohms}$$

Thus the resistance between A and B has been reduced from 0.1-meg. to 9,090 ohms, and again from Ohm's Law with a current of 20 microamperes the voltage will be 0.182-V. which is less than 10 per cent of the actual voltage before the meter was connected.

It is apparent that if the resistance of the meter is increased to a higher value the error will be reduced. It is interesting to calculate the results with meters having resistances of 20,000 ohms/volt and 100,000 ohms/volt. In the first case the meter resistance will be 0.2-meg., the equivalent resistance of the parallel circuit 66,666 ohms, and the voltage with the meter connected will be 1.33 V. The error is 33 per cent. At 100,000 ohms/volt the resistance of the meter on the 10 V. range becomes 1 meg., the equivalent resistance of the meter in parallel with R is now 90,900 ohms and the voltage indicated will be 1.82 V. The error in this case is 10 per cent. Further analysis will show that however high the meter resistance is made, an error still remains. Besides, meters having a resistance of 100,000 ohms/volt or higher are quite expensive and very delicate and are not adaptable to the requirements of a radio service tester.

voltage in series with a resistor. Figure 1B illustrates such a case. A constant potential of 100 V. is applied across points A and B in series with resistor R of 0.1-meg. If a voltmeter having a range of 100 V. full-scale at 1,000 ohms/volt is connected across A-B, the combination of the resistor R and the resistance of the meter Rm, which in this case is 0.1-meg., will constitute a voltage-divider network across the voltage E. Since the same current will flow through both the meter and the resistor R, the voltages developed across each will be directly proportional to the ratio of their resistances. In this case the resistances are equal and there will be 50 V. across each. The meter will indicate only the voltage across its terminals which is just 50 per cent of the voltage present before the meter was connected.

If the meter resistance is increased to 20,000 ohms/volt, as before, the accuracy is improved. At 20,000 ohms/volt the meter resistance in Fig. 1B becomes 2 megs. and the voltage across the meter is 95.2 V. The error is 4.8 per cent. If the meter resistance is increased to 100,000 ohms/volt the error is reduced to 1 per cent.

Circuits encountered in a receiver will usually be a combination of those used in the two examples above and may be reduced to the circuit shown in Fig. 1C. Calculation of the effect of the meter in such a circuit becomes involved and, as mentioned before, the disturbing of one voltage often so unbalances the entire circuit that operating conditions are changed to such an extent that all observations are valueless. Figure 1D illustrates a typical A.V.C. circuit, and Fig. 1E an A.F.C. circuit. If a conventional voltmeter of any commercial resistance is connected at any of the points indicated on the diagram inaccuracies of readings and circuit disturbances will result. However, it will be noticed in the examples given, that, as the meter resistance is increased the effect on the circuit and the resulting errors are decreased. From this it would appear that as the meter resistance approaches infinity the cumulative errors will reduce to zero. This is exactly what happens. The problem then is to build a meter which has an infinite resistance and will draw no current from the circuit to which it is connected.

POTENTIOMETER METHOD OF VOLTAGE MEASUREMENT

The "Potentiometer method" of voltage measurement has long been recognized as the only accurate method of measuring voltages in the cases illustrated in the above examples. Heretofore, potentiometers have been available commercially only in the form of extremely accurate laboratory instruments which required rather complicated and tedious adjustments.

The instrument shown in the photograph, which will be described, is based on the principle

P. A. is our business!

Your business is to obtain the best in **AMPLIFIERS and P. A. Equipment**

FREE CATALOG contains the greatest values ever offered. Consult us on your P.A. Problems, without obligation.

Amplitone Products Company
135 LIBERTY ST. NEW YORK, N. Y.

Learn SOUND RECORDING
TALKING PICTURE PROJECTION
TELEVISION-RADIO

Master training courses qualify you for good jobs. Practical, easy to learn. Newest equipment. Established 1905. Earn room and board while learning. Coach R. R. fare allowed to I. A. Write for FREE BOOK. Address Dept. 8-RC, 4000 S. Figueroa St.

NATIONAL SCHOOLS - Los Angeles

RADIOS 1/2 OFF!

Buy direct. New line of ZEPHYR WORLD-WIDE all-electric, battery and auto radios. 5 to 15 tubes. All latest features. Buy at WHOLESALE PRICES. MONEY-BACK GUARANTEE. Earn extra money with our Agent-User Plan. Write for FREE CATALOGUE.

ZEPHYR RADIO COMPANY
13141 Hamilton Ave., Detroit, Michigan

30 DAYS TRIAL

BE OUR AGENT!

BIG PROFITS FOR RADIO MEN

Sell our complete line of 16 MM and 35 MM motion picture equipment for theatres, institutions, clubs and home use. We have everything. Tremendous field; liberal profits. Write TODAY.

S. O. S. CORP. 636-RA Eleventh Ave., N.Y.C. CABLE—SOSOUND, N.Y.

BUILD IT YOURSELF

You can build this Trailer with ordinary tools easily from our step-by-step constructional sheets and large sized blueprints. Finest designed Trailer in existence, sleeps 4. Toilet, Shower, Electric Light, etc. Save 75% of the cost by building it yourself. Send 26c for plans sheet, illustrations and details.

THE PLAN SHOP, 910 Palmolive Bldg., Chicago, Ill.

RIDER
MANUALS

NOW IN SEVEN VOLUMES

JOHN F. RIDER, Publisher 1440 Broadway, New York City

CONSTANT-VOLTAGE CIRCUITS

Now consider the opposite condition: a fixed

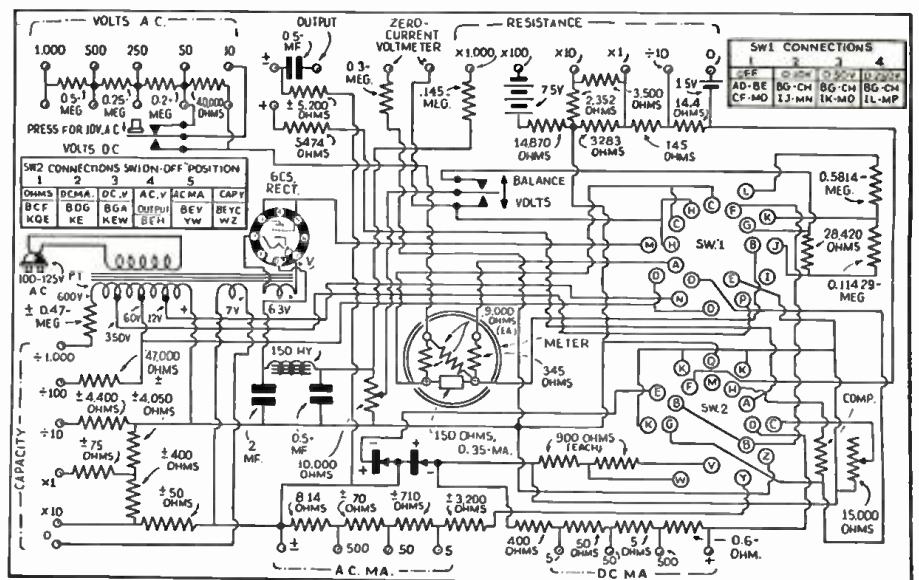

Fig. 2. Schematic circuit of the potentiometer voltmeter.

Please Say That You Saw It in RADIO-CRAFT

of the potentiometer and includes many of its advantages but is very simple to operate. The fundamental circuit of the potentiometer voltmeter is shown in Fig. 1F. The measuring system consists of a galvanometer G, a voltmeter VM., and a source of variable voltage E2 connected as shown. It is shown connected to measure voltage in a network such as was shown in Fig. 1C, which consists of a source of unknown voltage E and resistors R1 and R2. Voltage is to be measured between A and B.

The operation of the system from Fig. 1F is as follows. When the potentiometer voltmeter is connected across A-B with the pushbutton switch S open, the voltage across R2 will cause a current to flow through the galvanometer G and the voltmeter VM which will be indicated by G. Now, if switch S is closed and the voltage E2 is gradually increased, the potential across the galvanometer from A to C will, at all times, be equal to the difference between the potential across the points A-B and the potential of E2. If the potential at A-B is higher than E2 the current through G will be from left to right, and will be so indicated. If E2 is higher than A-B the current flow will reverse direction. When A-B and E2 are exactly equal there will be no flow of current through the galvanometer and the voltmeter VM. measuring the potential of E2 will give an indirect but exact reading of the potential A-B. More important still, since the reading is taken at the time that the galvanometer indicates no current is flowing to or from A-B the potentiometer voltmeter presents an infinite resistance in parallel with A-B and there is no disturbance of circuit conditions.

If the voltmeter VM., which, incidentally, need not be of high resistance, is provided with

several ranges and the voltage E2 is made variable to cover all these ranges, the system is equally accurate and presents an infinite resistance to the voltage being measured on any of these ranges. The accuracy of the measurements is dependent only on the accuracy of the voltmeter VM., the sensitivity of the galvanometer and the care with which the circuit is balanced. Unlike the vacuum-tube voltmeter, as the term is generally used, this system draws no current on any range; is unaffected by varying line or battery voltage; and, the calibration is not disturbed by changing of tubes.

This circuit, substantially as shown, is incorporated in a commercially-available radio-set tester. By a simple switching arrangement the one meter is made to serve as both the galvanometer and the voltmeter. A schematic circuit of the no-current voltmeter portion of the instrument is shown in Fig. 1G.

In addition to the potentiometer-type no-current voltmeter, this (Model 4900) instrument retains all the features of the standard radio set tester. These include precise measurement of D.C. and A.C. volts at 1000 ohms/volt, with ranges of 0/10/50/250/500/ and, 1,000 V. A.C. voltages are measured by an exclusively-designed rectifier meter circuit which gives a simple and easily-read scale. Milliampere ranges of 0/1/5/50/ and, 500 ma., both A.C. and D.C., are available. Complete coverage of resistance measurement is assured by a 5-range ohmmeter covering from 0.1-ohm. to 10 megs. Capacity, both paper and electrolytic types, can be measured from 100 mmf. to 200 mf. with a high degree of accuracy. All measuring circuits are brought out to a bank of pin-jacks clearly marked and grouped around the master switch in a unique arrangement which indicates, at a glance, the proper jacks to use for each type of measurement.

Power for the capacity meter and the no-current voltmeter as well as the highest range of the ohmmeter is obtained from the 110 V. A.C. line. Figure A shows the outward appearance of the instrument. The panel and meter case are of walnut bakelite with designations and trim in gold vericrome. Switch and rheostat control knobs are of harmonizing bakelite. The instrument is housed in a rubbed wood walnut finish carrying case of small dimensions and light weight for easy portability. Data and tube base charts are located in the cover.

This instrument covers all the needs of metering equipment of the modern radio service profession, including the measurement of voltages at any point in a radio receiver without disturbing the operating conditions. This last feature will undoubtedly prove of great practical value to the busy Service Man.

Our Information Bureau will gladly supply manufacturers' names and addresses of any items mentioned in RADIO-CRAFT. Please enclose a stamped and self-addressed envelope.



Under the TUNG-SOL CONSIGNMENT PLAN more than 8000 dealers and service organizations in the United States are drawing daily dividends from every tube sale... without tying up their capital in stocks.

They have no investment... yet they carry adequate stocks with no fear of loss from obsolete numbers.

Tung-Sol retailer partners simply keep the profits and remit the cost price after the sales have been made.

Dealers who can qualify for this attractive partnership may still secure a Tung-Sol agency. Write for the name of your nearest wholesaler.

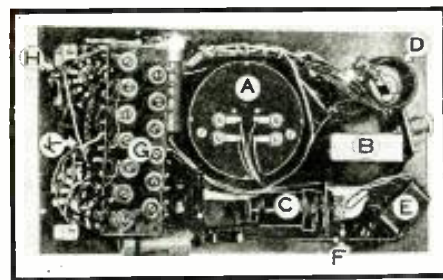

Fig. 8

Behind-the-panel view showing the arrangement of parts and wiring. At A, meter; B, power transformer; C, 6C5 tube used as rectifier; D, potentiometer for controlling balancing voltage; E, filter choke; F, ohmmeter and capacity meter adjusting rheostat; G, resistor subpanel, carrying the wire-wound resistance voltmeter; K, rotary switch, (volts, ma., capacity, etc.).

HOW TO ADD A 2-IN. C.-R. TUBE TO THE RADIO-CRAFT MIDGET OSCILLOSCOPE

(Continued from page 90)

Since the new tube is about twice as sensitive as the 913, a pattern which will cover the screen on the latter will cover that of the 24XH so that again no changes are required, and a simple substitution will suffice.

All parts of the original "gun" except the actual tubing itself may be reemployed. A new piece of steel tube 8 3/4 ins. long by 2 1/4 ins. dia. will be needed. Steel or iron tubing is required since the 24XH is not shielded as is the 913 and is very sensitive to external fields, a characteristic common to all cathode-ray tubes of the glass bulb type.

The tubing is cut to size, the ends smoothed and the necessary holes drilled. The same type of socket as used originally is needed. This consists of an aluminum cup about 1 1/2 ins. in dia. and 5/8-in high in which the socket is mounted. The socket is removable and the small tongue in the socket hole must be filed-off so that the socket may be turned. This allows the tube to be revolved so that the pattern may be aligned correctly. The socket should be placed so that the groove in the center hole is uppermost. Any slight variations in tubes may then be corrected

by rotating the latter slightly after it has been connected and is in operation.

The aluminum socket cup may be held with 3 screws, placing washers between the cup and the tubing so that a firm fit will result. A piece of 3/16-in. bakelite may be turned to a close fit for the rear of the tubing. This about finishes the job except for coating the tubing inside and out with flat-black enamel. When this dries, pads of felt may be put in the front end so that the 24XH will be held away from the walls.

This mount and the new tube will be found to greatly increase the usefulness of the original instrument and if properly interchanged with the 913, a truly versatile apparatus will result.

"R.-C." STAFF CHANGES

C. W. Palmer, formerly Technical Editor of Radio-Craft magazine, has joined the engineering staff of the Western Electric Co. Radio-Craft joins with the many friends he has made in wishing him success. He is succeeded by N. H. Lessem whose name is familiar to Radio-Craft readers.



TUNG-SOL
Flow radio Tubes

TUNG-SOL LAMP WORKS INC.

Radio Tube Division

SALES OFFICES: Atlanta, Boston, Charlotte, Cleveland, Chicago, Dallas, Detroit, Kansas City, Los Angeles, New York.

General Office: Newark, N. J.

Please Say That You Saw It in RADIO-CRAFT

Our New Address

GREN PARK COMPANY

1229 PARK ROW BLDG.
NEW YORK, N. Y.

RADIO MEN always need accessories for the service bench or kit. Here are a few tools which come in handy for any repair job. On just one or two service jobs you'll be repaid their nominal cost.

FLEXIBLE SHAFT SCREWDRIVER

Use this FLEXIBLE SHAFT SCREWDRIVER—the screwdriver that actually goes around a corner—in your service work. It reaches many awkward places where a screw cannot be reached by a straight or offset driver. Has a thousand and one uses—ideal for repairing radios, refrigerators, automobiles, oil burners, machinery, shop equipment, electrical appliances, vacuum cleaners, marine equipment, household jobs, etc. The FLEXIBLE SHAFT SCREWDRIVER has a shaft of laminated steel wire—tempered steel blade—chromium-plated fittings—fluted, hard-wooden handle—length overall 8".

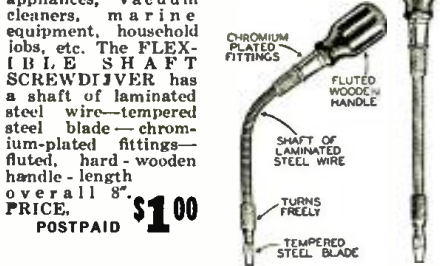

PRICE, **\$1.00**
POSTPAID

FLEXIBLE DRIVE SOCKET SET

The most practical socket set ever developed for radio work—ideal for "hard-to-get-at-places." Set consists of 10" Flexible Drive with six (6) removable sockets having hex openings in the following sizes:

- 3/16" 1/4" 5/16" 3/8" 7/16" 1/2"

The FLEXIBLE DRIVE SOCKET SET is similar in construction to the screwdriver. With each socket set is included a FREE, steel carrying case. PRICE, **\$3.00**



POSTPAID

COMBINATION SET SCREWDRIVER SOCKET SET **\$3.50**

SHOCK-PROOF SCREWDRIVERS

The finest set of shock-proof screwdrivers available for radio men—this set of four (4) screwdrivers has translucent, unbreakable, shock-proof handles, and is equipped with tempered steel blades. Blade sizes are: A—5" x 1/4" B—1" x 3/16" C—3" x 3/16" D—2" x 1/8". Set of four (4) screwdrivers. PRICE, **\$1.50**

GREN PARK COMPANY

1229 Park Row Bldg., New York, N. Y.

GREN PARK COMPANY RC-87
1229 PARK ROW BLDG., New York, N. Y.

Gentlemen: Enclosed you will find my remittance of \$..... for which please send me, POST-PAID, the equipment indicated by the cross (X) below:

() FLEXIBLE SHAFT SCREWDRIVER @ \$1.00
 () FLEXIBLE DRIVE SOCKET SET @ \$3.00
 () COMBINATION SET (Screwdriver and Socket Set) @ \$3.50
 () SHOCK-PROOF SCREWDRIVERS @ \$1.50 per set (Set of four)

Name

Address

City State

HOW TO MAKE A 2-TUBE CARRIER INTERPHONE

(Continued from page 85)

signal from the microphone (in this case the permanent-magnet dynamic type loudspeaker). When receiving, this is used to amplify the output from the detector. (4) Rectifier tube—to deliver requisite current. (5) Switching system—which will change the above elements to their proper relationships when sending and receiving.

These points are explained in the block diagram in Fig. 2. This shows graphically how the change-over system works.

The requirements for the tubes are that they shall be of the 0.3-A. type and that 2 tubes shall perform the functions listed above. The combination of the rectifier and power tube is accomplished by the use of the 12A7 tube.

The combination of the oscillator and voltage amplifier tube has been made easy by the recently-designed type 6C8G twin-triode tube. An important—for our purpose—design feature of this tube is the fact that it has separate cathodes. This enables us to completely isolate the oscillator-detector section (as we will use the tube) from the amplifier section of the tube. The grid (cap) section is used for the voltage amplifier, and the lower section for the oscillator—detector.

CIRCUIT ANALYSIS

This basic knowledge should make it easier to understand the circuit diagram which is given in Fig. 1. First examine the switching arrangement. Sw.2 is a 4-pole double-throw switch and is used to change-over from the talk to the listen position. The 4 sections of the switch are lettered A-B-C-D. The A section and the C section change the triode of the dual-function 6C8G from an oscillator in the talk position to a diode type of detector in the listen position. The B section of the switch is used to swing the input grid (cap) of the other triode of the 6C8G tube from the diode detector in the listen position or the P.M. speaker (used as microphone) in the talk position.

The D section of the switch is used to change-over the P.M. speaker from the T2 input transformer in the talk position to the T1 output transformer in the listen position. Note that as shown in the diagram of Fig. 1 the switch is in the talk position. (The front view of the switch is shown in the diagram.)

The "Talk" Position. Now let us trace the path of the signal when the unit is in the talk position. The "microphone" (Sp'kr) picks up the sound and the output voltage is brought to the grid-cap-triode of the 6C8G by the step-up transformer, T2. The amplified signal is sent to the pentode section of the 12A7. This signal which now is of the order of about 50-V. peak, is used to modulate the oscillations of the second triode of the 6C8G. This modulated R.F. signal is passed to the low-impedance primary of the R.F. transformer, L, and then on to the line by means of condenser C1.

The "Listen" Position. The other unit which is in the receive position picks up the signal from the line. Then it is sent through the R.F. transformer L to the grid of the second section of the 6C8G. This tube is now being used as a diode, the real plate of the tube being grounded by the C section of switch Sw.2. The detected signal then passes through a low-pass filter—R4, C8—which permits only the A.F. component of the signal to pass. After passing the volume control, R, the signal goes through section B of Sw.2 to the grid cap triode of the 6C8G. The signal is then amplified by the pentode section of the 12A7 and finally reproduced (after passing T1 and section B of the Sw.2) by the speaker, Sp'kr.

CONSTRUCTION DETAILS

The details of the construction of the oscillator coil L are shown in Fig. 3. Coil L1 includes 300 turns of No. 30 D.S.C. copper wire-wound, honeycomb fashion, on a dowel stick 3/8-in. in dia. and 3/4-in. long. When complete, the winding should be approximately 1 in. in dia. and 3/16-in. wide. A tap-off, T, is taken at 150 turns. Coil L2 is composed of 50 turns of No. 26 D.C.C. copper wire wound, straight layer fashion, between 2 cardboard washers (as shown). The outer end, O, of L2 goes to ground and the inner end, I, goes to condenser C1. The outer end, G, of L1 goes to the grid and the inner end, P, goes to the switch, Sw.2.

Tuning of the coil is effected by means of condenser C6 and trimmer C5. This trimmer may be omitted if desired as the tuning is quite broad. The frequency of the carrier is approximately 130 kc.

tone quality

The frequency response characteristic of the 2 communicators in cascade is flat within plus or minus 2 db. from about 350 to 5,000 cycles.

This range is sufficient for good, clear (understandable) tone quality. The cut-off at 350 cycles is accomplished deliberately by means of the 0.001-mf. condensers, C7. This is necessary due to the fact that most speakers have a decided peak in the region of 150 cycles. The combination of 2 such peaks in combination with the cavity resonance of the cabinets results in muffled and "boomy" tone unless the low frequencies are attenuated. In case a tone control is desired, the inter-tube coupling condensers, C7, should be of the variable type, with a capacity range of about 100 mmf. to 0.02-mf. Adjustment of these units will vary the intensity of the low-frequency end of the characteristic.

No choke coil is necessary in the "B" supply filter of the unit. This is due to the low current drain and the low-frequency cut-off of the audio frequencies. The filter, R1, C2, is used to isolate the R.F. which goes into the line from the "B" supply of the unit. This is necessary to eliminate the annoying buzz which is caused by the interaction of the half-wave rectifier.

The chassis consists of 2 parts, a front panel and the chassis proper. The details are shown in Fig. 4. The photographs indicate how the sections are bolted together. This type of arrangement allows for mounting in a metal box, or if desired in a suitable wooden cabinet. The proper places for mounting the parts are indicated by the letters next to the respective mounting holes. Note that all the parts on the chassis are mounted on top with the exception of a 5-terminal-lug strip which is mounted directly beneath the trimmer condenser. All other parts are fastened directly in place by soldering. The photographs should give many suggestions as to the proper method of wiring. The only shielded lead is the one leading from section B of switch Sw.2 to the grid cap of the tube 6C8G.

INSTALLATION AND OPERATION

The installation and operation of the radio-type intercommunicators is the height of sim-

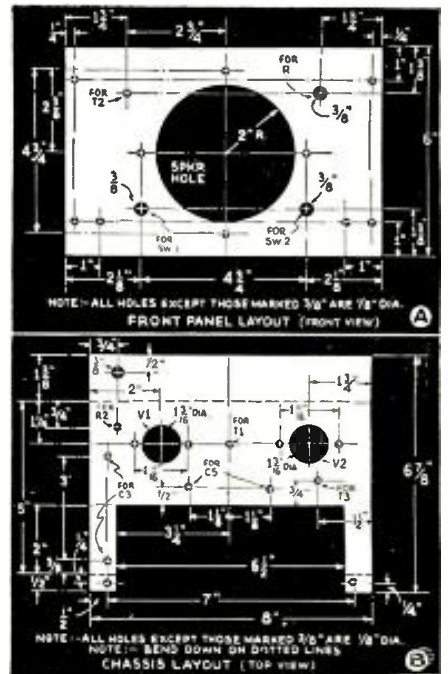

Fig. 4. Specifications of front panel and chassis.

Please Say That You Saw It in RADIO-CRAFT

plicity. The units are plugged into the A.C. or D.C. outlets near the places where they are to be installed. The volume control is turned full on and the talk-listen switch is left in the listen position. When either party wishes to talk, the switch is thrown to the talk position and upon completion of a portion of the conversation, the switch is thrown back to the listen position. The other unit may now be thrown to the talk position and the conversation continued.

There may be a small amount of static pick-up due to telephones or circuit breakers, etc., which ordinarily disturb radio reception, but this is not enough to cause annoyance. A number of units may be used on the same line but all parties will hear both sides of an individual conversation.

The communicators should work without any difficulty, but in case of incorrect connections, the following hints should be of help.

In the listen position there should be about 100 V. on the screen-grid of the 12A7. When switched to the talk position this should drop to about 96 V., due to the current drawn by the oscillator tube. The voltage drop across R6 is 1 V. and across R5, 7 V. With one unit in the talk position and the other in the listen position, the carrier should generate a voltage of about 5 V. across resistor R4 of the receiver.

(This instrument was built under the direction of R. D. Washburne.)

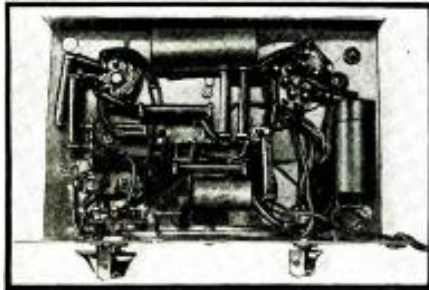

Fig. C. Under-chassis view of intercommunicator.

LIST OF PARTS

- *One R.F. oscillator coil, L;
- *One A.F. output transformer, 14,000 to 4 ohms, T1;
- *One A.F. input transformer, 4 ohms to tube grid, T2;
- One Aerovox resistor, 400 ohms, 1 W., R1;
- One Aerovox resistor, 330 ohms, 30 W., R2;
- One Aerovox resistor, 2,000 ohms, 1 W., R3;
- One Aerovox resistor, 0.1-meg., 1/2-W., R4;
- One Aerovox resistor, 1,000 ohms, 1 W., R5;
- One Aerovox resistor, 3,000 ohms, 1/2-W., R6;
- One Electrad volume control, 0.5-meg., R1;
- One General Electric S.P.S.T. switch, Sw.1;
- *One 4P.D.T. switch, Sw.2;
- *One magnetic speaker, 4 ohms;
- One Sprague dual electrolytic condenser, 8 mf., 200 V., C3;
- One Cornell-Dubilier paper tubular condenser, 0.1-mf., 400 V., C1;
- One Solar paper tubular condenser, 0.5-mf., 200 V., C2;
- One Cornell-Dubilier dual electrolytic condenser, 5 mf., 25 V., C4;
- One Hammarlund trimmer condenser, single plate, C5;
- One Cornell-Dubilier mica condenser, 500 mmf., C6;
- Three Cornell-Dubilier mica condensers, 0.001-mf., C7;
- One Cornell-Dubilier mica condenser, 250 mmf., C8;
- One Cornell-Dubilier mica condenser, 0.004-mf., C9;
- One ICA chassis;
- One cabinet to fit chassis;
- One large pointer knob;
- Two small pointer knobs;
- One Raytheon type 6C8G tube, V1;
- One Raytheon type 12A7 tube, V2;
- One ICA tube shield (for V1);
- One 5-lug terminal strip, assorted nuts, bolts, wire, sockets, etc.

*Names and addresses of manufacturers will be sent upon receipt of a stamped, self-addressed envelope.

DON LEE TELEVISION INAUGURATES NEW SOUND CHANNELS

Officially inaugurating its new television sound channel transmitter, the television division of the Don Lee Broadcasting System will broadcast two "sight and sound" programs today in observance of the 1st Anniversary of the opening of high-definition television demonstrations to the public.

Observing the same schedule as of a year ago, when this Californian television organization gave the first public demonstration in the nation, the programs will be aired from 3:00 to 5:00 p.m. and 6:30 to 8:30 p.m., P.S.T.

The "sight" portion of the televised program, composed of current newsreels and short film subjects, will be sent out on 45 kc. (6 2/3 meters). The "sound" portion of the film will be broadcast on the new frequency of 54.3 kc. (5 1/2 meters). The new transmitter is of latest grid-modulated design and reproduces sound frequencies from 40 to 10,000 cycles with fidelity.

During the past year more than 10,000 persons, including screen and radio stars and executives, renowned scientists and engineers, and government officials, have witnessed the daily television broadcasts. Periodic broadcasts had been witnessed by guests at a receiving set under normal home conditions at a location of 3 1/4 miles north of the transmitter, and at private residences elsewhere in Los Angeles. More difficult reception was successfully received during 74 separate demonstrations during April of this year in Pasadena, a distance of 10 mi. from the television broadcasting station, W6XAO, with a mile of hills of 3 peaks intervening.

Methods and technical apparatus used in these broadcasts are largely under patents to the Don Lee organization and Harry R. Lubeke, director of television. The sound portions of many television broadcasts were carried during the year by KHJ and other stations of the Lee chain at the same time that the sight program was being sent out on the higher frequencies.

The sight-sound transmissions of W6XAO occur

twice daily except on Sundays and holidays. The daylight schedule is as follows: Monday, 9 to 10 a.m.; Tuesday, 10 to 11 p.m.; Wednesday, 11 a.m. to 12 noon; Thursday, 12 to 1 p.m.; Friday, 1 to 2 p.m.; Saturday, 2 to 3 p.m. Evening broadcasts are from 6:30 to 7:15 o'clock.

2,000-BULB "TELEVISION" SIGN

(Continued from page 87)

Note however that both systems utilized gas-type tubes that could be modulated to produce halftone images.

Crowds on the West-side of Broadway, in mid-town Manhattan, stop traffic as they group to watch advertising copy and the antics of animal-cartoon routines, that continue for 8 minutes and repeat, on the side of a building on the East-side of 7th Ave., across the way.

Ordinary 6-W. filament-type lamps close-set in a large grid are used; unlike the neon tubes mentioned above they afford only silhouette images. And due to the limited number of lamps used the lack of detail in the outline is so great as to actually result in a new, striking effect that is amazingly artistic in its crudeness, as the illustration here reproduced clearly shows.

According to the N. Y. Daily News, about 200 graph drawings are required for a minute of running time. The completed drawings are transferred to a film that is then projected onto an apparatus, in back of the sign, which controls the on-off operation of the bulbs.

(Radio-Craft, upon suggestion to the operators of the Leigh-Epok Control, has been advised that attempts have been made to use ordinary 110-V. neon tubes in this simple on-off action, in view of the great economy in current drain that could be effected, but that to date these experiments have been "unsuccessful." Just why the low-drain neon tubes could not be used was not made clear.)

EVERY SERVICE MAN SHOULD OWN THIS COMBINATION VOLT-OHM-MILLIAMMETER AND FREE POINT TESTER



MODEL 640-740

Precision Built DEALER PRICE \$27.00

DESIGNED TO WITHSTAND ROUGH FIELD SERVICING NO EXTRA CASES TO BUY

Just what you need for field use. Every service shop should own duplicate servicing instruments as protection against rush work, instruments damaged in service, and for taking care of other emergencies.

The Ranger-Examiner Model 640 Free Point Tester has eight automatic switch type and ten single action jacks. Five sockets for any type radio tube.

Model 740 Volt-Ohm-Milliammeter has 3" Square Triplet Precision Instrument. Scale readings: 10-50-250-1000 A.C. and D.C. Volts at 1000 Ohms per Volt (D.C. Accuracy 2%; A.C. 5%); 1-10-50-250 D.C. M.A.; 0-300 low Ohms; High Ohms to 250,000 at 1.5 Volts. (Rheostat adjustment for 13 1/2 volts for Ohm readings to 2.5 Megohms.) Batteries may be added permitting such readings in 250,000 ohms steps. Low Ohms to 1/2 ohm with 25 ohms in center of scale. Backup circuit used. Current draw is only 1 M.A.

Dealer Net

Model 640-740 Portable Free Point Tester and Volt-Ohm-Milliammeter\$27.00

Model 640—Free Point Tester only, in Portable Case 9.90

Model 740—Volt-Ohm-Milliammeter only, in Portable Case 18.60

FREE Booklet. Lists 101 most frequent Radio Troubles, How to Detect and How to Cure. Nothing like it before. Greatly simplifies every-day servicing. Send coupon now.



Readrite Meter Works
816 Colgate Dr., Bluffton, Ohio

Please send me more information on Model 640-740; Model 640; Model 740; Free Booklet, "101 Radio Troubles and Their Cures."

Name

Address

(City State

Please Say That You Saw It in RADIO-CRAFT

NEW OSCILLOSCOPES USE 2-IN. C.-R. TUBE

(Continued from page 79)

G.E. PHONOGRAPH MOTOR

Formerly Sold for \$15.00



Only \$4.95

VARIABLE speed induction type self-starting, 110 volt, 25 to 60 cycle, AC, with speed control. Flare and cord. Speed range from 5 to 200 R.P.M. Can be installed in place of old-fashioned, hand winding speed motor. Also ideal for display turn table, and a hundred other uses. These General Electric Motors are brand new, in original factory cartons, \$4.95 G.E. Electric Phonograph motor as described. Shipping Weight—12 lbs.

WESTINGHOUSE UNIVERSAL MOTOR

\$2.95

110 Volts AC and DC

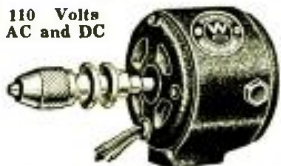

Shipping Weight 3 lbs.

THESE Motors are manufactured by the Westinghouse Electric Co. They are absolutely new. Specifications: 1/30 H.P. operates on either A.C. or D.C., 110 volts, 5000 R.P.M. Rheostat can be used to vary speed. Height 3 3/4", Length 3 3/4", Width 1 3/4", Shaft 1/4" one inch long. Can be used to drive Sewing Machines, Models, Buffing Lathes, Polishing Head, Drills, Grindstones, etc., etc.

MOTOR only \$2.95
 MOTOR with Arbor and 1/4" Chuck \$3.95
 Add 25c for special packing and mailing anywhere in U. S. A.

MICROPHONE and RECEIVER

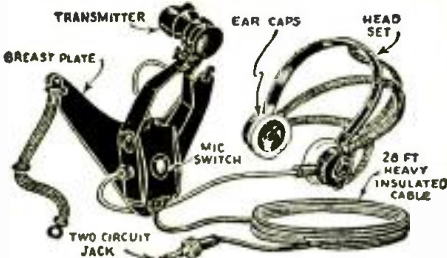

THIS Microphone and telephone headset outfit was built especially for the U. S. Navy Aviation Corps. The Holtzer-Cabot Electric Company constructed the outfit to Government specifications. The outfit consists of a low-impedance carbon microphone (transmitter), securely fastened to a metal breast-plate, and a set of heavy-duty, low-impedance earphones. A specially constructed switch on the back of the breast-plate controls the microphone circuit. The earphones are U.S.N. "fish" type, attached to adjustable headband. Twenty-eight feet of very heavy weather and waterproof conductor cable is furnished. Current of not more than 10 volts should be used. A storage battery is the most satisfactory current supply. U. S. Navy Airplane-type Microphone and Receiver as described \$4.96 The shipping weight is 9 lbs.

WESTINGHOUSE POWER GENERATOR

Manufactured for U. S. Signal Corps
 A.C. Electrical 200 Watt 110V. AC Power



from a Windmill, from available Waterpower, from your Automobile, from your Motorcycle, from your Bicycle, Foot-Pedals or Handcrank (for transportable Radio Transmitters, Strong Floodlights, Advertising Signs); do you want to operate AC Radio sets from 32 V. DC farm light systems; operate two generators in series to get 200 V. AC; obtain two phase and three phase AC, etc., etc. 1/4 to 1/2 H.P. needed to run generator. There Are Over 25 Applications, such as: A.C. Dynamo light from eight to ten 20 Watt 110 Volt lamps; Short Wave Transmitter supplying 110 Volts A.C. for operating "Hum" transmitter. Operating 110 V. AC 60 Cycle Radio Receiver in DC districts. Motor Generator, Public Address Systems, Electric Sirens on motor boats, yachts, etc. Camp Lighting, etc., etc. Blue-Print 22 x 28 in. and Four-Page 8 1/2 x 12 in. Instruction Sheets. Generator, as \$7.90 described including four replacement carbon brushes Shipping weight 18 lbs.

All merchandise in original packages—never used. Money-back guarantee.

We will forward Shipments by Express Collect if sufficient postage is not included.

WELLWORTH TRADING CO.

560 W. Washington Blvd., Dept. RC-837, Chicago, Ill.

Most radio receivers operate from power supplies delivering from 250 to 450 V. Most radio receiver rectifier circuit parts are designed for such work, and, as these parts are manufactured in vast quantities, do not cost, in proportion, nearly as much as parts which must withstand 2 or 3 times these voltages. Therefore, there was a definite need for a smaller cathode-ray tube which required no more than 450 V. Result—the 1-in. tube.

However—this tube came to us with mixed blessings. True, it required only 450 V. anode potential and could even be worked on as low as 250 V., but the effective screen area (the largest squared area within the circle) was only about 3/4-in. square which resulted in a mighty small picture. It is true the tube retailed at less than half the cost of the 3-in. tube, but did its advantages outweigh its disadvantages?

Engineers of one large test instrument manufacturer decided against the 1-in. tube and its relatively small screen and concentrated on a cathode-ray tube and equipment which would cost no more than present 1-in.-tube units, but would have a much larger screen. The result has been announced in 2 cathode-ray models, both employing cathode-ray tubes with 2-in. screens, yet costing no more than the current 1-in.-tube models.

Let us see why the 2-in.-screen tube is actually 4 times as effective as a 1-in.-screen tube. Figure 1 represents the outside screen diameter of a cathode-ray tube within which has been placed a shaded square representing the effective, or usable, screen area.

The total area and usable area of the 3-, 2- and 1-in. tubes are given in Table I.

Tube Screen	Total Screen Area	Usable Area
3 in.	7.0686 sq. in.	4.5 sq. in.
2 in.	3.1416 sq. in.	2 sq. in.
1 in.	0.7854 sq. in.	0.5 sq. in.

Therefore, it may readily be seen that (1) the usable area of the 2-in. tube is 4 times that of the 1-in. tube and 44 per cent that of the 3-in. tube. (2) That while the 2-in. tube has 4/9 the usable screen area of the 3-in. tube, the 1-in. tube has only 1/9 the usable screen area of the 3-in. tube. As a result, images as seen on the 2-in. tube are twice the height and width of those seen on the 1-in. tube and are much more satisfactory for solving all practical service problems.

REQUIREMENTS OF SMALL-TUBE OSCILLOSCOPES

What are the requirements for satisfactory oscilloscope equipment using less than a 3-in. cathode-ray tube?

- (1) The equipment must be sufficiently economical in first cost and upkeep so that the added profits resulting from its use will soon completely pay for its purchase and then return a good profit to its user.
- (2) The equipment should be as small and light as possible.
- (3) The instrument should present an attractive appearance so that it will present "customer eye appeal."
- (4) The unit should be portable and should be constructed ruggedly enough to withstand normal use.
- (5) It should employ a minimum number of controls for a maximum number of functions. Controls should be so grouped that there will be no necessity to grope for them.
- (6) It should employ at least a 2-in. cathode-ray tube since oscilloscope apparatus using the 2-in. tube may be manufactured to sell at no more than the price asked for 1-in. tube units.
- (7) In combination with a frequency-modulated signal generator, the equipment should be usable for either double- or single-image visual alignment—in fact, for any function or test that is provided by 3-in. tube units.
- (8) It should have some means of eliminating the linear sweep return at frequencies above 10,000 cycles where, in ordinary circuits, the return sweep becomes visibly confusing.
- (9) It should have a means of including or eliminating the return sweep when using the power supply frequency as a time base. For

the "double image" alignment method, the return trace is necessary but for "single image" work, the elimination of the trace is absolutely necessary.

(10) Positive synchronization of the time base with incoming signals is also required.

(11) Horizontal and vertical amplifiers for maximum usability. In a small unit, which might be used primarily for solving "ham" problems, the vertical amplifier only is necessary.

(12) Sawtooth oscillator (linear time base) should be essentially linear over a range of at least 15 to 30,000 cycles. This circuit is not required in a smaller unit.

(13) Means for controlling gain of its amplifiers, oscillator ranges, intensity, focus, etc., should be included.

(14) A switching system which is versatile enough to apply external or internal signals to either or both horizontal and vertical deflecting circuits, either through their respective amplifiers or directly to the plates through suitable isolating condensers, is essential.

The above is only a "skeleton" requirement list and could be amplified considerably to include definite electrical and mechanical specifications for each circuit, but it is sufficient to use as a guide by which two commercial 2-in. cathode-ray oscilloscopes may be judged.

COMMERCIAL 2-IN.-TUBE UNITS

Both instruments as manufactured by the Supreme Instruments Corporation employ the new 2-in. cathode-ray tube. The Model 535 is the larger of the two units, as pictured in Fig. A, and incorporates a variety of functions and ranges as will be described. The Model 530 is a small unit which has less extended functions and ranges than the Model 535 and was designed primarily for "ham" use, although both instruments may be used for visual alignment work when used in conjunction with a signal generator having a means of frequency modulation.

The Model 535 unit can be used as a complete visual servicer for receivers under conditions explained in the preceding paragraphs.

Many other advantages are claimed for this model including a "return sweep eliminator" which effectively eliminates the linear sweep return from the lowest to the highest frequency of the sawtooth oscillator (15 to 30,000 cycles). By applying part of the linear time-base oscillator signal to the grid of the cathode-ray tube, the return sweep is eliminated on frequencies between 10,000 and 30,000 cycles, below which the return sweep was not objectionable originally.

By means of another ingenious circuit, the user is allowed a choice of elimination or inclusion of the return trace when using, as a time base, the local power supply frequency.

For synchronization purposes, a very positive "snap-lock" system is used which literally "snaps" the signal under study into synchronization with the linear time base.

Another exclusive feature claimed for this model is a new type of control, the "uni-control." This is an unusual arrangement of 2 potentiometers which can be controlled separately by individual knobs on the panel, but which require only one mounting hole on the panel. Both

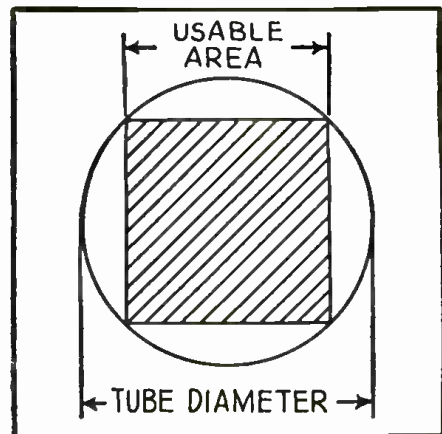

Fig. 1. Relative size of usable area compared with the total area of a 2-in. cathode-ray tube.

Please Say That You Saw It in RADIO-CRAFT

horizontal and vertical spot centering controls can thus be grouped on the panel instead of at the rear or side of the case. The potentiometer has a hollow shaft to which is affixed the knob closest to the front side of the panel. The shaft for the rear potentiometer runs through the hollow, larger shaft and is terminated by the forward control knob.

The 2-in. cathode-ray tube is operated from the local power supply, as are the balance of the tubes. The Model 535 is equipped with individual amplifiers for both the vertical and horizontal deflecting plates.

The resistance to the deflecting plate circuit has been maintained at a high level of approximately 0.5-meg. and the input capacity has been held to a low minimum of approximately 20 mmf. The amplifiers have a gain of approximately forty, a maximum allowable input potential of 800 V., and a flat-line frequency response curve from 15 to 90,000 cycles with graduated gain controls for making comparative tests. The sawtooth oscillator or linear time base employs a type 885 gaseous discharge tube with the necessary current limiting resistors to assure a maximum of linearity over its entire range. In addition to horizontal and vertical amplifiers and time base, there have also been incorporated the necessary facilities for allowing synchronization of the time base with the input signal either internally, externally or with the frequency of the local power supply. Provisions were made to include or eliminate the return sweep when using the local power supply frequency as a time base as well as when using the internal sawtooth oscillator as a linear time base. By clever grouping of controls, a

maximum of 16 controls was reduced to a minimum of 9, resulting in faster, more efficient and less confusing test procedure.

The incoming signal (signal under study) can be routed either through the vertical amplifier to the vertical plate or can be applied through a condenser directly to the vertical deflecting plate.

External sweep voltages (when desired) may be routed through the horizontal amplifier to the horizontal plate, or can be applied, through a condenser, directly to the horizontal plate.

The circuit diagram of the Model 535 is given in Fig. 2.

The five tubes incorporated in this model include a type 24XH 2-in.-screen cathode-ray tube, 1 type 885 gaseous discharge thyratron, 1 type 5T4 anode supply rectifier and 2 type 6J7 octal metal tubes used as vertical and horizontal amplifiers.

An illuminated green bezel is mounted directly on the panel so as to show when the instrument supply is connected. The instrument is so designed as to provide a maximum of magnetic shielding and it is protected by high-speed fuses in the power supply circuit. Mounted on a beautiful antique bronze metal panel and housed in a sturdy golden oak carrying case with a handy leather carrying handle, it fulfils all requirements for the complete 2-in.-screen cathode-ray oscilloscopic unit. Its outside dimensions are approximately 12 x 7½ x 8½ ins. and its weight is approximately 17 lbs.

This article has been prepared from data supplied by courtesy of Supreme Instruments Corporation.

THE LONGEST PATH IS THE SHORTEST

Yes Teacher

The shortest path to good control is the Centralab Variable Resistor because . . . the wall type resistor illustrated with the control hugs the inner circumference of the case. This resistor has these definite advantages:

1. Maximum resistor length for each case diameter.
2. Close uniformity between resistors.
3. Accurate tapers.
4. Uniform current distribution.
5. Lower specific resistance and attendant low noise level.
6. Better power dissipation.
7. Longer life.

Get your 1937
Volume Control Guide



Centralab

MILWAUKEE WISCONSIN

BRITISH CENTRALAB, LTD.
Canterbury Rd., Kilburn
London N.W. 6, England

FRENCH CENTRALAB CO.
118 Avenue Ledru-Rollin
Paris XI, France

RADIO-CRAFT'S INFORMATION BUREAU

(Continued from page 97)

Inasmuch as it takes a great amount of time, trouble and expense to work up a representative line of exact duplicate volume controls, there are many listings which are mainly suggestions as to standard units that may possibly be applied. The Service Man will do well to distinguish between exact duplicates and standard units. The former are in accordance with the original specifications of the set designer and manufacturer; the latter are simply improvisations.

What tube types would you advise me to stock? I can't stock all, because this would cost too much and in addition would tie up cash in stock which may never be made up—since some tubes have no demand. Can you help me?

(A.) The following material, taken from *Good News* a house publication of RCA Mfg. Co., while not entirely up to date, will be of assistance to you in setting up a stock of the tubes in demand. A few later types must be added, but we are sure you will have no trouble with these—it is with the older types you would be uncertain as to the desirability of stocking them or not. Incidentally, anyone contemplating the construction of radio equipment for the custom trade will want to check over this list to determine the relative obsolescence of the various types of tubes.

IMPROVING "QUALITY CONTROL" UNIT

(388) C. W. Rains, Bronx, N. Y.

(Q.) I have tried to make the unit described by C. K. Krause in the November 1935 issue of *Radio-Craft*, under the title "Quality Control an Aid to Old Sets," with only a certain amount of success. The unit does not seem to have sufficient effect, though the quality of my set is improved a little by its insertion. Can the unit be improved to give a more pronounced control over the high- and low-frequency response of the set?

(A.) The article by Mr. Krause specified the insertion of the "Quality Control" in the plate circuit of an intermediate A.F. amplifier stage. If your set has 2 stages of A.F. amplification, change the position of the filter to the plate circuit of the first A.F. amplifier, or even the detector plate circuit, where the signal level is lower. This will increase the effectiveness of the filter several times over the specified location.

If the above method is not practical, because of the use of a single A.F. stage in the set, it is desirable to insert an additional stage, and insert the filter in the plate circuit of the first stage. This will have 2 effects:— (1) increase the overall gain of the A.F. amplifier to make up for the attenuation in the filter; and, (2) increase the effectiveness of the filter to increase high- and low-frequency response of the set.

STOCKING TUBES IN RETAIL STORE

(389) R. D. Burroughs, Portland, Maine.

(Q.) I am preparing to open a radio service and sales shop here in the near future and wish you would help me to solve one problem which, so far, has me stumped.

I have a limited amount of money available to work with, so naturally I must order with caution, though at the same time I need an adequate stock of parts for immediate needs.

CLASSIFICATION OF TUBE TYPES BY DEMAND

Group 1

Heavy Renewal Demand Types Equipment Years

01A—1922 to 1928. 24A—1929 to 1932. 26—1928, 1929. 27—1928 to 1932. 35—1931, 1932. 45—1929 to 1931. 47—1930 to 1932. 71A—1926 to 1929. 80—1926, to date and still active.

All "old timers."
Every dealer should have representative stock of the above. Probably over 12 million sets in use using these types.

Group 2

A.C. 2.5-Volt—Newer Numbers 1932, 1933 55, 56, 57, 58, 2A5, 2A7—Large equipment volume in 1932 and 1933. Great bulk of the demand on 56, 57 and 58. Types 55, 2A5, 2A7 may be required in very moderate quantities for immediate service. True renewal demand yet to be developed.

53, 59, 2B7—RCA Victor and G.E. dealers particularly will require small quantities for service work only.

2A3—A. K., Colonial and Stromberg-Carlson sets.

2A6—A. K. sets.

The greatest need for these types for small stocks will come from dealers handling the sets noted

Group 3

6-Volt A.C. and Auto Types—Old Timers 36, 37, 38, 39—These types have been fairly active in the equipment market since 1931.

Large number of A.C. sets and universal A.C.-D.C. sets as well as auto sets went into the market in 1932 and 1933 using them.

(Continued on page 121)

Save Money on everything you buy . . .

The New BARGAIN BULLETIN

Your Guide to Hundreds of Outstanding Values.

FREE Write today for this outstanding new BARGAIN BULLETIN—there is no obligation on your part. High quality merchandise at sensationally low prices! Radio Sets, Parts, Sporting Goods, Watches, Clocks, Typewriters, Cameras, Novelties and many other items at real savings to you. Fair Dealing—Prompt and Courteous Service, always. Send for your Free BARGAIN BULLETIN now, try us, and be convinced of our superior values and service.

RADIO CIRCULAR CO., INC.
DEPARTMENT RC
315 Broadway New York, N. Y.

Please Say That You Saw It in RADIO-CRAFT

RADIO AND TELEVISION IN RECENT PUBLIC ADDRESSES

(Continued from page 87)

—DAVID SARNOFF—

electromagnetic waves to 150 social results, the links in the chain are continuous.

Since the beginning of the 20th Century, many men . . . have explored the physical phenomena which have given us the basis of the greatest developments in radio. You are all aware of the tremendously important part the vacuum tube plays in our industry. This device is the direct result of early work by physicists in the study of electron emission from heated filaments. Their work stimulated further study in the application of high-vacuum technique to the development of modern tubes. Many men who became famous in other fields of physics contributed substantially to the early growth of radio.

RADIO CANNOT DO WITHOUT PHYSICS

Today the radio industry includes not only countless radio devices as such, but sound-amplifying systems, sound motion-picture machines, photoelectric apparatus, and all sorts of vacuum-tube applications. Every branch of physics has contributed to the creation of these things:

- (1) Mechanics, (2) Heat, (3) Light, (4) Sound, (5) Atomic Physics, (6) Electricity and Magnetism.

(1) MECHANICS is applied to obtain uniformity of movement in sound-motion-picture machines and in photographs;

(2) HEAT, in the development of high-power vacuum tubes and loudspeakers;

(3) LIGHT, in the optical systems of photographic sound-recording and reproducing equipment;

(4) SOUND, in loudspeakers and other vibrating mechanisms, and in the design of broadcasting studios and auditoriums;

(5) ATOMIC PHYSICS, in vacuum and cathode-ray tubes; and,

(6) ELECTRICITY AND MAGNETISM, in all circuit design, as well as in construction of all magnetically-operated devices.

In our utilization of particles of the atomic system, for instance, we stand today where the early astronomers stood in their exploration of the heavens. They studied the planets, and the stars which seemed to be the heavenly bodies nearest them.

RADIO AND THE ATOMIC SYSTEM

In our knowledge of the atom, we first discovered and utilized the negative electron—the outermost and most easily accessible structural element, and the one which, in a sense, is nearest to us. Some day we shall know more about and doubtless utilize some of the other elementary nuclear particles which have been discovered in recent years—protons, neutrons, positrons, deuterons, and their various combinations. These new discoveries in turn may give us (a) new vacuum tube, (b) new sources of power, (c) new modes of travel and communication, (d) new manufacturing processes, (e) new forms of illumination, (f) new cures of dreaded diseases, (g) new highways to health.

Even as the astronomers penetrate farther and farther into the depths of space, using ever more powerful telescopes, so does the physicist, with his bombardment apparatus, penetrate deeper and deeper into the atom. The fact that one of his most powerful tools, the cyclotron, utilizes an ultra-short wave radio transmitter as one of its basic elements, illustrates the relationship which exists among all the physical sciences and their applications.

RADIO'S FUTURE DEPENDS ON SCIENCE

Radio—which grew from the seed planted by physicists to the point where it affects the life of nations—has "arrived," but only at an early station on its journey. We are just beginning to enter, in any practical way, the fascinating domain of ultra-high frequencies—in which "radio sight" will be added to "radio sound."

Short-wave transmission of pictures and printed or written material has been an accomplished fact for several years. It is now in daily service between Europe and America. The broadcasting of a facsimile newspaper into every business office and home—in half-hourly install-

ments if desired—is perfectly feasible. The establishment of such a service is now an economic rather than a technical problem.

TELEVISION—A ONE DAY MAJOR INDUSTRY

The new art of television is also making progress. For the past 10 months we have been transmitting experimental television programs from the Empire State Tower in New York City to receivers in the hands of engineers at observation points throughout the metropolitan area. We believe that acceptable standards of picture-definition, to which transmitters and receivers will be synchronized, have been reached.

No field of applied science leans more heavily on all branches of physics than does television. This is particularly true with respect to the recent work in atomic physics. Unexplained electronic phenomena occur in "Iconoscopes," the devices which convert light into electrical currents, and in the cathode-ray tubes, or "Kinescopes," which convert electricity back into light. Here is an absorbing and fruitful field of research for the modern physicist.

The major obstacles to the public introduction of television are no longer in the field of research and engineering. They lie in a new domain. Television now demands the creation of a new artform, allied with, yet distinctive from, the arts of the stage, of the motion picture, and of sound broadcasting. It requires new talent, new techniques of writing, direction, and studio control. It must set in motion an ascending spiral whereby good programs create a demand for receiving sets, thus creating a growing audience, which in turn will make possible better programs. Television must build networks, and justify an economic base capable of supporting an expensive program service. These are some of the problems of television, solution of which will one day make it a major industry.

NATURE'S GIFTS A SIEGFRIED SWORD

Note however that many of the gifts of science and industry are in the nature of a two-edged sword—it is a sword which, like the "Nothing" of Siegfried, can be used to slay the dragons of ignorance, intolerance, and greed; but—there is always a chance that it will turn out to be a weapon with which civilization may destroy itself!

One does not have to go far to find illustrations of the blessings and dangers that go side by side in the discoveries of science. The chemical that safeguards the world of the surgeon can poison the city's water supply. The airplane, that speeds transportation and commerce, can drop bombs from the air to blow women and children to atoms.

There are other dangers, less obvious and more subtle. Radio, for example, can be used for propaganda and incitement, as well as for education and entertainment. Science laid the same gift of radio at the feet of society in Europe as it did in America. It is true that in the United States there is room for improvement in some of the programs broadcast on the air, and that we still have to learn how to derive the greatest social benefit from radio. But no one raised in the tradition of liberty and democracy can doubt that our use of it is in the direction of social betterment, and that in certain parts of Europe, where radio has been commandeered by the forces of regimentation, its misuse points toward social degradation.

The new art of television has similar potentialities to build up or tear down social values. Like sound broadcasting, it can make friendly neighbors of people who differ in race, creed, politics, and language; while at the same time it offers a powerful weapon to the war-maker, and a medium of propaganda for the autocrat.

Fortunately, man's deliberate abuses of the gifts of science are the exception rather than the rule.

—THOMAS F. JOYCE—

velopment looking for constant improvement is an industry's best guarantee for the future, in

Speed up YOUR SERVICE WORK!
with Ghirardi's **NEW "GADGET TWINS"**

"HOME RADIO" and "AUTO RADIO" Pocket Trouble Shooters

Have you seen Ghirardi's two brand new time-saving Pocket Trouble-shooter "Gadgets"? They'll save you hours of servicing time, for they tell you just where the trouble spot may be and what test to use for every kind of trouble symptoms you'll ever find. All in half a minute! His HOME RADIO Gadget is completely revised and enlarged, with loads of fresh data. The AUTO RADIO Gadget, with lots of brand-new trouble-shooting dope, is just in time for summer auto-radio service work. Get 'em both—they're great little money-makers! Tear out this ad, pin a dollar to it with your name and address, and mail TODAY to—

RADIO & TECHNICAL PUBL. CO.
45 Astor Place, Dept. RC-57 New York
(Foreign—60c ea. \$1.20 for the pair.)

ORDER THEM NOW!

New ELGIN A.C.-D.C.

Volt-Ohm Milliammeter

A compact tester that accurately tests A.C. voltages, D.C. voltages, D.C. Mills, and resistance.

Reads obtainable: 0 5/50-500/1000 volts D.C., 0 5/50-500/1000 volts A.C., 0 5/50 and 500 Ma., 0.500/500000 ohms D.C. resistance. The unit can easily be adapted for use with oscillators as an output meter. **SHOULD BE PART OF EVERY SERVICEMAN'S AND EXPERIMENTER'S TEST KIT.**



Net Price to Dealers, service-men, and Dealers, **\$11.95**

MODEL 801, Similar to above with the following readings: 0-5-50-500-1000 Volts D.C., 0-500-5000-50000 ohms

Net Price **\$5.75**

TRY-MO RADIO CO., INC.
85 Cortlandt St. New York City

Correspondence Courses in RADIO and ELECTRICAL ENGINEERING

ELECTRICAL ENGINEERING Get good grasp of electrical field. Prepare yourself at Low Cost, for secure future. Modern, simplified, you can understand quickly.

RADIO ENGINEERING Extra fine course in radio, publishes the address, photoelectric work. Trains you to be super-service man, real vacuum tube technician. Exper. kits furnished. Diploma on completion. Tuition \$25. Further course. Data for assignment. **FREE** Get copies of school catalogs, student magazines, complete details. **SEND NOW!**

LINCOLN ENGINEERING SCHOOL, Box 931-35, LINCOLN, NEBR.

FREE RADIO AND PARTS CATALOG

Send for the new 1937 ALLIED Radio Catalog—156 pages with Everything in Radio 10,000 parts; 23 new All-Wave and Dual-Wave Knight Radios with latest developments—Automatic Tuning, AFC, Tone Expansion, etc.; Amateur gear; Build-Your-Own Kits; test equipment; Public Address; books, tools, etc. Write for **FREE** copy!

ALLIED RADIO CORP.
Dept. 2-W, 833 W. Jackson Blvd., Chicago, Ill.

Please Say That You Saw It in RADIO-CRAFT

TELEVISION NO BUGABOO

While on the subject of technological development, some of you might well ask: "How will Television affect the theatre owner?" As you undoubtedly know, the RCA Laboratories lead the world in television development and are now making extensive tests in New York with the National Broadcasting Company, another RCA service, looking to the eventual solution of the tremendous technical as well as commercial problems involved in making television a practical everyday service. In answer to the question, I would like to express a personal opinion that when television finally comes—and it won't be here tomorrow—it's going to help rather than hurt the theatre box office.

RADIO HELPED PUBLISHERS

Whenever any new development such as television comes along, the general cry is that it is going to put an existing service in an allied field out of business. It was thought by many that radio would affect the newspapers and magazines. Yet the newspaper and magazine publishing business not only continues to flourish but is making new strides ahead. Circulation figures for newspapers and magazines are higher now than ever in history.

RADIO HELPED CINEMA AND PHONOGRAPHS

We all heard, back in 1925, '26 and '27 that radio was hurting box office receipts. But that wasn't exactly so. The motion-picture business was becoming stagnant. There really had been no great technical improvement in the art of motion-picture projection since the inception of the business. Yes, there had been such improvements as elimination of flicker and greater light intensity on the screen. But nothing further. Then along came radio, and the electronic art, which made possible a tremendous contribution to the motion picture field—namely, sound. When "sound" was added to the motion picture, there was a tremendous revival of public interest in the motion picture and soon box office receipts reached new highs.

In our new company, we have a similar ex-

ample. I refer to the Victor record end of our business. Most people think that radio killed the record business. It didn't. The record industry killed itself. Actually, there was no great improvement in the art of disc sound recording and reproduction from the time Mr. Johnson made his first phonograph recordings in 1898 until 1926. The recordings in 1925 were thin. They had no life, no vitality, no sparkle. They were but a poor imitation of the original.

Then along came radio and forced a new contribution on the record industry—namely electrical recording and, later on, electrical reproduction. What happened? Victor record sales in the next two years increased 50% over that of the year 1925. But with no sustained effort to keep on improving the quality of the recordings and reproduction, with the coming of the depression, the business went into a tail spin.

At the bottom of the depression, RCA Victor decided that radio was not a competitor of recorded music,—that recorded music filled a need that radio could not fill—namely to give you the music you want when you want it. We put our engineers to work on improving the recordings and reproducers. The result was "higher fidelity" recording—making possible life-like rendition of the music and a revolutionary new reproducer incorporating, what the engineers chose to call, the "dynamic expander." To this was added some advertising and promotion effort. What has happened since then? Sales in 1936 were 300% over 1933. And this year we expect a 50% increase over last year.

TELEVISION WILL AID CINEMA

When television comes, I believe that the motion picture producers will make use of television to show advance trailers from their outstanding productions. A 2- or 3-minute sample of a super-production is going to make many, many million more people want to see these productions in entirety and the place that they will see them is in your theatres. I am sure that far-sighted motion-picture executives see in television the greatest advance agent and exploitation medium that the motion picture has ever had. When television comes, your theatres are not going to be big enough to hold the crowds that television exploitation will send to your box offices.

RADIO-CRAFT'S INFORMATION BUREAU

(Continued from page 119)

Group 4
Air Cell Types—Farm Market—Portable Battery sets

30, 32, 34—Active. Out in equipment over 2 years—in moderate quantity.

Dealers in farm markets where there is no A.C. house current should stock. Some dealers may require in wealthy neighborhoods where portable sets have been sold.

19, 31, 33, 1A6, 49—Slow. Only recently in equipment or else only used in few sets.

Ratio of these types to 30-32-34 very low. Anticipated average sale about one per dealer for renewal this year in battery markets.

Group 5
6-Volt A.C. and Auto Types

77, 78, 6A7, 42—These types (1932-33 numbers) came in heavy in equipment field and will probably be active for renewal this year. Expect renewal demand to develop this fall on first three. 42 already moderately active in renewal market and demand will increase.

Group 6
Tubes for Universal A.C.-D.C. Sets

1, 1V, 12Z3, 25Z5, 43—1933 first really big equipment year on these numbers. Used in small table model A.C.-D.C. sets and small amount in other miscellaneous equipment; 43 and 25Z5 by far the most popular.

Group 7
New Popular 6-Volt Equipment Types

76, 6C6, 6D6—These numbers came into the market in 1936 for initial equipment. Actual renewal demand will be small, but the dealer selling sets using them will require a small stock for service.

Group 8
Special 6-Volt Auto A.C.-D.C. Types

75, 79, 84, 6B7, 41—Moderate equipment

sales in the past. In most cases will remain popular for equipment this year.

Because of comparatively small equipment sales, only moderate renewal demand.

Group 9

Miscellaneous Types—Highly Specialized Demand

12A, 46, 50, 81, 82, 83, X99, 5Z3, 22, 85, 89—Type of dealer and trade he serves will determine whether stock is needed.

Group 10

Extremely Small Demand Types

V99, 48, 00A, 10, 11, 12, 20, 40, 874, 876, 886—Type 48, for example, sold only as equipment in direct-current markets. Equipment demand on 48 very small.

On others—very few old sets in use employing them.

CORRECTION NOTICE

Re: "An Excellent Coil-Testing Unit for the Service Man," Part I, by Walter L. Lyons.

With switch Sw.2 connected as shown in the original circuit inductance L2 could not be disconnected from the circuit.

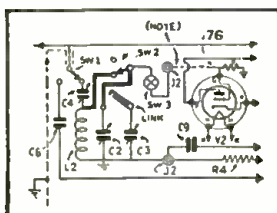

Switch Sw.2 is here shown properly wired-up to permit disconnecting L2 for making coil tests. The original circuit is Fig. 2 on pg. 18 of July, 1937 Radio-Craft.

Please Say That You Saw It in RADIO-CRAFT



With this great mass of information Ghirardi has gathered together, you'll have right at your finger tips EVERYTHING you need to know about modern radio servicing methods clearly explained, ready for instant use in your daily work. SUPPLEMENT SHEET SERVICE for the Data Book keeps you always up to date. You must have these 2 great books!

TEST INSTRUMENTS

Complete explanations and descriptions of the latest commercial models of test instruments (with circuit diagrams). Construction data, etc.

FIELD DATA

"Case Histories" of over 1,500 receivers, with trouble symptoms and remedies for each. I.F.'s for 5,424 super-hets. Over 25 other charts and tables.

SERVICING METHODS

Every latest test and repair method thoroughly explained. Receiver analysis. Repairing individual components. Aligning sets (including latest Cathode-Ray Oscilloscope methods). AVC and QAVC circuits, etc.

SPECIAL SERVICING PROBLEMS

—In Auto Radio, All-Wave, High-Fidelity sets, etc., all clearly explained.

1800 Pages

813 Illustrations

\$6 With Money-Back Guarantee

RADIO & TECHNICAL PUBL. CO.
45 Astor Place, New York, Dept. RC-87

Encl. find \$6 for both servicing books, including Jan. and June '37 Supplements to Data Book, postpaid. (Foreign \$6.50)

Please send free Circular "CO".

Name

Address

Fill Out - Tear Off - and Mail!

High-Powered High-Quality for PA work outdoors for indoor musical reproduction



U. S. E. Type 60-C Amplifier

60 Watts Output Three Mikes Electric-Eye Monitors

Tremendous power output for large installations or tremendous reserve power to eliminate "Peak distortion" on music.

U.S.E.'s new 16 page catalog lists Complete Sound Systems for every application from a night club to a football stadium.

Write for No. 107 Catalog and proposition.

United Sound Engineering Co.

2239 University Ave. St. Paul, Minn.



Licensed by arrangement with E. R. P. I., under patents owned and controlled by A. T. & T. and Western Electric Co. Inc.

Radio and Television



Test Equipment

Triumph makes 1, 2, and 3 inch oscillographs, vacuum tube and high resistance volt-ohm-milliammeters, plain and dramatised tube testers, frequency modulated wobulators, signal generators and capacity analyzers, all at the lowest prices on the market. Send for free oscillograph data, diagrams and catalogs.

TRIUMPH MFG. CO.

4021 W. Lake St. Chicago, Ill.

FREE!

**HAMMARLUND
25th YEAR
RADIO CATALOG**

The most complete catalog ever published with special illustrations, drawings, curves and a complete description of the famous 16 tube "Super-Pro." Write Dept. RC-8-37.

HAMMARLUND MFG. CO., INC.
424-438 West 33rd Street, New York

WHILE THEY LAST!

12" Magnavox Speakers with Curvilinear Cone—900 ohm field. Complete with output transformer to match a single **\$2.89**
Pentode Tube (47, 2A5, etc.)

No COD Shipments—Shipping Wt. 8 lbs.
Write for Our New Spring Flyer
ARROW SALES COMPANY
631 WASHINGTON BLVD., CHICAGO, ILL.

★

**BE SURE TO READ
THE
ANNOUNCEMENT
WHICH APPEARS ON THE
THIRD COVER
OF THIS ISSUE**

★

THE FUTURE STATUS OF TELEVISION PROGRAMS

(Continued from page 87)

chase of products, and a pronounced stimulation to the freer movement of goods.

The promise of television does not flow from the fact that it is merely a talking motion picture, but that it is such a picture in the home with potential simultaneous audiences of tens of millions of persons. A flow of pictures, each expressing more detail in a flash, than could be defined by a long string of words. The pictures can be understood by all including the illiterate, for the language of the eyes is universal. Sharper and more accurate impressions on the brain are obtained than could be had by the spoken word and these impressions are stored for long periods by our memory mechanism. As a homely illustration, we all know the difference between the bride's cake made from the words via a cook book or radio, and the cake of the same ingredients that another bride would make from learning its secrets by watching her mother prepare a similar one.

Programs must be timed to the audience. For example a morning hour between 10 and 11 will cater to the housewife. Menfolk are at work and growing children are at school. The subject matter might include a sponsored quarter-hour of cookery, a quarter-hour of light entertainment, a sponsored quarter-hour of household products, children's wearing apparel, home decoration and the like, and a quarter-hour of musical entertainment.

The main program should be in the evening when the audience is at a maximum and lighting conditions most favorable. Two hours should be adequate at the start.

Unlike radio, television must have the full attention of the audience. Therefore the program should be timed to come just after the evening meal—say 8 o'clock. It might start with a quarter-hour of news reel. Its sponsored portions could include the display of articles whose appeal is in the "charm" classification. Ladies' wear for example. What a powerful appeal attractive garments, worn by lovely models in home surroundings will make on the womenfolk, especially when their fine points are being described. What husband could refuse to supply the purchase price of the desired garment when he is under the contented influence of a tasty dinner and his home surroundings? No other form of advertising can reach so many people and deliver such a punch to sales as television. The sport program will show the critical moments of the games that are being described. Tennis, racing, football, baseball, fencing, boxing and myriad other activities which by their very nature must be seen to give play to their action. Travelogue material can be shown. Some of our present radio-sponsored programs can be improved by giving substance to the actor. The ladies on the reducing programs would be more convincing if we could but see them. The sponsored smile of a pretty girl would emphasize the value of the tooth paste she uses, fit looking folk would add something to the medical wares they describe, and the sight of well-groomed men and women would give some measure of confidence in the soaps, cosmetics and other beauty aids they urge us to use. Then there are plays, and mountains of motion picture film. In fact the motion picture theatres should use television with intelligent condensations of their features

to build up their own audiences. Science shorts, dancing, animated cartoons, children stories, vibrant personalities, these and much more will spring to life in the home with the advent of satisfactory television.

Bear in mind that the action can be broadcast directly, or it can be made up as a sound film and broadcast later from the film.

Are such programs costly? Not necessarily. Advertising film can be made very cheaply. The motion picture technique should not be used. It would be a mistake to use such technique and for example display garments with a background that takes in a marble palace, outdoor private swimming pool and a formal garden crowded with rare plants and flowers, and alive with uniformed servants. This is the motion picture technique. It does not sell merchandise. It gives the impression that the garments are designed for the palaces and pocketbooks of the very rich. In television a simple "homey" background will be used. Shots taken on the lawn of an average neat suburban home, or in a well-ordered middle-class living room are psychologically correct, for they image the setting of the prospective purchaser. Such shots are inexpensive and effective, while the normal professional motion picture shots are both extremely expensive and worthless as a display to create sales. This simplicity should be applied to the bulk of the material prepared especially for television.

Few people realize the enormous quantity of news reel material that is taken and never shown in the theatre. The discarded lengths are about on a par in interest with the selected lengths, and the quantity very much greater. This material could be had at very little cost.

Radio has accustomed us to the continuous serial. These have very few characters and changes of setting. The cost of sets and costumes which change but little from day to day would be small. We would accept the chosen costume much as we look forward to seeing Charlie Chaplin in his ridiculous get up.

Advertisers pay for results. Television should prove the strongest possible medium, and if it does, the advertisers will pay a huge bill without complaint. Television therefore could spend more on its programs than could be economy for the sound radio programs.

Then again, much of the television chain station business will be broadcast from film, due to the high cost of a coaxial hookup. This will cut the bill by substituting inexpensive film copies, carrying sound as well as sight, for expensive wire-line hookups and provide a margin of saving to the advertiser.

Illustrated newspapers and magazines are bound to lose some of their advertising revenue to the television broadcasting stations, for the advertisers cannot ignore the selling power of products televised in millions of homes. Small motion picture theatres will likewise suffer attendance, for it is unreasonable to expect those who have attended a 2-hour motion picture show at home to have a further appetite the same evening for something of the same sort. Outside of these two groups that will be hurt, television promises a great medium of remarkable benefits to the public as a whole.

CORRECTION NOTICE

"The 'Electric Eye' Auto-Speed Indicator."

This item, which appeared in April, 1937 *Radio-Craft*, page 590, was described in the article "Electric Eyes' See All—Do All." This item created considerable interest and it is unfortunate that due to a transposition of connections the circuit as originally shown on page 631 could not function exactly as described—the plates of the 25Z6 in the original circuit were shown reversed. The correction detail at right shows in heavy dotted lines how the 2 plates should be connected. We are indebted to Mr. M. Turner of Langdon, N. Dak., for calling this to *Radio-Craft's* attention.

This new speed indicator may be arranged to flash either a SLOW or STOP signal, as necessary, to control traffic.

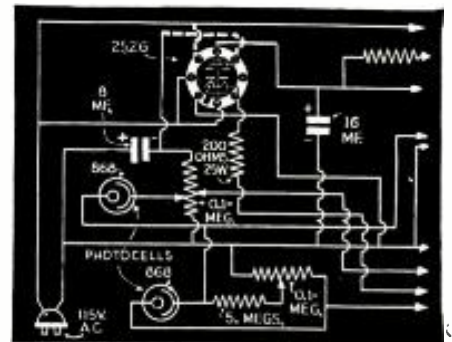

Please Say That You Saw It in RADIO-CRAFT

AN EXCELLENT COIL-TESTING UNIT FOR THE SERVICE MAN

(Continued from page 95)

OPERATION OF CAPACITY METER

From the method of calibration, the use of the instrument for measurement of capacity is fairly obvious. For completeness, however, directions for operation are here included.

To measure capacity up to 0.00125-mf. set C2 and C3 at zero and adjust the oscillator control C1 for resonance indication on the V.-T.V.M. milliammeter, using Cv to obtain an exact peak. Potentiometer No. 1 is adjusted to give about 3/4 of full-scale deflection. If now, an unknown capacity, Cx, is connected across the banana jack terminals (J1 and J2), C3 is then decreased in even hundreds of mmf. with C2 serving as a vernier to regain peak meter indication. The sum of C2 and C3 A scales equals Cx.

Sharper indications may be obtained in measuring capacities below 100 mmf. by disconnecting C3 and tuning the oscillator to a higher frequency with C2 A scale set at zero as before.

CALIBRATION OF THE B SCALES

The C2 and C3 B scales are used in testing R.F. inductances. The sum of the capacities indicated under the B hairlines gives the real internal capacity present across the banana jack terminals. This calibration is facilitated by the use of an auxiliary circuit CsLT which is connected directly to the type 76 tube grid lug and the grounded banana jack terminal as indicated in Fig. 4B. (Stand the chassis on end and remove the bottom chassis plate to make these connections.) Note that a temporary wire from the oscillator plate is placed near the control-grid end of LT as a "capacity turn" to supply voltage to the auxiliary calibration circuit. Condenser Cs is the standard condenser previously used and LT may be L2 or another coil of approximately the same inductance and Q. The B scale of C2 is calibrated with C3 disconnected. The capacity across the banana jack terminals with C2 set at minimum capacity first is determined, so as to include in the result, the distributed capacity of associated wiring, switches and terminals. The lead from the grid banana jack to the 76 tube grid lug is temporarily disconnected as indicated in Fig. 4B. The oscillator is sharply resonated to the circuit LTCs, using a harmonic if necessary, with Cs set (as an illustration) at 200 mmf. The grid lead is again connected and Cs reduced in capacity until the milliammeter indicates resonance with the oscillator. Assume this reduction to be 27 mmf. To this add 5 mmf. to account for the average grid electrode and grid socket lug capacity. A total of 32 mmf. is thus obtained as the minimum capacity of the C2 circuit and this is marked under the B hairline on the C2 B scale. Decrease 2Cs another 3 mmf. and increase C2 to resonance to obtain the 35 mmf. point. Condenser Cs is now decreased 5 mmf. at a time and C2 repeatedly increased to the corresponding resonance points until the remainder of the C2 scale is calibrated in multiples of 5 mmf.

By the same method, the C3 B scale is calibrated and during the process, C2 is kept at minimum capacity. While C3, set at minimum capacity, is disconnected, the oscillator is resonated to the circuit C2 (min.) LTCs with Cs set at 0.0015-mf. Upon reconnecting C3, Cs must be reduced, say 45 mmf., to regain resonance.

This value is taken as the minimum capacity of C3 and so marked on the scale under the B hairline. A further 55 mmf. decrease of Cs and a resetting of C3 for resonance gives the 100 mmf. point on the B scale. Condenser Cs may now be reduced 100 mmf. at a time to obtain calibration of the rest of the C3 scale, the marking and engraving of which should be carefully done, since a slight drafting error may represent a large discrepancy in terms of mmf.

ADDITIONAL DATA

In the construction of the experimental model, the 4-in. dials were covered with like-diameter discs cut from a good quality of drawing paper. These were inscribed with a 3/8-in. dia. circle in India ink, which served as a base line for the scales. Calibration should be done in pencil and the dials should then be inked-in, without removing them from the condenser shafts.

After all tube electrode voltages have been adjusted to their permanent value, the V.-T.V.M. may be calibrated by the method illustrated in Fig. 4C, which uses 60-cycle voltage obtained preferably from a step-down transformer. The voltmeter used should be checked for accuracy, if possible. During the calibration, switch Sw.2 is kept open to avoid damaging L2. The voltage E which gives a deflection of 0.80-ma. is first determined and denoted as 100 per cent. Then multiples of 10 per cent of E up to 120 per cent are calculated and their corresponding deflections on the milliammeter noted. It is then a simple matter to remove the glass protecting the milliammeter dial and inscribe these percentages thereon, preferably in India ink.

Figure 4F will suggest some methods of comparing various coils with standards for gain and inductance. A broadcast R.F. transformer, as an example, should first be tested at the lowest frequency for which it is designed to operate. The standard coil will be connected as in Fig. 4D; taking care to ground the coil shield-can if one is used. Switch Sw.2 is thrown to "open" and Sw.1 to the 6D6 control-grid. The oscillator is set at 550 kc. and C2 and C3 set for resonance indications. Assume C2 plus C3 amount to 350 mmf., the potentiometers Nos. 1 and 2 are adjusted to give 100 per cent deflection on the milliammeter. The coils to be tested may now be substituted for the standard. Condenser C2 is varied for exact resonance.

The coil under test may require 7 mmf. more than the standard; 7/350 equals 2/100 or 2 per cent. Thus the effective inductance of the coil tested is 2 per cent less than the standard. The voltage gain indicated on the milliammeter is in terms of the standard gain. If the absolute gain of the standard coil is known, that of the coil tested is easily calculated. Although the gain of a tested coil may be equal to that of the standard at the low-frequency end of the range, it does not follow that the same is true at the higher end of the frequency range. To compare test coils and standard at 1,500 kc., link L1 is opened and C2 is used alone for resonating the circuit. The oscillator 2nd-harmonic of 750 kc. may be used or an external oscillator coupled to the 6D6 control-grid. (For those unfamiliar with the L/C combinations at various frequencies, the latter procedure is less liable to error.) The external oscillator must also be used to supply frequencies for testing I.F.

(Continued on page 124)

COMPLETE STANCOR KIT



- 4 OSCILLATORS
 - Straight Pentode
 - Tritet
 - Jones
 - Bi-Push
- 2 BUFFER DOUBLERS
 - Triode
 - Dual Triode
- 4 AMPLIFIERS
 - Single Triode (T20 or Type 10)
 - Push-Pull Triode (T20 or Type 10)
 - Single Pentode (RK-39 etc.)
 - Push-Pull Pentode (Bi-Push)
- Forty-Eight Combinations

48 CIRCUIT COMBINATIONS FOR \$49.95

Here's a natural for the medium-power amateur. 4 Oscillators... 2 Buffer-Doublers... and 4 Amplifiers... 55 to 120 watts input... ALL FROM A SINGLE KIT. The kit includes circuits on the most recently released tubes... and circuits on older types of tubes that you probably have in your shack. The new Stancor "48-C" Kit contains all the parts you need FOR EVERY CIRCUIT—less crystal, tubes and meter. COMPLETE SCHEMATIC BLUE PRINTS FREE WITH EVERY KIT

STANDARD TRANSFORMER CORPORATION

850 BLACKHAWK STREET • CHICAGO

A NEW HIGH QUALITY SWITCH

The Shallcross Rotary Instrument Switches are designed for high voltage, high frequency and high insulation applications.



These switches can be made with any number of contact points up to fifteen, shorting or non-shorting, can be furnished with suitable insulation for metal panels, ganged in two or more decks, 1/4" shaft, single hole mounting. Ideally suited for band switching, high resistance voltmeters, multi-range instruments, etc.

Send for Bulletin 530-PA for details.
SHALLCROSS MFG. COMPANY
 Electrical Measuring Instruments and Accurate Resistors.
 700 MAD RAE BOULEVARD
 COVINGTON, LA.

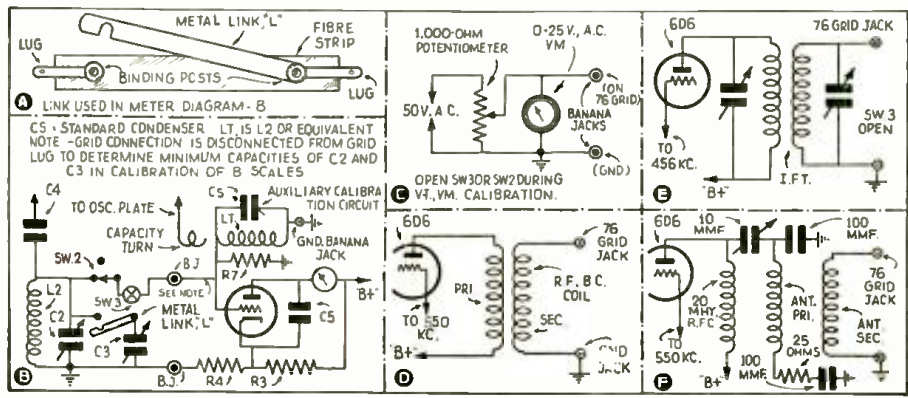
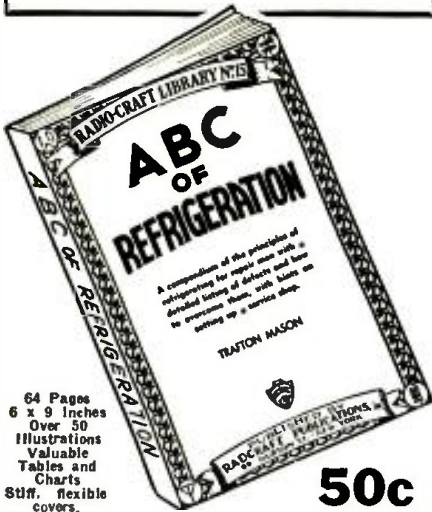

Fig. 4. Details for calibration; tests, etc. (See text.)

Please Say That You Saw It in RADIO-CRAFT

NEW!



64 Pages
6 x 9 Inches
Over 50
Illustrations
Valuable
Tables and
Charts
Stiff, flexible
covers.

50c

Trafion Mason, author of ABC OF REFRIGERATION, has written this book especially for those who are first becoming interested in the fertile field of Refrigeration Servicing. In this new volume you will find all the fundamental principles which underlie practical refrigeration systems in use today. While the contents of the ABC OF REFRIGERATION is somewhat elementary, a reading will still prove advantageous to experienced engineers since the author has included many valuable tabulations.

Brief Contents by Chapters

Principles of Refrigeration * Parts of the Refrigeration System * Installation * Servicing Refrigeration Machines * Servicing Procedure * Service Hints * Glossary of Refrigeration Books * Abbreviations and Symbols.

Send fifty cents in stamps, money order or coin for your copy of ABC OF REFRIGERATION—it is sent post-paid upon receipt of remittance.

RAD-CRAFT PUBLICATIONS, INC.
99-R HUDSON STREET NEW YORK, N. Y.

NEW—JUST OUT!

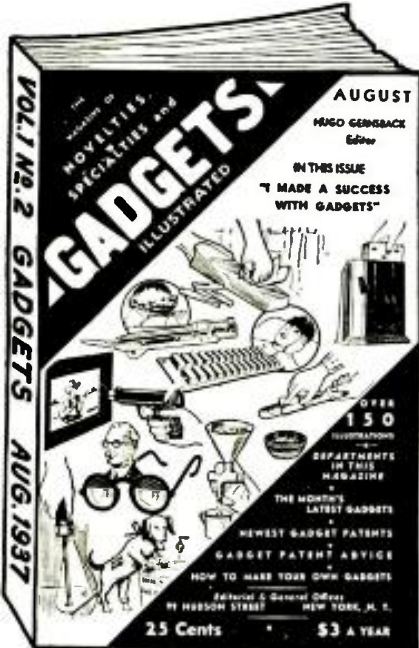

The world's only magazine on this subject. Contains 150 illustrations of the latest and best gadgets, novelties, and specialties. A veritable gold mine of information which you cannot get in any other way.

Every month, GADGETS ransacks not only America but the entire world for the newest, most useful articles of this type, including the latest gadget and novelty patents. Don't fail to read the article "I MADE A SUCCESS WITH GADGETS." Learn how inventors become rich in inventing or devising simple gadgets!

If your newsdealer cannot supply GADGETS MAGAZINE send 25c to

GADGETS Magazine
99-R Hudson Street, New York, N. Y.

SERVICING A STUDENTS' TELEVISION SET-UP

(Continued from page 84)

Obviously the two 75s, with an independent battery supply, constituted the preamplifier and the 85s followed as conventional gain amplifiers.

The plate-load resistor of the second 85 was also an intensity control as illustrated on the diagram reproduced here as Fig. 1. Rough calculations indicated this amplifier must have a gain through it of at least 120 to 130 db. As our problem was to locate a 60-cycle hum pick-up, the oscilloscope was determined upon as the most logical instrument.

We had been told that the amplifier should pass 100,000 cycles and as this was available from a standard-signal generator it was perfectly practical to couple the generator through a small capacity to the grid of the first 75 tube. The vertical plates of the oscilloscope could then be coupled to the plate circuit of successive stages and we could check the output either with a 400-cycle modulation signal from the generator or observe the pattern for any trace of 60-cycle ripple.

This greatly simplified our problem of locating the hum. It was now only necessary to go through successive stages of the amplifier with the ground terminal of the oscilloscope on the chassis and the high side of the vertical input of the oscilloscope touching each successive plate terminal of the high-gain amplifier.

In each case the output proved to be perfectly clean with no trace of the 60-cycle modulation. The output of the type 48 tube ran through a cable to the other station which was used for receiving.

Our next point of test was in the power-output stage that consisted of 2 type 50 tubes in parallel. Before checking the output of the 50s, the high D.C. range of a 1,000 ohms/volt meter was connected between the plate and ground. The reading indicated 525 V. on the plates of these tubes which was higher than the input condenser to our oscilloscope was rated for.

It was very easy, however, to connect 2—1/2-W., 1 meg. resistors in series from the plate circuit of the power tubes to ground and then connect the oscilloscope vertical plate input to the junction of the two resistors with the other oscilloscope common terminal grounded.

This gave us an image of the A.C. waveform in the output of the tube but the potential on the oscilloscope input was only one-half of the plate circuit voltage. Here our hum showed up.

To make sure it was not in the plate power supply, our next test was on the grids of the power tubes. Here also the 60-cycle trace was apparent, regardless of whether the power tubes were operating or not. This left only the cable between the two instruments to be suspected for trouble. It was apparent that the long cable was picking up the induced 60-cycle A.C. from the power lines in the baseboard or floor of the room.

The installation of shielded cable completely eliminated this trace of the 60-cycle induction. Low-capacity cable was used to avoid attenuation of the extremely high frequency which was employed.

It is plainly apparent that a television amplifier presents no greater difficulties in servicing than a good high-gain public-address system. A standard midget oscilloscope, costing less than \$50, a signal generator with a pure sine-wave output and a volt-ohmmeter of the conventional design are the only service instruments required for television work.

An oscilloscope can also be used in synchronizing the scanning discs although it is equally simple with an adjustment provided to rotate the motor frame and achieve synchronization mechanically.

In checking the characteristics of the amplifier, that is, its ability to transmit a sine wave without distortion, it was necessary to substitute a high-resistance load for the large neon tube across the output, as its reaction introduced what appeared to be distortion in the amplifier, whereas the load resistor disclosed a pure sine wave through the entire system.

Had the hum we were seeking originated in the power supply unit, it would have been equally easy to locate it as the waveform from the full-wave rectifier system would have indicated 120-cycle ripple—which is easily identified on a cathode-ray oscilloscope.

This article has been prepared from data supplied by courtesy of Triumph Manufacturing Co.

INTERNATIONAL RADIO REVIEW

(Continued from page 91)

bias is obtained from the speaker field coil voltage drop.

A 5-tube superhet. receiver designed around this amplifier is shown in Fig. 2 (just to show what can be done).

A FRENCH PHOTOELECTRIC STUNT

A CLEVER scheme for using a radio set as an alarm clock was described in the latest issue of *La Nature* (Paris). A selenium cell with two relays, one a sensitive type to operate directly from the cell and the second having heavy contacts to close a 110 V. line circuit are used in conjunction with a mirror to turn on a radio receiver, when the light from the mirror is sufficiently strong to close the relay contacts. See Fig. C.

The set is tuned to the desired station in the evening and the P.E. apparatus inserted between the electric light line and the set plug. Then in the morning, you are gently awakened by the sound of radio music—hi!

SOUND RECORDING ON FILM

AS A solution to the problem of making sound recordings which run for longer periods than the usual phonograph discs, one English manufacturer has placed on the market, according to the latest issue of *Wireless World* (London) a combined sound-film projector and all-wave radio receiver. Special 4 mm. film without

the usual sprocket holes is used. This film is recorded by dyeing the surface of the film with a light-sensitive dye and recording the sounds in the dye by a photographic process which embeds the recording in the film material.

Two sound tracks are recorded on the film which is then run through in one direction (from one 7-in. spool to another) for one recording and then reversed for the other selection. The recordings run for 20 minutes or a total of 40 minutes for the entire film.

The all-wave radio set uses the record amplifier for its A.F. channel. See Fig. D.

AN EXCELLENT COIL-TESTING UNIT FOR THE SERVICE MAN

(Continued from page 123)

transformers operating below 350 kc. If the experimenter so desires, however, the chassis may be so designed as to include a point-switch and oscillator coils for all desired frequency ranges.

Nevertheless, the specified value of L1 is necessary for the proper operation of the capacity meter and should not be changed.

Those without laboratory facilities for measuring the inductance of L1 may successfully use a broadcast receiver as a check. When C1 is set at maximum and Cv at half-setting, the oscillator output will be at 325 kc. The broadcast receiver should then catch strong C.W. harmonics at 650, 975 and 1,300 kc. A tuned-R.F. receiver should be used. If now, C2 and C3 are set at maximum capacity (with the switches in Capacity Meter position), the milliammeter will show a strong deflection if L2 is of the correct inductance. No external capacity is connected to the terminals during this check.

Please Say That You Saw It in RADIO-CRAFT

VOLTAGE-DOUBLING CIRCUITS

(Continued from page 100)

input, the half-wave rectifier can deliver a maximum output voltage equal to E. The full-wave rectifier can deliver a maximum output voltage of $\frac{1}{2}E$, while the bridge-type rectifier will deliver a voltage output equal to E. The maximum output of the voltage doubling circuit is 2E. (These values neglect the drop in the tube and in the transformer secondary and assumes conditions of very low drain.)

The voltage-doubler circuit subjects the rectifiers to an inverse peak voltage equal to the maximum output voltage which is also the case with the bridge rectifier. The full-wave and half-wave rectifier subject the rectifier tube to an inverse peak voltage equal to twice the output voltage. This shows another advantage of the circuit which permits the use of low-voltage rectifiers to obtain outputs up to 1,400 V. (the maximum peak inverse voltage for the popular rectifiers like the 5Z3, is 1,400 V.).

For purposes of calculation, the circuit can be considered as 2 half-wave rectifiers connected in series. Considering the condensers C1 and C2 to be discharged at a constant rate and neglecting the voltage drop in the tube and the transformer secondary, the relations between the secondary voltage and the average output voltage as well as the waveform of the ripple are illustrated in Fig. 1B. The calculation of the average voltage G across one condenser is rather complicated and was described by R. W. Armstrong in his article "Polyphase Rectification Special Connections" appearing in the January 1931 issue, Proc. I. R. E. Following are the equations which were used to plot the curves in Fig. 2.

OBTAINING VOLTAGE CURVES

While the condenser is discharging, the instantaneous voltage across it falls off according to the equation:

$$g = E - J\theta/2\pi fC$$

where g is the instantaneous voltage across C1, E is the peak voltage of the transformer secondary, J is the discharge current (load current), θ is the phase angle of the voltage vector, f is the frequency and C is the capacity of C1.

Recharging of the condenser begins when the instantaneous supply voltage is equal to g, or when

$$E - J\theta/2\pi fC = E \cos \theta$$

The average voltage across the condenser during discharge is

$$G' = (E + E \cos \theta_s) / 2$$

where θ_s is the phase angle at the moment the condenser starts recharging.

The average voltage across the condenser during the charging process is

$$G'' = [1/(2\pi - \theta_s)] \int_{\theta_s}^{2\pi} E \cos \theta d\theta = [E/(2\pi - \theta_s) \sin \theta]_{\theta_s}^{2\pi}$$

The average of the two is
 $G = [\theta_s G' + (2\pi - \theta_s) G''] / 2$

The curves in Fig. 2 show the ratio E_{ac}/E_{dc} plotted against the load resistance for different values of capacity. Factor refers to the r.m.s. value of the supply, a sine wave is assumed and the curves were calculated for 60 cycles only. The capacity values represent each condenser, in other words there are 2 condensers of the value shown on the curve. An example of the use of the curves follows:

USING THE CURVES

An amplifier requires a power supply of 400 V. at 200 ma. If the input condensers have a capacity of 16 mf. each, what is the required secondary voltage? The resistance of the load is 2,000 ohms. Enter the chart from the resistance scale, follow the 2,000-ohm line until it intersects the curve marked 16 mf. Then, following the horizontal line to the left, find the required ratio: $E_{ac}/E_{dc} = .425$, or $E_{ac} = .425 \times 400 = 170$ V. The effect of the variation of capacity is easily established by doing the same with other condenser values. It should be noted that the answer obtained does not take into consideration the drop in the tube.

In order to secure some idea of what this drop would be, it should be remembered that the voltage drop in a high-vacuum tube increases with the current but not linearly. Increasing the input capacity will increase the average current through the tube and therefore the voltage drop. Consequently, the drop in the tube increases with current and also increases with capacity when the current remains the same. Curves of the performance of a 25Z5 tube working directly from the 110 V. lines, were compared with the curves in Fig. 2. From this it was shown that for the same load resistance and the same input capacity, the curves of Fig. 2 gave a D.C. output voltage which was between 50 and 80 V. too high compared with the performance curves of the 25Z5. Thus the drop in the tube was 50 to 80 V. (These are approximate values and were calculated for drains between 20 and 100 ma. and for condenser values of 4, 8 and 16 mf.)

This article has been prepared from data supplied by courtesy of Aerovox Corporation.

ORSMA MEMBERS' FORUM

(Continued from page 100)

Thanks for your compliments, Mr. Steele—we don't blame you one bit for your staunch defense of television in England. Perhaps our Philco friend (*April Radio-Craft, pg. 583) was a bit near-sighted—or maybe he viewed English television at its worst. The application blanks have gone forward to you.

OUT "FLUNKYS", SAYS SERVICE MAN

RADIO-CRAFT, ORSMA Dept.:

I read the article (July 1936, pg. 23), some time ago, by Russell E. Lanning, on what he thinks of the service business, and am taking this opportunity to comment. I thoroughly agree with him that you cannot make your salt at radio service, because, there is nothing but grief in it. The whole trouble lies in the fact that there are too many "flunkys" in the radio service business.

These flunkys, just to make a few cents, will repair a radio set for practically nothing; they even show the customer the wholesale prices on parts they install and show the customer just what they make on a job. We have them here.

Mr. Lanning states that it is not enough money to charge \$3.00 for installing a volume control. It isn't, but he is still in heaven if he can even get that, as here they will do it for

\$1.75, or even less, just to get the job! I have had so many jobs that have been butchered by flunkys that it isn't even funny anymore. Then the customers expect me to put the sets back in first-class condition for a song.

If you charge over \$5.00 for a radio repair job in this town you are "a crook and a swindler," and as far as buying any test equipment to keep up with times, I wouldn't spend a dime the way things are today. If you can't make any money why spend any? ("No tickce—no washee," brother. You can't get to 1st-base, with the modern radio set, if all you own is a screwdriver, pliers, and a meter.—Editor)

I have had a wonderfully clear insight on the radio situation in the past years, I have contacted many, many Service Men in the middle-West and have yet to see one who is making a living, instead, they are all starving. I have also worked with radio engineers who design radio sets and have worked in a recently-developed radio factory in this city, but it went "busted":—too much chain store competition. (Many manufacturers are kept doing a rushing business, selling to chain stores.—Editor)

After having talked to hundreds of Service Men, engineers, factory men and builders of radio equipment, I have come to one conclusion: that the radio game is just a "racket" and the only way to make anything in the radio field is to start a racket of some kind, as there is no
 (Continued on page 126)

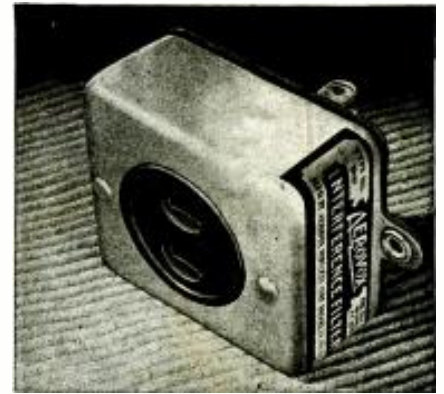

Kills that Noise!

- ★ Handy line filter. Plugs in wall outlet. Set plugs into receptacle.
- ★ One of several AEROVOX Interference Filters now available. New types shown in latest catalog.
- ★ Such accessories sell on your service calls. Every critical set owner wants one. Extra money for you.

Ask for DATA . . .

Let your local jobber tell you about these money-makers. Or write us direct for new catalog.



MILLION TUBE TESTER



FEATURES

1. Emission
2. Metal Tubes
3. Shorts Hot
4. Leakage Hot
5. Resistance
6. Electrolytics
7. By-Pass Condensers
8. Neon Alignment

MODEL CN
\$9.95
 NET

Here's what the Service Men say about the New Million Tube Tester! "Most valuable purchase of test equipment we made during the last year." "It shows up weak tubes better than my expensive—tester."

If your jobber cannot supply you—order direct—20% deposit required on C. O. D. orders. Tear out this ad and send it to us NOW for complete information on the entire Million line.

MILLION RADIO AND TELEVISION LABORATORIES
 559 N. UNION ST., CHICAGO, ILL.

SUCCESSFUL SERVICING

For Professional Servicemen

RSI advanced home-study training in Radio Service and Public Address work is the "Key" to Successful Servicing. It gives you the latest instruction on what goes into modern receivers, and basic knowledge of how complex circuits work. It familiarizes you with various types of vacuum tubes. It gives you the ability to progress from the "mechanic" stage to that of an expert specialist. For complete details write to—



RADIO SERVICE INSTITUTE (Dept. RC-8)
 3308-14th St., N. W., WASH., D. C.

WRITE TODAY FOR
FREE BOOK

Please Say That You Saw It in RADIO-CRAFT



NEW 10 CENT PUBLICATIONS for Experimenters

WE list below a large number of radio, short-wave, and mechanical "how-to-make-it" designs. Each is a special publication originated by masters in their respective fields. For the first time, at the low price of TEN CENTS, you are now enabled to buy a complete design with photographic reproductions, complete mechanical layout, and full description to make it possible for anyone to build the project in question.

The name of "Radio Publications" has become a household word because this company has for many years specialized in radio and other literature of special interest to the experimenter.

PLEASE ORDER EACH PROJECT BY ITS PUBLICATION NUMBER, and use the special coupon below.

We accept money-orders, cash, checks or new U. S. stamps. (No foreign stamps or currency can be accepted.) If you send cash or stamps, register your letter to safeguard against loss. Money refunded if you are not satisfied.

ANY TWELVE PUBLICATIONS FOR ONE DOLLAR

Partial List of New 10 Cent Publications

SHORT-WAVE RECEIVER PUBLICATIONS

- HOW TO MAKE THE 2 TO 5 METER TWO-TUBE LOUD-SPEAKER SET.** Just the thing for beginners who wish to have an easy-to-operate crystal set on all-waves and which will separate all the stations. Can be made for less than \$2.00. Uses no tubes or batteries. No. 107
- HOW TO BUILD THE CIGAR-BOX 1-TUBE "CATCH ALL" RECEIVER.** An effective short-wave battery set which fits into a small cigar-box, insuring high portability yet great efficiency. No. 111
- HOW TO BUILD THE PORTABLE MINDYNE SHORT-WAVE BATTERY SET.** Uses 25-cents worth of batteries. Total weight is 3 1/4 lbs. and measures 5x5x8 inches. Self-contained batteries, tube, condensers, and loop. Highly sensitive circuit. No. 114
- HOW TO BUILD THE HAM-BAND "PEE-WEE" 2-TUBER.** A dandy receiver with high efficiency and bandspread tuning. Works a loudspeaker, yet the entire receiver is no larger than your hand. Works with either batteries or an A.C. power pack. No. 115
- HOW TO BUILD THE DUO-AMPLIDYNE.** The ideal 1-tube set for the beginner. One of the finest 1-tube sets; it really gives 2-tube performance. Made for battery operation. With only ten-foot antenna brings in the best European stations. No. 116

RADIO BROADCAST RECEIVER AND SPECIAL RADIO PUBLICATIONS

- HOW TO BUILD A SUPER-SENSITIVE ALL-WAVE CRYSTAL SET.** Just the thing for beginners who wish to have an easy-to-operate crystal set on all-waves and which will separate all the stations. Can be made for less than \$2.00. Uses no tubes or batteries. No. 121
- HOW TO BUILD THE 2-TUBE "PENTODE PORTABLE" BROADCAST SET—the lightest, smallest set giving loudspeaker volume on batteries. Weighs less than 12 pounds. Built in a small, portable case. No. 122**
- HOW TO BUILD THE RADIO "TREASURE" FINDER.** This is a really sensitive and practical "Treasure" finder. Simple to build and guaranteed to work. Uses 4 tubes. Can be built for less than \$15.00. No. 123
- HOW TO BUILD THE GERNSBACK ONE-TUBE PENTODE LOUDSPEAKER SET.** This is the best one-tube loudspeaker set ever constructed. It works on batteries, and is for broadcast reception. Extremely sensitive. No. 124
- HOW TO BUILD THE WORLD'S SMALLEST ONE TUBE BATTERY RADIO.** So small that it is actually built in a cigarette case. The wonder set of the last New York radio show. No. 125
- HOW TO BUILD A SUPER-SENSITIVE ALL-WAVE CRYSTAL SET.** Just the thing for beginners who wish to have an easy-to-operate crystal set on all-waves and which will separate all the stations. Can be made for less than \$2.00. Uses no tubes or batteries. No. 126
- HOW TO MAKE AN A.C.-D.C. ONE-TUBE "DEAF AID."** An excellent aid for the hard-of-hearing and deaf. For theatres, churches, and the home. A godsend for all afflicted persons. Can be built for a few dollars. No. 127
- HOW TO BUILD A PIANOTRON.** For less than two dollars, plus a few junk parts which you have, you can now make a beautiful musical instrument. Operated by three radio tubes. It has an actual keyboard, and you can play tunes. Works on "A" and "B" batteries. A great novelty due to the unusual music which issues from the loudspeaker. No. 128
- HOW TO BUILD THE ONE-DOLLAR RADIO.** Impossible though it sounds, for one dollar you can build a radio set which includes a radio tube and a pair of headphones and batteries. You make everything yourself outside of the three last mentioned items, from wood and spare metal parts. No. 129

MECHANICAL PROJECTS PUBLICATIONS

- HOW TO BUILD A PEE-WEE AUTOMOBILE.** An ultra-small automobile that can be built for less than 10 dollars. Will carry two 17-year-old boys. Runs 35 miles per hour and 100 to 125 miles on one gallon of gas. No. 132
- HOW TO MAKE A BAND SAW FROM OLD AUTO PARTS.** Made from old Ford and Chevrolet parts. Capable of performing delicate and satisfactory work. Uses 25-gauge 10 and 12-inch old boys. Runs 35 miles per hour and 100 to 125 miles on one gallon of gas. No. 133
- HOW TO BUILD A REAL LATHE FOR \$5.00.** Requires a few hand tools, about \$5.00 worth of raw material and patience to build. The lathe is capable of drilling, milling, trimming, boring and thread cutting. No. 136
- HOW TO BUILD A SIMPLE PORTABLE REFRIGERATOR.** A real refrigerator. Does not use ice. The cooling unit operates from an alcohol flame, oil burner or open fire. Easy and inexpensive to build. Excellent for boats, camps, picnics, etc. No. 138
- HOW TO BUILD LARGE TESLA AND OUDIN COILS GIVING 18-INCH SPARKS.** Interesting high-frequency apparatus with which many high-frequency and x-ray experiments can be performed. Capable of producing 15,000 volts. No. 141
- HOW TO MAKE AN ARC WELDER.** A real arc welder capable of doing commercial jobs satisfactorily. Uses a heavy duty transformer which operates from the 110-volt A.C. main. The output of the machine ranges from 15 to 100 amperes. No. 142
- HOW TO USE AN A.C. ARC WELDER.** Companion publication to the one listed directly before. Very informative; especially to the garage man or mechanic who has had little or no experience with an arc welder. Contains many important diagrams and photographs of actual work done with an arc welder. No. 143
- HOW TO MAKE YOUR OWN MICROSCOPE.** A microscope which the home mechanic can easily build in his shop. The lenses are obtained from the finders of a camera. Although simple and easy to build, it is a thoroughly practical and efficient instrument. No. 144
- HOW TO MAKE A WIMSHURST ELECTROSTATIC MACHINE.** An easily constructed generator of static electricity capable of discharging a fat three-inch spark. Used in schools where electricity is taught. Can be built for less than \$2.00. No. 145
- HOW TO MAKE A POWER DRILL PRESS FROM SCRAP PARTS.** An excellent practical drill press that will make work easier for the mechanic. About \$2.00 worth of raw material and scrap iron are the only requirements. No. 146
- HOW TO MAKE AND EXPERIMENT WITH AN ELECTROPHORUS.** With this device numerous interesting experiments with static electricity can be performed. Many of these experiments are thoroughly explained and illustrated. No. 148
- HOW TO MAKE AN ARC WELDER FROM AN AUTOMOBILE GENERATOR.** No. 149

RADIO PUBLICATIONS 99A HUDSON STREET NEW YORK, N. Y.

RADIO PUBLICATIONS, 99A Hudson Street, New York, N. Y. RC-837

I enclose \$..... for the publications listed by number, at right, at 10c a copy (ONE DOLLAR FOR ANY TWELVE PUBLICATIONS.) These publications are to be sent me postpaid. I have placed a circle around each number which I want.

Send me also your list of 27 other 10c publications.

107	111	114	115	116
121	122	123	124	125
126	127	128	129	132
135	136	138	141	142
143	144	145	146	148
				149

Name Address

City State

ETCHED-FOIL DRY ELECTROLYTICS AFFORD IMPROVED FILTERING

A low power factor is a desirable characteristic in a condenser, it is true, but there may be compensating factors in a unit of high power factor that would greatly alter the answer as to which would be more suitable for use in a piece of apparatus.

With this thought as a starting point, Cornell-Dubilier Corp. engineers call to the attention of the technician the fact that the high-power factor etched-foil dry electrolytic condenser, in view of the increased capacity which the etched-foil design makes possible, actually affords better filter action than plain types of condensers of the same size.

SOUND SYSTEMS HELP IMPROVE LABOR RELATIONS IN FACTORIES

One method of obtaining closer unity down to the youngest workman in the factory, and in addition promote better working conditions, more pleasing surroundings, and of course if possible, increased efficiency, says G. J. Irving, Sales Promotion Manager of The Webster Co. (Chicago), is to install and utilize a sound system.

Such a system properly installed, with each reproducer adjusted to suit local-noise conditions, not only affords instant group-address by voice, during working hours, but also may supply music, news, and so-on, during rest periods (luncheon, etc.).

(Continued from preceding page)

money in the service field, but it is the Service Man and future Service Men who are the suckers today and keep alive the radio rackets.

Then there is the "parts racket," millions of dollars worth of gyp parts are sold daily in this country. Finally there is the magazine end which depends entirely on the Service Man; just think of all the magazines there are on radio today, and the money they take in on advertising.

It is in these various fields that the money lies and not in Service because if there was any money in servicing the chain stores would have gobbled it up a long time ago.

But setting all else aside as they do not hurt the Service Men in themselves something should be done to stop this misleading advertising about the big pay jobs and learning to repair radio sets after 2 lessons. If your magazine will champion this cause it will do more good for the Service Man than anything else in the field today, and I think if a canvass were made of this, three-fourths of all Service Men would agree with me.

ELMER HOEPPNER

Frankly, we can't entirely blame brother Hoepfner for feeling wrought-up over conditions which he has encountered, but, on the other hand, there is a great deal to be said not so much in defense of certain present, sporadic conditions such as Mr. Hoepfner mentions, but rather in fair and just recognition of the fine work many representative service organizations are doing, and the future that is in store for the service field as a whole.

Taking Mr. Hoepfner's comments in their sequence, we find that "flunkies" get under his skin. "Flunkies," we presume from Mr. Hoepfner's letter, are incompetent radio men who "chisel" on prices just to land the job. With this as a beginning our commentator proceeds to tear into various radio set-ups which, for the purposes of emphasis on his viewpoint concerning flunkies, he graces with the term "racket."

We believe that the crux of the situation is nicely summed in the editorial in July *Radio-Craft*, by Hugo Gernsback, entitled, "Modern Radio Servicing." One paragraph in particular merits being quoted:

"I believe the time will come when no radio owner will be foolish enough to trust his set to every stray Service Man who isn't known in his community, because the owner will be afraid to trust a set to any one unless he is generally known to be thoroughly reliable."

Now if you carefully analyze the present status of radio receiver construction it will be found that only experienced radio men can properly service these receivers, as the above-quoted paragraph points out.

Where then are these experienced radio men to be found? It is true that the present crop of practicing technicians is in position to take care of a certain amount of this business but at the same time it is necessary to break in new radio men to take the place of those who in time will leave the servicing field.

"The schools," is one answer of the question as to where these experienced radio men can be obtained. Contrary to the opinion of those who have not attended the correspondence or resident courses of well-known radio schools, none but persons well-versed in radio ever receive diplomas—the examinations are much too stiff to permit any but those who are well-up on the subject to pass the examinations. In the opinion of radio men who have completed servicing courses in well-known schools and who know whereof they speak, the radio schools cannot be termed a racket.

"Yes," some of our readers will remark, "but what about the parts racket?"—the daily sales of millions of dollars worth of "gyp" parts?

The answer to that includes reference, once again, to the quoted paragraph of Mr. Gernsback. The Service Man who continues the practice of considering his customers merely as "suckers" and continues to repair their radio sets with distress merchandise having characteristics ill-suited to the job in hand, or who uses replacement parts of an inferior quality, automatically is digging his own business grave into which he will be pushed by popular opinion. The legitimate parts supply houses are a

Please Say That You Saw It in RADIO-CRAFT

godsend to the Service Man—otherwise, where would he be without these organizations which are willing to "hold the bag" by purchasing radio equipment in huge quantities, from the manufacturer, in order to be able to sell the items piece by piece to the Service Man in Oscaloosa who needs only one of this and one of that? Without the parts supply houses the radio Service Man would have to go back to the old status, which many seem to have forgotten, of waiting weeks and even months for a manufacturer to get around to taking care of his individual orders for radio parts in retail quantities.

As regards magazines, we believe Mr. Hincks' letter, following, answers the question of whether they are of material help to the radio man.

There is lots more that can be said on these subjects but neither time nor space permit us to continue much further at this writing.

In conclusion we can only say that we deeply appreciate the economic situation of many Service Men as indicated by Mr. Hoepfner, but such conditions have always existed in varying degrees in every field and will continue to exist. However, where this situation in the radio field has been exaggerated in the past due to the fact that radio is a new industry that has grown too fast to enable it to completely accommodate itself in various branches, the pressure of necessity, as pointed out in the quoted editorial, is rapidly alleviating these fundamentally unsound conditions.

RADIO-CRAFT, ORSMA Dept.:

This note concerns the letter of Mr. Edward Rosmarin published in the May 1937 issue of *Radio-Craft*.

I have always admired *Radio-Craft* for being a radio publication that did justice to all interested in radio—the beginner and the veteran alike. Who would carry on the science of radio

if there were no beginners, and how could they begin if there were not one radio publication helpful and kind enough to start them on their journey? As to the objection to having kids enter one's store to ask information: if the Service Man in sympathy with this objection will recall, he, too, was a beginner who obtained his first knowledge of radio in much the same manner. Inasmuch as I was one of those beginners, *I am only too happy to assist those who come to me as I went to others in my green days.* (Italics, ours.—Editor)

If you (*Radio-Craft*) forget about the beginner as you were advised, I am positive that your circulation total will drop far below the statement on *Radio-Craft's* cover. Why? Because for every successful man in radio today there is at least one beginner, and, being omitted from your publication, these beginners will have no reason to purchase *Radio-Craft*. Hence, decreased subscription and newsstand sales.

The fear of decreased business due to beginners gaining confidence in themselves is comparable to the possibility of a 1-W. electric lamp's drawing more current than a 100-W. electric lamp.

I am confident that the editor and the broad-minded radio men can realize the importance of *Radio-Craft's* continued fairness to ALL interested in radio.

CHARLES S. HINCKS

P.S.—Inasmuch as you published Mr. Rosmarin's letter I think that your publishing this letter would be greatly appreciated by ALL.

C. H. S.

Radio-Craft agrees with Mr. Hincks. We will continue to help initiate the neophyte into the rapidly-growing fields of radio, public-address and electronics. We are certain that every broad-minded technician, recalling his early work, will say "Amen!" to that.

OPERATING NOTES

(Continued from page 89)

the trouble. More often the large roller on the shaft is at fault, working too loose and not rotating with the shaft. The remedy is to increase the tension of the small spring at the rear end of the drive shaft by tightening the 2 small nuts at the end of the shaft, the back nut serving as a lock nut.

Poor sensitivity on the short-wave band with the low-frequency end of the band almost dead is almost invariably caused by an open-circuited 0.003-mf. series condenser of the postage-stamp type. This unit is identified by orange, black and red dots on the condenser, and is located near the wave-band switch, connected from one terminal of the switch to chassis.

The complaint of intermittent reception and the symptoms of station hiss and widening of the shadowgraph indication when the volume level drops, has been traced to an open-circuited 0.05-mf. grid filter condenser in the R.F. secondary-return circuit. Faulty internal connections to the pigtail leads is the cause. Leakage in the same condenser, part No. 30-4020, produces the condition of 2-spot tuning on the more powerful stations, where 2 points of resonance are indicated upon the shadowgraph about 10 kc. on each side of the assigned frequency for that station, with distortion between the 2 peaks.

Philco 28, 29, 45. These models are similar, the 28 being an A.C.-D.C. chassis and model 29 employing a shadowgraph. With this difference, the 29 and 45 are essentially the same. The symptoms of weak and distorted reproduction or inoperation with the attendant circumstances of either low or lack of plate voltage on the 75 tube, is due to a leaky or short-circuited 75 plate filter 0.1-mf. condenser. This unit is mounted together with the two 70,000-ohm carbon plate resistors upon the terminal strip under the power transformer. In several instances where this 0.1-mf. plate filter condenser has been found short-circuited, the lower 70,000-ohm plate resistor has also been found open-circuited.

Noisy tuning and noisy reception at the high-frequency end of the short-wave band has been traced to the pressure of oil on the bearings of the dial-drive shaft and pulley of the condenser drive assembly. These components should be carefully cleaned with carbon tetrachloride to effect a repair. The same condition of noisy tuning with the additional symptom of inoperation at some point in either tuning band is due

to burrs or flakes on the plates of the condenser gang which short-circuits stator to rotor at intermediate points. By disconnecting the tuning coils from the stators of the tuning gang and applying high voltage, which may be obtained from the receiver itself, across each stator and rotor, turning the condenser gang through its full range will produce an arcing at the shorted points which will burn away the offending flakes or burrs.

Intermittent reception, fading, hum, and the inability to properly control volume have almost invariably been found to be caused by the volume control. This failure is usually made apparent by simple manipulation of the control. Replacement is essential and should be made with a new type unit that is being supplied by the manufacturer. When the action of the volume control is noisy due to the usual contact resistance, smooth and noiseless operation may be obtained by removing or isolating the volume control from the diode load circuit with a 0.25-meg. carbon resistor and 0.01-mf. condenser. The lead to the ungrounded lug of the volume control is unsoldered and the condenser connected between the lead and volume-control lug. The resistor is employed to complete the diode-load circuit.

A slipping condenser drive, although it may be, is not always due to a worn cable or insufficient tension of the drive-cable spring. Most often the large roller on the drive shaft is at fault, working too loose and not rotating with the shaft. The remedy is to increase the tension of the small spring at the end of the drive shaft by tightening the two nuts. In this case, the back nut serves only as a lock nut.

Philco 44, 44B, 144, 144X, 506. The seemingly unusual condition may be found in these models where the level of volume increases sharply when the wave band or range switch is rotated just off range No. 1 (the broadcast band) going to range No. 2. If left in this intermediate position, a further check will also disclose that although volume has increased, selectivity becomes poor. This can be seen from the fact that the higher powered broadcasting stations apparently run into one another. The trouble is due to the antenna or band-pass coil, which on these models is employed only with the broadcast band, being cut out of the circuit before reaching range

(Continued on page 128)

Please Say That You Saw It in RADIO-CRAFT

TALK-BAK*

The first word used to abbreviate inter-communication systems.

—NOKOIL—

The first small permanent magnet dynamic speaker to be used in Talk-Bak* Systems.



Model 482 T.B. 5"



Model 682 T.B. 8"

Write for information regarding these brand new speakers manufactured especially for Talk-Bak* Systems and requiring no equalization.

Ask for the name of our nearest distributor. Wright-DeCoster distributors are always anxious to cooperate.

WRIGHT-DECOSTER, Inc.

2251 University Ave., St. Paul, Minnesota
Export Dept.—M. Simons & Son Co., New York.
Cable Address: "Simonrice."
Canadian Office: Associated Sales Co., Guelph, Ont.

*Copyrighted

164 PAGES
RADOLEK
PACKED WITH PROFITS!
Everything in Radio

THE SUMMER AND EARLY FALL EDITION of the 1937 Radolek Profit Guide is the most complete and up-to-date radio parts book ever published. Over 1800 new items plus AN ADVANCE SHOWING OF 1938 RECEIVER MODELS. Radolek's new edition is the only absolutely NEW parts book in Radio! New repair parts, New test instruments, New auto radios, New home receivers, and New P.A. equipment. Contains over 12,000 parts—the most extensive listings of replacement condensers, resistors, volume controls, transformers, and auto radio parts and accessories ever assembled under one cover.

RADOLEK SERVICE IS FAST AND DEPENDABLE. There's no Sit-Down, Lay-Down, or Slow-Down at the Radolek—our organization is geared-up to serve you best, to give you what you want when you want it and at the Right Price. Send for this Big New Book TODAY—it's FREE!

RADOLEK

601 W. RANDOLPH, CHICAGO, Dept. C-8

Send me the Radolek Radio Profit Guide free.

Name

Address

Service man? Dealer? Experimenter?

ADVERTISERS' INDEX

A	
Aerovox Corporation.....	125
Allied Radio Corporation.....	120
Amperite Corporation.....	106
Amplifier Co. of America.....	108
Amplitone Products Company.....	114
Arrow Radio, Inc.....	101
Arrow Sales Company.....	122
B	
Brush Development Company.....	110
C	
Central Radio Laboratories.....	119
Classified Section.....	112
Clough-Bronckle Company.....	113
Cornish Wire Company.....	104
Cornell-Dubilier Corporation.....	Back Cover
Coyle Electrical School.....	102
E	
Electronic Design Corporation.....	105
G	
G & C Genuine Majestic Refrigerator and Radio Parts Service.....	112
Gadgets Magazine.....	124
General Cement Mfg. Company.....	112
Goldstone Radio Company.....	112
Greenpark Company.....	116
H	
Hammarlund Mfg. Company.....	122
Hydrate-Sylvania Corporation.....	111
I	
International Transformer Co.....	112
K	
Kenyon Transformer Co. Inc.....	105
Hotel Knickerbocker.....	110
L	
Lancaster, Alwine & Rommel.....	108
The Lifetime Corporation.....	112
Lincoln Engineering School.....	120
M	
Metal Cast Products Company.....	106
Million Radio & Television Labs.....	125
Modelt.....	101
N	
National Radio Institute.....	65
National Schools.....	111
National Union Radio Corp.....	101
P	
The Plan Shop.....	114
R	
RCA Institutes, Inc.....	112
RCA Mfg. Company, Inc.....	108
Radio & Technical Publ. Co.....	120, 121
Radio & Television Institute.....	110
Radio Circular Company.....	119
Radio City Products Company.....	110
Radio Publications.....	126
Radio Service Institute.....	125
Radio Training Assoc. of America.....	101
Rad-loc Company.....	117
Raytheon Production Corp.....	107
Readrite Meter Works.....	117
Remington Rand, Inc.....	108
John F. Rider.....	111
S	
S. O. S. Corporation.....	114
Shallcross Mfg. Company.....	123
Solar Mfg. Company.....	106
Standard Transformer Corp.....	123
Subreme Instruments Corp.....	Inside Front Cover
T	
Taylra Sales Company.....	106
Telex Company.....	108
Triplett Elec. Instrument Co.....	104
Triumph Mfg. Company.....	122
Try-Mo Radio Co., Inc.....	120
Tung Sol Lamp Works, Inc.....	115
U	
United Sound Engineering Co.....	121
W	
Wellworth Trading Company.....	101, 118
Weston Elec. Instrument Corp.....	103
Wholesale Radio Service Co.....	110
Wright-Detoster, Inc.....	127
Z	
Zephyr Radio Company.....	114

(While every precaution is taken to insure accuracy, we cannot guarantee against the possibility of an occasional change or omission in the preparation of this index.)

BOOK REVIEWS

ELECTRONIC TELEVISION, by George H. Eckhardt. Published by The Goodheart-Willcox Co., Inc. Size, 6 x 9 ins., 162 pages; 82 figures. Price, \$2.50.

On the assumption that "Practically all of the basic research in (electronic television) has been done in the laboratories of (Farnsworth and RCA) and it would be impossible to conceive any new development that would not encroach upon the basic research done in one or the other of these laboratories," the author proceeds to evolve a book that ties-in the major work in the field of television accomplished to date in the laboratories of these companies, into a homogeneous whole that is interesting, informative and authoritative reading.

The photographic illustrations reproduced exceptionally well on the coated paper which is used throughout the book.

The volume is divided into 3 parts as follows: Part I—The Pick-up and Transmission of Electronic Pictures; Part II—The Reception of Electronic Television Pictures; Part III—The By-Products of Electronic Television Research. Part I has 12 chapters, Part II has 6, and Part III, 3.

To print the contents-listing of a representative chapter, as it appears in the contents page, would not do justice to the book. Instead we will outline as representative text the actual contents of one chapter. Chapter IX, "The 'Sawtooth' Wave Current," discusses the basic action of the title subject in detail; 4 large figures adequately illustrate the text. The subject of direction in straightforward and interlaced scanning is described and illustrated. Considerations involving the backtrace are analyzed. Synonymous actions are utilized to clarify the effects obtained—a rubberband for instance serves as a suitable analogue for the scanning line beam path. The simple arithmetic involved in determining the dimensions of the picture field is clearly explained. And the problem of obtaining and synchronizing the sawtooth voltage is explained in abbreviated form.

We are inclined to "go to town" in describing this book since we are quite enthused over it. Anyone who is interested in modern television will find *Electronic Television* to be an excellent, practical reference.

ALIGNING PHILCO RECEIVERS, by John F. Rider. Published by John F. Rider. Size, 5 1/4 x 7 1/2, 136 pages. Price, \$1.00.

This collection of alignment instructions covers every Philco receiver from the earliest up to the latest 1937 model. Of special interest to the practicing radio man is the fact that an exceptionally terse method of presenting important servicing information has been followed—it is not necessary to wade through lengthy descriptive text in order to obtain essential data. Those data include trimmer identification numbers that appear in both tables and chassis layouts. The author merits special commendation for his unusual success in condensing and accurately presenting these aligning instructions.

TELEVISION—A GUIDE FOR THE AMATEUR, by Sidney A. Moseley and Herbert McKay. Published by Oxford University Press. Size, 5 1/4 x 8 1/4 ins., 144 pages; 50 figures, and 39 exceptionally informative plates. Price, \$2.00.

If the reader does not mind translating "English" into American (as for instance "wireless" into "radio") then this book is recommended for the beginner in television who has a smattering of knowledge on subjects radio.

This book is of interest as a modern reference work on present-day television that includes not only electronic but also mechanical systems. In this connection the volume is almost exclusively a reference to work in England. Companies generously represented in the book include Baird Television, B.B.C., G.E. (England), International Television Corp., Marconi-E.M.I. Television, and Scophony. The book is well supplied with photographic illustrations of commercial equipment—interesting views of details, mainly—and sketches that show all the outstanding principles of interest involved in these several systems.

This book concludes with a useful chapter on television terms.

IL RADIO LIBRO, by D. E. Ravalico. Third Edition. Published by Ulrico Hoepli, Milano, Italy. Size 5 x 7 1/2 ins., 613 pages, paper bound.

Written in Italian, this 3rd revised edition of *Il Radio Libro* is an important contribution to radio literature. Although the text of this extensive book will be intelligible only to those who understand Italian, many of the more than 400 illustrations contained in this volume will interest the technician. Note that this 3rd edition is completely revised and much outmoded material in the 2nd edition has been eliminated. The 22 chapters of this book embrace a practically complete discussion of radio from the elements of electricity through to the legal angles of radio technique. Included in the volume are over 450 pages of commercial European diagrams that will interest the designer of radio equipment for export.

TWO HUNDRED METERS AND DOWN, by Clinton B. DeSoto. Published by The American Radio Relay League, Inc. Size, 6 1/4 x 9 1/4 ins., 184 pages. Price, \$1.00.

Historical in character, this volume fills a most important niche in the annals of radio. A 9-page introduction entitled "The Radio Amateur" contains many important facts and figures. Part I—Pioneers, contains 8 chapters embracing the period from the inception of amateur radio to the war period. Part II—Development and Recognition, contains 4 chapters discussing post-war developments. Part III—International High-Frequency Communication, describes all the internal ramifications of present-day amateur radio. The conclusion, "Whither Amateur Radio?", takes into account possibilities for the licensed amateur in television.

OPERATING NOTES

(Continued from page 127)

No. 2 and is caused by the moving contact of the third section of the range switch engaging the second wiping contact before disengaging the first wiping contact. The remedy in this case is to bend the second wiping contact up slightly at one end so that the moving contact is fully disengaged from the first wiping contact before engaging the second wiping contact.

The condition of weak reception, if any at all, and a strong station or resonance hiss on the short-wave bands only has been traced to an open-circuited postage-stamp type coupling condenser connected between the two bottom contacts of the third and fourth switch sections of the wave-band switch. A mica replacement of any value between 0.001-mf. and 250 mmf. will turn the trick.

Intermittent reception, or as the complaint may be termed, cutting off or fading, is often the result of an open-circuit grid coupling condenser for the type 75 tube. Where the symptoms are very weak reception, slight hum and distortion, look for an open-circuited condition of the above coupling condenser. The models 44 and 124 are almost identical, with several minor refinements and a shadowgraph tuning meter incorporated into the latter.

BERTRAM M. FRED

Atwater Kent Model 40. The complaint on this set was that it would not operate. In checking the voltages from the power-pack terminals, with set connected, the voltages were found to be very low. A circuit-to-circuit analysis was made with the chassis disconnected from the power-pack.

In making continuity tests on the chassis for shorted or leaking condensers, the trouble was located in the R.F. filament-circuit by-pass condensers. After removing the defective condenser from the filament circuit and checking the voltages, both at the power-pack and the chassis, everything was found to be correct. But the loudspeaker had a mushy quality; which was traced to the speaker filter condenser in the output circuit on the chassis. After replacing this condenser the set worked perfectly.

GEORGE A. CARROLL

Here is a **NEW FREE BOOK**
Which Every Radio Man Can Use to Advantage!

OVER **125**
ILLUSTRATIONS

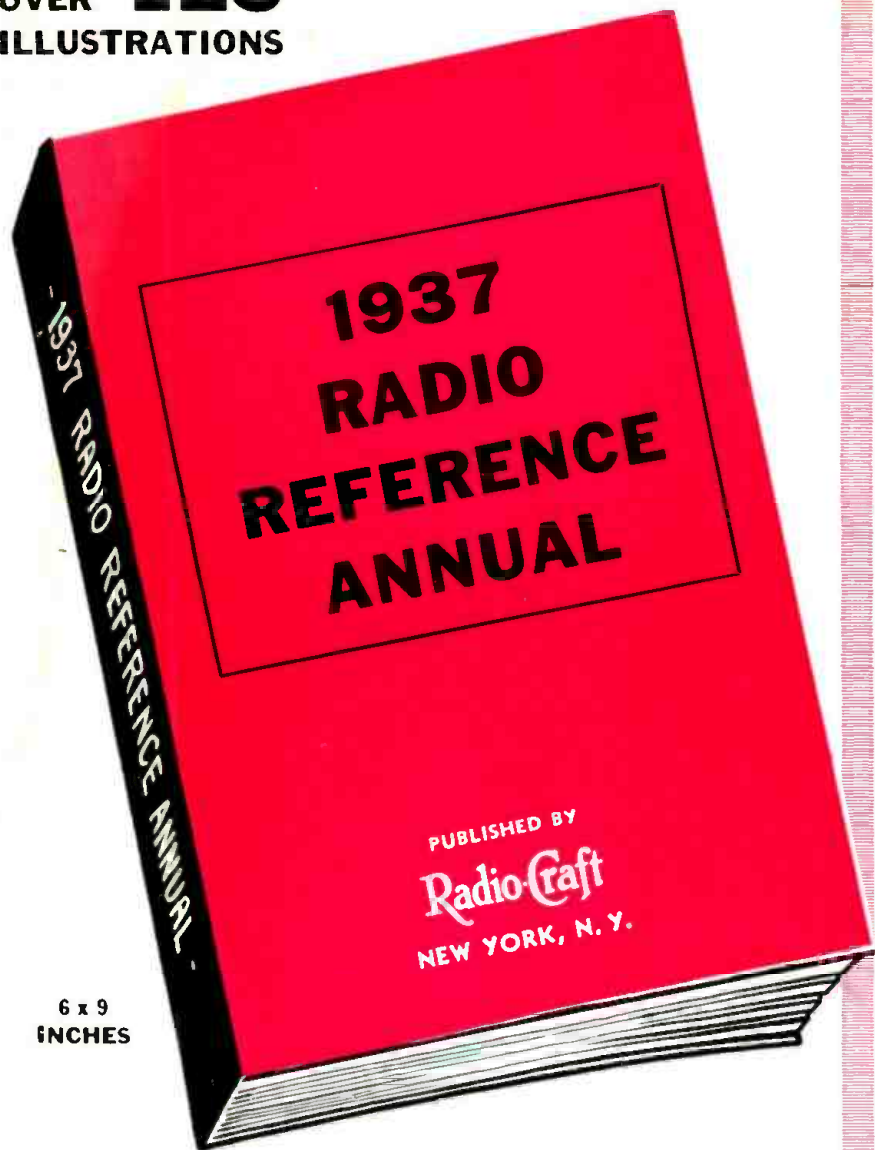

6 x 9
INCHES

THE Editors of RADIO-CRAFT have prepared a special book for you. The new book—1937 RADIO REFERENCE ANNUAL—is not for sale, but available only to subscribers, both new and old, with a Seven Months' Subscription to RADIO-CRAFT. The price of this Special Offer is only One Dollar (\$1.00)—and as an additional saving, the book is mailed to you postpaid, just as the magazine is each month. Carefully outlined below is the contents of this new book; it contains information which every radio man needs. The book contains 64 pages, size 6 x 9, and is replete with illustrations.

Read These Interesting Chapter Headings of 1937 RADIO REFERENCE ANNUAL

Receiver Construction

Building a 12-tube All-Wave DX receiver—How to make a modern 6-tube Car Radio set—building up a 2-tube Beginner's Set, with several different power supplies for various uses—Constructing a 2-tube midget set for portable use—How to build a "talking" briefcase—no aerial or ground needed.

Audio and P. A. Equipment

Making an Audio Bass Booster, using direct coupling—How to build and add a Dual-Channel Amplifier to your receiver—Constructing a High-Fidelity Amplifier—Construction of a 3-tube A.C.-operated Preamplifier—Fundamentals of "Decibel Level" and "Decibel Gain".

Test Equipment — Construction

How to make an "Electronic Eye" output meter—How to construct an ultra-compact Universal Volt-Ohm-Milliammeter—How to make a Resistance-Capacity tester—How to Build a Pocket Adapter for set testing—Building a Portable Capacity bridge—Construction of a V.T. Voltmeter in compact form—How to Make a Modern Set Analyzer.

Articles for the Service Man

Servicing with the Oscilloscope—Servicing with a Single Meter—"What's Wrong With Your Radio" chart—Tapers of Volume Controls, and use of various types—Ideas for the Service Shop—Aligning All-Wave receivers.

Time and Money-Saving Kinks

In this section you profit by the experience of other radio men. These kinks are really valuable "short-cuts" which save much time and, very often, money. They are "pet" ideas put into practice.

Important Articles Which Have Appeared in RADIO-CRAFT

General Interest Articles

Design of Transformers for Class "AB" and "B" operation—A table of Inter-Electrode Capacities for 30 different tube types—How to make a Floating-Grid Relay—Construction of a modern Treasure Locator—How to get DX on your All-Wave Radio—Making a 5-meter Transceiver for use in car or boat.

New Tubes Developed in 1936

Characteristics of the Newest Receiving Tubes of all manufacturers, giving uses, characteristics, present equivalents (if any) and all pertinent data.

MAIL COUPON TODAY!

RADIO-CRAFT, 99 Hudson St., New York, N. Y.

Gentlemen: Enclosed you will find my remittance of One Dollar (\$1.00) for which enter my subscription to RADIO-CRAFT Magazine for Seven Months. Send me ABSOLUTELY FREE, and POSTPAID, my copy of 1937 RADIO REFERENCE ANNUAL.

Name Address

City State

(Send remittance by check or money order. Register your letter if you send cash or unused U. S. Postage Stamps.) RC-837

RADIO-CRAFT

99 Hudson Street,

New York, N.Y.

SPEED

← SPEED



Symbols of Service

to the individual or organization
demanding the finest in condensers



ETCHED FOIL DRY ELECTROLYTICS

TYPE JR. Triply sealed in tiny silver-coated cardboard containers and equipped with convenient color-coded flexible wire leads. Ideal for the efficient servicing of difficult jobs. No need for a variety of expensive exact duplicate replacements.



MOLDED MICA TRANSMITTING CAPACITORS

TYPE 4 and 9. Constructed of only the finest of raw materials these capacitors are the standard by which others are measured in the condenser industry. Extensively utilized in aircraft, marine and submarine transmitters.



PAPER DIELECTRIC FILTER CONDENSERS

TYPE PE. Paper dielectric condensers with a high margin of safety, constant capacity rating and negligible power factor. Not intended to replace electrolytics, but similar in size and shape, to facilitate mounting in restricted space, where a paper condenser is preferred.



"DWARF - TIGER" TUBULAR PAPER CAPACITORS

TYPE DT. A compact, moisture-proof, non-inductive condenser that is wax impregnated and oil saturated. Wire leads are soldered and firmly anchored. The finest and most universally used tubulars available.



DYKANOL TRANSMITTING CAPACITORS

TYPE TJ. Dykanol impregnated and filled in hermetically sealed, non-corrosive metal containers, these capacitors can be safely operated at 10% above voltage rating. Extensively utilized by leading broadcast stations.

MAIL COUPON NOW!

CORNELL-DUBILIER CORPORATION
1014 Hamilton Blvd., So. Plainfield, N.J.

Please send FREE copy of C-D
House Organ
RMA Color Code Chart
Catalog

Check whether
Amateur
Engineer
Experimenter
Serviceman

Name

Address

City State

FREE

Remember! There is a C-D capacitor for your every circuit requirement

PAPER • MICA • DYKANOL • WET and DRY ELECTROLYTIC



CORNELL-DUBILIER CORPORATION

SOUTH PLAINFIELD • NEW JERSEY