

RADIO'S LIVEST MAGAZINE



August 1932

25 Cents

Canada 30c

# Radio-Craft

HUGO GERNSBACK Editor

Build This  
**A. C. - D. C.  
PORTABLE  
RECEIVER**

See Page 74

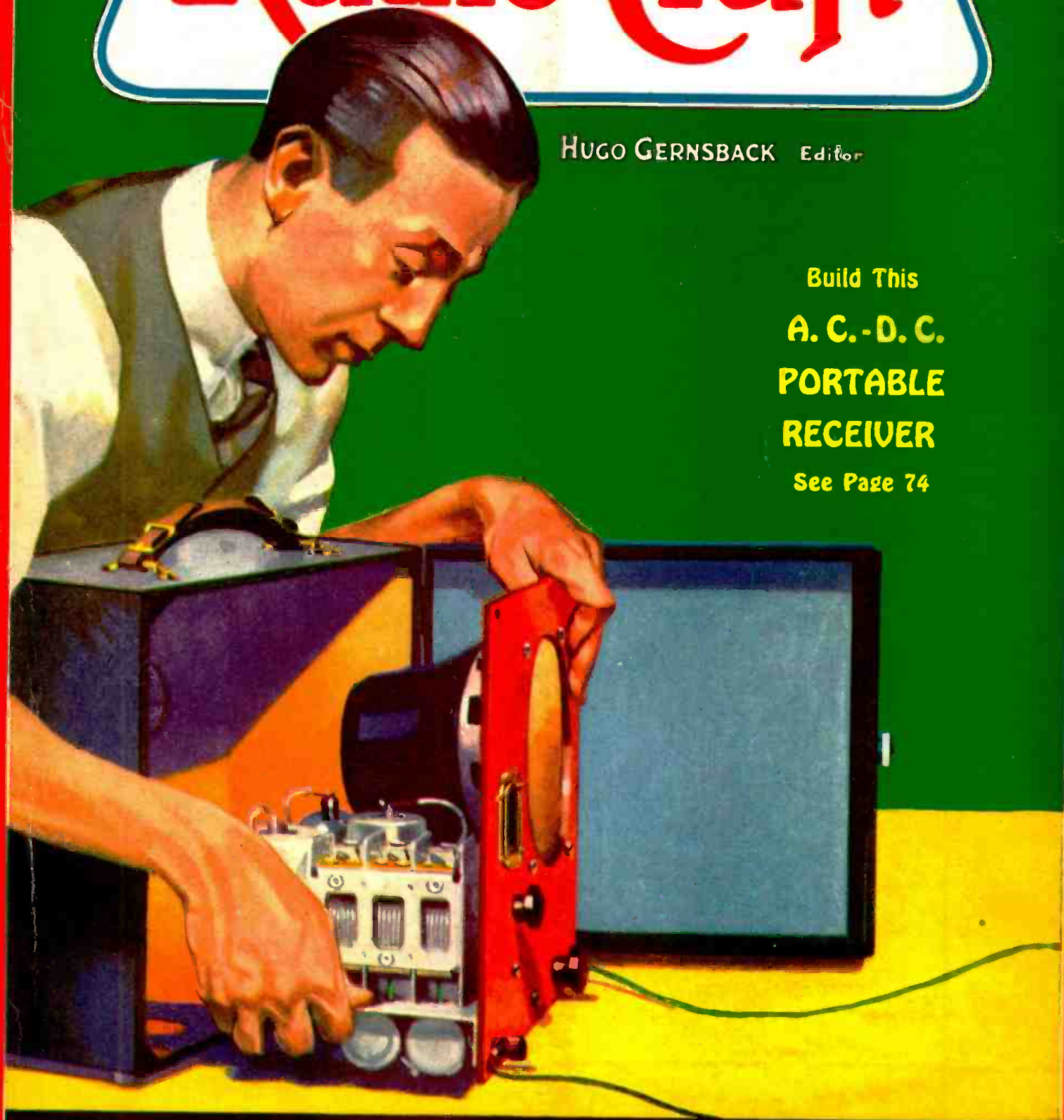

Eddy Current Speakers — An Ohm- and Output Meter — A "B" Tube  
Superheterodyne Developments — Non-Regenerative Amplification

---

**SPEED**

**SPEED**

**SPEED**

**"Reliability!" "Consistency!" "Superiority!"**

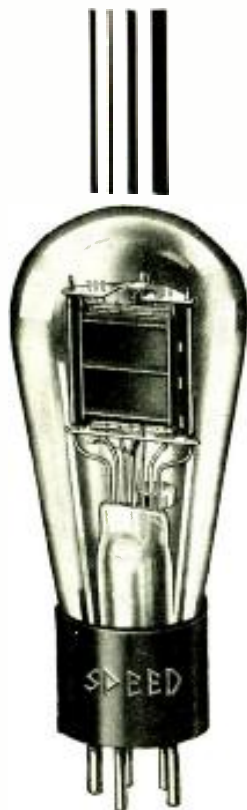

Not mere adjectives . . . but actual references made to SPEED tubes in thousands of letters sent to us from SPEED users all over the world. These features make SPEED the popular product it is . . . They prove that whatever their purpose, SPEED tubes function correctly!

**BUT SPEED** isn't resting on its laurels! The efficiency of the **NEW TYPE SPEED TUBES** has astounded the radio world. Exclusive development of the **TRIPLE-TWIN** Types by **SPEED** engineers is axiomatic of the progressive organization behind a justly famous product.

We are proud of our product and of the splendid reputation it has made for itself. We are determined that it shall continue to render the advantages of perfect performance. It's worth your while to get acquainted . . . There is no better product!

**That's**

**SPEED!**

*Keep abreast of the times! Turn to page 128-A for our card requesting current bulletins sent free of charge.*

---

**CABLE RADIO TUBE CORP.**  
**230-240 NO. NINTH ST. BROOKLYN, N.Y.**

---



# OPPORTUNITIES *are many* for the Radio Trained Man

Don't spend your life slaving away in some dull, hopeless job! Don't be satisfied to work for a mere \$20 or \$30 a week. Let me show you how to get your start in Radio—the fastest-growing, biggest money-making game on earth.

**Jobs Leading to Salaries of \$50 a Week and Up**  
Prepare for jobs as Designer, Inspector and Tester—as Radio Salesman and in Service and Installation Work—as Operator or Manager of a Broadcasting Station—as Wireless Operator on a Ship or Airplane, or in Talking Picture or Sound Work—HUNDREDS of OPPORTUNITIES for a real future in Radio!

## Ten Weeks of Shop Training

We don't teach by book study. We train you on a great outlay of Radio, Television and Sound equipment—on scores of modern Radio Receivers, huge Broadcasting equipment, the very latest and newest Television apparatus, Talking Picture and Sound Reproduction equipment, Code Practice equipment, etc. You don't need advanced education or previous experience. We give you—**RIGHT HERE IN THE COYNE SHOPS**—the actual practice and experience you'll need for your start in this great field. And because we cut out all useless theory and only give that which is necessary you get a practical training in 10 weeks.

## TELEVISION *and* TALKING PICTURES

And Television is already here! Soon there'll be a demand for THOUSANDS of TELEVISION EXPERTS! The man who learns Television now can have a great future in this great new field. Get in on the ground-floor of this amazing new Radio development! Come to COYNE and learn Television on the very latest, new-

est Television equipment. Talking Picture and Public Address Systems offer opportunities to the Trained Radio Man. Here is a great new Radio field just beginning to grow! Prepare NOW for these wonderful opportunities! Learn Radio Sound Work at COYNE on actual Talking Picture and Sound Reproduction equipment.

## All Practical Work At COYNE In Chicago

**ALL ACTUAL, PRACTICAL WORK.** You build radio sets, install and service them. You actually operate great Broadcasting equipment. You construct Television Receiving Sets and actually transmit your own Television programs over our modern Television equipment. You work on real Talking Picture machines and Sound equipment. You learn Wireless Operating on actual Code Practice apparatus. We don't waste time on useless theory. We give you the practical training you'll need—in 10 short, pleasant weeks.

### Mail Coupon Today for All the Facts

H. C. LEWIS, President  
**Radio Division, Coyne Electrical School**  
500 S. Paulina St., Dept. C2-8H Chicago, Ill.

Dear Mr. Lewis:— Send me your Big Free Radio Book, and all details of your Special Offer.

Name .....

Address .....

City ..... State .....



## Many Earn While Learning

You get Free Employment Service for Life. And don't let lack of money stop you. Many of our students make all or a good part of their living expenses while going to school and if you should need this help just write to me. Coyne is 32 years old! Coyne Training is tested—proven beyond all doubt. You can find out everything absolutely free. Just mail coupon for my big free book!

H. C. Lewis, Pres. **RADIO DIVISION** Founded 1899  
**COYNE Electrical School**  
500 S. Paulina St., Dept. C2-8H Chicago, Ill.





**HUGO GERNSBACK, Editor-in-Chief**

LOUIS MARTIN  
Associate Editor

R. D. WASHBURNE  
Technical Editor

## CONTENTS OF THE AUGUST, 1932, ISSUE

VOLUME IV

Number 2

### EDITORIAL:

"Trick" Amplifier Applications. By Hugo Gernsback 73

### NEW DEVELOPMENTS IN RADIO:

Latest Radio Equipment ..... 76  
Eddy Current Reproducers ..... By Dr. Fritz Noack 78  
Non-Regenerative Amplification By Walter M. Cusick 80  
A Tiny-Tube A.C. Loudspeaker Set. By J. V. Capicotto 82  
The "B" Tube ..... By Alvin B. Bedrossyan 84

### SERVICE MEN'S DEPARTMENT:

An I.F.-R.F. Oscillator (How to Make and Calibrate)  
By Clyde J. Fitch 90  
A Compact Ohm and Output Meter ..... By Jack Grand 92  
How to Use a Set Analyzer (Part II)  
By F. L. Sprayberry 93  
Operating Notes ..... By Bertram M. Freed 96  
The Service Man's Forum ..... 97  
Short-Cuts in Radio Service ..... 98

### RADIO SERVICE DATA SHEETS:

No. 71: Philco Model 15, 15X, 15DX 11-Tube, Twin  
Reproducer, Superheterodyne ..... 100  
No. 72: RCA Victor R-78 and G.E. J-125 "Conven-  
tion" Model 12-Tube Superheterodyne ..... 101

Radio Service and the Electric Code  
By Gus Jacobson 102

### TECHNICAL RADIO TOPICS:

An A.C.-D.C. Portable Receiver. By J. Burgess Davis 74  
Electrifying the "Megadyne" ..... By Hugo Gernsback 85  
The "3-Tube" Autodyne Superheterodyne  
By R. H. G. Mathews 86  
A Mobile P.A. System ..... By H. A. Blair 87  
Sound Recording at 33-1/3 R.P.M.  
By George J. Saliba 88  
Using the V.T. Voltmeter (Part III)  
By Beryl B. Bryant 89  
"I Equals E Over R" ..... By C. W. Palmer 94  
The Theory and Construction of Attenuators and  
Line Filters (Part III) ..... By Hy Levy 95  
An Amateur's S-W. Receiver ..... By Wm. H. Henton 103  
RADIO-CRAFT Kinks ..... 104  
The Radio Craftsman's Page ..... 105  
Information Bureau ..... 106  
Book Review ..... 107

## IN OUR NEXT FEW ISSUES:

A UNIVERSAL SET ANALYZER to be truly "universal" must, in the light of present-day circuit arrangements, be extremely flexible in control. Read the description of the manner in which such an instrument may be constructed at low cost.

SUPER-SELECTIVE T.R.F. RADIO SETS are of particular interest when they are associated with circuits of high-gain type. The author furnishes complete construction details for a radio receiver of this nature.

TUNING METERS AND CIRCUITS to many technicians are a bit of a mystery. In this interesting article the reader is enlightened on a subject of increasing importance.

ELECTROLYTIC CONDENSERS have been perfected to an extent not realized by many Service Men and instrument designers; these advancements are discussed in an authoritative article.

RADIO-CRAFT is published monthly, on the fifth of the month preceding that of date; its subscription price is \$2.50 per year. (In Canada and foreign countries, \$3.00 a year to cover additional postage.) Entered at the post office at Mt. Morris, Ill., as second-class matter under the act of March 3, 1879. Trademark and copyright by permission of Gernsback Publications, Inc., 98 Park Place, N. Y. C.

Text and illustrations of this magazine are copyright and must not be reproduced without permission of the copyright owners. We are also agents for WONDER STORIES and WONDER STORIES QUARTERLY. Subscription to these magazines may be taken in combination with RADIO-CRAFT at reduced Club rates. Write for information.

Copyright 1932. GERNSBACK PUBLICATIONS, INC.

H. GERNSBACK, President J. M. HERZBERG, Vice-President  
S. GERNSBACK, Treasurer I. S. MANHEIMER, Secretary

Published by TECHNICAL-CRAFT PUBLISHING CORPORATION. Publication office: 404 No. Wesley Ave., Mount Morris, Illinois. Editorial and Advertising Office: 96-98 Park Place, New York City. Chicago Advertising Office: 737 North Michigan Avenue, Chicago, Ill. Western Advertising office: 220 No. Catalina St., Los Angeles, Calif. L. F. McClure, Chicago Advertising Representative. Loyd B. Chappell, Western Advertising Representative.

London Agent: Hachette & Cie., 3 La Belle Sauvage, Ludgate Hill, E.C. 4  
Paris Agent: Hachette & Cie., 111 Rue Reaumur  
Australian Agent: McGill's Agency  
179 Elizabeth St., Melbourne



# I will train you at home



to fill a

# BIG PAY Radio Job!

**Here's Proof**



**\$100 a week**

"My earnings in Radio are many times greater than I ever expected they would be when I enrolled. They seldom fall under \$100 a week. If your course cost four or five times more I would still consider it a good investment."

**E. E. WINBORNE**  
1267 W. 48th St.,  
Norfolk, Va.



**Jumped from \$35 to \$100 a week**

"Before I entered Radio I was making \$35 a week. Last week I earned \$110 servicing and selling Radios. I owe my success to N. R. I. You started me off on the right foot."

**J. A. VAUGHN**  
Grand Radio and Appliance Co.,  
3107 S. Grand Boulevard,  
St. Louis, Mo.



**\$500 extra in 6 months**

"In looking over my records I find I made \$500 from January to May in my spare time. My best week brought me \$107. I have only one regret regarding your course—I should have taken it long ago."

**HOYT MOORE**  
R. R. 3, Box 919,  
Indianapolis, Ind.,

If you are earning a penny less than \$50 a week, send for my book of information on the opportunities in Radio. It is free. Clip the coupon NOW. Why be satisfied with \$25, \$30 or \$40 a week for longer than the short time it takes to get ready for Radio.

**Radio's growth opening hundreds of \$50, \$75, \$100 a week jobs every year**

In about ten years Radio has grown from a \$2,000,000 to a \$1,000,000,000 industry. Over 300,000 jobs have been created. Hundreds more are being opened every year by its continued growth. Many men and young men with the right training—the kind of training I give you—are stepping into Radio at two and three times their former salaries.

**You have many jobs to choose from**

Broadcasting stations use engineers, operators, station managers and pay \$1,200 to \$5,000 a year. Manufacturers continually need testers, inspectors, foremen, engineers, service men, buyers, for jobs paying up to \$7,500 a year. Radio operators on ships enjoy life, see the world, with board and lodging free, and get good pay besides. Dealers and jobbers employ service men, salesmen, buyers, managers, and pay \$30 to \$100 a week. There are many other opportunities too. My book tells you about them.

**So many opportunities many N. R. I. men make \$200 to \$1,000 in spare time while learning**

The day you enroll I send you material which you should master quickly for doing 28 jobs, common in most every neighborhood, for spare time money. Throughout your course I send you information on servicing popular makes of sets; I give you the plans and ideas that are making \$200 and \$1,000 for N. R. I. students in their spare time while studying. My course is famous as the course that pay for itself.

**Talking Movies, Television, Aircraft Radio included**

Special training in Talking Movies, Television and home Television experiments. Radio's use in Aviation, Servicing and Merchandising Sets, Broadcasting, Commercial and Ship Stations are included. I am so sure that I can train you satisfactorily that I will agree in writing to refund every penny of your tuition if you are not satisfied with my Lessons and Instruction Service upon completing.

**64-page book of information FREE**

Get your copy today. It tells you where Radio's good jobs are, what they pay, tells you about my course, what others who have taken it are doing and making. Find out what Radio offers you without the slightest obligation. ACT NOW!

**J. E. SMITH, President**  
National Radio Institute, Dept. 2 HXX  
Washington, D. C.

**Our Own Home**

Pioneer and World's Largest Home-Study Radio training organization devoted entirely to training men and young men for good jobs in the Radio industry. Our growth has paralleled Radio's growth. We occupy three hundred times as much floor space now as we did when organized in 1914.



## Special Free Offer

Service Manual on Trouble Shooting in Radio Sets Sent Free



Act now and receive in addition to my big free book "Rich Rewards in Radio," this Service Manual on D.C., A.C., and Battery Operated sets. Only my students would have this book in the past. Now readers of this magazine who mail the coupon will receive it free. Overcoming hum, noises of all kinds, fading signals, broad tuning, howls and oscillations, poor distance reception, distorted or muffled signals, poor Audio and Radio Frequency amplification and other vital service information is contained in it. Get a free copy by mailing the coupon below. ACT NOW.

## NEW Radio Equipment for Broad Practical Experience Given Without Extra Charge

With the aid of this equipment you can work out with your own hands many of the things you read in our text books. From it you get the valuable experience that tells an expert from a beginner. In a short time you have learned what it would take years to learn in the field. It's training like this that puts the extra dollars in your pay envelope. Some of the many circuits you build and experiments you perform are: Measuring the merit of a tube, building an ohmmeter, tube voltmeter, and a Grid dip meter for service work. You actually make experiments illustrating the important principles in the 25 best known sets.

**I have doubled and tripled the salaries of many. Find out about this tested way to BIGGER PAY**



Get a Job with a Future

**FILL OUT AND MAIL THIS COUPON TODAY**

**J. E. SMITH, President**  
National Radio Institute, Dept. 2HXX  
Washington, D. C.

Dear Mr. Smith: I want to take advantage of your Special Offer. Send me your two books, "Trouble Shooting in D.C., A.C. and Battery Sets" and "Rich Rewards in Radio." I understand this request does not obligate me.

Name.....  
Address.....  
City..... State..... "M"

**Lifetime Employment Service to all Graduates**

# 96 PAGES

OF NEW DATA HAVE  
BEEN ADDED TO THE

# OFFICIAL REFRIGERATION SERVICE MANUAL

To bring this useful service manual right up-to-date, Mr. L. K. Wright, the Editor of the OFFICIAL REFRIGERATION SERVICE MANUAL, has added a wealth of entirely new material on electric refrigerators. This new section, which totals 96 pages, has contained therein dozens of new models of recent manufacture which have been placed on the market during the past few months and in addition, information regarding improvements on older models. As usual every refrigerator has been accurately described from the viewpoint of servicing—diagrams to illustrate the essential parts, and simplified so that repairs can easily be made

## NO EXTRA COST FOR THIS MATERIAL

The addition of these new pages will not increase the cost of the book to those who order their copy now. With the inclusion of more pages, the OFFICIAL REFRIGERATION SERVICE MANUAL will have over 1,200 diagrams and over 450 pages. Its flexible, loose-leaf binder accommodates the extra pages very easily. When the material has been placed in the manual, you will have a complete 1931-1932 OFFICIAL REFRIGERATION SERVICE MANUAL.

**Radio Service Men—Turn Idle Summer Hours into Profit by Servicing Electric Refrigerators with the aid of this New and Complete Service Manual.**

THE idea of electricians, radio service men and other mechanically inclined men, servicing refrigeration units is self-evident and the thought has occurred to perhaps untold thousands ever since electric refrigeration started. Yet nothing was done, because the average man knows little or nothing about refrigeration. Compared with servicing a radio set or wiring a home for electricity, the servicing of a refrigerator is absurdly simple, once you get the hang of it.

The OFFICIAL REFRIGERATION SERVICE MANUAL has been edited by L. K. Wright, who is an expert and a leading refrigeration authority. He is a member of the American Society of Mechanical Engineers, American Society of Refrigeration Engineers, The National Association of Practical Engineers, etc.

In this Refrigeration Manual every page is profusely illustrated; every refrigerator part is carefully explained; diagrams are furnished of every known machine; special care is given to the servicing end. The tools needed are illustrated and explained; there are trouble shooting charts, and other service data.

Remember there is big money in the refrigeration servicing business. There are thousands of firms selling refrigerators every day and they need to be cared for often. Eventually there will be more re-

frigerators than radios. Why not increase your earnings with a full or spare time business by servicing refrigerators.

Here are some of the important chapters:

- Introduction to the Refrigeration Servicing Business
- History of Refrigeration
- Fundamentals of Refrigeration
- Description of All Known Types of Refrigeration.
- Service Tools and Shop Equipment
- Motors
- Trouble Shooting
- Unit Parts, Valves and Automatic Equipment
- Makes and Specifications of Units
- Manufacturers of Cabinets
- Refrigerants and Automatic Equipment
- and Many other Important Chapters.

Several thousands of copies of the OFFICIAL REFRIGERATION SERVICE MANUAL have been sold; and there still remains the greatest opportunity for thousands more to learn how to make more money in a short time through openings in this new field.

# NOW ..

## OVER 1,200 DIAGRAMS

### 450 Pages

### Flexible Looseleaf Binder

### Complete Service Data

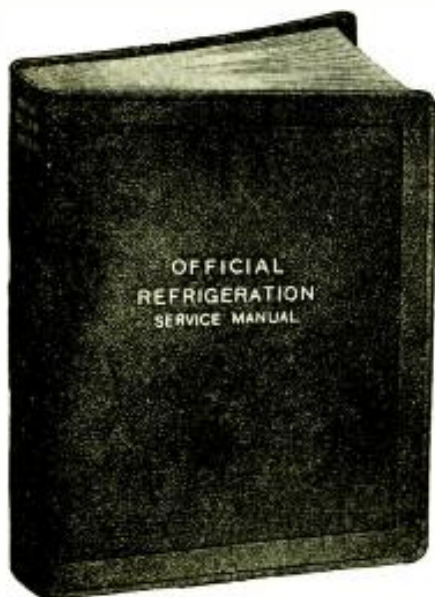

## THE FIRST COMPLETE REFRIGERATION SER- VICE MANUAL PUBLISHED.

**Clip and Mail Coupon  
TODAY!**

**GERNSBACK PUBLICATIONS, Inc. RC-832**  
96-98 Park Place, New York, N. Y.

I enclose herewith my remittance for \$5.00 (check, stamps or Money Order accepted) for which you are to send me, postage prepaid, one copy of the OFFICIAL REFRIGERATION SERVICE MANUAL, together with the extra 96 pages of new material at no extra cost.

Name .....

Address .....

City..... State.....



# RADIO

## Manufacturers, Distributors, Jobbers *and* Dealers

If in need of Service Men wire or write us and we will send you the name and address of Service Men in your city or vicinity.

THIS SERVICE IS FREE TO THE RADIO TRADE.

OFFICIAL RADIO SERVICE MEN'S ASSOCIATION, Inc.

98 Park Place, New York, N. Y.

## Radio Service Men—Join the ORSMA

EVER since the appearance of the commercial radio broadcast receiver as a household necessity, the Radio Service Man has been an essential factor in the radio trade; and, as the complexity of electrical and mechanical design in receivers increases, an ever-higher standard of qualifications in the Service Man becomes necessary.

The necessity, also, of a strong association of the technically-qualified radio Service Men of the country is forcing itself upon all who are familiar with radio trade problems; and their repeated urging that such an association must be formed has led us to undertake the work of its organization.

This is the fundamental purpose of the OFFICIAL RADIO SERVICE MEN'S ASSOCIATION, which is not a money-making institution, or organized for private profit; to unite, as a group with strong common interests, all well qualified Radio Service Men; to make it readily possible for them in keeping up with the demands of their profession; and, above all, to give them a recognized standing in that profession, and acknowledged as such by radio manufacturers, distributors and dealers.

To give Service Men such a standing, it is obviously necessary that they must prove themselves entitled to it; any Service

Man who can pass the examination necessary to demonstrate his qualifications will be elected as a member and a card will be issued to him under the seal of this Association, which will attest his ability and prove his identity.

The terms of the examination have been drawn up in co-operation with a group of the best-known radio manufacturers, as well as the foremost radio educational institutions.

We shall not attempt to grade the members into different classes. A candidate will be adjudged as either passing or not passing. If the school examining the papers passes the prospective member as satisfactory, we shall issue to him an identification card with his photograph.

If the candidate does not pass this examination the first time, he may apply for another examination three or six months later.

There is absolutely no cost attached to any service rendered by the Association to its members, no dues, no contributions.

If you wish to become a member, just fill out the coupon below and mail it to us. We will send you all the papers necessary to become a member.

The following firms have cooperated with us in formulating the examination papers.

- The Crosley Radio Corporation, Cincinnati, O. Mr. D. J. Butler, Service Mgr.
- Grigsby-Grunow Company (Majestic), Chicago, Ill. Mr. L. G. Wilkinson, Service Mgr.
- Stromberg-Carlson Telephone Mfg. Co., Rochester, N. Y. Mr. E. S. Browning, Service Mgr.
- Cullin B. Kennedy, Corp., South Bend, Ind. Mr. B. F. McNamee, Prod. Mgr.
- RCA-Victor Company, Inc., Camden, N. J. Mr. H. C. Grubb, Vice-President.
- Stewart-Warner Corporation, Chicago, Ill. Mr. T. N. Gotten, Service Mgr.

The schools who have consented to act as an examination board are:

- International Correspondence Schools, Scranton, Penna. Mr. D. E. Carpenter, Dean.
- RCA Institutes, Inc., New York, N. Y. Mr. D. O. Whelan, President.
- East Bay Radio Institute, Oakland, Calif. Mr. T. T. Tonnellit, Director.
- Radio Training Association of America, Chicago, Ill. Mr. A. G. Mohaupt, President.
- School of Engineering of Milwaukee, Milwaukee, Wis. Mr. W. Werwath, President.
- Radio College of Canada, Toronto, Canada. Mr. J. C. Wilson, President.
- Radio Division, Coyne Electrical School, Chicago, Ill. Mr. H. C. Lewis, President.

### MAIL COUPON TODAY!

OFFICIAL RADIO SERVICE MEN'S ASSOCIATION, Inc. RC-8  
98 Park Place, New York, N. Y.

I wish to become a member of your Association. Please mail me the examination papers and application blanks.

Name .....

Address .....

Town..... State.....

# WHAT ARE YOU DOING IN RADIO IN THESE DAYS OF KEEN COMPETITION AND SCARCITY OF JOBS AND POSITIONS?

IT is always the well-trained man who wins out over the horde of thousands of superficially trained and incompetent men. You are reading this magazine because you are interested in radio. Sooner or later, the time will come when you will wish to cash in on your knowledge. Your chance may come over night, and then the big and vital question will be, "How well equipped am I to fill the job?" You are in radio because you like it. You also realize that, at the present time, there are many branches of the radio art which you do not know as thoroughly as you should. Knowledge, these days, can be gotten cheaper than ever before. It isn't necessary for you to go to college to become proficient in radio. Start today, to build a REAL radio library and become acquainted with all branches of this great and growing art. In this page are listed the world's best radio books. We have combed the market for the really important books in radio; so that, no matter what branch you are interested in, you can pick out the best books that are now printed. Start, today, to build a complete radio library. You do not have to get all the books at once, but make up your mind to get one book a month; so that, when your chance comes, you will be fully equipped to win out over the others not so well equipped.

WE herewith present the most complete collection of recent important radio books. We have, after an exhaustive study, selected these volumes because they represent the foremost radio books of their kind in print today. There is such a great variety that we are sure it will satisfy any taste as well as any requirement that the student of radio might have. We publish no catalogue and ask you to be kind enough to order direct from this page. Prompt shipments will be made to you direct from the publishers. We merely act as a clearing house for a number of radio publishers and OUR PRICES ARE AS LOW OR LOWER THAN WILL BE FOUND ANYWHERE. Remit by money order or certified check. If you send cash, be sure to register it.

**IMPORTANT.—This list is changed every month to include the latest books. Note also new low prices.**

**THE RADIO HANDBOOK.** by James A. Moyer and John F. Westrel. Flexible covers, size 5½x8", 886 pages, 650 illustrations. Price ..... **\$5.00**

Comprehensive data on short-wave apparatus, vacuum tubes, modern radio receivers and transmitters, photoelectric cells, television, sound motion pictures, tables, graphs, diagrams, etc. No radio man should miss it.

**RADIO FREQUENCY ELECTRICAL REQUIREMENTS.** by Hugh A. Brown. Cloth covers, size 6x9", 386 pages, 235 illustrations. Price ..... **\$4.00**

One of the few great books on this important subject. Everything from thermionic-tube coefficients to piezoelectric measurements.

**PRACTICAL TELEVISION.** by E. T. Lerner. Cloth covers, size 5½x8", 223 pages, 127 illustrations. Price ..... **\$3.75**

This book explains television in full, including elementary principles, photo-electric cells, and all important types of television sets as well as basic principles of optics, images, mirrors, lenses, etc.

**TELEVISION, Its Methods and Uses.** by Edgar H. Felix. Cloth covers, size 5½x7¾", 272 pages, 73 illustrations. Price ..... **\$2.50**

A practical complete cross-section of television today. One of the very best books on this important art in print.

**MAGNETIC PHENOMENA.** by Samuel Robinson Williams. Cloth covers, size 6x9", 230 pages, 150 illustrations, and numerous tables. Price ..... **\$3.00**

All electric motors, coupling coils, magnetic and dynamic loud-speakers, transformers, choke coils, etc., are dependent on magnetic phenomena. This fine book is complete on the subject.

**HOW TO BUILD AND OPERATE SHORT-WAVE RECEIVERS.** by the Editors of SHORT WAVE CRAFT. Stiff Paper covers, size 7½x9¾", 76 pages, 250 illustrations. Price prepaid ..... **40c**

The greatest book on building and operating short wave sets and converters in print today. No better book printed.

**CINEMATOGRAPHY.** by James R. Cameron. Stiff covers, size 7½x8", 240 pages, 150 illustrations. Price ..... **\$3.50**

Everything on the subject from "silent" and "talkie" 16 mm. film to its manufacture and to the final projection is in this marvelous volume.

**QUESTIONS AND ANSWERS—Sound Motion Pictures.** by James R. Cameron. Cloth covers, size 7½x8", 250 pages. Price ..... **\$3.50**

The most important book on the technical subject of "Talkies."

**AUDEL'S RADIOMAN'S GUIDE.** by Frank D. Graham. Cloth covers, (flexible), size 5x6¾", 220 pages, 300 illustrations. Price ..... **\$1.00**

A practical, concise book presenting the theoretical and practical information for the proper operation, maintenance and service as applied to modern radio practice.

**THE RADIO AMATEUR'S HANDBOOK.** (New Revised Edition), by A. Frederick Collins. Cloth covers, size 5½x7¾", 391 pages, 116 illustrations. Price ..... **\$2.00**

If you wish to become a radio amateur (radio ham) this book tells you how. Everything in receiving and transmitter sets and how to build them.

**RADIO SET ANALYZERS AND HOW TO USE THEM.** by I. Van der Aal. Stiff Paper covers, size 6x9", 68 pages, 15 illustrations. Price prepaid ..... **40c**

The first book giving the fundamentals of radio servicing design in a manner which is clear even to the tyro. No service man can be without it.

**RADIO AND ELECTRONIC DICTIONARY.** by Harold P. Manley. Cloth covers, size 6x9", 300 pages, 550 illustrations. Price prepaid ..... **\$2.50**

A fully indexed volume, which places at your finger-tips definitions of 3,800 radio words and phrases; of inestimable value.

**FOUNDATIONS OF RADIO.** by Rudolph L. Duncan. Cloth covers, size 5½x8", 216 pages, 145 illustrations. Numerous tables. Price ..... **\$2.50**

This textbook gives you the fundamentals of electricity as applied to radio. It equips you for further study in the field of radio.

**EXPERIMENTAL RADIO ENGINEERING.** by John H. Morecroft. Cloth covers, size 6x9", 316 pages, 250 illustrations. Price ..... **\$3.50**

A student's book; devoted to the principles of radio apparatus; intended to accompany a course in electricity. The best of its kind.

**TALKING PICTURES.** by Bernard Brown. Cloth covers, size 5½x8¾", 327 pages, 161 illustrations. Price ..... **\$3.00**

The non-technical man reading this book feels that he has been transported to a wonderful; technicians refer to it time after time.

**RADIO THEORY AND OPERATING.** by M. T. Loomis. 5th revised Edition. Cloth-bound; size 5½x8" x1½" thick; 1,000 pages; over 800 illus.; 450 review questions and answers. Price ..... **\$4.50**

Written in textbook style, a tremendous amount of useful information has been crammed into this thin-paper, compact reference work. Radio transmission and reception have been covered, "from soup to nuts." A truly great book.

**THE RADIO MANUAL.** by George E. Sterling and Robt S. Kruse, E.E. 2nd enlarged edition. Flexible fabricoid covers. Size 5½x8", 805 pages, 318 illustrations. Price ..... **\$6.00**

A complete Radio Course for the operator, the technician, the amateur, the student and experimenter. Everything imaginable in the whole radio art is covered in this great book—the "radio bible" of the amateur. DON'T MISS THIS.

**RADIO AND ITS FUTURE.** by Martin Codel. Cloth covers, size 6x9", 349 pages, 8 plates. Price ..... **\$4.00**

Vivid chronicles of radio broadcasting, communications, industry, regulations, etc. If you are in radio you MUST have this book.

**SHORT WAVES.** by C. R. Leitz and H. B. Gable. Stiff Covers. Size 6x9", 384 pages, 258 illustrations. Price, prepaid ..... **\$3.00**

The biggest and most complete book on short waves. Covers every imaginable phase, including S.W. Superheterodynes. The authors are famous S.W. authorities.

**RADIO FREQUENCY MEASUREMENTS.** by E. B. Moullin. Cloth covers, size 6x9", 187 pages, 289 illustrations. Price prepaid ..... **\$12.50**

This large volume answers all questions which arise in the design and construction of R.F. circuits of every possible type. The greatest and most authoritative book of its kind in print for radio students and engineers.

**RADIO MOVIES AND TELEVISION.** by C. Francis Jenkins. Cloth covers, size 9½x6", 144 pages, profusely illustrated. Price ..... **\$1.00**

A complete volume by the master of television, giving everything in television, including constructional details for building your own television sets.

**RADIO VISION.** by C. Francis Jenkins. Cloth covers, size 9½x6", 144 pages, profusely illustrated. Price prepaid ..... **90c**

An excellent book. The Jenkins television system, as well as many other modern television systems fully described.

**A POPULAR GUIDE TO RADIO.** by R. Francis Dashiell. Cloth covers, size 5½x8¾", 286 pages, profusely illustrated. Price prepaid ..... **\$3.50**

The fundamental principles of radio. From crystal rectifiers to the latest electron tube amplification, etc.

## How to order

We cannot ship C.O.D. Our prices are net, as shown. Some of the books include postage. Those that do not will be shipped by express collect if sufficient postage is not included by you.

**RIDING THE AIR WAVES.** by Eric Palmer, Jr. Cloth covers, size 7½x5¾", 328 pages. Price ..... **\$2.00**

No radio amateur or "ham" can afford to be without this book, written by the author of "Around the World with 5 Watts."

**SOUND PICTURES AND TROUBLE SHOOTERS MANUAL.** by Cameron and Rider. Cloth cover, size 8½x7", 1120 pages, 750 illustrations. Price ..... **\$7.50**

The sturdy of every operator. It is the most thorough book on the subject.

**TELEVISION TODAY AND TOMORROW.** by S. A. Moseley and H. J. B. Chapple. Cloth covers, size 8½x7", 130 pages, profusely illustrated. Price prepaid ..... **\$2.50**

A most up-to-date work on television describing in detail the apparatus used by Baird.

**S. GERNSBACK'S RADIO ENCYCLOPEDIA** (Second Edition). Red Morocco Flexible Binder, 352 pages, 2201 radio definitions, 1253 illustrations, 34 tables. Price ..... **\$3.25**

The most comprehensive encyclopedia of its kind in print. Remarkably up-to-date in every way, with marvelous illustrations.

**ORDER DIRECT FROM THIS PAGE**

**DRAKE'S CYCLOPEDIA OF RADIO AND ELECTRONICS.** by H. P. Manly. Cloth covers, size 6x9", 1050 pages, 1080 illustrations. New 1932 Edition. Price ..... **\$6.00**

The largest work of its kind ever put between two covers. New and up-to-date; a standby for every radio man.

**RADIO TROUBLE SHOOTING.** by Ennor R. Haan, E.E. Flexible covers, size 6x9", 323 pages, 257 illustrations. Price ..... **\$3.00**

An intensely practical handbook for all radio service men and operators. Up-to-date in every respect.

**FUNDAMENTALS OF RADIO.** by R. H. Ramsey, Professor of Physics, Indiana University. Cloth covers, size 9½x6", 372 pages, illustrated. Price, prepaid ..... **\$3.50**

The backbone of the radio art. This book gives you the foundation on radio from A to Z.

**OFFICIAL RADIO SERVICE MANUAL.** Volume I, by Hugo Gernsbach and Clyde Fitch. Flexible loose-leaf binder, size 9x12", over 2,000 illustrations, 650 pages. COMPLETE WITH SIX SUPPLEMENTS. Price prepaid ..... **\$4.50**

The Service Man's Bible. Greatest book ever published on the subject. Contains all old circuits of every imaginable commercial radio set up to 1931.

**OFFICIAL RADIO SERVICE MANUAL.** Volume II, by Hugo Gernsbach, C. E. Benton and C. H. W. Nason, with 1932 Free Supplements. 1000 pages, 2000 illustrations. Flexible Loose-leaf Binder, size 9x12". Price, prepaid ..... **\$4.00**

The talk of the radio industry. This marvelous volume contains everything in radio, circuits, and radio developments, for 1932. Not a line of duplication between 1931 and 1932 volumes. (Vol. I and Vol. 2.)

**ELEMENTS OF RADIO COMMUNICATION.** by Professor John H. Morecroft. Cloth covers, size 9x6", 270 pages, 170 illustrations. Price ..... **\$3.00**

An authoritative volume embracing every imaginable phase in radio communication.

**RADIO SERVICE MAN'S HANDY-BOOK WITH ADDENDA DATA SHEETS.** Flexible covers, size 9x12", 200 pages, 400 illustrations. Price prepaid ..... **\$1.49**

The Service Man's standby. Contains the latest practical information on radio servicing.

**RADIO TELEGRAPHY AND TELEPHONY.** by R. L. Duncan and C. E. Drew. (New Edition.) Cloth covers, size 9½x6", 950 pages, 468 illustrations. Price ..... **\$7.50**

Everything from Ohms Law to vacuum tubes and detectors, to oscillography and radio compasses thoroughly treated in this great book.

**PRACTICAL RADIO CONSTRUCTION AND REPAIRING.** by J. A. Moyer, S.B., A.M. and J. F. Westrel. Cloth covers, size 8x5", 354 pages, 163 illustrations. Price ..... **\$2.50**

A handbook that every radio set tester and general student must have. The diagrams alone are worth the price of the book.

**PRACTICAL RADIO—INCLUDING THE TESTING OF RADIO RECEIVING SETS.** by James A. Moyer, S.B., A.M. and John F. Westrel. Cloth covers, size 8x5", 378 pages, 223 illustrations. Price ..... **\$2.50**

The title gives the story. Everything from crystal sets to the latest multi-tube receiver, and how they work.

**RADIO RECEIVING TUBES.** by Moyer and Westrel. Cloth covers, size 7½x5½", 298 pages, 181 illustrations. Price ..... **\$2.50**

One of the finest books on vacuum tubes. Everything worthwhile on the subject treated in a masterful manner.

**HOW TO PASS U. S. GOVERNMENT RADIO LICENSE EXAMINATIONS.** by R. L. Duncan and C. E. Drew. Flexible covers, size 9½x7", 170 pages, 92 illustrations, appendix. Price ..... **\$2.00**

The most important book on the subject ever published. Gives every conceivable angle which will help you to pass a radio license examination successfully.

**PRINCIPLES OF RADIO.** by Keith Henney, M.A. Cloth covers, size 8x5½", 478 pages, 308 illustrations. Price ..... **\$3.50**

A marvelously written textbook with the latest radio principles, including screen grid and pentode, amplifiers, etc.

**PHOTOELECTRIC PHENOMENA.** by Arthur Llewelyn Hughes and Leo Alvin Duhrlitz. Cloth covers, size 6½x9¾", 531 pages, 202 illus. Price ..... **\$5.00**

A critical survey of the whole field of photoelectric phenomena. Intended as a reference book for research workers, students and teachers. The most complete work in print.

**RADIO TRAFFIC MANUAL AND OPERATING REGULATIONS.** by R. L. Duncan and C. E. Drew. Flexible covers, size 9x12", 67, 186 pages. Price ..... **\$2.00**

A live wire book for all radio amateurs, including how to learn code, abbreviations, International Radiotelegraph Convention, Radio Act of 1927, etc.

**PRINCIPLES OF RADIO COMMUNICATION.** by J. H. Morecroft, Prof. of Electrical Engineering, Columbia University. Cloth covers, size 9½x6", 983 pages, profusely illustrated. Price ..... **\$7.50**

The radio classic, by the dean of radio. Covers entire radio art as does no other book.

**EXPERIMENTAL RADIO.** by R. B. Ramsey, Prof. of Physics, Indiana University. Cloth covers, size 7½x5½", 256 pages, 168 illustrations. Price, prepaid ..... **\$2.75**

A marvelous book for the experimenter. Experiments caloro in easy comprehensible language.

**FUNDAMENTAL PRINCIPLES OF RADIO.** by Louis Martin, B.S. Stiff Paper covers, size 6x9", 68 pages, 85 illustrations. Price ..... **40c**

Just what the title says, but it gives you the HOW and WHY of radio in plain English. THE book for beginners.

**MODERN VACUUM TUBES and How They Work.** by "Iob" Hertzberg. Stiff Paper covers, size 6x9", 68 pages, 150 illustrations. Price, prepaid ..... **40c**

Just published, this important book covers the art as does no other book. Describes all the latest tubes, including the "Triple Twin".

**RADIO PUBLICATIONS**

245-R GREENWICH STREET  
NEW YORK, N. Y.

**ORDER DIRECT FROM THIS PAGE**



# A NEW FREE SERVICE

Booklets that will be mailed to you free if you send in coupon below

## 55. PHILCO PARTS CATALOG

The manufacturers of the nationally-known line of Philco radio receivers have recently taken one of the most progressive steps in the tangled history of radio servicing, and in the interests of all Service Men we wish to give the matter prominent attention in this department. We quote directly from a letter written to RADIO-CRAFT by Robert F. Herr, service engineer for the Philco Radio & Television Corporation:

"Attached to this letter you will find a copy of the new Philco Parts Replacement Catalog.

"During the past few years more and more of the radio service work has been passing from the radio dealers to individual radio Service Men and radio service companies employing a number of men. We also realize that most of the radio set manufacturers have limited the sale of their parts to their authorized dealers and also most of the radio manufacturers have priced all their parts entirely too high. Philco is starting an aggressive sales campaign on replacement parts for Philco radios and also on the sale of those parts which can be used for other radio work. This Parts Catalog supplies the necessary information on part numbers and dealer net prices. All of the prices in this catalog have been greatly reduced so that today a genuine Philco replacement part costs less in most cases than a substitute part.

"This parts catalog is being distributed to radio Service Men in every country of the world. The sale of these parts is not limited to authorized Philco dealers; any Service Man capable of repairing a radio can secure a copy of this catalog. We believe that this catalog will be of great help to radio Service Men because it contains the only official, complete list of the more common replacement parts in every Philco radio from the very beginning up to and including the models shown at the R.M.A. show in Chicago in June."

Considering the large number of Philco receivers that have been sold during the past several years, this liberal attitude is sure to have beneficial results for everyone concerned. We congratulate the Philco company on its wisdom and hold it up as an example to certain other radio receiver manufacturers who keep the values of resistors and condensers a deep, dark secret—and wonder why they are so unpopular among people in the trade.

Readers of RADIO-CRAFT may secure copies of the Philco Parts Catalog by using the usual Readers' Bureau coupon on this page.

# Radio-Craft

## READERS' BUREAU

On this page are listed booklets, catalogs, pamphlets, etc., of Manufacturers, Schools, Institutions, and other organizations, which may be of interest to readers of "Radio-Craft." The list is revised each month, and it will be kept as up-to-date and accurate as possible. In all cases the literature has been selected because of the valuable information which the books contain.

This Service is absolutely free to all Readers of "Radio-Craft."

Fill in and mail the coupon below; make sure that your name and address are included and are plainly written. Order by number only.

## 56. THE GENERAL RADIO EXPERIMENTER

"The General Radio Experimenter" is a monthly house organ of the General Radio Company. It is devoted to electrical communications technique and its applications in allied fields, and contains a great deal of accurate, well-written, technical information. The May issue, of sixteen pages, has articles on a vacuum-tube bridge, an output-power meter; a beat-frequency oscillator, a standard signal generator, and a sweep circuit for the cathode-ray oscillograph. The last-named article is particularly good, and explains the need for and operation of "saw tooth" oscillators, which are re-

garded as complicated and mysterious by many radio men. The "Experimenter" is mailed free of charge to interested persons. *General Radio Company.*

## 57. EXPERIMENTS WITH THE PHOTRONIC RELAY

The experimenter who has gotten the idea that photoelectric cells require a lot of amplifiers and associated apparatus for successful operation will be surprised at the number and variety of practical stunts that can be performed with the Photronic cell without amplifiers of any kind. This cell has sufficient output to actuate a small relay directly, this relay in turn operating a slightly heavier one for control purposes. The following interesting devices are described in the booklet of the above name: a sunrise alarm to waken a sleeper; a sunset switch to turn on light; a light-beam burglar alarm; a smoke detector; an automatic alarm to announce visitors; and an automatic parking light. The ingenious constructor can readily think up numerous other applications for this versatile device. *Weston Electrical Instrument Corp.*

## 58. CONCOURSE ELECTROLYTIC CONDENSERS

This new catalog of electrolytic condensers will be of interest to all users of condensers, and particularly to Service Men because it describes a number of very convenient replacement units that will solve difficult service problems in some types of sets. The mounting of the replacement blocks has been simplified considerably by the adoption of a single-hole, metal strap bracket, which eliminates the large holes formerly required for many condensers of the inverted type. *Concourse Electric Company.*

## 59. PRACTICAL RADIO ENGINEERING

This handsomely prepared 24-page brochure describes in great detail the home-study courses in radio engineering offered by the school mentioned below. These are intended for the more advanced type of student who is interested in actual radio engineering, as they include mathematics running up to vector analysis, use of the slide rule, and even the operation of 50-kilowatt broadcasting stations. The instruction is intended to bridge the gap between college study which emphasizes the theoretical side and the "practical" courses which end with service work. The serious radio man who is looking ahead will find this booklet worth reading. *Capitol Radio Engineering Institute.*

RADIO-CRAFT 55-59  
Readers Bureau  
96-98 Park Place, New York, N. Y.

Please send me free of charge the following booklets indicated by numbers in the published list above:

No. ....

Name .....

Address .....

City..... State.....

# SEND NO MONEY--

Clip and mail to us the coupon below. We will send you either one or both books through the Express Company for your inspection. You have the privilege of keeping or returning them.

## If you want to have a complete set of all Radio Diagrams, both manuals should be in your file.

Both volumes of the OFFICIAL RADIO SERVICE MANUAL will give you the most complete set of circuit diagrams ever published for the Radio Industry. Every Radio Service Man and Dealer should have them available for immediate use in his business. Professional set-builders and amateurs will find them instructive and helpful.

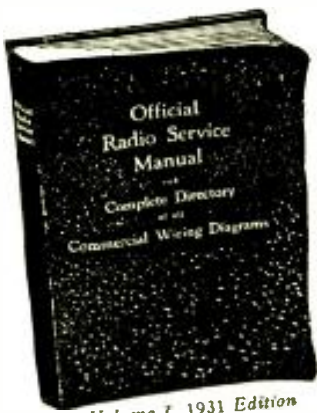

Volume I, 1931 Edition



Volume II, 1932 Edition

Briefly outlined below are the "high spots" that are to be found in the 1931 Manual—the first complete radio service manual ever to be published. Over twenty-seven thousand copies of this edition were sold to members of the radio industry. This assures you of its importance to those engaged in radio and how valuable it is to them.

### Partial Contents

Wiring diagrams of radio sets manufactured since 1927, and many earlier ones of which there is any record elsewhere.  
650 pages of radio-servicing material.  
Complete course of instruction for Radio Service Men, dealers, manufacturers, jobbers, set builders and amateurs.  
(Here are but a few of the subjects covered in the special course of instruction).

Amplifiers	Power-Supply Systems
Antennae	Radio Phonograph
Automotive Radio	Equipment
Condensers	Resistors
Detectors	Short-Wave Sets
Eliminators	Speakers
Meters	Tubes

**\$4.50 Complete with Supplements**

**650 PAGES**  
(Complete with Supplements)

**Over 1,500 Diagrams, Charts and Illustrations**

### Get Supplements FREE with the NEW 1932 MANUAL

There is so much new material in this Manual, that a Service Man or dealer would be lost without it when called to service a set. Information about new models which have been on the market only a few weeks are contained in this book. The 1932 Manual makes the service kit complete.

The 1932 Manual contains a Full Radio Service Guide and a Complete Directory of all 1931-1932 Radio Diagrams, also models of older design. Everyone in the Radio business should have a copy. Send for yours today!

### Partial Contents of Volume II

A step-by-step analysis in servicing a receiver which embodies in its design every possible combination of modern radio practice; it is fully illustrated and thoroughly explained. It is the greatest contribution to the radio service field.

Chart showing the operation of all types of vacuum tubes, whether new, old or obsolete. An exclusive resume of the uses of the Pentode and Variable-Mu Tubes and their characteristics.

Complete discussion of the superheterodyne and its inherent peculiarities. Also a special chapter on tools used on superheterodyne circuits. Schematic diagrams and circuits complete with color codings.

Important chapters on commercial aircraft radio equipment; new data on commercial short-wave receivers and converters.

Servicing and installation of public address systems and talking machine equipment.

Standardized color-codings for resistors.

Operation of old and new testing equipment; tube voltmeters, output meters, oscillators and aligning tools.

A full section on Midget radios—their design, circuits, and types. How to service them most economically. Hundreds of schematic diagrams of older radio receivers which have never been published.

Blank pages for recording notes, diagrams and sketches; these pages are transferable to any part of the book. Coupon page for free questions and answers.

**\$5.00 Complete with Supplements**

**OVER 1,000 PAGES**  
(Including Supplements)

**Over 2,000 Diagrams, Charts and Illustrations**

**Flexible, Looseleaf Binder,**  
9 x 12 inches.

### CLIP COUPON AND MAIL TODAY!

GERNSBACK PUBLICATIONS, Inc.  
96-98 Park Place, New York, N. Y.

RC-8

Please send me for FREE inspection the books I have checked below. I understand I may examine them carefully, and should I decide to keep them, I will pay the full cost, plus the few cents for carrying charges. This offer is good only in the U.S.A.

- Volume I, 1931 Manual, with Supplement, \$1.50.  
 Volume II, 1932 Manual, with Supplements to be mailed Free every 60 days, \$5.00  
 BOTH BOOKS FOR \$9.00.

Name .....

Address .....

City ..... State.....

*Flexible,  
Looseleaf  
Binder,  
9 x 12 inches.*

NOT ONE OF THE DIAGRAMS PUBLISHED IN VOLUME NUMBER I OF THE OFFICIAL RADIO SERVICE MANUAL IS REPEATED IN VOLUME NUMBER II.





"Takes the Resistance Out of Radio"

Editorial Offices: 96-98 Park Place, New York, N. Y.

HUGO GERNSBACK, Editor

Vol. IV, No. 2, August, 1932

## "TRICK" AMPLIFIER APPLICATIONS

An Editorial by HUGO GERNSBACK

LAST year, in one of my editorials, I suggested that Service Men and others connected with the radio industry can not only earn money but even a good living by installing A.F. amplifiers. I suggested that there is a great and ever increasing demand for this type of radio installation at the present time.

Besides public address and similar amplifying systems, there are many uses for amplifiers that have hardly been considered. Every day we receive letters suggesting new and useful purposes where amplifiers may be employed; and, strangely enough, we hear from laymen who have found uses for amplifiers that the radio man himself has overlooked. This clearly demonstrates that radio Service Men and others in the industry are not alive to the money-making opportunities that are now knocking at their doors.

A case in point: The recent deplorable Lindbergh case brought the fact home to many parents that additional safeguards are required for their children. Mrs. Godfrey Ludlow, wife of the well-known violinist, became so engrossed in thought on this subject that she turned inventor herself. She bought a microphone and placed it in the corner of the baby's crib and attached it to a commercial audio amplifier. This amplifier was then connected to a loudspeaker placed in her own bedroom which was some distance from the children's bedroom. This simple device worked so well that the child's breathing could be heard loud and clear through the loudspeaker in the parent's room, and the slightest noise in the children's room, such as footsteps, the opening of a window or creaking shoes would create a sufficient commotion in the loudspeaker to bring the parents instantly into the nursery.

Here, then, is a ridiculously simple device that could be sold to many families with young children. The cost is low, and the amount of current used is negligible. Why cannot Service Men and other radio people sell such a simple device at a good profit?

There are, of course, many other trick amplifier applications, and thousands of new and hitherto unthought of uses will be commonplace in a few years. Of the long list, I will only mention a few:

Every large organization, whether factory or office, has uses for amplifiers. The busy executive and general manager cannot be everywhere. He can, however, have microphones scattered all over the plant, and by pressing a button, get in touch with any part of the plant through the medium of his loudspeaker, and he will be enabled to listen-in to the various activities of his employees. The mere fact that the employees would know that their activities may be noted would often have a salutary effect, and would certainly help to raise the efficiency of the plant. It would do away with much useless talking and time wasting by employees, which in these days of efficiency is not tolerated by real executives.

Motion picture houses can bid for the patronage of the near-deaf or hard of hearing by installing a very simple device which, in some cases, does not even require a separate amplifier. If one or two rows in the auditorium are wired, and pin jacks are attached to the back of the chairs, it would be possible to plug in a pair of headphones

which can be given, or loaned for a deposit to the hard of hearing; the other end of the connection going to the amplifier. Thus, the hard of hearing who never get much satisfaction from the talkies would be able, by means of headphones, to enjoy the programs as well as their more fortunate brethren.

In most dining rooms of the better apartments and private houses, there is usually a foot push-button used to summon the maid or cook, whichever the case may be. Very often an order is to be given, and this results in much useless running about and delay. A microphone can be effectively concealed in the chandelier in such a way as to enhance the decorative effect. An artistic cord is suspended from the microphone; by pulling the cord, the microphone is put in the circuit. You talk in your natural voice, giving your order to the kitchen, where an amplifier and loudspeaker are installed. Instead of ringing a bell, therefore, the order is given orally, directly to the kitchen. This is a little innovation that will appeal particularly to many householders.

In the nursery, it is often necessary to admonish the children and keep them from talking when they do not wish to go to sleep, or to give other orders to them. At the present time, it means that the father, mother or nurse must go to the nursery in person, and close the door, etc.; thus creating further disturbance which is not always wanted. A microphone amplifier and loudspeaker is a simple solution of the problem and the scheme has actually been found to work exceedingly well in practice, because if the children hear their parent's voice, they pay attention, and the mystery of the unseen voice generally has an arresting effect upon most children.

In most apartment and private houses, there is a push-button in the master's bedroom to the servant's room or quarters. It is usually used to summon the maid or other servant. A microphone at the head of the bed, with a pull cord to make contact and a loudspeaker in the servant's quarters is a much better idea, and saves useless running around. The order can thus be given directly to the servant's room or servant's quarters. Of course, the microphone is only placed in use when the cord is pulled, making contact.

In busy restaurants, waiters and waitresses, nowadays, are apt to shout their orders to the kitchen if it is not too far away; and where the kitchen is downstairs, there is usually a good deal of useless running about. A microphone at a strategical position solves this problem to a nicety. The waiter or waitress approaches the microphone and by means of his or her foot closes a circuit, and the order is received instantly on the loudspeaker in the kitchen, much louder and clearer than it could be heard through intervening doors or other obstructions.

These are only a few of the more obvious applications of audio amplifiers. It should be a relatively simple matter for a Service Man or a radiotrician to make up a portable amplifier and give a spot demonstration. Talking about it, as a rule, means little to the prospect, but if the device can be demonstrated to him and the advantages shown, a sale can be made in most instances, and usually at a good profit.



Fig. A

# AN A.C.-D.C. PORTABLE RECEIVER

Construction details of a portable receiver using the latest tubes and operating from either 110 or 220-volts A.C. or D.C. without any circuit changes.

By J. BURGESS DAVIS

THE portable receiver illustrated in Figs. A, B and C will be a boon to many radio enthusiasts who have felt the need of a compact, light-weight receiver, capable of operating from A.C. or D.C. service, with dynamic speaker quality. A ten-foot antenna provides ample pickup for good speaker volume on locals, and many distant stations have been logged with an antenna of this length. No exterior ground connection is required, as the receiver circuit is directly coupled with the lighting circuit, which in most cases is grounded at the meter and/or the pole transformer. The sensitivity of the receiver is largely due to the use of two pentodes in the R.F. amplifier. A screen-grid power detector, feeding into two A.F. pentodes with grids and plates connected in parallel, provides the audio amplification. The remaining two of the seven tubes employed are so connected as to constitute a half-wave rec-

tifier. The tubes are all of the six-volt heater, automobile-type. Because of their rugged construction and the fact that the heaters are not critical to voltage variations over a comparatively wide range, these tubes are admirably suited for use in a receiver of this type.

### The Circuit

The circuit, like most good things when properly developed, is extremely simple, as reference to the schematic drawing of Fig. 1 will prove. Due to the universal feature, the circuit is treated as though the receiver were to be operated from direct current only and the line polarity indicated accordingly. When the receiver is operated from an A.C. line, the indicated polarity holds true, since only that half of the wave which corresponds in direction to the polarity indications is used. All the heaters as well as the flashlight lamp (which is used as a pilot

light) and the filament resistor R9, are connected in series across the 110-volt line. Resistor R8 is shunted across the pilot lamp to protect it from overload but is not of sufficient current rating to make it safe to operate the receiver without the pilot lamp.

In order to reduce the number of controls and to economize in space, the line-switch and volume-control are mounted on the same shaft. The side of the line connecting with the heater of the first R.F. tube is grounded to the chassis. This is effective in maintaining the same relative potential difference between cathode and heater at all times, as well as keeping this potential difference lowest at the input of the amplifier so that the possibility of amplifying hum is lessened.

The primary of the antenna-coil L1, is grounded through condenser C8 in order to prevent burning out the coil should the antenna accidentally become grounded.

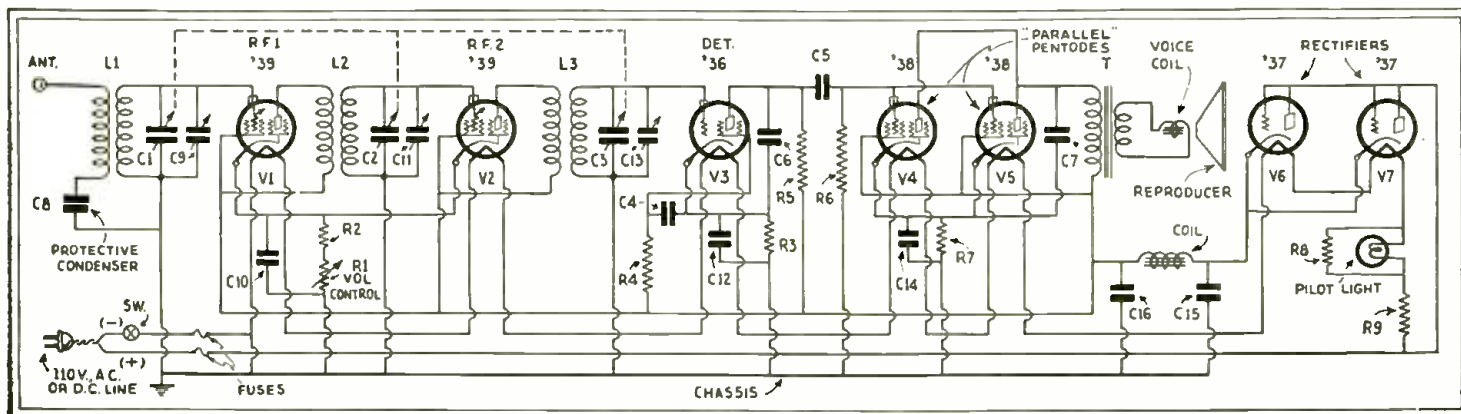

Fig. 1

Schematic circuit of the receiver designed by Mr. Davis. Note that the line plug may be inserted into either A.C. or D.C.





# THE LATEST RADIO EQUIPMENT

## NEW TELEVISION RECEIVER



The Western Television Receiver.

THE Western Television Corp. presents a new television receiver, incorporating two sets—one for the reception of pictures and the other for the accompanying sound transmitted in the broadcast band. A modernistic cabinet, shown above, together with a neat ground-glass screen are attractive features.

## A SIX PRONG SOCKET

THE advent of the new tubes, such as the 46, 57 and 58 demands new six-prong sockets in order to properly house them. To effect this, the H. H. Eby Manufacturing Co. announces the new socket illustrated above. The socket holes are arranged in a circle, the heater prongs being of slightly greater diameter than the remainder so that the tube may be placed in the socket in only one way.

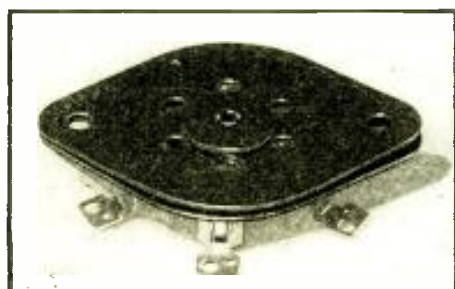

The six-prong wafer-type socket manufactured by the Eby Mfg. Co.

## ANOTHER SOCKET

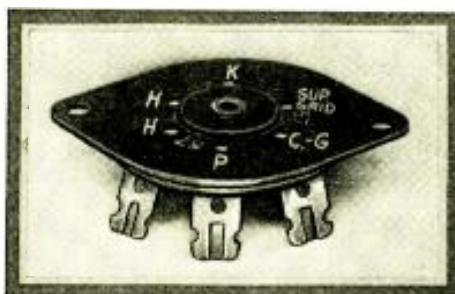

The six-prong socket by Cinch

ABOVE is illustrated another six-prong socket designed to accommodate the new tubes. As may be seen, it is of the wafer type, suitable for chassis mounting. The top of the socket is marked according to the type of tube. It is a product of the Cinch Mfg. Co.

## NEW REPLACEMENT UNITS

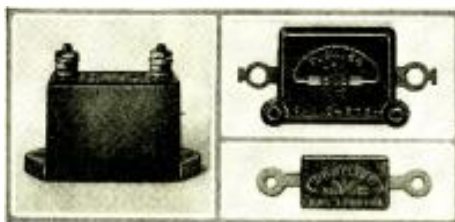

Dubilier Condensers for replacement.

REPLACEMENT condensers suitable for nearly all types of radio replacement work have been announced by the Dubilier Condenser Corp., manufacturers of radio condensers. The illustration above depicts three of the many types available to the radio Service Man. They are made in various shapes and sizes.

## SPARTON AUTOMOTIVE SET

THE new Sparton model 40 automotive receiver, illustrated here, is a typical example of what the modern auto receiver



Sparton Receiver.

will be like. Incorporating four type '36 tubes, a '37 as the A.V.C. and a '38 output pentode in a T.R.F. connection, it represents the latest advances made in this field by the Sparks-Withington Co., manufacturers. A significant feature is the use of the Lafoy system of automatic volume control described in the July issue of this magazine.

## VEHICLE SPEAKER

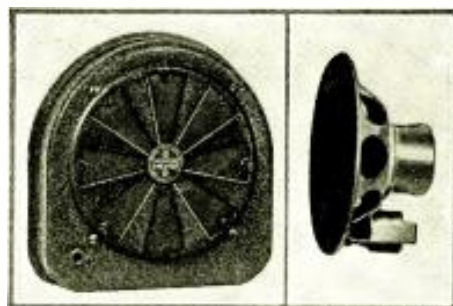

The Wright DeCoster Speaker

AUTOMOTIVE radio is in full swing, and a speaker specially designed for this purpose has been announced by Wright-DeCoster, Inc. Containing all of the features such as dust-proof cover, mounting screws, etc., it should prove a boon to set builders.

## REPLACEMENT CHASSIS

THE July issue of this publication contained a data sheet of a replacement chassis manufactured by the Transformer Corporation of America, a photograph of which appears below. Statistics compiled by the above firm indicates that of the 17,000,000 radio sets now in use in this country, the apparatus in approximately 11,000,000 is obsolete!

This chassis is designed to replace existing sets and at the same time retain expensive cabinets.

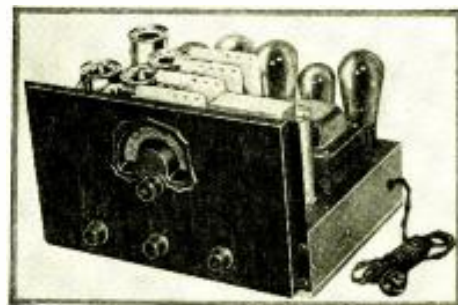

A replacement chassis designed to be used in existing cabinets. A product of the Transformer Corp. of America.



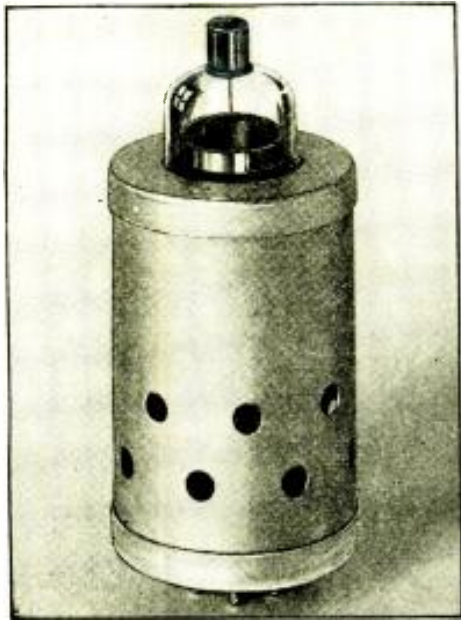

The new National tube shield.

### NEW TUBE SHIELDS

THE new tubes announced in past issues of RADIO-CRAFT demand an entirely new type of shield can if effective shielding is to be secured. These tubes, types 57 and 58, are equipped with a dome-shaped glass bulb which has been especially built to reduce inter-electrode capacity to a minimum.

In order to derive the best possible results from the use of these tubes, the shield can must be placed as close as possible to the internal shield in the tube. This has been admirably accomplished by the National Company, Inc., makers of the tube shield illustrated here. The tube shield inside the glass may be seen at the top while the holes at the bottom are for ventilation purposes.

### TUNE-A-LITE ESCUTCHEON

IN the November, 1931 issue of this publication, there was described a new type of tuning indicator which depended for its operation upon the ionization of neon gas in a vacuum. This device was unique in the sense that the height of the neon flare was proportional to the strength of the received signal.

While this device has been incorporated in several commercial sets, it may also be purchased by individuals for use in home-built receivers. One of the major disadvantages of its use has been the lack of a proper escutcheon which now may be secured from Blanche the Radio Man.

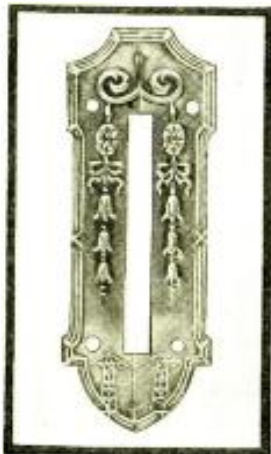

A Tune-A-Lite escutcheon

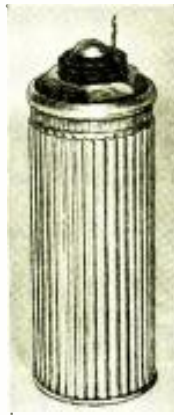

Concourse condenser.

### IMPROVED ELECTROLYTIC CONDENSER

AN improved type of electrolytic condenser with a ribbed aluminum case has been brought out by the Concourse Electric Company. The new container is more rigid than the old smooth type, is less susceptible to denting, and has greatly increased heat radiating surface. The latter feature is important in crowded midget receivers. In the 8-mf. size this condenser measures only  $3\frac{3}{8}$  inches long and  $1\frac{1}{8}$  inches in diameter. The voltage rating has been increased from 450 to 600 volts. The instrument is intended for inverted one hole mounting.

### NEW PHILCO SET

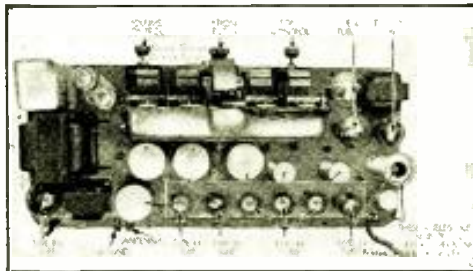

Philco 15 chassis.

THE Philadelphia Storage Battery Co. announces a new receiver chassis illustrated above, known as the "15" chassis designed for use with their models 15X and 15DX receivers.

It is an eleven-tube set incorporating four type '44 tubes in the R.F. first-detector and two I.F. stages; four type '37 tubes in the second-detector, first and second audio stages and as the oscillator; two type '42 tubes in a push-pull pentode output stage; and an '80 rectifier.

This receiver also incorporates such features as twin reproducers, tone control, automatic volume control, visual tuning and a local distance switch.

### CRYSTAL DETECTOR



Crystal detector.

"HISTORY repeats itself." This well-known adage seems to prevail in the radio as well as in other fields. The amount of correspondence that we have received warrants the announcement of the device shown here.

### FUSED ATTACHMENT PLUG

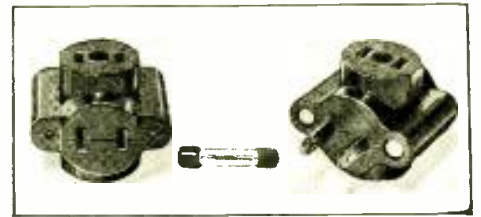

A fused attachment plug.

THIS new fused attachment plug is designed to protect radio receivers against overloads. It is made of molded bakelite, and holds two standard automobile type cartridge fuses, which are quickly replaceable. It fits in any electric fixture and provides three outlets which take the regular two-prong plugs fitted to the cords of radio and electrical appliances. This plug should be a profitable item for the Service Man, as it has good selling points and can be installed in two seconds. It is made by the Electro-Motive Engineering Corporation.

### NEW "BAND SPREAD" CONDENSER

TO assist amateurs in constructing short wave receivers having the much desired band spread tuning characteristic, the Hammarlund Manufacturing Company, Inc., has designed a new type "band spread" midget condenser.

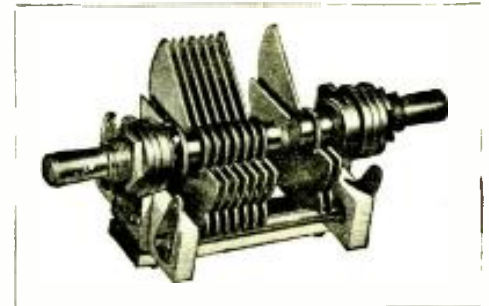

New band-spread condenser.

Two sections are provided in the condenser, one having a capacity of 100 mmf. and the other a capacity of 35 mmf. Each section may be individually tuned by its own shaft. Tuning to the center of the desired band is accomplished by the high capacity section, the low capacity section then being used for "spreading the band" and so greatly simplifying tuning within the limits of the band.

The condenser is specially designed for efficiency on high and ultra high frequencies. Isolantite is used for insulation, bearings are heavy and accurately fitted, plates are of brass, and no nuts or screws are used, all joints being securely soldered. Adapted for either base mounting or single hole panel mounting.

As may be seen by reference to the photograph above, the shaft of the condenser protrudes at both ends. The main condenser is set for the best position on any particular band and the three-plate variable unit is then used as the tuning unit.

In this manner, the tuning is spread over the entire band you are working on—hence the name.

# EDDY CURRENT LOUDSPEAKERS

Keen interest has been shown recently in new loudspeakers. The Eddy Current Types, described herewith, offer great possibilities.

By DR. FRITZ NOACK\*

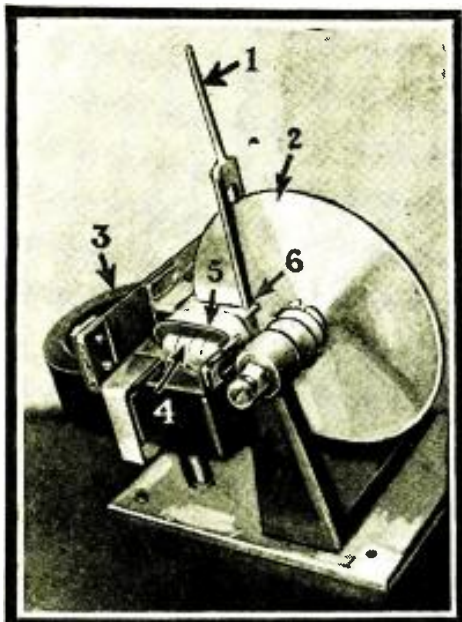

Photograph of the Eddy Current reproducer. The numbers are discussed in the text.

THE application of amplification to all radio circuits involves the use of some form of valve action whereby a small amount of energy is used to control a much larger amount. Crudely explained, the small amount of energy required to operate an electric switch manually may produce thousands of kilowatts of power. In the same way, the small amount of energy fed into the grid circuit of a vacuum tube controls a much greater amount supplied from a "B" battery or other source.

For many years engineers have been trying to apply this same principle to the operation of loudspeakers—so that a virtually unlimited external source of mechanical energy could be controlled by a relatively small amount of energy obtained from the output of a radio set or other device. The object was to either make the loudspeaker so sensitive and efficient that audio amplifiers could be eliminated; or, with their use, enormous volume could be obtained, depending upon the design of the speaker.

*The eddy current promises to attain this object!* Its use allows tremendous mechanical energy stored in a rotating disc driven by an electric motor to be harnessed and controlled by an electromagnet connected to the output of a radio set in such a way that the controlled energy is translated into sound waves. Before describing the speaker it may be well to explain briefly how eddy currents may be generated in a rotating disc and their effect demonstrated.

## How Eddy Currents Are Produced

Faraday showed that when a metal bar is moved between the poles of a magnet so as to cut the lines of force, an E.M.F. will be established between the ends of the bar and a continuous current will flow through an external circuit connected to the ends of the bar.

Likewise, when a metal disc is rotated between the poles of a magnet, a continu-

ous current will be generated—but it will flow through the metal of the disc which is cutting the lines of force in one direction and in its return path will circle through the disc outside the range of the lines of force. This is clearly illustrated in Fig. 1. A is a side view and the magnetic pole, N, is on the side of the disc towards the observer as shown in the end view at B. Both poles of the magnet are shown at N and S in Fig. 1 B.

As the disc rotates in the direction of the arrows, and since the magnetic lines of force are passing through the disc from N to S, a current will be generated which will flow in the disc in the direction indicated by the arrows marked E. This current, in Fig. 1 A, flows from left to right through that part of the disc between the magnet poles, and circles around in the direction shown. If either the poles of the magnet or the direction of rotation of the disc is reversed, the direction of the generated current will also reverse. This current, because of its circular path, is called an "eddy" current.

It is obvious that the eddy current, flowing in a closed loop, will act as a single-turn electromagnet and will set up a magnetic field of its own. Since there are two eddy current loops, two fields will be created, as shown at N'-S' and N''-S'' in the sketch at B. The polarities will be as indicated. It is also apparent that the eddy field N'-S' will repel the permanent field N-S, and the eddy field N''-S'' will attract the main field N-S, causing a strong magnetic pull *opposite* in direction to the direction of rotation of the disc. In other words, rotating a metal disc in a magnetic field caused an appreciable drag, and such a system is used to place a load on small motors used in watt-hour meters.

The drag, of course is, proportional to the strength of the eddy current generated which in turn is proportional to the speed of the disc. The greater the speed, the greater the drag. If a pulsating ex-

ternal magnetic field is employed, the eddy currents will also be pulsating and the mechanical drag on the disc will likewise pulsate or vibrate in unison. This will cause actual mechanical motion or vibration of the disc (which will increase and decrease in speed in unison with the magnetic pulsations) or the external magnet poles may be so mounted that they will vibrate under the influence of the pulsating drag, the speed remaining constant. It is this effect that is made use of in eddy current speakers. The mechanical vibrations are harnessed to a diaphragm or cone to produce sound waves and their strength varies in proportion to the speed of the disc. Therefore, to increase the volume of sound, simply rotate the disc at a higher speed.

The German graduate-engineer, Friedrich Gladenbeck of Berlin, has perfected an eddy current speaker which is likely to replace, to a certain extent, the audio amplifier. The inventor actually claims that this new loudspeaker if hooked up to the detector will give good loudspeaker reception.

The illustrations show what the speaker is like. The principle is shown in Fig. 2; it provides for an electromagnet, 1, around which is wound the coil, 2, which conducts the audio frequency current. The pole pieces of the electromagnet are marked 3. One lamination, 4, is solidly attached to each pole shoe. These laminations are made of iron and are exceedingly flexible. Their free ends, 5, are bent upward, so that two parallel end surfaces are formed. Between these two end surfaces

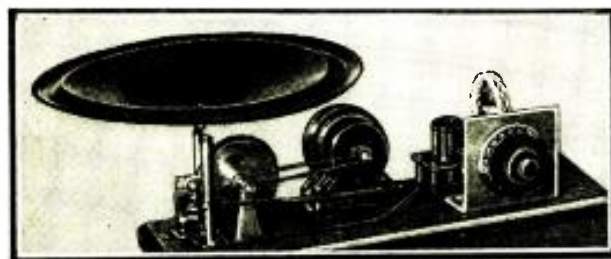

Another view of the Eddy Current reproducer showing the connection to the cone.

\* Berlin Correspondent.



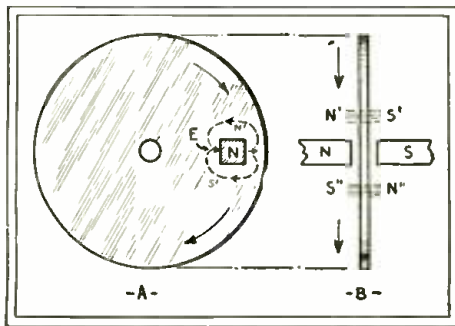

Fig. 1

The rotating disc cuts lines of force, developing an E.M.F. which causes a current to flow as shown at A; the field generated, at B.

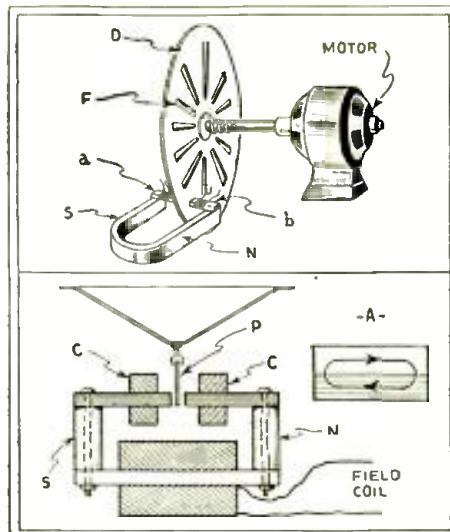

Fig. 3, above. Details of the speaker, designed by Mr. Clyde Fitch using the eddy current idea. Fig. 4, below. Still another type of speaker.

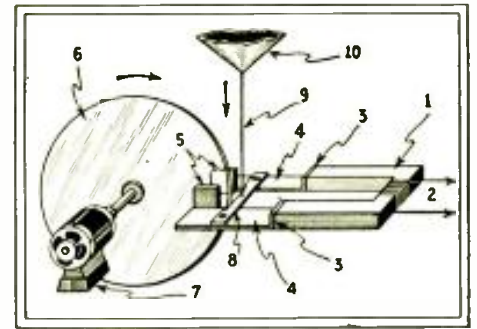

Fig. 2

Details of the Eddy Current reproducer. The theory is given in the text. In constructing this speaker, be sure that the speed is steady.

a disc, 6, rotates; which is operated by a motor, 7.

When the electromagnet, 1, is magnetized by the audio current in the coil, the two end surfaces, 5, are likewise magnetized. The end surfaces, 5, would have a tendency to swing against each other which is avoided by a bridge, 8. A connecting wire, 9, ties the cone diaphragm to the bridge, 8. If the springs, 4, are moved parallel to each other, either up or down, because of the magnetic drag, the cone, 10, through the connecting wire, 9, is also set in swinging motion.

Due to the fact that the two end surfaces, 5, are magnetized differently (one north and the other south) in accordance with the audio frequency current, eddy currents are generated in the disc, 6, setting up a field of force as previously explained. If the disc, 6, revolves, and its speed is held constant by motor, 7, then the bridge, 8, must move up and down at a frequency determined by the A.F. signal applied. Obviously, there is a certain relation between the magnetism of the cup springs, 5, their distance from each other, the material from which the disc, 6, is made, its thickness and the speed of 6.

The rotating disc has a diameter of about  $3\frac{1}{4}$  inches. The diameter does not matter much but the thickness of the disc and the material from which it is made, are of importance. All sorts of discs have been tried out made of various materials, magnetic and non-magnetic. No one knows which material is really the best. The disc revolves at about 2,000 R.P.M. though it is not certain that this speed will be necessary. The distance of the end surfaces of the two springs from the rotating disc must be as short as possible.

A total degree of efficiency has already been reached which is almost double that attained by standard types of magnetic loudspeakers. However, further improvement may be necessary before going into production so as to decide what material is best suited for the disc, how thick it should be and the number of revolutions necessary for satisfactory operation. Only a small amount of power is required by the starter motor.

Toy motors may be run by storage batteries to drive the disc. If a battery-operated radio set is available, its battery

may be used to run the motor. Inasmuch as the loudspeaker is supposed to have a much greater degree of efficiency, the radio receiver may be equipped with fewer tubes and the extra power made available for the motor. If electric lighting circuit is available, this current would, of course, be used to run the motor. Inasmuch as many electrodynamic loudspeakers need an exciting current, the special current supply would not present any difficulties.

#### Commercial Application

An eddy current speaker developed by Clyde Fitch in this country makes use of a rotating disc in a somewhat different manner. The principle is illustrated in Fig. 3. In this case the external magnetic field is rigidly fixed so that it will not vibrate, and the disc is made of very light material, such as aluminum, and attached to the motor shaft through a spring so that the vibrations will take effect in the disc, and the speed of the disc will vary at an audible frequency.

This variation in speed is transformed into sound waves by means of small fins F placed on the disc. These fins continually stir up the surrounding air due to the steady rotation of the disc; when the rotation wanes in speed, the vibrations are transferred to the surrounding air by means of the fins. Experimental work is still being done on this unit and definite data on its construction and operation cannot be given out at this time.

Another type of speaker that has been thoroughly tested and has proved equal to the average dynamic speaker is shown in Fig. 4. This is also an eddy current speaker but has no rotating or moving parts other than the motion of the armature and cone.

This speaker consists of an electromagnet connected to a D.C. source so as to magnetize the poles N—S. Laminated ends are placed on these poles forming a narrow gap in which the aluminum plate P is suspended. The coils C carry the audio frequency currents from the output of the radio set. These currents

cause a fluctuation of the magnetic lines of force that pass through the plate P and hence induce similar currents in P. Since one half of P is exposed to the magnetic field, the induced currents will flow through this half and return through the unexposed half, as shown in the sketch at A, Fig. 4. The shaded area of this sketch indicates that part of the plate which is exposed to the magnetic field.

Since there is a permanent D.C. field passing through the plate, and an alternating eddy current flowing through the plate between the pole tips, the plate will be set in vibration for the same reason that the voice coil of a dynamic speaker is set in vibration when carrying audio currents. The plate is attached to a cone, as shown, to which the vibrations are applied.

The moving parts of this speaker can be made very light, and in this way the frequency characteristics can be controlled so as to give faithful reproduction.

#### Conclusion

This article only attempts to outline some of the work which has been done along these lines. From the results obtained to date, it appears that in the not too far future, commercial loudspeakers will be available using the ideas outlined in this article.

The experimenter finds here a very fruitful and virgin field for experimentation. It is but a simple matter to construct a speaker as suggested in the article, and after noting the results obtained at first, change the constants of the units one at a time until best results are secured.

In the photograph shown on page 78, the numerals have the following significance; (1) connecting pin to the cone; (2) rotating disc; (3) permanent magnet for supplying the constant magnetic field; (4) transformer for applying the audio signal; (5) transformer core; and (6) pole face.

The photograph in the lower part of the same page shows an eddy current speaker connected to an R.F. tuner. As stated previously, no audio amplifier is necessary as the speaker is sensitive enough as it is.

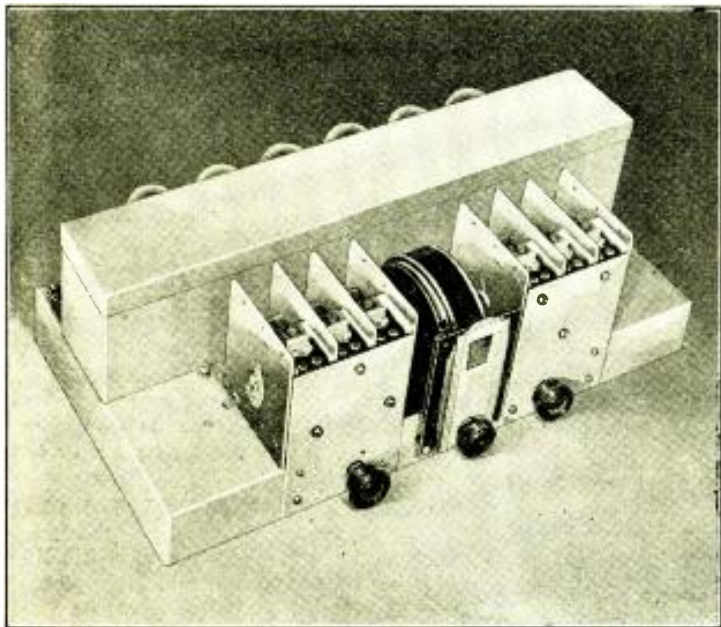

Fig. A  
Photograph of a laboratory model of the six-tube "Plerophone."

**A**T a recent demonstration in Fordham University, a distinctly new method of circuit connection which makes possible a degree of amplification, from a given tube, heretofore considered impossible with all but high- $\mu$  tubes, was announced. The novel feature of this connection lies in the fact that the receiver is free from all forms of oscillation, thus reducing the noise level to a minimum.

Laboratory models of receivers incorporating this new principle have been given the name "Plerophone" and patents for same have been granted to its inventor, Prof. Joseph J. Daley of Boston College. Photographs of two types of receivers using the new system are shown in Figs. A and B. A schematic circuit of a six-stage set is in Fig. 1 and of the four-stage in Fig. 2.

#### Theoretical Considerations

Receivers in general use today have inherent characteristics which tend to increase the distortion in the output. In the first place, the amount of amplification obtainable from a given tube is limited primarily by oscillation. If the im-

pedance of the load of an R.F. stage is increased in order to secure a reasonable gain, oscillation will result, and the impedance must be decreased in order to secure stable operation. If the impedance is maintained constant, then some external means such as suppressor resistors, neutralization and balancing methods etc. must be employed in order to prevent this oscillation. The latter only tends to prevent oscillation *after it is generated* and does not get at the *source* of the evil—the load impedance. The Daley system overcomes this difficulty.

Secondly, most receivers have the primary of the R.F. transformer connected directly in the plate circuit of the tube and, consequently, the current through the primary, and hence the magnetic field generated, varies above and below the value determined by the D.C. plate current flowing when no signal is impressed. Thus, slight variations in modulation (due to the audio signal to be heard) are obliterated. The Daley system eliminates this.

A third fault that arises in connection with most commercial receivers is the non-uniform amplification over the broadcast band (or short-wave band). This has been corrected in present-day receivers to some extent by the addition of a small amount of capacity between the

primary and secondary of the R.F. transformer in the form of a loop of wire from the plate to the grid-end of the transformer. However, much of what is to be desired is included in the system to be described.

Each of the above items will be discussed in turn.

#### Elimination of Regeneration

Theory indicates that when an inductance, capacity and resistance are connected in series and the terminals connected across a source of alternating current of variable frequency, there will exist one frequency at which the current through the circuit is a maximum, and furthermore, the *value* of this maximum current is determined solely by the resistance of the circuit. This frequency at which maximum current flows is called the *resonant* frequency of the circuit, and the circuit is said to be in *resonance*. Now, with a given E.M.F. applied and the current a maximum, the impedance of the circuit must be *low*, else maximum current could not flow, the current is in phase with the voltage and the circuit acts as though it were resistive only.

This principle is the basis of operation of all radio receivers, with the exception that the coil and condenser are connected in parallel, and at resonance, a *minimum* current flows. If a minimum current flows, the impedance of the circuit is a *maximum*, else minimum current could not flow.

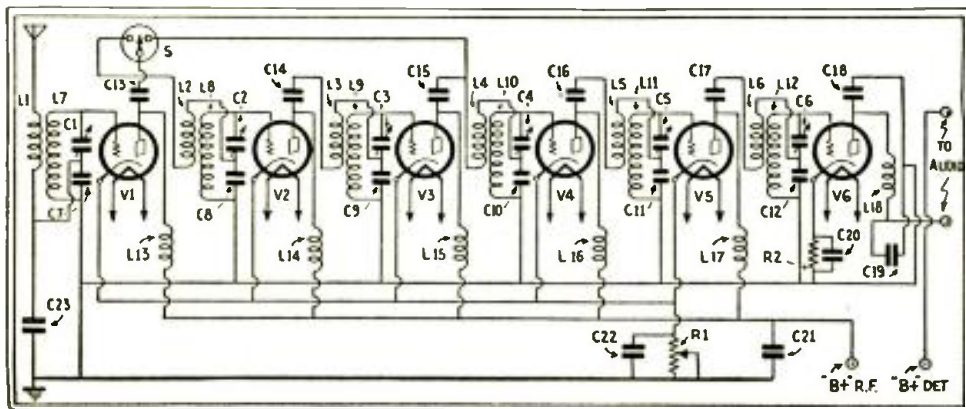

Fig. 1

Schematic circuit of the six-tube Daley receiver using the new system of tuning. The switch S is used so that either six or four tuned stages may be employed at will. In view of the fact that the receiver has been made for battery operation, no power pack has been shown.

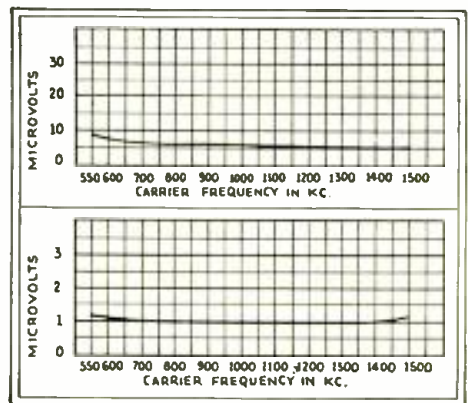

Fig. 4

Sensitivity curve of the six-tube receiver is given above, and of the four-tube receiver, below.



# Amplification

A description of a new type of receiver in which the tuning system is so arranged that oscillation is impossible.

With this latter method of connection, which is used substantially in all present-day radio sets, the load impedance of the tube is a maximum and oscillation results, with the aforementioned limited amplification.

Figure 3 is a schematic circuit of the Daley system in its essential form. As may be seen, the plate P of a tube connects to the grid of the succeeding tube through a complex circuit arrangement. L1 is the primary of the R.F. transformer; L2, the secondary of the transformer; C3, a tuning condenser; C2, a fixed condenser; G, the grid of a tube; C1, a fixed condenser; and R.F.C., an R.F. choke.

The primary L1 is coupled to the secondary as shown, the mutual inductance being indicated by M. The plate voltage for the first tube is conveyed via the choke R.F.C. in order to eliminate the D.C. from the primary of the transformer (this will be discussed later), and the condenser C1 is inserted in order to isolate the high voltage from the grid of the second tube; thus R.F.C. and C1 may be temporarily disregarded as far as circuit operation is concerned.

The signal from the plate of the tube V1 in order to reach the grid of V2 must pass through L1 and the complex tuned circuit consisting of L2, C2 and C3. The transfer of energy occurs in two different ways: First, because of the coupling be-

tween L1 and L2 (due to M) and second, because of the capacity coupling (due to the combination of C2 and C3). In other words, C2 and C3, in series not only tune the coil L2 to the desired frequency, but transfer energy from L1 to L2. When C3 has a low value, the combined capacity (of C2 and C3) is low and when turned to maximum value, the combined capacity is high. In any event, since the tuned circuit is in resonance with the signal to be received and connected in series with the plate of V1 and the grid of V2, the net reactance of the circuit is zero and the load of the tube V1 is purely resistive. Therefore, since the load is resistive, the tube cannot break into oscillation.

### Uniform Response

The energy induced in the secondary of the transformer by the primary increases as the frequency increases. This means that, ordinarily, the response of the set would be greater at the high-frequency end. But in this receiver, the energy transfer is not only due to electromagnetic coupling but also to capacitive coupling, and since the tuning condensers are so arranged that they constitute a coupling medium as well as a tun-

(Continued on page 109)

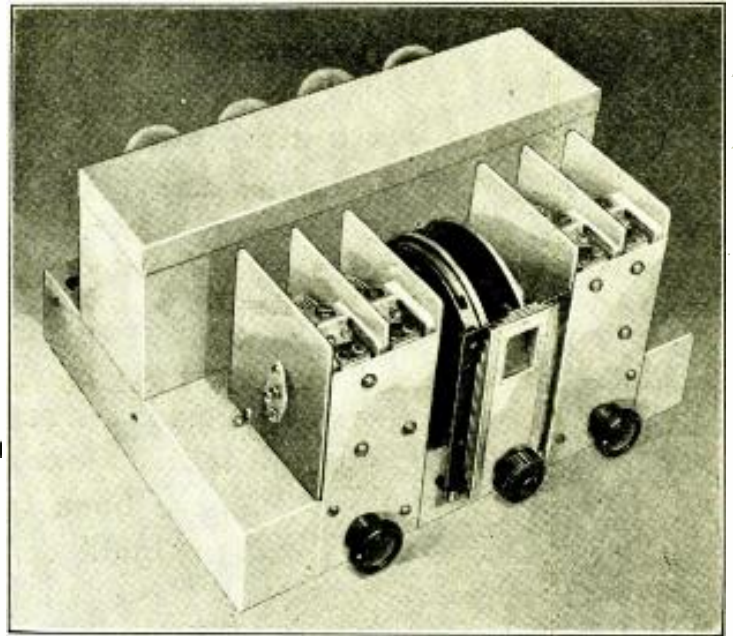

Fig. B  
Photograph of the Daley four-tube receiver.

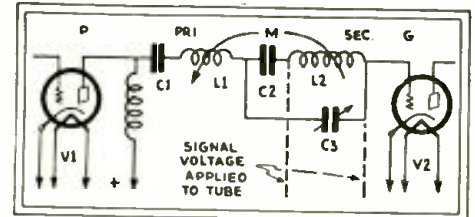

Fig. 3

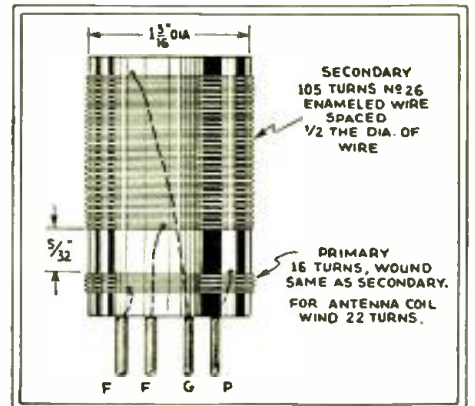

Fig. 7

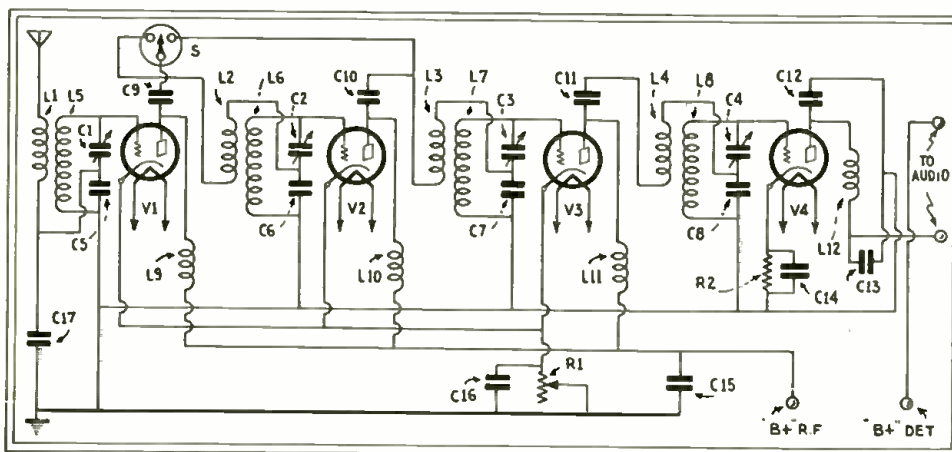

Fig. 2

Schematic circuit of the four-tube "Plerophone," designed by Prof. Daley. The switch S is thrown to the left when four tuned stages are to be used and to the right when three are to be used. Thus the sensitivity of the set may be varied for individual conditions.

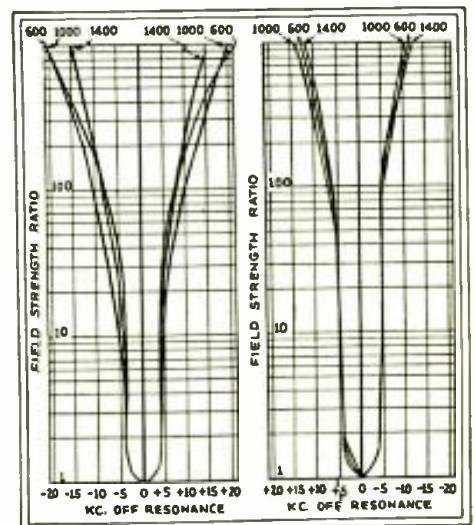

Fig. 5, left. Selectivity curves of the six-tube receiver.

Fig. 6, right. Selectivity curves of the four-tube receiver.

# A TINY-TUBE A.C. LOUDSPEAKER SET

A midget receiver that truly deserves its name. Not only is the speaker diaphragm of unusual design but the tubes have been specially built for the set, they, too, being of "midget" construction. Here is something for set manufacturers to shoot at.

By J. V. CAPICOTTO\*

A 6-TUBE radio set which might well be termed a "depression special" has just made its appearance on the market. The entire receiver has outside dimensions of only 10x10½x6½ ins. and includes an electric clock which operates independently of the receiver; the list price is less than twenty dollars. The Model 8 set, used as the basis of this article, weighs only 14 lbs.

Perhaps the most interesting of several features which have not been incorporated in previous instrument designs is the use of the Rochelle-salt crystal reproducer unit and its method of driving the unique diaphragm. Since a limitation imposed by the dimensions of the cabinet precluded the use of a standard cone diaphragm and motor, the diaphragm material has been designed to fit inside of the cabinet in the form of an inverted-U, as illustrated in Figs. B and C. The two extending arms

are driven at the two extremities through the medium of leverage bars, one on either side, which are set in motion by a crystal reproducer unit of double-action type, illustrated in Fig. B.

### Tone Quality

As described in the article, "The Rochelle Salt Crystal Reproducer," which appeared in the July, 1932, issue of RADIO-CRAFT, the crystal element *without a load* is responsive from 0-500,000 cycles! Consequently, the resulting tone quality of a reproducer incorporating this motor element is almost entirely a function of the diaphragm material and its method of mounting.

In Fig. F is shown the manner in which an aperture is made into each side of the cabinet to enhance the tonal effect; the illusion of reality is completed by making openings in the base and raising the cabinet about ½-inch, on rubber feet.

Since the reproducer diaphragm thus

fits almost snugly against the inside wall of the cabinet, there is ample room for the compact chassis which is shown in position in Fig. A.

As illustrated in Fig. 1, the circuit of this receiver varies but little from standard design. However, it is interesting to note that since the crystal reproducer is strictly a voltage operated device, it is convenient to use a *resistance load* in place of the regular output transformer; and as the tubes are connected in push-pull, this resistor is center-tapped. In this manner the tone quality is enhanced; and also there is effected a considerable reduction in the space required for the output coupling unit.

### Dwarfed Tubes

It would be quite impossible to achieve the remarkable small dimensions of the chassis illustrated in Fig. E were it not that there has been developed for use in this chassis an *A.C.-type tube having di-*

\* Radio Products Corp.

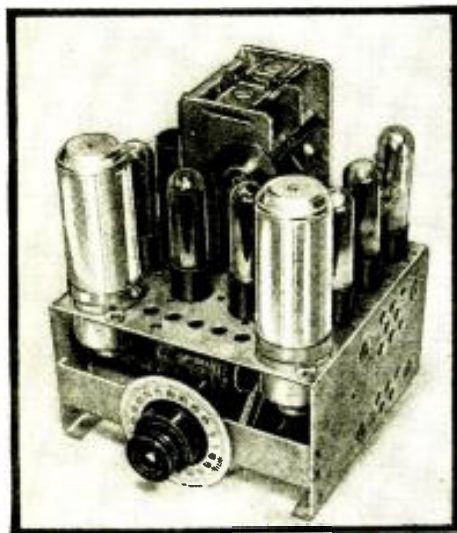

Fig. E  
An excellent chassis view.

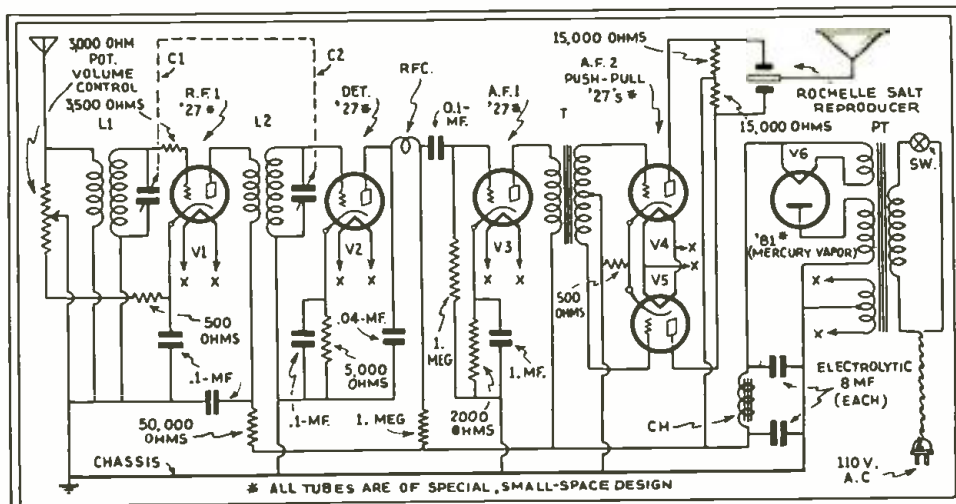

Fig. 1  
Schematic diagram of the receiver using the small tubes.



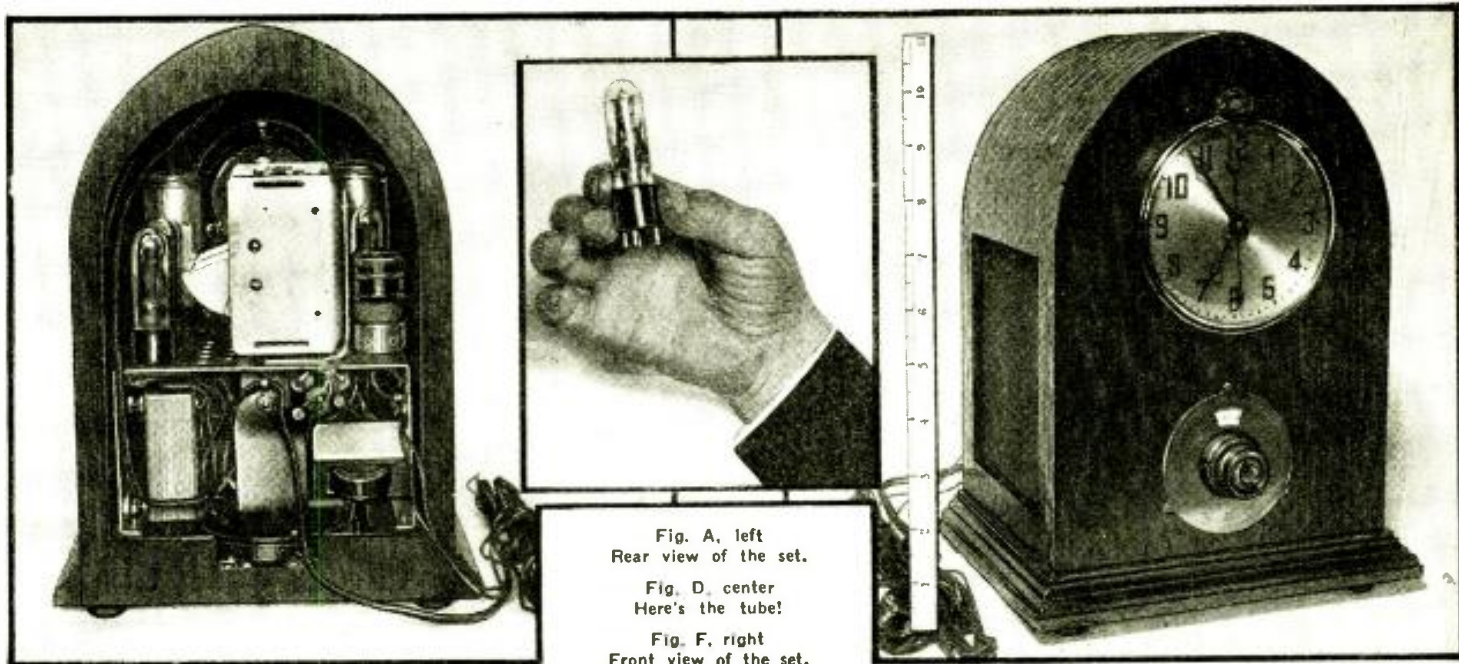

Fig. A, left  
Rear view of the set.

Fig. D, center  
Here's the tube!

Fig. F, right  
Front view of the set.

mensions smaller than those of any tube of similar type at present available; its minuteness is realized by the comparison exhibited in Fig. D: the outside diameter of the tube is only  $\frac{3}{4}$ -in. and its total length is slightly less than 3 in. The electrical characteristics are the same as those of standard '27-type tubes. In fact, by special design of the elements, even the same inter-electrode capacities have been obtained; thus it may be used as replacement for present '27-tube tubes by the use of an adapter.

These "Lilliputian" tubes are of the quick-heater type and although they have a cathode they do not use the customary insulating material such as a ceramic, between the cathode and heater; the latter is automatically located in the center of the cathode sleeve by means of two insulating bushings and spring tension on the heater absorbing expansion and contraction to prevent the heater shorting to the cathode.

As indicated in the schematic circuit and the photographs, a two-gang tuning condenser is used, one section tuning the R.F. amplifier circuit and the other the detector. The latter is resistance-capacity coupled to a single stage of A.F. amplification which drives two of the midget tubes connected in push-pull.

The rectifier in this receiver is a mercury-vapor tube of the half-wave type: its envelope, in size, matches the other tubes in the set. Since the voltage drop within a rectifier of this design is only about 15 volts, it is unnecessary to apply an external A.C. potential of more than 230 volts. Note that the filament of this tube consumes 2 amperes at 1.5 volts.

By an ingenious arrangement of the drive-cable, it has been found convenient to spread the dial readings of 0-100 over a full 360-degree scale, as shown in Fig. E.

The author believes that in this receiver has been achieved a design which will en-

able the public to have a radio receiver in more than one room—for instance, in sun-parlors, bed-rooms, etc. The color schemes which these various services demand will be met by the various finishes of the cabinets.

Experimental models incorporating the features described in this article have performed so well it is contemplated to extend the design to include several other circuit arrangements.

#### Increasing Sensitivity

For instance, it has been found that many people would like to have a set in which the same reproducer arrangement is followed, and in which the same type of tubes are used, but with a much greater sensitivity to power ratio than is possible in the present design. Naturally, this will take the set out of the "dwarf" class, since the additional stages of amplification will require considerably more space for the added tubes and associated equipment.

Nevertheless, by following the original design, and merely enlarging it to include the additional components, it still is possible to produce a set which, point for point, will have considerably smaller dimensions than could be obtained by following previous instrument designs.

Even in the planning of a portable set for battery operation, in which might be used earlier types of tubes, such as those generally classed by filament rating as "2-volt" or "6.3-volt," it still will be of considerable advantage to incorporate the inverted-U diaphragm and crystal motor type of reproducer. In the first place, this type of reproducer consumes practically no current; in the second, it is exceedingly compact. Tone quality is exceptionally fine on the higher frequencies; the quality of reproduction in the lower register is mainly a matter of obtaining a large baffle area.

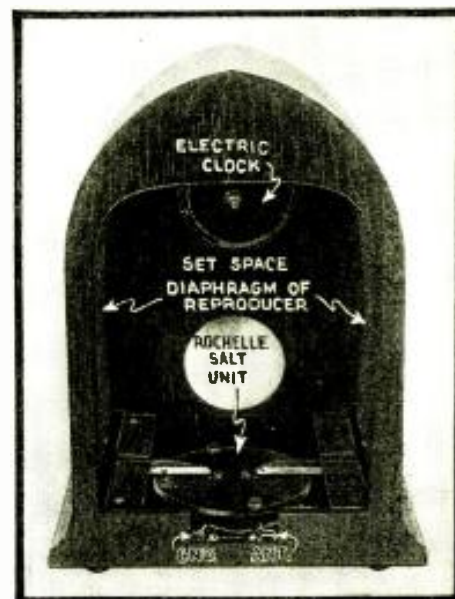

Fig. B  
View showing the location of the diaphragm.

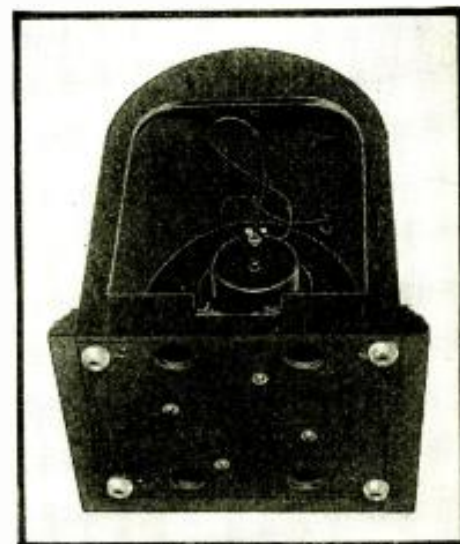

Fig. C  
Bottom of the set showing the location of the "air holes."

# THE "B" TUBE

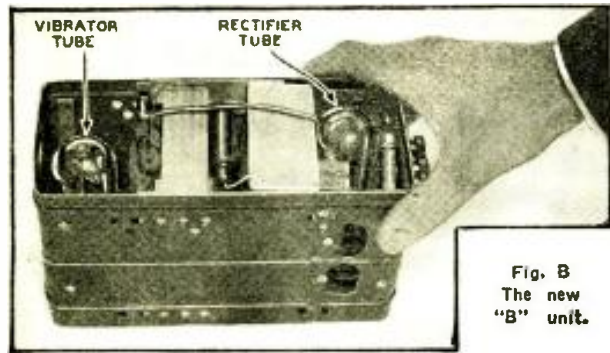

Fig. B  
The new  
"B" unit.

Here, at last, is a tube designed to convert D.C. into A.C. at all standard voltages. It is especially recommended for auto use.

By ALVIN B. BEDROSSYAN

**A**UTOMOTIVE radio "B" eliminators may be classed under two main groups.—

- 1—Rotating types, and,
- 2—Vibrating types.

The first group may again be subdivided into three types:

I. A small D.C. motor with an extra winding on the armature for generating high potentials in the order of 150-200 volts, pulsating D.C. A rectifier is not necessary, but a suitable filter is required.

II. Converters having a D.C. input and an A.C. output. Both rectification and filtering are required.

III. Devices that have a D.C. input which is chopped or broken up by the brush and commutators, and then fed into a transformer which delivers a high voltage ready for rectification and filtering.

Brush and commutator trouble, cost, and sales resistance to purchase of rotat-

ing equipment, are reasons for making general acceptance of these units rather difficult; although undeniably they serve the designated purpose.

Fundamentally, all vibrator-type "B" eliminators consist of a breaker or interrupter, step-up transformer, rectifier, filter system and, for best results, a voltage divider. By far, the most troublesome factor is the breaker or interrupter; the contacts stick rather frequently and although this may be cured to a large extent by employing suitable magnetic and ballistic means, another snag is encountered. The electrical arc or sparking at these points soon causes the contacts to oxidize, pit and, finally, become destroyed.

### Vacuum Contacts

Numerous metals and alloys were tried in an effort to overcome this latter difficulty, but in general, the desired results were not forthcoming when operating in

open air; therefore, the writer resorted to the logical expedient of enclosing the interrupter mechanism in an evacuated bulb.

Immediately, long life, stable operation with no fear of sticking (due to the lack of oxygen which plays havoc with the best of contacts) and permanence of adjust-

*(Continued on page 110)*

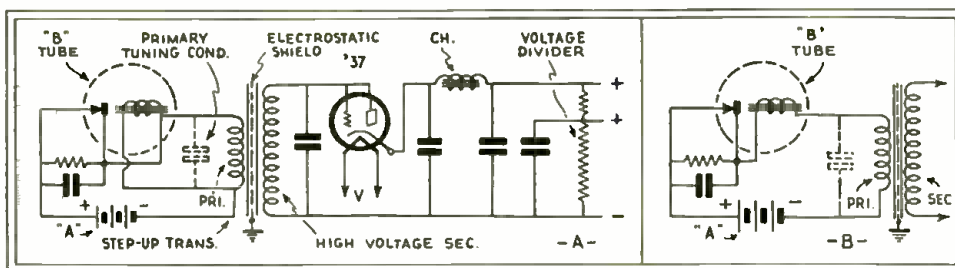

Fig. 1

Fig. 2

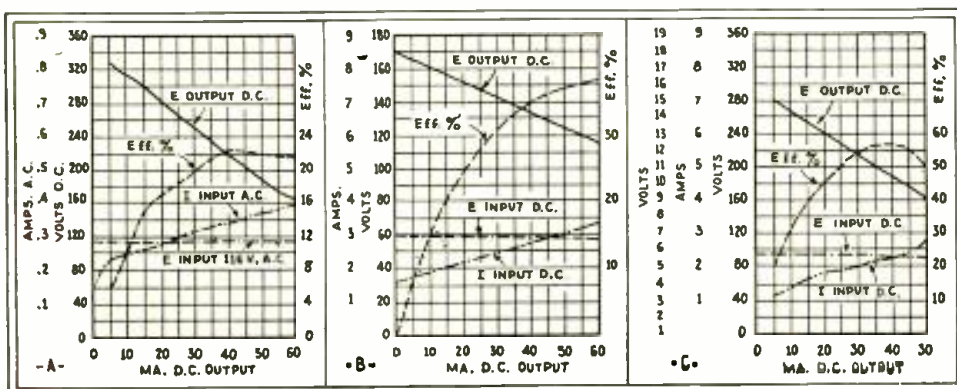

Fig. 3



Fig. A



# ELECTRIFYING THE "MEGADYNE"

The now famous "Megadyne," described in the July issue of this magazine, may be electrified by the addition of this simple power unit.

By HUGO GERNSBACH

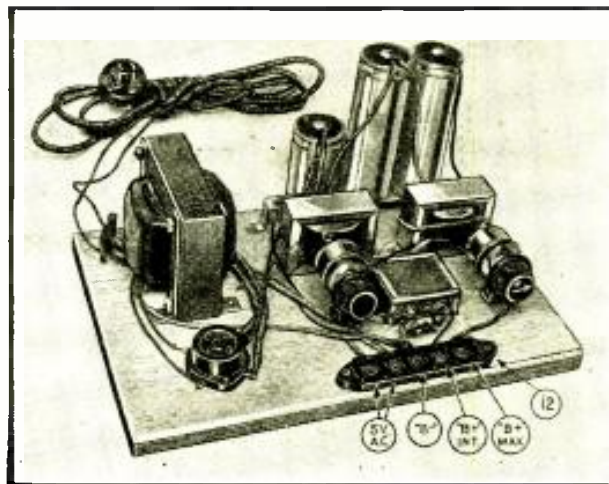

Fig. A. Photograph of the Megadyne's power unit.

IN the July, 1932 issue of RADIO-CRAFT I described a battery-model "Megadyne," the loudspeaker set that requires only one tube—a pentode, and a crystal. In the following description will be found all the details for operating this remarkable receiver from the house current, thus entirely eliminating batteries.

The only fundamental difference between the battery set and the electric set, is the use of a simple "B" eliminator. The original set was designed to use a "uni-potential cathode" type of tube, the '38, which possesses two outstanding advantages: First, the rugged filament may be operated with full efficiency under wide fluctuation in the D.C. voltage supply. Second: the thermal lag of the heater, and the uni-potential characteristic of the cathode, prevent the reproduction of hum when the filament is supplied with raw A.C. at approximately the rated operating potential of 6.3 volts.

This essential unit for electrifying the Megadyne, the "B" eliminator, is illustrated photographically in Fig. A; Fig. 1 gives a pictorial diagram of connections and the schematic circuit is shown in Fig. 2.

Although this unit has been built up in "breadboard" style, for convenience in

illustrating, the experienced constructor will have no difficulty in making a more compact arrangement. Inexperienced constructors are cautioned to observe a few fundamental rules, should they desire to revamp the parts layout to suit a particular condition.

If a metal chassis is desired, the builder is urged to use *only* the parts specified in order to obviate, so far as possible, inoperation due to faulty units, grounds, and shorts; for the "Megadyne" receiver, in wiring and electrical action, is like no other, and trouble-shooting may present some difficulty to inexperienced technicians.

An important point, and the one to which particular attention *must* be paid, is the adjustment of variable resistor 9 which controls the voltage at terminal B-PLUS INT.—the potential for the control-grid (cap lead) of the '38. *If this potential is permitted to exceed a certain critical value the grid will be seen, in a darkened room, to glow cherry-red, and continued application of this voltage, which is considerably beyond the setting for best operation, will result in the destruction of the pentode.*

For maximum bass response it was found best to use a type '80 tube as the

rectifier 2; the power transformer must be designed to deliver secondary potentials of 5 volts; 5 volts and 275 volts on each side of the center tap of the secondary.

Residents of D.C. districts may be interested to note that by breaking the leads of this power unit at X, to eliminate the power transformer and rectifier, and connecting the two wires to the 110 V., D.C. power-line leads having the polarities indicated (reversing the plug in the socket will check this condition), D.C. plate supply will then be available; the final step, to obtain filament current from the power circuit, is to connect the filament terminals to the light-line, with a 35- or 40-watt lamp in series. Suitable fuses *must* be connected in both sides of the power line; a ground is not necessary, a .01-mf. fixed condenser should be connected in series with the aerial.

Due to the design of this power unit, it is possible, whether operated from 110 volts D.C. or A.C., to secure very flexible control of the output potentials, by adjustment of resistors 8 and 9. Electrolytic bypass condenser 5 is particularly effective as resistor 8, in addition to act-

(Continued on page 109)

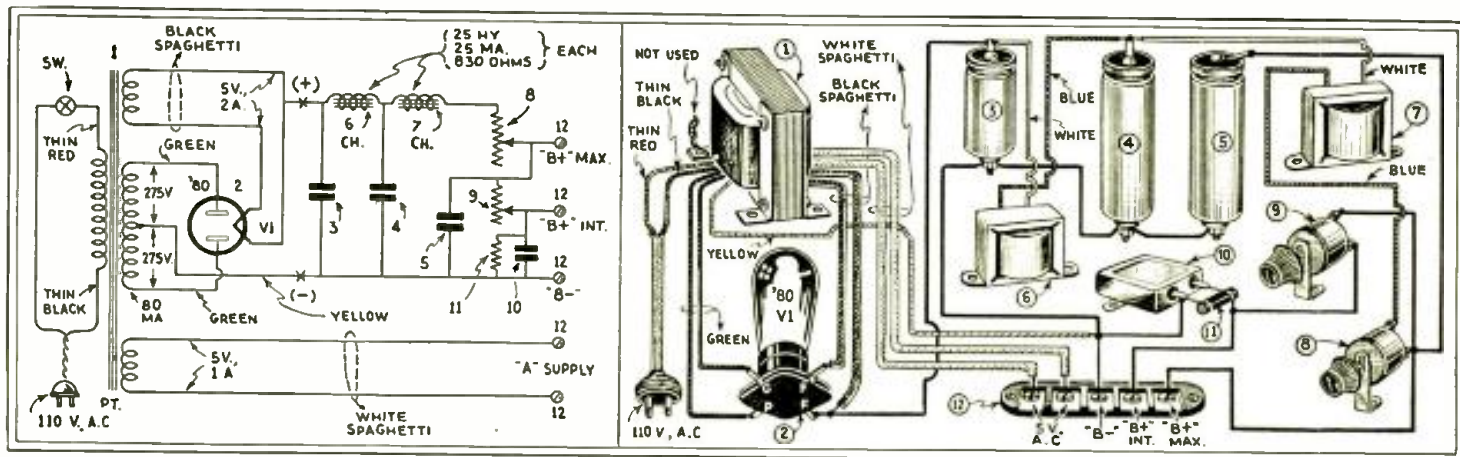
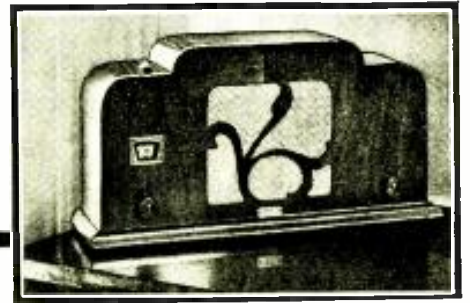

Fig. 1, right. Pictorial layout of the parts of the Megadyne. The numerals correspond to those in the diagram at the left, Fig. 2.

# THE "3-TUBE" AUTODYNE SUPERHETERODYNE

A description of one of the first commercial receivers to use the new 57, 58 and Triple-Twin tubes.



A photograph of an early model receiver using the principles discussed in this article.

By R. H. G. MATHEWS\*

## The Receiver

In an effort to produce a radio receiver economical in cost and small in size, but with enough sensitivity to allow good distance reception without sacrificing one-channel selectivity, the "3-tube" (4 tubes with the rectifier tube) autodyne superheterodyne described in this article was produced.

While many thousands of 4-tube tuned-radio-frequency sets have been sold, their primary appeal was that of size and cost, but their performance was fit only for local reception in metropolitan areas; while all attempts to improve their sensitivity were made at a sacrifice of selectivity. Although sufficiently sensitive to give distance reception, a set of this type is unable to do so because of broad tuning.

The superheterodyne obviously should be the ideal "3-tube" receiver circuit because sensitivity can be secured without sacrificing selectivity; and also because with this circuit, it is very easy to obtain equal sensitivity, i.e., equal performance from one end of the tuning band to the other.

Until the advent of the modern version of the autodyne circuit, a "3-tube" superheterodyne was at best a makeshift; since prior to this the only available detector-oscillator was the dynatron.

The dynatron oscillator depends on the "secondary emission" from a non-carbonized plate for its operation. Consequently, the introduction of carbonized elements in modern tubes has completely eliminated the dynatron from practical consideration. Moreover, the dynatron possesses no gain in itself, whereas with an efficient autodyne oscillator, a gain in this stage of close to 100 may be accomplished!

The advent of the new type 57 and 58 tubes makes the "3-tube" autodyne superheterodyne an ideal small radio because of the tremendous gain secured by the use of these tubes. The additional use of the triple-twin output tube, type 295, avoids the use of an ordinary combination detector-output tube, which is highly satisfactory.

Complete circuit diagram, parts identification table and parts list are shown in accompanying illustrations. In building a set employing this circuit, special care should be taken to place inter-connected parts as closely together as possible and to avoid long or closely coupled leads. Because of the high gain, complete shielding of the first two tubes is essential. The use of the new type metal shield, especially designed for use with the peculiar shaped envelope of the 57 tubes, is recommended.

In this design, use is made of one of the harmonics of the autodyne oscillator to provide, through a S.P.S.T. toggle switch, short-wave reception in addition to the regular broadcast reception. This part of the circuit is made up of the adjustable condenser C15, the inductance L4 and the switch SW.1 and should cover a band of from 90 to 200 meters.

An intermediate frequency of 262.5 kc. is used to avoid too many image repeats and the necessity of an additional tuned stage, which not only adds to the cost of the receiver, but also increases its size.

Properly built and adjusted, this "3-tube" receiver should have an overall sensitivity of approximately 10 microvolts absolute, and a band width of approximately 7 kilocycles at fifty times standard signal strength. The tone quality is

exceptionally good through the elimination of second harmonic distortion, this being accomplished through the use of the triple-twin output tube.

By careful assembly and the use of reliable and accurate parts, this radio set should compare favorably with ordinary receivers of six or more tubes. Inquiries, questions and comments on the set or design which may be forwarded to the author through this magazine will be welcomed and given prompt attention.

## Description of Apparatus

- One DeJur 2-gang type 3502 condenser, trimmers on short side, capacity increasing counter clockwise, shaft  $\frac{3}{8}$  x 1 inch long, low shields, C1, C2;
- One Crowe dial, numbers to run clockwise, for  $\frac{3}{8}$ -inch shaft with escutcheon plate;
- One speaker, 2,500-ohm field, transformer to match a single type 295 (4,000-ohm primary impedance);
- One socket marked "57";
- One socket marked "58";
- One socket marked "295";
- One socket marked "280";
- One Eby antenna-ground strip;
- One Carter power transformer 3562, P.T.;
- One Carter choke 4073 mounted on transformer shell, (10 hy. at 10 ma., resistance less than 200 ohms);
- One Meissner, 262 $\frac{1}{2}$  kc. output I.F. transformer with trimmer, I.F.T.2;

(Continued on page 121)

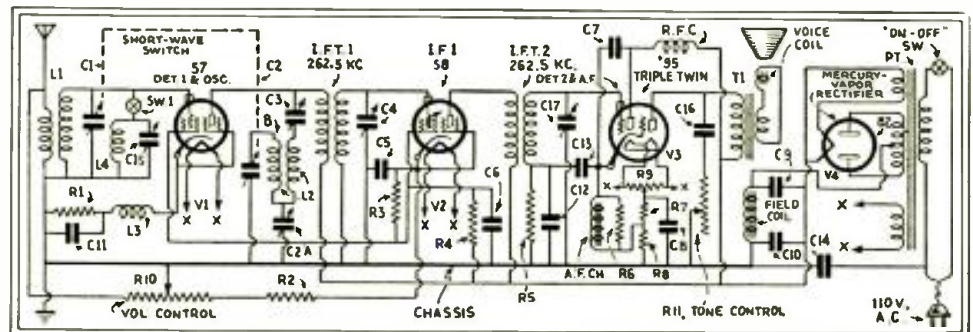

A complete schematic circuit of the "Autodyne Triplex." Observe the use of the combined oscillator-detector.

\* R. H. G. Mathews & Associates.



# A MOBILE P.A. SYSTEM

A mobile P.A. system, not installed in a truck but in a passenger car, and so arranged that the seating capacity is not reduced. It is completely described by the author in this interesting article.

By H. A. BLAIR

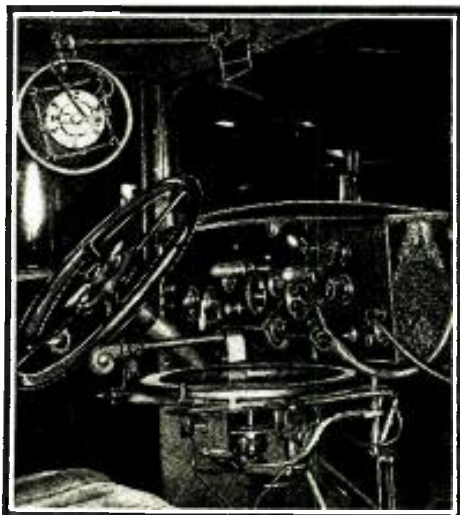

Fig. A

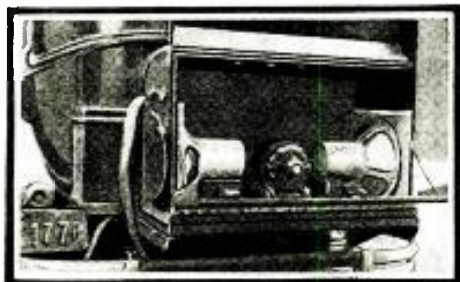

Fig. B

HERE is something new in a motorized sound amplification system. Through the application of advanced design and the utilization of waste space, the motor car sound system described and illustrated in this article does not interfere with the use of the car for other purposes. None of the passenger space is utilized, nor is the car cluttered up with loudspeakers and other equipment.

## Discussion of System

A traveling public address system of this kind offers numerous possibilities of profit to its owner. At election time, political candidates will use it for campaigning. At summer resorts, airports, church festivals, bazaars and other places where crowds gather, this sound system will be in demand; for it is inexpensive and easy to install.

The amplifier used is a special Blair Loftin-White two-stage job, using a single '24 screen-grid tube in the first stage and two '50-type tubes in push-pull in the output stage. Two '81 half-wave rectifier tubes are employed. It has 11½ watts output. The amplifier is mounted on a metal chassis, which is located below the instrument panel (dashboard) of the car at the right of the driver. It is bracketed to the floor board, standing on one end at an angle, out of the way of the passenger riding with the driver. Leads from the amplifier are brought from standard A.C. extension plug outlets which are screwed to the floor board. This method of construction permits the amplifier to be removed readily at any time. The amplifier is energized by means of a 110-volt alternating current system, described later.

A phonograph and microphone mixer is fastened on the dashboard at the right, as shown in Fig. A. This device is extremely compact. It contains a combination switch and microphone gain control; a phonograph gain control; a small toggle switch for changing over from pho-

nograph to microphone or vice versa and a starting switch, mounted on one side, for switching the battery current "on" or "off." There is also a compartment within the mixer for two small 1½-volt dry cells for microphone current supply. An efficient phonograph scratch filter is also built into the mixer box. All leads are brought to external binding posts, permitting easy checking when trouble shooting.

A standard G.E. induction motor is mounted beneath the phonograph turntable. This complete unit is mounted on a special metal plate which slides on  
(Continued on page 111)

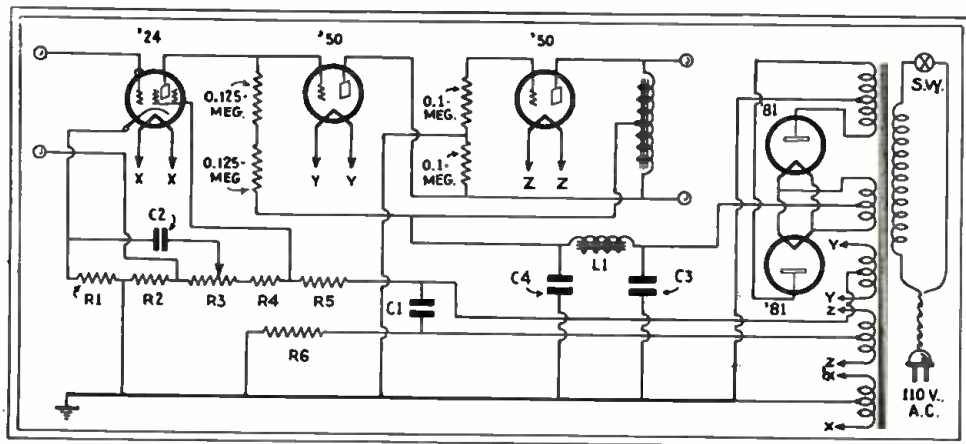

Fig. 1

Schematic circuit of the Loftin-White two-stage amplifier used by Mr. Blair.

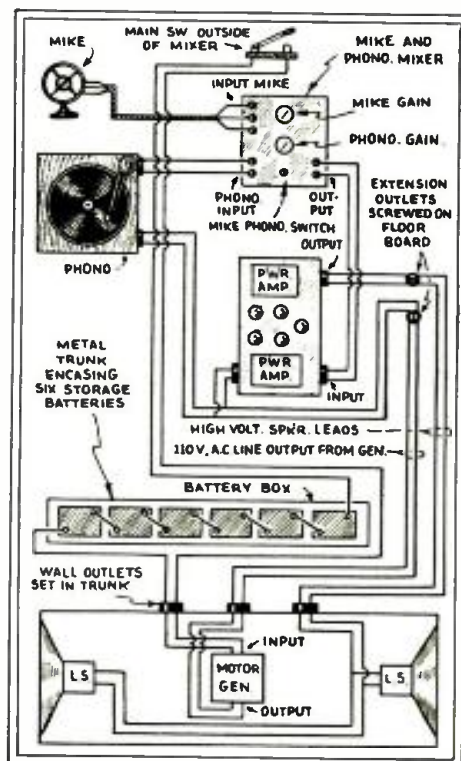

Fig. 2

Block diagram of the P.A. system.

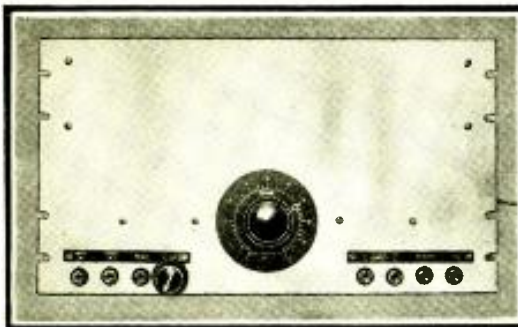

Fig. A  
A typical commercial mixer panel.

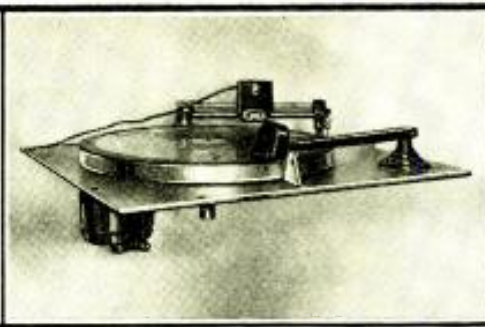

Fig. B  
A commercial recording turntable.

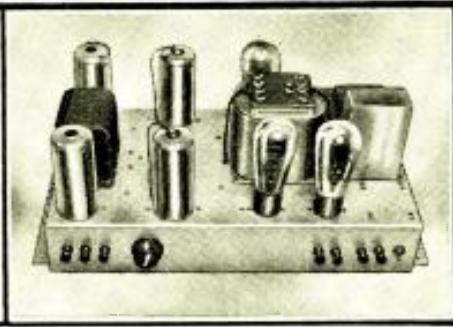

Fig. C  
An amplifier suitable for recording.

# SOUND RECORDING AT 33- $\frac{1}{3}$ R.P.M.

By GEORGE J. SALIBA, S.B.

RECENTLY, a great deal of experimental work has been done in instantaneous recording on 33- $\frac{1}{3}$  R.P.M. or *slow speed* records. These slow speed records have many practical applications, especially in the recording of radio programs, and a number of radio stations are now using this method.

In the past, the station had no comeback if the sponsor claimed that his program was not put over as agreed upon, but now, the station takes the recorded program from its files, plays it back and so settles the disagreement.

## Comparative Playing Time

Commercial types of sound recording equipment now available to the home recordist and designed for 33- $\frac{1}{3}$  R.P.M. operation are illustrated in Figs. A, B and C.

One 16-inch, 33- $\frac{1}{3}$  R.P.M. disc plays for 15 minutes; it contains a half hour's program if both sides are used. This long playing time appeals to those artists who keep their own files. Heretofore, it has been the custom to use 12-inch, 78 R.P.M. records, but since these play for only four minutes, three of them are required for a fifteen minute program. Continuity is maintained by fading from one record to another, and often this fading is necessary at a vital part of the program much to the chagrin of the artist. The 16-inch record overcomes this objection.

Recording at 33- $\frac{1}{3}$  R.P.M. entails more problems than at 78 R.P.M. In Table I are given the tangential velocities of 78 R.P.M. and 33- $\frac{1}{3}$  R.P.M. records.

TABLE I

Location of Groove	Tang. Velocity—Ins. per Sec.	
	(78 R.P.M.)	(33- $\frac{1}{3}$ R.P.M.)
Inside .....	16.25	13.5
Middle .....	31.5	20.5
Outside .....	46.5	27.5

Since the needle speed is much lower on the slower speed records, the recording and reproducing problems are increased; consequently, as the speed of the needle is lower, the track available for recording will be shorter. It is difficult to make good recordings on the inside of the record because of decreased velocity. This is especially true in reproducing high frequency modulations; for the lower the frequency, the greater will be the amplitude—the frequency varying in inverse proportion to the amplitude. Therefore, high frequencies are recorded with very little amplitude, but this small amplitude represents considerable energy, and no difficulty is experienced in reproducing these modulations if the needle is sharp.

When a needle is new, it does its best work, and for this reason the 33- $\frac{1}{3}$  R.P.M. records are always started from the inside. The diameter of the inside or starting groove should not be less than 7 $\frac{1}{2}$  inches; a smaller diameter would be detrimental to good quality.

## Position of Pickup

The proper placing of the pickup is also very important to good reproduction. Heretofore in 78 R.P.M. recording, it has been the custom to place the pickup so that the needle hits the exact center of the turntable. Because of the comparatively short radius of the record, this is considered the correct position, but for 16-inch records, *this rule does not hold*.

In recording, the cutting-head is guided in a straight line across the face of the record. Obviously, the correct way to reproduce such a record is to have the reproducer travel straight across the face of the record. This would necessitate the use of a feed screw, which is not practicable for commercial purposes. In the placing of the 78 R.P.M. pickup so that the needle hits the center of the turntable, straight-line reproduction is approximated because the arc obtained is almost equal to its chord. If we now take a 16-inch record and place the pickup in the same location, we note that from the start to the end, the arc described has a comparatively short radius and therefore is not equal to the chord, i.e., the plane of the

(Continued on page 112)

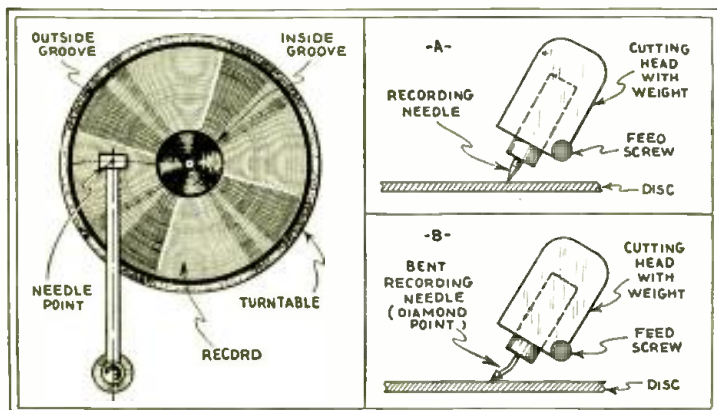

Fig. 1, left. Arrangement of record on a turntable.  
Fig. 2, right. Two types of recording needles.



# USING THE V. T. VOLT METER

The third of a series dealing with the use of the vacuum-tube voltmeter, described in the February issue of RADIO-CRAFT.

By BERYL B. BRYANT

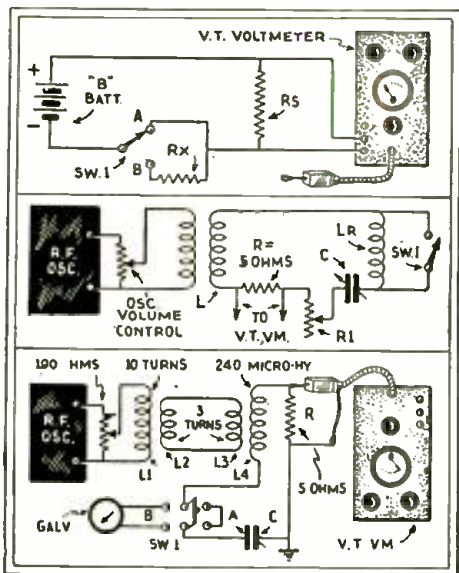

Fig. 1, above. Fig. 2, center. Fig. 3, below.

**R**ESISTORS of all sizes may be measured by the use of the setup given in Fig. 1. If desired, a permanent setup as an ohmmeter may be made; the accuracy of measurement is very close to that obtainable by the Wheatstone Bridge method. Should the experimenter desire a permanent setup as an ohmmeter, the scale of the V.T. voltmeter indicating meter may be calibrated. (See February issue of RADIO-CRAFT for a description of the voltmeter.—Editor.)

The procedure of measurement is to insert the resistor to be measured at RX. With SW. 1 placed on point "A," the voltage drop across the resistor RS is determined. Resistor RS may be of any value, although the lower its value, the lower the resistance that may be measured. It is recommended that two values one of 100 and a second of 10,000 ohms be used in order to have an ohmmeter reading from a low range to several thousand ohms.

After the voltage drop across RS, with the switch in position "A," has been determined, S.W.1 is thrown to position "B" and the voltage drop again measured. With the voltage drop measured across RS with the switch in position "A" known as Es, and the voltage drop across RS with the switch in position "B" known as Er, the value of the unknown resistance may be determined from the following formula:

$$\text{Resistance in ohms} = \frac{E_s - E_r}{E_r} \times R_S$$

### Coil Resistance Measurement

It is sometimes necessary that the engineer know the resistance of an R.F. inductance. This is especially necessary in modern receiver design because the value of the inductance may be decreased; it is also desirable to know the power factor of a coil when it is enclosed within its shield.

The setup given in Fig. 2, provides a

means whereby the operator may determine the resistance and then the power factor of a coil very quickly. The pickup coil L should have an inductance of approximately one-half that of the coil to be measured. The resistor R has a value of 5 ohms. The variable resistor R1 should have a range of 0 to 2,000 ohms and should be non-inductive. The condenser C should be of the precision type in which the change of resistance for capacity variations is a minimum, although any other variable condenser may be used and its resistance measured for particular capacity settings.

The circuit is tuned to resonance with the R.F. oscillator. The variable resistor R1 should be set at its zero position. The reading of the V.T. voltmeter when connected across the resistor R is noted. The S.P.S.T. switch across Lr is then closed. The circuit is now returned to resonance. Care should be taken that the deflection of the V.T. voltmeter microammeter is not off-scale, as otherwise the meter will be damaged. The resistor R1 is adjusted until the same V.T. voltmeter reading is obtained as before closing S.W.1. The resistance setting of R1 will now be the resistance of the coil at the particular frequency employed. If the resistor R1 is of the decade calibrated type, it will not be necessary to measure the resistance to determine the correct value.

In order to determine the power factor of the coil, its inductive reactance is determined by the formula:

$$X_L = 6.28 \times F \times L$$

Where  $X_L$  is inductive reactance in ohms; F the frequency in cycles per second, and L is the inductance in henries. Having determined the reactance of the coil, the power factor may be determined from the formula:

$$\text{P.F.} = \frac{R}{X_L}$$

where P.F. is the power factor, R the resistance of the coil, and  $X_L$  is the in-

ductive reactance of the coil.

The decrement of the coil in a circuit may be determined from the formula:

$$\text{Logarithmic decrement} = 3.1416 \times R \sqrt{\frac{C}{L}}$$

where R is the R.F. resistance of the circuit, C is the capacity in microfarads and L is inductance in microhenries.

### Measuring the Inductance of Thermo-Galvanometers

The setup for the measurement of inductance of thermo-galvanometers is given in Fig. 3. L1, the radiating coil of the oscillator, should consist of 10 turns of wire on any convenient diameter tube; L2 and L3 are 3-turn pickup coils in a link circuit, L4 may be a standard broadcast inductance of 240 microhenries; the variable R should be a non-inductive 5-ohm resistor, across which is measured the voltage drop of the circuit for resonance indication.

The procedure of measurement is to first set the condenser C at approximately half its capacity; the frequency of the oscillator is brought into resonance with the circuit; the D.P.D.T. switch S.W. 1 should be in the "A" position. The accuracy of the measurement will depend upon the care in obtaining the maximum resonance indication on the V.T. voltmeter.

When the maximum resonance has been obtained, the capacity of the condenser C is determined. (If possible, the condenser should previously have been calibrated.) The thermo-galvanometer is now placed in the circuit by setting the switch to the "B" position. The circuit is again brought into resonance with the condenser C, and its capacity determined.

The inductance in microhenries of the thermo-galvanometer may be determined by subtracting the inductance of the circuit without the meter from the inductance of the circuit with the meter; the inductance being computed.

# HOW TO MAKE AND CALIBRATE AN I.F.-R.F. OSCILLATOR

Because the service oscillator is of such vital importance in radio work, the author has consented to build and describe this compact and much-needed device. Details of construction and calibration without the aid of external oscillators are included.

By CLYDE J. FITCH

VARIOUS commercial oscillators have been described in the pages of this magazine, but until now no complete constructional details of an oscillator that can be built and calibrated by the average Service-Man have been described. The oscillator described here was designed, built and calibrated so that exact data could be given in answer to the many requests from our readers.

To expedite servicing, the instrument was made as simple and compact as possible; a simple oscillating circuit was used employing a type '30 tube operated by dry cells. No attempt was made to design the instrument for line-voltage operation; the tube draws so little current that small-size batteries will run it for a long time. Furthermore, calibration is simplified and more accurate. Tip-jack connectors, mounted on the panel, provide ready means for measuring filament and plate voltages with an external voltmeter, so that a check on the condition of the batteries can be quickly made. Once calibrated with fresh batteries, it is important for maintaining accuracy that the voltages remain practically constant.

The fundamental oscillator circuit is designed to cover nearly all the I.F. frequencies used in commercial superheterodynes. The circuit is self-modulated at an audio frequency by means of a grid condenser and grid-leak of the proper values. This produces rich harmonics of higher frequencies that are used to cover the broadcast range as well as some of the higher intermediate frequencies.

The instrument is calibrated by comparing it with an accurately calibrated radio receiver. Any good receiver can be used, calibrated by tuning-in broadcast stations of known frequencies.

## Construction of the Oscillator

The first procedure is to select the parts necessary for the complete instrument. While other makes of parts than those used in this oscillator may be employed it is recommended that the parts

specified should be as closely adhered to as possible.

## List of Parts

- 1—Blan, new type shield 10 x 6 x 5 inches deep;
- 1—National, .0005-mf. variable condenser, type EC;
- 1—National, precision dial, type M;
- 1—Clarostat, 3,000-ohm volume control, type P185;
- 1—Aerovox, .0005-mf. fixed condenser;
- 1—Durham, 1¼-megohm pig-tail grid leak;
- 1—Benjamin, four-prong cushion socket;
- 1—Filament switch;
- 4—Tip-jack connectors;
- 2—Ely binding posts;
- 2—Small Burgess 1½-volt dry cells, 4 x 1¾ inches;
- 1—Small Burgess 22½-volt "B" battery;
- 1—Type '30 vacuum tube;
- 1—15-ohm fixed resistor;
- 1—Bakelite tube 2 inches in dia., 4 inches long;
- ¼ lb. No. 30 D.C.C. magnet wire.

The aluminum shield box is of a new type with rugged corner posts that makes an excellent case for an instrument of this kind. Any of the sides can be quickly

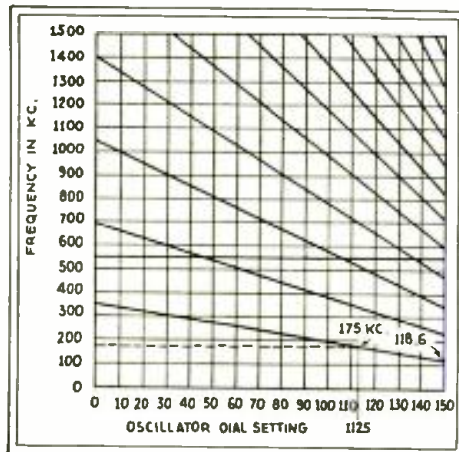

Fig. 5

Calibration curve of the oscillator. Each line is a harmonic of the one below it; in this manner both the I.F. and R.F. ranges are covered with one coil and one dial.

removed for replacing batteries or for other purposes. In the instrument illustrated, a bakelite-cloth covering was placed over the front panel for the sake of appearance. We recommend, however, that the panel be sprayed a dull black.

The tuning condenser is of the straight-line-frequency type; it proved its value when the oscillator was calibrated as the calibration curves obtained were virtually straight lines.

## Construction of Coil

The coil used in this oscillator was purposely wound by hand so that it could be duplicated by anyone; otherwise the builder might be handicapped by difficulty in obtaining a commercial coil if such a coil were specified.

The coil was first calculated by using well-known inductance formulas so that the circuit would tune to approximately 100 kc. with the condenser set at maximum or .0005-mf. From these calculations the coil illustrated in Fig. 1 was made. It has approximately 400 turns of No. 30 D.C.C. wire (the exact number

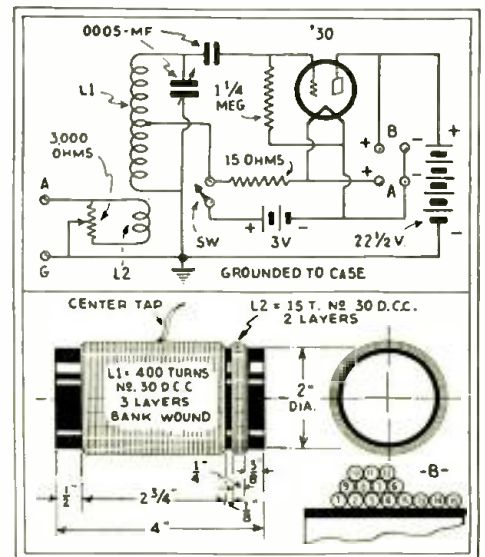
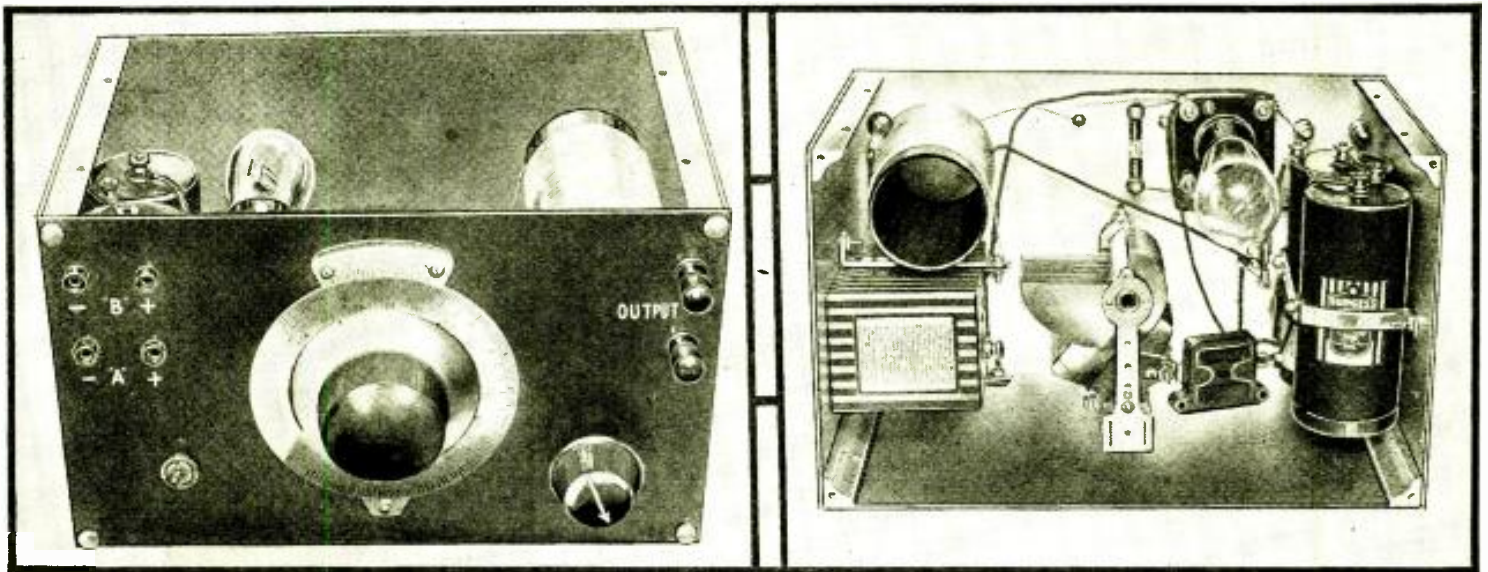

Fig. 3. above. Schematic circuit of this simple and efficient unit.

Fig. 1. below. Winding details of the coil used in the oscillator.





Left, the front and right, the internal view of the all-range oscillator. Its utter simplicity is only too apparent.

of turns is not important). The center tap was made at the approximate center of the winding after the coil was wound.

The wire was bank-wound in three layers. The manner of winding, which was found to be the simplest and best suited to this purpose, is illustrated in Fig. 1B. The turns are numbered in this sketch in the sequence in which they were wound; the process is continued in the same manner until the winding is complete.

The pick-up coil connected to the output posts consists of 15 turns of the same size wire. Both coils should be impregnated with boiling paraffine.

After the coil was finished and the circuit calibrated the lowest frequency which could be generated with the condenser set at maximum was 118.6 kc. Shielding, no doubt, caused the effect of a loss of inductance, which accounts for the higher frequency of the circuit than that on which the calculations were

based. Since the lowest I.F. used in commercial supers is about 130 kc., the range covered by this instrument is ample and the coil was left as originally wound.

#### Assembling the Apparatus

Figure 2 shows the drilling layout of the panel. The panel is 10 x 6 inches and the tuning condenser shaft passes directly through the center; templates for condenser and dial drilling are furnished with the instrument; the locations of the other parts are clearly indicated; the socket and the coil are mounted on the rear of the panel. The tip-jacks should be of the insulated type as they should not be in contact with the panel. One of the output posts is also insulated from the panel with bakelite washers; the other one is grounded.

The two dry cells are clamped to the left end of the case with standard brass angles and strips supplied by radio stores. The "B" battery is similarly clamped to the right end plate.

Figure 3 shows the complete wiring diagram. It will be noted that the negative terminal of the "B" battery is grounded to the case. The center terminal of the volume-control and the rotor plates of the condenser are also grounded. The values of the parts are clearly indicated on the diagram and agree with those called for in the list of parts. A study of the photographic illustrations will show more clearly how the apparatus is assembled.

the insulated output post of the oscillator to the aerial post of the receiver and connect the other post to the ground of the receiver. By switching on the oscillator, a series of harmonics may be heard by turning either the oscillator dial or the broadcast receiver dial. We are now prepared to make a very accurate set of calibration curves of the oscillator, after which the calibration can be further checked by heterodyning with crystal-controlled broadcast station waves.

The first step is to set the oscillator dial at its maximum or 150. Then tune in a harmonic of the oscillator at the highest dial setting heard on the broadcast receiver. Turn the volume-control of the oscillator until the harmonic signal is very weak and an accurate dial reading of the receiver is obtained. On this particular set a harmonic was heard at 87 on the receiver dial. This indicated, from Fig. 4, a frequency of 593 kc.

Now slowly decrease the tuning dial settings of the broadcast receiver (leaving the oscillator setting as it was) until another harmonic is heard. In this case one was heard at 70 on the receiver dial and from Fig. 4 indicated a frequency of 711.5 kc. The former figure subtracted from the latter, or 711.5 minus 593, equals 118.5. This is the fundamental frequency of the oscillator because each harmonic differs from adjacent ones by an amount equal to the fundamental.

We can check the accuracy by dividing 593 by 118.5, which gives 5 and a slight amount over indicating that our readings were not exact. Evidently we were working on the 5th and 6th harmonics. Dividing 593 by 5 gives 118.6 as the fundamental. Six times 118.6 would give a frequency of 711.6 for the 6th harmonic instead of 711.5, which was obtained from the curve.

Knowing that the fundamental frequency is 118.6 at the 150 degree setting of the oscillator dial, we can mark off on the calibration chart (Fig. 5) harmonics up to the 12th, spaced 118.6 kc. apart.

(Continued on page 121)

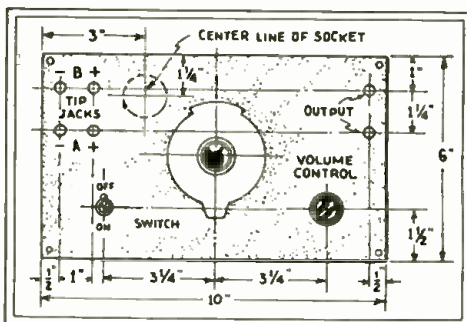

Fig. 2. Complete panel details.

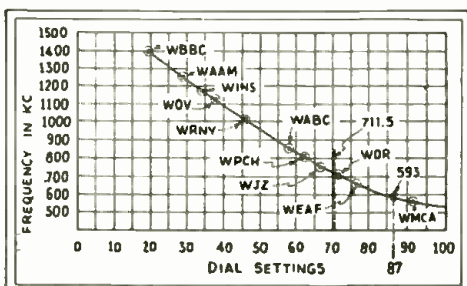

Fig. 4. Calibration curve of the broadcast receiver used by Mr. Fitch.

#### Calibrating the Oscillator

By tuning-in various broadcast stations on a standard receiver of good design, accurate frequencies are available, especially from quartz crystal-controlled broadcast stations; these are used for calibrating the oscillator. The simplest procedure is to first plot an accurate calibration curve of the broadcast receiver. Such a curve is illustrated in Fig. 4. Frequency in kilocycles is plotted against tuning dial settings.

The next step is to disconnect the aerial from the broadcast receiver and connect

# A COMPACT OHM-- AND OUTPUT METER

By JACK GRAND

THE ohm- and output meter described in this article is primarily meant for the Service Man who owns a good set tester and yet wants the improved features of the later types that he may not be able to afford at present.

The ohm- and output meter illustrated is a combination of instruments used to indicate resistance and A.C. output voltage on the same meter. This is accomplished by means of a copper-oxide rectifier and a 3-pole, 6-throw switch. This meter can be built at a nominal cost as all parts are standard and are easily obtained.

Some practical uses for this instrument are as follows: As an ohmmeter, it has three convenient ranges: 0-1,000, 0-10,000 and 0-100,000 ohms, and is used to find unknown values of resistors; for continuity testing; checking balanced conditions of tapped transformers; opens; shorts, etc.

The output-meter has three ranges as follows: 0-1, 0-10 and 0-100 volts A.C. It is used in conjunction with oscillators for aligning condensers and I.F. coils, for locating hum, level indicators, etc.

The parts used for the ohmmeter are a 100-ma. shunt for the 0-1,000-ohm range; (this range should be used as little as possible as the drain is quite heavy); a 10-ma. shunt for the 0-10,000-ohm range; and a 4,000-ohm resistor for the 100,000-ohm range.

By clever use of the 3-pole 6-throw switch the 1,000-ohm variable resistor is used to compensate for high or low battery variations on all ohmmeter ranges.

On the 0-1,000-ohm range, with the switch in position, a 50-ohm fixed-resistor is automatically placed in parallel with the 1,000-ohm variable resistor, serving a two-fold purpose—it will bypass current from the variable resistor as well as change its range to less than 50 ohms.

This low range is required to get full-scale deflection with a  $4\frac{1}{2}$ -volt battery. With the switch in position for 0-10,000 ohms, only the 1,000-ohm variable resistor is in series with the meter. In this manner 450 ohms is obtained for full-scale deflection with  $4\frac{1}{2}$  volts applied. With the switch in position for 0-100,000 ohms, the 4,000-ohm resistor is automatically placed in series with the 1,000 ohm variable resistor thus obtaining 4,500 ohms for full-scale deflection with the  $4\frac{1}{2}$ -volt battery.

All resistance readings are in multiples of 10. The scale on the meter is cali-

brated to 100,000 ohms. All that is necessary when using the 10,000-ohm scale is to leave one cipher off the indicated figures on the 100,000-ohm scale, i.e., when the reading of the scale shows 1,000 ohms, leaving a cipher off the end figure, gives us a value of 100 ohms. On the 1,000-ohm scale, two ciphers are left off for obtaining correct values.

For the output-meter ranges great care must be exercised in connecting the rectifier. The polarity must be correct and the D.C. side of the rectifier must go to the meter, otherwise—"it is just too bad."

The resistance of the rectifier at full-scale deflection of 1 ma. is about 460 ohms; therefore, a 500-ohm resistor is placed in series with the rectifier to get a 1-volt A.C. reading; on the 10-volt scale a 10,000 ohm resistor is connected in series and on the 100-volt range 100,000 ohms is used.

## The Parts

Standard stock-type resistors of good makes may be used. The 1,000 ohm variable resistor will compensate for resistance error and also for high and low battery voltage. The A.C. voltages are only approximate. If greater accuracy is required, precision-type resistors are recommended. (A rectifier calibration-curve is shown on page 656, May, 1932 issue of RADIO-CRAFT.) By the use of a switch with more poles, additional voltage ranges can be added.

The ohm- and output meter can be built in a small compact unit with self-contained battery as shown in the photographs. There are only a few wires and they can be neatly arranged. Heavy spaghetti covered bus-bar is recommended in connecting the shunts as fine wire has a high resistance and will introduce errors in the readings.

The entire unit can be mounted in a box  $4\frac{1}{2}$  x  $6\frac{1}{4}$  inches; the depth of the box is dependent on whether the builder desires to have the battery in or out of the box. If the battery is not wanted in the box it must be connected in series with one of the test leads and either of the ohm tip-jacks.

The list of parts used are as follows:  
 One Weston 301, 0-1-ma. meter;  
 One Tanrex rectifier, RX;  
 One Van 100-ma. shunt, R1;  
 One Van 10-ma. shunt, R2;  
 One Clarostat 50-ohm fixed-resistor, R4;  
 One ElectroRad resistor, type R1, 1000 ohms, R5;  
 One Lynch 4,000-ohm resistor, 1 watt, R3;  
 One Lynch 500-ohm resistor, 1 watt, R6;

(Continued on page 112)



Fig. A  
Front view.

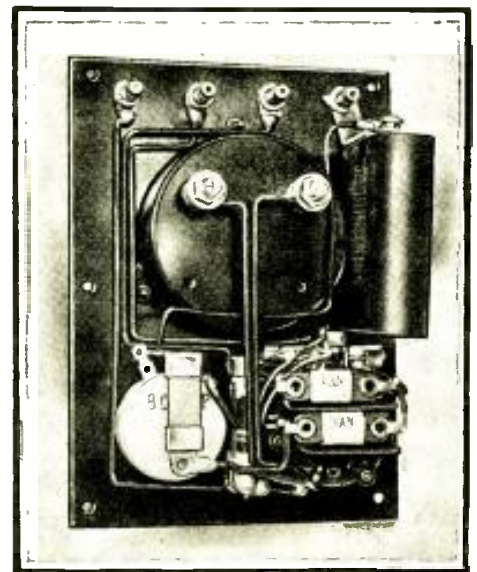

Fig. B  
Interior view showing connections.

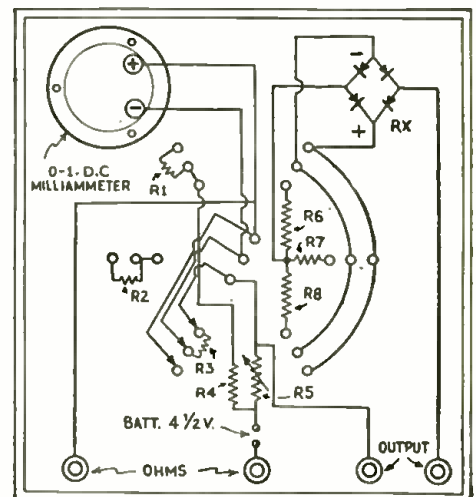
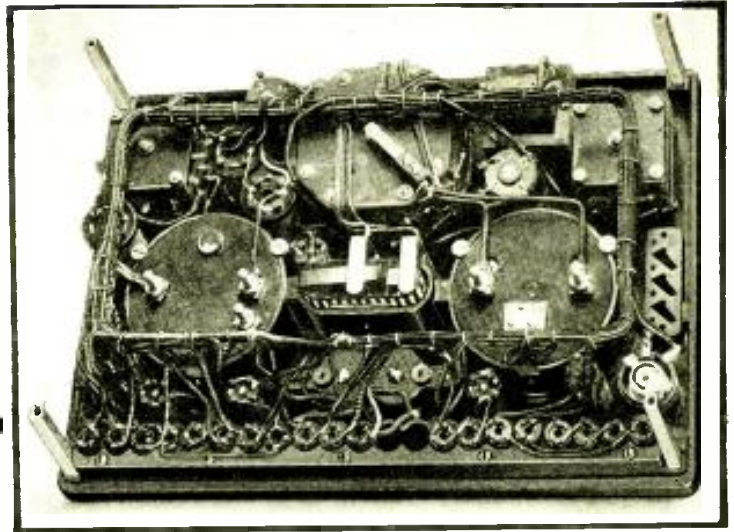

Fig. 1  
Schematic circuit.



In a series of articles of which this is the second, the author describes the circuit arrangement used.



Photograph of the internal wiring of the Jewell 444 analyzer.

# HOW TO USE A SET ANALYZER

By F. L. SPRAYBERRY

In the July issue of this publication the fundamental connections underlying the principle of operation of all set analyzers were described. In this installment we will discuss the actual switching arrangements used in a typical analyzer.

To enable you to understand how meters are connected to the circuits of four- and five-prong tubes in the Jewell 444, see Fig. 3, which shows the terminal designations for a four- and five-hole socket. The grid is indicated as "G," the plate as "P," the filament as "H" for negative and "H1" for positive, and the cathode as "K." These terminal designations are followed throughout in this analyzer.

The master selector switch is arranged for these designations, therefore, if you will keep these letters in mind you will always know how the meter is connected to the circuits.

## Master Selector Switch

There are twenty-two positions for the master selector switch including the "off" position. Counting from left to right beginning at the bottom, the first position is marked "R-C" meaning Resistance-Continuity (the function of this will be described later); No. 2 is "H-H-12V.," signifying that the D.C. voltmeter is connected across the filament circuit using the 12-volt scale; No. 3 is "K-H-60V" meaning that the voltmeter is connected between cathode and heater using the 60-volt scale; No. 4 is "K-H-300V.," meaning the voltmeter is between heater and cathode using the 300-volt scale; No. 5 is "K-12 MA.," meaning the milliammeter is in series with the cathode circuit using

the 12-ma. scale; No. 6 is "G-H-30V.," meaning the voltmeter is between grid and filament using the 30-volt scale; No. 7 is "P-H-300V.," meaning the 300-volt scale is between plate and filament; No. 8 is "G-K-12V.," meaning the 12-volt scale is between grid and cathode; No. 9 is "G-K-60V.," connected as No. 8 except that the 60-volt scale is used; No. 10 is "G-K-120V.," and is the same as Nos. 8 and 9 using the 120-volt scale; No. 11 is "G-12 MA" meaning the 12-ma. scale is in series with the grid circuit; No. 12 is "CG-K-6V" meaning the 12-volt scale is be-

(Continued on page 125)

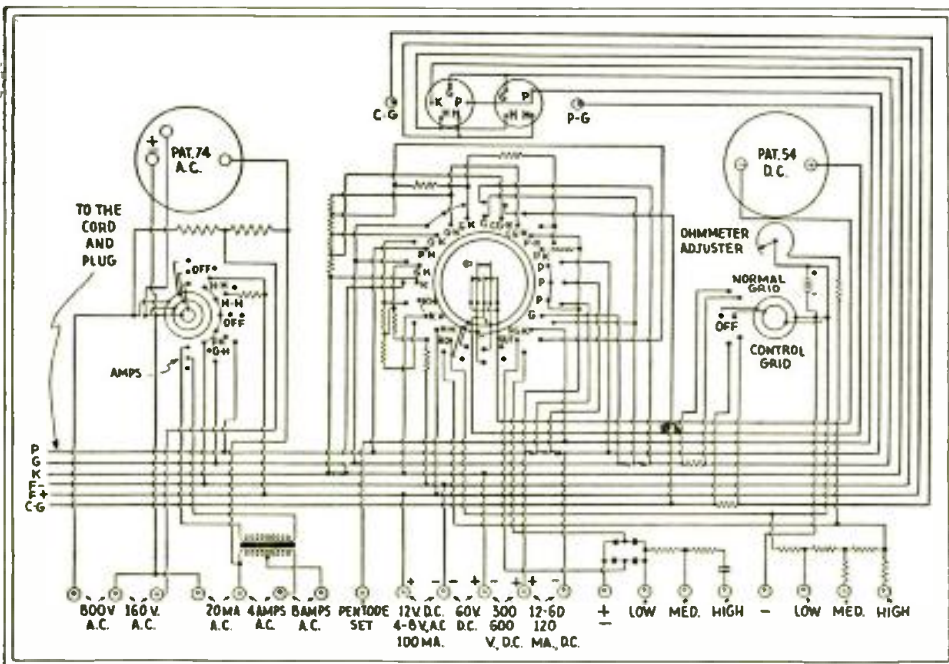

Complete schematic circuit of the Jewell 444 set analyzer. The numbers on the rotary switch correspond to those discussed by the author. In reality, they refer to those circuits in which the meter is connected for a given measurement; for instance, with the switch set on the "G-K" terminal, the meter is connected between the grid and cathode of the tube. The three "G-K" points correspond to three different scales on the meter.

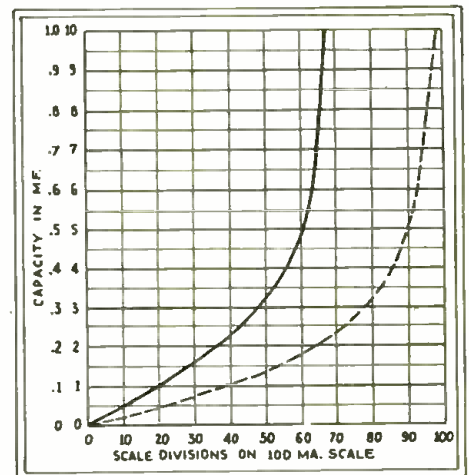

This instrument may also be used as a capacity meter. The solid line corresponds to the low range, and the dotted line to the high range.

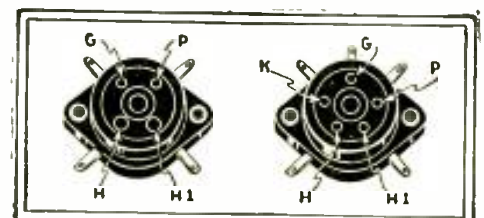

Fig. 3

# I EQUALS E OVER R

By C. W. PALMER

The fact that current flow in an electrical circuit depends upon voltage and resistance means nothing unless one can visualize what is actually going on. In this extremely novel presentation, the author shows not only "how" but "why."

PEOPLE not familiar with electricity have the idea that little is known about this subject. This assumption is incorrect, as probably more is known about this science than about any other. Because mechanical motions and forces can be seen and felt, it is easy for the average person to understand and foretell their actions and the results ensuing. For example, few people would question the result of striking a piece of wood with the sharp edge of an axe or dropping an egg on a concrete floor; but when the problem is to visualize what is taking place in an electrical circuit, they are entirely at "sea."

If we remember that we cannot see or hear electricity directly, but can only observe its effects, the study of electricity—and its companion radio—will be much simplified.

Electricity (according to the electron theory) consists of extremely small moving particles, these particles have been named *electrons* and *protons*. These electrons and protons do not carry electricity, as some people think, *they constitute electricity*. In other words, an electron or proton is nothing but a small quantity of electricity. Electrons and protons are separated because they act differently; the electron is said to be a negative charge while the proton is a positive charge.

The average person usually believes an electron to be a very small particle of matter; beyond this elementary conception his ideas are vague and usually confused.

Let us first consider "Matter." Matter is any substance having weight and volume—the air, the earth, the water, are all forms of matter.

## The Atomic Structure

Consider a bar of copper (an element) as shown in Fig. 1. This bar shows certain peculiarities which identify it as copper, and even a very small piece, such as B of Fig. 1, cut from this bar will be characteristic of the whole piece. If it were possible to keep cutting down the size of the piece of copper, we would arrive at a point where a further cut would result in changing its characteristics, and it would no longer be identified

as the same material as the whole. This particle containing all the peculiarities of the whole piece is called a molecule of the element.

Since the molecule has the same characteristics as the whole, it, too, must be subdivided if we are to discriminate between one substance and another. Now, since all substances have different constituents, their molecules must be different, and science has been able to break down the molecule into still smaller particles called *atoms*. An atom of hydrogen is different from an atom of helium; an atom of copper is different from an atom of zinc, etc. Atoms cannot exist by themselves in a normal state—at least two

atoms must be combined to form a molecule.

The atoms of every substance, regardless of its nature, are composed of *electrons*. This means that all substances contain electricity, which seems contradictory to our general knowledge, although it is apparently true as we shall soon see.

In its normal state, an atom contains a certain number of electrons and protons arranged in a particular manner. Each substance has a different combination and grouping of the charges. Hydrogen, for example, the lightest substance known, contains only one electron revolving

(Continued on page 118)

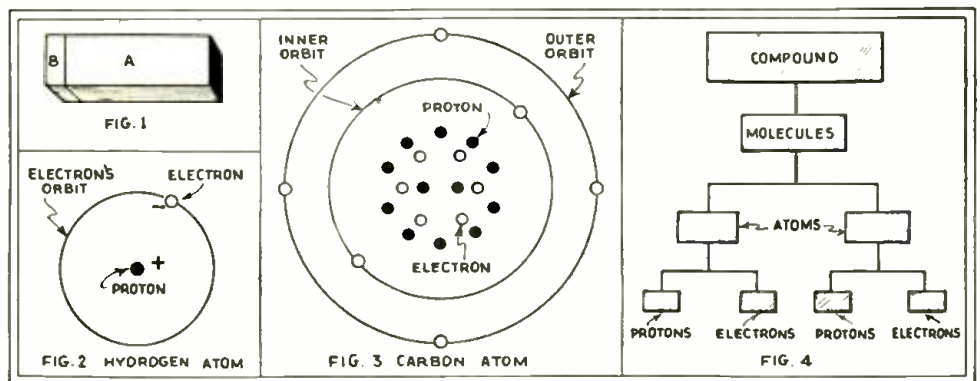

A molecule of a substance, say at B Fig. 1, is composed of positive and negative electrons such as illustrated at Fig. 2 or Fig. 3. Fig. 4 illustrates the logical sequence used in breaking down the substance.

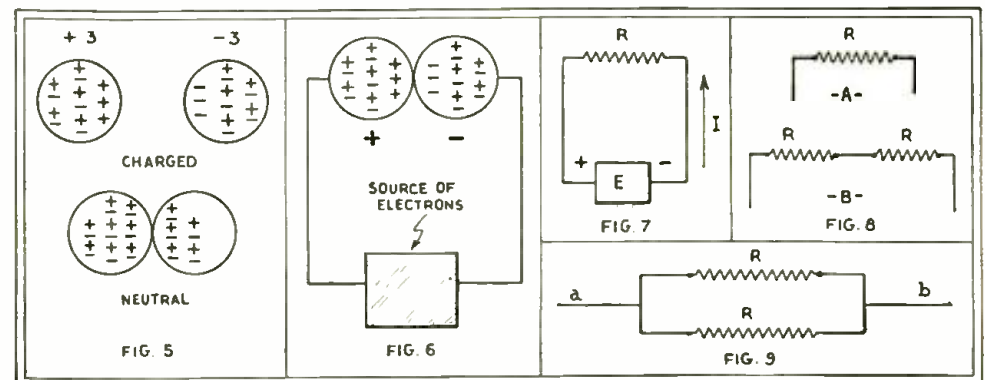

The uncharged, separated molecules in Fig. 5 cause a flow of current as shown in the lower part of the same figure when touched. This flow ceases in a very short time, but may be caused to flow for a longer time by the application of an E.M.F. as shown in Fig. 6.



# THE THEORY AND CONSTRUCTION OF ATTENUATORS AND LINE FILTERS

By HY LEVY

In the May and June issues of this publication, there was described the theory and operation of impedance matching. In this discussion, final calculations for "H"- and "T"-type pads are submitted by the author.

WE can now proceed with the design of an H-type pad to give us the desired 20 decibel loss as determined in our own problem under consideration. Assume we did not have Table 3 from which the values of  $Z_1$  and  $Z_2$  may be obtained, but that we wish to calculate our own values of  $Z_1$  and  $Z_2$  for the pad. To determine the constants of the pad, it is necessary to know the working formulas for an H-type network. The working formulas will not be derived in these papers, but it can be shown that the formulas for H-type networks are as follows:

$$\begin{aligned} \text{"Z}_1\text{" the series element} &= \frac{Z_0 (A - 1)}{2 (A + 1)} \quad (1) \\ \text{"Z}_2\text{" the shunt element} &= \frac{2 Z_0 A}{A^2 - 1} \quad (2) \\ \text{"Z}_0\text{" the characteristic impedance} &= \frac{2 \sqrt{Z_1 (Z_2 + Z_1)}}{A} \quad (3) \end{aligned}$$

### Examples of Design

We may now proceed with the application of these formulas to the design of the H-type pad to give us the desired 20 decibel loss as previously determined in our own problem under discussion.

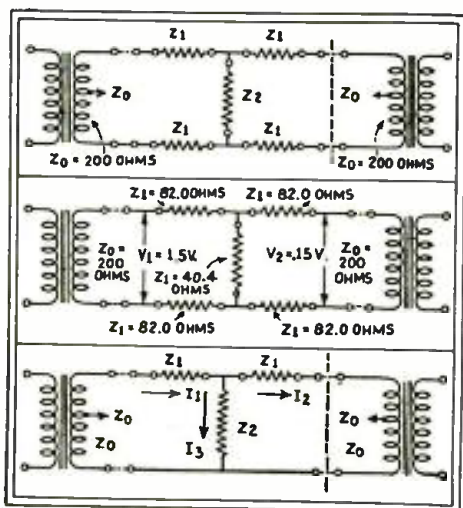

Fig. 10, above. H-type pad working between two 200-ohm impedances.  
Fig. 11, center. A completed H-type pad causing a 20 db. loss.  
Fig. 12, below. A typical T-type network.

TABLE 4

Decibels change	$\log \frac{V_1}{V_2}$ OR $\frac{I_1}{I_2}$	$\frac{V_1}{V_2}$ OR $\frac{I_1}{I_2}$	$Z_0 = 200$ Ohms		$Z_0 = 500$ Ohms		$Z_0 = 600$ Ohms	
			$Z_1$ Ohms	$Z_2$ Ohms	$Z_1$ Ohms	$Z_2$ Ohms	$Z_1$ Ohms	$Z_2$ Ohms
1	.05	1.12	11.5	1760	29	4400	34	5280
2	.10	1.26	23.0	858	58	2150	69	2574
3	.15	1.41	34.0	571	86	1428	102	1714
4	.20	1.58	45.0	422	113	1056	136	1266
5	.25	1.78	56.0	328	140	820	169	984
10	.50	3.16	104.0	140.6	259	361.8	312	422
20	1.0	10.0	164.0	40.4	410	101	492	181.4
30	1.5	31.6	190.0	13.5	476	35.8	570	40.5
40	2.0	100.0	198.0	2.0	495	5.0	590	6.0
50	2.8	316.0	200.0	1.3	500	3.2	600	3.8

Given: To design a 20 decibel pad to work between two 200-ohm impedances. (See Fig. 10.)

From Table 3, the value of "A," (see Fig. 9) the amplification constant, can be determined. The amplification constant  $V_1$  at 20 decibels is given as 10.

Therefore "A" is equal to 10. "Z<sub>0</sub>" is equal to 200 ohms (given).

Then "Z<sub>1</sub>" the series element from equation (1) is

$$\begin{aligned} Z_1 &= \frac{Z_0 (A - 1)}{2 (A + 1)} \\ Z_1 &= \frac{200 (10 - 1)}{2 (10 + 1)} \\ Z_1 &= 100 \left( \frac{9}{11} \right) \end{aligned}$$

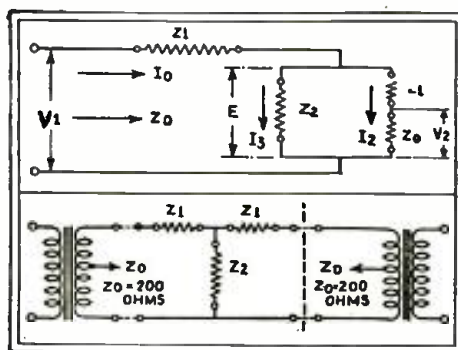

Fig. 13, above. Equivalent circuit of Fig. 12.  
Fig. 14, below. A T-type network working between two 200-ohm impedances.

$Z_1 = 100 \times .82$   
 $Z_1 = 82.0$  ohms  
and "Z<sub>2</sub>" the shunt element from equation (2).

$$\begin{aligned} Z_2 &= \frac{2 Z_0 A}{A^2 - 1} \\ Z_2 &= \frac{2 \times 200 \times 10}{10^2 - 1} \\ Z_2 &= \frac{4000}{99} \\ Z_2 &= 40.4 \text{ ohms.} \end{aligned}$$

The completed network will look as shown in Fig. 11. As shown in this figure, the H-type pad having the series element equal to 82.0 ohms, and the shunt element equal to 40.4 ohms, will cause a 20 decibel loss to be introduced between  $V_1$  the input terminals, and  $V_2$  the output terminals, reducing the input voltage of 1.5 volts to the desired value of .15 volts across "Z<sub>0</sub>" the load impedance, which was the problem under consideration. It will be noticed that the calculated values of "Z<sub>1</sub>" and "Z<sub>2</sub>" check with the values given in Table 3.

It was previously stated, that the image impedance must equal the characteristic impedance, in order to realize perfect impedance matching characteristics. This equality is shown below:

"Z<sub>0</sub>" the image impedance = 200 ohms (given).

"Z<sub>0</sub>" the characteristic impedance from equation (3).

(Continued on page 115)

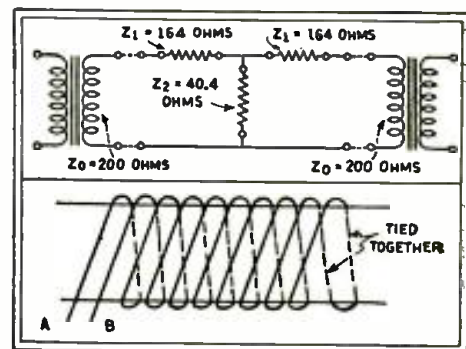

Fig. 15, above. A completed T-type network causing a 20 db. loss.  
Fig. 16, below. Illustrating a bifilar winding. A and B are the ends of the winding.





# THE SERVICE MAN'S FORUM

Where His Findings May Benefit Other Radio Technicians

## LASSOING BUSINESS

Editor, RADIO-CRAFT:

In Fig. A is illustrated our service shop. All of the equipment excepting the Jewell 199 set analyzer (which has been rewired) is home constructed. A description of the "lab." may be of general interest.

A standard large-size office desk covered with linoleum provides a working bench as well as eight drawers, one for each of the following: tools, hookups, condensers, resistors, volume controls, hardware and small parts, miscellaneous units. The test panel, at the rear of the desk, was constructed from veneer 38 in. x 58 in. x 1/4-in. thick, mounted on a heavy wooden frame.

On the panel at the lower right is an A.C. subpanel with "on-off" switches for all units as well as controlled outlets for a soldering iron and radio receivers under test; a master switch turns off everything. In the opposite lower corner is a complete power plant delivering "A," "B," and "C" voltages; and a Tungar battery charger.

A Jewell 199 analyzer rewired for quick socket voltage analysis and a complete set of adapters are handily arranged at the center. To the left of the Jewell instrument are the antenna and ground leads, brought to the panel on G. E. stand-off insulators. At the upper right is a broadcast-band shielded oscillator provided with a plug-in jack type of output connection.

On the subpanel in the upper left-hand corner of the panel is mounted a tube tester to indicate mutual conductance, filament emission, and shorted elements; a switching arrangement places the 8-scale Weston meter in series or shunt connection to any radio circuit; also, the meter may be used for external voltage and continuity tests. Provision is also made by means of tip-jacks to place any other meter in the circuit for adjustment or comparison. A line-filter reverse switch and control is built in.

In addition to the equipment on the panel there is one D.C.-type 90 to 1500 kc. oscillator; a two-button mike; and two dynamic and three magnetic test speakers. There also is available a Universal meter equipped with test prods and having four milliamp., three ampere, five voltage and three ohmmeter ranges; namely, a total of 15 ranges for one lone meter!

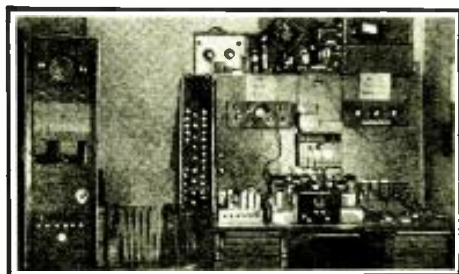

Fig. A  
How's this for a Service Shop.

A card index is kept for changes on sets, and duplicate analysis blanks. In the tube rack at the left of the panel there is kept a complete set of matched tubes. A total of about 200 good hand tools are provided.

At the extreme left (under the big Peerless speaker) is under construction for a local publicity company, a rack-and-panel type of amplifier. Radio, phono-

space in "our" magazine for this letter; I say "our" because I feel that "It" belongs to the Service Man.

I hardly know just how to put it but anyway here goes. I am sure that there is not a Service Man that has not heard these words or something similar, "Why, I can order that tube from a mail order house for about half that price," and the smaller the town the more often he hears this plaintive refrain.

Consequently, I have a far fetched suggestion to make; I am confident that if the Service Men of the country at large would stick to it, it would work.

If the Service Men as a body would back the product of some reliable tube manufacturer, handle his line exclusively and talk quality; and if this manufacturer would refuse to sell these tubes to the gyp houses I think, in my way of seeing things, that the result would be a big step towards helping all concerned.

I would appreciate hearing what other Service Men have to say on this subject; in fact, the small radio dealer also might well benefit by subscribing to the same plan.

LEE F. SCHLOSSER,  
Lee F. Schlosser Radio  
Service Co.,  
Haleyville, Ala.

(There are two sides to this story, as there are to most, so let's hear what the "anti's" have to say.—Technical Editor.)

## DANCE STATIC

Editor, RADIO-CRAFT:

The writer was called in to service a set in which there was interference.

The people danced quite a bit and when a couple passed (in the front room) a certain spot close to the front door the radio set seemed to want to fall apart due to the terrific noise it emanated. Well, I knew there was a loose connection but could not find it—so "Hawkshaw" went to work.

No loose connection in sockets or base plugs on the first floor, so up I went to the second. Nope, no luck. Nearly ready to give up, I went to asking questions.

I found out that Mr. Amateur a few years back had torn up a plank in the attic and done some wiring. Up comes the plank again and the mystery of a loose connection is solved—you know, resin joints.

T. E. DALY,  
8 Brookfield, Beulah Park,  
Cleveland, Ohio.

**THE Official Radio Service Mens Association, sponsored by RADIO-CRAFT, invites all Service Men who are not members of the Organization to write for an application blank. It is the official service organization of this maga-**



**zine and is maintained solely for the interests of Service Men. Membership cards are issued upon passing a written examination which is forwarded by mail. Write for yours today. The O. R. S. M. A., 98 Park Place, N. Y.**

graph and two mikes are switched by means of jacks and patch cords on the panel into two amplifiers; and from this combination, into five reproducers.

We are very proud of our radio library; a complete file of all radio publications is kept. Not shown in the photograph is another table for working tests; and long shelves provide for chassis, parts and tubes.

(Note—We may be radio men but we're not (type-mill pushers!)

R. M. CASTE,  
Dunbar Radio Co.,  
Dunbar, W. Va.

("Mill pusher" or no mill pusher, our correspondent writes an interesting letter. We are sure that if more service organizations would follow a clean-cut plan in laying out a service shop, as have the members of this company, sales resistance would be greatly reduced.—Technical Editor.)

## CONTROLLING THE PRICES OF TUBES

Editor, RADIO-CRAFT:

I wish that you would grant me a little

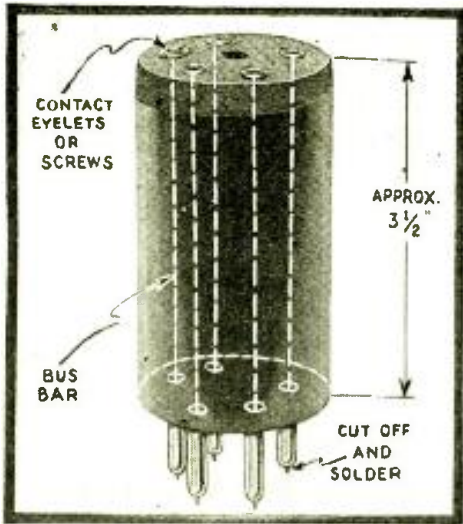

Fig. 1

Photograph of the new "resistance adapter."

## PRIZE AWARD

### ADAPTER FOR "RESISTANCE SERVICING"

By Robert Barton

WITH the coming of "resistance measurement" (prong of socket to chassis, etc.), as a basis of service procedure, the writer submits a description of a small unit which he has used for quite a while with satisfactory results. It speeds service work "like nobody's business!"

This device is a special plug adapter, illustrated in Fig. 1, which is cheaply and quickly constructed, its object being to provide a simple means of making electrical connection to the socket prongs when they are below the subpanel or surrounded by a non-removable shield. Contacts on the top plate are "straight through" connected to the prongs.

For its construction in UY-type, procure a 5-prong short-wave coil-form, such as the old Dresner, Octocoil, etc., and a flat piece of bakelite approximately the diameter of the coil form. Drill holes in the bakelite plate in the relative position of the tube prongs, and bolt short screws, to which are fastened lugs and lock washers, through these holes. To these lugs are soldered lengths of busbar which are then pushed through their respective holes in the prongs and drawn up snugly; soldering these pieces to the respective prongs ("grid" contact to grid prong, "plate" contact to plate prong, etc.) completes the job.

A unit of this type having low-resistance, convenient contacts to "jab up against" when making a resistance test instead of "fishing around" in a hidden socket, is something that I think will appeal to other Service Men.

Of course the same idea can be adapted for any type of socket; for instance in making such a device for a six-prong socket, procure a tube base with the required number of prongs in it, drill six holes in the top plate and then proceed as described for the 5-prong tube circuits.

By measuring the resistance between the chassis and each prong of each tube

# SHORT CUTS IN RADIO SERVICE

## \$10 for Prize Service Wrinkles

Previous experience has indicated that many Service Men, during their daily work, have run across some very excellent Wrinkles, which would be of great interest to their fellow Service Men.

As an incentive toward obtaining information of this type, RADIO-CRAFT will pay \$10.00 to the Service Man submitting the best all-around Radio Service Wrinkle each month. All checks are mailed upon publication.

The judges are the editors of RADIO-CRAFT, and their decisions are final. No unused manuscripts can be returned.

Follow these simple rules: Write, or preferably type, on one side of the sheet, giving a clear description of the best Radio Service Wrinkle you know of. Simple sketches in free-hand are satisfactory, as long as they explain the idea. You may send in as many Wrinkles as you please. Everyone is eligible for the prize except employees of RADIO-CRAFT and their families.

The contest closes the 15th of every month, by which time all the Wrinkles must be received for the next month.

Send all contributions to the Editor, Service Wrinkles, c/o RADIO-CRAFT, 98 Park Place, New York City.

Articles on the "chassis-to-tube-prong resistance" method of radio servicing for which this adapter is designed have appeared in contemporary publications, to wit: "The Resistance Measurement Method of Servicing," in the June 1932 issue of "Service" magazine, and; "Resistance Measurement," in the May 1932 issue of "Radio and Music Merchant" magazine.

## REMOTE CONTROL OF A. C. DYNAMIC SPEAKER FIELD

By C. M. Sager

WHEN operating a dynamic reproducer with an A.C. field which is entirely remote from the set, it is necessary to turn the field supply to the speaker "on" and "off," at the speaker, with the result that the current is often left turned "on," when not in use.

A small relay, of the type formerly used to control "B" eliminators and battery chargers, can be used to turn the speaker on and off automatically.

Remove the winding from the relay magnet (this being about No. 18) and rewind with No. 32 enameled wire, random wound, to completely fill the spool. The rewound relay is connected in the center lead to the speaker input transformer, and operates on the plate current of the power tubes. Using two '45 or '47 tubes, with a plate current of 60 to 65 milliamperes, only about 4 or 5 volts drop across the magnet winding is required to operate the relay. See Fig. 2.

## A "SHORTED TURNS" TEST

By Clifton E. Wellman

HAVE never seen described in any radio magazine the following method of testing for shorts in power transformers. It does not require elaborate or expensive equipment.

Many Service Men cannot tell when a power transformer is faulty, unless it has reached the point where it may be identi-

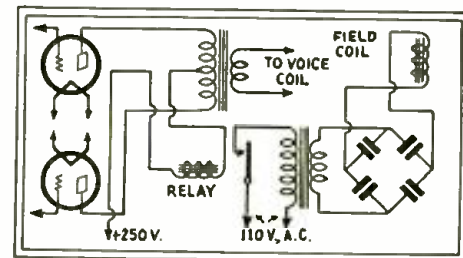

Fig. 2

Mr. Sager's remote control system.

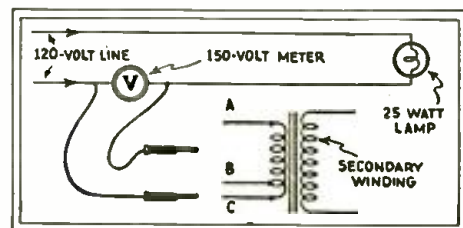

Fig. 3

Here's how to test those shorted turns.

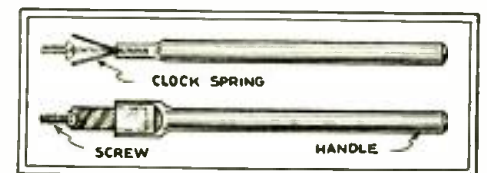

Fig. 4

The screw starter.



fied by the looks, the smell, or the open circuit condition of a secondary winding.

However, by utilizing the primary winding of the transformer to be tested as a shunt for an A.C. 150-volt meter, as shown in Fig. 3, shorts in the secondary windings are indicated by the drop in the meter readings. These should be checked against readings taken from transformers known to be O.K. A chart should be made up of these readings of the popular makes of radio sets that come into the shop; (the readings between different makes of transformers do not differ very greatly). Shorted turns in the primary windings may also be indicated in this test.

The following tests and readings, submitted as examples, were made upon a Victor model R-15 power transformer:

	Volts
Voltmeter readings, test prods open.	110
Voltmeter readings, test prods shorted .....	0
Test prods connected to primary of trans., A to C. No. load.....	90
Test prods connected to primary of trans., A to B. No. load.....	86
Test prods connected to primary of trans., B to C. No. load.....	1
Test prods connected from A to C.	90
Add the following load—dial light.	89
2 power tubes.....	71
Rectifier .....	52
4 screen-grid tubes.....	32
Short rectifier plate to grid....	1.5
Short rectifier filament.....	10.5
Short rectifier filament to plate..	70
Short power tube filament.....	28
Short '24 tube filament.....	26

Therefore, readings that differ very much from the chart below would indicate that the transformer is not O.K.

	Volts
Victor R-15—Sec. free.....	90
Load 2 pr. tubes and rect.....	52
Crosley 30S-31S-33S-34S—Sec. free..	85
Load-rectifier .....	58
Radiola 41—Sec. free.....	96
Load-rectifier .....	62
Atwater Kent 44—Sec. free.....	78
Load-rectifier .....	56
Philco 77-77A—Sec. free.....	84
Load-rectifier—all tubes .....	30

## A GOOD SCREW-STARTER

By Ray L. Mason

A SERVICE tool that I have found absolutely indispensable in my shop is made from a piece of copper tubing (such as refrigerator men or auto mechanics usually have around) about six inches long and with a diameter of about 1/4 in. or larger, (if copper tubing is not available an old curling iron will furnish the tubing) and, a piece of clock spring.

Pinch the end of the tube in a vise until almost closed, insert two pieces of clock spring about one inch long into the tube, leaving about a half inch protruding, then pinch tightly and you will have one of the best screw-starters you could ever find. The completed tool is illustrated in Fig. 4.

## A SCREEN-GRID DETECTOR FOR THE A.K. 37

By George Stoneham

VOLUME and sensitivity were increased approximately three times, selectivity was improved and tone quality was unimpaired by making a few slight changes in an A.K. model 37 receiver. The changes made in this radio set may be made in any receiver where the type '27 detector operates with comparatively low plate voltage and R.F. input.

The original circuit of connections is shown in Fig. 5A; B, the completed diagram, incorporates a type '24 tube as the detector.

## THE SERVICE MAN'S FRIEND

By Wilbert L. Misner

IN the life of every Service Man there comes a time when he will accidentally mar the surface of a radio receiver cabinet. The writer takes care of such contingencies by always carrying along a small bottle containing clear varnish and capped by a rubber stopper. The procedure is illustrated in Figure 6.

The rubber stopper moistened with a little varnish is rubbed over the scratch until the varnish flakes have been dissolved and mixed with the fresh varnish and presto, the scratch will have disappeared!

Where the scratch has gone through the surface of the varnish and reached the wood, use a soft-lead pencil to darken the surface and then follow the procedure previously described.

## REPAIRING A.K. POWER PACKS

By Herbert W. Jones

WE all know what a messy and tough job it is to repair A.K. Power Packs in which one of the condensers is "shot." However, there is one method which, insofar as the writer is aware, has never before been proposed to the main body of Service Men. This is a simple and effective method of repairing such A.K. models as the 37 and 38—and without tearing the can to pieces or melting out the sealing compound; the principle is applicable to other makes of receivers having similar power pack design.

If either the detector bypass or the filter condensers are shot, remove the cover and loosen the clamp which holds down the two cans, raise the filter system can and then place under it a piece of insulating material. Then, cut the bare lead that connects from the filter can to the center hold-down, bolt and solder a piece of insulating wire to this bare wire from the can. Replace the can, place another piece of insulating material under the hold-down clamp (that is, over the filter can) and tighten. The filter can should now be entirely insulated from the chassis.

The original connections of the filter system of an A.K. model 37 or 38 receiver pack are shown in Figure 7A; in 7B, the connections of the filter system are shown

after being revamped in accordance with the above procedure.

Since the filter system is now connected to ground through condenser C6 the resulting effective capacities of the condensers in the can will be a function of the capacity of C6; in other words, we are bringing into use the law of condensers in series.

Therefore, to raise the effective capacity of C2, the condenser C7 connected to the outside of the can is added in parallel to C2 and C6.

Although the effective capacity of C3 is lowered, it is not possible to notice any difference in operation of the set. However, if desired, its capacity, too, may be increased by connecting an external condenser from the can to the detector positive terminal on the terminal board. Condenser C5 is added to aid in the filtering.

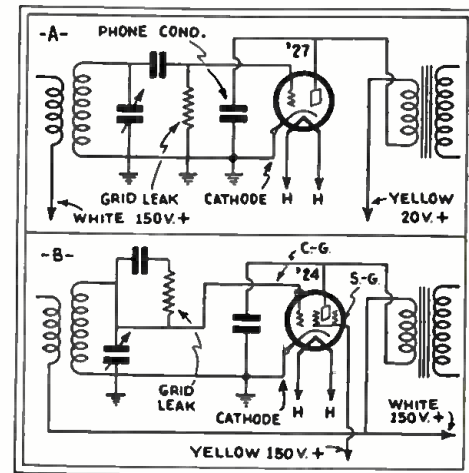

Fig. 5  
Changing for the screen-grid detector.

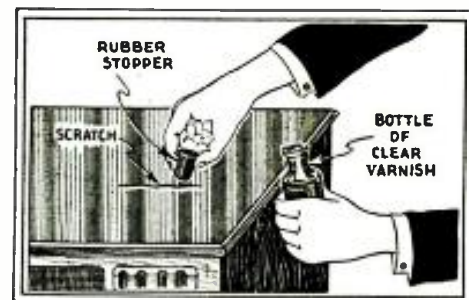

Fig. 6  
At last, a scratch eliminator!

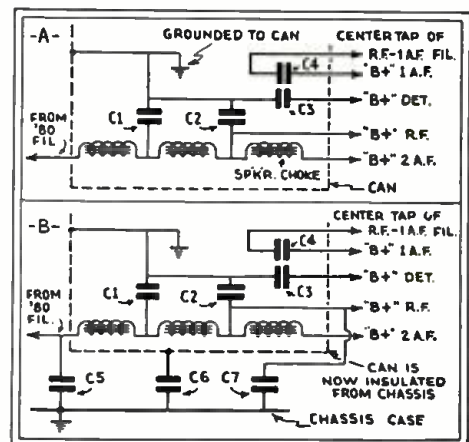

Fig. 7  
And for repairing that A.K. power pack—

PHILCO MODEL 15 SERIES, 11-TUBE SUPERHETERODYNE CHASSIS

(Used in Models 15X and 15DX receivers; and includes inclined sounding board, twin reproducers, tone control, A.V.C., visual tuning, local-distance switch.)

A feature of this chassis design is the exceptionally fine quality of the reproduction. Note that tubes of the 6.3-volt or "automotive" type are used in this ultra-modern receiver, a product of the Philco Radio & Television Corp. The following quotation is of particular interest.

"In efficiency, in economy of current and space, in uniformity, in freedom from trouble and in all-around performance, the new Philco 6.3-volt universal-service tubes are

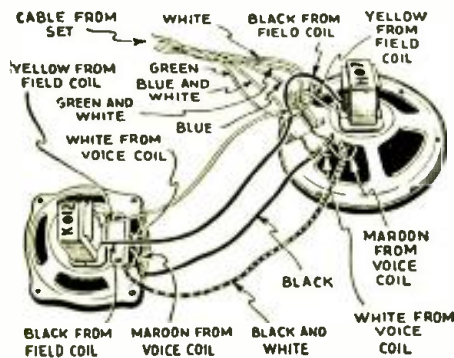

superior to any tubes that we know of, past or present.

"We will standardize on 6.3-volt heater tubes, since their use permits applica-

tion to automotive receivers and D.C. sets, as well as to A.C. instruments; thus, all new developments in future Philco tubes will be immediately available for all these classes of service."

Following is a list of the features of this set, as furnished by the factory: Inclined sounding board, twin-reproducers, A.V.C., automatic tuning silencer, distance switch, illuminated grille, tone control, shadow tuning, glowing arrow station finder, station-recording type of dial.

The resistors in the Model 15 chassis should measure as follows: R2, R17, 10,000 ohms; R3, R5, R18, 49-meg.; R4, .16-meg.; R6, 51,000 ohms; R7, 200 ohms; R8, R14, R16, 1 meg.; R9, 13,000 ohms; R10, 1,000 ohms; R11, 99,000 ohms; R12, .25-meg. (dotted; see text); R13, R19, 5,000 ohms; R15, 25,000 ohms; R20, .24-meg.; R21, R22, 50 ohms; R23, 205 ohms.

Condensers C1 to C9, tuning or trimming condensers. Condensers C10, C22, C23, are 110 mmf. units; C11, C12, C13, C18, C19, .05-mf.; C14, C17, .09-mf.; C15, C24, C25, .25-mf.; C16, .35 mmf.; C20, 1 mf.; C21, C27, .01-mf.; C26, C31, C33, 0.5-mf.; C28, C29, C30, tone control condensers; C32, .002-mf. (dotted; see text); C34, C38, C39, .015-mf.; C35, .18-mf.; C36, C37, 6 mf. electrolytic; C5A, 700 mmf.

The reproducer system of this receiver deserves special mention. Due to the fact that there are two separate dynamic re-

producers operating from a single receiver output, it is absolutely essential that the instruments be correctly "poled"—that is, the field and voice coils must be connected so that the correct "phase" relation is maintained between the two units. (Both diaphragms moving in or out at the same time.) For this reason a detail illustration of the reproducer leads, showing their color code and connections, is reproduced in this Data Sheet.

Chassis stamped at rear with a circle around Nos. 20 and 21 must have R12 and C32 added to reduce distortion due to powerful local stations; Nos. 22 and 23 have C32 but may require R12; subsequent chassis are equipped with both.

"Both speakers have identically the same frequency response characteristics," states the manufacturer. The two reproducers are used to obtain more uniform sound distribution. An echo-absorbing screen at the rear of the cabinet prevents echo and blur—and tends to increase front-projected sound volume.

The power rating of the set is 115 watts.

The tubes in the Model 15 chassis are very economical in their filament-current requirements. The types 37 and 44 tubes consume only 0.3-A; the 42's (the output pentodes), 0.7-A; the '80, 2 A. The filaments of all of these tubes, except the '80, are rated at 6.3 V.; the '80, 5 volts.

With an A.C. line potential of 115 volts, volume control at maximum, with the station selector turned to the low-frequency end and the power switch in the "middle" position, the following readings are normal: Plate potential (measured to cathode), V1, 165 volts; V2, V4, 250 volts; V3, 60 volts; V5, 275 volts; V6, zero; V7, 75 volts; V8, 100 volts; V9, V10, 255 volts; V11, 320 (per plate). Screen-grid (to cathode), V1, 55 volts; V2, V4, V5, 90 volts; V9, V10, 270 volts. Control-grid (to cathode), V1, V3, V9, V10, 15 volts; V2, V4, 0.85-volt; V5, 3.3 volts; V6, V8, 0.2-volt; V7, 0.4-volt. Cathode (to filament), V1, 30 volts; V2 to V9, 10 volts; V10, 15 volts; V2, V4, 0.85-volt; V5, 3.3 volts; V6, V8, 0.2-volt; V7, 0.4-volt. Cathode (to filament), V1, 30 volts; V2 to V9, 10 volts; V10, V11, 15 volts.

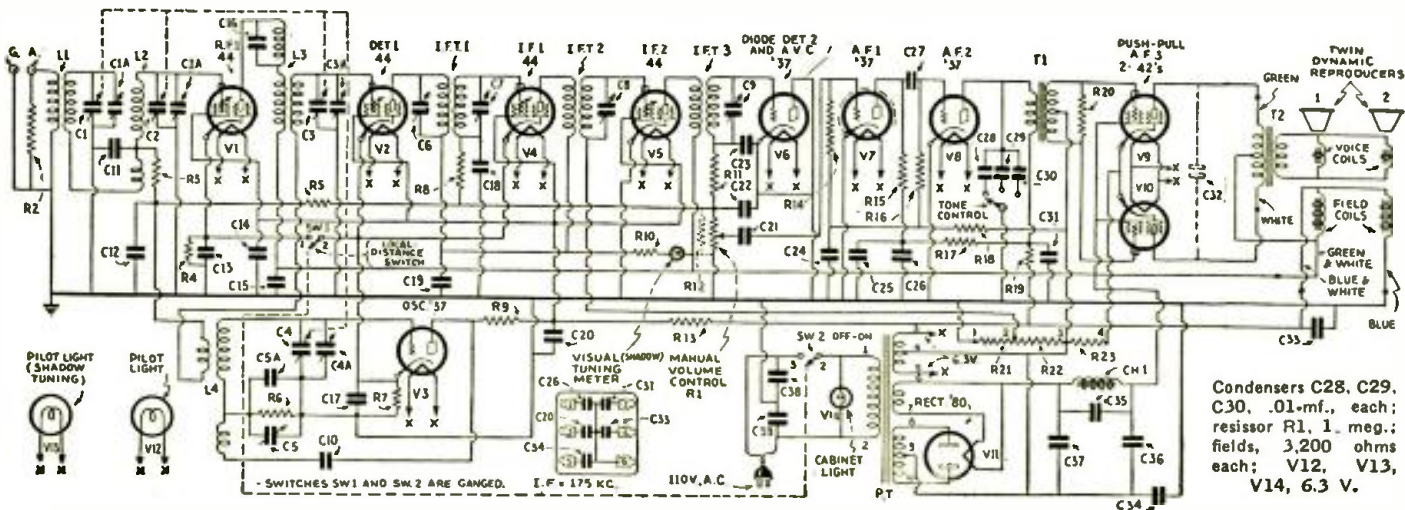
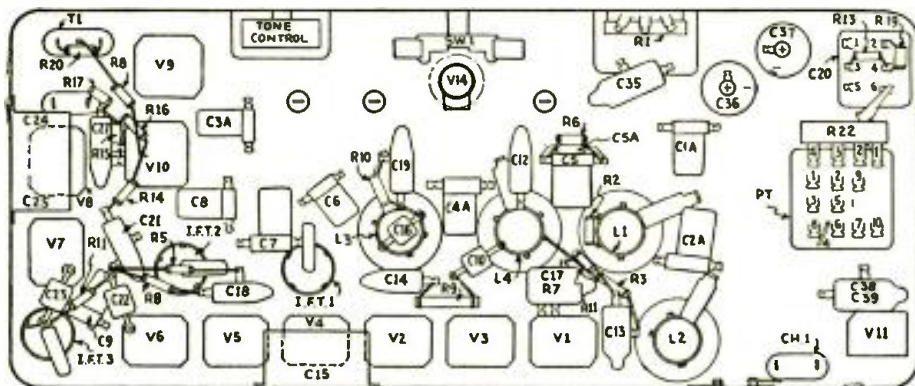

Condensers C28, C29, C30, .01-mf., each; resistor R1, 1 meg.; fields, 3,200 ohms each; V12, V13, V14, 6.3 V.



RCA VICTOR MODEL R-78 BI-ACOUSTIC 12-TUBE SUPERHETERODYNE

(Also, General Electric "Convention" Model J-125 Chassis.)

This is the first commercial receiver to incorporate the new "super-phonics" line of tubes which have recently made their appearance on the market. The tubes of this series incorporated in the R-78 (and J-125) chassis are the 58 R.F. pentode, 56 general-purpose, 46 Class B and 82 mercury-vapor rectifier. (The type 58 tubes are of 6-prong-base design.)

A feature of the receiver is the tone control, which is designed to maintain even reproduction of the low and high frequencies, regardless of the volume setting. Thus, bass reproduction at low volumes is not attenuated as when non-compensating circuits are used.

The resistance and capacity values of the respective units are indicated by figures within parentheses.

The following operating voltage and current readings are for a 120-volt line, the volume control set at "minimum," and no signal being received.

Filament potential, all tubes, 2.5 volts. Plate potential (to cathode or filament), V1, V2, V4, V6, V7, V10, 210 volts; V3, 70 volts; V5, 200 volts; V8, V9, 400 volts; V11, zero. Plate current, V1, V10, 3 ma.; V2, 1.5 ma.; V3, V6, V7, 5 ma.; V4, 2.5 ma.; V5, 1. ma.; V8, V9, 6 ma.; V11, zero. Control-grid potential (to cathode or filament), V1, V2, V3, V4, V8, V9, V10, V11, zero; V5, 12 volts; V6, V7, 8 volts. Screen-grid (to cathode or filament), V1, 100 volts; V2, V4, V10, 95 volts. Cathode (to heater) potential, V1, V3, V10, 7 volts; V2, 10 volts; V4, 8 volts; V5, 12 volts; V6, V7, 11 volts; V11, 15 volts.

The input signal potential for the I.F. amplifier is applied also to the A.V.C. amplifier tube due to the grids of both being coupled together by means of C22. The output of the I.F. amplifier V4 is applied to second-detector V5 through a sharply-tuned transformer I.F.T.2; however, the output of A.V.C. amplifier V10 is coupled to A.V.C. tube V11 through a broadly tuned unit.

Although too much selectivity ahead of V11 is undesirable, since it introduces excessive distortion and overload as a station signal is tuned in, still, a certain amount

is essential; otherwise, the A.V.C. will be caused to function by a local station when it is desired to tune in a weaker station on an adjacent channel.

The voltage developed across resistors R4, R21, R22, furnish control-grid bias for V1; the drop across R4, R22, is the control-grid bias for V2; and the drop across R4, control-grid bias for V4.

As the drop in these resistors is due to the signal potential applied to the A.V.C. tube and this voltage is in turn dependent upon the bias of the R.F. first detector, and I.F. amplifier, an automatic action is obtained; greater voltage is applied to the R.F. and first-detector than to the I.F. to prevent overloading of these tubes due to a strong, undesired adjacent carrier.

The undistorted power output of the R-78 is rated at 10 to 20 watts, depending upon the percentage of modulation of the incoming signal; consequently, to compensate for variations in sound intensity over the audio frequency band as the output is varied within these limits the volume control circuit is arranged to produce substantially flat response between the range of 35 and 5,000 cycles.

The trap circuit A.F.C.1, C11 tunes to approximately the middle of the A.F. response range and as the volume is reduced to one point, it causes greater attenuation of the middle register than at either end. From this point to the minimum position the volume control acts as a potentiometer across the trap circuit and reduces the volume without changing the frequency response to any greater degree.

This completes the description of the first half of the volume control; the second, which functions only over the last 20 degrees of the angular movement of the volume control, is resistor R1 connected between the R.F. and first-detector cathodes and varies the overall sensitivity.

Push-pull voltage amplifier V6-V7 is the driver stage for push-push amplifier V8-V9. Cabinet resonance has been nullified by means of two side chambers; the baffle area is large.

To prevent excessive hum and noise, it is essential that a good ground be connected to the yellow lead of the chassis; consider-

able hum also may be caused by insufficient twist in the volume control leads, due to pickup by A.F.C. 1.

In localities remote from strong stations it may be desirable to increase the A.V.C. action to obtain better than 100 mv. sensitivity. This is accomplished by shorting out R1, as indicated by the dotted line, "short."

To realign the chassis, an output meter will be necessary. (This may be a current-squared galvanometer connected to the secondary of T3 in place of the reproducer voice coil; an 0-5 ma. meter in the plate supply lead to V2; or a low-range A.C. voltmeter across the reproducer voice coil.)

A "dummy" 56-type tube having an open heater circuit is required to replace V11; make certain that the dial pointer reads exactly at the short line on the scale when the gang condenser plates are fully meshed. Then, align the circuits at 1,400 kc., with the volume control in the "maximum" position.

Follow this with the alignment procedure at 600 kc., then repeat the procedure at 1,400 kc. Condenser C4A, the 600 kc. trimmer, is reached through a hole in the top of the chassis, and about half-way along a line drawn from the tuning dial to the socket of the first-detector.

To adjust the I.F. circuits, set the service oscillator at 175 kc., replace the regular type 56 tube with the dummy 56, as previously described, couple the oscillator to the control-grid of the first-detector, and set the volume control at "maximum"; adjust first I.F.T.2, then I.F.T.1. Repeat the procedure. Looking at the rear skirt of the chassis, and reading from left to right, the trimmers of the I.F. transformers are arranged in the following order: C8, C7, C6, C5. Terminal panel P1 is below these adjustments. At the left of P1 is the "fidelity" switch, SW1.

It is a good plan after making the I.F. realignment adjustments to repeat the oscillator and R.F. adjustments.

Following is the color code of the power transformer: 1, black, red tracer; 2, black-red; 3, red; 4, 5, yellow; 6, 8, brown; 7, brown-black; 9, 11, blue; 10, blue-yellow; 12, 14, green; 13, green-yellow.

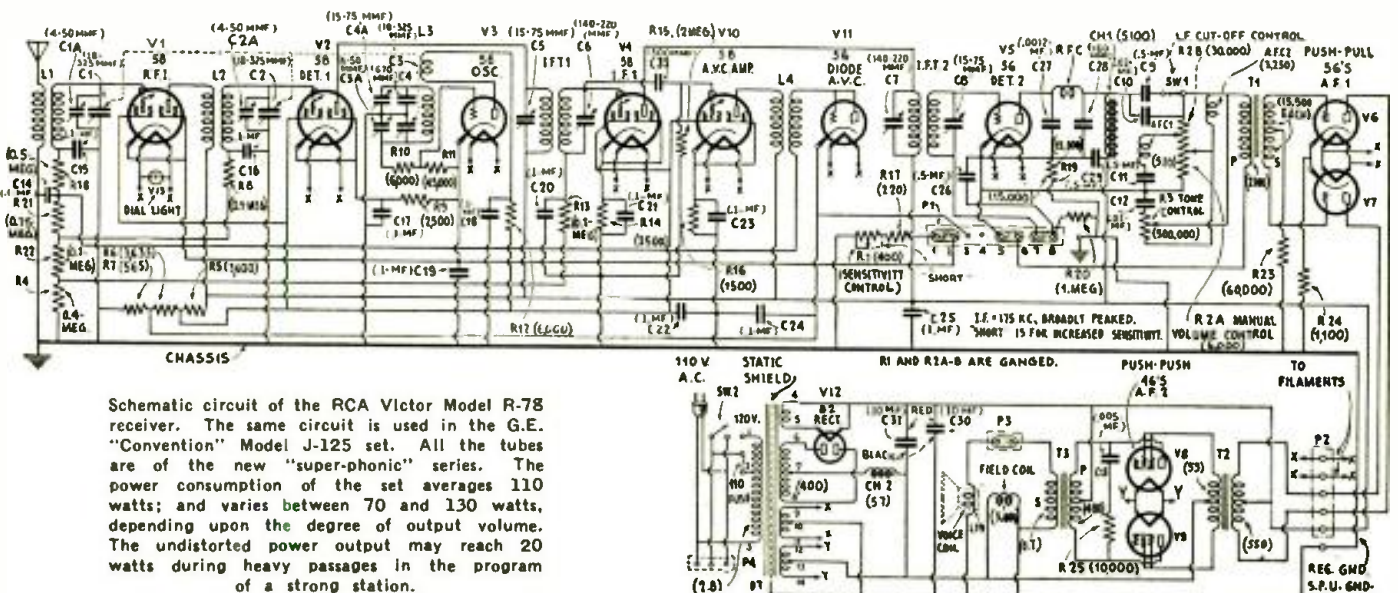

Schematic circuit of the RCA Victor Model R-78 receiver. The same circuit is used in the G.E. "Convention" Model J-125 set. All the tubes are of the new "super-phonics" series. The power consumption of the set averages 110 watts; and varies between 70 and 130 watts, depending upon the degree of output volume. The undistorted power output may reach 20 watts during heavy passages in the program of a strong station.

# RADIO SERVICE AND THE ELECTRIC CODE

The third of a series in which the need for proper radio installations is emphasized.

By GUS JACOBSON

In a recently issued report of the New York Board of Fire Underwriters, the following excerpt may be of interest to radio Service Men, home owners, or other unauthorized persons doing electrical wiring. "The records of proven electrical fires compiled by the Electrical Bureau of the New York Board of Fire Underwriters show that the losses for uninspected and unapproved electrical devices, materials and wiring constitute 81 percent of the total electrical losses."—J. C. Forsyth, Chief of the New York Underwriters Inspection Bureau.

Chicago reports 650 electrical fires during 1931. Of these, W. A. Jackson, City Commissioner of Gas and Electricity reports that 400 occurred in residences and 80 percent of these were due to faulty wiring installed by home owners and other persons untrained in the methods of installing electric wires.

Other figures compiled by insurance officials, electrical contractor associations, and power company inspectors throughout the country, with a few insignificant exceptions, show similar trends. In all summaries, the majority of electrical fires are shown to have occurred in homes where comparatively small amounts of power is consumed. The exceptions are several communities where electrical authorities do more than shake an admonitory finger at householders where violations are discovered or where a fire has caused enough loss of life to awaken a temporary public conscience.

When a comparison is made between the current used in the average single-family residence or apartment, and the large amounts of power used in factories, and the inverse ratio of electrical fires that seem to occur with these large amounts of power, the inevitable conclusion is that such fires are caused, not so much by the presence of heavy currents, as by the manner of confining these currents to their conductors and the prevention of arcs near combustible material.

This is well known in the electrical industry, and the National Electrical Code devotes as much attention to the insulation and protection of current-carrying conductors as to the conductors themselves. The false economy of using 250-watt sockets to operate 600-watt irons

has been proven time and again. The Association of Electragists, International, in 1931, inaugurated a campaign to bring the attention of landlords and small-home owners to the lack of sufficient convenience outlets in homes. Figures from member electrical contractors have been provided, proving that the cost of replacing burned-out sockets, accidents happening while the light was off due to fuses blowing from overloaded materials giving way, and mechanic's time lost travelling to and fro on these small blowout jobs, average in three years, more than the cost of installing convenience outlets.

## Profits for the Service Man

The intelligent radio man should use these facts as a means of adding to his income. That nearly all this unapproved wiring takes the form of extensions from electric light fixtures is self evident for all power companies require that certificates from local insurance authorities and municipal electrical bureaus be registered with them before permitting current to be turned on.

When a Service Man is called in to install or repair a receiver and finds one of these scrap telephone or bell wire extensions, he can become a salesman of safety and explain the menace contained in this type of electrical installation. To a woman, what argument is more potent than that offered by the fact that 236 children, aged six and under, have perished in fires of proven electrical origin within a radius of twenty-five miles of Manhattan during 1931? And 81 percent of these fires were due to uninspected and unapproved devices, materials, and wiring.

Every radio Service Man has found that, after solving a baffling case of trouble (especially after others have failed or the owner has become involved in a hopeless mess after attempting to repair a receiver himself) radio set owners are apt to place confidence in every statement the Service Man makes. A time like this is an opportunity for the radio Service Man to bring out his array of facts regarding unapproved wiring and to sell the set owner the idea of electrical safety.

Even householders who do not care to

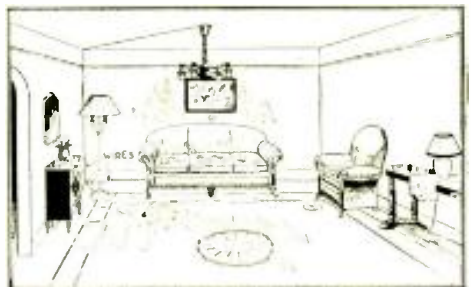

Radio installations may come and go but the good ones remain forever. This is well illustrated by the sketches above. The upper one shows how "the well-dressed installation will look," and the one below, how it will "not look."

go to the bother of having outlets installed at that particular time, may be so persuaded by the radio man's conversation that he will have such receptacles installed when the house or apartment is being painted. If contact is maintained with such a householder, as for example by means of free tube tests, this job should go to the Service Man or the electrical contractor he is associated with. In communities where licenses are required, or where Service Men have not been trained in methods of installing receptacles, radio men will save themselves plenty of grief if they contact electrical contractors and turn all possible jobs over to them, on a commission basis.

There is little reason why Service Men cannot utilize their continual contact with set owners to permit them to sell these latter electrical appliances, or any other merchandise they can obtain through regular wholesale channels. In a number of cases where radio service organizations are also electrical contractors, Service Men carry catalogues of standard electrical appliances with them in their cars and are able to quote prices and to give specifications of any particular type the set owner expresses an interest in.

(Continued on page 116)



# AN AMATEUR'S S.-W. RECEIVER

The "A. C. Portable Pentode" described in the September, 1931 issue of this magazine has created such enthusiasm that we are pleased to present this short-wave version.

By WM. H. HENTON

THE Pentode Portable receiver described in the September, 1931 issue of RADIO-CRAFT has worked to such perfection that the writer was tempted to build a short-wave receiver using the same general idea of construction as described in the article referred to. Having built and operated the new receiver, and securing results that equal that obtained on the broadcast set, I am passing the dope along to others who may be interested.

The schematic circuit of the set is shown below. It has but two controls; the tuning condenser C2 and the oscillation control R2.

## Construction

A metal case, preferably of aluminum, is cut to fit in the case to be used. The writer used an I.C.A. Insuline Midget Companion carrying case, the size of which is  $6\frac{1}{2} \times 7\frac{1}{2} \times 10\frac{3}{8}$  inches. Although any box of suitable size may be used, an old Victrola box would be suitable. The purpose of the metal box is, of course, to serve as a shield, therefore avoiding body-capacity effects which are very annoying on the higher frequencies.

All coils are of the tube-base type. Secure an old tube base and drill four holes; one directly over the plate prong, one  $\frac{1}{4}$  inch higher over the F prong, one  $\frac{1}{8}$  inch above the latter over the F— prong, and the last one at the end of the winding over the "grid" prong. Complete data for the coils are given in the list of parts.

In order that all those who build this short-wave portable receiver may secure the best results possible, several precautions must be taken.

First, the receiver must be capable of oscillating or no results will be secured. If all the connections have been properly made and the set still refuses to oscillate, the trouble may be due to some or all of the following:

1. Antenna condenser set wrong.
2. Low filament voltage.
3. Tickler coil connections reversed.
4. Tickler coil spaced too far from the plate coil.
5. Insufficient turns on the tickler.
6. The tube used is a poor oscillator.

This latter trouble rarely happens as long as the tube is good, but may fool you sometime.

## List of Parts

Referring to the circuit diagram, the parts have the following values:

- C1 Pilot type J5 5-plate midget condenser;
- C2 Cardwell type B 5-plate receiving condenser;
- C3 Aerovox .0001-mf. condenser;
- C4 Aerovox .0002-mf. condenser;
- C5A Aerovox .5-mf. bypass condenser;
- C6A Aerovox .01-mf. condenser;
- C5 Flechtheim 2 mf. filter condenser;
- C6, C7, C8 Aerovox 4 mf. electrolytic condensers;
- C9 Aerovox 1. mf. filter condenser;
- R.F.C. Hammarlund 85-mhy. choke;
- R1 9 megohms;
- R2 Centralab 0-75,000-ohm variable resistor;
- R3, R4 Electrad 12,000-ohm resistors;
- R5 Electrad 5,000-ohm resistor;
- R6 100,000-ohm resistor;
- R7 Lynch  $\frac{1}{2}$ -megohm resistor;
- R8 Lynch 400-ohm "C" bias resistor;
- V1, V2 NaAId UY-type socket;
- V3, V4 NaAId UX-type socket;
- PT. Earl power transformer.

The coils necessary for the various bands are as follows:

For the 85-meter band; L1, 26 turns No. 26 D.C.C. wire; L2, 12 turns No. 26 D.C.C. wire. Both coils are wound in the same direction—clockwise, as described in the text.

For the 40-meter band; L1, 13 turns No. 26 D.C.C. wire; L2, 8 turns of No. 26 D.C.C. wire. Both coils are wound in the same direction as described in the text.

For the 160 meter and police bands; L1, 63 turns of No. 26 D.C.C. wire; L2, 30 turns of No. 26 D.C.C. wire. Both coils are wound in the same direction as described in the text.

The above brief description should be sufficient for most set builders. Because it is housed in a carrying case, it is easy to handle and therefore easy to transport from one place to another; for this reason it is called a portable receiver. The appearance of the set is exactly the same as the "A.C. Portable Pentode" described in the September 1931 issue of this magazine, and the reader is referred to it for reference as to the general procedure to follow.

It might be well to state that the tuning condenser C1, while it is shown variable, is set once for best response, oscillation control, etc., and left alone; although its adjustment may have to be changed, in some localities when changing from one band to another.

After winding the coils as per the specifications given previously, the four wires resulting therefrom are connected to the tube-base prongs in the manner shown in the diagram below. For instance, referring to the diagram, it will be seen that the two ends of the tickler coil are marked "F+" and "P," signifying that that end of the winding marked "P" connects to the "P" prong of the tube base upon which the coil is mounted; the same reasoning applies to the remainder of the coil. Care should be taken, however, that the socket into which the coil plugs is connected up in accordance with the markings shown.

To construct the choke at home, wind (jumble wound) 800 turns of No. 36 S.S.E. wire on a form (which may be a dowel stick) one-half inch in diameter and cut to a length of approximately one inch. Thus, an efficient R.F. choke may be made.

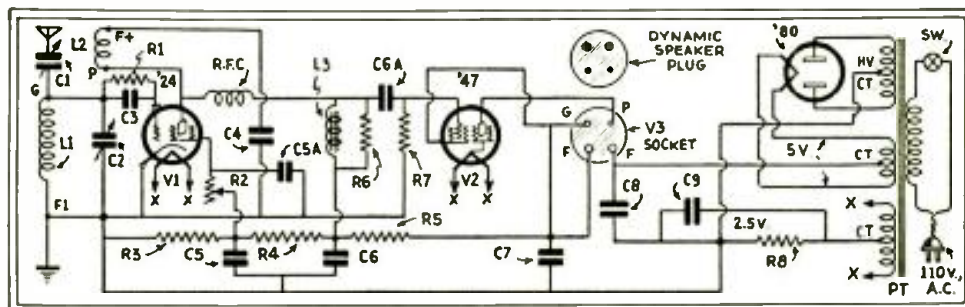

Complete schematic circuit of the short-wave portable receiver.

# RADIO-CRAFT KINKS

Practical Hints From Experimenters Private Laboratories

## PRIZE AWARD

### SIMPLIFIED SHORT-WAVE INDUCTANCE

By Russell Johnson

EXPERIMENTING around with my radio set, I made the interesting discovery that I could control a number of short-wave coils of the standard plug-in type by means of a single 4-pole switch, simply by connecting each of the primaries in parallel as indicated in the diagram, Fig. 1.

### HOW TO MAKE A CHEAP "B" UNIT

By D. E. Black

FOR an experimenter who wishes to make all of his own equipment, the author offers the following description of a simple "B" voltage supply-unit which may be built from parts borrowed from a "Lizzie."

Referring to Fig. 2, transformer T1 and filter chokes CH. may be made from the spark coils of model "T" Fords.

The first step is to take out the tar compound of a "Ford" spark coil and remove the windings. The length and diameter of the core is such that it will accommodate the new secondaries of 16,000 turns of No. 33 D.C.C. wire, center-tapped. As indicated in Fig. 2, considerable filtration is required; chokes CH. may be spark coil secondaries. This little "B" supply unit will work very nicely in conjunction with small automotive receivers.

### RAISING THE A. C. LINE POTENTIAL

By R. Foltz

WISHING to make a simple "B" eliminator which, without the use of a high voltage winding, would deliver about 150 volts at about 9 to 10 ma., the writer constructed the unit illustrated in Fig. 3. The increased voltage was ob-

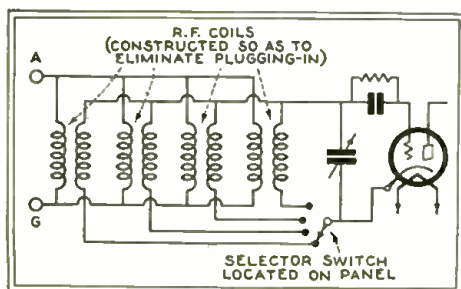

Fig. 1

This four-pole switch does the trick.

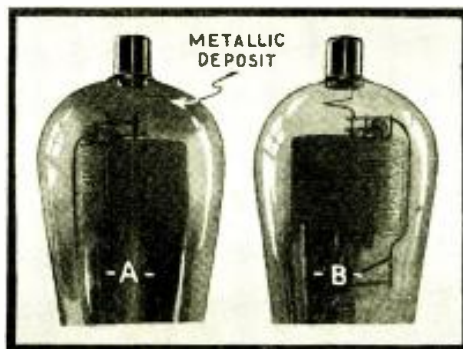

Fig. A

Here is a job for the treasure finder!

tained through the use of the auto-transformer principle of connection, center-tapping the primary of a filament transformer as shown.

Constructional details for such a transformer are as follows: Primary, 600 turns of No. 30 enameled wire tapped at 400 turns; secondary, 36 turns, tapped at 18 (in lieu of this tap a center-tapped re-

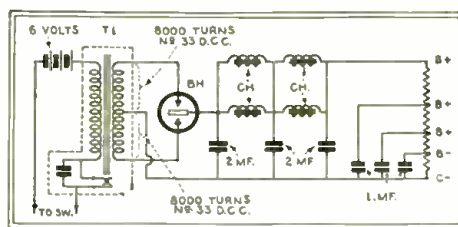

Fig. 2

The old Ford coil is here again.

istor may be used). The core has a cross-section of three-quarters of an inch and was obtained from a burnt-out transformer.

### "CHECKING UP" OLD TUBES

By Mark Hacker

LOOK your tubes over and if you find some as described in this article, replace them and revive your old set.

In the illustration, Fig. A, are shown two type '24 screen grid tubes. In one tube, left, Fig. A, appears at the top a definite metallic deposit under and around the grid cap, the connection to the control grid—the heart of the tube. The other tube, at B, shows no such deposit. Both test "good" on a tube checker such as is found in stores, and there is trouble!

Practically all test instruments (outside of the radio laboratory) check only the static condition of a tube; which means that while on such an instrument both tubes test the same, on a dynamic test (the duplicate of conditions under which the tubes would be operated if they were placed in a radio set), they would show a great discrepancy.

The tube at A, with the metallic deposit in the top, has suffered quite a change in in-built characteristics. This deposit is the condensation of metallic vapor from the filament and other hot portions of the tube, and is usually present only when the tube has had quite some use.

This metallic layer, due to its being around the control grid wire that goes to the cap, is connected to the control grid. This extra surface of metal changes the responsiveness of the tube considerably; also, being in the grid circuit it changes the tuning of the receiver. Since any abnormal change in the tuned circuit of a receiver is deleterious to its operation, a set in which is included one or more tubes of the type exemplified by A cannot function correctly.

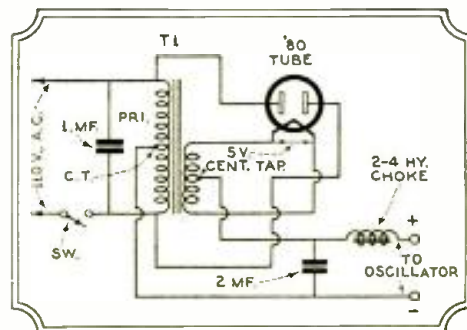

Fig. 3

Here's another way to raise that line voltage.



# THE RADIO CRAFTSMAN'S PAGE

The Bulletin Board for  
Our Experimental Readers

## THE A.C. PORTABLE PENTODE ON SHORT WAVES

Editor, RADIO-CRAFT:

In the September issue of RADIO-CRAFT you published the diagram and data for the "A.C. Pentode Portable" receiver designed for the broadcast band. Being tired of buying batteries for my short-wave receiver, I used your hookup for the 20, 40 and 80 meter bands and built the set as per your data with the following exceptions: Instead of using the speaker field for a choke, I used two 30 henry chokes; and instead of the output transformer specified, I used a type '45 push-pull transformer, all of the primary being used instead of just half. In other words, the center tap of the primary is not used at all. R.E.L. coils and bases were used and an old S.L.F. tuning condenser designed for the broadcast band was torn apart and all of the rotor plates and all but two of the stator plates were removed. One new rotor plate was cut from sheet brass and double spaced between the two stator plates that were left. This arrangement gives excellent band spreading of the "ham" frequencies. Headphones are uncomfortable because of the enormous volume. When a metal panel is used as a shield, hand capacity effects are negligible. We have tried most of the common tube combinations but have found that the '24 and '47 layout gives best results.

I have not missed a single issue of RADIO-CRAFT for the past three years; they are indexed, and the indices are kept in a loose-leaf binder so that the whole stack need not be gone over if an article two years old must be found.

Hoping that this may be of use to some other fellow, I am

J. B. SMITH, W5AXR,  
216 W. Stephenson Ave.,  
Harrison, Ark.

(We have received a number of congratulations on the use of this receiver in the broadcast band. Now, let's see how big a record we can pile up on the S.W. band.—Editor.)

## A SINGLE CIRCUIT AUTO RECEIVER

Editor, RADIO-CRAFT:

If you have never tried a single-circuit regenerative set in an automobile, you might be surprised at the results obtained under good conditions. I am not advocating it as a substitute for a standard auto radio, but in my case I often sleep

## IMPORTANT NOTICE

In the interest of those readers who do not like to mutilate this magazine, we have asked our advertisers not to place coupons in their advertisements.

Instead of the usual coupons, you will find a number of convenient post cards inserted between the last page and the back cover of this magazine.

This new service will save you time and work. No need to cut coupons, nor is it necessary to hunt for and address envelopes. Moreover, the space for your name on a coupon is usually so small that the advertiser is often not able to make out your writing and then you wonder why you do not get the literature sent for.

Then, last but not least—the postage for a postal card is only 1c whereas a letter costs 2c and will soon perhaps cost 3c if Congress raises the first-class postal rate.

Read the advertisements and then turn to the page containing the special postal cards. Detach, fill out and mail the card of the advertiser whose literature or offers you want to have sent to you.

Mail your card today! Show the advertisers that you appreciate their cooperation and thoughtfulness.

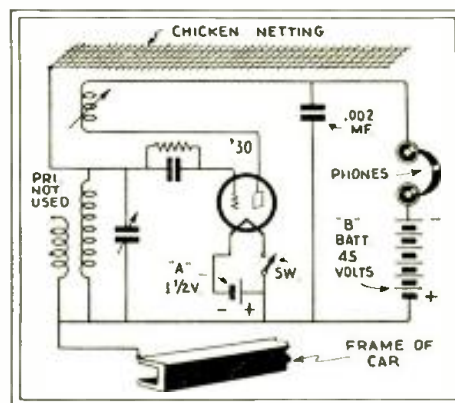

The "latest" advances in auto-radio design

in my car at night away from home, and I use a one-tube set with headphones to hear my bedtime story.

Stations up and down the Pacific coast can be heard quite plainly. With an audio tube added, it undoubtedly could be used to listen to local stations while riding, as instrumental music could be heard above the noise in my car (which is not a late model) from powerful stations 50 miles

away. The accompanying sketch clearly shows the mode of connection.

The set is of the conventional type assembled in a strong oak box. A type '30 tube is used with one dry cell for filament voltage; in this manner its operation is entirely independent of the condition of the car battery. The coil is a Birnbach 3-circuit tuner with the antenna connected to the top of the secondary and the primary not being used at all. The antenna I am now using is a piece of chicken netting about 2 feet wide and 4 feet long. The set is grounded to the frame of the car.

H. A. HARRIS,  
932 Clark St.,  
Santa Rosa, Calif.

## THESE TUBE VOLTAGES

Editor, RADIO-CRAFT:

From data sheets published by you, I note that operating voltages of the '35 tube vary greatly with different manufacturers. Some specifications call for 225 volts on the plate, others as low as 160. Also, screen-grid voltage, grid bias voltage and plate current show great variations.

I believe that a number of readers who, like myself, are not so well grounded in radio theory, would appreciate an article on this subject. Could you publish one in the near future? Have learned quite a bit about radio from RADIO-CRAFT.

WILLIAM J. RYAN,  
1053 Bryant Ave.,  
New York City.

(It is very difficult to write an article covering this subject. The same reasoning applies in the design of radio sets as would apply, for instance, in the design of automobiles. One manufacturer of a car might use one type of bearing and another manufacturer making the same class of car will use an entirely different bearing for exactly the same purpose. The reason seems to be a matter of opinion. While the rated voltages should be adhered to at all times, nevertheless, occasions arise where this condition would complicate design. For instance, the rated plate voltage of a certain tube may be 250 but when used in a resistance-coupled amplifier, an actual "B" voltage of approximately 750 may be required in order that the rated voltage of 250 be applied between plate and filament of the tube. In all probability the "B" voltage supplied in all cases cited are the same although the actual plate voltage on the tube itself varies with different designs.—Editor.)

# RADIO-CRAFT'S INFORMATION BUREAU

SPECIAL NOTICE TO CORRESPONDENTS: Ask as many questions as you like, but please observe these rules:

Furnish sufficient information, and draw a careful diagram when needed, to explain your meaning; use only one side of the paper. List each question.

Those questions which are found to represent the greatest general interest will be published here, to the extent that space permits. At least five weeks must elapse between the receipt of a question

and the appearance of its answer here.

Replies, magazines, etc., cannot be sent C. O. D.

Inquiries can be answered by mail only when accompanied by 25 cents (stamps) for each separate question.

Other inquiries should be marked "For Publication," to avoid misunderstanding.

## READRITE 550 OSCILLATOR

(164) Mr. Wm. B. Marshman, Washington, Pa.  
(Q.) I am not a subscriber to your magazine, but I buy it every month on the newsstand.

In the May, 1932 issue you have an article on the Readrite 550 service oscillator, but values for the parts were not given. Is this information now available?

(A.) Following are data recently released by the Readrite Meter Works, in connection with this service instrument.

The capacity of the broadcast and int. tuning condenser is .0005-mf.; I.F. loading condenser, .0005-mf.; grid condenser, .001-mf.; feedback condenser, .001- or .002-mf. The value of R1 is 0.1- to 1. meg., depending upon the tone desired. The broadcast coil form is 1 1/4 in. in dia. and contains 100 turns of No. 24 wire, center-tapped; the I.F. tuning coil is 1 1/4 in. in diameter and contains 485 turns of No. 34 wire, center-tapped; the value of the R.F. choke is 85 mhy.; the pickup coil contains 15 turns of No. 34 wire wound 1/2-in. from the grid end of the I.F. tuning coil.

## HARRISON & GREEN'S "ANALYZER AND TOOL KIT"

(165) Mr. Walter K. Tandar, Dubuque, Ia.  
(Q.) In connection with the article, "Analyzer and Tool Kit," by H. Harrison and W. Green, in the April, 1931 issue of RADIO-CRAFT, it seems impossible in some instances to obtain correct readings; in others, the meter reads backwards. What can be the trouble?

(A.) The circuit as it appeared in RADIO-

CRAFT was at fault. The authors have checked the corrected one we reproduce in Fig. Q.165; at A is shown a change in the panel lettering.

## MOTOR MAJESTIC RECEIVER MODEL 110 CHASSIS

(166) Mr. Karl Wegund, Tulsa, Okla.

(Q.) What service data is there available in connection with the automotive radio set of Majestic?

(A.) In Fig. Q.166 is shown the schematic circuit of the Model 110 chassis which is incorporated in the Grigsby-Grunow "Motor Majestic" car radio set.

Resistor R1, manual volume control, has a value of 0.1-meg.; R2, R3, R4, 0.2-meg.; R5, R6, 50,000 ohms; R7, 750 ohms; R8, 50 ohms; R9, R10, 0.1-meg.; R11, 800 ohms.

Condensers C1, C2, C3, tuning units, 410 mmf.; C4, C5, C6, band compensating con-

(Continued on page 114)

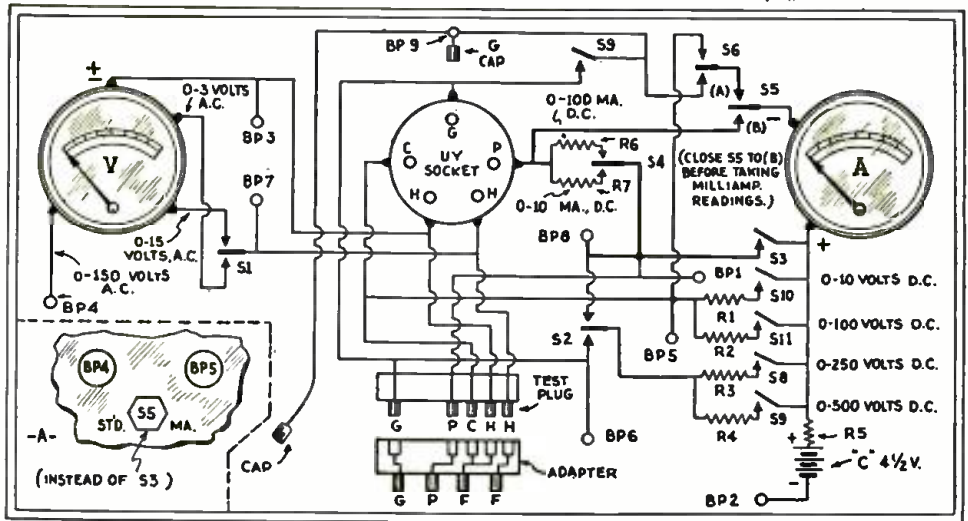

Fig. Q.165. Corrected diagram of the Harris and Green "Analyzer and Tool Kit."

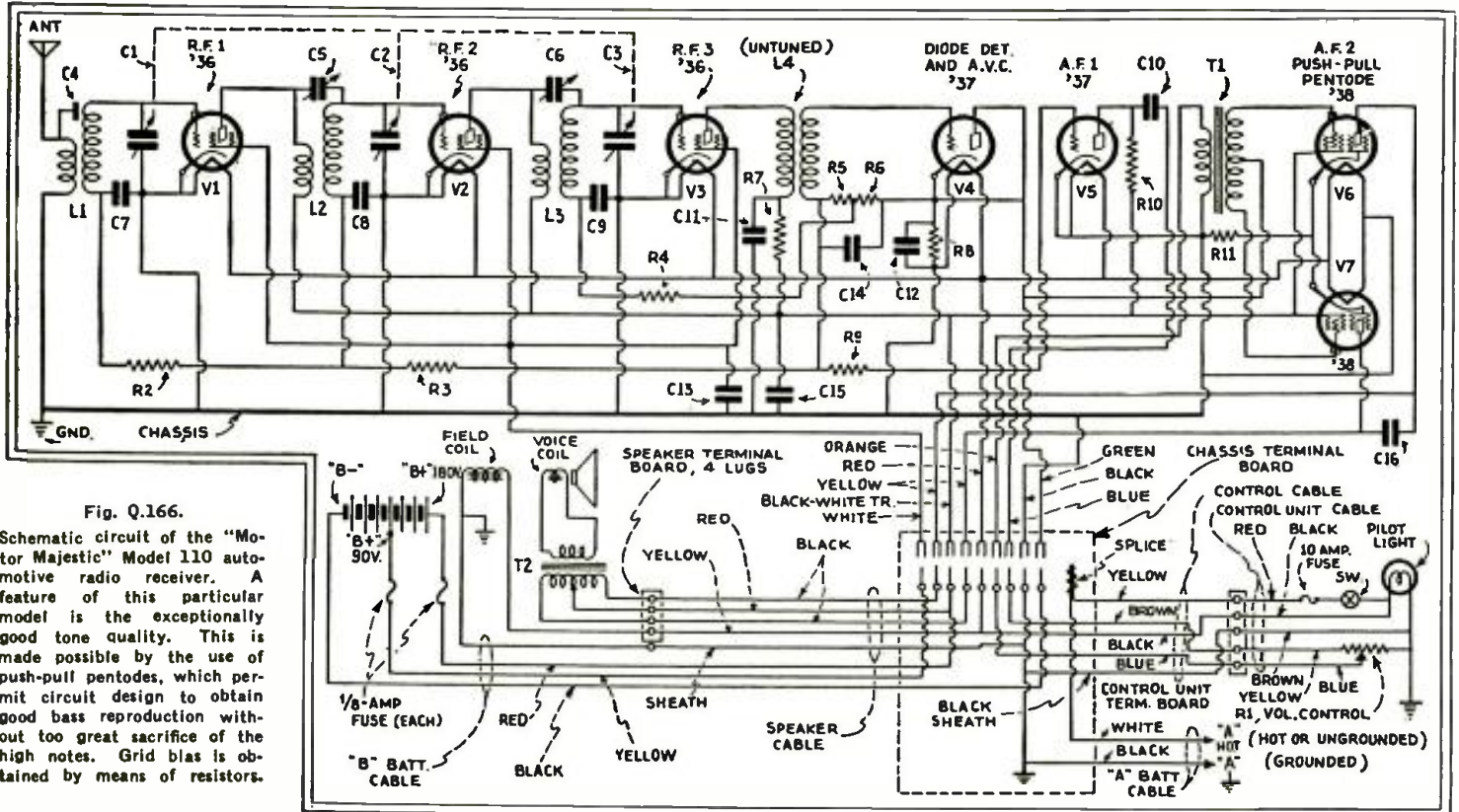

Fig. Q.166.

Schematic circuit of the "Motor Majestic" Model 110 automotive radio receiver. A feature of this particular model is the exceptionally good tone quality. This is made possible by the use of push-pull pentodes, which permit circuit design to obtain good bass reproduction without too great sacrifice of the high notes. Grid bias is obtained by means of resistors.



## BOOK REVIEW

"The Listener's Official Radio Log," published by All-American Service, 5707 North Clark Street, Chicago, Ill.; 36 pages, 5 1/4 x 10 inches, price 25c.

This is a very handy reference book for both the broadcast listener and the short-wave experimenter. It lists all the broadcasting stations in the United States, Canada, Cuba and the other principal countries of the world, and also short-wave broadcasting stations and police and aircraft stations. Two very useful radio time maps of the United States and of the whole world are included. The lists of call letters are arranged in such a manner that the user of the log can record his dial settings directly on the pages.

**Essentials of Television—Part I.** The first book of the National Radio Institute series on television is devoted to an introduction of the subject. The fundamental terms of television are defined, and the function of scanning explained. A number of different scanning methods are illustrated and recent television inventions such as colorvision and noctovision are described generally. In common with all the other books of the N. R. I. series, the last page is devoted to a series of test questions by means of which the reader or student can determine how much he has learned.

**Essentials of Television—Part II.** The peculiar frequency requirements for successful television transmission are treated thoroughly and at length in this book. The problem of adapting the allowable frequencies with a maximum of effectiveness is discussed, as is the use of the photoelectric cell and the neon tube. The last few pages are devoted to a description of elementary cathode-ray tube operation.

**Optics.**—Since the science of optics plays an extremely important part in television, this subject is treated at length, and particular emphases are given to those phenomena that have a direct relation to television problems. Among the matters discussed are the meaning of light, the properties of light waves, the reflection and refraction of light, the measurement of light intensities and the properties of various colors.

**Geometric Optics.**—This booklet is an extension of the preceding one and is intended to complete the student's knowledge of optics as applied to television art. The subjects here considered are the action of light on plain and spherical mirrors, prisms, lenses and the important properties of polarized light. The Kerr effect, which has been made use of by Karalous and Alexanderson, is explained in very clear language.

**Applied Optics.**—The third and last book on optics deals with the application of the previous lessons to such practical instruments as the camera, the motion-picture projector and sound film recorders and projectors. Various television systems involving the use of lenses are described.

**Television Quality Requirements.**—This lesson goes into detail on the subject of the picture elements necessary to good television transmission. The illumination of the subject to be scanned, and the cooperation of the eye in landing persistence of vision, lead in this book to a discussion of the electrical problems of television for the faithful reproduction of the image.

**Synchronization and Framing.**—The rigid necessities for synchronism between the scanning discs at both the transmitting and receiving ends is outlined in this book, as are the available methods for maintenance of this condition. Various types of synchronous motors are described. Special attention is given to synchronizing and framing troubles, such as the appearance of negative, ghost and inverted images.

**Telephotography and Facsimile Transmission.**—As telephotography and facsimile transmission bear a close relationship to television, they are dealt with at length in this book to complete the education of the television student. Data are given on the coded, modulated, dot-and-dash, and photo-radio systems. The illustrations in this book are unusually complete and interesting.

(Continued on page 114)

# Midwest 13-Tube, 15-Tube ALL WORLD-ALL WAVE



ENGLAND,  
HOLLAND, GERMANY,  
FRANCE, ITALY, SOUTH AMERICA,  
AUSTRALIA, HAWAII, JAPAN

These sensational new Midwest, ALL-WORLD, ALL-WAVE 13 to 15 tube sets bring you the WHOLE WORLD of radio! SHORT-WAVE and standard wave broadcasts not only from U. S. stations, coast to coast, but from many foreign countries. Canada, Mexico, Cuba, Hawaii, come in like locals. Scores of letters on file in our office show that Midwest users are regularly enjoying programs from all over the world.

**30 DAYS TRIAL:** Select the Midwest you want and try it 30 days—free—in your own home. Satisfaction or no sale... that's the Midwest way.

### Gets Germany, Italy, France

"March 2nd, I picked up Germany, France and Italy. On the following day, I got Rome again and heard all the music from the Royal Opera House." A. Musconi, 7122 Paschall Ave., Philadelphia, Pa.



Short Wave Converter

Converts any A.C. set of adequate sensitivity into a short-wave receiver for reception of U. S. and foreign short-wave broadcasts, airplane conversations, ships at sea. Only \$16.75 completely assembled. Coupon brings full details. Mail it now!

### AIRCELL BATTERY 8-Tube Sets

For homes without electricity. Amazing new AIRCELL Battery does away with all battery troubles. Never needs recharging. Brings the joys of radio to any home. 8-tube battery chassis completely assembled with speaker now only \$19.95.

only  
**\$37.50**  
COMPLETELY ASSEMBLED  
— WITH —  
LARGE DYNAMIC  
— SPEAKER —

### 11-TUBE SUPER HET

REAL AUTOMATIC VOLUME CONTROL, BALANCED SUPER-HETERODYNE UNIT, PIN-DOT SELECTIVITY, LARGE SIZE ELECTRO-DYNAMIC SPEAKER that reproduces voice or music without distortion. The season's outstanding radio sensation. And you buy it direct from the Midwest factory at a positive saving of 30% to 50%, 30 days free trial—and easy payments if you wish. Coupon brings full details—mail it NOW!

**TERMS**  
as low as  
**\$5.00 DOWN**

### Buy Direct From Factory—Save Up to 50%

Every Midwest set is fully assembled, thoroughly tested, comes to you ready to plug in, and is backed by an absolute guarantee of satisfaction. The big, new Midwest Catalog shows sensational bargains in 13 and 15 tube ALL-WORLD, ALL-WAVE Combinations, 9 and 11 tube Super Hets., 4-tube Short Wave Converter and new AIRCELL BATTERY sets. Get all the facts before you buy a radio of any kind. Mail coupon now!

**MIDWEST RADIO CORP.**  
Dept. 91 (Est. 1929) CINCINNATI, O.

**Sign and Mail! NOW!**

MIDWEST RADIO CORP., [ ] Send me special user agents proposition.  
Dept. 91, Cincinnati, Ohio.

Without obligation send me your new 1932 catalog and complete details of 13 and 15-tube All-World, All-Wave Combinations, 4-tube Converter, 9 and 11 tube Super-Heterodynes, low factory prices, easy terms and liberal 30-day free trial offer.

Name .....  
Address .....  
Town ..... State .....



# Now 3

## HANDY KITS

No two ranges alike

**1-Watt Kit**  
List price \$6.00  
Your price \$3.50

**2-Watt Kit**  
List price \$8.00  
Your price \$4.65

**Grid Bias Kit**  
List price \$3.70  
Your price \$2.15

(Prices higher in Canada)

THE first of these kits contains 20 Resistors; the second 20, and the third 10. Complete data goes with them showing how to obtain thousands of ranges from these units—also the proper biasing of tubes. See your jobber or write direct. Remember, with either of the 20-unit Kits, we send the famous I.R.C. Resistor Replacement Guide and Color Code Chart free.

INTERNATIONAL RESISTANCE CO.  
Philadelphia, Pa. Toronto, Can.



# Metallized RESISTORS

## Headquarters for Testing Equipment

WESTON, JEWELL, SUPREME, HICKOK, DAYRAD, AND READRITE. WE HAVE THE LARGEST STOCK IN NEW YORK AND INVITE YOUR INSPECTION. We have all parts for the OHM-OUTPUT METER Described in this issue.

Complete Parts—including Meter Drilled and Engraved Panel	<b>\$17.50</b>	Net
1 Special Dial for Weston Meter	.....	.45
1 Weston, No. 301, 0-1 ohm. Meter	.....	7.35
1 Taurex Rectifier, with Chart	.....	2.95
1 Rest, 3 NS 6 K Switch	.....	1.70
2 Van Sluents, .88 ea.	.....	1.76
1 Lynch, 4000-ohm Res.	.....	.18
1 Lynch, 500-ohm Res.	.....	.18
1 Lynch, 10,000-ohm Res.	.....	.18
1 Lynch, 100,000-ohm Res.	.....	.18
1 Electrad, R1-276 Var. Res.	.....	.55
1 Knob	.....	.10
1 Charostat, Res., 50-ohm	.....	.40
4 International, Tip Jacks	.....	.40
1 Bakelite Panel, Drilled & Engr.	.....	1.85
1 Blue Print	.....	.15
Individual Parts Total	.....	\$18.08

Due to the Cost of Packing, No Orders Can Be Accepted for Less Than \$3.00.  
20% Deposit Must Accompany All C.O.D. Orders.  
MR. JACK GRAND IS CONNECTED WITH THIS ORGANIZATION FOR YOUR ASSISTANCE.

**SUN RADIO CO.**  
64 VESEY ST. N.Y.

# AN A. C.—D. C. PORTABLE RECEIVER

(Continued from page 75)

panel laid away in a dry place for about three hours. A coat of thin shellac may then be applied and allowed to stand for about six hours. When the shellac has become thoroughly hardened the surface should be rubbed down with fine sandpaper, after which a coat of furniture wax may be applied with very attractive results, or a second coat of shellac followed by a coat of lemon oil will make a nice finish. A piece of speaker cloth should be glued to the back of the panel, over the large hole intended for the speaker opening.

### The Chassis

The chassis illustrated in Fig. 3 is made from 1/16-inch sheet aluminum, with but a single bend, which is downward, and located along the front. The two lower corners of the front are cut off, to allow the chassis to slide into the cabinet without striking the corner blocks. Each end of the front is also cut back a quarter of an inch from the edge to allow the chassis to slide into the grooves that are provided in the sides of the cabinet.

For the location of components, Figs. B and C should be consulted. It would be advisable to mount the sockets first. The first R.F. socket is mounted with the heater terminals facing the front of the chassis. The heater terminals of the second R.F. socket face to the right and those of the detector socket face to the back. The heater terminals of the two A.F. and two rectifier sockets all face to the right-hand end of the chassis. The R.F. coils can then be mounted followed by the tuning condenser.

In mounting the speaker, the two bolts securing the transformer to the frame should be removed and the mounting holes in the transformer frame enlarged. Care must be taken not to break the wires connecting the transformer with the voice coil. Replace the transformer using 3/16 by 2 1/2 in. stove bolts. Allow these bolts to pass downward through the transformer frame, the speaker frame and the chassis. By means of the same bolts, mount the filter choke, placing spacers between the chassis and the choke core; then screw on the nuts after the choke has been mounted, and tighten.

The vitreous enamel filament resistor R9, is mounted in an upright position by means of a four-inch bolt. An insulating washer should be placed at each end of the resistor. The 3/8-in. holes located to the left and front of it, as well as the one located in front of the tuning condenser, should have rubber grommets inserted to protect the covering of the wires from being cut where they pass through the chassis. The hole to the left of the filament resistor is intended for the transformer leads, passing beneath the chassis. The one in front of the resistor is for the accommodation of the condenser and beneath the shaft, it is intended for the leads going to the pilot lamp.

The next step in the assembly operation is to fit the tuning dial. Upon sliding the vernier dial over the condenser shaft, it will be seen that the mounting bracket extends below the top edge of the chassis, thus preventing the dial from being placed as far back on the shaft as it should go. Allowing the bracket to hang perpendicular, and pushing the dial as far back on the condenser shaft as it will go, mark the bracket flush with the top of the chassis with a pencil. Remove the dial and with a hacksaw, cut the bracket off at the place marked. Now replace the dial, pushing it back on the condenser shaft until the front edge of the bracket is flush with the front of the chassis. If the condenser shaft protrudes beyond the front edge of the dial bushing, score the shaft with a sharp instrument and saw the protruding length off with a hacksaw, afterward smoothing the edge with a file.

The panel can be bolted to the face of the speaker by means of four 8-32 screws under the heads of which finishing washers are used. The volume-control and switch, mounted beneath the speaker, also helps to secure the panel to the chassis.

In mounting the large electrolytic condensers, one lug of the mounting bracket is cut off, and the other lug straightened out parallel

with the side of the condenser. This lug is then bolted to the underside of the chassis, with a spacer between the chassis and the lug thick enough to allow the necessary wires to pass between the chassis and the condensers. The small electrolytic is mounted by soldering the can lug to a solder lug bolted to the chassis. The two R.F. tubes are the only ones shielded and the rings for holding the tube shields should be mounted on top of the chassis by means of the same screws that hold the sockets.

In connecting the R.F. coils, it should be remembered, that the top of the secondary is the grid end and the bottom end of the primary is the antenna end of the first coil and the plate end of the others. In the set of coils used by the author, there was no difference between the antenna coil and the others. This is not always true, however, and each set of coils should be carefully inspected to see if the primaries of all coils have the same number of turns. If one coil is found with less turns on the primary than the others that coil should be used in the antenna circuit. Shielded grid leads should be used on the R.F. and detector tubes with the shielding grounded to the chassis.

### Testing and Operating the Receiver

After connecting the antenna to the antenna binding post, attach the power-line plug to an electric light outlet of a 105- to 125-volt service. If the line switch is open, turn the knob under the speaker to the right until a snap is heard; the pilot lamp should light at once. If it does not, turn off switch and check over the wiring; look for wrong connections, unsoldered or poorly soldered joints, or an open in the filament-resistor R9. Also test flashlight lamp with a battery or a continuity tester.

When the pilot lamp lights, give the tubes about a half minute to warm up, and turn the knob beneath the speaker as far to the right as it will turn, then try to tune in a station by turning the tuning dial slowly. If the service is D.C. and no sound is heard, reverse the plug in the outlet. Reversing the plug in A.C. outlets may improve reception if the grounded side of plug is not connected to the grounded side of the service. Noisy reception can sometimes be eliminated in this way. If possible, a station with a rather weak signal should be tuned in on the higher frequency or minimum-capacity side of the dial; with a small screwdriver having a wood or bakelite handle, adjust each trimmer condenser by turning the screw in and out, until the position of maximum volume is found.

One condenser will be found to be far more sensitive to adjustment than the other two. An occasional readjustment of the tuning dial may be necessary during this operation. If the volume at any time during the adjustment reaches too high a level, it should be reduced by means of the volume-control. Broad tuning and cross-talk is usually the result of using too long an antenna.

In placing the receiver in the cabinet, the two overhanging ends of the chassis should slide into their respective slots, in the sides of the cabinet. The panel should then be fastened by means of four No. 8 wood screws, with finishing washers under their heads. The screws should be inserted in the four corner holes of the panel and screwed into the ends of the corner blocks of the cabinet.

### Operating from 220 Volt Service

The receiver may be operated from 220-volt service by connecting a 110-volt, 50-watt lamp in series with one side of the power cord. The lamp should be inserted in the positive lead, that is, the lead opposite the one grounded to the chassis.

(It will be recalled that the fundamental circuit used in the power supply of this receiver is identical with that used by Mr. H. G. Cish in a receiver described in the May issue of this publication. Mr. Davis, however, was not aware of Mr. Cish's work while designing this receiver.—Editor.)

### List of Parts

One aluminum chassis; Blank;  
One set of 3 R.F. coils and shields, Automatic  
(Continued on page 112)



# NON-REGENERATIVE AMPLIFICATION

(Continued from page 81)

ing element, the capacitive coupling is a minimum at the high-frequency end and a maximum at the low-frequency end. Thus the changes in capacitive coupling are exactly opposite to the inductive coupling and flat response over the entire band is secured.

Response curves of the receiver are indicated in Fig. 4. The upper part of the diagram illustrates the response of a 4-tube and the lower of a six-tube receiver using the Daley design. The sensitivity shown is in absolute values and must be divided by 4 to secure microvolts per meter. (The flatness of these curves are positively unanny and really represent a desirable feature, needed for a long time.—*Editor.*)

## Shielding

The second detail discussed in the first part of this paper is an important one. If the magnetic field of a coil is large, then the shield can must be abnormally large if complete shielding is to be accomplished. Since, with this system, the only field around the coil is due to the signal, the shield cans may be made very small, and in some cases actually dispensed with entirely!

This simple expedient, that of isolating the primary of the R.F. coil from the plate by a choke coil, has been used previously, but not with the idea of increasing fidelity and decreasing the necessity for shielding. If this choke is to be used, then the condenser C1 must also be added, as stated before, to isolate the grid of V2 from the plate of V1. This means that the load on V1 is no longer resistive at resonance, so to compensate for this, the leads of the primary of the R.F. transformer are reversed so that at all times the load current and the signal voltage are in phase, which, in technical language, means a resistive load.

Thus, in this system, the amount of amplification is, theoretically at least, limited only to the resistance of the coil; the lower the coil resistance the greater the load current; while in other systems, the amplification is limited not only by coil resistance, but by oscillation.

## Additional Features

Another feature of this receiver is the fact that many more tuned stages may be used than were heretofore possible. In an ordinary receiver, interstage coupling limits the number of tuned stages that may be successfully employed without oscillation. With the Daley

system, the R.F. currents are localized within its particular stage because of the chokes, and since the R.F. coils are shielded, interstage coupling is at a minimum. The number of tuned stages, consequently, depends upon the tolerances set in the design of the coils and the condensers. Six tuned R.F. stages were successfully employed, as indicated in the photograph of Fig. A.

## Selectivity

Real 10 kc. selectivity is secured. Fig. 5 shows the selectivity curve of this receiver (six-tube type) at 600, 1,000 and 1,400 kc. Note that the curve is 10 kc. wide and only deviates from this value when the applied signal strength is 100-times normal. (These curves were made in accordance with I.R.E. standards using a standard dummy antenna and maintaining a constant output of 50 milliwatts—*Editor.*) Fig. 6 shows the selectivity curve of the four-tube receiver, the same conditions obtaining. It will be noticed, of course, that the selectivity is better with the six tuned circuits than with the four stages, which is to be expected.

By further application, this principle may be applied to audio systems as well as to R.F. systems.

## Parts List

With reference to Fig. 1, the parts have the following values: C1 to C6 (inclusive), variable tuning condensers, .00035-mf.; C7 to C12 (inclusive), fixed condensers, .01-mf.; C13 to C17 (inclusive), fixed condensers, .00087-mf.; C18, C19, fixed condensers, .001-mf.; C20, C21, bypass condensers, 2 mf.; C22, bypass condenser .05-mf.; C23, fixed condenser, .005-mf.; L1 to L6 (inclusive), primary coil, 22.5 millihenries; L7 to L12 (inclusive), 275 millihenries; L13 to L18, (inclusive), R.F. chokes, 175 microhenries; R1, R.F. cathode resistor, 300 ohms, max.; R2, detector cathode resistor, 25,000 ohms; S, stage selector switch, 4 or 6 stages. Exactly the same values hold for the circuit shown in Fig. 2 as stated above.

The tubes used are of special design, having an amplification factor of 30, are similar to the high- $\mu$  40 with the exception that they have a cathode, as indicated in the wiring diagrams. The same design, however, may be used with present-day tubes that are readily available.

Winding details of the coils used in this receiver are given in Fig. 7, which is self explanatory.

# ELECTRIFYING THE MEGADYNE

(Continued from page 85)

ing as a voltage-limiting unit, also functions as a part of the filter system.

In the "breadboard" model, a common "can" connection for the three electrolytic condensers is obtained by mounting them on a strip of aluminum about  $\frac{3}{4}$  x  $5\frac{1}{2}$  x  $\frac{3}{32}$ -in. thick, supported,  $\frac{3}{4}$ -in. from the baseboard by means of two metal brackets. Resistors 8 and 9 are also mounted on brackets.

Due to the fact that the type of resistor specified for 8 and 9 has a case which constitutes one of the two connections, care must be taken to insulate these units in the event that they are mounted on either a common or a grounded strip of metal.

If a slight hum is heard, look for inductive coupling between this power pack and the receiver or its associated leads. Exceptional care has been taken in the design of this unit to reduce the hum level at the output potential terminals to the lowest possible point; however, the fields of the power transformer and the filter chokes are very strong, and if they are permitted to interact with the receiver equipment, hum from the reproducer will be heard, the strength being dependent upon whether the inductive pickup at one point adds to or subtracts from the pickup at another.

Although the power transformer has five secondaries, only three are used; consequently, only three are shown in Fig. 2. These unused (1.5 V. and 2.5 V.) secondary leads may be curled up and taped or, as in the unit illustrated in Fig. A, cut off close to the trans-

former. The unused leads are the following: heavy red; heavy black; thin red, black dot (the latter is a tap from the primary for matching the primary circuit to the available line voltage; whether this wire or the thin red one is to be retained is a matter of taste.)

As a final word of caution, the constructor is advised to make sure that all of the parts have the values specified. In addition to the usual miscellany, screws, wire, etc., the following components will be required:

The battery type "Megadyne" described in the July issue is now connected to the Power pack. Resistors 8 and 9 are adjusted so that stations come in loudest. The adjustments are then left in position and should not be touched thereafter.

Tuning and operating the Megadyne remains as before.

## List of Parts

- One Polymet power transformer, type TF-917, 1;
- Two Polymet filter chokes, type TC-796, 6, 7;
- One Concourse electrolytic condenser, 4 mf., 400 volts, 3;
- Two Concourse electrolytic condensers, 8 mf., 400 volts, 4, 5;
- Two Clarostat variable resistors, standard type, 8, 9;
- One Flechtheim, 1, mf., 200-volt condenser, 10;
- One fixed resistor, 10,000 ohms, 1 watt, 11;
- One binding post strip, 12;
- One Pilot tube socket, UX-type, for V1, 2;
- One G. E. power cable, with plug;
- One wood baseboard,  $7\frac{1}{2}$  x  $11\frac{1}{2}$  x  $\frac{5}{8}$ -in.

"Elected"

# to make RADIO HISTORY in 1932-33



The Crosley PUP

This 4-tube superheterodyne housed in a beautiful silver-gray metal cabinet is a radio marvel. It incorporates balanced image suppressor pre-selector—combined volume control and on-off switch—illuminated station selector—dynamic speaker and other outstanding features. Dimensions:  $7\frac{1}{2}$ " high,  $12\frac{1}{2}$ " wide, 7" deep.

**\$25.00**  
Complete with Tubes Plus Tax

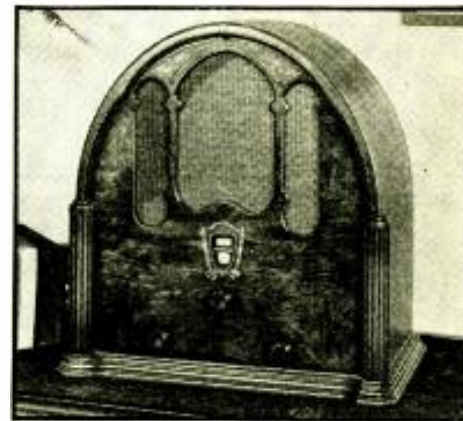

The Crosley MAYOR

The leader of the famous Crosley "Election" series. The 9-tube chassis includes silent automatic volume control— $2\frac{1}{2}$ -volt heater tubes—meter tuning—double tuned image suppressor pre-selector—four gang tuning condenser. Dynamic speaker is used. See your Crosley Distributor for full details of the sensational new Crosley line.

**\$49.95**  
Complete with Tubes Plus Tax

Western Prices Slightly Higher

THE CROSLEY RADIO CORPORATION

Powel Crosley, Jr., President

Home of "the Nation's Station"—WLW

CINCINNATI

YOU'RE THERE WITH A CROSLEY  
**CROSLEY  
RADIO**

# AUTO RADIO

**\$16<sup>95</sup>**  
**COMPLETE**

**"BUILD IT" — install it yourself. Save 100%. 5 Tubes — powerful Auto Type. "Dynamic" Speaker. Reception covers entire band, 195-550 meters. Range 100-1000 miles. Steering column control with illuminated Dial, Key Switch and 30" flexible shaft. Small size: 5 x 7 x 7". Mounts anywhere with universal bracket.**

### EVERYTHING FURNISHED

Our simple ABC instructions make assembly and installation easy. **Everything furnished.** Price includes all accessories. (RCA 6' d Tubes, remote steering column control, Dynamic Speaker, steel shielded Connecting Cable, Ignition Spark Suppressors, Antenna Equipment), **nothing else to buy except "B" batteries;** easily, cheaply procured locally. Send \$2 deposit. Balance \$14.95 C.O.D. We pay postage in U.S.A. Order today. Be sure to specify number of cylinders in car.

**5 Tubes**  
**REMOTE CONTROL DYNAMIC SPEAKER**

**MY OWN RADIO, Inc.**  
Dept. 102  
1800 Grace St., Chicago, Ill.



broadcasting through your own radio, at home, with a

### SYLKO HOME MIKE

Look it up in two minutes without tools. Simple instructions and diagram enclosed with microphone. More fun than a circus. Send 95c today or specify C.O.D.

**95c**

**SYLKO MICROPHONE CO., Dept. B.**  
131 Islington St. Toledo, Ohio

Be sure to turn to page 68 and read the important announcement about the extra pages which have been added to the **OFFICIAL REFRIGERATION SERVICE MANUAL.**

## THE "B" TUBE

(Continued from page 84)

ment were secured. The finished "B" tube is illustrated in Fig. A; and a complete "B" unit, in Fig. B. This device measures only 8½ x 5½ x 3½ ins.; and weighs only 8 lbs.

Other improvements were brought about by this simple yet potent expedient, namely, much better waveform with an absence of troublesome harmonics—as indicated by a cathode-ray oscillograph, and freedom from mechanical noise caused by the interrupter (the parts of which are cushion mounted inside the tube).

### The "B" Tube Eliminator

There are two ways in which the transformer primary may be connected with the interrupter: one, in parallel with the circuit, as shown in Fig. 1; the other, in series—indicated in Fig. 2. In the arrangement the interrupter operates directly from the storage battery, drawing some current on its own account; while the primary of the step-up transformer, being connected in shunt with the interrupter coil, is energized by the pulsating voltage across it. The eliminator illustrated in Fig. B utilizes this scheme.

Although very encouraging results were obtained by providing a separate set of contacts insulated from the primary contacts and employing them to make and break at the right intervals, thus eliminating the use of a separate rectifier tube, this scheme since it complicated the construction of the vacuum-interrupter was discarded in the course of experimentation. Although gaseous rectifier tubes have the advantage of requiring no additional current to heat a filament, this advantage is offset by low efficiency and rather fickle behavior.

A type 37 tube with plate and grid externally connected together, performed remarkably well. Its heater is rugged, and may be powered directly from the storage battery. To reduce the internal voltage drop and take some of the strain off the cathode, mercury was introduced into the bulb. Although the potential difference between cathode and heater is then in the order of 200 to 250 volts, and leakage of several microamperes takes place, the insulation between these elements does not break down. A disadvantage of this type of tube, even in quick-heater models, (partly compensated by the use of a voltage divider) is the thermal lag of the heater. A simple one-section filter with a small choke coil was quite sufficient as the waveform obtained was

very good. (Full-wave rectification was tried, and discarded in favor of half-wave rectification.) Since R.F. disturbance from the vacuum-interrupter is much less than that created by a breaker in open air, it is possible to "get by" without the use of R.F. chokes, etc.

A satisfactory unit was thus evolved; and at the October meeting of the Connecticut Valley Section of the I.R.E., held at the Charles Hotel in Springfield, Mass., a completed instrument was formally demonstrated. A critical audience gave its unqualified approval to the device as power supply for a standard motor-car radio set of high sensitivity.

### Comparative Efficiency

Speaking of efficiency, for the sake of comparison a standard 110 V, 60 cycle A.C. "B" eliminator of reputable make was tested; the disappointing results are revealed in Fig. 3 by the curve A. Curve B is that of a dynamotor type auto "B" eliminator which is considered of good make and representative of this class. Curve C is that of one of the vacuum-type units developed during our experiments.

A glance will suffice to show the reader that compared to the others, this latter unit has superior efficiency at about the normally required current drains—between 25 to 40 ma. At these currents the output voltages are 225 and 172 respectively and the efficiency over 50 and up to 56 percent. The input current in amperes varies from 1.2 to 2.4 and the battery voltage from 5.85 to 5.8.

Some set manufacturers deem it necessary to employ as many as eight tubes in order to secure high power output; hence, we must allow 2.4 A. for the heaters of these tubes alone; (It is presumed that 6.3 V. tubes are employed throughout.) Now, if we wish to limit the total current drain to no more than 5 amperes (and this is heavy enough) we shall have 2.6 A. at the most, available for the "B" supply. Taking 180 volts at 45 ma. as the requisite "B" voltage an overall efficiency of 52 percent *must be obtained* from the auto "B" eliminator. (A lower drain is imposed on the battery in the event the receiver has less tubes and requires lower "B" potentials; a six-tube receiver using 30-type tubes was operated very nicely with a total drain of 2.9 A., at 6 volts average.)

### Construction Details

The primary of the step-up transformer was wound *over* the secondary.

The dry electrolytic filter condensers have a working potential of 450 V.; the voltage divider resistors measure 50,000 ohms and are rated at 2 watts. Two condensers, one of .05-mf. and one of .01-mf., are sufficient for completely preventing the R.F. currents from entering the receiver circuit.

Of interest, also, is a unit which enables the operation of 110 V. A.C. receivers from 110 V., D.C. lines. Such a unit using the "B" tube is now under development since considerable demand exists for just this thing. Briefly, in order to obtain a sinusoidal waveform similar to that of the standard A.C. lines, the 110-volt D.C. must be broken up and fed into a transformer having a special primary, and a secondary capable of delivering 110 volts. Fortunately, miserly economy of current is not essential in this case.

Two units of this type have been designed, one for light midget receivers and another for standard radio sets of seven or more tubes. In the former instance, one "B" tube is used; and in the latter, two of them are so connected, that they operate 180° out of phase with each other. In both cases the primary of the special transformer is "tuned" to approximately 60 cycles. This new unit design may be readily adapted for 32-volt as well as 110-volt D.C. use.

For those people who do not care to have a radio in their car as a permanent installation but would like to be able to take their midget receivers along with them to picnics, seashores, camps or other outdoor places, a "B" tube vacuum-interrupter pack of 6 (or 12)

(Continued on page 111)

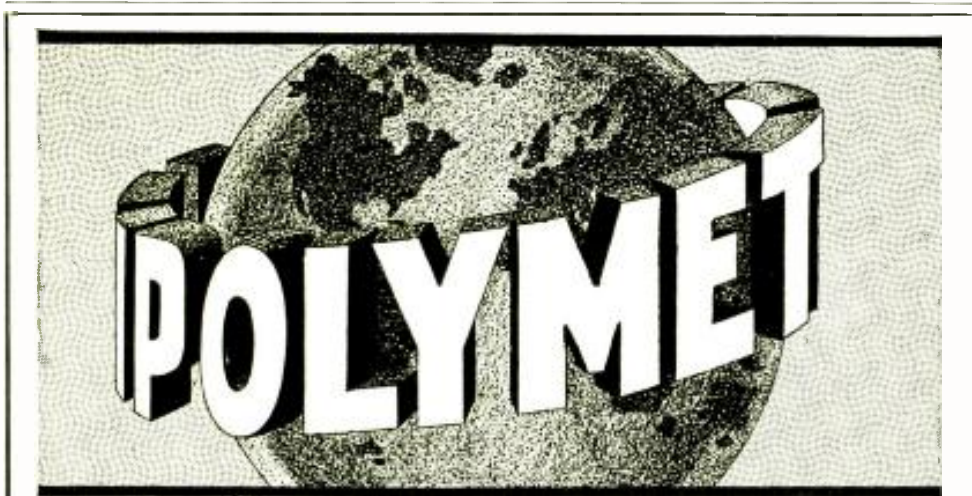

## POLYMET PRODUCTS World—Known World—Accepted

**POLYMET MFG. CORP.**  
834 E. 134th St., New York City

Send me your new and valuable catalog of quality replacement parts.

Name .....  
Address .....  
City ..... State .....  
 Jobber  Dealer  Service-Man

The new 1932 Polymet Catalog gives complete dimension data and electrical specifications of the parts used by leading receiver manufacturers. You can purchase identical parts from your local jobber, and give "guaranteed" service work—a sure way to increase your business and your reputation.

**MAIL COUPON FOR YOUR FREE COPY**



# A MOBILE P. A. SYSTEM

(Continued from page 87)

tracks underneath the dashboard, at the right. The metal plate that the turntable slides on, is notched, so that it can be set and locked in any position. In the illustration, the turntable is shown in the "playing" position. When the phonograph is not in use, the unit slides under the instrument board. The electromagnetic pickup is also arranged on a sliding arm, so when the turntable is pulled out to the playing position, the pickup can be centered and locked.

A small A.C. switch on the metal plate serves to start and stop the phonograph motor. Flexible leads run to an extension outlet on the floor board, so the entire job may be removed for trouble shooting, without unsoldering or resoldering the connecting wires. The design is very compact; and the ingenious method of sliding it out of the way, does not interfere with operating efficiency.

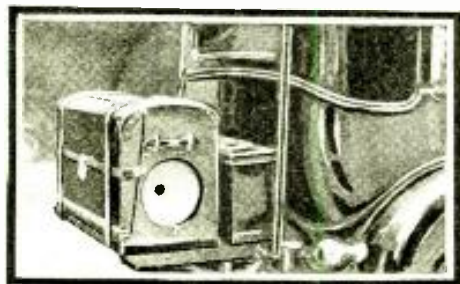

The photograph above illustrates how the power unit and speakers appear when in a normal operating condition. Note that the speaker cone is exposed. In bad weather a cover is placed over it which prevents the cone being damaged due to splashing, rain, etc.

The microphone is suspended vertically within a microphone ring, as illustrated. A high-quality two-button microphone is used. The method of suspension uses four points and eight springs, thus protecting the instrument from jars and mechanical vibration. The microphone ring is fastened on the end of a 3/8-inch diameter hollow brass arm in such a way that it can be pivoted in any direction. Connecting wires run through the arm. The other end of the arm is connected to a swivel mounted beside the rear vision mirror. When the microphone is not in use, the arm is pushed back until it is parallel with the windshield and close to the top of the car, causing it to snap into a spring which holds it in place. An automatic switch at the arm serves to open the microphone circuit when the arm is pushed back. The arm may be locked in any position when opened, by means of a set screw located at the swivel end. When the arm is swung forward, it moves down at an angle, facing the person at the steering wheel.

### The Power Supply

The 110-volt A.C. for operating the system is obtained from a motor-generator outfit. This consists of a 32-volt D.C. motor, operated by means of six storage "A" batteries. This motor drives a 110-volt A.C. generator capable of delivering 300 watts. Under load, the motor draws 15.5 amperes. In addition to supplying current to the amplifier, the generator also supplies field current to the two dynamic speakers. The method of mounting motor generator, speakers and storage batteries is unique and worthy of special attention.

Metal strips are welded on the trunk rack extending it about a foot. The trunk, which is standard equipment on the car, is bolted on the extension rack. The motor generator is

mounted on the bottom of the trunk at the center. Holes are drilled at each end of the trunk for the two loudspeakers and these are fastened in place against 1/2-inch celotex baffle boards, as shown in Fig. 1. Six one-inch diameter holes are drilled in the top of the trunk and four in the bottom, thus creating a continuous draft in order to provide adequate ventilation and prevent overheating. The ventilating holes, and speaker apertures are covered with copper-screening, light enough to be stretched taut, but heavy enough to protect the speakers. Wooden disks are provided for each speaker. The disks fit into metal clamps and keep dust and dirt from the speaker cones. Large size 110-volt A.C. Wright-De-Coster dynamic reproducers are used. These are able to handle the output of the amplifier without distortion.

Three A.C. wall socket outlets are fitted to the back of the trunk, for completing connections without unlocking the trunk. Outlets of three different colors are used, so that their functions are made apparent; these may be obtained from any 5- and 10-cent store.

The storage batteries are mounted in a sheet iron case, which is mounted on the original trunk rack, in back of the trunk. Six Exide 100-ampere storage "A" batteries are employed. Extra heavy double rubber covered wiring connects the batteries to the apparatus at the front of the car. The wiring is run beneath the right rear fender and then under the running board.

A sign on top of the car supported at each end by a heavy iron pipe completes the installation. This is run obliquely, so that it may be seen from any direction. One pipe is mounted on the right side of the trunk rack, while the other pipe is mounted on the left side of the front bumper. The pipes are threaded, so that they can be unscrewed, permitting the sign to be taken down when desired.

This installation is arranged for "one man" operation; the driver of the car can operate the sound system without additional assistance and the arrangement of the sound equipment is such that the car's use as a passenger vehicle is not affected, nor is space for riding convenience eliminated.

### Efficiency

This sound amplification instrument has ample range above the street noise level to be heard for a city block. When tested under an elevated structure, both voice and music could be heard distinctly above the noise of passing trains. The amplifier is pitched high enough, so that when used with the microphone, it is unusually distinct and the "boom" common to most installations is entirely eliminated. The higher pitch also permits the sound to carry without sacrifice of bass response. Due to the excellent design, careful matching of parts and proper selection of speakers, the tone quality is excellent, even at maximum volume.

The schematic wiring diagram in Fig. 1 shows the method of hooking up the various components on this group address system. The pictorial diagram, Fig. 2, gives an idea of the relative locations of the different units.

The author and his associates will be glad to render any assistance desired to those technicians who may undertake the construction of this public address system.

The values of the parts given in the circuit diagram of Fig. 1 are as follows: R1, 50,000 ohms; R2, 1,550 ohms; R3, 400 ohms; R4, 800 ohms; R5, 5,000 ohms; R6, 5,000 ohms; C1, 2 mf.; C2, 2 mf.; C3, 4 mf. (1,500 volt); C4, 2 mf. (1,500 volt); L1, 30 hy.

## THE "B" TUBE

(Continued from page 110)

volts input and 110 V., A.C. output was designed. However, due to the usual midget receiver drawing at least 40 watts and in most instances much more the current drawn from the storage battery is rather heavy.

The writer believes that this field may prove lucrative if a radio receiver is manufactured particularly for the purpose.

In this "universal current" radio receiver, automotive-type tubes could, perhaps, be used and the power pack so designed that with a simple switch to cut a resistor out of circuit the 110-volt A.C. input connections may be changed for 6 or 12 volts D.C. supply. In any event, a suitable interrupter design, in the "B" tube, is now available to manufacturers.



✓ Get it . . . .

✓ Use it . . . .

✓ Cash in on it

✓ Compare it

✓ For 10 days

✓ FREE!



Dealers' Net Price  
F.O.B. Greenwood, Miss.  
**\$147.50**

You have heard of the amazing ease, completeness, quickness and accuracy of the SUPREME DIAGNOMETER—5 instruments in 1. Takes care of ALL the new sets and ALL new tubes, including the seven-prong and six-prong tubes, triple-twin, Wunderlich, Duo-Diode, Mercury vapor Rectifier, etc., WITHOUT ADAPTERS. Maybe you have had no real chance to prove its real economy, its convenience and income producing power. Here's how you can guarantee yourself. Send coupon below and learn how you can use the new DIAGNOMETER for 10 days FREE. No obligation. Prepare now for the on-rushing service demands of the most exciting political grapple of this generation.

**5** ultra modern testing instruments **1**  
in 1 at the price of

Other Supreme Instruments, as follow, carry the same guarantee:

MODEL 90, Supreme Set Analyzer	.....	\$78.50
MODEL 60, Supreme Oscillator	.....	30.00
MODEL 70, Supreme Oscillator	.....	49.75
MODEL 40, Supreme Tube Tester	.....	30.00

We will soon announce the new Supreme Model 56 Analyzer, that will be a sensation. Information now.

All dealers' net prices F.O.B. Greenwood, Miss.  
ASK your Jobber to demonstrate.

**SUPREME INSTRUMENTS CORPORATION,**  
440 Supreme Building, Greenwood, Miss.

Tell me—absolutely without obligation—how I can use the new DIAGNOMETER for 10 days FREE.

(Here insert any other Supreme Instrument desired)

Name .....

Address .....

City..... State.....

Name of Jobber.....

City..... State.....

## Short-wave MOLDED Coil Forms



Four, five and six prong forms, 25c each. Code ring on top of each form in brilliant colors, red, yellow, green and blue. Four prong coil forms, set of four, precision wound, covering fifteen to two hundred meters, \$2.00 a set.

**Molded sockets with colored locator ring—**  
Base mounting

481X 4-prong.....	25c
481Y 5-prong.....	25c

481X      481Y

474 Laminated socket 4-prong ..... 10c

474-5      475 Laminated socket 5-prong ..... 10c

ANT      GND  
Antenna-Ground Binding Posts..... 10c

Grips large or small wires easily. Guard keeps antenna from grounding on chassis. Binding nut cannot come off and become lost.

Binding Post

949 FFP Disc adapter for bringing out filament and plate from pentode tube to provide filament and plate voltage for operating short-wave converters ..... 60c

947 KC 7

**NA-ALO** Adapters made with any type connections desired. New type for testing six prong '57-'58 tubes, the G-2 Diode and '82 Mercury Rectifier. Write your requirements.

3-4-5-6 Prong Speaker or Cable Plugs

905L and 906L Latch Lock Analyzer Plugs 5-prong.....	\$3.00
with 5-foot cable.....	5.00
6-prong.....	3.50
with 5-foot cable.....	5.50

905L and 954DS

965DS Adapter for use with 906L, six prong top, five prong bottom ..... 1.25

964DS same with four prong bottom ..... 1.25

954DS Adapter to use with 905 center locking stud ..... 1.25

954-KPC Pentode Adapter. Connects cathode to plate. Used for replacing 245's with 247 Pentode tubes ..... 1.00

247 Pentode Tubes ..... 1.00

954-FKP Pentode Adapter with resistance in filament reducing 5 volts to 2.5. For putting 247 Pentode tubes in 171 sockets ..... 1.25

954-FS for 171 push pull, are connected in series.....pair 2.00

954 KFP

Send for Price Sheets—Dept. R  
**ALDEN**  
MANUFACTURING COMPANY  
BROCKTON MASS.

### Power Generator

FOR SHORT WAVE BROADCASTING  
Reg. Price Was \$75

U. S. Gov. power generator for radio transmitting made by Westinghouse. Ideal for Amateur Broadcasting. Limited quantity purchased from U. S. Gov. Signal Corps. 900 cycles. 200 watts. 110 Volt R. P. M. 4500. Can be connected direct, belt driven or wind propelled for Aero-planes. Guaranteed new and perfect. Worth \$75.00, but while they last, only \$4.95, plus shipping charges. Send check or money order.

**NATIONAL ELECTRIC TOOL CO.**  
111 W. Lake St. Dept. 188 Chicago, Ill.

While They Last  
**\$4.95**

AERO SHORT WAVE RECEIVER.....	\$ 6.45
AERO AUTO RADIO, Complete.....	39.50
AERO SHORT WAVE CONVERTER.....	12.50

Send for Complete Catalog  
**CHARLES HOODWIN CO.**  
Dept. V-15  
4240 Lincoln Ave. Chicago, Ill.

## RECORDING AT 33-1/3 R. P. M.

(Continued from page 88)

armature is not perpendicular to the plane of the record, and as a result, fidelity of reproduction is not obtained. The pickup should be placed as shown in Fig. 1.

### Surface Noise

In 33-1/3 recording, surface noise is more pronounced than at the higher speed. The frequency of this scratch is in the neighborhood of 3,600 cycles and for this reason is more objectionable. In commercial recording, this surface noise has been diminished considerably by improving the record material, but in instantaneous recording, no determined effort has been made to overcome it. The use of a scratch filter is not recommended; if one were used, every frequency above 4,000 cycles would be eliminated, and the record would lose its brilliancy. In the use of aluminum, this noise becomes especially objectionable near the periphery of the record.

Scratch in recording is due to two things. First, the hardness of material used, and second, the angle the diamond needle makes with the record. Aluminum should be of medium hardness and should be well lubricated or waxed. If the material is too hard, the needle will rip and tear the record and terrific surface noise will result; if it is too soft, the danger of destroying the record will be increased. It is a good policy, after purchasing a ready-made 16 inch recording disc to go over it with a piece of waste that has been soaked in wax. The disc must be spotlessly clean, and when cleaning, soft cheesecloth should be used.

In Fig. 2A is shown how a steel recording needle normally sets in the cuttinghead; note the steep angle that it makes with the record. If a diamond needle is used, the shank should be bent to the position shown in Fig. 2B, so that the sides barely clear the record. Steel needles are made of hardened metal which cannot be bent, but the shanks of diamond needles are made of soft metal, and bending is a simple matter. See that the point of the needle is not too sharp; otherwise, it will tend to cut the record instead of compressing it.

Good 33-1/3 R.P.M. records can be made if care and patience are exercised, and the recordist should not be too easily discouraged if his first trials are unsatisfactory.

### Home Talkies

As stated before, the fields for slow-speed instantaneous records are developing rapidly, and the most interesting one is home talkies. Considerable work has been done on the sound-on-disc method, and in the near future such a machine will be marketed for use by the amateur. While no material is available for publication on this apparatus, the mechanism is quite simple.

From the turntable motor a flexible coupling is brought out which connects to the camera. In making the sound picture, the film is marked with a punch, and a corresponding mark is made on the record. The recording head is then placed on this mark and the section of film with the hole is placed in the aperture. The switch is then thrown and the action started after a few seconds have elapsed to allow the motor to reach operating speed. In showing the picture, the film is placed in the projector with the punched hole in the aperture, the pickup is placed on the "start" mark, and then the motor is started.

When the film breaks, each frame, preparatory to the patching, should be replaced with a blank frame. This protects against the loss of synchronism.

The question of playback needles is another serious problem in reproducing from 33-1/3 R.P.M. aluminum records. The fibre or thorn needle, unless treated, wears out before the end of the record is reached. To prolong the life of these needles, some manufacturers have impregnated the needle with bakelite or shellac, and it is surprising how much longer these needles last. Where a fibre needle barely finished one 12-inch 78 R.P.M. record in good condition, it is now possible to play four of them without resharpening the needle. This means that the needle will now easily last through a fifteen minute, 33-1/3 R.P.M. record.

## AN A. C.—D. C. PORTABLE RECEIVER

(Continued from page 108)

Winding Co., L1 to L6 inclusive;  
One 50-mf., 100-volt dry electrolytic condenser, Aerovox, C16;  
One 8-mf., 500-volt, dry electrolytic condenser, Aerovox, C15;  
One 10-mf., 20-volt, dry electrolytic condenser, Aerovox, C14;  
Five .1-mf., 200-volt, tubular condensers, Aerovox, C10, C12, C8, C4, C5;  
One .0025-mf., mica molded condenser, C7;  
One .0025-mf., mica molded condenser C6;  
One 250-ohm, 50-watt, vitreous enamel resistor R9;  
One 500,000-ohm, 1-watt, carbon resistor, Tru-test, R6;  
Two 250,000-ohm, 1-watt carbon resistor Tru-test, R4, R5;  
One 50,000-ohm, 1-watt carbon resistor Tru-test R3;  
One 100-ohm, 1-watt, carbon resistor, Tru-test, R7;  
One 100-ohm, flexible resistor, Truvolt, R8;  
One 300-ohm, flexible resistor, Truvolt, R2;  
One line switch and 10,000-ohm volume-control Carter, R1;  
One antenna binding post, Eby;  
Seven U. Y. wafer sockets, Eby;  
One wood panel;  
One Jensen-type P.M.I. dynamic speaker, with output-transformer for operation with pentode tubes;  
One A.F. transformer with 1,200-ohm secondary, Kenyon, (choke);  
Two-tube shields with bases, Hammarlund;  
One .000375-mf., three-gang condenser, De Jur, No. 3503; clockwise, min. to max., C1, C9, C2, C11, C3, C13;  
One vernier dial—De Jur type R, sector vision, flat, clockwise 0-100;  
Two large size brown bakelite knobs;  
One dial light, De Jur type U;  
One esentcheon, De Jur type D, sector vision;

One appliance attachment split plug;  
One and one-half feet shielded copper wire for grid leads;  
Ten feet of lamp cord;  
Ten feet of solid push-back hookup wire;  
Ten solder lugs;  
Eight No. 8—32 hex nuts;  
Four No. 8—32 x 1/4-in. nickel oval-head screws;  
Four No. 8 x 1/4-in. nickel, oval-head screws;  
Four No. 8, nickel finish washers;  
Thirty-five No. 8—32 x 1/4 in. screws;  
Thirty-five No. 8—32 hex. nuts;  
Four No. 8 lock washers;  
Thirty-five No. 6 lock washers;  
One stove-bolt 3/16 x 4 1/2 in. with nut;  
Two stove-bolts 3/16 x 2 1/2 in. with nuts;  
Three 1/4-in. rubber grommets;  
Five tube grid clips;  
Two brass spacers 1/2-in. long with 3/16-in. hole;  
Two fiber washers, 3/4-in. diameter with 3/16-in. hole;  
Two brass spacers 1/4-in. long with 1/8-in. hole;  
One square foot of speaker cloth;  
One wood panel, Hlan;  
One cabinet and cover;  
One pair separable hinges;  
One spring lock;  
Four rubber cabinet feet;  
One leather carrying handle;

### OUTPUT METERS

(Continued from page 92)

One Lynch 100,000-ohm resistor, 1 watt, R7;  
One Lynch 100,000-ohm resistor, 1 watt, R8;  
Four International Air tip-jacks;  
One bakelite panel 4 1/2 x 6 1/4 x 1/4 ins.;  
One Best switch, Type 3NS6K;  
One 4 1/2-volt battery;  
One pair International Air test leads, No. 128.



# WATCH YOUR WATCH

Those in vocations requiring contact with magnetic fields usually know from annoying experience that they cannot expect consistent service from their watches while working around electrical apparatus. Steel, of course, is readily magnetized, and the hairspring and most other parts of a watch movement necessarily have heretofore been made of steel.

But a means of avoiding the annoyance of permanently magnetized watches has been evolved by an eminent Swiss physicist of international fame, Dr. Charles Edouard Guillaume, well known as the recipient of the 1920 Nobel Award in Physics for the development of certain rust-resisting nickel steel alloys, particularly Invar and Elinvar.

Laboratory experiments show that the conventional watch with regulation steel hairspring and usual type of balance wheel will become so erratic after exposure to magnetic fields up to 360 lines per square inch as to be useless as a timekeeper; whereas, with an Elinvar hairspring and a non-magnetic balance wheel it is but slightly affected in fields of that strength.

that it contracts and therefore oscillates more quickly when a rise in temperature caused the hairspring to weaken—and vice versa.

This form of construction consists of making the rim of the balance wheel A, in Fig. A

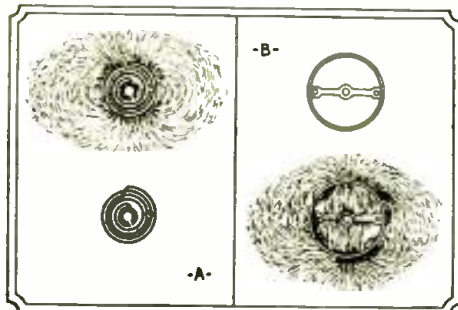

Fig. 1

and Fig. 1, of two different metals—brass and steel—and of cutting the rim at two opposite points in its periphery.

The Elinvar hairspring makes it possible to use a monometallic, uncut, non-magnetic balance wheel B, in Fig. A and Fig. 1.

The lack of magnetic susceptibility of these Elinvar components is shown in the lower and upper halves of A and B, respectively, of Fig. 1.

Without some means of counteracting a mag-

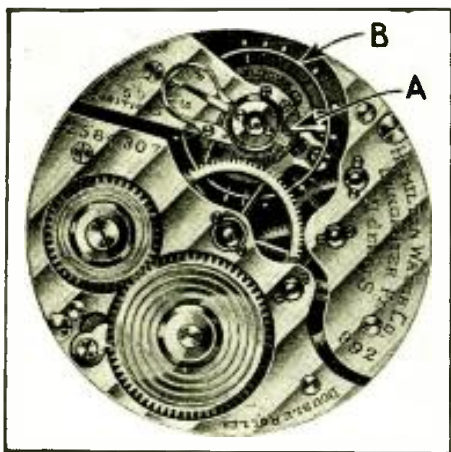

Fig. A

Photograph of the newly developed watch which may be used in a magnetic field.

An increase in temperature—whether due to weather conditions or to proximity of the watch to heat—causes the hairspring to lose some of its elasticity. Decrease in temperature, conversely, increases the elasticity of the hairspring. To offset the errors in timing which these changes would cause, the "compensating" type of balance wheel is so constructed

netic influence, the hairspring may be so strongly attracted to the balance wheel as to actually touch it, as shown in Fig. 2, when the watch will no longer keep time.

The whole assembly, therefore, renders a watch practically immune to permanent magnetism and unaffected by temperature changes. Furthermore, an Elinvar equipped watch when adjusted in two extremes of temperature operates at the same rate in intervening temperatures. Heretofore, a watch correct at say 40° F and 90° F would not be exactly correct between or beyond those temperatures.

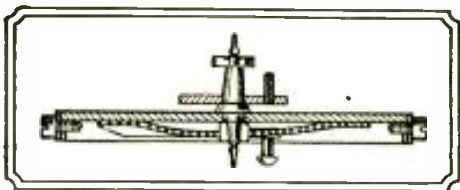

Fig. 2

## MEGADYNE CORRECTIONS

In the July issue of this magazine there was published an article dealing with the construction of the "Megadyne" receiver. In the pictorial representation of the receiver an error was unavoidably made. With the connection as shown in the July issue, the "A" battery will short circuit—use the corrected diagram

shown below. The schematic circuit shown in the same issue is, however, correct and may be relied upon when building the set.

In this issue of RADIO-CRAFT, there is described the power unit that goes with the receiver if the constructor desires to electrify it. See page 85.

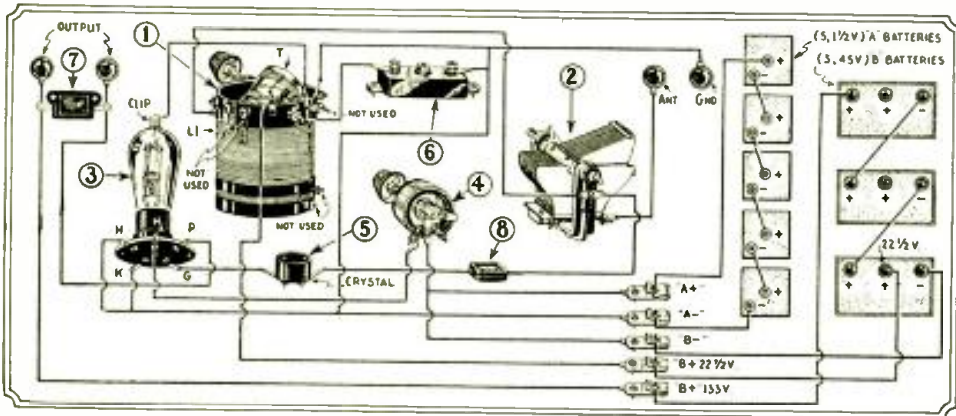

# ALUMINUM SOLDER

## New Discovery! ALUMAWELD Solders Any Metal

Here is the all-metal solder you have been waiting for! It will solder aluminum, pot metal, die castings, cast iron, steel, brass, bronze, copper or any other metal. It will join aluminum to cast iron—copper to steel—pot metal to brass. It will repair anything that is made of metal—quickly, surely and lastingly.

### EASILY APPLIED

Alumaweld all-metal solder is applied with a soldering iron, blow torch . . . or by the heat of your gas stove. It flows at an exceedingly low temperature. No experience required.

### SUPER STRENGTH

Alumaweld is 12 times as strong as ordinary solder. It is a good conductor of electricity but not at all subject to electrolysis inasmuch as it assumes the positive or negative character of the metal to which it is applied.

### USED FOR RADIO WORK

Since the discovery of Alumaweld, a few months ago, this solder has been extensively used in radio work. It is the only satisfactory means of soldering copper wires to aluminum. It repairs aluminum shields, and replaces riveting on aluminum cabinets. In a hundred and one different ways, it can save money and assure more satisfactory radio performance.

### MAKE THIS WELDING TEST

Make the welding test and prove to yourself how quickly and easily Alumaweld works. Along with each kit of Alumaweld we send 2 aluminum strips. Butt or lap these together—apply a small amount of flux and solder—heat over any kind of a flame. In approximately ten seconds the flux will smoke and the aluminum strips will weld together. If, after cooling, you can break these apart, with your fingers, or with pliers, return the kit and we will refund your money. Could anything be fairer?

## Agents! Dealers!

### MAKE BIG MONEY SELLING ALUMAWELD

Get in on the ground floor. Our agents are making up to \$30 a day selling Alumaweld. Be your own boss. Every home, factory and repair shop NEEDS Alumaweld. It sells on sight—100 per cent profit to you. Send 50¢ for a complete kit. Try it out. If you MEAN BUSINESS, we will grant you territory . . . give you leads from our advertising . . . and circulars for distribution. Don't delay. Alumaweld franchises are VALUABLE. They'll go FAST. Mail the coupon . . . TODAY!

### ORDER A KIT—TODAY!

Alumaweld is packed in handy kits, all complete. Each kit contains solder, flux, tempered steel cleaning brush, aluminum strips, and complete, easily followed directions. Enough material for 20 average jobs, only 50¢. Less than 3¢ a job. If, after using Alumaweld, you do not find it all we claim, simply return the kit and we will refund your money. You take no chances!

Every day jobs are coming up that require Alumaweld. Be prepared! Order a kit today. On the very first job you will save the 50¢ it cost you.

ALUMAWELD CO.  
710 East Broadway, Dept. 17,  
Glendale, Calif.

Gentlemen:

Mail me immediately a complete kit of Alumaweld, containing a generous supply of Alumaweld solder and flux, steel brush and directions, for which I am enclosing fifty cents. If, for any reason, I am not satisfied, you agree to refund my money . . . without question.

[ ] Check here if you want agents' proposition.

Name .....

Address .....

Town and State .....

**Here's the Answer**

Whatever Your Question about words, persons, places, look it up in The "Supreme Authority"

**WEBSTER'S NEW INTERNATIONAL DICTIONARY**

452,000 Entries, 2,700 Pages, 12,000 Biographical names, 32,000 Geographical subjects, and 6,000 Illustrations. Write for specimen pages, etc., mentioning this magazine, to

G. & C. MERRIAM CO., Springfield, Mass.

Read about our new plan for buying the 1931 and 1932 OFFICIAL RADIO SERVICE MANUALS. Full details concerning this will be found on page 72. Turn to it NOW.

## BOOK REVIEW

(Continued from page 107)

*Mechanical Television Systems*—This book offers a fairly detailed analysis and description of the prominent mechanically operated television systems. They include the Telehor, the Baird, the Telefunken, the Jenkins, the Sanabria, the Alexanderson, the Bell Telephone and the Gramophone systems. An attempt is made to estimate the peculiarities and value of each.

*Electronic Television Systems*—The attempts to overcome some of the inherent difficulties in mechanical systems by the use of varying electron streams are described here in the form of the Zworykin, Farnsworth and Von Ardenne electronic systems. The construction, qualities and use of each are outlined.

*Television Studios and Transmitters*—Although television is generally considered to be in an experimental state, nevertheless it has developed a studio technique and related problems peculiar to it alone. The layout of a television studio, the photo-cell arrangement, the studio equipment and wiring and outside pickups, as they are used in present practice, are fully described. The design, location and operation of the television transmitter itself is also taken up.

*How to Build Radiotrons*—A practical and detailed method for constructing a machine to receive television images is described here. The building of the scanning disc, the means of driving and synchronizing it, the building of lens discs and methods of connecting them, are all discussed.

*How to Build Radiovision Receivers—Part I.* This book discusses chiefly the radio problems in the building of a receiver. Adapting the receiver to the frequencies on which it must be used is covered fully, with special emphasis on detectors and picture frequency amplifiers.

*How to Build a Radiovision Receiver—Part II.* This book completes the work of 13 TA by discussing the complete television circuit, based both upon the mechanical type of scanning and the electronic systems. Commercial radiovision receivers are described.

## INFORMATION BUREAU

(Continued from page 106)

densers; C7, C8, C9, C10, .05-mf.; C11, 0.2-mf.; C12, C13, 0.4-mf.; C14, 100 mmf.; C15, 0.6-mf.; C16, .0015-mf.

The circuit has three stages of T.R.F., diode detector, magneto-dynamic reproducer, automatic volume control and, in the output circuit, push-pull pentodes. The R.F. transformer which is used to couple the R.F. amplifier to the diode detector is of aperiodic or untuned type. Grid circuit bias potentials are obtained by means of resistors in the return circuit of the "B" supply; thus, there is no need to supply a separate "C" battery.

If the R.F. tubes are slightly below normal in mutual conductance value, the receiver will not have its normally high gain. Realign the circuits (when necessary) at 1300 kc. All of the tubes are of "automotive" or 6.3 volt filament type.

In installing the reproducer, the best tone quality will result when the instrument is mounted on the dashboard facing the rear. It should not be mounted so that the reproducer is facing downwards toward the floorboards.

### A-A-A-A-H!

Los Angeles.—Radio service companies, wrestling for first listing in the classified phone lists, are seeing which can prefix the most 'A's' to its name.

Four radio shops on Western avenue now start their names with five 'A's' to squeeze ahead of the AAAA Radio Service, which has 16 branches.

List is currently headed by the AAAAA Anderson Radio Shoppe.

## Mr. SERVICE MAN

Thank You—Our advertisement in the July issue brought us hundreds of replies, and NOW hundreds of copies of "GOLD SEAL Radio Tube Sales Plans for the Service Man" are on the way. Step to GOLD SEAL Radio Tubes and Profits!

The tubes you need—for receivers, transmitters, public address or television are made by GOLD SEAL.

GOLD SEAL Sales Engineers have developed a special "Selling Plan" for the Service Man. It's yours in return for the coupon.



Newly Made  
Sales Resistance  
Fully Guaranteed  
Long, Useful Life  
Licensed by RCA  
And Double Tested  
An Experienced Staff  
Standard Specifications  
Best of Materials Used  
New and Modern Equipment

**STEPS TO GOLD SEAL  
 RADIO TUBES**

### Mail Coupon TODAY!

GOLD SEAL MFG. COMPANY  
 5 Central Ave., East Newark, N. J.

Please send me by return mail Specifications on GOLD SEAL Radio Tubes and your "Sales Plan" for Service Men.

Name \_\_\_\_\_

Address \_\_\_\_\_

City \_\_\_\_\_ State \_\_\_\_\_



# THE THEORY AND CONSTRUCTION OF ATTENUATORS AND LINE FILTERS

(Continued from page 95)

$$\begin{aligned} Z_0 &= 2\sqrt{Z_1(Z_2 + Z_1)} \\ Z_0 &\times 2\sqrt{82(40.4 + 82)} \\ Z_0 &= 2\sqrt{82 \times 122.4} \\ Z_0 &= 2 \times 100 \\ Z_0 &= 200 \text{ ohms} \end{aligned}$$

Therefore " $Z_0$ " the image impedance of 200 ohms equals " $Z_0$ " the characteristic impedance, which also equals 200 ohms.

## Design of "T" Pads

Having designed an H-type pad to give us the desired loss, let us proceed to do the same with a "T"-type pad.

This attenuator is so called, because it is composed of three resistors taking the form of the letter "T." This pad is known as an unbalanced network in that series resistors are used in only the high side of the line. The other side of the network may or may not be grounded depending on the type of circuit in which it is to be placed. This network is shown in Fig. 12.

The equivalent circuit of Fig. 12, is given in Fig. 13, and everything that has been said about H-type pads, holds true for the T-type pad, except that " $Z_1$ " the series arm for a T-type pad is exactly twice the value of " $Z_1$ " for an H-type pad giving the same loss. This is easily seen, for if we take the series arms out of the low side of the line, and still wish to maintain the same characteristic impedance in the circuit, the series arms in the high side of the line, must be exactly twice their original values. Therefore, knowing the constants for an H-type pad, and wishing to design a T-type pad to give the same loss, all that would have to be done, is to leave the two series arms out of the low side of the line entirely, and make the two series arms in the high side of the line just twice their original values. The shunt arm " $Z_2$ " remains the same in both cases.

The working formulas for T-type networks are as follows:

$$"Z_1" \text{ the series element} = Z_0 \left( \frac{A - 1}{A + 1} \right) \dots \dots \dots (4)$$

$$"Z_2" \text{ the shunt element} = \frac{2 Z_0 A}{A^2 - 1} \dots \dots \dots (5)$$

$$"Z_0" \text{ the characteristic impedance} = \sqrt{Z_1(Z_1 + 2Z_2)} (6)$$

## Example of Design

As an example of design to illustrate the use of this type of network, we may proceed to apply the above formulas to the design of a T-type pad to also give a 20 decibel loss.

Given—To design a 20 decibel pad to work between two 200-ohm impedances, (see Fig. 14).

Then " $Z_0$ " is equal to 200 ohms (given).

From Table 4, the value of "A," the amplification constant for 20 decibels, is given as 10.

Then "A" is equal to 10.

Solving for " $Z_1$ " the series element from equation (4).

$$Z_1 = Z_0 \left( \frac{A - 1}{A + 1} \right)$$

$$Z_1 = 200 \left( \frac{10 - 1}{10 + 1} \right)$$

$$Z_1 = \left( 200 \frac{9}{11} \right)$$

$$Z_1 = 200 \times .82$$

$$Z_1 = 164 \text{ ohms.}$$

" $Z_2$ " the shunt element is the same as for the H-type pad, as the formulas from which " $Z_2$ " the shunt arm is determined, is the same for both H and T-type pads. This is seen from inspection of the formulas for the two types of networks.

The completed network shown in Fig. 15, having the constants as determined above, of " $Z_1$ " the series element equal to 164 ohms, and " $Z_2$ " the shunt element equal to 40.4 ohms, when interposed between the two 200-ohm impedances, will give the desired 20 decibel loss.

It will be noticed (see Fig. 15) that the

series arm " $Z_1$ " as determined for the T-type pad, is exactly twice the value found for " $Z_1$ " in the H-type pad, and checks with the values given in Table 4, from which the constants " $Z_1$ " and " $Z_2$ " for T-type pads may be found, when working between 200- 500- and 600-ohm impedances.

## Design Information for Resistors Used in Attenuators

The resistors used in attenuators must be non-reactive (have negligible inductance and capacitance) so that the attenuator will maintain a constant impedance throughout the audio band to the impedances between which it is working. By designing the attenuator to have a constant impedance, it will offer the same degree of attenuation to all audio frequencies, with the result that the frequency response characteristics of the circuit will be practically flat, which is the ideal strived for in all voice transmission circuits.

The following constructional data on the resistors used in attenuators is given, so that the above mentioned characteristics may be obtained.

All resistors lower than 300 ohms are wound in bifilar fashion. The bifilar method consists of paralleling the wire throughout the winding as shown in Fig. 16.

For all resistors below 300 ohms, the following accuracy limits for resistance should be adhered to:

Resistor values in ohms	Accuracy limits
1.....50	$\pm .1\%$
50.....100	$\pm .25\%$
100.....150	$\pm .5\%$
150.....200	$\pm 1.0\%$
200.....250	$\pm 2.0\%$
250.....300	$\pm 5.0\%$

Resistors whose values are greater than 300 ohms, are wound in the well-known reversed layer method, in which the layers are wound upon each other in reversed directions.

For all resistors above 300 ohms, the following accuracy limits for resistance should be adhered to:

Resistor values in ohms	Accuracy limits
300.....450	$\pm .1\%$
450.....600	$\pm .25\%$
600.....750	$\pm .5\%$
750.....900	$\pm 1.0\%$
900.....1000	$\pm 2.0\%$
1000 ohms and above	$\pm 5.0\%$

The inductance of a resistor is expressed in micro-henries, and the capacitance of a resistor is expressed in micro-micro-farads.

The maximum allowable inductance in micro-henries for resistors below 1,000 ohms is given in the following table.

Resistor values in ohms	Inductance should not exceed
1.....25	3 micro-henries
25.....50	6 " "
50.....100	8 " "
100.....200	13 " "
200.....300	23 " "
300.....400	33 " "
400.....500	43 " "
500.....600	53 " "
600.....700	63 " "
700.....800	73 " "
800.....900	83 " "
900.....1,000	93 " "

The maximum allowable capacitance in micro-micro-farads for resistors above 1,000 is given below:

Resistor values in ohms	Capacitance should not exceed
1,000.....2,000	63 micro-micro-farads
2,000.....3,000	50 " " "
3,000.....4,000	44 " " "
4,000.....5,000	40 " " "
5,000.....6,000	37.5 " " "
6,000.....7,000	35.7 " " "
7,000.....8,000	34.3 " " "
8,000.....9,000	33.3 " " "
9,000.....10,000	32.5 " " "

If the resistors are wound as specified, and the accuracy limits for resistance, inductance, and capacity, as given above are maintained, a practically constant impedance attenuator will be the result.



# Readrite

No. 550

## OSCILLATOR

Licensed by A. T. & T. Co.

**\$18** Net to dealer  
\$30 list

**\$21** Net to dealer  
with output meter

If not at your Jobbers we will ship direct when remittance accompanies order.

A sturdy modulated instrument carefully made. Completely shielded with separate battery compartment. Furnished with 22½-v. and 3-v. batteries and one '30 tube. Direct reading broadcast band (550-1500 kc.) and intermediate band (120-185 kc.). Sharp 2d and 3d harmonics for 260 and 475 kc. Operating instructions attached in case cover with shielded wire leads. Very compact. In leatherette case, 6x11½x5½ in. Weighs but 8 pounds. Built to high standards. Every serviceman should have the No. 550 oscillator to align r.f. gang condensers, locate defective r.f. transformers, adjust i.f. transformers, check oscillator stage and determine sensitivity of a receiver. A necessary instrument. Get yours today. Write for catalog of servicing instruments.

Readrite Meter Works  
17 College Ave.  
Bluffton, Ohio

Please send all information about Readrite Oscillator and other service instruments.

Name .....

Address .....

City..... State.....

**Readrite Meter Works**

Established 1904

17 College Ave., Bluffton, Ohio

# Train Now for New RADIO Opportunities



Get Into a Line Where There's Action—Every Day—And a Pay-Every Week—You Be the Boss!

Right now while hundreds are looking for work where there isn't any, the radio service field can use trained men. With the proper training and the necessary equipment, you can enter this field and make a comfortable living. We include with our course this modern set analyzer and trouble shooter without any extra charge. This piece of equipment has proved to be a valuable help to our members. After a brief period of training, you can take the set analyzer out on service calls and really compete with "old timers." We show you how to wire rooms for radio—install auto sets—build and install short-wave receivers—analyze and repair all types of radio sets—and many other profitable jobs can be yours. Teaching you this interesting work is our business and we have provided ourselves with every facility to help you learn quickly yet thoroughly. If you possess average intelligence and the desire to make real progress on your own merits, you will be interested in our

**YOURS**  
without extra cost.

A modern set analyzer and trouble shooter. Finds what's causing the trouble—tests circuits and tubes—measures resistance—capacity of condensers, etc.

### NO-COST MEMBERSHIP PLAN

Start this very minute! Send for full details of this plan and free booklet that explains how easily you can now cash in on radio quickly. Don't put it off! Write today! Send Now!

Fill Out and Mail Today! RCA-8

**RADIO TRAINING ASSOCIATION OF AMERICA**  
Dept. RCA-8, 4513 Ravenswood Av., Chicago, Ill.

Gentlemen: Send me details of your No-cost Membership Enrollment Plan and information on how to learn to make real money in radio quick.

Name.....  
Address.....  
City..... State.....

### DON'T FAIL TO SEE THIS HIGH-GRADE SIMPLE CODE SET

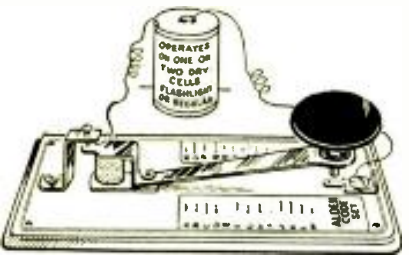

Adjustable pitch buzzer, nickel plated metal parts mounted on beautifully black molded Bakelite base. Continental Code relief molded each side of key. Clips can be put in binding post to hold fountain pen flashlight battery.

Great for practice—signals with wire up to 1000 feet—or grounded and connected to antenna acts as wireless transmitter for short distances—signal being received on any kind of set—connected to amplifier produces loud signal for group practice. Allen Code Set, Price 75c each at your dealers or post-paid.

ALDEN PRODUCTS CO., Dept. R., Brockton, Mass.

## Universal Bullet Type MICROPHONES

CARBON GRANULE TYPE WITH HISS ELIMINATING FILTER

A new Universal product designed to give the public address man the ultimate in appearance and proved UNIVERSAL performance at very reasonable cost. Elegant design. Rugged construction. Special adjustment screw for adjusting microphone to varying acoustic conditions. Hiss level far below background noises encountered. Finished in highly polished Aluminum Chrome Plate. Available in Models BB, KK and LL.

**UNIVERSAL MICROPHONE CO., LTD., 424 Warren Lane, Inglewood, Calif., U. S. A.**

## ELECTRIC CODE

(Continued from page 102)

The points in favor of replacing unapproved extensions with standard wiring, may be marshalled as follows:—

(1.) **SAFETY.** Where a householder knowingly permits an electrical menace to exist after his attention had been called to its dangers, responsibility for consequences must be his own. Loss of life or injury in fires, burns from short-circuit flashes, shock and possible heart failure from contact with live conductors, electrocution if such contact is made while the body is moist and is also making contact with a grounded object, are the possibilities arising from such systems. There is often found an attitude among householders who seem to feel that, while such results occur in other houses, they cannot occur to them. This resembles the state of mind of a man who has been used to dodging across streets laden with heavy traffic, secure in the feeling that a special providence is looking after him. After being bumped by a taxi or learning to drive himself, he finds that he had merely been lucky and had been depending upon the mechanical excellence of the automobile and the skill and attention of the driver for his safety.

(2.) **LITTLE ACTUAL DIFFERENCE IN COST.** Convenience outlets may be installed for slightly higher cost than the exposed lamppord, that is generally supplied. In new buildings, outlets are installed at an average cost of \$1.50 each, while the walls and floors of a building have not yet been finished. The actual wholesale value of the material used to install an attachment receptacle is about \$1.00, the items required being:

15 ft. 14/2 BX cable, @ .04 per ft.....	\$ .60
1 Gem Box, @ .12 ea. ....	.12
1 Duplex Receptacle, @ .21 ea. ....	.21
1 Brass Plate, @ .07 ea. ....	.07
<b>Total .....</b>	<b>\$1.00</b>

Contractors buying material in large quantities, can obtain prices as much as 25 per cent lower. If so, there remains \$ .75 for the labor. While this seems low enough, a journeyman electrician and helper, using labor saving devices and materials, can install as high as 35 to 40 outlets per day, which explains how an electrical contractor can still make a profit after paying \$13.20 and \$8.00 per day respectively to the electrician and helper. The prices to be quoted by Service Men must depend upon the type of household and the construction of the building. This will be taken up in a later section.

(3.) **UNSIGHTLINESS.** No matter how carefully lamppord is tacked across a ceiling, and down a wall, it will always show and be a collector of dust. Kalsomined ceilings cannot be washed without re-kalsomining and, while wires along walls may be cleaned, it is not a safe procedure to wash them with wet cloths. Since there is no substitute for soap and water to clean grime, the careful housewife leaves the wires decidedly alone. Approved installations are nearly always concealed in the plaster. Even when exposed, the conductors are enclosed in a fireproof or metal sheath and there is little danger of penetration to them without tools being used. Rats and mice do not seem to have developed a taste for cold rolled iron or zinc treated steel.

(4.) **OVERLOADING FIXTURE CONDUCTORS.** Most fixtures are wired with No. 18 Rubber Covered wire, known as fixture wire. This size wire has an allowable current-carrying capacity of 3 amperes. Most radios are placed in dining or living rooms and the fixtures in such rooms usually have 3 to 5 sockets. Fixtures so wired with No. 18 wire, while having current carrying capacity enough for lamps, are not designed to further supply the 125 to 175 watts required for an electric radio. The danger in overloading conductors is not immediately apparent. The rubber covering of the wire gradually loses its elasticity due to the heat from larger currents than it was designed to pass and it becomes brittle and drops off from the wire, then the bare conductors ground against the fixture and the householder assures the trouble shooter that, for no reason at all, the fixtures suddenly spat flame and the lights went out. Inspectors testing wiring materials

(Continued on page 123)

## AUTO-DIAL RADIO

Quality, tone, selectivity, and power

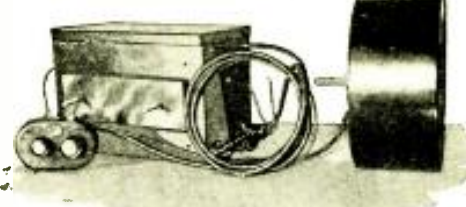

COMPLETE \$40.00—includes set, remote control, suppressor kit, tubes and dynamic speaker. Set only \$18.00. Dealers and agents wanted. Write today.

**J-M-P MANUFACTURING CO., INC.**  
3356 Fond du Lac Ave. Milwaukee, Wis.

### SERVICEMEN-DEALERS

Get Our Prices First  
Complete Stock of NEW  
Condenser Blocks  
Volume Controls  
Resistors  
and Radio Replacement Parts  
Write for our Catalogue

Hard to Get Parts—We have them. Send us your repair work for estimate.

**Grant Radio Laboratories**  
6521-C South Halsted St., Chicago, Ill.

### G.E. PHONOGRAPH MOTOR

Only \$3.95

Synchronous 110 Volt, 60 Cycle, 80 R.P.M.

Can be installed in place of old fashioned hand winding spring motors. Also many other uses. These G. E. motors are all brand new in original factory cartons. Fully guaranteed \$12.00 value only \$3.95. Shipped Prepaid. Manufacturers and dealers write for special quantity price.

**NATIONAL ELECTRIC TOOL CO.**  
111 W. Lake St. Dept. 178 Chicago, Ill.

### Knowledge Pays Big

We teach you how to build and operate Radio Treasure Finders and how to locate Metals Underground. Fascinating. Scientific. Accurate. Full details for 2c stamp—Write TODAY.

Exchange, P. O. Box 607-W El Monte, Calif.

ON Page 69 of this issue will be found full details of the

## OFFICIAL RADIO SERVICE MEN'S ASSOCIATION

Be sure to turn to this announcement and read it carefully.



## OPERATING NOTES

(Continued from page 96)

bayonet contact pin of the band-selector. To make the task more simple, it is best that the cable be disconnected from the terminal strip, so that the entire unit may be placed in a position where it may be easily handled.

The next step will be to remove the six machine screws holding the subpanel assembly to the can, one in each corner of the sub-panel and one on either side of the can. After the pilot-light bracket has been loosened and pushed back and out of the way, the sub-panel may be lifted out, the side opposite the cable being pulled out first. While this is done, the cable must be fed through the shield can as the panel is lifted. The entire procedure should take no more than ten minutes.

A screw and nut hold the bakelite socket in position over the contacts. When these are loosened, the socket is removed and the contact prongs bent into proper shape. They may be cleaned at the same time by the judicious use of steel wool.

The second common complaint on the same model is a strong hum *only on resonance*. Sparton employs a .006-mf. condenser connected from one side of the A.C. line to chassis ground (the black wire emerging from the pack and connected to the ground binding post is the lead which connects this unit to ground). On many occasions, it is possible to reduce this resonance hum by substituting a .25-mf. or .5-mf. condenser in place of the .006-mf. condenser.

In all cases, however, a good ground connection is important and essential. A cold-water pipe does not always prove to be the best ground and it may be necessary and expedient to experiment with several before the proper results are obtained.

### Stromberg Carlson 25, 26

Lack of volume control on the Stromberg Carlson models 25 and 26 is caused by a number of defects; in the main, however, the .04-mf. bi-resonator condensers have been largely responsible for this complaint. When one of these models with this complaint is serviced, the tubes should be tested and any below par replaced. The chassis must be removed from the cabinet to ascertain the source of the trouble, which is usually caused by leaky bi-resonators; a test procedure to determine this fact will be here outlined.

Switch the receiver "on" and tune for a fairly good broadcaster. Referring to the chassis arrangement A in Fig. 2, unsolder the two slate-colored leads (from the bi-resonator) at points (1) and (2). (The complete circuit of this chassis appears on page 427 of the OFFICIAL RADIO SERVICE MANUAL, Vol. 11.)

Shunt a wire across these two points and if the volume control is effective then the bi-resonator in this circuit is bad and should be replaced. However, if the first bi-resonator proves perfect, the same operation should be performed at points (3) and (4), after the leads have been soldered back to the correct lugs at (1) and (2).

It may, sometime, save time and trouble to determine which bi-resonator has failed by following a somewhat different method. With a good ohmmeter, measure the total resistance between the control-grid cap of the R.F. stage (nearest the rear of the chassis) and chassis. A reading of approximately 0.1-megohms should be obtained. A resistance measurement from the control-grid cap connection of the I.F. stage to chassis and from the control-grid cap of the first-detector to chassis should indicate approximately 0.2-meg. These values are correct for the 60-cycle models. In the 25-cycle receiver, the readings are about 60,000 ohms less, in both cases.

The bi-resonator condensers in this receiver are located within the close quarters of the condenser gang shield housing and therefore are very difficult to replace. If it is necessary to make a change, the leads to the condensers may be removed and the new units installed beneath the chassis in close proximity to the coils. A glance at Fig. 2B will disclose the internal connections of the bi-resonators (the additional lead was brought out to save an operation in manufacture).

Distorted reproduction on the same model has been traced to leaky detector-cathode bypass condensers, when the station selector is correctly tuned to resonance. This bypass unit is composed of two .5-mf. sections, connected externally, to make .6-mf. Distortion at low volume, has almost invariably been found to be caused by a poor type 24A tube in the second-detector stage. This quick heater or A-type tube in many instances has proven to be a poor detector in T.R.F. sets; or second-detector in superheterodynes.

A not infrequent cause for an inoperative receiver of this model—total lack of reception—is an open grid section of the oscillator coil.

At other times, a shorted trimmer condenser across one of the I.F. coils has produced the same condition. Ordinary tests with an analyzer will not reveal this failure—again the writer voices the Service Man's need for an ohmmeter capable of accurately measuring the lower resistance values. (See the article, "A Universal-Range Ohmmeter," in the July, 1932 issue of RADIO-CRAFT; the range available in this compact instrument is from 0.5-ohm to 15 megohms.—Technical Editor.)

We maintain for all radio Service Men a free REGISTRY SERVICE; since we receive each month letters and sometimes telegrams in which manufacturers and set owners request the services of expert service technicians IN THEIR LOCALITY.

Fill out the coupon below, paste it on a one-cent postal card and mail it to us.

There is absolutely no charge to the Service Man, manufacturer or set owner for this service, which makes every Registered Radio Service Man eligible.

### REGISTRY CARD FOR SERVICE MEN

O.R.S.M.A., c/o RADIO-CRAFT,  
98 Park Place, New York City.

Name .....

Address ..... Telephone No. ....

City ..... State .....

Type of Service in which you Specialize .....

Testing Equipment you use: .....

## SHALLCROSS Set Tester



### Compact, Convenient, and Light in Weight

This instrument, which is completely described and illustrated with diagrams and photographs in our Bulletin 160-P, uses a special set of Shallcross Super Akra-Ohm wire-wound Resistors.

Special prices on this complete kit of Resistors, together with a copy of Bulletin 160-P, which gives instruction details and full information on the operation of the Tester, will be supplied upon receipt of 4c in stamps.



Write for this book  
**FREE!**  
You cannot possibly afford to be without this valuable book. It is not just another Catalog—it is indeed a VERITABLE ENCYCLOPEDIA of the RADIO INDUSTRY.

**WHOLESALE PRICES**  
All that is New in Radio is Listed in this Money-Saving

Spring-Summer 1932 Supplement

WE ARE HEADQUARTERS FOR  
**Public Address Amplifiers and Installations**

You Pay ONE PROFIT! Purchase Direct From the Manufacturer! Our Amazing Low Quotations Will Astound You!

We manufacture P.A. Amplifiers and allied equipment suitable for any indoor or outdoor use. Investigate our 4 to 100-watt undistorted output class "A" and class "B" amplifiers.

Our amplifiers are available in fully assembled and wired, or, semi-assembled unwired form, and are furnished with simple blueprints. If you prefer to construct your own amplifiers, get our quotations on class "A" or "B" Power Transformers and other component parts. Classes, Bacon units and horns, Jensen 30-watt output Dynamic Speakers, Wright DeCoster, P.A. Dynamic Speakers, Microphones, P.A. ALL-PURPOSE Control Boards, Rack and Panel Framework, etc.

It will pay you to trade exclusively with the house of "Coast-to-Coast" . . . write for your copy of our free catalog today!



123 R West 17th St., New York N.Y.

**NOW  
THE WONDER OF  
MODERN SCIENCE**

NEVER SOLD FOR  
LESS THAN \$50.00

**COMPLETE KIT for \$10.00**

There are hundreds of interesting electrical devices that you can make with a photo electric unit. It will turn on the parking lights of your car when the sun goes down or light the lamps in your house at dusk. It will open your garage door when the beam from the headlight is flashed against it—it will detect smoke in your home or protect your safe—there is no end of jobs that a photo cell unit can do in your home.

- PICTURES THAT TALK
- GARAGE DOORS THAT OPEN AT A LIGHT FLASH
- MECHANICAL MEN
- BURGLAR ALARMS, ETC.

all owe their origin to photo electric cells. It is now possible for you to buy a complete photo cell unit in a kit, ready to assemble, including an extremely sensitive photo electric cell, all necessary tubes, wire, resistances, relay, etc., with complete diagrams and an instruction book showing you how to assemble it in an hour—all for \$10.00.

We also furnish you with a book giving complete wiring diagrams and instructions on how to build a number of amazing devices and showing you many uses for your photo electric cell unit. The actual value of this complete kit is over \$50.00—we are making a special introductory price of \$10.00 to popularize experimental work with photo electric cells.

Clip check or money order to the coupon below and mail it today!



**HERMAN A. DE VRY, Inc.**  
59 E. Wacker Drive  
Chicago, Illinois

CLIP THE COUPON BELOW... MAIL TODAY

Herman A. DeVry, Inc.  
59 E. Wacker Drive, Chicago, Illinois

Enclosed is \$10.00. Please send me the complete Photo Electric Cell Kit advertised in Radio-Craft.

Name.....  
Address.....  
Town.....State.....

**I EQUALS E OVER R**

(Continued from page 94)

around one proton as shown in Fig. 2. Carbon contains 12 protons grouped together with 6 electrons as a nucleus around which 6 electrons revolve as shown in Fig. 3.

The central portion of the atom is known as the nucleus and it may consist of a single proton or a group of protons and electrons. The electrons revolving around the nucleus are known as the planetary or free electrons, because they can be removed from the atom without changing its general character. These planetary electrons revolving around the nucleus may form a single ring or a number of rings around the nucleus, depending on the complexity of the atomic structure of the substance. The atomic structure is shown graphically in the form illustrated in Fig. 4—first, there is the molecule of an element which is composed of atoms and these in turn are made up of electrons and protons.

Single elements, as described, are familiar to all, but many substances we encounter consist of chemical combinations of the atoms of two or more different elements forming another substance—a compound—whose appearance and physical properties are different from any of the elements, such as salt, water, etc.

For the sake of simplicity, we will limit our explanation to the elements and atoms.

**The Charge**

We have shown that atoms are composed of minute charges of electricity which, normally, are in such a form that the sum of the charges of all the electrons or negative charges equal the sum of the charges of all of the protons or positive charges. We have also explained that some of the electrons are revolving around the nucleus in orbits in a manner similar to the stars around the sun. It is to be noted that although the substance contains electricity, (electrons and protons) it is uncharged simply because the charges are equal and balanced.

If we remove one or more of the planetary electrons from an atom, the atom becomes unbalanced and lacks negative electricity (electrons). In this case, the atom is said to be positively charged. On the other hand, if we place an additional electron or electrons in one of the planetary orbits of an atom, it also becomes unbalanced—in the opposite direction—and has too much negative electricity (too many electrons). In the latter case, the atom is charged negatively.

From this it can be concluded that a substance is electrified when it has more or less than its normal number of electrons and the amount of charge is determined only by the quantity of electrons displaced. Also, it can be deducted that all electrons are the same regardless of the element or compound from which they come.

**The Electric Current**

Every substance has a tendency when displaced from equilibrium, to return to a state of balance as quickly as possible. Just as water will find its own level, so atoms which have lost electrons (positively charged) will attempt to attract electrons to themselves, and atoms which have excess electrons will attempt to lose them and thus become neutral.

Therefore, if we have two substances, one charged positively and the other charged negatively, and we touch them together, the excess electrons from the negative will enter the other substance in order to reach a neutral state. If the two bodies are charged equally (and oppositely) the electrons will continue to transfer until both substances are neutral.

Figure 5 shows this effect. In the upper part of the illustration the two substances are charged; and in the lower part, the excess electrons from the negative body have entered the positively charged body and neutralized the atoms lacking electrons.

If we have some means of maintaining the charges on the two balls (shown in Fig. 5.) continuously, there would be a constant passage of electrons from the negative to the positive ball. This continual passage of electrons is what is known as an electrical current or simply a current. This follows logically from the statement we made before; that electrons are electricity.

It is not possible to add or remove electrons

**RADIO+**

A Host of Other Interesting Scientific Subjects—

- TELEVISION
- ELECTRICITY
- PHOTOGRAPHY
- AVIATION
- WOODWORKING
- AUTOMOBILES
- PATENTS AND INVENTIONS
- NEW DEVICES
- CONSTRUCTION
- METAL WORKING
- PHYSICS
- ENGINEERING
- METALLURGY
- PUBLIC ADDRESS AND SOUND EQUIPMENT
- HOUSEHOLD AND SHOP HINTS
- AND OTHERS



25c  
The Copy

4-Color Cover  
Over 450 Illustrations  
96 Pages—9x12 inches

MR. HUGO GERNSBACK's latest magazine contains the most important and recent developments in Science, Mechanics, Radio, Television, Aviation and Chemistry. For everyone, regardless of age, EVERYDAY SCIENCE AND MECHANICS will be found to be useful and instructive. Thoroughly illustrated with scientific events from all parts of the world, and helpful to thousands of high school, university students and instructors who wish to advance their scientific knowledge.

Many excellent pages for the home workshop man who finds pleasure in building things; experiments in electricity, chemistry and formulas of all kinds.

**SPECIAL OFFER!**

**8 Months for \$1.00**

Clip Coupon Now and Mail!

EVERYDAY SCIENCE AND MECHANICS  
100 Park Place, New York, N. Y. RC-8

I enclose herewith One Dollar for which you are to enter my subscription to EVERYDAY SCIENCE AND MECHANICS for the next Eight Months.

Name.....  
Address.....  
City.....State.....





### 3 Valuable New Books

#### Formulas and Recipes Radio — Mathematics

Presented here are three brand new books, of diversified nature, which are most educational and instructive. Each book carefully treats a subject in full, and is prepared by an expert in the field. The books are well written and thoroughly illustrated to make the contents easily learned. Get these books promptly—mail coupon below.

#### 1. FORMULAS AND RECIPES for the Practical Man

This book has been compiled by S. Gernsback, a well-known author of practical instructional manuals in various scientific fields. It is extremely helpful and will show you how to save money by making in your own home, at a fraction of the regular cost, the hundred and one preparations which you now buy for use at home or business.

#### HERE ARE PARTIAL CONTENTS:

1. Adhesives; Glues, Cements. 2. Cleansing: Stain Removers, Bleaches. 3. Metal Craft: Coloring, Oxidizing, Plating, Polishes. 4. Paints: Colors, Stains, Varnishes. 5. Glass-Working: Cutting, Drilling, Boring, Etching, Engraving. 6. Wood-Craft: Fireproofing, Acid-proofing, Waterproofing, Furniture Polishes. 7. Inks: Sympathetic, Invisible, Hectograph. 8. Photography: Developers, Emulsions, Fixers. 9. Antidotes for Poisons, Remedies for Burns and Scalds, Disinfectants. 10. Preparation, Manipulation, Handling, Mixing, Tables of Weights of Measures. Useful Tables.

#### 2. FUNDAMENTAL PRINCIPLES OF RADIO Radio Simply Explained—Its Origin, Nature and Functions

The book, written by Louis Martin, has been prepared with special consideration given to young members in the radio profession, and those who have gained their experience in a haphazard fashion. This radio primer is a handy fundamental aid for "checking up" and systematizing your knowledge of radio. Regardless of how much you know about the subject, you should read this book.

#### HERE ARE PARTIAL CONTENTS:

Chapter I—Fundamentals of Radio: Electricity, Resistance, Batteries, The Magnetic Circuit, The Magnetic Field, Inductance, Condensers, A.C. Circuits, Propagation of Radio Waves; Chapter II—The Simple Radio Set, Single, Two, and Three-Circuit Tuners, The Battery Set, Vacuum Tubes, Electric Sets, Loud Speakers; Chapter III—Diagrams, How to Read Them; Chapter IV—Amateurs and Broadcast Stations, Talking Pictures, Television.

#### 3. ELEMENTARY MATHEMATICS for the Technician and Craftsman

This manual has been especially prepared for the man who wishes to acquire a working knowledge of the elementary principles of mathematics. A complete treatment of the subject is given by the author, Mr. C. Shainmark, with special attention to the use of mathematics in Radio and other technical work for those who employ its formulas daily.

#### HERE ARE PARTIAL CONTENTS:

I—Arithmetic: Addition, Multiplication, Subtraction, Division, How to Use Decimals; II—Fractions, Percentages, Ratio and Proportions; III—Powers and Roots; IV—The Metric System; V—How to Measure Surfaces and Volumes; VI—Mathematics for the Manual and Technical Craftsman; VII—Special Mathematics for the Radio Technician; VIII—Commercial Calculations, Short-cut Arithmetic, Interest Calculation, Discounts; IX—Weights and Measures; X—Useful Tables.

All our books are of uniform size, 6 x 9 inches, and contain 64 pages. The books are printed on strong paper with stiff colored covers.

#### Clip and Mail Coupon TODAY!

PRESS GUILD INC., 16 Murray St., New York City. RC-8

Enclosed find \$.....for which mail me postpaid the following books:

- No. 1   
No. 2   
No. 3

50c each. Postpaid.

Name .....

Address .....

City and State .....

from a substance without the aid of some external force. This force is known as an electromotive force (E.M.F.). We will not go into the various means of maintaining an E.M.F. here. Several common sources of electromotive forces are dry batteries, storage batteries and generators.

The amount of current flowing in a circuit (for example the two bulbs in Fig. 6) depends on the number of electrons passing through the circuit. The number of electrons, in turn, depends (among other things) on the amount of the charge which is dependent on the E.M.F. applied to the circuit. We may safely conclude, therefore, that the amount of current flowing in a circuit depends on the value of the E.M.F. applied to the circuit.

When visualizing the motion of electrons through a solid body, such as copper, we must remember that the electrons are very small and that there are comparatively large spaces between the atoms. As an example, if a copper cent were enlarged to be the size of the earth's diameter, the distance between atoms would be about three miles and the electrons would be only a few inches in diameter!

#### Resistance

It is well known that certain materials such as copper, brass, silver, etc. will readily permit the passage of an electric current, while other materials such as rubber, mica, porcelain, cotton, silk etc., do not. The former materials are called *conductors* and the latter, *insulators*. The reason why metals are such good conductors of electricity is that their atoms apparently have a weak attraction for electrons and large numbers of them are either practically in a free state throughout the body of the metal or they are easily shifted by any outside electric forces. The more easily the electrons can be shifted in a metal, the lower its resistance to a flow of current, merely because a greater current flows for the same value of applied E.M.F.

This action of resistance in conductors introduces another factor in the consideration of the strength of current flow. Up to this point we have seen that the amount of current increases as the E.M.F. increases and since the *opposition* offered by the conductor of the current *decreases* the current, it may be said that the magnitude of the current flowing in any circuit depends upon the E.M.F. applied and the opposition offered by the circuit itself.

In order to facilitate the measurement and computation of electric currents, several units have been set as standards. The E.M.F. is measured in a unit called a *volt*; the current is measured in *amperes* and the opposition or resistance is measured in *ohms*. The first of these units is usually represented by the letter E, the second by the letter I and the resistance by the letter R.

To sum up: the current (number of amperes) flowing in a circuit depends upon the voltage applied and the resistance of the circuit. To state this in another way,

$$I \text{ (amperes)} = \frac{E \text{ (voltage)}}{R \text{ (resistance)}}$$

A problem involving this condition is shown in Fig. 7. This involves a resistance of 5

ohms in a 10-volt circuit. Then  $I = \frac{10}{5}$  or 2 amperes.

Another type of problem might arise in which it is desired to know the value of the resistance in a circuit when the voltage and the current are known. Here again, Fig. 8 illustrates the conditions. This may be deter-

mined from the ratio  $R = \frac{E}{I}$ ; or, if the *potential* (volts) is 50 and the current is 2 amperes, the resistance will be  $\frac{50}{2}$  or 25 ohms.

The third condition of the relation considered above is one in which the resistance and the current are known and it is desired to know the applied potential. In this case, the voltage E is equal to the product of the current and the resistance ( $E = I \times R$ ).

If a current of 10 amperes is flowing through a resistance of 20 ohms, then the potential applied is  $10 \times 20$  or 200 volts.

From these three examples, it is established

## Thousands of Servicemen are building the SPRAYBERRY SET ANALYZER

—because of the complete variety of tests it is capable of performing.

New tube and set requirements make this analyzer a positive necessity in your equipment. To build it, you need the new I.R.C. Kit of Precision Wire Wound Resistors. Ask your Jobber for this Kit—and write us for folder giving complete instructions.

Folder and other valuable data *free!*

International Resistance Company  
Philadelphia, Pa. Toronto, Ont.

**I.R.C. Metallized**  
and Precision Wire Wound  
**RESISTORS**

**Insure  
YOUR WORK**

with

**CLAROSTAT**

**Replacement  
VOLUME CONTROLS**

CLAROSTAT Replacement Volume Controls are "Custom-Made" to exactly suit the receivers for which they are offered. Not a makeshift job lot idea.

The resistance, taper, shape and shaft are made according to the proper specifications. There is no delay in installing them. There are no comebacks when you use CLAROSTAT products. See the new CLAROSTAT CONTROL HANDBOOK AND CATALOG for 32 pages of dope for service men. Send for your FREE copy.

**CLAROSTAT Mfg. Co.**  
285-287 N. 6TH ST. BKLYN. N.Y.

### SERVICE MEN

Delighted with ELECTRAD RESISTOR HAND BOOK. Permanent guide to resistor values in all receivers. Loose leaf InPort Fabricoid cover. \$1.00 a year, including 4 supplements.

Money back if not satisfied.

Mail \$1.00 Today 175 Varick St., New York, N.Y.  
to Dept. RC-8, **ELECTRAD**

# This Elaborate EXPERIMENTAL EQUIPMENT GIVEN TO ALL Students

AT NO EXTRA COST



Size of Cabinet: Height, 22 1/2", Length, 17 1/2"; Weight 25 lbs.

We give to every student without additional charge his chemical equipment, including fifty pieces of regular standard laboratory apparatus and supplies and forty-two different chemicals and reagents.

## Opportunities in Chemistry



Dr. T. O'Connor Sloane

Chemistry offers those who are ambitious and willing to apply themselves conscientiously, the greatest opportunities of any vocation today. Industrial firms of all kinds pay tempting salaries to get the right men. Opportunities abound on every hand.

You can study Chemistry under the well-known instructor, T. O'Connor Sloane, A.B., A.M., Ph.D., LL.D.

## You Can Learn at Home

Our home study course, written by Dr. Sloane himself, is practical, logical and remarkably simple. It is illustrated by so many experiments that are performed right from the start that anyone can thoroughly understand every lesson. Dr. Sloane will, in addition, give you any individual help you may need in your studies.

## Easy Monthly Payments

The tuition is very low, and includes your laboratory outfit—there are no extras to buy with our course. You can pay in small monthly amounts, and we show you how to earn the cost of the whole course as you go along.

## CHEMICAL INSTITUTE OF NEW YORK, Inc.

HOME EXTENSION DIVISION

19 Park Place New York, N. Y.

Mail the Coupon NOW!

CHEMICAL INSTITUTE OF NEW YORK.

Home Extension Division

19 Park Place, New York, N. Y.

Please send me at once, without any obligation on my part, your Free Book "Opportunities for Chemists," and full particulars about the Experimental Equipment given to every student. Also please tell me about the latest reduction in tuition price and your easy plan of payment.

NAME .....

ADDRESS .....

CITY ..... STATE.....

R. C.-832

that there are three individual conditions involving the relation of E.M.F., current and resistance. These three classifications are as follows:

When E and R are known and the current is desired:

$$I = \frac{E}{R}$$

When E and I are known and the resistance is desired:

$$R = \frac{E}{I}$$

When R and I are known and the voltage is desired:

$$E = R \times I$$

The above three formulas are known as Ohm's Law in honor of the noted physicist George Simon Ohm.

## Resistances in Series

We have already learned that resistance is the opposition of a substance to the flow of current. It is natural then, that the longer the substance composing the resistance, the greater will be the value of the resistance. Also, if two conductors are connected so that the current passes through each of them in succession, then the resistance of the circuit will be the sum of the individual resistances of the two conductors. This effect is illustrated at Fig. 8. The resistance of the conductor at SA is R. Then the total resistance of the two resistors at SB is the sum of the individual resistances.

When the area of a conductor is increased, the opposition to the flow of current will be decreased, as there are more atoms to lose and gain electrons. It also follows logically that if two conductors are connected as shown in Fig. 9, the resistance of the circuit will be less than that of either of the individual resistors R. This is known as a parallel method of connection.

The method of figuring the total resistance of the circuit for parallel resistances is different from that for series resistances. If we refer again to Fig. 9, it will be noted that the current flowing from point A to point B will be divided and part of it will pass through each resistance. If these resistances are equal, half the current will go through each. Then, if the applied E.M.F. is 10 volts and the current in each resistor is 1 ampere, the resist-

ance of each of the resistors will be  $\frac{10}{1}$  or 10

ohms. However, the total current flowing is 2 amperes, so the resistance of the parallel circuit is  $\frac{10}{2}$  or 5 ohms.

For those readers who are familiar with the elements of algebra, the above reasoning may be expressed in the following formula:

$$\frac{1}{R} = \frac{1}{R_1} + \frac{1}{R_2} + \frac{1}{R_3} \text{ etc.}$$

in which R is the total resistance and resistors R1, R2, etc., are the individual resistances of the parallel circuit.

The discussion of electricity and resistance given should be of assistance to many radio enthusiasts who are confused by the explanations of Ohm's Law usually given. It is suggested that the article be read over several times so that the details discussed will all be understood.

(It might be well to add that the current through a given part of a circuit will vary directly as the applied E.M.F. and inversely as the resistance, as stated by Mr. Palmer. It should be emphasized, however, that when part of a circuit is under consideration, the current, voltage and resistance of that particular part should only be considered, regardless of whatever else occurs in another part of the circuit.—Editor.)

## THOSE D. C. SETS

Did you ever service a D.C., power-operated set and flounder around for several hours before discovering that the D.C. line plug was reversed? Remember that it will only work with the plug in only one direction. And another thing, be sure that the set uses an antenna series condenser.

# Read 2 Magazines for The Price of One Pathfinder and Radio-Craft

Here is your opportunity to read two magazines for one year—at the cost of only one. Two real live magazines that afford many hours of reading pleasure. One in the radio field, the other, a weekly of big news events.

The PATHFINDER, a Weekly devoted to the important news of the day flashes from all parts of the world are brought to you in a concise, but interesting manner. Every page holds interest by prominence of well-written editorials. Also book reviews, national politics, foreign affairs, business, education, science, amusements, recreation, comics, personalities and dozens of other features.

RADIO-CRAFT, a monthly radio magazine devoted to helping men make money out of this big industry by teaching them how to properly service receivers, do odd jobs in the radio business and bring to them the new developments in this field. Each issue brings new advances in television, short waves and other allied divisions of radio.

The regular yearly subscription price for RADIO-CRAFT alone is \$2.50. For a limited time only, both magazines will be sent to you for the price of one—\$2.50. Fifty-two issues of the PATHFINDER and twelve issues of RADIO-CRAFT. Mail remittance in form of check, stamps or money order.

## RADIO-CRAFT Magazine

98-R Park Place

New York, N. Y.

# FREE! FREE!

## KNOW YOURSELF... YOUR TALENTS!



Ring Crosby, famous radio artist got a report on his writing from Frederick St. John, and this is what he says about it:

"Please accept my sincere thanks for your grapho-analysis. I am afraid you hit the nail on the head more times than one. It makes a very good study and should be very helpful. Thank you again and with sincere admiration for your work."

## FREE FOR YOU

You can have a correct, scientific report on your own writing. Your talents, character traits—strong points and weak ones are in your writing. Merely send a short letter with this coupon. A personal report from the world famous authority, Frederick St. John will be sent you promptly.

FREDERICK ST. JOHN,  
RADIO-CRAFT  
96 Park Pl., New York City.

I want to know what my handwriting tells. Enclosed find the in color and a stamped, addressed envelope for which send me a strictly personal report.

Name .....

Address .....

City and State.....

Be sure to use U.S. Postage for return of your letter.



... the rapid strides in Television come to you complete — from authoritative sources and fully illustrated.

**Now 25c**



GREATEST MAGAZINE IN TELEVISION

**T**IMELY developments in radio's latest wonder, Television, are published in every issue of TELEVISION NEWS—Mr. Hugo Gernsback's latest magazine. Rapid advancement in this art today is becoming a rebellion of the radio cycle of years ago. Daily broadcasts are becoming more numerous and experiments are following in quick order in building television sets for experimental purposes. Foresight of its development can be seen by the pioneers of radio—they are equipping themselves now with television experience.

The articles published in TELEVISION NEWS are of primary importance to experimenters—they are simple in construction, understandable and replete with diagrams, photographs and illustrations.

**Interesting Articles in the Current Issue**

- The Studio Aspect of Television.
- Single Side Band Television Transmission.
- Television in France.
- Television With a Short-Wave Converter.
- Latest Information on Cathode Ray Tubes.
- Frequency Requirements for Television.
- Single Control Super-Heterodyne.
- Television in Natural Colors.
- How to Make Accurate Scanning Discs.
- Flashing the Television Image.
- Synchronizing D.C. Motors.
- The 120 Line Scanning Disc.
- New Dynamic Scanning System.
- A History of Television Scanning Methods.
- Digest of Television Patents.

**SPECIAL OFFER COUPON**

TELEVISION NEWS RC-832  
101 Park Place, New York, N. Y.

[ ] As per your Special Offer, I enclose herewith \$1.25 (Canada and foreign \$1.50) for which enter my subscription in TELEVISION NEWS for One Year. You will also send me FREE the last two issues. I understand that the regular rate for such a subscription is \$2.00.

[ ] Mail me a sample copy of TELEVISION NEWS for which I enclose 15c (U. S. stamps or coin accepted).

Name .....

Address .....

City ..... State .....

**A "3-TUBE" SUPER**

(Continued from page 86)

- One Meissner, 262½ kc. composite oscillator coil and Input I.F. transformer, I.F.T. 1, L2, L3;
- One R.F. choke, 8 millihenries;
- One Meissner antenna coil, type X, L1;
- One chassis;
- Four knobs;
- One A.C. cord and plug;
- One 10,000-ohm vol. control with "on-off" switch R10 pot. type, cathode ant., ¼-inch shaft, 1 inch long;
- Two .00007-mf. padding condensers, C15, C17;
- One DeJur .001-mf. padding condenser, C2A;
- One DeJur dual trimmer, .00014, C3, C4;
- One 6 mf. 450-volt electrolytic condenser with leads, C9;
- One 8 mf. 450-volt electrolytic condenser with leads, C10;
- Two .001-mf. molded condenser, C7, C11;
- One .005-mf. molded condenser, C12;
- One .25-mf. cub type 200-volt condenser, C13;
- Two .1-mf. 200-volt cub condenser, C5, C6;
- One 20 mf. electrolytic condenser, 50 volt, C8;
- One shield can 2¼ inches long, 2⅝ inches diameter, drilled for dual trimmer;
- One base for same;
- One short-wave coil and bracket, L4;
- One rotary switch I.S.P.S.T., SW1;
- One 50,000-ohm variable rheostat (tone control), R11;
- One .05-mf. cub condenser, C16;
- One .01-mf. 400-volt cub condenser, C14;
- One 7,500-ohm, ½ watt resistor, R1;
- One 200-volt, ½ watt resistor, R2;
- One 25,000-ohm, 1 watt resistor, R3;
- One 25,000-ohm ½ watt resistor, R4;
- One 1-megohm, ½ watt resistor, R5;
- One 100,000-ohm, ½ watt resistor, R6;
- One 400-ohm, ½ watt resistor, R7;
- One 1,000-volt, ½ watt resistor, R8;
- One 20-ohm center tap resistor, R9.

**I. F.-R. F. OSCILLATOR**

(Continued from page 91)

The same procedure can be carried out at the zero setting of the oscillator dial. In this case the frequencies worked out accurately at the first trial. A harmonic was tuned in at 72 on the tuner dial, indicating a frequency of 700 kc., and at 43, indicating a frequency of 1050. The difference, 350 kc., is the fundamental frequency of the oscillator at this setting. The second, third and fourth harmonics are marked on the graph of Fig. 5. This procedure was carried out at every 10 degree setting of the oscillator dial. A series of curves, as shown on the chart of Fig. 5 were plotted. It was found that the curves were actually straight lines, due to the straight-line-frequency characteristic of the oscillator condenser.

If one desires very accurate readings, an output meter may be connected to the radio receiver so that a visual indication, rather than an audible one, may be had. A suitable output meter is described on page 92 of this issue.

To make an accurate check of the calibration curves of the oscillator, one of the side plates should be removed and a piece of wire connected across the grid condenser so as to short-circuit it. Then the side plate should be replaced. In this condition the oscillator will generate a non-modulated wave which can be used to heterodyne the wave of a crystal-controlled broadcast station tuned in on the receiver. When making this test a short indoor aerial, just sufficient to pick up the broadcast station, should be connected to the aerial post of the receiver. The oscillator is left connected to the receiver. By tuning-in a station, such as WDR at 710 kc., the oscillator should cause a heterodyne squeal at 73, 112½, and 135½ (dial) settings of the oscillator working on the third, fourth and fifth harmonics respectively. Tune the oscillator dial for zero-beat adjustment and the calibration will be exact. Several stations may be tuned-in in this manner and slight corrections can then be made to the previous plotted curves if necessary, after which the short-circuiting wire in the grid condenser may be removed.



**PRICE \$3.50** Sent Postpaid in the U.S.

With the EASY-CHAIR RADIO REMOTE CONTROL, you can control both volume and tone of your radio from any part of your room, from an adjoining room, porch, sun parlor, or sick bed. No longer necessary to sit within reach of your radio nor rush across the room whenever you radio "Tales." Controls and improves the tone of your set from brilliant treble to deep bass. Suppresses static and electrical interferences. Equipped with a detachable, ornamental leather arm-chair strap, enabling you to place the control on the arm of your easy-chair. Installed by anyone without tools in three minutes. Satisfaction guaranteed or money refunded.

Service men! Get your share of extra business installing these new unique controls. Every radio owner a customer. Write for proposition. Send no money—Just mail Coupon.  
**PLYMOUTH RADIO DEVICE CO., PLYMOUTH, PA.**  
Please send me C. O. D., \$3.50, one Easy-Chair Radio Remote Control with privilege of returning it within three days if not satisfactory.  
Name .....  
Address .....  
City ..... State .....



**AMPERITE** improves radio, protects tubes and parts. Money-maker for Service Men. Send \$1.62 to Dept. RC-8 for dealers' sample and sales help.



**To Tune The MEGADYNE Receiver**

A condenser is just a condenser to some set builders, but when results must be certain, it is safest to choose the Hammarlund specified by the circuit designer. Write Hammarlund Mfg. Co., 424 W. 33rd St., New York, for folder.



**TUBE CHECKER**

Oscillator and Short tester can be built using our Model 3 1, 1½, 2, 2½, 3, 5, 6, 7½. 900 transformer. Tests all old and new tubes including C-57 C-58 etc. Full instructions included. \$2.65. Model 1 transformer same as shown in "Meterless Tube-Checker." \$3.65. Can supply other parts.  
Adapter: 6 prong to 3 prong needed for testing C-57, C-58, 75 cents.  
8-Point Tap Switch. Breaks between contacts. 80 cents. All above shipped postpaid.  
**L. & L. ELECTRIC CO.**  
336 Madison Avenue Memphis, Tenn.

**FREE! The RADOLEK CO**  
**108 Canal Station Chicago, Ill.**  
Our new 1932 Radio Serviceman's Wholesale Price Guide will be sent to you upon request. Write, using your letterhead or business card. Send for it today.



# 10 NEW BOOKS in the Radio-Craft

Presented on these two pages are the new books of the RADIO-CRAFT LIBRARY—the most complete and authentic set of volumes treating individually, important divisions of radio. Each book has been designed to give radio men the opportunity to specialize in one or more of the popular branches of the industry. The material contained in these books will increase your

knowledge; you will find them a real help in your work and they will contribute to your money earning capacity. Read these books during your spare time at home.

The authors of these books are well-known to everybody. Each one is an expert radio man; an authority on the subject—each is thoroughly familiar with the field which he represents.

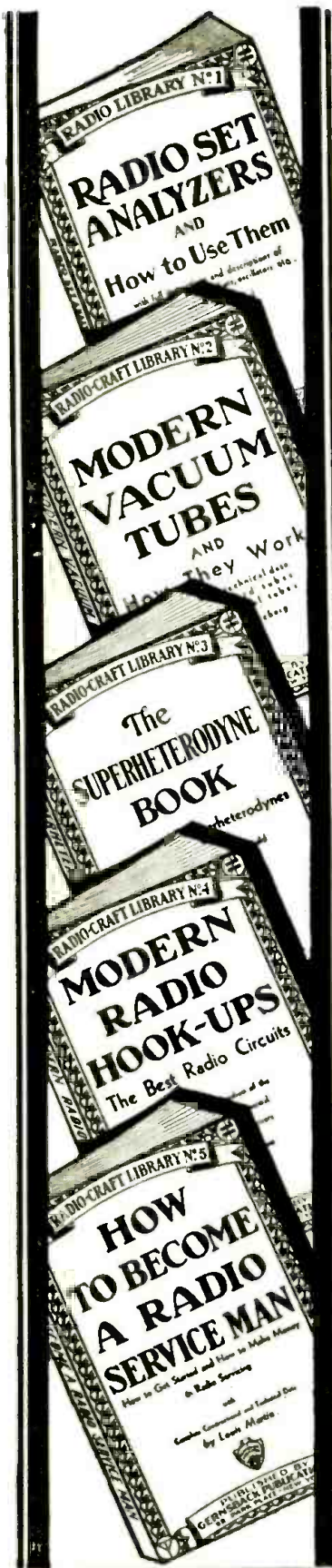

**Book No. 1**  
**RADIO SET ANALYZERS**  
 And How To Use Them  
 With Full Instructions and Descriptions of Set Analyzers, Tube Checkers, Oscillators, Etc.  
 By **L. VAN DER MEL**

This book explains thoroughly the operation of set analyzers, tube checkers, oscillators and other testing equipment. For every radio man this book is extremely helpful. It covers every phase of testing and gives you valuable short cuts, completely illustrated with photographs and diagrams to facilitate the use of modern testers.

The following chapters briefly outline the contents: **INTRODUCTION; THE ANALYZER; Fundamentals, Scales, A.C. and D.C. Voltmeters, Calibration and Design; TROUBLE SHOOTING WITH THE ANALYZER; Classification of Trouble, Analysis of Troubles, Uses of Various Analyzers, Care and Maintenance; CONCLUSION.**

**Book No. 2**  
**MODERN VACUUM TUBES**  
 And How They Work  
 With Complete Technical Data on All Standard and Many Special Tubes  
 By **ROBERT HERTZBERG**

**MODERN VACUUM TUBES** describes the fundamental electron theory which is the basis of all vacuum tube operation, and goes progressively from the simplest two-element tubes right up to the latest pentodes and thyatrons. It is written in clear, simple language and is devoid of the mathematics which is usually so confusing. Valuable reference charts and characteristic curves of standard and special tubes are to be found, also diagrams of sockets and pin connections.

Here are some of the chapters: **The Edison Effect and The Electron Theory; Electron Emitters and the Ionization Effect; The Three-Electrode Tube; Vacuum Tube Characteristics; Four- and Five-Element Tubes; Light Sensitive Cells and Other Special Tubes.**

**Book No. 3**  
**THE SUPERHETERODYNE BOOK**  
 All About Superheterodynes  
 How They Work, How to Build and How to Service Them  
 By **CLYDE FITCH**

There is no more fascinating a subject in the large array of radio circuits than the famous superheterodyne circuit. Whether you are a Service Man or experimenter, first-hand knowledge about the construction of superheterodyne receivers is very important. The book on Superheterodynes gives underlying principles of their construction, right from the very first set made.

The following is a short list of contents: **Basic Principles of the Superheterodyne; The Oscillator; First Detector; Single Dial Tuning Systems; Intermediate Amplifier; Second Detector; Audio Amplifier and Power Supply; Commercial Superheterodyne Receivers; Servicing Superheterodynes.**

**Book No. 4**  
**MODERN RADIO HOOK-UPS**  
 The Best Radio Circuits  
 A Complete Compendium of the Most Important Experimental and Custom-Built Receivers  
 By **R. D. WASHBURN**

It is fascinating to the experimenter, or even to the up-to-date Service Man, to take a commercial set and to change it into one using a famous hookup that is not found in any manufactured set. Many excellent circuits have never been commercialized, but limited only to home-set builders. Thousands of these popular circuits have been requested from time to time, and in this book we have included over 150 circuits, which include the famous Peridine, Cash-Box A.C.-D.C. Set and others.

The circuits cover the following: **Broadcast Receivers, All-Wave Receivers, Short-Wave Receivers, Converters and Adapters, Television Receivers, Home Recording Apparatus, Automobile Receivers, Audio and Power Amplifiers, Power Units and Miscellaneous Equipment.**

**Book No. 5**  
**HOW TO BECOME A RADIO SERVICE MAN**  
 How To Get Started and How To Make Money in Radio Servicing  
 By **LOUIS MARTIN**

The ambition of many men in radio today is to become a first-grade Service Man. It is not as difficult as one might believe, but it cannot be done in a few short months. Following very carefully the advice of Mr. Martin, who has dealt with the problems of thousands of Service Men, this book deals very carefully with the essential stages in the preparation for qualifying as a Service Man.

Here are the chapters: **The Small Independent Service Man; Advanced Commercial Aspects; The Radio Set; Semi-Technical Considerations; Advanced Service Data.** Each chapter is again subdivided to bring out in minute detail every point of importance.

**Book No. 6**  
**BRINGING ELECTRIC SETS UP TO DATE**  
 With Pentodes, Multi-Tubes, Dynamic Speakers—Complete Information How to Modernize A.C., D.C. and Battery Operated Receivers  
 By **CLIFFORD E. DENTON**

In this country there are over ten million electrically operated receivers that could be modernized—by placing in them new type tubes, new speaker equipment and other modern improvements. This business of improving old sets can go to the experimenters and Service Men if they will quickly jump into action.

Read in this book by Mr. Denton, how easily you can modernize any obsolete set, and with little additional costs.

Here are the high lights of this book: **Tubes Available for Replacements; Electrifying Battery Receivers; Use of the New 2- and 6-Volt Tubes; Operating Sets with Single Control; Conversion of A.C. Sets into D.C. and D.C. into A.C.; Replacing Output Tubes with Higher Output Tubes; Improving Old Supers; Lifting White Amplifiers; Adapters and Their Use.**

**Book No. 7**  
**RADIO KINKS AND WRINKLES**  
 For Service Men and Experimenters  
 A Complete Compendium on the Latest Radio Short-Cuts and Money-Savers  
 By **C. W. PALMER**

It often becomes necessary for experimenters and Service Men to call upon their memory for some short cut or radio wrinkle that will solve a problem quickly. In business, "short cuts" mean time and money saved, and to the Service Man "time saved" means money earned.

This book is a compilation of important radio kinks and wrinkles, and discusses only such items as are constantly used today. Here are some of the more important chapters: **Introduction; Servicing Short-Cuts; Testing Equipment and Meters; Vacuum Tubes and Circuits; Volume-control Methods; Amplifiers and Phonograph Reproducers; Power Supply Equipment; Cords and Tuning Circuits; Short Waves; Loud Speakers; Tools and Accessories.**

**Book No. 8**  
**RADIO QUESTIONS AND ANSWERS**  
 A Selection of the Most Important of 5,000 Questions Submitted by Radio Men During the Course of One Year  
 By **R. D. WASHBURN**

There has been collected a wide variety of questions which have come into our editorial offices during the past two years, and only those whose answers would benefit the majority of men engaged in radio have been incorporated in this amazing question and answer book.

The tremendously long list of topics better explains the subjects which are treated. Here are the titles:

**Radio Servicing; Receiver Design; Home Recording; Television; Sound Equipment; Short Waves; Antennas; Operating Notes; Test Equipment; Tubes; Ultra-Short-Waves; Police Radio; Reproducers; Superheterodynes; Automotive Sets; Power Packs; Automatic and Remote Control Devices; Aligning Procedure; Photoelectricity; Adapters; Measuring Apparatus; Band Selectors; Converters; Public Address Equipment; Midget Sets; Oscillators; Phonograph Pickups.**

**Book No. 9**  
**AUTOMOBILE RADIO AND SERVICING**  
 A Complete Treatise on the Subject Covering All Phases from Installing to Servicing and Maintenance  
 By **LOUIS MARTIN**

Automobile radios are up and coming, and someone has to service them properly. It therefore behooves you to read this immensely important new book on the art of Automobile Radio. The book is concise, and full of illustrations, photographs, diagrams and hookups.

Here are only a few of some of the really interesting chapters: **Introduction; Automotive Radio Installations; Complete Descriptions of Commercial Automotive Receivers; Servicing Automotive Receivers; The Ignition System; General Service Considerations; Effects of Temperature on Power Supply; Conclusion.**

**Clip Coupon and MAIL!**

GERNSBACK PUBLICATIONS, INC. 96-98 Park Place, New York, N. Y.

I have circled below the numbers of books in the RADIO-CRAFT LIBRARY, which you are to send me, and have deducted 20% for ordering five (5) books or more. I have included my remittance in full, at the price of 50c each, when less than five books are ordered.

The amount of my remittance is ..... (Stamps, checks or money orders accepted.)

Circle numbers wanted: 1 2 3 4 5 6 7 8 9 10

Name ..... Address .....

City ..... State ..... RC-832





# Library

This is perhaps the first real opportunity that you have ever had to build a radio library of books that are authentic, right-up-to-the-minute and written so that they are easily digested and clearly understood. Mail coupon on the opposite page for your books.

Book No. 10

## HOME RECORDING AND ALL ABOUT IT

A Complete Treatise on Instantaneous Recordings, Microphones, Recorders, Amplifiers, Commercial Machines, Servicing, etc.

By GEORGE J. SALIBA

If there is one subject that is fascinating to every radio man, it is that of Home Recording. Of course, this volume is not all on "Home" recording, but the information contained therein is important to commercial radio men, studio operators, engineers and others interested in this phase of radio.

The art of recording and reproducing broadcast selections is becoming more important every day to radio men, experimenters and Service Men. Equipping dance halls, auditoriums, churches, restaurants and homes with public address and amplifiers brings many extra dollars and often an excellent income.

In this book are found such topics as: Short History of the Art; Microphones; Recording Amplifiers; Cutting Heads; Types of Records; Commercial Machines; Adding Recorders to Receivers; Studio Layouts; Mechanical Filters for Turntables.

## BIG DISCOUNT OFFERED

In order to make it possible for everyone to buy these books, the fifty (50) cents price has been made uniform for all volumes. You can buy these books separately, but you should take advantage of our special offer.

When Five (5) Books or More Are Ordered Deduct 20% from Your Remittance

Simply fill in the coupon below, and mail it to us together with your remittance. Checks, stamps or money orders accepted.

## All Books Uniform

The books in the new RADIO-CRAFT LIBRARY are all strictly up-to-date, and written by men who know their subjects. The volumes are all uniform size, 6 x 9 inches, and contain on an average of 50 to 120 illustrations. Each book is printed on fine book paper, and no expense has been spared to make it an outstanding value, for its editorial contents as well as from the mechanical standpoint.



## ELECTRIC CODE

(Continued from page 116)

always dig into the insulation with a finger nail to determine the life in rubber covered wire.

(5.) LOWER INSURANCE RATES. All insurance organizations are merely pools wherein the supposedly unlucky few who have suffered reverses, are compensated for their losses by the fortunate many. Thus one fire loss is paid for out of the premiums paid by many who have not had fire losses. If many fires occur, more money must be paid in by those who have not had any fires, meaning higher insurance rates. If each householder did his bit to prevent fires, all fire insurance rates on this type of insurance would go down. Another thing to bear in mind is that insurance companies do not have inexhaustible pots of gold to ladle out to their policy holders, as seems to be the popular conception. All damages collected by a householder from the insurance company for loss caused by a fire or otherwise must come from the pockets of his friends and neighbors since the rates for the same risks for the same types of residences differ in various localities, due entirely to the poor risk and the frequency with which fires occur. Insurance rates are the force most electrical authorities use to compel removal of violations when peaceful requests have failed. By reclassifying a risk, as anything insured is known, into a grade where more losses occur, rates are doubled and tripled. For example, a building insured for \$100,000, and paying a rate of 1½ per cent or \$1,500., will have its rate doubled—3 percent or even 4½ percent rates are sometimes charged. Thus the cost of insurance is raised from \$1,500. to \$3,000. a year at 3 percent or \$4,500. at 4½ percent. The difference between these sums would pay for a lot of electrical wiring.

Doubtless, radio Service Men who will give the subject some study, can find many other reasons to advance against the natural objection of the householder to any change, absolutely not vital to the playing of his radio. Figures on reinspection are available and electrical contractors throughout the country are seeking legislation to provide enough inspectors so that every electrical installation may be inspected and reported upon every two years. The most common defense of unapproved wiring: "Everybody's doing it," does not seem to impress insurance authorities or magistrates as an adequate explanation of why the law is being violated.

For the Service Man operating in a section where a license is not required, or where a Service Man has made contact with an electrical contractor who will file for him and obtain the necessary certificates, we will take up the various approved methods of obtaining electrical connections for appliances, in the following section.



Hey, Service Man, how would you like to own a little side show like this?

## SKINDERVIKEN Transmitter-Microphone-Amplifier Units



### A FEW USES FOR THESE UNITS

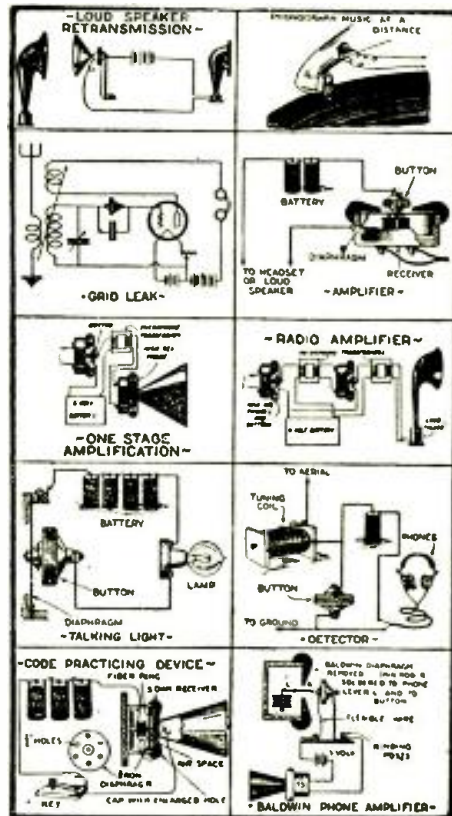

### HUNDREDS OF USES FOR THE EXPERIMENTER:

- RADIO AMPLIFIER
- DETECTOR
- STETHOSCOPE
- MICROPHONE
- PHONOGRAPH AMPLIFIER
- TELEPHONE AMPLIFIER
- LOUD SPEAKER AMPLIFIER
- CRYSTAL SET AMPLIFIER
- HOME RECORDING SUITS

### WE PAY \$5.00 IN CASH

for every new use developed for this unit and accepted and published by us.

One Unit 95c; Two for \$1.75  
12-PAGE INSTRUCTION BOOKLET  
containing suggestions and diagrams for innumerable uses, furnished with each unit.

EVERY AMATEUR SHOULD HAVE TWO OR THREE OF THESE AMPLIFIERS IN HIS LABORATORY

### SEND NO MONEY

When the postman delivers your order you pay him for whatever you have ordered, plus a few cents postage.

PRESS GUILD, Inc., RC-8-32  
16 Murray St., New York, N. Y.

Please mail me at once as many of the following items as I have indicated.

...Skinderviken Transmitter Units at 95c. for 1; \$1.75 for 2; \$2.50 for 3; \$3.20 for 4.

When delivered I will pay the postman the cost of the items specified plus postage.

Name .....  
Address .....  
City ..... State .....

..... where the thousands of Short Wave fans get their valuable information---quickly!

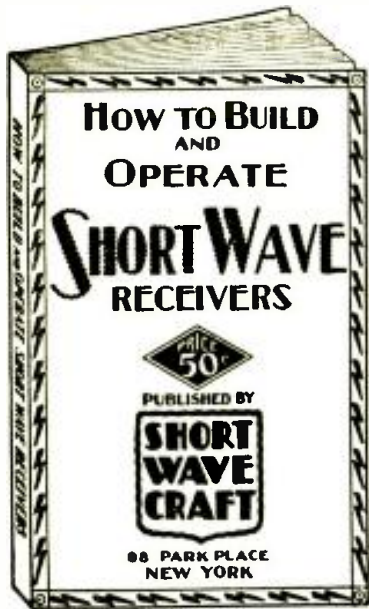

**T**HE greatest book of its kind ever published. **HOW TO BUILD AND OPERATE SHORT WAVE RECEIVERS** is the best and most up-to-date book on the subject ever put between two covers.

The book has been edited and prepared by the editors of **SHORT WAVE CRAFT**, and contains a wealth of material on the building and operation, not only of typical short wave receivers, but short wave converters as well.

Dozens of short wave sets will be found in this book, which contains hundreds of illustrations; actual photographs of sets built, hook-ups and diagrams galore.

**WE SAY—AND REPEAT IT—THAT NOTHING LIKE THIS HAS EVER BEEN PUBLISHED BEFORE.**

The book comes with a heavy colored cover, and is printed throughout on first-class paper. No expense has been spared to make this the outstanding volume of its kind. The book measures 7½ x 10 ins.

Published by the publishers of **SHORT WAVE CRAFT** magazine. This alone will be your guarantee that it is a really worthwhile publication.

We know that if you are at all interested in short waves you will not wish to do without this book. It is a most important and timely new radio publication. 76 Pages — 250 Illustrations — Stiff Paper Covers

**NOT SOLD ON NEWSSTANDS**  
*Mail Coupon At Left!*

**SHORT WAVE CRAFT** R.C. 8  
96-98 Park Place, New York City.

I enclose herewith fifty (50c) cents for which please send me a copy of your new book **HOW TO BUILD AND OPERATE SHORT WAVE RECEIVERS**. (Send money order, check, cash, or new U. S. Stamps. Register letter if it contains currency or stamps.)

Name .....

Address .....

City and State.....

## CLASSIFIED ADVERTISEMENTS

Advertisements in this section are inserted at the cost of ten cents per word for each insertion—name, initials and address each count as one word. Cash should accompany all classified advertisements unless placed by a recognized advertising agency. No less than ten words are accepted. Advertising for the September 1932 issue should be received not later than July 9th.

### BUSINESS OPPORTUNITIES

**ATTENTION:** Distributors, Dealers, Salesmen—Make money selling nationally known Hoover Range Oil Burners; retails at \$29 to \$39; your special price \$12.50. (order sample). Write Hoover Oil Burner Co., 1497 Main St., Bridgeport, Conn.

### INVENTORS

**PATENT YOUR INVENTION:** Send for FREE book, "How to Obtain a Patent," and "Record of Invention" blank. Consult us about how to protect your ideas. Victor J. Evans & Co., 62011 Victor Bldg., Washington, D. C.

### MISCELLANEOUS

"If You want to make new friends by mail, or go into business. We publish mailing lists of all descriptions. Write for free information. Box 100-AB, Fremont, Ohio.

### RADIO INSTRUCTION

**LEARN** Radio, television and talking pictures in Canada. Day, evening and home study classes. Free scholarship and trip to Toronto, all expenses paid. Booklet on request. Radio College of Canada, 310 Yonge St., Toronto.



**\$5,000 WILL BE PAID TO ANYONE WHO PROVES THAT THIS IS** not the actual photo of myself showing my superb physique and how the Ross System has increased my own height to 6 ft. 3 3/4 inches. Hundreds of Testimonials. Clients up to 45 years old gain from 1 to 6 inches in a few weeks!

**No Appliances—No Drugs—No Dieting. ROSS SYSTEM NEVER FAILS. Fee Ten Dollars Complete. Convincing Testimony and Particulars 5 cent stamp. "Allow time for return mails across the Atlantic." G. MALCOLM ROSS, Height Specialist, Scarborough, England. (P. O. Box 15).**



### RADIO

**GUARANTEED "Pocket Radio,"** \$2.00. Catalogue, 10c. Neil Tasker, Shamokin, Pennsylvania.

**GUARANTEED MICROPHONE REPAIRS—**Any make or model—24 hour service. Stretched diaphragm double button repairs, \$7.50. Others \$3.00. Single button repairs, \$1.50. Write for 1932 Catalog with diagrams. Universal Microphone Co., Ltd., Inglewood, Calif.

**MAKE Simple Crystal Radio. "MELOMITE"** Crystal with instructions. 25c. New "Melody King" crystal radio, \$1.00. Complete with phone, aerial, \$2.75. Melomite Co., 7787 Fairmount, Kansas City, Mo.

**TRANSFORMERS REWOUND,** varnished, baked, guaranteed, reasonable cost. **SPEAKER REPAIRING,** magnetic \$2.00-\$2.50; dynamic, voice coils, fields, etc., reasonable charges. Clark Bros. Radio Co., Albia, Iowa.

**RADIO Service Men Attention—**Power transformers rewound or rebuilt to your requirements. Meyke Radio Service, 2624 Margaretta, Maplewood, Mo.

### BACK ISSUES

of **RADIO-CRAFT** can be had at the price of 25c each. Address

**RADIO-CRAFT**  
98 Park Place New York, N. Y.

## Index to Advertisers

<b>A</b>	
Alden Mfg. Company .....	112, 116
Alumaweld Company .....	113
Amperite Corporation .....	121
<b>C</b>	
Cable Radio Tube Corporation..	Inside front cover
Chemical Institute of N. Y. ....	120
Clarostat Mfg. Company .....	119
Classified Section .....	124
Coast-to-Coast Radio Corp. ....	117
Coyne Electrical School .....	65
Crosley Radio Corporation .....	109
<b>D</b>	
DeVry, Inc., Herman A. ....	118
Drake Hotel .....	126
<b>E</b>	
Electrad, Inc. ....	116
<b>F</b>	
Hotel Flanders .....	126
<b>G</b>	
Gernsback Corporation, S. ....	125
Gold Seal Mfg. Company .....	114
Grant Radio Laboratories .....	116
Grenpark Company .....	125, 127
<b>H</b>	
Hammarlund Mfg. Company .....	126
Hoodwin Company, Chas. ....	112
<b>I</b>	
International Resistance Company .....	108, 119
<b>J</b>	
J M P Mfg. Company .....	116
<b>L</b>	
L & L Electric Company .....	121
Lincoln Radio Corporation.....	Inside back cover
<b>M</b>	
Merrim & Co., G. & C. ....	114
Midwest Radio Corporation.....	107
Hotel Montclair .....	126
My Own Radio, Inc. ....	110
<b>N</b>	
National Electric Tool Company .....	112, 116
National Radio Institute .....	67
<b>P</b>	
Plymouth Radio Device Company.....	121
Polymet Mfg. Company .....	110
Popular Book Corporation .....	121, 124
Press Guild, Inc. ....	119, 123
<b>R</b>	
Radio Trading Company .....	128
Radolek Company .....	121
Radio Training Assoc. of America .....	116
Readrite Meter Works .....	115
Ross, Malcom .....	124
Russian Village .....	126
Shallcross Mfg. Co. ....	117
Supreme Instruments Corp. ....	111
Sylko Microphone Co. ....	110
Sun Radio Company .....	108
<b>T</b>	
Triad Mfg. Company .....	Back cover
<b>U</b>	
Universal Microphone Company .....	116

(While every precaution is taken to insure accuracy, we cannot guarantee against the possibility of an occasional change or omission in the preparation of this index.)



# Headquarters FOR Materials and Parts FOR Building TREASURE LOCATORS

Radio, Audio, Ground Potential measurements, Hughes Induction Balances and other types; Oscillators and amplifying systems included.

*We can supply all materials needed for building and operating of any of the recognized treasure finders.*

With this apparatus you can locate buried treasures, metal war relics, mineral deposits, subterranean water veins, buried gas and water pipes, and lost objects, tools and treasures sunken in water, etc.

Write for pamphlet giving history and theory on this interesting subject. Twelve different circuits are described and explained. List of parts and prices included. (Price of pamphlet 10c.)

**Mail Coupon TODAY!**

GREN PARK COMPANY Dept. RC-8  
245 Greenwich St., New York, N. Y.

Enclosed find 10c for which kindly send me pamphlet on Treasure Finders.

Name .....

Address .....

State .....

## A SET ANALYZER

(Continued from page 93)

tween control grid and cathode of screen-grid tubes; No. 13 is "CG-K60V," and is the same as No. 12 but using the 60-volt scale; No. 14 is "P-K-300V," meaning the 300-volt scale is connected between plate and cathode; No. 15 is "P-K600V," and is the same as No. 14 using the 600-volt scale; No. 16 is "P-12MA," meaning the 12-ma. range is in series with the plate circuit; No. 17 is "P-60-MA," and is the same as No. 16 using the 60-ma. scale; No. 18 is "P-120-MA," and is the same as No. 16 and 17 using the 120-ma. scale; No. 19 is "G-120-MA," meaning the 120-ma. scale is in series with the grid circuit; No. 20 is "PG-K30V," meaning the voltmeter is between the "pentode grid" and cathode of an R.F. "pentode tube." This "pentode grid" is the one on the side of the base of an R.F. pentode tube. The 30-volt scale is used. The "P" in this case should not be confused with the "P" position on other positions of the switch which refer to plate connections. No. 21 is "Output" and the range covered is determined by the external connection to the output jacks. These are marked—Low—Med, and High. This scale is used as a visual indicator of resonance in connection with an oscillator. Directions for the use of this scale will be given later. No. 22 is not marked and represents the "off" position of the D.C. meter.

### A.C. Selector Switch

The A.C. meter is controlled by the smaller selector switch to the left. It has seven positions. Two of these are marked "off." Counting from the top, No. 1 is the "off" position. No. 2 is marked H-111-4V meaning the A.C. voltmeter is connected across the filament circuit using the 4-volt scale. No. 3 is H-111-8V meaning the 8-volt scale is connected across the filament circuit. No. 4 is the other "off" position and this "off" position separates the low-voltage scales from the high. No. 5 is "P-H800V," and means the 800-volt scale is connected from plate to filament. This refers to rectifier tubes and measures directly the A.C. voltage applied to one plate of an '80 rectifier or to the plate of an '81 rectifier. No. 6 is "G-11-800V," and measures the A.C. voltage applied to the second plate of the '80 rectifier. No. 7 is marked and connects the current range of the A.C. meter to the proper small jacks at the rear of the panel.

### Automatic Switch for Tube Tests

The small selector switch to the right is for testing tubes. It is automatic and springs back into the "off" position when released. All but rectifier tubes are tested with this switch. As the rectifier does not have a grid, such a test is not needed for it.

To test all other tubes, first record the normal plate current, if the tube is one of the screen-grid types such as the '22, '24, '35, '51, '37, or '38, push down on the selector switch and a second plate current reading should be obtained. If the tube under test is an ordinary three-element type, or '47 type, turn the switch in the "up" position to get the second plate-current reading. This change in plate current determines the condition of the tube. In most cases the greater the difference in the two plate current readings, the better the tube.

It is not possible to give any definite values to determine the condition of tubes. Receivers apply different voltages to tubes and therefore different current values will be recorded. However, after a little practice in testing good and bad tubes by this method, one can soon learn to tell when a tube is defective. When testing a detector, it is best to move the tube to another socket as in the detector stage a high bias is present which limits the plate current to a small value.

### LEAD-IN STRIPS

When servicing a receiver which is noisy, has intermittent reception or no reception at all, test the lead-in strip to be certain that the window, especially in the summer, has not broken through the insulation and ruined the strip.

## Would Not Part With It for \$100.00

YET ALL HE PAID  
WAS \$3.98

Dear Sir:

After receiving your new second edition Radio Encyclopedia, and looking through it, I find that it is one of the most valuable books I have ever laid my hands on, and I would not part with it for one hundred dollars, if I could not replace it.

Thanking you for giving me this opportunity of securing this valuable book, I remain,

Ralph Tomilson  
Myrtle Station,  
Ontario, Canada.

### What the New Second Edition Radio Encyclopedia Gives You

It gives you an explanation of every word used in radio. These explanations—or, rather, definitions—are not brief outline information like those of an ordinary dictionary, but they give in fullest detail and at considerable length the meaning and application of every word, phrase, general and special terms used in the science of radio. They are written in plain, everyday English, easily understood by anyone.

Practically every definition in the book is illustrated by drawings, photographs, diagrams, or charts. All you need to do is to look up as you would in a dictionary, the word or phrase about which you are seeking information. Furthermore, each page is key-indexed, for greater convenience and speed in locating any definition. All the Subject-Matter is Arranged in Alphabetical Order.

This greatly enlarged Second Edition Radio Encyclopedia is an absolute necessity to everyone interested in Radio. It answers all radio questions, increases your knowledge and saves your time. It covers every known radio problem, and is a goldmine of practical information for every radio man.

2,201 RADIO DEFINITIONS  
1,253 TECHNICAL ILLUSTRATIONS  
34 TABLES AND CHARTS  
24 PAGES OF APPENDIX  
Red Morocco-Keratol Flexible Binding  
Printed on strong ledger paper, Loose-Leaf  
Arrangement

352  
pages  
9 x 12  
inches  
Weight  
3  
lbs.

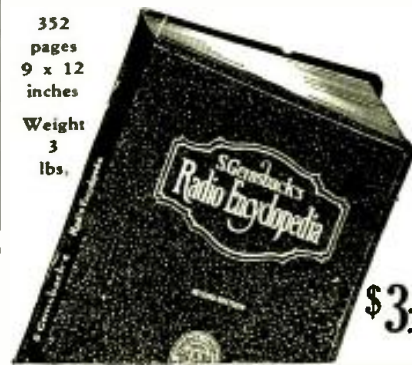

S. GERNSBACK CORPORATION,  
98 Park Place, New York, N. Y.

Send me one copy of the new Second Edition S. Gernsback's Radio Encyclopedia. I enclose herewith \$3.98, check or money order preferred. (Foreign and Canada, add 35c extra for postage.) Money refunded in full if not satisfactory.

Name .....

Address .....

City..... State.....

RC-832

# Hotel Directory of the Radio Trade

The Hotels on this page are Patronized by the Radio Trade. Make them your Headquarters.



## THE HOTEL MONTCLAIR

LEXINGTON AVE., 49th to 50th STS.  
NEW YORK

Directly Opposite the Waldorf-Astoria

### 800 ROOMS

Every Room With Bath  
From \$3.00 per day

Attractive Rates by the Month

### A RADIO IN EVERY ROOM

Short walking distance from Grand Central Terminal and B. & O. Motor Coach Station. Ten minutes by taxi from Pennsylvania Station.

American Home Cooking Served  
in a Notable Restaurant

OSCAR W. RICHARDS, Manager



## This Summer Enjoy Your Chicago Business Trips

A STAY at THE DRAKE adds pleasure to business. Overlooking Lake Michigan, your business days . . . and nights will be spent in resort-like comfort. Restfully quiet . . . convenient to all loop business . . . theatres, and with beaches, bridle path and beautiful Lincoln Park, close at hand. Rooms are light and airy . . . pleasantly comfortable. *Without extra cost*, extra accommodations are made available to the guest for large or small conferences. Room rates begin at \$4 per day.

THE  
**DRAKE**  
HOTEL, CHICAGO  
*Under Blackstone Management*

... "AN ADDRESS OF DISTINCTION" III

A HOMEY HOTEL IN THE  
HEART OF NEW YORK

## THE NEW FLANDERS

133 W. 47th Street through  
to 48th Street

One of the Finest Hotels in  
Times Square

Single Rooms with Adjacent  
Bath ..... \$1.50 and up  
Single Rooms with Bath... 2.00 and up  
Double Rooms with Bath.. 3.00 and up  
Suite—2, 3, 4 People..... 5.00

Special Weekly Rates

FRED W. BIZEL, Resident Manager

## Important Announcement!

On pages 122 and 123 of this issue will be found a very important announcement telling of the RADIO-CRAFT LIBRARY. Be sure to turn to these pages NOW and learn of the ten new and interesting books which are being published.

"The Gathering Place  
of  
Cosmopolitan New Yorkers."

The RUSSIAN VILLAGE  
100 West 57th Street  
New York City

Dining, Dancing, Russian and Gypsy  
Entertainment.

LUNCH — TEA — DINNER

No cover charge at any time.

Broadcasting WOR Circle 7-9434

THE SENSATIONAL  
**HOLLYWOOD**  
RESTAURANT  
B'WAY. at 48<sup>th</sup> ST. N.Y.C.

**NTG** and his  
NEW REVUE

Presents  
the great-  
est cabaret entertainment  
the world has ever seen.  
Broadway's Best Dinner  
\$1.50 \$1.75 \$2.00

AFTER  
THEATRE  
Popular Prices.

NO COVER CHARGE



# \$100,000 Speaker Sale!

Included in this tremendous speaker sale are the products manufactured by leading speaker makers. Every speaker is brand new and shipped in original factory sealed cartons. They are sold far below their regular list price because they were bought in exceedingly large quantities and our purchase price permits us to give you the benefit of low cost.

## LOFTIN-WHITE AMPLIFIER (Licensed)



LOFTIN-WHITE amplifiers in striking modernistic finish. Ideal for phonograph or public address work.

- 245 Model uses 1-224, 1-245, 1-280 **\$12.50**
- 250 Model uses 1-224, 1-250, 1-281 **\$15.95**
- 247 Single Pentode Amplifier **\$14.95**
- 247 Push-pull Pentode Amplifier **\$19.95**

## JENSEN

- A.C.—D.8 Dry Rectifier **\$14.95**
- A.C.—D.7 Jr. Audit Tube Rect. **\$10.95**
- A.C.—D.15 Concert Jr. Tube Rect. **\$7.95**
- D.9—2500 OHM D.C. Field **\$7.50**
- D.7—2500 OHM D.C. Field **\$7.95**
- D.15—Midget 2500 OHMS **\$4.75**

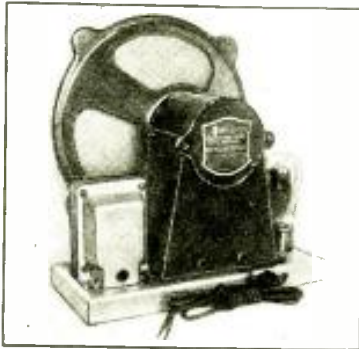

## ROLA SPEAKERS



- Model K. Midget A.C. using 280 Rect. **\$8.50**
- D. C. Models Model F **\$4.25** Each Model
  - 2500 ohm P.P. Output Trans.
  - 1000 ohm P.P. Output Trans.
  - 2500 ohm Single Pentode.
  - 2500 ohm Push Pull 238.
  - 1000 ohm Single 238.
- 1800 ohm Single Pentode 300 ohm Tap for Bias.

## BALDWIN

- A. C. using 280 Tube Rect. **\$6.95**
- D. C. 2500 OHM—110 Volts **\$4.95**
- D. C. 2500 OHM—110 Volts Field Less Stand **\$4.00**
- D. C. 2500 OHM—110 Volts Field Less Output Trans. **\$3.25**



## OXFORD

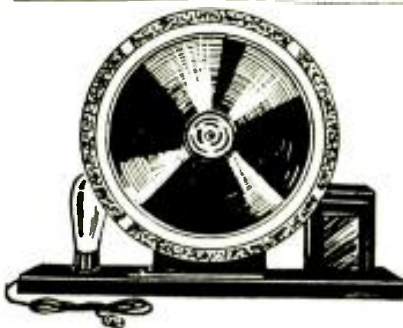

- A. C. Models **\$10.95**
    - 14" Audit using 280 Rect
    - 12" Concert Dynamic 280 Rect **\$8.50**
    - 9" Midget Dynamic 280 Rect **\$7.50**
  - D. C. Models **\$8.95**
    - 14" 5000 OHM Field **\$8.95**
    - 11" 2500 OHM Field **\$4.95**
    - 9" 2500 OHM Field **\$3.49**
- All 9" Midgets are supplied with Hum balancer

## Do Not Write For Catalog!

All offers are F.O.B. New York, and subject to prior sale. Terms: A deposit of 20% is required with every order. Balance may be paid on delivery. Or, deduct 2% if full amount is sent with order.

## UTAH "TREASURE CHEST"



### Magnetic Speaker

This beautiful walnut speaker, in three-tone effect, makes a handsome decorative speaker for any radio set. Tone qualities are excellent—cover raises and lowers to give various degrees of loudness desirable for the room. The "Treasure Chest" contains a UTAH Magnetic Speaker unit. The chest itself measures only 16½x11½x9½".

YOUR PRICE **\$2.95**

## NEW PRIME ELECTRIC MOTOR

For 110 Volt A. C.  
50 to 60 Cycles



A sturdy, powerful compact heavy duty induction type phonograph motor. Absolutely free from commutator brushes. It will not set up any disturbances. Equipped with large bearing surfaces to provide adequate support and insure long life.

YOUR PRICE **\$4.95**

## R.C.A. & VICTOR

- Victor A.C. Audit Model with Tube **\$12.25**
- Victor D.C. Audit 2500 Ohm **\$8.95**
- Victor D.C. Audit 2500 Ohms **\$7.95**
- Less output **\$7.95**
- R. C. A. A.C. With tube rect **\$12.50**
- D.C. 8000 ohm 300 V. Field **\$5.50**
- D.C. 8000 ohm 300 V. Field output **\$4.50**
- D.C. 800 ohm 110 V. Field 12 **\$7.50**

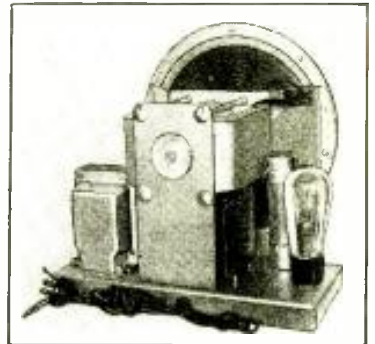

All latest type RCA speakers

## R.C.A. VICTOR HAND MICROPHONE



This microphone is furnished with the latest model Radiola 86 Home recording Super-Heterodyne Receiver and amplifier. Do not confuse this microphone with the "toy" type as it can be used for many professional and commercial uses. It is a single button "mike" with a gun metal finish. It's total length is 6½" and has as standard equipment a four foot cord.

YOUR PRICE

**\$2.95**

## PENTODE ADAPTER



This Pentode Adapter permits the insertion of a type 247 Pentode Power Tube in place of the type 245 tube. Simply remove 245 tube, and insert the Adapter, and plug in the 247.

OUR NET PRICE **\$1.20**

## FARRAND INDUCTION DYNAMICS

Used on A.C., D.C., and Battery Sets with Equal Results.

9" **\$5.95**

12" **\$6.95**



**GRENPARK CO., Dept. RC., 245 Greenwich Street, New York, N. Y.**



# AUGUST SPECIALS!!

EVERY month we list on this page certain **STAR** items, which are **NOT LISTED IN OUR CATALOG**. These are all specials of which the quantities on hand are not sufficient to catalog them. *Once sold out, no more can be had.* First come, first served. Save yourself disappointment by ordering NOW.

**STOP SHOPPING.** The lowest prices are right on this page. *No one undercuts us.* We meet any price on ANY NEW Merchandise. Order direct from this page and save money. 100% satisfaction on every transaction. Take advantage of these special offers. **ORDER NOW, TODAY.**

## IMPROVED READRITE MODEL 700 ANALYZER

Tests Latest Type '57 and '58  
6-Prong Tubes

### EIGHT METER SCALES AVAILABLE

The "Model 700" is an extremely compact device. The outside dimensions of the carrying case are only 10 3/4 by 7 3/4 by 3 3/4 inches. The analyzer contains a D.C. voltmeter, an A.C. voltmeter and a milliammeter. The D.C. voltmeter has three ranges: 0 to 60; 0 to 200; and 0 to 600 volts. The A.C. voltmeter has also three ranges: 0 to 10; 0 to 150; and 0 to 700 volts. The milliammeter has two ranges: one for 20-mill. reading and the other for 100-mill. This variety of ranges makes it possible to test every conceivable radio circuit; high voltage secondaries of power transformers, current drain of all radio tubes, including the high power 250 and 210 tubes, etc.

### CONVENIENT SELECTOR SWITCH

The instrument is equipped with a six-position bi-polar selector switch; by means of which readings may be obtained of "C" volts, "C" volts reversed, "K" volts, "K" volts reversed, plate voltage, and screen-grid voltage. A 4 1/2-volt battery is supplied with the analyzer, to provide "C" bias, for grid tests, continuity tests, etc.

### TESTS PENTODES—"MULTI-MUS"

'57's and '58's—and '80 RECTIFIERS There are two sockets on the panel of the analyzer, one for four-prong tubes and the other for five-prong tubes. There is a "grid-test" push-button. Pin jacks are available for the individual use of all meters, externally, in every range. There is a screen-grid pin jack, and there are two pin jacks for connecting the external battery. A two-way toggle switch controls the testing circuit for either regular or pentode tube.



Model 700 Analyzer. List Price \$35.00. Your Price **\$14.70**

Both plates of the '80-type rectifier may be tested by use of a special adapter furnished. Charts are provided for measuring resistances and capacitance.

## FREE

We take pleasure in offering with the purchase of each analyzer—**ABSOLUTELY FREE OF CHARGE**—the latest radio publication to come off the press.

"Radio Set Analyzers" Contains detailed descriptions, photographs and circuit diagrams of all commercial set analyzers and testers.—A Real Book.

The Analyzer is furnished complete with test leads, connecting cables, Burgess 4 1/2-volt battery, several battery leads, 1Y to 1X adapter, '80 rectifier, adapter and resistance and capacity charts. Shipping weight, 8 lbs.

## "MEGADYNE" ONE-TUBE PENTODE LOUDSPEAKER RECEIVER KIT

In the front part of our catalog—get your FREE copy now—there is presented a thoroughly illustrated discussion on the construction and operation of the

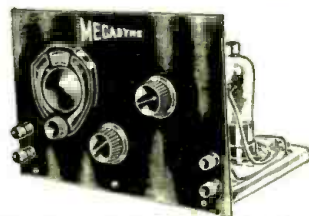

MEGADYNE Receiver by Hugo Gernsbach, editor. This ingenious circuit was originally described in the July issue of the RADIO CRAFT Magazine. FREE copy of which will be given with each purchase. This receiver is indeed one of the most outstanding developments in the radio industry. It is the first real one-tube receiver which will actually operate a loudspeaker. Thousands of experimenters and radio fans will want to build this remarkable receiver. For their convenience, we have compiled a complete list of parts required for its construction. These parts are of the highest quality and are exactly as specified by the author. The following parts comprise the complete kit:

1 B.M.S. Fixed Crystal Detector; 1 6-ohm Filament Rheostat; 1 3-circuit tuner for used with a .0005 mf. tuning condenser; 1 Na-aid type 481 UY 5-prong socket; 1 Hammarlund type M1-23 Variable Condenser; 2 sets of Clinch double binding posts; 1 Polymer .00025 mf. fixed condenser; 1 X-1. Variable; 1 Polymer .00025 mf. fixed condenser; or 1 Polymer .0005 mf. fixed condenser (NOTE: Only one of the latter two condensers is actually employed in the circuit); 5 Fahnestock binding posts; 1 25-ft. roll of hook-up wire; 2 black bakelite 1 1/2" knobs; 1 Kurz-Kasch vernier dial with 0 to 100 scale reading clockwise; 1 type '38 pentode tube, "Triad" or "Speed"; 1 Bakelite Panel already drilled with all holes, size 7 x 10 x 3/16 inch; 1 hardware assortment.

The wooden base is not included. No. 2545—Megadyne Receiver Kit. Your Price **\$10.25**

### WORLD-WIDE SHORT-WAVE SET

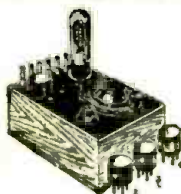

Range 18 to 200 meters. Employs low current drain 230 tube. Requires but 1 1/4 volt "B" battery, 2 No. 6 drycells and earphones to operate. No. 1666—S.W. Set Your Price **6.25**

### R.C.A. VICTOR HAND "MIKE"

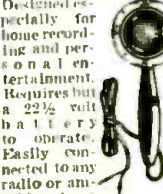

Designed especially for home recording and performance on a 1 entertainment. Requires but a 2 1/2 volt battery to operate. Easily connected to any radio or amplifier in a few minutes. Responds indiscriminately to all speech and music frequencies. Sold complete with 6 ft. cable. Shipping weight 2 lbs. No. SP9064. RCA-Victor Hand "Mike." Your Price **2.75**

### \*METALLIZED PIGTAIL RESISTORS AT ROCK BOTTOM PRICES

A very fortunate purchase enables us to offer these line resistors at prices which surprise even ourselves—prices more than three times lower than in our own catalog. Resistors are guaranteed to maintain their ohmage under even adverse operating conditions. The resistance element is based on the famous metallized principle which has proven its superiority wherever accuracy and uniformity are paramount requisites. The special ceramic casing of these resistors is of sturdy construction and affords maximum heat dissipation. A feature of these resistors is their unlined end-caps, tapered so they can be mounted in all standard resistor mounts. By means of their digitals, they may also be soldered in any convenient position. Available in the following sizes—all rated at one watt: 300, 150, 600, 8,000, 10,000, 12,000, 350,000. Act fast to take advantage of this offer, as the supply is limited. Sold only in lots of six or more.



Values Clearly Marked on Each Unit  
No. SP2226. Metallized Resistors. NOW YOUR PRICE **6c** EACH (12 for 60c.)

### AUTOMATIC BLOW TORCH



Heat intensely over 1200° Fahr. Requires no mouth-blowing. Entirely automatic. Used for heavy duty soldering, aluminum soldering, metal tempering, etc. Ship. wt. 1 lb. No. K1006—Torch. Your Price **\$0.60**

### \*8 MF. ELECTROLYTIC CONDENSERS

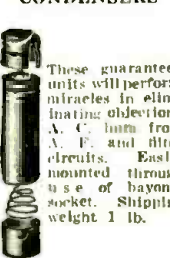

These guaranteed units will perform miracles in eliminating objectionable A.C. hum from A.C. filter circuits. Easily mounted through use of bayonet socket. Shipping weight 1 lb. No. SP 9054. Condenser. Your Price **\$0.49**

### A.C. SUPERHET S.W. CONVERTER

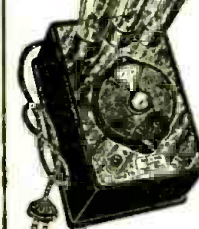

No. 1614—Converter. Your Price **NOW \$7.50**

### UTAH A.C. DYNAMIC SPEAKER

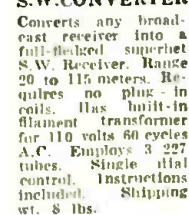

No. 1506—Speaker. Your Price **\$7.45**

## FREE RADIO AND SHORT WAVE TREATISE

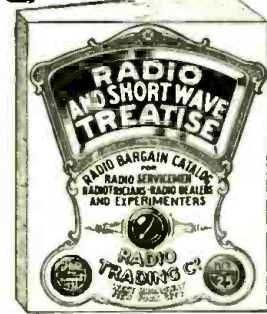

The new and enlarged Summer edition of our Radio and Short Wave Treatise, No. 26, has just come off the press—100 solid pages of useful information, radio items, diagrams and illustrations. Positively the greatest book in print—NOT JUST ANOTHER CATALOG. Contains a large editorial section with valuable information not found anywhere else. Considerable space is devoted to a TREATISE ON SHORT WAVES for both beginners and regular "hams." Among the new technical information listed are the following: Modernizing old radio sets—repairing speakers and headsets—making superhets out of old sets—data on constructing two-volt battery and automobile receivers—circuit of the famous Gernsbach Megadyne One-Tube Loudspeaker Set—short wave coil winding data—discussion on S.W. adapters, converters and receivers, etc., etc.

100 New Hook-Ups, Etc. 1000 Illustrations.

WRITE TODAY. Enclose 4 cents for postage. Treatise sent by return mail.

### MICROPHONE & PRE-AMPLIFIER OUTFIT



Excellent suited for P. A. work, inter-communication systems, etc. Comprises sensitive single button microphone, microphone coupling transformer and battery, cut-off switch, gain control and output terminals. Put up in neat black crackle-finished metal case, equipped with convenient carrying handle. Will correctly match the input impedance of practically all type amplifiers. Easily connected to the broadcast receiver for home recording. Ship. wt. 10 lbs. No. 1654—Pre-Amplifier. Your Price **\$8.25**

### \*ELECTRIC CLOCK



Naval observatory time right from your light socket! No spring to wind, no batteries. Never out of order. For 110 volts 60 cycle A.C. operation only. No. 1689—Clock. Your Price **\$1.00**

### RADIO MIRROR PENLIGHT



A clever device for looking around corners or other inaccessible spots on the radio chassis. Comprises pen flashlight and magnifying mirror. Complete with battery and bulb. No. 1695—Penlight. Your Price **\$0.85**

### NEW PENTODE ADAPTER



A new and simple device for replacing the old '45 type power tube with the latest super-power pentode. Remove the '45, insert adapter in vacuum socket and then place a pentode tube in the socket of the adapter. Gives added life and power to old receivers and amplifiers. Shipping weight 1/2 lb. No. 1873. Adapter. Your Price **65c**

### \*MIDGET MICROPHONE



A real microphone of single button type. Extremely sensitive. Excellent for P.A. work, etc. Standard resistance of 100 ohms. Responds up to 2500 cycles. Ship. wt. 1 lb. No. 1655—Mike. Your Price **\$2.25**

### MIDGET DYNAMIC SPEAKER



A real dynamic speaker with surprising volume and tone. 6 1/2" overall, 4 1/2" diaphragm. Standard and 2500 ohm field coil. Output transformer to match all type output tubes. Wt. 5 lbs. No. 1549—Speaker. Your Price **\$2.50**

### SPEED "295" TRIPLE-TWIN TUBE



Equivalent to one 227 detector and one 215 P. A. or r.t.t. tube. Constitutes a two-stage direct-coupled amplifier in itself. Filament, 250. 2 1/2 v.; Plate voltage 250. Large undistorted output. Ship. wt. 12 oz. No. S699. Tube. Your Price **\$1.85**

WE ARE A WHOLESALE HOUSE AND CANNOT ACCEPT ORDERS FOR LESS THAN \$3.00. If C. O. D. shipment is desired, please remit 20% remittance, which must accompany all orders. If full cash accompanies order, deduct 2% discount. Send money order—certified check—U. S. stamps.

**Radio Trading Co.**  
23 West Broadway  
New York, N. Y.

ORDER FROM THIS PAGE. You will find special prices from time to time in this magazine. Get our big FREE catalog for the greatest Radio Bargains. Should you wish goods shipped by parcel post, be sure to include sufficient extra remittance for same. Any excess will be refunded.



# TUBE CHARACTERISTICS AT A GLANCE

By C. H. W. NASON

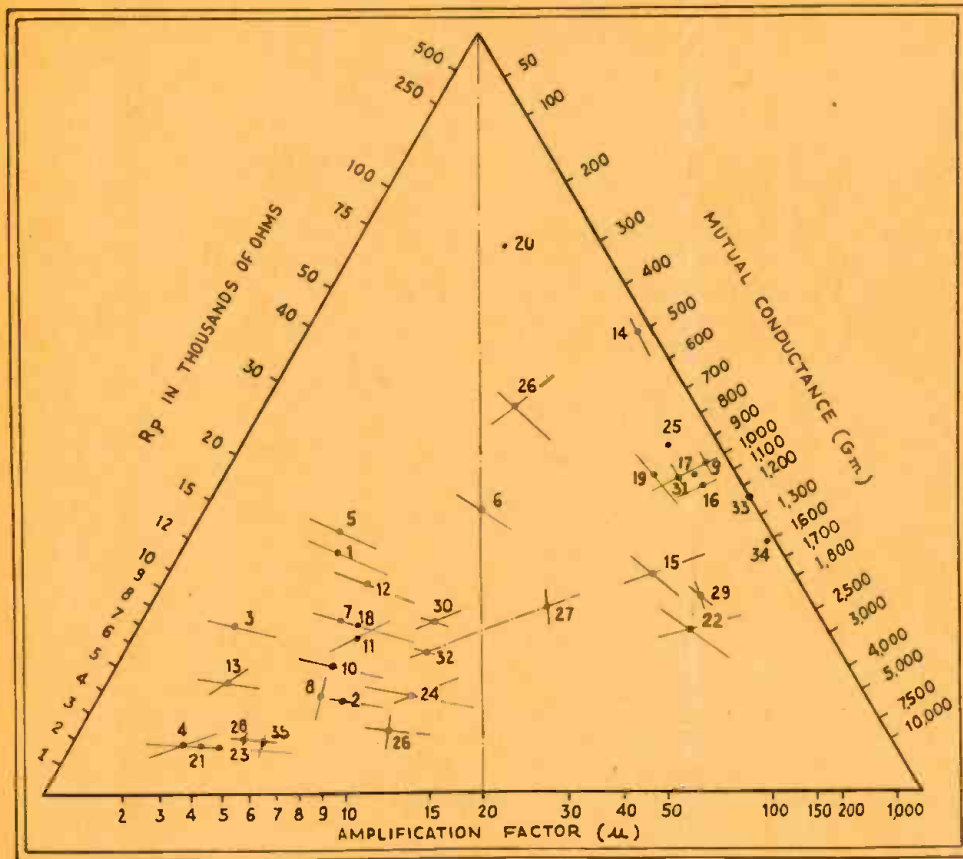

Fig. 1. A self-perpetuating nomograph for determining tube characteristics.

RECENTLY, in Europe, a graphic chart has been developed which represents directly the characteristics of the vacuum tube. It is based on the theorem of Ceva which states, briefly, that if lines be drawn through the apices of a triangle so as to pass through a point within the triangle, the sides will be divided by the lines into segments having a definite relation between one and the other. Conversely, if the location of a given point within the triangle is known, the relative length of the lines into which the sides of the triangle will be divided may be predetermined.

As shown in Fig. 1, a line drawn from an apex through an index number to a side of the graduated triangle will indicate amplification factor,  $\mu$ ; plate resistance,  $R_p$ ; and mutual conductance,  $G_m$ .

The tube reference numbers used in Fig. 1 are as follows: 1, WD-11, 12; 2, '12A; 3, '20; 4, '71A; 5, '99; 6, '00A; 7, '01A; 8, '10; 9, '24; 10, '26; 11, '27; 12, '30; 13, '31; 14, '32; 15, '33; 16, '35; 17, '36; 18, '37; 19, '38; 20, '40; 21, '45; 22, '47; 23, '50; 24, 852; 25, 865; 26, 211; 27, 841; 28, 845; 29, LA; 30, Wunderlich; 31, 44; 32, 56; 33, 57; 34, 58; 35, 46 (Class A).

The chart is self-perpetuating, since when a new tube is released it is only necessary to draw lines through the apices or corners of the triangle, cutting the points on the sides at the designated characteristics. These lines will meet at a point which may be marked for future reference as the locus of intersection for that particular tube.

Other data on tubes and other equipment may be plotted in this manner; and technicians may be interested to make a number of such nomographs for handy reference.

If these are accurately prepared, and uniformly arranged, they may be submitted to RADIO CRAFT for publication at space rates.

# A CONTINUITY- AND OHMMETER

By JOHN C. BANK

ONE of the most useful devices in making tests is a continuity meter; in other words, a voltmeter with a battery in series. However, in addition to straight continuity tests, it is often desirable to know the resistance of certain portions of the circuit. Volt-ohmmeters, on the market, depend

for their accuracy on the voltage of the battery being exactly the value to which the meter is calibrated. In the factory-made types they are equipped with a "regulator," consisting of a magnetic shunt (a piece of iron), which is moved in front of the poles of the instrument magnet by a screw, to compensate for changes in the reading as the battery voltage changes.

This method is not practical for one who wishes to construct his own ohmmeter, so we will show how one can be made with a regulator for voltage variations.

The best and least expensive meter to select is a 1. ma. milliammeter such as a Jewell Pattern 88, or a Weston Model 301. Connect in accordance with Fig. 1A. Resistor R1 is a 200-ohm rheostat; R2, an Electrad Truvolt type B-35 unit, 3,500 ohms. All of this equipment will mount nicely in a box measuring 8x4x2½ inches deep.

To find the value of an unknown resistance from the reading of the meter, consult column Dma., Table I, below:

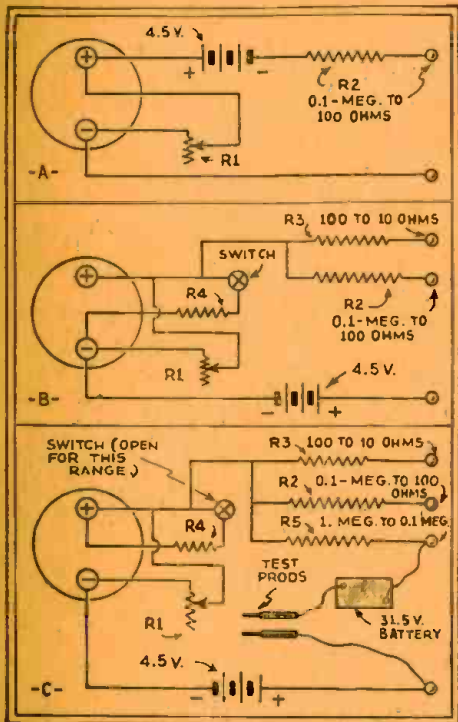

Fig. 1. Continuity-Ohmmeter Connections.

TABLE I					
Rx	Dma.	Rx	Dma.	Rx	Dma.
0	1.000	1,800	.687	10,000	.260
100	.972	1,800	.660	12,000	.226
200	.946	2,000	.637	14,000	.200
300	.921	2,500	.583	16,000	.180
400	.898	3,000	.538	18,000	.163
500	.875	3,500	.500	20,000	.143
600	.852	4,000	.467	25,000	.123
700	.832	4,500	.438	30,000	.104
800	.814	5,000	.412	40,000	.080
900	.796	6,000	.368	50,000	.065
1,000	.778	7,000	.333	75,000	.045
1,200	.743	8,000	.305	100,000	.034
1,400	.713	9,000	.281		

A better way, however, is to mark the points on the scale. To do this, remove the cover from the meter and mark the values along the top arc of the scale with a very fine pen and india ink. Put figures, over the cardinal points, starting with zero, 1,000, 2,000, 5,000, 10,000, 20,000, 30,000, 50,000 and 100,000. Since these run into a large number of figures it is necessary to use 1,

2, 5, 10, etc., and to multiply the reading by 1,000. Note that the cardinal points are positions on the ohm scale where the value of the divisions change. For example, from 0 to 1,000 we have ten divisions. This means that each mark is 100 ohms. From 1,000 to 2,000 we have five divisions, or 200 ohms per division. Thus, by consulting the numbered points we know where to look for a change in value.

Although the range of this instrument is from about 100 to 100,000 ohms, it may be necessary to increase the scope to include values above and below.

To extend the lower end of the range, below 100 ohms, add an "off-on" switch to the circuit so that shunting resistor R4 may be cut in and out around the meter itself, as shown in Fig. 1B; use an Electrad type B-05 resistor, 5 ohms, which has a sliding contact that can be adjusted and then clamped in position. Also, add resistor R3, of 350 ohms; its value is conveniently reached by connecting in series an Electrad type B-3 resistor of 300 ohms and a type B-5 unit of 50 ohms.

To calibrate, short the two posts for the 100,000 ohm range and set the pointer on the top mark by means of the regulator. The shunt must be disconnected. When this setting is made, cut in the shunt and vary it until the pointer is at 0.1, which is one-tenth of the full-scale deflection. Check back by opening the shunt and note whether the pointer is at full scale. When this calibration is complete and the test leads are connected to the common post and the one through resistor R3, the meter will read one-tenth the values on the scale. This will enable us to read down to at least 10 ohms.

To increase the range above 100,000 ohms we must add another resistor, R5, of 35,000 ohms; its value is conveniently checked by connecting in series an Electrad type B-300 resistor of 30,000 ohms and a type B-50 unit of 5,000 ohms.

To make the circuit complete, an additional battery of 31.5 volts must be placed in series externally, as shown in Fig. 1C. To use this combination, short the test leads and set to full scale by means of the regulator. Open the test points, connect in the unknown resistance, read the deflection and multiply by 10. This gives a scale up to 1,000,000 ohms.



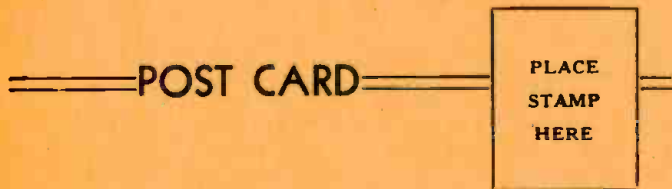

**H. C. LEWIS, President**  
**COYNE ELECTRICAL SCHOOL, Dept. C2-8H**  
**500 S. Paulina Street**  
**CHICAGO, ILL**

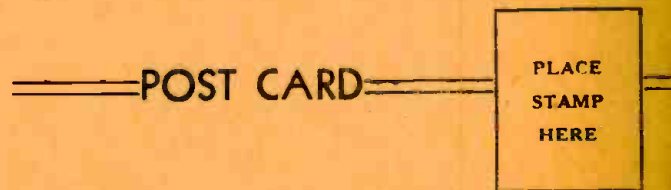

**LINCOLN RADIO CORPORATION**  
**Dept. RC-8**  
**329 So. Wood Street**  
**CHICAGO, ILL**

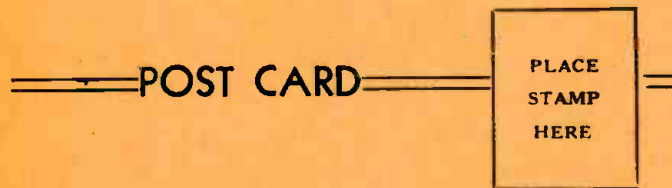

**CABLE RADIO TUBE CORP.**  
**230-242 North 9th Street**  
**BROOKLYN, NEW YORK**

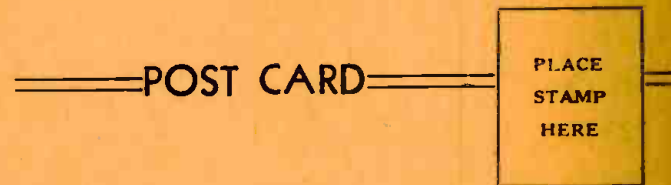

**J. E. SMITH, President**  
**NATIONAL RADIO INSTITUTE**  
**Dept. 2HXX**  
**WASHINGTON, D.**

LINCOLN RADIO CORPORATION  
Dept. RC-8, 329 So. Wood Street  
Chicago, Ill.

Please send literature to

Name .....

Address .....

City ..... State .....

Dept. 2HXX  
Dear Mr. Smith: I want to take advantage of your Special Offer.  
Send me your two books, "Trouble Shooting in D.C., A.C. and Bat-  
tery Sets" and "Rich Rewards in Radio." I understand this request  
does not obligate me.

Name .....

Address .....

City ..... State "M"

H. C. LEWIS, President  
Radio Division, Coyne Electrical School  
500 S. Paulina St., Dept. C2-8H, Chicago, Ill.

Dear Mr. Lewis:—Send me your Big Free Radio Book, and all de-  
tails of your Special Offer.

Name .....

Address .....

City ..... State .....

CABLE RADIO TUBE CORP.  
230-242 North 9th Street  
Brooklyn, N. Y.

Gentlemen: Please send me current bulletins, without charge or  
obligation on the items checked:

- |   |   |
|---|---|
| <input type="checkbox"/> SPEED Radio Tubes      | <input type="checkbox"/> SPEED Foto-Lectrie Tubes |
| <input type="checkbox"/> SPEED Television Tubes | <input type="checkbox"/> SPEED Triple-Twin Group  |

Name .....

Address .....

City ..... State .....



*You can now have-right in your own home*

# RECORD-BREAKING PERFORMANCE

You can equal the records of world famous LINCOLN owners whose sensational reports of International reception are published the world over ~ ~ ~

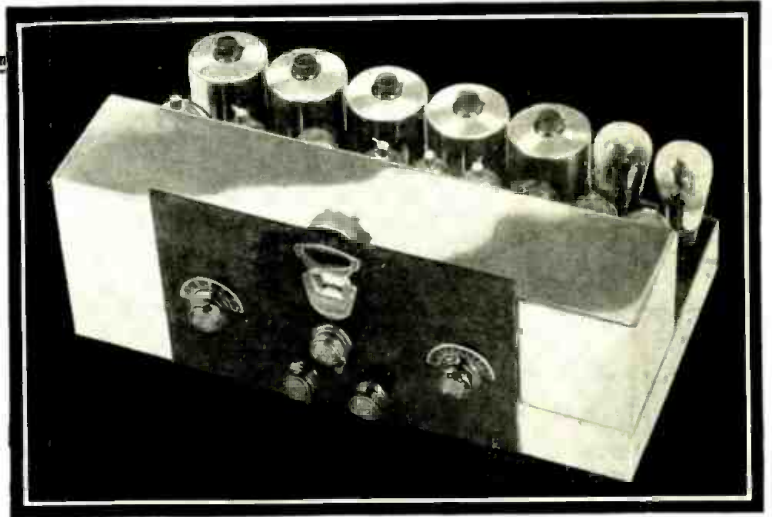

LINCOLN DE LUXE SW 33

**A New Receiver which has Revolutionized Radio Reception!**  
**Just Weigh these Few Performance Facts Carefully.**

• • •

## THE OLD WAY

1. 70% of the Short Wave Stations have been missed by the average tuner due to interfering noise and sharpness of tuning.
2. When distance was desired it was necessary to advance volume control, which raised noise level, often drowning out the signal.
3. Short wave stations fade completely out and then build up to heavy volume.
4. When volume was reduced, sensitivity dropped; when volume was increased, lack of handling power caused distortion.
5. The register of musical frequencies was limited in the old style detector circuit.

• • •

IN BRINGING OUT the new Lincoln DeLuxe SW-33, I believe we have advanced far ahead of the commonly known radio today. Personally I have been a confirmed DX lover for many years, and I simply could not be satisfied with the limitations of the present known receiver. In the SW-33, I am getting the biggest kick of my life out of performance I have never known before. A few days ago I tuned in G5SW, Chelmsford, England just to see how great an undistorted volume I could get. Every word of the broadcast could be heard 300 feet away from my home through an open window, and "Big Ben" was heard a block away. Pontoise, France, in the afternoon, and EAQ, Madrid, in the evening, were just the same. I can promise you a great treat with this great receiver.

W. H. HOLLISTER, *President.*

## THE NEW WAY

1. Visual meter tuning accurately registers even the weakest carrier waves, many of which are impossible to hear. Meter permits precision tuning and accurately measures comparative signal strength.
2. Volume control does not affect sensitivity. Distance may be tuned at low volume, eliminating noise.
3. All stations, regardless of distance, are received with automatically controlled volume held at constant level.
4. When volume is reduced, sensitivity automatically rises. When volume is advanced, handling power automatically increases, making distortion impossible.
5. Push-pull Twin-Grid detector circuit allows passage of greatly enlarged range of musical frequencies perfectly conveyed through double push-pull audio system.

• • •

## WRITE AT ONCE

for complete information on performance facts on the new DeLuxe SW-33, and world breaking records of Lincoln Equipment. Think! 39 Foreign Countries, 106 Foreign Stations, everyone voice or music, no code. Loud-speaker Operation on each. This one log is not a collection of foreign stations received by several thousand individuals collectively, but instead it represents only what one, of many, Lincoln owners has done in just an average location in his spare time.

LINCOLN RADIO CORPORATION  
Dept. RC-8, 329 S. Wood St., Chicago, Ill.

Please send literature to

Name

Address

City  State

**LINCOLN**  
*De Luxe Receivers*

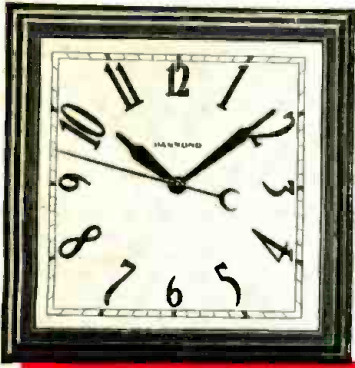

SQUARE WALL MODEL.—Like all other Hammond electric clocks, requires no winding, regulating or oiling. Gives exact time to the second. Wood case has mahogany finish. Size 14 7/8" x 14 7/8" x 4". Dial 12" x 12". Retail price \$18.00.

# Limited Introductory Offer



Remarkable  
Purchase  
Enables  
**TRIAD**

to give you  
this fine  
**Hammond**  
Electric  
Clock

A  
B  
S  
O  
L  
U  
T  
E  
L  
Y  
  
F  
R  
E  
E

There are no "ifs, ands or buts" about this offer. We want more dealers and servicemen to realize the advantage of selling CERTIFIED TRIAD TUBES. Fill in the coupon—attach your check for \$25.00 (\$50 worth of CERTIFIED TRIADS, list price, less 50%); attach a copy of your business card or letterhead. You get your introductory stock of tubes and the clock ABSOLUTELY FREE.

THIS LARGE GUAR-  
ANTEED HAMMOND  
SYNCHRONOUS  
ELECTRIC WALL  
CLOCK

SELLS AT  
**\$18.00**  
BUT GIVEN ABSO-  
LUTELY FREE

TO DEALERS AND  
SERVICEMEN  
with their first \$25.00  
(\$50 list, less 50% dis-  
count) order of  
CERTIFIED TRIAD  
TUBES.

## For SERVICEMEN

CERTIFIED TRIAD TUBES are the result of many years experience. All the guess-work has been eliminated. They are designed, manufactured and tested by the most modern machinery. They are produced by skilled operators. No better tubes can be bought.

A complete study of the proper method of merchandising tubes, in order to protect the seller as well as the buyer has resulted in the adoption of an entirely new form of distribution. The CERTIFIED TRIAD SERVICEMAN is the key stone. You can become one of the agents, who are taking a handsome profit from these tubes, by filling in the coupon. The whole interesting story will come to you by return mail.

If you are selected to represent TRIAD, we will protect your territory, for you. Every Tom, Dick and Harry will not be competing with you.



This is a reduced fac-  
simile of the Triad  
Radio Tube Certification  
Coupon, which is sealed in  
the box with tube to which  
it refers.

and  
**DEALERS**

Even a good radio receiver will sound like "nothing at all" if it is equipped with poor tubes. Most people realize that the radio tube is the heart of their receiver. Ordinary tubes can be bought for a song, but you usually get what you pay for. No one expects to get Cadillac or Lincoln service from an Austin. No one looks for custom-made shoes for three dollars. Those who expect the very best performance from inferior tubes are not logical and they are sure to be disappointed. No form of entertainment is as inexpensive as radio. Isn't it good business to keep it working at its best. You can be sure of doing so, by insisting on CERTIFIED TRIAD TUBES. A line to us will enable us to send you the CERTIFIED TRIAD SERVICEMAN, we have selected to serve your vicinity.

The TRIAD Line is complete. It includes all types of standard Tubes as well as Photo-Electric Cells and Television Tubes.

CERTIFIED TRIAD TUBES are licensed by RCA, and are sold at the same list prices.

**TRIAD** MANUFACTURING CO.  
Pawtucket, R. I.

A money order or check for \$25.00 is attached. In return, I want the CERTIFIED TRIAD TUBES listed from the regular TRIAD TUBE list amounting to \$50. less 50% discount. I am also to receive the \$18.00 HAMMOND ELECTRIC CLOCK. ABSOLUTELY FREE.

Name .....

Address .....

City ..... State .....

My letterhead or business card is attached.