

RADIO BROADCAST



CONTENTS

Announcing the 1928 Complete Sets
What the Set Manufacturer Offers the Public
A Radio Picture Receiver for Every Experimenter
Should the Small Broadcaster Exist?
What Loud Speaker Shall I Buy?

35 Cents

Doubleday, Page & Company
Garden City, New York

Oct · 1927

Cunningham RADIO TUBES

The Advance Guard of Radio

Ever alert, always on duty these delicate instruments of infinite precision and accuracy, are the sentinels that guard and protect the nerve center of your radio set through which every radio impulse is transformed and magnified into audible sound.

To equip your set throughout with new Cunningham Radio Tubes is to experience the very utmost that your set is capable of giving.

Consult your dealer today. See that he gives you the correct types of Cunningham Radio Tubes for which your set is designed.

*Twenty types—all in the
orange and blue cartons*

E. T. CUNNINGHAM, Inc.

New York Chicago San Francisco

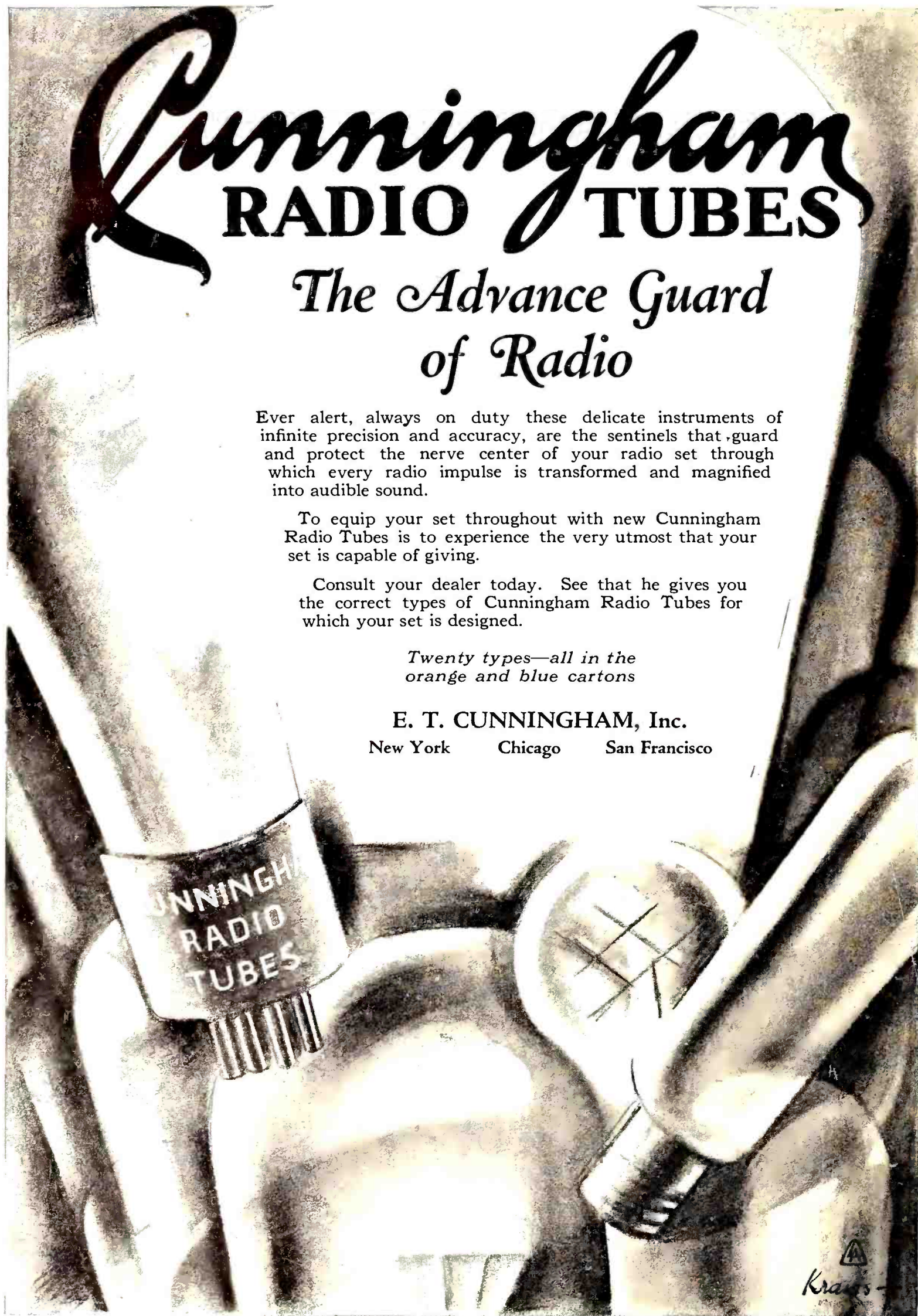

**30
DAYS
FREE
TRIAL**

7 Tube Set Single Dial Radio

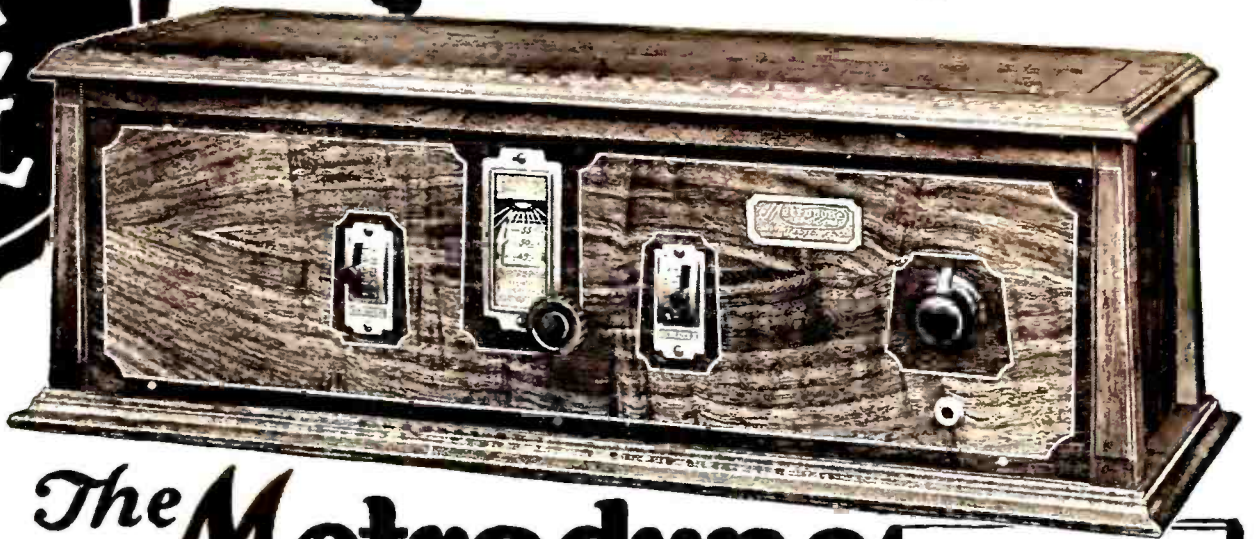

**Metrodyne
Radio Sets**

Are Equipped
For

**BATTERY or
ELECTRIC
operation**

The Metrodyne

ONLY ONE DIAL TO TUNE

RETAIL PRICE

\$75⁰⁰

**Completely Assembled
Big Discounts to
Agents and Dealers**

Wonderful offer direct from the factory! The world's greatest radio! A perfect working, single dial control, 7 tube receiver! And just to prove our claims, we will ship it to your home for 30 days' free trial. Test it under all conditions. Test it for distance, volume and tonal quality—and if you are not convinced that it is the best single dial set you ever heard, return it to the factory. We don't want your money unless you are completely satisfied.

Three Year Guarantee

**BIG PROFITS
TO AGENTS AND DEALERS**

Our Agents and Dealers make big money selling Metrodyne Sets. You can work all or part time. Demonstrate the superiority of Metrodynes right in your home. Metrodyne Radios have no competition. Lowest wholesale prices. Demonstrating set on 30 days' free trial. Greatest money-making opportunity. Send coupon, a letter or a postal for our agent's proposition.

Metrodyne Super-Seven Radio

A single dial control, 7 tube, tuned radio frequency set. Tested and approved by Popular Science Institute of Standards, Popular Radio Laboratory, Radio News Laboratory and by America's leading Radio Engineers. Designed and built by radio experts. Only the highest quality low loss parts are used. Magnificent, two-tone walnut cabinet with beautiful, gilt metal trimmings. Very newest 1928 model, embodying all the latest refinements.

Easiest set to operate. Only one small knob tunes in all stations. The dial is electrically lighted so that you can log stations in the dark. The volume control regulates the reception from a faint whisper to thunderous volume, 1,000 to 3,000 miles on loud speaker! The Metrodyne Super-Seven is a beautiful and efficient receiver, and we are so sure that you will be delighted with it, that we make this liberal 30 days' free trial offer. You to be the judge.



**6
Tube Set
\$48⁵⁰**

**RETAIL PRICE
Completely
Assembled**

30 Days' Free Trial—3 Year Guarantee

Metrodyne Super-Six

Another triumph in radio. Here's the new 1928 model Metrodyne 6 tube, two dial, long distance tuned radio frequency receiving set. Approved by leading radio engineers of America. Highest grade low loss parts, completely assembled in a beautiful walnut cabinet. Easy to operate. Dials easily logged. Tune in your favorite station on same dial readings every time — no guessing.

Mr. Howard, of Chicago, said: "While five Chicago broadcasting stations were on the air I tuned in seventeen out-of-town stations, including New York and San Francisco, on my loud speaker horn, very loud and clear, as though they were all in Chicago."

We are one of the pioneers of radio. The success of Metrodyne sets is due to our liberal 30 days' free trial offer, which gives you the opportunity of trying before buying. Thousands of Metrodynes have been bought on our liberal free trial basis.

**MAIL THIS
COUPON**

or send a postal or letter. Get our proposition before buying a radio. Deal direct with manufacturer—**SAVE MONEY—WRITE NOW!**

MAIL COUPON BELOW

Let us send you proof of Metrodyne quality—our 30 days' free trial offer and 3 year guarantee

Mrs. Wm. Leffingwell, Westfield, N. J., writes: "The Metrodyne Radio I bought of you is a wow! This is as good as any \$225 machine I have ever seen."

N. M. Greene, Maywood, Ill., writes: "My time is up and the Metrodyne works fine. I got Havana, Cuba, Oakland, Calif., Denver, Colo., Toronto, Canada, all on the loud speaker."

J. W. Woods, Leadville, Colo., writes: "Received the 7-tube Metrodyne in fine condition. Had it up and working same day received. Was soon listening to Los Angeles, San Diego, Oakland and other California points; also St. Louis, Kansas City and other east and south stations—all coming in fine. Am more than pleased. Sure enjoying it."

We will send you hundreds of similar letters from owners who acclaim the Metrodyne as the greatest radio set in the world. A postal, letter or the coupon brings complete information, testimonials, wholesale prices, and our liberal 30 days' free trial offer.

METRO ELECTRIC COMPANY
2161-71 N. California Ave., Dept. 17
Chicago, Illinois

Gentlemen:

Send me full particulars about Metrodyne 6 tube and 7 tube sets and your 30 days' free trial offer.

Name _____

Address _____

If you are interested in AGENT'S proposition, place an "X" in the square

METRO ELECTRIC COMPANY

2161-71 N. California Ave. . Dept. 17 . Chicago, Illinois

Your "B" Battery Eliminator
will give you better service with

Q · R · S

(Trade Mark Registered)

**Gaseous
Rectifier Tubes
ARE BETTER**

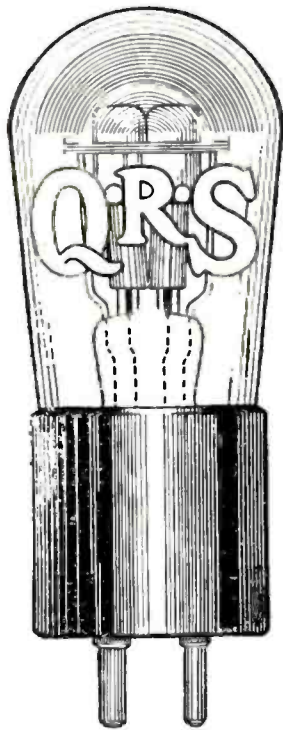

60 Milliamperes - \$4.50
85 Milliamperes - 4.50
400 Milliamperes - 7.00

Ask for Catalog of full line of Standard Tubes.

Guaranteed

The standing of the Q·R·S Company, manufacturers of quality merchandise for over a quarter of a century, establishes your safety.

Orders placed by the leading Eliminator Manufacturers for this season's delivery, approximating Four Million Dollars' worth of Q·R·S Rectifier Tubes, establishes the approval of Radio Engineers. Ask any good dealer.

THE Q·R·S COMPANY

MUSIC

Manufacturers

Executive Offices: 306 S. Wabash Ave., Chicago

Factories: Chicago—New York—San Francisco—Toronto, Canada—Sydney, Australia—Utrecht, Holland

Established 1900. References—Dun, Bradstreet, or any bank anywhere

Designer of Broadcast Station WEMC



Tours Europe On Inspection Trip.

How Would You Like to Have John Fetzer's Job?

Would you like to tour Europe, inspecting broadcast stations? You would? My friend John Fetzer DID! Maybe you'd like to hold a fine job as Chief Engineer of a widely-known American broadcast station? That's what John Fetzer is right now—Chief Engineer of Station WEMC, "The Radio Lighthouse", located at Berrien Springs, Mich. Read his interesting letter at the right.

Will You Take a Better Job—More Money?

If I offered you a job like John Fetzer's at \$100 or \$150 a week, would you take it?

If I told you that to get this job you would have to do a little studying, say half an hour a day for a few months, would you do that too?

You bet you would. You probably even think I'm foolish to ask you such questions. But, as a matter of fact, you today have such an opportunity in the same place John Fetzer found his—in the brand-new, growing Radio Industry.

Plenty of Plums Still Left On The Tree

We've just barely scratched the surface in the Radio business. There are plenty more opportunities just as good as the one John Fetzer grasped.

You'll have to do some studying before you can hold down one of the good jobs—only well-trained men are wanted.

But that part isn't hard—lots of men without a grade school education have done it. And it only takes a comparatively short time of studying about half an hour a day. You can keep right on with your present job, and learn in the quiet of your own home.

Get My Big Free Book

300,000 new openings have been created by the swift growth of the Radio business in the past few years. During the same years I have helped thousands of men to take advantage of opportunities like these.

John Fetzer, whose picture you see above, is only one man among these thousands I've helped. Lots of the others didn't climb as high as Fetzer, but there are some, too, who have gone higher.

I'm ready to help you, too, if you are looking for a better job and more money. The good jobs in Radio pay from \$50 all the way up to \$250 a week. And the accomplishment of television, trans-Atlantic Radio telephony, the other new inventions constantly being made, all point to even greater things for the future. If you're ambitious and dissatisfied with your job or your future, let me help you share in the Rich Rewards of Radio.

Mail the coupon below for my big free book about Radio, its opportunities, and how I train you, quickly and easily in your spare time at home, to take advantage of them. No previous experience needed. You learn by doing, with six big outfits of practical experimental material I send you at no extra cost. Mail coupon now for book. Address: J. E. Smith, President, National Radio Institute, Washington, D. C.

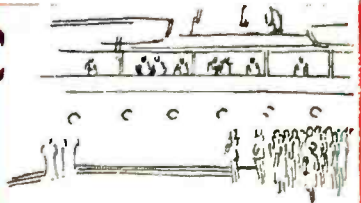

Dear Mr. Smith:

I went to Europe at the expense of my station, WEMC, to learn the best methods used there and bring them back for my station. I found about 20 stations in the British



Isles, mostly used to relay programs from 2LO. They were very kind to me at 2LO—their equipment is about like that



of our own good stations. French stations, I found, don't com-

pare with the British. There are 6 important stations in France. Eiffel Tower is the best known. I visited Holland, Belgium and Switzerland, and got a real thrill from seeing the big station at

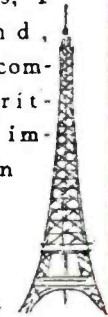

Nauen, Germany. On my return I designed and built the new high

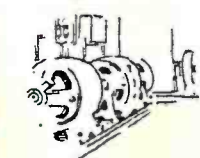

power station for WEMC, using best features of what I had

seen. Our first program was reported in 40 States. Your training

is the way to

lasting suc-

cess in Radio.

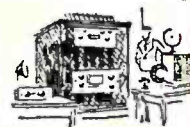

John C. Fetzer



J. E. SMITH, President of the National Radio Institute, Washington, D. C., has directed the training of more men for the Radio profession than any other educator. The National Radio Institute is the oldest and largest Radio home-study school in the world.

Originators of Radio Home Study Training

HERE'S THE SAME COUPON THAT FETZER CLIPPED

This Book FREE!

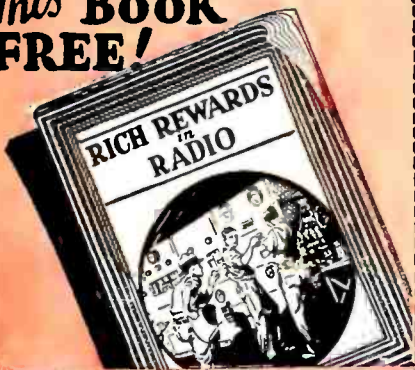

C O U P O N

J. E. Smith, President,
National Radio Institute,
Dept., M-94 Washington, D. C.

Dear Mr. Smith; Kindly send me your free book "Rich Rewards in Radio," and all information about your practical, home-study Radio training. I understand this places me under no obligation.

Name _____

Address _____

Town _____, State _____

Always the first choice
of leading manufacturers

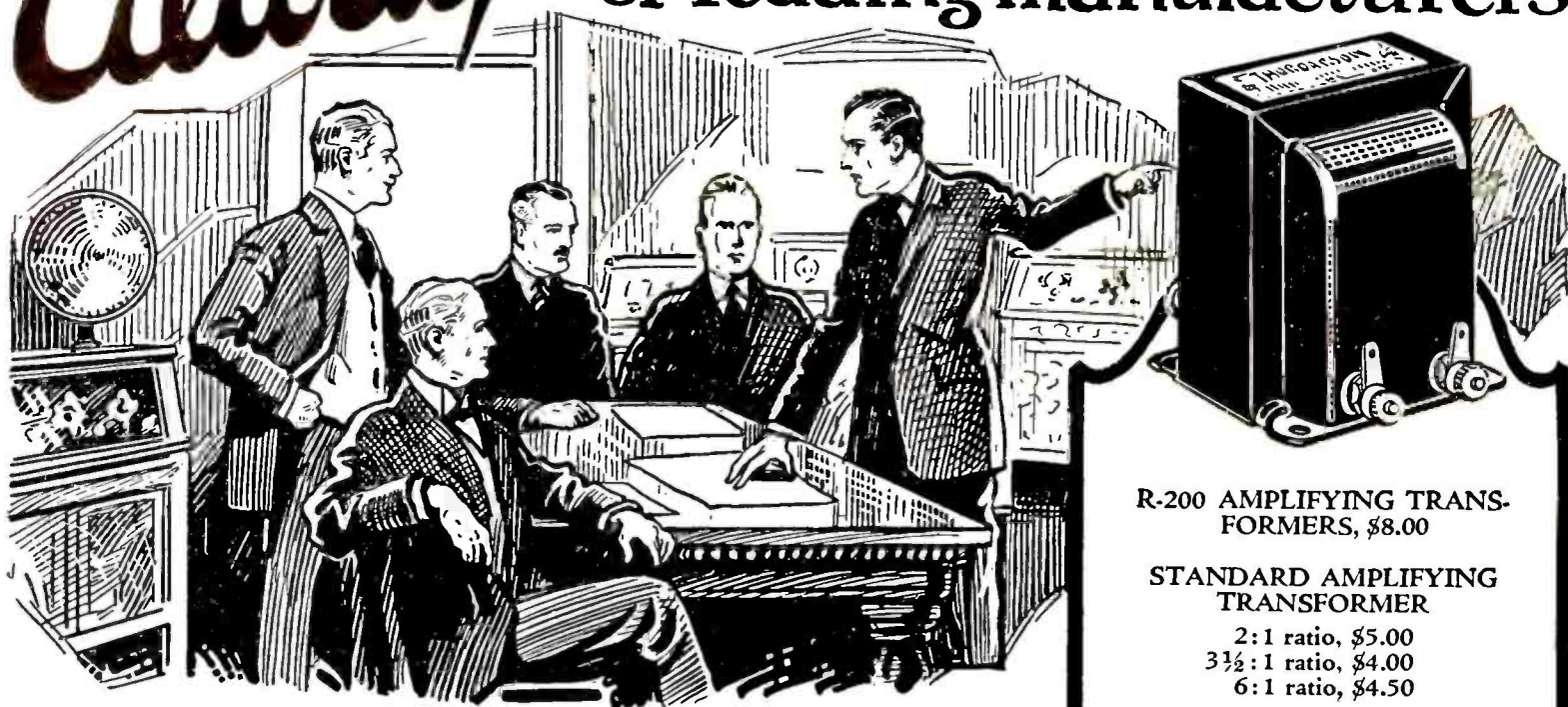

THORDARSON TRANSFORMERS

FEDERAL, Freed-Eisemann, Howard, Kennedy, Murad, Murdock, Pfanstiehl, Prestolite, Radiodyne, Sparton, Valley, Willard, Zenith. These outstanding trade names are representative of the highest degree of radio workmanship and performance.

No wonder, then, that they should all select Thordarson transformers as best in keeping with the high standards of performance maintained in their receivers and power units.

You, too, can benefit by the careful research of these manufacturers. Whatever your radio problem there is a Thordarson transformer ready for you at your parts dealer.

If you enjoy good musical reproduction, insist on Thordarson transformers.

THORDARSON ELECTRIC MANUFACTURING CO.
Transformer specialists since 1895
WORLD'S OLDEST AND LARGEST EXCLUSIVE TRANSFORMER MAKERS
Chicago, U.S.A.

3565

MAIL THIS COUPON

R-200 AMPLIFYING TRANSFORMERS, \$8.00

STANDARD AMPLIFYING TRANSFORMER

2:1 ratio, \$5.00
3½:1 ratio, \$4.00
6:1 ratio, \$4.50

SPEAKER COUPLING TRANSFORMER

R-76, \$6.00

OUTPUT CHOKE

R-196, \$5.00

POWER PUSH PULL TRANSFORMER AND CHOKE

T-2408 Input Transformer, \$8.00
T-2420 Output Choke, \$8.00

AUTOFORMER IMPEDANCE

R-190, \$5.00

POWER COMPACTS
(for power amplifiers)

R-171, \$15.00 R-210, \$20.00

130 M. A. FULL WAVE RECTIFIER

T-2098 (Transformer) \$20.00
T-2099 (Double Choke) \$14.00

R. C. A. A. C. TUBE SUPPLY TRANSFORMER

T-2445, \$10.00

McCULLOUGH A. C. TUBE SUPPLY TRANSFORMER

T-2504, \$7.50

VAN HORNE A. C. TUBE SUPPLY TRANSFORMER

T-2370, \$5.00

Thordarson Electric Mfg. Co., Dept. J
500 W. Huron Street
Chicago, Ill.

Gentlemen:

Please send me your free booklet on audio amplification and power supply.

Name.....

Street.....

Town..... State.....

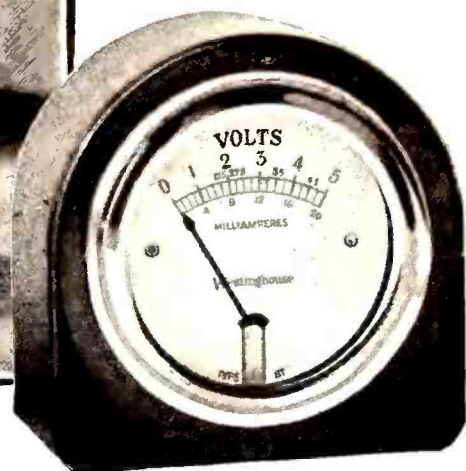

Here is a sturdy mantel-clock model voltmeter with moving-vane movement—three times as accurate as other makes of the same type. Acid and jar-proof. Ask your dealer. Price, \$4.50.

Two tubes saved pay for this voltmeter

ADJUST the voltage across your tubes to "right signal strength", say the direction books. But what is right signal strength?

To guess may prove expensive. It doesn't take long to burn out tubes when you give them too high a voltage. Too low gives weak reception.

A Westinghouse voltmeter soon pays for itself by the tubes it saves—you can buy the most accurate moving-vane radio voltmeter made for only \$4.50. With a Westinghouse voltmeter you *know* what is right signal strength—you gain battery life and better reception all around. Your dealer can show you several types of Westinghouse instruments.

Rectigon and Rectox chargers and Micarta panels and tubing are also Westinghouse products.

WESTINGHOUSE ELECTRIC & MANUFACTURING COMPANY
Offices in All Principal Cities Representatives Everywhere

Tune in with KDKA — KYW — WBZ — WBZA



The new Cabinet Portable Voltmeter made for sets with plug-in jacks. Antique bronze face plate, with gilt dial and pointer. Will fit any arrangement of jacks. Price, \$6.50 (west of Rockies, \$7.00).

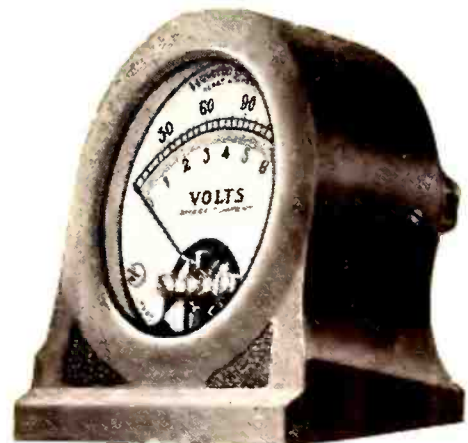

The finest money will buy. Approved and used by the U. S. Navy. Jeweled movement. Price, \$10.00.

Westinghouse

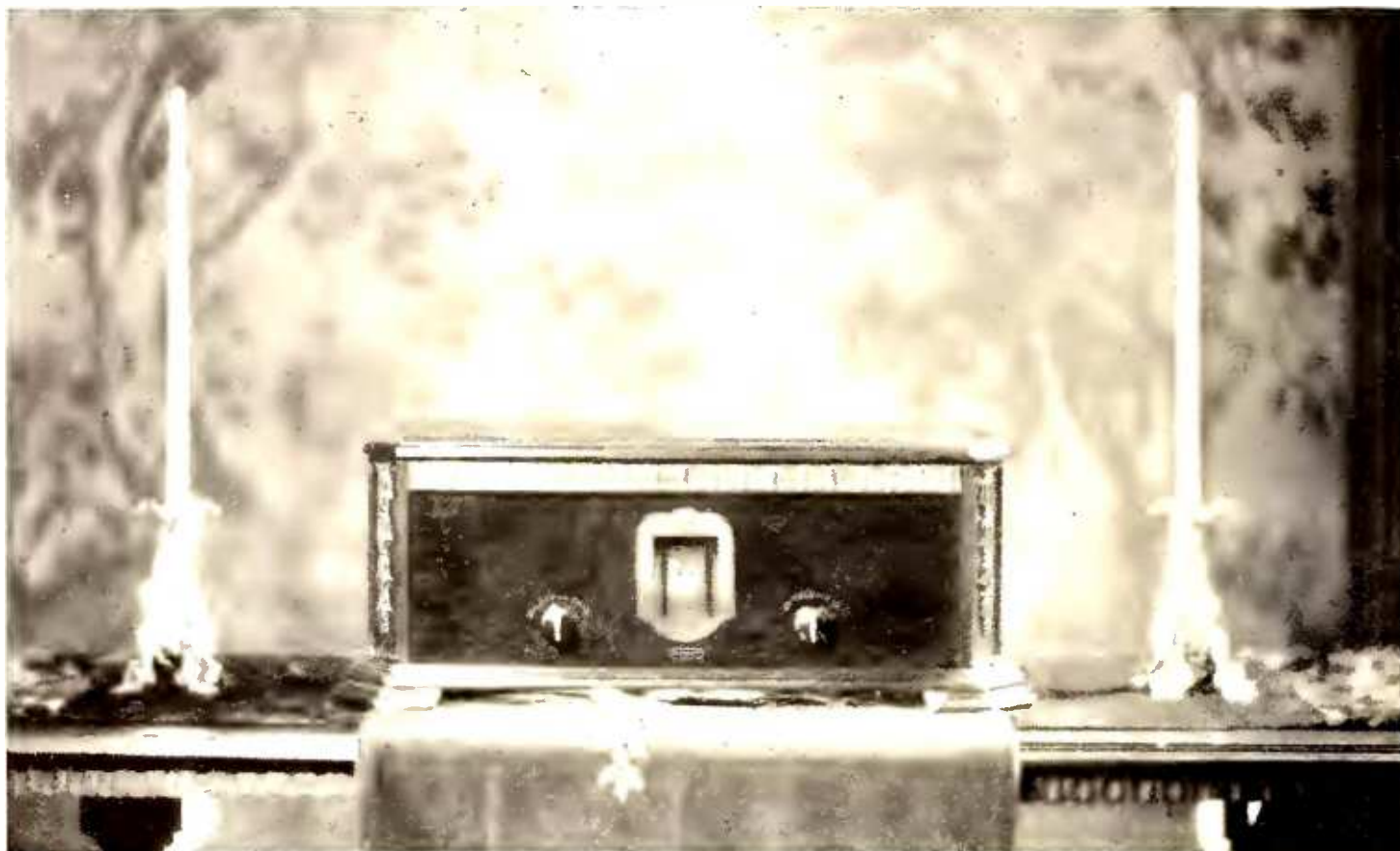

The New Improved Hi-Q Six—the creation of ten foremost American Radio Engineers—a receiving instrument that is far in advance of its time.

Exclusively CUSTOM-BUILT By Yourself at Home . . . from our Simple Instructions . . . and at Great Savings!

NO ordinary standards can be applied to this latest improved Hammarlund-Roberts Receiver, for it is the result of a determination to produce America's very finest instrument—*absolutely regardless of cost!*

Every modern constructional feature has been incorporated. Each part is the most efficient known to radio science, and the entire group has been purposely selected for perfect synchronization.

Complete isolation of four tuned circuits plus Automatic Variable Coupling effects maximum and uniform amplification over the entire wave band. Distortion is totally eliminated. Oscillation is utterly absent. Symphonic transformers

ASSOCIATE MANUFACTURERS

Acme Wire Company
Benjamin Electric Mfg. Company
Carter Radio Company
H. H. Eby Mfg. Company
Hammarlund Mfg. Company
International Resistance Company
Radiall Company
Samson Electric Company
Sangamo Electric Company
Yaxley Mfg. Company

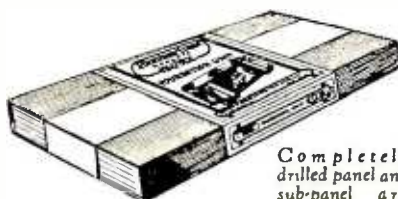

Completely drilled panel and sub-panel are foundation for easy building.

and a power tube faithfully reproduce the full musical scale. Selectivity, even in crowded areas is something to marvel at. *And tonal quality simply MUST be heard to be appreciated!*

Such a set, factory made, and sold through usual channels, would possibly cost around \$300.00, but through following our simple instructions you can purchase all parts for only \$95.80 and build this supreme receiver yourself—a CUSTOM-BUILT set which gives you CUSTOM-BUILT results at a saving of \$100 to \$150.

Get the complete Hi-Q Instruction Book from your dealer—or write us direct. Price 25 cents.

Hammarlund
ROBERTS
— Hi-Q SIX —

HAMMARLUND-ROBERTS INC.

1182 Broadway

New York City

NATIONAL

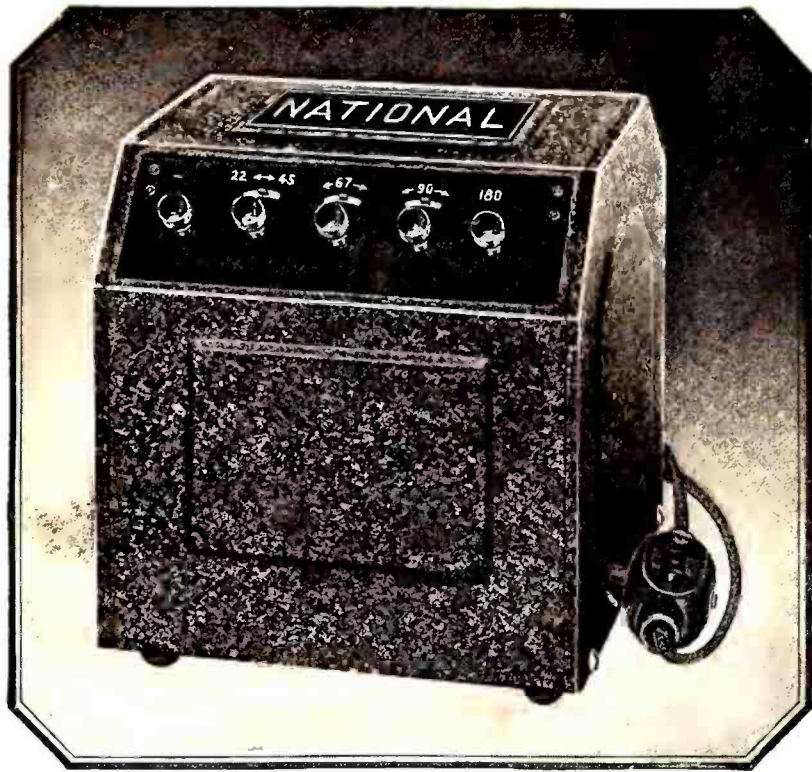

TONE-FILTER



A.C. FILAMENT TRANSFORMER



VELVET VERNIER DIAL



DUO-RANGE CHARGER



IMPEDAFORMER



ILLUMINATED DIAL

An entirely new and unique **HEAVY DUTY BETTER-B.**

Supplies detector voltages from 22 to 45, adjustable; R.F. voltages from 50 to 75, A.F. voltages from 90 to 135, Power tube voltage 180; fixed tubes and by-pass condensers are protected against excessive and harmful voltages.

An Exclusive Feature **DESIGNED FOR LASTING SERVICE WITH LIBERAL FACTORS OF SAFETY.**

A STRICTLY HEAVY-DUTY POWER UNIT. Output rating is 70 mills at 180 volts. Uses R.C.A. UX-280 or Cunningham CX-380 Rectron. Licensed under patents of Radio Corporation of America and Associated Companies. For 105-115 Volts, 50-60 Cycles A.C. List price with cord, switch and plug; \$40. Rectifier tube, \$5. Write National Co., Inc., W. A. Ready, Pres., Malden, Mass., for new Bulletin B.



NATIONAL-B

TYPE 7180

A "B" That's Built for Service

At Booth 5-Sect. F F New York Radio World's Fair—Booths 94 & 95 Boston Show

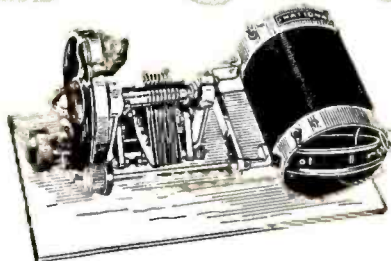

TUNING UNIT

RADIO BROADCAST

OCTOBER, 1927

WILLIS KINGSLEY WING, Editor
KEITH HENNEY
Director of the Laboratory

EDGAR H. FELIX
Contributing Editor

Vol. XI, No. 6

CONTENTS

Cover Design	From a Design by Harvey Hopkins Dunn	
Frontispiece	The Most Powerful Broadcasting Station in the World	340
Now—You Can Receive Radio Pictures . . .	Keith Henney	341
The March of Radio	An Editorial Interpretation	344
Modern Radio Receivers are a Good Investment	The Danger of Direct Advertising on the Air	
Listening to World-Wide Broadcasting is Near	The Month in Radio Licenses and What They Mean	
A Profound Study of Radio Law	The Columbia Broadcasting Chain	
The 1928 "Hi-Q" Has an Extra R. F. Stage . . .	John B. Brennan	348
Manufactured Receivers for the Coming Season		351
1928 Radio Receivers of Beauty and Utility		352
The Neutrodyne Group		354
Servants of Your Light Socket		356
Radiolas for 1928		358
Some New Offerings for the 1928 Season		360
A New Regulator Tube	James Millen	363
The 1928 "Equamatic" Receiver	Julian Kay	364
A New Principle of R. F. Tuning	David Grimes	367
Book Review	Carl Dreher	369
Using Radio in Sales Promotion, by Edgar H. Felix		
1928 Loud Speakers		370
Should the Small Station Exist?	John Wallace	372
"The Listeners' Point of View"		
Your A. C. Set	Edgar H. Felix	374
As the Broadcaster Sees It	Carl Dreher	376
Home-Constructing Transformers and Chokes for Power-Supply Devices	Homer S. Davis	379
"Radio Broadcast's" Laboratory Information Sheets		388
No. 129 The Type 874 Glow Tube	No. 133 Care of Power Supply Units	
No. 130 Data on Honeycomb Coils	No. 134 Loud Speaker Horns	
No. 131 Resistance-Coupled Amplifier	No. 135 Closely Coupled Circuits	
No. 132 Resistance-Coupled Amplifier Circuit	No. 136 Carrier Telephony	
Manufacturers' Booklets Available		394
What Kit Shall I Buy?		396
A Key to Recent Radio Articles		398
"Radio Broadcast's" Directory of Manufactured Receivers . . .		402
Making Radio Installations Safe	Edgar H. Felix	410
Book Review		416
Practical Radio Construction and Repairing, by Moyer and Wostrel		

AMONG OTHER THINGS. . .

SO MUCH is now being accomplished in the complete set field that beginning with this issue, RADIO BROADCAST will devote much of its space to reflecting the technical and other advances being made. The policy of this magazine remains as before, to present the news of radio surrounded by as much as possible of what the technical radio worker refers to as "dope." And much "dope" there is in this complete set side of radio as many articles which will appear in following issues will strikingly demonstrate. In all the other fields of radio endeavor which RADIO BROADCAST has covered heretofore—the construction of radio receiving apparatus, laboratory experiments, short-wave communication, broadcasting from the technical and program side, and many others which we have covered to the satisfaction of our readers, RADIO BROADCAST will be as active as before. The expansion in scope of our text pages is directly designed to keep our readers in close touch with all sides of radio.

WHERE is the radio experimenter who has not read of the rapid progress of the transmission of photographs by wire and radio and hoped that he would soon be able to share in the fascination of this new and intensely modern field? For the past few years, RADIO BROADCAST has watched the progress of the art, hoping that devices would be developed within the scope of the amateur laboratory and pocketbook. The leading article on page 341 describes the background of the Cooley "Rayfoto" system which in a very few weeks will be made available through the pages of RADIO BROADCAST to the home experimenter. To be able to construct a radio photograph receiver for less than \$100 should appeal very strongly to the experimental fraternity who are crying for something new to do. Here, in a manner of speaking, it is.

MANY pages of this issue are devoted to showing the offerings of the set makers for the coming season. Later issues of this magazine will describe in greater detail interesting technical features of these many receivers from many manufacturers.

THOSE of a technical turn of mind will read with great interest David Grimes' story on page 367 describing the theoretical features of a radio receiving system which is one of the most interesting that has come to our attention in many moons. Articles to follow by Mr. Grimes will describe the circuit constants and practical information about the system.

THE Federal Radio Commission is making every effort to popularize the use of the expression "frequency in kilocycles" instead of the familiar "wavelength in meters." It is hard going for some, but doing one's thinking in kilocycles does remove many serious complications from calculations. Ever since its August, 1925, issue RADIO BROADCAST has standardized the use of kilocycle designations, always printing at the same time, the equivalent wavelength in meters. We are in sympathy with the wishes of the Radio Commission and invite the expression of our readers on this subject.

—WILLIS KINGSLEY WING.

Doubleday, Page & Co.
MAGAZINES
COUNTRY LIFE
WORLD'S WORK
GARDEN & HOME BUILDER
RADIO BROADCAST
SHORT STORIES
EDUCATIONAL REVIEW
LE PETIT JOURNAL
L'ECO
FRONTIER STORIES
WEST

Doubleday, Page & Co.
BOOK SHOPS
(Books of all Publishers)
NEW YORK: } LORO & TAYLOR BOOK SHOP
} PENNSYLVANIA TERMINAL (2 Shops)
} GRANE CENTRAL TERMINAL
} 38 WALL ST. and 526 LEXINGTON AVE.
} 848 MADISON AVE. and 166 WEST 32ND ST.
ST. LOUIS: 223 N. 8TH ST. and 4914 MARYLAND AVE.
KANSAS CITY: 920 GRANO AVE. and 206 W. 47TH ST.
CLEVELAND: HIGBEE CO.
SPRINGFIELD, MASS.: MEEKINS, PACKARD & WHEAT

Doubleday, Page & Co.
OFFICES
GARDEN CITY, N. Y.
NEW YORK: 285 MADISON AVENUE
BOSTON: PARK SQUARE BUILDING
CHICAGO: PEOPLES GAS BUILDING
SANTA BARBARA, CAL.
LONDON: WM. HEINEMANN LTD.
TORONTO: OXFORD UNIVERSITY PRESS

Doubleday, Page & Co.
OFFICERS
F. N. DOUBLEDAY, President
NELSON DOUBLEDAY, Vice-President
S. A. EVERITT, Vice-President
RUSSELL DOUBLEDAY, Secretary
JOHN J. HESSIAN, Treasurer
LILLIAN A. COMSTOCK, Asst. Secretary
L. J. McNAUGHTON, Asst. Treasurer

DOUBLEDAY, PAGE & COMPANY, Garden City, New York

Copyright, 1927, in the United States, Newfoundland, Great Britain, Canada, and other countries by Doubleday, Page & Company. All rights reserved.
TERMS: \$4.00 a year; single copies 35 cents.

Tone Quality Superb

From Nature's Sounding Board



Lata Balsa Reproducer Model 150, Price \$50

THE strides made in the past few years by the broadcasting stations in bettering the quality of their transmission have been remarkable. The same principles have been applied to the phonograph, resulting in the new records and machines which are miles in advance of the older type.

These improvements are now available to every listener-in. However, there are some radio

receivers which will not reproduce the wonderful music being broadcast by the improved stations.

By applying the same principles to radio receivers which have proved so helpful in the broadcasting and phonograph fields it is now possible to make the most out of the broadcasting. By utilizing the scientific aids now available old and new receivers may be made to produce music which in every way resembles the original. There is as much difference between this new form of reproduction and the old as there is between the new phonograph and the old scratchy, squawky cylinder machine of yesteryear.

Resistance coupling simplifies receiver amplifier construction and greatly reduces the cost. It is recognized by leaders in the search for the best tone quality as being the ideal amplifying system. It permits the passage of the very low notes and the very high ones with the same ease. It brings to the loudspeaker a true but greatly amplified picture of what is picked up from the broadcasting station.

There is little use in having this wonderful

thing available if we do not make use of it. It can now be utilized very simply. Radio artists, editors and many musicians have expressed both pleasure and amazement on hearing the tone portrayal of symphony orchestras, as well as jazz bands which Nature's Sounding Board has made possible.

Nature's Sounding Board is known as the Lata Balsa Reproducer. It is more than a "loud speaker." It is science's latest contribution to the musical art. It will make any good radio receiver sound much more natural and pleasing.

Lata Balsa Reproducers are available in completed, artistically decorated models ranging in price from \$30. to \$50. Kits are also available in two sizes. The famous Lata Unit, or electrical driving mechanism is now ready for delivery and is ideal for use with the Lata Balsa Reproducer Kits.

The accompanying illustration will give you some idea of the attractiveness of the reproducer—to realize its superior tone quality you must hear it.

The Lata Balsa Kits are complete and may be assembled in a very short time by anyone. No mechanical skill or electrical knowledge is required to follow the simple instructions. Once you have heard this wonderful reproducer no other will satisfy you. The coupon below is for your convenience in ordering. Use it today and you will never regret it.



Everything necessary for the building of a modern three-stage resistance coupled amplifier which may be applied to any receiver. \$9.00

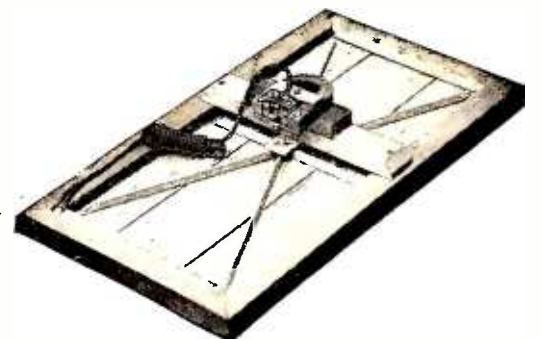

The number 2 Lata Balsa Kit and Reproducer unit assembled. You can duplicate this assembly in a very short time by using this kit and complete instructions

RETURN THIS COUPON—

ARTHUR H. LYNCH, Inc.
General Motors Building
1775 Broadway
NEW YORK CITY

Sole Sales Representatives

ARTHUR H. LYNCH, Inc.
General Motors Bldg. 1775 Broadway
At 57th Street, New York City

Gentlemen:

Please send me the items checked, for which I enclose my money order or cash, also information on prices and sizes of Art Models of Lata Balsa Reproducers.

- Lata Balsa Reproducer Kit, 13 x 24 \$ 8.00
- " " " " 21 x 36 10.00
- " " " Unit 8.00
- Lynch Resistance-Coupled Amplifier Kit 9.00

Name.....
Address.....
City-State.....

**BALSA WOOD
REPRODUCER, Corp.**
331 Madison Avenue
NEW YORK CITY



THE MOST POWERFUL BROADCASTING STATION IN THE WORLD

A view of the transmitting panel of the 100-kilowatt transmitter at the South Schenectady laboratories of the General Electric Company. Experimental programs are sent out with this set, using the standard wavelength of WGY, from midnight to one a. m., Eastern Time. The transmitter went on the air August 4th, marking the first time that power as great as 100 kilowatts has been used in broadcasting. The three water-cooled 100-kilowatt tubes in the foreground have an attachment for clearing out the gas from the tube while it is on the panel

RADIO BROADCAST

VOLUME XI



NUMBER 6

OCTOBER, 1927

NOW—You Can Receive Radio Pictures!

You Can Build Your Receiver for Less Than One Hundred Dollars—How It Works

By KEITH HENNEY

Director of the Laboratory

THERE is an undeniable thrill in witnessing an extraordinary scientific event, such as receiving one's first broadcast program, or in talking across the Atlantic for the first time, or in seeing photographs that have been sent by radio from England, or in talking via short-wave amateur radio with a fellow "ham" on a steamship a thousand miles up the Amazon river. In fact, as the French astronomer, Camille Flammarion says, "Unless one has a stone instead of a heart and a lump of fat in the place of a brain, it is difficult not to feel some emotion over the achievements of science."

The writer's first contact with Austin G. Cooley, who has been responsible for the picture transmission system to be described in RADIO BROADCAST, produced one of those technical thrills. Cooley was working down in the "shack" at 2 GY, the short-wave station of the RADIO BROADCAST Laboratory, a small place with scarcely room enough to stow his extensive gear. On one bench was a metal drum on which a photograph of a young lady with a large and floppy hat turned over and over. On the other side of the "shack" was another rotating drum covered with photographic paper with a small spot of light playing on it, and filling the shack was an undefinable sound like that of a high speed motor whirring away with whining and somewhat obnoxious tone. In two or three minutes, Cooley stopped the motor, took the photographic paper from the receiving drum, developed it in rather dim daylight, and there was the young lady again, hat, white plumes and all. Between the transmitter and receiver was an artificial telephone line 300 miles long so that for all practical purposes the young lady's picture had been sent to Garden City from, say, Washington, D. C.

Since that time, Cooley has produced several picture systems, one of which is applicable to present wire telegraph channels so that facsimile copies of original messages may be transmitted at a cost not exceeding present rates. Another system—the one in which we as radio experimenters are interested has been developed to the extent that with a not very expensive attachment to the ordinary radio set, one can receive at home photographs, letters, telegrams, pictures, or text torn from newspapers. This system is known as the Cooley "Rayfoto."

These radio-transmitted pictures are comparatively good reproductions, quite satisfactory

when one considers the simplicity of the apparatus and the compromises which were necessary in order to obtain them, it must be remembered that it is about seven years since the first small group of amateurs heard the human voice, and music, coming in by wireless. The early poor quality of reception must not be forgotten; nor must we lose sight of the fact that it has taken since 1835, when S. F. B. Morse performed his epoch-making experiment of transmitting slow and uncertain telegraph signals via wires, to send messages at the rate of several hundred characters per minute.

The Cooley pictures are better than most of the static-laden ones that have come across the

Radio pictures at home—that's what the experimenter has been waiting for. Now it is possible. For less than \$100, you can build your own picture receiver, connect it to your broadcast set and jump into a new and fascinating field of experiment. Exclusive articles in RADIO BROADCAST in the November number and in following issues will tell you how to build and operate the receiver.

Atlantic. Some of them are reproduced here. Improvement in detail and shading of the Cooley Rayfoto pictures will come. The important fact is that here is something the experimenter can have for his own and can have the sport of developing his experience as this apparatus is improved and refined.

To know the Cooley apparatus is to know Cooley, to visualize the young M. I. T. student who preferred his own researches into the then unknown field of picture transmission to the prescribed studies with the result that he was dropped from the college register during his fourth year; his long nights of work, sleeping—when sleep was necessary—beside his apparatus on a laboratory bench. One should know of twenty-four-hour days in the Arctic on the MacMillan Expedition in 1926 when Cooley

worked under great odds, trying to send picture signals by short waves back to the United States. This background is necessary to understand the years of effort that have gone before the present development. This development has been slow, and full of disappointments but the final result has been that his system is workable, comparatively simple to operate, and what is more important in the eyes of the average experimenter—it is inexpensive.

THE LURE OF HOME EXPERIMENT

WHY should one want to receive pictures by radio at home? As well ask: Why have thousands of experimenters built receivers for the reception of music, or code? In this, there has been always the thrill of accomplishment; making something with one's hands, something that works: creation. Secondly, there is the hope in everyone's heart that television, the art of transmitting scenes from life itself by wire or radio, shall become practical within his time. Before television shall be an accomplished fact, we must conquer the idiosyncrasies of the transmission of still life pictures, an art known as telephotography. By introducing legions of experimenters to the general problem of sending and receiving pictures by radio or wire, Cooley may have a share in advancing the day when the more difficult task of committing moving pictures to the ether shall be solved. The amateur has been thanked by engineers for his persistence in developing short-wave channels; many have said that to him alone belongs the credit for advancing the art of communication by the use of those very high frequencies. At any rate, he has had his share in making possible communication by short waves across vast distances with inexpensive apparatus. Who knows what his share may be when the ultimate success of telephotography and television has been achieved?

The transmission of a picture by the Cooley system differs from the transmission of music in one important respect: it takes a single audio frequency and performs tricks on it which at the receiving end are translated from sounds to other effects which influence a photographic paper. For example, good broadcasting requires that a band of frequencies 10,000 cycles wide shall be transmitted. These frequencies at the receiver are reconverted to sound waves. The picture system takes a given frequency, say 1000 cycles, and transmits its form of intelligence on it. In a way

it is less complicated than broadcasting music; in other ways broadcasting pictures is more complex.

The broadcasting station which may elect to transmit pictures as well as music or speeches will use its present equipment. Since pictures according to the Cooley system are first translated into sound impulses, and since the phonograph record is a means of recording for future use such sound impulses, thereby defeating two of nature's limitations, time and space, the broadcasting station that will invest in a phonograph turn-table needs no other equipment to fill the ether with pictures.

YOUR REGULAR RADIO RECEIVER IS USED

THOSE who will receive pictures will use their present broadcasting receiving set which should be equipped and operated so that overloading and severe distortion of other sorts do not occur. As in transmitting sounds, distortion at the receiving end produces an unintelligible or garbled reproduction. The receiver must be within the "service area" of the transmitter—that is, inside the distance at which fading takes place; the operator must be able to develop and fix ordinary developing-out paper, such as Azo, Velox, or other papers with which the amateur photographer is already well familiar. Here is an opportunity for the radio enthusiast who has dropped his photographic hobby to bring developing trays from the attic, and to renew his acquaintance with hydroquinone, metol, HQ, and hyposulphite of soda!

The present simplified system transmits and receives original photographs full of strong contrast, such as newspaper photographs, or those in which a loss of detail will not mar the recognizable features of the transmitted picture. The examples reproduced here will give an idea of the work that can be done. These limitations are largely due to the simplification of the receiving equipment, and, as experimenters become more familiar with the present apparatus, more refinements will naturally follow, refinements which will make it possible to receive greater detail, and naturally better pictures.

The process of getting the picture into the ether is not too complicated for anyone to understand. The picture is wrapped around an aluminum drum which revolves in front of a very strong light. As the drum revolves it moves along a shaft, so that the beam of light eventually has

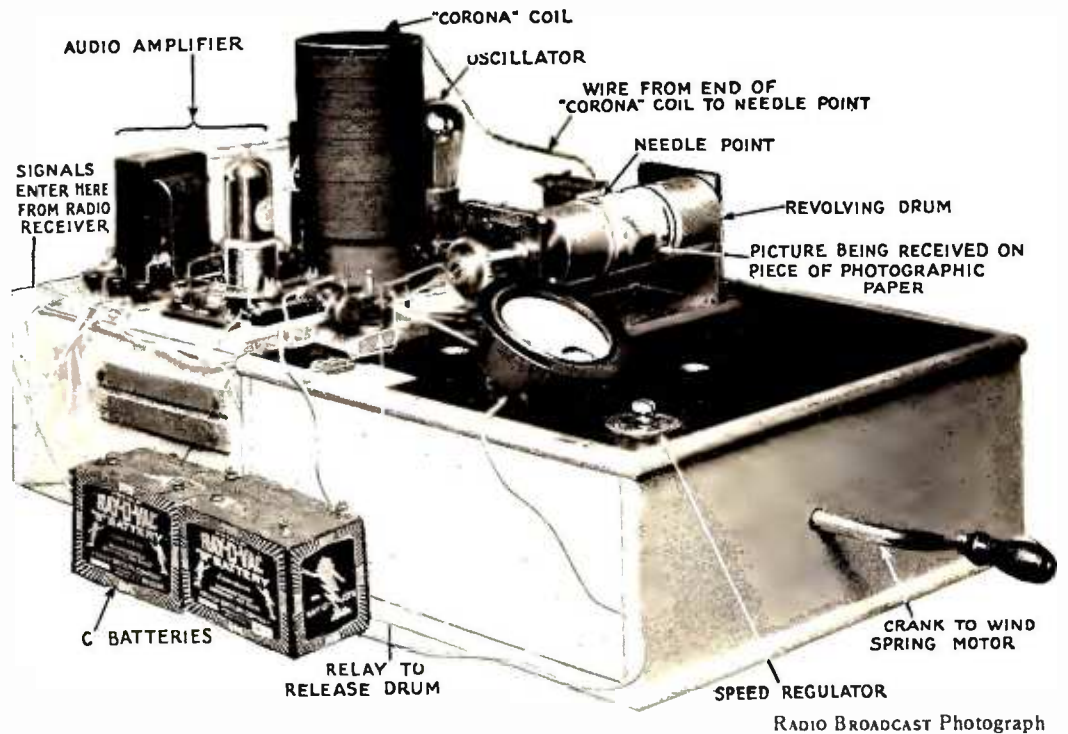

THE COOLEY "RAYFOTO" RECEIVER

Simplicity is the keynote of the Cooley picture transmission system. Signals in the form of an audio frequency tone enter at the point marked on this photograph, are amplified in a single-stage transformer-coupled amplifier, after which they are placed on the oscillator circuit through a modulation transformer not visible here. The signals in the oscillator circuit drive the corona circuit whose output is conducted to the rotating drum and photographic paper by the wire and needle point shown here. The drum is rotated by the familiar spring motor which usually turns phonographic records. The milliammeter, which is essential, usually reads the oscillator current

covered the entire picture, illuminating a small bit of it at a time. The light which is reflected by the picture passes into a sensitive photo-electric cell, another of modern science's marvels. When the beam of light falls on a black portion of the picture, most of the light will be absorbed and little reflected and consequently what passes into the photo-electric cell will be small—just as the part that comes to the eye is small; which explains what we mean by the word "black."

This sensitive photo-electric cell, whose history dates back many years and touches the lives of many famous scientists, consists of a potassium plate and a second metallic electrode which has a battery attached to it maintaining it at a potential positive with respect to the potassium,

much as the plate of a vacuum tube is maintained positive with respect to the filament by the B batteries. When light shines on this potassium plate, electrons, those omnipresent negative electrical charges, are given off, their passage to the second electrode toward which they are attracted constituting an electric current. This minute current, usually of the order of a few millionths of an ampere is greatly amplified and interrupted by another current of 1000-cycle frequency. The result is that what were originally black and white visual images have been translated into sound impulses which are then impressed on the radio transmitter, or a telephone line, and are sent out like speech or music.

At the receiving end the process must be reversed, i. e. sound impulses must be translated into light impressions, back into those original black and white spots. Assuming that nothing happens in the intervening space, no static is picked up, no fading has lost the signal, at the receiving end the conventional broadcasting set may be used, and if a loud speaker is attached to the output of the receiver in the normal manner we should hear this varying note which is about two octaves above middle C on the piano.

WHY LOCAL AMPLIFICATION IS NEEDED

IN MOST cases it will be necessary to boost this wavering note to sufficient strength to operate the rest of the translating apparatus which consists of an oscillator, similar to that used in superheterodyne receivers except that its wavelength is usually above the broadcasting band, and finally what Cooley calls a "corona" coil. It will remind old-time electrical experimenters of the Tesla coil, a device used to transform a.c. voltages into other voltages high enough to produce electrical discharges across intervening space, in this case about a quarter of an inch.

Under ordinary conditions, the carrier of the transmitter tuned-in but no picture being on the air, the oscillator will be oscillating so feebly that no corona is taking place, but when the signal arrives it supplies power to the oscillator so that a nice fat discharge is produced whose

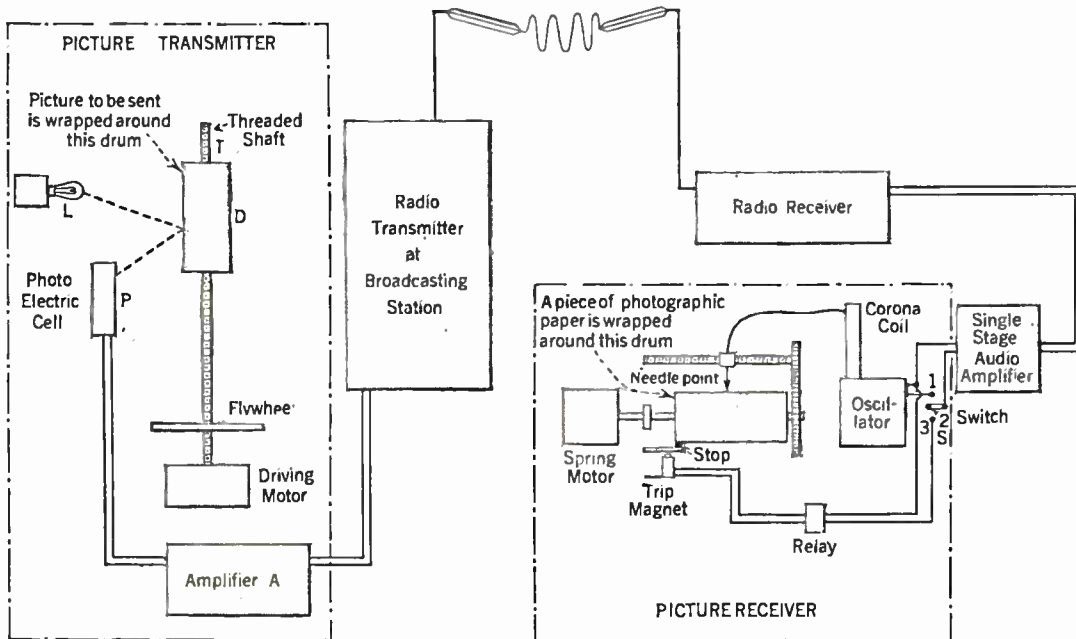

HOW THE COMPLETE SYSTEM WORKS

The owner of receiving apparatus need not worry about how the pictures get on the air, but in case he is interested, here is a layout of the complete system, transmitter, waves in the ether, receiver and all! The switch at the right of the receiving equipment and the trip magnet are part of the start-stop system that insures synchronism between transmitter and receiver



RADIO BROADCAST Photographs

THE COMPLETE RECEIVING APPARATUS

Here is the entire receiving apparatus. The receiver in this case was a well known set operating from a loop, picking up signals on 208 meters which originated in another part of the Laboratory. They are tuned-in and sent through the picture apparatus which is described in greater detail in the other photographs

intensity varies with the shading of the transmitted picture.

The counterpart of the rotating drum of the transmitter will be found at the receiver. Here, instead of an electrical motor we use for sake of simplicity a phonograph turn-table which is geared to a small aluminum drum around which the sensitive photographic paper is wrapped. The corona discharge sprays the paper from a fine needle and in some way not well understood affects the emulsion of the photographic paper. Whether this is an electrical or chemical effect or whether there is enough light from the corona to expose the paper is not fully known.

But for Cooley's purpose it does not matter. When developed, the paper shows black spots where the discharge was heavy; light spots where the corona was weak.

Now in all picture systems, some means must be provided to keep the receiver in exact synchronism with the sender; when the latter starts the receiver must start, and not in the middle of the picture which as anyone can see would have certain disadvantages! A simple scheme for hold-

ing the receiver and transmitter together has been employed. It is known as the "start-stop" system, and is very simple and flexible. In operation the receiving drum revolves slightly faster than the transmitting drum and it therefore completes a revolution in a slightly shorter time. At the end of each revolution the receiver drum is held by a trigger until the transmitting drum completes its revolution. A signal is transmitted then that releases the receiving drum so the two start off together. The radio signals are not strong enough in most cases to operate the trip magnet that releases the receiving drum at the beginning of each revolution so this magnet is operated through a more sensitive relay. Both the trip magnet and relay can be seen in the picture of the apparatus shown on this page. The single pole double throw switch S is really part of the trip magnet. When the armature of the trip magnet is against the stop on the drum, terminals 2 and 3 on the switch are pushed together and therefore all of the energy from the audio amplifier passes into the relay. When the synchronizing impulse is received it activates the relay and the trip magnet thus releases the drum and also causes the switch S to make contact between terminal 1 and 2 and then all of the energy passes into the oscillator.

The present apparatus transmits 4 x 5 photographs at a rate of one and one-half inch per minute or a little over 3 minutes for a picture.

The Cooley receiving apparatus consists of first of all one's broadcast receiver, then certain mechanical parts which will be on the market soon, and then certain electrical apparatus which any experimenter can build and operate. The

WHAT THE PICTURES LOOK LIKE

These photographs have been transmitted by the Cooley Rayfoto system. Pictures may be five inches wide and about six inches long and a little over three minutes for each picture is required.

These pictures have not been retouched

total cost of the apparatus, exclusive of batteries, tubes, and broadcast receiver will be less than \$100. All of the electric apparatus can be made from material easily available to the experimenter. Complete descriptions by Mr. Cooley of this equipment and how to operate it will follow.

A word about the availability of pictures. Inasmuch as the original equipment for a broadcasting station need involve no more than the expense of a phonograph, there is a certain source of these radio pictures in every broadcast station. Broadcast stations will find in the transmission of the Cooley "Rayfotos" a sensational extension of their activities and by the time this article is in the hands of experimenters, and by the time the receiving equipment is ready, pictures will be on the air. The Cooley system is being exhibited at the New York Radio Show this month.

And there you are: Pictures by radio—and in your own home.

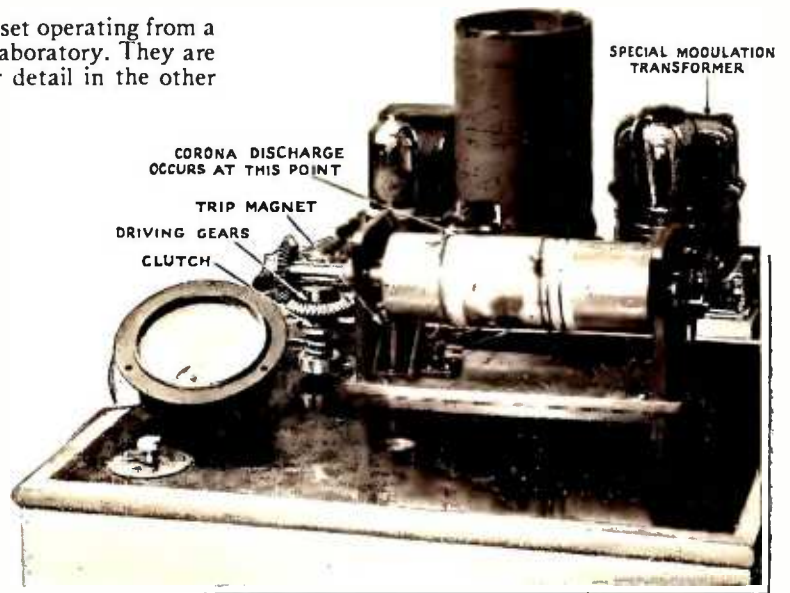

A CLOSE-UP

The modulation transformer, which was hidden in the view on page 342 by the corona coil is shown here. All of the parts for this apparatus have been especially designed, and will be available soon. A good idea of the gearing mechanism and of the width of the drum on which the picture is received may be had from this photograph. The picture may be as wide as the metal drum. The needle point actually rides on the paper as is shown here



The March of Radio

News and Interpretation of Current Radio Events

Modern Radio Receivers Are a Good Investment

THE Radio World's Fair opens the radio season for the broadcast listener. Fitting its significance, the Fair is held in mid-September at the huge Madison Square Garden in New York.

No radio season has ever started more auspiciously. Technical progress, represented by simple, easily operated and maintained radio sets, many powered directly from the electric light mains, with broadened tonal range, bring the manufactured receiver to a standard so high that revolutionary change can no longer be expected. Greater broadcasting programs and improved receiving conditions make the possession of these modern receivers all the more desirable.

Every industry goes through the same cycle of growth; first, it has a discouraging struggle for recognition, then a boom period with almost day to day improvement, and finally, stabilization, with slow, continued and healthy progress, keen competition among leaders and the gradual elimination of the less capable who thrived only during the boom period.

In stating that radio has reached a slower level of development and that the purchaser may now select his receiver with the confidence that it will not be hopelessly obsolete within a year or two, or even four or five years, we draw our conclusion from fairly simple and indisputable premises. Improvement of any device is a matter of rendering it so simple that no technical knowledge is required for its operation, so rugged and self-sustaining that but little attention is needed to maintain it in good condition, and so pleasing in appearance that it harmonizes with the most luxurious surroundings.

High standards of simplicity have been attained in radio when we have many receivers in which five circuits are simultaneously controlled by one dial and calibrated so that stations may be promptly logged. The only perishable elements in some receiving sets now are the filaments of the vacuum tubes themselves which need be replaced perhaps only once a year. In tone quality, radio

has reached a standard of reproduction far above that which satisfied the phonograph industry after twenty years of prosperity. This standard can be raised at will with our present knowledge and facilities, although the cost of doing so is prohibitive and the effect hardly noticeable to the average listener. As to appearance, there is still room for some improvement by the attainment of greater compactness in the more powerful receivers, but models are available for which no apologies need be made even in the most exacting surroundings.

Radio has certainly not reached its limit of development. Improvements will continue always and this year's sets will always be better than last. Two or three years ago, a radio receiver was but a one-year investment for those who would possess the best available in the market. This year's standards are making the latest and best models perhaps a five-year investment in approximately the best radio reception attainable.

It is a strange paradox that the substantial developments in manufactured receiving sets are not more widely appreciated by the technically minded radio enthusiast. From extensive contact with

the better informed element of radio listeners, we have analyzed this lack of familiarity as attributable in part to the experimenter's preoccupation with the intricacies of set building and the failure of the radio set manufacturer to lay before this group, so invaluable to the building of reputations, the real facts about the design and construction of his receiving set. Glittering generalities about performance do not intrigue the radio experimenter who, in past years, has successfully excelled in these proclaimed qualities with his home-made contraptions.

But a new day has dawned. The experimenter cannot deny the superiority of the better manufactured sets. Already he is turning his attention to new fields. While building radio receivers was still an experiment, the successful outcome of which depended upon skill, ingenuity and patience, this hobby had no rival in the hearts of those who considered the soldering iron an instrument of conquest. The element of mystery is disappearing. Set building has become the following of a well established formula. The thrill of accomplishment still exists but the procedure is so well charted that the joy of exploration and discovery is practically gone. These missing

elements, which satisfy the experimenter's insatiable desire to overcome obstacles and to conquer the unknown are being rapidly supplied by new lines of endeavor. Telephotography and, some day, television, international short-wave broadcast reception, modern installations with remote control of the radio receiver, laboratory experiments, home motion pictures, aviation, mechanical models and a thousand one avenues of expression beckon the experimentally inclined.

The pages which follow attempt to reflect accurately the trends in the interests of our readers. The manufactured receiver deserves an increasing amount of attention, as do new fields of development like telephotography and short-wave reception. We do not propose, in the least, to neglect the set builder, but rather to keep him in touch with the latest developments of the art. We

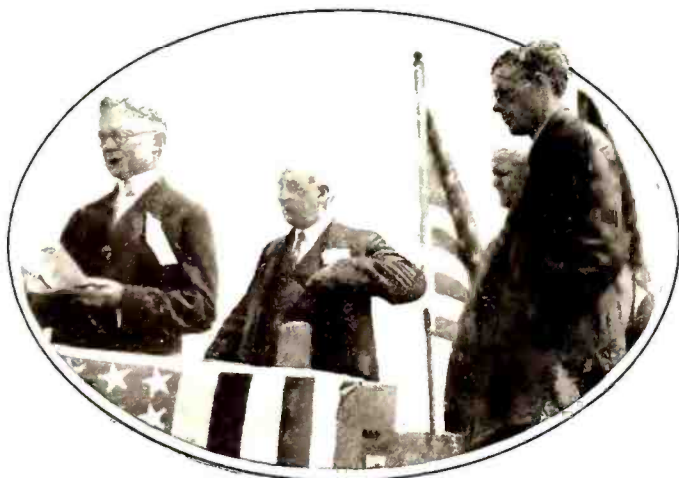

COLONEL LINDBERGH IN SCHENECTADY

"Aviation and radio are twin sisters engaged in the joint enterprise of overcoming time. Distances are no longer measured in miles, but in hours, minutes, and seconds. Colonel Lindbergh reduced the distance from New York to Paris from days to hours. Radio has brought all parts of the world into talking distance of the United States," said Martin P. Rice of the General Electric Company. Above: Martin P. Rice, and at the extreme right Colonel Lindbergh

feel the broadened scope of our pages will appeal to each of the three principal elements of our reader audience, the experimental group; those professionally interested in radio, ranging from dealer to engineer to manufacturer; and the radio enthusiasts who follow these pages to keep abreast of progress in radio.

Listening to World-Wide Broadcasting is Near

PRIOR to the development of broadcasting, experimenters built receiving sets having a wavelength range of from 200 to 25,000 meters, so that they could eavesdrop on every available radio channel. Experience has taught us to build more efficient receivers for much narrower ranges. Indeed the present broadcast band is the widest for which a high grade receiving set with easy control can now be made. Many of the services conducted on non-broadcasting channels are gradually being rendered by radio telephony rather than radio telegraphy. The objection that laborious study of the radio code is necessary to listen to them is thereby eliminated.

Almost every day of the year, new radio services open up. The possessor of a long-wave receiver picks his signals from every section of the globe. A slight movement of the dials may transfer his attention from a station in Java to another in Iceland. There are now nearly one hundred stations which can be heard in any part of the world.

Perhaps the most important development of all, so far as the broadcast listener is concerned, is the increasing interest in short-wave broadcasting. 2 XAF, the 32-meter (9150-kc.) Schenectady transmitter of the General Electric Company, is actually supplying the world with radio programs. Its signals are frequently and regularly heard in England, South Africa, South America, New Zealand and Australia. An increasing number of American broadcasting stations, including WGY, KDKA, WRNY, WLW, WAAM, WRAH and WHK are, or soon will be, broadcasting their programs on short wavelengths. British, German, and Dutch stations are within range of American short-wave sets. Short-wave programs are readily heard at great distances during the summer when the program range of most standard wavelength broadcast receivers is very limited. Several companies are already preparing to meet the demand for short-wave receivers.

The question may arise whether short-wave broadcasting will not replace our present services. A short-wave transmitter is ideal for long distance transmission but, because of fading and the skip distance effect, is of little or no local service. Within two hundred to six hundred miles of short-wave stations, their signals are usually inaudible but even moderate power delivers a strong signal for immense distances beyond the dead area. Hence every high frequency station requires an exclusive channel, placing a definite limit on the

number which may be accommodated throughout the world. Receiving sets, working on the high frequencies, are necessarily of the regenerative type and consequently, at the present time at least, no vast number of receiving sets can use these channels without causing destructive interference. Undoubtedly, the radiation problem will be overcome, but fading and transmission irregularities will prevent the use of short waves in the essential local and regional broadcasting services.

Since short-wave stations practically cover the earth with their signals, it is feasible to assign but one powerful short-wave broadcaster to a frequency. Consequently, it is desirable to select a short-wave broadcasting band at once and allot frequencies so as to meet the needs of all the countries of the earth. This matter should be considered in the International Radio Telegraph Conference, convening in Washington in October, lest confusion and congestion arise later. There is no need for a great number of short-wave broadcasters in any one country, and some means should be devised for limiting their increase before the problem becomes as serious as the congestion now obtaining on the conventional wavelengths.

A Profound Study of Radio Law

THE *Law of Radio Communication* by Stephen Davis, former Solicitor of the Department of Commerce, recently published by McGraw-Hill, is a valuable contribution to radio literature.

It has been awarded the Linthicum Foundation Prize by the faculty of law of Northwestern University, a dis-

HOW MUCH IT COSTS TO BROADCAST
Rate cards are used in selling "time" on the air just as publishers use rate cards in selling "space." The rates in these tables show exactly what it costs to send a program over the entire United States. A large part of the charges are consumed in the high cost of the special telephone wires connecting the stations

tion which will be recognized by the legal profession as one of no small moment.

The book deals comprehensively with all phases of radio communication and interprets the Radio Act of 1927 in the light of precedents already established by the Courts. The book studies exhaustively the complex problems raised by the existence of broadcasting stations, although the author has been seriously handicapped by lack of established legal precedents and decisions on most vital issues. Clearly, many important legal questions which will harass the Courts during the next few months are yet to be settled.

The preponderance of evidence and precedents which Judge Davis cites leads one to conclude that the question of confiscation of property, involved in cancellation of station licenses, is one which will be decided against the regulatory power of the Commission. On the other hand, established stations, which find their service curtailed by interference from newcomers, seem to have ample grounds for securing restraining injunctions on the grounds of prior rights. Reading these parts of the Judge's book leads us to regret all the more that our suggestion that station priorities be recognized, was not embodied in the law. That was urged in these pages long before the Radio Act was finally drafted.

The author considers federal jurisdiction and its relation to state and local regulation of radio communication, copyright questions, libel and slander, as well as the significance of every phase of the recent Act.

I. GENERAL BROADCAST ADVERTISING									
A. Basic Rates for periods between 7:00 P. M. to 11:00 P. M. Local Time.									
RED NETWORK <i>Available only as a Group</i>					BLUE NETWORK <i>Available only as a Group</i>				
<i>Cities</i>	<i>Charge Per Hr.</i>	<i>Charge Per 1/2 Hr.</i>	<i>Charge Per 1/4 Hr.</i>	<i>Cities</i>	<i>Charge Per Hr.</i>	<i>Charge Per 1/2 Hr.</i>	<i>Charge Per 1/4 Hr.</i>	<i>Charge Per 1/4 Hr.</i>	<i>Charge Per 1/4 Hr.</i>
New York	\$600.00	\$375.00	\$234.38	New York	\$600.00	\$375.00	\$234.38		
Easton	250.00	156.25	97.66	Boston	250.00	156.25	97.66		
Hartford	120.00	75.00	46.88	Springfield	210.00	131.25	82.03		
Providence	120.00	75.00	46.88	Baltimore	190.00	118.75	74.22		
Worcester	120.00	75.00	46.88	Rochester	200.00	125.00	78.13		
Portland, Me.	120.00	75.00	46.88	Pittsburgh	300.00	187.50	117.19		
Philadelphia	310.00	193.75	121.10	Detroit	340.00	212.50	126.56		
Washington	190.00	118.75	74.22	Cincinnati	250.00	156.25	97.66		
Schenectady	190.00	118.75	74.22	Chicago	460.00	287.50	179.69		
Buffalo	200.00	125.00	78.13						
Pittsburgh	250.00	156.25	97.66						
Cleveland	250.00	156.25	97.66						
Detroit	340.00	212.50	126.56						
Cincinnati	250.00	156.25	97.66						
Chicago	460.00	287.50	179.69						
Total for Network	\$3770.00	\$2356.25	\$1466.46	Total for Network	\$2800.00	\$1750.00	\$1087.52		
SUPPLEMENTARY CITIES									
<i>Selectively available</i>	<i>Cities</i>	<i>Charge Per Hr.</i>	<i>Charge Per 1/2 Hr.</i>	<i>Charge Per 1/4 Hr.</i>	<i>For use in conjunction with the Red or Blue Networks</i>				
	St. Louis	\$210.00	\$131.25	\$82.03					
	Minn. St. Paul	210.00	131.25	82.03					
MIDWESTERN GROUP									
<i>Available only as a group</i>	Davenport	\$190.00	\$118.75	\$74.22	<i>For use in conjunction with the Red or Blue Networks</i>				
	Des Moines	190.00	118.75	74.22					
	Omaha	190.00	118.75	74.22					
	Kansas City	190.00	118.75	74.22					
	Oklahoma City-Tulsa	190.00	118.75	74.22					
	Dallas-Ft. Worth	190.00	118.75	74.22					
	Total for Group	\$1140.00	\$712.50	\$445.32					
SOUTHERN GROUP									
<i>Available only as a group</i>	Louisville	\$180.00	\$112.50	\$70.31	<i>For use in conjunction with the Red or Blue Networks</i>				
	Nashville	190.00	118.75	74.22					
	Memphis	190.00	118.75	74.22					
	Atlanta	190.00	118.75	74.22					
	Total for Group	\$750.00	\$468.75	\$292.97					
PACIFIC COAST NETWORK									
<i>Selectively available with San Francisco</i>	San Francisco	\$300.00	\$187.50	\$117.19	<i>Requires special program production in San Francisco studio.</i>				
	Los Angeles	300.00	187.50	117.19					
	Portland	150.00	93.75	58.60					
	Seattle	200.00	125.00	78.13					
	Spokane	150.00	93.75	58.60					
	Total for Network	\$1100.00	\$687.50	\$429.71					
B. Basic Rates for periods other than between 7:00 P. M. - 11:00 P. M. Local Time are one-half above rates.									
Discounts on Basic Rates for number of periods under contract not to exceed one year									
ation:									
	Less than 25				Net				
	25 - 49				5%				
	50 - 99				15%				
	100 - 299				20%				
	300 and over				25%				

For the time being, it is the only authority available to the lawyer handling cases for broadcasting stations. We hope, for the good of radio, that Judge Davis will soon find it necessary to write a revised edition occasioned by court decisions to the unanswered questions which he so ably raises. His book thoroughly establishes Judge Davis as the outstanding American authority on the law of radio communication.

The Danger of Direct Advertising on the Air

THE United States Radio Society has sent us its literature, including a code of regulations and by-laws for local affiliated chapters of the society. By following these regulations, any local radio organization may become affiliated in the national group, and means are provided for representation of each chapter in the national deliberations. In absence of local chapters, a membership can be secured by individuals who may write Paul A. Greene, Managing Director of the Society, at the Temple Bar Building in Cincinnati Ohio.

The Society recently forwarded the returns from a questionnaire to the Federal Radio Commission which emphasized the unpopularity of certain broadcasters permitting blatant advertising, particularly two well known nuisances in Shenandoah, Iowa. The St. Joseph, Missouri *Commercial News*, writing of these "advertising sta-

tions," says "one of the best known of these nuisance stations reported, the first week in February, that it had in a month sold about 45,000 pieces of dress goods, amounting to approximately 175,000 yards. Figuring the mileage, this amounts to $99\frac{4}{13}$ miles of dress goods." Continuing, the article comments on the competition which this direct advertising offers to the small local merchant.

One of the claims made to the Federal Radio Commission by one of these stations was that it lowered the price of goods to the farmer. Refuting this claim, the St. Joseph newspaper says:

One of the best known stations, not far from St. Joseph, recently put on an active sale of cans of smoked salt for use in butchering on the farm. It offered two cans of a good quality of smoked salt for \$2.50, postage prepaid. Orders were accepted for not less than two cans. One Iowa farmer who fell for this great bargain was shown the identical product by his local merchant for only a dollar a can. Another radio bargain was ten pounds of prunes for \$3.50, of a quality purchasable locally in one pound packages for twenty-eight cents.

The Month In Radio

HENRY OBERMEYER of the Consolidated Gas Company of New York informs us that his company received more than 31,000 letters from its customers as a result of a radio course on homemaking which required

four and a half hours of broadcasting time to transmit. One of the important features of the gas company's radio campaign was that an amount equal to fifty per cent. of the broadcasting expense was spent in newspaper advertising to call the attention of radio listeners to the feature. It is an excellent example of successful commercial broadcasting which won its return by the real value of its service. ¶ ¶ ¶ The Bureau of Standards is prepared to calibrate crystal oscillators used in maintaining broadcasting stations on their assigned frequencies, for a nominal fee. Stations contemplating taking advantage of this service should first apply to the Bureau, giving call letters, assigned frequency, type, make and description of the oscillator to be calibrated. This information is required because the Bureau will not accept for calibration instruments which are not so constructed that they will remain in adjustment permanently. ¶ ¶ ¶ WHAM, Rochester, New York, which will soon have a 5000-watt equipment of the latest type, WTMJ, Milwaukee and WJAX, Jacksonville, Fla., have been added to one or the other of the N. B. C. chains, giving still greater coverage to its programs. ¶ ¶ ¶ The National Electric Manufacturers' Association recently completed a study of the question of the number of hours a week the listener uses his radio set. This information has an important bearing on the sale of tubes and maintenance accessories. According to the NEMA figures one listener out of a thousand uses his radio about twenty-two hours out of twenty-four; one out of a hundred, twenty hours out of twenty-four; one-tenth of the total more than seven hours a day and four out of five in excess of thirty hours a week, which means five hours a night, six nights out of seven. The statistics were

evidently obtained by making a record of the listening habits of a handful of the most rabid enthusiasts who could be found. We would particularly like to meet the person who uses his radio receiver twenty-two hours out of twenty-four. It is quite apparent that Mark Twain was right about statistics. Editor's Note: Mark Twain said: "There are lies, damn lies and statistics." ¶ ¶ ¶ The Canadian radio industry is developing rapidly. There are now at least a dozen first class Canadian-made broadcast receivers, and several factories engaged in the manufacture of radio tubes and batteries. Broadcasting has prospered with the backing of such powerful concerns as the Canadian National Railways and the Northern Electric Company. A patent pool, similar to that of the Radio Corporation of America, is licensing a number of first class manufacturers. On April 1, licensed broadcast receiving stations numbered 134,486, as compared with 92,000 at the end of the previous year. The fees collected from the listener are applied to the elimination of interference and the proper administration of commercial radio telegraphy. ¶ ¶ ¶ Danish statistics inform us that, on April 1, 1927, there were 130,805 radio receivers in that country, almost equally divided between crystal and vacuum tube sets, and an increase of 50,000 over the previous year. ¶ ¶ ¶ There is a great increase in the demand for radio receiving sets in Brazil and broadcast enthusiasm is spreading throughout the country with great rapidity. Most of the stations are



A TRANSCONTINENTAL CANADIAN BROADCAST

For the first time in history, twenty-three Canadian stations from Halifax to Vancouver were hooked up in broadcasting the Diamond Jubilee Celebrations of the Dominion. A feature of the broadcast was the program of carillon music from the Peace Tower in the Parliament Buildings at Ottawa (in insert, left). The illustration below shows the control room in the Parliament Buildings with telephones leading to the telegraph and telephone offices. Commander C. P. Edwards, head of Canadian radio, is at the extreme right



along the seaboard and long range receivers are consequently in special demand. American receivers are making the greatest headway in the market.

LICENSES AND WHAT THEY MEAN

THE most important patent decision rendered during recent months, which is, however, still subject to future appeal, was that of Judge Thacher, favorable to the Radio Corporation against E. J. Edmond & Co., Atwater Kent jobbers. The decision establishes the validity and scope of the Alexanderson patent 1,173,079, generally known as the tuned radio frequency patent. The result of this decision has been to place all concerns making multi-tube sets, not holding R. C. A. licenses in considerable jeopardy. About twenty-four important concerns have already secured Radio Corporation licenses and those outside the pale are making strenuous efforts to secure licenses. So far, no set company licenses have been granted which do not guarantee a minimum royalty to the R. C. A. of \$100,000 a year. Just what the future holds for small companies is, at the moment, doubtful. Radio dealers are universally demanding apparatus which is duly licensed and the position of those who cannot, because of small production, guarantee such substantial royalties is most doubtful. The Radio Corporation could not long withstand the adverse criticism which would result were they to force smaller manufacturers out of business.

The object of the patent law is to protect the rights of inventors so that they may derive just compensation for their inventive efforts. The use of patents for restraint of competition, even though patents themselves are an intentional and desirable monopoly, is not supported by public opinion. So long as a concern is willing to recognize inventors' rights and pay royalties it should not be prevented from engaging in competitive business. Dealers are justified in insisting upon licensed apparatus and it appears that the Radio Corporation and its licensees are the only ones who may legally make efficient, high grade radio receivers under present conditions. However, if patents are used in a coercive way to strangle smaller concerns, we doubt that it will result ultimately to the benefit of the patent holders. No one questions that the recent decisions have established definite supremacy of the R. C. A. in the patent situation, but the advantage should not, and probably will not, be used to force independents out of business. ¶ ¶ ¶ The Hazeltine Corporation won a vitally important decision against A. H. Grebe & Co. sustaining the Hazeltine patents 1,489,228 and 1,533,858. The distinction between the Rice and Hartley disclosures, upon which Grebe placed principal reliance, and that of Hazeltine, is clearly set forth in the decision. Although it is granted that both Rice and Hartley disclosed principles of neutralization, the superiority of the Hazeltine method, utilizing a capacity feed back of a voltage to neutralize the regenerative effect, is established as an improvement of great importance to the radio art. Professor J. H. Morecroft appeared as an expert for Grebe. The Court, in its opinion, quoted an item from the "March of Radio," which Professor Morecroft formerly prepared for RADIO BROADCAST, acknowledging the importance of the Hazeltine disclosure. ¶ ¶ ¶ A decision handed down in the Federal District Court at Baltimore sustained Messrs. Willoughby and Lowell over James Harris Rogers in their patent for a submarine reception system. Rogers claimed prior conception, but Willoughby and Lowell clearly anticipated him in reduction to practice.

¶ ¶ ¶ After yielding to a decree *pro confesso*

secured by John A. Victoreen against the Radio Art Company and others; the latter developed a substantially different device from that previously judged to infringe. An action was brought requesting that Radio Art be adjudged guilty of contempt but, upon submission of a brief that the new device was substantially different from that on which the earlier decree had been granted, the Court ordered the plaintiff to file a new suit. The case is cited in the interests of those who have yielded to consent decrees. ¶ ¶ ¶ The Eisler Engineering Company of Newark announces that it successfully defended itself against the General Electric's suit which sought to prevent it from manufacturing tipless tubes. The case was started in October, 1924, and the final decision is of interest to all vacuum tube manufacturers. ¶ ¶ ¶ A suit has been filed by the Balsa Wood Company, Inc. against the Balsa Laboratories Company, Inc. in connection with their patent 1,492,982, describing diaphragms for sound reproducing devices. ¶ ¶ ¶ One claim of V. K. Zworykin's patent 1,634,390, covering a secrecy system of transmission was denied because of an earlier patent, Alexanderson's 1,426,944. ¶ ¶ ¶ The Brandes Products Corporation has petitioned for a writ of certiorari which may bring the dispute regarding the Hopkins patent before the Supreme Court. Originally the Lektophone Corporation of Jersey City sued the Western Electric Company, which

suit resulted in a decision in favor of the latter. The R. C. A. has already paid \$200,000 for rights under the Hopkins patents, which will prove an unnecessary investment unless they are sustained before the Supreme Court. ¶ ¶ ¶ The Westinghouse Company secured an injunction against the Kenwood Radio Company in connection with Armstrong's radio patent 1,113,149.

THE COLUMBIA BROADCASTING CHAIN

THE United Independent Broadcasters, of which Major J. Andrew White, pioneer sports announcer, is a leading official, has given out a list of stations which will form its new network. The key station is WOR, which is the third most popular station in New York, exceeded only by WEFW and WJZ in number of listeners. The other stations are WEAU and WNAC in New England; WFBL, WMAK, western New York; WCAU and WJAS, Pennsylvania; WADC, WAU, WKRC, Ohio; WGHP, Michigan; WMAQ, Chicago; and KMOX, St. Louis. Although, in point of numbers and station standing, the stations comprising the chain are not everywhere in the lead, it would not take long, given good programs, for such a chain to corner a good part of the radio audience.

Nothing will help the broadcasting situation so much as real competition to the N. B. C. chains, so that both organizations will conduct a nip and tuck battle for program supremacy.



THE RADIO EQUIPMENT ABOARD THE "MORRISSEY" IN THE FAR NORTH
Edward Manley, of Marietta, Ohio, is shown before the radio apparatus aboard the Putnam-Baffin Island expedition. The *Morrissey*, known to the short-wave code world as VOQ has a generator-powered short-wave transmitter, a battery-powered transmitter using a UX-852 tube (on the top shelf), a short- and long-wave receiver, and a portable battery-operated transmitter. Signals from VOQ have been clearly heard at the short-wave laboratory of RADIO BROADCAST and occasional radio dispatches from the expedition have appeared in the *New York Times*

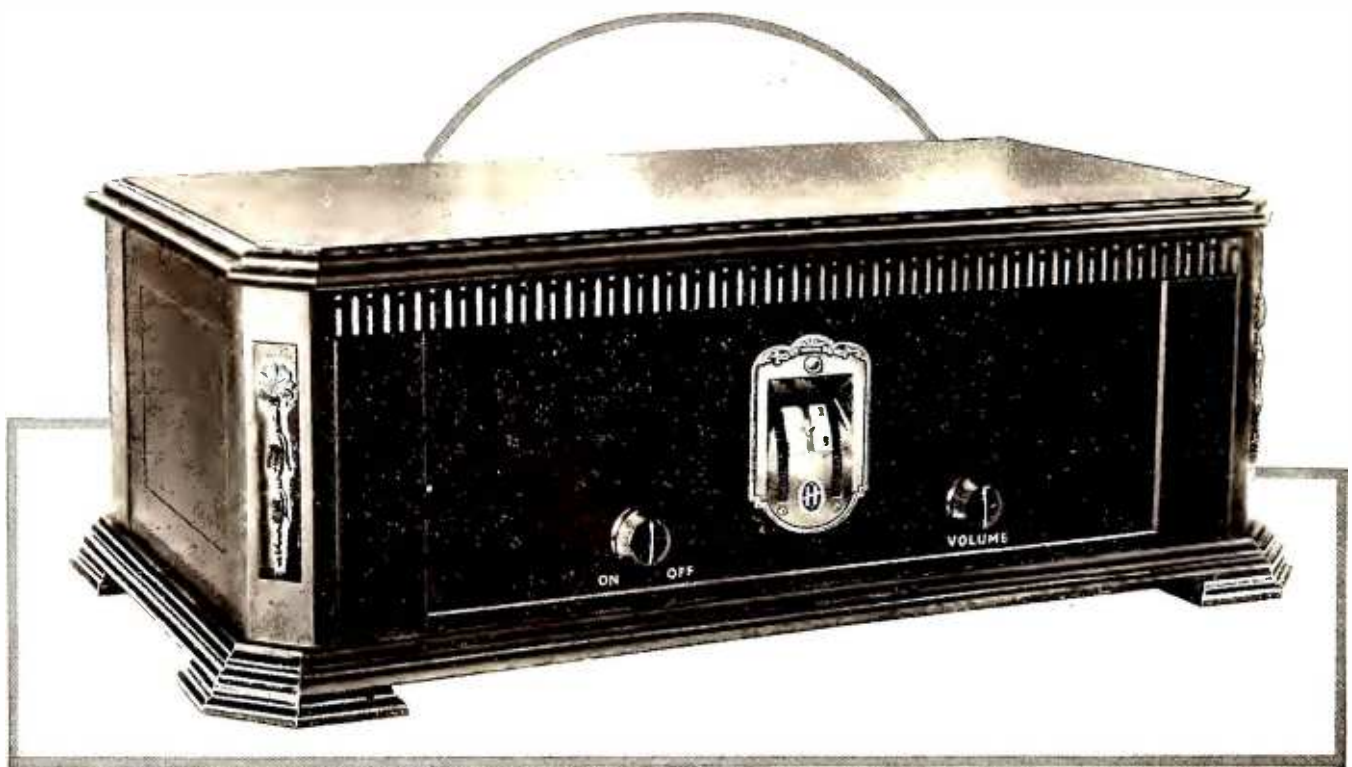

The 1928 "Hi-Q" Has an Extra R. F. Stage

By JOHN B. BRENNAN

Cascaded Stages Result in Sharpness of Tuning but Avoid the Cutting Off of Side-Bands

IN ANY discussion centering upon the predominant requirements of a modern receiver, it will generally be admitted that there are two outstanding things to strive for—good quality and a high degree of selectivity. Strangely enough, these two coveted qualities are diametrically opposed to one another—difficult of attainment in the combination.

Nowadays, a receiver is judged by its ability to faithfully reproduce music and speech, and this critical attitude on the part of the listener has resulted in the setting up of a remarkably high standard so far as the audio channel of the modern receiver is concerned.

The other outstanding requirement, that of selectivity, represents a problem which did not exist in the early days of radio. To-day the United States has over six-hundred broadcasting stations whereas there were barely a hundred five years ago.

It needs no stretch of the imagination to realize that there is no receiver which, in a given location, can tune-in all six-hundred of these stations. With an exceptionally good receiver, however, listeners may tune-in more stations—not merely the far-distant stations—than with just a fairly good receiver. Yet, in spite of this, there is no advantage gained in such a case unless the reception is of good enough quality reproduction to warrant listening to it.

To illustrate briefly the difficulties involved, reference to Fig. 1 will prove helpful. Here a suppositional case is presented where the vertical rectangular sections represent the ten-kilocycle bands occupied by several stations whose carrier frequencies are equally separated by a space of twenty kilocycles. The curve b represents the tuning characteristic of a selective circuit which

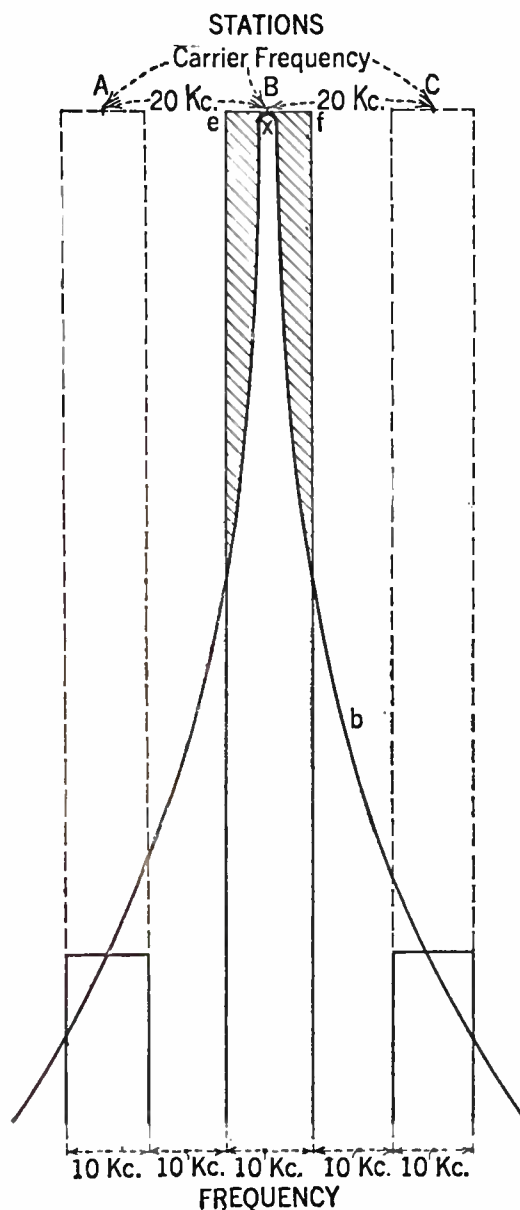

FIG. 1

Variable Interstage Coupling Provides for Equal Amplification Throughout Broadcasting Band

is slightly regenerative and which is set for resonance with the incoming signal of station B. It will be observed that, while a section of the curve falls in that part of the space taken up by stations A and C, the amplification of the signals from these two stations is much below the amplification of the signal to which the circuit is tuned. Maximum amplification of signal A is represented by X, the peak of the curve b. It may be said of this circuit that it is highly selective but it will also be observed that the quality of the signal is impaired due to the fact that all the side-band frequencies, e to f, within the ten-kilocycle band of the station to which the circuit is tuned, are not amplified equally. The shaded portion shows how unequal this amplification is and indicates the rapid cutting off of the side bands. A highly desirable curve would be one where equal amplification of all the frequencies within the band, e to f, is obtained, and where there will be no response obtained to stations in adjacent frequency bands.

Now, going to the other extreme, in circuits wherein there is no inherent regeneration, and where the characteristic curve indicates broadness of tuning, as in Fig. 2, it will be noted that the shaded portion has become greatly reduced and therefore practically an equal amplification of frequencies within the band to which the circuit is tuned, is obtained. It will also be noted, however, that in such a circuit the amplification of signals obtained from adjacent stations, even though the circuit is not tuned to them, is sufficient to cause them being heard as a background to the desired signal. It has been determined that where a number of slightly broadly tuned stages are arranged in cascade, each successive stage filtering the output of the preceding stage, and

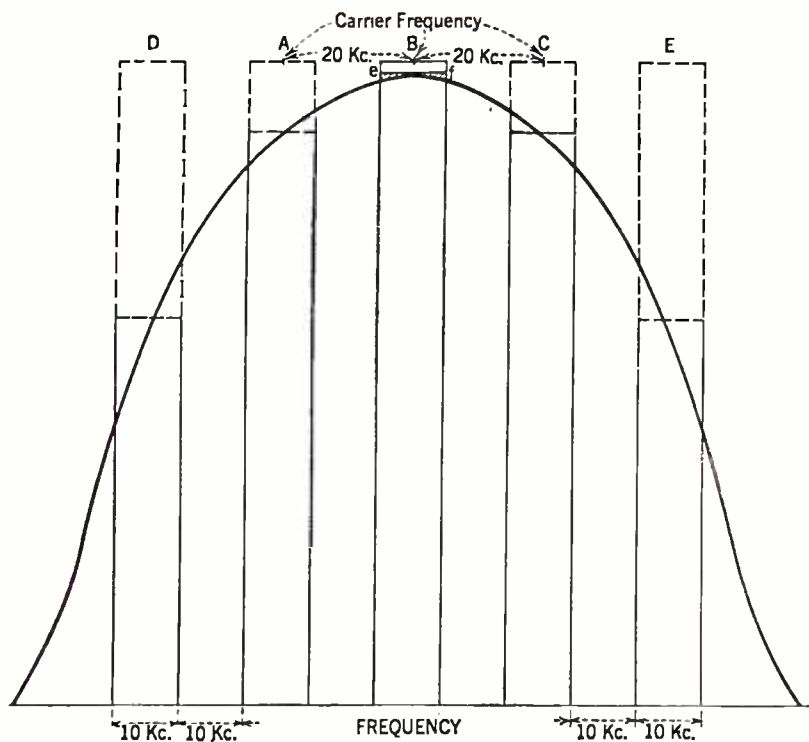

FIG. 2

where precautions have been taken to guard against inherent regeneration in the several stages, that the ideal response curve is approximately attained. This is graphically shown in Fig. 3.

From Fig. 2 we have observed that the response curve for a single stage is quite broad. It is reproduced again in Fig. 3 as curve No. 1. However, when a second tuned stage, having the same characteristics, is added, the curve obtained is somewhat altered in form. The top of the curve has practically remained the same but its sides have taken a deeper slope, as shown by curve No. 2. In adding a third stage, the curve obtained is similar to the curve No. 3, wherein there is a further constriction of the sides of the curve. The fourth stage confines the curve within limits which very nearly approach the ideal.

For those who desire a highly technical discussion on the points just outlined, it is recommended that reference be made to Professor L. A. Hazeltine's paper on the subject, which is contained in the June, 1926, issue of the *Proceedings of The Institute of Radio Engineers*.

THE NEW "HI-Q" RECEIVER

IN THE new Hammarlund "Hi-Q" Six receiver, four tuned stages are employed and the final response curve obtained from their use is similar to No. 4 of Fig. 3. In order to secure this result it was necessary to take precautions in setting up the four tuned stages to prevent the desired signal being received by any other way than through the antenna into the first tuned stage, and so on, up to the detector stage. Therefore, the necessity for completely shielding each of the stages arose. Also, each of the several tuned stages had to be completely filtered by the use of radio-frequency chokes and bypass condensers so that there were not present any intercoupling effects which would cause unstableness in operation and thereby defeat the purpose of the use of these several stages. Were not the radio-frequency currents confined to their own individual stages by means of chokes and bypass condensers, and also by the individual stage shields, intercoupling effects would undoubtedly be caused either by capacitive coupling from the wiring of the circuits, inductive coupling between the coils of the various tuned circuits, or resistance coupling in the batteries, since one set of batteries is employed to furnish the B potential and its impedance is common to all the tubes.

It was realized that all this must be achieved without sacrificing the sensitivity of the circuits, or in other words, their ability to bring in weak signals. This means that the various interstage transformers employed in the tuned circuits must be efficient enough so that weak antenna signals are built up to a strength sufficient to give a good response in the loud speaker considering that two stages of audio-frequency amplification are employed.

It is this desire for sensitivity that complicates the problem of combining these principal features of a high degree of selectivity and a high degree of re-

production into a practical receiver. It is well known that a three-stage radio-frequency amplifier can be built to give a high degree of amplification and smooth operating characteristics; that is, it will have freedom from self oscillation, etc., if it is desired to work at a single wavelength, say, five-hundred meters. However, where, under these conditions, the circuits are re-tuned to, say, two hundred meters, they will go into violent oscillation and destroy the stability which they formerly possessed. Explained in another way, this means that, due to the fact that radio-frequency amplifier circuits have the tendency to oscillate, this oscillation becoming more pronounced as the wavelength is decreased, a circuit satisfactory for operation at five hundred meters is wholly unsatisfactory for operation at two hundred meters, due to inherent oscillation, unless, of course, some corrective feature, either mechanical or electrical, is incorporated in the circuit to prevent this oscillation and yet at the same time maintain the circuit at its high degree of amplification.

It has been recognized that some system of securing uniform amplification at all broadcast frequencies is greatly to be desired and various methods for attaining this end have come into prominence during the last year. These systems in the main can be divided into two classes: (1) The mechanical control of coupling, such as is used in the King "Equamatic," "Hi-Q," and Lord systems and, (2) electrical systems, such as those relying on the function of combinations of capacity, inductance, and resistance—the Loftin-White and "Phasatrol" methods, for example.

A little calculation will readily show that these systems can be designed to produce a curve approaching the desired straight line indicating uniform amplification shown in Fig. 4. Since the resultant curve from the use of a fixed coupling between primary and secondary is so far removed from a straight line characteristic, as will be seen by Fig. 4, even remedial systems,

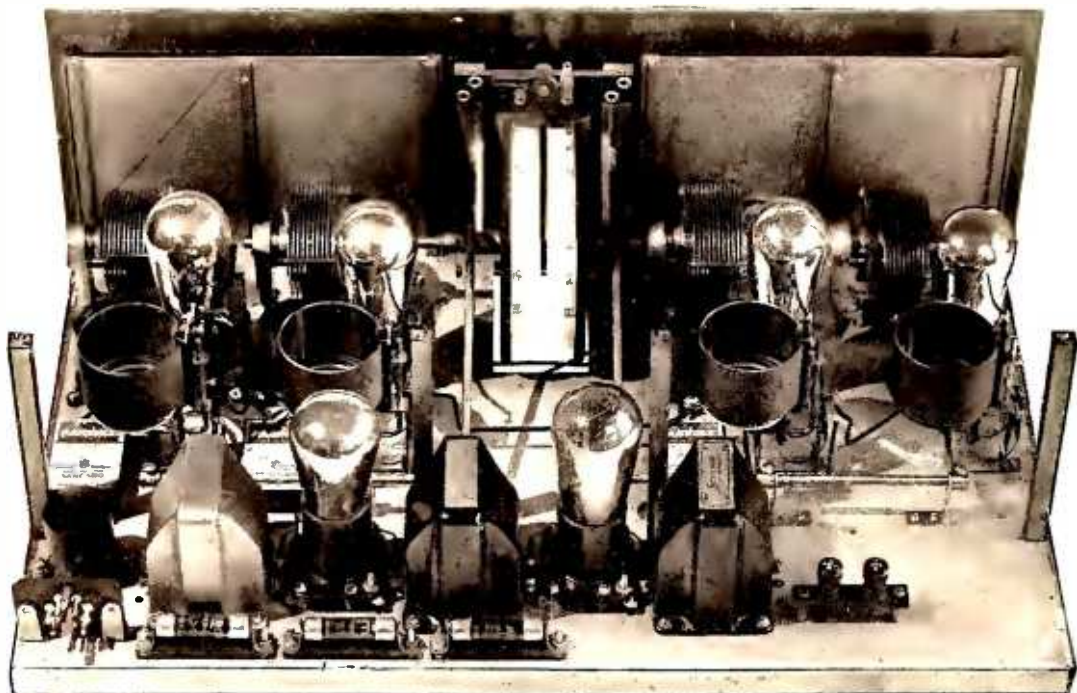

FROM BEHIND THE PANEL

The shield walls have been removed for this photograph so that it may be clearly seen how all the parts are disposed

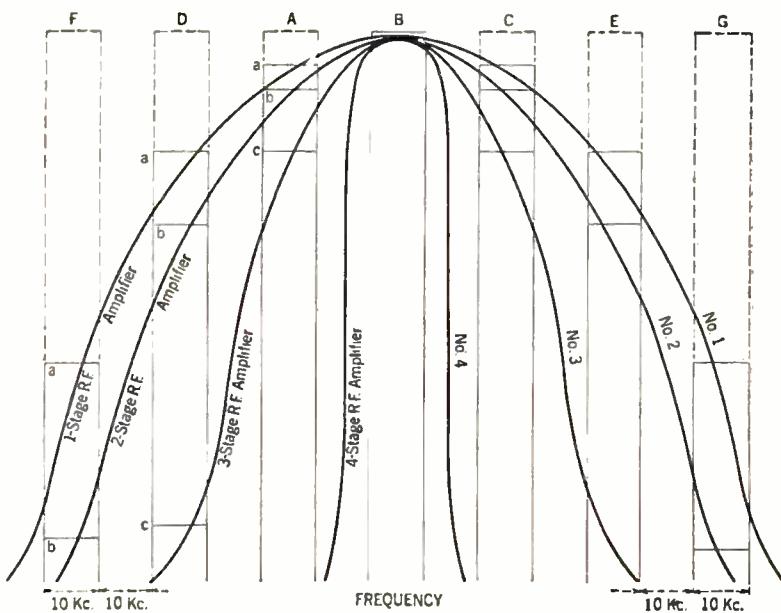
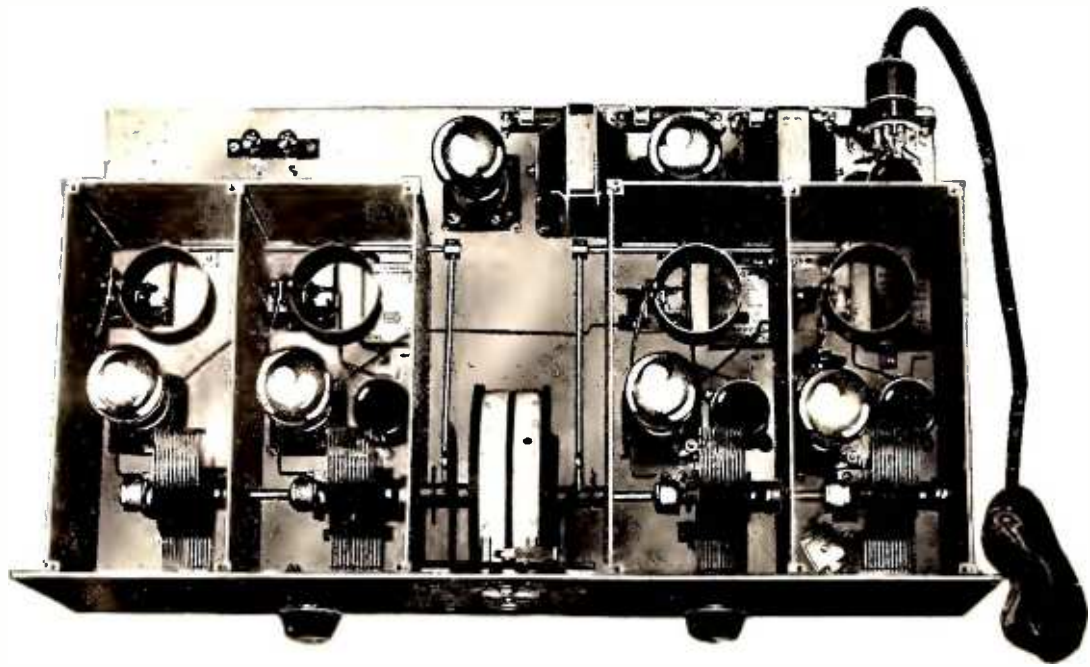

FIG. 3

though not absolutely perfect, are undoubtedly a step in the right direction.

In the Hammarlund "Hi-Q" Six the results obtained by the use of four well designed tuned stages depended not only upon complete isolation of each of the four stages by means of shielding but by a combination of mechanical and electrical systems which, in the end, produced as near as possible the desired straight line of amplification. The mechanical feature consisted of automatically varying the coupling between the several primary and secondary coils by means of a cam located on the shaft of the condensers, so that a variable degree of coupling was obtained to give an equal transfer of energy between primary and secondary regardless of whether the circuits were tuned to two hundred or five hundred meters. By the use of the cam method it is possible to secure the correct degree of coupling at any dial setting due to the fact that the shape of the cam can be predetermined to provide the desired coupling. Since all precautions are taken to prevent feedback by isolating the several tuned stages, through the use of radio-frequency chokes, bypass condensers, and individual stage shields, only the tube capacity of the tubes employed in these stages remains to cause undesired coupling. The electrical means referred to above is obtained by the use of grid "suppressors"—resistance units located in the grid circuits of these tubes. These grid "suppressors" will cancel the tendency of the tube capacity to act as a coupling agent and to cause feed-back.

From the detector grid to the loud speaker is a fixed circuit with constant audio amplification. The volume control, situated in the radio-frequency amplifier circuit, permits regulation of its overall amplification so that the correct amount of signal can be fed to the detector grid to produce a volume of signal from the loud speaker which is satisfactory to the listener. The control, a filament rheostat which regulates the voltage applied to the first three radio-frequency amplifier tube filaments, prevents the overloading of the detector, especially during reception from powerful local stations. Two stages of audio



READY FOR THE BATTERIES

This illustration clearly shows the gauged condenser arrangement employed in the new "Hi-Q" Six

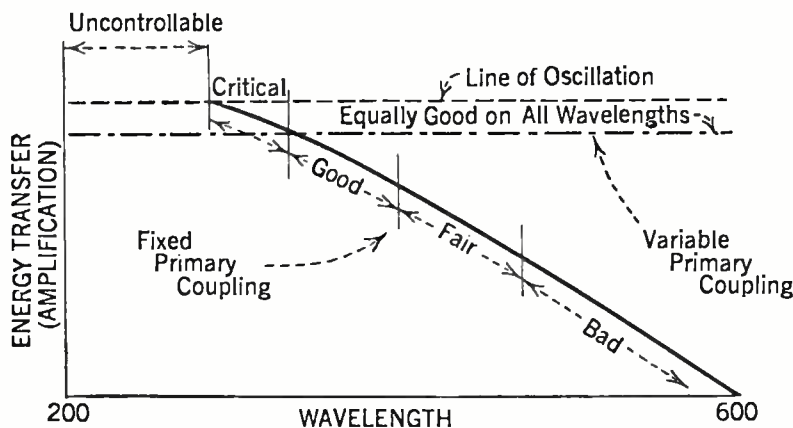

FIG. 4

frequency amplification are employed, good tone of signals being maintained by the use of high-quality audio-frequency transformers. To secure perfect amplification it is necessary that the advantageous results to be obtained by the use of expensive transformers be not offset by the unintelligent use of tubes in the audio amplifier. In the last or power audio stage either a UX-112 (CX-112) or UX-171 (CX-371) type of tube should be employed with the correct B and C batteries.

From the accompanying photographs of the

new "Hi-Q" Six receiver, it will be noted that directly behind the panel there are two metal boxes located at either end, between which is a central space in which is located the drum dials controlling the several tuning condensers. The left-hand box shield is divided into two compartments housing the first and second radio-frequency amplifier stages with their associated chokes and bypass condensers. In the right-hand box shield, also divided by means of a central wall, are located the third radio-frequency amplifier and the detector stages. The two tuning condensers in each of these box shields are located on common shafts which terminate at the central space in the drum dials. These dials are insulated from the shafts by means of insulated coupling units. The following parts are used in building the "Hi-Q" Six:

1—Samson Symphonic Transformer	\$10.00
1—Samson Type HW-A3 Transformer (3-1 Ratio)	5.00
4—Hammarlund 0.0005-Mfd. Midline Condensers	22.00
4—Hammarlund "Hi-Q" Six Auto-Couple Coils	12.00
4—Hammarlund Type RFC-85 Radio-Frequency Chokes	8.00
1—Hammarlund Illuminated Drum Dial	6.00
1—Sangamo 0.00025-Mfd. Mica Fixed Condenser	.40
1—Sangamo 0.001-Mfd. Mica Fixed Condenser	.50
1—Pr. of Sangamo Grid Leak Clips	.10
1—Carter 1R-6 "Imp" Rheostat, 6 Ohms	1.00
1—Carter "Imp" Battery Switch	.75
1—Durham Metallized Resistor, 2 Megohms	.50
3—Parvot 0.5-Mfd. Series A Condenser	3.00
6—Benjamin No. 9040 Sockets	4.50
3—Eby Engraved Binding Posts	.45
2—Amperites No. 1-A	2.20
1—Amperite No. 112	1.10
1—Yaxley No. 660 Cable Connector and Cable	3.00
1—Hammarlund-Roberts "Hi-Q" Six Foundation Unit (containing drilled and engraved Westinghouse Bakelite Micarta panel, completely finished Van Doorn steel chassis, four complete heavy aluminum shields, extension shafts, screws, cams, rocker arms, wire, nuts and all special hardware, required to complete receiver)	15.00
Total	\$96.00

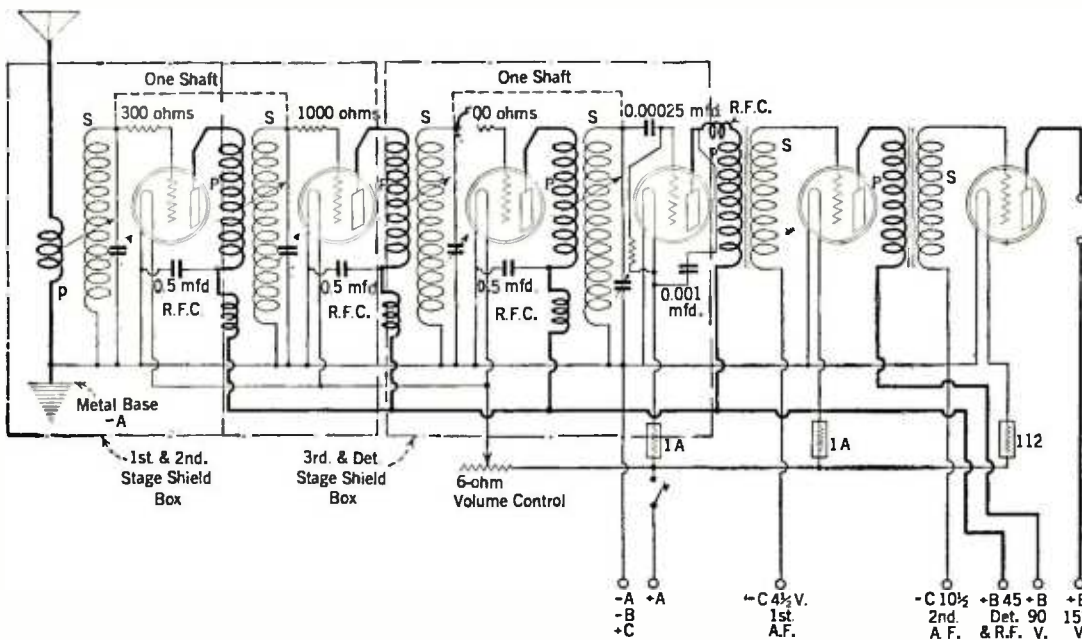

CIRCUIT DIAGRAM OF THE "HI-Q" SIX

1927-28

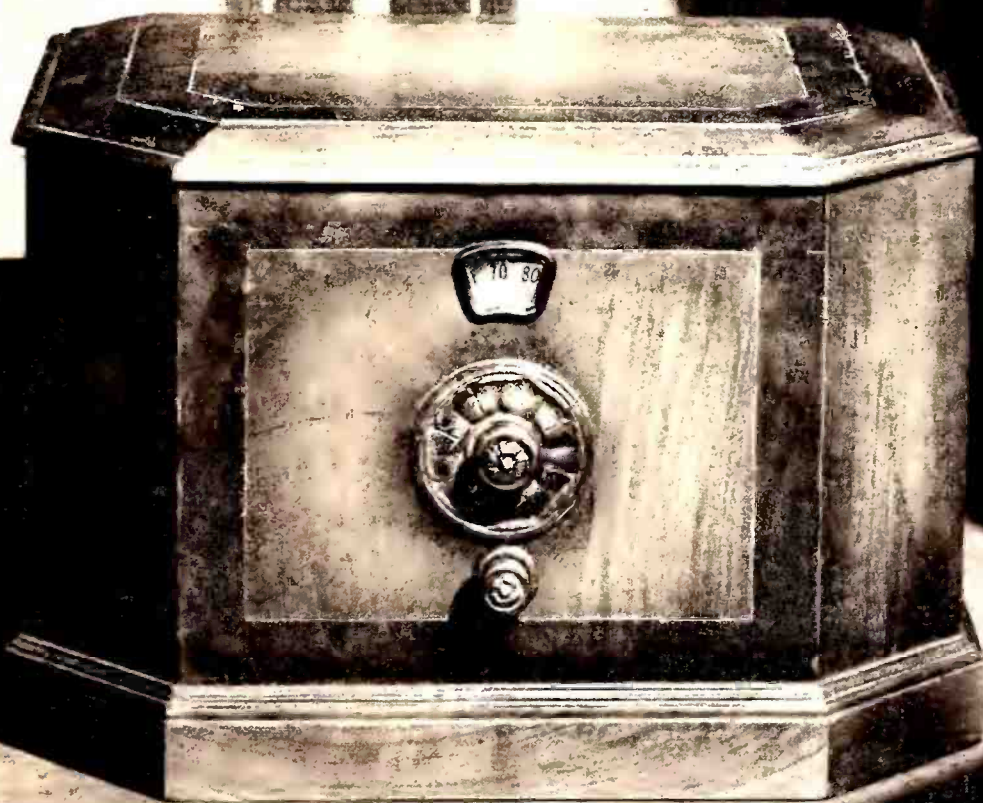

The work of the artist and interior decorator—as well as the labors of the radio engineer—are evident in 1927-28 radio receivers. This Splitdorf “Abbey” set, designed by Noel S. Dunbar after an old-world jewel case is a six-tube receiver, priced at \$100. This page and those which follow strikingly demonstrate how the manufacturer is successfully

harmonizing technical receiver design with the decorative demands of the home. Modern receivers are not one-year investments because the receiver bought to-day will be up-to-date for some time to come; for this, the engineer is responsible and in later issues of this magazine we shall report much of his fascinating work.

1928 Radio Receivers

FRESHMAN G-4

Here is a new electrically operated Freshman receiver, complete and ready to operate as delivered. The price is \$225.00, which includes new RCA a. c. tubes

OFTEN it is said that a radio receiver, to be fully appreciated by the feminine half of the domestic republic, must be encased in housings which are esthetically as well as technically satisfactory. It is natural and right that, as radio has become more an accepted part of the equipment of every home, women have had an increasing voice in the selection of the radio receiver. What, then, do the radio manufacturers offer to the prospective purchaser? To be brief, the radio receiver of 1927-28 is a thing of beauty as well as of utility. On these two pages, and on others in this issue, are grouped illustrations of the sets which have come from the manufacturers' designing laboratories. Various makers have grappled with the important problem of appearance, and, as these illustrations show, have met it in widely different

THE STEWART-WARNER 520

The tendency towards single-control is again manifest in this six-tube receiver. Two tuned and one untuned stages of r. f., detector, and two transformer-coupled audio stages, comprise the circuit. The cabinet is of dull polished walnut veneer. The price, \$125.00

BOSCH 66

Another single-control receiver employing six tubes, this one being priced under a hundred dollars. The beauty of the cabinet is a feature but the efficiency of the circuit itself has in no way been neglected. The illuminated dial is graduated into both kilocycles and arbitrary numbers

GREBE'S "SYNCHROPHASE" SEVEN

The five tuned stages (four r. f. and detector) are tuned by means of a single dial and vernier, the rigidity of the tuning condenser assembly insuring permanency of the accurate factory adjustment. The receiver has been carefully shielded, while the special coils employed enhance the selectivity and permit maximum amplification. These coils are of the binocular type and are wound with Litz wire

THE KELLOGG 507

This is a six-tube, non oscillating, t. r. f. set, balanced and shielded. "Inductance tuning" is employed, a system which requires no variable condensers and which permits equal amplification throughout the frequency spectrum covered. The price of the receiver is \$190.00

"COMMANDER"

Here is a King six-tube completely shielded t. r. f. receiver which makes use of single control tuning. There are three r. f. stages. The loop may be folded into the cabinet. Price \$220.00

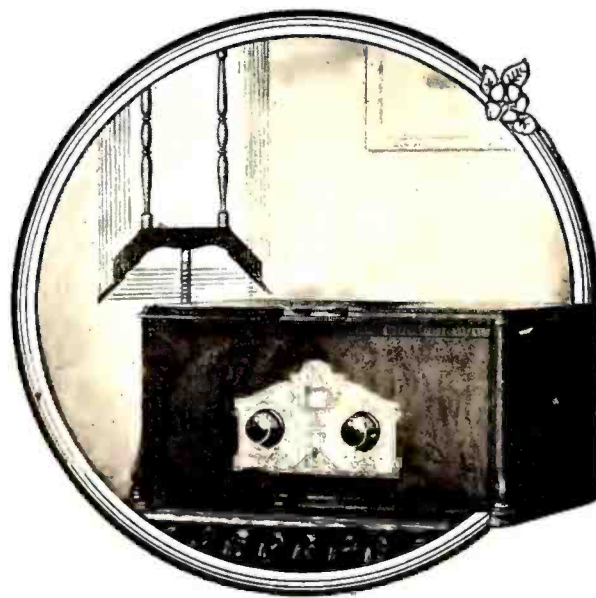
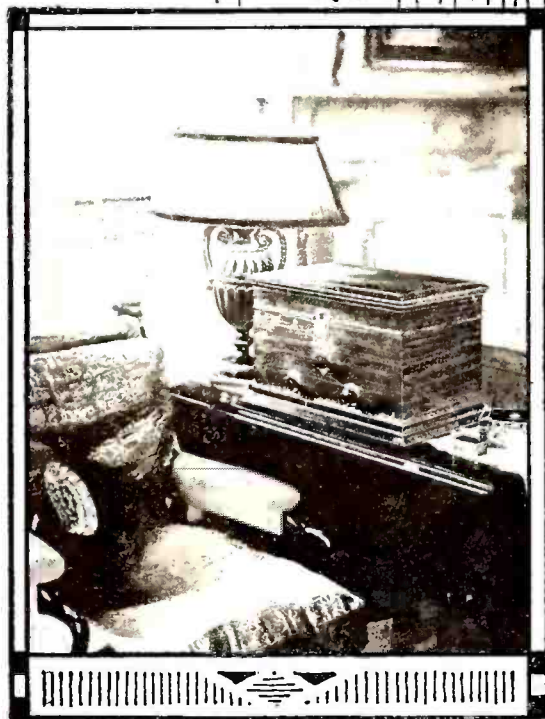
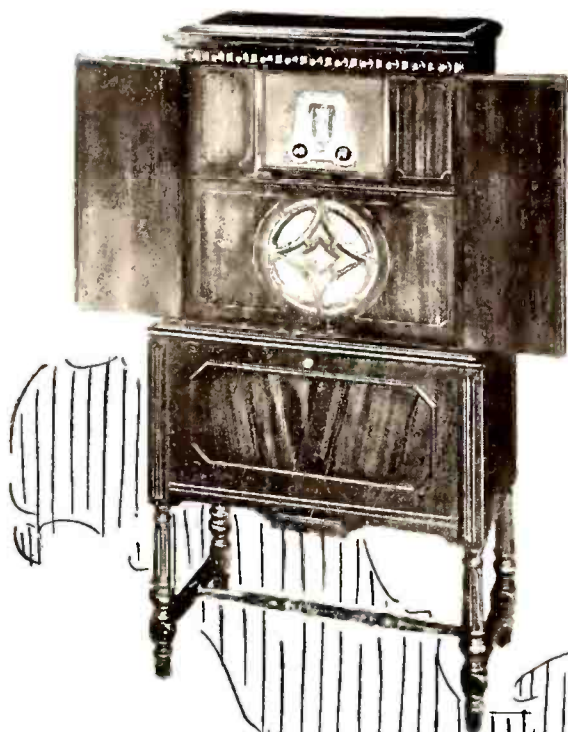

of Beauty and Utility

ways. Some of these models achieve their decorative effect through the dignity of utter simplicity; others are notable for the use of ornament in the treatment of the control elements. The metal tuning and control escutcheon is supplied with some decoration, slightly reminiscent of that simplicity to be found in the grouping of instruments on present day automobile dashboards. Illumination of the control escutcheon is also a feature which has much in common with the instrument panel on the modern motor car. From the representative models shown on these pages, the housewife can gain an excellent idea of the appearance of moderate priced radio receivers which are offered to suit her taste as well as that of her husband. Her ideas of the necessary limitations of her domestic decorative scheme should blend with her husband's technical opinions.

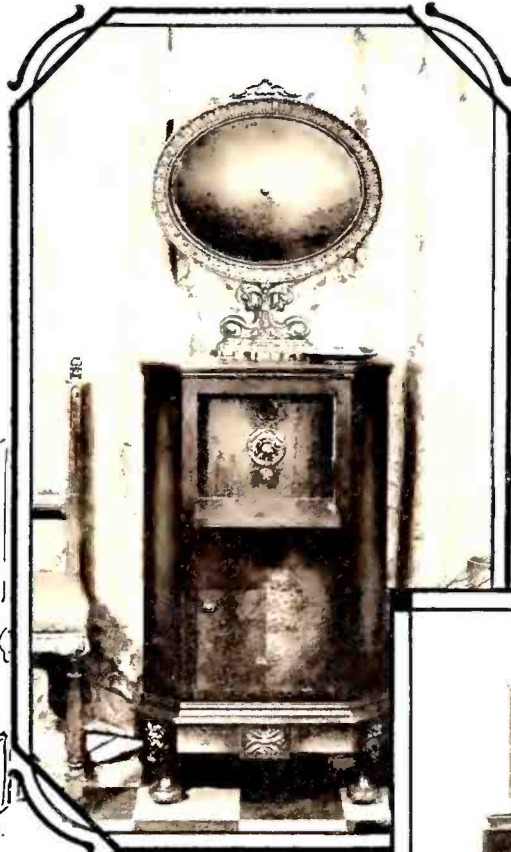

THE "WARWICK"
In a cabinet of Tudor period. A six-tube Splitdorf receiver, similar to that shown on page 351, is built in. Price, \$275.00 with cone and power-supply unit

ZENITH
The Model 17E electric. A single-tube 400-mA. unit supplies the necessary power. The receiver itself employs six tubes. The price is \$350.00. Spinet base, \$20.00 extra

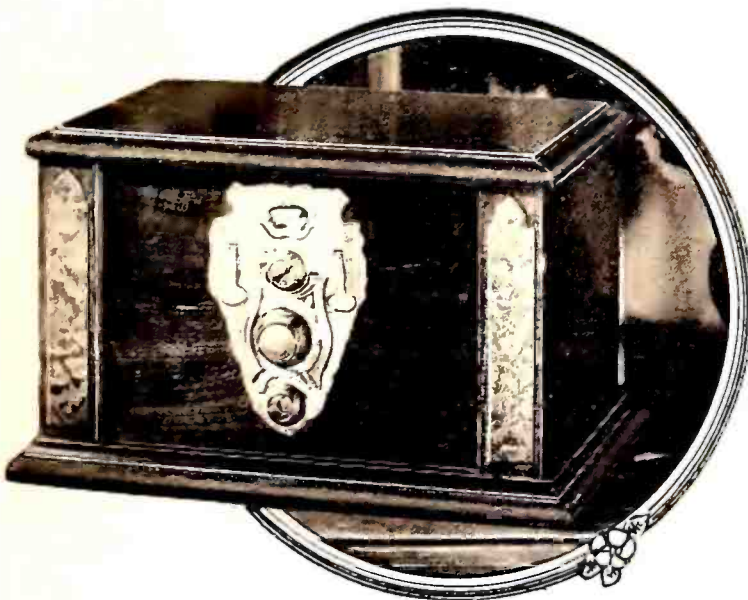

THE "NAVAJO"
Six tubes, shielded, single-control—these words describe this new Mohawk receiver just as they do other prominent receivers of the season, for this circuit combination predominates in 1928 models. The "Navajo" sells for \$67.50. Equipment to adapt it for a. c. operation is obtainable at additional cost



MU-RAD
Two t. r. f. stages, detector, and three audio stages are included in this receiver. The audio stages, all of the double-impedance form, give uniform response between 30 and 5000 cycles, according to the manufacturers. Single-control tuning is featured. Price \$98.00. In a console, equipped for complete a. c. operation, the receiver sells for \$265

WORKRITE

This eight-tube receiver has all-metal chassis, and complete copper shielding. There is a single illuminated drum type dial control. Price, \$160.00 without table

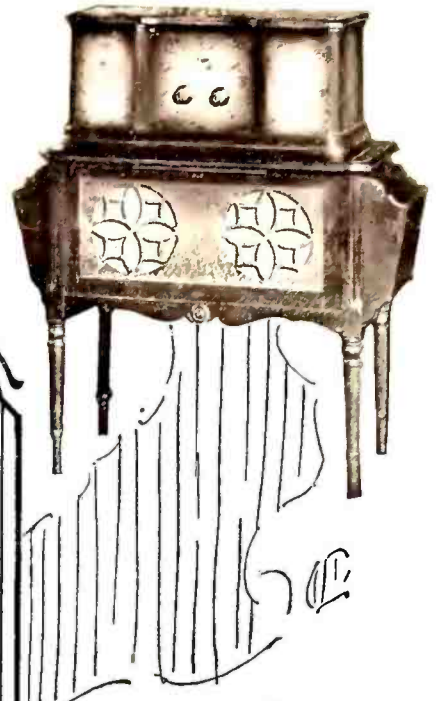

BELOW

The Kolster 6II consists of a six-tube receiver power cone reproducer, and B socket power unit. Space is provided for either an A socket power device or a storage battery, which is extra. Price, \$265.00



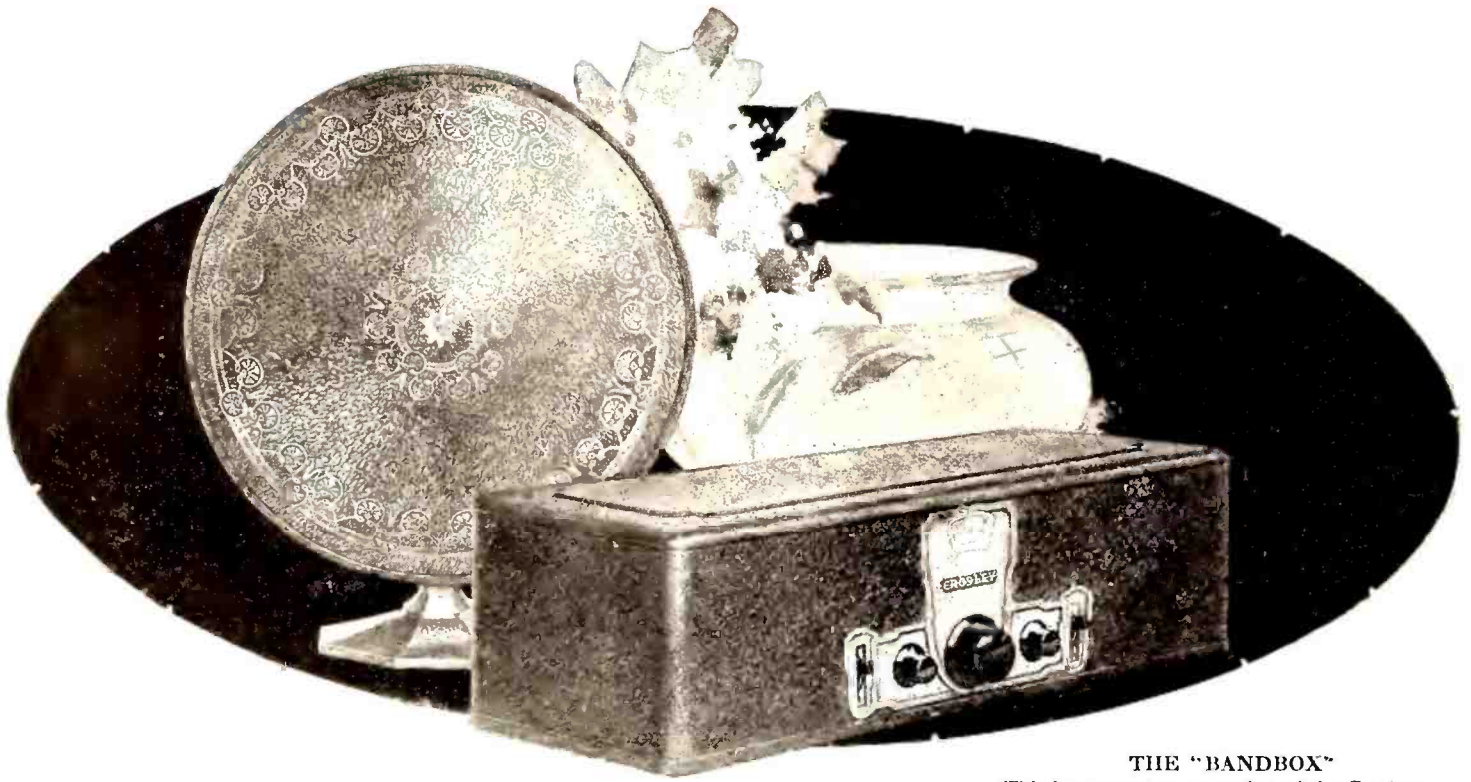

THE "BANDBOX"

This is a recent presentation of the Crosley Corporation. It is a six-tube neutrodyne made in two models, for battery or lamp-socket operation, is shielded, and has one-dial tuning. The prices are \$55 and \$65, for battery and a. c. operation respectively

The Neutrodyne Group

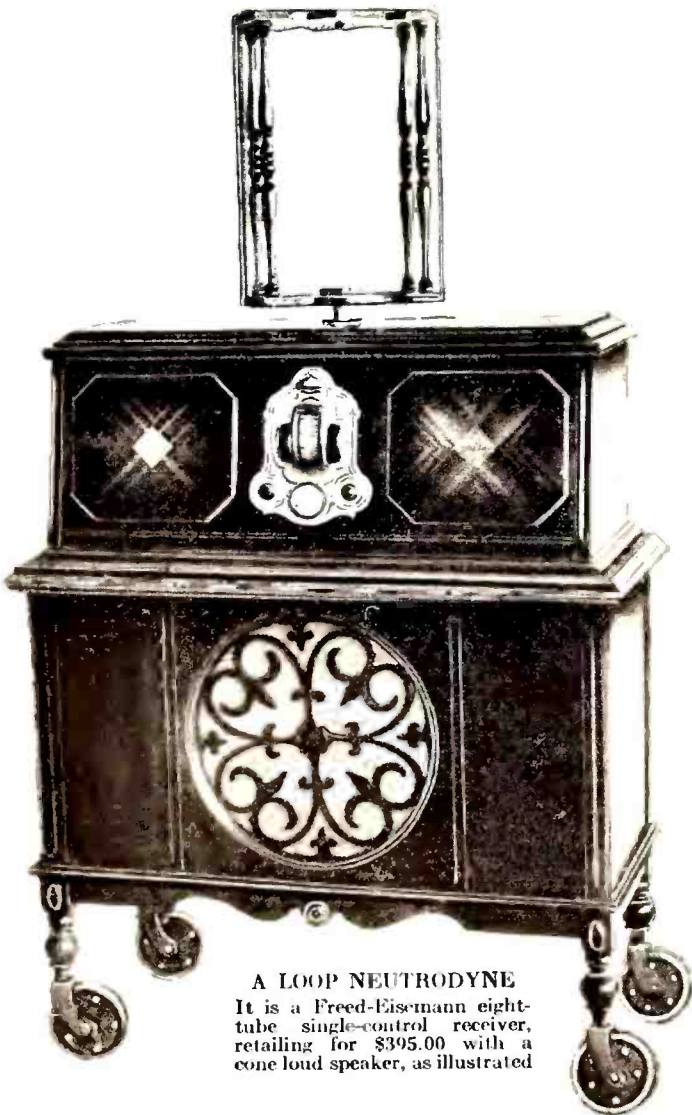

A LOOP NEUTRODYNE

It is a Freed-Eisemann eight-tube single-control receiver, retailing for \$395.00 with a cone loud speaker, as illustrated

THE RADIO-PHONOGRAPH

This Stromberg-Carlson masterpiece consists of a complete a. c. operated seven-tube single tuning control receiver combined with a modern electric phonograph. A concealed loop obviates the use of outdoor antenna. Price is \$1245 completely equipped with cone loud speaker





FADA

Three r. f. stages, two tuning controls, one-piece steel chassis, and equalized amplification, are features of the Fada "Special," retailing at \$95.00



FOR THE "BANDBOX"

This console has been specially designed for the Crosley "Bandbox," illustrated on the left-hand page. The "Bandbox," the chassis of which is completely shielded, may quickly be removed from its metal cabinet and inserted in the more pretentious console

TO THE lay radio reader the term "Neutrodyne" means a type of receiver only—a well-known type of long standing merit. To the engineer the term signifies much more. It recalls the researches of Professor Louis Hazeltine of Stevens Institute of Technology; it brings the patent office to his mind; it indicates one of the present group of radio set manufacturers who have availed themselves of Professor Hazeltine's inventions.

For four years, the neutrodyne group, now consisting of Amrad, Fada, Freed-Eisemann, Crosley, Murdock, Workrite, Gilfillan, Howard, Garod, and Stromberg-Carlson have built receivers that were representative of the best work of the best engineers. These receivers have become known for their reliability, their sensitivity, simplicity, and generally excellent service. They need no introduction to the American radio public. Of late, those who read the foreign radio press have noted the large number of times the French, English, Spanish, and German papers have described the neutrodyne, indicating that

Europe is following advances in American radio with great interest.

For the coming radio season, the neutrodyne group has been more than busy, as the accompanying photographs will show. In common with other well organized receiver manufacturers, the group has spent money and time in research for better radio components, for even greater simplicity of operation, and for greater fidelity of reproduction. A glance will show cabinet work that cannot help but amuse those who remember the early days of radio, when a conglomeration of wires and roughly assembled apparatus, frequently boasting no kind of housing whatever, was principally useful in collecting dust.



THE FADA 7

It is optional whether loop or antenna is used with this receiver, which has four stages of r. f. An improvement in the detector circuit reduces the possibilities of overloading. This seven-tube receiver sells for \$185.00



AMRAD'S "THE WINDSOR"

This artistic cabinet houses a very efficient seven-tube neutrodyne chassis. Tuning is accomplished by a single dial and a further adjustment is provided for volume control. Either an antenna or loop may be used and all parts are copper shielded. A tone filter is incorporated. The price is \$195



THE "MAYFLOWER"

Here is a five-tube completely a. c. operated receiver by Clearstone, of Cincinnati. Complete with a. c. tubes, loud speaker, and built-in power unit, the "Mayflower" lists at \$250.00



A MARTI RECEIVER

Another electric receiver, this one employing six tubes, three of which constitute the audio channel, resistance coupling being featured. Tuning is accomplished by means of two dials

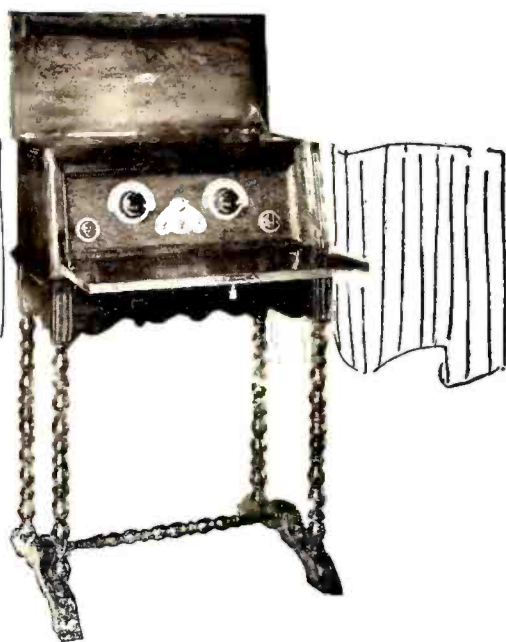

Servants of Your Light Socket

The Radio Receiver Powered Directly from the Light Socket is like the Automobile with a Self-Starter Pushing the Button Starts the Machine - Models on This Page are Representative of the Season's A. C. Set Offerings.



TO THE LEFT

The well-known Loftin-White circuit, six tubes, is employed in the Arbor-Phone Model 253 receiver. Tuning is accomplished by means of a single dial calibrated in wavelengths. A Peerless cone loud speaker is included, and the receiver may be used with either batteries or socket-power devices. The cabinet is of matched walnut, curly maple and rosewood veneers, and gumwood. Price, \$250.00

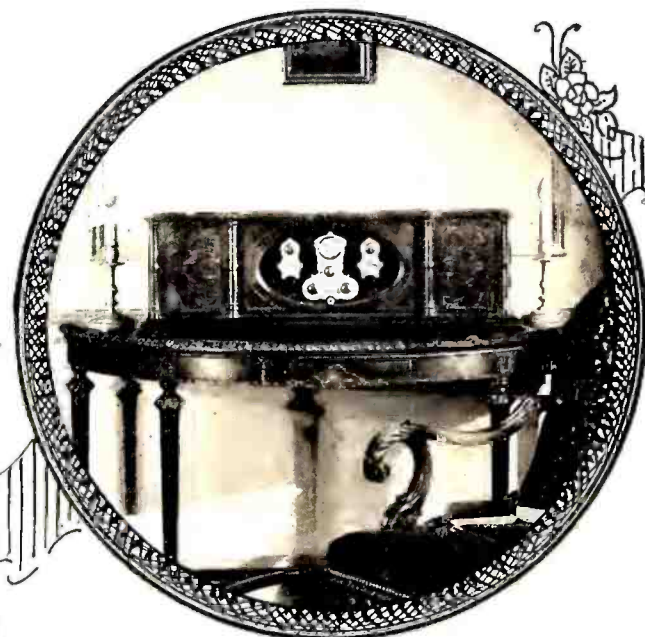

AN ECONOMICAL A. C. RECEIVER

The manufacturers of this receiver, the Argus Radio Corporation, of New York City, state that the cost of operating this receiver is no more than one fifth of a cent per hour. The receiver is completely a. c. operated, and employs no batteries or chargers. There are six tubes in all, three of which are r. f. in a combination of tuned and untuned stages. The final audio stage employs a 210 type tube, a plate potential of 400 volts being applied to it. Provision is made so that the audio amplifier may be used in conjunction with a phonograph pick-up device. Price \$195.00, less tubes and loud speaker

A NEW DEPARTURE IN POWER SUPPLY

The Day-Fan Electric Company, of Dayton, Ohio, has placed on the market receivers which are powered by motor generators, all batteries being eliminated. The efficiency of the motor generator principle of transforming alternating current to direct current has long been recognized, but its application to the powering of a radio receiver has hitherto been neglected, so far as receivers commercially available are concerned

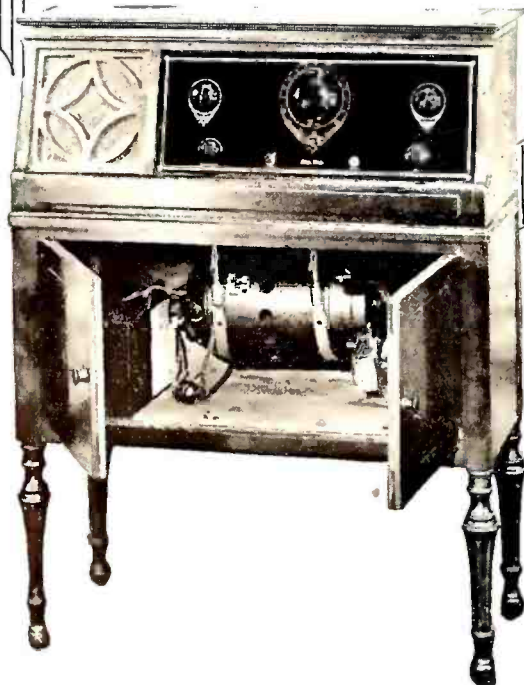

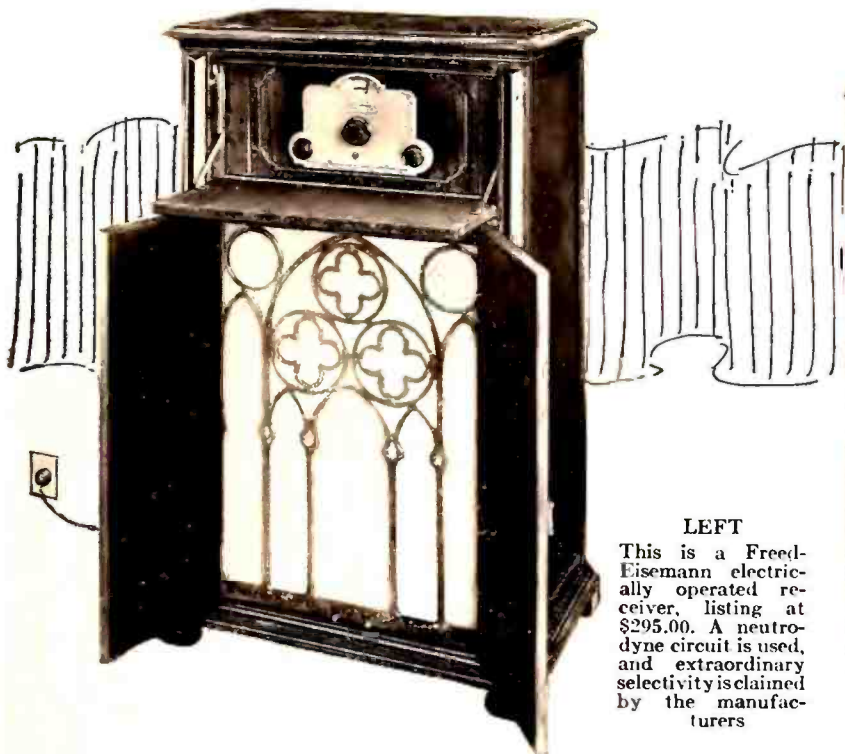

LEFT
This is a Freed-Eisemann electrically operated receiver, listing at \$295.00. A neodyne circuit is used, and extraordinary selectivity is claimed by the manufacturers



AN ALL-AMERICAN HIBOY
The receiver employs six tubes, and may be obtained either to use the new a. c. tubes or for ordinary tubes, batteries or power units being required in the latter case



SPARTON MODEL 62
Everything, with the exception of the loud speaker, is self-contained in this new electric receiver by Sparks-Withington. No batteries are required. The price, \$188.00

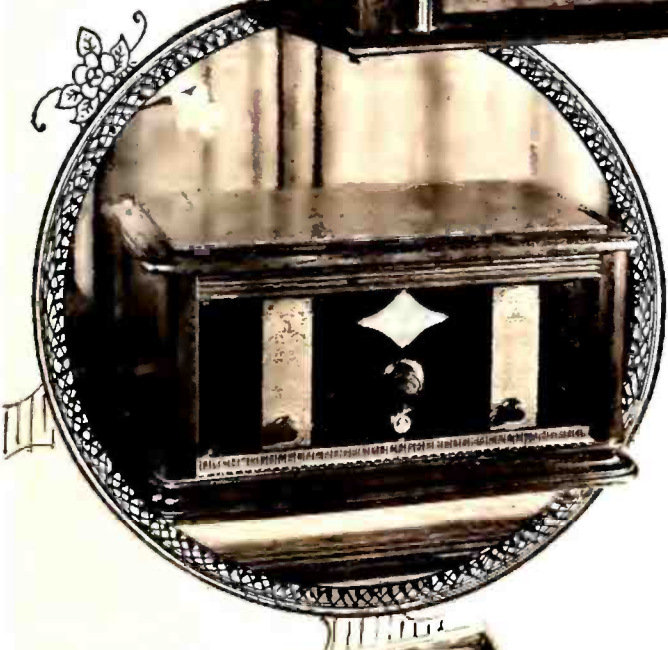

BUCKINGHAM
Here is a receiver which may be used with either batteries or power units. It employs six tubes, three of which are r. f. stages. The single-dial control system employed is a special Buckingham patent. The dial is illuminated and calibrated in both kilocycles and degrees

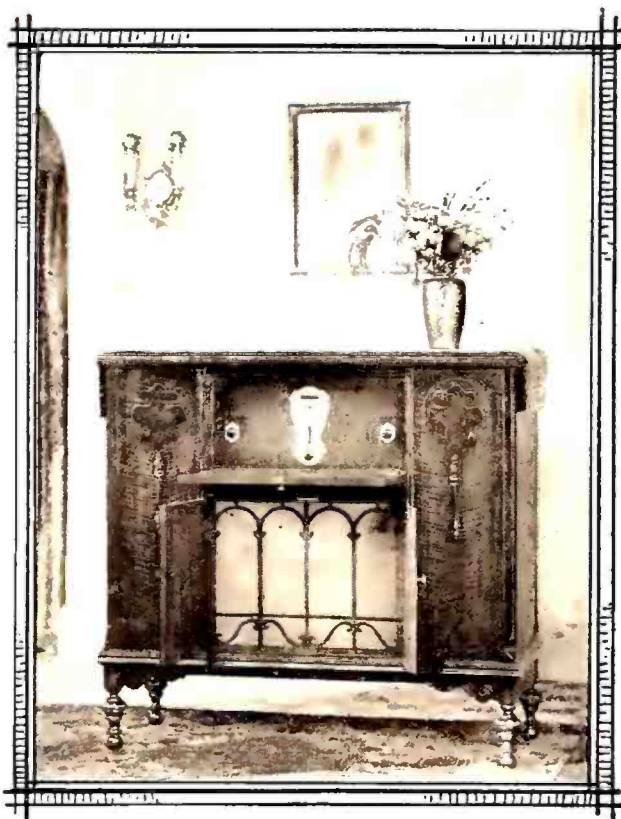

THE CASE CONSOLE
An enclosed loop, controlled from the front panel, obviates the necessity for an outdoor antenna. The receiver employs nine tubes and tuning is accomplished by means of a single dial. It is equipped with a Newcombe-Hawley loud speaker, which has an air column of seventy-two inches. The price of the console is \$350.00, less accessories. The receiver is also obtainable for use with a. c. tubes, in which case the list price is \$475.00 complete with tubes and ready to operate



TO THE LEFT
The electric receiver drawer of McMillan, Chicago. This drawer forms the nucleus of several attractive receivers by McMillan, ranging in price from \$260.00 to \$325.00. A table cabinet model lists at \$170.00



ELKAY "SENIOR"
Complete a. c. operation with every necessary piece of equipment built in, unified tuning control, "Truphonic" audio amplification, total copper shielding, six tubes—thus can this new Elkay receiver be described. The list price is \$195.00. Six McCullough a. c. tubes, and one Raytheon BH rectifier, are required as extras

THE NEW RADIOLA 17

A receiver which makes use of the new a. c. tubes in the first five stages and a 171 type tube in the final (second) audio stage. The receiver may therefore be supplied with A power from the house lighting circuit without the use of additional equipment. B and C batteries are also eliminated by the use of a suitable power device which is built in. Price \$130.00



Radiolas

A NEW CONE

The new 100-A cone loud speaker priced at \$35.00



THE super-heterodyne and the tuned radio-frequency circuit, with or without regenerative action, continue as the foundations of the 1927-28 line of receivers offered by the Radio Corporation of America. A parchment cone, with properly balanced drive for the moderate power of the battery set or again the high power of the socket-power set, likewise continues as the basis of the Radiola loud speaker offerings. Alternating-current operation, with certain refinements particularly by way of rectifier tubes of increased output and better voltage regulation, makes a bid for favor in the higher priced combinations. The Radio Corporation has also added the new a. c. tubes as a means of electrifying even the moderate-priced Radiolas, the UX-227 heater type for the detector socket and the rugged filament UX-226 for all other positions.

Starting out with the requirements of the modest home, there is the new Radiola 16, which fulfills the most rigid requirements of sensitivity, selectivity, ample volume, simplified operation, and excellent tone quality when used in combination with the new Radiola 100-A loud speaker. The Radiola 16 is a new uni-control six-tube receiver, embodying the well-known and perfected tuned radio-frequency circuit with three stages of radio-frequency amplification, a detector, and two stages of audio-frequency amplification, and utilizing five UX-201-A and one UX-112 tubes. The power tube in the last stage spells ample volume without possibility of distortion due to overloading. The internal construction of this Radiola is extremely rugged. The operation is reduced to one tuning control which can be logged for the station call letters. There is also a volume control, and a filament switch which starts and stops the reception of programs. To simplify the operation still further, the filament rheostats have been dispensed with. Radiola 16 may be operated from batteries or from a socket-power device. The cabinet of this receiver is of mahogany finish, and measures 16½" long, 8¼" high, and 7½" deep. The weight is 14½ pounds, and the price, \$69.50 less accessories.

Next comes the Radiola 17, aimed to produce, for a moderate price, a receiver completely operated from the a. c. house lighting mains. Simplicity of operation and maintenance are the main features of Radiola 17. It has three stages of radio-frequency amplification, a detector, and two stages of audio-frequency amplification. The new UX-226 a. c. tubes are used in the radio-frequency stages and in the first audio-frequency stage, while the new UX-227 a. c. tube is used as a detector. The last audio-frequency stage employs a 171 power tube. The B and C voltages are obtained from a power supply unit built into the set and employing the new high-power UX-280 full-wave rectifier. There are only three controls on this set, one knob for tuning, one for volume control—to regulate the output of the receiver, and a power control switch to turn the receiver on or off.

Inside this new Radiola 17 is located a switch whereby adjustment may be made for any variation in local line voltages between 105 to 125 volts. The size of the mahogany cabinet is 25½" long, 7¾" deep, and 8¼" high. The receiver weighs 36½ pounds, and retails for \$130.00 without accessories.

The well-known Radiola 20, with its two stages of radio-frequency amplification, its regenerative detector, and two stages of audio frequency, employing the economical UX-199 and UX-120 dry-cell



A CUSTOM-BUILT RADIO RECEIVER

The Radiola 32 combines the well-known RCA eight-tube super-heterodyne and a baffleboard loud speaker in a single cabinet. Since a loop, directionally variable, is built in this receiver, it may be used where facilities for outdoor antenna erection are not available although binding posts are provided for antenna and ground if such are used. All current is obtained by plugging into the house lighting supply. The model is obtainable for either a. e. or d. c. operation. Price \$895.00 complete



SIX TUBES AND SINGLE CONTROL

The new \$69.50 Radiola 16. This receiver, like the 17 illustrated atop the previous page, also employs three r. f. stages, detector, and two transformer-coupled audio stages, but the tubes are not of the a. c. type. The output audio tube is of the 112 type as opposed to the 71 in the Radiola 17. Tuning is accomplished by means of a single control knob, but there are also a volume-control knob and a filament switch.

for 1928

tubes, continues to occupy its place in the RCA line. This Radiola has proved a popular favorite, and for that reason it has been retained among the present offerings. It now lists for \$78.00 less accessories. Likewise with Radiola 26, the six-tube portable super-heterodyne with its self-contained loop, loud speaker, and dry batteries, which has provided vacationists and travelers with satisfactory and convenient radio service, and which retails at \$225.00 complete. Radiola 25, a six-tube super-heterodyne priced at \$165.00 with tubes, is also being retained for 1928 offering.

Turning to the higher-priced offerings, there remain the well-known Radiola 28, or eight-tube super-heterodyne, and the Radiola 104 loud speaker, which, in combination, provide an exceptionally sensitive set which may be completely powered from the a. c. house lighting system. The price of the Radiola 28 is \$260.00 with tubes. The 104 loud speaker units cost \$275.00 or \$310.00, for a.c. or d.c. operation respectively. Radiola 32, a newcomer to the Radio Corporation's line, with its handsome walnut grained cabinet in period design, consists of an eight-tube super-heterodyne, loop, Radiola 104 loud speaker, and is operated from the house lighting system. It provides maximum radio results in the most compact and attractive form. Certain refinements in design have permitted the inclusion of the powerful 104 loud speaker actually in the same cabinet as the super-heterodyne. The new 32 receiver has a self-contained loop which is turned by means of a knurled dial mounted near the loud speaker grille. Another feature is the small electric light bulb which is concealed in the top of the operating compartment to illuminate the dials and also to serve as a warning indicator when the current is turned on. The power is automatically switched off when the set is closed. The cabinet measures 52" high, 72" wide, and 17 $\frac{3}{4}$ " deep. The list price is \$895.00, which is inclusive of all accessories.

A somewhat lower-priced model, but likewise characterized by a distinctive cabinet and entirely self-contained equipment, is the Radiola 30-A, comprising the eight-tube super-heterodyne with the new 100-A loud speaker and an arrangement whereby the set may be powered from the house lighting supply. The Radiola 30-A measures 42 $\frac{1}{2}$ " high, 29" wide, and 17 $\frac{3}{4}$ " deep, and its list price is \$495.00, including all the necessary accessories. Unlike the more expensive Radiola 32, no loop is contained in the cabinet of the 30-A, antenna and ground connections being provided on the rear. A short indoor antenna is recommended for use with this receiver.

Both of the latter, Radiolas, 32 and 30-A, may be had for alternating current or direct-current operation. Furthermore, the 104 loud speaker unit is now available in a direct-current model, as mentioned above.

The new Radiola 100-A loud speaker referred to above is the improved loud speaker for use with all receivers, whether they are operating on batteries or with socket-power equipment. The cone itself is of smaller diameter than the well-known 100 type, which it replaces and, in addition, embodies a newly designed drive that provides increased response with even better tone quality than its predecessor. The cone is enclosed in an attractive metal case, suggestive of a mantelpiece clock, with silk screen bezel, the whole being finished in dull bronze. This new cone loud speaker measures approximately 15" x 11" and retails for \$35.



THE RADIOLA 20

This is not a new season's model but it has been carried over on account of its popularity. It is a five-tube t. r. f. receiver with knurled-dial tuning. Its price is \$78.00 and it may readily be adapted for a. c. operation.

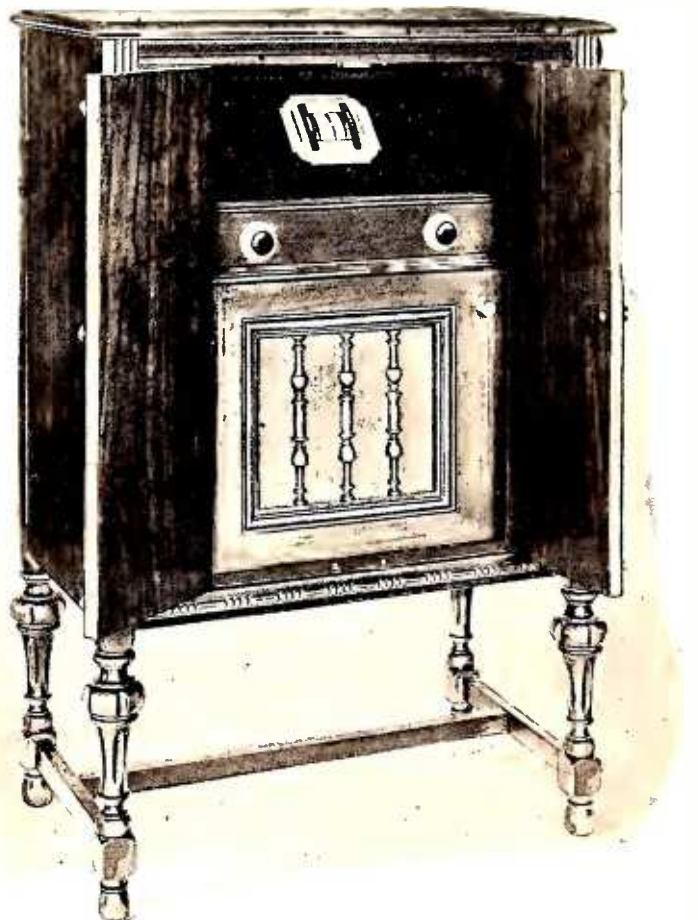

RADIOLA 30-A

The circuit employed in this new receiver is identically the same as that of the "Radiola" 36, i. e., an eight-tube super-heterodyne and it is operated from the light socket. The 30-A retails for considerably less than the 32, however, its list price being \$495.00 complete. The differentiating features of the less expensive model are: (1) The 100-A cone is employed instead of the more powerful and more expensive baffleboard loud speaker, and (2) no loop is supplied. Antenna and ground connections are provided, and for average reception an ordinary indoor antenna will be satisfactory.

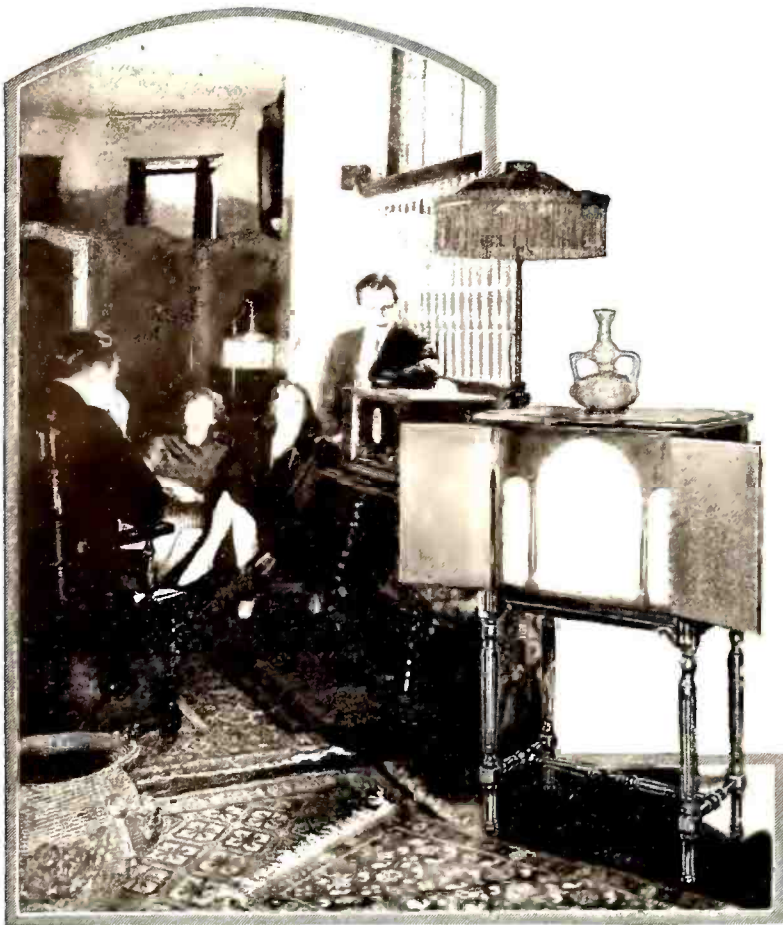

A POWER CONE REPRODUCER

In addition to the cone loud speaker, this Kolster power assembly comprises a B power device to furnish the necessary voltages to operate any commercial receiver. It is operated from the 60-cycle 110-volt a. c. house supply. The price is \$150.00 without tubes. Two rectifier tubes (CX-316-B or UX-216-B), a regulator tube, and a power tube (CX-310 or UX-210), are necessary.



FOR B AND C VOLTAGES

Grebe offers an attractive socket power unit for radio receiving sets of from five to seven tubes. There are three B taps, 180, 90, and 22 volts, and two C values, 40 and 4 volts. Special design features have been applied to obviate "motor boating"

Some New Offerings for

Loud Speakers, Cabinets and Accessories offered by Various Makers Show Definite New Trends—



VALLEYTONE MODEL 52

A five-tube receiver to suit the average pocket, its list price being \$85.00, less accessories. Tuning is accomplished by means of two dials. A simple switching arrangement built into the set makes the use of a power tube optional.



LEFT

The "Spinnet," a seven-tube balanced receiver by Colin B. Kennedy, Incorporated. There are four r. f. stages but just one tuning control. The finish is of two-tone antique mahogany, and there is ample storage space for power accessories. Price, \$195.00

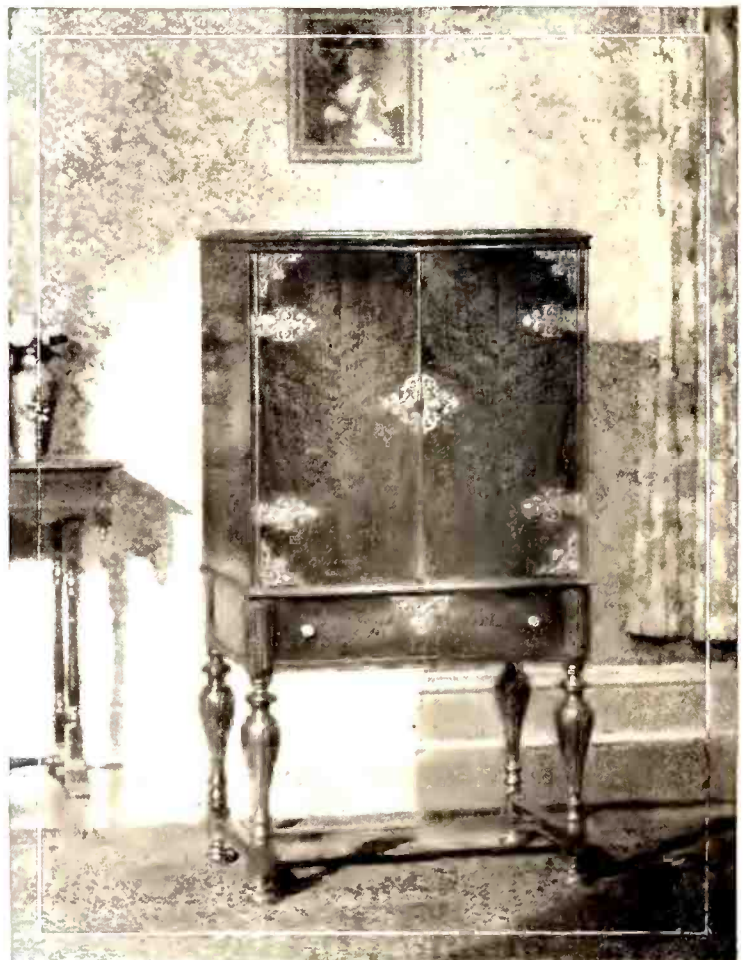

FOR THE SET CONSTRUCTOR

Keeping pace with the commercial set manufacturer, the home constructor nowadays builds his receiver into a luxurious piece of furniture. This beautiful walnut cabinet has a sliding frame for a radio panel not larger than 8 1/4" x 21", and 14" deep behind panel. The list price varies from \$80.00 for the straight cabinet to \$105.00 to include a Peerless cone. It is a product of the Radio Master Corporation, Bay City, Michigan

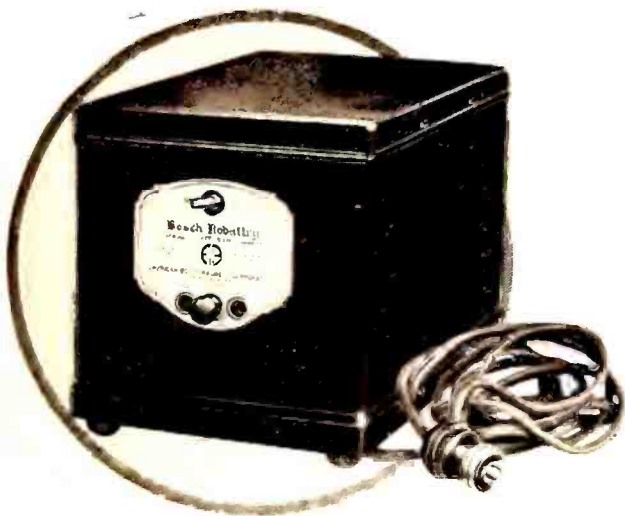

THE BOSCH "NOBATTERY"

This attractive unit is designed to deliver three B voltages, the taps being labelled "low," "medium," and "high." The list price of the device is \$48.00. Taps on the transformer provide for three separate voltage ranges.

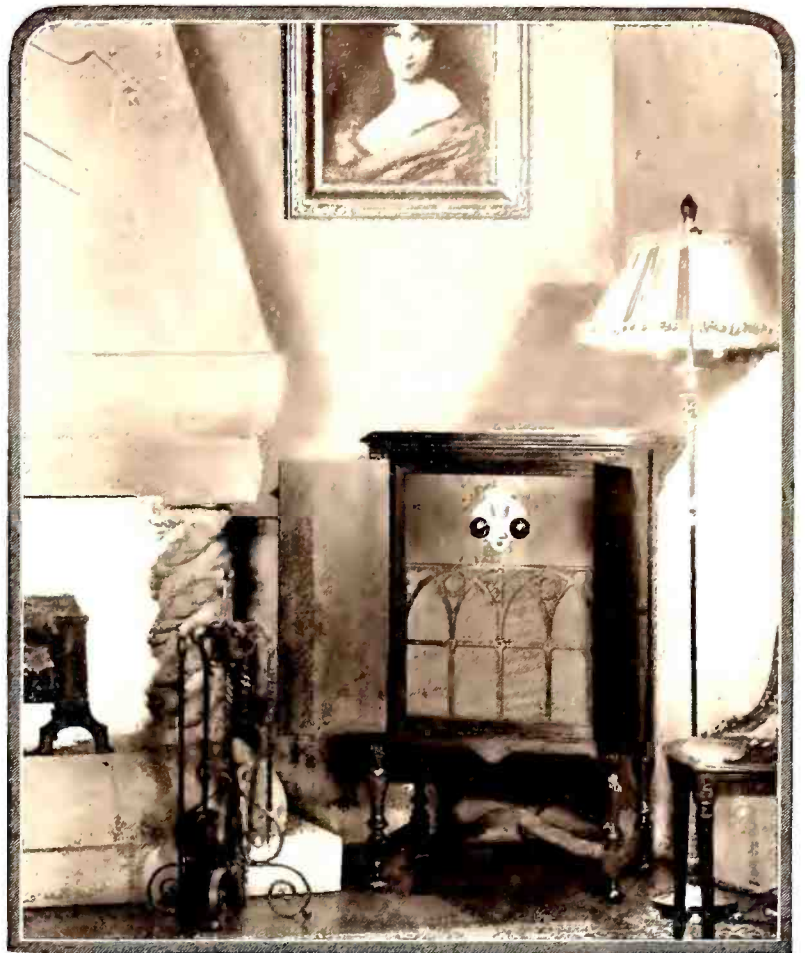

THE "MINSTREL"

A successful antenna operated receiver is this seven-tube, single-control, Apex set. The circuit employed is of the "Technidyne" variety, one that has become increasingly popular lately, and which makes use of a new form of neutralization. Less accessories, the "Minstrel" lists for \$225.00.

the 1928 Radio Season

All, while Serviceable and of Interesting Technical Design Are Made to Harmonize with Their Eventual Setting—the Home.



DESIGNED FOR A RADIO SET

Here is another example of the cabinet makers' efforts to produce a radio cabinet which is in every respect equally as beautiful as the furniture surrounding it. The finish of this particular cabinet is in walnut and maple, and it is equipped with a Farrand cone loud speaker. It is designed to accommodate all standard makes of radio receivers, and is a product of the Musical Products Distributing Company, New York City. Price, \$95.00.



ABOVE

This is the Pfanstiel Model 30 six-tube receiver. Its chassis is carefully shielded and equipped with flexible cable connections. Price, \$105.00.

RIGHT

The "Baby Grand," by Audiola, Chicago, comes with either an eight-tube or six-tube chassis, the former listing at \$275.00 and the latter at \$225.00. There are two knobs on each model, one for tuning, and the second for volume control. Individual stage shielding adds to the general efficiency of the set. A special long air-column loud speaker is built in.



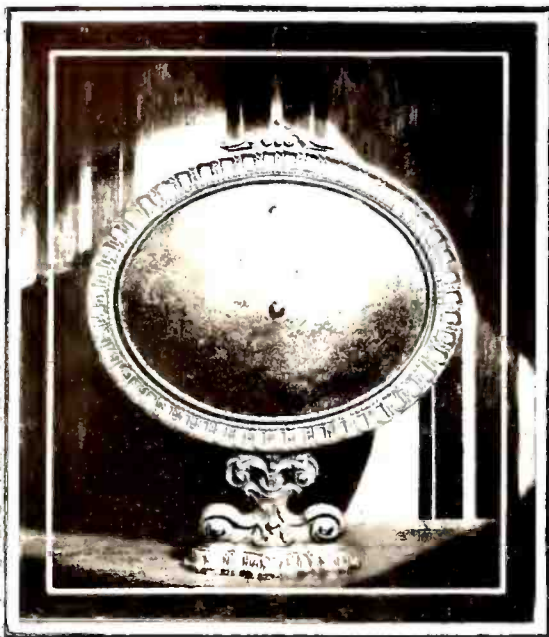

AN ELLIPTICAL CONE

The frame and base of this new Splittdorf cone is of rich antique walnut finish, deeply carved, the result being a loud speaker which will enhance almost any setting. The elliptical shape of the cone makes possible deep richly resonant tones, the short diameter of the ellipse favoring the high notes, and the long diameter sustaining the deep tones. A combination of design features enables the loud speaker to handle great power. The list price is \$35.00

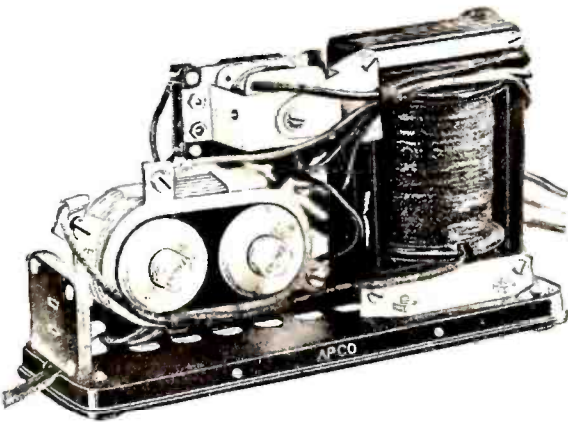

AN AUTOMATIC CHARGER

A charging unit developed by the Westinghouse Company is incorporated in this useful Apco device. Full-wave rectification is accomplished by means of a series of special analysis copper discs in the transformer circuit. An automatic relay is combined with the Westinghouse unit so that, once connected to the set, the charger is spontaneously set in operation when the receiver is not being used. The list price of this Apco unit is \$16.50

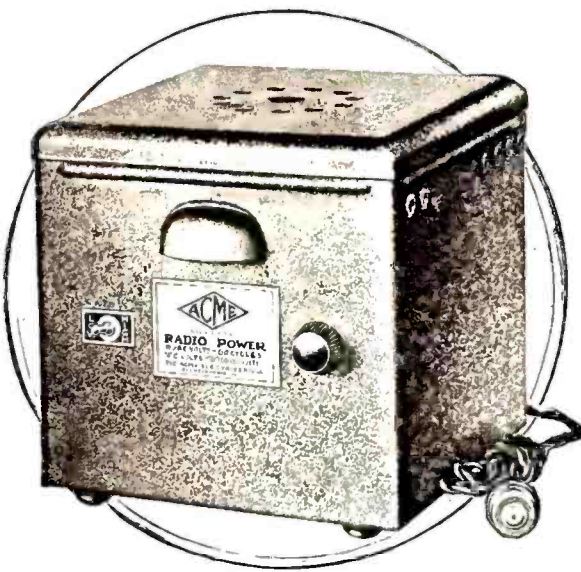

A AND B POWER FROM ONE UNIT

Acme, of Cleveland, is responsible for this useful power combination. Included in the unit is a B socket-power device, a 40 ampere-hour storage battery, trickle charger, and automatic control switch. The unit may be obtained for 25- or 60-cycle house supply, and for sets with varying amounts of tubes, the prices being between \$95.00 and \$108.50

B POWER

The Kellogg B power unit has the usual three taps, for "detector," "medium," and "high," but additional flexibility is obtainable by means of the knobs on the front panel. The detector voltage may be adjusted to any value up to 45, while the medium voltage tap may be set for anything up to 90 volts. The high-voltage tap is for a 171 type tube. Forty dollars is the price of the unit

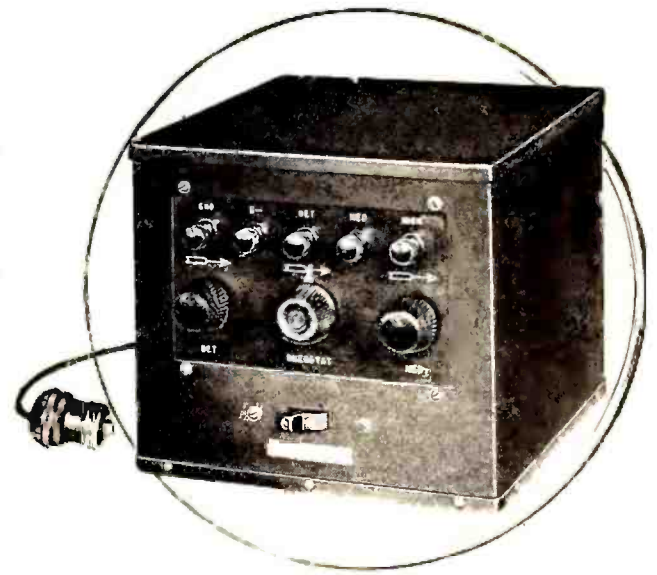

A UNIT THAT SUPPLIES BOTH A AND B CURRENT

Unlike many other units designed to supply both A and B current, this one does not use a storage battery in conjunction with a trickle charger. A rectifier and electrolytic filter condenser, combined in one cell, constitute the A unit. There are no tubes to burn out, the only attention necessary being the addition of water every three or four months. This Balkite "AB" is obtainable in two patterns, both with an output of 6 volts, 2 amperes, for the A supply, but one has a B output of 40 mA., 135 volts, while the second gives 55 mA., 180 volts. The prices are \$59.50 and \$67.50 respectively

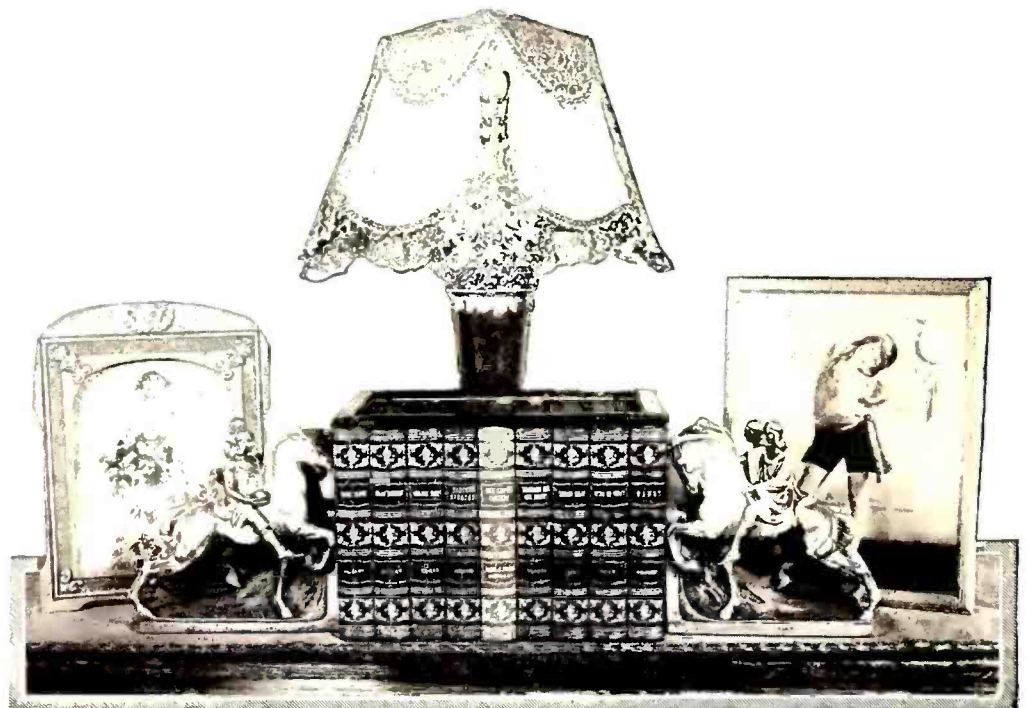

THREE LOUD SPEAKERS IN DISGUISE

The group of books, in the first place, is nothing less than a loud speaker in concealment. A forty-inch serpentine tone chamber winds behind the embossed leather book bindings. This "Choral Cabinet" lists at \$50.00, or \$75.00 if the equestrienne bronzes are included. The lamp too, in addition to serving its obvious purpose, hides an air-column loud speaker. Depending upon the finish, it lists at \$35, \$50.00, or \$60.00. The carved picture frame to the left also conceals a loud speaker, the tone chamber of which is a thirty-inch serpentine winding. The hand carved black walnut model lists at \$35.00, but other models are less expensive—even as low as \$20.00. Manufactured by Frank R. Porter, Washington, District of Columbia

A New Regulator Tube

Why It Is Desirable to Employ a Regulator Tube in B Devices—De-

THE voltage-regulator tube received its rather descriptive nickname, "glow tube," from the performance of some of the early models which, having an open top cathode, permitted an observer to see the ionized gas or "glow" in the space between the anode and cathode.

This tube is a device which, when connected across the 90-volt output of a B power-supply unit, will maintain that voltage at a constant value, regardless of any variations in load, within reasonable limits, applied to the power unit. Without the use of such a regulator, the voltage supplied by the device will fall off rapidly as the current drain is increased.

By using a regulator tube, it is possible to construct a B power unit, the 90-volt tap of which will, for all practical purposes, deliver just 90 volts to any radio receiver whether it has 3 or 10 tubes. In the case of the majority of radio receivers the 90-volt tap supplies the B power for the radio-frequency and first audio stages. In the case of a super-heterodyne, however, the 90-volt tap will also have to supply the B power for the intermediate-frequency amplifier. Incidentally, as the load drawn by the detector tube, in most sets, is substantially the same, a suitable resistor with mid-tap may be connected across the voltage regulator tube terminals to provide a fixed 45-volt tap. Now, it also happens that, when the regulator tube is used, variations in load on the 90- and 45-volt taps will have no effect upon the maximum voltage tap of the power unit. The voltage at this point will, however, vary with the load at the high-voltage tap; but as we know that the usual load to be applied to the high-voltage tap is a UX-171 or CX-371 type power tube, and that at 180 volts this tube will draw a plate current of 20 mA., we can so design our power unit to supply exactly 20 mA. at 180 volts.

The result is a fixed-voltage power device which will supply 45, 90, and 180 volts to almost any standard radio receiver. Fixed-voltage control, however, is but one of the many points of merit of a "glow-tube" equipped power-supply unit.

The action of the tube in holding the voltage of the output circuit constant serves also to eliminate the small ripples which may be present as a result of incomplete filtering, and thus makes possible a reduction in the capacity, and therefore the expense, of the final filter condenser. In fact, the tube, when in operation, has many properties in common with a large fixed condenser. One of these properties is extremely low a.c. impedance which, when combined with its instantaneous response as a voltage regulator, entirely eliminates the annoying "motor-boating" effect which generally results when an attempt is made to use one of the ordinary B power units with many forms of amplifiers.

A further advantage accruing from the construction of a B power unit employing a voltage regulator tube is an economical one. With its many electrical advantages, it need cost no more than that of a high-grade power unit of the conventional type. In the first place, the use of the "glow tube" results in a saving of the number of high-voltage filter condensers required—usually an expensive item. In the second place, it permits the use of fewer and

tails of a New Glow Tube Which Involves Some Novel Features

Its small size and low cost permit its ready use in many cases where the older form of tube was out of the question. Its silent non-oscillating operation, its long life, its close control of voltage (a variation of but 3 volts between a condition of no load and full load being allowed), and the use of a third or "keep-alive" element, are all features which make it one of the most interesting developments in the B power-supply field since the introduction of the filamentless full-wave gaseous conduction rectifiers.

The "keep alive" circuit is a most unique arrangement of what really amounts to a tube within a tube. The inner, or secondary tube, operates without load from a high-voltage point of the filter circuit and keeps the gas within the glass tube ionized at all times. Thus, should the voltage across the operating electrodes at any time fall below the value required to maintain the gas in an ionized state, the potential of the third element will be sufficient to maintain ionization. In order to minimize the extra drain on the rectifier and filter, a forty-thousand ohm resistor is employed to limit this parasitic current to approximately three milliamperes.

As a result of the third element and its associated "keep alive" circuit, the high starting voltage required by former types of regulator tubes is eliminated.

The base contacts on the new "R" tube, as it has been named by the manufacturers, the Raytheon Company, are so arranged as to permit its use in B units and combination power amplifier B units designed originally for the UX-874 (CX-374)—the original voltage regulator tube placed on the market. When so used, the third element does not operate.

While the tube may be added, along with suitable resistors, to some of the heavy-duty type B power units now on the market which have not been specially designed for use with a glow tube, it cannot be used with the average run of socket power-supply units due to the extra load it imposes upon the rectifier and filter chokes. Likewise, in home constructing a power unit employing the "R" tube, chokes capable of handling at least 85 milliamperes of direct current without core saturation must be selected. At this time we are familiar with only two chokes on the market that meet this condition—the National and the Amertran. The rectifier tube should be of the 85- and not the 60-mA. type. The power transformer should have a double high-voltage secondary with a voltage of 300 across each side.



RADIO BROADCAST Photograph
INNER CONSTRUCTION

The bulb has been removed to show the electrodes of the "R" tube

By JAMES MILLEN

lower voltage—and thus less expensive—bypass condensers at the various voltage taps.

The first type of voltage regulator tube to appear on the market was of the two-element type and, like the prototype of most things, had its disadvantages. Different tubes varied considerably in characteristics, some having a working voltage of as low as 70, while others had over 100. Then, the voltage across individual tubes would vary quite a bit between conditions of no load and full load. Another fault was that, should the power unit be heavily loaded for any reason, the tube would cease to glow and, before again becoming operative, the voltage across it would have to rise to a rather high value, which eliminated the possibility of partially providing for the initial cost of the tube by the use of low-voltage bypass condensers.

But perhaps the most serious objection to former voltage regulator tubes was the tendency of many of them to oscillate and introduce noise into the output circuit of the power unit. The use of a power unit equipped with such a tube would often introduce sufficient noise into the loud speaker to interfere with satisfactory reception. But now, after several years of research and experimental work, a new form of voltage regulator has been perfected.

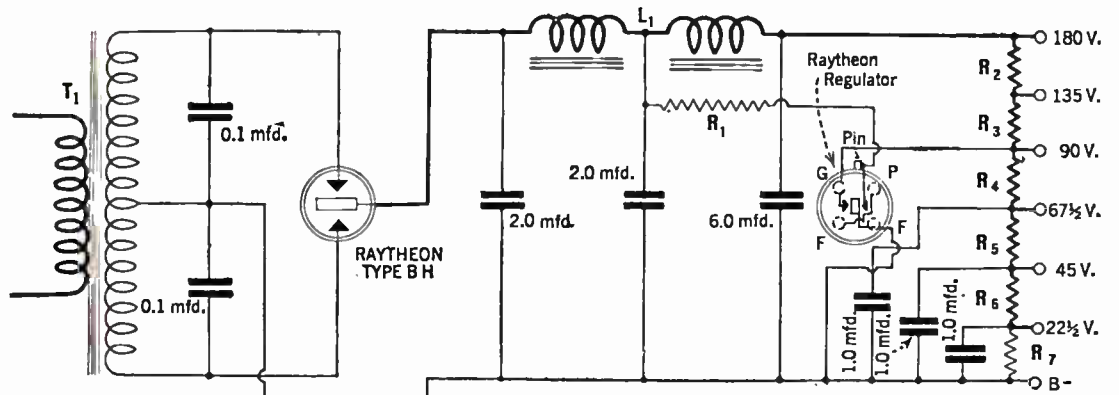

A B-DEVICE WITH THE NEW "R" TUBE

The new Raytheon tube has five leads, the fifth connecting to the metal pin in the tube base

The 1928 "Equamatic" Receiver



RADIO BROADCAST Photograph

A SYMMETRICAL FRONT PANEL REWARDS THE CONSTRUCTOR OF THE 1928 "EQUAMATIC" RECEIVER

Automatic Variation of Coupling between Primaries and Secondaries of Coil Units Provides for Equal Amplification Throughout Broadcasting Band—Simplicity of Control Is Marked Improvement over Earlier Model

By JULIAN KAY

ONE of the most difficult disadvantages to overcome in amplifying high frequencies by means of successive tuned stages is the apparent discrimination of the amplifier against the lower radio frequencies. The longer-wave stations on the average tuned r.f. set come in comparatively poorly, while there is no end of amplification on the shorter-wave stations. Any one who has operated one of these sets will vouch for this fact, and any service man who must answer questions from his clients will agree that his main difficulty is in explaining why such-and-such a set will not get KSD or KYW, longer-wave stations, while it will get less powerful and often more distant shorter wavelength stations.

Now the reason for this lack of pep on the longer waves is not difficult to explain. Whenever a tube has inductance in its plate and grid circuits, that tube does its best to regenerate, and if a certain balance between these inductances is maintained, this regeneration will break into open oscillation. Squeals, howls, and general instability result. This inductance is, however, necessary to transfer energy from one circuit to another. The tendency to oscillate increases as the frequency increases and as the amount of inductance increases, and more inductance is needed to transfer energy on the lower frequencies than on the high; but with this maximum amount of inductance the set will probably be uncontrollable on shorter waves.

Thus, sets that get the longer-wave stations with maximum r.f. amplification cannot be held down on the shorter waves; those that are especially stable on short waves are as quiet as the proverbial grave for DX on the longer waves.

The receiver shown in the photographs in this article does not suffer from the faults enumerated

The Facts About This Receiver

Type of Circuit
Number of tubes.

Tuned radio-frequency.

Five. Two stages of r. f. with 201-A (301-A) tubes; detector, using special detector tube; first audio stage, 201-A (301-A); second audio stage, 112 (312) or other semi-power tube.

Features

Maximum r. f. gain obtained by use of special automatic variable coupling arrangement. Only two tuning controls although there are three tuned stages. Switch for one or two a. f. stages.

Frequency range

1500 kc. to 500 kc. (200-600 meters).

above. It is the outgrowth of a popular receiver of last year, the Karas "Equamatic," and employs a mechanical means of maintaining "constant coupling" between the output of one tuned radio-frequency stage and the input of the next stage. This "constant coupling" means that the plate circuit of the preceding tube will have just enough inductance in it to transfer maximum energy at each frequency to which the circuit is tuned, but not enough inductance to make it oscillate. As the condensers are varied, the coupling is varied simultaneously, and in the proper proportion, to prevent troublesome oscillations, but at the same time to maintain more or less

constant amplification over the entire broadcasting frequency band.

The "Equamatic" system is not new to the readers of RADIO BROADCAST, for it was described in several issues of this magazine in 1926 by Zeh Bouck. The receiver itself differs somewhat in various ways from the set of last year; in each of these several respects it is better than last year's set. In the first place, it is a two-dialed receiver, an obvious advantage over the three-dial receiver previously described. The change is accomplished by means of a lever pantograph arrangement which permanently connects together the variable tuning capacities of the second radio-frequency amplifier and the detector circuits. Additional means have been taken to insure maximum amplification and complete stability, partly by filtering the radio-frequency circuits with chokes and condensers and also by a new means of partially neutralizing the inter-electrode capacity of the tube—the capacity that causes regeneration. In addition, an output filter has been added to the layout so that a power tube can be used without the d.c. plate current of this tube going through the windings of the loud speaker.

The receiver, then, consists of a two-stage radio-frequency amplifier with constant gain over the entire broadcasting band, a grid leak and condenser detector, a conventional two-stage transformer-coupled amplifier, and an output filter. The antenna or first-stage amplifier is tuned with the left-hand dial, while the second dial takes care of the other two tuned circuits, which are made to tune exactly alike. Ease of adjustment is secured by means of the ganged condenser arrangement without apparent loss in either selectivity or sensitivity over the three-dial model described in RADIO BROADCAST for October, 1926.

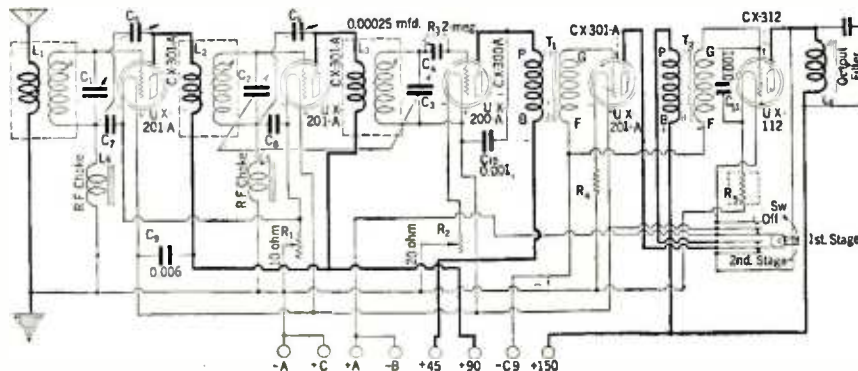
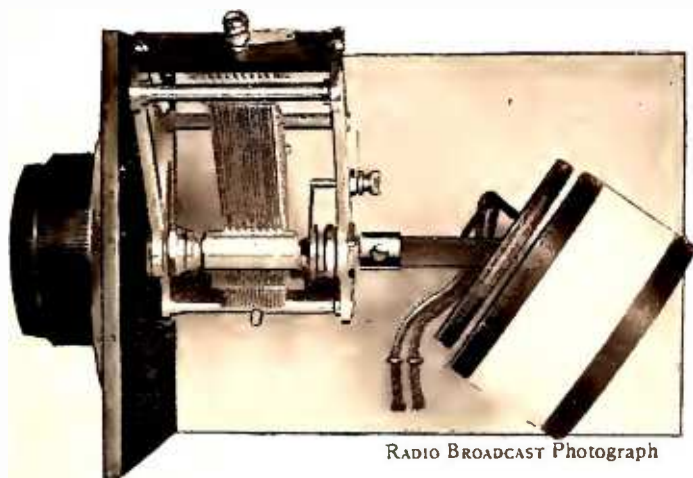

FIG. 1

Circuit diagram of the new "Equamatic" receiver



RADIO BROADCAST Photograph

FIG. 2

Left. When the condenser is tuned for maximum wavelength, the coil should be coupled in this manner, allowing the largest transference of energy. Right. Minimum coupling, for shortest wavelength

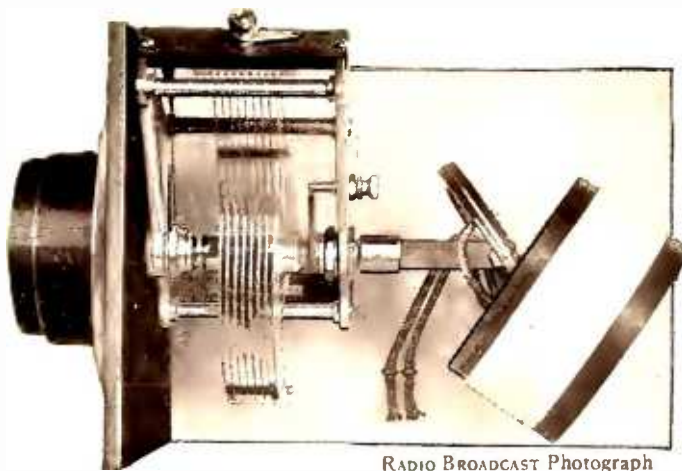

RADIO BROADCAST Photograph

FIG. 3

A special Yaxley interstage and filament switch is employed to cut out the final audio amplifier when desired, automatically shutting off the filament current to the tube in this circuit. Thus the loud speaker can be operated on local stations from the first audio amplifier, and when more volume is desired, the second amplifier may be thrown into the circuit.

A list of parts for the receiver follows:

T ₁ , T ₂ —Karas Type 28 Audio Transformers	\$16.00
L ₆ —Karas Output Filter	8.00
C ₁ , C ₂ , C ₃ —Karas Type 17 0.00037-Mfd. Variable Condensers	15.75
L ₁ , L ₂ , L ₃ —Karas "Equamatic" Coils	12.00
Two Karas Micrometric Dials 0-100	7.00
Three Karas Sub-Panel Brackets70
Karas Control System, Including Complete Hardware	3.00
L ₄ , L ₅ —Karas or Samson 100-Millihenry R. F. Chokes	5.00
Formica 7" x 24" Engraved Front Panel	5.68
Formica 9" x 23" Drilled Sub-Panel	6.00
R ₁ —Carter 10-Ohm Rheostat (Gold Arrow)	1.00
R ₂ —Carter 20-Ohm Rheostat (Gold Arrow)	1.00
Sw.—Yaxley No. 69-B Interstage Switch (Gold)	1.25
J—Carter No. 10 Tip Jacks20
C ₄ —Sangamo 0.00025-Mfd. Fixed Condenser with Clips50
R ₃ —Durham 2-Meg. Grid Leak45
R ₄ —1A Amperite	1.10
R ₅ —112 Amperite	1.10
Yaxley Cable Plug	3.00

Five Benjamin Cushion Sockets	3.75
C ₅ , C ₆ —Samson Mica Neutralizing Condensers	3.50
C ₇ , C ₈ —Sangamo 0.0001-Mfd. Fixed Condensers80
C ₉ —Sangamo 0.006-Mfd. Fixed Condenser85
C ₁₀ , C ₁₁ —Sangamo 0.001-Mfd. Fixed Condensers	1.00

The circuit diagram of the receiver is shown in Fig. 1, and panel and sub-panel layouts are also given in this article. Attention is called to the two neutralizing condensers connected from the plate of each input inductance, providing an additional means of stabilizing the receiver at high frequencies. The photographs show how simply the receiver goes together. The sub-panel, provided by the Formica Company, has three white lines engraved in it to show the position of the three tuning coils, which can be easily adjusted since they are attached to the sub-panel by means of machine screws.

After the receiver is properly wired, the next step is to adjust the variable primary coils, which are rotated when the condensers are turned. The condensers should be turned until the plates completely interleave, and in this position the primary coils should be parallel to the larger secondary inductance, as shown in Fig. 2. They should be fixed in this position. Under these conditions, the loosest coupling will exist between primary and secondary at the highest frequencies, as shown in Fig. 3.

The receiver can now be connected to its A, B, and C batteries. The diagram shows that the r.f. tubes are run with 90 volts on the plate. A negative bias of about one volt is placed on the grid of the r.f. tubes, and is obtained through the drop across the filament rheostat. The C bias battery for the audio tubes is fixed in the receiver, as the photograph of the complete set shows. The final audio tube should be a UX-112 (CX-312), with about 135 to 150 volts on the plate and a grid bias of negative 9. A separate ground wire can be run to the set, or the A battery may be grounded instead. Either method of getting the receiver grounded will be satisfactory.

This receiver is inherently easier to adjust for a non-oscillating condition than a bridge circuit, where an accurate and exact balance is necessary. The three tuning condensers are turned to the longest wave setting, or 100 on dial, and then, as the wavelength is slowly decreased again, with both the dials being turned in synchronism, a point will be found where the set breaks into oscillation. Then the neutralizing condensers should be screwed down slightly until oscillation stops, and the wavelength decreased again by rotating the condenser dial. This process should be repeated until the shortest-wavelength adjustment, zero on the dials, is reached. In actual practice, it will be found that no oscillation will occur if the condensers are adjusted properly, and at the same time it will be discovered that the longer-wave stations will not have lost any of their original strength, a phenomenon that few balanced receivers possess.

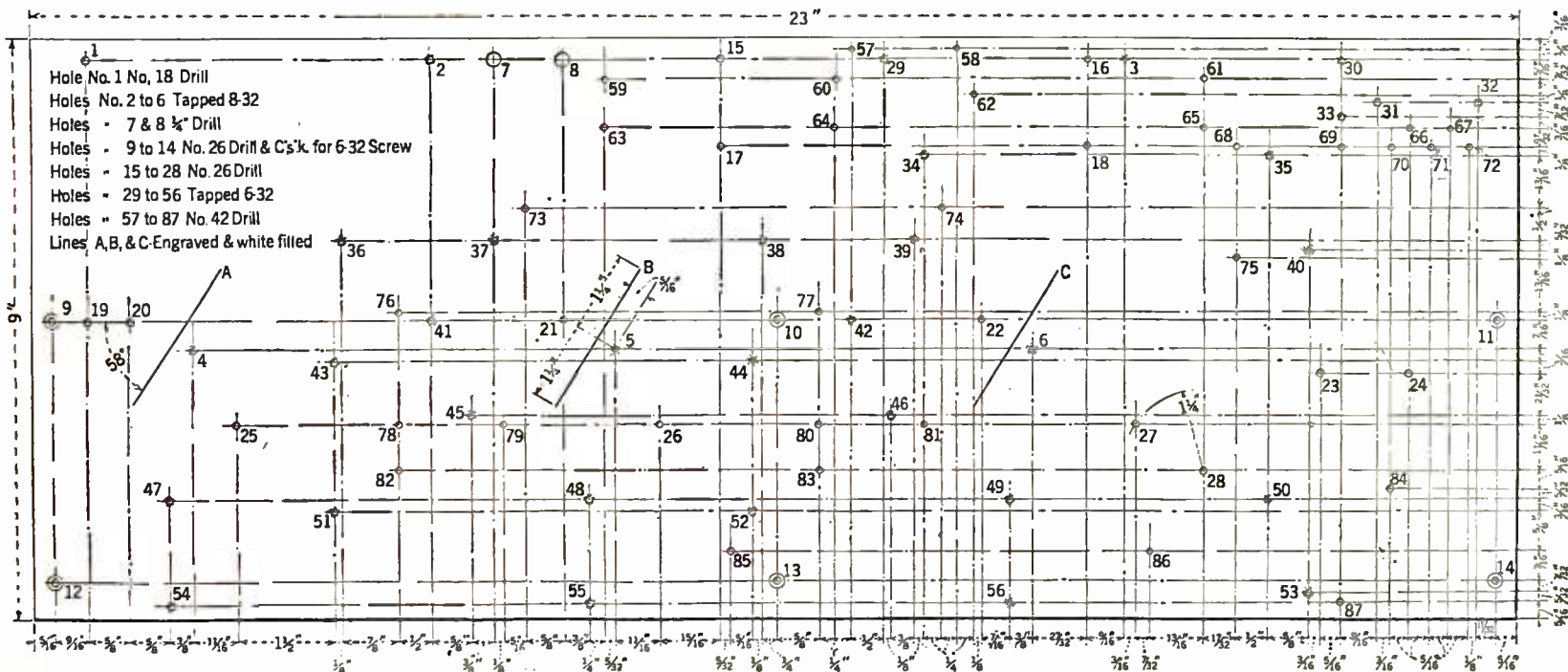

A SUB-PANEL TEMPLATE FOR THE 1928 "EQUAMATIC" RECEIVER

The builder of this new "Equamatic" receiver should have no difficulty in making a one hundred per cent. workable set at the first trial. The parts have been so placed that interaction between circuits, which ordinarily is a difficult problem with which to cope, is minimized, and the progressively increasing coupling between circuits at the longer wavelengths provides the proper interstage energy transfer. The first "Equamatic" coil, which transfers energy from the antenna circuit to the receiver proper, may be arranged to have a slightly different rate of change of coupling if desired—if the user wishes somewhat greater selectivity—for example. In this case, the coupling at the lowest frequency may be decreased by making the primary and secondary not parallel, but turned at a slight angle. In general, however, the greatest coupling should be used at all times, and a somewhat smaller antenna used if greater selectivity is desired.

The condensers which tune this receiver, if those specified are used, have a straight frequency-line characteristic, a decided advantage now that transmitting stations are again operating on ten-kilocycle separations. If it is desired to use a 171 type tube, somewhat different connections must be made to the last two tubes and their plate circuits. As wired according to Fig. 1, the last two tubes get the same B voltage, this being necessary on account of the interstage switch. Additional prongs would be necessary if the two audio tubes needed different B voltages. In the vicinity of broadcasting stations, however, the field strength is sufficient to give all the volume one can desire by using a semi-power tube of the 112 type. At some distance from stations, the 112 tube with its greater ampli-

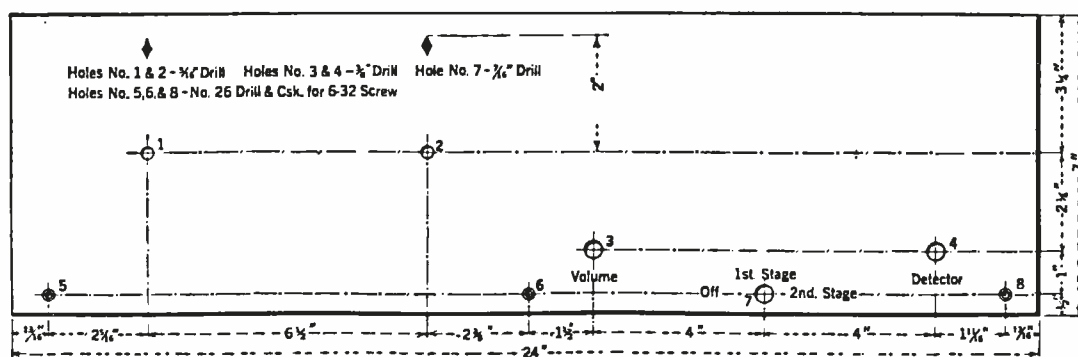

FRONT PANEL DRILLING INSTRUCTIONS

cation factor will have an actual advantage over the 171 type, and louder signals will be obtained. Thus weaker stations will operate a loud speaker.

Now that we have outlined the electrical features of this new "Equamatic" circuit, there are several mechanical notes which should be brought to the attention of the home construc-

ground potential. The output filter, which is new in this year's model, consists of a conventional choke and condenser combination and, as may be seen in an accompanying photograph, is built into a round metal box similar to the audio transformers. The latter, incidentally, have exceptionally high primary inductance, which is necessary for full reproduction of low audio frequencies.

Their turns ratio is about 2.5 to 1.

In all receivers employing two or more tuned circuits, tuning is inherently sharp, making necessary some form of fine adjustment. In this receiver the designers have used the familiar Karas dials which, with their 63 to 1 reduction, and their exceptionally smooth action, make tuning a joy. The writer



BY WAY OF CONTRAST

RADIO BROADCAST Photograph

Here is the 1927 "Equamatic" which is now improved. Note the three-dial tuning

tor. The condensers, for instance, are new, in that they are equipped with removable shafts so that insulated ones may be substituted for the metal ones, and complete insulation from hand capacity thereby realized. In some circuits this is important; in the present receiver, hand capacity will not be apparent owing to the fact that the rotor plates of the condensers are at

found that the receiver tuned with great ease although it was sharp enough to please a critical fan.

All in all, the home constructor should find this receiver a well designed, simple-to-construct, high-quality set, and in building one, he will be equipping himself with a receiver of which he can be deservedly proud.

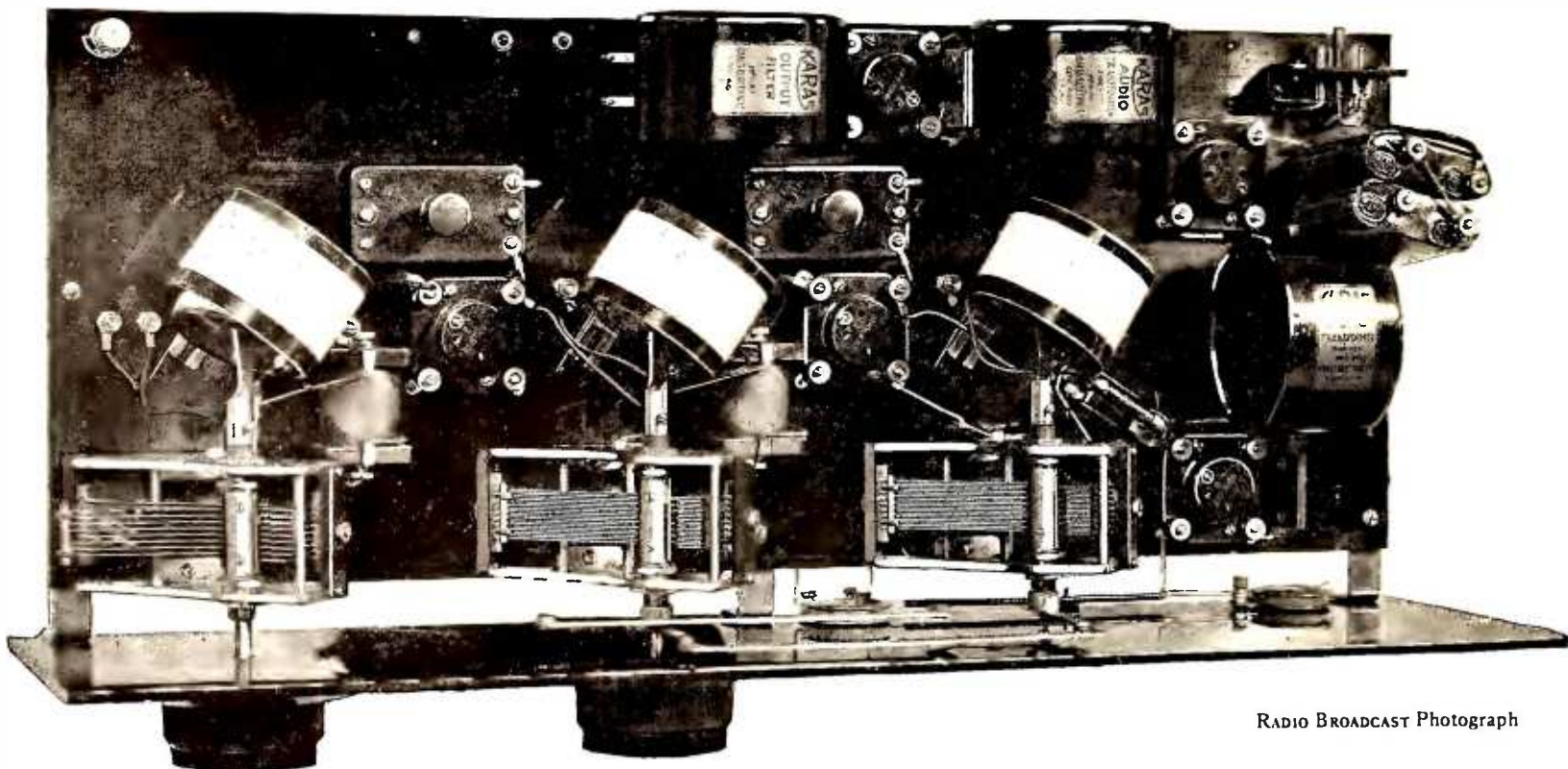

RADIO BROADCAST Photograph

LOOKING DOWN ON THE 1928 "EQUAMATIC"

The arrangement of parts is neat and efficient. Note the lever pantograph arrangement which makes possible simultaneous adjustment of the second and third tuned circuits

A New Principle of R. F. Tuning

The "Octa-Monic" System Resonates the Second Harmonic Instead of the More Usual Fundamental—Increasing the Selectivity

By DAVID GRIMES

UP TO the present time there have been just three fundamental radio circuits, and every type of radio receiver has employed some variation of these three arrangements. First, there was the regenerative system; next radio-frequency amplification was developed; and last, the War and Major Armstrong produced the super-heterodyne.

Regeneration is a principle by which increased signals may be obtained by a properly phased feed-back or reënforcement of the incoming signals. When radio broadcasting first became popular in 1922, the regenerative type of circuit was generally used. The feed-back action made the receiver very sensitive for distant reception and very selective at the particular frequency for which the receiver was tuned. As the number of stations increased, and two or more powerful local stations became established in many communities, the regenerative receiver ceased to give satisfaction because of its broadness of tuning. Near-by locals could not, therefore, be tuned out. The necessity for extra selectivity was met by sets with tuned radio-frequency amplification. But the standard two-stage tuned radio-frequency sets soon became inadequate because inherent resistances in the vacuum tubes and associated circuits limited the ultimate selectivity to be obtained therefrom. Attempts to offset these resistances by feed-back circuits have been somewhat successful in increasing the selectivity but in nearly every case the audio quality has suffered. The RGS Inverse Duplex, described in the January, February, and March, 1927 issues of RADIO BROADCAST, employed a tuned radio-frequency circuit with an automatic negative resistance circuit which greatly increased the selectivity at all wavelengths. The limiting factor was the tone quality, however, as super-selectivity tends to cut the side-bands on a carrier wave, thus sacrificing the high pitch audio tones. The selectivity of the RGS Inverse Duplex was carried to such a point that a special audio circuit was employed to give extra am-

plification to the high-pitched tones in an effort to provide for the reduction in side-bands.

The super-heterodyne came into general use mainly because of its selective properties and its extreme sensitivity, permitting loop operation. But the side-band limitation so characteristic of a really selective tuned radio-frequency set became very noticeable in super-heterodyne circuits employing low-frequency intermediate transformers. Here the plus and minus 5000-cycle variation which must pass through to insure good tone quality is a very large percentage of the intermediate carrier wave of 30,000 or 50,000 cycles. The resonant curve must therefore be quite broad, which somewhat offsets the very



DAVID GRIMES

advantage which the super-heterodyne possesses. Recently, super-heterodynes using higher intermediate carriers than the broadcast frequencies have been introduced to overcome the above detriment.

It is easy to see from this discussion that there is a real need for a new type of super-selective circuit that overcomes the side band limitation. With this thought in mind, a series of tests has been conducted during the last few months, which has resulted in the development of the "Octa-Monic" principle. This is a new system for obtaining a higher degree of selectivity and follows from the considerations below. It had long been realized that selectivity was a geometric function and that placing one tuning circuit after another created the geometric conditions. Naturally, every geometric function occurring in radio was then investigated with a view to employing that feature for selectivity. One of the most promising was the generation of second harmonics and it is this that forms the basis of the new RGS "Octa-Monic" receiver.

It is well known that a vacuum tube has a curved characteristic unless a very high external

impedance exists in the plate circuit. This curved characteristic leads to distortion which is another name for the generation of harmonics. In the plate circuit of the average r. f. amplifier is only a small impedance, therefore in this circuit exist the second harmonic as well as the fundamental image of what occurs in the grid circuit. It is from this second harmonic that the "Octa-Monic" gets its name. The idea of securing increased selectivity, not through the use of additional circuits, but by the use of an inherent tube characteristic, is believed to be new.

Reference to Fig. 1 shows the familiar grid-voltage plate-current characteristic of a standard vacuum tube. The curve follows a square law, and in doing such, causes some interesting results. It is desirable when using such a tube for an amplifier to operate the grid voltage on a relatively straight part of the curve, so that fairly undistorted amplification will result. For perfect amplification, this curve should be a straight line. The very fact that it is not, however, makes the vacuum tube a valuable device, as the non-linear performance permits its use as a modulator, oscillator, detector, and a harmonic generator. It is its use in this last capacity that is least understood and least employed.

Now, if a special negative C bias is placed on such a vacuum tube so that the grid variations take place about some such point as A in Fig. 1, the conditions will be favorable for the generation of second harmonics. Such harmonics are always the result of unequal amplification in the two halves of a carrier wave. By operating at point A it will be seen that each positive half of the carrier wave is amplified to a greater extent than each negative half. Such an unbalanced carrier wave may be resolved into a balanced carrier wave of the same fundamental frequency plus another carrier wave of twice the frequency. This is graphically illustrated in Fig. 2 and is known as Fourier's Theorem. Briefly stated, it is as follows:

If we have any single valued periodic curve, that is, one having only one value of the ordinate to one value of the abscissa, and repeating itself at regular intervals, then, no matter how irregular the curve may be, provided it does not exhibit

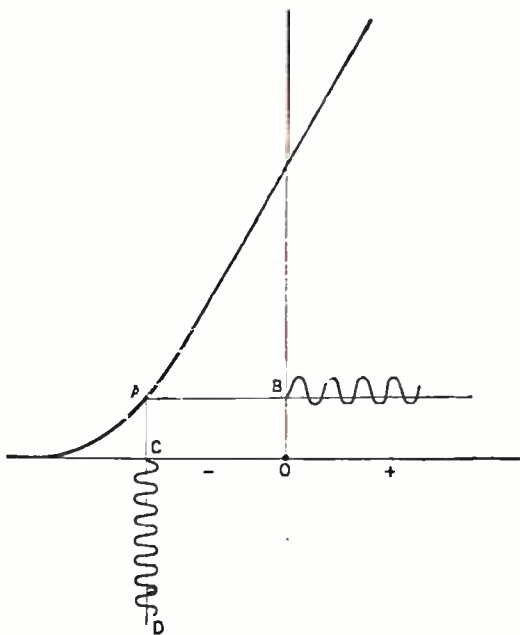

FIG. 1

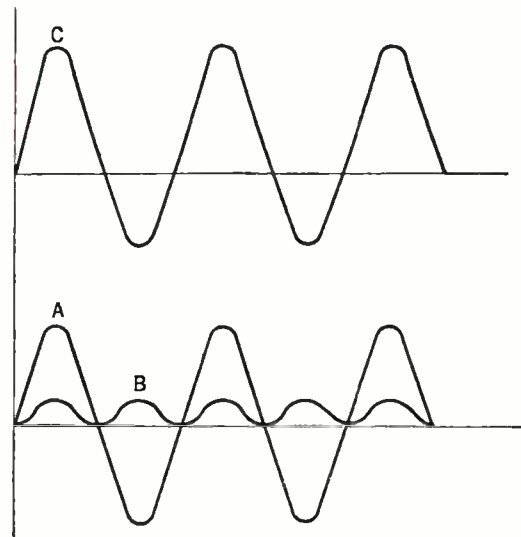

FIG. 2

discontinuities, it is always possible to imitate this curve exactly by adding the ordinates of superimposed simple periodic or sine curves of suitable amplitude and phase difference, having wavelengths which are in the integer relation to each other.

Curve C in Fig. 2 shows the unbalanced carrier wave in the plate circuit of the tube operated at point A on the characteristic curve in Fig. 1. Curve C is the equivalent of Curves A and B in Fig. 2. Curve A is the fundamental carrier wave similar to the one impressed on the grid of the tube. Curve B is the second harmonic wave.

None of the graphic representations pertaining to the second harmonic reveal the secret of selectivity. They merely indicate that such a second harmonic is present. The mathematical equation outlining the performance of the tube, however, does tell the story. The equation for the unbalanced carrier wave shown by Curve C in Fig. 2 is as follows:

$$C = 2\sigma \left(\frac{E_p}{\mu} + E_g + \varepsilon \right) e \sin pt + \frac{\sigma e^2}{2} \cos (2 pt + \pi)$$

The first part of the equation represents curve A in Fig. 2—the fundamental carrier. The second part of the equation represents Curve B in Fig. 2—the second harmonic component.

Now it will be noted that this second harmonic component is proportional to the square of the input voltage, e , and it is this squared function which gives the geometric requirement for selectivity. Reference is here made to Fig. 3, which shows a harmonic generator tube with the grid circuit tuned to some frequency, F , in the broadcast band. The resonant curve of this tuned input circuit is shown at A. Now the second harmonic currents, $2F$, in the plate circuit of this tube, are proportional to the square of the input voltages on the grid. As the incoming frequencies are varied, slightly, from the true resonant value of the circuit, the voltages on the grid fall off according to curve A. As the voltage has decreased from its maximum, y , to the half way point at x , due to a change in frequency, a , the second harmonic current decrease is much more rapid and abrupt than in the case of the fundamental current, resulting in a very sharp resonant curve in the plate circuit of the harmonic generating tube. In these figures the fundamental and second harmonic have been plotted so that they have equal maximum amplitudes to show the relative sharpness of resonance.

The next step was to incorporate such a principle into a working receiving circuit. The first

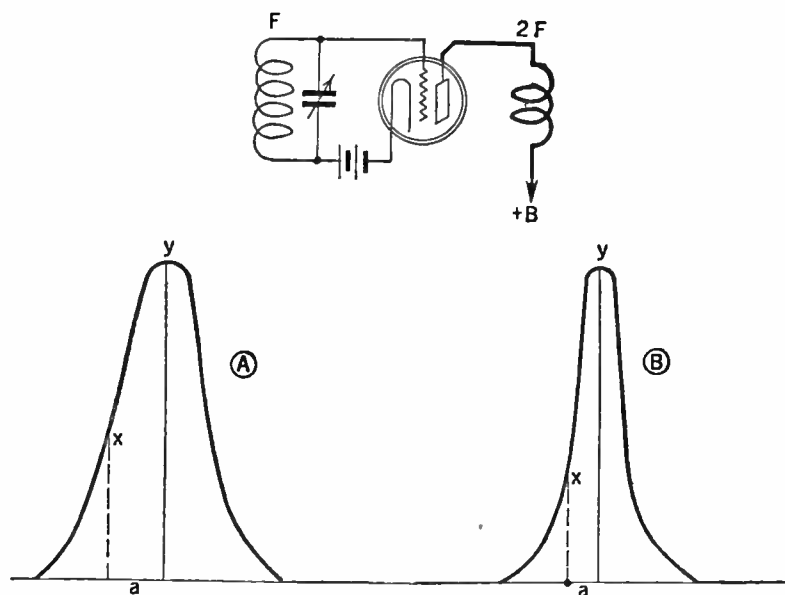

FIG. 3

attempt is shown in Fig. 4. Here the antenna is coupled directly to the tuned input of the harmonic generating tube. The grid is tuned to the fundamental frequency of the broadcast station to be received. The second harmonics are set up in the plate circuit where there is a tuned transformer, whose tuning condenser resonates the secondary at the second harmonic frequency. Signals are changed to audio fre-

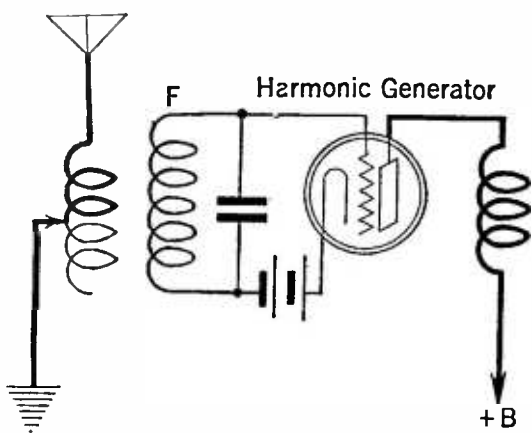

FIG. 4

quencies in the standard detector tube in the same manner as any other circuit. Selectivity superior to that obtained by a two-stage tuned radio-frequency system was noted, although the sensitivity of the arrangement was much less.

This would obviously be so because no amplification is present in Fig. 4, and because the amplitude of the harmonic is less than that of the fundamental. In all of these diagrams, which are

roughly drawn, no attempt has been made to show relative amplitude—only relative sharpness. In fact, quite a bit of energy is sacrificed in securing the second harmonic component. This sacrifice is more than justified because of the real selectivity obtained, and after all, amplification can always be added to a receiver. The additional amplification is easily added by the arrangements shown in Fig. 5, where one stage of radio frequency is placed ahead of the harmonic generator tube. This additional stage does not need to be particularly selective as the second harmonic principle gives all of this necessary. For this reason, the additional tube has been called a coupling or amplifying stage—the circuits being designed primarily for amplification and not for selectivity. Its input circuit is closely coupled to the antenna to give maximum energy pick-up with which to start. In order to

gain some idea of the real improvement offered by the "Octa-Monic" as compared with tuned radio frequency, reference is made to Fig. 6. This shows the schematic arrangement of a standard two-stage tuned radio-frequency receiver with the resonant curves of the various parts of the circuit beneath and numbered to correspond. Curve 1 shows the sharpness of tuning in the grid of the first tube. Curve 2 indicates that the fundamen-

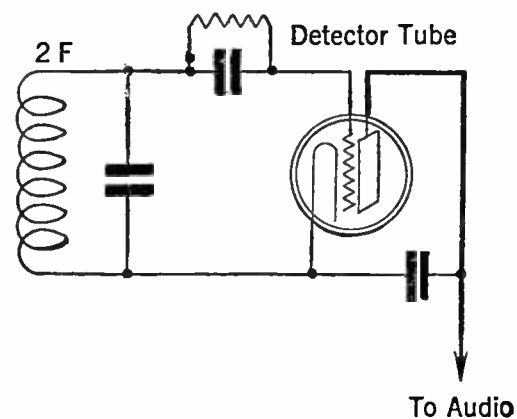

tal currents in the plate circuit of the first tube follow the same resonant curve. Of course, the energy is greater in the plate circuit but the curves have been drawn to the same scale for the purposes of comparison. Curve 3 shows a gain in selectivity through the addition of the second tuned circuit, while Curve 5 shows the final gain in selectivity through the employment of the 3rd tuned circuit. It can be seen that only

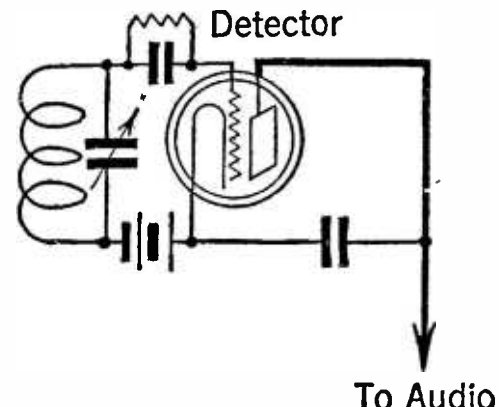
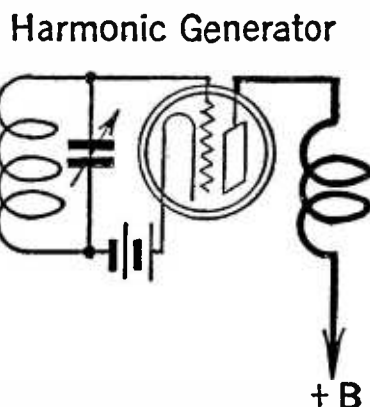
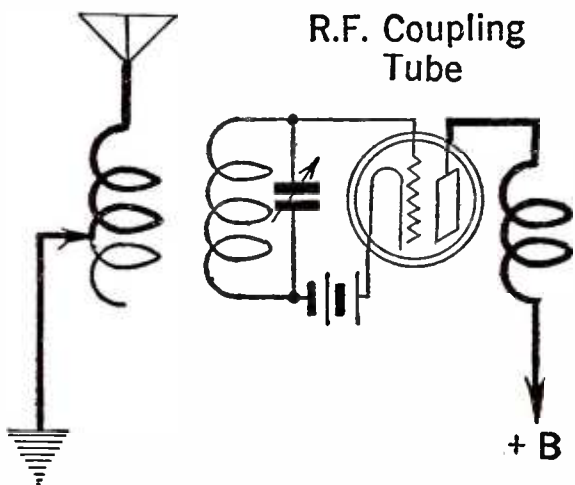

FIG. 5

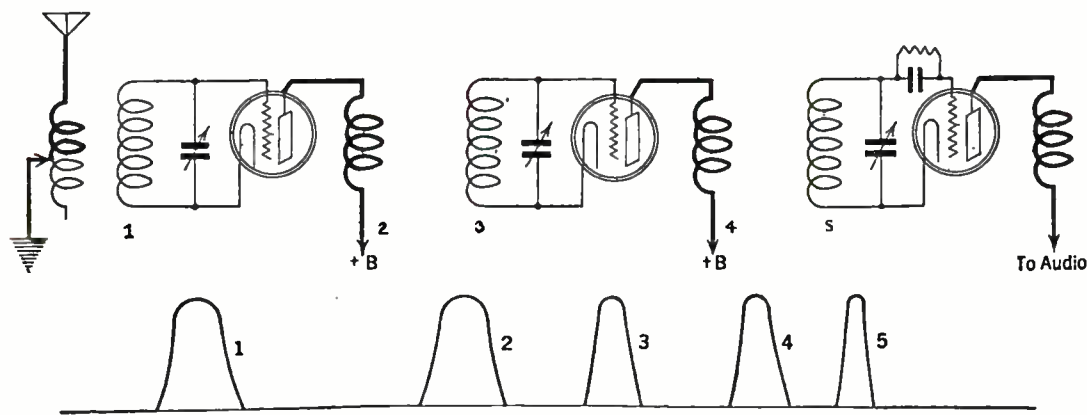

FIG. 6

the tuning circuits offer any selectivity whatsoever. Fig. 7 shows the schematic sketch of the "Octa-Monic" system and the associated resonant curves beneath the several circuits involved. Curve 1 indicates the sharpness of tuning in the grid circuit of the harmonic generator. This has the same shape as the first tuning circuit in the system. In the plate circuit the second harmonic currents follow the resonant Curve 2, and the harmonic tuning circuit in the input to the detector still further sharpen this up to resonant Curve 3. This resonant curve is similar in shape to the tuning curve No. 5, in the system. The resonant curves in Fig. 7 are drawn on the same scale for the sake of comparison. It must be remembered that Curve 2 representing the second harmonic selectivity has much less energy in it than Curve 1.

It would seem, offhand, that this excessive selectivity in the "Octa-Monic" would raise havoc with the side-bands, as is the case in tuned radio-frequency circuits. The very harmonic currents themselves, however, offer the solution. At the high frequencies existing in the harmonic

circuit the resonant peak may be much sharper than at broadcast frequencies without harming quality. A tuned circuit must be able to pass a

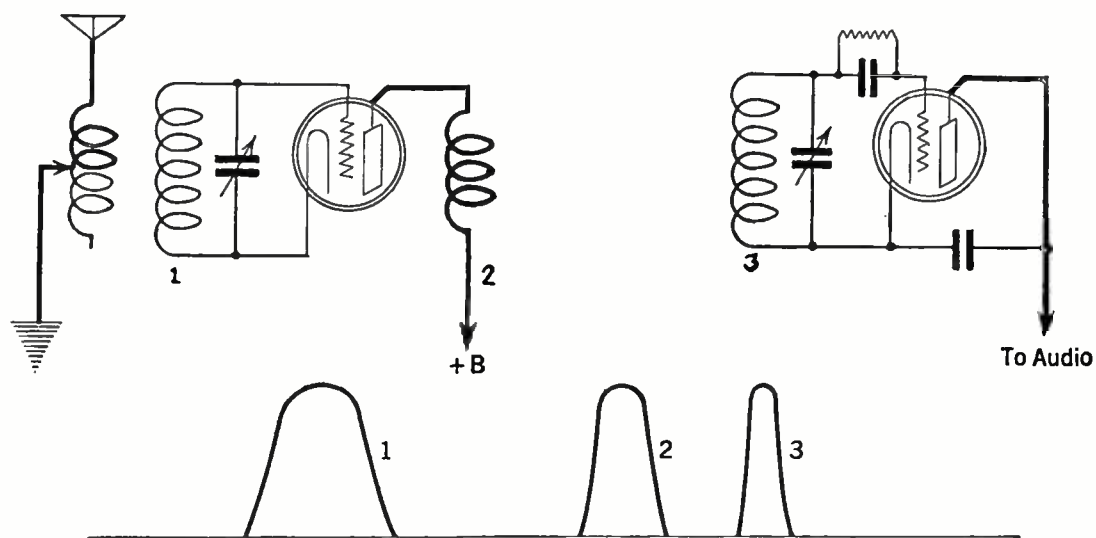

FIG. 7

Selling It by Radio

Using Radio in Sales Promotion. By Edgar H. Felix. Published by McGraw-Hill Book Co., Inc., New York City. 386 pages. Price, \$5.00.

IT IS not without a touch of embarrassment that I prepare to review this pioneer work on the subject of broadcasting as an aid to merchandising. The author has written in kindly terms of my own masterpieces on various occasions, and transported me over the highways in his private fleet of Minerva sedans. In finding his work good, therefore, I lay myself open to the charge of log-rolling. To preserve my honor, I should like to pan the author and his treatise, but he has done too effective a job. The book is original, informing, and vigorous. Its blemishes are slight and will probably be visible only to the reviewers.

Using Radio in Sales Promotion is written primarily for advertisers; it aims to instruct the man who contemplates spending a part of his advertising appropriation for time on the air. Throughout it names names, gives examples drawn from experience, and answers the questions which must occur to the man who signs the checks. What interests the client interests the professional broadcaster equally, whether he (or she) owns, manages, operates, sells time, writes publicity, or performs in the studio. Professional advertising men are in a similar position. So there is Felix's potential audience—in these groups and their fringes. He is qualified to speak to all of them, for he has himself

been a broadcaster, advertising man, merchandising consultant, and writer; and incidentally he is, among other things, a Contributing Editor of RADIO BROADCAST.

The author starts with a *résumé* of the seven-year history of the broadcasting art, and in his first chapter he sounds a note which recurs throughout the book; broadcasting is a medium, not for forthright advertising, but for securing the good will of the consuming public. Radio receivers are purchased for entertainment and instruction. A trade name, a brief slogan, a very few words of product description, may be mixed with the entertainment and instruction, but Felix always has his eye fixed on a psychological dividing line which cannot be crossed with either propriety or safety. Broadcasting is primarily for the advertiser who can afford to wait, who has the resources to build up public good will, who is not too short either in his bank account or his patience. As for the little fellow who demands sales tomorrow morning—Felix advises him to take his money to the local newspaper. The Midwestern broadcasting station which I am reliably informed at this writing, is selling over the air by direct description, gasoline, mattresses, gloves, overalls, radio apparatus, cancer and rupture cures, and a 50-cent chicken dinner, is outside of Felix's pale. "He (the broadcaster) does not earn the right to inflict selling propaganda in the midst of a broadcasting entertainment any more than an agreeable week-end guest may suddenly launch into an insurance solicitation at Sunday dinner," is the attitude expressed and implied on every other page of *Using Radio in Sales Promotion*.

band of the carrier frequency plus and minus 5000 cycles to insure good tone quality and 10,000 cycles variation is a much smaller percentage of the second harmonic currents than of the broadcast frequencies. For example, at 1000 kc. a 10,000-band represents 1 per cent. while in the second harmonic circuit this 10 kc. band is only 0.5 per cent. of 2000 kc. In this unique way a high degree of selectivity has been secured with a faithfulness of tone quality that is remarkable.

This RGS "Octa-Monic" arrangement is a fundamentally new development. The existence and generation of second harmonics has long been known, but the application of these currents to the selectivity problem is a new feature. It has created a fourth and distinct type of radio circuit.

The next article in the series will discuss this interesting development and will contain plenty of information in connection with the building of the RGS receiver.

The reason for the fundamental similarity of station programs is shrewdly analyzed in the second chapter. Almost all of them are planned to appeal to all tastes, thus including the largest possible audience. Artistic standards, not fundamental program appeal, are the variable quantity. Almost all the stations are shooting at the same target, but with guns of different calibre.

In the chapter on "Building a Broadcasting Station" and that on "The Broadcasting Station" near the end of the work, Felix discusses technical aspects of the broadcast situation, such as wavelength congestion, station organization, operation, and the like. He does not attempt to tell the reader how to build a station, and in fact advises him against trying it. What he does is to outline the formidable problems which must be faced, and the general economics of the situation. In discussing operation he describes the functions of the various members of the staff and the principles underlying their work. In many other chapters, as in those on "Potential Audiences of Broadcasting Stations" and "Selecting a Commercial Broadcasting Feature," Felix enters the engineering branch, and, dealing with field strengths and microphone characteristics, he exhibits only minor lapses from accuracy.

Using Radio in Sales Promotion is written in a business-like, straightforward style, but it is not devoid of sharp hits and epigrams. I quote a few: "An expert is usually one who has not yet learned enough of a subject to be aware of his ignorance."—"Broadcasting is free and therefore freely criticised."—CARL DREHER.

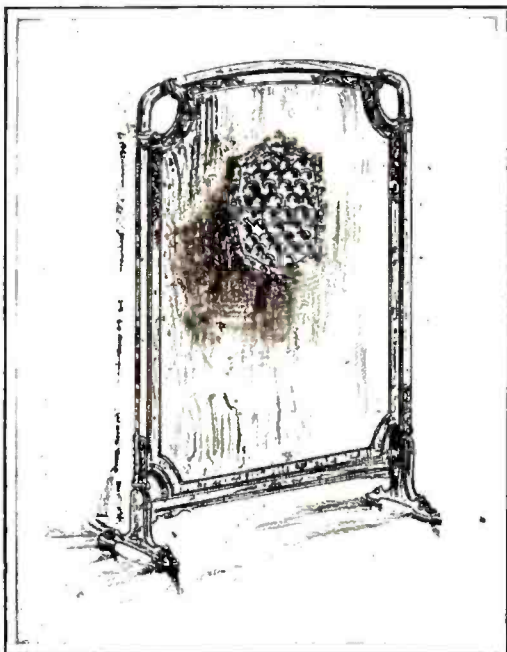

A DEPARTURE IN LOUD SPEAKERS
The Rola Model 20 combines a baffleboard loud speaker of remarkable efficiency with floor screen measuring three feet high by two feet wide. The price is \$85

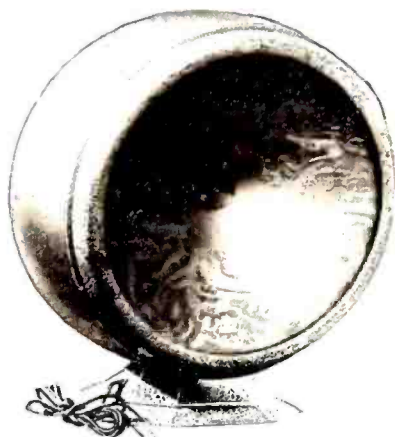

AN "ACME" OFFERING
This novel loud speaker makes use of a double cone arrangement, good amplification of the low notes being possible on account of the free edge cones. The manufacturers state that an output device is not necessary with this loud speaker. Price \$25.00

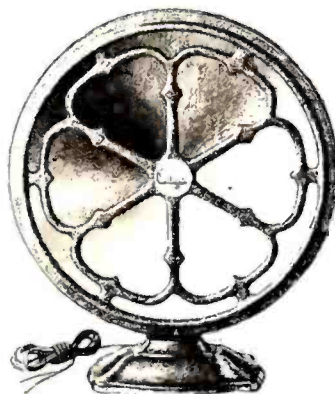

THE A. K. CONE
The new Atwater Kent Model E employs a novel method of cone suspension, permitting satisfactory response to minute vibrations. Price \$30.00



THE CROSLY MUSICONE
A baffleboard effect is obtained by the use of the tiltable surface. Price \$27.50



TRIMM "CONCERTO"
A \$10.00 cone, fourteen inches in diameter. The seventeen-inch cone retails for \$16.00



1928 Loud

THE BOSCH "LIBRARY AMBATONE"



OPERADIO
The "Junior" model has a 30-inch exponential air column while the "Senior" has one of 51-inches. The prices are \$15.00 and \$25.00



FADA "PEDESTAL"
This is a twenty-two inch free floating cone of attractive Grecian design. The overall height is fifty-five inches. Price \$50.00

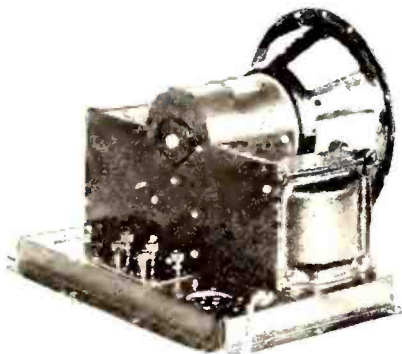

A NEW MAGNAVOX
Loud speaker and B supply in one unit, a. c. operated. A 210 type power tube should be used. The loud speaker is of the dynamic type. Price for the unit, \$110.00

IN GOTHIC DESIGN
A beautiful and well-proportioned free-edge periphery cone. The reproduction from the "Peerless" is in keeping with its appearance. Price \$35.00



THE "CASTLE"
A two-tone bronze relief pattern enhances the appearance of this Tower seventeen-inch cone. Price \$9.50





GREBE "20-20"
The numerals denoting this model refer to the cone diameter and the fact that it is constructed at an angle of twenty degrees. Price \$35.00



ALGONQUIN
A full floating cone of a moisture proof impregnated fabric. The Algonquin Electric Company retails this cone at \$15.00



BALDWIN
A special unit is responsible for the good tone of the Baldwin "99." This instrument sells for \$28.50

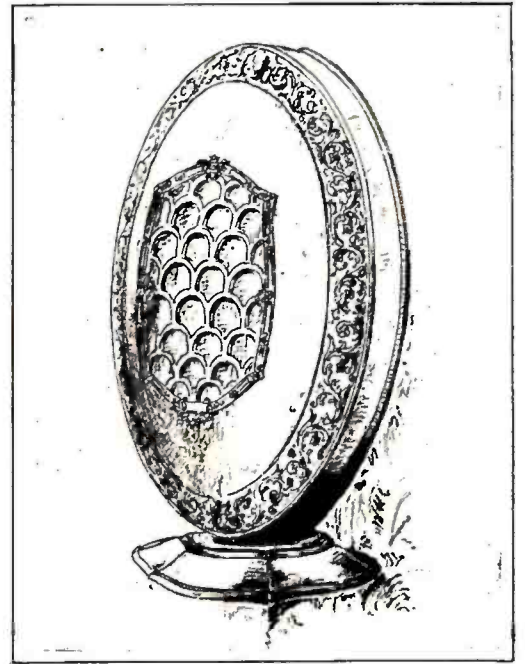

ANOTHER ROLA ART MODEL
A large and effective baffle surface is responsible for excellent tone quality. Rola manufactures less expensive models, from \$28.50 up. The one illustrated is priced at \$45.00

Speakers



UTAH
This \$30.00 instrument is of 5-ply natural finished walnut



AN INNOVATION
An up-to-date post-war map of the world surrounds the Symphonic Globe loud speaker, a \$35.00 product of the Symphonic Sales Corporation



A 22-INCH CONE
The new Sparton loud speaker, a product of the Sparks-Withington Company, retails at \$30.00



IN DISGUISE
A cone loud speaker in tip-table form—the Teletone Model 70. Price \$40.00



THE MOHAWK "PYRAMONIC."
The pyramidal construction in the diaphragm is responsible for very excellent quality from this \$25.00 instrument

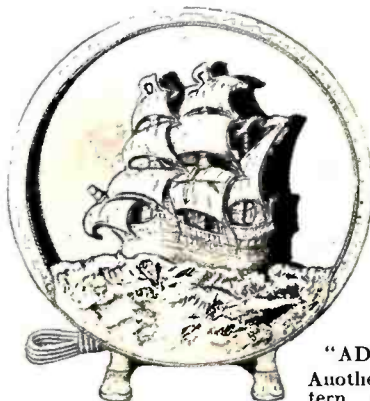

THE "ADVENTURER"
Another bas-relief pattern of the Tower Manufacturing Corporation. The ship is suitably and vividly colored. The price \$9.50



ANOTHER PEDESTAL
The Baldwin loud speaker illustrated elsewhere on this page is also obtainable in the attractive form shown here. Price \$39.50

The Listeners' Point of View

SHOULD THE SMALL STATION EXIST?

By JOHN WALLACE

THE case for the small broadcaster is seldom heard, because he is small, possibly and because the public through habit and for other reasons, directs its attention to the larger and better-known stations. Has the small broadcaster a place? Does he serve a local need? How can the small station better serve its public? An interesting letter from a reader in Devils Lake, North Dakota, discussing this topic follows:

I have been reading with a great deal of interest your department in RADIO BROADCAST and obtained very much enjoyment out of it. Numerous things that you say however lead me to believe that you are about as biased an individual as ever wrote.

The particular thing that seems to cause you the greatest amount of worry is the small station. I own and operate a small station, as far as power output goes. Some of the things you say get under my hide. Picture yourself out here in North Dakota, living in a small town or on a farm vainly twisting the dials looking for entertainment. None to be had. Then, "This is KEJM The University of North Dakota" or WDAY or KFJR or KDLR as the case might be. A program of good entertainment for an hour or two comes on the air. You listen, you are pleased, you swear by the small station, you pick up a paper and note the many excellent programs being sent out from a multitude of stations, *none of which are heard here*, except a few months in winter. Would you favor the abolishing of the small station? Would you dismantle your radio set in February and not use it again until November? Would you if you turned on your set night after night and listen for stations that cannot be heard? Would you? Or would you listen to the very excellent programs from our local small station?

The programs sent out here are not the high type of the big Eastern stations but they fill the bill. An example of our type of program, Monday evening at 9:30-10:00 the Oriental Trio, the pianist a graduate of one of the largest schools in the country, a student of a noted teacher in Berlin, the soloist a former member of the Minneapolis Symphony, the violinist a former member of the Detroit Symphony all doing their best. At 10:00 P. M. an hour of dance music played by an 8-piece organization composed of men who have been playing together for three years and who know and understand music. At 11:00 P. M. fifteen minutes of the finest kind of pipe organ music. And on a Wednesday evening a program of band music played by a band of sixty boys, "The Governor's Boy Concert Band of Devils Lake" an organization of six years standing under the leadership of the finest bandmaster in this section of the country and playing overtures and marches of the highest class. The soloist with the band is a lady who has recently returned from that famous music school in Philadelphia where you must have talent to get in. That was our program last week. Daily we run the noon hour program playing the finest available recordings of symphony orchestra and famous singers, played through an electric pick up. Daily we broadcast the weather reports and market information and the station is eagerly listened to.

You may wonder at our quality. We have the finest and newest type microphones, the best amplifying equipment that we can buy, tested and balanced pick up lines, a monitoring operator at each end, every piece of equipment meter-checked at both ends and we pride

ourselves on good quality. KDLR has a studio 18 by 25 built by ourselves following Sabine's formulas. For band concerts we have a band shell, the only in the state of North Dakota, that will seat a 100-piece band, built so that the focal point is 50 feet from the front of the shell and here we pick up every instrument with but one "mike." The shell so built that a speaker in the shell can talk in a whisper and the "mike" will pick it up and put it through an amplifier at any volume desired without its being overridden by hiss.

You, living in a city with the choice of a score of fine stations at your command, find cause to kick and kick loud, long, and lustily at what you hear. Come out here once and hear one station or possibly two, both in the same state, and after you are here awhile I guarantee you will go back home and enjoy what you hear. Then after you are home give a thought to the rest of the world and try to do a little boosting and cease knocking that about which you apparently know so little.

I hope that you have not been bored by the length of this thing but allow me to say another thing, you have a wonderful magazine, but do use a little judgment.

BERT WICK Operator, KDLR.

Mr. Wick's point is well taken—even if he does take us to task at the same time. In our own defense, let us say that he overestimates our dislike of the small station. We have not said many harsh words about it. More than likely he reaches this conclusion because of the fact that we ignore the small station in these columns. If we do neglect it too much, there are two reasons. First, the small local stations, being low powered, are difficult to "get" often enough to enable fair comment. Secondly, local stations are of especial interest only to the persons within their limited range and hence do not logically demand space in an article that considers radio nationally.

Our correspondent asks us: "Would you favor the abolishing of the small station?" Our answer is yes and no. For small stations situated as are those he mentions in his letter he gives an excellent vindication. There are long periods during which it is impossible for isolated communities to receive the distant stations, even though powerful, with any sort of satisfactory reception. They are entitled to local stations, of low power, to fill in these hiatuses. Moreover the very fact that the program is local must give it a certain interest to those in the hinterlands—who take a keen interest in local things, in contrast to the city dwellers who don't know their alderman's name nor the people in the apartment below. The farmers and other dwellers in the Centerville area are just as likely to prefer the wares of Centerville's 10-watt broadcasting station to those of WCCO as they are likely to prefer the Centerville *Bugle* to the Minneapolis *Tribune*. Probably they are personally acquainted with most of the performers who appear before the Centerville station's microphone, or at least they know the announcer's cousin Nellie or their nephew goes to the same District school as the Staff Organist's son. Hence their interest in the local program is natural enough, and since they enjoy it they are entitled to it.

THE SMALL STATION HAS NO PLACE IN CITIES

BUT we are all in favor of abolishing the small station from the metropolitan areas. If the Hyde Park district of Chicago, say, wants to publish a little four-page newspaper to retail the local gossip to the provincial minded of its neighborhood, and to advertise the wares of its local drug stores and meat markets, well and good. Nobody outside that section has to buy the paper, nor need even know that it exists. But when that same Neighborhood Association starts to operate a radio station to afford opportunity to the piano pupils of the neighborhood and to peddle the aforementioned meat market's wares, it becomes, however low its power, somewhat of a public nuisance. Even where it doesn't actually interfere with the first-class stations it needlessly clutters up the dials and is an unpleasant distraction while tuning. This complaint holds also for stations in suburbs and in small towns within a hundred miles or so of some large city.

We have never heard our correspondent's station KDLR; we hope to hear it when DX is again possible. Certainly the program he describes sounds like a very creditable one. Mere magnitude and wealth are not the only requisites for a good broadcasting station. While large financial resources must necessarily allow a station to present more varied and elaborate offerings they do not guarantee artistry in that station's mode of presentation.

It is perfectly possible for some small station, somewhere, to achieve a reputation equal, or even superior, to the large city stations. Whether or not you like the "Little Theater" there is no denying the fact that some Little Theater productions, financed on a shoe string, are superior in artistry and in manifestation of good taste to many of the costly Broadway productions. The same opportunity presents itself in the operating of a small radio station. An individual gifted with good taste and a certain sort of genius which we shall not attempt to label could, conceivably, operate a station *in time* which listeners the country over would labor with flattened ears to pick up. He would have to be an individual of extraordinary personality and that personality would have to manifest itself in every detail of the programs he offered. He would have to have complete supervision over every item he broadcasts and, essentially, do all his own announcing. In contrast to the impersonal, routine, and frequently "high hat" manner affected by the metropolitan stations, his mode of presentation would have to be decidedly personal and intimate. He would have to establish a very real bond between himself and his audience. The musical programs he offered would have to express his own tastes, as would every other sort of program he offered from time to time. And if he were a big enough man, his tastes would be broad, and he would, in consequence, attract a big enough audience. He would not have to have a lot of artists, but the few he had would have to be good, and show, in all their work, his fine Italian hand.

His position as "editor" of all that his station offered would very closely parallel that famous

instance in the history of American journalism wherein an editor of unusual genius, though attached to an unimportant newspaper in an unimportant Mid-Western town, gathered to himself such fame that his editorials were quoted the country over and his newspaper even enjoyed a scattered circulation over many remote states.

And finally his reward would be—considered in the form of dross dollars—about as great as is the financial reward of the operator of a Little Theater.

Why Not a Station Operated by a Foreign Language Group?

THERE are several broadcasting stations, mostly among the smaller ones, devoted to some special group of listeners. For instance there are the two labor stations which aim their output especially at the man in overalls; and then the stations operated by some religious group, as the Roman Catholic and Christian Scientist. It has puzzled us, from time to time, that no station has ever come into existence operated by a foreign born, or foreign descended, group for the benefit of its fellows in this country who cling to the mother tongue.

While we have no statistics at hand to lend weight to this proposal, isn't it said that there are as many Italian speaking people in New York as in the city of Naples, and more Swedes in Chicago than in the city of Stockholm? If these statements be exaggerated at least the "foreign-language" populations of these cities do run into large figures. Chicago, besides its vast area around Belmont Avenue where one can examine the store signs for blocks without seeing a name that does not end in *-son*, has populous settlements of persons of Polish descent, Italian and German. These people particularly the older generation, have recourse among themselves almost exclusively to their former native tongue. Their sons and daughters though they prefer the American idiom, have, nevertheless been acquainted with the second language since childhood. It seems to us they should be interested in hearing programs conducted entirely in their own language, featuring artists and speakers of their race, and in general devoted to their racial interests. The Great War is remote enough now so that no idiot would be likely to call the manoeuvre unAmerican.

There have been foreign language programs from various stations in the United States, but only intermittently. Some French programs were broadcast by a New York station. W180 in Chicago has for nearly two years broadcast a program in Swedish every Sunday morning from 8:35 to 10:00. Inquiry at W180 reveals the fact that this program has been enthusiastically received by Swedish people, not only in Chicago but by long distance experts in Wisconsin and Minnesota—both of which states have a large Swedish population. The same station recently inaugurated a program in German on Sunday afternoons from 2:30 to 3:30.

There is no doubt at all that a foreign language station, properly situated, would enjoy a large enough audience to make its efforts worth while. Nor does there seem to be much doubt that it could get artists; suppose an Italian station sent out a call for Italian singers! But there may be some question as to how well it could support itself. Perhaps here is the rub and the reason that none has so far appeared. However the foreign communities in the large cities manage to support flourishing newspapers, which are packed with

advertising. If the bonds of a common fatherland hold these people close enough together to make a newspaper self supporting, it would seem, by analogy, that an unpretentious broadcasting station would not be an impossibility.

The value to those, like ourself, who do their best talking and listening in the American patois, would be, perhaps, not large. But it would be a great thing for students of foreign languages to have a station they could tune-in on, on occasions, to supplement their reading and writing work. Moreover it would give a pleasant cosmopolitan tang to the air. And picture the delight of a listener out in Kansas tuning through to some Italian station in New York and imagining he had got Rome!

Thumb-Nail Reviews

WE WRITE in the middle of the summer, at a time when DX conditions are at their worst, so instead of trying to review some static-mingled distant squawks we shall confine ourself to considering some of the chain features which are received over a wide area.

The summer season, may we say, has been better than any previous summer in radio's



AN ESKIMO LULLABY AT WGY

In the Schenectady studio, Trixie Ahkla, Eskimo, sings a good night lullaby for her two sons Miles and Billy. Up North, where the night is long, this domestic duty need be discharged only once a year

history. Many features quite up to winter time standards were heard. The stations supported the annual vociferous protestation that "there is no summer slump in radio!" So many different agencies are engaged in re-iterating this phrase every year, particularly radio manufacturers, that it occurs to us that they do protest too much, and that a slump none the less exists. If it does exist it is because radio listeners have been able to discover other doings more intriguing than sitting in the front parlor of a warm summer's evening, and not because the stations have not made an effort to please.

THE RADIOTRONS (Blue Network) These artists in their program of alternated orchestra and voice strike a mood that nicely ties the whole shebang together. In the case of the program we have in mind the flavor persisting throughout was a decidedly saccharine one; such numbers as Tumble Down Shack in Ath-

lone, When You're in Love, Listening, Honolulu Moon, and Selections from the "Red Mill" following each other in sentimental succession. But Erva Giles has a beautiful soprano voice for these songs and the Radiotron's much featured Vaughn De Leath always delights us with her mellow alto and throaty half-spoken passages.

IPANA TROUBADOURS (Red Network)—continue to be one of the most reliable orchestras that are to be heard weekly. Their plucked instrument section (they have another section—strings) continues to lead in its field, which is probably to be expected considering all the practice it has had over the past two and a half years.

ELK'S MALE QUARTET (Blue Network)—The quartet is an unfailing radio standby. Mayhap our interest in the quartet springs from the fact that every one of us is a potential singer in a quartet and stands ready to contribute his services thereat under proper stimulus, such as a shower room, a clam bake, or a couple of stiff snorts. Be that as it may, the Elks' is an excellent quartet.

CONTINENTALS (Blue Network)—The Continentals is a very able organization made up of a chorus and soloists under the direction of Cesare Sodero and specializing in opera selections. The soloists include Astrid Fjelde, soprano—and an excellent one; Elizabeth Lennox, contralto; Julian Oliver, tenor, and Frederic Baer, baritone. The program is well selected and does not stick too exclusively to the threadbare arias. Tuesday evenings at nine Eastern time.

STROMBERG-CARLSON ORCHESTRA (Blue Network)—This is George Olson's band, playing under a trade name, and a first rate band it is, as others than ourself will assure you. Perhaps much of the credit for the smooth and beguiling manner in which it plays is due to its orchestrator, one Eddie Kilfeather, who specially arranges many of its numbers.

STADIUM CONCERT (Blue Network)—The Stadium concerts occupied, as last year, first place on the list of summer offerings. We were afforded mingled emotions in hearing our Mr. Stock as guest conductor of the Philharmonic musicians, what with the current prospects of having no Chicago Symphony Orchestra this coming season, due to wage disputes. (We wonder why the Orchestral Association didn't offer to sell broadcasting privileges to meet the increased demand for funds). To quibble about minor points: we saw no reason why the announcer should descend from his ponderous and dignified perch at intervals to refer to one of his fellow workers as "Jimmy." If they will be high-hat let them be consistent.

CITIES SERVICE CONCERT (Red Network)—An orchestra under the direction of Rosario Bourdon and a chorus called the Cavaliers. But what shall we say about them? we have exhausted our critical imagination. At any rate they are consistently good. They specialize in the lighter composers, Herbert, Friml, Straus, and so forth, with other occasional novelties.

ROYAL HOUR (Blue Network)—After having distributed roses the length of this column it is now our privilege to get mad. The Royal Hour's thirty-minute broadcast is a throw-back to radio's worst days. Advertising is jammed in so thickly that the musical part hardly has a chance to stick its nose out before it is drowned in further advertising. Every number on the program is introduced with a labored reference to the sponsoring company and its product.



Your A. C. Set

*How to Search for Defects
When Your A. C. Oper-
ated Receiver Goes Dead*

EDGAR H. FELIX

CALL THE SERVICE MAN

"Shut off the power, call for a trained professional service expert, and leave the set alone"—the advice to perplexed owners of a. c. sets in time of trouble by the head of the service department of one of the largest radio manufacturing concerns

THE head of the service department of one of the largest radio manufacturing concerns in the country was asked at a meeting recently what advice he would give to the owner of an a. c. operated set which has suddenly gone out of order.

"Shut off the power, call for a trained professional service expert, and leave the set alone," was his answer. "The troubles that arise with a. c. receivers are few and easily remedied by experts, but an experimentally inclined novice who doesn't know what he is doing can actually do great damage if he starts to tinker aimlessly. When a person gets sick, he calls on his doctor; when his automobile goes out of order, he brings it to the service station; but when a radio set goes wrong, three out of five listeners proceed boldly with soldering irons to change wires, to short-circuit transformers, to reverse connections, and to apply high voltages here and there, just to find out what happens. A competent man, familiar with the functioning of radio sets and their associated power supply, makes an inspection, analyzes the difficulty, and replaces whatever is necessary in a few minutes at a minimum of expense; a venturesome experimenter usually tinkers until he has done serious damage, then calls in an expert and, when he gets the bill, wonders why radio repairs are expensive. There is nothing mysterious or really troublesome about modern a. c. sets, and servicing them is usually a matter of the utmost simplicity."

Careless tinkering may prove an unhealthy pastime for the would-be radio expert who is accustomed to learn his radio by practical experience. Large condensers of several microfarads capacity, charged to 500 volts, may impress their effectiveness upon him with such force that he will find himself involuntarily, violently, and uncontrollably seated on the floor several feet from the radio set. But, if he temper his examination with knowledge, most of the likely faults of a. c. operated sets can be readily identified by their symptoms and, in some cases, the necessary measures for repair taken.

Servicing the a. c. set has brought a new dignity to the job of repairing radio sets because it has converted the receiver to an electric power device of considerable magnitude. Indeed, so marked is the change involved in the engineering design of a. c. sets that some of the earlier models, designed by radio engineers, failed prin-

cipally because of inadequate knowledge of power engineering.

The excessive service grief which attended some 1925 and 1926 a. c. sets has been largely cured by the application of the principles of power engineering to radio. These pioneer models taught us the stresses and surges to which the filter condensers are subject with the consequence that the latest receivers have condensers of considerably greater voltage-carrying power than those of past seasons. New rectifier tubes of greatly increased capacity have solved voltage regulation and life problems, while such refinements as ballast tubes and regulator tubes give the designer wide latitude in his work. Also we have new types of tubes which avoid the use of a rectifier by using alternating current for the A supply. All of these advances have brought us to the threshold of a new era in radio set design and the elimination of the burden of maintenance attention. Given capable engineering and adequate quality of materials, the modern alternating-current set, whether it be of one type or another, is reasonably reliable and a marked improvement in convenience over its less advanced predecessor.

Certain parts of the alternating-current receiver, however, depreciate with long use. It is no more possible to design a wear-proof radio receiver than it is to design a wear-proof automobile. Vacuum tubes lose their emission and condensers, unless of tremendously greater voltage capacity than their service requirements demand, eventually break down. It is only a matter of time, however, when the service attention required by a. c. sets will be reduced to a matter of annual inspection to replace rundown tubes. Indeed, some of the latest sets have actually reached that stage.

But we cannot expect a radio receiver to require no attention whatever. Filter condensers are really moving parts. They are constantly subjected to considerable voltages, and are charged and discharged rapidly and continuously. The atomic structure of their components is constantly strained so that in time they become less capable of resisting these rapidly changing voltage strains. The experience of the last two years has resulted in the widespread use of bypass and filter condensers which will, under ordinary conditions, serve for a period of years, rather than months, as was the standard heretofore. To men-

tion but one, if you have opportunity to look at the output condenser in the power supply of a Stromberg-Carlson a. c. receiver, you will observe that its size compares with that of condensers used in receivers of a year or two ago almost as does a match box with a steamer trunk! Expensive as these improvements are, they are an economy because they approach the ideal—"plug the set into the light socket and the receiver is ready to operate for a period of years without attention."

TWO TYPES OF A. C. SETS

IN GENERAL, there are two outstanding types of alternating-current sets—first, those in which the alternating current of the line is converted into direct current by rectifiers, smoothed by filters and then used to power filaments of the more familiar type of vacuum tubes and, second, those with tubes utilizing raw alternating current, either of the rugged filament or heater element type. Already considerable experience has been gained with the first type of set and its service and engineering difficulties are quite well known. With the second, there is less experience, and which of the two kinds will prove the ultimate winner is hard to say at this writing.

Tubes using raw a. c. for their A supply nevertheless need d. c. for B and C power, and therefore a rectifier of some kind is necessary unless A and C batteries are employed. The use of these tubes requires the introduction of an appreciable 60-cycle a. c. current right into the radio receiver, in and near the radio-frequency elements, introducing hum difficulties, and the life of the tubes under ordinary service conditions is yet to be determined. Considering that RCA, Cunningham, McCullough, Van Horne, and others are making a. c. tubes, it is certain that there has been much fruitful development work done since the first of this type of tube was introduced several years ago.

As to the first type of receiver, that is, those using conventional tubes, usually of the 199 type, with filaments in series and powered by a rectifier system, there is a wealth of practical experience in servicing them, gained during the last two seasons. The largest sellers in this class have been the Radiola super-heterodyne outfits used in connection with the 104 loud speaker and an a. c. rectifier power unit; the Garod, and the Zenith. By consulting not only manufacturers

but the service heads of responsible dealer organizations, it has been possible to learn what the service problems in connection with the sets are. The author is particularly indebted to the R. T. M. Service and to Mr. H. T. Cervantes of Haynes Griffin Radio Service for much of the information which follows, based on their experience with thousands of these sets in the New York area.

The procedure for locating trouble, the significance of symptoms, and the remedies, are described with a view to aiding the set owner in determining whether his set requires the services of an expert service man or whether a simple adjustment will put it back in service. Breakdowns with a.c. sets generally impose a strain on the rest of the outfit and, consequently, a certain amount of knowledge of possible difficulties may avoid more serious damage.

When the set goes dead, either shut off the power until the service man takes charge, or else immediately determine whether the rectifier tubes light and, if the set has them, note also if the ballast and the regulator tubes glow. If these tubes appear to be functioning, reduce the filament voltages by means of the filament rheostat. Sets with filament rectifiers do not, of course, give visual indication of their condition and inspection is of no avail. The usual procedure, with such rectifiers, is to test with a rectifier tube known to be good.

Next check the condition of the radio, detector, and audio tubes of the set. This is easy, if you can plug in phones in the detector and audio stages. A signal in the phones indicates that all the tubes supplying them, including radio-frequency and detector stages, and sometimes the first audio stage, are in good working order, as is the power supply for all but the final output tube.

In absence of this convenient test, examine the tubes in the radio receiver. If necessary, darken the room to do so because tubes of the dry-cell type do not generally light very brightly. With some series filament receivers, all the tubes go out when one filament fails. With others, a resistor is used in parallel with each filament as a protective measure and it will pass enough current to light the remaining tubes in the receiver when one or two filaments are burned out.

If you do not locate the tube out of order by inspection, substitute a good tube for each one in the receiver, one at a time, remembering, of course, the first instruction to keep the filament rheostats low.

In the case of sets without the filament resistors in parallel, an even more serious strain is impressed upon the filter condensers when one radio tube goes out, unless a regulator tube is employed. In some cases, when the filament load is removed from the rectifier system, the voltage builds up greatly, sometimes sufficiently, in fact, to cause the breakdown of filter condensers.

The capable service man who, from a brief inspection of the receiver, decides that one of the radio or audio tubes may be dead, tests the tubes with a tube tester rather than placing his reliance upon the power supply of the set to do so. This avoids undue overload of the rectifier condensers. The manufacturer's instruction book often explains the best course to follow when the receiver goes dead and, understanding the reasons for it, the reader will not leave his power supply turned on if his tube filaments do not light, should the manufacturer advise him not to do so. The best test of radio and audio tubes is to use a tube tester or to replace the entire lot. Otherwise substitute a good tube in each socket, one at a time, leaving the remaining tubes in their sockets.

Assuming that rectifier and ballast tubes light and that radio and audio tubes have been proved good, the next thing to examine is

the filament-type rectifier tubes. In most cases, if the rectifier tube or tubes show a blue or purple glow, it means that they have begun to leak. If so, place the set out of service at once, as there is no other repair possible than replacement of the rectifier tubes.

When there are two rectifier tubes, it may happen that the plates of one of them turns bright red while the other remains its normal color. Usually, this is a direct and simple indication that the tube which looks normal has lost its emission and the entire load of the set is being drawn from the other tube, which becomes red as a consequence of this overloading. The remedy is obviously replacement of the rectifier tube which does not overload.

On the other hand, when both rectifier tubes become bright red, it is due to an unusual load upon them, usually a broken-down bypass or filter condenser. Should this occur, the set should be placed out of service at once because this places an extreme overload on the rectifier tubes and the only remedy is replacement of the defective condensers. This is a job for an experienced service technician.

With those sets using regulator tubes, the simplest check which a service man is usually in a position to apply at once is the substitution of a good regulator tube to check the condition of the tube in service. When the regulator tube does not give a colored glow, either violet or pink, it is not receiving its necessary voltage supply, due to the shorting of a bypass condenser, failure of one or both of the rectifier tubes, a failing ballast tube or a radio or audio tube, the elements of which are short-circuited. It is the purpose of the regulator tube to keep the voltage supply constant. A prolonged loud signal or continued strong static may increase the brilliancy of its glow. But, if the antenna is disconnected any flashing of the regulator tube which occurs indicates that it is defective.

This completes the only frequent troubles encountered with a. c. sets. It is needless to go into the usual defects—loose connections, defective plug or flexible cord to power line, lost emission of power tubes, dirty contacts with socket, incorrect adjustment of reproducer, and other difficulties which are not specifically assignable to the a. c. set. They are the kind of difficulties which occur with increasing rareness as the mechanical and electrical design of receiving sets improve.

It may be worth while, however, to mention that a sudden increase of hum in the reproducer,

which has previously been quiet, may be due to the breaking down of a bypass condenser, a change in the load conditions of the power line, or reversed line connections. The latter is sometimes correctable by pulling out the plug, giving it half a turn, and re-inserting it. The power-line noise may require the attention of the power company as, quite frequently, it is the result of using an appliance in the immediate vicinity which sets up power surges in the line. These can be cured by installing an interference preventor at the device.

From the foregoing, it is obvious that there is nothing unusual or startling about the service requirements of a.c. sets. They introduce new problems but, once these problems have become familiar, they will not cause any serious modifications in radio servicing. The radio trade is learning that it must take its service responsibilities seriously while the consumer is recognizing that service is something which he should pay for, just as he does when he has his watch or automobile repaired. Free service has worked as much harm for the consumer as it has for the industry itself, because dealers giving extensive free service ultimately fail in business. And there can be no redress when the dealer has gone out of business. Amateur servicing with power sets, also, may result in more serious damage, just as does inexpert tinkering with an automobile. Just why there is hesitancy in admitting these simple facts is a little hard to understand, since, with a little consideration, anyone will understand that free service, inexpert service, and promises of perfect reliability do not promote satisfaction to the radio user.

It is premature to set up rules for the selection of a. c. sets at this stage because the relative merits of the various a. c. systems have not yet been fully proved by user experience. One of the safest guides is to consider the engineering reputation and stability of the manufacturer and the service reputation of the dealer from whom the set is bought. A manufacturer who has a reputation worth losing will not skimp by using a cheaper filter condenser in the hope that it will not break down prematurely, nor will a dealer of established standing in his community jeopardize his standing by taking on a line without adequate test and engineering examination. The day of the a. c. set is here. It means simplified radio and adequate power, essential to beauty of reproduction. It means a broader market for radio receivers, with the inevitable consequences of larger production and more radio for the money.

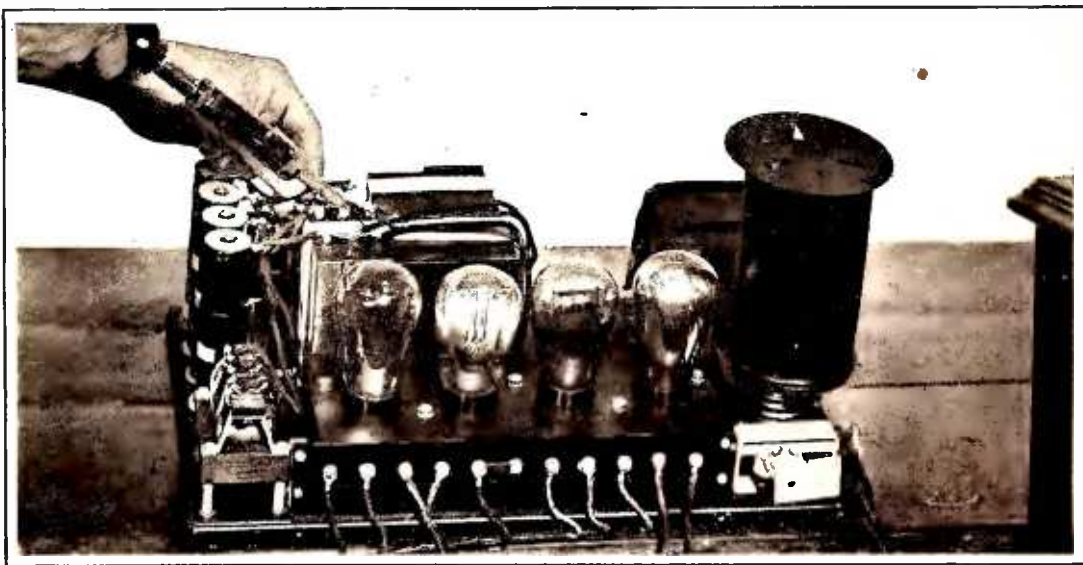

MAKING TESTS ON AN A. C. UNIT

The two-microfarad condensers on the RCA 104 loud speaker power unit are here undergoing tests for possible defects

AS THE BROADCASTER SEES IT

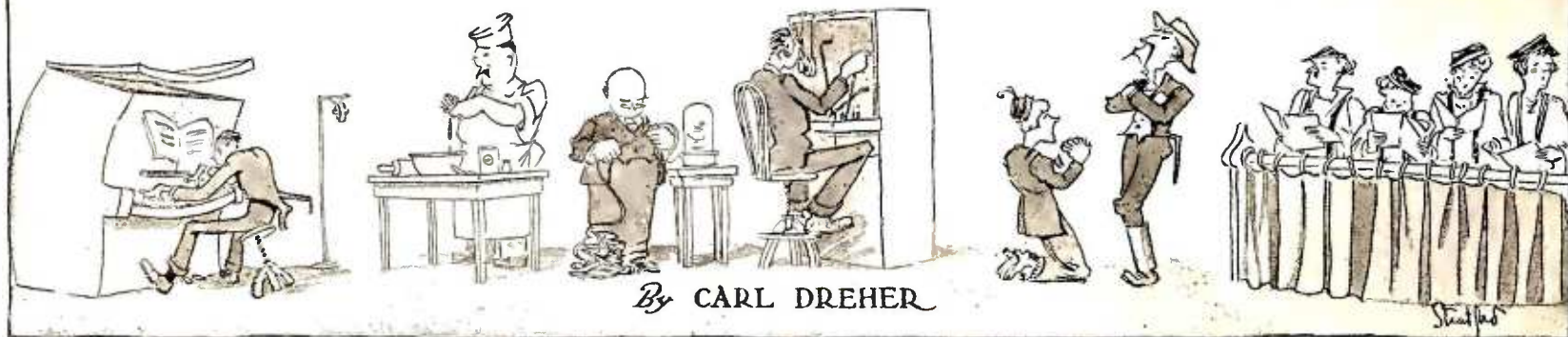

Going to Jail for Radio in Germany

IN THE United States, a good many, broadcast listeners are in jail, but not for listening to the programs. They went to prison first and listened to the radio afterward, broadcasting being one of the inducements offered in all up-to-date penitentiaries. In Germany however, radio has been the direct instrumentality whereby one gentleman went behind the bars. It appears that he was a *Schwarzhoerer*, which means, literally, a black listener, i.e., one who neglects to pay a fee and secure a license for his receiving set, as required by German law. The first time this recalcitrant BCL was caught he was fined and his set confiscated. The second time the authorities, with due process of law, clapped him into the jug for three weeks. If they catch him a third time presumably he will be tried by a court martial of studio managers and shot some Greenwich Mean Time morning.

As a practicing broadcaster, I regard this incident as a bad precedent, and am relieved that it occurred in a foreign country. For, if a broadcast listener may be sent up for a little radio bootlegging in this style, it is only a matter of time when the broadcasters themselves will spend their week-ends behind stone walls with spikes and sentry boxes on top. A program impresario permitting one of his flock of baritones to sing "Rolling Down to Rio" will be sent away for six months. The singer himself will merely receive a black eye at the hands of one of the catchpols, for delicate psychological tests have proved that all baritones are subject to an irresistible impulse to warble this tune. When one of the water-cooled tubes lies down in the middle of a program, interrupting the festivities for a minute or so, the engineer of the station will be set to breaking rock for one year. When the transmitter deviates from the assigned frequency, the jolly technician will be separated from his wife and children one year for each kilocycle high or low and if another station has been heterodyned the owner thereof will be permitted to extract the offending engineers' teeth. This may seem a cruel, unusual, and hence unconstitutional punishment, but it is a sound maxim of law that a statute may be constitutional in one age and unconstitutional under later circumstances, and some judge may reverse the process and decide that, as broadcasting was not known to the Founding Fathers, new and appropriate punishments may properly be devised for erring broadcasters. On this principle, announcers who read telegrams of appreciation to the radio audience will be forced to eat a pound of coarsely ground Celotex. Announcers who read their own poetry over the air will be thrown to the tigers

in the nearest zoo, thus relieving the tax-payers in two ways.

Some of these penalties, I admit, appeal to me, and I have derived pleasure in contriving them. But, as I said, I disapprove the principle, since I am a broadcaster myself, and might be one of the first to be dragged to the hoosegow. I therefore appeal for moderation in this instance, and shall telegraph to my Congressman requesting that our government make representations to the Reich on behalf of the imprisoned *Schwarzhoerer*.

Radio's "Aristocracy of Brains"

I OFTEN reflect on the melancholy fact that the men who really made radio, the Marriotts, Alexandersons, Fessendens, Hogans and the rest, are not as well known as the more popular announcers of fifty-watt stations. Compared to the coruscating luminaries of the networks, like MacNamee and Cross, the engineers do not shine at all. For this there are, of course, sufficient reasons, psychological and sociological; one might as well lament that Dr. G. W. Crile is not as well known a man as Babe Ruth. I shall not waste my tears in this cause, yet I cannot refrain, coming down to cases, from pointing an accusing finger at our contemporary and friend, *Popular Radio*, which on Page 402 of its April, 1927, number, prints a picture with the caption, "A Group of Radio's 'Aristocracy of Brains.'" The description which follows is reprinted verbatim:

Dr. Ralph Bohn (in front of the desk) is receiving the Liebman Memorial Prize of the Institute of Radio Engineers from Mr. Donald McNicol, former President of the Institute. Dr. Bohn himself is the new president. At Mr. McNicol's left is Mr. John V. N. Hogan, Contributing Editor of *Popular Radio*. Next to him is Mr. R. H. Mariott. Behind Dr. Bohn are Professor Michael I. Pupin, of Columbia University, Mr. L. E. Whittemore, and Mr. E. F. W. Alexanderson, well-known inventor and radio engineer of the General Electric Company.

Children, what is wrong with this description? In the first place, the President of the Institute of Radio Engineers is Dr. Ralph Bohn. The prize is awarded each year in memory of Colonel Morris N. Liebmann. Mr. Hogan's middle initials are V. L. Robert Henry Marriott, the first President of the Institute, spells his name with two "r's." Finally, the gentleman in the picture just behind Professor Pupin looks suspiciously like Dr. J. H. Dellinger, and not at all like Mr. Whittemore. The total of errors appears to be five. I call loudly for a more flattering vigilance

in such matters on the part of Messrs. Kendall Banning and Laurence M. Cockaday. They run altogether too good a magazine to permit such a high concentration of mistakes to the cubic centimeter of printer's ink to pass unnoticed, especially in reference to the Brahmins of the radio art.

Memoirs of a Radio Engineer. XX.

MY FIRST assignment at the Aldene factory was in the test shop. This was a good-sized room in the old stone building, which later became merely an annex to the modern factory structure erected to fill the war-time requirements of the Army and Navy. Along one wall there was a switchboard controlling the supply of a.c. and d.c. to various outlets. For the rest the room was crowded with quenched spark transmitters of all sizes from one-quarter to five kilowatts, miscellaneous apparatus in various states of disarray, work tables, meters, and a few men: W. H. Howard, the Chief of Test; Baldwin Guild, now practicing patent law with Pennie, Davis, Marvin, and Edmonds; my present colleague O. B. Hanson; a tall gentleman named Lieb; a more medium-dimensional gentleman named West, and myself. I may have omitted someone, but I think this comprised the list in May, 1917.

The engineering staff of the Marconi Company had the privilege of using the facilities of the test room for experiments when they could get in. By experiments I do not mean research on electron velocities or anything else at all recondite, but merely such incidental tests and measurements as always accompany the design of apparatus. This work had to be sandwiched in between the routine test functions of the department. Inasmuch as I was known to possess some engineering training, I was assigned temporarily as a sort of assistant to engineers who required work to be done in the test room. My first job was handed to me laconically by Mr. Woodhull, one of the transmitter engineers. A five-kva transformer was trundled into the test shop and dumped off. "Measure the iron losses," said Mr. Woodhull, and disappeared.

I gazed at the transformer. It contained plenty of iron in the form of a shell core, and no doubt there were losses. I could identify the primary leads, which were to be fed at 110 volts a.c., and the secondary terminals, which were expected to deliver juice at 10,000 volts or so to the quenched spark gap of the five-kilowatt transmitter. I had never measured the iron losses of a transformer, but I had some vague recollection, from

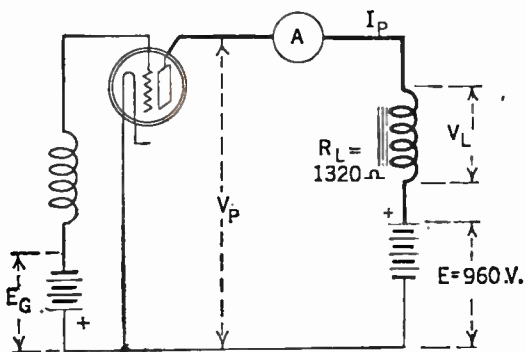

FIG. 1

my studies, that the procedure was to put rated voltage across the primary, leave the secondary open, and measure the power input with a wattmeter under this no-load condition. So I looked around for a wattmeter. The only one I could find had a full scale deflection of 7.5 kw., so I hooked it up and threw the switch. Nothing happened. I disconnected the wattmeter and tested it on another set which was under load. There was nothing obviously wrong with the instrument; it read several kilowatts. I put it back in my circuit and tried again, still without results. After an hour or so Woodhull came back and wanted to know what the iron losses of his transformer were. With much embarrassment I confessed that I did not know, and showed him my predicament. He looked over the circuit, and then glanced at the wattmeter. The scale made him laugh. "The iron losses are only of the order of a hundred watts," he told me. "You can't read that value on this scale. Get a 0.5-kw meter out of the storeroom and try again." Following these directions, I measured the iron losses of the 5-kva transformer at 70 watts, if I remember the figure correctly. Then we went ahead with some other tests involving loads.

This incident illustrates what the engineering student just out of school is up against. He usually has only a vague idea of magnitudes. I had studied under first-rate teachers and my preparation in some directions, was not at all bad. But there were numerous other fields in which I really did not know whether the answer would come out in millimeters or meters, or watts or kilowatts. If that wattmeter had swung up to a reading of a kilowatt or two for the iron losses of a small transformer, I should not have been surprised. A bonehead idea? Certainly, at that

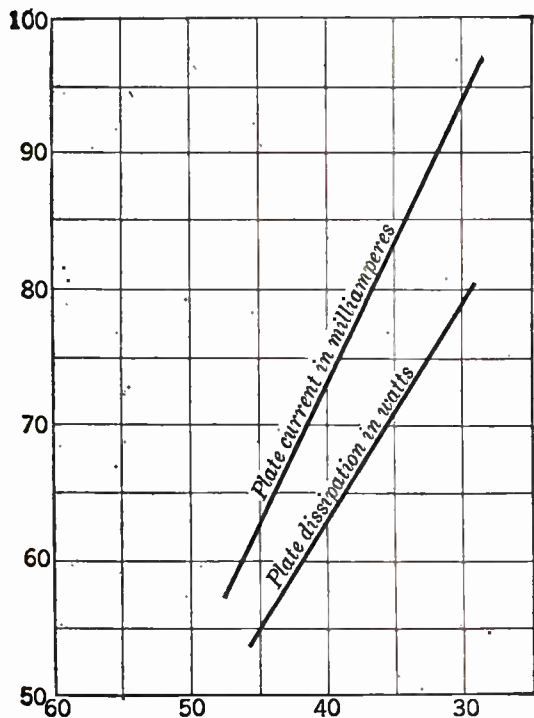

FIG. 2

place and time. But what is a good engineer? One who has, in the course of practice, got rid of a few thousand of such bonehead ideas. He gets paid largely for the relatively accurate judgment of physical magnitudes (always checked by measurement) and economic results (always checked by the balance sheet) which he has been able to put in their place.

(To Be Continued)

Technical Problems for Broadcasters. IV

THE plate feed of a fifty-watt (oscillator rating) tube used as a reactance-coupled amplifier in a broadcast transmitter is shown in Fig. 1. Plate potential is supplied by a storage battery with an output voltage E of 960 volts, the internal resistance being negligible. The reactor in the plate circuit has 50 henrys inductance and the d.c. resistance R_L is 1320 ohms. The resistance drop across it is designated by V_L , and this will necessarily depend on the mean current plate current I_P which is indicated by a milliammeter A in the plate circuit. This plate current varies with the negative grid bias E_G according to the upper characteristic curve of Fig. 2. The problem is, Given a safe plate dissipation of 70 watts for the tube in question, what is the minimum allowable negative grid bias under the conditions shown?

Solution

We are told that 960 volts is the steady output potential of the storage battery under all conditions, since its internal resistance may be neglected. Hence, in order to find the actual voltage V_P on the plate of the tube, all that is required is to find the voltage drop along the reactor for various plate currents, and subtract these values from 960. The plate dissipation W_P of an amplifier of the type shown is the product of the mean plate current and voltage, as indicated by d. c. instruments in the circuit. We may therefore draw up the following table:

E_G Volts	I_P Mill-Amperes	V_L Volts	V_P Volts	W_P Watts
30	94	124	836	78.5
35	83	105	855	71.0
40	72.5	95.5	864.5	62.5
45	62	81.5	878.5	54.4

The first two columns are obtained from the plate current-grid voltage characteristic. The V_L column follows when the value of plate current in each case is multiplied into 1320, the d.c. resistance in ohms of the reactor, giving the direct voltage drop across the winding. Subtracted individually from 960 volts, these values yield the actual plate potentials corresponding to the various grid bias figures. The plate dissipation is then calculated in each instance as the product of the V_P and I_P . As it happens, the plate dissipation results are numerically of about the same order as the plate currents in milliamperes, so that they may be plotted in the form of the lower curve of Fig. 2. (This is an accident, resulting from the fact that the plate potentials are near 1000 volts, but of course an independent characteristic could be drawn in any case.) From this curve we note that 70 watts dissipation corresponds to 35.5 volts negative grid bias. The answer to the problem is, therefore, that 35.5 volts is the minimum allowable bias to be used with the tube in question if the plate is not to be overheated.

Abstract of Technical Article. VI

"Making the Most of the Line—A Statement Referring to the Utilization of Frequency Bands in Communication Engineering," by Dr. Frank B. Jewett. Presented before Philadelphia

Section of the American Institute of Electrical Engineers on Oct. 17, 1923. Reprinted May, 1924 by Western Electric Company, Inc. (Bell Telephone Laboratories, Inc.).

ALTHOUGH telephone wires used in connection with broadcast transmission are in general not utilized for other communication services during program periods, technical broadcasters will find it instructive to learn something about the multiplication of channels on expensive long distance circuits by the use of separate frequency bands for different purposes. Doctor Jewett, who is himself responsible for much of this development, has outlined the main features in this paper.

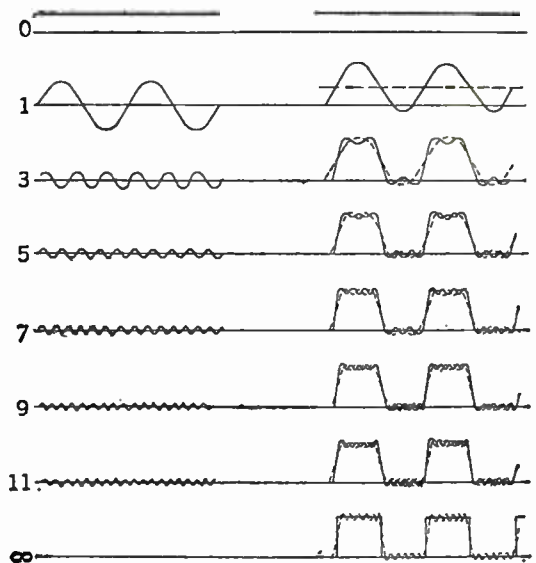

FIG. 3

The first point which concerns us is the analysis of a square-topped wave, reproduced here as Fig. 3. Such a wave is produced in a direct current telegraph system which has neither capacity nor inductance, as the circuit is made and broken by a key. It may be established mathematically and graphically that such a square-topped wave is composed of a continuous direct current and a number of sine wave alternating currents, comprising a fundamental frequency corresponding to the keying frequency, and, theoretically, an infinite number of odd harmonics. Fig. 3 shows this d.c., and the a.c. components up to the eleventh harmonic, with the resultant wave form in each case, and the ideal rectangular shape which is secured when all the harmonics are preserved. Fig. 4 is a diagram showing the same components in their relative amplitudes. If the current at the receiver is to be a strict reproduction of that at the keying end, frequencies considerably higher than the keying frequency must be transmitted. With hand sending it may be necessary to pass over the line frequencies as high as 40 cycles, to preserve the wave shape. With a multiplex printer the range is preferably extended to 100 cycles per second. Even in telegraphy, we note, accurate reproduction (what we call "good quality" in broadcasting) requires widening the frequency band.

Instead of keying a direct current for telegraph

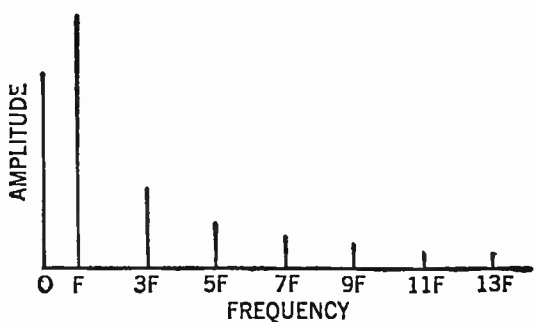

FIG. 4

communication, we may make and break an alternating current carrier. The resulting wave is shown in Fig. 5, the carrier being assumed to obey a sine law, and the line to be without inductance or capacity. This wave may be resolved into a fundamental and harmonics, as shown in Fig. 6. The difference between Fig. 4 and Fig. 6 is that in the former (d.c.) case the harmonics are grouped in ascending order on the positive side of the horizontal axis, starting with the frequency 0, which is the direct current component, while with an a.c. carrier the harmonics are grouped on either side of the carrier frequency. In the latter method we employ a process of modulation and remodulation (now more

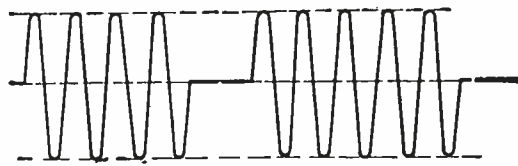

FIG. 5

In low frequency telephony a complex combination of frequencies corresponding to the sounds of speech and music must be transmitted, with fair fidelity in the case of commercial toll circuits and with considerable fidelity for broadcast purposes. In high frequency telephony, whether by radio or line carrier current, the same process of modulation and demodulation is carried out, but the representative chart of current components shown in Fig. 7 indicates the infinite number of harmonic mixtures and proportions. This particular combination corresponds to the sound of long o modulated by the human voice, and is relatively lacking in high overtones.

In transmitting a number of signal waves over a common circuit it is necessary to generate and

separate various kinds of currents. The devices used in the latter process fall generally into two classes:

1. Elements such as transformers, condensers, and choke coils, which discriminate between alternating and direct currents.
2. Filters.

The use of (1) is familiar in urban telephone systems of the central energy type. Low frequency (usually 16-cycle) alternating current is employed to ring subscribers' bells, direct current is supplied from a common battery for the transmitters, and alternating currents of voice fre-

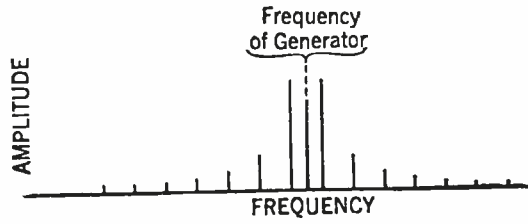

FIG. 6

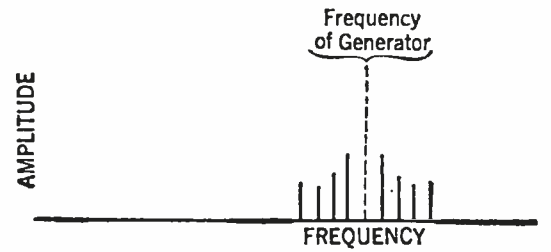

FIG. 7

commonly called demodulation). The process of modulation consists in taking a group of currents which have a certain relation to each other, mixing them with a carrier and thus translating them to a more convenient frequency band, while not disturbing the relation between them, and then, in demodulation, getting back the original group at its original frequencies. This is what we do in radio telephony as well as in the carrier telegraph illustration here used. Fig. 6, it will be noted, shows a carrier with both sidebands. For the transmission of intelligence only one of the sidebands need be retained, a locally generated carrier being substituted for the transmitting carrier, at the receiver, for the purpose of demodulation.

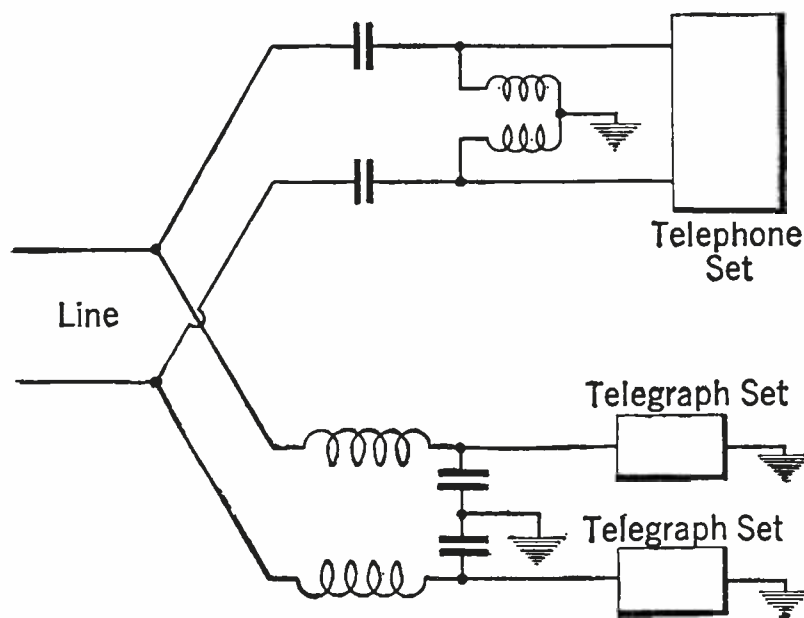
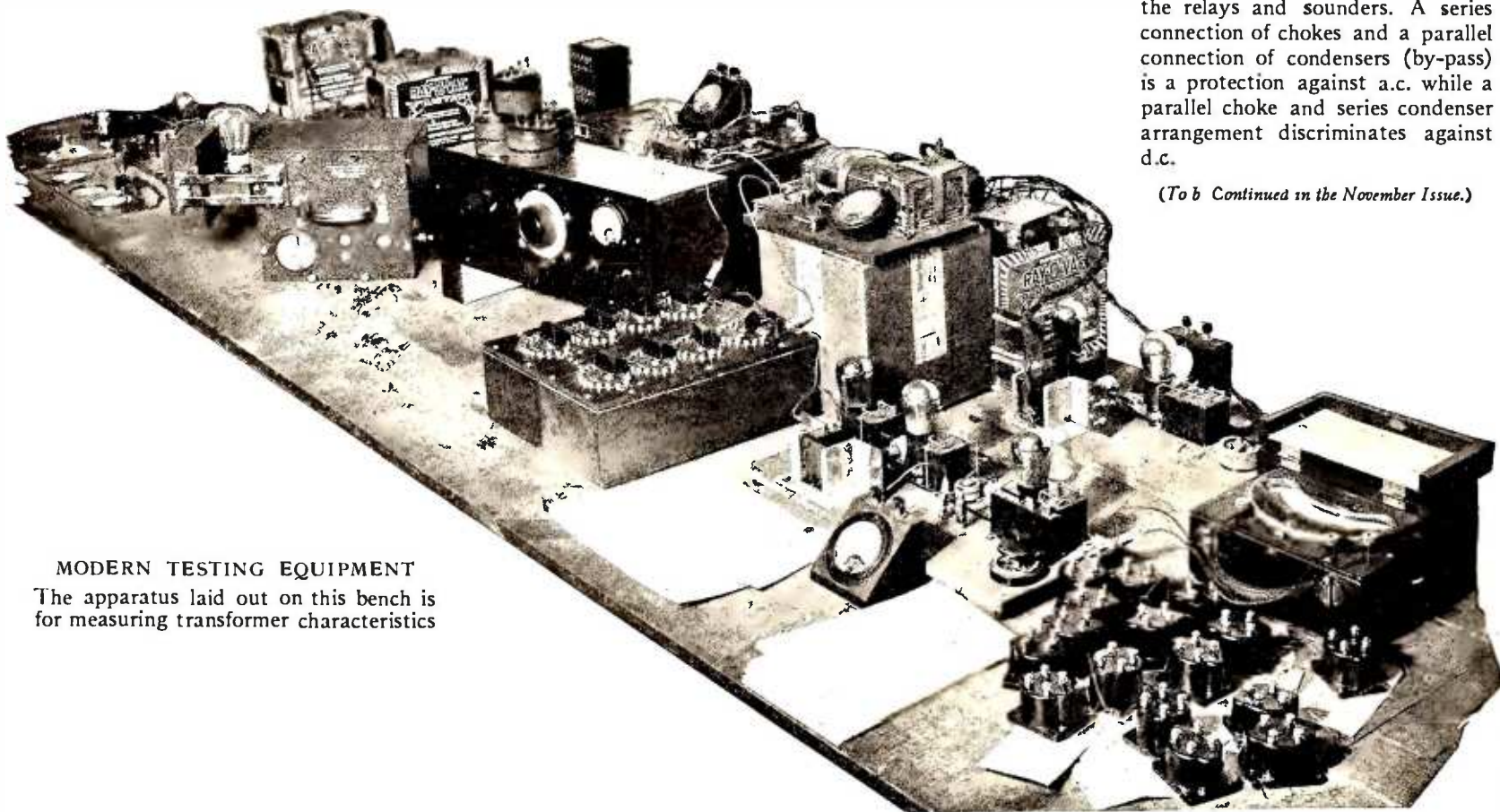

FIG. 8

quency pass between the subscribers and operators. Direct current is supplied only when the receiver is off the hook, being controlled by the hook switch. The operator's ringing key controls the low frequency a.c. used for signalling. The voice currents pass from one trunk circuit to another through repeating coils, but d.c. is confined to subscribers' loops by the same agency. (Audio amplifiers, and such devices as output transformers for loud speakers, utilize inductances and capacities for similar purposes.) A.c.-d.c. separation is also required in joint use of telephone and direct current telegraph services on one line. Fig. 8 shows one such arrangement, blocking condensers being used to keep the d.c. telegraph currents out of the telephone set, and chokes to keep the voice currents away from the relays and sounders. A series connection of chokes and a parallel connection of condensers (by-pass) is a protection against a.c. while a parallel choke and series condenser arrangement discriminates against d.c.

(To be Continued in the November Issue.)



MODERN TESTING EQUIPMENT

The apparatus laid out on this bench is for measuring transformer characteristics

Home-Constructing Transformers and Chokes for Power-Supply Devices

The Second of Two Articles Intended to Obviate Tricky Mathematical Calculations when Building These Units—The Design of Choke Coils, and the Actual Construction of Both Chokes and Transformers, Is Discussed

By HOMER S. DAVIS

CHOKES are used in radio work chiefly to introduce opposition to the flow of alternating current, while at the same time allowing direct current to pass easily. In general, the lower the frequency of the alternating current, the more the inductance required. At radio frequencies, air-core chokes may provide sufficient opposition, but at audio frequencies and for smoothing out the ripple in power-supply units, an iron core is provided to make possible a greater inductance in a more compact unit, since the magnetic flux will flow through iron more easily than through air.

A different situation exists in the core of the choke coil than in the transformer core. In the latter, the magnetic flux due to the alternating current has the core all to itself, while in the case of the choke it has to share the core with the flux due to the direct current. To make certain that the direct current flux does not saturate the core, an air gap must be placed somewhere in the core. This greatly complicates the design, and a reasonable length of gap is difficult to maintain. Too great a gap will reduce the inductance and therefore require a larger choke for the same amount of inductance, while too small a gap will increase the harmonics, thus impairing the filtering action. It is generally agreed that a good value to use is one that uses up about ninety per cent. of the magnetizing force. For an ordinary silicon steel core this means a gap about 0.005 inches long for each inch of core length. The actual value to give best results can be determined only by trial with the other apparatus with which the choke coil is to work. Only the core type of construction will be considered in this article, as was done in the case of the transformer, design data for which were given in last month's article.

The inductance of the choke coil is proportional to the cross section area of the core, to the square of the number of turns of wire, and inversely to the length of the air gap. This is expressed mathematically as:

$$L = 3.2 \frac{AN^2}{G10^9} \dots\dots\dots (1)$$

where L is the inductance in henries, A the net area of the core cross section in square inches, N the number of turns, and G the equivalent air gap in inches. The equivalent air gap is defined as the total reluctance of the core, including the actual air gap, reduced to an air gap of the same cross section, which will replace it. The value of equivalent air gap to use in designing the choke is uncertain. It is best figured from the formula:

$$G = 3.2 \frac{NI}{B} \dots\dots\dots (2)$$

in which N is the number of turns of wire, I the current in amperes, and B the flux density in lines per square inch. The value of I being predetermined, adjust the number of turns so as to give a flux density of not more than about

50,000 lines per square inch, with a reasonable value of G. This is relatively easy with small currents, but with the larger currents it is very difficult to maintain reasonable flux density. The value of G increases with the size of the choke, starting with about 0.03 inches as a minimum.

To avoid the mathematical difficulties of using the above formulas, calculation charts have been devised to replace them, formula No. 1 being represented by Chart II and formula No. 2 by Chart I.

The first things to begin with in designing a choke coil are the inductance and the current capacity. A reasonable length of air gap is then decided upon, and a flux density of about 50,000 lines per square inch assumed to start with. The number of turns can then be found from formula No. 2 or Chart I, after which the size of core may be figured from formula No. 1 or Chart II. Here it may be found that either the amount of copper or the size of the core is excessive from the standpoint of economical and compact design, in which case it may be necessary to try again with a larger air gap or a smaller flux density, or both. Several trials are often necessary before a reasonable design is arrived at. Then with these vital factors settled, the next step is to choose the size of wire to handle the current, just as was done with the transformer.

Here again it is convenient to lay out a full-size drawing of the choke coil, to see just how its proportions will work out. As with the transformer, a compact arrangement should be striven for. Enamelled wire is best for the choke, as the voltage difference per turn is small and thicker insulation would make the choke unnecessarily bulky. Allow for about $\frac{1}{16}$ " of insulation between the winding and the core. Insulating papers between layers are seldom used with choke coils. If the layout looks unwieldy with all the winding on one side of the core, it may be split into two coils on opposite legs. Although this requires less wire per turn, about 10 per cent. more turns should be added to each coil to make up for the effect of leakage of flux between them. With the drawing completed, the length around the center line of the core may be measured and the theoretical length of air gap computed on the basis of 0.005 inches per inch of core length, and compared with the value used in the design, to make sure that the latter was not assumed too small. The amounts of wire and core material may be estimated in the same manner as with the transformer. The resistance of the choke coil is an important factor, and, knowing the total length of wire and looking up its resistance per thousand feet in the wire table, on page 277 of the August article, it may be readily estimated. If the resistance proves greater than desirable, use a larger size of wire.

The solution of a typical example should

clear up any doubtful points remaining. Suppose a 20-henry choke coil is desired, capable of carrying 85 milliamperes of direct current. Where a choke is connected directly to the output of a rectifier without previous filtering, the maximum value of the rectified alternating current may be as high as 1.57 times the value of the direct current. Since both the alternating and direct currents contribute to the flux in the core, and only the direct current component has been used in the formulas, it is customary to allow for the alternating current component by modifying the value of flux density substituted in the formulas. About 35,000 lines per square inch will be satisfactory. Assume an equivalent air gap of about 0.05 inches. The number of turns of wire to wind on the coil may be found from Chart I. The key at the bottom of the chart shows which scales to connect together. Accordingly, draw a straight line from 0.085 on the current scale to 35,000 on the flux density scale. Through the point at which this line crosses the index line, draw a second line from 0.05 on the equivalent gap scale until it meets the turns scale, at 6500 turns in this case. Next, the size of core to use is obtained from Chart II. Draw a line from 20 on the inductance scale to 0.05 on the equivalent gap scale. Through the point at which this line intersects the index line, draw a second line from 6500 on the turns scale until it meets the core area scale. This point indicates a net area of 0.74 square inches, which is approximately equivalent to a core $\frac{7}{8}$ " square.

As mentioned before, the design is not so straightforward for the larger currents. It is difficult to arrive at a compact, economical design, and frequently it is necessary to make several trials. Sometimes a faulty design will not be evident from the plain figures, but will show up when the full-size drawing is made. The only remedy is to try again.

Having settled on the number of turns and area of the core, the next step is the determination of the wire size. This is done in exactly the same manner as with the transformer. Then comes the full-size layout, estimation of materials, and resistance calculation. If the resistance proves excessive for the particular use to which the coil is to be put, choose a larger size of wire and make a new layout. The design is then complete.

CONSTRUCTION

THE preparation of the core of the transformer or choke coil should be undertaken first. Several sources of the material are open to the constructor. Oftentimes a junked pole transformer may be obtained for a small sum from the shops of the local power company or from a junk yard, the core of which may be removed, cleaned with kerosene or alcohol, and cut down to the required size. For use in a B socket power-supply device, the core of a toy

IRON CORE
CHOKES COILS

URNS

CORE

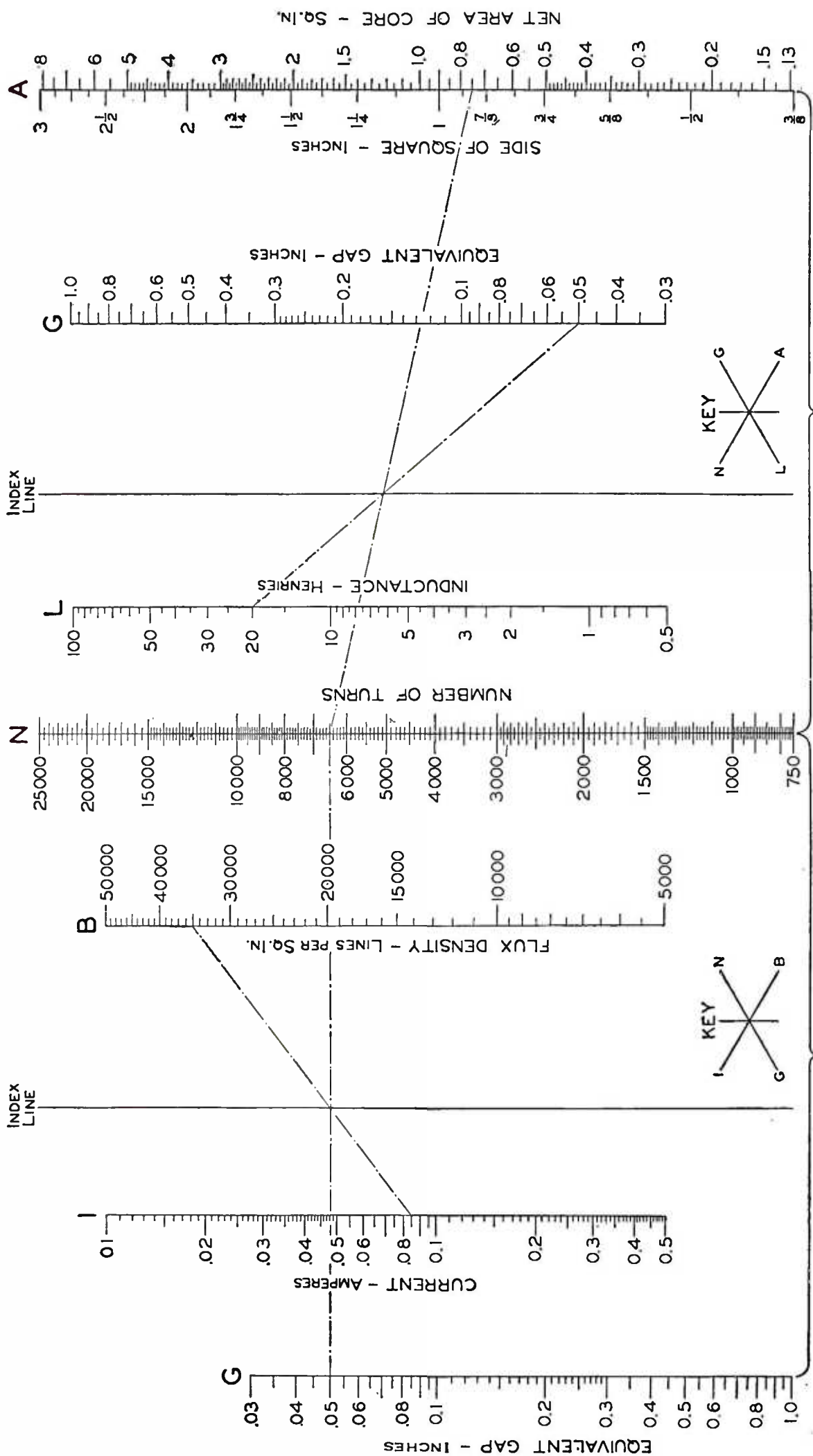

CHART I

CHART II

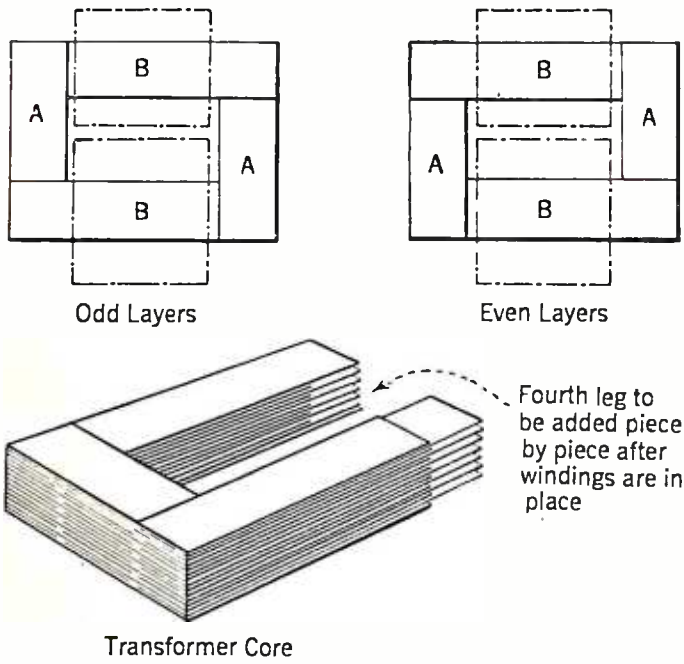

FIG. 1

transformer will often be found to be about the right size without cutting. Ordinary stovepipe iron may be cut to size and used, but it will increase the losses, resulting in excessive heating and waste of power unless a much larger core is used. The use of regular transformer steel is recommended wherever possible. Motor or armature repair shops sometimes handle it. Supply houses that cater to transmitting amateurs often stock it and will cut it to any desired size. Their advertisements may be found in current amateur periodicals or their addresses obtained from a neighboring "ham." This source lacking, purchase the best available grade of soft sheet iron or steel from a local tin shop. It should be not more than 0.014" thick. It is best to cut the material to size with squaring shears, or to have a tinsmith do it, as accurate work is essential. Unless the pieces are square and of uniform size, poor joints at the corners will be inevitable and the resulting small air gaps will increase the core losses due to reduction of effective area. All rough edges should be removed and the pieces should lie flat.

If an old core is used, the construction of the transformer will of course depend upon whatever conditions are encountered. But assuming that the raw material is available, several types of core arrangement are possible. The one shown in Fig. 1, using interleaving joints, is most convenient for transformers. Two different sizes of pieces are required, shown as A and B, with enough of each to stack twice as thick as the completed core when tightly clamped. Another way of building up the core is indicated in Fig. 2, but this type is not practical unless the pieces of the core are very accurately cut and closely butted together. This construction may be used for choke coils, however, since an air gap is required somewhere in the core, its location being immaterial as long as the requisite total length is provided. Fig. 3 illustrates a modified construction for chokes which has the advantage of being easier to clamp. In this case the pieces are cut to four different sizes, with enough of each to make up the full thickness of the core.

Some sort of insulation between the laminations should be provided, to reduce the core losses due to eddy currents. Commercial transformer steel usually comes with an oxide coating for this purpose. Ordinary rust is often sufficient when the oxide coating is not present, but it is better to apply a thin coat of shellac to one side of each piece, allowing it to dry thoroughly before assembling.

If the interleaving type of construction is used, the building up of the core may be expedited by providing some sort of square corner as a guide, such as a cigar box with two adjacent sides removed. Only three sides of the core should be assembled at first, alternating the layers as shown in Fig. 1; the fourth side is to be put in place by piece after the coils have been slipped into place. The partially completed core is carefully removed to a vise and clamped, and the legs that receive the coils bound tightly with a layer of tape, or with heavy string, which may be later unwound as the coils are pushed onto the core. The joints should be carefully trued up, making sure that the pieces butt together well. A wooden mallet, or a rawhide or lead hammer may be used for this purpose.

Preparing the coils is not difficult if done properly. They should be evenly wound in layers, not only to make for compactness, but to prevent the possibility of two turns of widely different voltages coming together. Coils of small enameled wire should have a layer of paper between each layer of wire, to keep the winding even and to improve the insulation. If special insulating papers are not available, tracing paper such as used by draftsmen, will serve the purpose nicely; ordinary wrapping paper can also be used. These papers may be omitted with the larger sizes of enameled wire, since they are easier to wind evenly and the voltage difference between layers is less. They may be dispensed with entirely if cotton-covered wire is used.

Windings of cotton-covered wire may be made moisture proof and more rigid by applying a thin coat of shellac to each layer as wound, and baking the finished coil to dry it out. Enameled wire cannot be treated in this way, however, as the shellac may soften the enamel. Small coils of enameled wire may be made rigid by dipping them in melted wax, such as a mixture of beeswax and rosin. Ordinary paraffin is not suitable, as it may soften if the transformer runs at all warm. Large coils may be painted with insulating varnish or black asphaltum paint.

The windings may either be made self-supporting or wound on a fibre spool which is slipped over the core. The former is the more common method. A square wooden mandrel the same size as the core cross section is first prepared, cut to the same length that the winding is to be, and sanded smooth. For the larger core sizes it may have to be built up of several thicknesses of wood glued together. Flanges a quarter of an inch thick are then screwed to each end, as shown in Fig. 4; these are later to be removed in order that the winding may be slipped off.

Some means of rotating the winding form must be provided. A convenient arrangement is to

drive a spike in the center of one end of the mandrel, grind or file off the head, and secure the end of the spike in the chuck of a hand or breast drill which is clamped horizontally in a vise. A lathe may also be used. A small geared emery wheel is excellent for the purpose. Another common method is to fasten the mandrel to a wooden disc which is clamped or wired to the flywheel of a sewing machine. If a geared emery wheel or hand drill is used, the number of turns of wire may be computed by determining the turns ratio between the crank and the spindle, and then counting the turns of the crank. Another way is

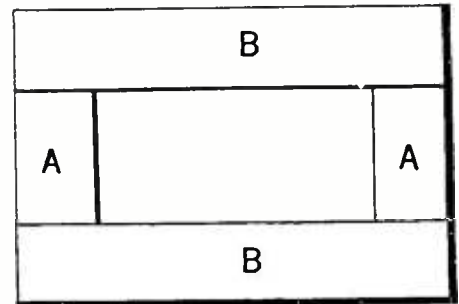

All Layers

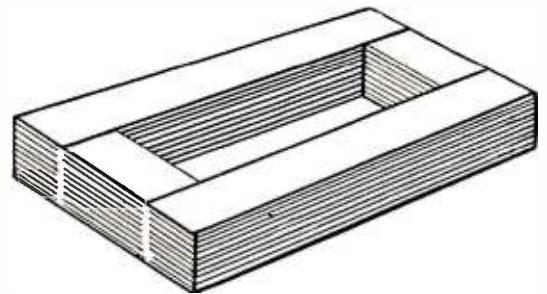
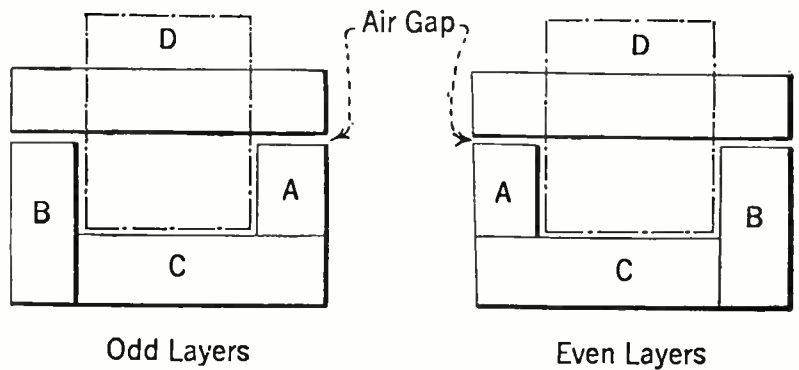

FIG. 2

to insert the spindle of a revolution counter into a hole in the free end of the mandrel, as shown in Fig. 4.

As the coils are to be taped when finished, wind a layer of heavy string around the mandrel and fasten the ends. This is to be unraveled after the coils are wound, enabling them to be slipped off easily and allowing room for the tape. A layer or two of fibre is then cut to size and squarely



Odd Layers

Even Layers

Choke Core.

FIG. 3

bent around the string-covered mandrel and glued in place. On high-voltage windings, above about 500 volts, add a few layers of empire cloth, which may be obtained at motor repair shops.

WINDING THE COIL

THE coil is now ready to be wound. Pass the free end of the wire through a small hole drilled in the flange, leaving enough wire to provide a lead to the panel. If fine wire is used, the lead and the first few turns should be of insulated flexible wire, to avoid any possibility of the lead breaking off. The fine wire is then soldered to this, carefully cleaned of any excess flux, and the joint covered with a bit of tape. The rest of this first layer is then wound. If the wire is cotton-covered, this layer, and each succeeding layer as wound, may be given a thin coat of shellac as a binder, or insulating papers may be used as described above, for enameled wire. The wire should be wound as tightly as its strength will permit. It may be necessary here to wear a glove on the guiding hand, or to pass the wire over a piece of cloth held in the hand. Guiding the wire will be made easier if the hand is held as far away from the coil as is convenient. The turns should be kept close together and not allowed to overlap, and extreme care should be exerted to avoid any possibility of shorted turns. A shorted turn acts as an independent short-circuited secondary and will burn out as soon as the transformer is connected to the line. Where taps are brought out, the turns per layer should be so arranged, if possible, that the taps will come at the end of a layer. Be especially watchful here for shorted turns. In finishing the winding, pass the end of the wire through another small hole in the flange and fasten the last few turns with a bit of sealing wax. With fine wire the last few turns and the lead should be of flexible wire just as at the start. If another winding is to be placed over the first, they should be separated by several layers of friction tape or empire cloth.

Where a split secondary is used, the two coils may be wound side by side, each covering half the mandrel, rather than one on top of the other, to insure their having symmetrical characteristics. An end flange may be removed while a fibre separator is slipped in place, and one side filled tightly with cloth strips while the other is being wound, to prevent the separator being crowded over. A split or center-tapped filament winding of only a few turns may be wound by means of a pair of wires, each comprising half of the total number of turns, the end of one wire being connected externally to the beginning of the other so as to put them in series. The connection between the two is used as the center tap.

The finished winding may be removed from the form by taking off one of the flanges and pulling out the layer of string, after which the coil can be slipped off. It may then be taped, as in Fig. 5, using ordinary friction tape and advancing half the width with each turn. High-voltage coils

should be covered with empire cloth tape. The tape should not be allowed to bunch at the inside corners, or trouble will be experienced in inserting the core. The coils should not be taped too heavily, or they will not cool well.

Small coils of enameled wire may be conveniently made by winding them on spools made of pieces of fibre glued together. After being wound the wire may be covered with a layer or two of heavy paper or one layer of friction tape.

The finished coils, after painting or moisture-proofing, may now be placed on the core, unwinding the string on each leg as its coil is pushed on. The fourth leg of the core is then put in, piece by piece, hammering the corners up tightly. If the winding fits too loosely, extra core pieces may be forced in, taking care not to damage the insulation of the coil, or small wooden wedges may be driven between the coil and the core.

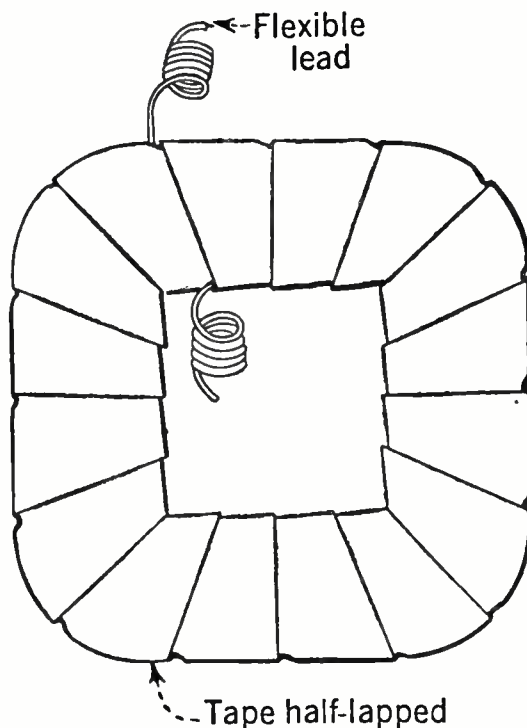

FIG. 5

The whole assembly should be made rigid, to reduce any audible hum when the transformer is in use.

Methods of mounting the transformer or choke coil are shown in Fig. 6. Angle iron, strap iron, or square lengths of wood may be used for clamping the core. Another method is to drill a hole

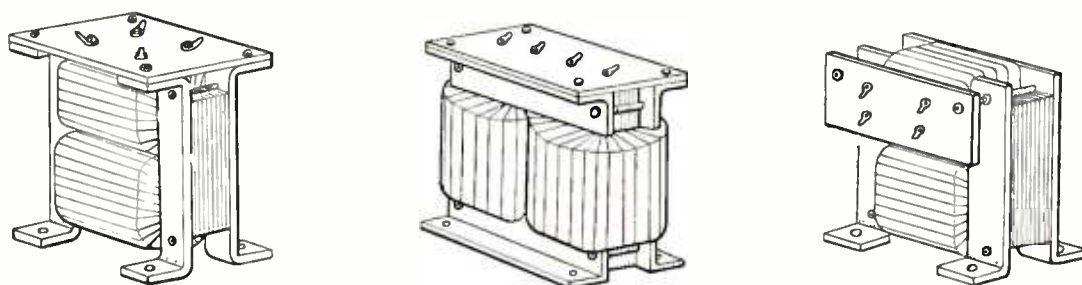

FIG. 6

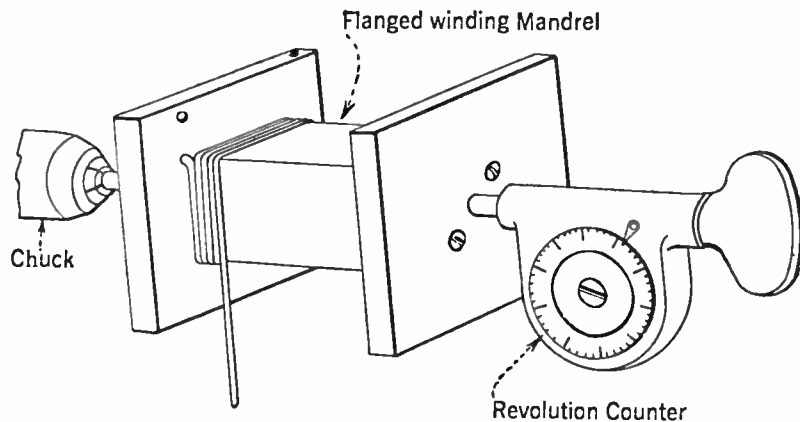

FIG. 4

in each corner of the core for a small bolt, but the diameter of the hole should not exceed one-fifth of the width of the core leg, otherwise the effective area of the core will be reduced. A panel of bakelite or hard rubber may be provided to hold the terminals, which may be ordinary binding posts or soldering clips. The leads may be brought up to the back of the panel and soldered to the terminals. They should be kept well separated from each other and insulated with "spaghetti" or similar tubing. Flexible insulated hook-up wire makes good leads. The terminals of the transformer should be plainly and permanently labeled with their voltages.

The transformer should be tested before being connected to any other apparatus. First connect the primary to the line without any load on the secondary, to detect any shorted turns, which will show up as excessive heating or as an actual burn-out. If after several hours the transformer is only slightly warm, it is probably all right. The terminal voltages may be checked with an a. c. voltmeter, if desired.

After the choke coil is completed the air gap must be adjusted to the proper value. This can only be done experimentally, by connecting the choke to its associated apparatus and changing the gap until the best filtering action is obtained. The gap should then be filled with cardboard or a cloth pad and the core permanently clamped, to prevent the gap being gradually closed by the magnetic pull between the two parts of the core. The inductance of the choke cannot be measured directly. If the necessary meters are available, it may be found as follows. Connect the choke in series with a battery and measure the voltage across the coil and the current in amperes through it. Its resistance may then be calculated from Ohm's Law:

$$R = \frac{V}{I}$$

Then connect it across a source of a. c. voltage of known frequency, such as the 110-volt line, and again measure the current and voltage. The impedance is then:

$$Z = \frac{V}{I}$$

The inductance, L, may then be calculated from the formula:

$$Z = \sqrt{R^2 + (2\pi fL)^2}$$

Or its equivalent:

$$L = \sqrt{\frac{Z^2 - R^2}{(2\pi f)^2}}$$

The writer wishes to acknowledge his indebtedness to Prof. F. S. Dellenbaugh, Jr., of the Massachusetts Institute of Technology, for the design formulas applying to the choke coil.

Employing the New  *"Octa-Monic" Principle*

Not a Super-Heterodyne
 Not Tuned Radio Frequency
 Not Regenerative
But —



The "OCTA-MONIC"
 RGS

All models of the R. G. S. "OCTA-MONIC" will be on display at the Radio World's Fair, New Madison Square Garden, between the 19th & 24th of September inclusive at the booth of the R. G. S. Mfg. Co., Inc.

BUILT FOR MODERN  **BROADCAST CONDITIONS**

Employing the New  "Octa-Monic" Principle

The New and R. G. S. One of the Outstanding Contributions

A. C. Tube Models

R. G. S. "Octa-Monic" A-C Tube Kit

including detailed instructions and graphic blue-prints; all necessary apparatus, power (A-C Tube) transformer, four-way line voltage switch, carefully tested and selected heavy duty wire, lamp socket connections and cable etc., etc., ready to build, \$114.60



R. G. S. "Octa-Monic" A-C Tube Chassis

Completely assembled according to latest laboratory methods, with instructions and blue-prints for installation, ready to plug-in your lamp socket and operate, \$129.60

R. G. S. "Octa-Monic" A-C Tube Receiver

housed in an attractive, partitioned, walnut table cabinet, \$149.60

NOTE: In A-C Tube Models of the R. G. S. "Octa-Monic", the performance is practically as startlingly satisfactory as the Battery models. Volume and selectivity are about the same; the Tonal Quality is slightly better on strong local stations but on distant stations or stations of weak signal strength, a slight hum is noticeable.

To all intents and purposes, elaborate experiments have proved all A-C models of the new and revolutionary R. G. S. "Octa-Monic" quite satisfactory.

Price Notice

Above prices do not include Cunningham A-C and Power Tubes nor the "B" Battery Eliminator. All A-C models will operate on any good eliminator. This, therefore permits the use of your own "B" Battery Eliminator. It goes without saying, of course, that B Batteries will also perform perfectly satisfactorily.

The fundamentally new R. G. S. "Octa-Monic" Receiver developed by David Grimes is one of the four great radio developments of the past 10 years. The R. G. S. "Octa-Monic" principles are fully as important and represent as basic a contribution to the Radio Art as did any of the discoveries of DeForest, Armstrong, Alexanderson, etc., etc.

These new and revolutionary principles of tuning, or the radio frequency end of the R. G. S. "Octa-Monic", produce results not only superior *but*, these principles of tuning place this Receiver far in advance of any receiver developed to date. The R. G. S. "Octa-Monic" is fundamental and is as radically new as was the Super-Heterodyne.

These highly efficient principles employed in the new R. G. S. "Octa-Monic" cover not only the tuning or radio frequency end of this receiver but they cover the amplification end as well. The R. G. S. "Octa-Monic" amplifier (Power tube in the last stage,) gives, unquestionably, as perfect reproduction as it is possible to buy, regardless of cost.

The R. G. S. "Octa-Monic" comes to you more heavily endorsed by able authorities than any other receiver ever presented to the Radio Public. The editor of one of the most important radio publications in America said that it was the only receiver he had ever seen in his career as an editor to which the terms "new and revolutionary" could be applied in good faith.

Selectivity superior to the super-heterodyne without cutting side bands. Selectivity enough to eliminate the heterodyne squeals of local stations, operating on a higher octave; selectivity that is equal over the whole dial without being at all critical at any point; selectivity enough to separate with ease the local jumble of Metropolitan (New York City, Chicago, San Francisco, etc.) stations; selectivity enough to give five (5) degrees of silence between stations WEAJ and WNYC in a location 200 yards away from WNYC.

Selectivity positive enough to make use of vernier control unnecessary.

Sensitivity or Distance-Getting Ability. Can work right down to static level. This insures trans-continental or trans-oceanic reception on favorable occasions.

Volume sufficient to fill a hall that will seat 3500.

Tonal Quality that is as nearly perfect as development in the Radio Art will permit.

Straight Line Audio Amplification.

Stability Margin of 800 ohms. The average receiver has a stability margin of from 6 to 20 ohms. This high stability margin of the R. G. S. "Octa-Monic" eliminates any possibilities of howling from poor batteries or "motor-boating" from eliminators. Batteries registering as low as 10 volts will deliver a clear tone, free from howling, in this receiver.

Straight Line Radio Amplification insuring reception at all broadcast wavelengths.

Straight Line Volume Control that makes distorting of tone impossible.

Automatic Wavetrap for prevention of heterodyning and whistling resulting from stations operating on one-half wave-length or on first octave beat.

Automatic Filament Control.

Employs 135 Volts or 180 Volts. Draws 22 mils.

Each R. G. S. "Octa-Monic" is carefully tested with scientific apparatus and under actual broadcasting conditions before it leaves the laboratories; while every piece of apparatus is just as thoroughly tested before it is built into this receiver.

The R. G. S. "Octa-Monic" is a closely co-ordinated Receiver built of quality apparatus. Careful tests are the basis for the choice of each piece of apparatus, tests that not only determine the merits of each individual part, but more importantly its relation to the whole receiver.

Standard Cunningham tubes (5CX 301-A's and 1CX 371, Power tube in last stage) and Western Electric Cone are recommended for best results.

The R. G. S. "Octa-Monic" is highly attractive in appearance. It is built on five-ply, specially shellaced sub-panel (20½ x 9½) to which is mounted beautifully designed panel, walnut finished, 7 x 21. The panel and dials are trimmed in gold.

The R. G. S. "Octa-Monic" is unusually simple to construct. The instructions and blueprints are more comprehensive and complete than any issued to date. They are very easy to follow and come, attractively bound, with your R. G. S. "Octa-Monic," which is one of the simplest receivers

DEALERS: Write for Complete Merchandizing Plans

BUILT FOR MODERN



BROADCAST CONDITIONS



Revolutionary

"OCTA-MONIC"*

of Ten Years of Radio Development

to operate. There are but two dials, the nearest possible approach to tuning efficiency, and you will find that stations actually "click" or "tumble-in" for you as you slowly rotate your dials.

The customary need of wooden screw-drivers or involved balancing devices is entirely removed in the R. G. S. "Octa-Monic." Major or minor adjustments are unnecessary. The R. G. S. "Octa-Monic" is free from ordinary service. Tuning condensers are the only moving parts, and as a consequence, there are no fussy mechanisms, either mechanical or electrical, to get out of order.

The R. G. S. "Octa-Monic" operates satisfactorily on either a good "B" battery eliminator or batteries without "motor-boating" or howling.

The R. G. S. "Octa-Monic" is so designed that it will fit any good cabinet or console. Write for cabinet and console literature.

Orders cannot be accepted for individual pieces of apparatus or blueprints.

The R. G. S. "Octa-Monic" is sold as follows: 1. R. G. S. "Octa-Monic" kit of parts including all required apparatus, transformers, rheostats, drilled and engraved aluminum panel, etc. even the necessary Acme Celatsite wire is enclosed in the attractive container, complete instructions and blueprints, ready to build, \$79.60 2. R. G. S. "Octa-Monic" chassis, completely assembled according to latest laboratory methods with complete thorough operational instructions, ready to operate, \$89.60, 3. R. G. S. "Octa-Monic" Receiver housed in an attractive, well-designed, walnut table cabinet, \$104.60, 4. R. G. S. "Octa-Monic" Tuning kit, including all necessary apparatus and complete blue-prints and instructions on how to build the radio frequency end of this Receiver and on how to hook-up to your favorite amplifier, \$59.60 5. R. G. S. "Octa-Monic" Tuning Chassis, completely assembled according to latest laboratory methods with complete instructions and ready to wire to your amplifier, \$66.60.

All models of the R. G. S. "Octa-Monic" have been adapted to the Cunningham A-C and Power Tubes (Four (4) CX 326, one (1) C 327, and one (1) CX 371. The "B" Battery Eliminator and the Cunningham Tubes are not included in the following prices. This eliminates an unnecessary expenditure on your part because the A-C Tube models of the R. G. S. "Octa-Monic" have been designed to operate satisfactorily with any good "B" Eliminator. It is recommended if your "B" Eliminator has no "C" battery tap, that you use the regular 40 volts of C battery.

The A-C Tube models are sold as follows (1) The R. G. S. "Octa-Monic" A-C Tube kit, including all necessary apparatus with complete and thorough blue-prints, and instructions, ready to build, \$114.60 (2) The R. G. S. "Octa-Monic" A-C Tube Chassis, completely assembled according to latest laboratory methods, with thorough operational blue-prints and instructions, ready to plug-in your light socket and operate, \$129.60 (3) The R. G. S. "Octa-Monic" A-C Tube Receiver housed in an attractive, well-designed, walnut table cabinet, \$149.60

The R. G. S. "Four" employing the Inverse Duplex System (1) R. G. S. "Four" Kit, all parts, complete instructions, \$74.40. (2) Chassis, assembled according to latest laboratory methods, \$84.40.

All prices slightly higher west of Denver. Canadian and Export prices on request.

Go to your dealer to-day and insist on a demonstration. If he hasn't stocked the R. G. S. "Octa-Monic" yet, tear off and mail to us the attached coupon with the required information. Every effort will be made to arrange a demonstration for you.

Arrange for that demonstration now because you have a real radio thrill waiting for you. In the R. G. S. "Octa-Monic" you will hear radio at its best. And when you hear the R. G. S. "Octa-Monic" you will know why it is: **"The Synonym of Performance"**

All models of the R. G. S. "Octa-Monic" and the R. G. S. "Four" are fully protected by Grimes Patents issued and pending.

*Trade Mark Registered.

DEALERS: Write for Complete Merchandizing Plans

R-G-S Manfg. Co., Inc.

of the

Grimes Radio Engineering Company, Inc.
Staten Island New York

Battery or "B" Eliminator Models

R. G. S. "Octa-Monic" Kit
of parts including all required apparatus, transformers, rheostat, drilled and engraved panel, etc., etc., even the necessary Acme Celatsite wire is enclosed in the attractive container, complete and thorough instructions and blue-prints, ready to build, \$79.60.



R. G. S. "Octa-Monic" Chassis
completely assembled according to latest laboratory methods, ready to operate, \$89.60

R. G. S. "Octa-Monic" Receiver
housed in an attractive, well-designed, walnut table cabinet, \$104.60

R. G. S. "Octa-Monic" Tuning Kit
including all necessary apparatus and complete blue-prints and instructions on how to build the radio frequency end of this receiver and on how to hook up to your favorite amplifier, \$59.60

R. G. S. "Octa-Monic" Tuning Chassis
completely assembled according to latest laboratory methods with complete instructions and ready to wire to your amplifier, \$66.60

R. G. S. MANFG. CO., Inc.
Staten Island, New York

Gentlemen:
I want to hear your R. G. S. "Octa-Monic." Please arrange with my dealer, whose address I have printed below, for a demonstration. I am much interested in this receiver but this request for a demonstration and literature, you understand, entails no obligation on my part.

My Name.

Street.

City or State

My Dealer's Name

His Address.





Tireless Performance

These gulls fly and fly until we wonder *how* such stamina can be contained in so frail an object.

Just so with CeCo Tubes. A strong combination of frail materials. Glass for a covering; hair-like wires for filament; fine spun metal for grid.

But so carefully engineered, so cleverly assembled so skillfully exhausted, so thoroughly tested that their durability is astounding to the radio operator and fan who judges CeCo performance by ordinary standards.

You expect *MORE* of CeCo Tubes—and *get more*.

A Type for Every Radio Need

General Purpose Tubes, Special Purpose Tubes, Power Tubes, Filament Type Rectifiers, Gas Filled Rectifiers and A. C. Tubes.

Ask your radio dealer for complete data sheet of CeCo Tubes.

C. E. MANUFACTURING CO., Inc., Providence, R. I.



Write for Data Sheet giving characteristics of all CeCo Tubes

Announcing Our New Gas Filled Rectifier (NO FILAMENT) TYPE D-G

Maximum Volts—300 Maximum Cur.—85 M-A

Long Life without decrease in output is assured if these values are not exceeded.

Easy Filtration. Less strain on Filter condensers and smoother output with less Hum or Ripple.

These tubes are tested in a Standard rectifying circuit using well designed parts. The unit is connected to a ripple test position, and tube checked both by phones and observed on an oscillograph, insuring a perfect tube which will give excellent results in *well designed and constructed units.*

PRICE \$5.00

Makes a Good "B" Eliminator—BETTER



Restored Enchantment



This is the Eveready Layerbilt that gives you Battery Power for the longest time and the least money.

THERE is no doubt of it—radio is better with Battery Power. And never was radio so worthy of the perfection of reception that batteries, and batteries alone, make possible. Today more than ever you need what batteries give—pure DC, Direct Current, electricity that flows smoothly, quietly, noiselessly. When such is the current that operates your receiver, you are unconscious of its mechanism, for you do not hear it humming, buzzing, crackling. The enchantment of the program is complete.

Batteries themselves have improved, as has radio. Today they are so perfect, and so long-lasting, as to be equal to the demands of the modern receiver. Power your set with the Eveready Layerbilt "B" Battery No. 486. This is the battery whose unique, exclusive construction makes it last longer than any other Eveready. Could more be said? In most homes a set of Layerbilts lasts an entire season. This is the battery that brings you Battery Power with all its advantages, conferring benefits and enjoyments that are really tremendous when compared with the small cost and effort involved in replacements at long intervals. For the best in radio, use the Eveready Layerbilt.



Radio is better with Battery Power

At a turn of the dial a radio program comes to you. It is clear. It is true. It is natural. You thank the powers of nature that have once more brought quiet to the distant reaches of the radio-swept air. You are grateful to the broadcasters whose programs were never so enjoyable, so enchanting. You call down blessings upon the authority that has allotted to each station its proper place. And, if you are radio-wise, you will be thankful that you bought a new set of "B" batteries to make the most out of radio's newest and most glorious season.

NATIONAL CARBON CO., INC.  New York—San Francisco

Unit of Union Carbide and Carbon Corporation

Tuesday night is Eveready Hour Night—8 P. M., Eastern Standard Time

- | | | | |
|------------------|-----------------|--------------------|------------------|
| WEAF—New York | WGR—Buffalo | WGN—Chicago | WRC—Washington |
| WJAR—Providence | WCAE—Pittsburgh | WOC—Davenport | WGY—Schenectady |
| WEEL—Boston | WSAI—Cincinnati | WCCO { Minneapolis | WIIAS—Louisville |
| WDAF—Kansas City | WTAM—Cleveland | { St. Paul | WSB—Atlanta |
| WFI—Philadelphia | WWJ—Detroit | KSD—St. Louis | WSM—Nashville |
| | | WMC—Memphis | |

Pacific Coast Stations—9 P. M., Pacific Standard Time

- | | |
|-----------------------|-----------------|
| KPO—KGO—San Francisco | KFI—Los Angeles |
| KFOA—KOMO—Seattle | KGW—Portland |

Have you heard the new Victor record by the Eveready Hour Group—orchestra and singers—in Middleton's Down South Overture and Dvořák's Goin' Home?

EVEREADY
Radio Batteries
—they last longer

Improved Positive VOLTAGE CONTROL for "B" Eliminators

HEAVY DUTY Centralab Variable Resistor

To carry plenty of power and withstand high voltage this new unit provides outstanding advantages. A single turn of the knob gives full resistance variation. Units are practically heat-proof, and will dissipate up to 20 watts through the entire resistance, without danger of burning out. Resistance remains constant at any knob setting.

Used as improvement over present controls, or add to the "B" eliminator that has no variable voltage. A 50,000 ohm unit attached to high voltage terminal, provides a tap adjustable to any voltage. When replacing present controls, use 100,000 ohms for detector and 50,000 ohms for intermediate voltage. Also 10,000 and 500,000 ohms. Each \$2.00



HEAVY DUTY Centralab Potentiometer

Identical with above Resistor, plus a third terminal. Potentiometers provide better voltage regulation for "B" Eliminators than the two-terminal type and are economical because no fixed resistors are needed. Have ample current carrying capacity for any "B" power circuit. Try this improved regulation on your Eliminator. Resistances up to 10,000 ohms all wire wound. 2,000, 3,000, 10,000, 25,000, 50,000, 100,000 ohms, \$2.00.



WIRE WOUND Centralab Fixed Resistor

Built for the heavy current of A & B power circuits. The wire is wound over asbestos,

fixed with heat-proof cement. Ample area. Flat and thin, making them easy to mount. Resistance values for all ABC Power Circuits.

At your dealer's or C. O. D. Send for the new Centralab A and B power circuit Literature.

CENTRAL RADIO LABORATORIES
22 Keeffe Ave. Milwaukee, Wis.



The Radio Broadcast LABORATORY INFORMATION SHEETS

THE RADIO BROADCAST Laboratory Information Sheets are a regular feature of this magazine and have appeared since our June, 1926, issue. They cover a wide range of information of value to the experimenter and to the technical radio man. It is not our purpose always to include new information but to present concise and accurate facts in the most convenient form. The sheets are arranged so that they may be cut from the magazine and preserved for constant reference, and we suggest that each sheet be cut out with a razor blade and pasted on 4" x 6" filing cards, or in a notebook. The cards should be arranged in numerical order. An index appears twice a year dealing with the sheets published during that year. The first index appeared on sheets Nos. 47 and 48, in November, 1926. In July, an index to all sheets appearing since that time was printed.

The June, October, November, and December, 1926, issues are out of print. A complete set of Sheets, Nos. 1 to 88, can be secured from the Circulation Department, Doubleday, Page & Company, Garden City, New York, for \$1.00. Some readers have asked what provision is made to rectify possible errors in these Sheets. In the unfortunate event that any such errors do appear, a new Laboratory Sheet with the old number will appear.

—THE EDITOR.

No. 129

RADIO BROADCAST Laboratory Information Sheet

October, 1927

The Type 874 Glow Tube

HOW IT FUNCTIONS

THE type 874 tube is a special voltage regulator designed for use in B power units to maintain the voltages, supplied by the unit, constant. An ordinary B power unit operated without a glow tube has a comparatively poor regulation, i.e., the voltage changes considerably with changes in the amount of current being drawn from the unit. It would obviously be of decided advantage if this voltage could be made to remain practically constant at all loads. The power unit could then be used with any receiver irrespective of the amount of current being drawn by it (within reason) with the knowledge that the actual voltages designated on the binding posts of the B device were being supplied. How the glow tube functions to maintain the voltage constant may be understood by reference to the curve A. This curve is plotted by measuring the voltage across the glow tube with various load currents and it should be noted that the voltage across the tube is practically 90 at all loads up to more than 40 mA. In ordinary operation, when there is no current being drawn from the 90-volt tap, the glow tube current is about 45 milliamperes. Then, if current is drawn for a receiver from the 90-volt tap, which would ordinarily cause the voltage to go down, the current through the glow tube automatically decreases, providing for the current required by the set. The voltage thereby is maintained at exactly 90.

Curve B illustrates the curve of output voltage

that might be obtained from a B power unit not using a glow tube. At no load the voltage is 123, while at a load of 10 mA. the voltage drops to 90. If, however, the receiver requires 20 milliamperes, the actual voltage available would be only 60 volts.

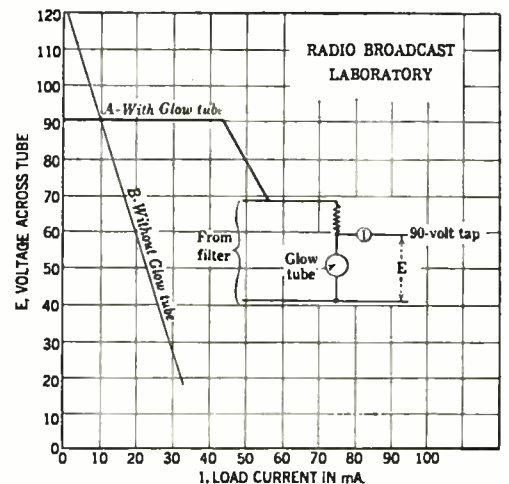

No. 130

RADIO BROADCAST Laboratory Information Sheet

October, 1927

Data on Honeycomb Coils

No. OF TURNS	INDUCTANCE, AT 800 CYCLES, IN MILLIHENRIES	NATURAL WAVELENGTH, METERS	DISTRIBUTED CAPACITY IN MMFD.	WAVELENGTH RANGE, METERS	
				0.0005-MFD. CONDENSER	0.001-MFD. CONDENSER
25	.039	65	30	120 to 245	120 to 355
35	.0717	92	33	160 to 335	160 to 480
50	.149	128	31	220 to 485	220 to 690
75	.325	172	26	340 to 715	340 to 1020
100	.555	218	24	430 to 930	430 to 1330
150	1.30	282	17	680 to 1410	680 to 2060
200	2.31	358	16	900 to 1880	900 to 2700
249	3.67	442	15	1100 to 2370	1000 to 3410
300	5.35	535	17	1400 to 2870	1400 to 4120
400	9.62	656	13	1800 to 3830	1800 to 5500
500	15.5	836	13	2300 to 4870	2300 to 2000
600	21.6	1045	14	2800 to 5700	2800 to 8200
750	34.2	1300	14	3500 to 7200	3500 to 10400
1000	61	1700	13	4700 to 9600	4700 to 13800
1250	102.5	2010	11	6000 to 12500	6000 to 18000
1500	155	2710	13	7500 to 15400	7500 to 22100

Balkite has pioneered— *but not at public expense*



Balkite "A" Contains no battery. The same as Balkite "AB" below, but for the "A" circuit only. Not a battery and charger but a perfected light socket "A" power supply. One of the most remarkable developments in the entire radio field. Price \$32.50.



Balkite "B" Has the longest life in radio. The accepted tried and proved light socket "B" power supply. 300,000 units in use show that it lasts longer than any device in radio. Three models: "B"-W, 67-90 volts, \$22.50; "B"-135,* 135 volts, \$32.50; "B"-180, 180 volts, \$39.50. Balkite now costs no more than the ordinary "B" eliminator.



Balkite Chargers

Standard for "A" batteries. Noiseless. Can be used during reception. Prices drastically reduced. Model "J,"* rates 2.5 and .5 amperes, for both rapid and trickle charging, \$17.50. Model "N"* Trickle Charger, rate .5 and .8 amperes, \$9.50. Model "K" Trickle Charger, \$7.50.

*Special models for 25-40 cycles at slightly higher prices.

Prices are slightly higher West of the Rockies and in Canada.

The great improvements in radio power have been made by Balkite.

First noiseless battery charging. Then successful light socket "B" power. Then trickle charging. And today, most important of all, Balkite "AB," a complete unit containing no battery in any form, supplying both "A" and "B" power directly from the light socket, and operating only while set is in use.

This pioneering has been important. Yet alone it would never have made Balkite one of the best known names in radio. Balkite is today the established leader because of Balkite performance in the hands of its owners. Because with 2,000,000* units in the field Balkite has a record of long life and freedom

from trouble seldom equalled in any industry. Because the first Balkite "B," purchased 5 years ago, is still in use and will be for years to come. Because to your radio dealer Balkite is a synonym for quality. Because the electrolytic rectification developed and used by Balkite is so reliable that today it is standard on the signal systems of most American as well as European and Oriental railroads. Because Balkite is permanent equipment. Balkite has pioneered — but not at the expense of the public.

Today, whatever type of set you own, whatever type of power equipment you want, whatever you want to pay for it, Balkite

has it. And production is so enormous that prices are astonishingly low.

Your dealer will recommend the Balkite equipment you need for your set.



BALKITE "AB"

Contains no battery. A complete unit, replacing both "A" and "B" batteries and supplying "A" and "B" current directly from the light socket. Contains no battery in any form. Operates only while the set is in use. Two models: "AB" 6-135,* 135 volts "B" current, \$59.50; "AB" 6-180, 180 volts, \$67.50.

FANSTEEL PRODUCTS COMPANY, Inc.
North Chicago, Illinois

FANSTEEL

Balkite

Radio Power Units

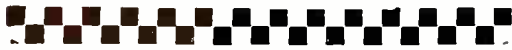

Bradleyunit-A PERFECT FIXED RESISTOR

Unaffected by temperature, moisture or atmospheric changes. Does not age or change in resistance.



A solid-molded fixed resistor, baked under high pressure, and accurately calibrated. Can be soldered without affecting accuracy.

Two Remarkable Radio Resistors

Bradleyunit-A is an outstanding success! It is a fixed resistor for radio circuits of all kinds, and has a capacity of 2 watts. It is rugged and can be soldered easily, without affecting the rating of the unit.

Bradleyohm-E is widely used by manufacturers of B-Eliminators for plate voltage control. Its remarkably wide, noiseless range, accomplished with two columns of graphite discs, accounts for its tremendous popularity.

Use Allen-Bradley resistors in your own hook-ups for superlative results. Follow the example of prominent radio manufacturers. They know!



Bradleyohm-E is available in several ranges and ratings. Sold in distinctive checkered cartons. Ask your dealer for Bradleyohm-E

Allen-Bradley Co.

ELECTRIC CONTROLLING APPARATUS

278 Greenfield Ave.  Milwaukee, Wis.



No. 131

RADIO BROADCAST Laboratory Information Sheet

October, 1927

Resistance-Coupled Amplifier

DATA ON CONSTANTS

ON LABORATORY Sheet No. 132 is given a circuit diagram of a resistance-coupled amplifier using the new type 240 high- μ tube (Cunningham type 340). To obtain satisfactory operation from such an amplifier it is essential that several points be given careful consideration. In the first place it is essential that excessive C bias is not used on any of the high- μ tubes. The following values should be used in combination with the voltage shown in the circuit diagram to prevent overloading: 1 volt on the first stage, 3 volts on the second stage, and 40.5 volts on the 171 power tube. The second consideration of great importance in the construction of such an amplifier is that the coupling condensers, C_1 , C_2 , and C_3 , be of the best quality that can be obtained. Even a small amount of leakage across the condenser, due to faulty insulation, will permit some of the plate potential to leak through it to the grid of the next tube and this will not only cause distortion but very frequently will make the amplifier absolutely inoperative. Use only the best of mica condensers.

It is, of course, also essential that the plate and grid resistance be noiseless in operation but it is not necessary that they be exactly of the values given in the circuit. A variation of ten or twenty per cent. in these values is quite unimportant. The plate supply for the amplifier may either be a well con-

structed B power unit or batteries. No trouble whatsoever should be experienced when operating the unit from new batteries, but it is possible that "motor-boating" troubles will develop when the amplifier is used with some B power units. The overall gain is comparatively high and difficulties of this sort become more pronounced as the ampli-

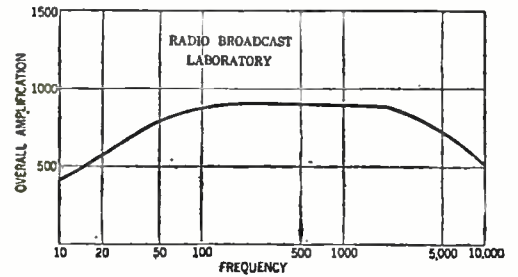

fication is increased. Large bypass condensers across the output of the power unit will frequently be necessary in order to prevent the occurrence of "motor-boating." The frequency characteristic of the complete amplifier is shown by the accompanying curve.

No. 132

RADIO BROADCAST Laboratory Information Sheet

October, 1927

Resistance-Coupled Amplifier Circuit

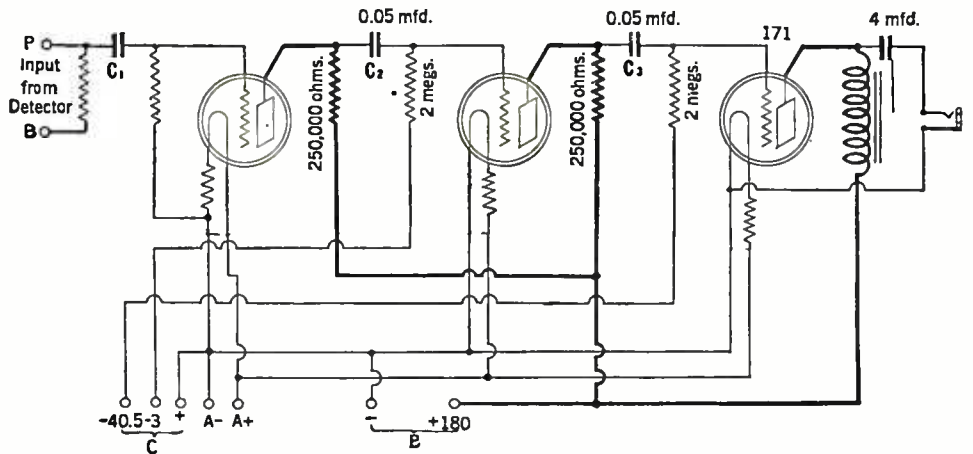

Data concerning resistance-coupled amplifiers appear on Laboratory Sheet No. 131

No. 133

RADIO BROADCAST Laboratory Information Sheet

October, 1927

Care of Power Supply Units

FREQUENT CHECKING NECESSARY

MANY modern radio receiver installations employ a B power unit for the plate voltage, and a storage battery in conjunction with a trickle charger for the filament supply, the entire combination being controlled by means of an automatic relay. If well manufactured units are used throughout, such an installation should require practically no attention other than the addition of water to the storage battery and the trickle charger, if the latter is of the electrolytic type.

In order to make certain that the entire power plant is functioning satisfactorily, it is a good idea to make some simple tests every six months or so. Little can go wrong with the B power unit without it becoming noticeable in the operation of the receiver. If the rectifier tube deteriorates the volume produced by the receiver will be lowered and also the quality will be impaired. A total failure of the power unit will, of course, mean that it will be impossible to hear anything at all on the receiver.

The simplest check to make on the A power unit in order to make certain that it is functioning satisfactorily is to take a hydrometer reading of the storage battery. If the battery reads "fully charged" it is possible that the trickle charging rate is ex-

cessive and it will be a good idea to somewhat reduce the rate and then make frequent tests with the hydrometer to determine how the battery is standing up. If the total charge in the battery now gradually decreases it will be best to increase the rate of trickle charge again. If, on the other hand, the battery continues to remain in a fully charged condition, we have a good indication that the previous rate of trickle charge was too high and that very probably the battery was being continually over charged, which is very harmful. If a hydrometer reading of the battery indicates that the battery is very low the trickle charge rate should be increased so that the battery is brought up to practically full charge and then the rate should be adjusted so as to maintain the battery in this condition. The contacts in the relay controlling the installation should be inspected every so often. There is a certain amount of sparking at the contacts which tends to pit them and it might be necessary to smooth them with a piece of emery cloth. Badly pitted contacts in the relay might at times prevent the unit from closing the trickle charger circuit and consequently the battery will not always be charged while the receiver is not being operated.

\$1 Only Down Brings You Either of These Guaranteed Eliminators

Super-Power "A" Eliminator

Here is a constant, unvarying, smooth, humless current at 6 volts for any radio receiver using 201-A and power tubes. **Uncertain storage batteries** with their changing power, **chargers** and other bothers are **done away with**. This eliminator completely replaces "A" batteries. In addition your set gets perfect current at all times—it is always ready to do its best. Stations come in easily and quickly.

Not a Battery-Charger Combination

This Super-power "A" Eliminator consists of a large capacity rectifier which changes the alternating house-lighting current into direct current. Then a highly efficient heavy duty filter system of extremely high capacity changes the pulsating direct current from the rectifier into smooth, even current for lighting the filaments in the radio tubes. Anyone can install this Super-power "A" Eliminator in a few minutes. Just attach it to your set and plug it into an electric light socket. Your set is instantly supplied with the correct amount of hum-free current, used only when set is in use. You are assured of good current whenever you want it. This "A" Eliminator works perfectly whether used once or thousands of times a year. It has no moving parts to wear out. Operates from light socket 110-120 volts, 50-60 cycle A.C., output 6 volts direct current for all sets up to 12 tubes with power tubes. **There are no batteries to be charged.** It is fool-proof in operation. Once attached it is permanent — **you can forget you ever heard about "A" batteries.**

Test It for 30 Days Before You Buy

Just fill out the coupon below and mail it to us with a dollar bill. We will send you this "A" Eliminator to test. It must deliver satisfaction before you buy. After 30 days trial pay only \$5.00 a month until you have paid \$31.50. Only our great buying power enables us to make this liberal offer and to also sell this Super-power "A" Eliminator for easily 1/4 less than is ordinarily asked.

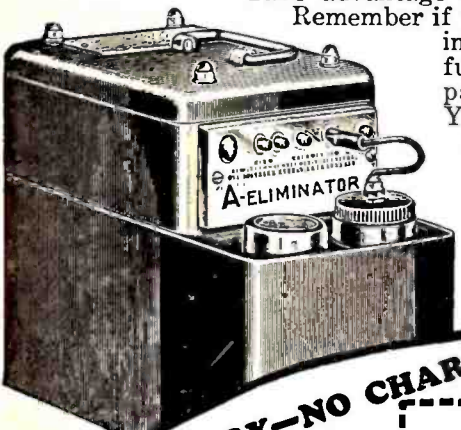

**NO BATTERY—NO CHARGER
NO BULBS
NO HUM
NOTHING TO WEAR OUT OR REPLACE**

ELECTRIFY ANY RADIO

Super-Power "B" Eliminator

Do away with "B" batteries—their annoyance—and the constant expense of always getting new ones. The great "B" Eliminator offered here replaces them permanently. Just attach this eliminator to your set—plug it into an electric light socket—and a steady flow of power is delivered to your set. Hum, noise, distortion and all other disturbances are gone. Built with heavy duty chokes, transformers and the finest of condensers in the filter system, it is 100% efficient at all times—the most modern and flexible "B" Eliminator in the world. **Used with any good "A" Eliminator it completely electrifies your set.**

Complete With Raytheon Tube

This Super-power "B" Eliminator can be used with any set up to 12 tubes. It comes complete with full wave rectifying 85 mil. Raytheon tube, making possible the delivery of great current at a high voltage. This Raytheon tube has indefinite life as it has no filament to burn out. Delivers up to 180 volts.

The case is beautifully finished in olive green Duco with black panel etched in gold. Equipped with rubber-covered cord and socket plug. High voltage taps and variable adjustments enable the use of new power tubes. Operates from 110-120 A.C., 50-60 cycle current. Has tap for intermediate voltage on which 67½ to 90 volts may be obtained. The detector tap will supply 22½ to 67½ volts. Variable adjuster will deliver any desired detector voltage. On and off switch and high and low voltage switch are integral parts of the eliminator. No additional switches or cords are necessary.

Only \$1.00

We make the same liberal offer on both the "B" and the "A" Eliminator. Fill out the coupon and mail it to us with a dollar indicating which eliminator you wish. If both are desired send \$2.00. Each eliminator must then make good while you test it for 30 days before you pay another cent. After test the balance is due in easy installments. This "B" Eliminator ordinarily sells for as high as the cash price of \$42.50. This



is your opportunity to get it for only \$29.50 payable in easy installments.

Complete instructions with each unit for wiring to set.

AT REDUCED PRICES

**COMPLETELY REPLACES "B" BATTERIES
EASY TO ATTACH
Plug Into Electric Light Socket**

Mail This Coupon NOW!

ELLIOTT RADIO CORPORATION, DEPT. 172
709 West Lake Street, Chicago, Illinois

Attached find \$1.00 for which you agree to send me () "A" Eliminator at \$31.50, () "B" Eliminator at \$29.50. (Send \$2.00 if both are desired, as described in your ad.) Full particulars will be sent me by return mail and my money refunded if I do not accept your offer.

Name _____
Address _____
City _____ State _____

More
for your
money in this
\$28.50
Sterling
"B" Power Unit



\$28.50 is an amazingly low price for this "B" Power Unit. Yet, in spite of price, Sterling quality is maintained throughout.

For efficiency, long life, in fact for permanent operation, only the genuine Raytheon BH rectifier is used. For convenience there's an "on" and "off" switch.

Current regulation? It's perfect! Amplifier and detector voltages are variable. An additional primary control regulates all voltages to suit large or small sets.

No wonder the Sterling R-81 is found today on thousands of 3 to 8 tube sets, giving constant, dependable light socket service. Ask your dealer for a demonstration of the Sterling R-81.

THE STERLING MFG. CO.
2831-53 Prospect Ave. • Cleveland, Ohio



The Sterling Mfg. Co.'s 21-year reputation stands behind every dealer who sells the Sterling line.

Perfect current Regulation for your set
Genuine Raytheon BH Equipped

No. 134

RADIO BROADCAST Laboratory Information Sheet

October, 1927

Loud Speaker Horns

THE EXPONENTIAL TYPE

A CORRECTLY designed horn makes a very good type of loud speaker. The best horn is one which radiates most uniformly over the required range of frequency and it has been proved mathematically that the exponentially shaped horn conforms closely to this requirement. A horn is of the exponential type when its cross section area doubles at equal intervals along its length. For example, a horn would be of the exponential type if at the orifice it had an area of $\frac{1}{4}$ square inches and an area of $\frac{1}{2}$ square inches, 1 square inch, and 2 square inches, at distances of 1, 2, and 3 feet respectively from the orifice. The rate of expansion determines the lowest frequency of which the horn will be a good sound producer. A horn which doubles in area every foot will reproduce down to about 64 cycles, and a horn which expands twice as rapidly will only reproduce well down to 128 cycles.

A properly designed horn should be free from noticeable resonance, and to prevent this the mouth of the horn should be made large enough to transmit the sounds coming from it without any great amount of back pressure. In the design of loud speaker horns it has been found that, if the mouth is made comparable to $\frac{1}{4}$ of the wavelength corre-

sponding to the low frequency cut-off point of the horn, the resonance in the horn will be negligible. The wavelength in feet is determined by dividing the velocity of sound in feet per second, which is 1120, by the frequency. For example, a horn whose cut-off frequency is to be 32 cycles, corresponding to a wavelength of 39 feet, should have a mouth of 39 divided by 4, or 9 $\frac{3}{4}$ feet. These facts indicate definitely that a horn, to be a good one, must be large. Small horns, whether they are or are not exponential, cannot radiate the low frequencies.

The horn makes it possible for a comparatively small diaphragm to get a good grip on the air and thereby produce a large volume of sound. The small diaphragm and the large horn may be replaced by a large diaphragm, as is done in a cone type loud speaker.

The material of which the horn is made is important. Although a horn may be well designed, and constructed to the correct size, total length and expansion per unit length, it may still fail to give really good results because of resonant effects in the material used in the construction. The material used should have no marked resonant frequency unless it is very low, where it might help to increase the low note radiation.

No. 135

RADIO BROADCAST Laboratory Information Sheet

October, 1927

Closely Coupled Circuits

RESONANCE CURVES

IF TWO circuits are coupled together by a condenser, as shown in the sketch, and they are both adjusted so that they are tuned to slightly different frequencies, we will find that a resonance curve of

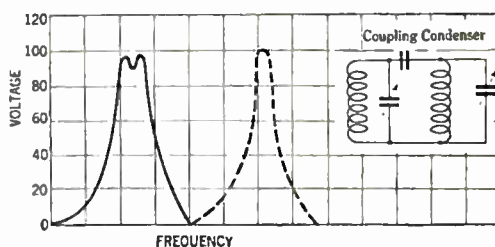

the combination has the form shown by the solid curve. The resonance curve of either separate circuit alone would have the form indicated by the dotted

curve. It is evident from the resultant curve that the combination of these two circuits produces a resultant characteristic curve which is quite broad and flat on the top in comparison with the quite sharp peak of either circuit alone. This double peaked effect is a characteristic of closely coupled circuits and has been used to some extent in radio receivers.

An ordinary resonance circuit consisting of a single coil and condenser has a comparatively sharp resonance curve and therefore frequencies slightly above or below the resonant frequency are not amplified as well as the latter and, therefore, the tuned circuit tends to cut down the amplification of the side bands of the incoming wave and this causes some loss of high frequencies. If a receiver is made up, however, with two coupled circuits, such as we have indicated, this cutting of the side bands will not take place because the flat top of the resonance curve can be made sufficiently broad so as to give equal amplification over a band 10,000 cycles wide and therefore practically equal amplification can be obtained at all frequencies 5000 cycles above or below the carrier frequency. The circuit has not been used in actual practice to any great extent because of the difficult tuning required and because of the careful adjustments necessary.

No. 136

RADIO BROADCAST Laboratory Information Sheet

October, 1927

Carrier Telephony

THEORY AND USES

THE use of power lines for the dissemination of intelligence is becoming increasingly common throughout the country. Large power companies have in many cases installed radio equipment for inter-communication between various power plants; these radio-frequency signals are transmitted over the power lines rather than through the air, and, in this way less interference is encountered. The system has also been used in some communities in order to make it possible to receive musical programs at home by connecting a suitable device directly to the power socket.

For commercial use, this system has certain advantages, such as lack of interference, which make its use valuable, but it is unlikely that the system will ever replace broadcasting. The number of different stations that can be "tuned-in" by a subscriber using the system is naturally limited, and this is a definite disadvantage.

The system actually differs very little from that of ordinary broadcasting, the major difference being that the power of the transmitter, instead

of being radiated into the air by means of an antenna, is coupled directly to the power line. The coupling between the transmitter and the power line is generally made through high-voltage coupling condensers and special filter and protective circuits. At the receiving end an ordinary radio receiver can be used to detect the signals. It also must, of course, be coupled in some way to the transmission line. The system is generally operated in duplex so that transmitting or receiving can be accomplished at any of the various terminals of the system.

In carrier telephony it has generally been found best to use carrier frequencies somewhat above 50,000 cycles. For comparatively low radio frequencies, around 10,000 cycles, there is considerable loss in the various power transformers in the line, and at frequencies intermediate between about 10,000 and 50,000 cycles there will very likely be sharp resonance peaks causing excessive loss at particular frequencies. Above 50,000 cycles an ordinary transmission line is fairly satisfactory as a transmitting medium.

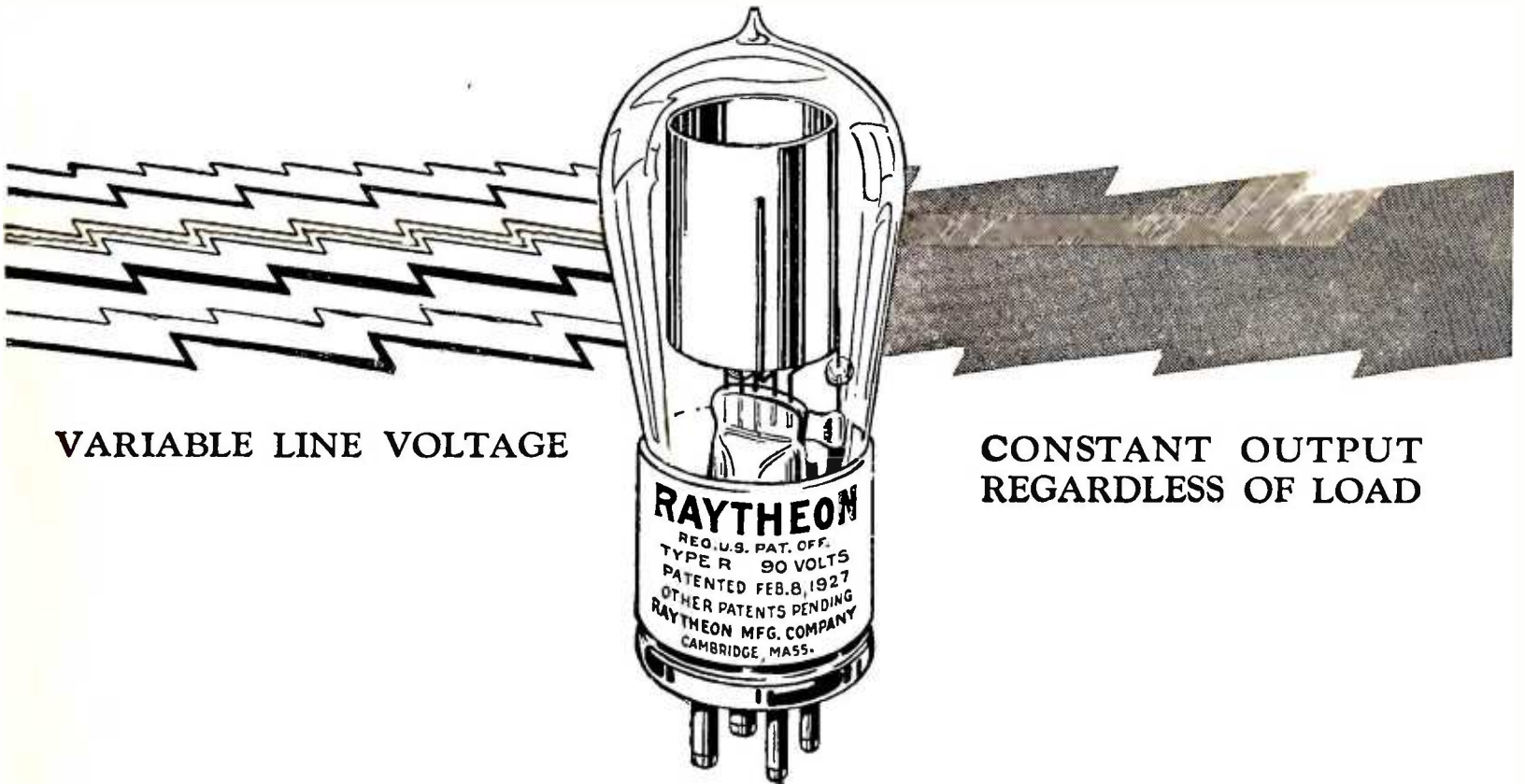

VARIABLE LINE VOLTAGE

CONSTANT OUTPUT REGARDLESS OF LOAD

Raytheon Voltage Regulator Tube

EXPERIENCE gained in seven years of exhaustive research, experiments and tests, have enabled the Raytheon Research Laboratories to produce a new and fundamentally improved Voltage Regulator Tube of marked characteristics.

Raytheon—Type R, when incorporated in the proper B Power circuits, maintains constant voltage on the 90 and lower voltage taps and greatly improves the voltage regulation on the 180 and 135 volt taps, *regardless of variations in either the line voltage or load current.* The variable voltage controls can be thus eliminated and the construction of the unit simplified.

Furthermore, this new tube has a very pro-

nounced effect in eliminating the last vestige of ripple from the output, and when connected to an amplifier will completely eliminate “motor-boating”.

A new feature—the *starting anode*—incorporated in type R, maintains constantly a state of ionization in the tube to prevent any “going out” regardless of the load fluctuation.

Raytheon—Type R, can be used in any power unit circuit now on the market employing a glow tube with greatly improved results. Diagrams of an approved Type R tube installation, in connection with the heavy duty Raytheon BH tube, can be had from the Raytheon Research Laboratories upon request.



Raytheon BH—a 125 milliamper rectifying tube, because of its constant heavy duty output, is especially designed for use in conjunction with the Raytheon Type R Regulator Tube in light socket power units.

Raytheon, Type R, 90 volts, 60 milliamperes—Price \$4.00



Raytheon A—the compact efficient rectifier, new in principle and construction. For A battery chargers and A battery eliminator units.

Raytheon BA—a 350 milliamper rectifying tube for complete battery elimination. Watch for the new ABC power units employing this rectifier.



RAYTHEON MANUFACTURING COMPANY
CAMBRIDGE, MASS.

Raytheon

THE HEART OF RELIABLE RADIO POWER



New Transformers for A. C. Power Supply

The AmerTran Power Transformer
Type PF-281, \$25.00 each

AS IN audio transformers, AmerTran products stand first in the power transformer field. They are up-to-date in design, well made and dependable.

Type PF-281, illustrated above, becomes virtually an A-B-C eliminator when used with AC tubes and the proper filter circuit for DC voltages of from 425 to 650 volts, plate current 110 milliamperes. This unit is designed for use with the new UX-281 rectifying tube, and has a 750 volt plate winding which enables it to be used with a UX-281 or 216-B rectifying tube. In addition, there are filament heating windings for the new AC tubes. Therefore, this single unit will convert AC house current into filament and plate current, and grid bias potential. Used with types 709 and 854 AmerChokes in the filter circuit, a receiver may be constructed to operate entirely from the house lighting circuit.

Type H-67 Heater Transformer is a new unit recommended for use with the RCA UX-226 raw AC amplifier tubes and the UY-227 detector tube. It also has a third filament winding capable of handling two UX-171 tubes. In connection with the new AC tubes, type H-67 becomes the power source for the filament and is therefore a real "A" battery eliminator. This transformer sells for \$12.00.

Write for Booklet, "Improving the Audio Amplifier," and data on Power Supply Units.

AMERICAN TRANSFORMER CO.
178 Emmet Street Newark, N. J.

We also make Audio Transformers
Choke Coils and Resistors.

Transformer Builders for
Over Twenty-Six Years

Manufacturers' Booklets

A Varied List of Books Pertaining to Radio and Allied
Subjects Obtainable Free With the Accompanying Coupon

READERS may obtain any of the booklets listed below by using the coupon printed on page 396. Order by number only.

1. FILAMENT CONTROL—Problems of filament supply, voltage regulation, and effect on various circuits. RADIALL COMPANY.
2. HARD RUBBER PANELS—Characteristics and properties of hard rubber as used in radio, with suggestions on how to "work" it. B. F. GOODRICH RUBBER COMPANY.
3. TRANSFORMERS—A booklet giving data on input and output transformers. PACENT ELECTRIC COMPANY.
4. RESISTANCE-COUPLED AMPLIFIERS—A general discussion of resistance coupling with curves and circuit diagrams. COLE RADIO MANUFACTURING COMPANY.
5. CARBORUNDUM IN RADIO—A book giving pertinent data on the crystal as used for detection, with hook-ups, and a section giving information on the use of resistors. THE CARBORUNDUM COMPANY.
6. B-ELIMINATOR CONSTRUCTION—Constructional data on how to build. AMERICAN ELECTRIC COMPANY.
7. TRANSFORMER AND CHOKE-COUPLED AMPLIFICATION—Circuit diagrams and discussion. ALL-AMERICAN RADIO CORPORATION.
8. RESISTANCE UNITS—A data sheet of resistance units and their application. WARD-LEONARD ELECTRIC COMPANY.
9. VOLUME CONTROL—A leaflet showing circuits for distortionless control of volume. CENTRAL RADIO LABORATORIES.
10. VARIABLE RESISTANCE—As used in various circuits. CENTRAL RADIO LABORATORIES.
11. RESISTANCE COUPLING—Resistors and their application to audio amplification, with circuit diagrams. DEJUR PRODUCTS COMPANY.
12. DISTORTION AND WHAT CAUSES IT—Hook-ups of resistance-coupled amplifiers with standard circuits. ALLEN-BRADLEY COMPANY.
13. B-ELIMINATOR AND POWER AMPLIFIER—Instructions for assembly and operation using Raytheon tube. GENERAL RADIO COMPANY.
14. B-ELIMINATOR AND POWER AMPLIFIER—Instructions for assembly and operation using an R. C. A. rectifier. GENERAL RADIO COMPANY.
15. VARIABLE CONDENSERS—A description of the functions and characteristics of variable condensers with curves and specifications for their application to complete receivers. ALLEN D. CARDWELL MANUFACTURING COMPANY.
16. BAKELITE—A description of various uses of bakelite in radio, its manufacture, and its properties. BAKELITE CORPORATION.
17. POWER SUPPLY—A discussion on power supply with particular reference to lamp-socket operation. Theory and constructional data for building power supply devices. ACME APPARATUS COMPANY.
18. AUDIO AMPLIFICATION—A booklet containing data on audio amplification together with hints for the constructor. ALL AMERICAN RADIO CORPORATION.
19. HIGH-FREQUENCY DRIVER AND SHORT-WAVE WAVE-METER—Constructional data and application. BURGESS BATTERY COMPANY.
20. AUDIO-FREQUENCY CHOKES—A pamphlet showing positions in the circuit where audio-frequency chokes may be used. SAMSON ELECTRIC COMPANY.
21. RADIO-FREQUENCY CHOKES—Circuit diagrams illustrating the use of chokes to keep out radio-frequency currents from definite points. SAMSON ELECTRIC COMPANY.
22. TRANSFORMER AND IMPEDANCE DATA—Tables giving the mechanical and electrical characteristics of transformers and impedances, together with a short description of their use in the circuit. SAMSON ELECTRIC COMPANY.
23. BYPASS CONDENSERS—A description of the manufacture of bypass and filter condensers. LESLIE F. MUTER COMPANY.
24. AUDIO MANUAL—Fifty questions which are often asked regarding audio amplification, and their answers. AMERTRAN SALES COMPANY, INCORPORATED.
25. SHORT-WAVE RECEIVER—Constructional data on a receiver which, by the substitution of various coils, may be made to tune from a frequency of 16,600 kc. (18 meters) to 1099 kc. (150 meters). SILVER-MARSHALL, INCORPORATED.
26. AUDIO QUALITY—A booklet dealing with audio-frequency amplification of various kinds and the application to well-known circuits. SILVER-MARSHALL, INCORPORATED.
27. VARIABLE CONDENSERS—A bulletin giving an analysis of various condensers together with their characteristics. GENERAL RADIO COMPANY.
28. FILTER DATA—Facts about the filtering of direct current supplied by means of motor-generator outfits used with transmitters. ELECTRIC SPECIALTY COMPANY.
29. RESISTANCE COUPLING—A booklet giving some general information on the subject of radio and the application of resistors to a circuit. DAVEN RADIO CORPORATION.
30. RESISTORS—A pamphlet giving some technical data on resistors which are capable of dissipating considerable energy; also data on the ordinary resistors used in resistance-coupled amplification. THE CRESCENT RADIO SUPPLY COMPANY.
31. RADIO-FREQUENCY AMPLIFICATION—Constructional details of a five-tube receiver using a special design of radio-frequency transformer. CAMFIELD RADIO MFG. COMPANY.
32. FIVE-TUBE RECEIVER—Constructional data on building a receiver. AERO PRODUCTS, INCORPORATED.
33. AMPLIFICATION WITHOUT DISTORTION—Data and curves illustrating the use of various methods of amplification. ACME APPARATUS COMPANY.
34. SUPER-HETERODYNE—Constructional details of a seven-tube set. G. C. EVANS COMPANY.
35. IMPROVING THE AUDIO AMPLIFIER—Data on the characteristics of audio transformers, with a circuit diagram showing where chokes, resistors, and condensers can be used. AMERICAN TRANSFORMER COMPANY.
36. PLATE SUPPLY SYSTEM—A wiring diagram and layout plan for a plate supply system to be used with a power amplifier. Complete directions for wiring are given. AMERTRAN SALES COMPANY.

37. FIVE-TUBE RECEIVER—Data are given for the construction of a five-tube tuned radio-frequency receiver. Complete instructions, list of parts, circuit diagram, and template are given. ALL-AMERICAN RADIO CORPORATION.
38. BETTER TUNING—A booklet giving much general information on the subject of radio reception with specific illustrations. Primarily for the non-technical home constructor. BREMER-TULLY MANUFACTURING COMPANY.
39. SIX-TUBE RECEIVER—A booklet containing photographs, instructions, and diagrams for building a six-tube shielded receiver. SILVER-MARSHALL, INCORPORATED.
40. SOCKET POWER DEVICE—A list of parts, diagrams, and templates for the construction and assembly of socket power devices. JEFFERSON ELECTRIC MANUFACTURING COMPANY.
41. FIVE-TUBE EQUAMATIC—Panel layout, circuit diagrams, and instructions for building a five-tube receiver, together with data on the operation of tuned radio-frequency transformers of special design. KARAS ELECTRIC COMPANY.
42. FILTER—Data on a high-capacity electrolytic condenser used in filter circuits in connection with A socket power supply units, are given in a pamphlet. THE ABOX COMPANY.
43. SHORT-WAVE RECEIVER—A booklet containing data on a short-wave receiver as constructed for experimental purposes. THE ALLEN D. CARDWELL MANUFACTURING CORPORATION.
44. SUPER-HETERODYNE CONSTRUCTION—A booklet giving full instructions, together with a blue print and necessary data, for building an eight-tube receiver. THE GEORGE W. WALKER COMPANY.
45. SHORT-WAVE TRANSMITTER—Data and blue prints are given on the construction of a short-wave transmitter, together with operating instructions, methods of keying, and other pertinent data. RADIO ENGINEERING LABORATORIES.
46. IMPEDANCE AMPLIFICATION—The theory and practice of a special type of dual-impedance audio amplification are given. ALDEN MANUFACTURING COMPANY.
47. B-SOCKET POWER—A booklet giving constructional details of a socket-power device using either the BH or 313 type rectifier. NATIONAL COMPANY, INCORPORATED.
48. POWER AMPLIFIER—Constructional data and wiring diagrams of a power amplifier combined with a B-supply unit are given. NATIONAL COMPANY, INCORPORATED.
49. A, B, AND C SOCKET-POWER SUPPLY—A booklet giving data on the construction and operation of a socket-power supply using the new high-current rectifier tube. THE Q. R. S. MUSIC COMPANY.
50. USING CHOKES—A folder with circuit diagrams of the more popular circuits showing where choke coils may be placed to produce better results. SAMSON ELECTRIC COMPANY.

ACCESSORIES

22. A PRIMER OF ELECTRICITY—Fundamentals of electricity with special reference to the application of dry cells to radio and other uses. Constructional data on buzzers, automatic switches, alarms, etc. NATIONAL CARBON COMPANY.
23. AUTOMATIC RELAY CONNECTIONS—A data sheet showing how a relay may be used to control A and B circuits. YAXLEY MANUFACTURING COMPANY.
24. ELECTROLYTIC RECTIFIER—Technical data on a new type of rectifier with operating curves. KODEL RADIO CORPORATION.
25. DRY CELLS FOR TRANSMITTERS—Actual tests given, well illustrated with curves showing exactly what may be expected of this type of B power. BURGESS BATTERY COMPANY.
26. DRY-CELL BATTERY CAPACITIES FOR RADIO TRANSMITTERS—Characteristic curves and data on discharge tests. BURGESS BATTERY COMPANY.
27. B BATTERY LIFE—Battery life curves with general curves on tube characteristics. BURGESS BATTERY COMPANY.
28. HOW TO MAKE YOUR SET WORK BETTER—A non-technical discussion of general radio subjects with hints on how reception may be bettered by using the right tubes. UNITED RADIO AND ELECTRIC CORPORATION.
29. TUBE CHARACTERISTICS—A data sheet giving constants of tubes. C. E. MANUFACTURING COMPANY.
30. FUNCTIONS OF THE LOUD SPEAKER—A short, non-technical general article on loud speakers. AMPLION CORPORATION OF AMERICA.
31. METERS FOR RADIO—A catalogue of meters used in radio, with connecting diagrams. BURTON-ROGERS COMPANY.
32. SWITCHBOARD AND PORTABLE METERS—A booklet giving dimensions, specifications, and shunts used with various meters. BURTON-ROGERS COMPANY.
33. COST OF B BATTERIES—An interesting discussion of the relative merits of various sources of B supply. HARTFORD BATTERY MANUFACTURING COMPANY.
34. STORAGE BATTERY OPERATION—An illustrated booklet on the care and operation of the storage battery. GENERAL LEAD BATTERIES COMPANY.
35. CHARGING A AND B BATTERIES—Various ways of connecting up batteries for charging purposes. WESTINGHOUSE UNION BATTERY COMPANY.
36. CHOOSING THE RIGHT RADIO BATTERY—Advice on what dry cell battery to use; their application to radio, with wiring diagrams. NATIONAL CARBON COMPANY.
37. TUBE REACTIVATOR—Information on the care of vacuum tubes, with notes on how and when they should be reactivated. THE STERLING MANUFACTURING COMPANY.
38. ARRESTERS—Mechanical details and principles of the vacuum type of arrester. NATIONAL ELECTRIC SPECIALTY COMPANY.
39. CAPACITY CONNECTOR—Description of a new device for connecting up the various parts of a receiving set, and at the same time providing bypass condensers between the leads. KURT-KASCH COMPANY.

(Continued on page 396)

VITROHM RESISTORS and RHEOSTATS

cover every resistance requirement in current supply unit circuits

CHOOSE to build the power circuit you will this year and there is a *dependable* Vitrohm Resistor and Rheostat exactly engineered to meet your requirements.

Resistance is the heart of power circuits. Assure yourself of quiet, permanent, and unfailing service by insisting upon Vitrohms for radio. Each of the 95 Vitrohm Radio Resistors and Rheostats is guaranteed unconditionally for continuous duty in any circuit where it operates within its watts-dissipation rating. And Vitrohms have the highest watts-dissipation rating without resistance change of all resistance units.

The Adjustat

The Adjustat is a new Vitrohm Rheostat designed for use in radio current supply unit circuits.

Each Adjustat has 15 steps of resistance and is arranged for potentiometer connection. Its compact size, $2\frac{3}{4}$ inches in diameter, permits the use of several Adjustats in circuits where adjustable resistance is desirable.



Like all Vitrohm Products, the resistive element, wire having a low temperature coefficient of resistivity, is embedded and permanently protected by a fuse-on coating of vitreous enamel.

11 Types are available as listed below. The Adjustat is priced at \$3.00.

{ 507-79, 1 ohm, 4 amp.—507-71, 2 ohms, 3 amp.—507-72, 6 ohms, 1.5 amp.—507-73, 20 ohms, 1.0 amp.—507-74, 30 ohms, 0.75 amp.—507-80, 50 ohms, 650 m.a.—507-81, 600 ohms, 180 m.a.—507-75, 1000 ohms, 125 m.a.—507-76, 2250 ohms, 90 m.a.—507-77, 10,000 ohms, 40 m.a.—507-78, 25,000 ohms, 10 m.a. }



Raytheon and QRS ABC Units

Three new Vitrohm Radio Products are immediately available for use in the Raytheon 350 m. a. and QRS 400 m. a. ABC Current Supply Units. Vitrohm Resistor 507-62, priced at \$7.50, is tapped for all voltages needed in the QRS Circuits.

Vitrohm Resistor 507-70, priced at \$7.50, is officially approved by the Raytheon Laboratories for use with their rectifier. (Illustrated.)

Vitrohm Rheostat 507-59, priced at \$5.50, is designed for series primary control in both circuits.



Vitrohm Grid Leaks for Transmitting Circuits

Vitrohm Transmitting Grid Leaks are now available for the R.C.A. UX 852 and De Forest P and H transmitting tubes.

Ward Leonard has developed a complete standard line of transmitting grid leaks and rheostats covering all circuits up to and including those of 1,000 watts input. If you are interested in this and other radio apparatus, write for Radio Bulletin 507 (1927-1928). It will be sent without charge.

Ward Leonard Electric Company

31-41 SOUTH STREET

MOUNT VERNON, N. Y.

resistor specialists for more than 35 years

Build Bigger Values into Your Radio Set

with



APPROVED RADIO PRODUCTS

Modernize your radio set construction with these two great Yaxley contributions to convenience, efficiency and good appearance;

Automatic Power Control



A new and better power control that cuts in the B eliminator and cuts out the trickle charger when the set is switched on. Cuts out the B eliminator and cuts in the trickle charger when the set is switched off, automatically, un-

failingly. No. 444—Series Type. With the exclusively Yaxley feature that keeps the voltage drop less than two-tenths (2-10) volts when used with sets having a current draw equivalent to four 199 type tubes up to eleven 201 type tubes \$5.00

Cable Connector Plug

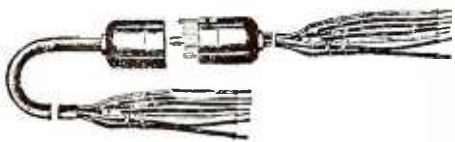

Preserve the neat appearance of your set by centering all battery wires in one neat, compact cable. Safe, simple and sure. Plug is of handsome Bakelite construction. Contact springs of phosphor bronze. Positive contact.

- No. 660—Cable Connector Plug, Complete. \$3.00
- No. 670—Cable Connector Plug for Binding Post Connections, Complete \$3.50

At your dealer's. If he cannot supply you, send his name with your order to

YAXLEY MFG. CO.
Dept. B-9 So. Clinton Street
CHICAGO, ILL.

68. CHEMICAL RECTIFIER—Details of assembly, with wiring diagrams, showing how to use a chemical rectifier for charging batteries. CLEVELAND ENGINEERING LABORATORIES COMPANY.

69. VACUUM TUBES—A booklet giving the characteristics of the various tube types with a short description of where they may be used in the circuit. RADIO CORPORATION OF AMERICA.

77. TUBES—A booklet for the beginner who is interested in vacuum tubes. A non-technical consideration of the various elements in the tube as well as their position in the receiver. CLEARTRON VACUUM TUBE COMPANY.

87. TUBE TESTER—A complete description of how to build and how to operate a tube tester. BURTON-ROGERS COMPANY.

91. VACUUM TUBES—A booklet giving the characteristics and uses of various types of tubes. This booklet may be obtained in English, Spanish, or Portuguese. DEFORREST RADIO COMPANY.

92. RESISTORS FOR A. C. OPERATED RECEIVERS—A booklet giving circuit suggestions for building a. c. operated receivers, together with a diagram of the circuit used with the new 400-mill ampere r. c. tifier tube. CARTER RADIO COMPANY.

97. HIGH-RESISTANCE VOLTMETERS—A folder giving information on how to use a high-resistance voltmeter, special consideration being given the voltage measurement of socket-power devices. WESTINGHOUSE ELECTRIC & MANUFACTURING COMPANY.

102. RADIO POWER BULLETINS—Circuit diagrams, theory constants, and trouble-shooting hints for units employing the BH or B rectifier tubes. RAYTHEON MANUFACTURING COMPANY.

103. A. C. TUBES—The design and operating characteristics of a new a. c. tube. Five circuit diagrams show how to convert well-known circuits. SOVEREIGN ELECTRIC & MANUFACTURING COMPANY.

MISCELLANEOUS

38. LOG SHEET—A list of broadcasting stations with columns for marking down dial settings. U. S. L. RADIO, INCORPORATED.

41. BABY RADIO TRANSMITTER OF 9XH-9EK—Description and circuit diagrams of dry-cell operated transmitter. BURGESS BATTERY COMPANY.

42. ARCTIC RADIO EQUIPMENT—Description and circuit details of short-wave receiver and transmitter used in Arctic exploration. BURGESS BATTERY COMPANY.

43. SHORT-WAVE RECEIVER OF 9XH-9EK—Complete directions for assembly and operation of the receiver. BURGESS BATTERY COMPANY.

44. ALUMINUM FOR RADIO—A booklet containing much radio information with hook-ups of basic circuits, with inductance-capacity tables and other pertinent data. ALUMINUM COMPANY OF AMERICA.

45. SHIELDING—A discussion of the application of shielding in radio circuits with special data on aluminum shields. ALUMINUM COMPANY OF AMERICA.

58. HOW TO SELECT A RECEIVER—A commonsense booklet describing what a radio set is, and what you should expect from it, in language that any one can understand. DAY-FAN ELECTRIC COMPANY.

67. WEATHER FOR RADIO—A very interesting booklet on the relationship between weather and radio reception, with maps and data on forecasting the probable results. TAYLOR INSTRUMENT COMPANIES.

73. RADIO SIMPLIFIED—A non-technical booklet giving pertinent data on various radio subjects. Of especial interest to the beginner and set owner. CROSLY RADIO CORPORATION.

74. THE EXPERIMENTER—A monthly publication which gives technical facts, valuable tables, and pertinent information on various radio subjects. Interesting to the experimenter and to the technical radio man. GENERAL RADIO COMPANY.

75. FOR THE LISTENER—General suggestions for the selecting, and the care of radio receivers. VALLEY ELECTRIC COMPANY.

76. RADIO INSTRUMENTS—A description of various meters used in radio and electrical circuits together with a short discussion of their uses. JEWELL ELECTRICAL INSTRUMENT COMPANY.

78. ELECTRICAL TROUBLES—A pamphlet describing the use of electrical testing instruments in automotive work combined with a description of the cadmium test for storage batteries. Of interest to the owner of storage batteries. BURTON ROGERS COMPANY.

95. RESISTANCE DATA—Successive bulletins regarding the use of resistors in various parts of the radio circuit. INTERNATIONAL RESISTANCE COMPANY.

96. VACUUM TUBE TESTING—A booklet giving pertinent data on how to test vacuum tubes with special reference to a tube testing unit. JEWELL ELECTRICAL INSTRUMENT COMPANY.

98. COPPER SHIELDING—A booklet giving information on the use of shielding in radio receivers, with notes and diagrams showing how it may be applied practically. Of special interest to the home constructor. THE COPPER AND BRASS RESEARCH ASSOCIATION.

99. RADIO CONVENIENCE OUTLETS—A folder giving diagrams and specifications for installing loud speakers in various locations at some distance from the receiving set. YAXLEY MANUFACTURING COMPANY.

USE THIS BOOKLET COUPON

RADIO BROADCAST SERVICE DEPARTMENT
RADIO BROADCAST, Garden City, N. Y.
Please send me (at no expense) the following booklets indicated by numbers in the published list above:

.....
Name.....
Address.....
(Name) (Street)
(City) (State)

ORDER BY NUMBER ONLY

This coupon must accompany every request. RB 1027

What Kit Shall I Buy?

THE list of kits herewith is printed as an extension of the scope of the Service Department of RADIO BROADCAST. It is our purpose to list here the technical data about kits on which information is available. In some cases, the kit can be purchased from your dealer complete; in others, the descriptive booklet is supplied for a small charge and the parts can be purchased as the buyer likes. The Service Department will not undertake to handle cash remittances for parts, but when the coupon on page 398 is filled out, all the information requested will be forwarded.



201. SC FOUR-TUBE RECEIVER—Single control. One stage of tuned radio frequency, regenerative detector, and two stages of transformer-coupled audio amplification. Regeneration control is accomplished by means of a variable resistor across the tickler coil. Standard parts; cost approximately \$58.85.

202. SC-11 FIVE-TUBE RECEIVER—Two stages of tuned radio frequency, detector, and two stages of transformer-coupled audio. Two tuning controls. Volume control consists of potentiometer grid bias on r.f. tubes. Standard parts cost approximately \$60.35.

203. "HI-Q" KIT—A five-tube tuned radio-frequency set having two radio stages, a detector, and two transformer-coupled audio stages. A special method of coupling in the r.f. stages tends to make the amplification more nearly equal over the entire band. Price \$63.05 without cabinet.

204. R. G. S. KIT—A four-tube inverse reflex circuit, having the equivalent of two tuned radio-frequency stages, detector, and three audio stages. Two controls. Price \$69.70 without cabinet.

205. PIERCE AIR KIT—A six-tube single-dial receiver; two stages of radio-frequency amplification, detector, and three stages of resistance-coupled audio. Volume control accomplished by variation of filament brilliancy of r.f. tubes or by adjusting compensating condensers. Complete chassis assembled but not wired costs \$42.50.

206. H & H-T. R. F. ASSEMBLY—A five-tube set; three tuning dials, two stages of radio frequency, detector, and 2 transformer-coupled audio stages. Complete except for baseboard, panel, screws, wires, and accessories. Price \$35.00.

207. PREMIER FIVE-TUBE ENSEMBLE—Two stages of tuned radio frequency, detector, and two steps of transformer coupled audio. Three dials. Parts assembled but not wired. Price complete, except for cabinet, \$35.00.

208. "QUADRAFORMER VI"—A six-tube set with two tuning dials, two stages of tuned radio frequency using specially designed shielded coils, a detector, one stage of transformer-coupled audio, and two stages of resistance-coupled audio. Gain control by means of tapped primaries on the r.f. transformers. Essential kit consists of three shielded double-range "Quadraformer" coils, a selectivity control, and an "Ampitrol," price \$17.50. Complete parts \$70.15.

209. GEN-RAL FIVE-TUBE SET—Two stages of tuned radio frequency, detector, and two transformer-coupled audio stages. Volume is controlled by a resistor in the plate circuit of the r.f. tubes. Uses a special r.f. coil ("Duo-Former") with figure eight winding. Parts mounted but not wired, price \$37.50.

210. BREMER-TULLY POWER-SIX—A six-tube, dual-control set; three stages of neutralized tuned radio frequency, detector, and two transformer-coupled audio stages. Resistances in the grid circuit together with a phase shifting arrangement are used to prevent oscillation. Volume control accomplished by variation of B potential on r.f. tube. Essential kit consists of four r.f. transformers, two dual condensers, three small condensers, three choke coils, one 500,000-ohm resistor, three 1500-ohm resistors, and a set of color charts and diagrams. Price \$41.50.

211. BRUNO DRUM CONTROL RECEIVERS—How to apply a drum tuning unit to such circuits as the three-tube regenerative receiver, four-tube Browning-Drake, five-tube Diamond-of-the-Air, and the "Grand" 6.

212. INFRA DYNE AMPLIFIER—A three-tube intermediate-frequency amplifier for the super-heterodyne and other special receivers, tuned to 3490 kc. (86 meters). Price \$25.00.

213. RADIO BROADCAST "LAB" RECEIVER—A four-tube dual-control receiver with one stage of Rice neutralized tuned-radio frequency, regenerative detector (capacity controlled), and two stages of transformer-coupled audio. Approximate price, \$78.15.

214. LC-27—A five-tube set with two stages of tuned-radio frequency, a detector, and two stages of transformer-coupled audio. Special coils and special means of neutralizing are employed. Output device. Price \$85.20 without cabinet.

215. LOFTIN-WHITE—A five-tube set with two stages of radio frequency, especially designed to give equal amplification at all frequencies, a detector, and two stages of transformer-coupled audio. Two controls. Output device. Price \$85.10.

216. K.H.-27—A six-tube receiver with two stages of neutralized tuned radio frequency, a detector, three stages of choke-coupled audio, and an output device. Two controls. Price \$86.00 without cabinet.

217. AERO SHORT-WAVE KIT—Three plug-in coils designed to operate with a regenerative detector circuit and having a frequency range of from 10,000 to 2306 kc. (15 to 130 meters). Coils and plug only, price \$12.50.

218. DIAMOND-OF-THE-AIR—A five-tube set having one stage of tuned-radio frequency, a regenerative detector, one stage of transformer-coupled audio, and two stages of resistance-coupled audio. Volume control through regeneration. Two tuning dials.

219. NORDEN-HAUCK SUPER 10—Ten tubes; five stages of tuned radio frequency, detector, and four stages of choke- and transformer-coupled audio frequency. Two controls. Price \$291.40.

USE KARAS PARTS FOR THE FINEST POSSIBLE RESULTS

in building your 2-Dial Karas Equamatic or
in building any other high grade receiver

KARAS PRODUCTS



The NEW Karas Type 28 Audio Transformer
Price, \$8.00



The NEW Karas Output Filter, Price \$8.00

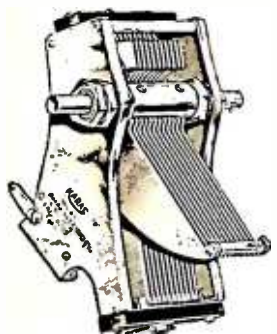

The NEW Karas S.F.L. Condenser with Removable Shaft, Price: .0025 mfd., \$5; .0037 mfd. \$5.25; .0005 mfd. \$5.50

YOU must, of course, use Karas Parts when you build your NEW Karas 2-Dial Equamatic Receiver—the powerful 5-tube completely balanced and perfectly neutralized radio frequency circuit with which Karas scores again in another sensational success for 1927-28. This new receiver was designed by Karas engineers to operate at maximum efficiency with Karas parts—and will only do so when these parts are used exactly as specified. But ALL Karas parts are adapted for use in scores of other popular circuits—are specified in the leading successes of 1927-28 by many leading radio publications—and to get the maximum of efficiency—the finest possible results—you should be sure to use Karas parts when building ANY receiver. There is not a circuit in popular use which cannot be vastly improved through the use of these parts in place of less efficient ones.

Karas Engineering is Known All Over the World

All over the world, wherever radio has penetrated, Karas parts are known for their precise, careful engineering. The reputation of the entire Karas line has been built upon sound radio engineering practice, allied with precision manufacturing methods, insuring positively and certainly that each Karas part will do exactly what we claim it will do. Other manufacturers do not bother to work within limits of accuracy as close as those established in the Karas factories. Yet we know of no other way to build radio apparatus and have it exactly right. Our standards are high, but they are essential to best results in radio performance. Sound engineering practice, scientific study of every problem presented, and the finding of the correct solution, are Karas essentials upon which we have built the remarkable reputation Karas Products enjoy. For example, in our new Type 28 Transformers we use hermetically spun-sealed steel clad cases in which the impregnated windings are sealed. Moisture cannot enter this case, nor can the insulating compound ever get out. Thus the delicate windings are forever protected from injury. In our new S. F. L. Condensers we work within such close limits that the shafts of any Karas Condenser may be instantly removed and interchanged with the shaft of any other Karas Condenser of the same type. In the Karas Micrometric Vernier Dial we obtain a 63 to 1 gear ratio and you obtain 1/1000th of an inch tuning as a result. You will discover for yourself many other examples of Karas engineering as you use Karas parts in building your sets.

Use these Karas Parts for the 2-Dial Equamatic

You will wish to build a Karas 2-Dial Equamatic right away when you know how marvelously simple it is to operate—how powerful and sweet-toned it is—and what selectivity and volume it possesses. There is nothing else to equal it in a 5-tube receiver—many 6 and 7 tube sets cannot rival the 2-Dial Equamatic.

This new Karas receiver is extremely easy to build. Our Complete, detailed instructions make every step very clear and very easy to follow. You can build this receiver in a few hours and thus have one of the finest, most selective radio frequency sets you have ever owned. To build this receiver you will need, in addition to certain standard parts easily obtainable anywhere, the following Karas parts which your dealer has in stock for you:

- 3 Karas Equamatic R.F. Transformers, each \$4\$12.00
- 3 Karas Equamatic Type 17 Removable Shaft S. F. L. Variable Condensers, each \$5.25 15.75
- 2 Karas Micrometric Vernier Dials, each \$3.50 7.00
- 2 Karas Type 28 Impregnated Audio Transformers, each \$8.00 16.00
- 1 Karas Output Filter 8.00
- 3 Karas Subpanel Brackets, set of 370
- 1 Karas 2-Dial Control System, complete with three extra shafts and all necessary assembly hardware for set 3.00

Mail the coupon to-day for complete list of parts, and full information about this receiver. Then order the necessary Karas and other parts from your dealer so you can build this set without delay. You will be delighted with it—will find it a receiver of tremendous power, volume and tone, and the most satisfactory receiver you ever built. Be sure to mail coupon to us to-day.

Address

KARAS ELECTRIC CO.

4033-J North Rockwell Street

Chicago



Karas Micrometric Vernier Dials, Price \$3.50



Karas Equamatic Inductance Coils, Set of 3, \$12.00

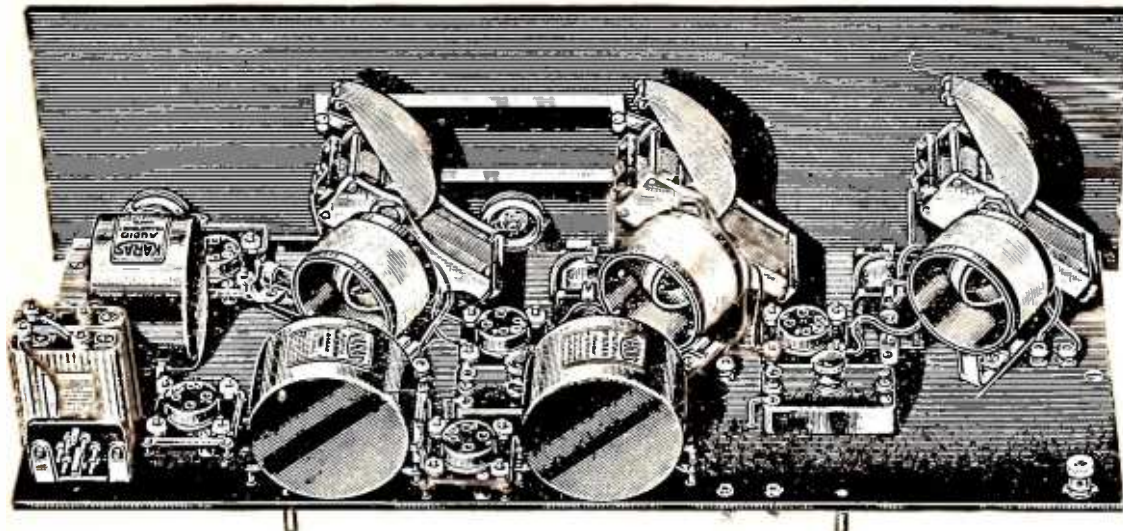

KARAS ELECTRIC CO.
4033 J North Rockwell St.
Chicago

Please send me complete data on the new 2-Dial Karas Equamatic Receiver, and also data on the Knickerbocker 4, as well as information about the new Karas parts.

Name

Address

City

State

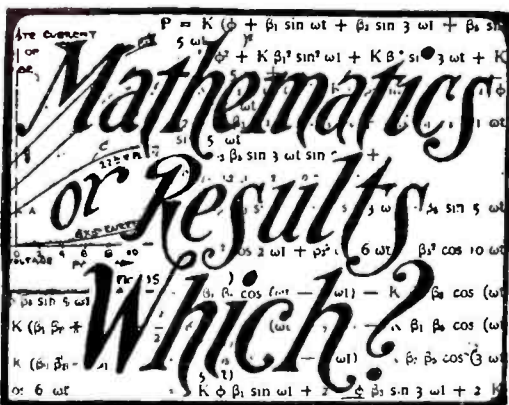

YOU can't get away from "variables" in the radio power unit. Line voltage fluctuations, changes in receiver tubes, differences in rectifier tubes, lowered rectifier output with age, unequal drain for different yet inter-related circuits—well, there are many "variables" present and for which you must compensate with suitable resistance values.

Of course, if you are an expert mathematician and engineer, preferring to work the slide rule than to enjoy radio programs, then by all means get the fun out of figuring the necessary resistance values. And don't forget to change the resistors from time to time to compensate for the changing conditions.

But if you are just the average radio enthusiast, seeking the best results with the least troubles, then use variable resistors to take care of all "variables." And when you say variable resistor—that means.

CLAROSTAT

CAUTION! Clarostat is being imitated
Look for the name stamped on the shell!

GET THE FACTS!

Ask your local dealer regarding Clarostats and how you can apply them in that new or old radio power unit. Better still, send a quarter for our big 32-page book "The Gateway to Better Radio," which contains a vast fund of information on radio in general.

AMERICAN MECHANICAL LABORATORIES, Inc.

285-87 North Sixth St. Brooklyn, N. Y.

The POWER CLAROSTAT
A husky for handling real power. In several turns of knob, it covers wide range. Handles up to 40 watts. In three ranges—0 to 10 ohms, 25-500 ohms, 200-100,000 ohms. Price \$3.50.



The STANDARD CLAROSTAT
The ideal B-voltage tap control, providing the precise voltage for each circuit and for any type of tube. Universal resistance range of from practically 0 to 5,000,000 ohms, with a current-carrying capacity of 20 watts. Noiseless, nonpacking, foolproof and indestructible within its working capacity. Price \$2.25

WHAT KIT SHALL I BUY? (Continued)

220. BROWNING-DRAKE—Five tubes; one stage tuned radio frequency (Rice neutralization), regenerative detector (tickler control), three stages of audio (special combination of resistance- and impedance-coupled audio). Two controls

221. LR4 ULTRADYNE—Nine-tube super-heterodyne: one stage of tuned radio frequency, one modulator, one oscillator, three intermediate-frequency stages, detector, and two transformer-coupled audio stages.

222. GREIFF MULTIPLEX—Four tubes (equivalent to six tubes): one stage of tuned radio frequency, one stage of transformer-coupled radio frequency, crystal detector, two stages of transformer-coupled audio, and one stage of impedance-coupled audio. Two controls. Price complete parts, \$50.00.

223. PHONOGRAPH AMPLIFIER—A five-tube amplifier device having an oscillator, a detector, one stage of transformer-coupled audio, and two stages of impedance-coupled audio. The phonograph signal is made to modulate the oscillator in much the same manner as an incoming signal from an antenna.

USE THIS COUPON FOR KITS

RADIO BROADCAST SERVICE DEPARTMENT
Garden City, New York.

Please send me information about the following kits indicated by number:

.....
.....
.....
.....

Name

Address

(Number) (Street)

(City) (State)

ORDER BY NUMBER ONLY. This coupon must accompany each order.

RB1027

A KEY TO RECENT RADIO ARTICLES

By E. G. SHALKHAUSER

THIS is the twenty-third installment of references to articles which have appeared recently in various radio periodicals. Each separate reference should be cut out and pasted on 4" x 6" cards for filing, or pasted in a scrap book either alphabetically or numerically. An outline of the Dewey Decimal System (employed here) appeared last in the January RADIO BROADCAST.

R344.4. SHORT-WAVE GENERATORS. TRANSMITTER, QST. April, 1927. Pp. 15-16. Short-Wave.

"A 15-Meter Commercial Station-2 XS." The General Electric station 2 XS, operating on 15 meters, built for the purpose of transmitting to Buenos Aires 365 days in the year, regardless of weather conditions, is described. The set is rated at 7 kw. and radiates its energy from a horizontal doublet with reflector.

R134. DETECTOR ACTION. DETECTOR ACTION. QST. April, 1927. Pp. 17-18.

"Which Is the Detector Tube?" L. W. Hatry. The difference in operation of detectors and amplifiers in standard radio circuits is discussed. Whether a tube functions as a detector as an amplifier, or both, depends upon various factors in the circuit, such as grid return, connection of grid leak, etc.

R330. ELECTRON TUBES. ELECTRON TUBES. QST. April, 1927. Pp. 26-30. UX-240.

"CX-340-UX-240," R. S. Kruse. In making a comparison between the UX-201-A and the new UX-240 amplifier tube, the writer presents the details upon which good amplification depends, namely: (1) The amplification constant of the tube; (2) the plate impedance of the tube; (3) the impedance of the transformer. The UX-240 is said to be excellent for c. w. and for resistance-coupled broadcast sets. As a detector, this new tube is said to eliminate considerable interference because of its peak characteristics.

R251.2. THERMO-ELEMENT. THERMO-COUPLE QST. April, 1927. Pp. 31-32. DEVICE.

"A Sensitive Thermo-Couple," B. J. Chromy. A very inexpensive and useful thermo-couple, made of tellurium and platinum wire, is described. The method of constructing the device and calibrating its range, together with a wiring diagram and experimental data, are given.

R 375.3. ELECTROLYTIC RECTIFIERS. RECTIFIERS, QST. April, 1927. Pp. 34-38. Dry Electrolytic.

"Developments in Dry Electrolytic Rectifiers," R. S. Kruse. A new type of rectifier, using a combination of copper, magnesium, and composition discs (the last mentioned consisting of zinc selenide and copper selenide, among other things), has been perfected for A battery chargers up to 3 amperes output, and also for A battery substitutes, as stated. Complete details concerning mechanical and electrical characteristics of this new type of dry rectifier are given.

RO07.1. UNITED STATES LAWS AND REGULATIONS. LAWS, QST. April, 1927. Pp. 39-44. Radio Act, 1927.

"The New Radio Law," The complete text of the new Radio Law, as enacted by Congress in February, 1927, is printed for the benefit of the readers of QST.

R113.5. METEOROLOGICAL. METEOROLOGY, QST. April, 1927. Pp. 45-46. Distance Calculations.

"How Far Is It?" C. C. Knight. A method whereby distances on the earth's surface from place to place may be determined with accuracy, is outlined in terms of spherical trigonometric formulas. As stated, the plan is very simple and the average person may obtain very good results using these formulas. Distance on flat maps are very inaccurate ordinarily, since it is difficult to make allowances for the curvature of the earth.

R261. ELECTRON-TUBE VOLTMETERS. VOLTMETER, QST. April, 1927. Pp. 47-53. Electron-Tube

"The Most Useful Meter," R. F. Shea. A comparison made between ordinary types of meters used in radio measurements and the vacuum-tube voltmeter shows how far superior the latter is when making accurate tests for small current and voltage values. Five types of commercial vacuum-tube voltmeters, their apparatus, and circuit arrangement, and their operation, are outlined in detail. The following are some of the many measurements that can be made with this handy instrument: (1) Obtaining gain through a radio-frequency or audio-frequency amplifier; (2) Checking the wave form of an oscillator; (3) Measuring high impedance; (4) Employing it as a wavemeter of high precision.

R381. CONDENSERS. CONDENSERS, QST. April, 1927. Pp. 55-57. Electrolytic.

"Electrolytic Filter Condensers," L. F. Lenck. The operation of electrolytic filter condensers, employing aluminum "pie-plates" and ammonium phosphate in their make-up in smoothing out the rectified a. c., is outlined. The method of forming plates and precautions to take in getting good results are discussed in detail.

R344.4. SHORT-WAVE GENERATORS. TRANSMITTER, RADIO BROADCAST. April, 1927. Pp. 570-573. Short-Wave.

"A 20-40-80-Meter Transmitter," K. Henney. Supplementing data given in the April, 1926, and Nov. 1926, RADIO BROADCAST, on the construction and operation of a short-wave transmitter, additional information is presented concerning a similar set which operates from the power mains, using two 216-B rectifiers and two UX-210 oscillators. The circuit is of the well-known Hartley pattern. Considerable information on details of construction is presented so that any one interested in transmitters may set up the outfit. Data on DeForest transmitter tubes are also given.

R351. SIMPLE OSCILLATORS. OSCILLATOR, QST. March, 1927. Pp. 23-27. Calibrator.

"Quartz Crystal Calibrators," A. Crossley. Two circuits, in which the quartz crystal may be used to set up continuous oscillations, are discussed. These employ either a crystal placed between plate and grid or between grid and filament of a vacuum tube, the latter method being preferred. With large inductance and small capacity in the phase adjusting circuit of the plate, many harmonics are said to be obtainable. The crystal calibrator, as described, may be used to measure accurately inductances, capacities, frequency meters, transmitters, etc.

R536. MINING. MINING AND RADIO. Radio. Feb., 1927. Pp. 28-ff.

"Experiments in Radio Prospecting," J. G. Alverson. The author gives some of his findings regarding the propagation of radio waves through the crust of the earth, showing how the wave-front of the electromagnetic wave changes with a change in rock, earth, and minerals. Data are presented of many observations made with a small transmitter operating on a wavelength of 1000 meters (300 kc.) and using an ordinary type receiver.

R343.5. SUPER-HETERODYNE SETS. SUPER-HETERODYNE, Radio. Feb., 1927. Pp. 25-ff. Best 1927 Model.

"The 1927 Model of Best's Super-Heterodyne," G. M. Best. The improved model of Best's super-heterodyne receiver is outlined for the set builder. The set consists of nine tubes, with two tuning dials, and is completely shielded.

RO84. MAPS AND CHARTS. CHART, Radio. Feb., 1927. Pp. 140-141. L. C. f. Data.

"Chart for Radio Circuit Calculations," E. L. Hall. A graphic chart, showing the relation between frequency, inductance, and capacitance for values as used in radio circuits, is drawn for purposes of rapid calculation. The accuracy of results obtainable may be within several per cent. of the mathematical calculation, as stated. The range may be extended beyond those actually shown by a simple process.

R350. GENERATING APPARATUS; TRANSMITTING SETS. QST. March, 1927. Pp. 33-37. TRANSMITTER, Flexible.

"A Flexible Transmitter," F. J. Marco. A transmitter is described which uses the Armstrong tuned-grid tuned-plate circuit. It is said to be capable of a quick change to either the 20-, the 40-, or the 80-meter band (1500-, 750-, or 3750-kc. band) by means of plug-in coils. Tubes giving an output power up to 7.5 watts may be used with the apparatus. Complete circuit diagrams, methods of tuning, and operation data are given.



The
Majestic
 Most popular "B" Power Unit
 for radio sets in the world

*The Super "B," illustrated above
 is only \$29⁵⁰, complete with
 Majestic Super-Power
 B-Rectifier Tube.*

GRIGSBY = GRUNOW = HINDS = CO. 4572 ARMITAGE AVE. CHICAGO-ILL.

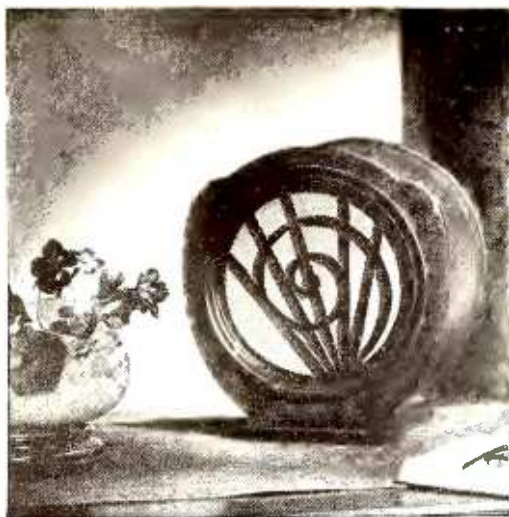

The NEW Moorish design Pacent Cabinet Cone in two-tone antique finish mahogany \$35.00

TONE QUALITY

is their outstanding feature

THESE three new Pacent products bring a new and keener enjoyment of radio by the true fidelity and realism of their reproduction.



The new 17-inch Pacent Balanced Cone establishes a new standard in cone speaker performance \$22.50



The Pacent PHONOVOX (electric pickup) attached to your phonograph and radio, reproduces records with the tone quality rivaling the electric phonograph . . . \$12.50

Ask your dealer for a demonstration or write us if dealer doesn't handle.

Pacent
RADIO CORPORATION
156 W. 16th Street, New York City

R113.5. METEOROLOGICAL. METEOROLOGY.
Proc. I. R. E. Feb., 1927, Pp. 83-97.
"The Correlation of Radio Reception with Solar Activity and Terrestrial Magnetism," G. W. Pickard.
Atmospheric changes and the resulting magnetic storms affecting radio reception are discussed. Atmospheric changes are said to be due to radiations and emissions from the sun. The author compares observed radio reception data, obtained over a continuous period, with meteorological data, and finds a close correlation of sunspot disturbances and radio reception on the upper broadcast wave spectra. Graphs drawn from observed data obtained from station WBBM show that, when average results are compared with magnetic storms, both variations appear to be more or less in phase.

R201. GENERAL METHODS AND APPARATUS. MEASUREMENTS, RECEIVER.
Proc. I. R. E. Feb., 1927, Pp. 99-111.
"Importance of Laboratory Measurements in the Design of Radio Receivers," W. A. MacDonald.
A series of thirteen fundamental tests are outlined for determining individual and overall characteristics of commercial receivers. A series of graphs gives the results obtained from a typical circuit and depicts to what degree a high precision standard may be used.

R134 DETECTOR ACTION. DETECTOR, ACTION.
Proc. I. R. E. Feb., 1927, Pp. 113-153.
"A Theoretical and Experimental Investigation of Detection for Small Signals," E. L. Chaffee and G. H. Browning.
Data are given on the detecting properties of diode and triode valves as used in radio circuits. The mathematical presentation is expressed in terms of the circuit impedances and the first and second partial differential coefficients of the static characteristic curves of the device, taken at the points on the curves determined by the steady polarizing voltages. It is then assumed that the impressed signal is so small that for any given steady voltages these coefficients can be assumed constant within the range of the variation due to the signal voltage.

R430. INTERFERENCE ELIMINATION. INTERFERENCE, ELIMINATION.
QST March, 1927, Pp. 9-14.
"Cures for 'Power Leaks,'" R. S. Kruse
The article states that power leaks and other sources of high-frequency interference may be eliminated by proper filtering. The 'Tobe,' the 'Dayfan,' and other interference eliminating devices are described.

R142.3 INDUCTIVE COUPLED CIRCUITS. TRANSFORMERS, TUNED R.F.
QST March, 1927 Pp. 20-22.
"The Theory of a Tuned R. F. Transformer," G. H. Browning and F. H. Drake.
A mathematical presentation, supplemented by experimental curves of tuned radio-frequency transformers, is given. The results show that the secondary inductance should be made as large as possible, the losses made very small, and the primary-secondary capacity kept as low as possible, in order to obtain maximum efficiency.

R140. RADIO CIRCUITS. MASTER-OSC. AND POWER-AMP. CIRCUITS.
QST March, 1927 Pp. 38-ff.
"How Our Tube Circuits Work. Part 4," R. S. Kruse.
In this fourth of a series of articles on radio circuits the writer takes up the many phases of oscillator circuits with and without amplifier hook-ups. A variety of subjects dealing with this type of circuit are taken up, as for instance: "Wobulation," its causes and remedy; steadiness of wave with and without the use of a crystal; the characteristics of the Armstrong circuit, single- and multi-stage amplifiers and their use as wave-changers in order to prevent troublesome feedbacks.

R900. MISCELLANEOUS. FUTURE OF RADIO.
Popular Radio March, 1927, Pp. 229-ff.
"Radio in 1950 A. D.," Dr. Lee DeForest.
The author enumerates some of the future possibilities found in the stored-up energy of waves as utilized for radio transmission and reception. The newly discovered cosmic ray, having a wavelength of 0.0004 angstrom units, and traveling at a much greater speed than light waves, as stated by Millikan, is said to have many possibilities.

R342.7. AUDIO-FREQUENCY AMPLIFIERS. AMPLIFIERS, AUDIO-FREQUENCY.
Popular Radio March, 1927 Pp. 253-ff.
"Audio Amplifiers," E. L. Bowles.
The underlying principles covering audio-frequency reproduction and amplification are outlined in an elementary discussion. Causes and effects of distortion, at either the transmitting or receiving end, may be corrected, it is said, by proper design and construction of the apparatus.

R201.5 SHIELDING AND GROUNDING. SHIELDING.
Radio News Feb., 1927 Pp. 988-ff.
"Shielding in Radio Receivers," M. L. Hartmann and J. R. Meagher.
A brief and elementary discussion on the theory of shielding of radio receivers is given. Some of the benefits of shielding are said to be increased amplification, increased selectivity, better neutralization, and decreased body-capacity effects.

R175.3 ELECTROLYTIC RECTIFIERS. RECTIFIERS, CHEMICAL.
The Transmitter, Dec. 1927, Pp. 10-ff.
"Practical Chemical Rectifiers," C. R. Stedman.
In constructing a practical chemical rectifier, the writer suggests that pure aluminum should be used. Both the lead and aluminum plates, however, should be of the same size. The solution recommended is either bicarbonate of soda or ammonium phosphate. Constructional details and wiring diagrams are given.

R342.7. AUDIO-FREQUENCY AMPLIFIERS. AMPLIFIERS, AUDIO-FREQUENCY.
Radio World, Feb., 19, 1927, Pp. 5.
"More Volume from Lower Ratio in Audio Transformers, a Frequent Condition," K. B. Humphrey.
In analyzing the importance of proper relation of audio transformer winding ratios to tube resistance, it is stated that consideration should be given the various factors involved from an engineering standpoint when selection is made. Usually, it is said, more volume and less distortion is obtained from properly constructed low-ratio transformers than those of high ratio.

R582. TRANSMISSION OF PHOTOGRAPHS. PHOTOGRAPH TRANSMISSION.
Radio World, Feb., 26, 1927 Pp. 4-5.
"First Television Hookups Elucidate Alexander and Baird Plans," H. Wall.
The Alexander and the Baird systems of television are shown in schematic diagram. The two systems are compared and the advantages and disadvantages outlined.

R113.4. IONIZATION; HEAVISIDE LAYER. HEAVISIDE LAYER.
Radio World, Feb., 26, 1927 Pp. 8.
"Radio Ceiling Again Verified"
Experiments conducted by the Carnegie Institute regarding the existence and probable nature of the Kenelly-Heaviside layer have established that such a layer actually exists at an altitude varying between 50 and 130 miles. Whether the radio waves are reflected or refracted from this upper layer is not definitely known. Fading may be explained on the assumption that interfering waves neutralize each other.

R200. TEXTBOOKS. TEXTBOOKS.
The New York Sun. Radio Section. Nov. 6, 1926. *Radio.*
"An Expert's 3-Foot Shelf of Radio Books," S. R. Winter.
The following is a list of textbooks and published material selected by Doctor Dellinger, of the Bureau of Standards, for the radio man:
1. "Signalling Through Space Without Wires,"—H. Hertz.
2. "The Principles of Electric Wave Telegraphy and Telephony,"—J. A. Fleming.
3. "Electric Waves,"—H. Hertz.
4. "The Principles Underlying Radio Communication,"—Bureau of Standards
5. "Radio Instruments and Measurements,"—Circular 74, Bureau of Standards.
6. "Robinson's Manual of Radio Telegraphy,"—United States Navy
7. "How to Become a Wireless Operator,"—Chas. B. Hayward.
8. "Direction and Position Finding,"—R. Keen, of Sheffield, England.
9. "I. C. S. Handbook for Radio Operators,"—International Correspondence Schools.
10. "Radio Telephony for Amateurs,"—S. Ballantine.
11. "Radio for Everybody,"—A. C. Lescarboura.
12. "Radio for All,"—H. Gernsback.
13. "Elements of the Mathematical Theory of Electricity and Magnetism,"—J. J. Thompson.
14. "Handbook of Technical Instruction for Wireless Telegraphists,"—C. Hawkhead and H. M. Dowsett.
15. "Wireless Telegraphy and Telephony,"—H. M. Dowsett.
16. "The Thermionic Vacuum Tube and Its Application," H. J. Von der Bijl.
17. "The Radio Amateur's Handbook,"—F. E. Handy.
18. "Yearbook of Wireless Telegraphy,"—Wireless Press, Ltd (Published annually).
19. "Electromagnetic Oscillations in Oscillators and Radio Telegraphy,"—J. Zenneck.
20. "Wireless Telegraphy and Telephony,"—Chas. R. Gibson.
21. "Radio Laws and Regulations of the United States,"—U. S. Department of Commerce.
22. "The Realities of Modern Science,"—John Mills
23. "Electric Oscillations and Electric Waves,"—G. W. Pierce.
24. "Principles of Radio Communication,"—J. H. Morecroft.
25. "Principles of Radio Transmission and Reception with Antenna and Coil Aerials,"—Bureau of Standards.
26. "Methods of Measurement of Properties of Electrical Insulating Materials,"—Bureau of Standards.
27. "Handbook of Safety Rules for Radio Installations,"—Bureau of Standards.
28. "Wireless Telegraphy and Telephony,"—W. H. Eccles.
29. "Thermionic Tubes in Radio Telegraphy,"—John Scott-Taggart.
30. "Radio Broadcast's Knockout Receiver,"—Doubleday, Page and Company.
31. "How to Build Your Radio Receiver,"—Popular Radio Publishing Company.
32. "The Radio Service Bulletin,"—United States Department of Commerce. (Monthly).
33. "Introduction to Line Radio Communication,"—Signal Corps Pamphlet.
34. "Modern Radio Operation,"—J. O. Smith.
35. "The C. W. Manual,"—J. B. Dow.
36. "Radio for Amateurs,"—A. H. Verrill.
37. "Circular No. 24,"—Bureau of Standards.
38. "Copper Wire Tables,"—Bureau of Standards.
39. "The Radio Direction Finder and Its Application to Navigation,"—Bureau of Standards.
40. "Formulas and Tables for the Calculation of Mutual and Self-Inductance,"—Bureau of Standards.
41. "The Outline of Radio,"—J. V. L. Hogan.
42. "Qualitative Experiments in Radio Transmission,"—Bureau of Standards.

R134.8. REFLEX ACTION. REFLEX ACTION.
QST, Feb., 1927, Pp. 21-27.
"Developments in Tuned Inverse Duplex," David Grimes. Part 2.
In this second of two articles, the Inverse Duplex System of amplification in the radio and audio circuits, developed for duplexing, are discussed. For the audio stage, a transformer-resistance-transformer arrangement is said to be the most desirable and effective. In order to obtain equal amplification over the entire broadcast band, a radio frequency-audio frequency filter circuit, comprising a choke coil and a large fixed condenser, is connected between stages. Circuit diagrams and panel layouts are shown.

R344.5. ALTERNATING CURRENT SUPPLY. A.C. FOR RADIO BROADCAST. FEB., 1927, Pp. 393-396. FILAMENTS.
"A.C. As a Filament-Supply Source," B. F. Miessner.
The writer discusses the problems encountered in lighting the filaments of radio vacuum tubes from the regular direct or alternating current obtained from the light socket. Filter systems, devised to eliminate the hum in the a.c. line, which presents many varying characteristics, as shown in graphs, are given. The 112 type tube, as compared to the 190, the 201-A type, and the wx-12 type, is considered the best tube to use for radio-and audio-frequency amplification in a.c. lighted filament circuits.

SM

87%
At 30 Cycles!



In this standardized black shielding case are housed the famous 220 audio and 221 output transformers, 222 output, 230 push-pull input, 231 push-pull output, 325 filament, 329, 329A and 330 power transformers, 331 Unichoke and 332 condenser bank. And a new super-power full wave ABC supply transformer is on the way—type 328, at \$18.00, for one or two 216B or 281 tubes.



Silver-Marshall now offers two smaller size audio transformers for replacement work in old sets, wherever price and size is a consideration. Type 240 audio transformer is equal or superior to the majority of high-grade audio transformers, but does not reproduce frequencies below 80 cycles to the extent that the famous 220 does. Its single stage amplifier curve is shown above—in two stages, the 240's afford practically the same 5000 cycle cut-off as do 220's, although this is not evident in the single stage curve above. 241 output transformer offers the same low frequency compensation as type 221 and 222. Due to their small size, these transformers will fit in almost any of the older receivers, and once installed, will work wonders in tone quality improvement, for their performance nearly equals that of 220's and 221's. Size $3\frac{7}{16}$ " high, $2\frac{1}{4}$ " wide, $2\frac{3}{8}$ " deep, weight 2 lbs. 4 ozs. each. Price, 240 audio \$6.00, 241 output \$5.00.

Laurence Cockaday, for the preferred audio amplifier for the LC-28 receiver uses two 240's and a 241 with an S-M power supply!

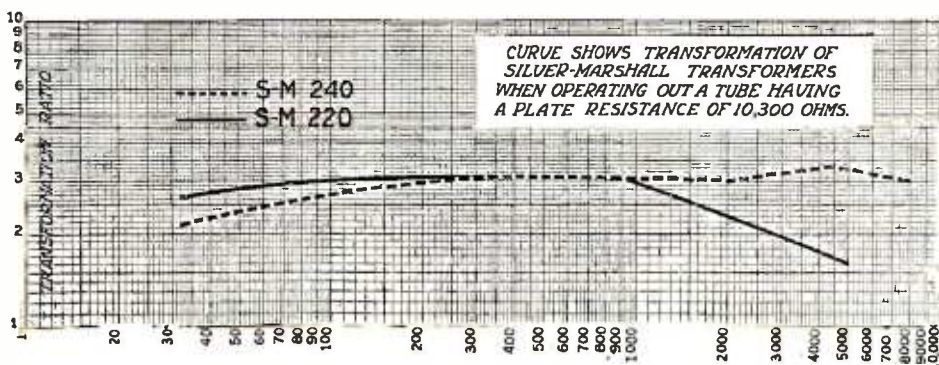
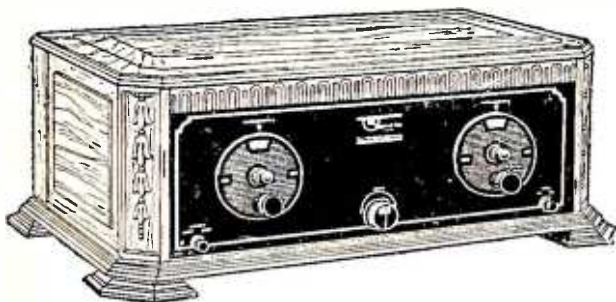

At 30 cycles, an S-M 220 audio transformer in a standard amplifier circuit gives 87% of the amplification obtained at 1000 cycles, while its curve is substantially flat from 100 to 1000 cycles. Above 2000 cycles, the curve for a single stage falls off gradually, while in a standard two stage amplifier circuit, the curve is substantially flat up to 5000 cycles above which frequency it falls off rapidly to keep static, heterodyne squeals and "set noise" at a minimum.

The above paragraph sums up at once the desirable characteristics of an audio amplifier for realistic recreation of broadcast programs, and the actual performance of S-M audio transformers. It is just this fact that has made 220's the choice of over half of the designers of the new 1927-1928 circuits, for engineers know that the short cut to the finest of quality is to use S-M audios. Experienced fans know this too, as is proven by the fact that 220's have outsold every other transformer in their class by a wide margin for over a year. And S-M audios are signally favored by being used in more broadcasting stations than any other types. WCAE, WBBM, WEBH, KFCR, WTAQ, KGDJ, WLBF, and many others. WCFL, the "Voice of Labor" checks quality of all programs with them. Nathaniel Baldwin, Inc., famous speaker experts, test with 220's and 221's.

Your guarantee of quality is to use S-M 220's and 221's in every circuit you build, and you'll find that over half the popular 1927 and 1928 circuits will give you just this same guarantee of quality. But S-M promises unconditionally that you can improve any set by using 220's and 221's, and backs the promise by the offer of your money back if 220's and 221's don't give you more satisfactory quality than you've ever heard before.

The 220 audio is the biggest value on the market, and its performance measures up to its 4 pound size. It contains more steel and copper than any other transformer—the measure of transformer merit. Price \$8.00.

221 output transformer not only protects loud speakers against power tube plate currents, but compensates low frequencies for all loud speakers. Price \$7.50, or with cord and tip jacks, No. 222, \$8.00.

230 push-pull input and 231 push-pull output transformers are priced at \$10.00 each.

The New Shielded Six Is Ready!

The Improved Shielded Six is ready, the very latest model of this excellent receiver which has over a year of successful and satisfying performance to its credit. The Improved model has vastly increased selectivity, greater distance getting ability, and the same fine tone that has made almost every builder say of the original, "That's the finest set I've ever heard!"

This year the Six offers the additional possibilities of push-pull amplification with 210 tubes for the man who wants the utmost. All in all, the Six deserves the reputation as the finest tuned R. F. kit you can buy, equalled only by \$200 to \$400 factory built sets. Yet it's priced at but \$95.00 for the complete kit, or \$142.00 assembled, in cabinet, and guaranteed to satisfy you. S-M will be glad to tell owners how last year's model can be converted to the Improved Six, or push-pull 210 amplification installed with simple changes.

We can't tell you the whole story of new S-M developments, so if you'll just fill in the coupon, and mail it with 10c to cover postage, we'll send you free more up-to-the-minute advance radio information than you could buy in a text book.

Silver-Marshall Inc.,
838 West Jackson Blvd. Chicago, U. S. A.

SILVER-MARSHALL, Inc.
838 West Jackson Blvd., Chicago, U. S. A.
Please send me information on new S-M developments, for which I enclose 10c.

Name.....
Address.....

"RADIO BROADCASTS" DIRECTORY OF MANUFACTURED RECEIVERS

☐ A coupon will be found on page 416. All readers who desire additional information on the receivers listed below need only insert the proper numbers in the coupon, mail it to the Service Department of RADIO BROADCAST, and full details will be sent. New sets are listed in this space each month.

KEY TO TUBE ABBREVIATIONS

99—60-mA. filament (dry cell)
01-A—Storage battery 0.25 amps. filament
12—Power tube (Storage battery)
71—Power tube (Storage battery)
16-B—Half-wave rectifier tube
80—Full-wave, high current rectifier
81—Half-wave, high current rectifier
Hmu—High-Mu tube for resistance-coupled audio
20—Power tube (dry cell)
10—Power Tube (Storage battery)
00-A—Special detector
13—Full-wave rectifier tube
26—Low-voltage high-current a. c. tube
27—Heater type a. c. tube

DIRECT CURRENT RECEIVERS

NO. 424. COLONIAL 26

Six tubes; 2 t. r. f. (01-A), detector (12), 2 transformer audio (01-A and 71). Balanced t. r. f. One to three dials. Volume control: antenna switch and potentiometer across first audio. Watts required: 120. Console size: 34 x 38 x 18 inches. Headphone connections. The filaments are connected in a series parallel arrangement. Price \$250 including power unit.

NO. 425. SUPERPOWER

Five tubes: All 01-A tubes. Multiplex circuit. Two dials. Volume control: resistance in r. f. plate. Watts required: 30. Antenna: loop or outside. Cabinet sizes: table, 27 x 10 x 9 inches; console, 28 x 50 x 21. Prices: table, \$135 including power unit; console, \$390 including power unit and loud speaker.

A. C. OPERATED RECEIVERS

NO. 508. ALL-AMERICAN 77, 88, AND 99

Six tubes; 3 t. r. f. (26), detector (27), 2 transformer audio (26 and 71). Rice neutralized t. r. f. Single drum tuning. Volume control: potentiometer in r. f. plate. Cabinet sizes: No. 77, 21 x 10 x 8 inches; No. 88 Hiboy, 25 x 38 x 18 inches; No. 99 console, 27½ x 43 x 20 inches. Shielded. Output device. The filaments are supplied by means of three small transformers. The plate supply employs a gas-filled rectifier tube. Voltmeter in a. c. supply line. Prices: No. 77, \$150, including power unit; No. 88, \$210 including power unit; No. 99, \$285 including power unit and loud speaker.

NO. 509. ALL-AMERICAN "DUET"; "SEXTET"

Six tubes; 2 t. r. f. (99), detector (99), 3 transformer audio (99 and 12). Rice neutralized t. r. f. Two dials. Volume control: resistance in r. f. plate. Cabinet sizes: "Duet," 23 x 56 x 16½ inches; "Sextet," 22½ x 13½ x 15½ inches. Shielded. Output device. The 99 filaments are connected in series and supplied with rectified a. c., while 12 is supplied with raw a. c. The plate and filament supply uses gaseous rectifier tubes. Millammeter on power unit. Prices: "Duet," \$160 including power unit; "Sextet," \$220 including power unit and loud speaker.

NO. 511. ALL-AMERICAN 80, 90, AND 115

Five tubes; 2 t. r. f. (99), detector (99), 2 transformer audio (99 and 12). Rice neutralized t. r. f. Two dials. Volume control: resistance in r. f. plate. Cabinet sizes: No. 80, 23½ x 12½ x 15 inches; No. 90, 37½ x 12 x 12½ inches; No. 115 Hiboy, 24 x 41 x 15 inches. Coils individually shielded. Output device. See No. 509 for power supply. Prices: No. 80, \$135 including power unit; No. 90, \$145 including power unit and compartment; No. 115, \$170 including power unit, compartment, and loud speaker.

NO. 510. ALL-AMERICAN 7

Seven tubes; 3 t. r. f. (26), 1 untuned r. f. (26), detector (27), 2 transformer audio (26 and 71). Rice neutralized t. r. f. One drum. Volume control: resistance in r. f. plate. Cabinet sizes: "Sovereign" console, 30½ x 60½ x 19 inches; "Lorraine" Hiboy, 25½ x 53½ x 17½ inches; "Forte" cabinet, 25½ x 13½ x 17½ inches. For filament and plate supply: See No. 508. Prices: "Sovereign" \$460; "Lorraine" \$360; "Forte" \$270. All prices include power unit. First two include loud speaker.

NO. 403. ARGUS 250B

Six tubes; 2 t. r. f. (99), 1 untuned r. f. (99), detector (99), 2 transformer audio (99 and 12). Stabilized with grid resistances. Two dials. Volume control: resistance across 1st audio. Watts required: 100. Cabinet size: 35½ x 14½ x 10½ inches. Output device. The 99 filaments are connected in series and supplied with rectified a. c., while the 12 is run on raw a. c. The power unit requires two 16-B rectifier tubes. Millammeter included in d. c. supply. Price \$250.00 including self-contained power unit. Other models: No. 125, \$125.00; console model, \$375.00.

NO. 401. AMRAD AC9

Six tubes; 3 t. r. f. (99), detector (99), 2 transformer (99 and 12). Neurodyne. Two dials. Volume control: resistance across 1st audio. Watts consumed: 50. Cabinet size: 27 x 9 x 11½ inches. The 99 filaments are connected in series and supplied with rectified a. c., while the 12 is run on raw a. c. The power unit, requiring two 16-B rectifiers, is separate and supplies A, B, and C current. Price \$142 including power unit.

NO. 402. AMRAD AC5

Five tubes. Same as No. 401 except one less r. f. stage. Price \$125 including power unit.

NO. 484. BOSWORTH, B5

Five tubes; 2 t. r. f. (26), detector (99), 2 transformer audio (special a. c. tubes). T. r. f. circuit. Two dials. Volume control: potentiometer. Cabinet size: 23 x 7 x 8 inches. Output device included. Price \$175.

NO. 406. CLEARSTONE 110

Five tubes; 2 t. r. f., detector, 2 transformer audio. All tubes a. c. heater type. One or two dials. Volume control: resistance in r. f. plate. Watts consumed: 40. Cabinet size: varies. The plate supply is built in the receiver and requires one rectifier tube. Filament supply through step down transformers. Prices range from \$175 to \$375 which includes 5 a. c. tubes and one rectifier tube.

NO. 407. COLONIAL 25

Six tubes; 2 t. r. f. (01-A), detector (99), 2 resistance audio (99). 1 transformer audio (10). Balanced t. r. f. circuit. One or three dials. Volume control: Antenna switch and potentiometer on 1st audio. Watts consumed: 100. Console size: 34 x 38 x 18 inches. Output device. All tube filaments are operated on a. c. except the detector which is supplied with rectified a. c. from the plate supply. The rectifier employs two 16-B tubes. Price \$250 including built-in plate and filament supply.

NO. 507. CROSLY 602 BANDBOX

Six tubes; 3 t. r. f. (26), detector (27), 2 transformer audio (26 and 71). Neurodyne circuit. One dial. Cabinet size: 17½ x 5½ x 7½ inches. The heaters for the a. c. tubes and the 71 filament are supplied by windings in B unit transformers available to operate either on 25 or 60 cycles. The plate current is supplied by means of rectifier tube. Price \$65 for set alone, power unit \$60.

NO. 408. DAY-FAN "DE LUXE"

Six tubes; 3 t. r. f., detector, 2 transformer audio. All 01-A tubes. One dial. Volume control: potentiometer across r. f. tubes. Watts consumed: 300. Console size: 30 x 40 x 20 inches. The filaments are connected in series and supplied with d. c. from a motor-generator set which also supplies B and C current. Output device. Price \$350 including power unit.

NO. 409. DAYCRAFT 5

Five tubes; 2 t. r. f., detector, 2 transformer audio. All a. c. heater tubes. Reflexed t. r. f. One dial. Volume control: potentiometers in r. f. plate and 1st audio. Watts consumed: 135. Console size: 34 x 36 x 14 inches. Output device. The heaters are supplied by means of a small transformer. A built-in rectifier supplies B and C voltages. Price \$170, less tubes. The following have one more r. f. stage and are not reflexed: Daycraft 6, \$195; Dayrole 6, \$235; Dayfan 6, \$110. All prices less tubes.

NO. 469. FREED-EISEMANN NR11

Six tubes; 3 t. r. f. (01-A), detector (01-A), 2 transformer audio (01-A and 71). Neurodyne. One dial. Volume control: potentiometer. Watts consumed: 150. Cabinet size: 19½ x 10 x 10½ inches. Shielded. Output device. A special power unit is included employing a rectifier tube. Price \$225 including NR-411 power unit.

NO. 487. FRESHMAN 7F-AC

Six tubes; 3 t. r. f. (26), detector (27), 2 transformer audio (26 and 71). Equaphase circuit. One dial. Volume control: potentiometer across 1st audio. Console size: 24½ x 41½ x 15 inches. Output device. The filaments and heaters and B supply are all supplied by one power unit. The plate supply requires one 80 rectifier tube. Price \$175 to \$350, complete.

NO. 536. SOUTH BEND

Six tubes. One control. Sub-panel shielding. Binding Posts. Antenna: outdoor. Prices: table, \$130, Baby Grand console, \$195.

NO. 537. WALBERT 26

Six tubes; five Kellogg a. c. tubes and one 71. Two controls. Volume control: variable plate resistance. Isosfarad circuit. Output device. Battery cable. Semi-shielded. Antenna: 50 to 75 feet. Cabinet size: 10½ x 29½ x 16½ inches. Prices: \$215; with tubes, \$250.

NO. 538. NEUTROWOUND, MASTER ALLECTRIC

Six tubes; 2 t. r. f. (01-A), detector (01-A), 2 audio (01-A and two 71 in push-pull amplifier). The 01-A tubes are in series, and are supplied from a 400-mA. rectifier. Two drum controls. Volume control: variable plate resistance. Output device. Shielded. Antenna: 50 to 100 feet. Price: \$360.

NO. 545. NEUTROWOUND, SUPER ALLECTRIC

Five tubes; 2 t. r. f. (99), detector (99), 2 audio (99 and 71). The 99 tubes are in series and are supplied from an 85-mA. rectifier. Two drum controls. Volume control: variable plate resistance. Output device. Antenna: 75 to 100 feet. Cabinet size: 9 x 24 x 11 inches. Price: \$150.

NO. 490. MOHAWK

Six tubes; 2 t. r. f., detector, 2 transformer audio. All tubes a. c. heater type except 71 in last stage. One dial. Volume control: rheostat on r. f. Watts consumed: 40. Panel size: 12½ x 8½ inches. Output device. The heaters for the a. c. tubes and the 71 filament are supplied by small transformers. The plate supply is of the built-in type using a rectifier tube. Prices range from \$65 to \$245.

NO. 413. MARTI

Six tubes: 2 t. r. f., detector, 3 resistance audio. All tubes a. c. heater type. Two dials. Volume control: resistance in r. f. plate. Watts consumed: 38. Panel size 7 x 21 inches. The built-in plate supply employs one 16-B rectifier. The filaments are supplied by a small transformer. Prices: table, \$235 including tubes and rectifier; console, \$275 including tubes and rectifier; console, \$325 including tubes, rectifier, and loud speaker.

NO. 417. RADIOLA 28

Eight tubes; five type 99 and one type 20. Drum control. Super-heterodyne circuit. C-battery connections. Battery cable. Headphone connection. Antenna: loop. Set may be operated from batteries or from the power mains when used in conjunction with the model 104 loud speaker. Prices: \$260 with tubes, battery operation; \$570 with model 104 loud speaker, a. c. operation.

NO. 540. RADIOLA 30-A

Receiver characteristics same as No. 417 except that type 71 power tube is used. This model is designed to operate on either a. c. or d. c. from the power mains. The combination rectifier—power—amplifier unit uses two type 81 tubes. Model 100-A loud speaker is contained in lower part of cabinet. Either a short indoor or long outside antenna may be used. Cabinet size: 42½ x 29 x 17¼ inches. Price: \$495.

NO. 541. RADIOLA 32

This model combines receiver No. 417 with the model 104 loud speaker. The power unit uses two type 81 tubes and a type 10 power amplifier. Loop is completely enclosed and is revolved by means of a dial on the panel. Models for operation from a. c. or d. c. power mains. Cabinet size: 52 x 72 x 17¼ inches. Price: \$895.

NO. 539. RADIOLA 17

Six tubes; 3 t. r. f. (26), detector (27), 2 transformer audio (26 and 27). One control. Illuminated dial. Built-in power supply using type 80 rectifier. Antenna: 100 feet. Cabinet size: 25½ x 7½ x 8½. Price: \$130 without accessories.

NO. 421. SOVEREIGN 238

Seven tubes of the a. c. heater type. Balanced t. r. f. Two dials. Volume control: resistance across 2nd audio. Watts consumed: 45. Console size: 37 x 52 x 15 inches. The heaters are supplied by a small a. c. transformer, while the plate is supplied by means of rectified a. c. using a gaseous type rectifier. Price \$325, including power unit and tubes.

NO. 517. KELLOGG 510, 511, AND 512

Seven tubes; 4 t. r. f., detector, 2 transformer audio. All Kellogg a. c. tubes. One control and special zone switch. Balanced. Volume control: special. Output device. Shielded. Cable connection between power supply unit and receiver. Antenna: 25 to 100 feet. Panel 7½ x 27½ inches. Prices: Model 510 and 512, consoles, \$495 complete. Model 511, console, \$365 without loud speaker.

NO. 496. SLEEPER ELECTRIC

Five tubes; four 99 tubes and one 71. Two controls. Volume control: rheostat on r. f. Neutralized. Cable. Output device. Power supply uses two 16-B tubes. Antenna: 100 feet. Prices: Type 64, table, \$160; Type 65, table, with built-in loud speaker, \$175; Type 66, table, \$175; Type 67, console, \$235; Type 78, console, \$265.

NO. 522. CASE, 62 B AND 62 C

McCullough a. c. tubes. Drum control. Volume control; variable high resistance in audio system. C-battery connections. Semi-shielded. Cable. Antenna: 100 feet. Panel size: 7 x 21 inches. Prices: Model 62 B, complete with a. c. equipment, \$185; Model 62 C, complete with a. c. equipment, \$235.

NO. 523. CASE, 92 A AND 92 C

McCullough a. c. tubes. Drum control. Inductive volume control. Technidyne circuit. Shielded. Cable. C-battery connections. Model 92 C contains output device. Loop operated. Prices: Model 92 A, table, \$350; Model 92 C, console, \$475.

BATTERY OPERATED RECEIVERS

NO. 512. ALL-AMERICAN 44, 45, AND 66

Six tubes; 3 t. r. f. (01-A, detector) 01-A, 2 transformer audio (01-A and 71). Rice neutralized t. r. f. Drum control. Volume control: rheostat in r. f. Cabinet sizes: No. 44, 21 x 10 x 8 inches; No. 55, 25 x 38 x 18 inches; No. 66, 27½ x 43 x 20 inches. C-battery connections. Battery cable. Antenna: 75 to 125 feet. Prices: No. 44, \$70; No. 55, \$125 including loud speaker; No. 66, \$200 including loud speaker.

NO. 428. AMERICAN C6

Five tubes; 2 t. r. f., detector, 2 transformer audio. All 01-A tubes. Semi balanced t. r. f. Three dials. Plate current 15 mA. Volume control: potentiometer. Cabinet sizes: table, 20 x 8½ x 10 inches; console, 36 x 40 x 17 inches. Partially shielded. Battery cable. C-battery connections. Antenna: 125 feet. Prices: table, \$30; console, \$65 including loud speaker.

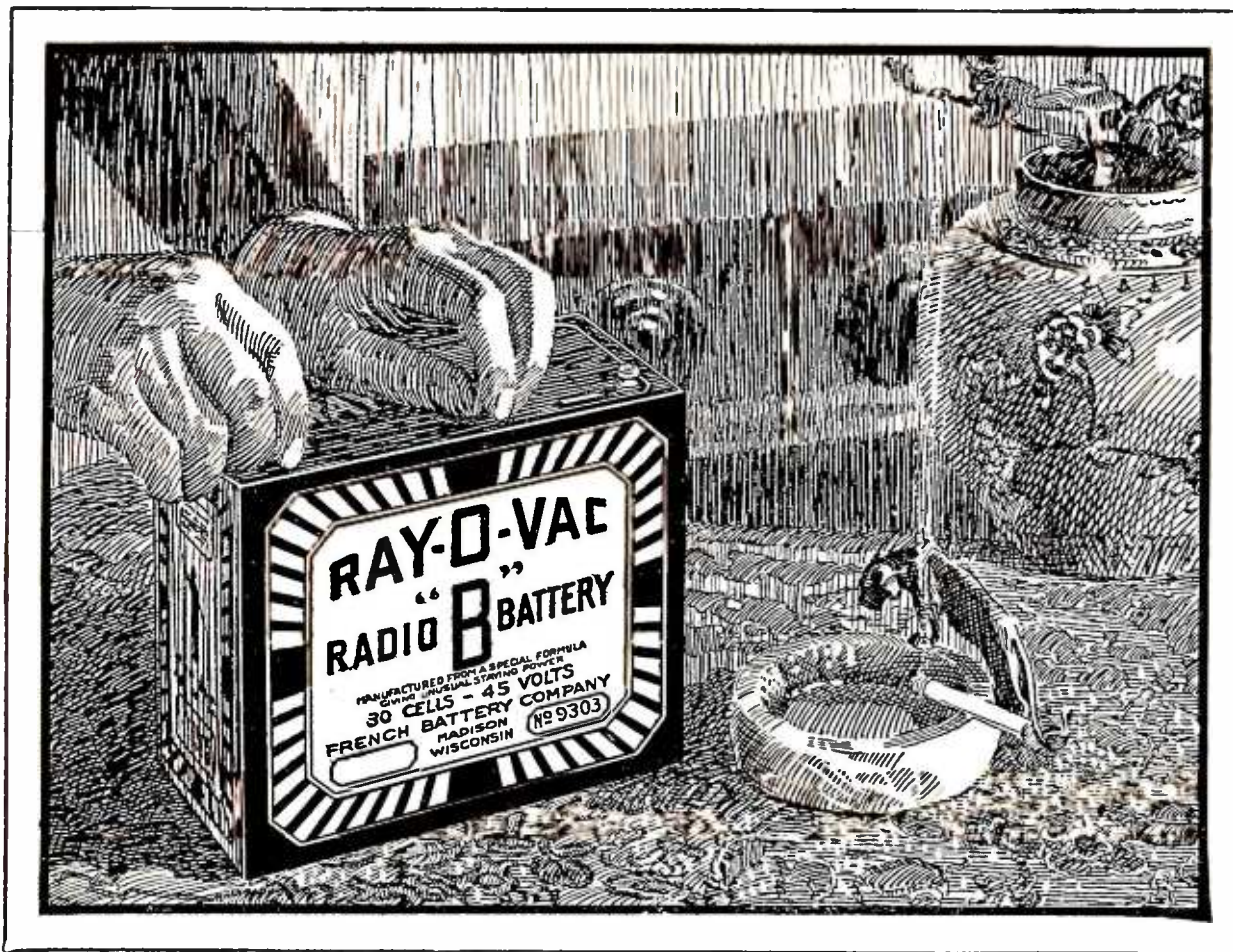

Above is the master Ray-O-Vac 45-volt "B" battery, with the new construction, made especially for sets using four or more tubes.

Improve Reception and reduce operating expense

EMINENT engineers say that for the best radio reception the "B" power supply should have as little internal resistance as possible.

Otherwise signals are liable to be distorted in amplification, and natural, rounded tones cannot come out of the loud speaker.

The special formula used in making Ray-O-Vacs produces batteries that have only from $\frac{1}{6}$ to $\frac{1}{3}$ the internal resistance of ordinary sources of "B" power supply.

At the same time, this special formula makes batteries that deliver a strong, steady voltage over an unusually long time. It gives them *staying power*.

And the long-life of Ray-O-Vac batteries is now still longer, because a

new method of construction prevents internal short circuits and prolongs the life of the battery from 10% to 15%.

There are twice as many radio owners using Ray-O-Vacs today as there were a year ago. They know what low internal resistance and staying power in "B" batteries mean.

Ray-O-Vac batteries are sold by the leading dealers in radio equipment and supplies. If you have any difficulty getting them write us for the name of a nearby dealer who can supply you.

**FRENCH BATTERY COMPANY
MADISON, WISCONSIN**

*Also makers of flashlights and batteries
and ignition batteries*

NO. 485. BOSWORTH B6

Five tubes; 2 t.r.f. (01-A), detector (01-A), 2 transformer audio (01-A and 71). Two dials. Volume control: variable grid resistances. Battery cable. C-battery connections. Antenna: 25 feet or longer. Cabinet size 15 x 7 x 8 inches. Price \$75.

NO. 513. COUNTERPHASE SIX

Six tubes; 3 t.r.f. (01-A), detector (00-A), 2 transformer audio (01-A and 12). Counterphase t.r.f. Two dials. Plate current: 32 mA. Volume control: rheostat on 2nd and 3rd r.f. Coils shielded. Battery cable. C-battery connections. Antenna: 75 to 100 feet. Console size: 18½ x 40½ x 15½ inches. Prices: Model 35, table, \$110; Model 37, console, \$175.

NO. 514. COUNTERPHASE EIGHT

Eight tubes; 4 t.r.f. (01-A), detector (00-A), 2 transformer audio (01-A and 12). Counterphase t.r.f. One dial. Plate current: 40 mA. Volume control: rheostat on 1st r.f. Copper stage shielding. Battery cable. C-battery connections. Antenna: 75 to 100 feet. Cabinet size: 30 x 12½ x 16 inches. Prices: Model 12, table, \$225; Model 16, console, \$335; Model 18, console, \$365.

NO. 506. CROSLLEY 601 BANDBOX

Six tubes; 3 t.r.f., detector, 2 transformer audio. All 01-A tubes. Neutrodyne. One dial. Plate current: 40 mA. Volume control: rheostat on r.f. Shielded. Battery cable. C-battery connections. Antenna: 75 to 150 feet. Cabinet size: 17½ x 5½ x 7½. Price, \$55.

NO. 434. DAY-FAN 6

Six tubes; 3 t.r.f. (01-A), detector (01-A), 2 transformer audio (01-A and 12 or 71). One dial. Plate current: 12 to 15 mA. Volume control: rheostat on r.f. Shielded. Battery cable. C-battery connections. Output device. Antenna: 50 to 120 feet. Cabinet sizes: Daycraft 6, 32 x 30 x 3¼ inches; Day-Fan Jr., 15 x 7 x 7. Prices: Day-Fan 6, \$110; Daycraft 6, \$145 including loud speaker; Day-Fan Jr. not available.

NO. 435. DAY-FAN 7

Seven tubes; 3 t.r.f. (01-A), detector (01-A), 1 resistance audio (01-A), 2 transformer audio (01-A and 12 or 71). Plate current: 15 mA. Antenna: outside. Same as No. 434. Price \$115.

NO. 503. FADA SPECIAL

Six tubes; 3 t.r.f. (01-A), detector (01-A), 2 transformer audio (01-A and 71). Neutrodyne. Two drum control. Plate current: 20 to 24 mA. Volume control: rheostat on r.f. Coils shielded. Battery cable. C-battery connections. Headphone connection. Antenna: outdoor. Cabinet size: 20½ x 13½ x 10½ inches. Price \$95.

NO. 504. FADA 7

Seven tubes; 4 t.r.f. (01-A), detector (01-A), 2 transformer audio (01-A and 71). Neutrodyne. Two drum control. Plate current: 43 mA. Volume control: rheostat on r.f. Completely shielded. Battery cable. C-battery connections. Headphone connections. Output device. Antenna: outdoor or loop. Cabinet sizes: table, 25½ x 13½ x 11½ inches; console, 29 x 50 x 17 inches. Prices: table, \$185; console, \$285.

NO. 436. FEDERAL

Five tubes; 2 t.r.f. (01-A), detector (01-A), 2 transformer audio (01-A and 12 or 71). Balanced t.r.f. One dial. Plate current: 20.7 mA. Volume control: rheostat on r.f. Shielded. Battery cable. C-battery connections. Antenna: loop. Made in 6 models. Price varies from \$250 to \$1000 including loop.

NO. 505. FADA 8

Eight tubes. Same as No. 504 except for one extra stage of audio and different cabinet. Prices: table, \$300; console, \$400.

NO. 437. FERGUSON 10A

Seven tubes; 3 t.r.f. (01-A), detector (01-A), 3 audio (01-A and 12 or 71). One dial. Plate current: 18 to 25 mA. Volume control: rheostat on two r.f. Shielded. Battery cable. C-battery connections. Antenna: 100 feet. Cabinet size: 21½ x 12 x 15 inches. Price \$150.

NO. 438. FERGUSON 14

Ten tubes; 3 untuned r.f., 3 t. r.f. (01-A), detector (01-A), 3 audio (01-A and 12 or 71). Special balanced t.r.f. One dial. Plate current: 30 to 35 mA. Volume control: rheostat in three r.f. Shielded. Battery cable. C-battery connections. Antenna: loop. Cabinet size: 24 x 12 x 16 inches. Price \$235, including loop.

NO. 439. FERGUSON 12

Six tubes; 2 t.r.f. (01-A), detector (01-A), 1 transformer audio (01-A), 2 resistance audio (01-A and 12 or 71). Two dials. Plate current: 18 to 25 mA. Volume control: rheostat on two r.f. Partially shielded. Battery cable. C-battery connections. Antenna: 100 feet. Cabinet size: 22½ x 10 x 12 inches. Price \$85. Consolette \$145 including loud speaker.

NO. 440. FREED-EISEMANN NR-8. NR-9, AND NR-66

Six tubes; 3 t.r.f. (01-A), detector (01-A), 2 transformer audio (01-A and 71). Neutrodyne. NR-8, two dials; others one dial. Plate current: 30 mA. Volume control: rheostat on r.f. NR-8 and 9; chassis type shielding. NR-66, individual stage shielding. Battery cable. C-battery connections. Antenna: 100 feet. Cabinet sizes: NR-8 and 9, 19½ x 10 x 10½ inches; NR-66 20 x 10½ x 12 inches. Prices: NR-8, \$90; NR-9, \$100; NR-66, \$125.

NO. 501. KING "CHEVALIER"

Six tubes. Same as No. 500. Coils completely shielded. Panel size: 11 x 7 inches. Price, \$210 including loud speaker.

NO. 441. FREED-EISEMANN NR-77

Seven tubes; 4 t.r.f. (01-A), detector (01-A), 2 transformer audio (01-A and 71). Neutrodyne. One dial. Plate current: 35 mA. Volume control: rheostat on r.f. Shielding. Battery cable. C-battery connections. Antenna: outside or loop. Cabinet size: 23 x 10½ x 13 inches. Price \$175.

NO. 442. FREED-EISEMANN 800 AND 850

Eight tubes; 4 t.r.f. (01-A), detector (01-A), 1 transformer (01-A), 1 parallel audio (01-A or 71). Neutrodyne. One dial. Plate current: 35 mA. Volume control: rheostat on r.f. Shielded. Battery cable. C-battery connections. Output: two tubes in parallel or one power tube may be used. Antenna: outside or loop. Cabinet sizes: No. 800, 34 x 15½ x 13½ inches; No. 850, 36 x 65½ x 17½. Prices not available.

NO. 444. GREBE MU-1

Five tubes; 2 t.r.f. (01-A), detector (01-A), 2 transformer audio (01-A and 12 or 71). Balanced t.r.f. One, two, or three dials (operate singly or together). Plate current: 30 mA. Volume control: rheostat on r.f. Binocular coils. Binding posts. C-battery connections. Antenna: 125 feet. Cabinet size: 22½ x 9½ x 13 inches. Prices range from \$95 to \$320.

NO. 426. HOMER

Seven tubes; 4 t.r.f. (01-A); detector (01-A or 00A); 2 audio (01-A and 12 or 71). One knob tuning control. Volume control: rotor control in antenna circuit. Plate current: 22 to 25 mA. "Technidyne" circuit. Completely enclosed in aluminum box. Battery cable. C-battery connections. Cabinet size, 8½ x 19½ x 9½ inches. Chassis size, 6½ x 17 x 8 inches. Prices: Chassis only, \$80. Table cabinet, \$95.

NO. 502. KENNEDY ROYAL 7. CONSOLETTA

Seven tubes; 4 t.r.f. (01-A), detector (00-A), 2 transformer audio (01-A and 71). One dial. Plate current: 42 mA. Volume control: rheostat on two r.f. Special r.f. coils. Battery cable. C-battery connections. Headphone connection. Antenna: outside or loop. Consolette size: 36½ x 35½ x 19 inches. Price \$220.

NO. 498. KING "CRUSADER"

Six tubes; 2 t.r.f. (01-A), detector (00-A), 3 transformer audio (01-A and 71). Balanced t.r.f. One dial. Plate current: 20 mA. Volume control: rheostat on r.f. Coils shielded. Battery cable. C-battery connections. Antenna: outside. Panel: 11 x 7 inches. Price, \$115.

NO. 499. KING "COMMANDER"

Six tubes; 3 t.r.f. (01-A), detector (00-A), 2 transformer audio (01-A and 71). Balanced t.r.f. One dial. Plate current: 25 mA. Volume control: rheostat on r.f. Completely shielded. Battery cable. C-battery connections. Antenna: loop. Panel size: 12 x 8 inches. Price \$220 including loop.

NO. 429. KING COLE VII AND VIII

Seven tubes; 3 t.r.f., detector, 1 resistance audio, 2 transformer audio. All 01-A tubes. Model VII has one more stage t.r.f. (eight tubes). Model VII, two dials. Model VIII, one dial. Plate current: 15 to 50 mA. Volume control: primary shunt in r.f. Steel shielding. Battery cable and binding posts. C-battery connections. Output devices on some consoles. Antenna: 10 to 100 feet. Cabinet size: varies. Prices: Model VII, \$80 to \$160; Model VIII, \$100 to \$300.

NO. 500. KING "BARONET" AND "VIKING"

Six tubes; 2 t.r.f. (01-A), detector (00-A), 3 transformer audio (01-A and 71). Balanced t.r.f. One dial. Plate current: 19 mA. Volume control: rheostat on r.f. Battery cable. C-battery connections. Antenna: outside. Panel size: 18 x 7 inches. Prices: "Baronet," \$70; "Viking," \$140 including loud speaker.

NO. 489. MOHAWK

Six tubes; 2 t.r.f. (01-A), detector (00-A), 3 audio (01-A and 71). One dial. Plate current: 40 mA. Volume control: rheostat on r.f. Battery cable. C-battery connections. Output device. Antenna: 60 feet. Panel size: 12½ x 8½ inches. Prices range from \$65 to \$245.

NO. 449. NORBERT "MIDGET"

One multivalve tube; detector, 2 transformer audio. Two dials. Plate current: 3 mA. Volume control: rheostat. Binding posts. C-battery connections. Headphone connection. Antenna: 75 to 150 feet. Cabinet size: 12 x 8 x 9 inches. Price \$12 including multivalve.

NO. 450. NORBERT 2

Two tubes; 1 t.r.f., detector, 2 transformer audio. One multi-valve tube and one 01-A. Two dials. Plate current: 8 mA. Volume control: special. Battery cable. Headphone connection. C-battery connections. Antenna: 50 to 100 feet. Cabinet size: 20 x 7 x 5½ inches. Price \$40.50 including multivalve and 01-A tube.

NO. 452. ORIOLE 90

Five tubes; 2 t.r.f., detector, 2 transformer audio. All 01-A tubes. "Trinum" circuit. Two dials. Plate current: 18 mA. Volume control: rheostat on r.f. Battery cable. C-battery connections. Antenna: 50 to 100 feet. Cabinet size: 25½ x 11½ x 12½ inches. Price \$85. Another model has 8 tubes, one dial, and is shielded. Price \$185.

NO. 453. PARAGON

Six tubes; 2 t.r.f. (01-A), detector (01-A), 3 double impedance audio (01-A and 71). One dial. Plate current: 40 mA. Volume control: resistance in r.f. plate. Shielded. Battery cable. C-battery connections. Output device. Antenna: 100 feet. Console size: 20 x 46 x 17 inches. Price not determined.

NO. 543 RADIOLA 20

Five tubes; 2 t. r. f. (99), detector (99), two transformer audio (99 and 20). Regenerative detector. Two drum controls. C-battery connections. Battery cable. Antenna: 100 feet. Price: \$78 without accessories.

NO. 480. PFANSTIEHL 30 AND 302

Six tubes; 3 t.r.f. (01-A), detector (01-2A), transformer audio (01-A and 71). One dial. Plate current: 23 to 32 mA. Volume control: resistance in r.f. plate. Shielded. Battery cable. C-battery connections. Antenna: outside. Panel size: 17½ x 8½ inches. Prices: No. 30 cabinet, \$105; No. 302 console, \$185 including loud speaker.

NO. 515. BROWNING-DRAKE 7-A

Seven tubes; 2 t.r.f. (01-A), detector (00-A), 3 audio (Hmu, two 01-A, and 71). Illuminated drum control. Volume control: rheostat on 1st r.f. Shielded. Neutralized. C-battery connections. Battery Cable. Metal panel. Output device. Antenna: 50-75 feet. Cabinet, 30 x 11 x 9 inches. Price, \$145.

NO. 516. BROWNING-DRAKE 6-A

Six tubes; 1 t.r.f. (99), detector (00-A), 3 audio (Hmu, two 01-A and 71). Drum control with auxiliary adjustment. Volume control: rheostat on r.f. Regenerative detector. Shielded. Neutralized. C-battery connections. Battery cable. Antenna: 50-100 feet. Cabinet, 25 x 11 x 9. Price \$105.

NO. 518. KELLOGG "WAVE MASTER," 504, 505, AND 506.

Five tubes; 2 t.r.f., detector, 2 transformer audio. One control and special zone switch. Volume control: rheostat on r.f. C-battery connections. Binding posts. Plate current: 25 to 35 mA. Antenna: 100 feet. Panel: 7½ x 25½ inches. Prices: Model 504, table, \$75, less accessories. Model 505, table, \$125 with loud speaker. Model 506, consolette, \$135 with loud speaker.

NO. 519. KELLOGG, 507 AND 508.

Six tubes, 3 t.r.f., detector, 2 transformer audio. One control and special zone switch. Volume control: rheostat on r.f. C-battery connections. Balanced. Shielded. Binding posts and battery cable. Antenna: 70 feet. Cabinet size: Model 507, table, 30 x 13½ x 14 inches. Model 508, console, 34 x 18 x 54 inches. Prices: Model 507, \$190 less accessories. Model 508, \$320 with loud speaker.

NO. 427. MURDOCK 7

Seven tubes; 3 t.r.f. (01-A), detector (01-A), 1 transformer and 2 resistance audio (two 01-A and 12 or 71). One control. Volume control: rheostat on r.f. Coils shielded. Neutralized. Battery cable. C-battery connections. Complete metal case. Antenna: 100 feet. Panel size: 9 x 23 inches. Price, not available.

NO. 520. BOSCH 57

Seven tubes; 4 t.r.f. (01-A), detector (01-A), 2 audio (01-A and 71). One control calibrated in kc. Volume control: rheostat on r.f. Shielded. Battery cable. C-battery connections. Balanced. Output device. Built-in loud speaker. Antenna: built-in loop or outside antenna, 100 feet. Cabinet size: 46 x 16 x 30 inches. Price: \$340 including enclosed loop and loud speaker.

NO. 521. BOSCH "CRUISER," 66 AND 76

Six tubes; 3 t.r.f. (01-A), detector (01-A), 2 audio (01-A and 71). One control. Volume control: rheostat on r.f. Shielded. C-battery connections. Balanced. Battery cable. Antenna: 20 to 100 feet. Prices: Model 66, table, \$99.50. Model 76, console, \$175; with loud speaker \$195.

NO. 524. CASE, 61 A AND 61 C

T.r.f. Semi-shielded. Battery cable. Drum control. Volume control: variable high resistance in audio system. Plate current: 35 mA. Antenna: 100 feet. Prices: Model 61 A, \$85; Model 61 C, console, \$135.

NO. 525. CASE, 90 A AND 90 C

Drum control. Inductive volume control. Technidyne circuit. C-battery connections. Battery cable. Loop operated. Model 90-C equipped with output device. Prices: Model 90 A, table, \$225; Model 90 C, console, \$350.

NO. 526. ARBORPHONE 25

Six tubes; 3 t.r.f. (01-A), detector (01-A), 2 audio (01-A and 71). One control. Volume control: rheostat. Shielded. Battery cable. Output device. C-battery connections. Loftin-White circuit. Antenna: 75 feet. Panel: 7½ x 15 inches, metal. Prices: Model 25, table, \$125; Model 252, \$185; Model 253, \$250; Model 255, combination phonograph and radio, \$600.

NO. 527. ARBORPHONE 27

Five tubes; 2 t.r.f. (01-A), detector (01-A), 2 audio (01-A). Two controls. Volume control: rheostat. C-battery connections. Binding posts. Antenna: 75 feet. Prices: Model 27, \$65; Model 271, \$99.50; Model 272, \$125.

NO. 528. THE "CHIEF"

Seven tubes; six 01-A tubes and one power tube. One control. Volume control: rheostat. C-battery connection. Partial shielding. Binding posts. Antenna: outside. Cabinet size: 40 x 22 x 16 inches. Prices: Complete with A power supply, \$250; without accessories, \$150.

NO. 529. DIAMOND SPECIAL, SUPER SPECIAL, AND BABY GRAND CONSOLE

Six tubes; all 01-A type. One control. Partial shielding. C-battery connections. Volume control: rheostat. Binding posts. Antenna: outdoor. Prices: Diamond Special, \$75; Super Special, \$65; Baby Grand Console, \$110.

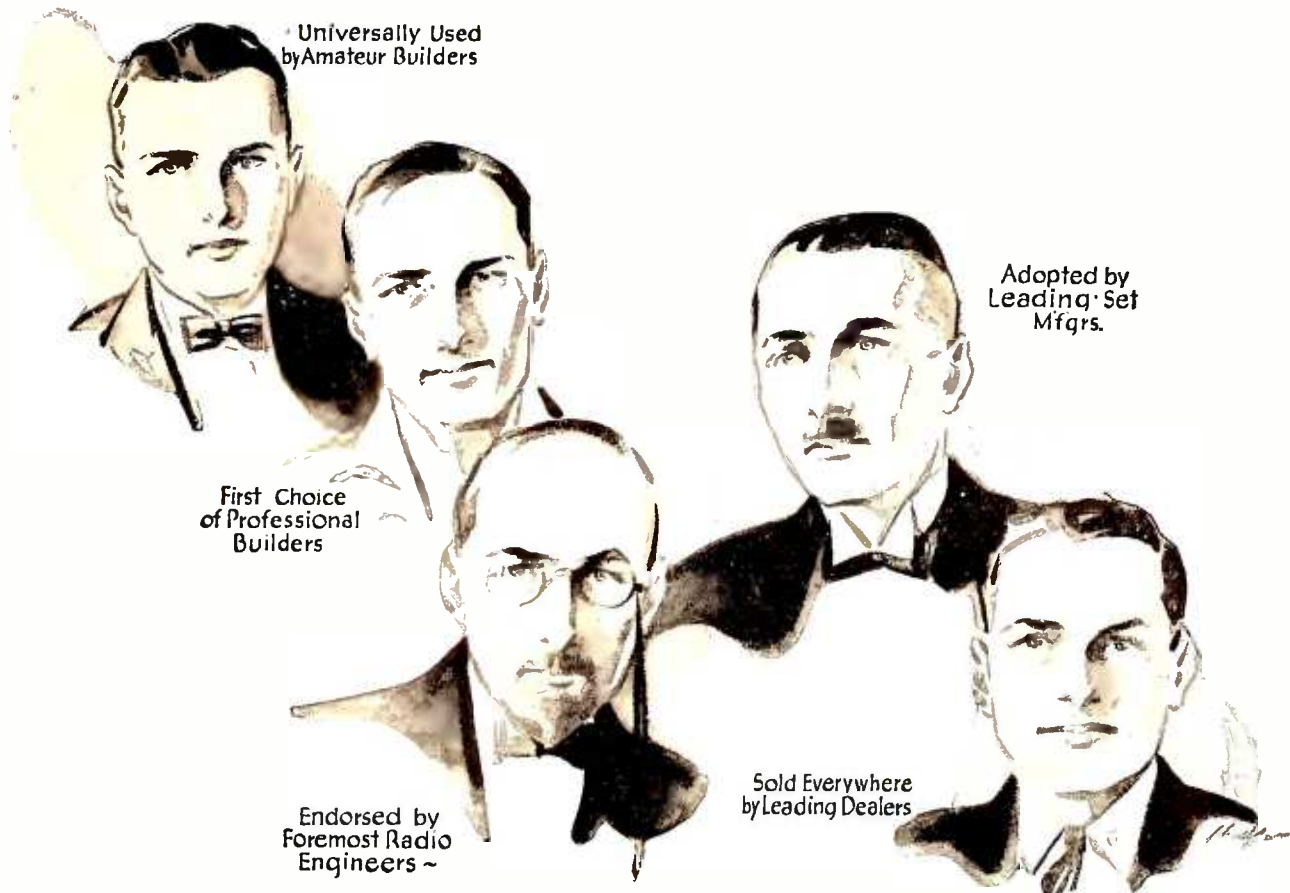

FIRST CHOICE of the Keenest Minds in Radio!



Durham standard resistors are made in ranges from 500 ohms to 10 megohms. Durham Powerohms for "B" Eliminators and Amplifier circuits are made in 2.5 watt and 5 watt sizes in ranges from 500 to 100,000 ohms.

Adopted by Leading Radio Manufacturers

- Philco
- Fansteel Products Co.
- Kellogg-Switchboard
- Western Electric
- F. A. D. Andrea
- Sterling Mfg. Co.
- Kokomo Electric
- Garod Radio Corp.
- Browning-Drake
- Howard Radio
- A-C Dayton

FIRST CHOICE—because Durham was the first and original "metallized filament" resistor—because years of heavy production and the confidence of leading radio manufacturers have given us *time* to produce a perfect product.

Durham Resistors and Powerohms are the leaders in their field because their uniform, unfailing accuracy and absolute reliability have been proved time and time again.

This is why they are the first choice of foremost engineers, leading manufacturers, professional set builders and informed radio fans who demand quality results.

Like Durham Resistors and Powerohms, Durham Resistor Mountings are also the leaders in their field. The only upright mountings made; takes minimum space—made of high resistance moulded insulation—best quality tension-spring bronze contacts. Single and double sizes.

DURHAM

← METALLIZED →

RESISTORS & POWEROHMS

INTERNATIONAL RESISTANCE CO., Dept. D, 2½ South 20th Street, Philadelphia, Pa.

NO. 530. KOLSTER, 7A AND 7B

Seven tubes; 4 t.r.f. (01-A), detector (01-A), 2 audio (01-A and 12). One control. Volume control: rheostat on r.f. Shielded. Battery cable. C-battery connections. Antenna: 50 to 75 feet. Prices: Model 7A, \$125; Model 7B, with built-in loud speaker, \$140.

NO. 531. KOLSTER, 8A, 8B, AND 8C

Eight tubes; 4 t.r.f. (01-A), detector (01-A), 3 audio (two 01-A and one 12). One control. Volume control: rheostat on r.f. Shielded. Battery cable. C-battery connections. Model 8A uses 50 to 75 foot antenna; model 8B contains output device and uses antenna or detachable loop; Model 8C contains output device and uses antenna or built-in loop. Prices: 8A, \$185; 8B, \$235; 8C, \$375.

NO. 532. KOLSTER, 6D, 6G, AND 6H

Six tubes; 3 t.r.f. (01-A), detector (01-A), 2 audio (01-A and 12). One control. Volume control: rheostat on r.f. C-battery connections. Battery cable. Antenna: 50 to 75 feet. Model 6G contains output device and built-in loud speaker; Model 6H contains built-in B power unit and loud speaker. Prices: Model 6D, \$80; Model 6G, \$165; Model 6H, \$265.

NO. 533. SIMPLEX, SR 9 AND SR 10

Five tubes; 2 t.r.f. (01-A), detector (00-A), 2 audio (01-A and 12). SR 9, three controls; SR 10, two controls. Volume control: rheostat. C-battery connections. Battery cable. Headphone connection. Prices: SR 9, table, \$65; console, \$95; console, \$145. SR 10, table \$70; console, \$95; console, \$145.

NO. 534. SIMPLEX, SR 11

Six tubes; 3 t.r.f. (01-A), detector (00-A), 2 audio (01-A and 12). One control. Volume control: rheostat. C-battery connections. Battery cable. Antenna: 100 feet. Prices: table, \$70; console, \$95; console, \$145.

NO. 535. STANDARDYNE, MODEL S 27

Six tubes; 2 t.r.f. (01-A), detector (01-A), 2 audio (power tubes). One control. Volume control: rheostat on r.f. C-battery connections. Binding posts. Antenna: 75 feet. Cabinet size: 9 x 9 x 19½ inches. Prices: S 27, \$49.50; S 950, console, with built-in loud speaker, \$99.50; S 600, console with built-in loud speaker, \$104.50.

NO. 481. PFANSTIEHL 32 AND 322

Seven tubes; 3 t.r.f. (01-A), detector (01-A), 3 audio (01-A and 71). One dial. Plate current: 23 to 32 mA. Volume control: resistance in r. f. plate. Shielded. Battery cable. C-battery connections. Output device. Antenna: outside. Panel: 17½ x 8½ inches. Prices: No. 32 cabinet, \$145; No. 322 console, \$245 including loud speaker.

NO. 433. ARBORPHONE

Five tubes; 2 t.r.f., detector, 2 transformer audio. All 01-A tubes. Two dials. Plate current: 16 mA. Volume control: rheostat in r.f. and resistance in r.f. plate. C-battery connections. Binding posts. Antenna: taps for various lengths. Cabinet size: 24 x 9 x 10½ inches. Price: \$65.

NO. 431. AUDIOLA 6

Six tubes; 3 t.r.f. (01-A), detector (00-A), 2 transformer audio (01-A and 71). Drum control. Plate current: 20 mA. Volume control: resistance in r.f. plate. Stage shielding. Battery cable. C-battery connection. Antenna: 50 to 100 feet. Cabinet size: 28½ x 11 x 14½ inches. Price not established.

NO. 432. AUDIOLA 8

Eight tubes; 4 t.r.f. (01-A), detector (00-A), 1 transformer audio (01-A), push-pull audio (12 or 71). Bridge balanced t.r.f. Drum control. Volume control: resistance in r.f. plate. Stage shielding. Battery cable. C-battery connections. Antenna: 10 to 100 feet. Cabinet size: 28½ x 11 x 149 inches. Price not established.

NO. 542. RADIOLA 16

Five tubes; 3 t. r. f. (01-A), detector (01-A), 2 transformer audio (01-A and 112). One control. C-battery connections. Battery cable. Antenna: outside. Cabinet size: 16½ x 8¼ x 7½ inches. Price: \$69.50 without accessories.

NO. 456. RADIOLA 20

Five tubes; 2 t.r.f. (99), detector (99), 2 transformer audio (99 and 20). Balanced t.r.f. and regenerative detector. Two dials. Volume control: regenerative. Shielded. C-battery connections. Headphone connections. Antenna: 75 to 150 feet. Cabinet size: 19½ x 11½ x 16 inches. Price \$115 including all tubes.

NO. 457. RADIOLA 25

Six tubes; five type 99 and one type 20. Drum control. Super-heterodyne circuit. C-battery connections. Battery cable. Headphone connections. Antenna: loop. Set may be operated from batteries or from power mains when used with model 104 loud speaker. Price: \$165 with tubes, for battery operation. Apparatus for operation of set from the power mains can be purchased separately.

NO. 493. SONORA F

Seven tubes; 4 t.r.f. (01-A), detector (00-A), 2 transformer audio (01-A and 71). Special balanced t.r.f. Two dials. Plate current: 45 mA. Volume control: rheostat in r.f. Shielded. Battery cable. C-battery connections. Output device. Antenna: loop. Console size: 32 x 45½ x 17 inches. Prices range from \$350 to \$450 including loop and loud speaker.

NO. 494. SONORA E

Six tubes; 3 t.r.f. (01-A), detector (00-A), 2 transformer audio (01-A and 71). Special balanced t.r.f. Two dials. Plate current: 35 to 40 mA. Volume control: rheostat on r.f. Shielded. Battery cable. C-battery connections. Antenna: outside. Cabinet size: varies. Prices: table, \$110; semi-console, \$140; console, \$240 including loud speaker.

NO. 495. SONORA D

Same as No. 494 except arrangement of tubes; 2 t.r.f., detector, 3 audio. Prices: table, \$125; standard console, \$185; "DeLuxe" console, \$225.

NO. 482. STEWART-WARNER 705 AND 710

Six tubes; 3 t.r.f., detector, 2 transformer audio. All 01-A tubes. Balanced t.r.f. Two dials. Plate current: 10 to 25 mA. Volume control: resistance in r.f. plate. Shielded. Battery cable. C-battery connections. Antenna: 80 feet. Cabinet sizes: No. 705 table, 26½ x 11½ x 13½ inches; No. 710 console, 29½ x 42 x 17½ inches. Tentative prices: No. 705, \$115; No. 710 \$265 including loud speaker.

NO. 483. STEWART-WARNER 525 AND 520

Same as No. 482 except no shielding. Cabinet sizes: No. 525 table, 19½ x 10 x 11½ inches; No. 520 console, 22½ x 40 x 14½ inches. Tentative prices: No. 525, \$75; No. 520, \$117.50 including loud speaker.

NO. 459. STROMBERG-CARLSON 501 AND 502

Five tubes; 2 t.r.f. (01-A), detector (00-A), 2 transformer audio (01-A and 71). Neutrodyne. Two dials. Plate current: 25 to 35 mA. Volume control: rheostat on 1st r.f. Shielded. Battery cable. C-battery connections. Headphone connections. Output device. Panel voltmeter. Antenna: 60 to 100 feet. Cabinet sizes: No. 501, 25½ x 13 x 14 inches; No. 502, 28½ x 50 x 16½ inches. Prices: No. 501, \$180; No. 502, \$290.

NO. 460. STROMBERG-CARLSON 601 AND 602

Six tubes. Same as No. 549 except for extra t.r.f. stage. Cabinet sizes: No. 601, 27½ x 16½ x 14½ inches; No. 602, 28½ x 51½ x 19½ inches. Prices: No. 601, \$225; No. 602, \$330.

NO. 486. VALLEY 71

Seven tubes; 4 t.r.f. (01-A), detector (01-A), 2 transformer audio (01-A and 71). One dial. Plate current: 35 mA. Volume control: rheostat on r.f. Partially shielded. Battery cable. C-battery connections. Headphone connection. Antenna: 50 to 100 feet. Cabinet size: 27 x 6 x 7 inches. Price \$95.

NO. 472. VOLOTONE VIII

Six tubes. Same as No. 471 with following exceptions; 2 t.r.f. stages. Three dials. Plate current: 20 mA. Cabinet size: 26½ x 8 x 12 inches. Price \$140.



It isn't a Question of DX-ing any more— Quality of Tone is the thing

MOST listeners-in want crystal clear, undistorted tones more than distance.

They seem to want to set their dials for a desired program and get it right—to get it full, strong and free from the annoyance of blurring and what might be termed "warped" tones.

The one big thing that Carborundum Stabilizing Detector Unit does in any set is to improve the tone quality. Besides you will find that it increases the volume and gives you greater distance—if you want it.

The Carborundum Stabilizing Detector Unit

Reg. U.S. Pat. Off. **CLARIFIES RECEPTION**

So will Carborundum Grid Leaks and Resistors

Send for Hook-Up Book D-2

THE CARBORUNDUM COMPANY, NIAGARA FALLS, N. Y.

SALES OFFICES AND WAREHOUSES IN New York, Chicago, Boston, Philadelphia, Cleveland, Detroit, Cincinnati, Pittsburgh, Milwaukee, Grand Rapids
The Carborundum Company, Ltd., Manchester, Eng.

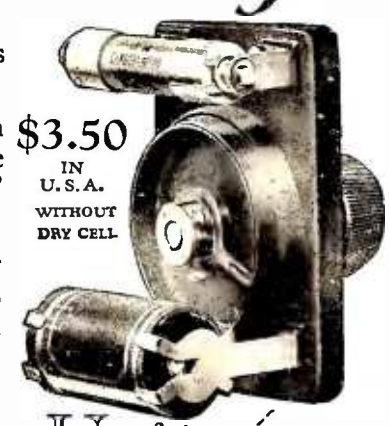

\$3.50
IN
U.S.A.
WITHOUT
DRY CELL

The Carborundum Company
Niagara Falls, N.Y.

Please send free
Hook-Up Book D-2

Name _____
Street _____
City _____
State _____



Sickles Coil Set No. 18A for Roberts Circuit

SICKLES Diamond-Weave Coils

THE new Sickles Shielded Tuned Radio Transformer prevents both outside and local interference. It is remarkably compact, sharp tuning, sturdy.

Sickles Diamond-weave coils have established an enviable reputation for low distributed capacity, low dielectric losses, and large range of frequency with small variable capacity.

The ideal coil for the Naald Localized Control Tuning Unit and for the Tru-phonic Catacomb Assembly.

There are Sickles Diamond Weave Coils for all Leading Circuits.

The F. W. Sickles Co.
132 Union Street
SPRINGFIELD, MASS.

COIL PRICES

- No. 30 Shielded Transformer... \$2.00 each
- No. 24 Browning-Drake..... 7.50 Set
- No. 18A Roberts Circuit..... 8.00 "
- No. 25 Aristocrat Circuit..... 8.00 "

Nathaniel BALDWIN LOUD SPEAKERS

A Famous Speaker

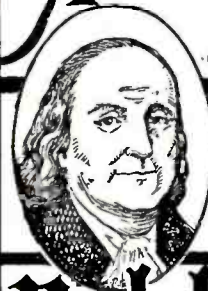

Benj. Franklin once said:
"My performance devotes itself entirely to thy service and will serve thee faithfully and if it has the good fortune to please its master, its gratification enough for the labor of—"
Poor Richard

The New "99" Baldwin 99

is without comparison, due to the super-fine quality of its unit. To-day, as 15 years ago, Baldwin performance is still the standard by which others are judged, comparable to the sensitive mechanism of a fine watch. The New Baldwin "99" can be used on any set. Ask your dealer to demonstrate it.

At all **\$28.50**
Good Dealers

Write For Booklets
BALDWIN UNITS

Loudspeaker units, Phono adapters, and head sets are standard the world over.



J. W. & W. L. WOOLF
Distributors and Exporters For
NATHANIEL BALDWIN, Inc.
227-229 Fulton St. New York



Why all this stuff for an aerial ~

when all you need is this ~?

The trouble and expense of erecting an outdoor antenna are now absolutely unnecessary. The Dubilier Light Socket Aerial has taken the place of loose wires, crazy poles, lightning arresters and all the other accessories of an old-fashioned antenna. Full volume is guaranteed. So is clarity and distance. You'll find, too that this remarkable device greatly reduces both static and interference. Convince yourself without risk—all dealers sell the Dubilier Light Socket Aerial on a 5-day money-back basis.

Price \$1.50



Dubilier
Approved Blocks
for Power Units

If you're building an A-B-C eliminator, insist on the high factor of safety found only in the approved Dubilier condenser blocks. Raytheon and all standard circuits provided for.



The Accurate
Dubilier Metaleak

Don't underestimate the importance of accurate and quiet tubular leaks in the performance of your receiver. Metaleak is smaller than most, but interchangeable on any standard mounting. All resistances —40c to 65c.

DUBILIER CONDENSER CORPORATION

4377 Bronx Blvd. New York

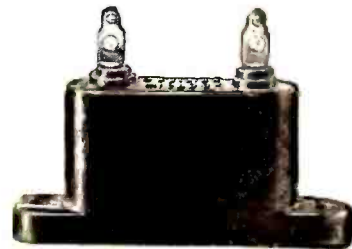

You'll like the new
Dubilier Micadon

A new shape and moulded Bakelite case have made the "Standard Fixed Condenser of Radio" a better and better-looking Micadon. Fully protected from injury and outside capacity. Terminals adapted to screwed or soldered connections.

Prices 45c to \$1.50

Dubilier Condensers

More than 1,000,000 owners of
General Electric
Battery Chargers
now have peppy radio batteries - always



5-Ampere Tungar

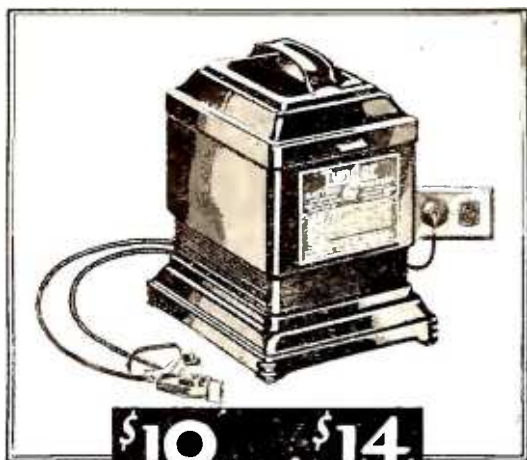

G-E Trickle Charger

\$10 \$14
\$24

Keep your radio set ready—at all times—for all the good things that come over.

Just turn on Tungar (the name of the General Electric battery charger) at night, leave it as you would the light in the hall . . . in the morning your storage batteries are pepped up and ready for active duty

More than 1,000,000 G-E Tungars are in use today. For the Tungar long ago established its reputation for dependable, trouble-free, economical service.

Your dealer can help you. Ask him to show you the popular 2-ampere Tungar that gives both trickle and boost charging rates. It charges "A" and "B" radio batteries and auto batteries, too.

Tungar causes no radio interference. It cannot blow out tubes.

An overnight charge costs a dime.

It is a G-E product developed in the Research Laboratories of General Electric.

The 2- or 5-ampere Tungars charge 2-, 4-, and 6-volt "A" batteries, 24- to 96-volt "B" batteries in series; and auto batteries, too. No extra attachments needed.

New Low Prices
(East of the Rockies)

2-ampere Tungar, now \$14
5-ampere Tungar, now \$24
G-E Trickle Charger, now \$10

Merchandise Department
General Electric Company
Bridgeport, Connecticut



Tungar—a registered trademark—is found only on the genuine. Look for it on the name plate.

GENERAL ELECTRIC

just out!
GET YOURS QUICK

Don't wait! Send today for this wonderful book. See how 14,000 live radio dealers make bigger profits by buying from The Harry Alter Company, America's foremost wholesalers of receiving sets, kits, parts and accessories—the largest stock of standard, nationally advertised radio goods carried anywhere.

RADIO'S GREATEST CATALOG

Compare its low prices with those of any other catalog. You will be amazed. Note: We sell only to radio retailers. Write for your copy NOW.

The Harry Alter Co.

1754 Michigan Avenue CHICAGO

CARTER

NEW VITREOUS ENAMEL RESISTORS

(1/2 size)

These Resistors are wire-wound and coated with a vitreous enamel which protects the wire from mechanical injury and oxidation.

This hard, glassy enamel has the same rate of expansion as the porcelain tube and the resistance wire that is wound on it. Consequently the Resistor may be operated at high temperatures without damaging it.

These Resistors are guaranteed permanently accurate within 5 per cent. of rated value.

Resistors from 750 to 20,000 ohms, two types—2 in. long, dissipating 20 watts; 4 in. long, dissipating 40 watts.

In Canada: Carter Radio Co., Ltd., Toronto
Offices in principal cities of the world

MEMBER RMA

Sovereign



Tube and Kit

MODERNIZE YOUR RADIO!

BUILD your own Battery-Less receiver with the ADVANCED 1928 MODEL SOVEREIGN A-C KIT. No more A Battery—No A Battery Eliminator—No Hum—No Microphonic Disturbance—JUST CLEAR—CLEAN CUT—TRUTHFUL REPRODUCTION—powered from the never failing light socket by the mere snap of the switch.

CONVERT YOUR PRESENT RECEIVER TO 1928 STANDARDS WITH THE ADVANCED 1928 MODEL SOVEREIGN A. C. KIT

with but slight modifications, easily accomplished by following the detailed instructions supplied in each Sovereign A.C. Kit ANY CIRCUIT becomes light socket powered receiver. You need not be a Radio Engineer—or master "radiotrician" to construct an A. C. Receiver or convert your present set. Just follow the very simple, definite, detailed instructions given FREE with Sovereign Equipment. That's all! When you purchase Sovereign Products you have the knowledge that nothing in the radio industry today carries greater assurance of proper design construction—satisfaction or guarantee.

Sovereign A. C. Tubes acknowledged the "Crowning Achievement" in the Radio Tube Field are unconditionally guaranteed. They have more rugged construction—a longer life! Sovereign A-C Tubes improve tonal quality as they are non-microphonic. Summing it all in a few words, Sovereign Equipment means ECONOMY—EFFICIENCY—MINIMUM SERVICING—THE IDEAL IN RADIO RECEPTION—

If your dealer cannot supply you, we will ship direct to you C.O.D. Sovereign A-C Kit can be furnished for use on 110 or 220 Volts—25 or 60 Cycles.

SOVEREIGN A-C Kit 110 or 220 Volts—60 Cycles. Price \$8.75
SOVEREIGN A-C Kit 110 or 220 Volts—25 Cycles. Price \$9.75

In ordering Kits specify Voltage of House Current—No. of Cycles—Type of Circuit—No. of Tubes.

SOVEREIGN A-C TUBES—Price \$5.00
SOVEREIGN A-C POWER TUBES FOR LAST AUDIO STAGE—Price \$6.00

We have prepared for you a comprehensive NON-TECHNICAL—pamphlet on A-C Receivers and Tubes. Write for your copy today!

SOVEREIGN ELECTRIC & MANUFACTURING CO.

12 No. Sangamon Street

Chicago—Illinois



In Trouble??

Has a moisture permeated bypass condenser ruined your receiver or amplifier? A defective bypass condenser or coupling condenser in a receiver or amplifier mars reception—causes distortion.

Insure against such troubles—use the latest AEROVOX development—an AEROVOX bypass condenser sealed in a Bakelite case—non-inductively wound—impervious to moisture—its electrical condition is as good after a year as the day it was installed.

Made in all capacities up to 1 mfd and rated at 200 volts D C working voltage.

AEROVOX
"Built Better"
70 Washington St., Brooklyn, N. Y.

FROST-RADIO

DE LUXE APPARATUS

now is available at your favorite dealer's. These new De Luxe items of Frost-Radio include Rheostats, Potentiometers and Variable High Resistance Units, with and without switch, Gem Rheostats and Fixed Resistances, all in a wide range of resistance windings. You'll like them—find them dependable, high in quality and fairly priced.



FROST-RADIO

S-1810 De Luxe 10 ohm Bakelite Combination Rheostat and Battery Switch, \$1.35

HERBERT H. FROST, Inc.
Main Offices and Factory
ELKHART, IND.

4 Adjustable "B" Voltages in any combination from 0 to 180

also adjustable "C" Voltage from 0 to 50

Type 445
Plate Supply
Price \$55

UX-280 or CX-380
Rectifier Tube for
above, \$5

Type 445
Plate Supply
complete with
Tube, \$60

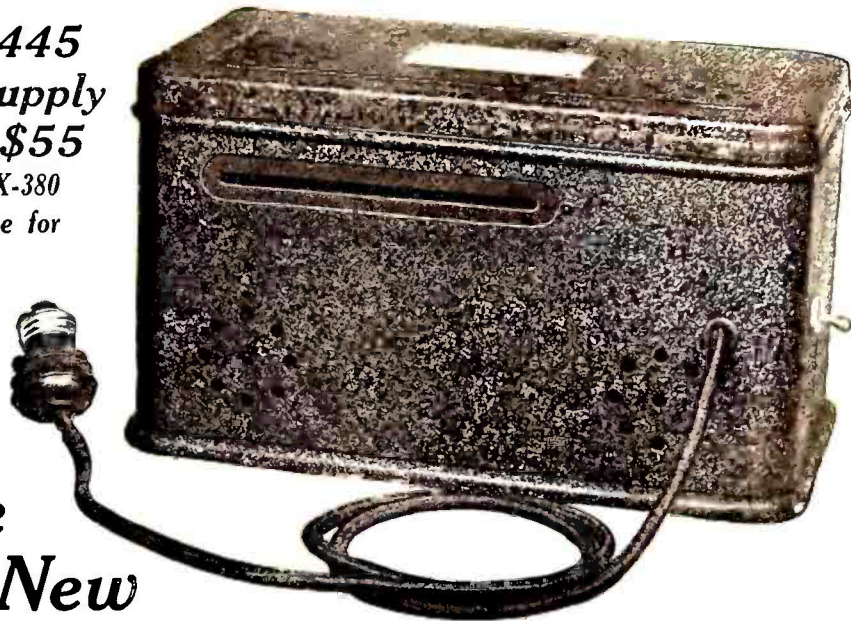

The
New

GENERAL RADIO PLATE SUPPLY

Embodying new and distinctive features in plate supply design

1. Adjustable wire wound resistance with sliding taps which control voltages so that any combination of voltages from 0 to 180 may be taken from the four positive "B" terminals. This method of voltage control is superior to the use of several resistances with exterior knob controls. It has the advantage that once the sliding taps are adjusted to the proper operating voltages of the tubes, they are tightened in place by thumb screws and voltages will remain constant, but are immediately available for readjustment whenever the unit is used with a different set.
2. Adjustable "C" voltage for power tube
3. High voltage test condensers in filter circuit
4. Uses UX-280 or CX-380 rectifier tube which has maximum output of 100 milliamperes, thereby providing sufficient current for sets of the multi-tube type.
5. Automatic cut-out switch breaks the 110 volt A. C. circuit when cover is removed for adjusting voltages or connecting wires to taps, thereby making unit absolutely safe even in the hands of persons not familiar with electrical apparatus.
6. Designed to meet specifications adopted by the National Board of Fire Underwriters.
7. Absolutely guaranteed against mechanical and electrical defect upon leaving the General Radio factory.

Cost, which has been a secondary consideration to over-all efficiency has been kept as low as peak performance and production economies permit.

Price from your dealer, or direct from the factory if your dealer cannot supply you

Type 445 Plate Supply Unit \$55.00

Type UX-280 or CX-380 Rectifier Tube for above \$5.00

Licensed by the Radio Corporation of America only for Radio Amateur, Experimental and Broadcast Reception.

Under terms of R. C. A. license unit may only be sold with tube.

GENERAL RADIO COMPANY

CAMBRIDGE, MASS.



Radio's Best Wire

"From The Ground Up"



CORWICO "FLEXIBUS" HOOK-UP WIRE

"Corwico" Flexibus (Solid or Stranded) is a flexible insulated tinned copper hook-up wire which makes a neat and efficient product for "point to point" and sub-panel wiring. It is covered with a varnished cambric flame proof insulation finished in red, green, yellow, brown or black.

No chain is stronger than its weakest link. That's why the wire you use in your radio set or the wire that is used in the set you buy, is an important factor. Why take a chance, when for the same price and in many cases less, you can have the best by specifying "Corwico" radio wires. Their superior merits and all-around efficiency have been proven by amateurs, experts and radio receiving set manufacturers everywhere.

The next time you need wire for any radio purpose, ask your dealer for "Corwico." If he can't supply you, write us direct.

"Corwico" Radio Wires

Antenna Wire (Solid, Stranded and braided)	Hook-up Wire
Complete Aerial Kits	Lead-in Wire
Magnet Wire	Annunciator Wire
Battery Cable	Loop Aerial Wire
Bus Bar Wire	Litz Wire
	Flexible Wire

"Corwico" Radio Wires are sold by all leading dealers. Write for free booklet on radio wires and their uses.

CORNISH WIRE COMPANY
30 Church Street

New York City

Making Radio Installations Safe

Safety Provisions Specified by the Board of Fire Underwriters in Making Antenna Installations—The Lightning Hazard—Danger From Power Lines

By **EDGAR H. FELIX**

AN ONCOMING bolt of lightning never stops to argue. It has only one thing in mind—an incredible hurry to reach Mother Earth. Your little, puny pound of copper antenna wire, strung up a few feet above the surface of the earth, has no more influence in attracting a bolt of lightning than a mosquito has to entice you to a symphony concert. If lightning ever strikes your antenna, it is merely a coincidence. The presence or absence of an antenna on a building has nothing to do with either the attraction or repulsion of lightning.

There is in the atmosphere at all times, but more especially during the summer months, a certain amount of static electricity present. Any body of metal or wire tends to collect this atmospheric electricity if it is not connected to ground, and the electrical potentials built up may become of dangerous proportions. A lightning arrester provides an easy path to ground for these charges which tend to accumulate on the antenna, but is so constructed that it does not afford a path to ground for the radio signals. When there is a thunder-shower in the immediate vicinity, the potentials induced in the antenna are greater than at other times, and almost continuous discharges take place through the arrester to ground.

With a lightning arrester properly installed, there seems to be very little danger from this atmospheric electricity, or induced currents from near-by electrical disturbances. To support the contention, let us consider the evidence of experts. Victor H. Tousley, Chief of Electrical Inspectors in the Chicago District, reports that of the 34 cases where the Chicago Fire Department was called out in response to a fire caused by lightning, only 12 of the buildings had antennas; and, in only four of these was there any evidence that lightning had followed the antenna wire to the ground.

William S. Boyd, an electrical engineer of Chicago, has, for some years, been compiling statistics regarding fires caused by lightning striking radio installations. His report lists only 15 damaged by lightning during the years 1922 to 1924—not a very formidable figure. Six of these accidental "hits" damaged only the antenna because the lightning arrester did its work effectively.

In the entire district of Philadelphia, there is a record of only one fire caused by lightning striking a radio antenna, according to an officer of the Fire Underwriters' Association in that city. The antenna and lightning arrester were destroyed, but no damage was done to the receiving set.

Another hazard, which depends purely on the matter of placement of the antenna and good workmanship in putting it up, is the likelihood of the antenna coming into contact with electrical wires, either low tension or high tension. The most important provisions, formulated by

(Continued on page 412)



Condensers

"Superior to all others tested"

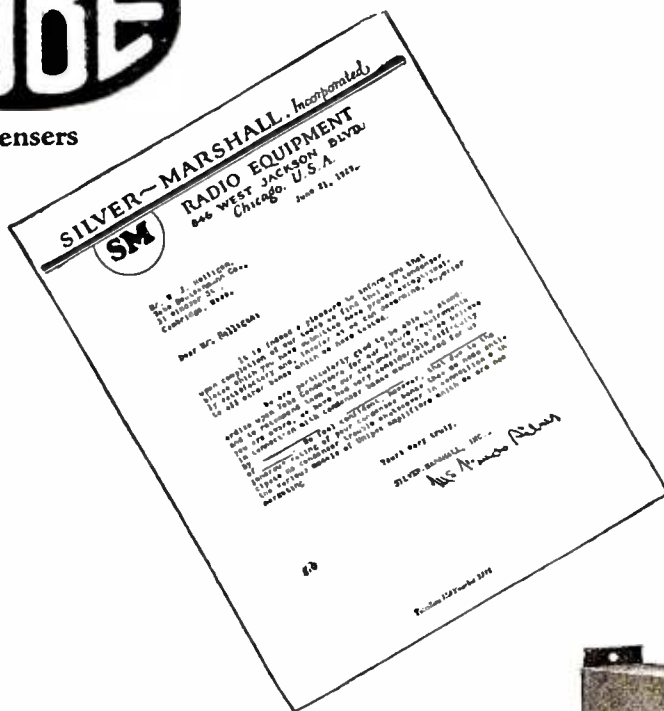

Recognized radio engineers have for a long time known the excellence of Tobe Condensers. They have the quality of continuing to function perfectly over long periods of time. Now the Tobe No. 662 high voltage B Block has been selected exclusively by McMurdo Silver for use with the new Silver-Marshall UNIPAC and Mr. Silver has written us the above reproduced letter. Send for price list B-10.

Tobe Deutschmann Co.
Cambridge - - Mass.



New!



No More Socket Trouble

A socket's only job is to provide a perfect contact. The New Eby Socket has a 3 point wiping spring contact the full length of the prong, the most scientifically perfect type known. The prongs are completely enclosed and fit snugly against the phenolic walls of the socket—they can't spread.

With the New Eby Socket your socket troubles are gone. Easy to mount above or below Bakelite, Wood or Metal.

Specified in most of the leading popular circuits.

List Price 40c

THE H. H. EBY MFG. CO.

INCORPORATED

4710 Stenton Ave.
Phila., Pa.

Makers of Eby Binding Posts



EARN'S \$500.00

In His Spare Hours

That's the record of Member Lyle Follick, Lansing Mich. Member Werner Eichler, Rochester, N. Y. writes, "I have made over \$50. a week in my spare time"

With its proven money making plans, advice, co-operation in furnishing parts at wholesale and training, the Radio Association of America is helping its members start radio stores, secure better positions, increase their salaries, earn \$3. an hour upwards in spare time building sets and serving as radio "doctors."

Join the Association without delay, because we have a plan whereby your membership may not—need not—cost you a cent. Only a limited number of these memberships are acceptable. Write before it's too late.

RADIO ASSOCIATION OF AMERICA
Dept. RB-10 4513 Ravenswood Ave., Chicago

Send me your book and details of your Special Membership Plan.

Name

Address

City State

TRY IT 30 DAYS FREE BEFORE YOU BUY

FACTORY PRICES—SAVE 50%
Choice of beautiful cabinets offered

3 Year Guarantee

8 tube one dial MIRACO
TRADE MARK REGISTERED

only \$69.75
Retail List Completely Assembled

MAGNIFICENT TONE—SUPER SELECTIVE—POWERFUL DISTANCE GETTER

All Electric or Battery Set!

America's big, old, reliable Radio Corporation* (8th successful year) guarantees its big, powerful, latest 6, 7 and 8 tube Miraco sets to give "the finest, most enjoyable performance obtainable in high grade radios." Unless 30 days' use in your home fully satisfies you and everybody who hears it that a Miraco is unbeatable at any price for beautiful, clear cathedral tone, razor-edge selectivity, powerful distance reception, easy operation, etc.—*don't buy it!* Your verdict final—absolutely no strings to this. Save or make lots of money on sets and equipment by writing for testimony of nearby users and *Amazing Special Factory Offer.*

Run from "AC" Current or Batteries
Miraco's work equally fine on electric house current or with batteries. Take your choice. Many thousands of Miraco users—who bought after thorough comparisons—testify they enjoy programs Coast to Coast, Canada to Mexico, loud and clear—with the magnificent cathedral tone quality of costliest sets. Don't confuse Miraco's with cheap, "squawky" radios. Miraco's have finest parts, latest approved shielding, metal chassis, etc.—as used in \$200 sets.

Dealers Write! * MIDWEST RADIO CORP.
Cincinnati, Ohio
BEAUTIFULLY ILLUSTRATED
Free! Catalog and amazing Special Offer
mail coupon

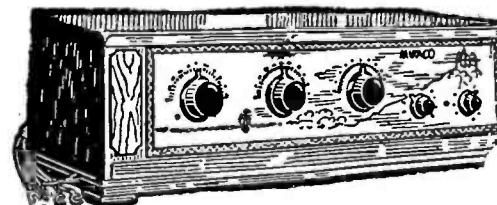

Deal Direct with Big Reliable Makers

Your Miraco reaches you completely assembled, rigidly tested, fully guaranteed. Easy to connect and operate. 30 days free trial. 3 year guarantee if you buy. Choice of beautiful consoles [with latest built-in orthophonic type speakers having 8 feet of tone travel] and table cabinets, also offered. You take no risk, you insure satisfaction, you enjoy rock-bottom money-saving-prices by dealing direct with one of radio's oldest, most successful builders of fine sets.

Big Discounts to User-Agents

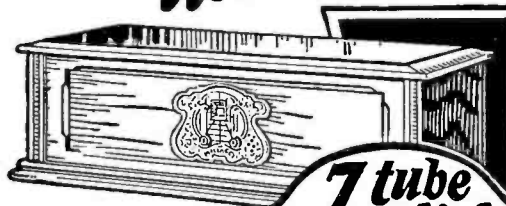

7 tube one dial METAL SHIELDED CHASSIS \$49.75 RETAIL LIST

MIRACO "Powerplus" sets—both in 8 and 7 tube models—have magnificently beautiful, clear cathedral tone quality. Turn one dial for stations everywhere. Ultra-selective. Miraco multi-staged distance amplification gives "power-plus" on far-off stations. Latest all-metal shielded chassis. Illuminated dial. Fully guaranteed. Try one free for 30 days! Choice of beautiful cabinets.

Electrify Any Radio with MIDWEST NO-BATTERY "A-C" Light Socket Power Units

"A" "B" and "C" power, direct from light socket, without batteries! Write for Midwest prices and discounts. Midwest Units are highest grade—lastingly dependable, quiet in operation, full guaranteed.

6 tube Super \$36.75 RETAIL LIST

30 Days Free Trial

MIDWEST RADIO CORPORATION
Pioneer Builders of Sets
406-C Miraco Building, Cincinnati, Ohio.

Without obligation, send free catalog, AMAZING SPECIAL WHOLESALE PRICE OFFER, testimony of nearby Miraco users.

NAME

ADDRESS

THIS COUPON IS NOT AN ORDER

A "Million-Dollar" Front For Your Receiver



FRONT VIEW

HAMMARLUND waited to produce a drum dial that would make the single-control of tuning condensers really practicable.

Local stations can now be tuned in over the entire wave band by the simple movement of two fingers. Distant stations, requiring a finer adjustment, are brought in by a slight realignment of the individual halves of the dial.

Viewed from the front, the new Hammarlund Drum Dial gives to any receiver a delightful, professional finish. The bronze escutcheon plate, richly embossed and oxidized, endows the panel with a classic beauty.

The New HAMMARLUND Illuminated Drum Dial

An up-to-the-minute tuning improvement every set-builder will want to install.



BACK VIEW

Mechanical Features

Over-size die-cast frame; Bakelite drums, with knurled edges; translucent celluloid wavelength scales, illuminated by a small electric light, with handy switch, connecting with the "A" Battery circuit. Adaptable to all standard panel proportions.



HAMMARLUND MANUFACTURING COMPANY,

424-438 W. 33rd Street, New York

Already many leading radio designers have officially specified Hammarlund Precision Products for their latest circuits.

For Better Radio
Hammarlund
PRECISION
PRODUCTS

Dealer inquiries invited concerning several other new and appealing Hammarlund developments, having a wide sales appeal.



BIG RADIO CATALOG

From the "Big, Friendly Radio House"

NEW 1928 Book offers finest, newest well-known sets; parts, eliminators, accessories at lowest prices. Set-builders, dealers, agents—WRITE for this CATALOG!

Western Radio Mfg. Co.

134 West Lake St.

Dept. 47

CHICAGO, ILL.

RADIO PANELS

BAKELITE—HARD RUBBER

Cut, drilled and engraved to order. Send rough sketch for estimate. Our complete Catalog on Panels, Tubes and Rods—all of genuine bakelite or Hard Rubber—mailed on request.

STARRETT MFG. CO.

521 S. Green Street

Chicago, Ill.

6 TUBE RADIO
ONE DIAL
Only \$32.50

Latest advanced circuit. All steel chassis totally shielded. Balanced parts of best quality. Marvelous power and selectivity. Gets the long range stations as clear as a bell. One dial single control. An unsurpassed value—just one of our many mighty bargains.

FREE Log and Call Book and Big New Catalog—just off the press. Full of Radio Bargains. Send for your free copy now!

American Auto & Radio Mfg. Co.
HARRY SCHWARTZBERG, Pres.
Dept. 122 American Radio Bldg., Kansas City, Mo.

Safe Radio

the Board of Underwriters, are abstracted as follows:

PERTAINING TO THE LIGHTNING HAZARD

1. **LIGHTNING ARRESTER.** Each lead-in wire shall be equipped with an approved lightning arrester, operative when 500 volts or more are impressed on it, and connected to a ground either inside or outside the building, as near to the arrester as possible. The arrester should not be installed near any inflammable material. If a grounding switch is used, it should shunt the arrester, and should have a capacity of 30 amperes at 250 volts.

2. **APPROVED GROUNDS.** The ground used is preferably made to a cold-water pipe, where such a pipe is available and is in service and connected to the street mains. Other permissible grounds are: the grounded steel frames of buildings, the grounded metal work in the building, and artificial grounds such as driven pipes, rods, plates, cones, etc. Gas pipe shall not be used for a ground. The ground should be installed so as to be safe from mechanical injury. An approved ground clamp should be used for connecting the wires, and the pipe should be thoroughly cleaned.

3. **GROUND WIRE.** The protective grounding conductor may be of bare or insulated wire made of copper, bronze, or approved copper-clad steel. The ground wire shall in no case be less in current-carrying capacity than the lead-in wire, and in no case shall it be smaller than No. 14 if copper, nor smaller than No. 17 if of bronze or copper-clad steel. The ground wire should be run in as straight a line as possible from the protective device to the ground connection. Inside wiring should be fastened in a workmanlike manner and should not come closer than two inches to electric conductors, unless porcelain tubing forms a permanent separation from such conductors. This last applies to all inside wires.

7. **FUSES IN GROUND LEADS.** No fuses shall be used in any lead-in conductors or in the ground wire.

REQUIREMENTS FOR PROTECTION FROM HIGH VOLTAGE

8. **INSTALLATION NEAR HIGH VOLTAGE MAINS.** The antenna and counterpoise, outside the building, shall be kept well away from any wires carrying a potential of 600 volts or more, including railway, trolley, or feeder wires, in order to avoid accidental contact. These voltages are sufficient to cause shock dangerous to life and to cause fires. Antenna installations near electrical wires of less than 600 volts potential must be installed in a durable manner and shall be provided with suitable clearances so that there is no possible chance of accidental contact, due to sagging or swinging.

9. **SPLICES IN ANTENNA WIRE.** Splicing in antenna or lead-in wires should be soldered unless made with an approved splicing device.

10. **LEAD-IN CONDUCTORS.** Lead-in conductors shall be of approved copper-clad steel or other metal which does not corrode excessively, of no smaller gauge than No 14, unless approved copper-clad steel is used when the gauge may be No. 17.

11. **LEAD-IN CONDUCTORS OUTSIDE THE BUILDING.** The lead-in conductor shall not come closer than four inches to any electric light or power wires unless separated therefrom by a porcelain tube or other firmly fixed non-conductor.

12. **LEAD-IN INSULATOR.** An approved lead-in insulator should be used.

13. **STORAGE BATTERY CIRCUIT.** An important and new provision rarely obeyed is the requirement that fuses of not less than 15-amperes capacity shall be installed and located preferably at or near to the battery. An approved circuit breaker of the same minimum capacity may be used. The leads from the battery to the receiver shall consist of conductors having approved rubber insulation.

Clearly, these rules are simple and easily com-

(Continued on page 414)

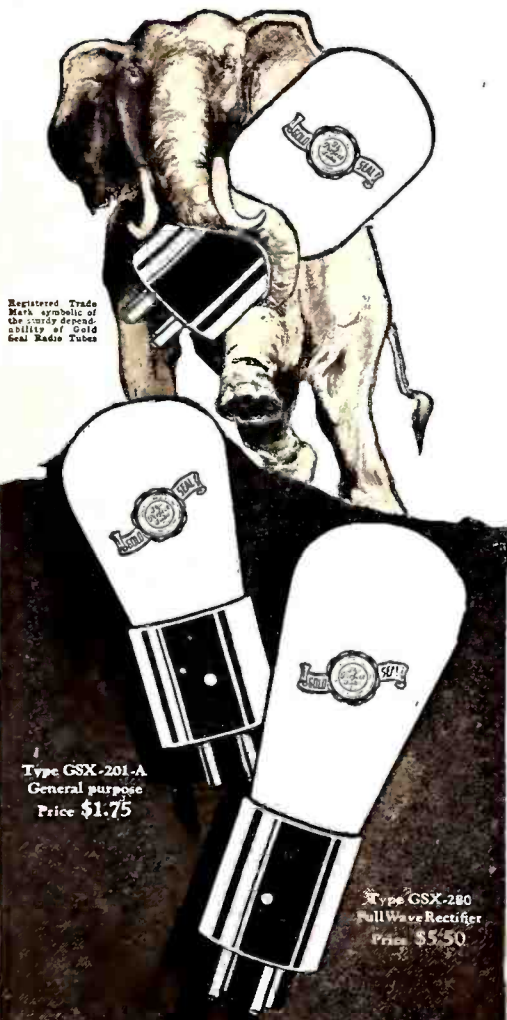

Registered Trade Mark symbolic of the superior dependability of Gold Seal Radio Tubes

Type GSX-201-A
General purpose
Price \$1.75

Type GSX-280
Full Wave Rectifier
Price \$5.50

**Best tubes—
Best reception**

New broadcast developments make it necessary to have the latest types of tubes for fullest enjoyment of your receiving set.

Bring it up to date with a complete installation of the new Gold Seal radio tubes—specially developed for modern reception. You will be delighted with the improvement.

You can make the changes yourself—no trouble. Our new booklet tells you all about it. Send today for your copy—it is free. Use coupon below.

All Standard Types

**Gold Seal Electrical Co.
250 Park Ave., New York**

Send me copy of the new booklet.

Name _____

Address _____

R. R.

**Gold Seal
Radio Tubes**

Vee Dee

All-Metal Cabinet

For 1927-28 Hook-Ups!

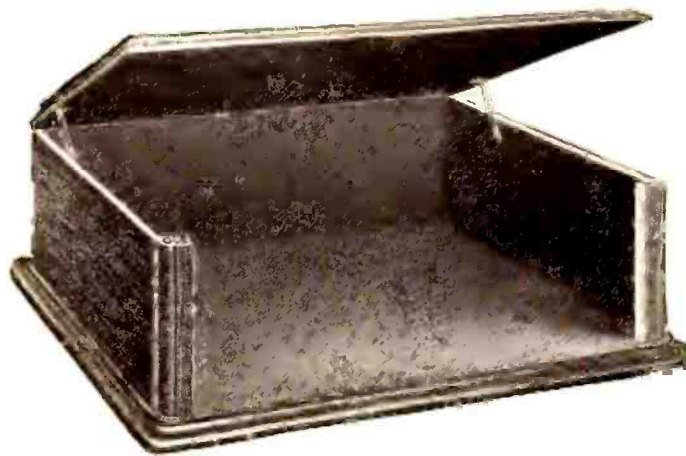

Model 250

For A. C. or
Battery Sets

Using
7x18
7x21
8x18
8x21
Panels

Inside dimensions 25"x14 1/4"x9 1/8". Hinged top—with stay joint. Rigidly formed for strength and appearance. Felt foot rest—rubber lid stops. A welded job doing away with troubles of swelling, shrinking, cracking, splitting and uncertain fit.

The original beauty of natural wood grains combined with the efficiency of all metal construction! By our photo litho process, we reproduce mahogany and walnut hardwood, and novelty finishes, so gorgeous in their conception that they excite the admiration of all who see it.

Spacious interior dimensions are demanded for housing all the latest hook-ups! Vee Dee metal cabinets are designed for that purpose. 90% of all the 1927-1928 hook-ups are covered by the dimensions of Vee Dee No. 250 cabinet illustrated above. Beautiful—practical! Low price!



Metal Panel for Citizens Super Eight

Constructed in accordance with
Citizens Radio Call Book and

McMurdo Silver, Remler, Cock-
aday co-ordinated designing

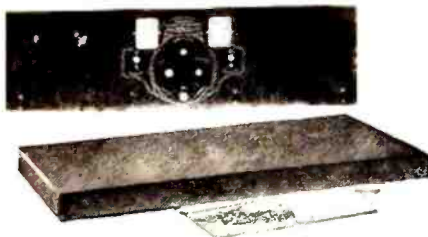

Metal Panel and Chassis for Silver-Marshall 1927 Model Super-Heterodyne

Complete assembly consisting of panel and chassis, fully drilled, beautiful wood finish with special two-color decoration, all fibre bushings and washers included, also screws, bolts and hardware accessories.

S. C. 2 Assembly Unit

Complete Panel, Chassis, 7x18, fully drilled. Beautiful wood grain finish, handsomely decorated. Kit includes all necessary bushings, washers and hardware accessories.



Unipac Housing

Especially designed and provided for Silver-Marshall Power Hook-ups—including cabinet and chassis, drilled and with all small hardware.

Metal Panels and Chassis in All Standard Sizes

JOBBERS, DEALERS—WRITE FOR PRICES

Set Builders—If your dealer cannot supply you, write direct

The Van Doorn Company

160 North La Salle Street

Factory, Quincy, Illinois

Chicago, Illinois

What Kind of Voice Has Your Loud Speaker?

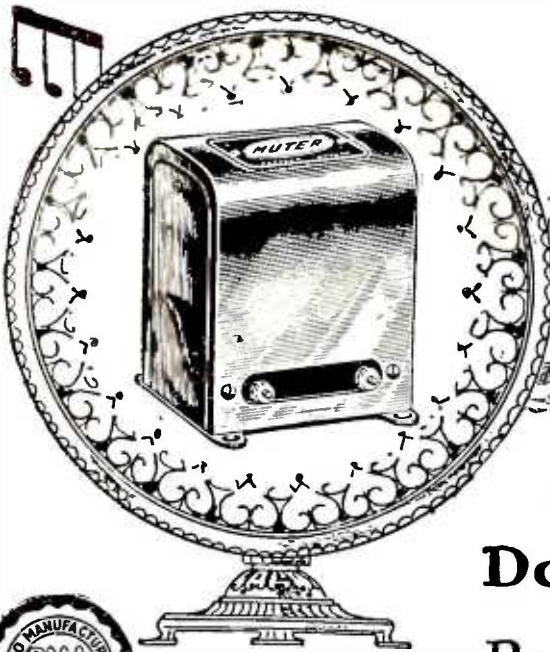

Does It Sn-n-narl?

Does It Whine? or Does It Register

Clear, Natural Human Tones?

The Muter Clarifier

[NEW OUTPUT TRANSFORMER]

on your set will astonish and delight you by immediate, almost unbelievable improvement in reception. In nine cases out of ten that weak, distorted voice issuing from the speaker unit is suffering paralysis from high "B" Voltage. The Clarifier protects Speaker coils from this shattering current, assuring longer life as well as strong, full tone, clarity and volume.

If your speaker is one of the great majority that fail to respond properly to the output of the set—you need a Muter Clarifier. It's the only thing that will remedy the cause. Easily attached in a few seconds without disturbing set. Try it out to your own satisfaction on our liberal guarantee—you won't recognize your set!

SEE YOUR DEALER—or SEND DIRECT

Dealers can easily secure Muter Products for you from leading Jobbers. If, however, you have any difficulty in obtaining from your dealer, mail coupon direct to us. Prompt shipment will be made upon receipt of price or C.O.D. if preferred. Give your speaker a chance to produce its utmost. Mail coupon today.

LESLIE F. MUTER CO.

76th & Greenwood Ave., Dept. 822-N, CHICAGO, ILL.



DEPENDABLE PRODUCTS

The complete Quality Popular Priced Line
Send for comprehensive catalog



Use This Coupon!

LESLIE F. MUTER CO.

76th & Greenwood Ave., Dept. 822-N
Chicago, Ill.

- Send Muter Clarifier at once, postage prepaid. \$5.00 is enclosed.
- Send C. O. D.
- Send complete Muter Catalog.

Name.....

Address.....

City..... State.....

Set Builders!

Be first to build the new Magnaformer 9-8 Circuit—Commander-in-Chief of the Air—featured by Radio Authority G. M. Best in Sept. and Oct. Radio. Read his articles. See also Sept. and Oct. Popular Radio and C. R. Call Book. Two years ahead of the field. Outstanding feature is its marvelous Tone-Quality. Women, musicians and experts especially are enthusiastic in their praise of its amazing fidelity of tone. The NEW scientifically designed and precisely matched Magnaformer Intermediate Long Wave K. F. Transformers are the cause. Everyone who hears or tunes a Magnaformer 9-8 decides to own one immediately. Beautiful in appearance. Changes from 9 to 8 or 8 to 9 tubes instantly. Great distance getter—super-selective—a world of volume—quiet operating—easy to tune—easy to build. Any one can do it. All standard parts. NO AFTER-SERVICE. The Ideal set to build for others. Send NOW for free descriptive literature.



RADIART LABORATORIES COMPANY
19 S. La Salle Street Dept. 57 Chicago

MAIL COUPON NOW

Radiart Lab. Co., Dept. 57, 19 S. La Salle St., Chicago.
Please send me free descriptive literature regarding Magnaformer performance.

Name.....

Address.....

Independent Radio Corporation

Manufacturers of

Precision Radio Apparatus

1516 Summer Street

Philadelphia



Write for my Big 1928 Radio Catalog—just off the press. Thousands of marvelous bargains in nationally advertised goods. All the LATEST IN RADIOS and equipment. Lowest wholesale prices.

It's a regular encyclopedia on Radio. All about trouble finding. **FREE Log and Call Book and Catalog.** Get your copy today. Send postcard now! **American Auto & Radio Mfg. Co.** HARRY SCHWARTZBERG, PRES. Dept. 123 American Radio Bldg., Kansas City, Mo. 3



Safe Radio

plied with. Compliance with them gives you a safe installation. Failure to follow them invites unnecessary and totally avoidable risk. Furthermore, failure to comply invalidates your fire insurance policies automatically.

BOOK REVIEW

A Home-Constructor's Handbook

PRACTICAL RADIO CONSTRUCTION AND REPAIR. By James A. Moyer and John F. Wostrel. Published by the McGraw-Hill Book Company, Incorporated, New York. 319 Pages and 157 Illustrations. Price \$2.00.

PRACTICAL Radio Construction and Repair" contains a potpourri of useful and practical information. Its authors have compiled their pages out of a large practical knowledge and experience in set building. The title implies a handbook of radio construction and repairing—a reference volume for the dealer's service man. It does not fail in that respect so much from incompleteness as it does from poor arrangement. But it has much to commend it.

The first part of the book deals with what may be termed the accessories of the radio receiver—the antenna, the vacuum tube and its power supply, and, tucked away with these subjects, a chapter on the tool equipment needed for radio construction. Then follows a series of chapters on radio-frequency amplifiers, describing several methods of controlling regeneration and including a few words about super-heterodyne amplification. Next follows a brief description of systems of audio-frequency amplification.

The subsequent few chapters deal with constructional details. The first set to be described in detail is the Browning-Drake receiver. The writers then again return to audio-frequency amplifiers, presenting a strong case for a popular resistance-coupled amplifier kit. The superiority of resistance coupling over transformer coupling is emphasized by means of a set of curves. Apparently, an inferior transformer and a superior resistance amplifier were used as the basis of the test. A chapter on impedance amplification, devoted to a description of the Thordarson amplifier, follows that comparing resistance and transformer coupling.

Returning again to receiving sets, the authors next describe the "Universal," the Acme reflex, the Cotton super-heterodyne, and a short-wave receiver. In general, these descriptions follow closely the conventional magazine style of exposition, with lists of parts, and details for assembly and operation. No commercial receivers are described or even considered.

The appeal of this book is confined generally to the home constructor and his problems and not to those of the dealer service man; an outstanding exception is the last chapter, where the service man is suddenly remembered. This last chapter makes interesting reading, containing, as it does, a fairly complete and practical set of troubles likely to be encountered in a radio receiver under various conditions. A few brief samples are quoted to show the type of information in this section:

SET GIVES SQUEALING SOUND CONSTANTLY.—A constant squealing sound in a receiving set is generally due to a defective vacuum tube which in the course of time has become soft or gassy. Continuous squealing may also be due to a very badly run-down B battery or, to a less degree, to a worn-out C battery. A burned-out primary

(Continued on page 416)

Radio • Is • BETTER • With • Dry • Battery • Power

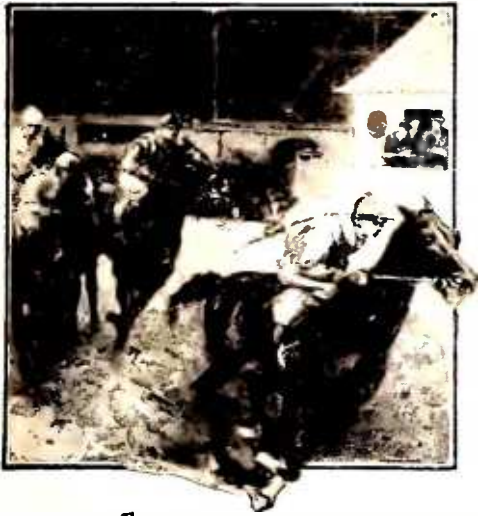

made to run
the *full* race!

ANY horse can make a good start But it takes real stamina to *finish!*

So it is with batteries. *Staying* power is the quality to look for—unfailing power over a long period of service. Millions prefer Burgess *Chrome* Batteries for just this reason. They hold up They *last*.

Next time, buy black and white striped Burgess *Chrome* Batteries. You are certain to get longer and better service for your money.

Chrome—the preserving element used in leather, metals, paints and other materials subject to wear, is also used in Burgess Batteries. It gives them unusual *staying* power. Burgess *Chrome* Batteries are patented.

Ask Any Radio Engineer

BURGESS BATTERY COMPANY
General Sales Office: CHICAGO
Canadian Factories and Offices:
Niagara Falls and Winnipeg



BURGESS
FLASHLIGHT & RADIO
BATTERIES



Transformers



Two additions to last year's Radio Sensation
The Amazing Achievement in
Audio Amplification

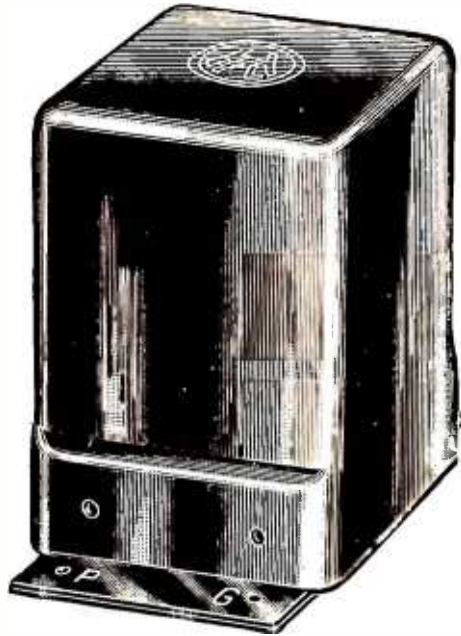

H. F. L. C-16 Audio Transformers and C-25 output Transformer—New companions of a Great Unit, will work in any circuit and improve any radio set.

Designed to fulfill the exacting requirements of set builders who demand

EFFICIENCY
SENSITIVITY
PRECISION AND
HIGH QUALITY

The new C-16 and C-25 Transformers will work in any circuit and will improve any Radio Set.



H. F. L. Units Give Wonderful Clear Reception

Engineers acclaim H. F. L. C-16 a marvellously efficient Audio Transformer. It carries signals at highest volume and lowest amplitude without blasting or developing harmonics. Operates with all power tubes as well as standard tubes.

H. F. L. C-25 Output Transformer handles the voltage output of power amplifying tubes, at the same time matches the impedance of the average speaker to the tubes. Protects loud speaker unit without reducing plate voltage.

Mechanical features of these two transformers are: A coil designed and treated to exclude moisture and withstand heavy electrical surges without breaking down—complete magnetic shielding to avoid interstage coupling—terminals brought out so as to insure short leads.

Endorsed by America's Leading Engineers—Guaranteed by the Manufacturers

PRICES

No. H-210 Transformer	\$8.00
No. H-215 Transformer	8.00
No. C-16 Transformer	8.00
No. L-425 R. F. Choke	5.50
No. L-430 R. F. Transformer	5.50
No. C-25 Output Transformer	8.00

Set Builders—Dealers

If your jobber cannot supply you with H. F. L. Transformers, write us for name of nearest jobber.

H. F. L. Facts

H. F. L. Units have been used, approved and most highly endorsed by *Radio News*, *Citizens' Call Book*, *Radio Review*, *Radio Age*, *Radio Engineering*, *Radio Mechanics*, *Chicago Evening Post*, the *Daily News* and others. Thousands of engineers and fans, who have turned to H. F. L. Units for better reception, hail them as the finest transformers known to Radio—unexcelled for Power, Selectivity and Purity of Tone.

Perfectly matched, skillfully designed, carefully made, rigidly tested—in a word, H. F. L. transformers are technically correct to the minutest detail.

All H. F. L. transformers are designed for baseboard mounting or invisible sub-panel wiring—each unit is enclosed and sealed in a genuine bakelite moulding.

H. F. L. Units are easily connected into the assembly, simplify set construction, and make a beautiful finished job.

HIGH FREQUENCY LABORATORIES

131-M NORTH WELLS STREET,

CHICAGO, ILL.

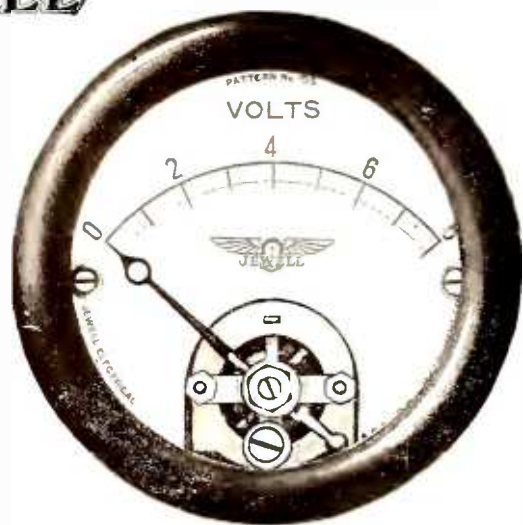

Pattern
No. 135
Radio
Voltmeter

A
Quality
Instrument

Your Radio Will Be Better

Voltmeter control of filament voltage will make any radio receiving set better. It enables you to retain that nicety of balance in filament emission, which brings in reception clear and exact with maximum volume. It will prevent premature burnout of the radio tubes due to excessive filament voltage, for, with a voltmeter mounted on the panel and connected to the filaments, you will know at all times just what voltage is being applied to the filaments.

The Jewell Pattern No. 135 voltmeter is good looking and rigidly constructed and is the ideal instrument for filament control. The black enamelled case is two inches in diameter and contains a miniature, but very high grade, D'Arsonval moving coil type movement, which is equipped with a zero adjuster. Movement parts are all silvered and the scale is silver etched with black characters.

The addition of this meter to your set will improve its appearance besides being a great help to better and economical reception

Write for descriptive circular No. 776 and ask for a copy of our radio instrument catalog No. 15-c

Jewell Electrical Instrument Co.

1650 Walnut Street, Chicago

"27 Years Making Good Instruments"

Book Review

winding of one of the transformers or a poor connection in the jack connecting the loud speaker and closing the battery circuits will also cause this same effect.

SET OPERATES WHEN PLUG OF TELEPHONE RECEIVER IS PUT IN JACK OF DETECTOR CIRCUIT, BUT DOES NOT OPERATE IN STAGES OF AMPLIFICATION.—This difficulty may be due to reversed connections of the A battery, or the primary winding of the audio-frequency transformer in the detector circuit may be burned out.

No serious attempt is made to correlate the practical information in this last section in a manner lending itself to easy reference.

The set constructor will find much of interest in the book because it is, on the whole, reliable and accurate. We might pick out statements here and there to quibble over, such as that in the chapter on audio-frequency amplifiers. Speaking of audio-frequency transformers, the authors say: "Some manufacturers claim that they can make transformers which amplify consistently over a wide range of wavelengths," a correct, though rather unconventional way of referring to audio-frequencies. Another case of a different kind: "If the sound volume from the loud-speaker is weak, tap the vacuum tubes with a finger nail to determine whether or not the audio amplifiers are operating satisfactorily; if they are not, the tapping by the finger nail will cause a ringing sound in the loud speaker." To include, in a final summary of testing instructions, so broad a generality, having so many conceivable exceptions, is, to say the least, somewhat careless.

A general criticism which may be made of many radio books is the superficial knowledge of their authors. Moyer and Wostrel are certainly exempt from any such accusation because they have the outstanding virtue of knowing what they are talking about. But they have not met the needs of service men working for the radio dealer; the authors' viewpoint is that of the amateur set builder.

The preferred circuits for home construction are well selected and described; there are plenty of diagrams to browse among and, to one who reads the book from cover to cover, many new facts are likely to be discovered. But, if one wants to find out in a hurry such a practical constructional point as whether the jack should be so wired that the sleeve or the tip of the plug goes to the B-plus lead, or the quickest way of finding safely which tube is burned out with a set in which the filaments are wired in series, there is no telling if, how, and where the desired information will be found.

EDGAR H. FELIX.



Set Builders!

All socket power devices must depend upon condensers for successful operation. Fast Hi-Test Condensers have extra capacity and are built to withstand every requirement. Millions now in use and since 1919, one of the oldest established and reliable manufacturers.

Illustration shows condenser pack used in Q. R. S. or Raytheon A-B-C unit. For perfect operation, build your A.B.C. units with Fast condensers, whether specified or not. They fit all units.

Features of Fast Hi-Test Condensers

Condenser life depends upon its dielectric strength. Fast condensers have extraordinarily high insulation resistance. By-pass condensers are all of the short-path type, affording zero resistance to radio frequency curve. Absolutely non-inductive.

An exclusive feature—by-pass condensers enclosed in one-piece die-press steel housing, makes them positively impervious to all climatic conditions or abuse. Before being encased condensers receive special laboratory treatment whereby moisture content is effectually removed and once removed, they stay that way, for the housing seals them permanently thereafter. That's why Fast Hi-Test condensers give such excellent, dependable service. Free condenser booklet brings the facts. Dealers and jobbers, send for price list.

JOHN E. FAST & CO. 3982 Barry Ave., Dept. D, Chicago, U. S. A.

BIG NEW CATALOG FOR RADIO BUILDERS

FREE My big 1928 Radio Catalog, Call Book and Trouble Finder. 132 pages about Radio. Chock full of newest circuits—kits, transmitter parts, short wave outfits, eliminators and speakers. Thousands of bargains at lowest wholesale prices. A regular Radio Encyclopedia—Free. Write today.

American Auto & Radio Mfg. Co.
HARRY SCHWARTZBERG, PRES.
Dept. 125 American Radio Bldg., Kansas City, Mo.

LATEST RADIO CIRCUITS

ASSOCIATION OF ELECTRICIANS IN RADIO

R U ONE?

Co-operative membership in E I A RADIO is establishing an honest, industrious man in each locality in a successful radio industry of his own. Young married men preferred. Apply by letter, giving the name of your county, to

EQUITABLE INDUSTRIES ASS'N, RADIO DIV.
350-B Broadway, New York

USE THIS COUPON FOR COMPLETE SETS

RADIO BROADCAST SERVICE DEPARTMENT
RADIO BROADCAST, Garden City, New York.

Please send me information about the following manufactured receivers indicated by number:

.....

.....

.....

.....

Name.....

Address.....
(Number) (Street)

.....
(City) (State)

ORDER BY NUMBER ONLY

This coupon must accompany each order. RB 1027



Kingston

Everything that Radio Has to Give

The Kingston B Supply Unit brings to your radio evenings a new richness and a new delight—full tones, clearness and perfect reception always! It maintains your set at its perfection peak, operates silently, and forever removes the trouble and expense of batteries. The Kingston is beautifully made, is smartly finished in satin black, and is built by experts with extreme care and accuracy. There are provided three voltage terminals, each adjustable over a wide range, making possible any desired voltages from 5 to 200. In keeping with Kingston quality, the Raytheon 125 milliamper type BH tube is used as a rectifier.

Kingston service goes all the way through, and Kingston dealers know that this company stands squarely behind its products. The new Kingston B Battery eliminator is fully guaranteed to be all and do all that is claimed for it.

If your dealer can't supply you ask us

KOKOMO ELECTRIC CO.

KOKOMO, IND.

PRICES

Type 2, for 110-120 Volt AC 50 or 60 Cycle Current, \$35.00.
 For receiving sets having not more than eight tubes and not having type UX171 power tube or equivalent.

Type 2A, for 110-120 Volt AC 50 or 60 Cycle Current, \$42.50.
 For all sets using type UX171 power tube or equivalent and for all large sets having nine or more tubes.

Type 2C, for 110-120 Volt AC 25, 30 or 40 cycle current, \$47.50.

Prices include type BH Raytheon tube.

Any of these models will be furnished with an automatic control switch built in the unit for \$2.50 additional. With this the B unit is automatically switched on or off when switch on the radio set panel is turned.

RADIO MEN—LOOK!

The Last Word in Radio

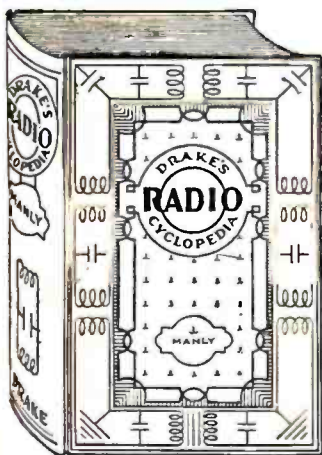

Radio is an *exact* science. There is a right and a best way for everything. But it is so new there is still much that is incorrect and unscientific in radio. The results are faulty reception, complaints and service problems for the dealer.

You can now *be the man who knows!* To meet this need we have compiled the exact facts covering every type of receiver and the entire scope of radio into a fine, big, new book.

DRAKE'S RADIO CYCLOPEDIA

Solves the Dealer's Service Problem

If you design, build, rebuild, repair or service radio receivers, this book will prove of great value. All subjects from "A-Battery" to "Zero Beat" are alphabetically arranged and clearly explained, with hundreds of cross references, 1672 headings, 985 illustrations, diagrams, etc., and 240 combinations of receiver layouts. All arranged so you can quickly find what you want.

SEND FOR THIS BOOK TODAY. There is nothing else like it. You will surely need it, and it quickly earns many times its cost. Distributed through main branches of American News Company and for sale at all book stores, or we will send you direct on receipt of price, \$6.00. Order today.

FREDERICK J. DRAKE & CO. Publishers
 1013 S. Michigan Blvd. Chicago

F. J. DRAKE & CO.,
 1013 S. Michigan Blvd., Chicago.

I enclose \$_____. Please send me at once _____ copies of Drake's Radio Cyclopedic, postpaid. Also send catalog of 200 other practical mechanical books, free.

Name _____
 Street _____
 City _____ State _____

New Formica Kit Panels!

FORMICA panels handsomely printed in Gold—to enable home set builders to construct radio sets of fine appearance—have been prepared and are now available for the following popular kits:

Magnaformer: Front Panel 7 x 26 x $\frac{3}{16}$ " Black Polished; Decorated in Gold; Sub-Panel 8 x 25 x $\frac{3}{16}$ " Black Polished; Drilled.

Tyrman: Front Panel 7 x 26 x $\frac{3}{16}$ " Dull Walnut; Decorated in Gold; Sub-Panel Ivory 7 x 26 x $\frac{3}{16}$ " Drilled.

Camfield Nine: Front Panel 7 x 30 x $\frac{3}{16}$ "; Black Polished; Decorated in Gold; Drilled; Sub-Panel 10 x 29 x $\frac{3}{16}$ " Black Polished; Drilled.

World's Record Super Ten; Front Panel 7 x 26 x $\frac{3}{16}$ " Black Polished; Decorated in Gold; Drilled; Sub-Panel 10 x 25 x $\frac{3}{16}$ " Black Polished; Drilled.

Karas (NEW) Front Panel: 7 x 24 x $\frac{3}{16}$ " Black Polished; Decorated in Gold; Drilled; Sub-Panel 9 x 23 x $\frac{3}{16}$ " Black Polished; Drilled.

Other kits include Madison-Moore "One Spot"; Mellow-Heald Superheterodyne; World's Record Super Nine; Victoreen (one and two dial); H. F. L. Nine-in-Line Front and Sub-Panels; Aerodyne; St. James and Infradyne.

The FORMICA INSULATION COMPANY
4628 Spring Grove Avenue Cincinnati, Ohio

Formica Panels are sold by leading jobbers everywhere.



Formica has a complete service on insulating parts for manufacturers.

RADIO CATALOG free

2000 Exceptional Radio Values

1928 WHOLESALE CATALOG

Radio Sets, Kits and Everything in Radio

LOWEST PRICES TO DEALERS

Every Set Builder Needs This Book

Every live dealer in radio sets, parts, accessories, supplies, etc., should have a copy of this bargain catalog. You will be amazed at the thousands of money saving radio items illustrated and listed in this storehouse of everything you could possibly need in radio.

The GUIDE BOOK to Bigger RADIO PROFITS FOR YOU

The book contains all the latest and most popular kits—all the famous, nationally known radio parts, accessories and supplies—the very newest types and designs of table cabinets and consoles—everything at prices that mean bigger profits for you.

Short Wave Section Our catalog contains a section devoted to a showing of the highest grade short wave receiving and transmitting apparatus. Also the finest electrical appliances for use in the home.

Dealers! Make More Money! Tie up with a house that carries large, complete stocks, that gives you the highest quality radio parts, that insures speedy shipments and 100% satisfactory service. Our wholesale vest pocket price list and discount sheet and catalog will be sent to you on request. Write on your letterhead. **BUT WRITE QUICKLY.**

SHURE RADIO COMPANY
337 Madison Street Chicago, Illinois

BIG DEALERS DISCOUNTS thousands of

Lowest Wholesale Prices

Just Out

Write for FREE BOOK

NATIONALLY ADVERTISED

RADIO SETS PARTS KIT

Midland Wholesale Co.
5116 Ravenswood Ave.
Chicago, Illinois
Dept. R. B.

RADIO AGENTS

Make Big Money

EASY to sell American Radios and Supplies. Nationally advertised, high quality merchandise at wholesale. Big profit on every sale. No capital to invest. No stock to carry. Order direct from my huge warehouse as you sell.

Get My Liberal Offer and also Big New 152-page Catalog and Guide—"How to Sell Radios"—Free. Full of Bargains—all latest in Radio. Write today.

AMERICAN AUTO & RADIO MFG. CO.
HARRY SCHWARTZBERG, PRES.
Dept. 125 American Radio Bldg., Kansas City, Mo.

BIG BARGAIN CATALOG

FREE



Learn Radio

and command a worth while salary

Study at Home . . . Radio Institute of America has for the last eighteen years offered the finest radio instruction obtainable—qualifies you to pass the U. S. Government Commercial or Amateur License Examination. The low cost of the course makes it a real investment that pays dividends in higher wages. Study at home! Send the coupon now for full information.

Radio Institute of America
328 Broadway, New York City

RADIO INSTITUTE OF AMERICA
328 Broadway, New York City

Please send me full information about your Home Study Course of code and technical radio instruction which qualifies for the U. S. Government Commercial or Amateur Radio License.

Please send me full information on your technical course for radio dealers, jobbers and salesmen.

Name

Address

Hoyt

Model 300 RADIO SERVICE SET TESTER



This new HOYT instrument makes all continuity tests on any Radio set and gives instant readings of the filament and plate voltages on any tube, the plate current, and a test of grid connections. It may be used in addition as an accurate tube tester.

Equipped with precision moving coil voltmeter, resistance, 1000 ohms per volt, with knife-edge pointer highly damped, and 3-inch hand calibrated, 4-range scale—0-10 and 0-500 volts and 25 and 100 M. A. Equipped also with external binding posts, and rubber covered leads with prods, for external tests of batteries and B-Eliminators. Dimensions: 9 by 7 by $3\frac{1}{2}$ in. Cased in finished hardwood box with cover and leather carrying handle. Price complete with Adaptors \$65.00.

Send for new Radio Catalog B-10

BURTON-ROGERS COMPANY
BOSTON SOLE SELLING AGENTS MASS.

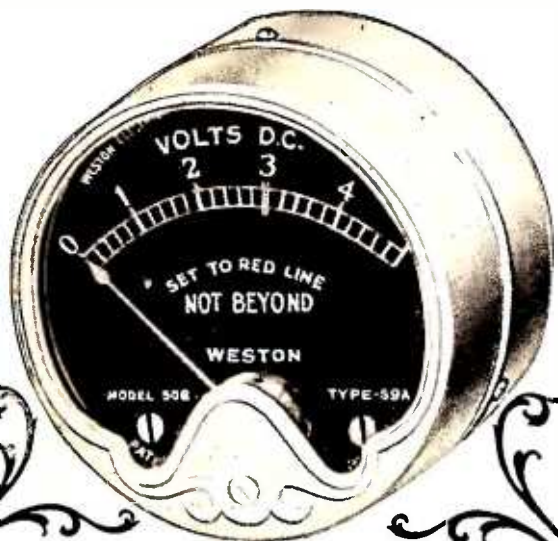

**IN KEEPING WITH THE
CHARM OF THE FINEST SET**

This little instrument with its green gold finish and black dial with gold markings will richly adorn even the most expensive cabinet.

Unusual accuracy and other typical Weston features augment this attractive design, but its great value, however, is its aid to better reception and the service it renders in extending the useful life of tubes and batteries.

It is intended for use with dry cell operated sets equipped with voltmeter pin-jacks — inexpensive, too, so that every set should have one. Accurate for a life-time and this mark is your guarantee of highest quality.



STANDARD THE WORLD OVER
WESTON
Pioneers since 1888



This new model 506 Pin-Jack Voltmeter is an ideal instrument for insuring the best performance from your Radiola 20 or 25, Victor or Brunswick set. Because of its unusually high internal resistance (125 ohms per volt) it requires only a very slight amount of current for its operation, and may be left permanently plugged in on the set without wasting the batteries.

WESTON ELECTRICAL INSTRUMENT CORP.
179 Weston Avenue Newark, N. J.

ADJUSTS UPRIGHT WITH ANY PIN-JACK ARRANGEMENT

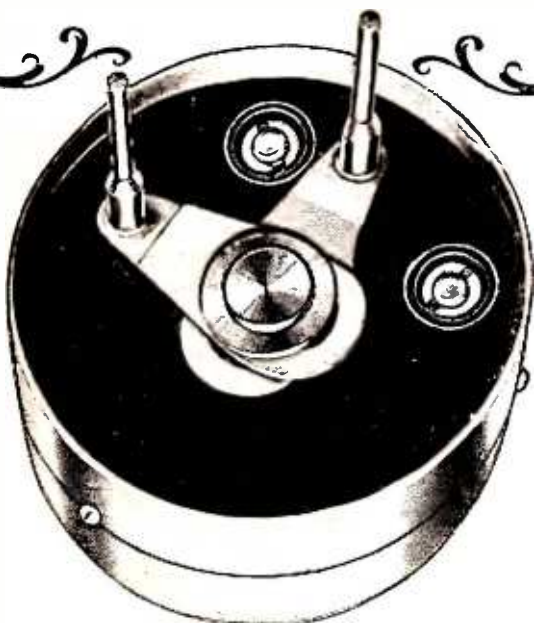

**Over 200,000
Have Been Built!**

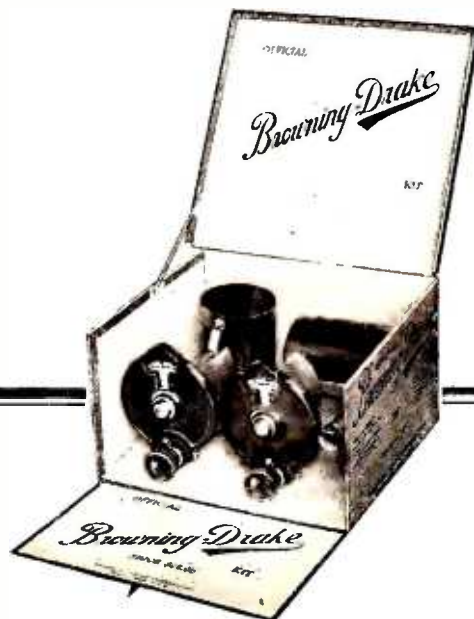

BROWNING-DRAKE has been the outstanding kit set for over three years. Countless designs for home construction have come and gone but ONLY Browning-Drake remains as popular to-day as it was during the weeks following its presentation.

Over 200,000 Browning-Drakes have been built. Such popularity is explained by the fact that Browning-Drake is based on the sound, scientific research of Prof. Glenn H. Browning and Dr. Frederick H. Drake at Cruft Laboratory of Harvard University.

The Official Kit Set now standard on the market, was designed to take care of modern broadcasting conditions. It is unsurpassed for all around performance. Get the genuine parts TO-DAY and build this dependable receiver — the Official BROWNING-DRAKE Kit Set. Constructional booklet will be sent on receipt of twenty-five cents.

DEALERS: Write TO-DAY for information on the parts for the Official Kit Set and the Browning-Drake line of factory-built receivers.

Visit our Booth at
FOURTH ANNUAL RADIO WORLD'S FAIR
Madison Square Garden, New York City
September 19th to 24th Booth 1, Section PP

BROWNING-DRAKE CORP.
CAMBRIDGE - - - MASS.

Look for this  Trade Mark

**BROWNING
RECEIVERS** **DRAKE** **CABINETS**
KITS PARTS

Note the Aluminum Shielding

At the Radio Shows

THIS year's Radio Shows will demonstrate that Aluminum has been adopted for shielding by more of the leading manufacturers than ever before.

This metal is especially effective at radio frequencies and has been accepted as standard by many of those whose names mean progress in Radio.

Aluminum has more applications in radio than any other metal, and is rapidly becoming a mark of quality quickly recognized by the layman.

You will be interested in the exhibit of the Aluminum Company of America, Booth No. BB5.

ALUMINUM COMPANY OF AMERICA

2464 Oliver Building, Pittsburgh, Penna.

Offices in 18 Principal American Cities

"ALUMINUM IN EVERY COMMERCIAL FORM"

Now is the time to subscribe for **RADIO BROADCAST**

Through your dealer or direct, by the year only \$4.00

DOUBLEDAY, PAGE & CO.

GARDEN CITY, NEW YORK

RADIO PRODUCTS

manufactured under the BRUNO trade mark have been produced by the same management for over five years. The story of BRUNO quality is best told in the results obtained from BRUNO Parts.

BRUNO Coils, Brackets, Kits, Uni-tunes, Condensers & Light Switches can be had at your Dealer or direct from us. Our NEW 36 page booklet thoroughly explains our line.

Send 25 cents for your copy

BRUNO RADIO CORPORATION

Long Island City

New York



ELKAY
TRADE MARK REG.

TUBE EQUALIZER

INSTEAD OF RHEOSTATS

Permits instant change from one combination of tubes to another without rewiring. Simply insert Equalizers to match the different voltages. Self-adjusting. Made for all tubes. Unmounted, 50c. mounted 75c.

Elkay Suppressors, made in same form, suppress regeneration and thus annihilate the squeals. Unmounted, 75c; mounted, \$1.00.

Langbein-Kaufman Radio Co.
(Dept. B)
62 Franklin St., New Haven, Conn.

RADIO ACCESSORIES
at **WHOLESALE**

Radio Sets, "B" Eliminators, Changers, Tubes, Kits, Parts—everything new in Radio at lowest wholesale prices. Thousands of nationally advertised bargains. All listed and illustrated in my Big New Catalog and FREE Call Book. 132 Pages of valuable Radio information—trouble finding, set building—Radio knowledge of all kinds. Write today. HARRY SCHWARTZBERG PREN.

AMERICAN AUTO & RADIO MFG. CO.
Dept. 124 American Radio Bldg.
Kansas City, Missouri

FREE BIG BARGAIN CATALOG

Learn the Code at Home With the Omnigraph



Morse and Wireless—taught at home in half usual time and at trifling cost. Omnigraph Automatic Transmitter will send, on Sounder or Buzzer, unlimited messages, any speed, just as expert operator would. Adopted by U. S. Govt. and used by leading Universities, Colleges, Technical and Telegraph Schools throughout U. S. Send 6c for Catalog.

OMNIGRAPH MFG. CO., 15K, Hudson St., New York

IMPORTANT

-as
the
TUBE
Itself

Amperite alone can supply automatically, the self-adjusting filament control your tubes require for perfect rheostat regulation under all varying conditions. Insist upon Amperite, and accept nothing else. Simplifies wiring. Eliminates hand rheostats. Specified by leading engineers in every popular circuit. Types for all tubes. Price \$1.10 mounted (in U.S.A.) At all dealers.

Radiall Company
50 FRANKLIN ST., NEW YORK

Amperite alone can supply automatically, the self-adjusting filament control your tubes require for perfect rheostat regulation under all varying conditions. Insist upon Amperite, and accept nothing else. Simplifies wiring. Eliminates hand rheostats. Specified by leading engineers in every popular circuit. Types for all tubes. Price \$1.10 mounted (in U.S.A.) At all dealers.

Radiall Company
50 FRANKLIN ST., NEW YORK

FREE
Write for
Hook-ups
to Dept. R.B.-10

AMPERITE
REG. U.S. PAT. OFF.

The "SELF-ADJUSTING" Rheostat

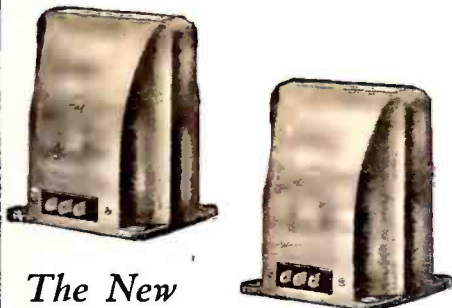

**The New
Symphonic Push Pull
gives great power
with quality**

You who love rich bass notes and tonal brilliancy will find this beautiful pair of Samson brush-copper finished audio units—Push Pull Input Transformers and Push Pull Output Impedance have brought back into its own the push pull circuit, which eliminates tube harmonics.

With two type 171-power tubes having but 180-volts on their plates as much undistorted volume can be obtained as with a type 210 tube having 400 volts on its plate in an ordinary amplifying circuit—and two type 210 tubes can be used with these units for dance-hall volume.

The Samson Symphonic Push Pull Input Transformer will satisfactorily work into tubes up to 50 watts capacity. Unfiltered AC current may be used on the filament in push pull circuits without hum in either first and second stages, or both stages. The Push Pull Output Impedance eliminates the distortion always found in any transformer—no matter how well it is made. Price per pair, \$19.50.

For those desiring to use more than one stage of push pull the new Symphonic Interstage Push Pull Transformer, Type Y is now available. Price, \$14.00.

This is the first announcement of the availability of these units for public use.

Send for free reprint article on a complete audio amplifier.

Those who desire to know how to get supreme coil efficiency can obtain our new "Inductance Units Bulletin" which will be sent on receipt of 10 cts. to cover cost of mailing.

You will desire to know how to apply R. F. and A. F. Chokes to 17 popular circuits or your own receiver as illustrated in our Make-EM-Better Sheet. Send 5 cents to cover cost of mailing.

Our book—"Audio Amplification"—already accepted as a manual of audio design by many radio engineers—contains much original information of greatest practical value to those interested in bettering the quality of their reproduction. Sent upon receipt of 25c.

SAMSON ELECTRIC COMPANY



MAIN OFFICE: CANTON, MASS. *Manufacturers Since 1882*
Factories at Canton and Watertown, Mass.



**IT DELIVERS
FULL "B" VOLTAGE**

Burns

B-Battery Eliminator

Operates from lighting current like other household appliances. No hum or vibrations. Smooth constant plate supply. Once connected it requires no further attention or adjustment. Remarkable results on local and long distance reception. Price \$47.50.

Slightly higher west of Rockies

Write for data

American Electric Company, Inc.

State and 64th Streets Chicago, U. S. A.
Makers of Burns Speakers



**RADIO PARTS DEALERS
PROFESSIONAL SET BUILDERS
and SCHOOLS and COLLEGES**

Should first get our free 400 page Radio Catalog illustrating the products of over 100 radio manufacturers. Save time and money by consolidating your purchases with us. Parts and accessories for all the popular circuits.

F. D. PITTS COMPANY
219-223 Columbus Ave., Boston, Mass., U. S. A.
Distributing Radio Since 1919



**ACME
Celatsite
Wire**

Tinned copper bus bar hook-up wire with non-inflammable Celatsite insulation, in 9 beautiful colors. Strips easily, solders readily, won't crack at bends. Sizes 14, 16, 18, 19; 30 inch lengths.

**Flexible Celatsite
for sub-panel wiring**

A cable of fine, tinned copper wires with non-inflammable Celatsite insulation. Ideal for sub-panel or point-to-point wiring. Strips easily, solders readily. Nine beautiful colors; sold only in 25 ft. coils, in cartons colored to match contents.

Spaghetti Tubing

Oil, moisture, acid proof; highly dielectric—used by leading engineers. Nine colors, for wire sizes 12 to 13; 30 inch lengths. (We also make tinned bus bar, round and square, in 2 and 2½ ft. lengths.)

**Stranded Enameled
Antenna**

Best outdoor antenna you can buy. Seven strands of enameled copper wire. Presents maximum surface for reception, resists corrosion; this greatly improves the signal. Outside diameters equal to sizes 14 and 16. (We also offer solid and stranded bare, and stranded tinned antenna.)

Loop Antenna Wire

Sixty strands of No. 38 bare copper wire for flexibility, 5 strands of No. 36 phosphor bronze to prevent stretching. Green or brown silk covering; best loop wire possible to make.

Battery Cable

A rayon-covered cable of 5, 6, 7, 8 or 9 vari-colored Flexible Celatsite wires for connecting batteries or eliminator to set. Plainly tabbed; easy to connect. Gives set an orderly appearance.

Send for folder

THE ACME WIRE CO., Dept. B
New Haven, Conn.

ACME WIRE
MAKES BETTER RADIO

MAGNAVOX

(electro dynamic)

Power Cone Speaker Units

Built under exclusive patents on electro dynamic principle made famous by Magnavox. Recognized by technical experts and music critics as the one method of construction for perfect reproduction.



R-4 Unit

Type R-4 for 6 volt $\frac{1}{2}$ ampere field. Type R-5 for A. C. radio or phonograph circuits using field as the choke in filter pack. Unit designed for easy installation in radio and phonograph cabinets. Each type, unit only, list \$45.



Beverly Cabinet

Beverly cabinet speaker complete with R-4 unit, cords, switch \$60. Requires 6 volt A battery for power supply.



R-50 Unit

Type R-50 unit is R-5 with built-in power amplifier and B supply using one 216 and one 210 tube. List \$110. Easily installed in your radio or phonograph cabinet.



Loboy Cabinet

Loboy cabinet speaker, complete with R-50 unit, cords, etc. \$160.

Order through nearest dealer or write us for special bulletin about electro dynamic and permanent magnet type speaker units.

THE MAGNAVOX CO.

Oakland, California

Chicago Sales Office 1315 So. Michigan Ave.

Write today
for your copy of
"Copper Shielding for Radio"

This new book shows how to improve the reception of your set. There is no charge.

Copper shielding means greater selectivity and sensitivity.

COPPER & BRASS
RESEARCH ASSOCIATION
25 Broadway, New York

Radio on Terms
Play While You Pay!
A marvelous set for distance, tone, selectivity, 6 tube-1 dial (illuminated). Beautiful cabinet. Easy monthly payments while you enjoy nation-wide programs. FREE Log and Call Book and Big Catalog containing thousands of Radio Bargains. Write today for copy.
AMERICAN AUTO & RADIO MFG. CO.
HARRY SCHWARTZBERG, PRES.
Dept. 187 American Radio Bldg., Kansas City, Mo.

\$985
PUTS IT IN YOUR HOME

Electrostatic condensers
for all purposes

Faradon

WIRELESS SPECIALTY APPARATUS COMPANY
Jamaica Plain
Boston, Mass.

NEW ZEALAND

SPEDDING LIMITED

(Head Office)

20, Fort Street

AUCKLAND

Established
30 years.

Branch & Associate
Offices throughout
New Zealand

We are open to represent manufacturers of wireless material. A complete Dominion-wide organization, available to those desirous of establishing their lines in New Zealand.

We have acted as Radio Manufacturers' Representatives in New Zealand since the inception of Radio, and are the largest organization in New Zealand handling Radio Material exclusively on a manufacturers' representative basis. Only interested in lines capable of volume of business and on an exclusive agency basis.

Bankers: **Bank of New Zealand**

1, Queen Victoria Street

London, E.C.4.

New AERO Circuits Worth Investigating

The Improved Aero-Dyne 6 and the Aero 7 and Aero 4 are destined to be immensely popular this season!

Here are three new Aero circuits of unusual merit. Each is constructed around a set of improved Aero Universal Coils—the finest and most adaptable inductances ever offered! Learn about them NOW if you are interested in securing finest selectivity, greatest range and power, truest tone quality and best all-round radio reception.



AERO Universal Tuned Radio Frequency Kit

Especially designed for the Improved Aero-Dyne 6. Kit consists of 4 twice-matched units. Adaptable to 201-A, 199, 112, and the new 240 and A. C. tubes. Tuning range below 200 to above 550 meters. This kit will make any circuit better in selectivity, tone and range. Will eliminate losses and give the greatest receiving efficiency.

Code No. U-16 (for .0005 Cond.)...\$15.00
Code No. U-163 (for .00035 Cond.)... 15.00



AERO Seven Tuned Radio Frequency Kit

Especially designed for the Aero 7. Kit consists of 3 twice-matched units. Coils are wound on Bakelite skeleton forms, assuring a 95% air dielectric. Tuning range from below 200 to above 550 meters. Adaptable to 201-A, 199, 112, and the new 240 and A. C. tubes.

Code No. U-12 (for .0005 Cond.)...\$12.00
Code No. U-123 (for .00035 Cond.)... 12.00



AERO Four Kit

An exceptionally efficient kit for use in the Aero 4 and other similar circuits. Consists of one Aero Universal Radio Frequency Transformer and one Aero Universal 3-Circuit Tuner. Uses 201-A, 112, 199 and new A. C. tubes.

Code No. U-95 (for .0005 Cond.)...\$8.00
Code No. U-953 (for .00035 Cond.)... 8.00

A NEW SERVICE

We have arranged to furnish the home set builder with complete Foundation Units for the above named Circuits and for the Chicago Daily News 4-Tube Receiver and the Aero Transmitter Set, drilled and engraved on Westinghouse Micarta. Detailed blueprints and wiring diagram for each circuit included with every foundation unit free. Write for information and prices.

You should be able to get any of the above Aero Coils and parts from your dealer. If he should be out of stock order direct from the factory.

AERO PRODUCTS, Inc.

1772 Wilson Ave. Dept. 109 Chicago, Ill.

AT LAST! CONTROL of Radio Reception from Your Easy Chair!

Turn set on and off—get station after station—swiftly—surely—DX—with-out leaving your easy chair.



The NEW
Thermodyne

REMOTE CONTROL
RADIO TUNING
UNIT

No other tuning unit in the world like it. Tune your set from any room of your home. Attached to any single dial receiver with removable dial in a few minutes by removing old dial and attaching adapter plate with remote Control Unit.



Mechanical Model...\$18.00

Electrical Model... 60.00

West of Rockies, add 10%

Write today for circular describing radio's newest and most revolutionary development.

ALGONQUIN ELECTRIC CO., INC.

Leo Potter, President

245 Fifth Ave., New York City

LOOP SET OWNERS

ON RECEIPT of your order we will ship you by return mail one of our famous JENKINS INDUCTANCE-COUPPLERS, which we unconditionally guarantee to INCREASE VOLUME, DISTANCE, and NUMBER OF STATIONS you are now receiving.

ANY OWNER CAN INSTALL IN FIVE MINUTES. STARTLING DISTANCE RECORDS FREQUENTLY REPORTED BY PURCHASERS.

Especially adapted for use with RADIOLA 30, 28, 25, Radiola Super Portable, and Semi-Portable. Absolutely guaranteed performance on all other loop sets.

Your money cheerfully refunded IMMEDIATELY without question to any purchaser NOT ENTIRELY SATISFIED.

ORDER ONE TODAY

\$5.00

CASH—CHECK—MONEY ORDER

JENKINS RADIO CO.

BOX 41

BETTENDORF

IOWA

BENJAMIN
TRADE MARK

Cle-Ra-Tone Sockets

are specified for the

**Hammerlund-Roberts
Hi-Q Circuit**



Spring Supported
Shock Absorbing

Tube holding element "floats," independently of the base, on four perfectly balanced springs. Positive tube to terminal connections. Shock absorbing feature is not affected by stiff bus wiring.

Non-Microphonic. The greatest aid to the non-noisy operation of the set. Gives longer life to the tubes.

The choice of experts and amateurs for practically every prominent and successful circuit for several years.

Among the most recent circuits, in addition to the Hammerlund-Roberts Hi-Q, for which it has been specified, are:

Magnaformer 9-8, Camfield Super-Selective 9, Lynch Suppressor Circuit, H.F.L. Nine in Line, World's Record Super 10, Melo-Heald Fourteen, St. James Super, Two-Dial Equamatic, Knickerbocker 4, 8-Tube Strobodone.

Push Type, on Mounting Base:

Benjamin Cle-Ra-Tone Sockets, 75c each
Without Mounting Base 50c each

New Y Type Socket

Specially designed, for use with 5-pronged A. C. Radio Detector Tubes:

For direct attachment to panel . . . 90c each
For mounting on top of panel . . . \$1.20 each

At all Radio Jobbers and Dealers

Made by

Benjamin Electric Mfg. Co.

120-128 S. Sangamon St., Chicago

247 W. 17th St.
New York

448 Bryant St.
San Francisco

Manufactured in Canada by the Benjamin Electric Mfg. Co., Canada, Ltd., Toronto, Ontario

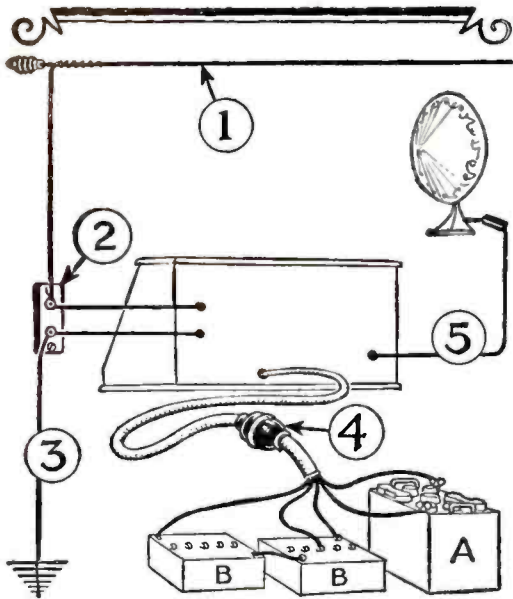

5 Important Accessories for Your Radio Set

1—Beldenamel Aerial Wire

Each strand protected by several coats of baked Beldenamel. Cannot corrode, even after long use. Maintains high set efficiency for range and volume.



2—Belden Lightning Arrester



A safeguard that is essential with every outdoor aerial. A high quality lightning arrester, approved by Fire Underwriters.

3—Belden Ground Wire

A special rubber-covered flexible conductor for lead-in and ground wires.



4—Belden Battery Cords



Furnished with or without A & B-battery fuses. Protects tubes and batteries. Improves appearance of set.

5—Belden Extension Cord

25-ft. extension cord for loudspeakers. Provided with connector. No tools required. Conductors are rubber-covered.

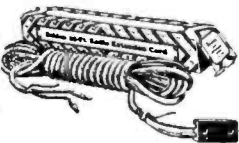

Belden Manufacturing Co.
2312a South Western Ave., Chicago, Ill.

Specify
Belden
Radio Accessories

Pure Tone

The ingenious TELEVOCAL SUPPORT eliminates "bongs" and rasping noises and prevents shorting in Televoctal Quality Tubes. Tested, balanced and proven perfect by technical experts before leaving the factory. A Televoctal tube for every radio need—each backed by our unconditional guarantee.

If your dealer cannot supply you, write us sending his name.

TELEVOCAL CORP'N
Televoctal Building
Dept. B-1, 588 12th St., West New York, N. J.

TELEVOCAL QUALITY TUBES

The Best in Radio Programs

The first to review programs, RADIO BROADCAST has maintained its interesting department of news and comment about broadcasters and their programs in "The Listeners' Point of View." A regular and lively department, conducted by John Wallace from his "listening-post" in Illinois.

5 TUBE RADIO ONLY \$19.98

It's a wonder for power and selectivity. Famous ARL circuit. Coast to coast reception! Finely built of selected, tested parts. Thousands now in use. FREE Log and Call Book and New 132-p. Catalog with thousands of nationally advertised bargains. Latest in radio at big savings. Write for Free copy.

AMERICAN AUTO & RADIO MFG. CO.
HARRY SCHWARTZBERG, PRES.
Dept. 121 American Radio Bldg., Kansas City, Mo.

Set Builders! Dealers! Catalogue

FREE

Money-saving prices—discounts that show you a real profit! All popular kits—new A C tubes and transformers—Parts for any circuit—power audio equipment—short wave supplies—all in our big new 1928 Catalog. Write for it today.

Dan-Ashe Radio Co.
202 North 10th St. ST. LOUIS, MO.

FOR RADIO DEALERS ONLY

ROCK BOTTOM PRICES on everything in Radio

Only the newest and latest (1927-1928) radio goods; no obsolete products; no "seconds" or sub-standards. All goods of tested and proved quality and established reputation—absolutely guaranteed.



Get This Wonderful New Price Guide

Compare its money saving values. Test our "Minute-Man" shipping service with a trial Rush order. Write NOW for your copy of Harry Alter's new "Radio Book."

The Harry Alter Co.

1752 Michigan Avenue

CHICAGO

For the Latest and Best in Radio Get the New Miller-Welles 1928 Catalog—FREE SILVER SUPER KIT

As described in September issue, ready for immediate shipment. Kits on all popular receivers in stock. This new book contains the complete lines of such well-known manufacturers as Tyrman Electric Corp., Camfield, Silver-Marshall, Karas, Carter, Aero Coil, etc. Dealers and professional set builders will receive this new book free and without obligation, upon request. Write today!

MILLER-WELLES CO.

18-B W. Kinzie St. Chicago, Illinois

The NEW "ENSCO" 3 Ft Cone Loud Wall Type Speaker



STANDARD "ENSCO" KIT With Hardwood Frame \$10.00 \$11.00

See our Exhibit: New York, Chicago, and Boston Shows
Anyone can assemble the "World's Finest Loud Speaker" in less than an hour, from the complete "Enesco" Kit. Six styles and 3 sizes to choose from. All described in the illustrated instruction book. Fully patented. At your dealer's or direct from any of the offices listed below. Send check, money order or C. O. D. Shipping charges paid In Canada \$11.50 and \$12.50. Absolute money back guarantee.

ENGINEERS' SERVICE COMPANY

25 Church Street, New York
28 E. Jackson Blvd., Chicago

73 Cornhill, Boston
331 Bay St., Toronto, Canada

Finally—the Perfect “A” Eliminator

For Your Present Set or the Set
you eventually buy



Our 4-volt “A” Eliminator
Fits Into All Radiola Consoles

Silver **A** Beauty POWER

Replaces “A” storage battery and charger; has full wave “dry” rectification; maintains required voltage in uniform, constant flow; operates automatically by moving a switch; economical—uses minimum amount of current (about 1-10 cost of using electric iron); has rheostat control for additional refinement in voltage and reception; gives maximum power to radio tubes and lengthens their life; no acids to test or spill. Satisfactory results guaranteed.

Its principle is simple and correct!

The 110 volts Alternating Current is scientifically reduced with the famous “Silver Beauty” transformer coil to deliver the proper voltage to an *especially developed dry, noiseless rectifier*, which transforms the electricity to direct current. This current of exact voltage, is then transmitted through a patented special filter which clarifies the current, eliminating all foreign noises caused by rectifier or generator.

The Silver Beauty “A” Eliminator is endorsed by prominent radio engineers—adopted by leading distributors and dealers—approved by thousands of users. These are sufficient reasons for making Silver Beauty your choice.

~~\$39⁵⁰~~ ~~\$43⁵⁰~~ ~~\$39⁵⁰~~

6-volt; 2 amp. 6-volt; 3 amp. 4-volt; ½-amp.
\$2 Higher West of Rockies

Silver Beauty “B-C” UNIT

Does away with “B”
and “C” batteries

Embodies every up-to-date refinement and principle, insuring smooth, unflinching reception. As beautiful as it is efficient.

180 Volts—40
Milliamperes

~~\$45⁰⁰~~

Individual adjustment
adapted to all sets



Silver Beauty CHARGERS

Employing an entirely new method of rectification. Two models—with or without bulbs.



Triple-A-Specialty Company
Manufacturers of the famous Silver Beauty Chargers
312-316 South Hamilton Ave., Chicago, Ill.



PARVOLT WOUND CONDENSERS

It is not “horse sense” to jeopardize the success of a circuit or the investment made in the parts by the use of inefficient by-pass or filter condensers.

Parvolt Wound Condensers are made in 3 service voltage ratings and in a wide variety of capacities and styles. Use them wherever the circuit calls for capacity. Their use is assurance of—

Continued accuracy within 10 percent of rating.

Continuous duty at full rated voltage.



6131-5

THE ACME WIRE CO.

New Haven, Connecticut

Announcing finer reception—through a finer audio transformer



MODERN Type M

A new standard of perfection in audio amplification. High inductance, perfect proportioning, and liberal core sizes give uniform amplification as low as 30 cycles and eliminate high harmonics. Satisfactory performance is guaranteed. Install Type M in your set. First and second stage \$8.50 each; Push-pull \$10.00 each; Output \$8.00 each.

If your dealer cannot supply
you order direct by mail

The Modern Electric Mfg. Co.
Toledo, Ohio



Practical, Economical A C Operation

—with the new AC Tubes
and Dongan Low Voltage
Transformer



You can replace the A battery and charger with the ideal A C current supply by using the new UX 226 amplifier

No. 4586
Low voltage Transformer for UX 226 and UY 227 tubes. List \$8.

tubes and the UY 227 detector tube and the Dongan A C Power Transformer.

For complete electrical operation get Power Transformer (list \$15.) and Double Choke (list \$15.) for use with A B C 350-400 m.a. rectifier tube.

No. 4586 A C Power Transformer is designed to function also with U X 171 power amplifier tube; No. 4587 with U X 210 power amplifier tube.

Order from your dealer—or send check or money order to factory direct.

Only a few slight changes are required to operate your set with this ideal A C current supply.

Headquarters for Power Unit Parts

Manufacturers of sets and power units have come to regard Dongan as the logical headquarters for parts (transformers and chokes) for the latest approved types of eliminators. For all types of tubes and rectifier units Dongan engineers have perfected authorized parts. This close co-operation of the Dongan laboratories with tube manufacturers, plus the advantageous production facilities in the Dongan plant, offers the ideal source of supply.

Set and eliminator manufacturers are invited to make use of these facilities.

Dongan Low Voltage Transformers for the new A C Power Tubes are ready for manufacturers (in mounted or unmounted types.)

DONGAN ELECTRIC MFG. CO.
2991-3001 Franklin St., Detroit, Michigan

TRANSFORMERS of MERIT for FIFTEEN YEARS

—when the crown stands or falls....

— You're there with a Crosley ...

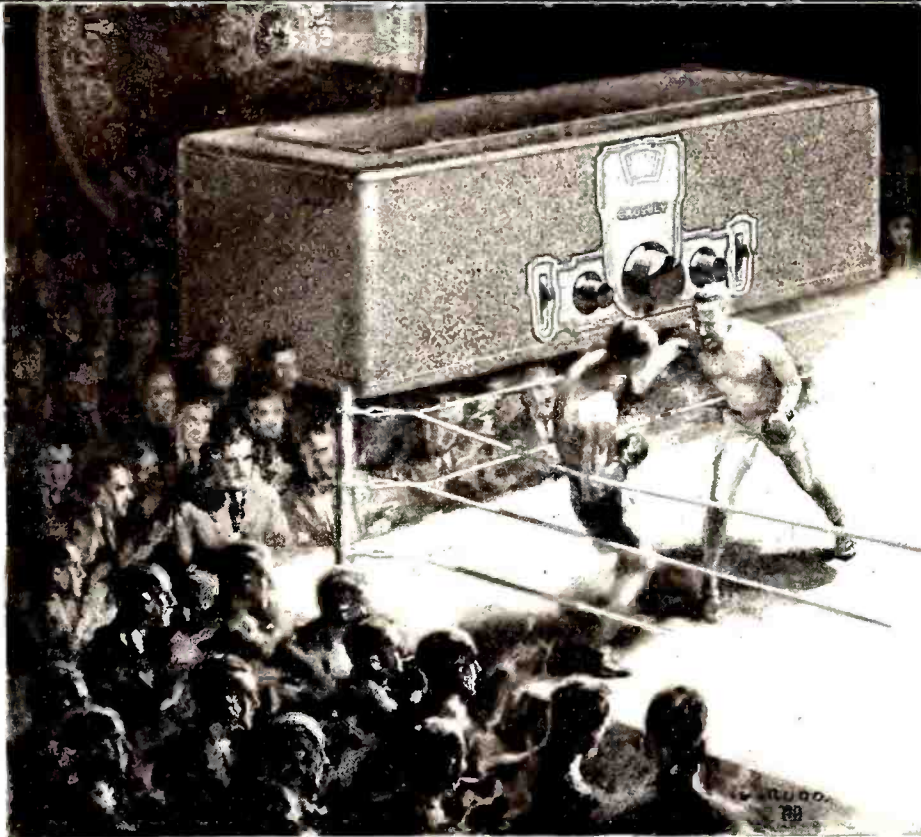

The Crosley Radio Corporation
Folks who buy radio are vitally interested in what they get for their money. Why don't you radio manufacturers stop talking like a lot of doctors and tell us what it's all about in one cylinder words? What's this "shielding" business anyway?
Yours truly
Electric Parts Corp., Syracuse, N. Y.

Shielding is necessary in a modern radio receiver. The more sensitive the set is, the more you need it. Some sets are merely housed in a metal case. This helps to keep strong local

TWO COILS ALL SET TO SQUAWK

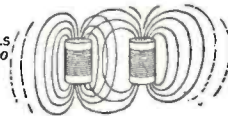

signals from breaking through, but it is even more important to keep them where they belong after you get them the proper way from the antenna. A set has tubes, condensers and coils. Here is a coil. The lines around it are the magnetic field. You know the earth's magnetic field will work a compass down in a mine, or up in a plane (it certainly worked for Lindbergh) and the fields around unshielded coils get all mixed up and the set howls and squeals and has to be choked off by turning down the filaments in the tubes.



Now if the coils are housed in copper shields the fields can't mess each other up, and the tubes can do a real job of amplifying. The coils in Crosley sets have these copper shields, and there isn't anything better.

Then there are the condensers, and if it wasn't for the shield around them, the fields would act like those



in the coils, and the results would be just as bad, or worse.

It isn't enough to shield the coils and the condensers, because even the wiring of the set has fields around it. This too is shielded, as it is in all really high grade sets.

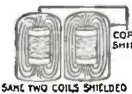

Of course, it's all in knowing how to do it, but that's why Crosley sets can be as good as the best without costing half as much.

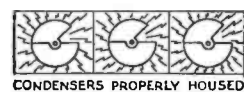

APPROVED CONSOLES

Selected by Powel Crosley, Jr., as ideal acoustically and mechanically for the installation of the Crosley "Bandbox" Genuine Musicone built in. Crosley dealers secure them from their jobbers through

H. T. ROBERTS CO.
914 S. Michigan Ave.,
Chicago, Ill.
Sales Agents for Approved Console Factories
Showers Brothers Company
The Wolf Mfg. Company



\$35



\$65



\$85

The BANDBOX

A 6 Tube Receiver of unmatched quality at \$55

LIGHT SOCKET MODEL \$65

Many features of this set have been found heretofore only in the most expensive radio. Since Crosley is licensed to manufacture under nearly all important radio patents, this combination with Crosley leadership and experience, naturally produced an amazing radio, the remarkable value of which can be judged by the following features incorporated and by seeing it and hearing it at your dealers.

1. Completely shielded coils, condensers and wiring.
2. Acuminators for sharper tuning.
3. Completely balanced genuine neutrodyne.
4. Volume control.
5. Single tuning knob.
6. Illuminated dial.
7. Single cable outside connections.
8. Designed for easy installation in consoles.
9. Beautiful frosted brown crystalline finished cabinet.



AC model using new R. C. A. AC tubes and working directly from electric light socket through Crosley Power Converter is \$65. Power Converter \$60 extra.

Hear this wonderful new contribution to the enjoyment of radio. If you cannot find one of the 16,000 Crosley dealers near you, write Dept. 20 for his name and literature.

IMPROVED MUSICONES
Musicones improve the reception of any radio set. They are perfect affinities in finish, beauty and reproductive effectiveness for Crosley Radios. A tilt-table model, with brown mahogany finish stands 36 inches high, \$27.50—16-inch Super-Musicone as pictured above with "Bandbox," \$12.75—12-inch Ultra-Musicone, \$9.75.

CROSLEY RADIO

The Crosley Radio Corporation,
Powel Crosley, Jr., Pres.
Cincinnati, Ohio.

Crosley Radio is licensed only for Radio Amateur, Experimental and Broadcast Reception.

Prices slightly higher west of the Rocky Mountains

30 Days FREE TRIAL

Single Control

7-Tube

\$ 77

RETAIL PRICE

Completely Assembled

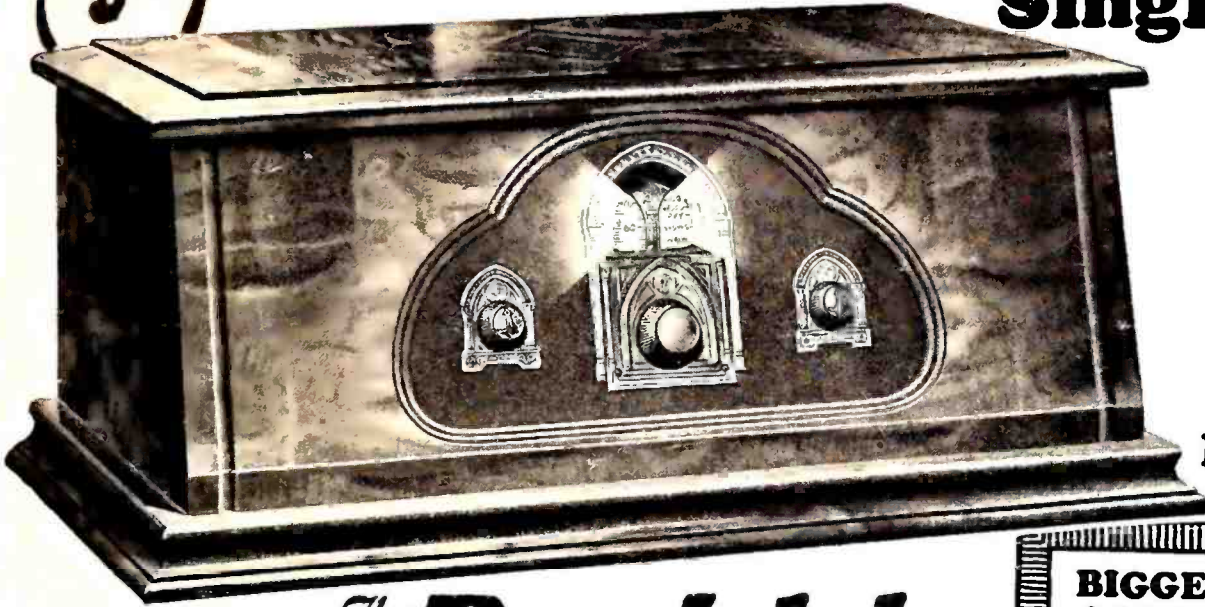

The **Randolph**

SINGLE CONTROL - ILLUMINATED - DRUM

POWERFUL seven-tube radio at factory price. Test it without spending a cent. We claim the Randolph Seven will out-perform any radio and we want you to satisfy yourself that it will. To do this, we will send you this powerful radio to try for 30 days. Test it for distance, clearness, ease of operation, tone and every other way you can. Unless it more than satisfies you, return it to us. **Every Randolph set must make good before it is sold.**

Battery **ALL ELECTRIC OPERATION**

The Randolph Seven is sold for use with batteries or connected for operation direct to electric light socket—absolutely batteryless—no chargers or batteries—just plug in socket and tune in. 100% efficient either way. Its construction and performance have been tested and approved by leading radio engineers and authorities and leading radio and scientific publications.

Single Control—Illuminated Drum

One drum dial operated by one simple vernier control tunes in all stations with easy selectivity to tremendous volume. No overlapping of stations. Illuminated drum permits operation in the dark. Volume control for finer volume modulation. This is a 7-tube tuned radio frequency receiver with power transformers and power amplification. Space wound solenoid coils Full and completely shielded. A real receiver of the highest quality. Tremendous distance, wonderful tone quality, simple to operate.

The Randolph cabinets are in themselves beautiful pieces of furniture made of carefully selected solid burl walnut. Bas-relief bronze escutcheon plates are mounted on the dial panel. In design and appearance it is a cabinet worthy of the high-quality radio it contains. Solid walnut beautifully shaped surrounds the soft verdi-green panel. Nothing has been spared to make the Randolph Seven the leading radio receiver. We are so sure that it will surpass even your best hopes that we know how safe we are in making the **30 day free trial offer.**

Read What Owners Say

I have logged more than 50 stations from coast to coast.—Lloyd Davenport, Littlefield, Texas.
I have logged 52 stations from Cuba to Seattle—the set is a world beater.—J. Tampkinson, Detroit, Mich.
Your set is a revelation—has all others tied to the post for distance and selectivity.—Waldo Powers, Vergennes, Vermont.
On strength of its performance sold two more sets this week. T. Scanlow, Orlando, Florida.

Beautiful Ampliphonic Console Set

Made of the finest carefully selected solid walnut. Two-tone shaded finish. Has built-in cone loud-speaker that compares with any on the market and accurately reproduces high and low notes. Send for the folder today that shows this beautiful console in full colors and gives complete details. **Compares with most table sets in price.** For battery or all-electric operation ready to plug in and tune in. Write for complete descriptions.

Randolph Radio Corporation
711 W. Lake St. Dept. 121, Chicago, Ill.



BIGGEST DISCOUNTS to AGENTS and DEALERS

WORK either full or part time and make big money. Tremendous advertising campaign helps you sell. Regardless of whether you have ever sold before, be sure to get our proposition. The Randolph sells on first demonstration. Men and women both can make money this easy way. Get your demonstration set for thirty days **FREE TRIAL.**

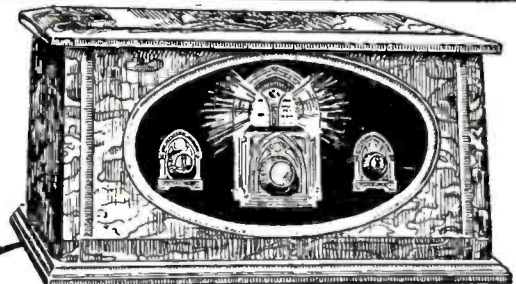

6-Tube

\$ 55

Retail Price
SINGLE CONTROL

The **Randolph**

Now you can have a new, modern, single-control, six-tube radio. Do not compare this set with old style 2-dial 6-tube sets selling for about the same price. The Randolph 1928 Senior Six has also been tested and approved by the leading radio engineers. Comes in a beautiful solid walnut cabinet of hand-rubbed finish. Single control. Illuminated Drum with space for logging. Absolutely dependable and very selective. Sent for 30 Days Free Trial. You test it before you buy.

Mail Coupon Now

The Randolph Radio Corporation are pioneers in the manufacture of radios. All of its vast and unlimited resources have been used in making and perfecting of the Randolph Receivers. Because of our long and successful experience in the radio business, we are perfectly confident in sending out a Randolph Radio on trial. We know what it will do. Mail us the coupon now for the greatest radio offer ever made.

USE THIS COUPON TODAY!

Randolph Radio Corporation.
711 West Lake Street, Dept. 121
Chicago, Illinois.

Send me full particulars about the RANDOLPH Six and Seven-Tube Table and Console Sets with details of your **30 Day FREE Trial Offer.**

Name.....

Address.....

City..... State.....

Mark here () if interested in Agent's proposition.

Plug In—and Tune In.

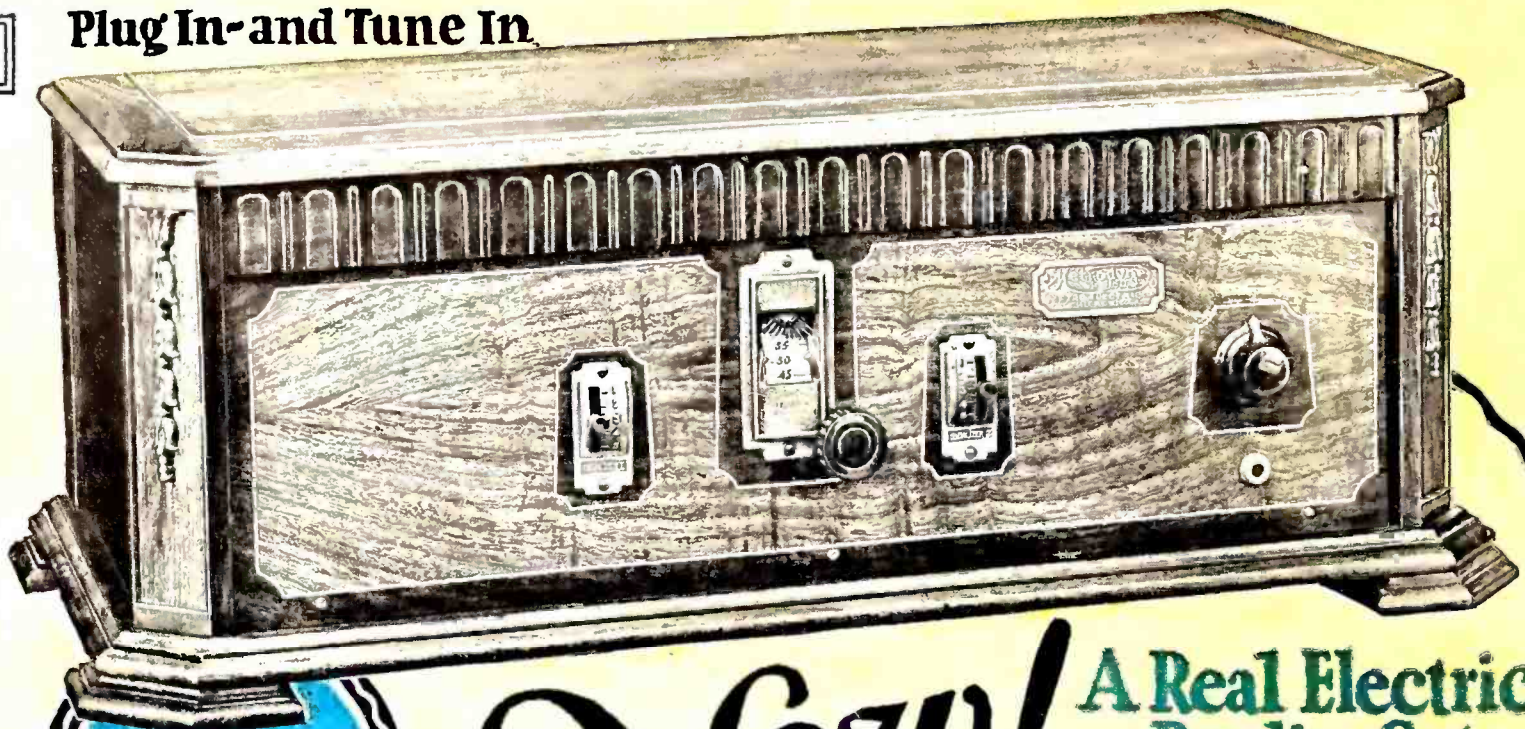

30 Days Free Trial

Now! A Real Electric Radio Set

Three Year Guarantee
 Shipped direct from our factory at rock bottom prices—cost less than most battery sets

No Batteries, Chargers or Eliminators
No Acids; No Liquids—Plug In—Press Button—“Tune In”

Metrodyne

ALL ELECTRIC RADIO

AGENTS! DEALERS! BIG PROFITS!

Make big money taking orders for Metrodynes. All or part time. Metrodyne All Electric Radios are in a class by themselves. Unequaled for quality, performance and price. Demonstrate at home and take orders. Lowest wholesale prices. Your demonstrating set on 30 days' free trial. Mail coupon below for details.

7 Tubes—Single Dial Set

100% Electric Radio

**BEAUTY—EFFICIENCY
 DEPENDABILITY**

At last! The radio you've dreamed about! If you have electricity in your home you can now really enjoy coast to coast radio reception without the care, bother and muss of batteries, chargers, eliminators, etc. The Metrodyne All Electric is a real, genuine batteryless radio set. Simply insert the plug in the socket, press the switch button and “tune in.” You could not possibly buy a better radio set than the Metrodyne All Electric, no matter what price you paid.

The Metrodyne All Electric Radio is a 7 tube, single dial set. Only the highest quality low loss parts are used throughout. Solid walnut cabinet, beautiful two-tone effect, with handsome gilt metal trimmings. Size of cabinet, 28 inches long, 13 inches deep, 10 inches high. Has electrically lighted dial so that you can log stations in the dark. Only one dial to tune in at all stations. Excellent tone qualities—wonderful volume—very selective.

Costs Less Than Most Battery Sets

Do not confuse the Metrodyne electric radio with ordinary light socket sets, because the Metrodyne is truly an all electric radio—consumes less than 2c worth of power a day. Comes to you direct from the factory. Its low cost brings it down to the price of an ordinary battery set. We are so confident that you will be delighted with this wonderful, easy-to-operate batteryless radio that we offer to ship it to your home for thirty days' free trial—you to be the judge.

Mail This Coupon

We are one of the pioneers of radio. The success of Metrodyne sets is due to our liberal 30 days' free trial offer, which gives you the opportunity of trying before buying. Thousands of Metrodynes have been bought on our liberal free trial basis—**WRITE TODAY!**

METRO ELECTRIC COMPANY
 2165 N. California Ave., Dept. 607
 Chicago, Illinois

Gentlemen:
 Send me full particulars about Metrodyne All Electric Radio and your **thirty days' free trial offer.**

Name _____
 Address _____
 If you are interested in AGENTS' proposition place an "X" in the square

MAIL COUPON NOW!



Gorgeous Console Electric Radio

Here is the Metrodyne All Electric Console Radio—a gorgeous, genuine walnut cabinet, in a beautiful two-tone finish. Has a built-in genuine Metro-Cone large size speaker. Brings in programs with great volume, reproducing the entire range from the lowest to the highest notes with remarkable clearness and distinction. All metal parts are finished in old gold. Wonderful electric radio, in a cabinet that will beautify the appearance of any home.

METRO ELECTRIC COMPANY

2165 N. California Ave. Dept. 607, Chicago, Illinois