

JUNE

15 CENTS

Popular Electricity Magazine

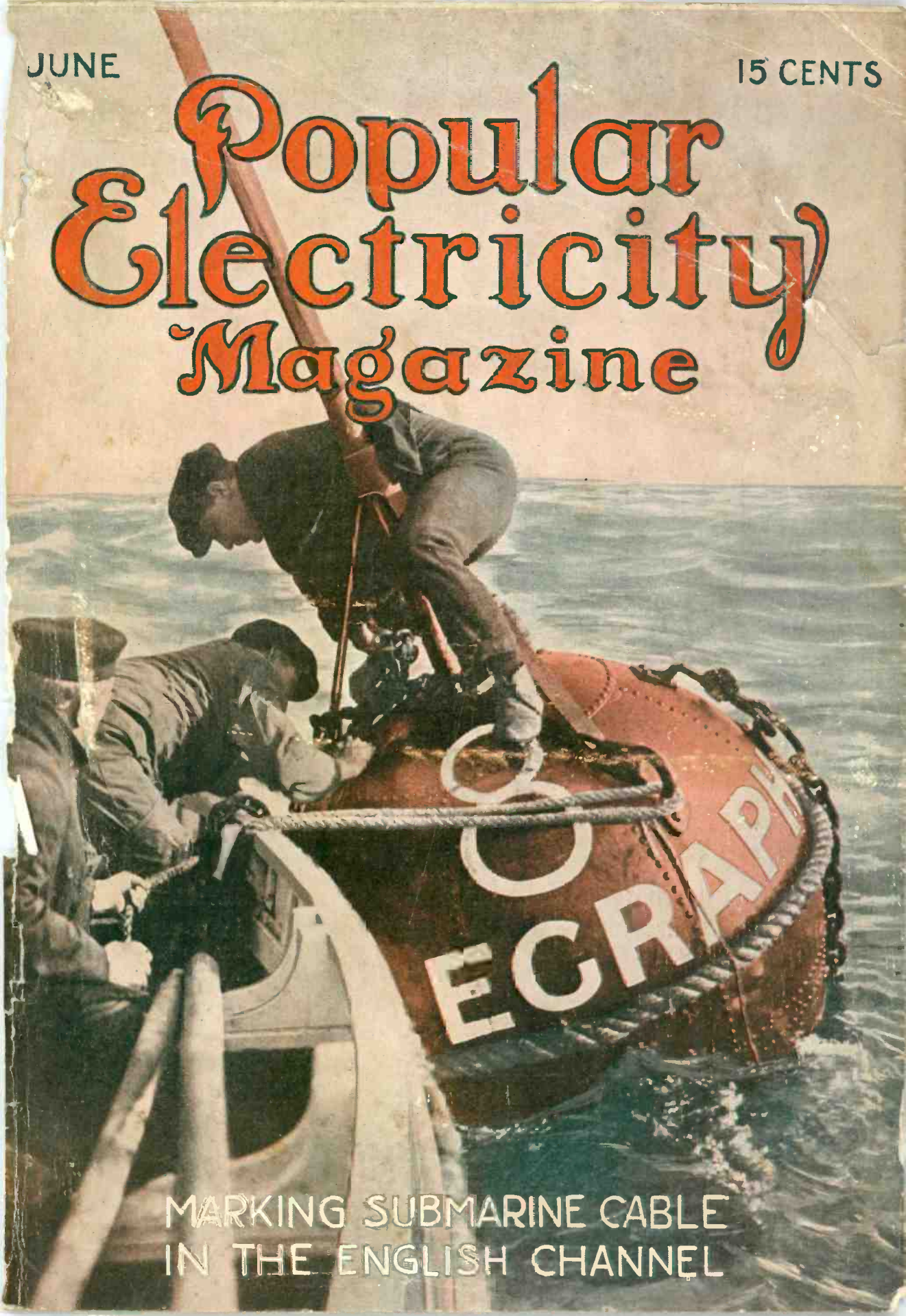

MARKING SUBMARINE CABLE
IN THE ENGLISH CHANNEL

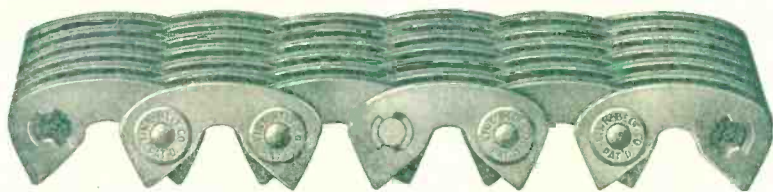

Link-Belt Silent Chain

*Flexible as a Belt—Positive as a Gear
More Efficient than either*

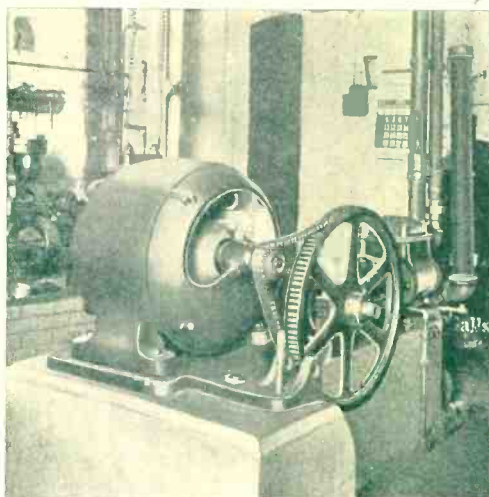

1 1/2-H. P. Link-Belt Silent Chain Drive, 17" centers,
operating Pressure Pump.

Link-Belt Silent Chain—made of stamped steel links, round case-hardened steel pins, and removable case-hardened bushings and washers—is a superior power transmitter, because—

- It is 98.2 per cent efficient.
- It is compact—occupies little room.
- It will transmit any amount of power.
- It operates quietly.
- It can be run at high speeds—in either direction.
- It may be run on very short centers.
- It cannot slip.
- It can be used in a hot, cold or damp place.
- The chain is run slack and there is therefore no journal friction as with leather belts.
- There is no danger of sparking.
- It gives a positive velocity ratio.

Everyone Interested in Power Transmission

should read about the increased production—saving in power—elimination of costly leather belts, shafting, pulleys, and accessories—resulting from the substitution of Link-Belt Silent Chain for leather belting and spur gearing.

WRITE TODAY FOR THIS NEW BOOK

And other literature which we will send postpaid to those interested in transmitting power

LINK-BELT COMPANY,
Chicago, Illinois

.....1912.

Send me your Book No. 141 and other literature describing Link-Belt Silent Chain Drives. I am particularly interested in drivingmachines.

Name

Address

A summer dining room cooled by fresh, stirring air, with buzzing flies banished by cool, sweeping breezes—that can be your dining room with a

GE. Electric Fan

GENERAL ELECTRIC COMPANY

The G-E 8-inch Oscillating Fan is just right for homes and small offices. It is the only *small* swinging fan you can buy. Its gentle, side-to-side motion brings cool comfort to every part of the room.

Attached to a lamp socket, the swinging breezes of this G-E Oscillating Fan add the zest of coolness to summer's pleasures and summer's work at a cost for electricity of

Less Than a Cent for Four Hours.

By day they drive out the close, sultry air, and let in the freshness and purity of outdoors. By night they bring the coolness that means refreshing sleep.

And with a G-E Fan, all this summer comfort

requires less electricity than an ordinary 16-candle-power light.

G-E Fans last a lifetime. They are smooth-running, quiet and clean—no oily parts are exposed to catch dust.

Make your home folks comfortable all summer long with a G-E Electric Fan. G-E Fans are made in fixed as well as oscillating types and in many sizes and styles—for homes, offices, stores and factories. But whatever size or style you get, be sure it bears the G-E trade mark.

Electric shops, stores carrying electrical goods or any lighting company can supply you.

"The Twitch of a Switch"

illustrates many new and inexpensive ways of making electricity save housework and servant troubles.

GENERAL ELECTRIC COMPANY

The World's Largest Electrical Manufacturer

(Dept. 30 C) Schenectady, New York

The Guarantee of Excellence on Goods Electrical.

This trade mark insures reliability in anything that generates, transmits or utilizes electricity. It protects you on house-wiring materials, it is on all Edison lamps, and it identifies the most highly perfected electric flat-irons, fans, cooking devices, small and large motors and apparatus.

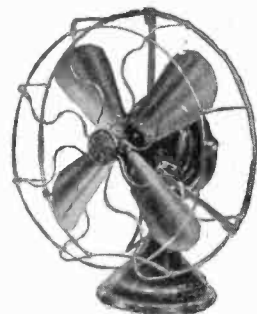

[3605]

For our Mutual Advantage mention Popular Electricity when writing to Advertisers.

PART SCHOLARSHIP FREE



OUR NEW HOME

We offer a limited number of part scholarships gratis to really ambitious young men desirous of taking advantage of the idle vacation months and learn while others loaf.

Full Particulars Upon Request

Thorough Practical Training

This school is like a fully equipped and modern electrical work-shop. Our students learn by actually working with electrical appliances, while studying under the guidance of an expert practical and theoretical faculty. Graduates from this school command big salaries because by our thorough and practical training they become Expert Electricians and Electrical Engineers. Successful graduates everywhere. Names on request. More positions than we can fill.

Write To-Day for Free Tuition Offer and School Catalog

SCHOOL OF ENGINEERING of MILWAUKEE

161-171 Michigan St.,

Stroh Industrial Bldg., Milwaukee, Wis.



Don't be a Drudge

You can have Health, Comfort, Money if you want them!

Get off the hose

Let the Stream of Prosperity Flow

Let Chiropractic, the rising science of common sense applied to the adjustment of human ills, carry you with it to usefulness, comfort and independence.

Get Out of the Small Income Rut

A year ago one of our students earned \$2 a day as a common laborer. Now he has a practice of 30 patients who each pay him \$5 a week, \$150 a week; \$7,800 a year! Few graduate Chiropractors earn less than \$2,000 yearly, nearly all \$5,000, and many more than \$10,000! You can have a big income if you

Learn To Be a Chiropractor

You can become a competent Doctor of Chiropractic by studying at home. Our home study course is complete, simple, easily understood. There are 250 lessons, thousands of photos from life. One month's free tuition where Chiropractic started is included.

SPECIAL OFFER: First lesson of our course free if you write today.

Palmer School of Chiropractic

"Chiropractic Fountain Head"

Home Study Department

Davenport, Iowa, U. S. A.



Learn Telegraphy

MORSE and WIRELESS

At My Practical School. Splendid demand for operators and agents. We also teach Station Agency Work. Graduates assisted. We occupy our own 2 large modern buildings equipped with R. R. Dispatchers and Western Union Wires and Wireless Station. Endorsed by Railroad, Wireless and Western Union Officials. Exclusive Methods. Teachers are practical experts. Living expenses earned. Easy payments. Correspondence course if desired. Catalogs Free. GEORGE M. DODGE, Pres., Dodge's Institute. Established 1874. 21st St., VALPARAISO, IND.

FREE BOOK ON MOTORING



Explains how we can start YOU in the Auto Business as Repairman, Chauffeur, Salesman or Auto Expert with Dyke's New Idea Working Model System of teaching by mail and our new idea Employment Plan. Let us tell you the names of some of our students and the salaries they are drawing today—more than you are making. Don't miss it—Send for Booklet NOW!

Dyke's School of Motoring, Box 2, Roe Bldg., St. Louis, Mo.

LEARN WATCHMAKING

Engraving and Jewelry repairing.

Earn while learning. Our school Endorsed by leading jewelers. Positions secured for graduates. Send for Free catalogue.

CHICAGO SCHOOL OF WATCHMAKING, Dent. 30, Bush Temple, Chicago



I TEACH BY MAIL

WRITE FOR MY FREE BOOK "How to Become a Good Penman" and beautiful specimens. Your name elegantly written on a card if you enclose stamp. Write today. Address F. W. Tamblin, 457 Myer Bldg., Kansas City, Mo.

WIRELESS TELEGRAPHY

Expert instruction—full equipment—low fees. Meets U. S. Government requirements—grants certificates —Prepares for positions with Postal Western Union, United Wireless or U. S. Government.

BOOKLET "T" FREE TO ANY ADDRESS
East Side Y.M.C.A. Telegraph School
153 East 86th St., New York

Electricians Wireless Operators Telegraphers

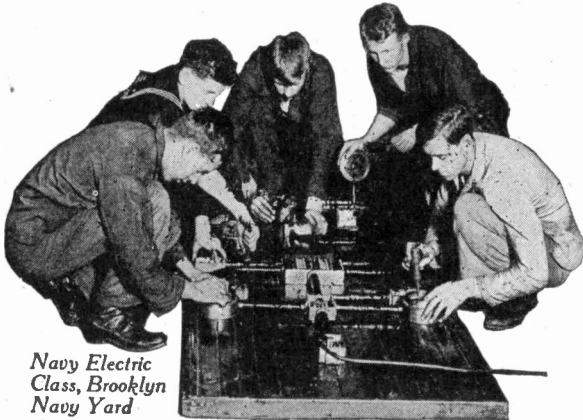

Navy Electric
Class, Brooklyn
Navy Yard

THE United States Navy offers exceptional opportunities to men who have had experience as electricians, radio (wireless) operators or telegraphers.

It offers them *permanent employment* at pay which is better than that of most electricians on land. And it offers *chances for promotion* and positions of responsibility which come to few men in civil life.

If you have ambitions to become a first-class electrician or wireless operator; if you have had experience in electrical work or telegraphy; and if you are healthy in body and mind and not over 25 years of age—you will do yourself the best turn you've ever done by investigating the Electrical Branch of the Navy.

Send for full information about pay, hours and promotion. We will send you matter which will inform you truthfully about the pleasant healthy life in the Navy; the companionship of steady, ambitious men; the incentive to rise and to save money. You will find this information interesting. Send today to

Bureau of Navigation, Box 5
Navy Department, Washington, D. C.

UNITED STATES NAVY

Salesmen Wanted

Trained Salesmen earn from \$1,200 to \$5,000 a year and expenses. There are hundreds of such positions now open. No former experience needed to get one of them. We will teach you to be a Salesman in eight weeks by mail and assist you to secure a position where you can earn good wages while you are learning Practical Salesmanship. Write today for full particulars, list of good openings, and testimonials from over a thousands men we have recently placed in good positions. Address Nearest Office, Dept. 131

National Salesmen's Training Association

Chicago New York Kansas City Seattle New Orleans Toronto

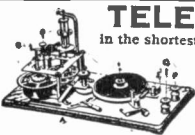

TELEGRAPHY TAUGHT

in the shortest possible time. The Omnigraph Automatic Transmitter combined with standard key and sounder. Sends you telegraph messages at any speed just as an expert operator would. Five styles, \$2 up; circular free.

OMNIGRAPH MFG. CO.

39 H Cortlandt Street New York

TELEGRAPHY

The Only Trade That Is Not Crowded

It insures steady employment and good wages. Promotion is assured for the ambitious.

We are official instructors for the Western Union Telegraph Company, and the only school instructing Western Union employes.

Largest attendance of any Telegraph school. Also official instructors for Illinois Central Railway Company. Agency course free.

Practical instructors. Main line wires.

Employment furnished to earn expenses if desired. State your age.

JONES SCHOOL OF TELEGRAPHY

305 S. La Salle Street, Chicago, Illinois

Mechanics Institute

ROCHESTER, N. Y.

Summer Session June 24th to August 16th

Regularly accredited courses in manual training, applied arts, domestic science, domestic arts, pedagogical and academic. \$26.00 per session for not exceeding three courses.

AUTUMN SESSION begins September 10th. Valuable practical courses in applied electricity, mechanic arts, manual training, etc.

147 Courses, 70 Instructors

SEND FOR BULLETIN

Men Wanted Right Away



\$5.00
to
\$8.00
Per Day

Big Demand for

Electricians

Plumbers

Bricklayers

Painters

Decorators

Draughtsmen &

Moving Picture Operators



No Experience Necessary

Take advantage of these big openings right now. More men are wanted for these trades all the time. We will help you earn from \$5 to \$8 per day or start a business of your own, so that you can earn from \$3,000 to \$5,000 per year. We will teach you in a few months' time, at small expense, one of the following profitable trades: Electricity, Plumbing, Bricklaying, Painting and Decorating, Mechanical Drawing and Moving Picture Operating. Unlimited opportunities for making big money. No experience necessary.

Start Your Own Business— \$3,000 to \$5,000 Per Year

If you want to go into business we will equip you so that you can start right in for yourself, at very small expense, and make from \$3,000 to \$5,000 a year. Our school is the oldest, largest and best equipped trade school in the world. Open all the year round—enter any time at any age. Day and night sessions. Tuitions very low. Easy payments if desired. We will help you earn your way through school, too. And our employment bureau places students in big paying positions all the time.

Write Today Get our 1912 catalog which explains all about our practical course of instruction. Learn how students make big money—how you can insure your future by taking our course. Get this information at once. Everything sent absolutely free. Just send us a post card. We will help you make a big success, so write today to

L. L. COOKE, Director

Coyne National Trade School

110 E. Illinois St., Dept. 140X, Chicago, Ill.
Oldest and Largest Practical Trade School in America



We
Occupy
This
Entire
Building
of
Over
30,000
Square
Feet



Learn a Paying Profession
that assures you a good income and position for life. For 17 years we have successfully taught

PHOTOGRAPHY

Photo-Engraving and Three-Color Work
Our graduates earn \$20 to \$50 a week. We assist them to secure these positions. Learn how you can become successful. Terms easy—living inexpensive. Write for catalogue—NOW.
ILLINOIS COLLEGE OF PHOTOGRAPHY
989 Wabash Avenue, Effingham, Illinois



QUICK, THOROUGH ELECTRICAL INSTRUCTION

A complete college course in two years. Time and money saved. Taught by graduate engineers. Practice on apparatus and machines—construction, operation and repair. Every branch of generation, transmission and application. Graduates in leading electric companies. New classes July and September

—WRITE FOR DETAILS—

BRYANT & STRATTON COLLEGE
No. 115 College Building BUFFALO, N. Y.



EARN A BIG SALARY BE AN AUTO EXPERT

Learn the automobile business thoroughly. We teach in 12 simple lessons at home, and assist students to get good positions. Send **TO-DAY—NOW—**for **FREE BOOK**, particulars, and endorsements of ten leading automobile manufacturers.

Free Model Furnished Each Pupil

Practical Auto School, 68 M. Beaver St., N. Y. City



BE A BANKER

Learn a profession in a few months that will give you standing and independence the rest of your life. No matter where you live or what your occupation we will teach you by mail. No business or profession offers better opportunities. The work is pleasant, hours short, salary good. Endorsed by leading bankers. Very low cost, easy payments. **WRITE TODAY FOR CATALOG.**

AMERICAN SCHOOL OF BANKING, 139 McLene Bldg., Columbus, Ohio



Do You Like to Draw?

That's all we want to know
Now we will not give you any grand prize or a lot of free stuff if you answer this ad, or do we claim to make you rich in a week. But if you are anxious to develop your talent with a successful cartoonist, so you can make money, send a copy of this picture with 6c. in stamps for portfolio of cartoons and sample lesson plate, and let us explain.

THE W. L. EVANS SCHOOL OF CARTOONING
325 Kingmore Bldg. Cleveland, O.



FRENCH—GERMAN SPANISH—ITALIAN

Is Easily and Quickly Mastered by the

LANGUAGE PHONE

Combined with the
**Rosenthal Method of
Practical Linguistry**

This is the natural way to learn a foreign language. You hear the living voice of a native Professor pronounce each word and phrase. He speaks as you desire—slowly or quickly, night or day, for minutes or hours at a time. It is a pleasant, fascinating study; no tedious rules or memorizing. It is not expensive—all members of the family can use it. You simply practice during spare moments or at convenient times, and in a surprisingly short time you speak, read and understand a new language.

Send for Booklet and Terms for Easy Payment
THE LANGUAGE PHONE METHOD
946 Putnam Building, 2 West 45th Street, N. Y.

YOUNG MAN!



ENTER THE ELECTRICAL FIELD

Electrical men are the highest paid tradesmen in the world. Electrical Instrument and Meter work is one of the most important branches in the great electrical industry. Everywhere that electricity is used for heat, light and power, Instruments and Meters are used.

Every lighting company must have trained men—meter experts—to install, test, inspect and maintain the Instruments and Meters required for measuring the electricity consumed by its patrons.

POSITIONS PAY \$900-\$1800 A YEAR

The work is pleasant and healthful. Easily learned from our Complete Course. Advancement rapid and certain. Unlimited possibilities.

Our booklet, "Instruments and Meters," tells all about this fascinating and profitable work, and HOW WE ASSIST OUR GRADUATES. Write for it. It's FREE.

Fort Wayne Correspondence School,
610 Shoaff Bldg., Fort Wayne, Indiana.

"HELP WANTED"

—Uncle Sam.



Railway Mail Clerks
Clerks in the Departments at
Washington, D. C.
City Carriers—Postoffice Clerks
Examinations Announced Everywhere July 15
Over 15,000 positions will be filled
during 1912.

\$800⁰⁰ to \$1800⁰⁰ a Year for LIFE

No "layoffs" without pay, because of strikes, financial flurries or the whims of some petty boss. Excellent opportunities for quick advancement to Higher Government Positions. If you want immediate appointment, send TODAY for our schedule showing locations of the coming examinations. Any delay means the loss of just so much time in preparing yourself for examination.

SEND COUPON BELOW

FRANKLIN INSTITUTE
Dept. O 118, Rochester, N. Y.

The Coupon, filled out as directed, entitles the sender to a free copy of our book, "Government Positions and How to Obtain Them," Free Sample Questions, and to consideration for Free Coaching for the examination here checked.

COUPON

— Railway Mail Clerk	\$800 to \$1400	— Customs Positions	\$800 to \$1500
— Postoffice Clerk	\$600 to \$1200	— Internal Revenue	\$700 to \$1800
— Postoffice Carrier	\$600 to \$1200	— Stenographer	\$300 to \$1500
— Rural Mail Carrier	\$500 to \$800	— Clerk in the Depart-	ments at Washington
— Bookkeeper	\$900 to \$1800		\$800 to \$1500

Name C118
Address
Use this before you lose it. Write Plainly.

Stop Forgetting!



The Dickson Method of Memory Training Makes You "Forget Proof"

Ten minutes of your spare time, each day, will give you this training. Enables you to remember faces, names, facts, think on your feet and overcome self-consciousness. My course has transformed thousands of failures into successes. It will make you successful. Write for free booklet of facts.

How to get a FREE copy of this Valuable Book, "How To Speak in Public"

DeLuxe edition, exactly suited for needs of any one desiring to become a public speaker. Price, \$2. Write today and learn how to secure a free copy.

DR. HENRY DICKSON, Prin., Dickson Memory School, 929 Auditorium Bldg., Chicago

BE AN ENGRAVER

Learn at Home; Earn \$25 to \$50 weekly. We give personal instructions and furnish necessary tools Free. Terms reasonable. Complete particulars by mail.

CHICAGO ENGRAVING SCHOOL
Dept. 30, 110 West Chicago Ave. Chicago

I will send as long as they last my 25c. Book

STRONG ARMS

For 10c in stamps or Coin.



Illustrated with 20 full page halftone cuts, showing exercises that will quickly develop, beautify, and gain great strength, in your shoulders, arms, and hands, without any apparatus.

PROF. ANTHONY BARKER
1294 Barker Bldg. 110 West 42d Street, New York

ELECTRICITY

Complete in One Year

SCIENTIFIC ELECTRICITY
IN ALL ITS BRANCHES

Bliss Electrical School



Studies restricted to theoretical and practical electricity, mechanical drawing and necessary engineering work. Teaches simplicity, concentration, hard work. For young men of energy and character. 20 years of greatest success. Graduates hold first-class positions. Opens Sept. 25. Write for new catalog.

10 Takoma Ave., WASHINGTON, D. C.

LEARN WIRELESS-TELEGRAPHY



at my practical and superior school. Outlook in the Wireless field is excellent. Wages are good and the work pleasant, instructive and intensely interesting. My school is recognized by wireless, telegraph and railway officials as being the foremost one. Teachers are practical men with years of experience. This school owns and occupies exclusively two large, modern buildings with complete high power wireless station. Investment \$25,000.00. Oldest school in America—established 37 years. Morse or Wire Telegraphy and Railway Accounting also taught. Graduates assisted to positions. Living expenses low and may be earned while learning. Easy payments. Correspondence courses also.

Write today for free illustrated catalog and interesting testimonials

G. M. Dodge, Pres., Dodge's Telegraph, Railway and Wireless Institute, Erie St., Valparaiso, Ind.

For our Mutual Advantage mention Popular Electricity when writing to Advertisers.

BRAINY

Popular Educational Food Campaign

Striking Effects of Different Foods

NOTE. The New Brainy Diet System was originated by S. Leppel, the London dietitian, and is a science based on Dr. Bellows' standard work "The Philosophy of Eating."

YOU probably know something of the effects of different foods. For instance, an excess of starchy (paste making) foods produces sluggishness, dull, splitting headaches, lack of memory and concentration, drowsiness and inertia. A change to digestible brainy foods, such as suitable meats, dairy produce, fish and game will produce a marked improvement. An excess of viscid foods, such as eggs, cream, butter, cheese, etc., causes catarrh, which frequently results in deafness and other complaints. Irritating or foreign elements, such as table salt, soda water, and some other drug-store beverages, and certain elements of foods, cause kidney and bladder troubles. Some foods specially affect the liver or the heart or the lungs and skin, according to the nature of the food. Accumulated waste, deposits of foreign elements and poisons from wrong combinations of right foods cure. Diseases supposed to be incurable and to bear no relation to foods and some diseases uselessly treated by surgery have yielded to the new dietary treatment. I CAN TEACH YOU TO CURE YOURSELF.

One group of foods, such as lean tender fresh meat, game, poultry, fish, curdled custard, curd cheese, apples, lemons, tomatoes, cucumbers, rice, bread, etc., when rightly combined and proportioned, generates great vitality and magnetism. Another group, including game, poultry, whites of eggs, almonds, pears, asparagus, spinach, celery, etc., is productive of superior intelligence and psychic development. Another group is chiefly productive of strong nerves, moral strength, presence of mind, strong eyes, an even temper and the strong will power which underlies success.

Undesirable foods, such as pork pies, bacon, rich and spiced dishes, grocers' cheese, alcohol, coffee, etc., make one irritable, violent tempered and even immoral; and still others, such as tea and wrong quantities of fatty, starchy and sweet foods, make one nervous, shy and low spirited and lead to premature old age.

Whites of eggs are the elixir of life for the toothless and aged.

Dried peaches and dried apricots are suited to society ladies who wish to be attractive.

Juicy fresh fruit is far more suitable than stewed fruit for business people who interview their clients and wish to be persuasive.

Brilliance as a speaker or writer is secured by eating green grapes, provided that strong brainy meals have previously been taken.

Knowing something about these effects, would you not like to know all about the influence of foods in your own case and for your own ambitions? No subject is more important—none strikes home more closely to your own welfare, and the welfare of your family.

No technical terms, such as "proteids," "carbo-hydrates," etc., are used. No foods for sale. No fasting, exercising nor drugs are required. FULL NOURISHMENT IS ESSENTIAL.

To Increase or to Reduce Weight

Thin people after strengthening their nerves and digestive power by suitable brainy foods increase their weight by the proper use of cereal foods. Similarly in combination with a simple exercise women can develop the bust.

One chronic sufferer, weighing 415 pounds, unable to exercise, took correct combinations of ordinary daily foods and reduced over 150 pounds, gaining strength with firmness of flesh and losing rheumatism.

Eczema, other skin troubles, and all blood diseases yield to suitable diet.

A Few Opinions

"Your criticism of osteopathy, physical culture, Fletcherism and fasting, in Booklet No. 2, is enlightening. Your recipe in Booklet No. 3, for clear complexion, bright eyes and alert brain, is worth dollars to every one."

"Your little books eliminated chronic catarrh from my system in about three weeks. To put it weakly, I was astonished."

"My brain power and general efficiency have been doubled this year by selecting brainy foods. I have made a fortune in real estate and the credit is honestly yours."

"The government should investigate and teach the Brainy Diet System for the good of the nation."

Send ten cents for mailing. Send addresses of sick friends to—

G. H. BRINKLER, Food Expert, Dept. 19 F, Washington, D. C.

Memorize this address to give to friends in urgent need.

Wire BRINKLER, WASHINGTON, D. C.

DIET

For our Mutual Advantage mention Popular Electricity when writing to Advertisers.

GENERAL CLASSIFICATION OF FOODS

VITAL OR BRAINY



MUSCLE



STIMULATING



SOLVENTS



BLOOD PURIFIERS OR LAXATIVES



SWEET ELEMENTS



Four booklets which have taught many TO CURE themselves:

1. The New Brainy Diet
2. Diet versus Drugs
3. Effects of Foods
4. Key to Longevity

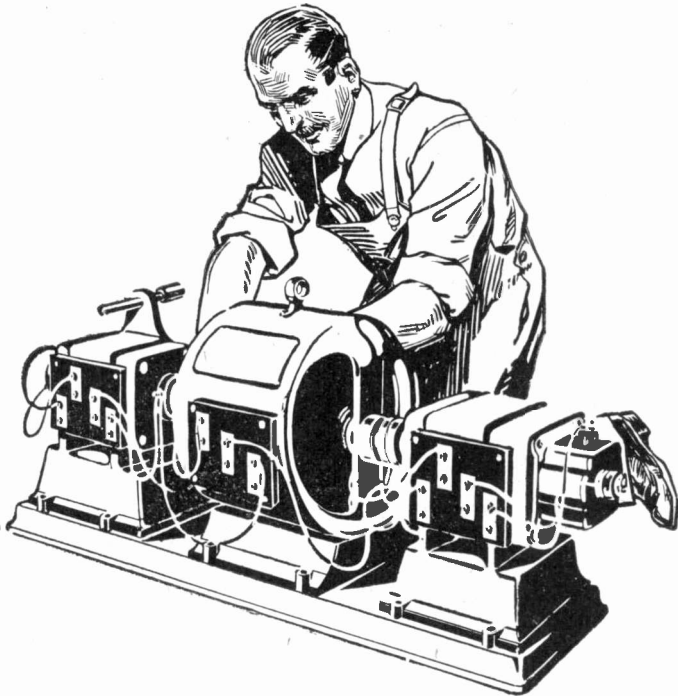

LEARN ELECTRICITY IN ALL ITS APPLIED BRANCHES

DON'T waste your time and money studying simply "wiring". You'll never get ahead in the Electrical field if "wiring" is all you know about Electricity.

We teach a complete course in the practical study of dynamos, motors, telephones, wireless telegraphy, storage battery and third rail systems, interior light and proper wiring, estimating and contracting, illumination, etc.

Here You Learn by Doing!

Our building is completely equipped with electrical apparatus and machinery. You get individual instruction from competent "know-how-to-do-it" teachers. No previous preparation or electrical knowledge necessary. You can start any time. You progress as fast as you are able. Day and night sessions.

Send this coupon for free illustrated catalogue that tells you all about this practical, small cost, "learn-by-doing" school.

The New York Electrical School
40 WEST 17TH STREET, NEW YORK

P. E.
6-12

**Free
Coupon**

**Geo. J. Cox,
President**

**The New York
Electrical School,
New York**

Kindly send me free booklet
telling all about this practical,
small cost of "Learn by Doing"
School.

Name

Address

CLASSIFIED ADVERTISEMENTS

The cost of advertising in this section is 5 cts. per word. All Discounts Will Be Discontinued After June 1st, 1912. Remittance must accompany order, or advertisement will not be inserted. Forms for the July issue close on June 1st.

234 Smith St., Winnipeg,
April 14th.

Popular Electricity:

Gentlemen—I consider your Classified Medium one of the best, particularly because of your large type and prominent headings. Besides, it reaches those persons who are directly interested in electricians and mechanics.

Yours respectfully,
JOHN DOUGAN.

AERONAUTICS

BUILD AN AEROGLIDER AND FLY, SIMPLEST, inexpensive, 22 feet wide. Designs, instructions, 50c. Aeroglider Co., Box 262, Grand Rapids, Mich.

COMPLETE EQUIPMENT FOR CONSTRUCTING Nieuport Monoplane, \$300.00 supplies at attractive prices. Herbert D. Doyle, 321 Lake Avenue, Rochester, N. Y.

HOW TO CONTROL AN AEROPLANE, price 50 cents. Used successfully by the largest schools. Worth its weight in gold. Aviators' Exchange, 58 W. Washington St., Chicago.

"THE FLYING SQUIRREL MONOPLANE," smallest successful model, flies by its own power. Complete, with motor, etc., 34c prepaid. Gearhart, Box 12, Fresno, Calif.

AGENTS WANTED.

CHOICE NEW OPPORTUNITIES FOR stamp. New Century Co., Enid, Okla.

WONDERFUL—SECRETS EXPOSED; BIG illustrated list for stamp. "Sentenn," P737 Ursulines St., New Orleans.

AGENTS, RARE OPPORTUNITY, WILL pay you to investigate. Address Ezra B. Landis, Waynesboro, Pa.

AGENTS—\$20 WEEKLY; COMBINATION key-ring. Seven tools in one. Lightning seller. Sample 10c. Arthur Beers, Bradley Beach, N. J.

AGENTS, STREETMEN; "STICKALL" mending cement costs 5c, sells 25c. Occidental Supply Co., Seattle, Wash.

AGENTS, WHEN YOU GET THROUGH handling cheap propositions and want something right in Vacuum Cleaners, write Jaeger Bros. Mfg. Co., 1106 Heyworth Bldg., Chicago.

AGENTS—EMBOSSER GOLD AND SILVER sign letters. Immensely profitable. Samples free. Knight Letter Co., 2548 Milwaukee Ave., Chicago.

500 PER CENT PROFIT WITH OUR POST-card camera; small investment, circulars free. International Metal and Ferro. Co., Dept. P, Chicago, Ill.

AGENTS WANTED

SEE WHAT WE SAY UNDER AUTOMOBILES. The Union Motor Sales.

DON'T ACCEPT AN AGENCY UNTIL YOU get my samples and particulars. Money makers. Address SAYMAN, 706 Sayman Bldg., St. Louis, Mo.

AGENTS CAN MAKE 1,000 PER CENT profit selling our new gold letters for window signs. Easily applied. Samples free. Thomas Letter Co., 2533 Milwaukee Ave., Chicago.

ALUMINUM SOLDERING FLUX—USE ORDINARY solder, 2-ounce can, 25c. Guaranteed to solder. Agents wanted. L. L. Bain Co., Villa Heights, Norfolk, Va.

SIGN PAINTING AGENTS—1,000 PER CENT profit. Best and cheapest window letters made. Mounted sample free. Success positively guaranteed. Goodwin Letter Co., 2468 Milwaukee Ave., Chicago.

AGENTS, PORTRAITS 35c, FRAMES 15c. Sheet Pictures 1c. Stereoscopes 25c. Views 1c. 30 days' credit. Samples and catalogue free. Consolidated Portrait Co., Dept. 1406, 1027 W. Adams St., Chicago.

AGENTS AND MAIL ORDER MEN; INTRODUCE our aluminum antiseptic telephone mouthpiece; 667 per cent profit; exclusive territory; send 18 cents for sample; Niagara Stamping and Aluminum Company, Buffalo, N. Y.

SOLICITORS—SECURE TERRITORY FOR most beautiful pictorial monthly ever published. You can earn \$10 every day. "International Fair Illustrated," 1915, 441 Pacific Bldg., San Francisco.

AGENTS MAKE BIG MONEY SELLING our new window letters for office and store windows, glass signs, etc. Write today for free samples and particulars. Reliable Letter Co., 2598 Milwaukee Ave., Chicago.

A BIG POWERFUL "MOGUL" CHEMICAL fire extinguisher (mounted on wheels) gives absolute fire protection. Hustling agents make \$30 to \$50 weekly. Write Mogul Fire Extinguisher Co., Dept. 4, Cincinnati, Ohio.

AGENTS—50C WORTH OF GUARANTEED sign letters gives you \$5 profit. Instantly put up by anyone, with kerosene and roller. Samples free. Success guaranteed or money back. Embossed Letter Co., 2551 Milwaukee Ave., Chicago.

AGENTS—OUR GUARANTEED SIGN LETTERS cost you 2c, sell for 25c. Instantly put on by anyone, with kerosene and roller. Samples free. Success or money back. Boss Letter Co., 2588 Milwaukee Ave., Chicago.

SALESMEN WANTED EVERYWHERE FOR new office specialty. Duplicate orders every month. Chance of a life time for a live wire. Best office seller. You can work sub-agents. A. Lowell Mfg. Co., 258 E. Broadway, New York City.

SIGN LETTER AGENTS—PAINTERS—Something new and better. Attracto Gold or Silver letters. 21 different kinds. Anyone can apply them. Make big money lettering store windows and selling our sparkling, flashing, ready-made chipped glass name plates and signs. 1912 catalogue and sample letter free. Attracto Sign Co., 2649 North Clark St., Chicago.

AGENTS WANTED

SEE WHAT I SAY UNDER "TYPE-writers." ATCHISON.

MAKE BIG MONEY SELLING ONLY PRACTICAL fruit strainer and fried food turner known. Rapid sellers; exclusive territory. C. L. Armstrong, Springfield, O.

AGENTS CAN MAKE QUICK SALES AND big money handling our line of newly patented Electric Heating Appliances. Presto Electrical Mfg. Co., 325 Geary St., San Francisco.

AGENTS—MY POCKET STEEL-DIE HAND embosser does perfect work; initial 30c, monogram 75c; booklet for stamp. Box 462 (C), Greenfield, Mass.

ESTABLISH PERMANENT BUSINESS! WE import fast-selling oriental staples and novelties exclusively for agency trade. Enormous profits. Never before advertised. Joseph Kanematz, Box 529, Portland, Ore.

YOU CAN MAKE \$\$\$\$ AS OUR GENERAL or local agent. Household necessity; saves 80 per cent. Permanent business; big profits; exclusive territory; free sample. Pitkin & Company, 96 Pitkin Block, Newark, N. Y.

WE MAKE GAS PIPE STRAPS AS "BY-Product." Prices very attractive. Easy selling for agents. Pocket samples. Write for commission proposition. Peck-Hamre Mfg. Co., Berlin, Wis.

BOKARA DIAMONDS—AGENTS, EVERYONE wanted to wear and sell these famous gems. Big profits. Samples, offer and catalogue free. Northwestern Jewelry Co., 1123 Wilson Avenue, Chicago.

AGENTS—BOTH SEXES. EXPERIENCE unnecessary. 400 per cent profit. Gliding casters; new; 3c set. Save floors, carpets. Sell thousands 10c set. Child can attach. Samples 4c. Evergrip Co., Dept. 110, 22 Warren St., New York.

AGENTS WANTED—ELECTRICIANS AND shopmen make over \$100.00 a month in spare time selling Transparent Handled Novelty Knives and Razors. Big profits. Sales easily made. Write for terms to-day. Novelty Cutlery Co., 27 Bar St., Canton, Ohio.

ACTIVE SALESMEN EASILY MAKE \$300 monthly selling our perfect dry Chemical Fire Extinguisher; 500 per cent profit; buyers everywhere; exclusive territory assigned; District Managers Wanted. United Mfg. Co., 1135 Jefferson, Toledo, O.

AGENTS—SELL OUR 3 NEWLY PATENTED articles, each a necessity and money saver. Automatic and lasting. Sell on sight. Repeat orders. Big profits. Not sold in stores. Get our new selling plan. National Lighter Company, 110 W. 34th, New York.

AGENTS—TO SELL THE NEWEST ELECTRIC appliance on the market; sold everywhere there is electricity, in the home and office; liberal profit; sales-driving sample, weighs a pound, no experience or knowledge of electricity required; it shows how to use one light instead of two and get the same results; sells for \$3.50 and saves the purchaser an investment of \$25; write for particulars. The Handy Light Co., 723 E. Eighth Ave., Cincinnati, Ohio.

AGENTS WANTED

QUALIFIED MEN AND WOMEN, HIGH grade educational specialty, travel in south during winter, work backed by twenty-five years' success. Write today. Lewis E. Myers, Chautauqua Park, Valparaiso, Ind.

BE INDEPENDENT! START A MAIL order business in your own home. We tell you how and furnish everything needed wholesale. An honorable and profitable business for man or woman. Particulars free. Many make \$3,000 a year. Murphy Mfg. Co., South Norwalk, Conn.

AGENTS MAKE BIG MONEY SELLING our new gold letters for office windows, store fronts and glass signs. Anyone can put them on. Write today for a free sample and full particulars. Metallic Sign Letter Co., 400 N. Clark St. Chicago, Ill.

MANUFACTURER OF NEW, EXCLUSIVE linen heel and toe guaranteed hosiery, wants agent in every county. Sales enormous. Re-orders insure permanent, increasing income. Exclusive territory. Credit. Parker Mills, 707 Chestnut St., Philadelphia, Pa.

AGENTS WANTED—SELL RICH LOOKING imported 36 x 68 rugs, \$1 each. R. H. Carter, Milan, Tenn., sold 115 in four days; his profits, \$57. You can do as well. Write for sample offer and unique selling plan; exclusive territory. R. Condon, Rug Importer, Stonington, Maine.

LIVE AGENTS WANTED—HUSTLERS TO handle our attractive 1912 combination packages of soap and toilet articles with valuable premiums. One Michigan agent made \$65 in 47 hrs., another \$21 in 8 hrs., another \$22.50 in 10 hrs. Write today. Davis Soap Works, 263 Davis Building, Chicago.

AGENTS WANTED TO SELL "RUSE Klean," the only article on the market that will remove corrode from electrical fixtures, and guaranteed to positively remove rust and corrode from metals of every description. Big profits. Write Corey Specialty Co., Dept. "C," 1332 Spring Garden St., Philadelphia, Pa.

LOCAL REPRESENTATIVE WANTED IN each town to sell our underwear, hosiery, neckties and sweaters direct to wearer on commission. Profitable opportunity with permanent future because every article is guaranteed satisfactory or money refunded. Write for spring and summer catalogue. Steadfast Mills, 36 Courtland St., Cohoes, N. Y.

WE MANUFACTURE GLASS PAPER. Plain glass windows made to look like real stained glass. Easily applied and beautifies the home. Something new for agents. Two sheets of this glass paper sent as a sample with catalogue in colors and complete instructions on receipt of 10c. S. H. Parrish & Co., 202 S. Clark St., Chicago.

BIG MONEY IN SELLING USED AUTOMOBILES. No business so easy to learn, so profitable, so congenial. On \$50 to \$200 investment our agents make \$50 to \$100 per week. We furnish the cars and teach you how to drive, sell and repair them. Write today for particulars and territory. The Automobile and Cycle Company of America, Dept. 2, 1769-1787 Broadway, New York City.

AGENTS WANTED

AGENTS — WONDERFUL OPPORTUNITY; act quick, sell "Ambrew" Concentrated Beer Extracts; makes real genuine beer right at home by adding water; saves 100 per cent brewers' price; not near beer, not substitute, but real lager beer; no liquor license required; small package; carry week's supply, deliver as you sell. "Ambrew" is the concentrated ingredients of real lager beer; same material used by all brewers for brewing the best beer; big seller; enormous demand; large profits. Just send postal, we'll show you how to make money quick. American Products Co., Dept. 2804, Cincinnati, O.

AUTOMOBILES

AGENTS WANTED TO SELL NEW AND slightly used automobiles and motorcycles. Send stamp for circular. Eureka Auto Co., Beavertown, Pa.

FORD 1910 TOURING, COMPLETELY AND elegantly equipped, good as new, must sell, \$300. Kokesch, 2537 Belmont Ave., Bronx, New York City.

FORD 4 CYLINDER RUNABOUT TOP, wind shield, three oil, two gas lamps, excellent condition, \$200. Wilson, 2230 Seventh Ave., New York City.

WHITE STEAMER, 30 H. P., MODEL "G," luxurious seven-passenger touring. Elegantly and completely equipped. Cost \$4,700; sell \$375. Suite No. 337, Thoroughfare Building, 972 Eighth Ave., New York City.

FORD SIX-CYLINDER TOURING — 40 horsepower. Everything perfect. Cost nearly \$3,000. Finely equipped. Sell first offer \$400. H. W. S., 17 Washington St., East Orange, New Jersey.

FORD 3-PASSENGER LIGHT ROADSTER, Model "S," 4-cylinder. Expensively equipped, top, windshield, magneto, clock, five lamps, has everything. Like new. \$225. Shonnard, 114 Fifth Ave., New York City.

BRAND NEW 1912 AUTOMOBILES—ANY make, any model, fully guaranteed, \$50 to \$500, less than regular prices. State make wanted. Referenced agent wanted every town. Owners, get our selling-cost-eliminated prices tires and accessories. The Union Motor Sales Co., 2127 CPA, Dayton, Ohio.

A. C. C. A. PRICES TALK! SPRING SALE is on! Hundreds of runabouts, racy roadsters, five and seven-passenger touring cars, elegantly and completely equipped! Guaranteed five years! Freight prepaid! We offer 29 runabouts, formerly cost \$500 to \$1,000, now \$50 up; 18 roadsters, three and four-passenger, formerly cost \$1,000 to \$2,000, now \$175 up; 36 touring cars, five, six and seven-passenger, formerly cost \$1,500 to \$5,000, now \$200 up! All best American and foreign makes, such as Packards, Pierce Arrows, Stevens, Wintons, Stoddard Dayton, Peerless, Stearns, Pope Hartfords, Locomobiles, White, Renaults, Buicks, Maxwells, Fords, etc., etc. Write today for our illustrated Catalog, the largest and most complete list of its kind ever published! The Automobile and Cycle Company of America, Dept. F. P., 1769-1787 Broadway, New York City.

AUTOMOBILES

AUTOMOBILE TIRE BARGAINS — OLD tires taken in exchange. Tire Trading Co., Newark, N. J.

AUTOMOBILES—SAVE DEALERS' PROFITS, buy your car direct from owners. I have all makes on my lists. A few specials for Runabouts. Oldsmobiles, \$45. Reos, \$60. Cadillacs, \$75. Maxwells, \$135. Fords, \$150. Touring Cars, Cadillacs, \$90. Reos, \$150. Buicks, \$175. Fords, \$300. Ford six cylinder, \$375. Wintons, \$275. Pope Toledos, \$300. Send for my latest lists, it means dollars to you. I guarantee a saving to you of 5 per cent on any car offered by any dealer. P. E. King (Automobile Broker), 217 W. 125th St., New York City.

BOOKS AND PERIODICALS

BOOK 200 (SUCCESSFUL) FORMULAS, 12c. Publisher, 49 Clinton St., Albany, N. Y.

NEW BOOK, "JANE," 10c; CATALOGUE of books and den pictures free. Bond Pub. Co., S-3, Columbus, Ohio.

BOOKS ON DICE, CARDS, SLOT MA- chines, etc. Hammond B. Co., Box 1671, Hammond, Ind.

"SCIENCE OF SUCCESS," 120 PAGES, 25c. Satisfaction guaranteed. Book catalog free. Science Elec Institute, Englewood, Chicago.

RACY BOOKS, CATALOGUE, AND 5 CLAS- sy photos 10c. National Nov. Co., 421A East 77th St., New York.

BOOKS—FASCINATING BOOKS! SEND 2c stamp. Paul James Duff, 2713 Mozart St., Chicago.

STEEL TEMPERING BOOK FOR MECHAN- ics and Mechanical Digest one year, special offer, 25c, Mechanical Digest, Grand Rapids, Mich.

THREE LITTLE BOOKS FOR LADIES, postpaid, in plain cover, for 25c. (Tell what you want to know.) O. K. Pub. Co., Decatur, Ill.

\$5 WILL FURNISH ALL BOOKS AND THOR- oughly teach you bookkeeping in 3 weeks or refund your money. C. E. Enkelmann, 164 Belmont Ave., Springfield, Mass.

HAVE YOU READ "HOW TO SUCCEED"? It is the greatest satire ever written on the get-rich-quick craze. 15c postpaid. A. Ruhnau, Dept. 40, 280 Columbus Ave., New York.

WONDERFUL BOOK ON HYPNOTISM, PER- sonal magnetism, magnetic healing and occult science sent free to anyone. Send your address today. M. D. Betts, Sta. 161, Jackson, Mich.

TELEPHONE TROUBLES AND HOW TO find them. New 15th (1912) edition. Phantom circuits and diagrams how to install. Price, 25c. Hyde Publishing Co., Telephone Bldg., 183 5th St., Milwaukee, Wis.

THE PROGRESSIVE MACHINISTS MAN- ual. Vest pocket ready reference of most needed Rules and Tables, also valuable General and Economic information. List of representative shops throughout the country. 16 Colored Maps. Blank Memoranda, etc. 120 pages, size 5¼ x 2¾. Leather finished covers. Price 35c. Circular on request. Wm. Cuthbertson, 39 N. Springside Ave., Pittsfield, Mass.

BOOKS AND PERIODICALS

NINE DEGREE COURSE IN HYPNOTISM—sold originally for \$5—sent prepaid with year's subscription to *Wheel of Life*, the great "Cheer Up" monthly, for 25c. Life Pub. Co., St. Louis.

BOOKS—I. C. S. AND A. S. C. TECHNICAL books of all sorts—shopwork, electrical, mechanical, wireless, encyclopedias, dictionaries, medical, law, and standard fiction. New and second-hand. Get my prices. Geo. F. Williams, Box 408, New Orleans, La.

MY TREATISE, ILLUSTRATED, ON deafness and head noises, explains how complete, lasting relief may be effected without drugs or batteries. Experience 32 years. Book sent free by author. Geo. E. Coutant, M. D., 97B, Sta. E., New York, N. Y.

JUST OFF THE PRESS—"PRACTICAL APPLIED Electricity," by David P. Moreton. A book written for practical electrical workers and presented in a practical manner in plain English. Unusually complete, containing 450 pages and 300 illustrations. Price, \$2.00. Send for complete description. Popular Electricity Book Department.

STANDARD BUSINESS BOOKS LOANED by mail, for return or purchase at option. Advice on short reading courses free. Personal training; salesmanship; advertising; bookkeeping; banking; investments; choosing a career; system and efficiency; agriculture; popular law; business letter writing; speakers' and writers' books, etc. Also, health; house and home; public questions; occultism; science; religion. Ask for lists and Library Critic, and state subjects in which interested. Oriental Esoteric Library, 220, Washington, D. C.

BUSINESS OPPORTUNITIES

LARGE PROFITS. NEW NOVELTY. MOISTENER Sealer Mfg. Co., Spokane, Wash.

MAKE BIG PROFITS MAKING COLD cream. 25c tells how. Reliance Supply Co., Taunton, Mass.

SQUABS—BIG PROFITS RAISING SQUABS. Work easy—expense light. Free booklet. Walnut Grove Squab Farm, Hoopeston, Ill.

PATENTS BRING WEALTH; PROOF ON request; \$58,000 offered for an idea; advice free; highest references. Alexander Wedderburn, Patent Attorney, Department 43, Washington, D. C.

FORM A CORPORATION—CONGRESS LAW for D. C. and all States; cheap. Raise money easily. U. S. Legal Corporation, Washington, D. C. Representing \$1,225,000,000.

LOOKING FOR MONEY MAKERS? OVER 100 chances made plain; all ages; male or female; dime today brings complete collection; worth dollars. Wm. Waelder, Hannibal, Mo.

WE HELP RAISE CAPITAL AT ONCE TO start you in retail—manufacturing—patent—real estate—mail order or any legitimate business by means of "Our Practical Method." Particulars free. The Business Aid Co., K 508, Detroit, Mich.

NEW BUSINESS PLAN ACTUALLY NETTING \$300 to \$700 monthly. No scheme, no canvassing. Money back if not as represented. Full plans for Dollar Bill. "ADMAN," 1816 College Ave., Spokane, Wash.

BUSINESS OPPORTUNITIES

SEE WHAT I SAY UNDER "TYPEWRITERS." ATCHISON.

BE INDEPENDENT; START MONEY-MAKING mail order business at home; new plans; everything furnished; only small capital required; free booklet and particulars tell how. W. E. Miller Co., Box 254, Muskegon, Mich.

AGENTS, SELL TO SALOONS—MACHINE sold like whirlwind last season. 100 per cent profit. Free sample and course in salesmanship. Only two sales a day means \$15 a day for you. It's easy. Write. Simplex Mfg. Co., Dept. 6, Kewanee, Ill.

YOU CAN MAKE SIX DOLLARS A DAY with only a small capital invested. Write for our descriptive circular of the free gift proposition for agents, don't pass this opportunity; you cannot lose. Multiscope & Film Company, 423 Jefferson St., Burlington, Wis.

I WILL POSITIVELY SECURE THE POSITION you desire, or show you how to start a profitable mail order business, quickly, inexpensively and sensibly. Not a get-rich-quick scheme, but good common sense business. Address, Expert, Home Bank Bldg., Baltimore, Md.

WOULD YOU LIKE TO OWN A GOOD PAYING mail order business? We have a line that gets the orders every time. You can start in spare time, invest a dollar or two a week and soon own a nice business of your own. Write for particulars. Antiseptic Mfg. Co., 1872 Barry Ave., Chicago.

WE START YOU IN BUSINESS, FURNISHING everything; men and women, \$30.00 to \$200.00 weekly operating our original "New System Specialty Candy and Popcorn Crispette Factories"; home or small room anywhere. Opportunity lifetime; booklet free. H. Ragsdale Co., East Orange, N. J.

BIG DEMAND FOR SKILLED MOTION PICTURE operators. The "Motion Picture Handbook" by F. H. Richardson will equip you with a complete knowledge of perfect motion picture projection and enable you to command high wages. Price \$1.50 postpaid. Absolutely the best handbook of its kind. Money refunded if not satisfactory. Popular Electricity Book Department, 54 W. Lake St., Chicago, Ill.

GET INTO ELECTRICAL WORK AND make money. Our booklet "Eighteen Ways to Make Money and Advance Yourself in the Electrical Field" is written from actual experiences of winners and may suggest a line of work that you are in a position to act upon and make yourself financially independent. Send stamp for a copy today. Popular Electricity Publishing Co., 54 W. Lake St., Chicago, Ill.

EARN \$10 to \$15 A WEEK AND HOLD your position besides; no canvassing. We, as manufacturers of patented just-in season specialties, have new easy mail order plans to keep factories busy. We furnish everything. Large profits. Small capital. Experience unnecessary. If you are one of the want-to-go-ahead kind, write for our most modern (copyrighted) plans. Sworn statement. J. M. Pease Mfg. Co., 550 Pease Bldg., Michigan St., Buffalo, N. Y.

BUSINESS OPPORTUNITIES

PATENTS ON SALEABLE ABRASIVE wheels and cloth. Manufacturers, it will pay you to investigate. For full particulars address Ezra B. Landis, Waynesboro, Pa.

BOOM YOUR BUSINESS BY HAVING A Chicago office also. Our mail service system makes it very easy and inexpensive; fully explained for stamp. Model Service System, Morton Bldg., Chicago, Ill.

MAIL ORDER MEN—GRAND NEW LINE. Established demand for goods; big profits; quick sales; completest mail order line; no stock to carry; printed matter furnished. Antiseptic Mfg. Co., 1873 Barry Ave., Chicago.

\$1,000 YEARLY PROFIT FROM YOUR BACK yard. Complete plan (170 pages illustrated) and a profitable mail-order proposition, \$2. Free for six stamped envelopes addressed to electricians and 10c. Particulars free. Science Elec Institute, Englewood, Chicago.

MAKE MIRRORS AT HOME. BIG PROFITS with little outlay. One 18x36 in. mirror costs \$2.00 to \$5.00. You can silver a glass this size for 20c. Send \$1.00 in stamps or money order and we will send you **EXPLICIT DIRECTIONS** how to do it; also how to emboss, grind, foil, gold leaf, frost chip and make imitation stained glass. How to transfer photos on glass, bore holes in glass and cut skylights. George L. Paterson & Co., Dept. 4, Brooksville, Ky.

I WON'T PROMISE TO MAKE YOU INDEPENDENTLY rich for two hours' work, but I have a proposition which will enable you to add a substantial amount to your income each month if you are willing to devote a few hours a week to representing Popular Electricity Magazine. The work is easy, congenial and any one with common sense and pluck can make good. If you want particulars of a good thing send 2c stamp for "Salary Plan." Address Circulation Manager, 400 Commercial Bldg., Chicago.

ANY AMBITIOUS MAN CAN ADD SEVERAL dollars a week to his income with a good mail order specialty as a side line, and a business of many thousand dollars can be built up if you start right. Start with a good side line and work up. We offer an exceptional opportunity to handle a high profit article requiring extremely small investment. We require representatives to handle the retail sales by mail and will make unusually liberal arrangement to secure your co-operation; we furnish high grade advertising matter, and coach you fully. Write today for free explanation. The Queen Trading Co., Flushing, N. Y.

COINS AND STAMPS

STAMPS—105 CHINA, ETC., STAMP DICTIONARY and list, 2c. Bullard Co., Sta., A, Boston.
DANDY PACKET—100 DIFFERENT STAMPS 5c. 50 per cent approvals. "Hawkins," Raton, N. M.

205 DIFFERENT FOREIGN STAMPS FREE by remitting 25c, six months subscription MacKeel's Weekly Stamp News, Boston, Mass.

STAMPS, 100 ALL DIFFERENT, FREE. Postage 2c. Mention paper. Quaker Stamp Co., Toledo, Ohio.

COINS AND STAMPS

24 VARIETIES CUBAN STAMPS, 10 CENTS. List of 6,000 low priced stamps free. Chambers Stamp Co., 111 H. Nassau St., New York city.

OLD COINS BOUGHT AND SOLD—BUYING Catalogue 10 cents. New 55-page 1912 Selling Catalogue to collectors only, "Free." William Hesslein, Malley Bldg., New Haven, Conn.

\$3.00 PAID FOR THE RARE CENT OF 1856; \$25.00 for the rare silver dollar of 1858. Keep money dated before 1890, and send 10 cents for new coin value book. A. H. Kraus, 278 Kraus Bldg., Milwaukee, Wis.

FREE! 100 FOREIGN STAMPS, SEND 4C postage, mention Gift C. 218. Just out, "A. B. C." illustrated, priced Catalogue of World's Stamps for 1912, 863 pp. (U. S. fully illustrated), 70c, post free. Bright & Son, 164 Strand, London, Eng.

STAMPS BOUGHT—U. S. POSTAGE (1847-1872), Departments (Justice, etc.), Postal Savings, British North American and West Indian. Single stamps, collections or barrels. Enclose return postage with samples for prices paid. A. W. Dunning, Newton, Mass.

FOR SALE

A DAYDARK POST CARD MACHINE; complete outfit. J. H. Reed, Greenville, W. Va.

FOR SALE—U. S. PATENT NO. 986289, FOR door and sash holding means. Rion Hoel, 444 Hubbard, Detroit, Mich.

WORN-OUT DRY BATTERIES MADE BETTER than new for about 3c each; 15c for receipt. Willamae, Grampian, Pa.

LATHE FOR SALE, SCREW-CUTTING, foot power, size 9 ins. x 25 ins. only \$45.00. Never used. Paul J. Hayes, East Union, St. Louis, Mo.

ELECTRIC TATTOOING MACHINES, NEEDLES, colors, designs and stencils. Price list free. EDWIN E. BROWN, 805 E. WASHINGTON ST., Springfield, Ill.

VACUUM CLEANING STATIONARY plants for houses. High efficiency. Parts for plants and cleaner wagons wholesale. Koch Vacuum Machine Co., Ann Arbor, Mich.

A SUPERIOR INK POWDER PRODUCES 40 cts. worth of blue-black writing ink, when dissolved in water. Sent postpaid on receipt of dime. A. J. Dehon, 901 Townsend St., Syracuse, N. Y.

EXPERIMENTERS—BRASS, PER FOOT, 1/2 square, 12 1/2c; 1/4 square, 8c; 1/8 square, 25c; spring brass 4 1/2 wide, 20c. Tubing, copper, aluminum. Write for price list. Swain-Heiser Co., Hamilton, Ohio.

EDISON ROTARY MIMEOGRAPH, NO. 75, as good as new. Cost \$35.00. Duplicates type-writing perfectly and rapidly. Price \$15.00. Also, first-class Caligraph Typewriter, \$10.00. H. E. Cassino, Peabody, Mass.

\$5.00 BUYS OUR IMPORTED RAZOR. Warranted the easiest shaving razor on the market. As a special inducement will include a pair of specially prepared Barber Stropps, with full instructions as to their care and use. M. L. Kant, 2 Maiden Lane, Torrington, Conn.

FOR SALE

PONIES. MANY BREEDS STOCK. DOGS. Catalog. Beachhurst, Shelbyville, Ky.

FOR SALE. ONE 20 KILOWATT AND ONE 30 kilowatt 220 volt dynamos or motors. Good order, low prices. Sell them for us and get liberal commission. A. B. Co., 1134 Fulton St., Chicago.

GASOLINE AGE. ELECTRIC DRY CELL No. 6 igniters. Peerless formula. Written demonstration and exclusive territory to manufacturers guaranteed, \$25. J. Dougan, 234 Smith St., Winnipeg, Canada.

AMMETERS 1,000 WATCH SIZE NICKEL plated guaranteed. Battery testers in chamois leather cases. Read 0-30 amperes, 25c postpaid. Stamps taken. Auto Repair Co., 521-23 West 144th Street, New York.

SPLENDID WHITE STEAMER, MUST SELL, \$185.00, lately overhauled, five good tires, speedometer, extra. Runs beautifully. Exchange for Model T. Ford runabout. Columbia Poultry Yards, Toms River, N. J.

WILL SELL OR TAKE PARTNER TO PUT on the market an automatic street car indicator just issued. Can be used on street, elevated or subway cars. Will beat the Bell Telephone. A world future. U. S. Patent, 1,013,485. Robert Ekron, 110 S. Hoyne Ave., Chicago.

SOMETHING NEW—TO ADVERTISE OUR mineral collections, curios, etc., we will sell our regular \$2.50 Genuine Nugget Stick Pins at \$1.00 each for a limited time. They are sure beauties and will last a lifetime. Just the thing for gifts. Order now. Western Supply Co., Silverton, Colo.

TATTOOING—IMPROVED ELECTRIC TAT- tooing machines, \$2.50 each. Sold with a guarantee. Cheapest and best line of tattooing supplies on the market. Send 15c for 6 beautiful hand colored tattoo designs. Write now for free price list. F. Barber, 1019 Vine St., Cincinnati, Ohio.

FORMULAS

ANY FORMULA YOU WANT, 25c. ROBERT C. Fink, Kane, Pa.

FORMULAS — SIX MONEY-MAKERS, \$1. Warren Stewart, Hope, Ind.

ANY FORMULA YOU WANT 20c. SCIENTIFIC Book Shop, Box 311, Syracuse, N. Y.

FORMULAS AND RECEIPTS FOR ANY- thing—25c each. E. B. Stauffer, Ephrata, Pa.

ONE, ONE-SIXTH (1/6) H. P. 110 VOLT, D. C. motor, good condition. N. A. Johnson, 325 S. Olive, Newton, Iowa.

“BLACOLA”—SHOE AND STOVE POL- ishes. Make them yourself. Save money. Both formulas, 10c. Madrian, 66 Sumner Ave., Brooklyn, N. Y.

FOR GOODNESS SAKE GRAB IT. NEARLY 400 formulas sent postpaid for 20c. Absolute satisfaction. Send at once to Johnson & Co., Box 231, Phoenix, Ariz.

SEE THIS FORMULA FOR REVIVING dead cells, silvering mirrors, soldering flux; satisfaction guaranteed; choice 25c. Harrison Mfg. Co., 1037 Knight St., Seattle, Wash.

GAMES AND AMUSEMENTS

AMUSEMENT AND PROFIT IN JOKERS' novelties and puzzles. Circular free. Novelty Supply House, Gibson City, Ill.

PLAYS, VAUDEVILLE SKETCHES, MON- ologues, dialogues, speakers' minstrel material, jokes, recitations, tableaux, drills, musical pieces, entertainments, makeup goods. Large catalog free. T. S. Denison & Company, Dept. 26, Chicago.

INSTRUCTION

LEARN VENTRILOQUISM AT HOME. PAR- ticulars for stamps. M. Bailey, Box 253, St. Paul, Minn.

LINOTYPE INSTRUCTION; twelve weeks, \$80; thirty weeks, \$150. Empire School, 419 First Ave., New York.

MAKE YOUR OWN SPARK-COILS, IN- structions and drawings, 20c. Nomus Electric Co., 1216 48th Ave., Cicero, Ill.

FULL INSTRUCTIONS FOR DIP-PLATING knives, forks, spoons, etc., 25c stamps. Rogers Metal Works, Kansas City, Mo.

MAKE MONEY RENEWING OLD DRY BAT- teries. Complete instructions, 25c. Guaranteed. Clark, 2030 Arch, Philadelphia.

GINSENG, \$35,000 PER ACRE. SEND 10 cents for my Ginseng Culture, giving information. W. N. Long, Florence, Ky.

INCREASE YOUR KNOWLEDGE OF ELEC- tricity. Send for our illustrated catalog of electrical book. It's free. Popular Electricity Book Department.

LEARN SIGN WRITING! MAKE BIG IN- come—\$25 to \$50 weekly. \$30 course NOW \$5. Folders FREE. Address G. F. Cook, PE785 White St., Dubuque, Ia.

LEARN SHOW CARD WRITING—BIG DE- mand; talent unnecessary; \$30.00 course of instruction now \$5.00. Send today for particulars. Dellfield Co., Box 268, San Fernando, Cal.

WE WILL SEND BLUE PRINT AND 2,200- word description on how to build and operate an incubator. Costs less than \$1.00 to build. Sent for 35c coin. R. T. Kalb, 2631 Sutton Ave., Maplewood, Mo.

SINGING LESSONS BY MAIL. LEARN “how to produce rich, pure tones.” Four lessons mailed on receipt of \$1.00. P. J. McCarthy, Voice teacher, St. Johns, Newfoundland, says, “Easily the best I have seen on paper.” A. Francke, Voice Builder, 512 Kimball Hall, Dept. “O,” Chicago, Ill.

MAGIC

LATEST CARD MIRACLE, “PYSCHOTE- tism,” 25c. Stanley Strauss, 5225 Lexington Ave., Chicago, Ill.

LEARN TO HYPNOTIZE AND MAKE FUN and money. Send for free book to M. D. Betts, Sta. 161, Jackson, Mich.

FREE MAGIC CATALOGUE, 208 PAGES, 800 tricks, 350 illustrations. Send 6c stamps for particulars and sample pocket trick. Magic Co., Dept. 17, W. 39th St., New York.

MISCELLANEOUS

SEE WHAT I SAY UNDER "TYPE-writers." ATCHISON.

YOUR 25-WORD AD. IN 100 MAGAZINES \$1. G. F. Cook, P. E., 785 White St., Dubuque, Ia.

TO SELL YOUR PROPERTY, WRITE Northwestern Business Agency, Minneapolis.

CANADIAN REVENUES, CATALOGUE value 70 cents, for 12 cents. Mrs. Oughtred, 28 Lincoln Avenue, Montreal, Que.

\$10.00 EACH FOR NAMES OF PERSONS INTERESTED IN PATENTS. For conditions, address P. O. Box 2343, Washington, D. C.

PUBLISH A MAGAZINE—COST, SMALL; profit, large. Plan and sample, 5c. Magic Syndicate, Big Flats, N. Y.

DE-ELIGHTED YOU'LL CERTAINLY BE when your lips touch the Kid (folding) Pipe, 25c. Helwig, 49½ Clinton St., Albany, N. Y.

START A MAGAZINE OF YOUR OWN AND an advertising agency too, on a capital of \$1. Particulars and sample magazine, 5c. Life Pub. Co., Desk P., St. Louis, Mo.

AMERICANA—GENUINE JEFFERSON DAVIS ballots. Limited supply. One dollar postpaid. A. W. Dunning, Newton, Mass.

INVENTORS, WE MAKE MODELS EITHER electrical or mechanical. Good work and low prices. Ludlow Model and Electric Works, Ludlow, Ky.

BOYS MAKE \$1.75 A DAY VACATION money with my specialty. Sample and full particulars twenty cents. C. R. Hewitt, 305 W. 30th St., Indianapolis, Ind.

ANYBODY CAN MAKE GOOD CUTS WITH my simple zinc etching process; price, \$1.00; specimens and particulars for stamp. T. M. Day, Box E., Windfall, Ind.

LIQUOR HABIT—GENUINE HOME CURE, 3 days. Absolutely reliable. Guaranteed. Book mailed free. Edw. R. Woods, 534 6th Ave., New York.

I WILL START YOU EARNING \$4.00 DAILY at home in spare time, silvering mirrors; no capital; send for free instructive booklet, giving plans of operation. G. F. Redmond, Dept. H., Boston, Mass.

MAIL ORDER MEN—LET THE MEMBERS OF THE "Circular Mailers' League" mail your circulars. 9x12 or less, for 15c per 100; or \$1.50 per 1,000. Service of every member is guaranteed. Write on your business stationery for free list of our members. Address Circular Mailers' League, Box 121, Oakland, Cal.

FREE HOROSCOPE—PAST, PRESENT, FUTURE revealed. Business, social, personal adviser. Habits corrected, evil influences removed, separated reunited. Mail five questions, birthdate, dime. Hammond, 21 Macdougall Street, New York.

CUBA AND PORTO RICO ARE NEW fields for mail order men. They have not been worked to death like the United States. Large English and Spanish daily papers. Classified columns, 1c per word. Sample copies free. George B. Fiske, 265 Broadway, New York.

MISCELLANEOUS

INCREASE YOUR BUSINESS BY LETTING me write your form letters, advertisements, circulars, and other business producing literature. David E. Victor, 156 Broadway, New York.

"MODERN ELECTRICAL CONSTRUCTION," a reliable and practical guide for the beginner in electrical construction, showing the latest and approved methods of installing work of all kinds according to the safety rules of the National Board of Fire Underwriters. Numerous systems of wiring are given, including the three wire systems now so much in use. 358 pages, 173 illustrations. Price \$1.50 postpaid. Popular Electricity Book Dept., 54 W. Lake St., Chicago, Ill.

MOTORCYCLES

WANTED—MOTORCYCLE, ANY MAKE, year or condition; must be cheap. Spillane, 211 West 125th St., New York City.

MOTORCYCLES—ANY MAKE, REBUILT, from \$25 up. Motorcycle tires, \$3 up. New motorcycles at factory prices. Buy direct. Save dealers' profits. Write for catalogue. Deninger Cycle Co., Rochester, N. Y.

MOTORCYCLES, NEW AND SECONDHAND; motors, castings and accessories. Our attachable motor outfit converts any bicycle into a motorcycle at small cost. Write for catalogue and bargain list. Shaw Mfg. Co., Dept. 31, Galesburg, Kan.

MOTORCYCLE TIRES, LARGEST STOCK and lowest prices in the world. All makes guaranteed from \$4.00 up. Shipped C. O. D., examination allowed. Write today for prices and be convinced. Guaranteed Tire Co., 213-217 West 125th St., New York City.

MOTORCYCLES—LOWEST PRICES, LARGEST stock. Save dealers' profits, buy direct from the owners. I have all makes. Indians, \$20.00 up; Marshes, \$20.00 up. Don't purchase any motorcycle until you get my prices. All guaranteed for one year. King, 213-217 West 125th St., New York City.

JUST OFF THE PRESS—1912 MOTORCYCLE Manual, a cyclopedia of useful motorcycle information. Complete trade directory; how to operate and manage motorcycles; best trouble chart ever published; how to tour, etc.; 125 pages. 25c a copy; cloth bound, 50c. Motorcycle Publishing Co., 51 Chambers St., New York.

A. C. C. A. PRICES TALK—ENDLESS VARIETY, latest models, every make—Indians, Merckels, Harleys, M. M.'s, hundreds others, \$20 up. Every machine guaranteed five years. Freight prepaid. Largest and only illustrated catalog published sent free. The Automobile and Cycle Company of America, Dept. H. H., 1769-1787 Broadway, New York City.

MOTORCYCLE TIRE BARGAINS! A. C. C. A. prices talk! Diamond, Goodrich, G. & J. and other standard makes. Guaranteed. Gridiron, Basket and Bailey treads. 26x1¾, \$3.00; 28x2, \$4.95; 28x2¼, \$5.70; 28x2½, \$6.20; 26x2¼, \$5.45; 26x2½, \$6.20. Guaranteed. Tubes priced proportionately low. Shipped on approval. Don't buy until you receive our price list! The Automobile and Cycle Company of America, Dept. G. G., 1769 to 1787 Broadway, New York City.

PATENTS

MONEY IN GOOD IDEAS—My patents get it for the inventor. Twenty years' experience. Fees low—payments liberal. "The Truth About Patents" sent free. Jas. R. Mansfield, Dept. C, Washington, D. C.

"**PATENTS AND PATENT POSSIBILITIES**," a 72-page treatise sent free upon request; full of valuable and interesting information; tells what to invent and where to sell it. Write today. H. S. Hill, 929 McLachen Bldg., Washington, D. C.

PATENTS SECURED OR FEE RETURNED—Send sketch for free examination. Milo B. Stevens & Co., Estab. 1864, 640 F St., Washington; 351 Monadnock Blk., Chicago. Guaranteed by Bankers' Register. Highest rating by Martindale's Law Directory.

PATENT ATTORNEYS

SEE WHAT I SAY UNDER "TYPE-writers." ATCHISON.

INVENTORS—SEND COPY OF YOUR PATENT and we will submit our special offer. Atlantic Supply Co., Long Branch, N. J.

SEND FOR FREE BOOKLET, "ALL ABOUT Patents and Their Cost." Shepherd & Campbell, 500 B Victor Bldg., Washington, D. C.

C. L. PARKER, PATENT ATTORNEY, 915 G St., Washington, D. C. Inventors' handbook, "Protecting, Exploiting and Selling Inventions," sent free upon request.

INVENTIONS PERFECTED, PATENTS OBTAINED, strictest confidence. Dies, models, patterns accurately made. Metal Novelty Co., 1921 Olive St., St. Louis.

PATENTS THAT PROTECT—CAREFUL, honest work in every case. Patent your ideas, they may bring you wealth. 64-page book free. Fitzgerald & Co., 807 F St., Washington, D. C. Established 1878.

PATENTS SECURED OR FEE RETURNED. Send sketch for Free Expert Search and Report as to patentability. Books on inventions and patents, and reference book, sent free. John S. Duffie & Co., Dept. 2, Washington, D. C.

PATENTS OF VALUE—PROMPT AND EFFICIENT service. No misleading inducements. Expert in mechanics. Book of advice and Patent Office rules free. Clements & Clements, Patent Attorneys, 705 Colorado Bldg., Washington, D. C.

PATENTS—SEND SKETCH OR MODEL FOR free advice on patentability. Book telling truth about prizes, "No Patent, No Pay," sent free. John J. Thompson, Pat. Atty., Box R, 1110 F St., Washington, D. C.

MONEY IN IDEAS—EDISON, GREATEST inventor, tells "How to Invent" in booklet sent free by Henry N. Copp, Registered Patent Attorney, 52 Washington, D. C.

PATENT BOOKS MAILED FREE—SHOWING 100 mechanical movements invaluable to inventors and mechanics—and telling what is patentable, how to obtain patent or partner, etc. Free on request. Chas. E. Brock, 703 Eighth St., Washington, D. C.

PATENT ATTORNEYS

PATENT—ADVICE AND BOOKS FREE. Highest references. Best results. I procure patents that protect. Watson E. Coleman, Patent Lawyer, 622 F St., N. W., Washington, D. C.

MEN OF IDEAS AND INVENTIVE ABILITY, write Randolph & Briscoe, Patent Attorneys, 619 F St., Northwest, Washington, D. C., for list inventions wanted, and prizes offered by leading manufacturers.

PATENT BOOKS ON HOW TO OBTAIN AND sell patents, containing exhaustive information on these subjects, with 100 mechanical movements, mailed free on request. F. G. Dieterich & Company, 602 Ouray Bldg., Washington, D. C.

PATENTS BRING RICHES WHEN OF value. Our free books cover the subject in a thorough manner. We give personal service. Wide experience. Trade Marks Registered. Write today. Beeler & Robb, 240 McGill Bldg., Washington, D. C.

PHOTOGRAPHY

HIGH GRADE ENLARGEMENTS, 8x10, 25c each. Developing and printing equally low. Diamond's Photo Shop, 416 6th Avenue, New York City.

PHOTOISMS — THE PHOTOGRAPHIC monthly. Good articles, illustrations, prizes, competitions. Subscribe now, 50c a year. Photoisms, 24 John St., New York.

FILMS DEVELOPED, ANY SIZE ROLL, 10c. Prints, 2¼x3¼ to 3¼x4¼, 3c. 4x5 to 3¼x5½, 4c. Postcards, 50c dozen. Superior, conscientious work. D. R. Freeman, 1224 Booth Street, Rosedale, Kan.

NON-POISONOUS DEVELOPER FOR plates and paper. Has great latitude. Simply dissolve in water. Six powders make 72 oz., 50c., or 6 powders to make 32 oz., 25c. P. O. Schohl, 6433 Monroe Ave., Chicago, Ill.

PHOTOGRAPHS WANTED BY PUBLISHERS. I'll find a buyer for all prints I deem worthy of publication. Send stamp for Leaflet of Instruction. A. S. Dudley, Photographic Expert, Box 775 T, Philadelphia, Pa.

DEVELOPING AND PRINTING—BROWNIE films No. 1 and No. 2 developed, 5c per roll; Velox prints, 3c each. All other films, 10c per roll. Velox prints, 4c each. Harold R. Parmelee, 108 Calhoun St., Springfield, Mass.

8x10 PHOTOGRAPHIC ENLARGEMENTS 25c each; made from any size negative or film. All size 6 exposure Kodak Films developed, 5c roll; 12 exposures, 10c roll. Send for price list and sample print. Scarlett Studios, 45-49 N. 13th St., Philadelphia.

DOGS

COLLIE PUPS, GRADE AND THOROUGH-bred, \$3 up. Furnished cottage for rent or sale. Adirondacks. M. Tack, Rainbow, N. Y.

ARE YOU INTERESTED IN DOGS? SEND 10c for a copy of the last edition of the Sportsmen's Review containing many articles of interest to dog owners, also 3 beautiful mounted pictures of Field Trial Winners, that will decorate any home or den. Sportsmen's Review, 51 W. Sixth St., Cincinnati, O.

PICTURES AND POST CARDS

JUST GIRLS—20 POST CARDS OF GIRLS, 25c, postpaid; no landscapes. O. K. Pub. Co., Decatur, Ill.

PHOTOS. "PRETTY GIRLS FROM LIFE," 4 for 10c, 12 for 25c. Curtis Co., F-146 W. 73d St., Chicago.

JOIN HOOSIER CARD EXCHANGE. MEMBERSHIP, 10c. O. Prendergast, 2006 N. 9th St., Terre Haute, Ind.

YOU'LL GET CARDS FROM EVERYWHERE. Membership 10c. Idaho Card Exchange, Dept. O, Box 906, Boise, Idaho.

15 FASCINATING PHOTOS OF BEAUTIFUL women, 25c. 5 for 10c. Real classy. National Nov. Co., 421A East 77th St., New York City.

SIXTEEN HIGH-GRADE POST CARDS—Pretty girls, floral, love scenes, etc., only 10c. H. E. Wolke, 2023 Murray Ave., Louisville, Ky.

EXCHANGE POSTCARDS WITH LADIES and gentlemen everywhere. Interesting pastime. Membership 10c. C. C. Club, 3937b Tracy, Kansas City, Mo.

WE HAVE PHOTOGRAPHED LIVE skunks! Astonish your friends! Four postcards, 10c. Skunk Development Bureau, Box 554E, Chicago, Ill.

20 NIAGARA FALLS POSTCARDS, SUMMER and winter scenes, reproduced from photos finished in finest art colors, 25c. Peake, 2829 Calumet Ave., Chicago, Ill. D-211.

IF YOU WANT TO RECEIVE POST CARDS from our members in Wales, Holland, China, Japan, Egypt and everywhere join the Travelers' Post Card Exchange, membership 10c. 3508 Carroll Ave., Chicago, Ill.

REAL PHOTOGRAPHS OF WOMEN OF beautiful form. Three fascinating poses, 25c; 7, including one 6½ x 8½ photo, 50c. Catalogue classy books and den pictures. Atoz Co., B-5 West Jefferson, O.

KEEP UP WITH THE TIMES, READ THE world happenings. "The International Monthly" contains them, also large exchange list. Copy and membership, 10c. International Post Card Exchange, Dept. 22, Endicott, New York.

WANT TO EXCHANGE POST CARDS WITH people in other cities and countries? Then try our large progressive club. One dozen beautiful colored California view post cards free to each member. Membership, 10c. Golden West Post Card Club, Box 1828, Los Angeles, Cal.

POST CARDS OF LIGHTHOUSES, WE ARE specialists in these, carrying the largest variety of any firm in the world. We can also supply cards of Irish scenery, etc., post cards of any place in the Old Country, our list and two sample cards to any address in the world for five cents. Lighthouse Mission, Dept. P. E., The Lighthouse, Belfast, Ireland.

PRINTING.

125 BOND LETTERHEADS AND 125 ENVELOPES, white, pink, blue or green, printed, \$1.00 prepaid. Samples. Kinnier, Box 206, Brooklyn, N. Y.

PRINTING

500 GUMMED STICKERS OR GUMMED Labels, 1 inch by 2½ inches, for 25 cents, postpaid. A. B. Averill, Station C, Portland, Ore.

LOOK HERE!—100 LETTERHEADS, 100 envelopes, 100 return envelopes or business cards, printed for \$1, postpaid. Walden Press, Roxbury, Mass.

RUBBER STAMPS

NAME ON RUBBER STAMP 15c, WITH address 25c. National Stamp Works, 44 N. Fifth Ave., Chicago. Catalogue.

SCHOOLS

SEE WHAT I SAY UNDER "TYPEWRITERS." ATCHISON.

WE TRAIN DETECTIVES. YOU CAN BE one. Splendid opportunities. Travel. Earn \$100 to \$300 monthly. This fascinating profession taught practically and scientifically by mail at a nominal cost. American School of Criminology, Dept. G, Detroit, Mich.

AUTOMOBILE SCHOOL—LEARN THE Automobile business, repairing and driving, in which you can earn good wages and have healthful and pleasant work. We give a thorough and practical course in road work and repairing. For full particulars address Academy of Automobile Engineering, 1420 Michigan Ave., Dept. "C," Chicago, Ill.

TELEGRAPHY

LEARN TELEGRAPHY—RAILROAD DISPATCHERS wires in school. Positions guaranteed our telegraph graduates. Catalogue free. Northwestern Telegraph School, Eau Claire, Wis.

TELEGRAPHY—MORSE AND WIRELESS; railway accounting (station agency) taught quickly. Railroad dispatchers and Western Union wires and complete wireless station in school. Splendid opportunities. Graduates assisted. Living expenses low—may be earned. Largest and oldest school—established 37 years. Investment \$25,000.00. Correspondence courses also. Catalogue FREE. DODGE'S TELEGRAPH & RAILWAY INSTITUTE, 16th St., Valparaiso, Ind.

TYPEWRITERS

TYPEWRITERS OF ALL MAKES—LOW prices; satisfaction guaranteed. Edward Quimby, Dover, New Hampshire.

STENOGRAPHER MUST SELL HER Remington typewriter, \$9.00. Miss King, 2230 Seventh Ave., New York City.

SURPRISING TYPEWRITER BARGAINS—No matter what make, will quote you lowest prices and easiest terms, or rent, allowing rental on price. Write for big bargain list and catalogue 14. L. J. Peabody, 278 Devonshire St., Boston, Mass.

I WANT TO CORRESPOND WITH PERSONS who are about to buy a high-grade typewriter, object to paying the high prices generally asked by manufacturers and dealers. Any make on approval. Catalogue, bargain list and valuable information sent free. A. E. Atchison, 4125 West 21st St., Chicago.

TYPEWRITERS

TYPEWRITERS: CALIGRAPH, \$6.00; Hammond, Yost, Densmore, Williams, \$10.00; Remington, \$12.00; Smith-Premier, \$15.00; Oliver, \$24.00; Underwood, \$30.00; all makes on hand; fifteen days' trial allowed, and a year's guarantee. Send for catalogue. Harlem Typewriter Exchange, Dept. 89, 217 West 125th St., New York City.

NO. 6 REMINGTONS \$18.00. NO. 2 SMITH Premiers \$17.00 and all other standard makes of typewriters at lowest prices. Many only slightly used. Fresh stock. Perfect condition. True bargains. Satisfaction guaranteed. Catalogue, specimens of writing and price list on request. N. Y. Typewriter Exchange, 92 Leonard St., New York.

WANTED

WANTED. PERSONS TO EARN GOOD commissions getting members for Nests and Auxiliary Nests, Order of Owls, South Bend, Ind.

WIRELESS

GUARANTEED DETECTOR STANDS 10c. Robert Schimmel, 2220 North Penn. Street, Indianapolis, Indiana.

\$9.75 BUYS \$15.00 ¼ KILOWATT TRANSFORMERS. Sends 30 miles. \$14.50 buys \$22.00 ½ kilowatt. 70 miles. Fully guaranteed. Nomus Electric Co., 1216 South 48th Ave., Cicero, Ill.

CLOSED-CORE TRANSFORMERS, SELF-controlling, four variations. ¼ K. W., \$10; ½ K. W., \$15; 1 K. W., \$25; 2 K. W., \$50; guaranteed. Sent on trial. Send stamp for circular. Phillips-Roadhouse, Shelby, Mich.

WIRELESS APPARATUS—WHY NOT have the best when selecting the instruments for your station? We handle the best and most advanced type of apparatus on the market. Send 2c stamp for descriptive matter and catalogue. The Merker-Flocker Electric Co., 957 Liberty Ave., Pittsburgh, Pa.

“WIRING A HOUSE,” BY H. PRATT, shows a house already built; tells you just how to start about wiring it; where to begin; what wire to use; how to run it according to insurance rules; in fact, all the information necessary for wiring a house and shop. Postpaid, 25c. Popular Electricity Book Department.

HELP WANTED

BIG MONEY WRITING SONGS. SEND FOR free booklet. Tells how. Conway, 49 Tuscola St., Detroit, Mich.

WANTED — 5,000 DISTRIBUTORS OF ADVERTISING matter everywhere. American Distributor, Mount Pleasant, Pennsylvania.

WANTED—CHIEF OPERATOR WHO CAN keep double entry books. Address Fruit Belt Telephone Company, Fort Valley, Ga., for particulars.

WRITE MOTION PICTURE PLAYS. ANY-one, anywhere, can do this work. Big demand. Complete instructions, 10c. Silverman Pub. Co., 48 Clinton St., New York.

HELP WANTED

EARN GOOD PAY COPYING ADDRESSES; particulars six stamps. Hinchey, 167, Middleport, N. Y.

CAN FURNISH PERMANENT EMPLOYMENT to three educated Christian men, organizing ability necessary. State age and former occupation. Address, L. S. Higley, Valparaiso, Ind.

CANVASSERS WANTED — “BUSINESS Men's Collection Method”; quick sales; big profits; re-orders; sample outfit, 25c postpaid. Walter's Printing House, 37 Dean St., Brooklyn, N. Y.

WANTED—MEN AT LOS ANGELES. CAN learn trade. Fair wages after second month. Automobiles, electricity, plumbing, bricklaying. Practical work on actual jobs. 1,200 students last five years. Only few months required. United Trade School, Los Angeles.

SALESMEN AND BRANCH MANAGERS everywhere to handle best selling proposition known. Experience unnecessary. Legitimate, permanent and commands instant attention. Big commissions. Exceptional opportunity. W. E. Bryan & Co., Cincinnati, Ohio.

ANY FIRST-CLASS COMPETENT SALESMAN capable of selling the wholesale machinery trade who desires to handle a newly invented machine of great merit in which there is no competition, should write National Mfg. & Sales Co., 399 Huron St., Toledo, O.

MORE MEN WANTED AS SIGNAL ENGINEERS, \$8 to \$12 a day. Rapid advancement. We teach you in short time at small expense to become expert signal engineers. Write at once for full particulars. Department of Signalling, Desk 9405, 493 Cass St., Chicago, Ill.

FREE ILLUSTRATED BOOK TELLS ABOUT over 360,000 protected positions in U. S. service. More than 40,000 vacancies every year. There is a big chance here for you, sure and generous pay, lifetime employment. Easy to get. Just ask for booklet A50. No obligation. Earl Hopkins, Washington, D. C.

BE AN ELECTRICAL METERMAN—\$900 to \$1,800 a year. New field. Demand for competent metermen greater than supply. Personal, practical mail instruction qualifies you for splendid position. Graduates assisted. Write for particulars. Fort Wayne Correspondence Schools, Dept. 30, Fort Wayne, Ind.

MEN AND WOMEN WANTED FOR GOVERNMENT positions, \$80.00 month. Annual vacations. Short hours. No “layoffs.” Common education sufficient. Over 12,000 appointments coming. Influence unnecessary. Farmers eligible. Send postal immediately for free list of positions open. Franklin Institute, Dept., B-54, Rochester, N. Y.

BIG MONEY WRITING SONGS—HUNDREDS of dollars have been made by writers of successful words or music. Past experience unnecessary. Send us your song poems, with or without music, or write for free particulars. Acceptance guaranteed if available. Washington only place to secure copyright. H. Kirkus Dugdale Co., Dept. 13, Washington, D. C.

HELP WANTED

RAILWAY MAIL CLERKS, LETTER CARRIERS, Custom House Clerks wanted. Good pay, fine positions. Write for our easy payment tuition plan. Liberty Institute, Dept. E, Rochester, N. Y.

SALESMAN, TRAVELING; SALARY AND expenses or commission; must be active, ambitious, energetic; splendid opportunity; former experience not essential. Landmark Cigar Co., Denver, Pa.

MEN WANTED—AGE 18 TO 35, TO PREPARE for firemen or brakemen on all railroads, \$80 to \$100 monthly. Experience unnecessary; no strike. Promotion—engineer or conductor, \$150 to \$200 monthly. Good life careers. State age; send stamp. Railway Association, Dept 134, 227 Monroe St., Brooklyn, N. Y.

SALESMEN—SEND YOUR NAME AND ADDRESS to Raymond E. Wood, 903 E. Eighth St., Cincinnati, Ohio. I am the manufacturer's sales manager for the best household and office electric specialty ever invented. Sells for \$3.50 and \$2.50. Guarantee for credit or deposit required. Capable men only need apply. I want only a few men; the work is permanent, profitable and high-grade. You will be given territory and expected to produce business.



YOU CAN HAVE IT, TOO.
Auto experts are wanted everywhere. Short hours and fascinating work. We teach you the entire subject in 10 simple, practical lessons, and assist you to secure a good position. Study at home in spare time. No automobile necessary—we furnish free model. Expert and experienced instructors. Send for First Lesson Today—It's Free.
Get started at once. Let us prove our claim. Send postal now. The Original Auto School. OWNERS—We supply competent men.
EMPIRE AUTO INSTITUTE 147 Empire Bldg., Rochester, N. Y.

THE INVENTORS OUTLOOK

Educates Inventors on Patents

It tells the whole truth about patents; wasted energy; failures; successes, and has a free department of opportunities. Not an attorney's magazine; for patent reform and inventive success. Contains important articles from leading inventors; important patent news of all countries; and useful hints to inventors. Personal note—an extract from this was published in Popular Electricity, Joseph J. O'Brien, author of "The Inventions of Edison." Founder-Editor; member of Franklin Institute and National Geographical Society. Special offer: four months for 25c; One dollar a year. Office: Room 19, Provident Bldg., opposite U.S. Patent Office, Washington, D.C.

LOTS OF FUN FOR A DIME



Ventriloquist Double Throat
Fits roof of mouth; always invisible; greatest thing yet. Astonish and mystify your friends. Neigh like a horse, whine like a puppy, sing like a canary, imitate birds, beasts, of field and forest. **Lots of fun.** Wonderful invention. Thousands sold. Price only 10c; 4 for 25c, or 12 for 50c.

FUN MAKERS, Dept. 10 Kewanee, Ill.

For the Amateur OR PRACTICAL ELECTRICIAN

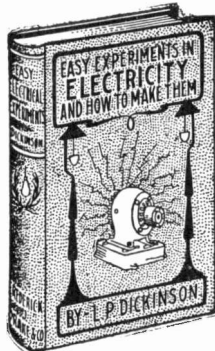

This is one of the most valuable works ever published.

Written in simple, easily understood language, fully illustrated with cuts and working drawings.

Presents a wonderfully interesting and entertaining series of electrical experiments, giving full directions for constructing apparatus required with inexpensive materials and tools easily obtained.

Shows you how to make all kinds of batteries, electric bells, rheostats, condensers, large and small induction coils, an electrophorus, an automatic circuit closer; how to construct and use telegraph and telephone instruments, measure electrical resistance and pressure and make and use galvanometers and voltmeters.

Gives detailed directions for building a 1-20 horse power motor, explaining exactly how to make each of the various parts and assemble them correctly. Shows you how to do electro-plating at home, design a small dynamo, build an electric engine, an electric locomotive, a model fire alarm telegraph, make simple arc lamps, and light lamps by electricity. Also how to make an electric bomb, electric gyroscope and other electrical toys, etc., etc.

204 pages. Handsomely stamped cloth covers.

Price \$1.00 Postpaid

Popular Electricity Book Department
54 West Lake Street Chicago, Ill.

INDEX TO VOLUME IV Popular Electricity

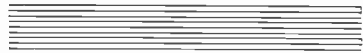

Any reader of Popular Electricity Magazine wishing a complete index to the contents of Volume IV (May 1911 to April 1912) may obtain one free by making request to this office.



POPULAR ELECTRICITY MAGAZINE
Commercial Bldg., Chicago, Ill.

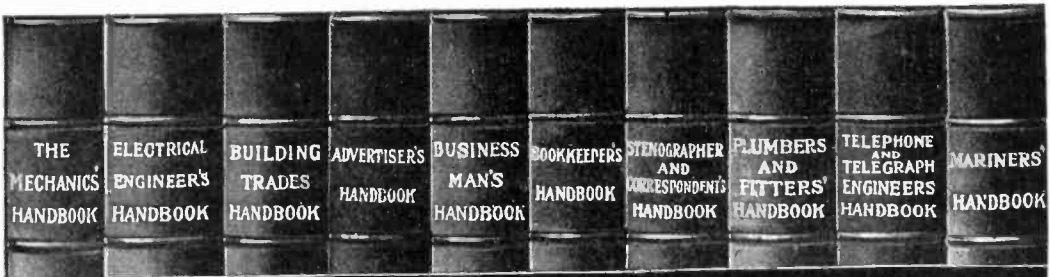

\$1.25 Handbooks for 50c.

No books in existence contain in so small space as much information about the trades and professions of which they treat as do these Handbooks. They are little giant encyclopedias of practical knowledge giving data and information that is hard to find in ordinary books. These Handbooks have been prepared by the well-known textbook writers of the International Correspondence Schools whose textbooks are recognized the world over as the most practical treatises on applied sciences ever published. These Handbooks are consulting experts of the highest rank, and are the most powerful force in the world for the promotion of ambitious men. They are an indispensable help to quicker and better work that will command advancement. They are printed on a high-grade book paper in clear type, and durably and handsomely bound in cloth with gilt titles; contain on an average of 364 pages and 175 illustrations and are regularly sold for \$1.25 each.

SPECIAL OFFER.—We are selling these Handbooks, durably bound in cloth with gilt titles, at a special price for each Handbook of 50 cents.

Mechanics'—Tables; formulas; measurements; belting; mechanical powers; hydro mechanics; strength of materials; shafting; boiler design; care of boilers; power of boilers; chimneys; exhaust heating; machine design; machine tools; slide valve; pulleys; cylinders and steam chests; pistons; gearing; transit surveying; triangulation; curves; radii and deflections; earth work; track work; electricity; etc.

Advertiser's—How to plan and write an advertisement; type and type measurements; points on printing style; display; preparation of manuscript; proof reading; engraving and printing methods; electrotypes; matrices; advertisement illustrations; magazines; newspapers; retail, department-store, general, trade-paper, and mail-order advertising; trade marks; circulars; advertising agencies; etc.

Stenographer's & Correspondent's—Advice to beginners; shorthand speed; letters of application; punctuation; correct and faulty diction; business correspondence; type-writing; abbreviations; addressing; mailing; rates of postage; duplicating work; etc.

Telephone and Telegraph—Useful tables; mechanics; electricity; magnetism; primary batteries; storage batteries; electrical measurements; telephony; tests with magnetogenerator and bell; telegraphy; Morse telegraph systems; multiplex telegraphy; etc.

Electrical Engineer's—Mechanics; electricity; electrical units; symbols and quantities; physical and electrical properties of metals and alloys; wire gauges; magnetism; dynamos and motors; electric batteries; alternating current apparatus; alternators; transformers; wattmeters; electric transmission; electric lamps; wiring; electric heating and welding; electromagnets; controllers; car wiring; etc.

Business Man's—Arithmetic; tables; business forms; card systems; measures of extension; weight and capacity; time; value of foreign coins; duties on imports; bookkeeping; stenography; correspondence; postal information; financial terms; money and the money market; brokers and brokerage; patents; copyright and trade marks; corporations; business law; publicity; etc.

Plumbers and Fitters'—Arithmetic; involution and evolution; powers, roots, and reciprocals; circles; decimals; geometrical drawing; weights and measures; formulas; mensuration; mechanics; hydro-mechanics; building construction; heating and ventilation; gas-fitting; plumbing; etc.

Mariners'—Logarithms; trigonometry; navigation; terrestrial navigation; celestial navigation; organization of a man of war; naval ordnance; explosives; torpedoes; ship building; speed, tonnage, and fuel consumption; ropes; wind and weather; signals; nautical memoranda; etc.

Building Trades—Loads and structures; strength of materials; properties of sections; strength of rivets and pins; materials of construction; footings and foundations; masonry construction; woods used in building; qualities of timbers; joinery; framing; estimating; elements of architectural design; drainage systems; plumbing fixtures; plumbers' tables; heating and ventilation; gas and gas-fitting; etc.

Bookkeeper's—Arithmetic; formulas; tables; money; percentage; interest; equation of accounts; money and the money market; business law; financial terms; banks and banking; postal information; distances and time between various places; bookkeeping; business forms; card systems; modern office methods; cost accounting; bank bookkeeping; clearing house methods; etc.

International Textbook Co.

Box 1102, SCRANTON, PA.

I enclose \$_____ for which please send me the books BEFORE which I have marked X.

- Mechanics' Handbook
- Elect. Eng. Handbook
- Bldg. Trades Handbook
- Plum. & Fit. Handbook
- Tel. & Tel. Handbook
- Advertiser's Handbook
- Business Handbook
- Bookk'per's Handbook
- Sten. & Corr. Handbook
- Mariners' Handbook

Name _____

St. and No. _____

City _____ State _____

For our Mutual Advantage mention Popular Electricity when writing to Advertisers.

Electrical Books for Boys

IF Thomas A. Edison could have obtained books of this kind when he was a newsboy on the Grand Trunk Railway he would have devoured them with great eagerness, but very little was known of electricity at that time, or of the many ways in which it is now utilized in our every-day life. However, we have not accomplished all that is to be done and it is therefore essential that the wide-awake boy equip himself with a knowledge of the principles and present day applications of this great force by reading the books now obtainable.

These books present the subject in a manner that will furnish both interesting and instructive reading for boys of all ages.

Electricity Book for Boys

By J. H. ADAMS

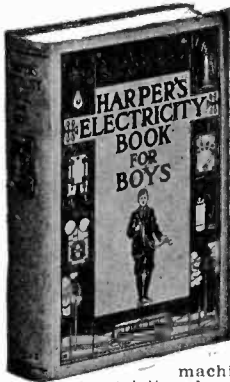

This is a book that the boy will eagerly devour. Shows him what he can do with his own hands and how he can accomplish results with inexpensive materials.

Explains briefly and in simple language the working of electricity in its daily application and has an appendix of electrical terms and phrases.

How to make simple batteries, horse shoe magnets, induction coils, burglar alarms, push buttons, electrical buzzers, bells and horns, electric alarm clocks, telephones, telegraph and "wireless" apparatus, dynamos and motors; how to run a sewing machine, fans and toys by electricity; how to make a "Wimshurst Influence Machine" and conduct interesting experiments in frictional electricity; how to do electroplating and electrotyping, make electrical insect and animal traps, toys, etc. These are but a few of the hundreds of interesting things a boy may learn to do by studying this book.

407 Pages

274 Illustrations

Price \$1.75 Postpaid

The Boy Electrician

By E. J. HOUSTON

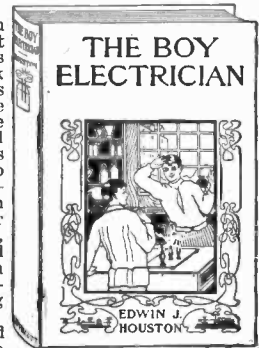

Any boy who can read this book and not become absorbed in its contents must lack those peculiar qualities which go into the make-up of a real live boy. It is a story full of fun and adventures of two bright boys who possessed marked scientific powers in addition to their fondness for baseball, swimming, and other sports, and who managed to learn a great deal about electricity while having lots of fun.

The remarkable and quaint doings of the "Jolly Philosophers,"

the exciting adventures they met with and the interesting experiments they carried on, can not fail to be attractive and furnish a source of amusement and instruction to boys of all ages.

If you are looking for a gift book that your boy will enjoy, and which at the same time will prove of real value to him—here it is.

326 Pages

Illustrated

Price \$1.50 Postpaid

The Boy's Life of Edison

By Wm. H. Meadowcroft

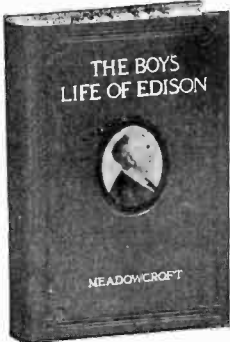

It is probably as a worker of wonders, an actual wizard of science, that Edison fascinates the imagination of almost every boy. In this picture of the real facts of the inventor's life from his early boyhood up to the present time, the reader will find that while Edison is just as great as imagined, yet this greatness has not been reached by chance, but honestly earned by the hardest kind of hard work. The wonderful things that he has accomplished have been the things that he purposely set out to do, and are not the result of some happy thought or chance. Each page has been read by Mr. Edison and he has given it his personal endorsement. Every boy should read it.

331 Pages

Fully Illustrated

Price \$1.25 Postpaid

Story of Great Inventions

By Elmer E. Burns

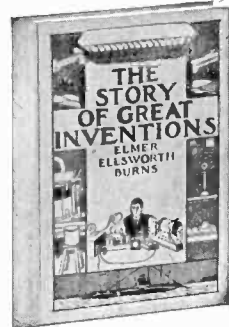

The purpose of this book is to tell in simple language how our great inventions came into being, to depict the life-struggles of the men who made them and in the telling of the story, to explain the working of the inventions in a way the boy can understand.

The stories are so woven together as to give the young reader a connected view of how our great inventions have arisen out of scientific discovery on the one hand and social and economic conditions on the other.

This well written romance of great inventors will appeal strongly to young readers as well as to many older ones.

249 Pages

Fully Illustrated

Price \$1.25 Postpaid

POPULAR ELECTRICITY BOOK DEPT., 54 West Lake St., Chicago, Ill.

BE AN EXPERT ELECTRICIAN

LEARN IN SPARE TIME

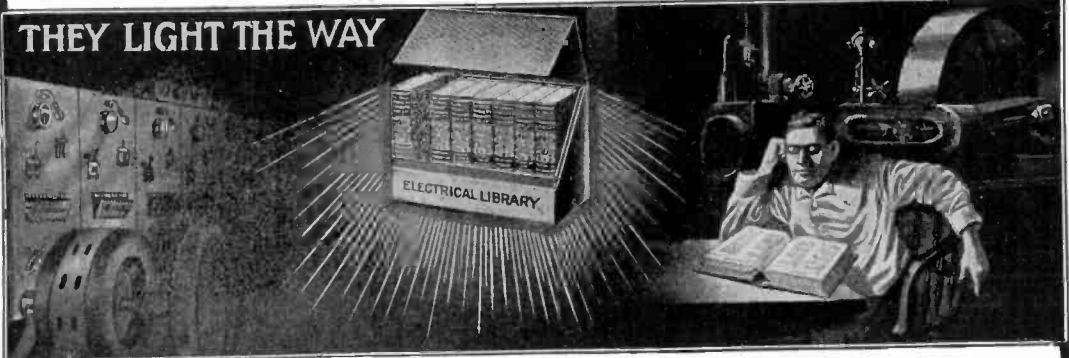

Electrical Workers' Standard Library

Text books for those who wish to easily and quickly master the Electrical profession. A Complete Course of Easy Lessons. Arranged in progressive order in Questions and Answers. Plain everyday English. Hundreds of diagrams and drawings make everything so clear that even a boy can understand.

Eight volumes, pocket size, about 380 pages each, profusely illustrated with diagrams, drawings and plates. One has about 750 pages and covers everything connected with up-to-date American Telephone practice. This volume alone has upward of four hundred engravings.

A Complete Electrical Dictionary and also the Civil Service Examination Questions and Answers. Make an elegant appearance. The books are bound in full leather, round corners, and red edges. Complete in a cloth covered case, as shown above.

The FREE CONSULTATION SERVICE of this Institute for a term of THREE YEARS is at the command of every purchaser.

COUPON

National Institute of Practical Mechanics, P. Ec.:

Without any obligation on my part to purchase, please send me particulars, price and easy payment terms, of the Electrical Workers' Standard Library with the Consultation Service of your Institute.

Name.....
 Address.....
 Age.....
 Occupation.....
 Employer.....

NATIONAL INSTITUTE OF PRACTICAL MECHANICS
 1825 Michigan Avenue CHICAGO, U. S. A.

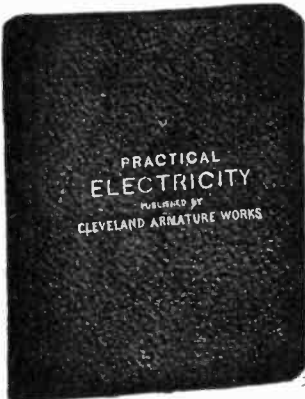

A School Within Itself

designing, care and operation of a dynamo or motor, and 1 chapter on electric automobiles, outlining their construction, care and operation, and all about storage batteries and how to handle them. Each subject is carefully written and to the point. After a student studies a subject, he is questioned on that subject in such a manner as to bring clearly to his mind the points he needs to know regarding same. A DICTIONARY in back of book will enable him to learn the meaning of any electrical word, term or phrase used in this book, as well as hundreds of others in common use. All required tables necessary in the study are in it.

CHAPTER
 I—Wiring.
 II—Electric Batteries, Electro Plating.
 III—Magnetism.
 IV—The Magnetic Circuit.
 V—Magnetic Traction.
 VI—Magnetic Leakage.
 VII—Energy in Electric Circuit.
 VIII—Calculation of Size of Wire for Magnetizing Coils.

CHAPTER
 IX—Calculation of EMF's in Electric Machines.
 X—Counter EMF.
 XI—Hysteresis and Eddy Currents.
 XII—Armature Reaction.
 XIII—Sparking.
 XIV—Winding of Dynamos and Motors.
 XV—Proper Method of Connecting Dynamos and Motors—Self Excitation.

CHAPTER
 XVI—Diseases of Dynamos and Motors, their symptoms and how to Cure Them.
 XVII—Arc and Incandescent Lamps.
 XVIII—Measuring Instruments.
 XIX—Alternating Current.
 XX—Automobiles.
 A dictionary of over 1500 Electrical Words, Terms and Phrases, giving a brief meaning of all which are in common use.

\$2.00 Per Copy—Sixth Edition—30,000 Copies Sold

The offer we make of refunding money if book is not satisfactory upon examination is AN UNUSUAL ONE in connection with the sale of a book. But we have no fear of its return. Your decision will be what thousands of others have been. Money would not buy it if it could not be duplicated. We could print testimonials by the hundreds. It is best to order and be your own judge of its merits.

CLEVELAND ARMATURE WORKS, 4730 St. Clair Ave., Cleveland, Ohio

Armatures and Fields Wound, Commutators Filled

AMERICA'S GREATEST REPAIR WORKS

For our Mutual Advantage mention Popular Electricity when writing to Advertisers.

A Conservative Investment Tax Exempt in Illinois Paying 7% Dividends

No investment is more worthy of investigation than the stock of the **Commonwealth Edison Company** of Chicago. Notwithstanding its astonishingly rapid growth and its present strategic position, this Company is as yet doing only a fraction of the business that it will do in the near future.

The **Commonwealth Edison Company** is at present supplying electricity for lighting and power in a territory that covers 200 square miles, but that territory is only "tapped," so to speak. There is expert authority for the statement that three times the present volume of business should naturally come to the Company's Central Station. Yet, gigantic as is the retail business of the **Commonwealth Edison Company**, it forms only one-third of its total business, two-thirds of which is wholesale. It supplies electricity to 1250 miles of street and elevated railway track and its service to smaller Central Stations extends 85 miles to the north, 55 miles to the south and 35 miles to the west of Chicago.

A very considerable portion of the Company's wholesale business is concerned in the sale of electricity for light and power to manufacturers. In this field there is still opportunity for a vast increase of business in replacing private power plants with the more economical Central Station service.

The **Commonwealth Edison Company** represents an investment of over \$70,000,000, and is paying dividends at the rate of 7% per annum on its capital stock. The future prospects of this stock are indicated by the recent advance in the dividend rate from 6% to 7%. At the present market price of about 145, the net return to the investor is nearly 5%. While the stock was paying 6% dividends it sold at average prices that yielded a smaller net return. This justifies us in the belief that **Commonwealth Edison stock** is now a more desirable investment than ever before.

Commonwealth Edison stock is listed on the Chicago Stock Exchange. We recommend this stock as an investment of exceptionally high character, paying 7% dividends, and as being exempt from taxation under Illinois laws. Full information will be gladly supplied in answer to all inquiries.

Russell, Brewster & Company

Members: { New York Stock Exchange
Chicago Stock Exchange

116 W. Adams Street
Chicago, Ill.

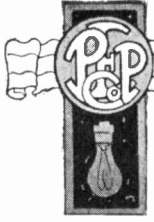

Popular Electricity

In Plain English

Henry Walter Young, Editor



Vol. V

June, 1912

No. 2

CONTENTS

	Page		Page
Phonographs and the Man That Invented Them. By Frank Parker Stockbridge.	105	Electric Dryer for Letter Press Copies.	163
Double Deck Electrobros in London.	111	Automatic Temperature Regulator.	164
A Public Unfamiliar with Coal.	111	Fans for Sealing Room.	164
Ripening Walnuts by Electricity.	111	A New Type of Fan.	164
Electric Radiators in Bears' Dens.	111	Bolling Water in a Hurry.	165
Laying Telephone Cable in the English Channel.	112	European Farm Motor.	165
Arc and Incandescent Lights.	114	Shoe and Hosiery Display Device.	165
Men Who Follow the Law of Ohm. By John F. Gilchrist.	115	New Type Instantaneous Water Heater.	166
Brief Sketch of the National Electric Light Association. By T. Commerford Martin.	116	Filtering Air for Dynamos.	166
W. Winans Freeman.	118	Paper Drier for the Job Printer.	167
Louis A. Ferguson.	119	Handling Cane in Sugar Mills.	167
Dudley Farrand.	120	Trimming Off the Rough Spots.	167
Charles L. Edgar.	121	ELECTRICAL MEN OF THE TIMES. Matthew C. Brush.	168
W. C. L. Eglin.	121	Adapting the X-ray to Minor Surgery.	169
Henry L. Doherty.	122	ELECTRICITY IN THE SUMMER HOME.	170
William H. Blood, Jr.	123	Home Refrigerating and Ice-making Plant.	172
Electric Pumping Plants.	124	Telephone Etiquette.	173
Cars Helped by Counter Weights.	124	The Silent Servant.	174
Aids to the Partially Deaf.	125	The Federal Portable Power Table.	176
Electricity from Peat.	125	Tools for Housekeeping.	176
CHARLES PROTEUS STEINMETZ.	126	Washing Machine with the Washboard Principle.	177
Regulator for Street Car Lights.	128	Electric Cooking Utensils.	177
"EAVESDROPPING BY SCIENCE." By Edward Lyell Fox.	129	THORNE ELLIOT'S BURGLAR ALARM. By Clark DeBall.	178
Mouse Carries Thread Through Pipe.	132	To Make an Electrophorus.	181
ELECTRICAL SECURITIES. By "Contango".	133	Chemical Flasks from Electric Bulbs.	181
A New Use for Tungsten.	135	The Magic Toboggan Slide.	182
An Automatic Wheelman.	135	Electricity Introduces Juggling Act.	182
An Outdoor Elevator.	136	Projecting Postcard Pictures.	183
Miniature Motion Picture Machine.	136	Electric Bell Attachment for Dart Board.	183
Street Cars to the Leaning Tower.	137	The Dancing Doll.	183
Two Shows in One.	137	The Magnetic Detector.	184
A Pennsylvania Farm Electrified.	138	Wireless at Catalina Island.	185
Telephone Dispatching System for Taxicabs.	139	Wireless Hints.	185
Electricity Cheaper than Steam in Seattle Mills.	140	TESTING WIRELESS IN THE DESERT. By Jesse H. Bufum.	186
Beefsteak by Wire.	140	San Francisco Hears Wireless from Korea.	189
Measuring Starlight.	141	Hook-up for Long Distance Work.	190
Some Odd Facts About the Telephone.	141	Directory of Wireless Clubs.	190
Floating Power Plant Protects Piling.	142	TRANSFORMER CONSTRUCTION. By Wesley G. Paulson.	192
Toned Telegraph Signals.	143	Watch Demagnetizers.	197
Electric Truck Makes Record Run.	143	Motor Operated Valve.	197
THE CASINO TECHNICAL SCHOOL FOR WOMEN. By R. J. Watson.	144	Shock Absorber in a Rosette.	197
An Electrical Hygrometer.	146	Electro-Magnet with Automatic Switch.	198
Death of Prof. Antonio Pacinotti.	146	A Homemade Electric Sign.	198
Monorail System for Lumber Mills.	148	Increasing a Telephone's Range of Usefulness.	199
Proving the Engineer Alive.	149	A Floor Tread Switch.	199
A Rat's Handiwork.	149	Neat Fastening for Entrance Wires.	199
Individual Telephone Transmitter.	150	Electro-Plating on Glass and Porcelain.	199
ELECTRICITY AIDS THE DATE INDUSTRY.	151	Improvements in Moving Picture Machines.	200
Electricity Direct from Heat.	151	For the Amateur Wireman.	201
Deaf Mute "Telephone".	152	Pliers Made from Fiber.	201
U. S. Asbestos Production Doubled.	152	A Cheap Mellow Light.	201
Portland Regrade Operation.	153	Refinement of Electrical Measurements.	202
HOW TO BECOME A TELEGRAPH OPERATOR. By an Operator.	154	Aging Cheese Electrically.	202
Walking on a Magnetized Floor.	155	Power from the Ocean Waves.	202
Unusual Feature of the Paris Subway.	156	Proposed London Postal Subway.	202
Electric Versus Gravity System for Irrigating.	157	Naples Deep Running Subway.	203
Searchlight on Repair Wagon.	158	Electric Cars of Aluminum.	203
Largest Lightning Arrester in the World.	158	Central Station Power in Time of Strikes.	203
A New Coat Adjuster.	159	Wireless from Airships.	203
THE NEW CAMBRIDGE SUBWAY TO BOSTON. By Livingston Wright.	160	The Dignity of the Wireless.	204
The Modern Sculptor.	162	Electric Heating in Swedish Homes.	205
Electric Fans in India.	163	The Firefly's "X-ray" Light.	205
		Short Circuits.	207
		Common Electrical Terms Defined.	208

RENEWALS When your subscription expires, you will find a renewal blank enclosed here. You should fill out and return with remittance at once to avoid missing a number. Positively no copies will be mailed on any subscription after same expires unless renewed, and we cannot agree to begin subscriptions with back numbers. The date on wrapper of your magazine shows issue with which your subscription ends. The extension on this date to period covered by renewal is sufficient receipt. If any other is desired it should be requested at time of renewal.

CHANGE OF ADDRESS Notify us promptly of any change in your address, giving both the old and new location. Since our mailing list for each issue closes the 5th of the preceding month (i. e., list for February closes January 5th), changes received after the 5th must necessarily take effect with issue for second month following. Postmaster as well as Publisher should always be notified of changes in order to forward mail sent to old address.

ISSUED MONTHLY BY POPULAR ELECTRICITY PUBLISHING CO., Commercial Bldg., Chicago, Ill.
 YEARLY SUBSCRIPTION, \$1.50; CANADIAN, \$1.85; FOREIGN, \$2.25; SINGLE COPY, 15 CENTS

No additional copies will be sent after expiration of subscription except upon renewal.
 Entered as Second Class Matter April 14, 1908, at the Post Office at Chicago. Under Act of March 3, 1879.

Copyright 1912, by Popular Electricity Publishing Co.

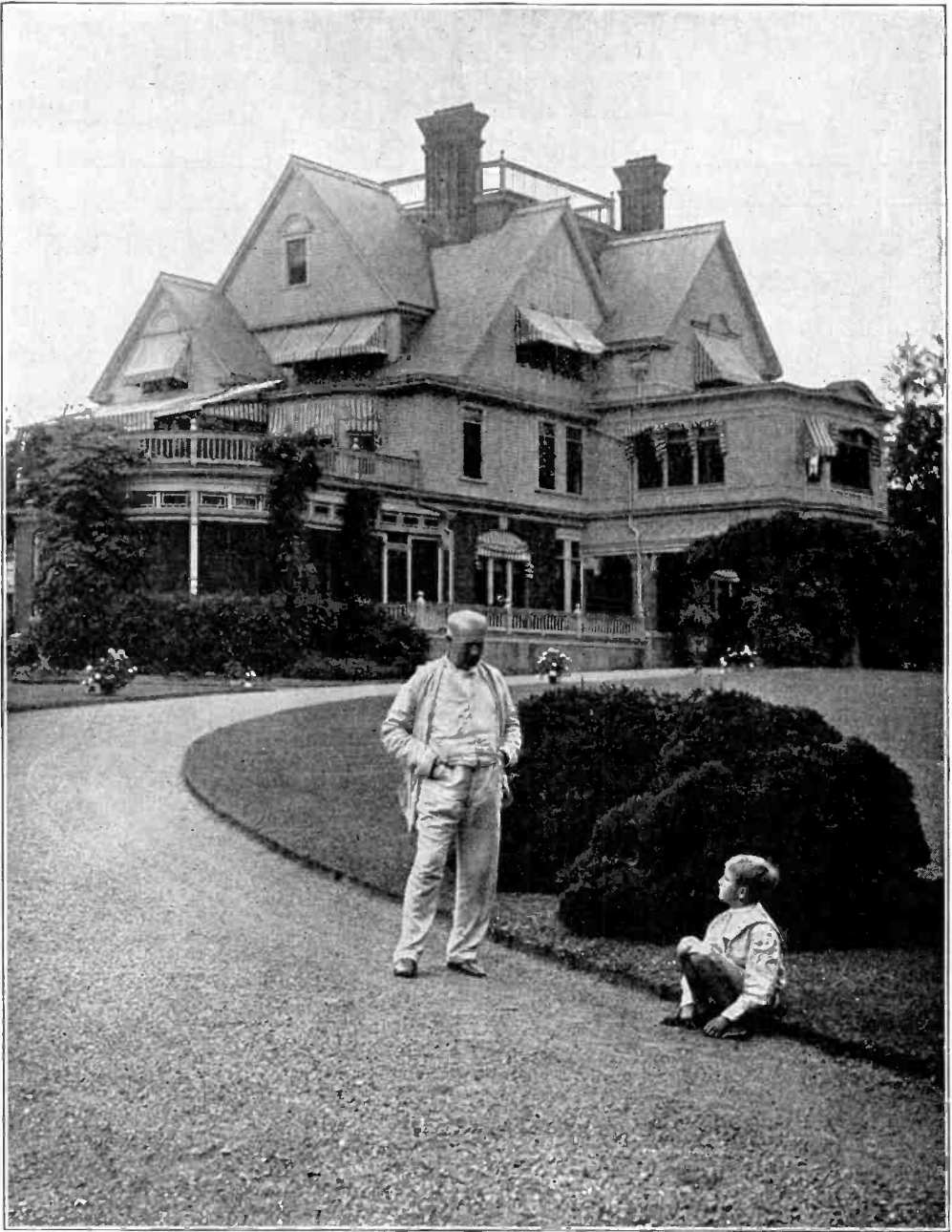

**MR. EDISON AND HIS YOUNGEST SON CHARLES—A YOUNGSTER WITH AN
INSATIABLE APPETITE FOR KNOWLEDGE**

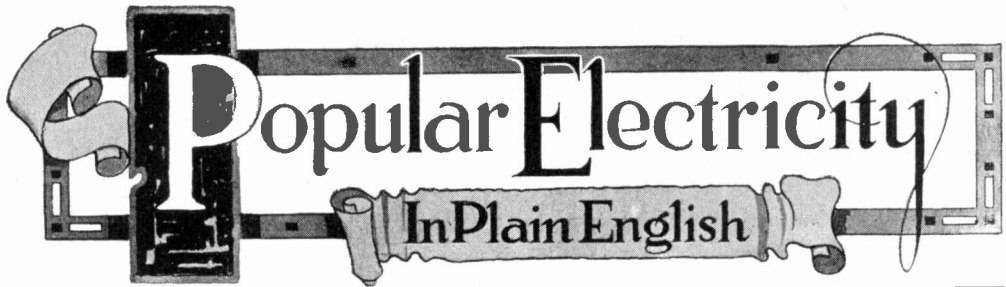

Popular Electricity

In Plain English

VOL. V

JUNE, 1912

No. 2

Phonographs and the Man that Invented Them

By FRANK PARKER STOCKBRIDGE

When I was a very small boy a man came to our school one day and showed us the queerest looking machine we youngsters had ever seen. It looked as though he had borrowed his mother's rolling pin, covered it all over with the tinfoil from as many yeast cakes as Daniel Clark ever had in his grocery store at once, put a little crank on the end of the pin and hung it between two uprights so that when the crank was turned the tinfoil-covered rolling pin would revolve. Any boy could see that far into the mechanism; but what we couldn't understand was the big tin funnel that stuck out at right angles to the rolling pin—such a shaped funnel as every one would call a "megaphone" today, but as megaphones hadn't been heard of then, the only thing we could compare it with was the speaking trumpet Peter Hopkins hollered through when the fire company turned out. Peter Hopkins was the captain, and all he had to do was to holler.

Of course, we were curious, and our curiosity was only whetted when the man informed us that the odd looking device was called a "phonograph." "It is a talking machine," he said. "It was invented by Thomas A. Edison. Now, I am going to let one of you little boys talk into it, and you will hear the machine repeat what is said."

It was very plain that we didn't believe what he said. I know I didn't. I turned to Charlie Decker, who sat next to me, and whispered, loudly: "Aw, machines can't talk. He's going to do a trick."

I don't know whether the teacher heard that whisper or not, but just at that moment she caught my eye. "Come up here, Frankie, and talk into the machine," she commanded. I hesitated, but her compelling eye was upon me, and up to the platform I scrambled. There my wits forsook me utterly. I was rather proud of my prowess as a public speaker. Never a school "concert" occurred but I had to "speak a piece." But the notion of talking into the wrong end of a tin fish horn, as if I really believed the machine would talk back, completely unnerved me. I was dumb. I tried to remember the last "piece" I had recited, but not a word came. The man who owned the machine came to my rescue.

"Say 'Mary had a little lamb,'" he suggested, with kindly intent.

If I hadn't been completely benumbed and bewildered and utterly "rattled," I would have resented the suggestion indignantly. Why, that was only a "first-reader piece," and I had been spouting such advanced declamations as "Sheridan's Ride" and "The Wreck of the Hesperus" all winter. But not a syllable of one of these gems of rhetoric could I

cudgel out of my brain, so, after an instant of hesitation, which seemed an hour, I shouted the venerable nursery rhyme into the tin funnel.

The boys all laughed. What was worse, the girls laughed. I could feel my ears turning red as I stepped aside and feigned intense scientific interest in the next step of the experiment. I fervently hoped the machine would slip a cog somewhere and fail to work—for by this time I was convinced that the man took it seriously, at any rate. But there was no such luck in store for me. The man slid the tin horn back along the rolling pin, turned the crank, and out of the speaking trumpet issued such a squeaky, high pitched, ridiculous caricature of my own voice that even I had to smile. But the smile didn't last long. After the first word or two, I began to hope against hope that the thing would stop at the end of the first line. But the man who owned the machine was evidently proud of its accomplishments, and he ground away relentlessly to the bitter end.

The last few words were utterly lost in the gale of laughter that swept the school from the little ones in the front seats to the "sixth-reader class" in the back rows. I don't know how I got off the platform, but I know my face seemed as if it were on fire, and I had to bite my lips to keep the tears of chagrin and rage from flowing. I felt that I had been imposed upon and put in a false position as embarrassing as it was undeserved. I didn't hear a word the man said in the "lecture" that followed the—to me—painful exhibition, but when we went out for recess I *did* hear one of the boys call me "Mary." The fight that followed was a delightful relief to my pent-up emotions, but I still feel foolish whenever I think of my first adventure with the phonograph.

That was the first time I had heard of Thomas A. Edison. Not long afterwards, however, they began putting in telephones in our town. People today do not always think of Edison in connec-

tion with the telephone, but in that day he shared the honors with Professor Bell. There was rhyme that comes back to me out of the "weis-nicht-wo" which people used to regard as very clever indeed. Its title was "Electricity," and it ran like this:

" 'Twas Franklin first that caught the horse;
'Twas harnessed by Professor Morse;
'Twas shod by Bell and Edison,
Inventors of the telephone."

There began to be a great deal of talk about Edison. We heard about electric lights. Then one day—I was in the High School then—it was announced that Main Street would be illuminated that night by electricity for the first time. Everybody in town went out and paraded up and down Main Street. They were arc lights and they spluttered, and lots of us were very much disappointed indeed. We had expected to see that part of town as bright as day. However, I don't remember that anyone blamed Mr. Edison very much, even though most of us were under the impression that he was responsible for the arc lights. The papers were full of a new kind of electric lights he was said to have invented, which would put the arc lights completely out of business. I don't suppose any scientific subject has ever commanded the space the incandescent light got for many years. Some one started a story that Edison had sent his new light up in a captive balloon—a wire running up the anchor cable—and that it gave a light brighter than the evening star, and was going to become a permanent beacon for ships entering New York harbor. People talked about that—called it the "Edison star"—and named the inventor "The Wizard of Menlo Park." Every little while some one would "discover" the Edison star through a telescope and write a letter to the papers about it. And before long the incandescent lights began to creep into use—looking like white-hot hairpins in bottles. And pretty soon Edison began to be regarded as an institution rather than a personality, and all sorts of

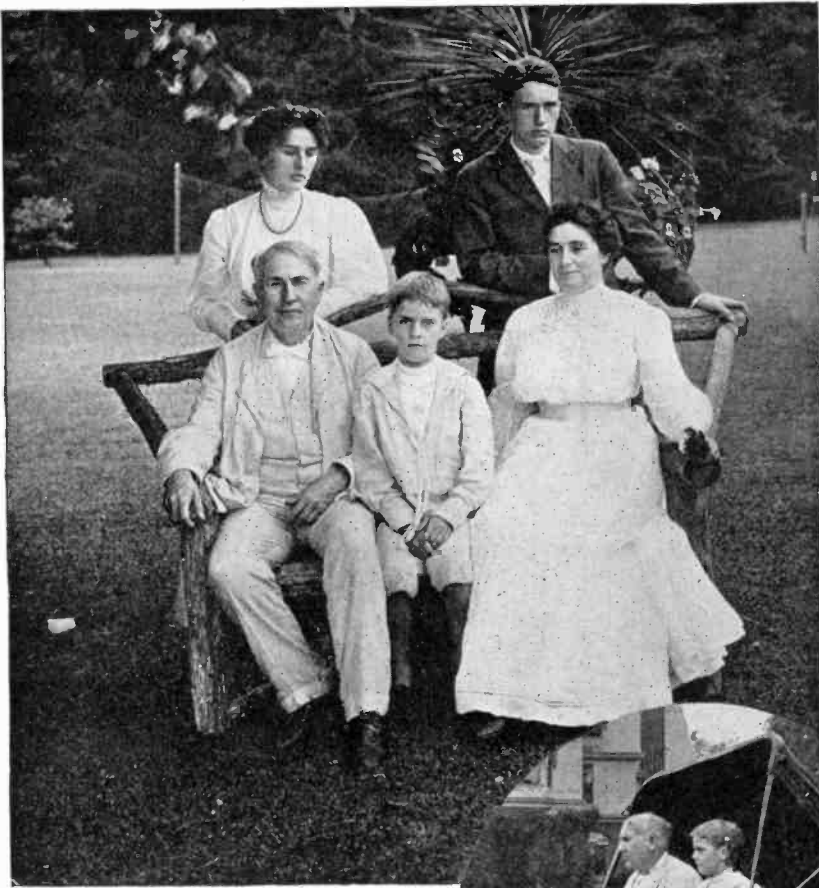

MR. AND MRS. EDISON AND
THEIR THREE CHILDREN,
MADELINE, THEODORE
AND CHARLES

impossible and fantastic inventions and theories began to be attributed to him, and the world whizzed along so fast that people took every new thing as a matter of course, and hardly batted an eyelash when the moving pictures came out with Edison's name as inventor, or when phonographs began to sing instead of to squeak, or when anything else that was marvelous happened.

A good many years after the adventure of "Mary's lamb" I held an editorial position on a New York newspaper.

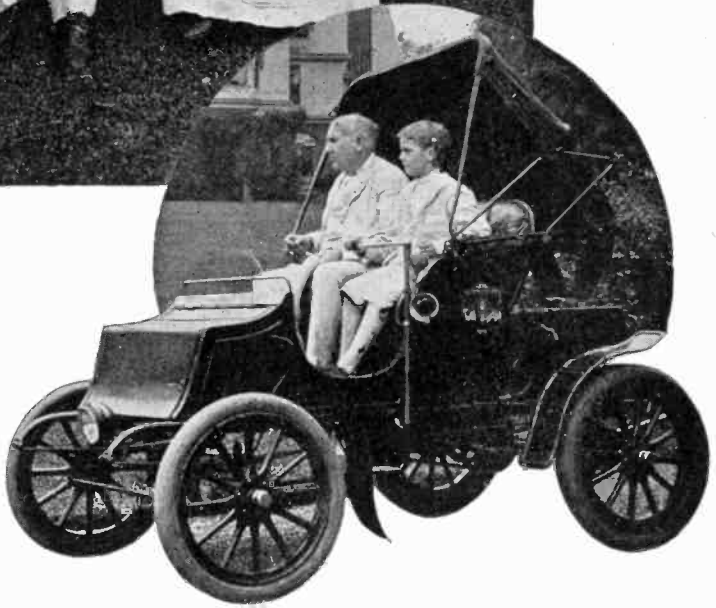

One of my jobs was to open the "letters to the editor" and answer the questions of "Anxious Reader," "Constant Subscriber" and "Vox Populi." One day a man in Brooklyn wrote in to ask how he could identify the Edison star, which he understood was sent up every night

to a height of a few miles or more. A week or two later some one else wrote a similar inquiry. I found in the course of a year that I could rely on getting an average of two letters a month from people who still believed in the Edison star myth, 30 years after it had first gained currency.

Then, one day, going through some papers in the "morgue," as the files in which clippings and reference material generally are kept are termed in newspaper offices, I found an old, yellow, pen-written manuscript—40 or 50 pages of it—dealing with the life of Thomas A. Edison. The name at the head of it was that of a man who had been a "star" reporter in his day, but who, for years, had been merely a tradition in the office. And the date affixed to the document was 1879—nearly 30 years before!

Thirty years ago—and Edison was then already so famous that the newspapers had prepared for possible emergencies by having several thousand words of "obituary" material prepared and ready for use! It staggered me for a minute. I was almost 40, yet when I was a little boy Edison was already one of the world's great men—and he was still at it. And from another point of view, there was something almost equally staggering in the thought that although I was not yet 40, I had seen almost the whole development of electric science, and the very beginnings of the wonders which the world of today accepts as commonplaces, bearing the name of Edison. I decided that, at the very first opportunity, I would visit Mr. Edison and see with my own eyes the man who had done so much in one lifetime to change the whole aspect of men's affairs. The opportunity came, not once but several times, and I found Mr. Edison all that my fancy had painted him.

The first time I visited Mr. Edison at his laboratory and factory at West Orange he was deeply immersed in experiments with the X-Ray. It was a comparatively new thing then—at least, not

as well understood as it is now. Two of his workmen had been badly burned by it—one, I believe, died afterwards. Mr. Edison himself had been affected.

"I've pulled one eye eighteen inches out of focus," he told me, "and have about ruined my stomach, but I'm still working eighteen hours a day."

I had read, of course, about those eighteen-hour work days of the great inventor—the story of his ability to work for weeks on end with only four hours of sleep nightly, and sometimes not that much, has been current for years. I had classed it with the Edison star myth, but found it to be literally true. I asked him how he did it.

"One secret is that when I feel sleepy I sleep," he said. "I don't hear things that would disturb other people, for one thing."

Mr. Edison is not at all sensitive about his deafness. It has been a help to him, rather than a hindrance, the defective hearing caused by a railroad man lifting him by the ears when he was a train boy in Michigan, away back before the Civil War. It shuts out all the little sounds that keep most ordinary men's attention subconsciously diverted from the work in hand, and enables him to concentrate on the task before him, oblivious of what is going on around him. Once, however, it nearly cost him his life.

"I was working in the Western Union office in Cincinnati, in the '60's," he said, "handling press matter on a night wire. I always had a lot of books to read—everything I could get about electricity. One morning, about 3 o'clock, I was walking rapidly up Vine Street toward my room, with a bundle of books under my arm. I felt, rather than heard, a faint concussion behind me. I looked around and saw a policeman with his revolver pointed at me. I stopped and the policeman came up to me, angrily inquiring why I hadn't stopped before. It seemed he had seen me hurrying along with a bundle in the small hours of the

Mr. Edison showed me some of the interesting things in his great phonograph factory—he bought back the phonograph patents, after having sold them for a huge sum, and now makes the machines and the records himself.

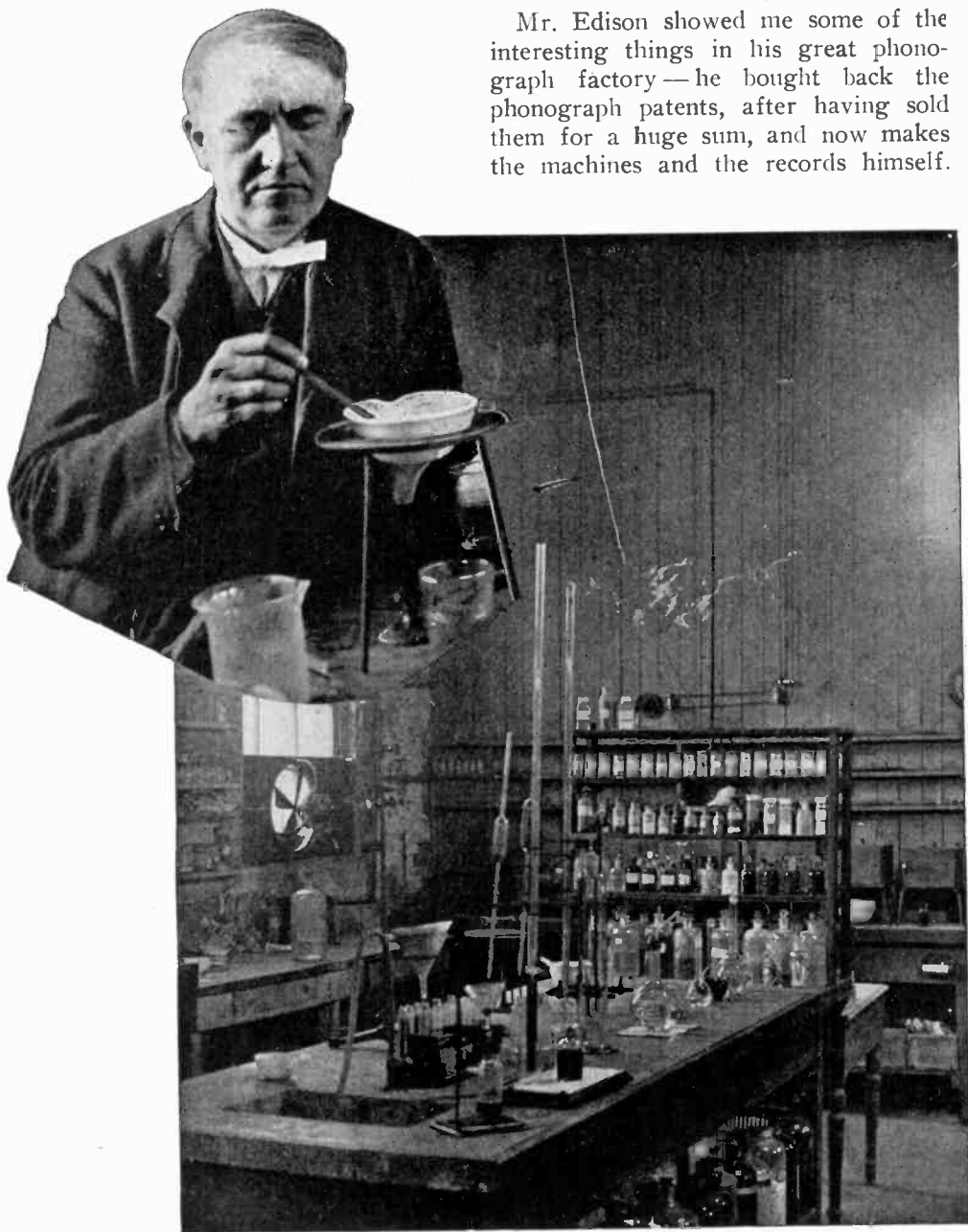

FORTUNATE INDEED IS THE OUTSIDER WHO CAN GET TO HIM WHEN IMMERSSED IN HIS EXPERIMENTS

morning and, suspecting me of being a thief, had called to me to stop. I had not heard him, and when I kept on without stopping, his suspicions had been confirmed, so he had fired at me. Luckily, he was a bad marksman."

Here was the concert hall, where musical "master-records" are made.

Since his illness of four years ago—from which he has entirely recovered—Mr. Edison, who is only 65 years young, has been giving a large share of his

attention to improving the motion picture camera. He has been working along two different lines. One is his plan of connecting the phonograph and the motion picture machine—synchronizing them—so as to enable the exhibition of “talking pictures.”

“That problem is principally one of detail,” he said, recently. “It is practically solved.”

The other motion picture improvement is that of reducing the dimensions of the film, so that the cost is not only greatly reduced but the moving picture camera is made portable enough to be taken anywhere and used even by amateurs. And the inspiration for this came largely from Mr. Edison’s twelve-year-old boy—a youngster with an insatiable appetite for knowledge.

“The motion picture machine with the quarter-inch pictures will replace text books in many lines,” Mr. Edison says. “It will teach geography, for instance, as it is impossible to teach it now. I have a man now in Africa, taking motion pictures of everything he can find in the Dark Continent, the films of which will be more useful in schools than any books you can buy.”

Once a year Mr. Edison allows himself a short vacation. Then he plunges into his work again, eighteen hours a day, and fortunate indeed is the outsider who can get to him while he is immersed in his experiments. There are a round thousand of patents to his credit already, and he keeps a patent attorney or two busy all the time preparing new applications. In his laboratories alone he employs a large number of the most skillful electrical and mechanical engineers, chemists and other experts, to work out the details of his ideas and carry on

experiments under his direction. He is an organizer and business man of the first rank, and has probably made more money out of his inventions than any other inventor in the history of the world, with the possible exception of Alfred Nobel, inventor of dynamite.

The other day a man came into my office and suggested that I needed a commercial phonograph. He offered to send one in on trial. It came, and one night, when there was nobody around, I tried it. There was something the matter with the adjusticator of the whiffledorf, or something like that, and I couldn’t get much satisfaction out of it. A day or two later the agent called again. I explained that the thing didn’t seem to work as it ought to. “Let me try it,” he said. He inserted the record with which I had been tinkering, twisted a screw here and tightened a nut there, and said: “Now I think it will work all right.”

There were several friends in the room—people whose respect I want to retain, if possible. Naturally, they were interested in the phonograph. So was I, when the agent turned the switch and out of the depths of the instrument came, in my own unmistakable voice:

“Mary had a little lamb;
Its fleece was white as snow,
And everywhere that Mary went,
The lamb was sure to go.”

Again I felt my ears burning and my face flushing. For a minute I was back in the old schoolroom again. I glanced at my visitors to see if they were laughing. I mentally dared them to laugh. They were more polite, at least, than the boys and girls of thirty-odd years ago. But if any one of them ever calls me “Mary”—



Double Deck Electrobus in London

London is noted for its cheap taxicab and omnibus service, and a large proportion of the people prefer to travel in

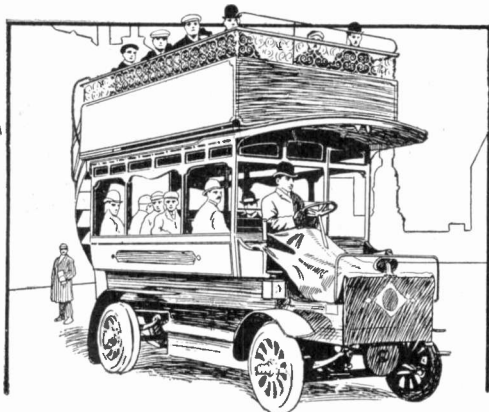

DOUBLE DECK ELECTROBUS

that way. Following the method there in vogue of building street cars with double decks, the London Electrobus Company is building its electric omnibuses with two decks.

A Public Unfamiliar with Coal

A statement was recently made by Mr. Edison to the effect that the time will come when the public as such will be unfamiliar with coal. All coal utilized will be consumed in central stations from which energy will be distributed for all lighting, heating and industrial purposes. In view of this prophecy, the proper work for the central station is to supply electrical energy for all possible services. Where such a result is accomplished the lighting load forms only from fifteen to twenty-five per cent of the total load on the station.

Ripening Walnuts by Electricity

An interesting new application of central service has been discovered in the California walnut country. The ripening of the nuts is now being artificially accelerated by placing the green nuts in trays, arranged in cabinets, beneath which there are electrically heated grids. Air is blown through the heated grids at low speed and warmed and thoroughly dried before passing over the walnuts, and it is possible by this means to accomplish in 24 hours a drying process that usually takes from a week to ten days, according to the weather.

Electric Radiators in Bears' Dens

During the extreme weather of* last winter those of the bears not belonging to the polar variety in the Bronx Zoölogical Gardens, New York, were affected by the cold. To prevent the brown and the grizzly bears from the danger of pneumonia their cages were kept warm by electric radiators.

There was some fear lest the bears form too great an affection for electrical warmth, and bear-like try to embrace their glowing friend, so heavy iron bars were placed in the dens in front of each radiator.



BRUIN FINDS COMFORT BY THE ELECTRIC RADIATOR

cable, which was done from a pontoon of three boats lashed together with a platform laid across their thwarts. The cable was reeled overside from the vessel, where it was wound on a large drum. When near the shore another boat acted

Arc and Incandescent Lights

It is a curious fact that while the average person knows that, roughly speaking, there are two kinds of "electric light," the arc light and the incandescent light, he has a hazy notion of the difference between the two.

The arc light and the incandescent light differ in principle, in brilliancy, in appearance and in the mode of use. The distinguishing difference to an ordinary observer between arc and incandescent lights may be briefly stated thus: Arc lights burn in air with carbon sticks or pencils, the points or ends of which are heated to a white heat by the current and gradually consumed.

Incandescent light, on the contrary, is produced inside small glass globes of various shapes from which air has been exhausted. These lights are caused by the passage of electricity through a fine resisting wire or filament which is thereby raised to a white or incandescent heat without being consumed on account of the ab-

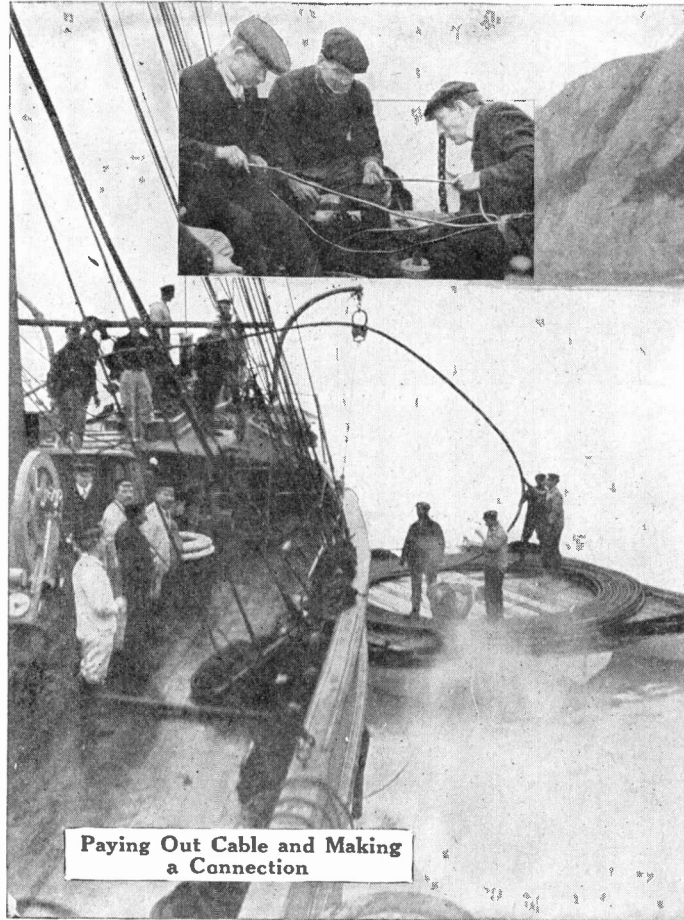

Paying Out Cable and Making a Connection

as a guide and drag for the cable pontoon. Then it was carried ashore through the surf and among the rocks to the beach at Dover.

The work was done under the charge of Chief Electrician Redgrave of the Telegraph Construction and Maintenance Co., Ltd., for the French government.

sence of air. If air leaks in, the filament immediately burns up, and that is the end of it.

The term "arc" is an old one, adopted years ago, referring to the shape of the electric spark in passing from one carbon point to the other with the carbons in a horizontal position.





Men Who Follow the Law of Ohm

By JOHN F. GILCHRIST

President of the National Electric Light Association



Not infrequently you may observe a man who wears in the lapel of his coat a button of the above design. He acquires the right by becoming a member of the National Electric Light Association, and he may be identified at once as being connected in some way with the electric light and power industry of the country. He may be an engineer or an officer in one of the great metropolitan companies furnishing light and power to the extent of hundreds of thousands

of horsepower, or he may own or operate a small plant in Texas or Idaho or Maine whose sphere of influence is only a small village. The men of this great association are all bonded together by a common interest—to advance the methods of production, distribution, utilization and sale of electric current, and so their influence is felt in the communities where current is used.

The central emblem in the design of the button is very expressive, to the electrical man at least. The equation

$$E$$

$$C = \frac{E}{R}$$
 represents the fundamental law

$$R$$

of electricity announced by George Simon Ohm over a century ago, and



named after him "Ohm's Law." The fact expressed by the simple mathematical equation (that the current flowing in a circuit is equal to the electromotive force or pressure, divided by the resistance of the circuit) is one of the foundation stones of modern electrical science and achievement, and particularly so where electricity is distributed over lines of wires as in the case of an electric lighting system.

Members of the National Electric Light Association

are found in all parts of this country, in Canada, Alaska, Mexico, South America, Cuba, Hawaii and the Philippines. Every year they hold a great convention in some city in the United States, where they gather together, two or three thousand strong, and discuss matters pertaining to the engineering and commercial phases of the industry, the papers and discussions being printed and sent to all members of the Association. This year, June 10 to 14, the convention will be held in Seattle, Wash., and although the city is in the extreme West a record breaking attendance is expected. Special trains will be run from Boston, New York, Chicago and St. Louis. Some of these tours de luxe will include side trips to Yellow-

stone Park, Denver, the Grand Canyon and points in California.

The city of Seattle, under the guidance of the Seattle Electric Company, is making elaborate preparations for the reception of the guests. A great armory will be placed at the disposal of the association. Here the sessions will be held and there will be an extraordinary exhibition of electrical machinery and appliances of every type. Special illuminations in the streets will be a feature and

inspection tours to points of interest in the western city and neighboring points provided.

In addition to the above message to the general reader I wish to say to the members of the N. E. L. A. that the Seattle gathering is going to be one of the greatest, in all respects, in the history of the Association, and your attendance there will be a benefit and pleasure to yourselves and a compliment to the present administration.

Brief Sketch of the National Electric Light Association

By T. COMMERFORD MARTIN, Secretary

The greatest body of its kind in the world today is the National Electric Light Association; born in Chicago, February, 1885, and now about to hold its thirty-fifth annual convention at Seattle, where it visits the Pacific Slope for the first time. This industrial and engineering body now has a membership of close upon 12,000 and spends on its general work upwards of \$100,000 a year. In the early days of electric lighting anybody who had a plant, even if it was a small dynamo to run one arc lamp, could come into membership, but for some years past this membership has been limited to central station companies and their officers and employes and similarly to the manufacturing companies which supply apparatus for use in the generating plants

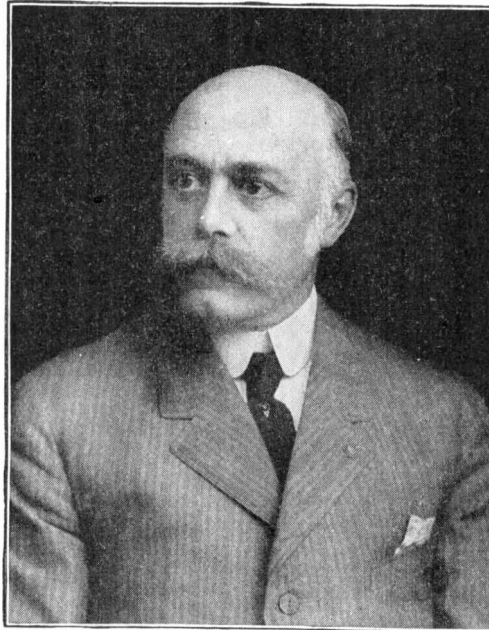

and on the consumption circuits.

Some idea of the scope and influence of the Association may be gathered when it is stated that in an industry representing about \$2,500,000,000 of capital and with an income of over \$300,000,000 a year, it embraces in the 1,100 operating companies that are members not less than 90 per cent of the investments and the earnings. The re-

sult is that when the Association issues reports and recommendations whether as to line construction, accounting, electrical apparatus, terminology, lamps, motors, underground construction, power transmission, or as to other features of the business, its conclusions are adopted at once and virtually become law throughout the industry. From this ac-

crues an enormous gain in economy and efficiency, one result of which is seen in the fact that central station electrical supply is one of the very few things which has grown steadily cheaper in the age when every other necessity and all the luxuries have practically reached the highest prices known since the Civil War. There has also followed an enormous extension of the services and it may be safely asserted that, the country over, the relations between the companies and the public to which they supply electric light, heat and power, etc., are more friendly and more harmonious than ever before. This gain is largely due to the work of the Association.

In the way of organizing the industry the Association has proceeded along three parallel lines. One of these has been to affiliate or create state or geographical sections so that more than half the country and the Dominion of Canada are thus represented in its ranks and in its governing body through the local organizations. The second line of development has been that of company sections, of which there are now some 50 in the larger companies, with several thousand members from among the officers and employes. An enormous amount of educational work is done through these adjuncts. The third parallel line is that of national sections, devoted to a specific part of the industry such as Commercial, Power Transmission, etc., and these national sections are growing rapidly in interest and importance. The Commercial Section for example has already between 1,200 and 1,500 members. It is believed that by means of these processes of development the membership of the Association will easily be carried during the next five or ten years to 25,000 or even 50,000 members.

The great work of the Association is done through its annual convention, which usually lasts three or four days, with two or three sessions daily, at which some 60 or 70 reports and papers are presented and discussed by the leaders in

the art. The papers are always carefully selected and the reports come from some 50 standing committees made up of the best known experts connected with the member companies. The proceedings of these conventions are issued annually and are in great demand. The Association in addition does a large amount of publishing and has issued for example an electrical solicitors' Handbook, of which some 12,000 copies have been sent out: a standard system of accounting; an annotated index of its proceedings for the first 25 years; a digest of the first seven years of its Question Box; valuable reports dealing with welfare work and the laws relating to Public Service Commissions, and single reports which are in steady demand on meters, overhead line construction, preservation of poles and cross-arms, and kindred subjects. The Association issues also a monthly Bulletin, which has rapidly become a standard magazine in interest and contents, and now has attained an edition of 12,000 copies per month and a size of from 80 to 100 pages. Its special feature is the Question Box, which publishes every month questions and answers as to problems which have arisen in the conduct of the business. This enables every reader to bring himself right up to date on even the most difficult subjects and perplexities of the hour.

As an example of the work which the Association assumes in its public and national capacity may be mentioned the Commission, which it organized recently with the aid of the American Medical Association, for inquiry into the best methods for resuscitation from electric shock. A body of distinguished men are now engaged in promulgating a report which will be final and conclusive and which is being eagerly awaited by the entire electrical world. It is in this and other public spirited, high minded ways that the Association has reached its present position of commanding influence and bids fair in the near future to transcend all the many notable achievements that have already attended its career.

Some Past Presidents of the N. E. L. A.

ANECDOTES AND REMINISCENCES OF SOME OF THE MEN WHO IN
THE PAST HAVE GUIDED THE AFFAIRS OF THE
NATIONAL ELECTRIC LIGHT ASSOCIATION

W. Winans Freeman

Vice-president and General Manager of the
Edison Electric Illuminating Com-
pany of Brooklyn

Associates of W. Winans Freeman are fond of saying that he possesses marked power of hypnotism, and though he scoffs at the suggestion, they offer many incidents in proof. The truth is that Mr. Freeman is a close student of the psychology of human nature and profits by reason of the knowledge he has acquired. He is a natural leader of men because he has the rare power of per-

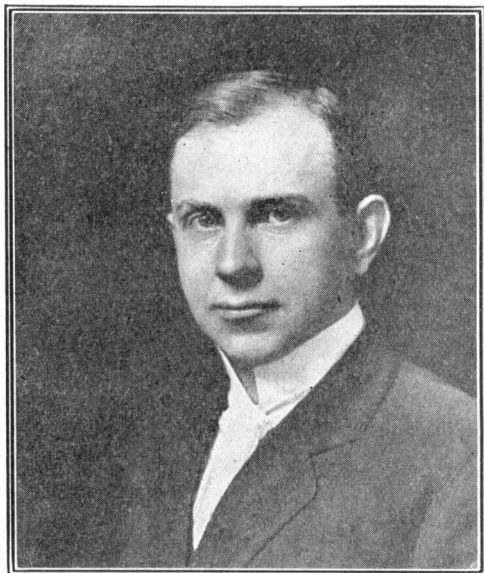

suading men to do as he desires them to do, and yet leaves them convinced that they have had their own way.

His methods are peculiarly his own. Ideas are one of his best stocks in trade. These ideas are suggested to others in authority, while no one but Mr. Freeman is conscious of the process. Then with

infinite patience he waits until his ideas have been digested and assimilated by the one to whom they have been given, and when the results have been produced he is the first to offer congratulations upon the good work done and the power of initiative displayed. That is what his friends mean when they say that he is a hypnotist.

It is methods such as these that have made a great big working family out of the employees of the Brooklyn Edison Company.

About six years ago Mr. Freeman became convinced of the advisability of treating business corporations as profit sharing institutions. Service annuities for the employees also won his approval. Quiet inquiries convinced him that those then in authority in the Brooklyn Edison Company were not quite ready for the innovation. So he started his hypnotic influence at work, and with only a few knowing of what he was attempting to do, he successfully prepared the minds of his associates for the suggestion which he intended they should themselves make.

So it happened that profit sharing and service annuities were introduced as a part of the Brooklyn Edison Company's policy, with more than one hugging to his heart the delusion that the plan had been born of his initiative. Mr. Freeman has been satisfied to note the result—the tremendous efficiency of the corporation which commands his services.

W. Winans Freeman started with the Edison Company 22 years ago at a salary of \$22 a week. He began as stenographer to the general manager. His first promotion came when he was made assistant secretary. He was not satisfied to do his work and go home; he made a study of the affairs of the corporation, and in a very few years, when

his official supervisors desired any information that concerned the Edison Company, and which was not readily at hand, they asked Freeman. So general became this custom that "Ask Freeman" passed into an axiom and a byword. Naturally, now that he is vice-president and general manager, it is more in use than ever.

There are never any peaks in Mr. Freeman's temperament curve. He always has complete control of himself under all conditions. One of his friends tells an amusing story illustrating this characteristic.

Mr. Freeman is an ardent golfer, and, as the story goes, he undertook to make a mashie shot over a bunker of stones, striking the ball with a long stroke. The ball encountered one of the large stones and came back as fast as it went, striking him in the right eye which promptly swelled to large proportions. Now the average man under such circumstances would have become vicious and said things more expressive than elegant. But Mr. Freeman's only comment in this particular case was: "My, but that was a hard crack!" Then, with his usual whimsical half smile—in the uninjured optic—he set about, very methodically and coolly to make that bunker.

Louis A. Ferguson

First Vice President of the Commonwealth Edison Company, Chicago

Ten years have passed since Mr. Louis A. Ferguson was president of the National Electric Light Association, and since which time he has also been president of the Association of Edison Illuminating Companies, and of the American Institute of Electrical Engineers, being the only man who has thus been honored with the presidency of the three great electrical associations of this country. Notwithstanding all these honors and the natural cares of a strenuous business and professional life he is still the same jolly, good natured "Louie," as his intimate friends call him, and has still the same wonderful resource and sledge hammer

energy as in the days when he furnished allopathic doses of ginger and "light" to the N. E. L. A. conventions by his discussion with John W. Howell on incandescent lamps, or with H. A. Wagner on distribution, or with H. L. Doherty on rates.

There is just one subject that even his most intimate friends do not mention in the presence of the versatile Mr. Ferguson and that subject is "Pants." The natural instinct to be watchful over one's wallet or other possessions of value is in his case concentrated on that particular article of his wearing apparel and when

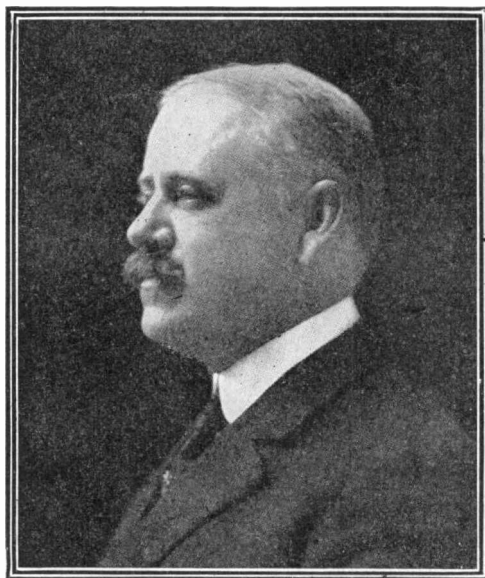

he retires aboard the sleeper now he restores their accustomed creases by the pressure of his leonine head on the pillow above them rather than trust them to the valet in the "baggage car ahead."

All this is due to the gossip that this prominent authority on matters electrical, technical and commercial, could have been seen, and, in fact, was seen promenading the railroad track near Rochester, New York, one cold winter morning about 2 o'clock with some of the famed ladies of Chicago society. In addition to the unusual features of the time and place for such a promenade it was observed that as far as one could see

Mr. Ferguson was clad in overcoat and shoes with some inches of gray colored pajama legs showing between.

The explanation is that Mr. Ferguson was on his way to New York and there had been a wreck, in a small way, of the "Century;" the front portion of the train speeding miles down the track before it was discovered that the rear coaches had been derailed and left behind. The valet had the trousers some miles further on the way to New York.

Dudley Farrand

General Manager of the Public Service Electric Company of New Jersey

Two New Jersey "commuters" were standing on the forward deck of a North River ferry boat, discussing human nature and its vagaries.

"I'm looking for a man," said one of them. "I've got a mechanical wonder

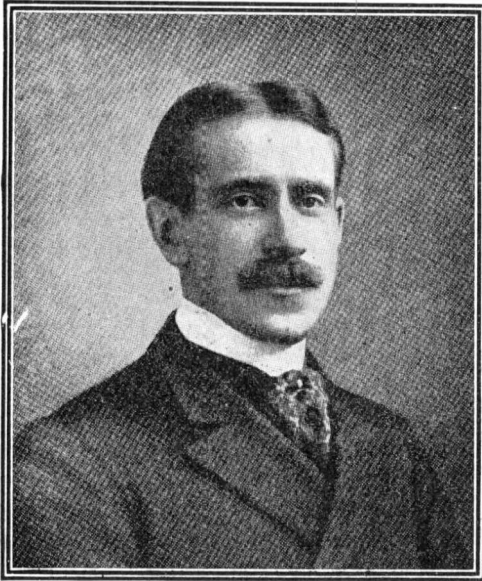

who can take any old kind of raw material and construct a machine out of it that will work. I've got a fellow who can carry out orders to the letter—provided the orders are carefully written out and explained to him. I've got another fellow who can do anything either of

the others can, but when it comes to trying something new, he always comes back with the objection, 'It can't be done.' Now, I'd swap the three of them for one man who could tell other people how to do things—who doesn't have to have a book of rules to go by."

"There's only one man like that, so far as I know, and he's got a good job now," replied his friend. "He can take a cake of soap and a coil of wire as a starting point, and show a gang of workmen how to construct a piano player or an aeroplane around that nucleus. I don't think he ever paid any attention to a rule in his life—he makes up his own rules as he goes along."

"Who is he, and can I get him?" asked the first "commuter." "I'll pay a man like that any salary he demands."

"His name is Dudley Farrand, but you can't get him at any price," replied the other. "He is general manager of the Public Service Electric Company, and he's never worked anywhere else in his life. It doesn't make any difference how high you bid—they'll bid higher to keep him."

A friend of Mr. Farrand, who overheard the conversation just quoted, declared that he had never heard a better characterization of the man who is responsible for the electric lighting service in 161 municipalities in the State of New Jersey.

Mr. Farrand's early ambition was to go to Princeton University and study civil engineering. The death of his father, just as he was preparing to enter college, made this impossible. He was offered an opportunity to study law, but instead accepted an offer to become the entire office force of the Newark Electric Light and Power Company. His friends say, incidentally, that he has been pretty nearly the whole company ever since. At that time—1887—the company was equipped for 365 incandescent lights and 175 arcs—the largest central station in New Jersey. It did a gross business of around \$25,000 a year, and young Farrand got the munificent

salary of \$5 a week. But while he was running the clerical end of the business he was studying the operating end, giving his evenings and all his spare time to electrical engineering, and in 1892 he took hold of the "real work," as he calls the operation of an electric generating station.

Charles L. Edgar

President of the Edison Electric Illuminating Company of Boston

Mr. W. P. Hancock of the Boston Edison Company relates a good story concerning Mr. Edgar's early career. "In March, 1883," he says, "in the early days of the electric lighting business, I had a

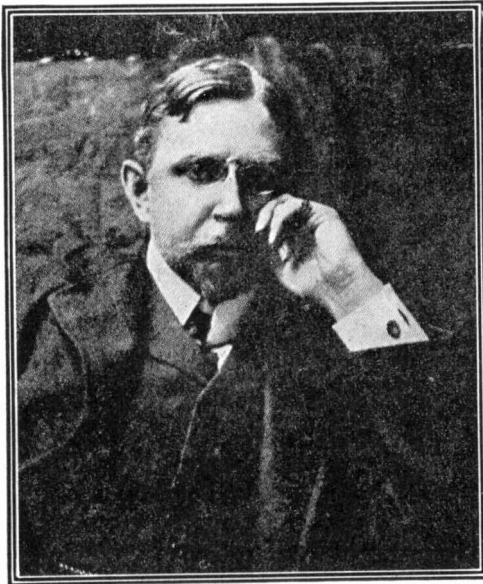

job on the installation of an electric lighting plant in the factory of Seamon, Bache & Company, corner of Desbrosses and Greenwich Streets, New York.

"The second day we were at work there, a tall, young man made his appearance in the basement doorway. He was rather lightly built, nicely dressed, and in one hand he carried a tin, japanned box, marked 'Cake' in large, gilt letters on the sides. If I read his thoughts correctly, after first observing the ex-

pression on his face, he was mentally saying, 'What miserable hole is this?' To my great surprise, however, he put the box on a packing case, opened it, and what do you think—it contained wiring tools, and he was to help us out on that job.

"For the first time since I had been in my new employment as an electrician, I moved out of range and laughed—not at the man but the tool box. He went at the work, but there was nothing to indicate that he was overflowing with the enjoyment of it. I mentally took one guess that he despised that work, and some time afterward he told me that I guessed right. That man was Mr. Charles L. Edgar, now president and general manager of The Edison Electric Illuminating Company of Boston, and a very honored past president of the National Electric Light Association.

"He didn't give up the work and go searching aimlessly for something easier, cleaner and more congenial. He stuck—'like a dog to a root,' and his determination, supplementing his ability, has carried him successfully upward.

W. C. L. Eglin

Electrical Engineer of the Philadelphia Electric Company

A few months ago the business of the Philadelphia Electric Company necessitated the erection and complete equipment of a 9,000 kilowatt sub-station. Now a 9,000 kilowatt sub-station is no toy, for be it remembered that 9,000 kilowatts is equivalent to over 12,000 horsepower. Moreover, the whole outfit with its frequency changers, exciters, switchboard, concrete compartments and auxiliary apparatus, had to be finished within the short period of four months. This was a job of the kind that mildly interested Mr. Eglin. He went at it, starting with the fundamental design, and saw it clear through, from the building foundation up to the throwing of the switches which connected it to the sys-



Henry L. Doherty

Head of the Firm of Henry L. Doherty & Company of New York

"Doherty luck" has been quoted so many times in public utility circles that probably some may believe that luck has played a great part in his advancement. Nothing could be further from the truth. Incessant work has had the most to do with the success of Henry L. Doherty. Even the time most men take for recreation is spent by him in work, but work that to him is the same as play to many other business men.

As an instance of this, some time ago Mr. Doherty had been for days engaged with some difficult engineering and financial questions which, finally solved, left him in need of what he calls "change of brain diet." Some days previous a friend had brought to his attention a chemical problem, which so far had failed of solution. It had to do with distillation and the friend said that if it could be solved, it would mean much for his business. A problem such as this is just the relaxation required by Mr. Doherty and so forgetting matters electrical for a time, he began to study the subject of distilling.

tem. Piles had to be driven. There were delays incident to inclement weather. There were other unavoidable delays in getting the apparatus together. But inside of the four months it was done.

For many years Mr. Eglin has been the electrical engineer of the Philadelphia Electric Company and its affiliated companies, and it is very largely due to his forceful personality and recognized engineering ability that the company is today in the front rank with the largest electric lighting companies of the world.

One of his most prominent characteristics is his constant thought for the advancement and uplift of the employee, and for protecting him against accident while engaged in the discharge of his duties. This being well recognized, a few months ago Mr. Eglin was appointed a representative of the Association on the Commission on Resuscitation from Electric Shock. This is a subject of vital importance to every one connected with the electrical industry; and the complete recommendations of this Commission, which also includes representatives of the American Medical Association and of the American Institute of Electrical Engineers, are being awaited with interest.

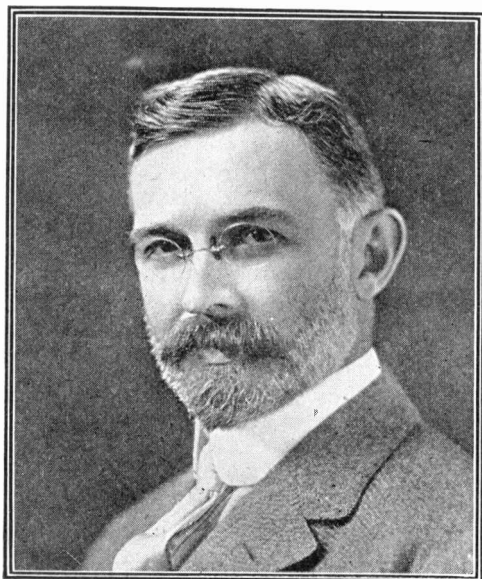

He solved the problem and the process evolved by him is now in use in the plants of his friend and incidentally an application for a patent on this process is now pending. With the solution of this question Mr. Doherty's play time was over and he returned again to his work.

A year ago Mr. Doherty was importuned by his partners and friends to forget business matters for a time, take a long vacation and go to Europe. He decided to do so and his friends declared that he would now have to have a real playtime away from all business. As events proved, however, they did not know their man. Mr. Doherty made the trip, had a good time, saw many countries and journeyed north to the midnight sun. But all the time his busy brain was at work, and after his return to his office the results of this work appeared in the announcement that the markets of Europe have been opened to the securities of the Doherty companies.

William H. Blood, Jr.

Of Stone & Webster; Insurance Expert of the N. E. L. A.

There is a certain resemblance between Mr. William H. Blood, Jr., and the great Cato, of whom it was said that "his powers were confined in no pent-up Utica." While Mr. Blood may not be able to exclaim with the Count of Monte Cristo "The world is mine," he is entitled to feel that the United States is his. For he has traversed it at the rate of about forty thousand miles a year for the last 20 years.

Practically every city in this country of over 10,000 population has been visited by him, and he has examined properties which represent over \$1,000,000,000.

He is the peripatetic philosopher of the Stone & Webster organization. He is here today, and there tomorrow; now you see him, and now you don't. In his

office he has a large map of the United States, and on every city that he has visited he has stuck a small black seal—it reminds one of a blackberry pasture when the picking is good.

Mr. Blood's activities have been many sided and far reaching. For many years



he has had charge of the expert examinations conducted by Stone & Webster. He had a prominent part in the creation of the electric code. He has an intimate knowledge of insurance. He has displayed a lively interest in the development of the electric vehicle, and is now president of the Electric Vehicle Association of America. He is well known as a lecturer on electrical and industrial subjects, and as a writer on matters affecting public utilities.

But it is impossible to describe Mr. Blood without resorting to the language of the real estate dealers—"This property must be seen to be appreciated." One must know him personally, must note the calm judgment of his business views, must listen to his witticisms (which always instruct as well as entertain), must be the recipient of his un-failing good humor, in order to estimate him properly.

Electric Pumping Plants

Operating irrigation pumps by electricity is rapidly becoming general in Texas and the Southwestern States. In the shallow-water belt of the plains country of western Texas and in many

which Brown University is situated. The grade is about eight per cent and is the scene of the heaviest traffic on the local trolley lines. The rise is close to a foot in every ten feet and the hill is half a mile long so that the climb is a hard one. It is manifestly impossible for any ordinary car to successfully negotiate such a grade and after the street railway company had tried and considered many

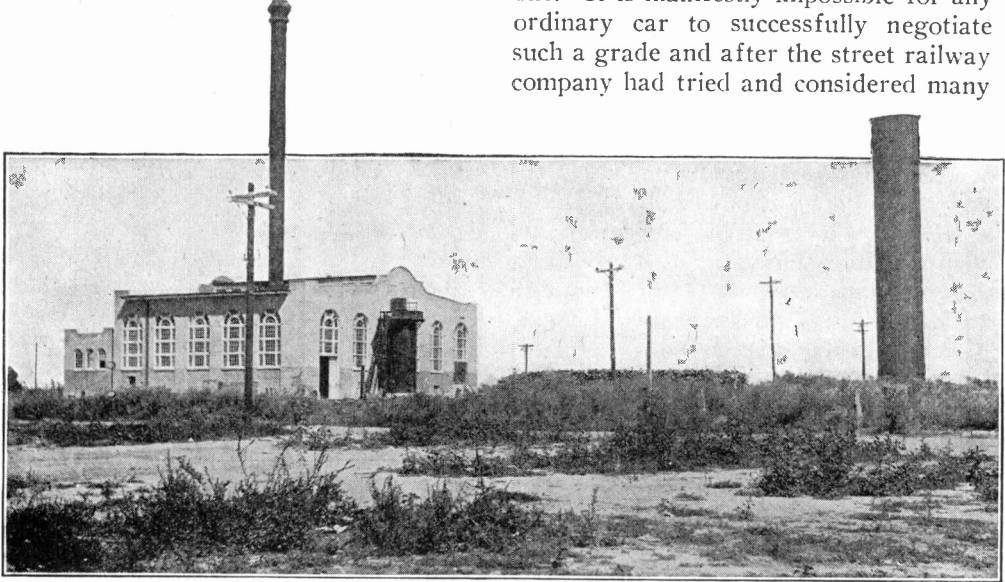

PUMPING PLANT IN THE LOWER RIO GRANDE VALLEY

parts of New Mexico and Arizona many small electric pumps have been installed in wells during the last two or three years. These pumps receive the power over transmission wires from central stations in the respective irrigated districts. In the lower Rio Grande valley of Texas is one of the largest electric power plants in the country devoted to operating irrigation pumps. The pumping station is situated upon the bank of the Rio Grande, from which stream the water supply for irrigating many thousand acres of land is obtained. The transmission lines run from the power plant to the pumping station.

Cars Helped by Counter Weights

What is claimed to be the steepest smooth rail hill climbed by electric cars is located in Providence, Rhode Island, called "College hill," the elevation on

of the cograil propositions without success the engineers hit upon the scheme of counterweights, which was installed with most satisfactory results.

The counterweights weigh about sev-

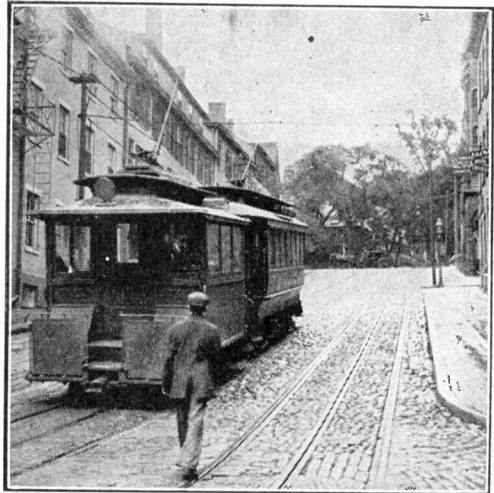

BELOW THE TRACK SLOT RUNS THE COUNTERWEIGHT CABLE

enteen tons each and run on an underground track and down the same incline that the cars do. The hill is double tracked and accordingly two sets of weights are in use, one to each track. In the center of each track a cable slot is utilized for a rolling grip to attach itself to the under part of the car. Special cars containing a single motor are used, which, exerting its full force, is just sufficient to move the grip car up or down against the effort of the counterweight. When other motor cars are being assisted up or down the hill they are switched in and coupled up behind the grip car and the power of both is used to make a fast trip up or down. This system gives a speed of more than twice that of any cog railroad known and though it would hardly work on a grade steeper than the one in which it is used on, it has proved eminently satisfactory where it is installed.

Aids to the Partially Deaf

Persons who are only partially deaf can often be made to hear very well by the use of a small electric device in the



SORET APPARATUS IN USE

shape of a telephone, which fits into the ear. We illustrate one of the newest of these and it is the invention of Dr. Soret, of Havre. He uses a telephone transmitter which is acted on by the voice, and also a receiver so as to act

upon the ear, but both of these are mounted together in a single box-like device. This is of very small size, and has a rubber tube made in the shape of the inside of the ear, so as to fit well into the ear.

Sometimes only one ear need be thus treated, just as a single eyeglass is carried. For both ears, the two devices can be joined by a light head piece passing in the rear. A small pocket battery gives the current.

Of another kind is the "microtelephone" made by Dr. Le Nouène, and here the transmitter is made in the shape of a small disk-like box with perforated cover which hangs upon the breast. In the ear is inserted a very small telephone receiver which is almost invisible. A flexible cord connects the different parts, including the battery.

Electricity from Peat

The St. Petersburg Electric Lighting Company has acquired an extensive peat field near Moscow where it is proposed to erect a large electric plant. Electrical energy will be transmitted to Moscow.



MICROPHONE OF DR. NOUENE

where the prices of naphtha and coal are unusually high. The quantity of peat available is sufficient to cover the fuel requirements of Moscow for a period of 100 years to come, according to conservative estimates.

Charles Proteus Steinmetz

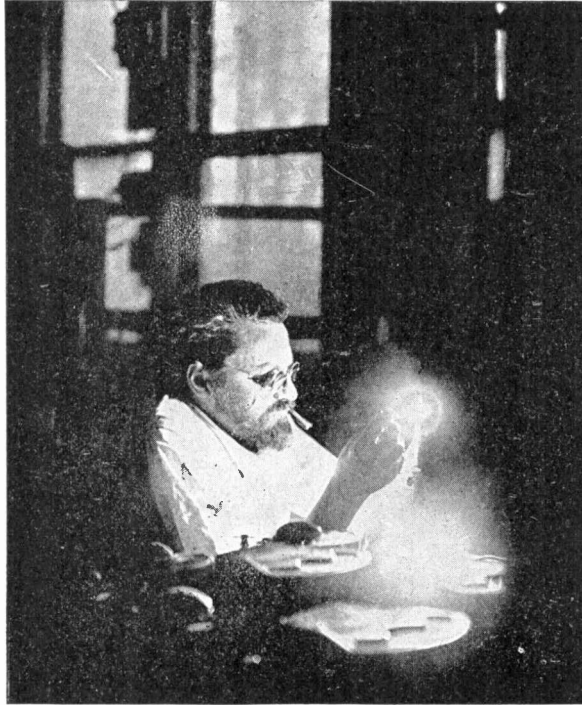

Photo by L. S. Uphoff
DR. STEINMETZ EXPERIMENTING WITH THE FLAMING ARC

When it was announced, a few weeks ago, that Charles Proteus Steinmetz had been appointed to head the school board of the city of Schenectady, N. Y., many persons who had known of him only as a famous electrical engineer wondered why and how this had come about. To those who really know Mr. Steinmetz, however, there was nothing surprising in his appointment.

"It's just another instance of Steinmetz living up to his middle name," remarked one of the men who knows him best. That sent those who heard the jesting comment to their encyclopedias. There they found that Proteus, in Greek mythology, was a prophet who knew all things, past, present and future, and who was able to take on any shape at will. Then they saw the point of the apt re-

mark, for if Mr. Steinmetz has a claim to distinction beyond his skill as an electrical engineer and inventor, it lies in the fact that he knows more different things and has played more different parts in the world drama than most men. There is one important difference between Mr. Steinmetz and his mythological namesake, however. The ancient Proteus was loth to tell what he knew. Charles Proteus Steinmetz has no such scruples.

It is because he is always ready to tell what he knows, and has the ability to tell it interestingly and intelligibly to those who are not as well informed as himself that he is known familiarly to the men in the General Electric works at Schenectady as "The Professor." More than that, he really is a professor, occupying



Photo by Geo. D. Rosenthal
TWO GREAT INVENTORS IN MEDITATION—SAID TO BE THE BEST PHOTOGRAPH EVER TAKEN OF MR. EDISON AND DR. STEINMETZ

the chair of Electrical Engineering at Union University, Schenectady, which he has held for many years. And his earliest ambition—or at least one of his early ambitions—was to be a professor of mathematics in a great German university. If he hadn't tried being an editor first he might have achieved that distinction, and Germany, rather than the United States, would be claiming the credit of his inventions.

It was while he was a student at the University of Breslau, in which city he was born in 1865, that the editorial bee found lodgment in young Mr. Steinmetz's bonnet. A friend of his was editor of a Socialist paper and was sent to jail in the cheerful way they have of sending Socialist editors to jail in Ger-

many. Steinmetz undertook to edit the paper while his friend was doing time. He succeeded so well that the police confiscated the whole paper. Thereupon Steinmetz started another, using the name of a harmless acquaintance as "responsible editor." Before long this publication was also suppressed. Incidentally, the police discovered that Steinmetz was the man who had been writing the articles that had got under the official skins of the ruling powers and reported the fact to the university authorities. They did not want to expel Steinmetz, for he was their most brilliant student, but he learned, through one of the student-detectives, that there was a warrant out for him and went away from there. He threw the police off the scent by buy-

ing a round-trip ticket—it is easy to throw the Prussian police off the scent, apparently, for the destination of his journey was a point on the Austrian frontier. He did not use the return half of his ticket, but continued across the frontier to Vienna, thence to Zurich, where he wrote articles for the Breslau papers, studied chemistry and electrical engineering, decided to go back to Breslau and try for the post of professor of mathematics, but finally fell in with a young American whom he accompanied to this country, arriving at New York with \$20 between them. He went to work for an electrical concern which soon after was bought by the General Electric Company.

“Steinmetz was the most valuable part of the whole plant,” said one of his friends recently. “The General Electric got a real bargain without knowing it.”

That he would have made good as professor of mathematics nobody who has come in contact with his tremendous faculty for figures doubts for a moment. It was told as a joke on the late General Frederick Dent Grant that when he was a cadet at West Point he misunderstood the instructions of the professor of mathematics and sat up all night trying to commit the table of logarithms to memory. But it is no joke to say that Professor Steinmetz really did that very thing—or what amounted to an even more stupendous feat of mental labor.

A few years ago he consented to accompany a party of friends on a hunting expedition in the Adirondacks. Not being much of a hunter, he remained alone in the camp while the others went out after deer. While they were away he thought of a mathematical problem the solution of which required the use of a table of logarithms. There was no such table within several hundred miles, so, remembering a few of the figures, he sat down with pencil and paper and calculated a complete table. Then he solved his problem.

It may be relied upon that the pupils

in the Schenectady public schools under the Steinmetz administration will have to learn arithmetic. Yet he has none of the adoration of mathematics for its own sake that some great mathematicians have had. “Mathematics is only valuable to attain results,” he says. Mathematics for mathematics’ sake is foolish.” And it was not because he was a mathematician, or even because he is a university professor, that he was made head of the school board. It so happens that the present city administration of Schenectady is Socialist, with a Socialist minister, the Rev. Mr. Lunn, as mayor, and it was Professor Steinmetz’s editorial experiences—together with his continuous advocacy of Socialism ever since—that had as much to do with his selection as anything else.

Of course, the work of the school board will not take him away from the General Electric Company, where he will continue to smoke his long, black cigars and to go without an overcoat, no matter how cold the weather—likewise to draw his salary of somewhat more than \$50,000 a year, which isn’t so bad for a Socialist.—FRANK PARKER STOCKBRIDGE.

Regulator for Street Car Lights

Those who read the morning and evening papers on street cars are aware of the fluctuating intensity of the light during the rush hours on account of the varying voltage. The lamps in street cars are usually connected in series; that is, five 110 volt lamps are connected in series with the trolley wire and the rail. A device to keep the current through the lamps steady is promised. It consists of a bulb, in appearance resembling a filament lamp. Within the vacuum bulb is a calculated length of iron wire the temperature and resistance of which change with the voltage. This bulb placed in series with the five lamps causes them to burn without flickering, according to reported experiments.

Eavesdropping by Science

By EDWARD LYELL FOX

The dime-novelist who first wrote "Hist! The very walls have ears!" wrote better than he knew. Then he wrote figuratively. Today he could write it literally because walls, you see, have grown ears! They're wonderfully alert ears, too. They catch the faintest voice; the rustle of clothing. They're susceptible to the slightest sound.

Of course, I mean the dictograph; the tiny instrument that in the last six months has revolutionized criminal detection. In walls, under sofa and chair, in chandelier, behind a desk, beside a window, it has hidden—the unseen listener to secret conversations. The secrets of prison cells have been tapped, hotel rooms and offices have given up incriminating conversation. To representatives of the law it has proclaimed loudly the whispered words of cunning malefactors. It has figured sensationally in the undoing of dynamiters, legislative bribe takers, grafters high and crooks low, across the continent. It eavesdropped in McManigal's cell in the Columbus, Ohio, bribery case, in the Lorimer case, in the office of the Iron Workers' Union at Indianapolis, in Gary, Ind., in—who knows? Always listening where we

know not, it promises more and more sensational disclosures, more confessions—an "automatic third degree."

It was to learn more about this instrument that I went to see the man who invented it. I had read about it. The word dictograph had appeared frequently in the public prints, but always in a report of something criminal. Its importance

morally was established. But was it of any use to the business man? Could it be made as essential to his office as, say, the typewriter? Surely the inventor could tell me. So I went to see him—K. M. Turner—and found him in a Broadway office building. It was in the theatrical district, very properly. Later, I learned that Mr. Turner made his dictographs in a factory out on Long Island, but one couldn't hold that against him. In his desk, you see, there are plenty for demonstrating purposes.

For a time he generalized in scientific theories applied to his invention. This over, he confessed the invention of the

acousticon and the interior telephone, as well as the dictograph. And as abruptly he asked:

"Have you been dictographed?"

On general principles, I said "No,"

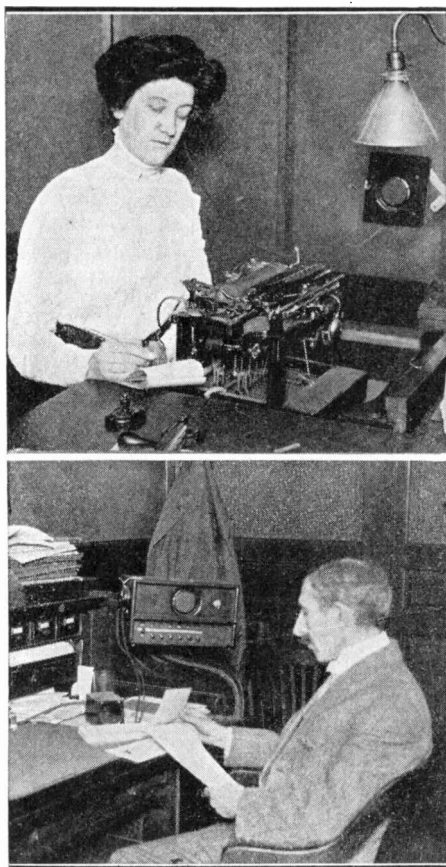

THE DICTOGRAPH IN BUSINESS LIFE

whereupon he asked me to stand in the most remote corner of the room and whisper, "Do you hear me?" This I did, pitching my voice so low that Turner himself couldn't have heard me. Imagine my surprise then, when, an instant later, there issued from a small wooden box beside his desk a distinct, full-toned voice that said:

"Yes! Of course I hear you."

I moved toward the box, and stood close against it. In a moment the invisible voice reported that a queer rustling sound had been heard. Mr. Turner said it was the motion of my clothes caused by breathing. I wondered if that infernal ear with its electric charged wires leading to some man in another part of the building could hear my heart beat.

"That!" suddenly re-

marked Turner, with a wave of his hand, "is the dictograph for the business man!"

And, rising, he dissected it verbally for me. The "commercial dictograph" consists principally of the transmitting disk or sound collector, which is the same as that of the "criminal dictograph," and an orifice which talks back the answer of the person at the "other end of the wire." In the box are half a dozen pegs which may be depressed to put the user in touch with as many instruments in adjoining offices. In fact, it is a wonderfully simplified form of the interior telephone. Only there is no "leaking" switch-board and no bother of taking down receivers from hooks. All you do is to sit in your office, talk and listen to the answers that, full-toned, come throbbing from the box. Thus you can dictate to a stenographer



PROF. FRANK PERRET, AMERICAN SCIENTIST ON MOUNT VESUVIUS, USING THE DICTOGRAPH TO COMPREHEND THE EARTH RUMBLINGS
CONVERSATION IS TRANSMITTED TO AN ADJOINING ROOM, UNKNOWN TO THE VISITOR, THROUGH A DIAPHRAGM CONCEALED IN THE CLOCK ON THE DESK

in an adjoining room and hold a business conference with several other rooms simultaneously.

"Corporations will have their meeting rooms fitted with dictograph ears," remarked Turner when we were seated. "It is applicable to all lines of business and professions. Then he told me how an officer of a corporation wanted to know the secrets of a room which had solid walls and no furniture except a desk in the center. Over the desk hung a chandelier, and at the base of the chandelier was a metal ball. In this was rigged a dictograph sound collector—the unseen ear. And a noted banker, he told me, has the instrument hidden in a clock on his desk. If he wants the conversation of a caller recorded he presses a button under the rug, with his foot, to notify a stenographer in the next room. She, pad and pencil in hand, sits beside her dictograph and writes.

Let us dwell momentarily now upon the "detective dictograph." Last year William J. Burns was regarded as the flesh and blood unification of Sherlock Holmes and M. Lecoq, with an Arsène Lupin dare-deviltry. That was before it became known that he used the dictograph. This with all respect to Burns' acumen as a detective, for he knew enough to make use of the latest that science had devised for catching criminals. Burns was the first American to see the immense possibilities of the instrument in detective work. He is so enamored with it that he always carries one in his pocket. Fictional detectives carry automatics and handcuffs. Burns carries a dictograph.

Let us see what this instrument is. Turning it over in our hand we estimate that it weighs a half pound. If we put it in a little leather case it looks like a small pocket kodak. Regarding its mechanics, there is a sound collector or transmitter, a receiving desk, a couple of small dry batteries and a double length of black silk covered wire. The sound collector is a disk of black hard rubber

weighing a few ounces. It is about three inches across and an inch thick. There is a metal eye by which it may be hung on a nail behind a desk or a picture. The wires are inserted at the lower end of the disk. To the receiving disk which the eavesdropper holds to his ear the wires are connected at their terminus. Necessary current is provided by the dry batteries. Unlike the "commercial dictograph," no provision for a chat between

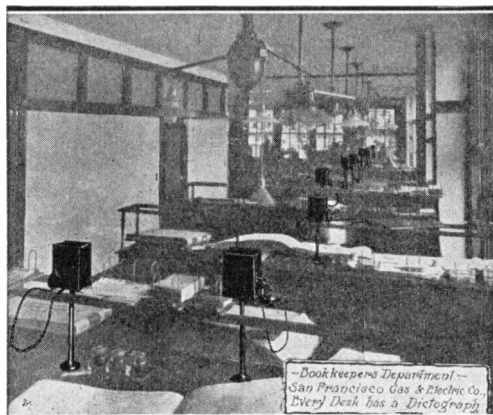

ANOTHER EXAMPLE OF THE COMMERCIAL
DICTOGRAPH

two persons is made. An eavesdropper doesn't want to talk back to the person whose conversation he is overhearing.

This sounds simple. The construction of the mechanical ear, however, is most intricate. On the outer extremity of the sound-collecting disk is a series of oblong, semi-circular openings. Through these pass the vibrations of air which constitute sound. Inside there is a cone, the point of which is an electrode and which reaches the center of the disk. Vibrations of air, striking the bottom of the cone, are reflected back and forth. They climb a circular mountain, so to speak, and become focused at the center and peak of the cone. The action suggests a burning glass focusing the rays of light on a central point. The disk gathers the sound vibrations within a circle about nine and a half inches in circumference and transforms them into electrical impulses to be sent over a wire.

So much for the mechanics of the ear, that is said to multiply sound four hundred times. Now let us see how it came to be. One day when Turner, experimenting with his interior telephone, was waiting for the person at the end of the wire to speak, he chanced to overhear snatches of a conversation. Like a flash the idea of the eavesdropping dictograph came to him. Upon perfecting his interior telephone he turned his efforts toward the dictograph. At first he had a difficult time getting anyone to take his machines seriously for detective purposes. At the Thaw trial an assistant district attorney turned down his suggestions flatly. Then, as many other inventors have done upon meeting rebuffs in this country, he crossed the Atlantic. Obtaining an audience with the late King Edward of England, Turner showed him a form of his invention, and the monarch said: "Scotland Yard should have it." Later, Paris and other continental cities took it up. The European detectives used it and kept their mouths shut. Also, the European newspaper man is not a prying person like his brother in America. So we on this side of the ocean did not know that such an instrument existed. Finally the United States Secret Service got wind of it, and an alert, red-haired man, called "Billy" Burns, began to dabble with it. Now he's known as William J. Burns.

Not until a year ago did the first published notice of the dictograph come. Then it was in connection with the Illinois shop grafting case. Burns had such success with the metal ear in running down the grafters that he tried it on the McNamara dynamiters. He's been trying it on people ever since. Last summer the ear overheard the legislative grafters at Columbus, Ohio. The incident disgusted these higher crooks exceedingly. Not so the honest population of the city. They held a dictograph celebration. Today you can buy dictograph cocktails at Columbus. What better proof of its popularity could be given?

Moreover, the Ohio Supreme Court upheld the dictograph as a legal evidence getter.

The surprising part about it all is that despite the publicity, the more it is used the more effective it becomes. Most people scoff at it until they have been sent to jail by its agency. Even then many of them are inclined to doubt. You cannot get around the fact that men must talk and the dictograph must listen. They cannot see it; they cannot find it. It's more elusive than the "dimmed elusive pimperl" of Fred Terry fame. Wallpaper may hide it. Under a ventilator its ears may be cocked; the stone wall of a cell may hold it, unseen—yet it is always listening.

I recall an instance that Mr. Turner told me. Two Italian crooks were placed in the cell of a Pennsylvania jail. In the cell was a dictograph, and some distance away, waiting for the electric current to carry their conversation to him over the wires, sat an operator. For five days, fearing that they would be overheard, the Italians kept silent. On the sixth day they could endure it no longer and broke into speech. And the metal eavesdropper heard every word.

Mouse Carries Thread Through Pipe

The fact that even so small a creature as a mouse will prove invaluable at times was realized by a contractor, who had without success tried every available means to pass a pair of wires through 197 feet of conduit having a right angled bend about half way of its length. Finally it was suggested that a mouse might be used. One was caught and a thread was fastened to its leg. It was then placed in the mouth of the pipe and given a start by a whiff of compressed air. It appeared at the other end in a minute or so with the cord. The rest proved easy as the cord drew tape through the pipe and the tape drew the wires in.

Electrical Securities

The Proper Time to Buy Stocks and Securities in So Far as the General Public is Concerned—How to Buy Them—What to Buy and Why You Should So Invest Your Money.

By "CONTANGO"

You as an individual, part of the general public, doubtless have on various occasions had this or that electrical share or bond brought to your notice as a good opportunity for getting good dividends or interest on your money, year in, year out, and without any risk of losing it. This short article will endeavor to tell you when, how and what to buy.

The ground has been carefully covered in this "Contango" series in so far as good faith, the wide prospect before you, the pitfalls in the past, and other necessary considerations are concerned. It is now time to particularize a little more closely, without giving names, for after the suggestions set forth concerning frauds and fraudulent companies that is scarcely necessary, even though it would be quite easy to place before you a list of such undesirable companies.

Though much has been made clear as to what public service and public utility companies are, yet would-be investors are probably still in the dark as to when to buy with the best advantage, because prices sometimes seem high and sometimes suspiciously low, and in either case there is much uncertainty as to what to do and what not to do.

In times of business depression, in panicky times, there is no greater opportunity, but usually you are afraid to part with your money then, afraid to make a single forward step, lest you lose your small capital or savings. In times of booming business and of general confidence and good faith, you often hesitate because you are apt to think the price too high, or else your money might possibly find a better opportunity in some small business chance in the improving business conditions. In the slack period between the extremes you are hopelessly at

sea, drifting along, fearing to take any initiative whatever. But opportunities for investment are always at hand, though you must be able to differentiate between the good and the bad.

The public utility or service company depends on the certain and constant growth of population and development of the country locally and generally. You can no more stop this than you can mark time in your steps through life. We have already in past articles discussed the question of management, amounts of stocks and bonds, and the like, and as a result it has certainly been made clear that when all these requirements of soundness have been fulfilled, you would have to search the world over to find a better stock or security for bringing you reasonable but certain returns than the issues of such corporations. On your stock—that is, shares—you may net, in strong companies, as high as 5 to 7 per cent per annum on your investment, and still the company be judged in the financial world as perfectly sound and reliable, and $4\frac{3}{4}$ to $5\frac{1}{4}$ per cent on your bonds is not too high a rate to expect.

The very fact that state commissions regulating such companies are being appointed from time to time only means further safeguards for your dividends and interest. Therefore the present time—and that means *now*—is always the best in which to invest your money in sound enterprises of this character. Do not for one moment lose sight of the fact that such opportunities come along from month to month, and if your money is not in them, it is probably idle or wasted in speculative chances.

Naturally, the electrical public service or utility—and this comprises many

power development companies—should prove very attractive, because electricity is so fast superseding every other form of light and power. The conclusions you should have drawn, and doubtless have drawn, then lead up to this *final note of action*—get your money busy and put it into the shares and securities of such enterprises.

Now, as to “How to Buy?” such stocks and bonds.

You will doubtless have noticed from time to time the advertisements of bond houses, bankers and brokers. As to the reliability of these houses you should judge by the class and standing of the publication in which they appear, and by making inquiries of your bankers or friends familiar with financial affairs. Sometimes they announce that they offer the stock or securities of this or that company at such and such a price; they also give particulars as to the rate of dividends or interest paid. It is to such houses you should write. You can also apply to your local banker in the case of companies whose circulars concerning their securities come to you direct, or who put out their own advertisements concerning the financial offerings or investment opportunities they are making to the public.

In practically all cases you pay a deposit on the allotment of stock to you, then the balance in two or more subsequent payments. The more important and substantial corporations, when declaring a dividend, declare it also on those shares partially paid up. On the other hand, cases have been known where, even when an individual has agreed to buy, say, ten shares in installments, and has paid up a quarter of the total amount, dividends have been withheld.

If you happen to buy some stock from an acquaintance or locally through your banker, be sure and have the transfer made at once at the offices of the company by which they are issued, or its transfer agent, usually some trust company or bank. If you buy by application

to the particular corporation's brokers or bankers, this transfer should be taken care of in all cases. Having your shares transferred to your name and thus registered insures immediate participation in the dividends as declared.

It is always better to buy outright if you have the money ready, as the matter is thus disposed of as one transaction. But where you are anxious to secure a number of shares at the then price, on which you fear there may be an advance, then by all means secure the number for which you can afford to pay in the specified time, by two or three installments.

Having bought shares in a great public service or public utility corporation at a high price, in times of activity in the stock market and when business sentiment is optimistic and all markets are strong, do not let go and sell out because there comes a time when the price shrinks. The stock of such corporations is always good as long as the management is efficient and honest, and in these days it has to be. At the time of the 1907 panic it was the stocks and securities of the great public service and utility companies that showed the lowest shrinkage, and their business, following natural conditions, in most cases continued to increase, so that they had much cash coming in at a time of prevailing dearth and shortage.

The price of bonds varies, as a rule, but a few points in the case of the larger electric undertakings, and most of them have excellent security and value behind them.

A few words as to the rate of interest on bonds will be in place here. Great estates, life insurance companies and other large investment institutions are still good buyers of low interest yielding bonds, but the average investor wants more, and he is getting it from the class of high grade public utility, municipal and industrial bonds now on the market. Moreover, dealers in investment securities are beset at this time with demands for “safe investments

yielding not less than five per cent." A few years ago safety and five per cent were considered almost incompatible, especially the degree of safety suitable for women, but nowadays five per cent appears to be the minimum of income demanded. The request for a list of safe securities yielding five per cent or more is repeated in every banking house. For a long time brokers said it was impossible to furnish it. A list of five per cent investments was not a list of absolutely safe investments, but the demand persisted and was met partly by new issues and partly by the decline in the prices of old securities, but mainly by the advent of the securities of the big, strong utility and public service corporations, so that now when an investor wants five per cent with safety he has a big selection from which to choose. Hundreds of five per cent lists may now be had, and in these incomparably the best companies named are the public utility and service corporations. And this steady demand for the five per cent bond brings naturally to the question of—"What to Buy?"

The answer is ready and is absolutely convincing. Buy the bonds of those companies giving public service or supplying the public with necessities, particularly the securities of those companies doing business in a territory where there is a constantly increasing population, and in places where there is concentration of population at many points, for the public service company, the public utility company, or even the industrial company supplying public needs has an ever growing source of revenue if its business is at all properly managed.

Municipal bonds of a high grade character, and that is to say such issues as have been tested by experts in their relation to their respective municipalities' revenues, and have then been brought out by reputable bond houses, are equally desirable.

A progressive future is before such corporations, and your income is as secure as the "Rock of Gibraltar."

As to the general outlook at this pres-

ent time—and never forget that the present makes the future—the British Chancellor of the Exchequer, Mr. Lloyd George, one of the ablest and brightest business heads in the world, in forecasting his budget for fiscal plans for his government for this year, referred, only a few weeks ago, very pointedly to the prospects in the United States as well as in the British Isles and to the future of international trade. His most convincing speech indicated that, in the opinion of those best posted and most certainly familiar with business and trade conditions the world over, there was nothing but satisfactory readjustment of all existing obstacles to renewed and continued prosperity for both nations ahead of us.

This, too, is the conclusion of the writer of these "Contango" articles. There is no time like the present in which to get the advantage of reasonable prices for both the stocks and bonds of those great electrical undertakings, which, of all utility companies, have the greatest certainty of development.

A New Use for Tungsten

Tungsten, which has become so well known through its use in metallic filament electric lamps, promises to find many useful applications in the industrial field. One of its latest applications is in replacing platinum on the contact points of induction and spark coils. It has a high melting point and is found to be much cheaper and many times more durable than platinum. Experiments are being conducted on tungsten points for spark plugs which promise great success.

An Automatic Wheelsman

A device for automatically steering a boat has been long sought for and has been the subject of much thought and invention. One device of this kind seeks to make use of the compass needle, through an auxiliary circuit, automatically to open and close the circuit of a motor which swings the rudder.

An Outdoor Elevator

This interesting view was taken at one of the mountain lakes of Switzerland. As is well known, much profit results

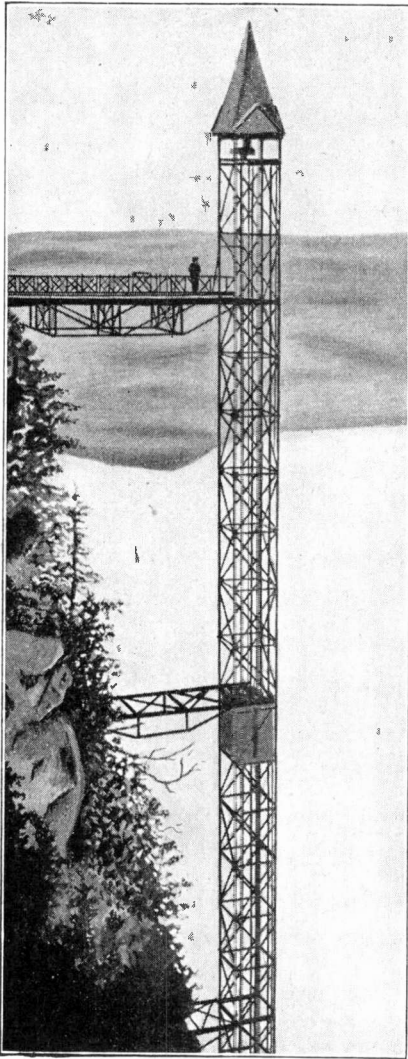

CURIOUS OPEN AIR ELEVATOR IN SWITZERLAND

to the people of that country through showing tourists the beauties of its natural scenery. But not all tourists care for the climbing part. So when there is some popular vantage point which cannot well be reached by the mountain electric railway, an outdoor electric elevator is often built to cut off some hundreds of feet of difficult climbing.

Miniature Motion Picture Machine

At a recent demonstration in the Minneapolis schools, motion pictures were shown, produced by a miniature machine, that were complete reproductions of "The Battle of Trafalgar," "The Declaration of Independence," "Niagara Falls," "The Cocoa Industry," "Magnetic Lines of Force," and other subjects of educational nature.

The machine itself is a complete model of the larger machine and has a regular hand feeding arc. The carbons used for the arc are only a trifle over $\frac{1}{4}$ inch in diameter and are cored and copper coated. The machine can be used with slides as well as motion films.

The chief novelty appears to be in the film, which is fire proof and which contains as many pictures in 80 feet as the regular film has in a reel 1,000 feet long. The pictures are only about $\frac{1}{4}$ by 3-16 inch in size and arranged in three rows on the one film. The two outer rows face in the same direction but the middle row faces in the opposite direction. The machine has an arrangement for shifting the light onto the rows separately.

Starting from one end the film is wound with the outer row in front of the light until it reaches the end. It is then shifted to the middle row and the direction of winding reversed. When the end is again reached it is shifted to the outer row and the direction of winding is again reversed. In this manner the three rows are made practically continuous. Some of the larger films last about eighteen minutes, the same as the regular films. The projected picture is about four by six feet and is very clear.

It is difficult for the layman and the student to get a clear idea of magnetic lines of force for the very reason that they are invisible to the eye. In fact, it is not definitely proved that these magnetic lines take the shapes which are given by the modern theories.

A thorough understanding of the mod-

ern theories is essential to an understanding of practical electricity. With this end in view a series of moving pictures have been prepared by the Edison company to show the magnetic lines in motion exactly as the modern theory demands.

The film is one of these new Edison miniature films. First a magnet is shown with a keeper moving to it and then a hand pulls it away again. The expanding and increasing magnetic lines are shown in a striking manner. In a similar manner, the lines of force about a wire, an alternating current magnet, a motor armature, a dynamo field and the Hertzian waves used in wireless telegraphy, are all shown. The lines are shown in motion and convey a lesson which is not possible in any other manner.

The pictures were produced from a great number of drawings and are quite remarkable.

Street Cars to the Leaning Tower

An electric street car line has just been constructed in Pisa, Italy, where the famous Leaning Tower is located. The building of the car line has long been bitterly opposed by local cab drivers, who immemorially have depended for their livelihood upon carrying tourists to the place where are located the world famed tower and a number of other celebrated structures. As the street car fare will be only two cents, it may be expected that some of the hackmen will be forced into other channels of industry.

Two Shows in One

A most unusual and effective scheme for attracting the passing public to take note of "Today's Program" and to patronize a moving picture theater is illustrated in the accompanying picture.

The operator's booth upon the street side is fitted with a large plate glass window. With the booth lights on as they always are during the show the movements of the operator can be easily seen from the sidewalk below. At all times while the theater is open a crowd may be seen watching the "free show" and a goodly number always become interested enough to part with a nickel to see the "inside show."

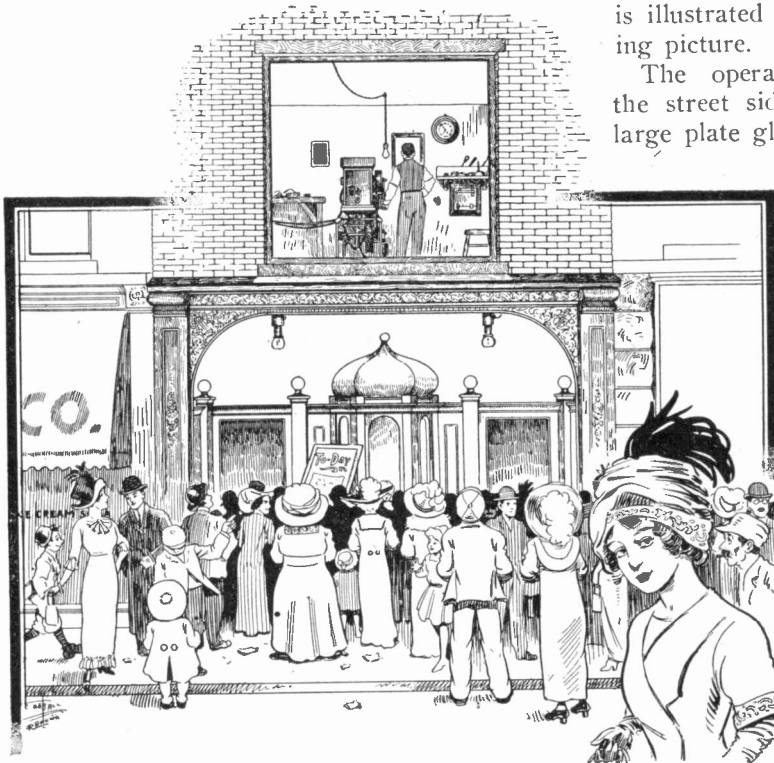

MOVING PICTURE OPERATOR IN FULL VIEW OF THOSE ON THE STREET

A PENNSYLVANIA FARM ELECTRIFIED

Electricity has been harnessed to a surprising extent by William Hazard at his home in Fallsington, Bucks County, Pa. He uses it as a motive power for



IN THE WASH ROOM JUST AFTER A BIG DAY'S WASH

work around the house and barn and the neighbors are calling his establishment the "Electrical Farm." Mr. Hazard took up the study of electricity after retiring from active work and has accomplished results through his own efforts.

In his house he has an electric stove and bake oven, and if coffee is wanted quickly there is a coffee percolator, and there is also a small stove to cook eggs, cakes, etc. Another step saving device is an electric dumb waiter running from cellar to top floor for small articles. The sewing machine has a motor and there are electric lights throughout the house, electric fans, and an electric vacuum cleaner.

In the large wash house the washers, wringers, etc., are entirely operated by electricity, and Mr. Hazard says, "The washing machines have saved enough money to pay the interest on my whole investment."

The great advantage which Mr.

Hazard has in his homemade plant is seen in the conveniences in the barn. He can shell, crack and grind his own horse feed, cut corn, corn stalks and hay and the same motor is also used to lift the hay into the barn from the hay wagon.

"In most barns and mills," says Mr. Hazard, "there is required much line shafting to get all the machines onto the engine, or else the inconvenience of moving the machines to the engine is involved. Here I have everything so as to get current direct. A small motor placed in an out of the way place can be used to run as many different kinds of machines as you have room to use, and your power is always direct from the power source."

His latest hobby is a wireless station. The mast stands 78 feet in the air, and messages can be taken from stations ten and twelve hundred miles away. He has caught messages from ships many miles



THE ELECTRIC IRON IS APPRECIATED IN THE FARM HOME



CUTTING FODDER FOR THE HORSES AND CATTLE

at sea and also from several inland stations.

The power plant is in the cellar. There are 70 cells of storage battery, 62 cells being in series with eight end cells for regulation. The eight regulating cells are to keep the voltage uniform at 110 volts.

The engine which Mr. Hazard uses for running the dynamo for charging the batteries is an especially constructed Fairbanks-Morse engine for running electrical machinery. He started his plant with a few storage batteries and a few lights, and kept on increasing until he now has the only plant of its kind in western Pennsylvania. He says the plant is only in its infancy as he intends to have everything complete before ceasing the work. In his opinion if the farmer of today cannot increase his profits 100 per cent through improved methods there must be something wrong.

Telephone Dispatching System for Taxicabs

It has long been recognized in the taxicab business that the principal source of loss lies in long hauls without passengers. To eliminate this leakage in revenue the Pittsburg Taxicab Company has originated in this country for the first time a system of taxicab telephone stations which are distributed over the territory served by the com-

pany. These sets are built much after the style of the ordinary patrolmen telephones which are a common sight now in all of the larger cities.

They are weatherproof and consist of a ringer and combination receiver and transmitter mounted in a locked iron case. Twenty-one of these stations are installed throughout the city of Pittsburg and its suburbs for the exclusive use of the taxicab drivers. In the system in practice before the adoption of the taxicab stations a passenger making a four mile trip to one end of the town would pay his fee and if the car on its return was not flagged by a chance fare the return trip would have to be charged up to loss by the company. With the adoption of the present system, however, the cars are run much as a well regulated steam railroad. The wires from

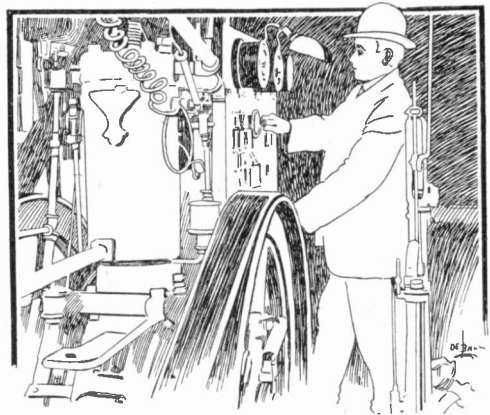

AT THE FARM PLANT SWITCHBOARD

the 21 stations of the company converge at the main office of the company in a switchboard at which a special operator constantly stays on duty. Here a record is kept of each taxicab, where it is bound for, the fare, and distance. When the passenger is delivered, the chauffeur calls up the central office at the nearest taxicab station and finds out from the operator the nearest return fare. He secures his new fare and delivers him, calls up the office again and learns of the nearest third passenger who has telephoned and so on.

Electricity Cheaper than Steam in Seattle Mills

In Seattle, Wash., one of the largest sash and door factories in the city is operated by electric power, from the Seattle Electric Company—some 400 electrical horsepower being used. This is somewhat surprising in view of the fact that there is plenty of fuel at hand, in the form of sawdust, shav-

The refuse such as shavings and sawdust, other than that required for producing steam for dry kilns, is sold for commercial purposes, the sawdust going to a chemical factory.

Similarly in the cases of the Balcom and the Canal Lumber Company mills, electricity is found to be the cheapest power. The output of these great mills aggregates 100,000 feet of high grade lumber per day of ten hours.

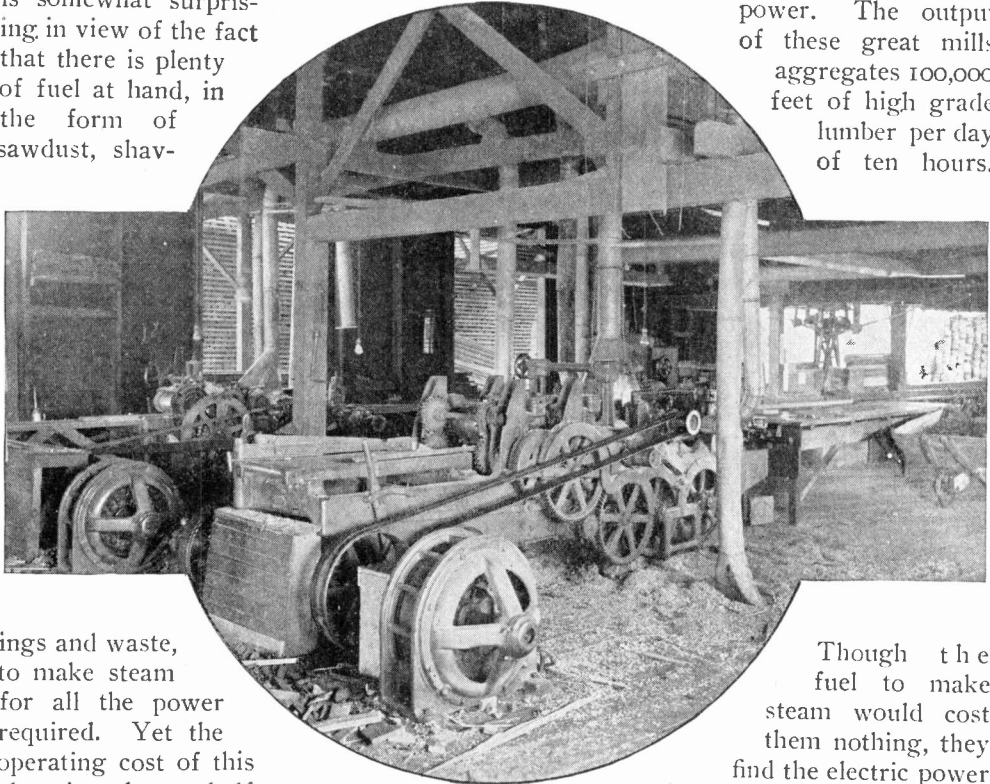

ELECTRICALLY DRIVEN MACHINERY IN A SEATTLE MILL

ings and waste, to make steam for all the power required. Yet the operating cost of this plant is only one-half of what it would cost to operate with steam or any other source of power, and the maintenance cost is practically nothing, amounting to less than \$25.00 per year, which is a record hard to beat. In a plant like this there are a great many machines that are not continuously in use, and with the direct connected motor drive it is very convenient to close a switch, start the machine and open it to stop when through. Another great advantage is that there are no belts in the way, no shafting to be getting out of line, and the machines may be spotted on the floor at any angle desired.

Though the fuel to make steam would cost them nothing, they find the electric power more economical, due to the low maintenance cost and greater flexibility of operation of the electrical machinery.

Beefsteak by Wire

A New York restaurant has abandoned the shouting of orders to the chef and has installed a telegraph system. The waiter takes your order, and then signals it back on a small clicker where the message is caught by a man in the kitchen. The regular telegraph code is, of course, not used but one better suited to the needs of the restaurant has been devised.

Measuring Starlight

Nearly all the measurements of the brightness of our heavenly bodies have heretofore been dependent on the observations of the human eye or the photographic plate. Recently a new method

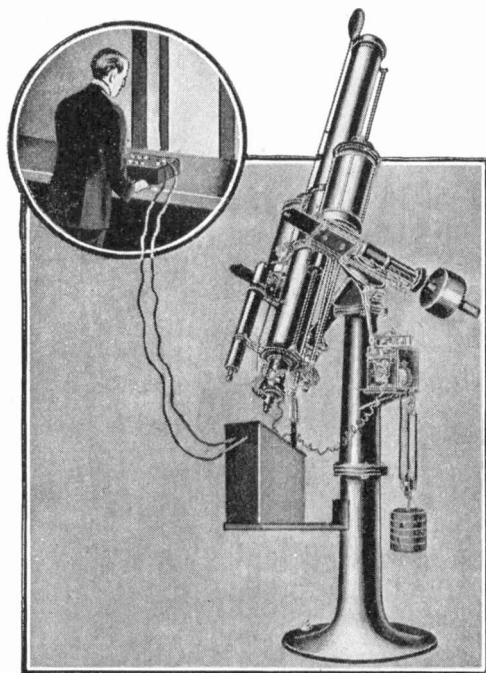

MEASURING STAR LIGHT

has been devised which utilizes a certain property of the wonderful element—selenium. Selenium, when properly treated, is an element which in the dark offers a high resistance to the flow of electric current, but when illuminated it becomes a much better conductor of electricity. The selenium cell, as the instrument is called, is made by winding two parallel wires on a flat insulator. The wires are kept separated by melting selenium on their surfaces and then baking the cell at a temperature below the melting point of the selenium.

The usual procedure is to place the selenium cell in the focus of a telescope. The cell is contained in a light-proof box provided with a photographic shutter. When the measurement is taken the shutter is opened for a few seconds and

the cell is illuminated by the light from the star whose brightness is to be determined. The increase in the flow of electric current through the cell when illuminated is measured with exceedingly accurate instruments, and by comparison with measurements on objects of a known brightness the unknown brightness is readily obtained.

Stars are classified according to their "magnitude," which is determined by their brightness. By this method the light from any star can be focused on the selenium cell and a direct measurement of its brightness can be made. The method has also been used to study eclipses. It is especially valuable in determining the exact middle or maximum of solar and lunar eclipses. Measurements of the variation of the moon's light throughout the year have been studied. As an example of the measurements on the variation of the candlepower of the moon during its various phases it was found that the brightness was nine times greater at full moon than at half moon.

Some Odd Facts About the Telephone

Eight million miles of wire have been added to American telephone systems in five years.

Iowa, Nebraska, Washington, Nevada and California lead the states in number of telephones to population.

Texas sends more messages per capita than New Jersey; Utah is ahead of Pennsylvania.

Cleveland is the city with the most telephones to every thousand inhabitants; New Orleans the least.

In Chicago the company has 60,000 requests daily for the time.

The busiest hour on the telephone exchange is between 10 and 11 a. m.; the busiest day in the year, the day before Christmas.

Five office buildings in New York have telephones enough for a city of 100,000 people.

Floating Power Plant Protects Piling

Electricity has solved another problem of great importance to commerce by affording protection for wharves and docks against the destructive teredo and other marine borers which destroy piling. The man who is not closely connected with marine business has no idea of the alarming ravages of this bivalve, a tiny threadlike creature which is almost invisible when it first attaches itself to pier timbers, but which burrows into the wood and grows greater as it honeycombs the piling, until it sometimes reaches a length of eleven feet and a diameter of an inch.

Electricity has been tried before, a

ing burrow, thus forming a natural insulation against electric shocks.

But a novel application of electricity has recently been devised by Prof. George Delius and Mr. Charles Pembroke Tatro, of Seattle, which finds the vulnerable point of the teredo. It destroys the borers by electrolysis, using the following ingenious method: A floating power plant is installed on a barge, carrying from 20 to 40,000 amperes at very low voltage. This is brought close to the piling to be treated, the wharf having been wired, and electrodes (of cheap cast iron) having been

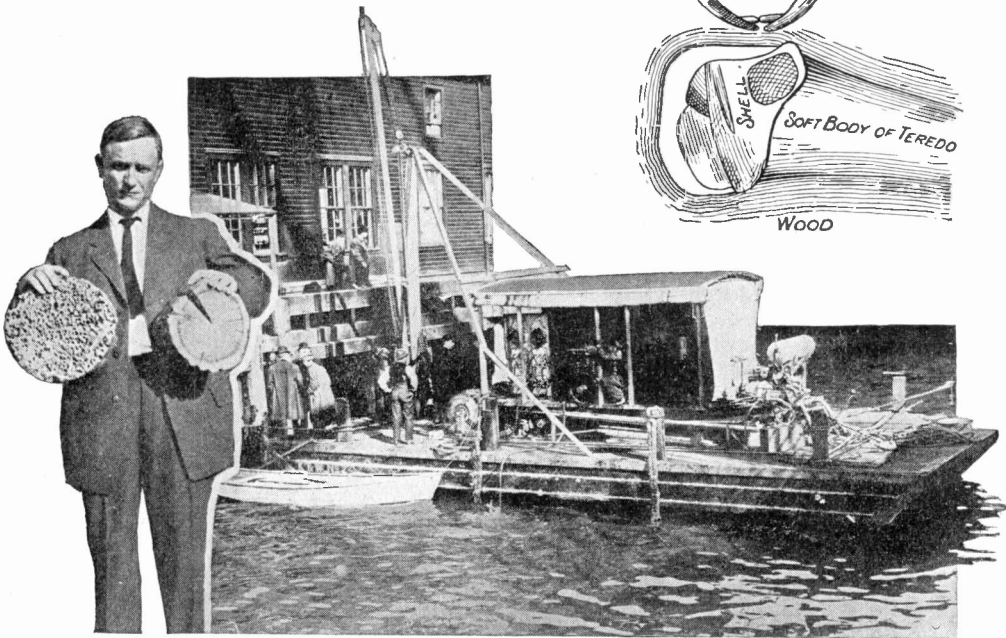

AN EXAMPLE OF THE WORK OF THE TEREDO AND THE UNIQUE POWER PLANT PLANNED FOR ITS DESTRUCTION

current being passed through the infested piling to destroy the borers, but it was expensive, dangerous on account of the fire risk, and ineffectual, for the reason that the teredo as it eats into the wood secretes a calcareous matter which is deposited on the surface of its wind-

suspended in the sea water under the wharf. When the current is turned on the effect of the electrolytic action in salt water is to release large volumes of deadly chlorine gas. As each cubic inch of gas will permeate four cubic feet of water to the extent of destroying the

teredo and other wood borers, the method is highly efficient. No teredo within the affected zone escapes alive, no matter how deeply it may have bored into the wood, as the gas reaches every burrow, and not only destroys the life of the teredo but coagulates its body to the consistency of a soft boiled egg.

The treatment must be repeated at regular intervals, which will differ according to the locality. In tropical waters the teredo works very rapidly and grows with alarming speed, while in cooler latitudes its destructive efforts are slower. However, while this treatment must be regarded as an upkeep charge in wharf maintenance, it is not expensive compared to the replacement of piles at frequent intervals, to say nothing of the danger of accidents from insecure dock supports. As an example of this danger, it will be recalled that a few years ago the dock at the foot of Broad street, Seattle, fell into the water only two years after it had been built. Its creosoted piling had been eaten by the teredo.

Toned Telegraph Signals

In England there is coming into use a method of telegraphing in which the operator sends signals by his key, but at the other end of the line there is used only a telephone to take off the messages. The method differs from the usual Morse signals in the use of a high and a low musical note in the line, so that each high note signal represents a dash and each low note a dot. Thus the letter "A" on the usual code is a dot and a dash, and "B" a dash and three dots, while on the new method "A" is a low note signal followed by a high note, "B" is a high note followed by three low note signals. Seeing that all the signals are now of the same length, that is, only dots are used, it takes less time to send the messages, as the dashes take up three times the length of the dot, and we thus have a saving of about 27 per cent of time, which is quite an item. An-

other point is that the signals are much clearer, and when there is trouble on the line for any reason, it is easier to read off the messages, and mistakes are not as likely to occur. The present apparatus is designed by Mr. E. Raymond-Barker, a London engineer. Two vibrating tongues set in movement by electro-magnets are used, and one of these gives the high musical note and the other the low pitch. The operator works two keys so as to put in one or the other note.

Electric Truck Makes Record Run

A run from New York to Boston, a distance of 252 miles, in 21 hours actual running time, is the record of the Walker balanced drive truck shown in the picture. During this trip only two charges of the Edison cell battery were made.

The driving mechanism of the car is particularly interesting, as all of the mo-

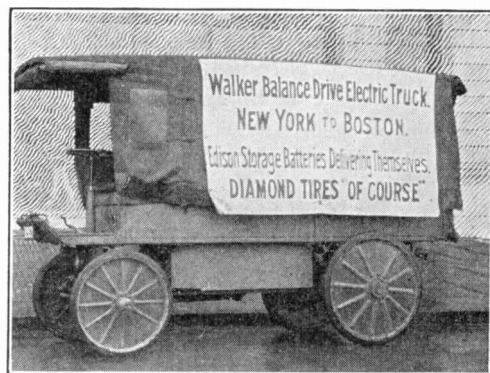

ELECTRIC TRUCK THAT MADE 252 MILES IN 21 HOURS

tive parts are in the rear axle and the rear wheels, with the exception of the batteries and the connecting wires. The motor on the rear axles has a direct drive to two pinions running to idler gears in the wheels. These latter engage in teeth in the extreme rims of the wheels, propelling the car by this means.

The car weighs 3,000 pounds and the load brought from New York weighed 2,800 pounds, to which was added the weight of two men.

The Casino Technical School for Women

By R. J. WATSON

All over the country we hear of various methods by which large industrial corporations are seeking to help those of their employes who wish to help themselves. Located in the vicinity of the Westinghouse interests of the Pittsburgh district, the Casino Technical Night School is carrying on several courses of training, not the least important of which is a department for women.

The course of instruction now embraces stenography, typewriting, cooking, sewing, music and preparatory work in the common school branches, the aim and object being to give a fundamental training in these lines and to give the student a broad view of her work and its relations to the various activities of life.

Classes meet Monday and Wednesday evenings of each week from seven to nine o'clock. There are two terms of four months each in the school year.

The work in stenography is designed not only to give the student the speed and accuracy essential to successful work, but to train her also to use thought and judgment in her work, to become familiar with business terms and practices; in short, to be self-reliant.

The instruction in cooking is designed to give a practical knowledge of plain cooking and the serving of simple food. The economy of buying, both in regard to quality and quantity; the use of material, especially of food materials that are often thrown away, is emphasized as essential to good housekeeping. The classification of foods, their composition, and the chemical changes which take place by the application of heat and moisture, and the best methods of cooking food to preserve the nutritive value in the most digestible form, are some of the things aimed at in this course.

Instruction in the fundamental points of sanitation in connection with sinks, drawers, garbage cans, etc., is attested by the scrupulous cleanliness.

The instruction in sewing embraces both hand and machine work. In the beginning, simple garments, such as small sewing aprons, are made, and as the student progresses, more difficult work is undertaken. The idea is to give a thorough knowledge of the fundamentals of sewing and to guide the girl in her taste for dress so as to develop an individuality of style in keeping with her income.

Because of economic conditions in the homes, many girls are forced to leave school at an early age and seek employment. The Westinghouse Electric and Manufacturing Company alone employs over 1,600 women who are engaged in the various occupations of winding and taping electrical apparatus, etc., as well as in clerical positions. The night school offers a preparatory course in the common school branches to all who have not previously had such training.

Last, but not least in importance, is the course in music. Piano and voice are taught, the choice of which is optional with the pupil. The aim is to give a general knowledge of good music, to cultivate an appreciation of and a desire for the better class of music, and to reach a certain proficiency in piano playing.

The subject of cost is one that naturally arises. In this case it has been put within the reach of all, for those who are in charge and have the welfare of the community at heart believe that the individual rarely wishes a gratuity, and appreciates most that which can be purchased with his or her own efforts. Tuition per term of four months is as follows:

Cooking and sewing.....	\$5.00
Stenography and typewriting.....	5.00
Music	3.00
Cooking only.....	3.00
Sewing only.....	3.00
Preparatory department.....	5.00

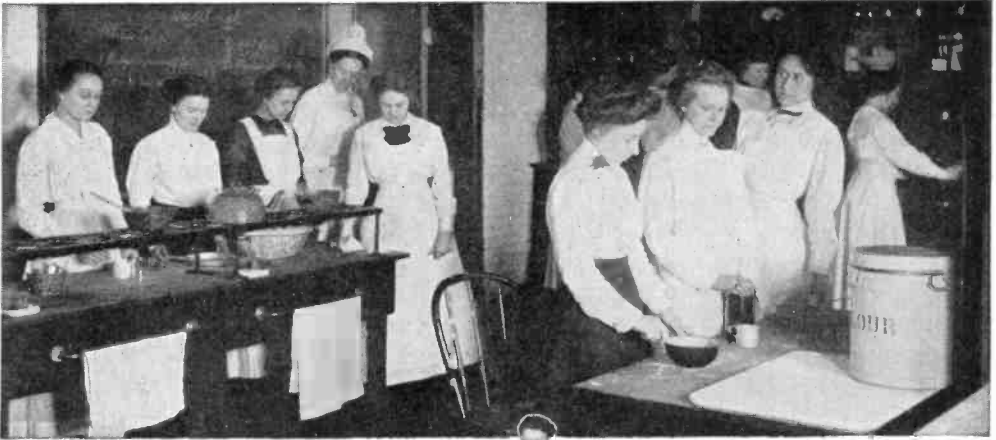

COOKING CLASS, ENGLISH CLASS AND MUSIC CLASS IN THE CASINO TECHNICAL SCHOOL FOR WOMEN. THESE COURSES ARE SUPPORTED LARGELY BY ONE OF THE GREAT ELECTRICAL MANUFACTURING COMPANIES WHICH IS SEEKING TO HELP ITS EMPLOYEES TO HELP THEMSELVES

The income from tuition pays about one-half of the expenses of the school. The balance is made up by contributions

from the Westinghouse Electric and Manufacturing Company. In addition to the tuition, the students are put to a

small expense for pencils, paper, tablets, needles, patterns, sewing materials, music, etc. It must be borne in mind that all articles made in the sewing department become the property of the student and time and material are not wasted in making useless niceties or articles that can not be worn.

The social side of life is not neglected. The school has a regular lecture course, which is free to the students and their friends. Once a month a social hour is provided when all the students assemble in the auditorium, and recitations, music, and general sociability hold sway.

An Electrical Hygrometer

Selenium is a substance which through its peculiar properties is being used in many unique processes. The electrical resistance of this element changes when illuminated by light. Selenium cells are

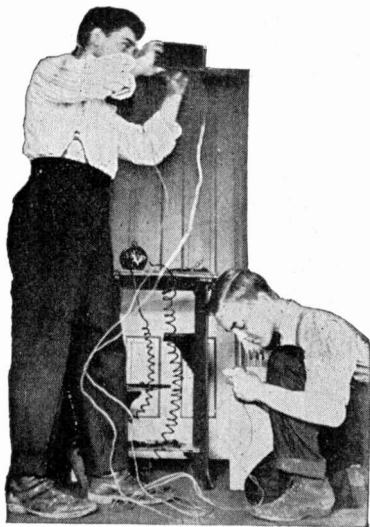

ELECTRICAL HYGROMETER IN USE

made by winding two wires on a porcelain or mica core. These wires are kept apart by melting selenium between them and permitting it to harden. The cell is then baked and treated in various ways and the resultant operation of the cell depends upon this treatment. The resistance of some cells increases when illuminated, while in others it decreases.

Another interesting property has recently been discovered; namely that the resistance of a selenium cell changes with moisture. Immediately it became evident that the selenium cell could be used as a hygrometer to detect the amount of water vapor in the air. Experiments have shown that the instrument will indicate humidity with considerable accuracy when precautions are taken to standardize conditions. The selenium cell will readily lend itself for use as a regulator of moisture in the air in buildings. Modern buildings are equipped with apparatus controlling the amount of water vapor in the air and as the selenium hygrometer is an electrical device it will be possible to make the hygrometer automatically control the humidifier.

Again a practical instrument has grown out of a scientific toy.

Death of Prof. Antonio Pacinotti

Prof. Antonio Pacinotti, original inventor of the direct-current dynamo with its commutator and of the ring and toothed types of armature, died at Pisa, Italy, on March 24.

Professor Pacinotti was born in Pisa, Italy, June 17, 1841. Under the direction of his father he early began the study of electro-magnetism, and by the time he was seventeen years of age had the principles of the direct-current generator well in mind, constructing in 1860 the celebrated machine which ten years later was reinvented by Gramme. After three years of experimentation with his models, Pacinotti published an illustrated description of his dynamo in the *Nuovo Cimento* in 1864, but this received little attention at the time.

It was not until 1873 that he exhibited, at the Vienna Exposition, the dynamo model which he made in 1860. He then, for the first time, received wide credit for his invention, interest in which had meanwhile been reawakened by the invention of the ring armature by Gramme, in 1870.

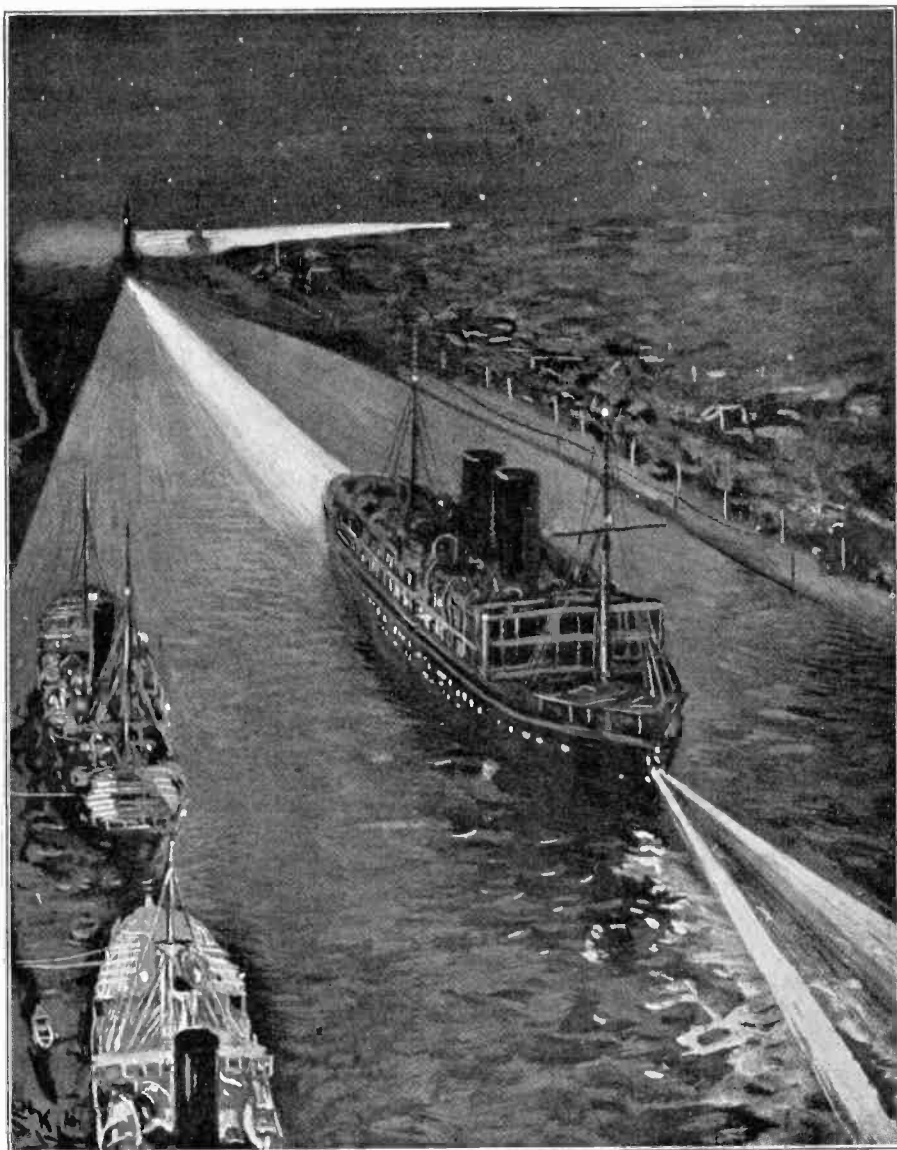

SEARCHLIGHT PILOTS OF THE NIGHT

In the Suez Canal a crude though effective arrangement prevails to light each vessel's way. Over the bow of the ship is hung a cage in which is an arc light and an operator. The blinding glare to the crew of an approaching boat is avoided by dividing the arc light's beam at the lamp by cutting off some of the rays and projecting a dark angle as shown in the picture.

MONORAIL SYSTEM FOR LUMBER MILLS

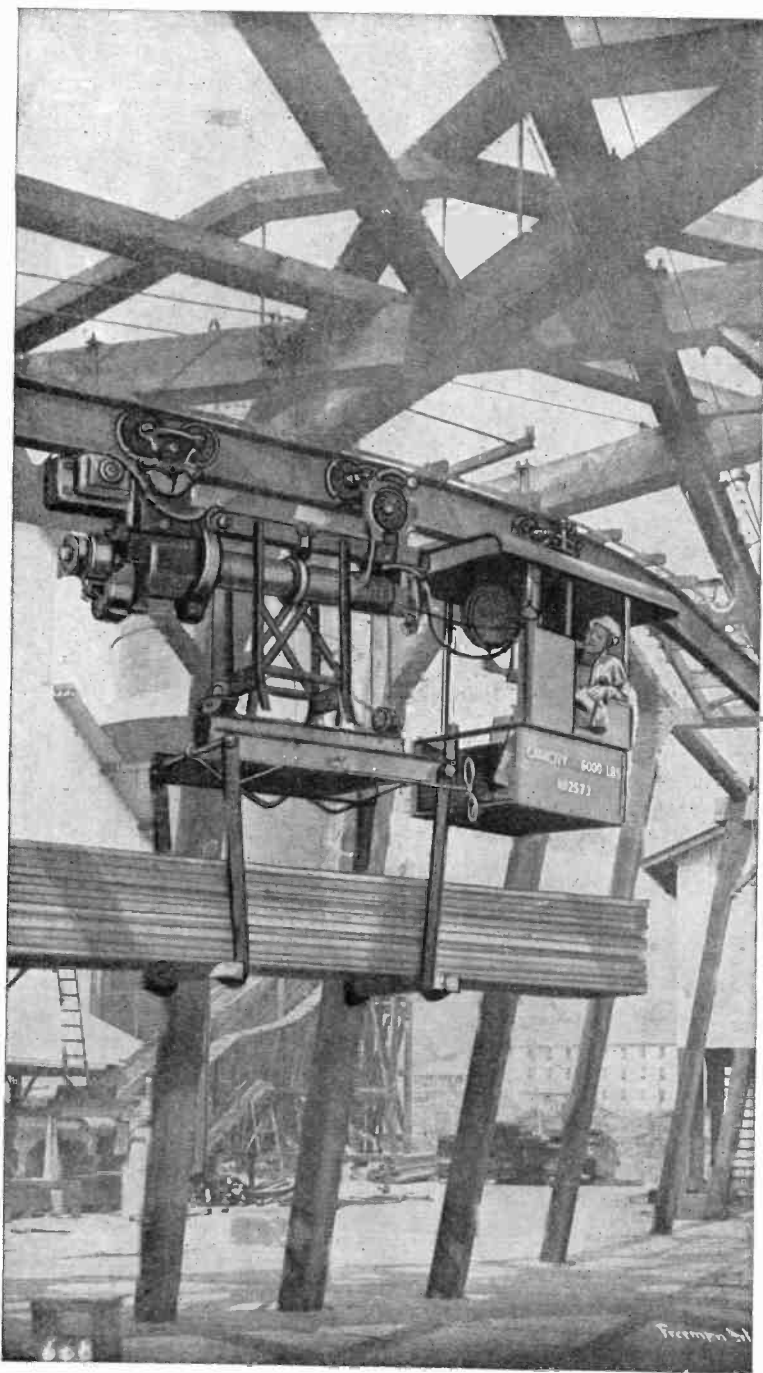

A RAILWAY ON STILTS THROUGH THE LUMBER YARDS

In the most up-to-date lumber mills and yards it is not unusual to find a sort of railway on stilts which meanders around through the various yards and into and out of the mills and drying sheds. It carries on its under side a single rail from which is suspended a monorail car driven by motors which derive their power from a trolley wire. In addition to driving the car along on the rail the motors also operate a drum which lowers or winds up grappling irons which can lift several tons of lumber at a load.

In moving lumber from one shed to another and in sorting out the various sizes the use of such a system results in a marked economy. One man in the little cage directs the motors in doing all this laborious work, making it possible greatly to reduce the cost.

Proving the Engineer Alive

Last summer quite a number of lives were endangered on one of our western roads when the engineer was stricken with heart failure in his cab and the locomotive kept thundering along with no one at the throttle. An inventor has since come forward with a practical solution of the problem involving this danger. He mounts an electric push button in the lever of the throttle so that the hand of the engineer will press on this button. Should the hand be withdrawn while the engine is going at high speed, an electro-magnet will automatically shut off the steam and set the brakes. At low speeds, or when the engine is standing still, the safety device is not connected in service and as it only requires a trifling pressure of the hand to keep the button operative, this would seem to be the simplest and most dependable way of watching the engineer to make sure that he is both alive and awake.

A Rat's Handiwork

This piece of lead armor was taken from a 400 pair aerial telephone cable and was found where the cable made its entrance to a building. The hole was cut

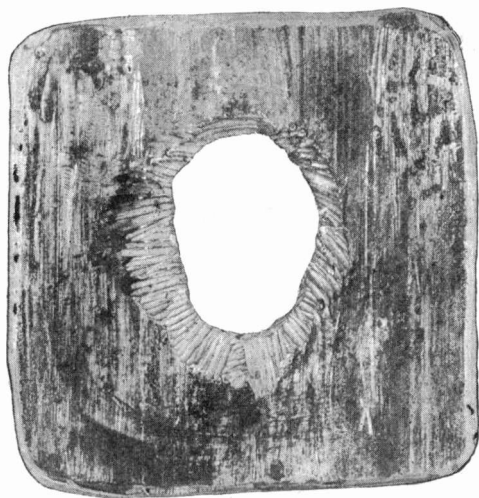

Courtesy of the Cumberland Telephone Journal
CABLE ARMOR GNAWED THROUGH BY A RAT

by a rat which evidently sat on the messenger wire outside of the building to do the work—a clean cut, workmanlike job.

Individual Telephone Transmitter

The unsanitary condition of the public telephone transmitter has led to the invention of a vest pocket instrument.



VEST POCKET TRANSMITTER AND ITS APPLICATION TO A SPECIAL DESK SET

The transmitter and collapsible mouth piece are contained within a watch case. On pressing a button the case springs open and a coiled spring within forces the mouth piece out into operating position. Two terminals are provided for connection to the telephone instrument.

Of course, where the ordinary desk set is in use there is no way of attaching the pocket transmitter. In this case it is proposed to provide a special set adaptable to its use. For instance, in a hotel or railway station one of the several booths might be provided with a special set so that travelers having their own transmitters could be able to use them.

Electricity Aids the Date Industry

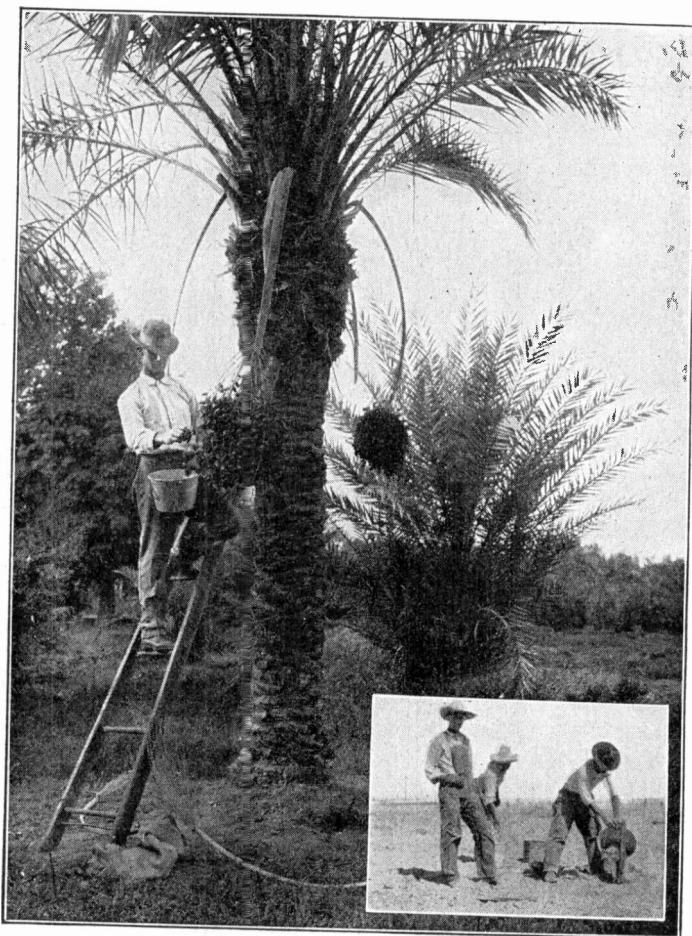

HARVESTING DATES IN ARIZONA. IN THE LOWER PICTURE A YOUNG DATE GROVE IS BEING SET OUT

The date industry in our southwestern states is developing into one of importance, as large shipments of shoots from the African oases have been imported and set out in Arizona and Southern California during the past year. For several years the United States government has carried on experimental work at Tempe, Ariz., with various kinds of dates, but it was found that one of the most valuable varieties known as the Deglet Noor would not ripen in that climate under ordinary conditions. The summers, while hot, are not long enough

to complete the ripening process with certainty.

Electricity has come to the date grower's aid, however, being employed in the artificial ripening of the fruit. The credit for this device belongs to Prof. George F. Freeman of the University of Arizona in Tucson. He has invented an electrically heated metal oven in which the dates are placed when they have ripened naturally as far as possible. The fruit is washed and "incubated" in these ovens for three days; a temperature of between 45 and 50 degrees C. being

maintained. This is not a dry heat, but sufficiently moist to keep the dates luscious and juicy. In fact the same treatment will restore fruit which has been allowed to remain on the tree until partially dried and withered, though in this case a preliminary soaking is required. The ovens treat 100 pounds of dates at a time.

By this invention, which assures the date grower that his crop can be ripened for the market, the industry will be on a firmer basis. Already immense areas in the Coachella Valley of California and various parts of Arizona have been set out to dates. Shipments of the electrically ripened fruit have been exported to all parts of this country and to Paris, France, and have arrived in good condition. The fresh dates sell at from 30 to 50 cents a pound, and the demand is great.

Electricity Direct from Heat

To obtain electricity direct from heat is a dream which is likely at some time

to be realized. At present there are numerous methods of obtaining electricity direct from heat but the power obtainable is very minute. However, a new method has been devised which employs two insulated carbon rods heated in an electric furnace or oxy-acetylene flame. The two carbons are kept separated at one end, but the other ends are connected through a current-measuring instrument. When one of the carbons is suddenly displaced a current of several amperes will flow. By displacing one of the carbons periodically an alternating current can be generated.

When a slight voltage is applied to the carbons the current increases to more than ten amperes at about 450° Fahrenheit.

These experiments are interesting inasmuch as such a result would hardly be expected at atmospheric pressure. The same phenomenon has been noticed before on a much smaller scale, but in a high vacuum. Such seemingly insignificant discoveries often mark the beginning of wonderful developments.

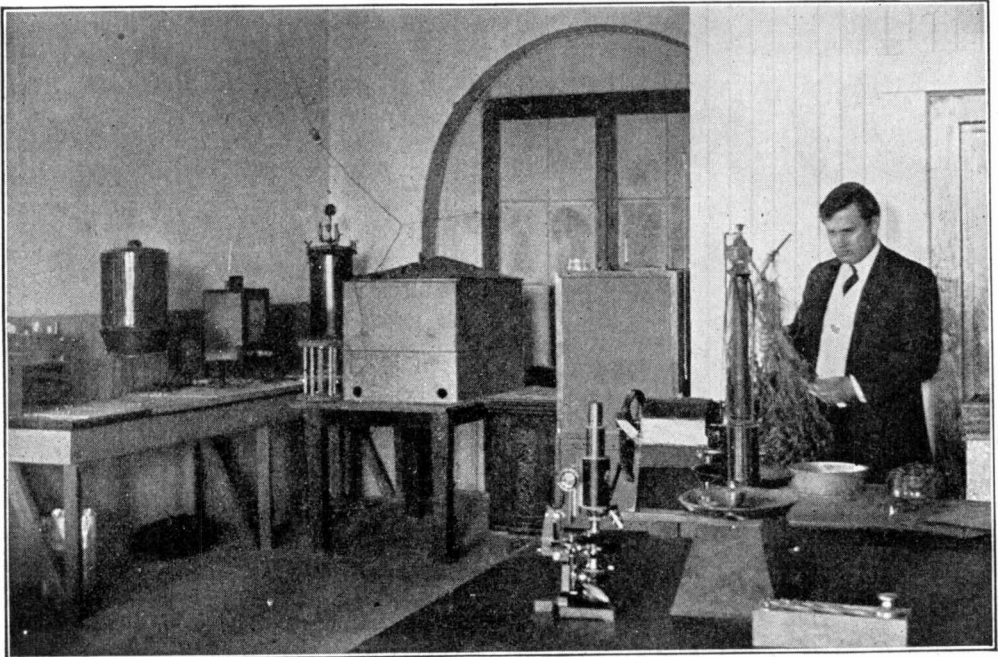

PROF. GEORGE F. FREEMAN AND HIS ELECTRICALLY HEATED OVEN FOR RIPENING DATES

Deaf Mutes' "Telephone"

William E. Shaw, a deaf mute, of 11 Grove Street, Lynn, Mass., has invented what he calls a "deaf mutes' telephone," to enable them to converse rapidly not only with each other but with those who possess their sense of hearing and speech without the use of the finger sign language.

The "phone" comprises an electrical keyboard, something in appearance like that of a standard typewriting machine. It has, like a typewriter, the "universal system" or arrangement of letters. This keyboard is connected by wire with the electric signal board, which is the talking machine proper, consisting of 36 incandescent light globes, each painted on the end of the bulb with a large letter of the alphabet or one of the numerals.

The deaf mute who wishes to talk with another person presses the keys in order, spelling out the words as on a typewriter, his vis-a-vis reading off the letters as they flash up on the lamps. The keys come down onto points of contact in the same manner as the printing-typewriting telegraph machines, instead of striking by means of a lever bar as does a typewriter key. This does away with any false or lost motion and insures perfect contacts. But the keyboard can be operated as quickly by an expert as an ordinary typewriter, and the letters can be read as quickly as they can be flashed up.

Mr. Shaw has perfected his invention so that two machines may be installed in separate rooms or houses some distance apart and the conversation carried on swiftly and silently. Two machines

may even be connected up over an ordinary telephone line and conversation carried on at any time, the line being left open for signals.

Mr. Shaw is employed by the General Electric Company and has made several other inventions for deaf mutes, including an alarm clock, where electric lights

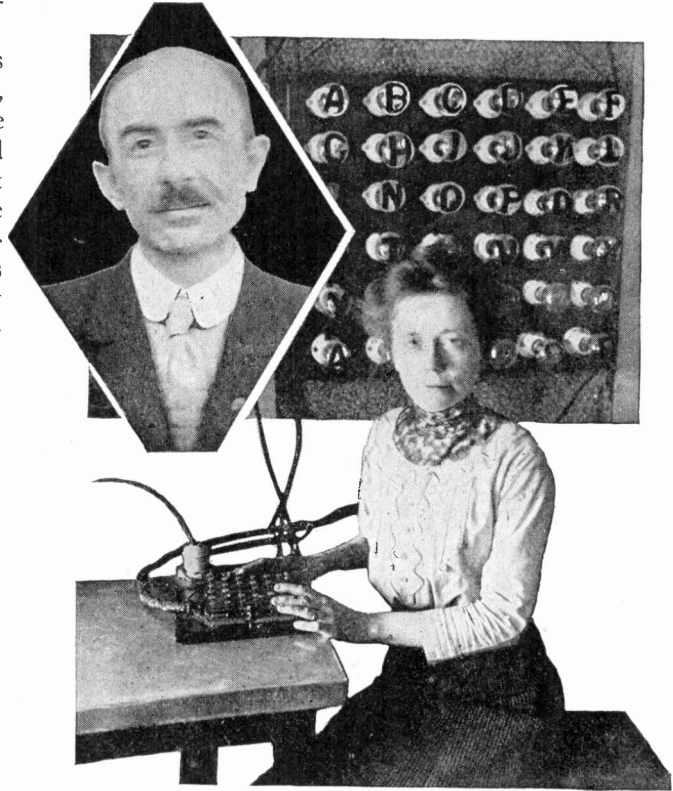

DEAF MUTES' TELEPHONE, WITH THE INVENTOR
WILLIAM E. SHAW AND HIS WIFE

take the place of the customary bell, and a door signal for houses of deaf mutes.

United States Asbestos Production Doubled

Asbestos is important as an electric insulator and in the electric fireless cooker serves as an excellent non-conductor of heat. It is a matter of interest therefore to note that in the year 1911 the production of asbestos in the United States more than doubled. Vermont and Georgia produced nearly all of 7,604 tons valued at \$119,935.

Portland Regrade Operation

It is well known that Seattle, Wash., has in recent years veritably remodeled herself. From a city of steep hills she has been changed to one of gentle grades. This great project was eminently successful, largely because of the use of high grade modern electrical and mechanical hydraulic apparatus.

Portland, Ore., 200 miles to the south, noticed the miracles being worked in

The trestle supporting the sluice through which the debris is conducted to the lake also supports two eighteen inch pipes carrying the water pumped from the same lake.

The pump house, a temporary structure, of course, is located near the lower end of the trestle. Its foundations were laid in the bottom of the lake at low water before any filling had been done. Now, however, the pump house is in

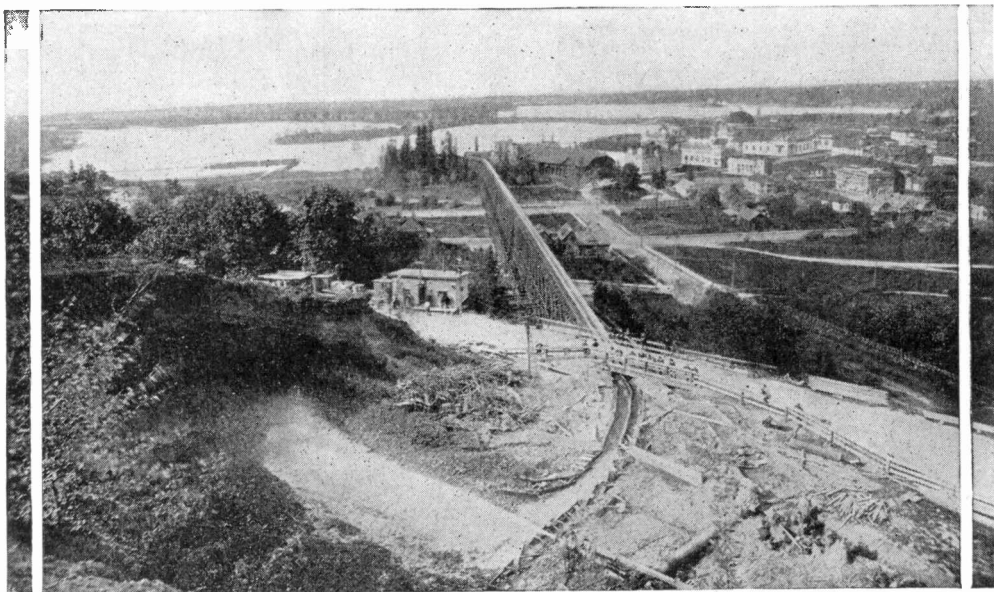

REMOVING GOLDSMITH'S HILL AND DUMPING IT INTO THE LAKE.

Seattle and is now following suit by hydraulically reducing an abrupt prominence within her limits, known as Goldsmith's Hill. Because of the great satisfaction given by the motors used to operate the pumps which washed the hills of Seattle into the sea, these same motors were later taken to Portland, where they are now being used to drive the pumps in the regrading there.

The composition of Goldsmith's Hill is especially gravelly. The streams, therefore, are directed by huge nozzles so as to undermine the lower part of the bank, and the weight of the material above brings down the sand and gravel from the working face. From here it is washed into Guild's Lake.

the middle of a filled tract of several acres.

It is expected that by the spring of 1913 the so-called Goldsmith's Hill will be no more and that its site will be suitable for no less than 300 residences, while the operation will reclaim to the city several acres of land from Guild's Lake, half a mile away. The project is, therefore, serving a two-fold purpose.

The pumping plant, driven by great 650 horsepower Westinghouse motors, is capable of supplying 500,000 gallons of water an hour at a pressure varying between 200 and 300 pounds per square inch, according to the demand. Electric energy is supplied by the Portland Railway, Light & Power Company's plant.

How to Become a Telegraph Operator

By AN OPERATOR

In the old days the only way to learn to be a telegraph operator was to work as a messenger in a telegraph office and rely on the generosity of the operator to teach the dots and dashes. Many operators would do this for a small sum of money. However, progress in this manner was always slow and generally took several years before it was possible to hold a position. There are also operators who will claim that they taught themselves. Maybe they did, but if they did they wasted many years before it was accomplished. The only practical and thorough way to learn telegraphy is to enroll in a good school. In regard to enrolling, investigate thoroughly the school you want to attend. Talk with the students, talk with the graduates, look up their guarantee, then if satisfied enroll and your career as an operator will be started.

Let us take, for example, the Jones School of Telegraphy, the official school of the Western Union Telegraph Company, Chicago, Ill.

The student is placed in one of the class rooms at a table with other beginners. He is then instructed by one of the school's instructors, and spends his time in learning the Morse code, and how to make the letters. The school is open both day and night, and students can attend either class. Students who are required to work while learning can obtain positions as clerks with the Western Union at from \$25 to \$35 per month. This does not require any previous knowledge of the work.

After the student has learned the Morse code and can make the letters without hesitation, he is graduated to another table, where he begins to practice sending and receiving. Regular telegraph messages which have been transmitted over regular wires are used.

In this way the student becomes accustomed to handling telegrams and also learns the method of putting them down right.

As the student progresses, he is changed to tables doing faster work. When the student can send and receive at a fairly good speed, he starts copying from the wire with a typewriter, "mill" as the operators call it. This requires a lot of practice, as it is necessary for an operator to be a first class typist. This is absolutely necessary to obtain a position. Typewriters are furnished free by the school for the use of the students. As there are main line wires running through the class rooms of the school over which actual commercial messages are being sent, the student finishes up by copying from these wires. This gives the best practical experience possible.

When the student is able to send and receive at not less than 30 words per minute, and is able to turn out good copies from the typewriter, he is instructed in the managing of a branch office, how to look up rates, route messages, handle branch office switchboards, etc. When he is fully trained in these things he is ready for a position.

The first position given to commercial students is generally that of operator in some small town. Many operators are sent to Rockford, Elgin and Joliet, Ill., Racine, Wis., Cedar Rapids, Ia., etc. The average pay of these positions is \$55 per month. From any of these positions the operator is promoted to a larger office in another town, where he will probably get \$60 or \$65 per month. Many operators come back to Chicago and work in the main office of the Western Union. Here they receive from \$60 to \$70 or more, depending upon their ability.

First class operators generally get about \$80 per month. Operators on

overland wires are paid \$90 to \$100 per month. The positions of assistant division chief, division chief, switchboard man, wire chief, assistant chief operator, chief operator, etc., are always there to smart progressive operators in both day and night shifts.

The Illinois Central Railroad Company has opened a school for the purpose of qualifying operators for positions as railroad operators and station agents. This school has made arrangements with the Western Union school to accept all graduates for this course absolutely free. The student must be able to send and receive 20 words a minute. While in the Western Union school he is instructed in taking and sending train orders, etc.

This school of the Illinois Central offers exceptional opportunities to those desiring to become railroad operators. To this railroad school the company has assigned one of its experienced agents as instructor, and his entire time is taken up in instructing the students in the routine of station work. Students work eight hours a day, five hours are devoted to actual station work and three hours to copying from main line telegraph wires, practicing on train dispatcher's telephone equipment, and to telegraphic practice work on a local telegraph circuit. Each student receives individual instruction, and his advancement toward graduation depends solely on his attention and ability. The time required to complete this course is about four weeks.

After a student has qualified in this course of study, he is placed in a position as a station agent's helper on a salary of at least \$25 per month. Here he remains for about three months. From the position of station agent's helper he is promoted to the position of scheduled telegrapher at a salary ranging from \$55 per month upward, or agent at one of the smaller stations where the salary and commissions usually amount to \$50 per month or more. The opportunities for

the young man entering the field of station service are many and very desirable. The opportunities of the railroad operator are to be envied. He is actively engaged in railroad work at all times, and is always familiar with the managing of trains, etc. In fact, he has the best position for learning railroading. The positions of train dispatchers are filled from the ranks of the operators, and these salaries are very high. Railroad operators average \$75 a month.

Walking on a Magnetized Floor

A "magnetic floor" is one of the latest amusement devices in Paris. The persons who walk on it wear shoes with iron soles and as the floor can be magnetized or not by throwing on switches they will



THE MAGNETIZED FLOOR

sometimes stick fast to the floor and at other times walk with perfect ease. By manipulation of the switches, the operator can produce the most grotesque actions on the part of the walkers.

The construction is quite simple and consists in the use of iron beams running along parallel, with wood strips between, so as to make up the floor surface. Between the iron beams are electro-magnets and these are spaced at the right intervals so as to have the floor well magnetized over all its parts. Switches are used in the circuits of the magnets so that all or any number may be energized.

Unusual Feature of Paris Subway

A somewhat original piece of work in the way of subway construction is being carried out on one of the new Paris lines at a point lying near the Seine. Here is located the subway station

tunnel with one track lying above the other after leaving the station. Together with the station itself, this part of the subway makes up a length of 280 feet. As the second view shows, the station is built up of three sections which increase in height so as to allow for the rise of

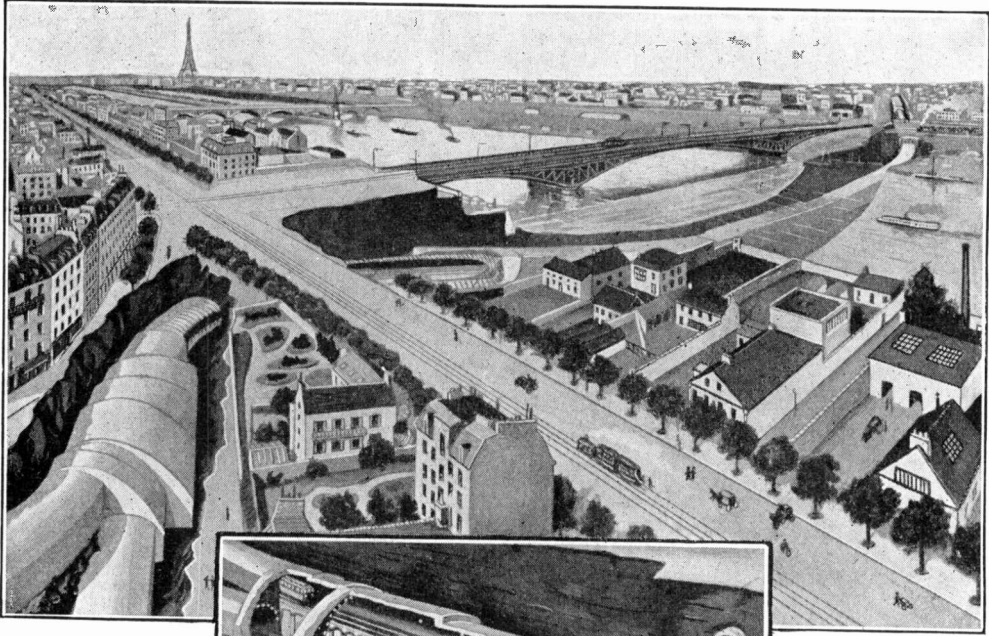

known as Mirabeau. Through it runs one of the electric subway tracks which keeps about on the same level and serves to take passengers from the station platform. Alongside it is a second track, but what is peculiar is that this track enters at one end at the same level as the other and then mounts up on a steep slope within the station so that on leaving, it is about ten feet higher up than the first track.

Owing to the arrangement of the two lines, the engineers were led to give an unusual shape to the station and the part of the tunnel lying next it, as will be noticed. One of the views shows the

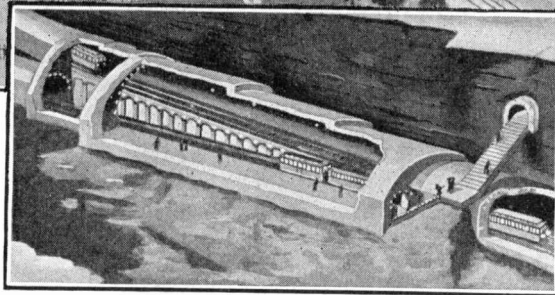

A SECTION OF THE PARIS SUBWAY AND ONE OF THE ODD STATIONS

the second track. Then come two short sections and after this each of the tracks continues on its way in its own tunnel. At the other end of the station, on the contrary, both tracks lie in a common tunnel of the usual somewhat elliptical section. This latter tunnel then runs down considerably and passes under the Seine, rising on the other bank and then proceeding on its course.

The present section of the subway belongs to the new line which connects the west end of town or the Auteuil district with the center of town at the Opéra.—*Abstract from La Nature by F. P. Mann.*

ELECTRICITY VERSUS GRAVITY SYSTEM FOR IRRIGATING

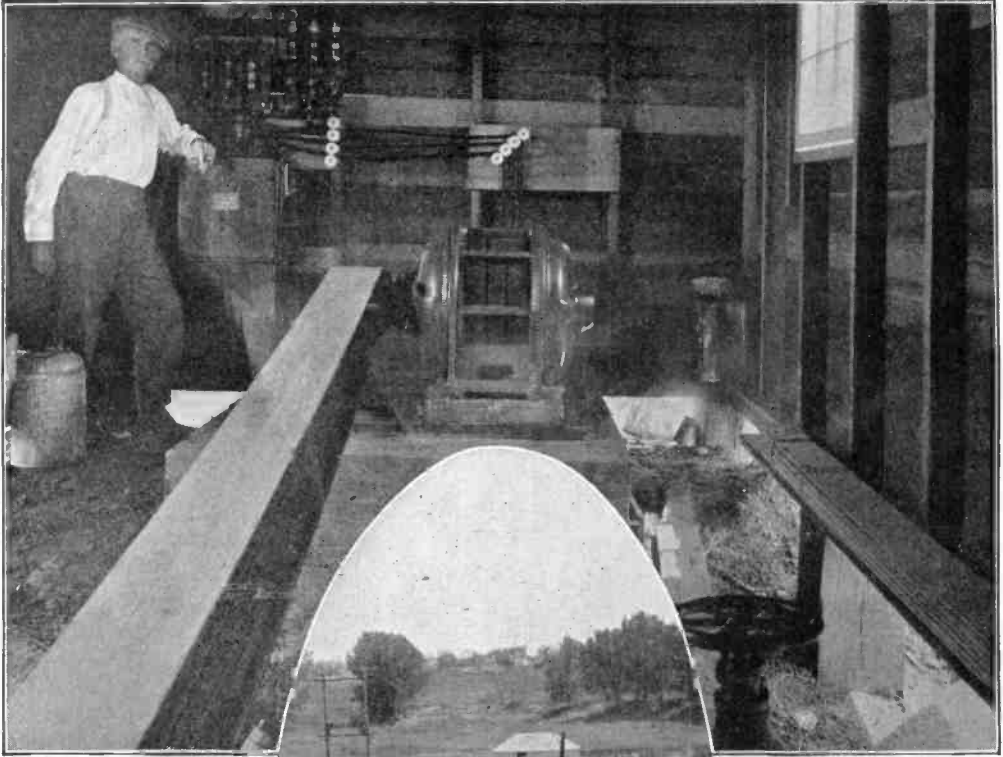

Martin A. Lum, the owner of a 90 acre farm two miles west of Denver, has been able to triple the output of his land by the use of electricity for irrigation purposes. He distributes water over his acreage through pipes and an electric pump in connection with auxiliary ditches.

The reservoir is located in the center of the ranch and the water is conveyed through two ten-inch mains to



IRRIGATING PLANT FOR A 90-ACRE FARM
AND THE RESULTS WHICH IT PRODUCES

the high places of the property and from these points distribution is made through ditches. Each of the high points is 80 rods from the reservoir, one having an elevation of 50 feet, the other of 45 feet. The water is raised with a six-inch centrifugal pump operated by a 35 horse power electric motor, having a capacity of 1,100 gallons per minute.

The plant was installed at an ex-

pense figuring \$50 per acre and the cost of operation in a year amounts to \$3 per acre. But the owner declares that the ranch has increased in value by \$150 per acre.

It is pointed out that there are many advantages of electric pumpage over the ditch water. There is an absence of sediment and weed seed in the water and the water is warmer than from the ditch. The storage in the reservoir gives it a chance to attain a degree of warmth which the chilly mountain stream does not have. Current for the pumping is furnished by the Denver Gas and Electric Company.

Searchlight on Repair Wagon

A new wrinkle with the Dayton Lighting Company is to equip one of its electric repair wagons with a searchlight for

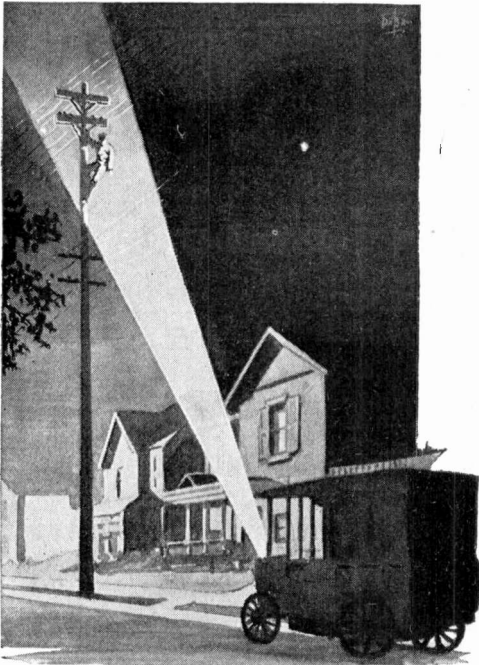

LINE REPAIRING BY SEARCHLIGHT

after-dark emergency work on its pole lines. The truck is run alongside and its beam, directed at the pole top, enables the lineman to make connections as conveniently as in daylight.

Largest Lightning Arrester in the World

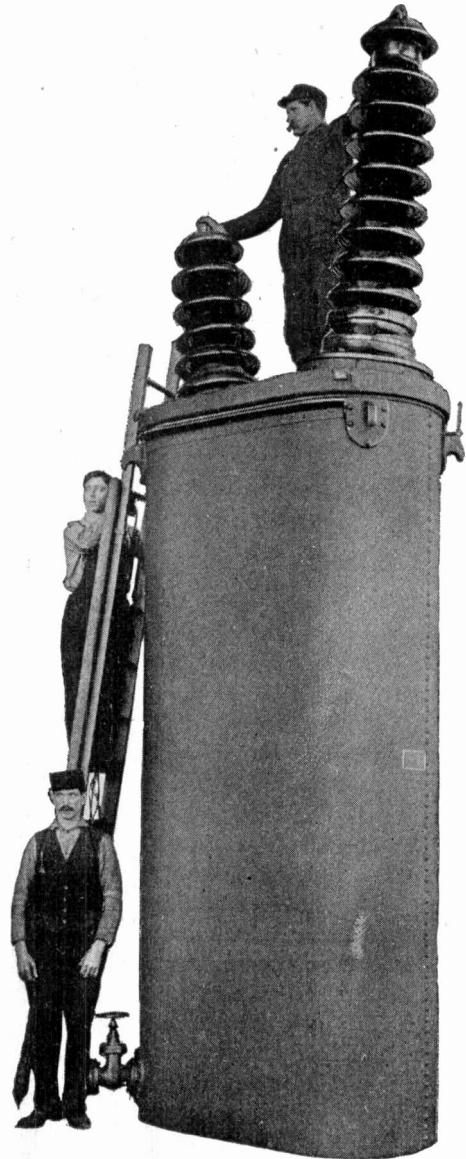

IMMENSE LIGHTNING ARRESTER TO PROTECT HIGH VOLTAGE LINES

A lightning discharge takes place at a voltage far beyond measurement and exceeding any electrical pressure that man has thus far utilized. However, a slight approach towards lightning's high pressure is the operation of 110,000 volt transmission lines. To protect these lines gigantic lightning arresters are neces-

sary. In the illustration is shown one of the four tanks required to make one of the General Electric Company's 140,000 volt aluminum lightning arresters. A lightning discharge in striking a high voltage line would play havoc with the generating plant were it not quietly disposed of in the ground near the entrance to the plant by these carefully built and insulated protective devices.

A New Cord Adjuster

A cord adjuster operating on the principle of the shade roller is shown with the small boy just about to complete the insertion of the drop cord. The grooved wooden roller is wound up against its spring far enough to have the necessary tension to take up the cord to the desired length. The light is raised and lowered in the same manner as a window shade, an upper and lower guide carrying the cord.

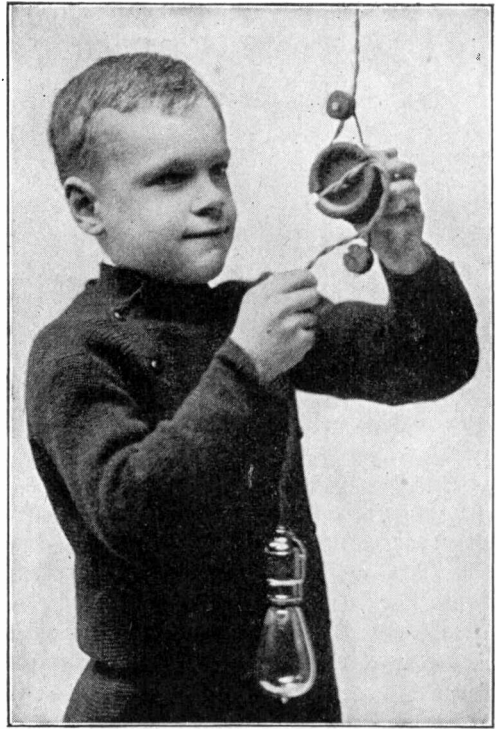

Frightening Badgers with a Searchlight

In some parts of Portugal a queer method is pursued in regard to the hunting of badgers and foxes. Badger hounds are used—short-legged animals that can crawl into the burrows of their

quarry. Each dog is provided with a collar on which is mounted, like a tiny searchlight, a little electric light operated from a small battery which can be carried about by the hunter.

When the dog enters the hole the light is turned on, and the glare frightens the hunted animal out at some other hole, where he is bagged.

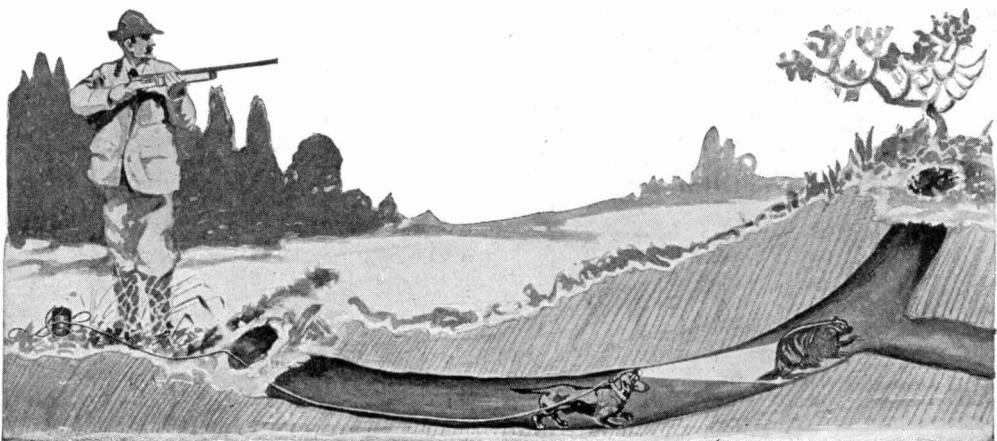

THE BADGER HOUND AT WORK WITH A SEARCHLIGHT TO SCARE THE GAME

The New Cambridge Subway to Boston

By LIVINGSTON WRIGHT

Cambridge and Boston's \$20,000,000 outlay on street railway subways, power houses, tunnels and equipment is the latest effort to solve this mighty problem of transportation that is puzzling the cities of the world. In the just-completed "Cambridge subway," as goes the popular expression for the vast system of improvements being brought to the finishing touch by the cities and transportation interests of Boston and her sister municipality, there exists, if not absolutely the finest, certainly one of the most perfectly constructed pieces of municipal engineering in the world.

The stamp of "Boston" is all through

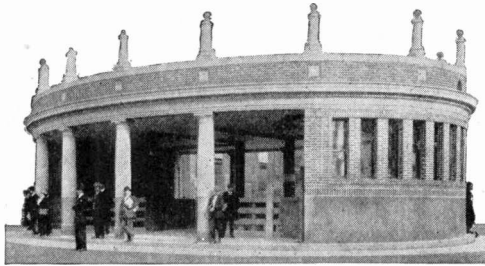

SUBWAY ENTRANCE NEAR HARVARD SQUARE

the huge project, as unmistakably, uniquely and genuinely as if the word were cut into every bit of steel, concrete, copper and glass employed in construction. Carefully, calmly, conservatively solidly and for-all-time designed; built with exactness and such care that only five deaths resulted in the entire subway and tunnel work; finished and embellished in that peculiar Boston way of soberness and chasteness which at the same time result in a true elegance, this mighty undertaking may well be studied as the apotheosis in the latest method of scientifically alleviating city traffic troubles.

Properly to complete the original project of building a tunnel under

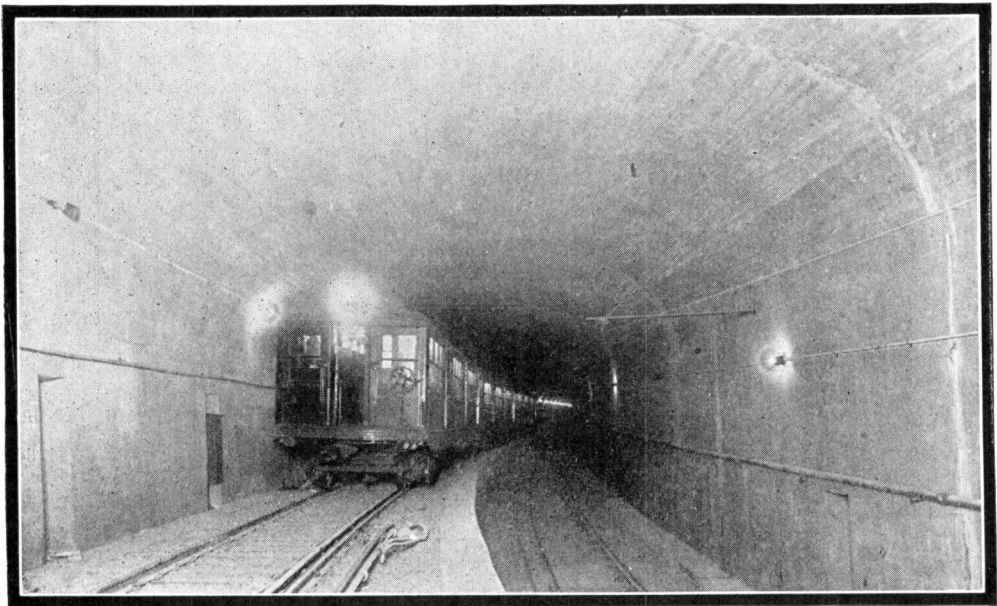

INTERIOR OF THE NEW BOSTON-CAMBRIDGE SUBWAY

Beacon Hill upon which the State House stands, on crossing the Charles river and making a subway thence, $2\frac{1}{4}$ miles to Harvard Square (near the University), in Cambridge, many incidental and monumental works had to be planned and constructed. The total cost of the work was \$19,050,000.

The largest single piece of new construction is the tunnel and subway venture which costs \$10,000,000. There are three sections in the Cambridge subway. The first is the subway proper 13,200 feet long, including the elevated track over Boston bridge (1,950 feet long), for which the Boston Elevated, the concern which operates the street railway system of Boston, Cambridge and other suburbs, paid Boston and Cambridge some \$425,000 for the right to use. The second section (675 feet long), is the short piece of elevated structure which fills the gap between the end of the West Boston bridge in Boston and the Beacon Hill tunnel. The third section is 2,500 feet long. This makes a total of 3.1 miles.

The \$3,500,000 power house expenditure represents the big new power station in South Boston and its seven substations where power is transformed for the use of cars. Six of these latter are now operating and for the last two months this power station has been generating power at the lowest cost of production in the history of the Boston Elevated. The two steam turbine genera-

tors develop together 40,000 horsepower.

The expenditure for equipment includes 40 Cambridge subway cars, 50 prepayment surface cars and 20 elevated cars. The Cambridge subway cars are a

new idea. They are of steel entirely, seat 72 persons and cost \$11,000 each.

Some idea of the the scope of details in construction may be gained from remembering that 2,500 men have been employed each day of the more than two years of subway building, and that for much of the time 4,000 men were at work! There was over 500,000 yards of excavating in Cambridge, and 4,000 tons of structural

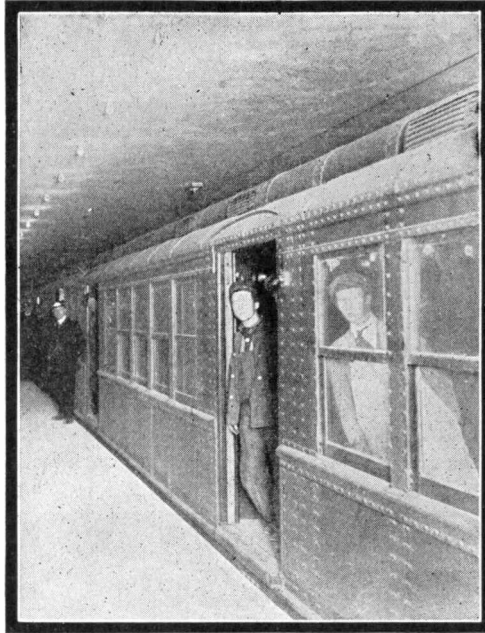

THE ALL-STEEL SUBWAY CAR

steel used; 6,000 tons of steel rods for concrete; 350,000 barrels of cement; 350,000 tons of crushed stone; 200,000 loads of sand.

The Cambridge subway extends just $2\frac{1}{4}$ miles from Harvard Square, along Massachusetts Avenue, past the entrance station at Central Square, and turns in southwesterly under Cambridgeport to arise to the surface at Kendall Square near the West Boston Bridge. A graceful, concrete-arched elevated structure takes the trains across this bridge at the Boston end at Charles and Cambridge streets. The elevated structure carries them on to the mouth of Beacon Hill tunnel at Grove Street, a comparatively short distance. From thence through the tunnel to Park Street Station (near the famous Park Street church) is but a swift, short shoot.

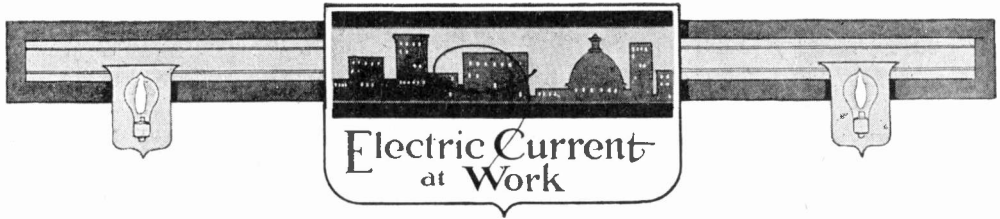

The Modern Sculptor

The great Shield of New York State, destined to occupy the place of honor above the doorway of the new Immigrant's Savings Bank in the Metropolis of America, is being sculptured in marble by the six sons of Joseph Piccirilli, a sculptor of Rome. These six boys, Horace, Thomas, Furio, Attilio, Furuccio and Getulio, came to New York in 1887 to carve out fame and fortune for themselves in the art of their father.

Fame has come to them, as they are known as among the leading sculptors of America. Unlike their father, who chiseled away in the slow and tedious process of the old school, these six sons caught the American spirit of the times and have substituted electricity for hand power wherever practicable, without sacrificing one whit of art and all that it signifies.

The first thing to be done to a block of marble is the roughing-out, at best a laborious and lengthy task when done by hand. Modern drills operated by compressed air, produced by electricity, chisel out the superfluous corners and the portions of the marble that will not enter into the making of the statue. These drills

drive a row of small holes several inches deep, where the split is desired; wedges are then inserted and driven in by hand, until the piece drops off. The work of roughing-out is expedited seven-fold by the use of the rapidly pulsating drills.

Electricity and compressed air also supply the means of finishing the work on a piece of marble. This process consists of reducing the surface of the statue from a chiseled-out state to a smooth one, ready to receive the polish. The electric finishing tool gives a great variety of finishes not to be obtained by



SCULPTURING BY ELECTRICALLY DRIVEN TOOLS

hand work, and does in one day the work of a whole week.

The Piccirilli Brothers' plant consists of two tanks of compressed air, in one of which a pressure of 100 pounds is maintained. This is used for the roughing-out work and gives 200 pulsations to the minute in the drills. The air in the other tank is kept under 25 pounds pressure and gives the finishing chisel 90 beats to the minute. A 35-horse-power motor supplies the power.

Electric Dryer for Letter Press Copies

In almost all business houses where press copies are made of the outgoing typewritten letters more or less trouble is encountered in drying the copies rapidly. To solve just this difficulty an ingenious and comparatively inexpensive electric dryer has lately been perfected by one of Uncle Sam's experts and has been introduced most successfully in several of the most up-to-date government offices at Washington. Espe-

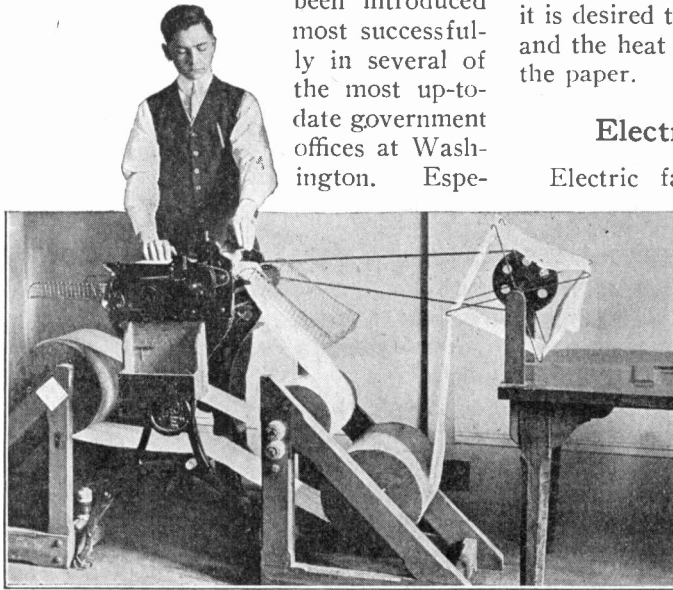

COPYING LETTERS AT THE RATE OF TWELVE PER MINUTE

cially significant is the fact that being a governmental invention no patents have been taken out on the device so that it may be duplicated by any firm or individual whose needs it might serve.

The new electric dryer may be used in connection with any of the standard models of rapid roller copiers now on the market and it virtually requires no extra power—the whole operation of the dryer being dependent upon the “pull” of the copy paper as it unwinds from the roll and passes between the various rollers. Essentially the dryer consists merely of three rollers, cylinders or drums hung in a wooden frame.

All the drums have wooden ends (perforated for ventilation), but the circular face is formed from a good grade of galvanized iron. Inside each revolving cylinder are three 32 candlepower incandescent lamps which furnish the heating power. At the outset Mr. W. Musser, the Federal expert who invented this dryer, installed electric heaters in the cylinders, but it was found that the heat could not be regulated so minutely as by means of the ordinary lamps. Under operating conditions the current is turned on fifteen or 20 minutes before it is desired to begin the drying of copies and the heat is never sufficient to scorch the paper.

Electric Fans in India

Electric fans seem to be replacing some coolie labor in India where, at certain seasons of the year, it becomes necessary to employ some means of fanning and keeping mosquitoes away. The regular price for four coolies to divide up the 24 hours between them is six cents each per day. With electric fans the cost is reduced, and considerable inconvenience is avoided as well. The day shifts of coolies do reliable work while they are being watched, but the night shifts are likely to quit work while their employer sleeps. The electric fan works all the time.

Automatic Temperature Regulator

The addition of an automatic control to a heating system takes away much of the care of operating it when the control system is simple. The Utility electric thermostat, with a motor in connection,

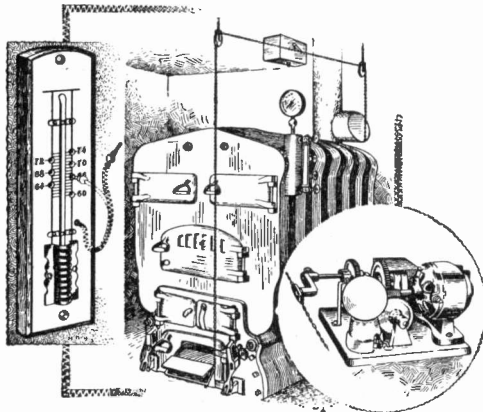

AUTOMATIC TEMPERATURE REGULATOR

does this work. The thermostat is a thermometer. The expansion or contraction of the mercury column of the thermometer brings it into contact with platinum wires woven at intervals into the glass tube, and completes an electrical circuit. The current then passes along the wires to the motor box in the basement, starts the mechanism therein, and by a simple turn of a shaft controls the furnace or boiler drafts and dampers.

Suppose it is desired to maintain a temperature of 66 degrees. The small plug is inserted in the socket corresponding to the 66 degree point on the thermometer. While the mercury is below the wire connected to the plug, the mechanism will keep the front draft open and the rear check damper shut. This causes the fire to burn briskly. But, as soon as the temperature of the room rises so that the mercury touches the contact point (66 degrees) opposite the plug, an electrical circuit is completed which in turn, through a simple relay, controls the current to a small motor operated from the lighting circuit. Current flows through the wires to the motor, causing it to move

the elbow shaft in the opposite direction to which it had been moved. This immediately reverses the position of the draft and damper and instantly checks the fire. Should the temperature fall as much as 1-10 degree below the point at which the contact plug is set, the motor operates long enough to again open the draft and close the damper.

The electric thermostat can be installed in any house wired for electric light. The thermostatic thermometer is placed in the living room, or any central room in the house from which it is decided to govern the house temperature. The wires run through the wall down to the basement and there connect with the motor box. This box, which contains the operating mechanism, is attached to the ceiling over furnace or boiler or to any convenient place nearby. A projecting shaft with elbow attachment operates the draft door and check damper by a simple chain arrangement.

A New Type of Fan

An electric fan with such special features that the manufacturers have named it "Unique" is here illustrated. The fan has two sets of blades and revolves in

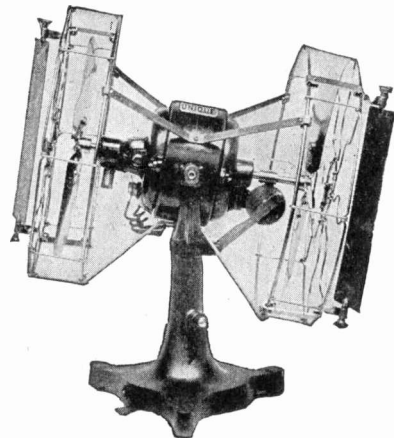

FAN WITH TWO SETS OF BLADES

a circle. While running, it also tilts or see-saws. Three running speeds are provided for and by adjusting a set screw the amount of the tilt is regulated.

Boiling Water in a Hurry

While the breakfast toast and coffee are being made, the eggs may at the same time be boiled by turning the

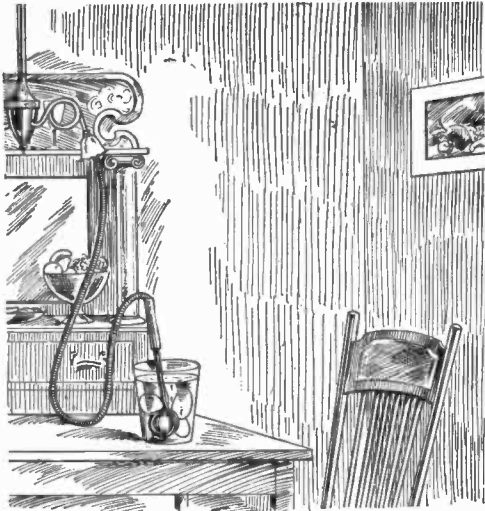

THE UTILITY WATER HEATER

switch to which a little electric heater is connected. This device, called the Utility heater, is small enough to plunge into an ordinary water glass. The heated portion is entirely under the water when used, so that no heat is lost and the device can be used on either direct or alternating current.

European Farm Motor

The cost of installing and maintaining a number of small motors, each of which is used only occasionally, is often considered as an argument against the use of electricity on the farm. This

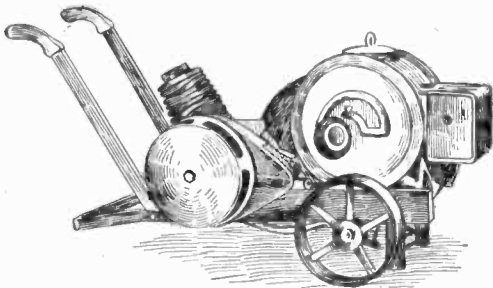

FARM MOTOR

objection, however, disappears if a single portable motor is used. A Swiss firm is placing upon the market a portable motor built in sizes from two to six horsepower. The weight of the motor is so well distributed that in handling, only 49 pounds fall upon the handles. The uses to which the equipment has already been applied are threshing machines, wine presses, wood saws, corn shellers, feed cutters, etc.

Shoe and Hosiery Display Device

A clever advertising device for displaying successively upon the same figure several styles of shoes and hosiery

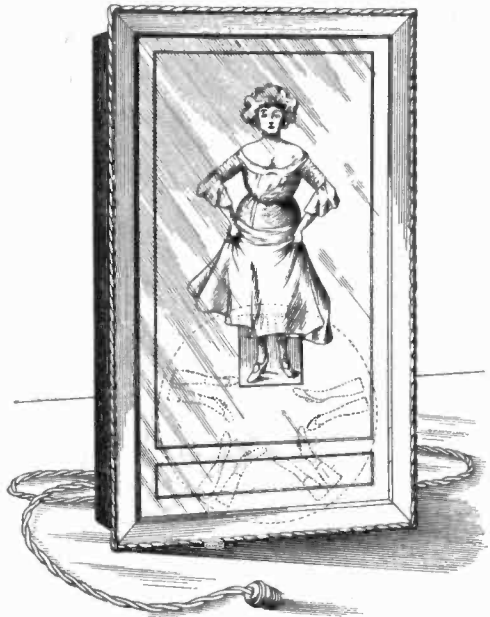

SHOE AND HOSEIERY DISPLAY

is the invention of G. T. Fielding, Jr., of New York City. Within a suitably framed casing is arranged a female figure. Upon a circular revolving display board are placed the articles to be exhibited. The revolving board is entirely hidden except for an opening in the proper position to make the goods appear as if upon the figure. When the outfit is connected to an electric circuit

the motor driven mechanism causes the arms to drop the skirt for a moment, during which time the display board revolves, bringing a new pair of shoes or hose to the opening. The board stops for an instant and the arms of the figure lift the skirt. In a few seconds the operation is repeated with the next articles upon the board.

New Type Instantaneous Water Heater

This is an instantaneous water heater consisting of bare resistance wire coils within a series of passages in a porcelain cylindrical body through which the water flows when the faucet handle is turned.

The faucet handle is arranged to operate a special snap switch turning the current on and off with the water. The heater may be connected to either direct or alternating current, and where

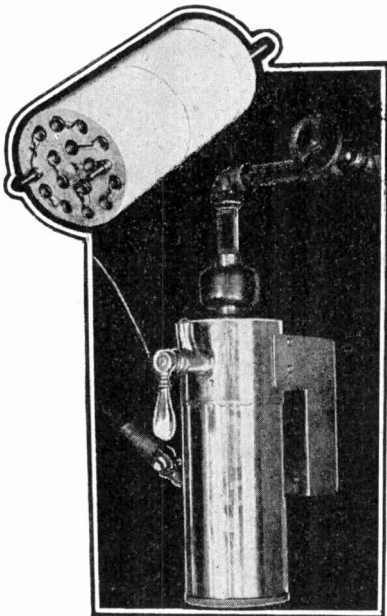

INSTANTANEOUS WATER HEATER

attached to the water pipe it is provided with an insulating joint. This is to eliminate the leakage of current except through the water, which as shown in the open porcelain cylinder comes in

actual contact with the electrically heated wires.

Filtering Air for Dynamos

In modern German power stations where turbo electric generators are used it is now quite commonly the practice to filter the air which circulates through

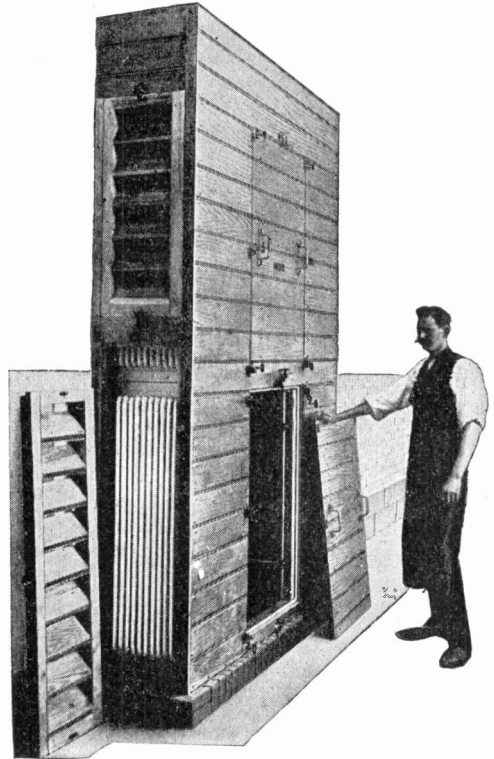

AIR FILTER WITH DUST PROOF WOODEN CASE

the generator or dynamo coils and about the collecting rings. All dust and flying particles are taken out, which might eventually be harmful to the insulation of the machine.

There are various types of filters, one of which is shown in the picture. Pockets are provided inside the case, lined with cloth, and through this cloth all the air must pass on its way to the pipes leading to the dynamo.

In some cases the cabinet or case containing the filtering screens is built permanently into the wall. In others it is made portable so as to be moved easily to any convenient wall opening.

Paper Drier for the Job Printer

A Kentucky printer has found that a 770 watt electric heater is one of the biggest money savers in his shop. He has constructed a drying cabinet, with the heater in the lower compartment, while above it, on light wooden frames, the sheets to be dried are placed. Work which would require lying undisturbed

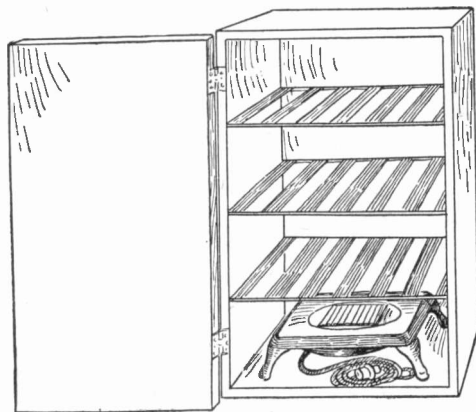

PRINTERS' DRYING CABINET

24 hours at the ordinary temperature of the room will dry in the cabinet in less than an hour, and can then be printed on the reverse side or handled without any danger of "offsetting" or smearing. As so many printing jobs are rush orders, an electric drying cabinet would be a valuable addition to any printing office, for it will clip off many hours in time.

Handling Cane in Sugar Mills

The sugar mills of the West Indies yield rich returns on investments, so that it is not difficult to understand why millions of dollars are invested there in mills and lands. But to bring these returns, well handled mills and a steady supply of cane are necessary. To both of these needs electrical equipment contributes. The cane cut in the fields by natives is loaded upon ox-drawn wagons and hauled to the nearest railroad. Cars are stacked with the cane, which is then forwarded to the mill, where it is unloaded in a small fraction of the time re-

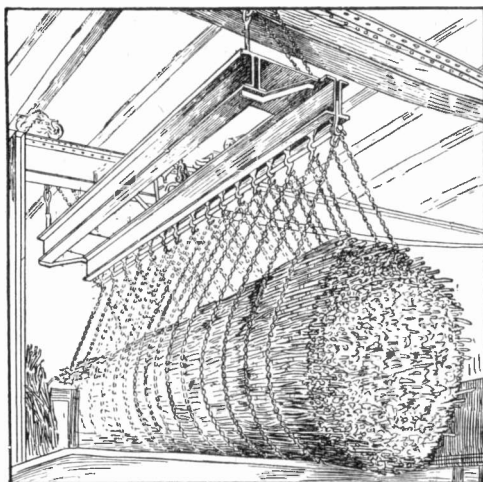

ELECTRIC CRANE HANDLING SUGAR CANE

quired to load it. An electrically operated hoisting crane especially fitted with numerous chains and hooks lifts the entire mass at one time and dumps it into the crusher, where it is cut into small pieces and starts upon its journey by passing immediately through the first set of rolls.

Trimming Off the Rough Spots

Another one of the former hand operations in large shops is doomed. When castings were too heavy to be held up against an emery wheel it used to be

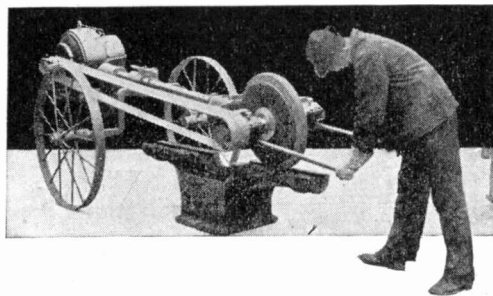

WORKING WITH THE PORTABLE GRINDER

customary to chip off the rough projections by hand. Now the up-to-date workman comes along with his motor driven grinder mounted on a little cart, so that he can touch up the castings in a very few minutes and without either moving the castings or greatly exerting himself.

Electrical Men of the Times

MATTHEW C. BRUSH

Matthew C. Brush, one of the most noted street railway and traction executives in the East, has just been appointed second vice president of the Boston Elevated Railway, with special duties to be assigned by the executive committee and by the president.

The rise of Matthew Brush in the street railway world has been rapid but fully merited by his talents. He is only 37 years old, but has had a thorough practical experience from the ground up. He was born in Stillwater, Minn., and graduated from Armour Institute in 1897. He graduated from the Massachusetts Institute of Technology in 1901. He paid for his higher education in these technical institutions by his own work and enterprise, pegging steadily away until he won his degrees. When he launched into the whirl and competition of the railway business this steadfastness of purpose became the foundation of his later successes.

Finely equipped technically, he has the added gifts of practicability and executive ability, combined with tact and a genuineness that makes every one coming in contact with him feel that he is a friend. It is said of him that he could do more business in an hour offhand, with less fuss and feathers, than the average corporation official could transact in a day. On one occasion, while playing pool at a clubhouse, a salesman

intruded upon his leisure to show him a sample of bellcord. Mr. Brush examined it carefully, told the salesman that if goods delivered came up to the sample they would be accepted, gave him a substantial order and resumed his pool playing. Many another official would have refused to talk business and have forced the salesman to come around to the com-

pany's offices next day and cool his heels in the anteroom for two or three hours, thus to be duly impressed with that official's importance, regardless of the fact that the salesman had other customers equally important with whom he had appointments.

After leaving Massachusetts Institute he entered the machine shops of the Union Pacific at Omaha as an apprentice, where he served his time. He then went to Council Bluffs as a machinist,

and from there went back to Chicago, where he took a position with the Chicago, Burlington & Quincy road. He had already served as a rodman in Kansas for the Chicago & Rock Island.

In 1904 he joined the staff of the Boston & Suburban Electric Companies, as assistant to the president. At that time the properties consisted of nine street railways, a gas company and two amusement parks. In eight months he was elected general manager of the properties. In 1905 he was made vice president and general manager and a year

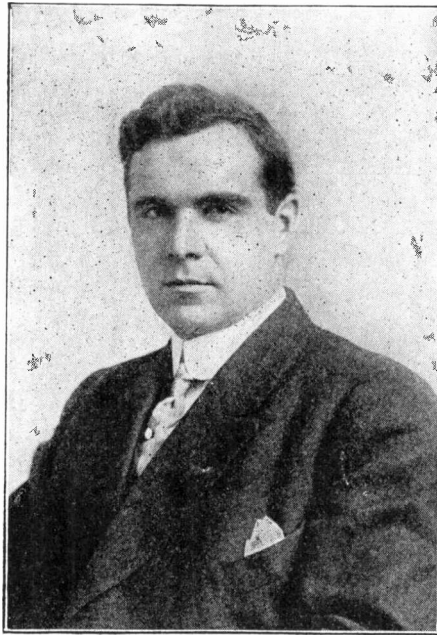

later was also made head of the Suburban Manufacturing Company, which was formed to build a \$300,000 power house in Waltham.

Through his efforts the Boston & Suburban lines, which had previously been losing a great deal of money, were put upon a sound financial basis. His administration was marked by a co-operative policy between officials and employes, and when he resigned in 1909, 500 officials and employes of the company gathered in the theater of Morumbega Park to express their regard for him.

He left the Boston & Suburban to become general manager of the Buffalo & Lake Erie Traction Company, the Jamestown, Chautauqua & Lake Erie Railroad and the Jamestown & Chautauqua Steamship Company, operating 200 miles of electric lines, 50 miles of steam road and a fleet of steamboats on Lake Chautauqua. He remained in this position a year, when he was called back to Boston to become assistant to the vice president of the Boston Elevated Railway, which controls the largest traction system under one unit in the world. For the past year he has been chairman of the efficiency committee, which acts as an advisory and assistant committee to the president, executive committee and the vice president.

Mr. Brush is a member of the Newton Club, the Pales Club, the Waltham Business Men's Club, Delta Kappa Epsilon, New England Street Railway Club, the Boston City and University Clubs and is an associate member of the American Street & Interurban Railway Association.

Speaking of the Boston traction service at a meeting in Wells Memorial Hall held recently to discuss the subject, "How Can Overcrowding in Street Cars Be Avoided?" Mr. Brush said he believed that the solution was in overcoming the physical peculiarities of Boston by new facilities and by using the new large prepayment, semi-convertible cars, of which 100 are now in use and more

ordered. Eventually the entire system will be using them. The company now has 28 miles of cars, and extra cars are impossible in the congested section of the city, which contains only five miles of outward bound tracks, against over 700 miles on the entire system.

Adapting the X-ray to Minor Surgery

The assistance rendered the physician by the X-ray in the examination of broken bones and in the setting of these has given impetus to the designing of apparatus for this service.

The accompanying illustration shows a piece of apparatus devised by Dr. Grashey of Germany to use in operations

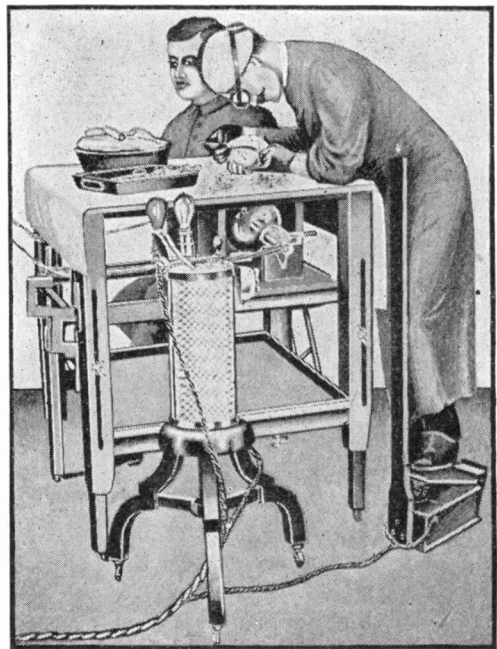

USING THE X-RAY IN SURGERY

in which the bone structure or material worked upon is small. A needle buried in the flesh of the hand is being removed. The surgeon wears a special eye piece which shields the eyes from daylight, the work being performed in the daytime. A foot switch serves to turn the current on and off the tube which is supported on the underside of the table.



Electrical Interests of Women



EDITED BY GRACE T. HADLEY

Electricity in the Summer Home

"We are fitting up a summer home on the North Shore," chatted Mrs. Arthur Dainty, over a cup of tea at the home of a very dear friend. She was an Easter bride and bubbled with enthusiasm and the mere joy of living. Her best friend and adviser was Mrs. Eleanor Beach, a famous club woman, with whom she frequently spent an afternoon. Mrs. Beach beamed upon her petite and pretty visitor with a kindly smile of approval. She approved most heartily of bubbling brides, blithe joyousness and home happiness.

"That's good news," she remarked in her even, musical voice. She had a well trained voice and could address a fashionable club with fervor and brilliance.

"You know I have had such charming chats with you over this electric samovar," bubbled little Mrs. Dainty, "that it gave me an idea. I have been studying things electrical and I am fitting up our home with the new power appliances and if I am left without a servant I shall not be entirely helpless.

"All the domestic power appliances today are a long step toward the solution of the servant problem," remarked Mrs. Beach.

"Of course I shall use electricity as an illuminant," Mrs. Dainty ran on with enthusiasm, "and I shall have a chafing dish and a toaster. But best of all, my husband has promised me an automatic

electric cook stove, a power table and we are to have an auto-electric refrigerating plant on our ice-box."

"Wonderful!" exclaimed Mrs. Beach. "Housekeeping today is not the awful drudgery it used to be, and the furnishing of a home is not the task it once was, especially the fitting up of a summer home."

"Oh, yes," pursued the little bride, "with the modern reed craft furniture, wicker craft chairs, comfort rockers and electric wicker lamps, one can manage to make a summer home quite comfortable."

"Then there is the rattan furniture for porches and dens," she continued, "and the Chinese grass chairs imported from Hongkong. They are simply ideal for lawns on account of their resistance to moisture."

"Speaking of Hongkong," interrupted Mrs. Beach, "reminds me of the exquisite suggestions for artistic summer homes that come to us from the far east, from Japan, for example. We do not see nature as the Oriental sees it and as his art proves that he sees it. The Japanese artist with a few dashes of the brush, seizes and reproduces with an incomprehensible power of interpretation, not the recollection of any individual blossom, but the perfect realization of the general law of form. The Japanese artist gives you that which he



EXQUISITE SUGGESTIONS COME
FROM JAPAN

feels, the precise sensation of an hour or the mood of a season. He steps his distances in mist or bands his landscapes with clouds and stimulates the imagination."

"And the western artist?" queried Mrs. Dainty.

"Too often renders minute detail and satisfies the imagination."

"The Japanese decorative designs are exquisite. I love them and I believe I shall have a Japanese suite in my summer home. Would not that be delightful?"

"Indeed it would be," responded Mrs. Beach with enthusiasm.

"Then help me plan it, this very minute."

"First there must be the finest matting for the floors and a Japanese rug over that and the furniture of polished wood

with tapestry backs. The electric lamps must be encased within those unique and delicate silken shades decorated so wonderfully by Japanese art, and of course there should be screens."

"And dragons?" inquired Mrs. Dainty with breathless interest.

"Yes," laughed Mrs. Beach, "and some lacquer ware, a statuette of ivory, a few pieces of that lovely porcelain, and an incense vase of bronze. How would

that do?"

"I am delighted with your suggestions. I think they are quite



A GENERAL LIVING ROOM SOMEWHAT COLONIAL IN STYLE

perfect. I was wondering just how I would fit up the suite in the west wing, but you have solved the problem for me. My general living room is somewhat Colonial in style with a fireplace for chilly mornings and cool evenings. Above the mantel are paneled decora-

tions in color, suggestive of summer blooms. Huge beams of oak project outward and bear the lighting fixtures, which are imitations of the Colonial candle, and there is a lantern effect on the lower side of the beam. The wood trim is ivory white paneled with Japanese grass cloth. There will be plenty of fumed reed furniture with brown leather cushions, built-in book cases and similar accessories, while the window fabrics are in two tones, a delicate green combined with golden brown."

"I think your summer home will be a most enjoyable place and I shall give myself the pleasure of visiting you often," laughed Mrs. Beach. In fact, I am almost persuaded to abandon my northern trip and camp in that Japanese suite we have just planned."

"Nothing would please me better," cried the little bride, giving her friend a joyous hug. "You know we thought of going abroad on our wedding trip and then we said: 'Oh no, let us spend our money here and make a home that shall be the perfection of comfort and convenience.'"

Home Refrigerating and Ice-making Plant

"Just what I have been looking for!" This is the expression of every up-to-date housekeeper who sees the auto-electric refrigerating plant, another silent, automatic servant for the modern home and a safe, sure, labor saving device. There is no uncertainty about the ice supply during a continued hot spell in the summer time. Many a housekeeper has had the following experience in the middle of a hot afternoon on a very hot day. The perspiring maid trails up the stairs and announces that the ice is nearly gone. Company is expected to tea and worse still it is a holiday!

"But I told you to order an extra supply to last over the Fourth," protests the perplexed hostess.

"I did, ma'am," replied the maid, "and

the ice man said he couldn't because he was running short on all his orders, and I had to wipe up after him because he always comes in just after I clean the floor. It makes no difference when I clean that floor, the ice man comes in afterwards, and makes tracks," continues the maid in an injured tone.

"Well, send the yard man out and tell him to buy some ice somewhere," interrupts the mistress, "we're expecting a guest to tea and we must have ice."

"Please, ma'am, the yard man has gone for the day——" the maid begins again. Every housewife knows the story. It is just the day when the last straw breaks the camel's back, and the housekeeper is convinced of a conspiracy on the part of



NO UNCERTAINTY ABOUT THE ICE SUPPLY WITH ONE OF THESE MODERN REFRIGERATORS IN THE KITCHEN

the weather, the ice man, the maid and the invited guest, to make her life as miserable as possible. Not so with an electric refrigerating plant in the home. You can have the ice when it is most needed. Best of all, you can have the

niciest little cubes of ice made to order in your own ice box, ready for the ice tea or for a glass of lemonade.

A small motor driving a compressor with a system of piping and a storage tank inside the ice box are the essential elements of the refrigerating plant. Down in the lower part of the refrigerator is a marvelous instrument, the thermostat, which regulates the temperature and maintains an even 45 degrees or so, never varying over two degrees. The contents of the ammonia tank may be replaced twice a year at a cost of one dollar. When the required temperature is reached, the motor stops. Should the ice box be opened so that the temperature rises, the motor, in obedience to signals from the thermostat, starts automatically and the temperature is reduced.

Telephone Etiquette

A newspaper in Michigan is authority for the statement that four hours and fifteen minutes were consumed by a couple of estimable ladies in a telephone chat one Sunday afternoon in a town of that state. Needless to say this town has flat rates. But think of it! Count up the time consumed, four times 60 minutes plus fifteen more. It is said that the connection was put up soon after noon and from that time until after dark there was continuous talk. No one could get in on the line. Everybody else was talked off the wire. No transcript of the conversation has been preserved but it probably ran along like this:

"Say, Mrs. X, I want to ask you about that pattern you promised me. You said you had loaned it to Lydia Smyth but that I could have it as soon as she returned it. Did you ever get it back?"

"No? Well, wasn't that careless of Lydia? Did you notice her dress at church this morning? Didn't it hang simply awful? And that is the one she made herself! Well, if I couldn't sew any better than that I wouldn't borrow other person's patterns and then neglect to return them.

"Have I heard about the Brown's baby? No, what is it? Measles! And I better not let Tommy go over there! Indeed I won't, but I saw the other Brown children at Sunday school today and I don't think they should be allowed to run at large. Oh, you're not sure it's the measles, you merely heard that some



PERHAPS A YOUNG GIRL AND HER SWEETHEART MONOPOLIZE THE PHONE

one else thought it might be the measles!"

Imagine 255 minutes of such conversation and other people waiting to use the line. A record breaking conversation of this length shows an utter lack of consideration for the rights and necessities of other people, and yet many of us, who are on party lines, recall that we have waited while similar estimable ladies or perhaps a young girl and her sweetheart monopolized the phone beyond the limits of patience. The telephone is one of the greatest modern conveniences. It has placed all mankind within earshot of each other but it should be used in a businesslike manner even by women in their homes.

The Silent Servant

It was Saturday afternoon and baking day at the home of Mrs. B. T. McCanna, 6320 Ingle-side avenue, in Chicago. Two visitors trudged up the steps and rang the bell, but Mrs. McCanna did not mind a bit because visitors called on baking day; neither did the Silent Servant. Now right here is the first great advantage of this remarkable new servant. It is never the least bit flustered or embarrassed over the advent of visitors or company to tea.

"We came to see the Silent Servant," was our explanation, and Mrs. McCanna laughingly led the way to the kitchen.

"Well, here it is," she said. "Inspect it as much as you like. It doesn't mind at all."

A modern automatic electric cook stove, made of solid oak, stood in a corner of the kitchen. It was 35 inches high with top and doors of finished asbestos and nickel trimmings.

"Now, let's see what it will do," we demanded with interest.

"Well, I'm going to stir up a sunshine cake first and here is the recipe I use: Whites of seven eggs, yolks of five; $1\frac{1}{4}$ cups granulated sugar, one cup flour, scant third teaspoon cream tartar, a pinch of salt added to the whites of the eggs before whipping, and flavor to taste. Sift, measure and set aside flour and sugar. Separate the eggs, putting the whites in a mixing bowl and the yolks in a small bowl; beat yolks to a very stiff froth. Whip whites to foam, add cream tartar and whip until very stiff; add sugar and beat in (always using a spoon to mix cakes with), then flavor and beat in; then flour and fold it lightly through.

This cake was put into a cold oven at

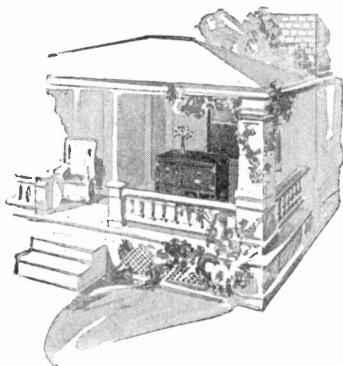

2:40 by the clock. The thermostat was set at 250 degrees and the electric current was then turned on. When the oven reached the degree of heat indicated by the thermostat, there was a sudden click and the current was automatically cut off and the baking was done with the heat stored in the oven chamber. The

cake was beautifully baked and delicious to taste. In fact, it melted in the mouth. Several pans of biscuit were then put in at 300 degrees of heat and were baked in the same way. Four apple pies went into the oven at half past four o'clock. Pies require 350 degrees, and when taken out they were so well baked they shook loose from the pans.

Rice was cooked in the boiling compartment. Mrs. McCanna used one cup of ordinary rice. This was washed thoroughly and put into an aluminum utensil, not a double boiler. Three cups of water and two of milk were poured over the rice. The thermostat was set at 212 degrees or boiling point. The current was on 20 minutes, then was automatically cut off and the rice cooked on the receding heat principle.

"I often set rice or oatmeal to boil this way," said Mrs. McCanna, "for the boys' luncheon, and I go down town. In a third of an hour the current is cut off, but the cereal continues to cook until the boys come home at noon. Then they take the nice warm food out of the oven and make their lunch on it together with bread, milk and jam."

"This is certainly an easy way to cook," remarked one of the visitors.

"Oh, I wouldn't go back to a gas range for anything," said Mrs. McCanna with

emphasis. "I cannot imagine a greater hardship. Now I will stir up some cup cakes." After the cup cakes were taken out of the oven, a pan of apples went in. Last of all four loaves of bread in an aluminum bread pan were put in and the thermostat was set for 350 degrees. The bread went into the oven at 5:20 o'clock and baked for 50 minutes, during which time the current was on for 30 minutes, and the balance of the time the bread baked in receding heat.

"Do you wonder I like to bake?" asked Mrs. McCanna, with pride, as she took out of the oven chamber four of the most beautiful loaves the visitors had ever looked upon. "The only drawback to the new stove

This Twentieth Century stove, twin companion in science to the wireless telegraph, the aeroplane and the automobile, has come to stay and its use will broaden the activities of the home and lighten the burdens of womankind. The

last and final step in the development of this modern method of cooking is the application of the automatic control feature, an improvement that has eliminated one-half of the labor and drudgery of cooking. Imagine an automatic, silent servant that will get up at any hour that you may predetermine—four, five or six o'clock in the morning—start the cereal, heat the water, cook the coffee in the percolator and prepare everything correctly and keep it in perfect condition,

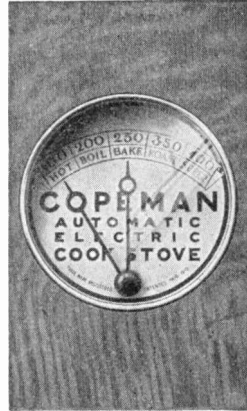

THE THERMOSTAT DIAL

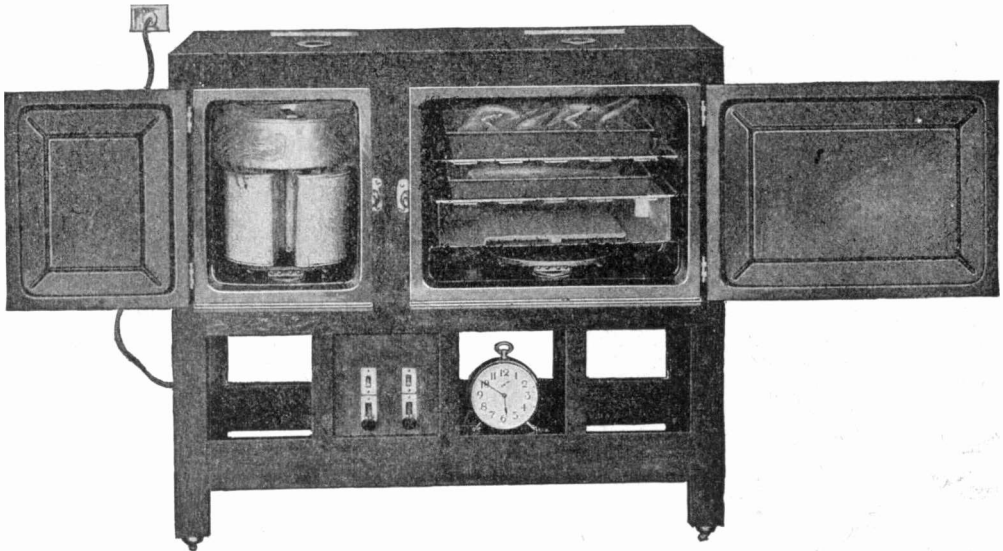

A MODERN AUTOMATIC COOKSTOVE MADE OF SOLID OAK

is this: the family eats more than it ever did before, because the things taste better and are so well cooked. I bake three times a week and four loaves each time, besides the pies, biscuit and cup cakes of which every member of the family is so fond."

until such time as you are prepared to eat.

The stove is really a marvelous appliance to free the housewife from the heart-breaking, shriveling heat of the kitchen and preserve her disposition and appetite to grace the daily meal.

The Household Portable Power Table

The Federal household power table is not only a source of power for household machinery but is a veritable little work shop in itself. This compact oak table, standing 30 inches high, can be moved as easily as a chair to any point where it is most convenient for operation. Mounted on a lower shelf is a $\frac{1}{4}$ horsepower electric motor which transmits power directly to an upright shaft or power arm, from which two horizontal shafts with protected couplings give available power at the top of

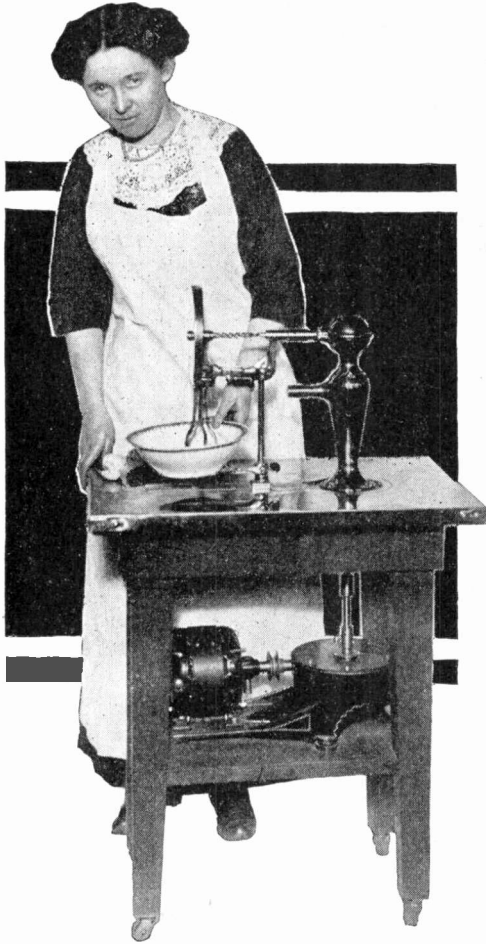

THE POWER TABLE WILL PERFORM PRACTICALLY ALL THE OPERATIONS IN PREPARING FOOD

the table. Electricity is supplied through a ten foot connecting cord securely fastened to the table and fitted with a detachable connecting plug for connection with the nearest lamp socket. The current is turned on or off by a snap switch conveniently placed on the right hand side of the front of the table.

In the kitchen, the power table will perform practically all the operations necessary in the preparation of food formerly done by hand. The nickel plated utensils, table top and all are easily kept clean and shining. It is hardly necessary to touch the food with the hands. Think what this means, not only from a sanitary viewpoint, but in the time saved in washing the hands the number of times necessary in handling and mixing the materials for cooking.

In the laundry the power table can be used to run the washing machine, wringer or the mangle and still have one hand free to turn the ice cream freezer, run the knife sharpener, or shave the soap for washing at the same time. The attachments for the power table are a bread mixer, cake mixer, coffee grinder, food chopper, ice cream freezer, egg beater, vegetable slicer, food grater, apple peeler, knife sharpener and knife polisher.

Tools for Housekeeping

In a current magazine, Elizabeth Atwood writes: "It is strange how many very good housekeepers are careless about the tools of their routine work, both in regard to the completeness of the equipment and in the care of them. It is the old story, almost anything will do, as long as it holds together, and is allowed to serve in the average kitchen or in connection with the care of the house. This, however, is far from being true

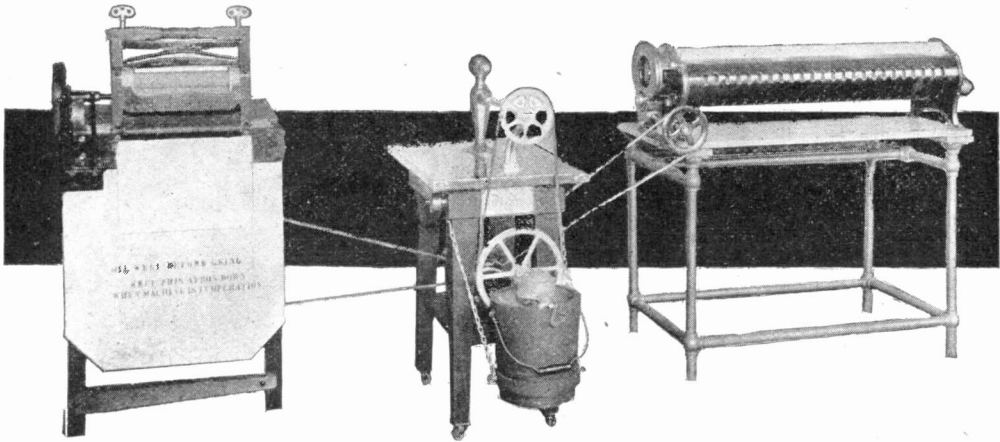

THE POWER TABLE AT WORK IN THE LAUNDRY

economy. The simplest furnishings, the really needful, should be of the best, and it goes without saying they should be kept in perfect order."

Washing Machine with the Washboard Principle

An electric washer that utilizes the principle of the washboard but does away with hand rubbing is a feature of a new washing machine called the "New-

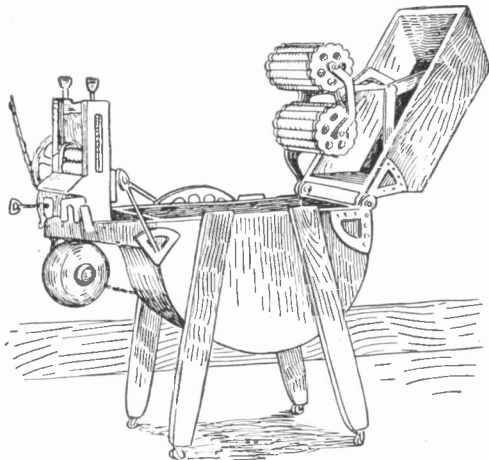

ELECTRIC WASHING MACHINE

disco." It will wash few or many clothes, is very light running and the cost of operation is low. Raising the lid throws the washer out of gear. No clumsy lever is necessary to do this, neither is it necessary to stop the motor

while the machine is running. The clothes can be inspected or more water added while the machine is running. It has a reversible wringer and the washer and wringer can be run at the same time, enabling clothes to be run through from the rinsing water while another lot is being washed.

Electric Cooking Utensils

The individual articles manufactured for electric cooking certainly cost more than ordinary cooking utensils, but there is no necessity for having so many of them. With a little forethought it is surprising how many of the usual cooking pots and pans can be discarded. Once the electric outfit is purchased, it will need renewal only a third as often as the others, owing to its careful manufacture and good material.

In addition to this one of the special features of cooking by electricity is the uniformity of temperature that can be maintained. The heat is not greater in the oven one day than on another, and so, with each of the electric cooking appliances.

Electric plate warmers are convenient and inexpensive to operate and are very useful in the pantry. When dinner is delayed for any cause, plates and food can be kept warm while waiting.



Junior Section

Thorne Elliot's Burglar Alarm

By CLARK DeBALL

The first time I ever saw Thorne Elliot he was preparing to drop a model Bleriot monoplane from the window of what he called his laboratory.

"I knew it," said I looking up at him from the back yard.

"You knew what?" he asked.

"Knew you was about fourteen and had red hair and freckles. We moved into the flat under yours five days ago and we're only just beginning to get used to the racket you make. Nobody but a red-haired guy could make such—"

"Yea," he interrupted, "I've been making an airship."

"Who plays all that rag on the piano?" I asked.

"Oh, that there's only my big sister. I'm an inventor," he said. "Come up to my laboratory and I'll show you some of my inventions."

I went up there. It was a room partitioned off on the back porch of the second flat. On the door was a sign, "Thorne Elliot, Inventor and Electrician—Crimes also ferited. Office Hours After School."

Inside, a person could hardly move, there was so much electrical junk, wires, clock works and things. A white tom cat minus one ear lay blinking on a red cushion on the work bench.

"That's my cat," said Thorne. "His



THORNE ELLIOT—INVENTOR
AND ELECTRICIAN

name's Old Scratch. He's grieving for his lost Lenore."

"He looks it," I said.

"And here's my new burglar alarm."

"Why that looks like one of those little short-horned phonographs."

"Sure," explained Thorne. "That's what it is. It runs by a dry battery. You put it by your bed.

These here wires go to the windows. When Mr. Burglar opens the window, he closes the circuit and—"

"I got you," I broke in. "The phonograph gives the alarm."

"Alarm!" exclaimed Thorne. "She gives a regular battle cry of freedom."

"Let's hear it once," I suggested.

Thorne carefully closed the door.

"Us inventors 've got to be careful," he explained. "I ain't applied for any patent yet. Besides I don't want the folks or any of the neighbors to hear it till I know whether it's going to be a success or not."

Then he started the machine.

Well, I've heard some pretty bum noises, but believe me I never heard anything like the heart-rending screech that came out of that phonograph. That old tom cat tore around and yowled so we had to let him out. After this screech came gurgling groans. Then in ghastly accents the words "Burglars! Burglars! Arise before ye are slaugh-

tered in thy bed! Thy throat will be gashed from ear to ear!" After this came more of those bubbly groans mixed in with wails. Then in graveyard tones the words: "Blood! Blood! Seven buckets of blood! Gore!" It ended with more yells. It was fierce.

Then the machine started to play it all over again.

"Stop that thing," I cried. "How long will it keep playing like that?"

"As long as the window stays up and keeps the circuit closed," said Thorne. "You see," he went on, "when that needle gets to the end of the record that disk hits that little lever and she reverses.

"Tonight'll be a fine time to try it out. Ma's going to spend the night over at Aunt Sadie's and Pa, he's out of town. I'm gona try it on my big sister Maude. I'll hide it under her bed."

"Gee! Won't she know it's there? Say, she'll be scared into fits."

"Not her," said Thorne. "She's got an automatic pistol. I loaded it for her, only I put in blanks so she can't do any damage. Anyhow, if she is startled a little, it'll be good for her. It'll teach her to be on her guard. About two a. m. I'm gona get up and sneak out and burglarize the flat. See? I'll get in the back window. It'll be just like the real thing."

"Say, let me in on that. Will you?"

"Sure," agreed Thorne.

So that night I didn't go to bed when the rest of the family did. I sat up and read "The Fall of the House of Usher."

About two o'clock Thorne scratched on the door. I went out into the hall. He had a black mask on. In one hand he carried a big old army revolver, in the other he had an electric torch and a can opener.

"Ssh," he hissed. "Tread softly, ole pard. Here; you take the dark lantern and the jimmy. I'll carry the barker. I'm Bill Sikes."

"This here is no jimmy," I whispered. "It's a can opener."

"Come on," replied Thorne.

Well, we treaded softly out doors and around the house. It was quite dark and rather chilly for a June night. I was a little sleepy. Thorne in the lead, we sneaked up the back stairs. Half way up Thorne stopped and grabbed hold of me. We listened. Sure as fate some one was up on the porch fooling with a window.

"Dang this thing!" we heard someone mutter.

In a minute we heard another voice say, "Too bad we haven't a jimmy." We could hear the fellow at the window breathe hard and grunt like he was straining at the window. Then the other one whispered: "Let me try a while, brother."

"Well, be careful," came the low reply. "We don't want to wake em up."

One of the men went over to the edge of the porch. We could see him against the sky. He seemed to have a checked cap on, but no mask. When he went back we crept down stairs. My heart was making an awful noise.

"Gimme that gun," I whispered, "and run for the cop."

Thorne nodded and was gone. It was no time for words. At first I thought I would go up there and capture them so I would have my picture in the papers as a hero. But after a while I decided to wait for Thorne and the cop.

Because while we had heard only two men speak, how was I to know there were not more up there who had not spoken? One against seven or eight you know is no cinch. Well, after a while the window suddenly went up.

"Aha!" ejaculated one of the men. I guess he must have started to crawl in, when a terrible shriek rang out. Then, "Burglars! Burglars! Arise before ye are slaughtered—"

It was the phonograph and it was awful. The two men up on the porch began stamping around or fighting or something. "Bang! Bang!" went Thomas' sister's automatic—eight times in all. One of the burglars came down

the stairs about four at a time. He fell at the bottom. Then the other came banging down on top of him. One of them seemed to be clawing at something white on his back. I had gone toward the back fence in order to head them off if they came that way. To intimidate them I began letting off the old army revolver. "Bang! Bang!" answered the automatic upstairs. It sounded like the Monitor and the Merrimac. The burglars jumped up and hiked around the corner of the house.

Windows were going up all over the neighborhood. Between other noises I

of half-dressed neighbors were standing around. One fat fellow had a broom.

The man with the checked cap was shouting, "Leggo my collar. I tell you, officer, I'm no burglar. My name's John Elliot."

"That's my old man, I tell you!" yelled Thorne.

"And this is my friend Rev. W. L. Wharton," continued Thorne's father. "He's a preacher."

"What was ye runnin fer, then?" bawled the cop.

"Listen," said Thorne's father. "We came in unexpectedly on a late train. He



THERE WAS A COP HOLDING TWO MEN BY THE COAT COLLARS

could hear the phonograph. I heard someone screaming, "Gimme the Chicago Avenue Police Station quick." Thorne's sister yelled "Help! Help! Murder!" Some one must have turned in a fire alarm. Oh! it was a glorious mess.

I went around to the front of the house. There in the glow of the electric light was the cop holding two men by the coat collars. Sure enough one of the men had a checked cap on. The cop seemed to be bawling them out. Thorne was there with his mask still on. A lot

was to stay all night with me. I had no key. We were trying to get in the back window so as not to wake up the house."

The preacher broke in, "Brother Murphy put up the back window and must have frightened some member of the family into fits. Some one is in agony up in that flat."

"Look at my face!" cried Thorne's father. "Some furry wild animal jumped out of the window and scratched me!" Sure enough, his face was all bloody.

"That was Old Scratch!" yelled

Thorne. "He was scared of a phonograph."

"Well, what the—" said the cop and stopped.

"Brethren," said the preacher. "I tell you some one is in agony up in that flat. I heard them groan."

Just then the front window went up with a bang. Thorne's sister screamed "Burglars! Help! Help!" And out came a lot of water. It went all over us.

Then a lot more half dressed neighbors came and also a wagon with about ten policemen. Also the fire department. We all went up stairs. When the lights were switched on there was Thorne's sister in her night gown. She had another bucket of water.

"Burglars," she gasped.

"Where?" asked one of the cops.

"There were some down in front of the house a minute ago," she panted, "and there were some in the back yard, and there were several on the back porch. They opened the kitchen window. And oh! there was a crazy one under my bed. He must have escaped when I was out in the kitchen closing the window."

"That was only my burglar alarm under your bed," cried Thorne.

"So!" exclaimed his father, "It was you again, was it? Another one of your fool inventions, I suppose. What are you doing with that mask on?" And he started towards Thorne with a peculiar light in his eye.

Chemical Flasks From Electric Bulbs

Those interested in electricity are frequently also interested in chemistry, and find it necessary to keep on hand a goodly number of flasks. Anyone who possesses some burned out incandescent bulbs can readily transform them into flasks, the various sizes of bulbs making flasks of different dimensions.

The base of the globe should be held in a flame until the binding material has softened sufficiently to allow the brass part to be pushed off. After cleaning

the glass, a sharp file should be used to make a scratch around the glass just back of the place where the little filament tube is sealed in. A sharp glancing blow with the file will then break out the end, leaving a round hole. The edges should be held in a hot flame until they are soft, when they may be smoothed over and formed into a lip. After this has been done, the large end should be held in the flame until it softens, when if it is pressed down on a dry board the bottom will be flattened out so that the flask will stand steadily.

To anneal, the flask should be placed in a pan of strong salt water, gradually allowed to come to a boil, and then set aside to cool.

To Make an Electrophorus

A simple piece of apparatus for experimenting with static electricity is the electrophorus. It may be made as follows: Take an ordinary tin dish and after melting in an iron dish two parts of resin and one part of gum shellac in such a quantity as to nearly fill the tin, pour into the tin and let cool. Next

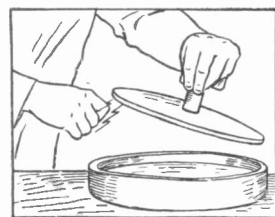

ELECTROPHORUS

make a wooden disk a little smaller in circumference than the dish. Sandpaper well, round off the edges and fit a short wooden handle to the center of the disk. Tinfoil obtainable at a tea or tobacco store should now be smoothly pasted over the entire surface of the disk. Over the wooden handle should be tightly fitted a glass rod or bottle. In using the electrophorus rub the resin with a piece of flannel or fur, then place the disk firmly upon the resin. Touch the tinfoil for an instant with the other hand. Upon removing the disk with one hand and bringing the finger of the other hand close to it, a very good spark will jump to the finger.

A Static Motor

To those interested in electricity, static energy has always had a peculiar fascination, even in spite of the fact that experiments in it are not likely to result in anything that can be placed to mechan-

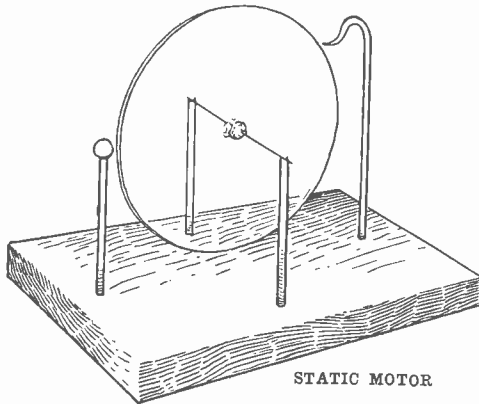

STATIC MOTOR

ical advantage. And yet these experiments are always interesting.

The static motor is a simple instrument, and will well repay the amateur for the slight labor its construction involves. A disk of mica about $4\frac{1}{2}$ inches in diameter should be secured, with a large needle acting as the axis, the ends of which rest loosely into indentations near the top of two vertical brass rods. Little pieces of wax, or two small wooden disks, will hold the mica securely to the needle. An insulated brass ball placed opposite the horizontal diameter of the mica disk, as closely as possible to its edge, and a pointed conductor at the opposite side, complete the arrangement. The ball and point are then connected, respectively, with the opposite poles of a static machine in operation, when the mica disk will revolve at a speed of about 2,000 revolutions a minute, developing considerable momentum.

The Magic Toboggan Slide

Much wonderment and fun may be created with the magic toboggan slide. The slide consists of an ordinary pasteboard shoe box and a small horseshoe magnet fast-

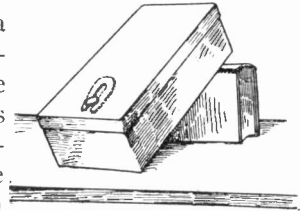

MAGIC TOBOGGAN SLIDE

ened with a little glue upon the inside of the cover as in the illustration. A piece of tin cut in the form of a circle to avoid sharp corners and with edges carefully smoothed serves as the toboggan. With the box set on a slant the disk when started at the top will slide down until it nearly reaches the lower edge of the cover and there stop, much to the surprise of those not in the secret.

Electricity Introduces Juggling Act

The use of pleasing electrical effects to introduce a novelty juggling act is presented in the accompanying illustration. The Carrays open their act with Mrs. Carray upon a large rolling globe, where she is as much at home as upon the floor. In her hand she carries a parasol attractively trimmed with numerous electric lights. This rather unexpected in-

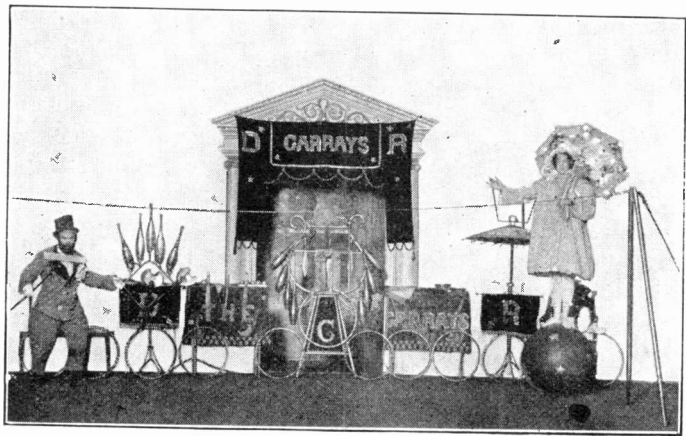

A NOVEL JUGGLING ACT

production gains attention and is followed by clever slack wire, club and hoop work.

Projecting Postcard Pictures

In using photographs, postcards, newspaper and magazine clippings in a projecting apparatus to produce enlarged images on a wall or screen, the difficulty has been in obtaining a very bright white light. This difficulty is overcome in the Victor postcard projector by using an arc light. The arc is hand fed and arranged to keep the arc automatically where it belongs. Five feet from the screen a $2\frac{1}{2}$ foot image is made, while 30 feet from the screen a fifteen foot image is produced. The machine is only 9 by 12 inches and is finished in nickel plated trimmings.

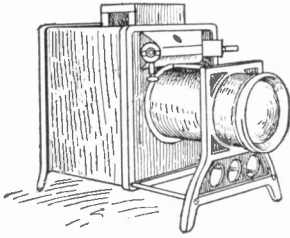

POSTCARD PROJECTOR

Electric Bell Attachment for Dart Board

In playing the game of darts arguments arise as to whether the person playing is entitled to the number limited by hitting the cork center. To settle this question secure a piece of brass tubing about $\frac{1}{2}$ inch in diameter and long enough to go through the board. Force the brass tube through the board, making it to fit firmly. File the ends off

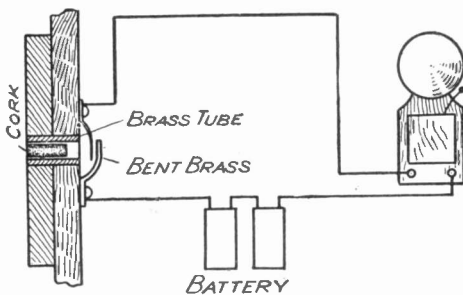

ARRANGEMENT OF DART BOARD ALARM

the tube even with both surfaces of the board.

Secure a cork which will fit the tube, but be loose enough to move readily. On the back of the board across the hole fasten strips of brass slightly bent as shown. These two strips form contact points to which are fastened the copper wires of a bell and battery. Hitting the cork forces it through the tube with enough momentum to push the contacts together, thus ringing the bell.

STANLEY HELVERSON.

The Dancing Doll

The dancing doll and apparatus shown in the accompanying illustration may be readily constructed from the mechanism

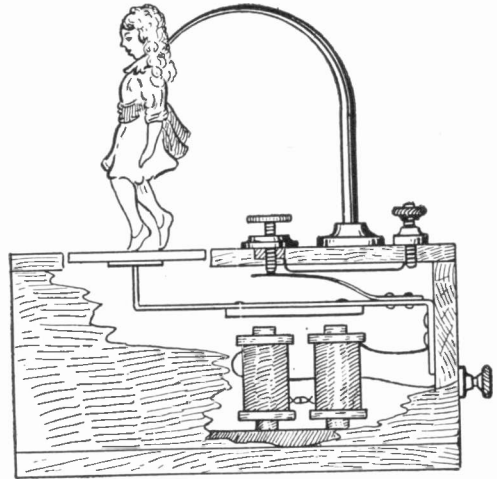

THE DANCING DOLL

of an ordinary electric bell and a neatly made wooden box. The magnets, contacts, armature and hammer arm should be placed as shown. A small circular or square platform is cut from the box and fastened to the bell hammer arm. Upon the top of the box is fastened a curved spring supporting the figure. The joints of the hips and knees should be quite loosely fastened and the figure suspended so that the feet just touch the movable platform. With one or two dry cells the platform will vibrate rapidly, causing the doll to do many fantastic steps.

The Magnetic Detector

The magnetic detector, invented by Marconi and much used by his stations, is unlike all other detectors and possesses many good points. It has been little used by experimenters, perhaps for the reason that it is necessary to have a motor, clockworks or other motive

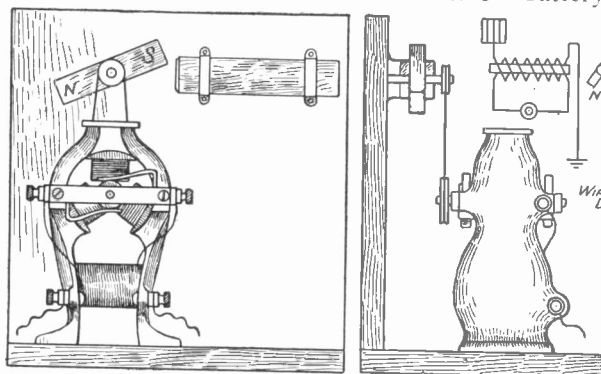

MAGNETIC DETECTOR

power to run it. But the main point in its favor is that it needs no adjustment and that if a message is within its range it will pick it up at once. No adjustment which may result in a partial loss of the message is necessary. The following directions will explain construction of a simple form of this detector.

A core about $\frac{3}{8}$ inch in diameter and two inches long should be constructed of small iron wires. Bind tight and insulate with a layer of paraffin paper. On this wind about eight feet of No. 23 copper wire and insulate with paraffin paper. Then over this wind another layer of the same amount and size of wire. Leaving the four terminals free, the whole may be covered for mounting. The figure shows a good arrangement of this detector.

An "L" shaped base should be constructed, and the coil mounted. Just opposite the end of the coil a bar magnet about one inch long is mounted on an axis and connected to a small pulley with both free to rotate just in front of the core. Below and connected by a belt to this magnet is placed a small battery motor. The remaining space is occupied by a rheostat switch with which to regulate the motor.

The connections are shown in the diagram, one layer of the coil being connected direct to the phones and the other to the aerial and ground. Any tuning apparatus may be inserted between the aerial and coil. One battery is sufficient to run the motor and should give

a speed of about 30 revolutions per minute.

A few words as to the theory may be well. The slowly revolving magnet before the soft iron core causes magnetic changes within the core. But these changes, due to a peculiar property of the iron, lag behind, thus not causing much current in the coil. But if this iron be subjected to electrical oscillations the effects of this magnetic hysteresis are reduced. So when the message is sent the oscillations travel down the aerial to the coil and have the above explained effect upon the core. Under this influence the core is readily affected by the revolving magnet and these changes of magnetism in the core produce a current in the coil, and is heard in the receiver.

M. MILLER.

Wireless at Catalina Island

As the steamer slowly rounds a point and into the beautiful bay at Avalon, Catalina Island, Cal., the first thing to catch the visitor's eye is the tall mast and aerial system of the Avalon wireless station. This is wonderfully placed on a steep, rocky bluff, overlooking the city and ocean, and seeming to come up directly over the clear blue water of the bay. At the foot of the mast a neat

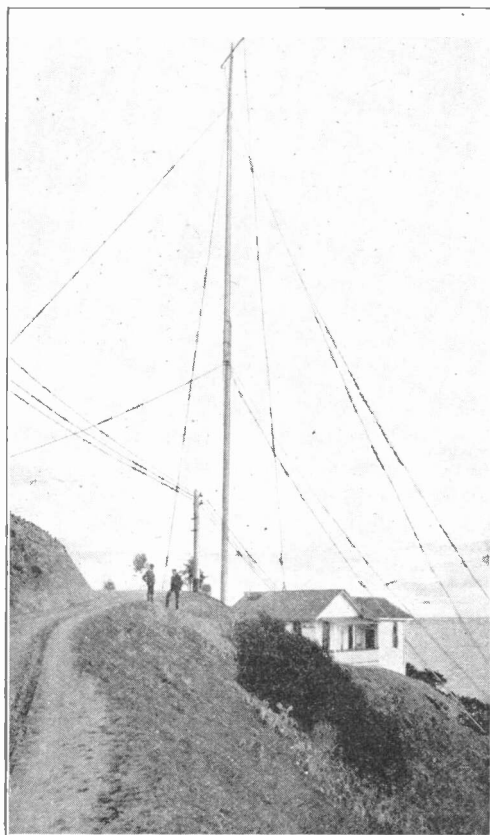

WIRELESS STATION ON CATALINA ISLAND

white cottage is seen, and perhaps the crash of the transmitting spark is carried faintly over the water to the incoming steamer.

Catalina Island—well termed "The Magic Isle"—is situated 22 miles off the coast of Southern California, making an enjoyable two hours' trip by steamer from Los Angeles. This island

is the permanent home of several hundred people and is visited each year by thousands of tourists.

One of the most interesting points about this lovely resort is that its only means of communicating quickly with the mainland is by wireless telegraph. No submarine telephone or telegraph cables connect it with Los Angeles—all messages are transmitted by wireless.

The wireless company maintains an office in the city which is connected with the station by telegraph and telephone. Commercial messages are taken here and sent by wire to the operator far up on the hill.

The station is a standard two kilowatt, 60 cycle set, and on account of its exceptionally good location above the city and bay, has a range of about 500 miles. However, practically all of the Island's wireless business is with the Los Angeles stations and the two steamers which run between Avalon and the mainland.

Wireless Hints

Two small strips of brass across the aerial and ground binding posts of your receiving set, forming a lightning gap, may be the means of saving your condenser or phones or perhaps both in case of a hard thunderstorm.

A telephone cam makes an excellent quick action short circuit switch for your detector.

When wiring your receiving set use No. 20 green silk lamp cord. It makes a neat and well insulated job.

A rotary spark gap would increase your radius fully 20 per cent. Why not make one?

To break or cut off a piece of wire when no pliers are at hand lay the wire upon the sharp edge of a piece of iron and hammer lightly. After a V-shaped dent is made in the wire it can be readily broken off.

Don't take your wireless down in the summer time, but ground your aerial outside the building. N. E. HOLT.



THE LAYOUT AT A DESERT STATION

Testing Wireless in the Desert

By JESSE H. BUFFUM

A forward step in portable wireless telegraphy is signalized in the recent remarkable automobile tour conducted by the Buffum brothers, who recently won national recognition by their notable pedestrian trip from Boston to Los Angeles, one walking on meat diet, the other subsisting on vegetables only.

Shortly after reaching the Pacific coast at the termination of their long hike, the two brothers, Warren H. and the writer, organized a unique enterprise based on an automobile tour carrying a wireless telegraph set of exceptional power. Their intention was to penetrate the desert regions of southern California in the direction of the Salton Sea, endeavoring to keep in communication, direct or by relay, with their starting point.

For this purpose two automobiles were employed, one a seven passenger 45 horsepower car, principally for the conveyance of the personnel of the party; the other equipped with the wireless apparatus and carrying, besides the driver, the wireless operator. In the forward part of this car was the dynamo, or alternator, while in the tonneau beside the operator the transmitting and receiving sets were permanently secured.

The party consisted of the two Buffum brothers, projectors of the idea and

organizers of the tour; J. B. Walker, a wireless apparatus expert and operator; Darwin B. Hull, factory expert in charge of the two automobiles; Geo. Meehans, mechanic, and Warren Vance, agent for the make of cars used.

The party left Los Angeles on February 28, returning eleven days later, having covered about 900 miles on a most remarkable tour over bad roads and through desert sands, including in the itinerary the crossing of the border into Old Mexico, where the advent of the wireless in troublous times gave rise to speedy suspicion.

What at its inception promised to be a very important experiment was unfortunately entirely misrepresented by a scare-head, false report advertising campaign built up about the trip, and through no fault of the Buffum brothers. But in spite of this the trip bore scientific fruit important enough to give to the world.

A rather new feature in portable wireless, an interest in which it is hoped will be stimulated by what we achieved, is the use of kites for elevating the aerials. Two Bluehill type box kites, labeled No. 8 in size, were carried along. Only once on the tour were both employed at the same time. Twice the kite attained a



PREPARING A SET-UP BY THE OCEAN SIDE

height of 600 to 800 feet, remaining at that altitude five hours steadily. Throughout, a No. 6 stranded picture wire served as kite string and antennæ in one.

Desert conditions were found usually bad for kite flying. Radiation seriously interfered with sustaining the kite in the air currents prevailing at a given height. Once the effort was made to raise the kite to this strata, on the desert, by attaching the kite string to the automobile and speeding along until 1,000 feet of wire was played out. The experiment was unsuccessful.

The equipment in detail as carried on the tour is of interest as throwing light on practical field work.

Transmitting: The spark system of transmission was employed. The transformer, which was of the closed core type, developed one-half k.w. This stepped up the 110 volts to 22,000 volts. The energy supplied to the transformer was 60 cycle, 110-volt alternating current, supplied by a generator mounted on the car, belt-driven from the engine of the automobile. The high tension condensers were the Murdock molded type, which were chosen on account of their compactness, ease of handling and great efficiency.

It was easy to see that an ordinary helix would be out of the question on account of space economy, so the "pancake" type was used, invented by Dr. DeForest several years ago, and built by J. B. Walker, of Los Angeles, who him-

self is originator of several improved pieces of wireless apparatus.

Receiving Circuit: No wireless receiving outfit is stronger than its detector. Special care was taken to have the best possible instrument of its kind, which was the crystal rectifying type, the mechanical design and application of the principle being the work of our operator, Mr. Walker.

The receivers were a 3,000 ohm Murdock head set, with the variable and fixed condensers of the same make.

The standard loose-coupled receiving transformer was employed.

The full power of the generator was never utilized. The alternator, a $1\frac{1}{4}$ k. w. special design, built in Los Angeles, was intended to develop 70 volts at 1,750 revolutions. It was often run, however, at 2,100 revolutions and developed 110 volts. This current was passed through a 400 watt transformer that therefore had to carry at times 700 watts. The condensers were so overloaded that on one occasion several sections were "shot."

A sectional pole, carried on special brackets on the smaller car, made of $1\frac{1}{2}$ inch material, soft wood, spliced roughly by bolting together when erecting. Five ten-foot sections gave an approximate height of 48 feet. Rope guys from the middle and top gave ample stability.

One of the discoveries of the trip was that frost can give surprising annoy-

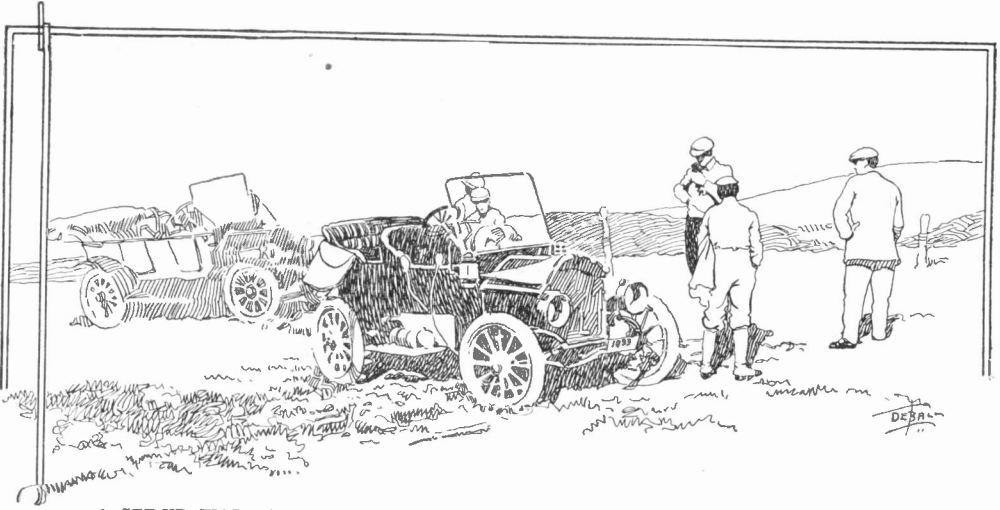

A SET-UP WAS ACCOMPLISHED AT THE ROADSIDE IN LESS THAN AN HOUR

ance. It was one night in particular so heavy as to cause, finally, suspension of operations. One effect that frost can have and that may not be generally known is to create trouble in the receiving apparatus by coating the silicon, as happened in this case. The remedy was to use two pieces of the crystal, warming one while the other was in use.

Moisture as well as frost, and of course more frequently, is a fruitful cause of trouble in the open, and characterizes portable difficulty. With the air full of moisture the leakage from the high voltage circuit of the transformer was so great that a person touching the metal parts of the car would receive at any time a severe but harmless shock. This leakage took place in the form of invisible brush discharge.

It was found that the variable climatic conditions encountered by the car in its travels rendered it difficult to keep the belt driving the generator at proper tension. It was found that as a remedy for this an idler is invaluable.

Anent the position taken by numerous experts, particularly government operators, we found that the whistling spark, and next to that the rotary gap, is heard with a pronounced clearness compared with the 60 cycle spark. The latter cannot be read well over desert and mountainous country, on account, largely, of

static, which is very troublesome in such places. The whistling spark proved its great superiority. It alone can be read through excessive static.

Careful observation led to the conclusion that a spark operating at 600 cycles would be far better for cross country transmission, particularly where mountainous and desert in character.

What has been largely a mathematical theory, not much proven in practice, we checked up on to our entire satisfaction, viz., that long wave lengths across dry (desert) country reach more effectively than short wave lengths.

The total distance traveled on the trip approximated 900 miles. Six set-ups were made, varying in distance from each other from 50 to 100 miles. Most of the trip was made, much against the wish of the Buffum brothers, outside the distance the set carried, and but few messages were picked up that we sent. A few ships at sea and one or two government stations picked us up, as did an amateur or two, but never when we were more than 100 miles distant. On our part, we picked up messages from almost unbelievable distances, including San Francisco; and we listened in on one three-cornered conversation between Point Loma, San Francisco, and a third party so far away that I guess I'll not hazard a guess, publicly, at its identity.

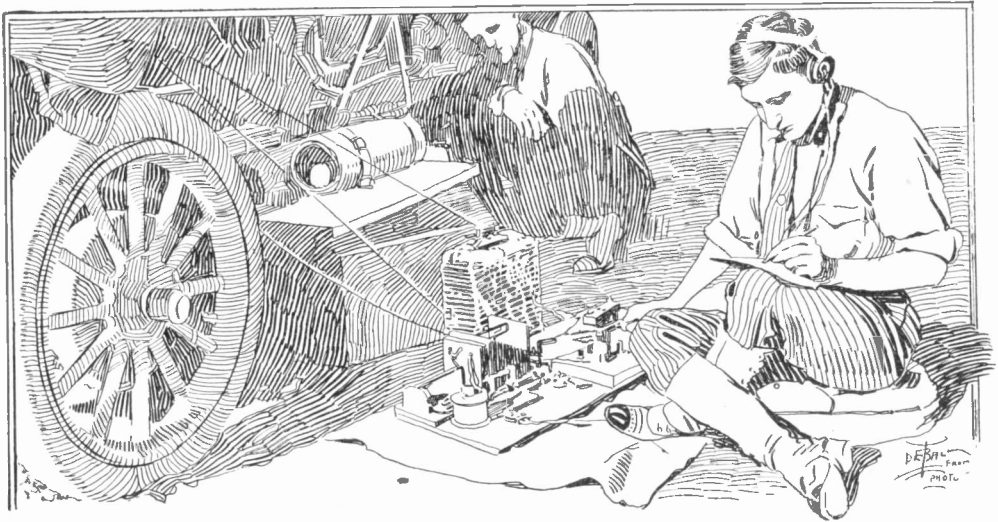

IN OLD MEXICO LISTENING TO MARE ISLAND NAVY YARD NEARLY 800 MILES AWAY

Once, on the desert, we heard San Francisco when we had no ground, but were using at the moment our kite.

Unique in automobiling was our equipment for lighting and cooking by electricity. Generating our own current wherever we went, we strung our electric lights out over the sage brush

and cacti, startling the natives who flocked around awed by the sight; and, to add to the wonder of it all, with our little electric stove prepared hot suppers on dreary deserts and amid the vast silences of the majestic hills. The little $1\frac{1}{4}$ k. w. generator gave abundance of power.

San Francisco Hears Wireless from Korea

On February 28th last, Operator Kessler in the Hillcrest station of the United Wireless Telegraph Company, San Francisco, was checking up some messages he had dispatched and received. Suddenly, at 1:30 a. m., he detected in his wireless receivers a faint and strange call for a station. Listening intently, and carefully adjusting his tuning instruments, he made out the call to be "J O I." Realizing that he was in touch with far distant Korea, he pressed the receivers closely to his ears and very shortly the dots and dashes resounded as clearly and distinctly as if they were being transmitted by a station only a few hundred miles away. When the sounds had ceased, he looked back over his sheet and read the following message: "English consul sends greetings to operator

and says that the new wireless is a great success. (Signed) J. O. C."

Hardly believing that this message came from far away Asia, the matter was reported to the main office of the United Wireless Telegraph Company. In order to have the occurrence authenticated, a cablegram going fully into details was forwarded to the Japanese authorities. They responded the same day, verifying the accuracy word for word of the entire message.

The Japanese government had just completed the erection and installation of a powerful wireless station on the peninsula of Korea, and it was on the occasion of the opening of this that the message was dispatched to the station at Hakodate in the northern part of Japan.

Several months ago Mr. Kessler made a record by "picking up" signals transmitted by the Hakodate station. The

new Korean station is 5,390 miles from San Francisco, whereas Hakodate is 600 miles nearer.

Hillcrest station in San Francisco is finely situated. It is located on the top of a hill 300 feet above sea level, close to the southwesterly limits of the city, and although several miles inland from the beach it has an unobstructed view of the ocean. The station is equipped with the standard sending and receiving apparatus of the United Wireless Telegraph Company. The power used in transmitting is either five or ten k.w., as occasion requires. The masts for supporting the aerial are 200 feet high, being equal in height to the standard masts adopted by the Navy Department for its coast stations. W. ZACHERT.

Hook-up for Long Distance Work

A comparison of the long distance receiving accomplished by the amateur several years ago and the amateur of

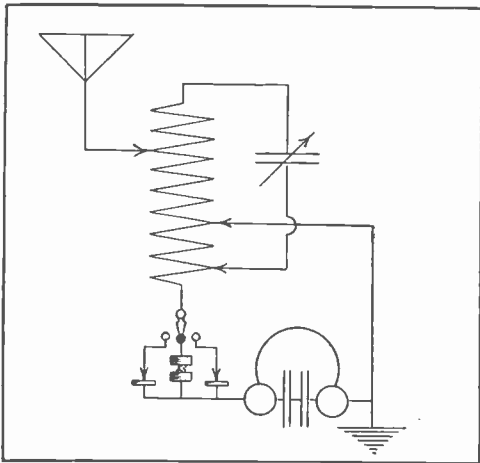

WIRELESS HOOK-UP

today will in every case show a marked increase in range. It was but a short time ago that the majority of the experimenters in and around Chicago believed themselves to be obtaining good results upon hearing the commercial stations at various ports on the Great Lakes, but now it is not an unheard of

occurrence for them to pick up commercial stations on the Atlantic Coast.

The hook-up illustrated in this article is identical with the one which I have used all winter and has given excellent results in long distance work and in selectivity. My receiving set consists of a large triple slide, bare wire, tuner, a Murdock silicon detector, a Ferron detector, a galena detector, a rotary variable condenser, a fixed condenser in steps and a pair of Brandes navy type phones shunted around a fixed condenser. My aerial is 84 feet high, being suspended from a pole 44 feet high, and consists of six No. 12 aluminum wires on eight foot bamboo spreaders and is 175 feet long. Running in the opposite direction I have one long wire 400 feet in length which has proved of great value for long distance work.—JESSE JAY.

High Power Navy Equipment

The high powered Navy wireless station now building at Arlington, outside of Washington, which will be in operation next month, uses a power of 100 kilowatts and has a range of 3,000 miles with a wave length of 4,000 meters.

WIRELESS ON FISHING BOATS

Small wireless telegraph outfits are being fitted on several fishing boats in the French waters about the Channel, and what is needed here is a simple apparatus which is not expensive and above all to have it operated by the men on board so that a special man need not be employed, as this would be too great an addition to the boats' expenses. An apparatus of the kind is designed by Engineer Bethenod which works for 200 miles in the daytime or 500 at night, and uses a mast running to 60 feet above the water line. At Boulogne, one of the fishing centers on the Channel, there are wireless and mechanical courses organized for the fishermen, and after three months the student has his diploma and engages on board with a slight raise of salary.

Directory of Wireless Clubs

This directory of amateur wireless clubs and associations will be published each month. When a new club is formed the names of the officers, also the street address of the secretary, should be forwarded to us at once. Any changes that should be made in the directory, when designated by an official of a club, will be made in the next issue after receipt of such advice.

Aerogram Club.—J. Stedman, President; A. Hayward Carr, Chairman Board of Directors; Albert S. Hayward, Treasurer; Donald P. Thurston, Secretary; Walter B. Clarke, 17 May St., Newport, R. I., Corresponding Secretary.

Aerograph Club of Richmond, Ind.—H. J. Trueblood, President; Richard Gatzek, Vice President; James Pardieck, 320 South 8th St., Richmond, Ind., Secretary.

Aero Wireless Club.—A. Garland, President; W. Ladley, Vice President; D. Beard, Napa, Calif., Secretary and treasurer.

Allegheny County (Pa.) Wireless Association.—Arthur O. Davis, President; Theodore D. Richards, Vice President; James Seaman, Leetsdale, Pa., Secretary and Treasurer.

Alpha Wireless Association.—L. L. Martin, President; F. A. Schaeffer, Vice President; G. F. Girtton, Box 57, Valparaiso, Ind., Secretary and Treasurer.

Amateur Wireless Association of Schenectady, N. Y.—D. F. Crawford, President; L. Beebe, Vice President; C. Wright, Treasurer; L. S. Uphoff, 122 Ave. "B," Schenectady, N. Y., Secretary.

Amateur Wireless Club of Geneva (N. Y.).—H. B. Graves, Jr., President; C. Hartman, Vice President; L. Reid, Treasurer; Benj. Merry, 148 William St., Geneva, N. Y., Secretary.

Berkshire Wireless Club.—Warren A. Ford, President; William Jarke, Vice President; Charles Hodecker, Treasurer; Jas. H. Ferguson, 18 Dean St., Adams, Mass., Secretary.

Canadian Central Wireless Club.—Alexander Polson, President; Stuart Scorer, Vice President; Benj. Lazarus, P. O. Box 1115, Winnipeg, Manitoba, Can., Secretary and Treasurer.

Cardinal Wireless Club.—K. Walthers, President; F. Dannenfeler, Vice President; Miss A. Peterson, South Division High School, Milwaukee, Wis., Secretary.

Chicago Wireless Association.—John Walters, Jr., President; E. J. Stien, Vice President; C. Stone, Treasurer; F. D. Northland, Secretary; R. P. Bradley, 4418 South Wabash Ave., Chicago, Ill., Corresponding Secretary.

Fargo Wireless Association.—Kenneth Hance, President; John Bathrick, Vice President; Earl C. Reineke, 518 9th St., Fargo, N. D., Secretary.

Forest Park School Wireless Club.—W. S. Robinson, Jr., President; William Crawford, R. F. D. No. 1, Springfield, Mass., Secretary.

Frontier Wireless Club.—Chas. B. Coxhead, President; John D. Camp, Vice President; Franklin J. Kidd, Jr., Treasurer; Herbert M. Graves, 458 Potomac Ave., Buffalo, N. Y., Secretary.

Gramercy Wireless Club.—James Platt, President; John Gebhard, Vice President; John Diehl, Treasurer; John Jordan, 219 East 23d St., New York, N. Y., Secretary.

Northwestern Wireless Association of Chicago.—Rolf Rolfsen, President; H. Kunde, Treasurer; Edw. G. Egloff, 2729 Noble Ave., Chicago, Ill., Recording Secretary.

Hannibal (Mo.) Amateur Wireless Club.—Charles A. Cruickshank, President; J. C. Rowland, Vice President; William Youse, Treasurer; G. G. Owens, 1306 Hill St., Hannibal, Mo., Secretary.

Haverhill (Mass.) Wireless Association.—Riodel G. Sprague, President; Charles Farrington, Vice President; Leon R. Westbrook, Haverhill, Mass., Secretary and Treasurer.

Independence Wireless Association.—Boyce Miller, President; Ralph Elliott, Secretary; Joseph Mahan, 214 South Sixth St., Independence, Kan., Vice President.

Jonesville Wireless Association.—Frederic Wetmore, President; Webb Virmylia, Vice President; Richard Hawkins, Treasurer; Merritt Green, Lock Box 82, Jonesville, Mich., Secretary.

Lake View Wireless Club.—E. M. Fickott, President; R. Ludwig, Treasurer; R. F. Becker, 1439 Winona Ave., Chicago, Ill., Secretary.

Long Beach Radio Research Club.—Bernard Williams, 555 E. Seaside Blvd., Long Beach, Calif., Secretary.

Manchester, (N. H.) Radio Club.—Homer B. Lincoln, President; Clarence Campbell, Vice President; Elmer Cutts, Treasurer; Earle Freeman, 759 Pine St., Manchester, N. H., Secretary.

New Haven Wireless Association.—Roy E. Wilmot, President; Arthur P. Seeley, Vice President; Russell O'Connor, 27 Vernon St., New Haven, Conn., Secretary and Treasurer.

Oakland Wireless Club.—H. Montag, President; W. L. Walker, Treasurer; W. R. Sibbert, 916 Chester St., Oakland, Calif., Secretary.

Oregon State Wireless Association.—Charles Austin, President; Joyce Kelly, Recording Secretary; Edward Murray, Sergeant-at-Arms; Clarence Bischoff, Lents, Ore., Treasurer and Corresponding Secretary.

Pacific States Wireless Association.—Howard W. Lewis, President; W. N. Hickman, Vice President; Earl C. Hanson, Recording Secretary; Stanley McClatchie, 288 Wilcox Ave., Los Angeles, Cal., Corresponding Secretary.

Peterboro Wireless Club.—G. B. Powell, President; C. V. Miller, Vice President; E. W. Oke, 263 Engleburn Ave., Peterboro, Ontario, Can., Secretary and Treasurer.

Plaza Wireless Club.—Paul Elliott, President; Myron Hanover, 156 E. 66th St., New York, N. Y., Secretary and Treasurer.

Rockland County (N. Y.) Wireless Association.—W. F. Crosby, President; Tracey Sherman, Vice President; Marquis Bryant, Secretary; Erskine Van Houten, 24 De Pew Ave., Nyack, N. Y., Corresponding Secretary.

Rosindale (Mass.) Wireless Association.—O. Gilus, President; E. T. McKay, Treasurer; Fred C. Fruth, 962 South St., Rosindale, Mass., Secretary.

Sacramento Wireless Signal Club.—E. Rackliff, President; J. Murray, Vice President; G. Barnard, Treasurer; W. E. Totten, 1524 "M" St., Sacramento, Calif., Secretary.

Santa Cruz Wireless Association.—Orville Johnson, President; Harold Senter, Vice President; Harrison Lane, 23 Riverside Ave., Santa Cruz, Calif., Secretary.

Southern Wireless Association.—B. Oppenheim, President; P. Gernsbacher, 1435 Henry Clay Ave., New Orleans, La., Secretary and Treasurer.

Springfield (Mass.) Wireless Association.—A. C. Gravel, President; C. K. Seely, Vice President and Treasurer; D. W. Martenson, Secretary; Club Rooms, 323 King St., Springfield, Mass.

St. Paul Wireless Club.—Thos. Taylor, President; L. R. Moore, Vice President; E. C. Estes, Treasurer; R. H. Milton, 217 Dayton Ave., St. Paul, Minn., Secretary.

Tri-State Wireless Association.—C. B. DeLahunt, President; O. F. Lyons, Vice President; T. J. M. Daly, Treasurer; C. J. Cowan, Memphis, Tenn., Secretary.

Waterbury Wireless Association.—Weston Jenks, President; Alfred Upham, Treasurer; H. M. Rogers, Jr., 26 Linden St., Waterbury, Conn., Secretary.

Wireless Association of British Columbia.—Clifford C. Watson, President; J. Arnott, Vice President; E. Kelly, Treasurer; H. J. Bothel, 300 Fourteenth Ave. E., Vancouver, B. C., Corresponding Secretary.

Wireless Association of Canada.—W. Fowler, President; E. G. Lunn, Vice President; W. C. Schuur, Secretary and Treasurer.

Wireless Association of Montana.—Roy Tysel, President; Elliot Gillie, Vice President; Harold Satter, 309 South Ohio St., Butte, Mont., Secretary.

Wireless Club of Baltimore.—Harry Richards, President; William Pules, Vice President; Curtis Garret, Treasurer; Winters Jones, 728 North Monroe St. Baltimore, Md., Secretary.



Transformer Construction

By WESLEY G. PAULSON

The step-down transformer here described is of the "Ferranti" shell type and its efficiency is high. The design is for a capacity of 50 watts with the primary connected to a 110 volt, 60 cycle circuit. Taps from the secondary winding as planned will give 2, 5, 10, 15, 20, 25 and 30 volts.

For the core special transformer iron, or steel if available, should be used.

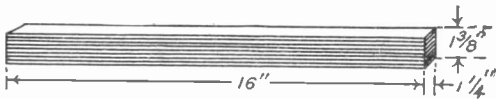

FIG. 1. CORE

However, the thinner gauges of stove-pipe iron will serve. In the following discussion, where dimensions are given in the diagrams they will not be repeated in the text.

The core, Fig. 1, consists of a pile of iron strips about 1 3/8 inches high when compressed. Sheet iron will be much improved by annealing, but special transformer iron need not be subjected to that process. To anneal sheet iron, wrap the iron strips in several thicknesses of sheet asbestos and bind with a few turns of heavy wire. Place the iron in the stove at night and allow it to reach a red heat, then gradually cool as the fire dies out.

After the iron is thoroughly cool, mix up some thin shellac (by dissolving in alcohol shellac gum obtainable at a drug store). Dip half of the iron strips in the shellac and set them up to dry. In

assembling the core, one of these shellac coated strips is interposed between each two bare iron laminations.

The spool or bobbin for the windings is made of fiber or heavy cardboard, in the preparation of which a wooden block or form will be required. Cut a block of wood as in Fig. 2. Wind a strip of paper around the block four or five times, which will compensate for any little inaccuracy in cutting the laminations. It will also facilitate removal of the bobbin from the form after the windings are in place. Cut a piece of 1-16 inch fiber or heavy cardboard as in Fig. 2. Soften

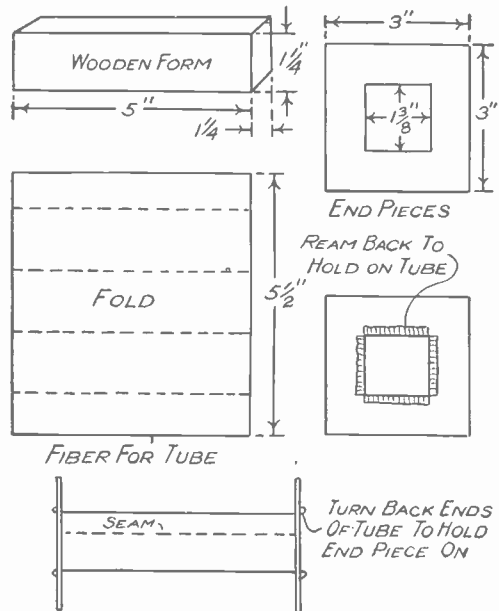

FIG. 2. SPOOL OR BOBBIN

by soaking in warm water for a moment or two and then bend tightly around the wooden form, starting so that the lap seam will be in the middle of one of the sides of the form. Secure the joint

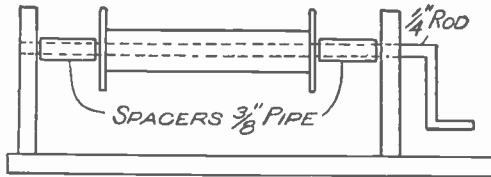

FIG. 3. COIL WINDER

with glue or thick shellac and slip on one or two rubber bands.

Two fiber pieces are now cut to the dimensions shown in Fig. 2, to slip on each end of the bobbin tube. Slip the two end pieces in place on the tube and make a large number of small cuts in the ends of the tube with a sharp knife and ream or turn back against the end pieces, securing with thick shellac or glue.

If a lathe is available the winding process will be greatly facilitated. Otherwise a very satisfactory arrangement can be improvised as shown in Fig. 3.

The secondary coil is first wound in place and consists of 246 turns of No. 14 gauge, double cotton covered copper wire. Nearly two pounds will be required.

Make a hole in one of the end pieces as shown at (A), Fig. 4, through which pass about eight inches of the No. 14 secondary wire. Cut also six pieces, each about ten inches long for taps. Proceed to wind the wire carefully and evenly up to the seventeenth turn. A tap is brought out here for two volts through a hole in the end piece at (B), Fig. 4. At the seventeenth turn, mark where the tap is to be attached, then unwind two turns and bare the insulation for half an inch. Push back the insulation at the end of one of the taps, and hammer the copper flat for an inch or so from the end, then twist this flattened end tightly around the bare copper of main winding and

solder in place. Bind carefully with tape, which should be varnished over with shellac. Be careful that the joint is thoroughly insulated.

At the 41st turn, another tap is brought out in the same manner for five volts, excepting that it is to pass out through the hole (C) in the end piece. At the 82nd turn another tap is brought out for ten volts, through the hole (D). At the 123rd, 164th and 205th turns taps are brought out through the holes (E), (F) and (G) in the opposite end piece, for 15, 20 and 25 volts. On the end piece should be marked above the taps the different voltages so there will be no confusion as to which tap is which. At the 246th turn, which will give a voltage

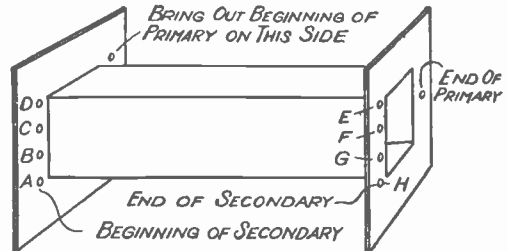

FIG. 4. BOBBIN READY FOR WINDING

of 30, the wire is then cut and about a foot brought out through the hole (H).

Each layer as completed should be varnished over with shellac. The insulation in the secondary must be thorough and without a break at any point.

As the primary winding is placed over the secondary, adequate insulation must be provided between the two windings. After shellacking the secondary, wrap a layer of cardboard or heavy wrapping paper around it, securing it with a couple of layers of tape well varnished over with shellac.

The primary winding is next applied, and may be wound in the same direction as the secondary. The primary consists of 900 turns of No. 23 gauge, double cotton covered wire which will weigh about a pound. Each layer as completed is to be varnished over with shellac. Make a hole in the bobbin end piece on the side just opposite to that on which

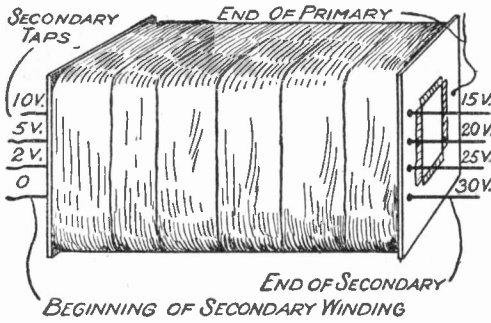

FIG. 5. WINDINGS COMPLETED

the hole (A), Fig. 4, was made. This is shown in Fig. 5. The end of the primary winding is brought out of the same side of the opposite bobbin end. Varnish over the last layer in the primary well with shellac, wind around two thicknesses of heavy wrapping paper and bind in place with a layer of tape well shellacked.

In mounting prepare a baseboard preferably of slate or asbestos of the dimensions given in Fig. 6, and a yoke by means of which the transformer is bolted down on the base and a switch. For the latter a piece of 1-16 inch phosphor bronze will serve best. For contact

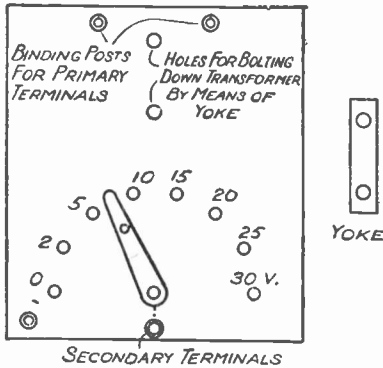

FIG. 6. SWITCH AND CONTACT POINTS

points the writer used brass headed paper fasteners to which the ends of the taps were soldered, on the under side of the baseboard. Four binding posts are placed on the baseboard, two for the primary and two for the secondary terminals. The switch and contact points are also shown in place in Fig. 6.

Now slide the bobbin on the core, with the taps on the side, as shown in Fig. 7. The ends of the laminations are bent half over, and half underneath the bobbin as shown in Fig. 8. Bend the strips one at a time, lapping the ends to make a good magnetic joint. Make sure and wedge the bobbin so it fits tightly on the core. The transformer is now bolted down tightly on the base, as in Fig. 9. Bore holes and cut grooves in the under side of the board for the connections.

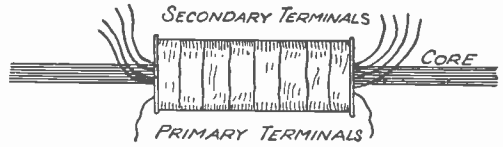

FIG. 7. BOBBIN MOUNTED ON CORE

The wiring scheme is shown in Fig. 10. Sliding the switch over the contact points will give a range of from 2 to 30 volts. The switch must not touch two contact points at the same time.

For service on a 220 volt circuit, the primary should consist of twice as many turns of smaller wire; that is, 1800 turns of No. 25 gauge with the same secondary. For 52 volts, with the same secondary windings, use 450 turns of No. 20 wire.

The writer has built and operated with complete success this 50 watt unit as de-

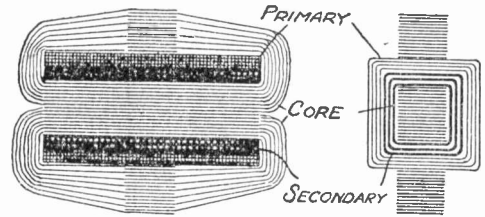

FIG. 8. CORE LAMINATIONS BENT OVER

scribed. The design is liberal and the transformer will stand a considerable overload. The primary connections are to be made direct to the supply mains without the use of any resistance or impedance. Possibly, some may desire other secondary voltages than those given. In this connection it should be

noted that about every eight turns in the secondary windings will give an electromotive force of one volt. Therefore any voltages may be arranged for by bringing out taps from the secondary at any desired multiple of eight turns.

Some may desire a larger transformer, and data is here given for a 100

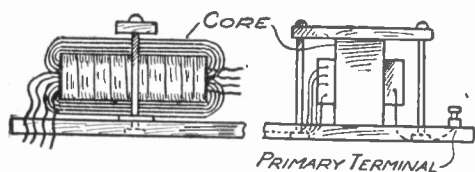

FIG. 9. TRANSFORMER BOLTED TO BASE

watt unit of the same type, the method of building being the same as already described.

The core laminations are to be cut 18 by 2 inches, and enough provided for a pile $1\frac{1}{2}$ inches high when pressed tightly together.

The bobbin should be six inches long. Make a wooden form six inches by two inches wide by $1\frac{1}{2}$ inches thick, on which the bobbin is constructed. Cut

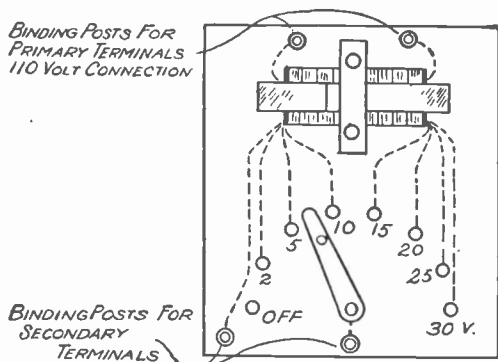

FIG. 10. WIRING SCHEME

the fiber or cardboard for the tube, $7\frac{1}{2}$ by 6 inches, making the lap or seam in the middle of one of the sides. The end pieces should be about $3\frac{3}{4}$ by $4\frac{1}{4}$ inches. The hole in the center of the end pieces, for the tube, is cut $1\frac{5}{8}$ by $2\frac{1}{8}$ inches.

The secondary consists of 138 turns of No. 10 double cotton covered wire, of which between two and three pounds

will be required. The No. 10 wire is very heavy and stiff, and it would be much easier to use two strands of No. 13 wire wound side by side. This will have practically the same carrying capacity as one strand of No. 10.

Taps should be soldered to both of the No. 13 wires and be brought out as follows:

At the 9th turn for two volts, at the 23rd turn for five volts, at the 46th turn for ten volts, at the 69th turn for fifteen volts, at the 92nd turn for 20 volts, at the 115th turn for 25 volts, at the 138th turn for 30 volts. About every five turns will give a secondary e. m. f. of one volt.

The primary winding consists of 500 turns of No. 20 double cotton covered wire wound over the secondary with adequate insulation between the two windings. Each layer of the primary as well as the secondary should be varnished over with shellac as wound. For other supply voltages, retaining the same secondary winding, the primary should consist of 260 turns of No. 17 gauge for a 52 volt circuit, 1,000 turns of No. 23 gauge for a 220 volt circuit.

A low voltage transformer is very convenient to operate small electrical toys and to ring bells. A late application is to have a small low voltage light mounted on the door casing so as to cast its rays on the keyhole. Such a light can be connected in parallel on the regular door bell circuit with a separate push button if a small step-down transformer is used on the bell circuit. A lamp of the same voltage as that supplied by the transformer must be used. The full arrangement is shown in Fig. 11.

Last Christmas the writer made a small switchboard with separate switches for lamps of each color, by means of which all the red lamps could be lighted at once, then the blue, the white, the green and the yellow, and finally any combination or all together. The effect was very pleasing. The wiring scheme is shown in Fig. 12. Regular fourteen

volt lamps connected together in parallel and supplied by a fourteen volt tap from a step-down transformer, were used. A separate line was run into the tree from each switch for the lamps of each color, and one common or neutral line was pro-

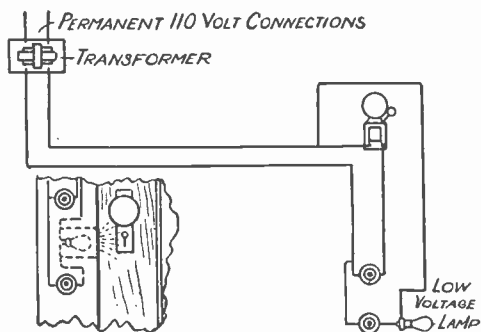

FIG. 11. TRANSFORMER USED AS BELL RINGER AND FOR LOW VOLTAGE LAMPS

vided to which the other terminals of all the lamps were connected.

Low voltage lamps will be found very convenient about the home, as in the dark room, the pantry, the closets, the cupboard, the refrigerator, in front of the alarm clock in the bedroom and on the sewing machine. If desired, a switch can be very easily arranged to switch on the light when a door is opened.

Bare the thick lead for about an inch at the ends of two drawing pencils. At the other ends cut two notches through

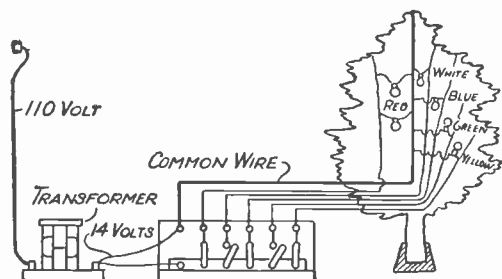

FIG. 12. TRANSFORMER USED FOR CHRISTMAS TREE LIGHTING

the wood to the lead, attaching two pieces of bare copper wire about No. 16 gauge, being sure there is good contact between the copper and the graphite. Applying ten or fifteen volts pressure bring the points of the pencils together

and then withdraw them slightly. A dazzling arc will result. Twenty or 25 volts will consume the pencils rapidly.

Charges of powder, flashlight mixtures or explosive gases may be fired very safely with low voltage current. Use No. 32 iron wire, a spool of which may be obtained at any five or ten cent store. Run two No. 16 gauge wires from the transformer over to the powder, between the ends of which connect a piece of the iron wire two or three inches long. Imbed this in the powder to be fired, then move the switch over to the five or ten volt tap on the transformer and the small piece of iron wire will instantly fuse, igniting the powder.

Twist about two feet of No. 28 Calido wire around a piece of glass tubing, Fig. 13, to be bent, winding the coils close

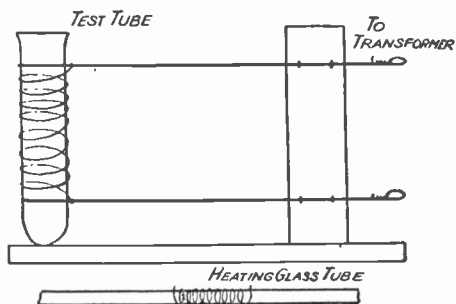

FIG. 13. HEATING A GLASS TUBE AND THE CONTENTS OF A TEST TUBE

together. Apply about 25 volts, and if the glass does not become soft enough shortly, use the 30 volt tap, and if this does not do the work, shorten the heating element a turn or two. However, if the temperature is raised too high, the wire will simply fuse and melt at some point.

Take a test tube, Fig. 13, and twist around the top of it one end of a piece of bare No. 16 gauge copper wire about a foot long. Twist another piece around the bottom. Measure off about two feet of No. 28 Calido wire. Attach one end securely to one of the copper wires by twisting tightly several times. Then wind the Calido wire around the test tube, in a helix up to the other copper

wire to which the end is to be secured as shown in Fig. 13. Fill the tube with the fluid it is desired to heat, and connect to the transformer terminals. Twenty-five or 30 volts will soon bring the fluid up to the boiling point.

Watch Demagnetizers

Those who carry a watch while working about dynamos, motors or in electrical laboratories soon find their time-keeper inaccurate. The steel of the watch has been magnetized. To demagnetize it, the watch must be placed in a field of magnetic lines produced by alternating current and withdrawn

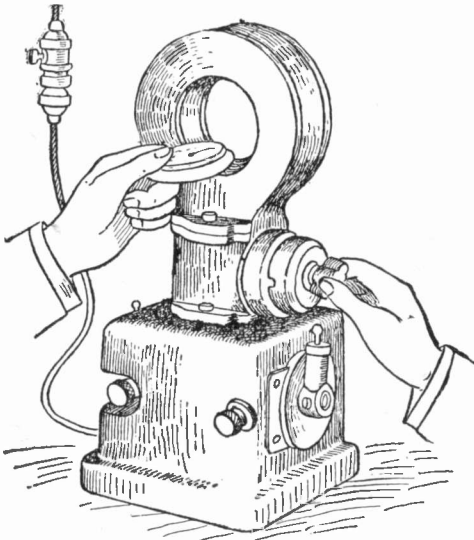

WATCH DEMAGNETIZER

slowly. The Green automatic demagnetizer shown in the accompanying illustration consists of a motor driven alternator that sends current back and forth around the coil at the top. The circular opening is thus filled with lines of force that change direction as often as the current alternates in the coil. By placing the watch at the center of the coil, starting the motor and slowly withdrawing the watch, it becomes demagnetized. The device is powerful enough to demagnetize a steel bar 4 by 2 by 2 inches.

Motor Operated Bell

The Adnil Company of London is making an electric motor driven bell. It is intended to be used where a very loud sound is needed, as in factories, mines or rail-ways, and it is very useful as a fire alarm bell since the sound can be heard above the noise of the machinery. It is operated by the small ironclad motor

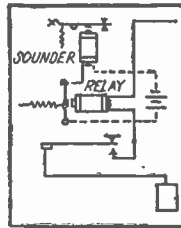

which is placed under the gong and the motor is very well protected from injury in this position. The "gigantic" bell, as it is called, is made to run either on direct or alternating current. The size of the gong is listed up to 20 inches diameter, but very large ones of a yard diameter are also made for special cases. The same firm has a gas and water tight bell in which the hammer rod is connected to the armature by means of a ball joint embedded in gasoline. This makes the connection quite tight and at the same time allows of an easy movement of the hammer. Such bells give a very loud sound.

Shock Absorber in a Rosette

A shock absorber as a part of an ordinary ceiling rosette from which incandescent lamps are suspended by drop cord is the subject of a patent issued to

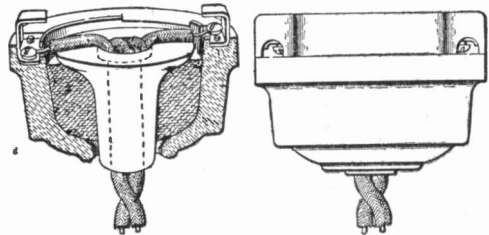

SHOCK ABSORBER

S. B. Paine, Newton, Mass. The cord from the circuit is tied in a knot in the top of a tubular plug which rests upon some elastic material, preferably felt, thus forming a cushion.

Electro-Magnet with Automatic Switch

The magnet here described consists of essentially two parts which when completely assembled form a very neat and practical instrument. The cut is actual size. The outside portion—cover and attachments—consists of a cup shaped shell (A) and a ring (R) fitted into a hexagonal shank (I), which can move up and down slightly, due to the elasticity of spring (H) surrounding (I). The spring is held in place by washer

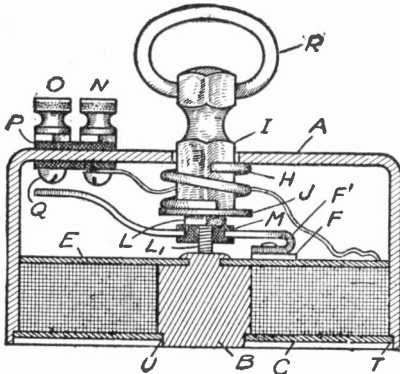

SMALL ELECTRO-MAGNET

(J) and screw (L) which has a shank (L'). Two binding posts are arranged on the cup for connections as shown.

The electro-magnet is composed of a soft iron core (B) having a brass washer (C) riveted at (U) and a soft iron washer (E) riveted at (L'), the opposite end of core (B). The soft iron washer (F) supports a spring (F') which is insulated therefrom and has a hole pierced at (M). The tendency of this spring is upward. The space on core (B) between the brass washer (C) and the iron washer (E) is wound with No. 22 s.c.c. wire. Core (B) should be insulated by winding on a thickness of good wrapping paper before winding with the magnet wire. Paint the washers on the inside with a good insulating varnish or line with paper. Spring (H) is slightly more powerful than spring (F). The brass washer (C) is riveted to cup (A) at (T), which seals the de-

vice. The soft iron washer conducts the magnetism from core (B) to shell (A), which acts as one pole of the magnet, the core acting as the other pole.

When the binding posts are connected to a suitable battery no action takes place until the device is lifted by handle (R), when the weight of the device acts against the spiral spring (H). At the same time spring (F) rises and makes contact at point (Q). This allows the current to pass from binding post (N), through connecting wire (G) to the coil and out of the coil at (S), through spring (F) and binding post (O).

The device thus acts as its own switch. If the experimenter wishes to lay it aside now and then while experimenting, it is not necessary to disconnect the batteries each time. The act of laying it aside breaks connections at (Q) and saves the batteries from useless discharging.

This device will lift several pounds on one dry cell.—CLARENCE HURLBUT.

A Homemade Electric Sign

A merchant in a small town, who was confronted with the problem of making his sign luminous without the expense

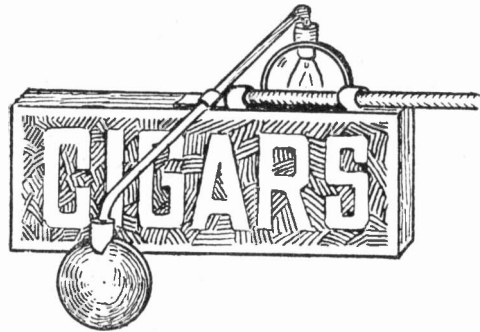

HOMEMADE ELECTRIC SIGN

of buying an electric one, solved the problem by fastening a piece of pipe crosswise over his sidewalk signboard and rigging up an electric bulb in a parabolic shade on either end of it. The light was thus directed upon his business announcement, which was rendered quite prominent.

Increasing a Telephone's Range of Usefulness

It sometimes happens that two people in adjoining offices desire to use the same telephone. If the partition be a light wooden one, this can be accomplished very easily by making use of a swinging shelf as illustrated in the cut. A small opening similar to a cashier's window is cut through, and the shelf is equipped with two sides which just fit into the opening. Both parties thus have the use of the same telephone, while at the same time both offices are entirely private and shut off from each other.

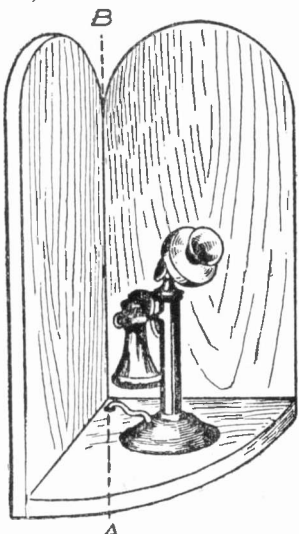

SWINGING TELEPHONE SHELF AND DOOR

A Floor Tread Switch

A simple and effective floor tread switch may be made cheaply in the following manner:

Bore two holes through the floor about $1\frac{1}{2}$ inches apart, at a point where there

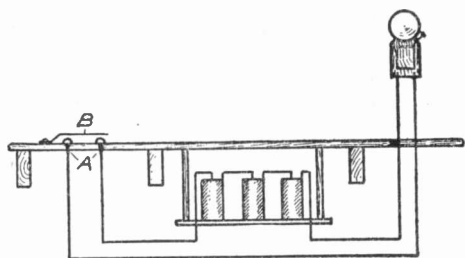

FLOOR TREAD SWITCH

is the most wear from constant treading of persons coming in or going out the door. Next secure two flat headed brass

screws (A) long enough to go through the floor. To each of these fasten an end of copper wire. Tack a piece of tin (B) about 8 by 6 inches directly over the two screws, securing it only at one end as shown. Lay a light rug over the tin, place the bell in any desired position and the alarm is finished. Anyone opening the door and stepping into the hallway will readily be detected.

STANLEY HELVERSON.

Neat Fastening for Entrance Wires

Two porcelain insulators on wooden brackets are often provided to anchor a pair of wires where they enter a building. A deviation from this method is presented in the Universal insulator, consisting of a single piece of molded porcelain. Grooved knobs at right angles to the main body form a support for each wire and present a pleasing appearance.

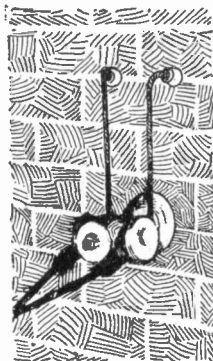

ANCHOR FOR ENTRANCE WIRES

Electro-Plating on Glass and Porcelain

A new method of electro-plating upon glass, porcelain and the like, which is said to give very good results, is the invention of an Italian engineer, Q. Marino, and he obtains an adherent deposit of different metals on such surfaces.

In the first place, the surface of the glass is roughened in the sand blast, then it is covered with a paste made with dyrofluoric acid and a chloride or other salt of the metal which is to be deposited on the surface. Then the object is put in an electro-plating bath in order to receive a coating of the metal, the deposit taking place on the adhesive conductive paste.

Improvement in Moving Picture Machines

A very ingenious arrangement of a number of tungsten lamps of a special type has been proposed by a French investigator to replace the arc lamp for use with moving picture machines. The arc lamp is objectionable owing to the enormous amount of heat developed which

close to it. The lamp has a small spiral filament and has a bulb only a half-inch in diameter. It is at once evident that a much greater percentage of the total light is made use of in this case. There is no danger of the lens cracking because there is but little heat developed by the lamp.

The arrangement actually proposed is to place a large number of these special

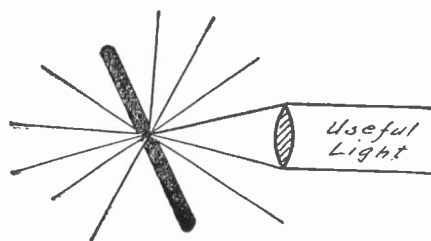

FIG. 1



FIG. 2

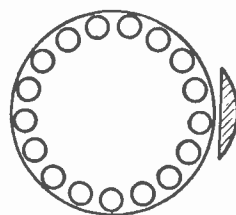

FIG. 3

often sets fire to the inflammable films, causing fatal panics in several cases. Aside from this danger there is a further objection, owing to the discomfort of the operator from the excessive heat. In order to clearly describe this proposed arrangement a brief outline of the optics of the subject must be indulged in.

With every arc lamp used in connection with moving picture machines there are a number of lenses. To us only one lens—the condenser—is of interest. This lens gathers the light rays and sends them in a bundle to the other lenses, as shown in Fig. 1 by the parallel lines. The amount of the total light depends on the solid angle subtended by the lens. Owing to the excessive heat, the lens must be kept at a considerable distance from the arc in order to avoid cracking the lens. It will be noted that the further away from the arc the lens is placed the smaller is the angle subtended, and therefore the less is the amount of light gathered by the condensing lens. In other words, a large amount of the total light is not made use of when the lens is at a considerable distance from the light source. In Fig. 2 is shown a special tungsten lamp of high candlepower, arranged with the condensing lens very

close to it. The lamp has a small spiral filament and has a bulb only a half-inch in diameter. It is at once evident that a much greater percentage of the total light is made use of in this case. There is no danger of the lens cracking because there is but little heat developed by the lamp. The arrangement actually proposed is to place a large number of these special lamps on a wheel with the condenser located as shown in Fig. 3. The wheel is revolved so that a lamp is opposite the lens when a picture on the film is in proper position to be projected on the screen. The lamps are connected so that only the lamp in front of the lens is lighted. In order that the lamps will give a high candlepower they are burned at an excessively high voltage. Being burned only for very short intervals, the life of the lamps will be sufficiently long to warrant their use in this manner. A proper reflector behind the lamp increases the amount of useful light obtained from the lamp.

In ordinary moving picture machines about sixteen pictures are thrown on the screen per second, hence if there are sixteen lamps on the wheel, the latter must revolve once per second. While the arrangement has not yet been adopted, it shows great possibilities. It would decrease bills and add to the comfort of the operator and safety of the audience.

To straighten short wires lay one or two at a time upon a flat board and place another board upon them. Roll the top board back and forth, pressing down upon it.

For the Amateur Wireman

In wiring a house it is frequently necessary to run tubing through two consecutive timbers and sometimes these may be quite a distance apart. It may be easy to get at either side to bore the holes for the tubing, but if a hand hole

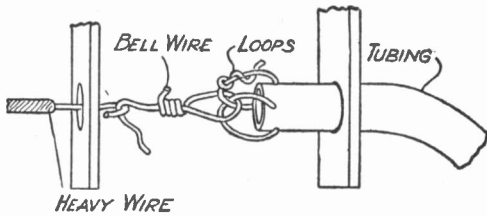

METHOD OF DRAWING TUBING THROUGH CONSECUTIVE TIMBERS

is not made, it is impossible to get the tubing started through the second hole. The illustration shows a very simple method by which it may be quickly done without tearing up boards or making unnecessary holes.

Two holes are made through the tubing at right angles to each other and just far enough from the end to prevent pulling out. Now thread a small piece of cleaned bell wire in one pair of holes, then through the other two and splice the two ends, leaving two small loops at right angles. Take another piece of wire of more than sufficient length to reach the second hole and stick through the two loops. Splice to itself, turning all ends backward so they will not catch on the hole. With the aid of a piece of heavy copper wire with its end cleaned and bent in a hook, the bell wire may readily be caught and pulled through. When the tubing reaches the hole, the small bell wire loops guide it into the hole.

Pliers Made from Fiber

For anyone that is called upon to remove "blown" cartridge fuses from circuits in difficult places, as from the back of switchboards or from any other live circuits where there is no switch to open the circuit while replacing a fuse, I

have found a pair of gas pliers made of fiber 5-16 inch thick just the thing. Such a tool is easily made after examining an ordinary pair of pliers, and the two parts may be riveted together with the rivet-holes countersunk and filled with shellac, sealing wax, etc.

The pliers come in handy around all live circuit work and their use in replacing a fuse in a circuit that has a "short" on it may save the owner a pair of burned fingers. ANTON PERTLE.

A Cheap Mellow Light

When the tungsten lamp appeared it was hailed as the beautiful white light. The efficiency of the tungsten lamp is about three times that of the old carbon lamp. In fact, the latest tungsten lamps give us one candlepower with an expenditure of only 1.2 watts, while the carbon lamp produces the same amount of light for an expenditure of over three watts. In order to produce certain æsthetic effects a more yellowish light is sometimes desired. Often there is a desire for a soft mellow light of a color approximating that of the inefficient carbon lamp. It is a mistake to install carbon lamps for this purpose, however, on account of their inefficiency.

Take a tungsten lamp and dip it into a coloring solution of the proper hue. A soft mellow light is thus obtained with an efficiency as high as 1.5 watts per candle. Lamps are easily colored by the use of gelatine. A small amount of gelatine is soaked in cold water, then boiled and strained through a cloth. An aniline dye of the desired color is now mixed in water and added to the solution and the lamp is dipped and allowed to cool.

A more satisfactory method is to use a celluloid solution. Take old photographic films and dissolve them in ether and alcohol of equal parts. The coloring solution is then added and the lamp is dipped. This latter method produces a coating which has the advantage of being impervious to water.

SCIENCE EXTRACTS FROM FOREIGN JOURNALS

REFINEMENT OF ELECTRICAL MEASUREMENTS

It would not be thought that a solution of 1-200,000,000th part of any substance in water would give any kind of an effect which could be measured, but even this exceedingly minute quantity was noted by M. Grumbach in some recent experiments which he made at Paris, according to his report to the Academy of Sciences. He made use of bichromate of potash in this case, and in order to detect it in the solution he devised an apparatus somewhat like a battery cell, with a pair of plates dipping in a liquid, but using two separate vessels connected together by a short tube, with a plate in each vessel. Both were filled with acid solution, and the bichromate in very small quantity was added to one vessel. By using a very sensitive instrument to measure the electrical effect, he found that he could still observe an action when the amount of bichromate was not more than above stated. From this it will be seen that our modern methods of measurement are becoming more exact than ever.—*Report of the Académie des Sciences, Paris.*

AGING CHEESE ELECTRICALLY

We have already heard of aging wines by electricity, but the newest idea is the aging of cheese. M. Gokkes of Rotterdam claims to be able to do this, and he takes fresh cheese and applies alternating current to it, using a high voltage of about 10,000 volts. The cheese is put in a receptacle which corresponds to its shape, but it is not tightly enclosed as it is found that the air should act on the cheese at the same time that the current is passing. It takes only a short time, about 24 hours, to carry out the process, and the cheese is said to have all the properties of naturally-aged cheese.—*La Nature, Paris.*

POWER FROM THE OCEAN WAVES

Every now and then we hear of projects for getting electricity from the sea, that is of using the waves so as to operate plants for producing current. There is nothing impossible of course in the idea of using the great force of the waves, and it only remains to find a happy idea for doing this. An Italian officer, Col. Agostino Ravelli, claims to have done this, and his patents are to be put in practice by a Milan company which was formed not long since. The idea is to make some experimental machines on a large enough scale to prove that the plan is a feasible one and then it will not be hard to get capital engaged in the scheme.—*Industrial Italian.*

PROPOSED LONDON POSTAL SUBWAY

An interesting project is the new postal subway for London, and it seems likely that it will be carried out, as an official commission has been looking up the matter and made a favorable report on the question not long ago. The engineers think that a small subway tunnel with trains of cars for carrying only the sacks of mail matter can be run without trouble, and this will take a good part of the mail traffic off the streets, which are already overcrowded. A tube will be laid, six or seven feet in diameter, so as to hold two tracks of two-foot gauge for the small mail cars. These are to be small motor cars built like a subway car in miniature, and will run at 40 miles an hour. But they are to run automatically without needing a motorman. It is claimed that 36,000 mail bags an hour can be transported in this way. Probably a line of some length will be run in the first place in order to try it, and then if all works well the different postoffices throughout the city will be connected in this way.—*Industrie Electrique, Paris.*

NAPLES DEEP RUNNING SUBWAY

Naples is to have a line of electric subway, according to the present plans. It will run across the city and thus bring the different quarters within easy reach of each other. What will make the new subway unique in some places is that it is to run about 500 feet below ground, especially when under the elevated heights of Vomero, overlooking the sea. Electric elevators will be needed in quite a number of the stations in this part of town so as to bring passengers to the surface. Near the city limits, the subway will make connection with the electric line which is now running in the neighborhood of Vesuvius, and at the other end it will be continued by a suburban tramway line which runs for some distance into the country. Laid out on about the same lines as the Paris Metropolitan, the Naples subway will have a double track tunnel, with trains of four cars in general. The cost of the work is estimated at \$6,000,000.—*Genie Civil, Paris.*

ELECTRIC CARS OF ALUMINUM

One of the Swiss electric tramway companies is commencing to build its cars of aluminum, at least a good part. One reason for using this metal is that the weight of the car is much lessened and another point is that the painting of the car lasts much longer. It was found that cars built with iron plates soon showed rusting, and the paint suffered much from this. In Zurich, where the new method is being tried, this is an important point, as the cars are painted in a light color. In the first place the metal was used for the roofs of the cars, and the result was so good from the absence of rust that it was decided to go further and to use it for the body covering of the car and part of the flooring. A metal known as dura-aluminum is used here, and it has a small amount of copper added so as to make it harder.—*L' Electricien, Paris.*

CENTRAL STATION POWER IN TIME OF STRIKES

A somewhat curious point about the English coal strike is that it is likely to have a good effect on the electrical industry, and this in an indirect way. Factories in several of the large centers had to shut down for want of coal, but on the other hand the factories which were fitted with electric motors were able to keep on running as usual. This is due to the large coal supplies which the electric stations took care to store up before the strike, so that they had enough coal to keep them running for three months. As a result, it is very likely that the other manufacturers will be led to subscribe for a current supply and this will naturally benefit the central stations and the electrical industry in general.—*Industrie Electrique, Paris.*

WIRELESS FROM AIRSHIPS

Considerable progress is being made in sending wireless messages from airships in Germany. Among the leading workers is F. Eckelmann, chief engineer of the "Albatros" aeronautic establishment, and he is now able to send and receive at distances up to 100 miles. Instead of his first storage battery, which proved to be very heavy, he now uses a small dynamo which is run by the airship motor. It was found that the heavy copper wire of 300 feet length hanging down from the airship caused a bad effect from its swinging, and rocked the airship, so that now he uses an antenna made up of jointed sections of 30 feet each and finds this to be much better. It is hung down from the fore end and has a lead ball fastened below so as to weight it. Using his wireless apparatus, he is able to work with the land stations when flying as high as 2,000 feet and claims that he can go much higher without any trouble. The whole of the wireless outfit is made very light, and does not go above 70 pounds.—*L' Electricien, Paris.*

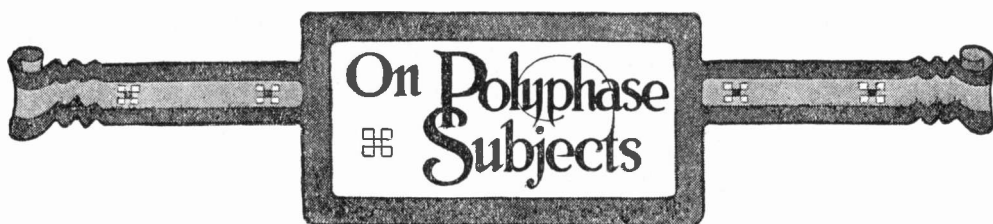

On Polyphase Subjects

The Dignity of the Wireless

Whatever may have been the status of wireless telegraphy before the Titanic disaster, its place is now clearly and definitely marked. Every ship upon the sea and upon the lakes should be compelled by governmental authority to carry duplicate sets of high efficiency. These should be upon the topmost part of the boat, one forward and one aft, and provided with an adequate storage battery reserve to furnish current to the last. Trained and reliable men—not youths—should be the operators, and at least one of them should be constantly on watch day and night. To these men salaries should be paid commensurate with one of the most important duties on board. The wireless equipment on a ship is no longer to be considered as a convenience to business men and as a means of getting out a chatty newspaper for the entertainment of the passengers. It takes its place at once with the elaborate and costly systems of railroad signaling—a lifesaving proposition.

It is true that hundreds went down with the Titanic. But hundreds were also saved and the wireless deserves the credit. Only by the merest chance could a passing ship have saved the shivering, water-soaked passengers on the lifeboats, before the terrible exposure had made an end of them. Wireless brought the help. Thanks to wireless, the lifeboat must once more be considered a necessity on the great ocean liner, instead of a matter of sentiment assumed by steamship companies, who thought their floating palaces unsinkable.

Another instance, demonstrating the great practical value of wireless telegraphy to maritime interests, recently oc-

curred on the Pacific. On March 23, the S. S. Enterprise sailed from San Francisco, bound for Hilo in the Hawaiian Islands. Two days out, the sudden breaking of the tailshaft, at one o'clock in the morning, rendered the steamer helpless. This happened when she was 300 miles from land, and no ship was in sight, with bad storms prevalent.

The Enterprise is equipped with a Marconi wireless system, and Operator J. B. Taylor immediately began to flash the wireless distress signal, "S. O. S." He soon got a response from the Marconi wireless station in San Francisco.

The president of the steamship company was at once communicated with, and, from the information given him regarding the position of the Enterprise, he knew that the liner Lurline, homeward bound from Hawaii, 300 miles from the Enterprise, could reach her more quickly than a tug sent from San Francisco. Operator Taylor was advised and began calling for the Lurline. He very shortly picked her up, and she immediately started at full speed to the rescue of the distressed steamer. At three o'clock in the afternoon of March 27, the Lurline, proudly leading her captive, safely reached the harbor of San Francisco.

Before the day of the wireless, the accident to the Enterprise would have resulted very seriously. About eleven or twelve days would have elapsed before the non-arrival of the liner attracted attention. Furthermore, a month or two would possibly have gone by before steamers sent in search would be able to locate her. In the meantime, those on board the drifting steamer would suffer severe hardships, while underwriters and

owners, shippers and consignees, as well as the relatives and friends of the missing ones, would be put to much expense and be burdened with extreme worry.

With instances such as these, and that of the "Republic," wireless telegraphy has assumed a position of dignity—of downright necessity—in navigation.

There is fuss and worry and talk about legislation restricting amateur operators—congressional committees, half a dozen pending bills, visiting delegations to Washington and all that. Such legislation is trivial compared with real legislation regarding this broader and far more vital aspect of the wireless question. Legislative bodies of this and other countries should see to it that laws are passed requiring not simply a wireless set on every ship, but one that will work well enough, reach out far enough and be sufficiently well manned to accomplish everything that such a method of signaling and receiving signals can be made to accomplish.

At Gothenburg, Sweden, the coal for household use costs the consumer about

Electric Heating in Swedish Homes	\$5.22 per ton delivered and
	firewood sawed and split,
	delivered and piled in the wood cellar, costs roughly
	\$10.00 per cord, and wood

is the fuel most generally used for heating, despite its high cost. Most of the city's population of 170,000 live in apartment houses and tenements and in all these buildings tile stoves designed to burn wood have been built into almost every room.

It is said that the heat that these tile stoves give off is pleasant and the economy of fuel consumption is surprising. They require a minimum of care and attention. A wood fire is started in the morning and allowed to burn down to coals, whereupon all the dampers are tightly closed, confining the heated air and gases to the long winding flues that fill the interior of the stove and bringing the whole to a temperature such that it

radiates no small amount of heat. The radiating surface is large, as the stoves usually extend from floor to ceiling and the heat from a single firing is retained for twelve to fifteen hours.

Now that electricity is becoming so cheap in that country owing to the great development of water power, electric heaters are used in these porcelain stoves in order to take advantage of their heat-retaining properties. Portable electric heating elements are inserted in the ordinary combustion chamber and produce during the night sufficient heat to last throughout the following day.

It is stated that the total water power of Sweden is 10,000,000 horsepower for six to nine months of the year, and 2,500,000 horsepower for three months, during the low water period. Of this total 75 per cent is in North Sweden. About 1,000,000 horsepower is now being utilized in Sweden, half of which is hydro-electric power. In some cities the rates range as low as 1.07 to 1.61 cents a kilowatt hour day use and even as low as .54 cent for electric heating current used at night.

Some recent experiments on the light emitted by a firefly which is found in India seemed to show that the light was of the nature of X-rays. Three of the insects were placed on top of a photographic plate-

The Firefly's "X-Ray" Light

holder which contained a sensitized plate. Although there was interposed between the insects and the plate the plateholder slide of hard rubber, there was a photographic action on the plate. The action not only showed immediately under the insects, but affected the whole plate. While there may be some error in the experiments, the evidence points to the radiation from fireflies of that species at least as being of a penetrating nature like X-rays. All other experiments seem to show that the radiation from the firefly is no different than ordinary yellow-green light.



Teacher—Who was the first electrician?
 Pupil—Noah. He made the arc light on Mount Ararat.

* * *

On one of the most prominent street corners of Victoria, B. C., two Englishmen were deeply engrossed in conversation.

A trolley car had turned the corner, stopped for some passengers to alight, and started off again, when a man turned the corner on the run and boarded the moving car.

The Englishmen looked at each other in amazement.

“My word! Did you see him run?” one remarked.

“The blooming ass!” replied his companion. “I wonder if he didn’t know there was another car in 20 minutes.”

* * *

Rook—Taylor was always a fortunate man, but doesn’t it seem wonderful that his luck should stay with him to the very last?

Raleigh—How was that?

Rook—Why, he was operated on for the removal of a pearl which he had accidentally swallowed while eating oysters, and when the pearl was examined it was found to be valuable enough to pay for both the operation and the funeral.

* * *

A Yankee clinched his heated argument with an Englishman as to the relative size of the Thames and Mississippi by saying:

“Why, look here, mister, there ain’t enough water in the whole of the Thames to make a gargle for the mouth of the Mississippi.”

* * *

Corporal (to soldier reporting sick)—What’s the matter with you?

Tommy—Pain in my abdomen.

Corporal—Abdomen! Abdomen, indeed! You don’t ’ave no abdomen; you ’ave a stomach. It’s only orficers what ’as abdomens.

* * *

“Here’s a nickel,” said a thrifty housewife to a tramp at the door. “Now, what are you going to do with it?”

“Well, mum,” replied the hungry man, “if I buy a touring car, I sha’n’t have enough left to pay my chauffeur; if I purchase a steam yacht, there won’t be enough left to defray the cost of manning her; so I guess, mum, I’ll get a schooner and handle her myself.”

One day in a crowded New York car—mostly all women—a man gave up his seat in due and ancient form, whereat the pretty maiden exclaimed, “You’re a jewel.” “No, madam,” cried the man, “I’m a jeweler. I set jewels.” The incident is now famous among the wise in Gotham.

* * *

Standing in the middle of the car tracks at the corner of Broadway and Twenty-ninth street, a much frustrated lady asked the traffic policeman where she could get a car to South Ferry. “Stand still, madam,” was the reply.

* * *

Fond Mother—To be quite frank, doctor, the poor girl has been eating her heart out.

Doctor—Ah, that’s very imprudent. I’ll have to order a change of diet.

* * *

Dugan, the roofer, was sent to a millionaire’s palatial home, to try to find a leak in the roof. As he entered the front hall, the butler whispered to Dugan:

“You are requested to be careful of the hardwood floors as you go upstairs, they’ve just been polished.”

“Sure, there’s no danger av me slippin’ on thim,” Dugan replied. “Oi hov spikes in me shoes.”

* * *

An Irishman was called upon to give evidence in a shooting affray.

“Did you see that shot fired?” asked the magistrate.

“No, sor; but I heard it,” replied the witness.

“That is not satisfactory. Step down.”

As the Irishman turned to go, he laughed, and was rebuked by the magistrate, who told him it was contempt of court.

“Did yez see me laugh?”

“No; but I heard you.”

“That is not satisfactory.”

And then the court laughed.

* * *

The teacher had asked the children to write their autobiographies, and the essays were very materialistic.

“Now, children,” she said, “I don’t want you simply to write the happenings of your life; write what you really feel inside.”

Little Willie, in his second attempt, wrote: “Inside I feel a heart, liver, lungs and stomach, and inside the stomach I feel an apple, a corn ball, a pickle and a glass of milk.”

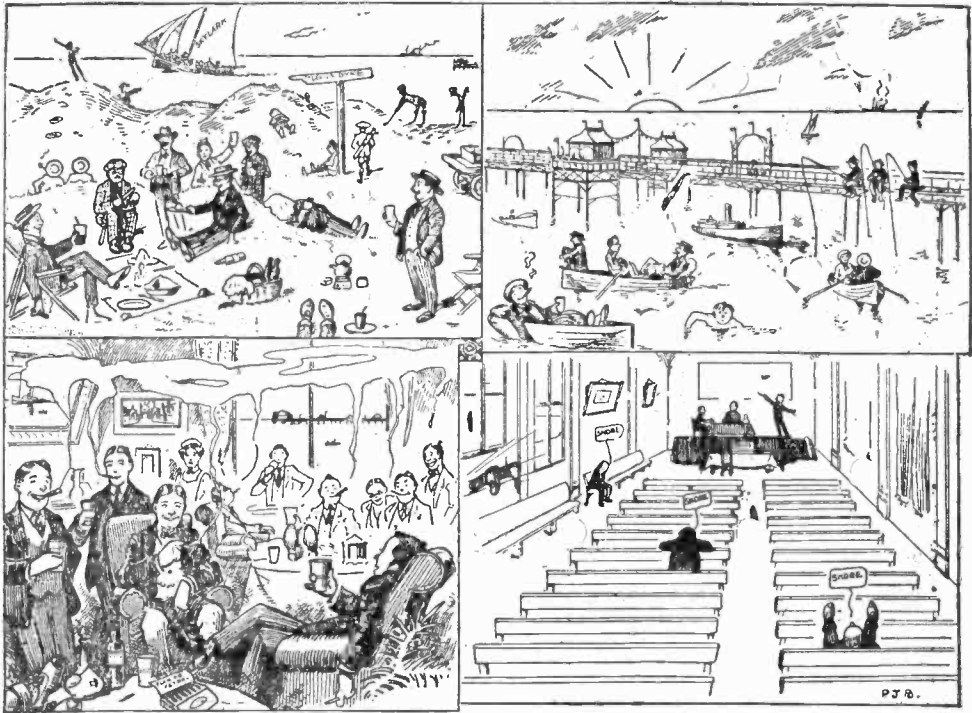

From *Electrical Industries*, London

Above is a London cartoonist's idea of an electrical convention and below is our cartoonist's conception. Neither one claims ever to have been at an electrical convention.

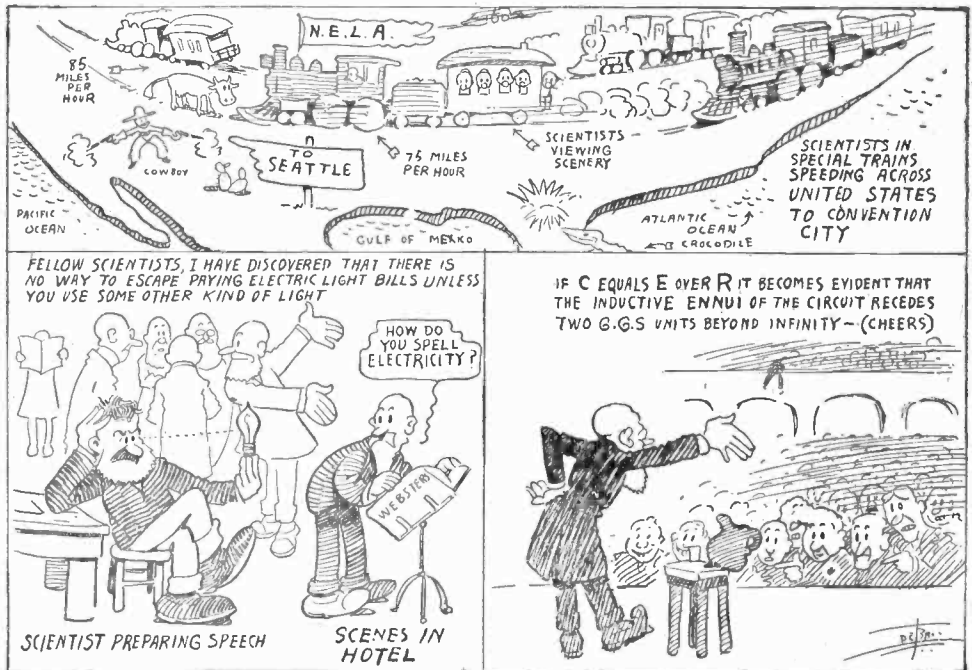

Common Electrical Terms Defined

In this age of electricity everyone should be versed in its phraseology. By studying this page from month to month a working knowledge of the most commonly employed electrical terms may be obtained.

PARAFFINE.—A wax used in condensers and other electrical apparatus as an insulator. It is made by distillation from cannel coal, coal tar, or petroleum.

PEAK OF LOAD.—The greatest load an electric power plant is called upon to carry during any given period.

PENDANT PULL SWITCH.—A switch usually installed in a fixture or upon the ceiling and operated by successive pulls of a cord.

PERMANENT MAGNET.—A bar of steel which has been magnetized and which retains its magnetism after the magnetizing force has been removed.

PERMEABILITY.—A term applied to the ease with which a magnetizing force such as a magnet or a coil of wire carrying current can impart magnetism to another material or body, which accordingly is said to be more or less permeable.

PERMEAMETER.—An apparatus invented by Silvanus P. Thompson for roughly measuring permeability.

PHASE.—In alternating current the electromotive force and current each pass many times a second from a zero value (O_1) to maximum (+), then back to zero (O_2), then to the negative maximum value (—) and thence back to zero (O_3), as shown by the diagram. This complete set of values is called a cycle and the time taken to complete a cycle is a period. When a cycle is taken as a unit, the phase is the portion of the cycle completed, as expressed by the time elapsed of the part of a cycle completed, divided by the total time of the cycle or a period. Thus assuming any given point in these changing values, as (O_1), the illustration shows the portions of a period which may be designated as $\frac{1}{4}$ phase, $\frac{1}{2}$ phase, $\frac{3}{4}$ phase, etc.

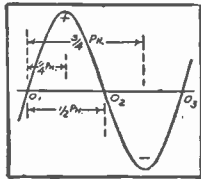

Diagram of an Alternating Current Wave

PHASE DETECTOR.—An instrument for determining when two alternators running in parallel are producing currents of the same phase.

PHOTOMETER.—An apparatus for finding the intensity of light given by a luminous source.

PILOT LAMP.—An incandescent lamp connected to the circuit of a dynamo so as to show the building up of the voltage by its brightness when the machine is started.

PLATE CONDENSER.—A condenser in which glass upon which tinfoil is pasted is used.

PLATING BATH.—The solution from which by

electricity metal is taken and deposited upon articles suspended in it. (See Electroplating.)

PLUNGER.—A movable iron rod or bundle of soft iron wires within a solenoid or coil of wire. When current is passed through the wire the plunger is drawn into the coil.

POLARIZATION.—When a cell or battery of cells is connected to produce current it is found that the strength of the current falls off after a few minutes and may even stop. This effect is due to the collection of hydrogen bubbles on the plate to which the current is flowing in the cell. The hydrogen bubbles are electro-positive and set up a counter electromotive force and are also bad conductors and offer resistance. This action of the cell is termed polarization, for which various remedies are applied.

POLARIZED RELAY.—A relay in which the two coils are mounted on one pole of a permanent magnet. When no current flows through the two coils their cores have the same polarity as the pole of the magnet to which they are attached. The tongue between has an opposite polarity and is attracted to one or the other of the coil cores. If a current is passed through the coils their cores immediately become of opposite polarity and the tongue is repelled by one

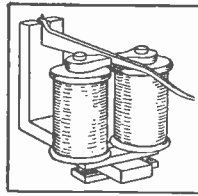

Polarized Relay

core and attracted by the other. If now a current be sent through the coils in the opposite direction the tongue flies to the other side. A properly made polarized relay is highly sensitive. (See cut.)

POLE PIECES.—The extension of the cores of the magnets of a dynamo, motor or other device depending upon the lines of force from the pole extensions for operation. Pole pieces are so shaped as to give proper distribution of the lines of force.

POLE TIPS.—The extreme ends of the pole pieces of a field magnet.

POROUS CUP.—A cup of unglazed earthenware used in voltaic cells to separate two liquids and yet allow action. The Daniell and the Grove cells are examples of this type of cell.

POSITIVE ELECTRICITY.—An arbitrary name applied to the kind of electricity with which a piece of glass is charged when rubbed with silk.

POSITIVE PLATE.—In a voltaic cell having a zinc and copper plate it is the zinc plate. The plate from which current flows in the cell.

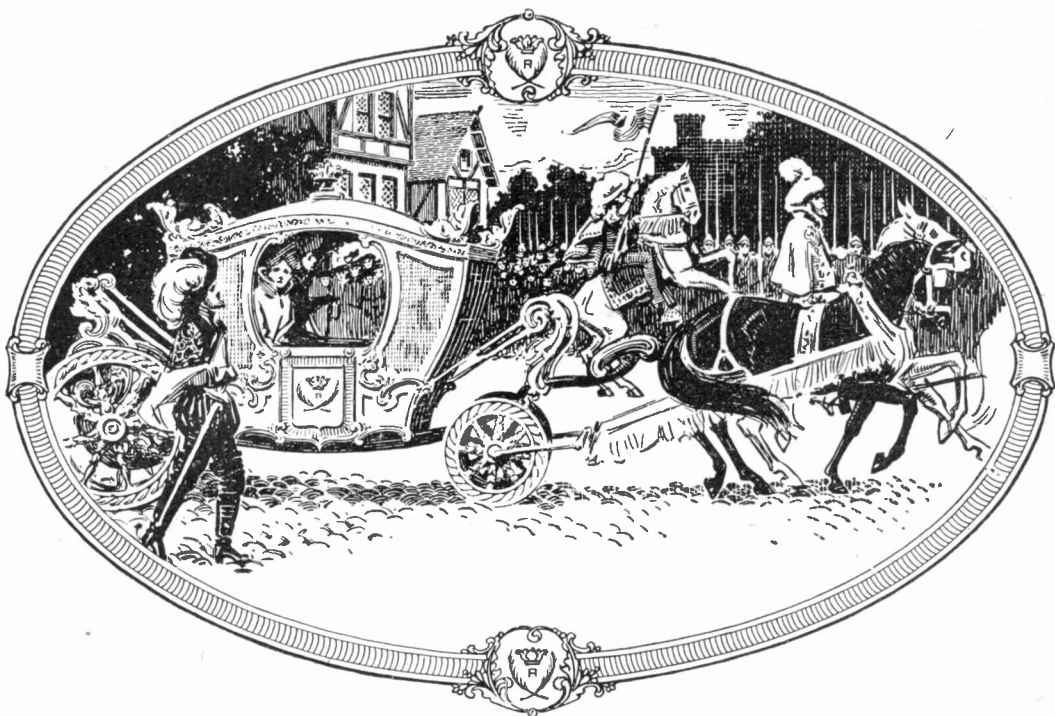

The Royal Coach—Then and Now

DURING the 16th and 17th centuries, only the nobility rode in coaches—hence the name *royal coach*, signifying the highest type of vehicle construction.

In the Electric Vehicle of today we have the modern royal coach; but there is more real comfort and luxuriousness in the Electric than ever was possible in those splendid equipages of the past.

¶ The Electric Vehicle is refined enough and exclusive enough in appearance to suit the most aristocratic, formal occasion. It is commodious enough for a family outing—dignified enough for the business or professional man.

¶ With all its niceties of design and equipment, the Electric is the staunchest, sturdiest specimen of carriage building. It has sufficient power to sat-

isfy every normal desire for speed, but even children may drive it with safety.

¶ The Electric does away with the necessity for a chauffeur—it takes scarcely any time to learn its simple operation. Its general serviceability in all sorts of weather and its extreme economy of maintenance make it the one car for every member of the family—the car desirable for *you*.

Before you buy any car—consider the Electric

ELECTRIC VEHICLE ASSOCIATION OF AMERICA

BOSTON

NEW YORK

CHICAGO

(2)

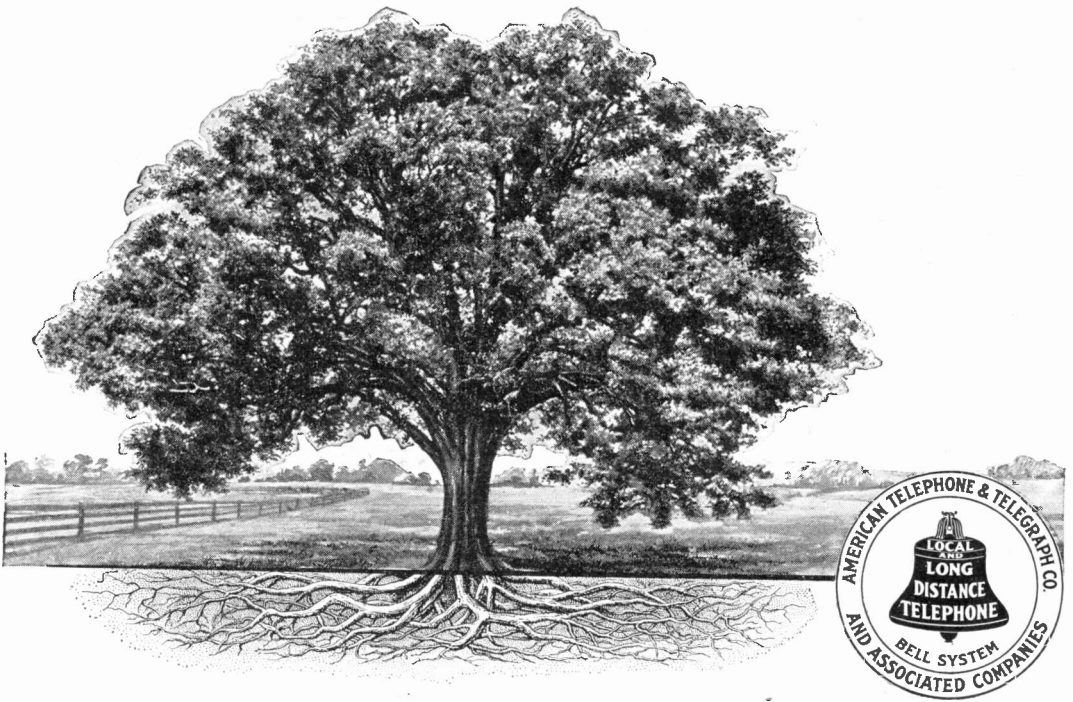

The Tree System—The Bell System

A NOBLE tree thrives because the leaves, twigs, branches, trunk and roots are all working together, each doing its part so that all may live.

Neither the roots nor the branches can live without the other, and if the trunk is girdled so that the sap cannot flow, the whole tree dies.

The existence of the tree depends not only on the activity of all the parts, but upon their being always connected together in the "tree system."

This is true also of that wonderful combination of wires, switchboards, telephones, employes and subscribers which helps make up what is called the Bell Telephone System.

It is more than the vast machinery of communication, covering the country from ocean to ocean. Every part is alive, and each gives additional usefulness to every other part.

The value of telephone service depends not only on the number of telephones, but upon their being always connected together, as in the Bell System.

**AMERICAN TELEPHONE AND TELEGRAPH COMPANY
AND ASSOCIATED COMPANIES**

One Policy

One System

Universal Service

For our Mutual Advantage mention Popular Electricity when writing to Advertisers.



Easy To Adjust Easy To Use

The Keen Kutter Junior Safety Razor is as easy to use as it is to adjust. It is *ready* for a fine, cool, close shave; and not a pull or a balk. The *hang* of the head and blade are right for the natural diagonal cutting stroke. That hang is the result of months and months of study and careful trials. Not a single razor was sold until the angle of the blade was correct to a *certainty*.

KEEN KUTTER

Junior Safety Razors

are made with unerring precision by men who know how—who put their best in their work. The blades—HIGHEST GRADE SWEDISH cutlery steel, tempered by an automatic process that *can't go wrong*—a frequent occurrence with man-tempered steel. All in all, the Keen Kutter Junior is a fine razor to buy and will prove the following motto true:

**"The Recollection of Quality Remains
Long After the Price is Forgotten."**

Trade Mark Registered.

—E. C. SIMMONS.

If not at your dealer's, write us.

SIMMONS HARDWARE COMPANY, Inc.
St. Louis and New York, U. S. A.

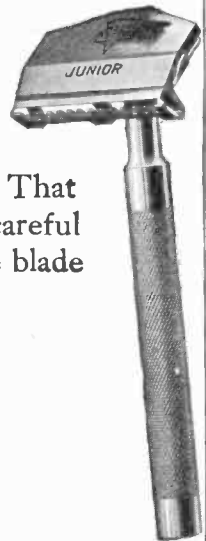

No. KJ10N
Keen Kutter
Junior with
Seven blades
and case
Price \$1.00

If you use alternating current it means dollars in your pocket to read this "Ad" through carefully

The Kimble A. C. Motor

Has saved money for others. Is there any reason why it should not save money for you? We have yet to meet the doubtful man whom our motors have not quickly converted

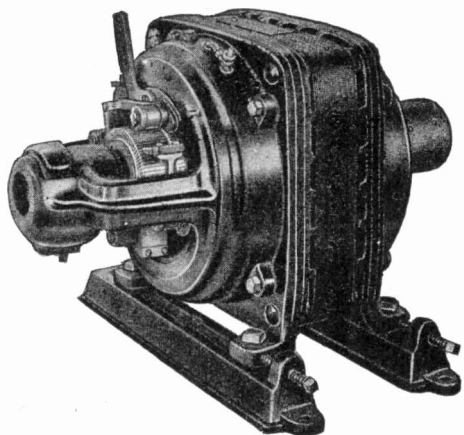

Here Are Some of the Things It Does:

"Impossible," the old heads may say, but TRUE, nevertheless—and it keeps on doing them year after year:

1. Gets from A. C. power the full efficiency of the current you pay for, without the usual waste in starting boxes, controllers and other juice-eating contrivances.
2. Costs less than any other variable speed A. C. Motor, and is twice as easy to install.
3. Uses no more current to start than for full running load. Current, speed and power all increase and decrease together, which means economy.
4. Can be operated interchangeably on a single phase, a two phase or a three phase circuit.
5. Changes speeds, forward or back. Just pull the chain or move the lever, lightly for a slight change, firmly for a great change, and with less wear than you'd think possible.
6. Runs at any speed without noise
7. Reverses from full speed forward to full speed backward by a pull of the chain or movement of a lever.

KIMBLE A. C. VARIABLE SPEED REVERSIBLE MOTORS

Are NOT SUITED for variable loads, as for instance, on lathes, punch presses, etc.; BUT for machines like PRINTING PRESSES, WASHING MACHINES, ICE CREAM FREEZERS, LAUNDRY MACHINES, PIPE ORGANS, AMUSEMENT PARK DEVICES, and in fact for ALL purposes where it is desirable to VARY SPEEDS, or to REVERSE, no other motor in the world begins to approach the Kimble in its economy, efficiency and durability.

KIMBLE VENTILATING FANS

Embody the A. C. variable speed reversible motor feature. By simply pulling one or the other of the pendent chains the fan may be run at any speed from minimum to maximum, forward or backward. With the same fan the foul air can be pushed outward or pure air drawn in as desired.

KIMBLE MOTORS ARE SOLD ON A TWO YEARS' GUARANTEE

Sizes from $\frac{1}{4}$ H. P. to $7\frac{1}{2}$ H. P. Single Phase and Polyphase, Variable Speed and Polyphase Constant Speed

Send for Catalog and Expert Advice

KIMBLE ELECTRIC COMPANY
1119 WASHINGTON BOULEVARD CHICAGO

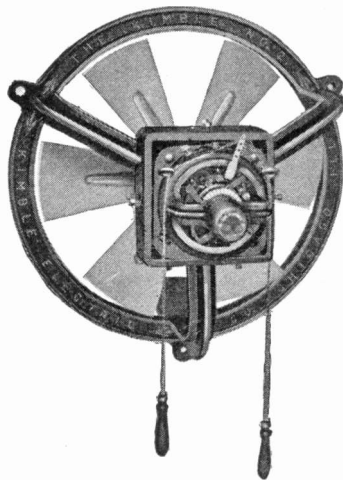

The Watch-Like Precision of The Oliver Typewriter

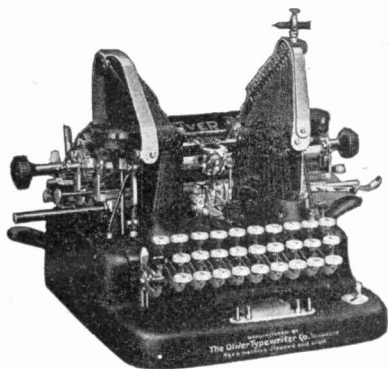

There is something approaching the marvelous in the accuracy and precision that characterize the movements of The Oliver Typewriter. All parts work in perfect unison, with an action as smooth as oil. This smooth precision, this responsiveness to the touch, is the result of infinite care, multiplied safeguards and an almost fanatic zeal on the part of its makers.

The Starting Point of Oliver Accuracy

The first operation performed on the metal base of The Oliver Typewriter is the drilling of a tiny hole—the pivotal point from which the subsequent millings and drillings are measured. Thus the foundation of every typewriter is absolutely uniform.

Each separate part that enters into the construction of The Oliver Typewriter is an absolute duplicate of all other similar parts.

The **OLIVER**
Typewriter
The Standard Visible Writer

Every part down to the smallest screw is tested and re-tested at every stage of its manufacture—

Tested by delicate instruments of precision which detect a variation of a ten-thousandth part of an inch. The inspection system is interlocking. Each man tests a particular part before passing it on for the next operation. The man who receives it, tests the work of the preceding man before he accepts it.

As the various parts are assembled these rigid tests continue. Thus the completed machine has run the gamut of over a thousand tests.

Factory Force of Experts

The great Oliver Typewriter Works are located in the beautiful city of Woodstock, in the garden spot of Illinois, amid picturesque surroundings. Here in a light, airy, sanitary plant which the State Factory Inspection Bureau holds up as a model, a great army of well-paid, highly-skilled workmen build the world's masterpiece typewriter. Each feels a personal pride and an individual responsibility in giving his best efforts. One man has indi-

vidually placed nearly 350,000 "pointers" or indicators on Oliver Typewriters within the last five years. This serves to illustrate how each man becomes an expert in his line.

The Oliver Typewriter Works are equipped with wonderful automatic machines which perform a multitude of delicate operations with most astounding precision.

Oliver Steel and Bronze

We know of no factory in the world where the makers go to such extremes to insure perfection of product. We buy the virgin metal without regard to cost, and its quality is insured by the most thorough and accurate analyses and tests in our Chemical and Physical Laboratories. Our specifications for raw materials are extremely exacting. We could easily save at least 20 per cent of the cost of production by relaxing our rigid standards.

The working parts of The Oliver Typewriter are tempered to such extreme hardness that a file makes no impression upon the wearing surface.

And the Oliver Bronze bearings in which they play give utmost wear-resistance.

Why The Oliver Costs Only \$100

The only reason why we can sell The Oliver Typewriter at the price of other standard machines is because it is built in immense quantities. Its precision, its durability, its versatility, its simplicity, its agreeable touch and easy action, form a combination of advantages which no other \$100.00 typewriter offers.

Our "17-Cents-a-Day" Purchase Plan is still in force. If interested, ask for details.

We are opening new Local Agencies constantly. Applications from qualified men will receive careful attention.

Copies of our latest catalog and special literature on the new Oliver Prototype Typewriter, mailed anywhere on request. Write for the name of nearest local agent and secure a free demonstration of our newest Model No. 5 with its beautiful Printtype and many time-saving innovations. Address

THE OLIVER TYPEWRITER CO., 893 Oliver Typewriter Bldg., Chicago

For our Mutual Advantage mention Popular Electricity when writing to Advertisers.

Take a Trip to **FOREIGN AMERICA**

A TWELVE DAY vacation cruise, \$60.00 up; berth and meals included, first cabin, to **HALIFAX, NOVA SCOTIA and ST. JOHN'S, NEWFOUNDLAND**, will be one of the most delightful and novel experiences of your life; and the fact that the whole trip is free from hotel bills or transfer charges, makes it most economical and care free. The ship is your home for the entire cruise.

The splendid powerful new steamships, **STEPHANO and FLORIZEL**, of The

Red Cross Line

are especially built for tourists, and are fitted with every modern device for comfort and safety. Novelty, grandeur and delightful climate and remarkable economy are combined in this cruise. The tourists are seven days at sea and five days in port. A foreign tour, costing four times as much, could not be more delightful. The foreign cities of Halifax and St. John's, with beautiful Nova Scotia and grand Newfoundland scenery, are sights never to be forgotten.

Send for handsome booklet 6 giving full particulars.

BOWRING & COMPANY
17 Battery Place New York City

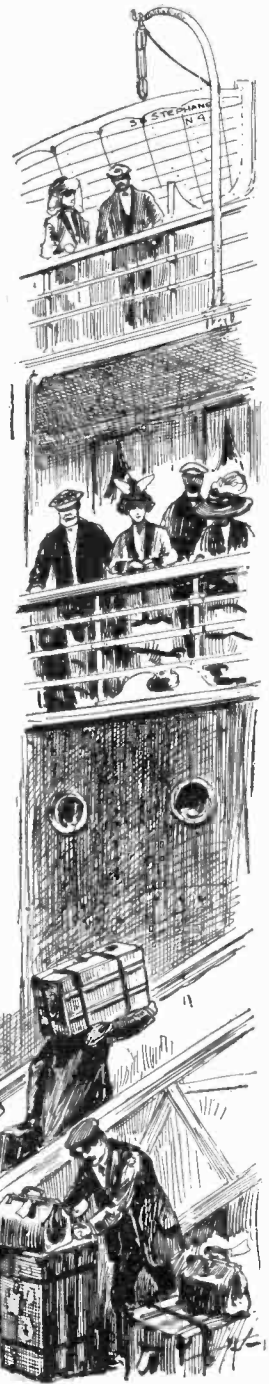
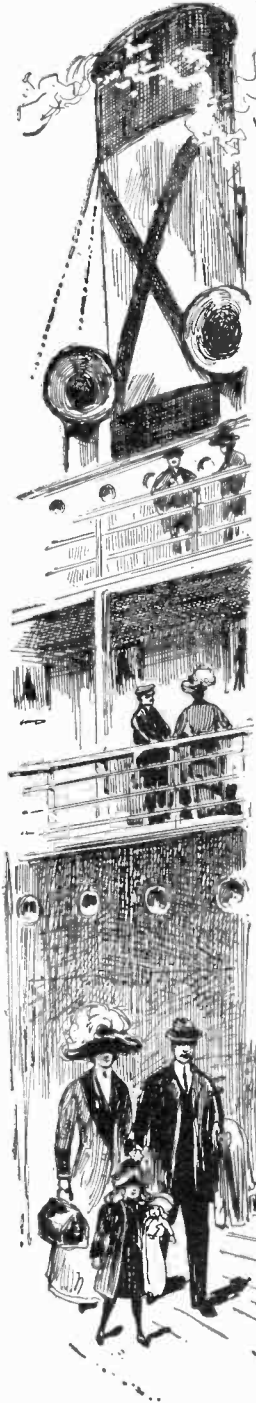

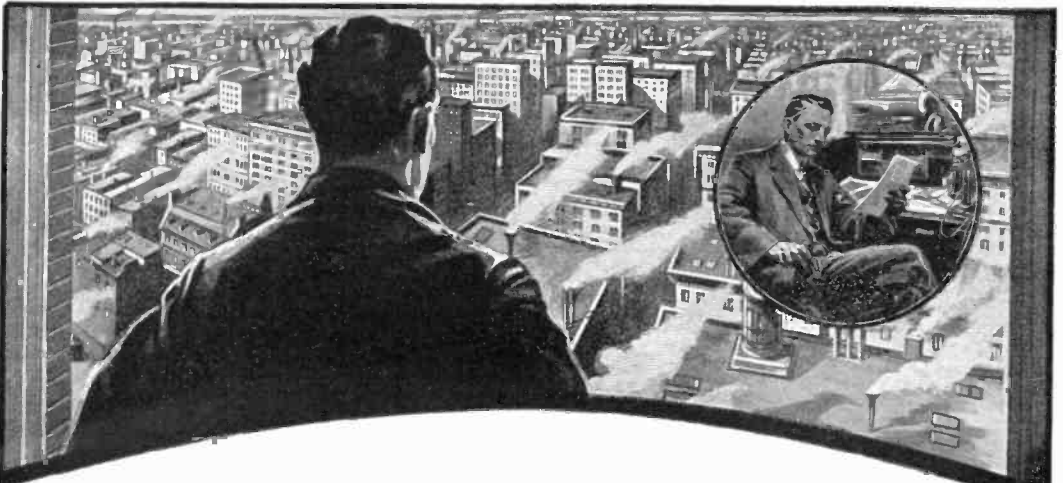

Your Chance Awaits You Somewhere

This country abounds with opportunities—chances ready and waiting for the trained man.

Business men in all lines are seeking trained men—men that can “produce.” You may find your chance right in your own town if you have the training to “deliver the goods.” Training produces wealth, happiness, comforts, independence.

What the world wants of you is success. And what you want is success.

I. C. S. Courses have taken the pick out of the laborer’s hands and replaced it with the civil engineer’s transit; they have taken the lathe hand from behind the machine and placed him at the draftsman’s board; they have lifted the fireman from the boiler room and set him in the chief engineer’s chair; they have transformed carpenters into Architects; clerks into Advertising Managers; masons into Contractors; apprentices into Mining, Mechanical, and Electrical Engineers.

THE CHANCE THAT CAME TO FINE

I was a stationary engineer, earning \$18.00 a week, when I enrolled with the I. C. S. for the Electric Power and Lighting Course. I became an applicant for the position of Electrician at the new plant of the borough of Lansdale, Pa. Through the recommendation of your Students’ Aid Department I secured the position, afterwards becoming superintendent. I am now mechanical superintendent of the Williston and Buford-Trenton Projects, U. S. Reclamation Service, Department of the Interior, having from 50 to 75 men under my control. My salary is \$2,700 a year.

J. M. FINE, Williston, N. Dak.

An I. C. S. Course will place you where you want to be, and where you ought to be.

Mark and mail the coupon. The I. C. S. will show you where to find your chance, and send you the names of men and women in your vicinity who have won out through I. C. S. training.

Mark and Mail the Coupon NOW

International Correspondence Schools Box 1102, Scranton, Pa.

Please explain, without further obligation on my part, how I can qualify for a larger salary and advancement to the position, trade, or profession before which I have marked X.

Electrical Engineering
 Electric Lighting
 Electric Railways
 Electrician
 Electric Car Running
 Dynamo Foreman
 Wireman
 Mining Engineer
 Telephone Expert
 Surveyor
 Civil Engineer
 Automobile Running
 Agriculture

Mechanical Engineer
 Mechanical Draftsman
 R. R. Constructing
 Concrete Construction
 Architect
 Contracting & Building
 Architectural Draftsman
 Plumbing & Heating
 Chemist
 Bookkeeper
 Advertising Man
 Civil Service Exams.
 Salesmanship

Name _____

St. and No. _____

City _____ State _____

Present Occupation _____

Practical 25c Handbooks

No other books contain in such compact form as much reliable and up-to-date information on Electrical subjects, and at a price within reach of all

SMALL DYNAMOS AND MOTORS HOW TO MAKE AND USE THEM. A practical handbook. By F. E. POWELL. Contents of Chapters: 1. General Considerations. 2. Field Magnets. 3. Armatures. 4. Commutators and Other Details. 5. Tables of Windings. 6. How to Build a Small Machine. 7. Useful Data. 8. Testing and Repairing. 76 pages, fully illustrated with detail drawings.

WIRING HOUSES FOR ELECTRIC LIGHT By N. H. SCHNEIDER. Contains complete directions for wiring a house according to Insurance Rules, tells you just how to start about the wiring, what wire to use, how to estimate the materials required and completing the installation. Directions apply equally well to a shop. 86 pages; 42 illustrations.

LOW VOLTAGE ELECTRIC LIGHTING WITH THE STORAGE BATTERY By N. H. SCHNEIDER. Gives practical information on small low voltage electric light plants suitable for farms, stores and country homes in general. Full details are given showing how to estimate the number and size of lights required, their best location and most convenient means of control, and the plant necessary to supply the current. 85 pages; 23 illustrations.

ELECTRICAL CIRCUITS AND DIAGRAMS Being a selection of original up-to-date and practical diagrams for installing annunciators, alarms, bells, electric gas lighting, telephones, electric power light and wiring circuits, induction coils, gas engine igniters, dynamos and motors, armature windings. By N. H. SCHNEIDER.

ELECTRICAL BELLS AND ALARMS How to install them. By N. H. SCHNEIDER. Including batteries, wire and wiring circuits, pushes, bells, burglar alarms, high and low water alarms, fire alarms, thermostats, annunciators, and the locating and remedying of faults. With 56 original diagrams.

MODERN PRIMARY BATTERIES Their construction, use and maintenance, including batteries for telephones, telegraphs, motors, electric lights, induction coils and for all experimental work. By N. H. SCHNEIDER. 94 pages; 55 illustrations. The best and latest American book on the subject.

EXPERIMENTING WITH INDUCTION COILS By H. S. NORRIE, author of "Induction Coils and Coil Making." A most instructive little book, full of practical and interesting experiments fully explained in plain language with numerous hints and suggestions for evening entertainments. Arranged under the following headings: Introduction; The Handling of Ruhmkorff Coil; Experiments with Sparks; Effects in the Vacuum; Induction and Wireless Telegraphy. With 36 original illustrations.

SIMPLE SOLDERING BOTH HARD AND SOFT. Together with descriptions of inexpensive home-made apparatus necessary for this art. By EDWARD THATCHER. Contents of Chapters: 1. Soldering. 2. Soft Soldering. 3. Methods of holding work. 4. Hard Soldering and brazing. 5. Cleaning up work, polishing. 6. Standard apparatus. 7. Home-made apparatus. 84 pages; 52 illustrations.

ELECTRICITY The study of, and its laws for beginners, comprising the laws of electric current generation and flow. Ohm's law, galvanism, magnetism, induction, principles of dynamos and motors, wiring, with explanations of simple mathematics as applied to electrical calculations. By N. H. SCHNEIDER. With 55 original illustrations and 6 tables.

WIRELESS TELEPHONE CONSTRUCTION By NEWTON HARRISON. A comprehensive explanation of the making of a Wireless Telephone Equipment. Both the transmitting and receiving stations fully explained with details of construction sufficient to give an intelligent reader a good start in building a Wireless Telephone system and in operating it. 74 pages and 43 illustrations.

ALTERNATING CURRENTS SIMPLY EXPLAINED An Elementary Handbook on Alternating Current Generators, Transformers and Motors. By ALFRED W. MARSHALL. This book is written for those who desire elementary information about Alternating electric currents, simply written and yet intensely interesting. Contents of Chapters: 1. What an Alternating Current is. 2. How Alternating Currents are Produced. 3. How Alternating Currents are Measured. 4. Transformers and Choking Coils. 5. Alternating Current Motors. 6. Rotary Converters. 7. Rectifiers. 82 pages, 32 illustrations.

INDUCTION COILS How to Make and Use Them. By P. MARSHALL. New edition revised and enlarged by K. STOYE. A practical handbook on the construction and use of medical and sparking coils for wireless telegraphy, gas engines, automobiles, gas lighting, X-rays, and all other purposes. With complete tables of windings for coils, giving $\frac{1}{4}$ -inch up to 12-inch sparks. With full directions for the construction of mercury interrupters. 76 pages, 35 illustrations.

SMALL ELECTRICAL MEASURING INSTRUMENTS How to Make and Use Them. By PERCIVAL MARSHALL. Contents of Chapters: 1. Instruments for testing the presence of an electric current, detectors, galvanometers. 2. Instruments for measuring the pressure or quantity of an electric current, amperemeters; voltmeters. 3. Instruments for measuring electrical resistance, wheatstone bridge. 4. Instruments for measuring static electricity. 5. Practical details for construction. 6. The principles upon which electrical measuring instruments work. 7. How to use electrical measuring instruments. 8. How to choose electrical measuring instruments. 90 pages; 59 illustrations.

Special Offer: FOR A LIMITED TIME WE WILL SEND ANY TEN OF THESE BOOKS TO ONE ADDRESS FOR \$2.00. TO SECURE THIS PRICE SEND US YOUR ORDER AT ONCE.

POPULAR ELECTRICITY BOOK DEPARTMENT
54 W. Lake St., Chicago, Ill.

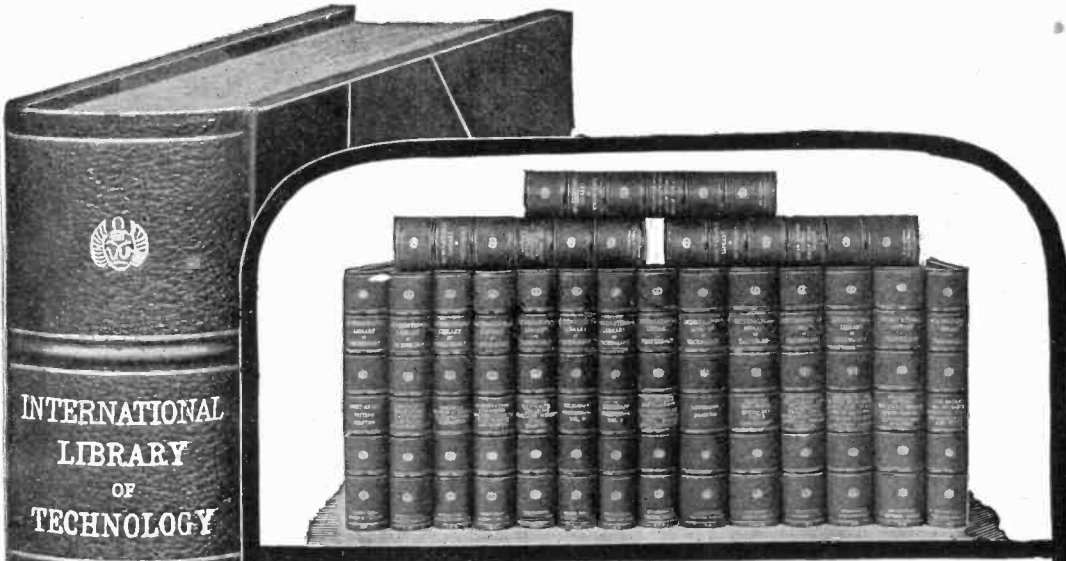

The Greatest Electrical Library in the World

The Electrical Engineering Library is part of the International Library of Technology that cost \$1,500,000 in its original preparation. It contains the knowledge given from the life experience of some of the best electrical engineering experts in the country, edited in a style that nineteen years of experience in publishing home-study textbooks has proved easiest to learn, to remember, and to apply. There is no other reference work in the world that so completely meets the needs of the electrician as the Electrical Engineering Library. The volumes are recommended by the highest authorities and are used in nearly all the leading universities and colleges. They treat of practical electrical methods, starting from the simplest problems and comprehensively covering every branch of the work. Not only can they be used to great advantage by superintendents, foremen, and engineers as an authoritative guide in their work, but since they can be so clearly understood, even by persons having no knowledge of higher mathematics, they can be used by all classes of electricians that are desirous of advancing to higher positions. The Electrical Library contains 17 volumes durably and handsomely bound in three-fourths red morocco, stamped and numbered in gold. The books are printed on a high-grade book paper, and the type is large and easy to read. Each volume is 6 by 9 inches in size. If you wish to know more about the most practical electrical library in the world, send the coupon NOW.

International Textbook Co.
Box 1102, Scranton, Pa.

Please send, without further obligation to me, full particulars in regard to your Library of Technology, with special reference to the Electrical Library.

Name _____

St. & No. _____

City _____ State _____

For our Mutual Advantage mention Popular Electricity when writing to Advertisers.



Samuel S. Thorpe
Owner of Cadillac Tract

Fine Farm for 12½c an Acre Monthly—

—make your future sure
—be master of your own time

The day approaches when you, too, will get the blue slip—be ready. Get a Home Place as a shelter for your declining years, a safe nest for the kiddies, and a well of deep contentment for Mother, while you may. I will sell you an ideal, a beautiful Home Place, that can make you happy, independent and free, near Cadillac, Mich., a fine town of live people with plenty of money—at terms (on 20 to 40 acres) of 12½c an acre monthly. It lies open and free, high and healthy, only a few hours' ride from Chicago, all ready to pay you profits up to \$500 an acre net.

Suppose you owned 40 acres of this—half in pasture, ten acres in potatoes, five in orchard, and the balance lawn, yard, garden and cattle pens? You'd be a man of substance, whom bank presidents would earnestly shake hands with, a man worry-proof and content.

Satisfy that Heart Hunger

—it's natural, it's human, it's right. Stop pondering and longing. Don't waste energy wishing. Get you a Home Place—some money-making land—and get it now—while I hold the price down. Venture to write me for the plain story about this excellent land of mine at Cadillac, Mich. Hear my side—the Bible truth about this, your opportunity. I own this land outright, title clear and cloudless. My faith—in the shape of coin—is in it. It's located in a salubrious and charming lake-dotted, rolling country. There's plenty of sport—fishing and hunting. The climate (I prove it) is as mild as Missouri, and the soil, a loose loam, easy to work, is so rich in plant food that some farms there haven't cost a cent for fertilizers in years.

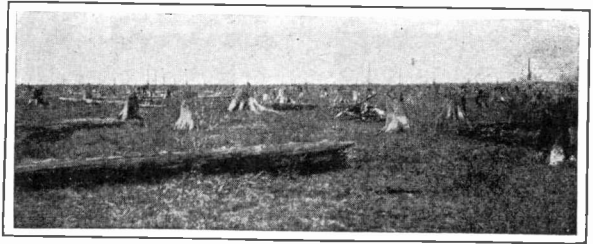

Norway Stumps Removed Free

My Unparalleled Offer

This property—every acre of it—is so honestly valuable that any time within 12 months if you want your money back on the purchase price you can have it. So for a year from now, your money, which invested now gets you a Home Place at my present very low acre price, will not be spent, but saved. You can't help but be benefited whether you keep the land or not.

You see, the financial burden is trivial and the risk of

loss is nil. I've eliminated DOUBT—the sailing is plain. Send for details. If I ever get the facts into you, you'll find it hard to stay away. You'll long to come to this pleasant, well-settled country, where crops are sure, markets are close, freights are low, shelter, elevation and drainage are excellent, people are white, roads are good, schools are thick and phones are cheap.

This land is surely going to increase wonderfully in value. The 37th Annual State Board Report says it's the natural home of the cherry—a superb apple country—and so perfectly adapted to berries and grapes they grow RANK. I'll send you a copy and let you read the SCIENTIFIC reasons why our soil and climate combine to produce "better growth of vegetation" than land you'd be glad to pay five times as much for—if you could get it.

DON'T RESIST—WRITE

Get the details—and get them now—while my terms on twenty to forty acres are as low as \$10 down and 12½c an acre, monthly. Find out from my references, including banks and governors, I am a man you can do business with safely—a man who does not exaggerate—who in fourteen years has never foreclosed a mortgage—a real estate owner who does not take advantage of the law's consent to gouge or grind, but who plays fair, practices the Golden Rule—and makes it pay.

Let me show you the road to Independence—write me NOW. Agents wanted.



The Result—Independence

SAMUEL S. THORPE, Owner of the Cadillac Tract
Dept. 3, 1627 First National Bank, Chicago, Illinois

For our Mutual Advantage mention Popular Electricity when writing to Advertisers.

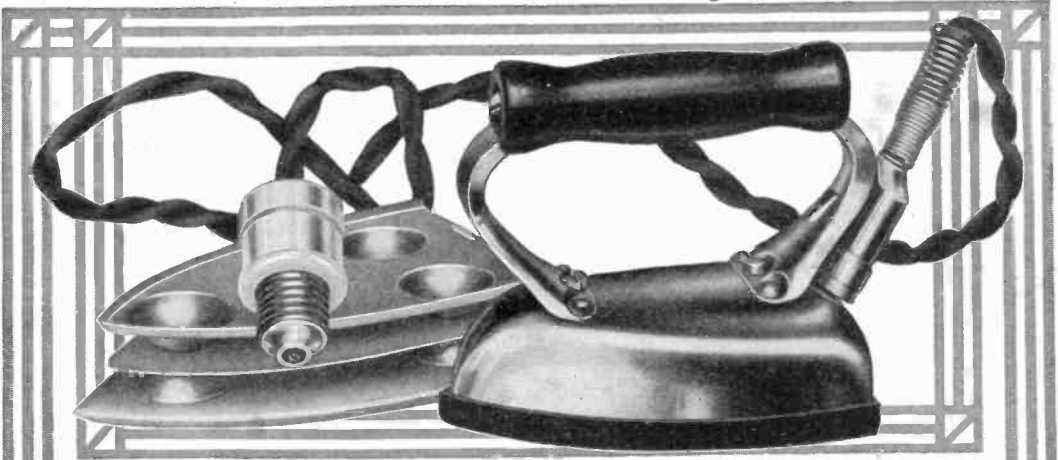

You Cannot Judge the Westinghouse Electric Iron By the Use of Any Other Electric Iron

MANY women who have discarded other electric irons make the mistake of putting all electric irons in the same class.

The Westinghouse Electric Iron is the one absolutely dependable electric iron. You get an iron-clad guarantee with it. If anything whatever happens to it you get a new iron without question.

Experienced laundresses will tell you that the smooth, *natural* ironing surface is by far the best. That is what you get in the Westinghouse Iron. No imperfections that have to be covered by nickel plating.

We want your name if you have electricity in your home. We want to tell you all the good points of the Westinghouse Iron and tell you how we protect each purchaser of the iron. Write "Westinghouse Household Dept. F, East Pittsburgh, Pa."

Westinghouse Electric & Manufacturing Company
Pittsburgh

Sales Offices in 45 American Cities

Representatives All Over the World

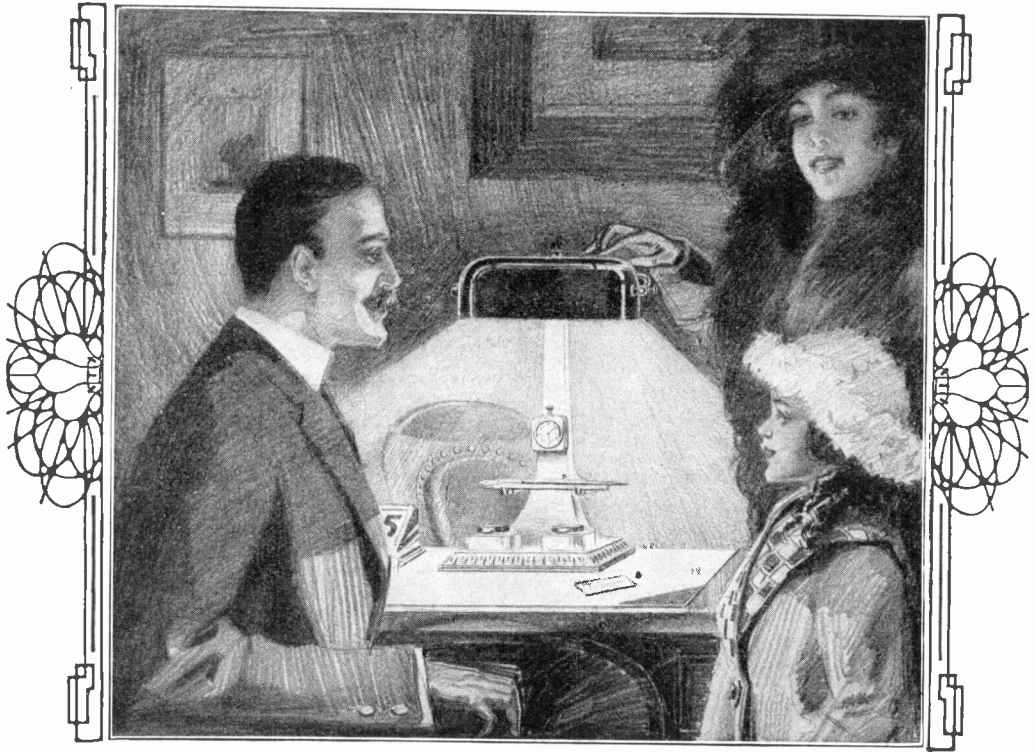

Here Is Just the Desk Lamp You Have Wished for

This rich and substantial looking Desk Lamp will add not only to the attractive appearance of your desk, but it will help you to do your work better. The soft emerald green glass of the shade relieves the eyes from strain, while the opal lining concentrates the maximum of light just where it is most needed, leaving the eyes in restful shadow. The lamp is equipped with a watch, an inkstand base, two covered ink wells and a pen rack.

Save Your Eyes from Strain

Most desk lamps are very tiring on the eyes—this Desk Lamp is a protection to your eyes. It is equally desirable on your office desk or in your study at home. Beautiful in design and staunch in construction, it will last indefinitely.

This lamp stands 17 inches high and is finished either in Old Brass with green relief, or in Statuary Bronze with green relief. The shade is adjustable by a simple and efficient clamp at the right end, which holds it securely at any desired angle.

Price, complete with shade, watch, pull-chain socket, plug and 6 feet of silk cord, \$18. Price without watch, \$15.

ELECTRIC SHOP — CHICAGO
Michigan and Jackson Boulevards

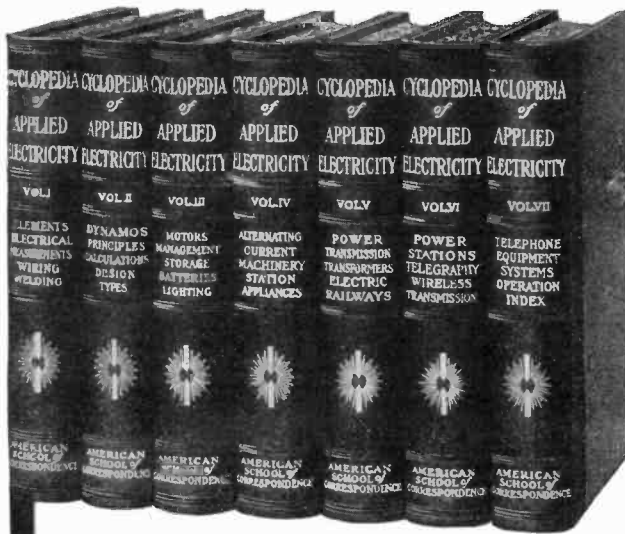

SEVEN ELECTRICAL EXPERTS

Here is a set of electrical books published especially for the student, worker and expert—every chapter written by an expert in his special line—every subject brought down to date—an absolute authority on everything electrical from wiring to alternating current machinery—from motors to power stations, etc. Read table of important subjects below.

The American School's Cyclopedia of

Applied Electricity

is compiled from the instruction papers used in the regular correspondence work of the school; contains 3,200 pages; 2,600 full page illustrations, diagrams, formulas, etc., with a special cross index for quick reference. The seven large volumes are bound in half morocco and are printed in large, clear type on special quality paper.

Important Subjects Covered by These Great Books

Theory, Calculation, Design and Construction of Generators and Motors—Electrical Measurements—Electric Wiring—Electric Welding—Types of Generators and Motors—Management of Generators and Motors—Storage Batteries—Electric Lighting—Alternating-Current Machinery—Station Appliances—Power Stations—Power Transmission—Central Station Engineering—Electric Railways, including Single-Phase—The Electric Telegraph—Telephone Equipment, Systems and Operation—Wireless Telegraph and Telephone—Telautograph—Telegraphone, etc.

Sent Absolutely Free—Express Prepaid

The complete seven volumes, not a sample volume, will be sent, express prepaid, for seven days' free examination; returnable at our expense if the books do not contain the information you want. If you keep the books, pay \$2.00 seven days after receipt and then \$2.00 a month until you have paid the special introductory price of \$19.80.

Just fill in and mail the coupon. It won't cost you a cent to examine the books. We know they'll be worth many times their cost to you. Mail the coupon now and you'll receive your books promptly.

Another Great Free Offer

With every set is included a year's Consulting Membership entitling you to the advice of our business and engineering experts free. This will give you practical help in handling working problems which are too specific to be taken up in detail in the Cyclopedia. There will be no limit to this service. A single problem solved for you might be worth more than the first cost of the books.

AMERICAN SCHOOL OF CORRESPONDENCE
CHICAGO, U. S. A.

Pop.
Elec.
6-12

A. S. of C.

Please send me Cyclopedia of Applied Electricity for seven days' free examination. I will send \$2.00 within seven days and \$2 a month until I have paid \$19.80; otherwise I will notify you and hold the books subject to your order. Title not to pass until fully paid.

NAME

ADDRESS

OCCUPATION

EMPLOYER

For our Mutual Advantage mention Popular Electricity when writing to Advertisers.

This Is the Advertisement that Won the

SECOND PRIZE OF \$50.00

In the Recent Ad-
Writing Contest

Particulars of Which Were
Given in the April Issue

As announced in connection with first prize advertisement, published in the May issue, subscriptions in response to this advertisement may be sent through your news-dealer or direct to us, as most convenient.

The last two prize-winning advertisements will be published in their order in the July and August issues respectively.

Popular Electricity Magazine

Benjamin Franklin's Kite

The Trend of Modern Thought is towards Electricity

in science, home life, business or profession. Lives are sacrificed or saved by its subtle mysteries. Without electricity our communications with foreign lands, with our sister states and cities, or even friends in our own cities, would be badly hampered.

The boy of seven years who a few years back found complete enjoyment in a clock works toy, will today demand electrically operated toys.

The average boy of ten or twelve years of today will converse as intellectually as did the average man of mature age, some ten years back.

Knowledge of facts as discovered and set forth by different scientists, inventors, and writers, has brought about this present state of advancement.

"Popular Electricity" deals with problems of today, of tomorrow; its pages reflect the thoughts and deeds of the world's brightest men; it is concise, brief, and to the point; it is a practical educational work for practical people.

"Popular Electricity" is a powerful field glass, bringing within range the doings of the electrical world.

Let "Popular Electricity" blaze the trail to greater understanding; you owe yourself that much.

Send your subscription today

was responsible for a primitive knowledge of electricity

The key at the end of the string supplied the spark that was eventually to develop the worlds greatest power

Modern Up-to-date knowledge of this all absorbing question is supplied by

Popular Electricity

THE MODERN KEY

**451 COMMERCIAL BUILDING
CHICAGO**

\$1.50 per year is one **of a copy**

CANADA \$1.85 FOREIGN COUNTRIES \$2.25

For our Mutual Advantage mention Popular Electricity when writing to Advertisers.

Back Numbers

Information and a Special Offer

Ever since the first volume of **Popular Electricity Magazine** was completed, we have been receiving orders for back numbers which could not be filled on account of being sold out. In many cases we have been offered more than the regular price, some enthusiastic readers being willing to pay as high as 50c, and even \$1.00 for a certain number, sufficient proof, we believe, of the permanent value of **Popular Electricity**.

At present we have from 25 to 75 copies each of the back numbers listed below, which we will furnish, while they last, at the nominal prices shown. We also have, or can get, a few copies of some earlier issues, prices of which will be given on request.

Any of the issues listed, to those who have not read same, are just as interesting and instructive as the current number, while for reference every number of **Popular Electricity** is equally valuable as when first published. In fact, the value increases with age, in the opinion of many readers who would gladly secure certain back numbers even at a premium.

Here are the issues now available:

At 5c Each—6 Copies for 25c

March 1911	August 1911
April 1911	September 1911
May 1911	October 1911
June 1911	November 1911
July 1911	December 1911

At 10c Each—2 Copies for 15c

January 1912	March 1912
February 1912	April 1912

Orders for Canada are 3c a copy additional; for foreign countries, 6c a copy additional, to cover extra postage.

Check over the list and send us your orders before those you want are all gone. If we are already sold out of any numbers desired, will send those we have and refund the difference. You can remit in coin, currency, money order, bank draft, or U. S. stamps, as most convenient. No Canadian or foreign stamps accepted. Address orders to:

Popular Electricity Magazine
BACK NUMBER CLERK
54 West Lake Street, Chicago

Every Reader of Popular Electricity

SHOULD HAVE A COPY OF

Our New Book Catalog

CONTAINING PRICE AND DESCRIPTION OF THE MOST UP-TO-DATE AND PRACTICAL BOOKS OF ALL PUBLISHERS, BEST SUITED TO THE NEEDS OF BEGINNERS, STUDENTS AND THE PRACTICAL WORKER

Every Electrical Subject IS COVERED, INCLUDING

Elementary Electricity, Static Electricity, Electric Toy Making, Magnetism, Wiring for Light and Power, Contracting, Armature and Magnet Winding, Dynamos and Motors, Design and Construction of Alternating and Direct Current Machinery, Power Stations, Transmission, Practical Applications, Switchboards, Storage Batteries, Measuring Instruments, Transformers, Railways, Electricians' Hand Books, Telegraphy, Telephony, Wireless Telegraphy and Telephony, Induction Coils, High Frequency Apparatus, Electroplating, Ignition, Automobiles, Aeronautics, Practical 25c Handbooks on all subjects, etc.

A complete description of each book is given, showing the contents and purpose of the work, to assist you in selecting those best suited to your needs.

TEAR OFF AND MAIL COUPON TODAY

POPULAR ELECTRICITY BOOK DEPT.
54 West Lake Street, Chicago, Ill.

Enclosed find 2c stamp for which please send me your New Catalog as advertised.

Name.....

Address.....

Charge Your Batteries from A. C.

Do it in the simple modern way. Use the Wagner Rectifier. Light, small and portable. Works from any alternating current lamp socket; cord and plug provided. Charges in a simple and efficient manner. Six volt storage batteries used for automobile lighting, electric horns and ignition. No fragile parts or complications. The Wagner Rectifier makes such storage batteries inexpensive and practical in service and removes disadvantages previously met. The charging operation is exceedingly simple, requiring merely connection of the battery and Rectifier terminals regardless of polarity. The battery cannot discharge through short circuit due to interruption of current supply.

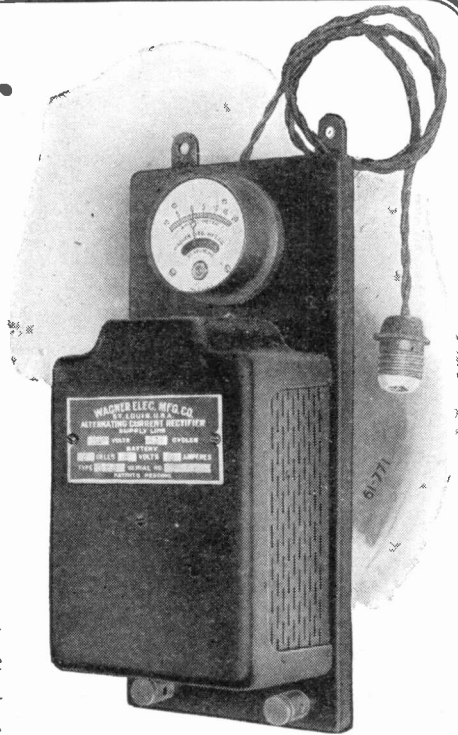

THE WAGNER RECTIFIER

The Wagner Single Phase Converter is the best means for charging electric vehicle and similar heavy service batteries. Also for X-ray work. It is high in efficiency and in addition to converting alternating current for the purposes mentioned, can be used as either an alternating or direct current motor.

Wagner Electric Manufacturing Company, Saint Louis

WRITE FOR
DESCRIPTIVE BULLETINS

Offices
In All the Principal
Cities



Motors
Single-phase and Polyphase
Transformers
Power and Lighting
Generators
Alternating Current
Instruments
Switchboard and Portable

ELECTRIC LIGHT for COUNTRY HOUSES

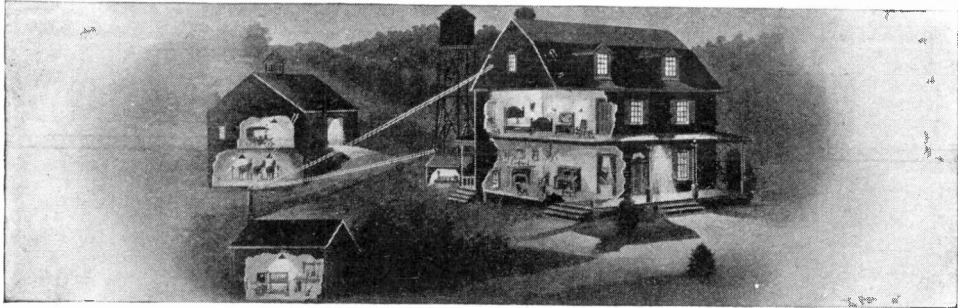

The convenience and safety of electricity both as an illuminant and as a domestic labor-saver appeal as strongly to the isolated farmer or country resident as to the city dweller. Heretofore, there has always been the obstacle of remoteness from an electric power line; this has now been overcome by the advent of inexpensive and easily installed private electric plants.

Electric Light for the Farm, by N. H. Schneider

Contains practical information on small low voltage electric plants operated by storage batteries and gasoline engines, giving full details for wiring a house according to the Underwriters' Rules, tells you just how to start about the wiring, what wire to use, how to estimate the materials required and complete the installation. Tables and rules are given for estimating the number and size of lights required and the outfit necessary to supply the current.

No technical knowledge is necessary to install or operate these outfits except what may be learned from this book.

172 Pages

PRICE \$1.00 POSTPAID

66 Illustrations

POPULAR ELECTRICITY BOOK DEPT., 54 W. Lake Street, Chicago, Ill.

Just Off the Press

House Wiring

By THOMAS W. POPPE

ELECTRICAL ENGINEER AND CONTRACTOR

Absolutely new and up to the minute, describing and illustrating all up-to-date methods of installing Electric Light Wiring according to the latest rulings of the National Board of Fire Underwriters. All systems of wiring are covered, including the three-wire system now so much in use. Practical diagrams and illustrations are given to show just how the work is done.

It Solves All Problems

FOR THE PRACTICAL WIREMAN OR AMATEUR

and in fact contains all the essential information for the successful wiring of a building.

Among the subjects covered are—Planning and laying out the work — Locating the Meter — Meter Connections—Feed Wires—Switches—Plug Receptacles—Brackets—Ciling Fixtures — Flexible Conduit System—Rigid Conduit System—Steel Armored Cable System — Knob and Tube System — Various Switching arrangements explained and diagramed—The easiest method of testing Three and Four-way circuits explained and illustrated—Current carrying capacity of Wires—Etc.

103 Pages, 74 Illus.

Flexible Cloth Cover, Pocket Size

PRICE, FIFTY CENTS POSTPAID

Money refunded if not satisfactory

POPULAR ELECTRICITY BOOK DEPARTMENT

54 W. Lake St.,

Chicago, Ill.

Every Wireless Operator or Amateur Needs This Book

The handiest and most useful Book for the Wireless Operator, Amateur or Professional, ever published.

What It Will Do for You

Contains a complete list of wireless Call Letters, 1,500 in all, enabling you to locate the origin of any certain call immediately; also the owner of the station or ship and power rating.

The Morse and Continental Codes are shown on two large full page charts so that they can be read from a distance, also a Beginner's Speed Chart so arranged to assist in learning the Codes quickly.

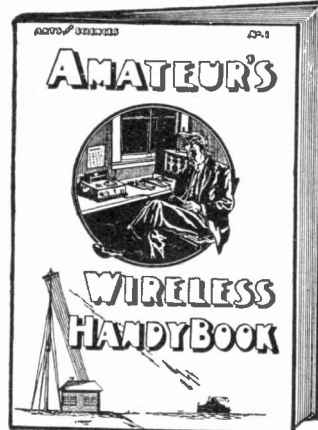

All the abbreviations used by operators to save time and labor. And last but not least over 100 Hook-ups and Diagrams. No matter what instruments you have you will find a perfect hook-up that works in this book. Blank pages are provided for keeping a record of your own hook-ups.

Price Twenty-five Cents

POPULAR ELECTRICITY BOOK DEPARTMENT
54 W. Lake St., Chicago, Ill.

For our Mutual Advantage mention Popular Electricity when writing to Advertisers.

Beardslee Lighting Fixtures Make Pleased Customers for You

WHETHER your customers want rich designs, and make cost a secondary consideration; or whether they want moderate priced fixtures that are artistic and attractive, you will find a suitable pattern in one of BEARDSLEE'S new catalogs.

Beardslee fixtures are designed, built, assembled and packed with a view to making their installation as easy and inexpensive as possible.

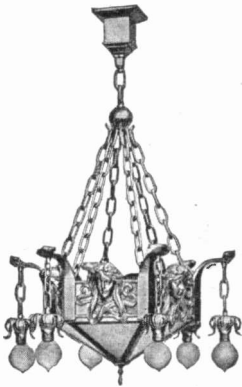

In fact, Beardslee's careful service and prompt shipments give the same satisfaction to the dealer that Beardslee quality and exclusive designs give to the consumer.

Far sighted dealers realize that trade-marked quality, 24-hour shipments and Beardslee co-operation mean better business—more profit. Are you getting these?

BEARDSLEE CHANDELIER MANUFACTURING CO.

227 South Clinton Street,

CHICAGO

Bound Volume IV

NOW READY

Popular Electricity Magazine

Issues May, 1911, to April, 1912, Inclusive

SECURELY BOUND IN HANDSOME BLUE SILK CLOTH
TO MATCH PREVIOUS VOLUMES. GOLD STAMPED.

1,200 pages of intensely interesting and instructive reading on everything electrical during the past year, illustrated with over 1,500 pictures. Practically a history of the year's progress in electrical science written in plain English.

A complete index serves to locate any desired subject immediately.

All advertising matter is excluded from this volume, making it a convenient size for your library.

Price \$2.00 Postpaid

Popular Electricity Book Department

54 West Lake Street

Chicago, Illinois

Eighteen Ways to Make Money and Advance Yourself in the Electrical Field

WHEN seeking any line of work you should get in touch with men in the field who are doing successfully the thing you want to do. "Eighteen Ways to Make Money and Advance Yourself in the Electrical Field" is the result of personal talks with winners who are engaged in doing the things they give "pointers" about. Advice from a building electrician on how to become one, how one man became an electrical contractor, etc. You can't get anything more direct than that.

This Book May Be Your Opportunity

It may suggest a line of action that had not occurred to you and which you are in a position to act upon and make yourself financially independent. Moreover it is full of suggestions to the wide-awake fellow who is anxious to "make good."

WRITE FOR A COPY NOW SEND STAMP FOR POSTAGE

POPULAR ELECTRICITY PUBLISHING COMPANY

54 West Lake Street - Chicago, Ill.

You Can Do a Bigger Business

Writing and placing advertising is the largest part of our business. But it is not *all* of it. With the idea of giving our clients the most help possible, we maintain a department that devotes its talents to devising ways and means of turning inquiries into orders.

Let Us Help You

Out of 1000 inquiries you sell an average percentage. What about the remainder? They fail to respond to *your* efforts. They can be reached in a *different* way. Let us study your problem and find *that* way. Letters, booklets, mailing cards, selling ideas, house organs—*whatever* we suggest are unusual and our clients tell us they are *effective*.

Wm. D. McJunkin
Advertising Agency

35 S. Dearborn St. CHICAGO

HESS MEDICINE LOCKER



The Only Modern, Sanitary STEEL Medicine Cabinet

orlocker finished in snow-white, baked everlasting enamel, inside and out. Beautiful beveled mirror door. Nickel plate brass trimmings. Steel or glass shelves.

Costs Less Than Wood

Never warps, shrinks, nor swells. Dust and vermin proof, easily cleaned.

Should Be In Every Bath Room

Four styles—four sizes. To recess in wall or to hang outside. Send for illustrated circular.

The Recessed Steel Medicine Cabinet **HESS, 912 L Tacoma Bldg., Chicago**
Makers of Steel Furnaces. Free Booklet.

Make \$200.00 a Month With the 1912 Camera Sensation



Six entirely different style Pictures, including Post Cards, instantly developed. No experience. My New Model Camera is the sensation of the Camera world. Twenty years ahead of them all. With it you can take and instantly develop, before the very face and eyes of enthusiastic customers, six entirely different style pictures, including POST CARDS, 4 styles of Tintype Pictures and Brooch Pictures. You can take either one person or as many as seven persons in one group. The demand for the photographs is universal. Not the slightest experience is required, and I send with the outfit everything ready to begin work with. The Camera comes to you complete and you begin making money the very first day it arrives on any street corner or wherever people gather. All you have to do is to set the machine up and the money starts pouring into your pocket at once. **\$15.00** complete with Tripod, 25 Buttons and Frames, 25 Tintypes and Mounts (2 1/2 x 3 1/2), 25 Tintypes and Mounts (1 3/4 x 2 1/2), 25 Post Cards, 1 bottle Liquid Developer. I will make a generous introductory offer to anyone who will write for free particulars. **L. E. LASCELLE, Manager, 627 West 43rd Street, Dept. 369, New York, N. Y.**

For our Mutual Advantage mention Popular Electricity when writing to Advertisers.



30 Days' Free Trial 365 Days' Test 3 Years To Pay

We Save You \$128 to \$222 On Your Piano

Send No Money

Let Us Put This Piano In Your Parlor—Not a Dollar To Pay Us.

For over 69 years this celebrated **Reed & Sons Piano** was sold through jobbers, dealers and agents, but we have wiped out their profits, giving the saving to our customers. We offer you direct-from-factory to-home wholesale prices on **Reed & Sons Pianos** giving you the highest artistic quality possible, at a price much lower than your dealer would charge you for a cheap inferior instrument.

30 Days' Free Trial In Your Home —AND WE WILL PAY THE FREIGHT

Let your family and friends enjoy the beautiful tone-qualities and examine the handsome design and finish—easy responsive action. We want every owner of a **Reed & Sons Piano** to be absolutely satisfied. That's why, in addition to our 30 days' Free Trial in your own home, we also offer you a

365 Days' Approval Test

If we cannot satisfy you with the piano we will pay the freight for its return. This is the fairest offer ever made. It means 365 days' Approval Test, besides 30 days' Free Trial and three years' time to pay if satisfied.

A 25 Year Guarantee Bond goes with each

REED & SONS PIANO

It has a world-wide name as the sweetest-toned piano, handsomely designed—constructed to uphold a hard-earned reputation, gained during sixty-nine years. At the **World's Columbian Exposition** it won the highest award medal. Thousands of owners praise **Reed & Sons Pianos**, so will you. Own one on our plan. Prove it at our risk.

Take Your Own Time To Pay

No Interest—No Collectors

Here is the fairest, squarest offer ever made. When absolutely satisfied, you can pay by the week, month, 3 months or twice a year—3 years' time to pay if satisfied.

BIG BOOK FREE Clip coupon below. We will secure for you our Special Proposition and Prices—all in handsome colored illustrated catalog sent free. We guarantee we can offer you a better proposition than any other piano concern in the world. A 2c stamp will save you dealer's profit.

Fill in the Coupon Now.

Dept J27 Cor. Jackson Blvd. & Wabash Ave. CHICAGO, ILL.

Reed & Sons Piano Mfg. Co.

Send me your Big Free Piano Book & Offers
Name.....
Street.....R. F. D.....
Town.....County.....State.....
Capital and Resources, \$1,750,000



Self Heating Iron

"NEW STANDARD"

Makes and contains its own heat. Works while it is heating, heats while it is working. Saves miles walking. Saves its cost every month. Economical, safe, convenient. The "Standard" is stove, fuel, heat—all in one. Fire is inside. Carry it about, go where you please. Don't stay in hot kitchen; iron any place, any room, on porch, or under shade tree. Go right along, one thing after another. All kinds of clothes ironed better in half the time. No waiting, no stopping to change irons. Right heat. Easily regulated. No time wasted.

Iron on table all the time, one hand on the iron, the other to turn and fold the clothes. The "Standard" is neat, durable and compact; all parts within radius of iron and handle. No tanks nor fittings standing out at sides or ends to hinder and be in the way. No wires or hose attached to bother. Right size, right shape, right weight. Cheapest fuel, two cents does ordinary family ironing. Every iron tested before shipping. Ready for use when received. Price low—\$4.50. Sent anywhere.

be in the way. No wires or hose attached to bother. Right size, right shape, right weight. Cheapest fuel, two cents does ordinary family ironing. Every iron tested before shipping. Ready for use when received. Price low—\$4.50. Sent anywhere.



"Standard"

AGENTS MAKE MONEY

Men or Women. Quick, easy, sure. All year business. Experience not necessary. Sells on merit—sells itself. They buy on sight. Every home a prospect. Every woman needs it. Price low—all can afford it. **HOW THEY DO SELL.**—Even 2 or 3 a day gives \$27 to \$40 a week profit; 6 sales a day is fair for an agent; some will sell a dozen in one day. Show 10 families—sell 8. Not sold in stores. Send no money. Write postal today for description; agent's selling plan. How to get **FREE SAMPLE.**

C. BROWN MFG. CO., 214 Brown Bldg., Cincinnati, O.



WHITE VALLEY GEMS IMPORTED from FRANCE

SEE THEM BEFORE PAYING!

These Gems are chemical white sapphires. Can't be told from diamonds except by an expert. Stand acid and fire diamond tests. So hard they scratch a file, will cut glass. Brilliance guaranteed 25 years. All mounted in 14K solid gold diamond mountings. Will send you any style ring, pin or stud on approval—all charges prepaid—no money in advance. Write for Free Illustrated booklet, special prices and ring measure.

WHITE VALLEY GEM CO., 6742 Saks Bldg., Indianapolis, Ind

50 ENGRAVED CARDS OF YOUR NAME \$1.25

In Correct Script, Copper Plate

THE QUALITY MUST PLEASE YOU OR YOUR MONEY REFUNDED

Sample Cards or Wedding Invitations Upon Request

SOCIETY STATIONERS **HOSKINS** 801 CHESTNUT ST. PHILA.

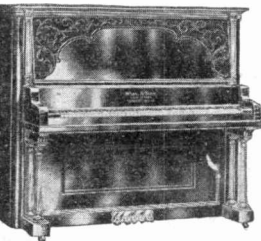

VALUABLE PIANO BOOK FREE

piano now, or if you ever expect to own a piano, you should send for this splendid book right away. Tells how you can judge a piano as well as any expert and gives the Ten Tests for judging a piano. With this free book we send you full explanation of the matchless WING and why we can afford to make you the most amazing offer ever known in the whole history of the piano business. Just your name and address on a postal card or letter brings you the free book. Now, don't wait—write now for this big book free.

WING & SON. Estab. 1868. Wing Bldg., 9th Ave. and 13th St., Dept. 1406, New York

Are You Building?

Then let us send you copy of our new booklet P. E. 6, which tells all about the proper method of finishing floors and interior woodwork.

Johnson's Wood Dye

makes inexpensive soft woods just as artistic and beautiful as hardwoods. Tell us the kind of woods you will use and we will mail you panels of those woods artistically finished—together with our 25c booklet—all free and postpaid.

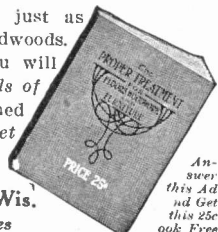

Answer this Ad and Get this 25c Book Free

S. C. Johnson & Son, Racine, Wis.
The Wood Finishing Authorities

3¢ a Day Buys This Famous ILLINOIS Watch



If you can save three cents a day, we will sell you an Illinois Watch at a price lower than you can buy a high-grade watch anywhere else in the country. We are the Big Old-Reliable Credit House you have heard so much about—the large firm which has furnished over 1,000,000 homes all over the United States on the 3c-a-day plan, and we have just made a special deal which enables us to quote astonishingly low prices on the World-Famous Illinois Watch. If you have any use for a watch, either man's or lady's, write us. Just say, "Send me your Free Watch Catalog."

Spiegel-Mau, Stern & Co.
938 W. 35th Street, Chicago, Ill. (187)

VENTRILOQUISM

Learned by any Man or Boy at Home. Small cost. Send today 2c stamp for particulars and proof. O. A. SMITH, Room W 124 823 Bigelow St., Peoria, Ill.



Nulite Portable Parlor Lamp

The cheapest, best and most beautiful light obtainable for town or country. Makes and burns its own gas; 300 C.P. 5 hours for 1 cent. Can be used anywhere with amazing results. Low in price. Thoroughly reliable. Many new and exclusive features. Best proposition of the year for agents. Write today for full details.

NATIONAL STAMPING & ELECTRIC WKS.
443 S. Clinton Street, Chicago

A GENUINE WING PIANO Shipped to You on This Special Offer—Freight Prepaid Absolutely FREE!

Yes, absolutely free. An astounding liberal offer direct to you and from one of the largest manufacturers of high-grade pianos in the world. We will ship you a genuine, tested and guaranteed Wing Piano without asking you for a cent. We will even pay all the freight in advance, so that you are not out a single penny on this ultra generous offer. **FOUR WEEKS FREE TRIAL.** We will allow you to keep this superb Wing which we send you for four weeks just as though it were anybody a cent. Use this grand instrument for four full weeks, without paying your own, then, if for any reason, you are not more than satisfied with the Wing in every single respect, merely let us know and we will pay all return freight charges. But if you decide to keep the Wing after the four weeks free trial we will allow you the privilege of either cash or time payments, and at the factory price. And besides we give you an absolute 40 year guarantee, backed by a factory 42 years old.

The biggest and most valuable book ever published—the "Book of Complete Information About Pianos" sent absolutely free on your simple request. If you own a piano now, or if you ever expect to own a piano, you should send for this splendid book right away. Tells how you can judge a piano as well as any expert and gives the Ten Tests for judging a piano. With this free book we send you full explanation of the matchless WING and why we can afford to make you the most amazing offer ever known in the whole history of the piano business. Just your name and address on a postal card or letter brings you the free book. Now, don't wait—write now for this big book free.

WING & SON. Estab. 1868. Wing Bldg., 9th Ave. and 13th St., Dept. 1406, New York



This Signal Combination Shirt

Neat for work—stands hard wear

THIS shirt is made to serve two purposes. It gives you the neatness that you want in shop, office or home—it gives *long wear* for your money. Made of close-woven shrunk percale, light or dark colors, with double strength seams. Soft collar attached or two detached four-ply collars—as desired. Extra buttonholes for attaching white cuffs.

Cut Coat Style—for your comfort

Open all the way down. Slips on and off as easy as your glove. A three-inch overlap and an extra button at the waist keeps the flap in place. Sleeves are slit in the side—this protects your underwear.

Order two from us—no money required

Ask your clothing man first. If he hasn't Signal Coat Shirts tell us his name, your size and we'll express you a couple C.O.D. If you like them pay expressman \$1.00 per garment (\$1.25 west of Missouri River). Write for folder showing styles. Also makers of Signal Work Shirts and Overalls.



Trade Mark
"The Mark of QUALITY"

HILKER-WIECHERS MANUFACTURING CO.

1248 Mound Avenue

Racine, Wisconsin

PRICE
\$7.50
UP



Make \$20 a Day

with our wonderful **Champion Picture Machine**. Takes, develops, finishes photo in half minute; 300 an hour. No dark room. **Experience unnecessary**. Photo Post Cards and Buttons are all the rage! You coin money anywhere. Small investment; big profits. Be your own boss. Write for Free Book Testimonials etc.
AMERICAN MINUTE PHOTO CO.
558 Nehoc Bldg., Dept. B-558, Chicago, Ill.



BIG MAIL FREE

Your NAME PRINTED in our Mailing Directory and sent to firms all over the world so they can send you **FREE** Samples, Catalogs, Books, Papers, Magazines, etc. Send 25c to cover cost of printing your name and you'll receive a big mail **FREE**. **Proof**—Iverson, Va., Mar. 1, 1912 Gentlemen—I have already received 2000 parcels of mail, and still they come, scores of papers, samples, magazines, etc., for which I had often paid 10 to 25c each.
R. T. JAMES,
Send to Big Mail Co., Q-120 W. North Ave., Chicago, Ill.



AGENTS AMAZING INVENTION!

An entirely new lamp burner. Changes ordinary kerosene illumination into beautiful large white light. Rivals gas or electricity. Scientifically made. Beats the old style lamp. Not a mantle. Can't break.

Big Profits Easy to show; quick to sell. \$8 to \$10 daily for you. Experience unnecessary. Sample outfit 35c. postpaid. Particulars free.
The Radliolite Co., Dept. "FF," Toledo, Ohio

"AN EDEN"

(ELECTRIC)

Home Laundry Machine

THE WORLD'S BEST

Brokaw Eden Mfg. Co., St. Louis, Chicago



MAKE YOUR BOY HAPPY by giving him **THE BOYS' MAGAZINE**. You could not give him a greater pleasure or a stronger influence for good. **Walter Camp** one of the ablest American writers and acknowledged to be the foremost authority on Athletics, edits **THE BOYS' MAGAZINE**

Each issue of this splendid magazine is filled with clean, fascinating stories and instructive articles all of intense interest to every live boy. Departments devoted to the Boy Scouts of America, Electricity, Mechanics, Athletics, Photography, Carpentry, Stamps and Coins. A new handsome cover in colors each month. Beautifully illustrated throughout.

SPECIAL OFFER! For only 50c we will send you **THE BOYS' MAGAZINE** for 6 months, AND a copy of the most useful and practical book you ever read, "Fifty Ways For Boys to Earn Money." AND this splendid baseball glove. This glove is made by one of the foremost American manufacturers, of finest tan leather, felt padded, web thumb and deep pocket.



Send in your order today. Your subscription will be entered at once and the book and baseball glove will be sent to you by return mail. Satisfaction, or money refunded.

Address, **The Scott F. Redfield Co., 800 Main St., Smethport, Pa.**

THE BOYS' MAGAZINE at all news-stands, 10c a copy.



1.6
Volts

25
Amperes

Figures That Count

In purchasing a dry battery, everyone wants a battery which will not have to be replaced every week or so. This can be avoided by the selecting of

THE 1900 DRY BATTERY

which by actual test has proven its efficiency for all kinds of work.

Send for Booklet which contains full particulars.

The Nungesser Carbon & Battery Co.
CLEVELAND, OHIO

General Sales Office: 627 W. Jackson Blvd., Chicago

ELECTRIC LIGHT AND POWER

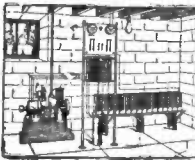

DAY AND NIGHT SERVICE
The Junior No. 1 Equipment
Direct Connected Dynamo, Gasoline Engine Set, Complete Switchboard, 16-Cell "American" Storage Battery } **\$265**
The most complete, reliable equipment ever offered at this price. We want a representative in every county.
AMERICAN BATTERY COMPANY
Est. 1889 1143 Fulton St., CHICAGO



ELECTRIC MOTORS
SHOULD BE
"ROTHMOTORS"
Polishers, Grinders, Blowers
Write for Literature
ROTH BROS. & CO.
1385 W. Adams St., Chicago 136 Liberty St., N. Y.

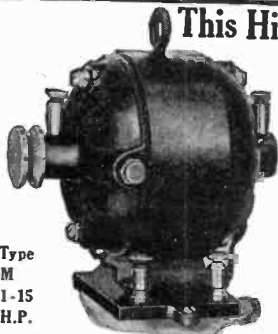

This High Class Motor
Unassembled
\$3.50

Runs on a. c. and d. c. current, 110 volts. Includes complete set of blue prints showing how to assemble. Has laminated field and armature, mica insulated commutator 3-16 carbon brushes, bronze bearings, brass grease cups, pulley and terminals. Assembled complete ready to run

\$5.50

Set of blue prints showing motor in detail 12c. Catalogue 4c.

JOSEPH WEIDENHOFF
1215 S. Ashland Ave. CHICAGO, ILL.

Type
M
1-15
H.P.

MODERN ELECTRICS

"THE ELECTRICAL MAGAZINE FOR EVERYBODY"

For the Novice, the Amateur, the Experimenter and the Student

THE brightest and most interesting "plain English" electrical monthly magazine published, nearly five years old. 112 to 144 pages monthly. New departments on aeronautics and "with the inventor."

THE AUTHORITY ON WIRELESS

THE magazine to read if you want to keep up to date on wireless and progress in electricity. With one year's subscription to Modern Electrics for a limited time only we are making the following:

THREE OFFERS

- 1 BLERIOT MODEL MONOPLANE—GUARANTEED TO FLY. FREE.**
- 2 MARBLE'S POCKET SCREW DRIVER and Prest-o-lite Key.** Three sizes of blades locked in nickel plated handle which closes up like a knife. Closed 3 1/4 in. Open 5 1/4 in. Just out and it's a dandy. **FREE.**
- 3 DOUBLE MAGNETIC REVERSIBLE ENGINE WITH SPEED CONTACT LEVER.** 1000 to 2500 revolutions per minute. **FREE.**

SEND \$1.50 TO-DAY in cash, stamps or M. O. and get **MODERN ELECTRICS** for one year and your choice of the above offers postpaid **ABSOLUTELY FREE.**

Money refunded immediately if not pleased in every way.

MODERN ELECTRICS, 262 Fulton St., New York
15c per copy (Act quickly as our supply of) **\$1.50 per year** the above is limited

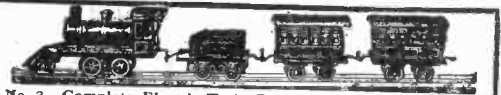

No. 2. Complete Electric Train Outfit, consisting of Locomotive, Tender, 2 trailers, and set of third rail track (2 straight and 4 curved). Will operate on 1 or 2 dry cells. Holiday price, complete, by express **\$1.85**
Acetylene Moving Picture Machine. Throws a 5x5 picture 20 feet. 500 candle power. Safer than kerosene oil. Regular price, \$10.00.

Our price, with 5-ft. film..... **\$4.35**
Complete Wireless Outfit. Will receive 50 miles, and send two miles. Consisting of Auto Coherer, Receiver, Fixed Condenser, Double Slide Tuning Coil, 1 inch Spark Coil, Rheostat Regulator, Key, Spark Gap, and 1 pound aluminum wire. Will operate on from 4 to 6 dry cells, and can be tuned perfectly. Regular price \$11.50. Special, by express.... **\$9.35**
Send 4c in stamps for our 3 Catalogs describing Electric Trains, Electrical Toys, Christmas Tree Electric Lights, Wireless Supplies

ANDERSON LIGHT & SPECIALTY CO.
KNOWN AS LASALLE LIGHT STORE
140 No. LaSalle St. Dept. B CHICAGO, ILL.

Will Not Burn Out

An important feature of these motors is that they will not heat under any circumstances 1/12 and 1/4 H. P. for A.C. and D.C. Finished in Black Enamel



THE BARNES

Variable Speed and Reversible
Are especially adapted for
Washing Machines, Printing Presses,
Coffee Mills, Dental Apparatus, Vacuum
Cleaners, Wireless Apparatus, etc.

Let us figure on your requirements

BARNES MFG. CO. 107 Belmont Street
Susquehanna, Pa.



How to Buy a Vacuum Cleaner

There are these five features to look for: First, a *Powerful Machine* that will take up all the dirt and dust, even that deeply imbedded in the very texture of heavy floor coverings.

SECOND, A *Simple Machine*.
THIRD, A *Durable Machine*.

FOURTH, A *Vibrationless Machine*.
FIFTH, A *Silent-Running Machine*.

Buy your Vacuum Cleaner as you would buy a watch—look for the “works”. It isn’t the *appearance* alone that counts—it’s what is *inside*. Vacuum cleaning is a misnomer if there is not a powerful suction such as you find in

The Silent Running

Federal Vacuum Cleaner

The *Rotary Pump* makes the FEDERAL excel other vacuum cleaners. It is the *Rotary Pump* that gives it powerful suction—that takes up all dirt and dust, no matter how deeply imbedded. It is the *Rotary Pump* that makes the FEDERAL a simple machine, a durable, vibrationless and silent running vacuum cleaner.

This is only a small part of the FEDERAL story. Now really aren’t you interested? Let us give you all the facts. Just send the coupon today for our complete descriptive booklet, “The Purity of Home”—our offer of 10 days’ trial in your home—our monthly payment plan—our broad Guarantee. *Be sure to send the coupon right away.*

Vacuum Cleaner Department

Federal Sign System (Electric)
597 Home Insurance Bldg., Chicago

CUT OUT, SIGN AND MAIL TODAY

P. E.
June '12

**Federal
Sign System**
(Electric)

597 Home Ins. Bldg.
Chicago, Ill.

Kindly send me your illustrated booklet, “The Purity of Home,” and further particulars concerning the FEDERAL. It is understood that this places me under no obligation whatsoever.

Name.....

Address.....

City.....

ELECTRIC LIGHTING PLANTS For Country Homes, Farms, Factories, etc.

It is no longer necessary for districts not within the reach of the wires of a public lighting station to be deprived of all the advantages of electricity.

Small low voltage electric lighting plants can now be furnished which occupy little spaces, are easily installed, inexpensive, and can be operated by anyone. A few hours operation of a small gas engine and dynamo will charge a storage battery, thus giving a full 24-hour service.

With these plants various sizes of storage batteries can be furnished, so that the engine can be run each day, every other day or only once a week.

The "Chloride Accumulator"

furnished with these plants is exactly the same style of battery as is used by the large electric lighting companies, electric railways, telephone and telegraph companies and the U. S. Government. In order to have continuous and reliable service, the very highest grade of battery is necessary.

Our book "How to have Your Own Electric Lighting Plant" gives full information. Send to the nearest office for a copy.

THE ELECTRIC STORAGE BATTERY CO.

1888

PHILADELPHIA, PA.

1912

New York
Detroit

Boston
San Francisco

Chicago

Portland, Ore.

St. Louis

Cleveland
Seattle

Atlanta
Los Angeles

Denver
Toronto

For Gas Engine Ignition, the "Exide" Battery will give you the very best service



Don't Use Batteries To Ring Electric Bells

The Thordarson Junior Bell-Ringing Transformer eliminates battery troubles forever. Can't get out of order. Lasts a lifetime when properly installed. Rings bells up to 4 inches in diameter. Fine for buzzers and light signal work.

Thordarson Junior Bell-Ringing Transformer

has a larger output than any other small capacity transformer and the current it consumes does not register on an ordinary wattmeter. For alternating current only. Weight 3 lbs. Price..... **\$3.00**

Write for full particulars today

THORDARSON ELECTRICAL MFG. CO.
220 South Jefferson Street, Chicago, Ill.

WASHING A PLEASURE

Not a Terror with a

"Domestic" Electric Washer and Wringer

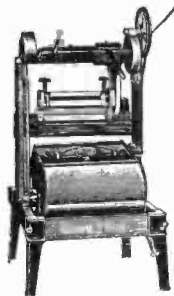

Washes clean anything washable, in from 3 to 10 minutes, without injury to the most delicate fabric. In an average family will save its cost every year. Cost of Electricity is about 2c an hour or 5c for the average family wash. The tub is made of metal; no wood to warp, shrink, leak or smell. Can be cleaned in 15 seconds. All the working parts are enclosed. Equipped with a quickly reversible metal frame electric wringer.

SIMPLE EFFICIENT DURABLE

Washing Machines, Hand, Belt and Motor Driven \$15 to \$125. Send for Catalogue, and our easy payment plan.

DOMESTIC EQUIPMENT CO.
DEPT. P. 30 W. LAKE ST. CHICAGO

A PERFECT ELECTRIC FAN \$6.50

SIX-INCH, SUITABLE FOR INDIVIDUAL OFFICE, HOUSE OR HOSPITAL USE



8 inch fan, three speeds and 8 switch..... **\$8.50** 8 5/8 inch fan, 3 speeds and 8 switch..... **\$8.85**

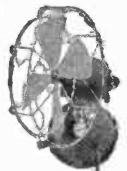

110 VOLT ALTERNATING OR DIRECT CURRENT
FINISH: Fine black enamel; guards and blades heavily nickelled on brass. All absolutely of the finest quality, noiseless, and no competition. Desk or bracket. Every conceivable adjustment. Price refunded if not satisfactory.

We prepay express and include free a 75c double-covered silk cord with plug, if you mention dealer's name and voltage desired.

Also **SIX VOLT BATTERY FANS, 6 AND 8 INCH (NOT TOYS)** at same price and with such small current consumption that they can be run economically on any wet, dry or storage batteries. Fine for boat cabins, sick rooms, and all places which lack lighting current. Special voltages wound to order.

The Carleton Company

Also an exclusive line of **SMALL MOTORS, ORIGINAL "IMP" TORCHES, TOASTERS, IRONS, BELL RINGERS, ETC.**

178 Summer Street

BOSTON, MASS.

For our Mutual Advantage mention Popular Electricity when writing to Advertisers.

2c a Week Pays Wash Bill!

Write for
FREE Book

Electricity or Water-Power Does the Work

Just a "Twist of the Wrist" Starts or Stops the Machine!

The 1900 Motor Washers are now at work in thousands of homes. They are doing the work formerly done by women, at a cost of 2c a week for power! Saving thousands upon thousands of dollars in wash bills. Saving worlds of wash-day troubles. Leaving the women free to do other work while the machines are doing the washing.

The 1900 Motor Washer

Washes a Tubful in Six Minutes!

1900 Water Motor Washer
Can be connected with
any water tap instantly



Handles Heavy Blankets or Dainty Laces
The outfit consists of the famous 1900 Washer with either Electric Motor or Water Motor. You turn on the power as easily as you turn on the light, and back and forth goes the tub, washing the clothes for dear life. Then, turn a lever, and the washer does the wringing. All so simple and easy that it is mere child's play.

A Self-Working Wringer Free With Every Washer!

The motor runs Wash or and Wringer. We guarantee the perfect working of both. No extra charge for Wringer, which is one of the finest made. Write for **FREE BOOK and 30 Days' FREE TRIAL OFFER!** Don't doubt! Don't say it can't be done. The free book proves that it can. But we do not ask you to take our word for it. We offer to send a 1900 Motor Washer on absolute Free Trial for an entire month to any responsible person. Not a cent of security—nor a promise to buy. Just your word that you will give it a test. We even agree to pay the freight, and will take it back if it fails to do all we claim for it. A postal card with your name and address sent to us today will bring you the book free by return mail. All correspondence should be addressed to **1900 WASHER CO., 5076 Court St., Binghamton, N. Y.** Or, if you live in Canada, write to the Canadian Washer Co., 355 Yonge St., Toronto, Canada. (23)



Doing the wringing with
1900 Electric Motor Washer

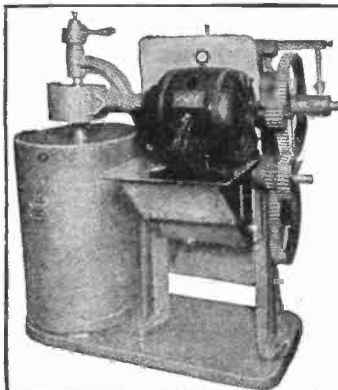

The Dewsberry ELECTRIC Power Freezer

Will enable you to produce a better grade of ice cream at a lower price and in less time than by any other method. These machines are built unusually substantial, and are guaranteed to give satisfaction. Made in 20 and 40 quart sizes. The 40 quart size runs both fast and slow on A.C. current. Write to-day for circular.

R. A. Dewsberry
216 N. Morgan St.
CHICAGO.

"Pelouze" Electric Iron

Has Heat Control at Finger Tip

No need to reach up to the chandelier switch—nor disconnect the cord at iron. Heats quickly—about half usual time. Has hot point and edges.—consumes less current than any other iron. 4 or 6 1/2 lb. size \$5. For sale by all leading dealers. Send for booklet.



You Can't Burn Your Hair

with a Pelouze Electric Curling Iron. Never gets too hot. Handle revolves. Cord can't kink. Shield is removable. No flame, no danger from fire. Cost of current less than one-third cost of alcohol lamp. Iron always bright and clean. Complete with nickel plated stand. \$3.50. For sale by all leading dealers. Send for booklet.



PELOUZE MANUFACTURING COMPANY
242 East Ohio Street, Chicago, Ill.

COOK BY ELECTRICITY

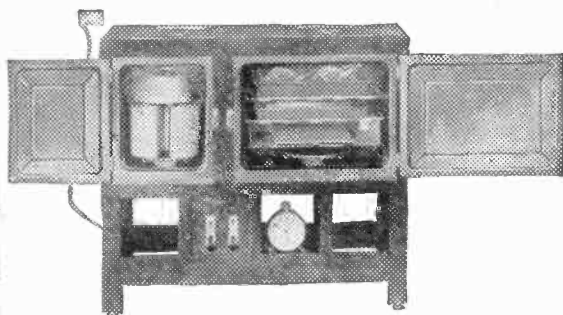

THE SILENT SERVANT

The COPEMAN AUTOMATIC ELECTRIC COOK STOVE

which has Revolutionized the Art of Cooking, is a Conservator of Time, Labor, Health and Dollars. The operation of the stove is very simple—the current being turned on at a predetermined time, and cut off at a predetermined temperature—all absolutely automatically, the stove taking on the fireless cooker principle after the desired heat has been obtained in the compartment.

The Copeman Stove will perform all the functions of any gas, coal or wood stove, and the food tastes better. These stoves are made in three sizes to accommodate families ranging in size from two to twenty people.

Write for literature and prices
COPEMAN ELECTRIC STOVE CO.
424 North Saginaw Street, Flint, Michigan

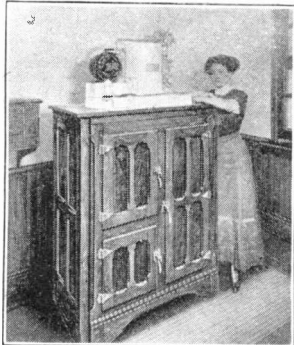

Auto-Electric Refrigerating Plant

This is a miniature refrigerating and ice-making plant and it can be attached to any ice box. It is suitable for stores, meat shops, hotels, homes and hospitals, where pure, clean ice is required. It insures a dry cold ice box free from germs, with a refrigeration in 24 hours equal to that obtained by 200 lbs. of ice, and in larger sizes up to three tons. It maintains an even temperature, never varying more than 2 degrees. Makes from 10 to 50 lbs. of ice a day. Motor requires no special wiring for small machine, can be connected to any electric light socket. No unnecessary plumbing. Machines are made in all sizes, to fit any ice box.

Write today for full particulars

Auto-Electric Refrigerating Company
Suite A243, Railway Exchange, CHICAGO, ILL.

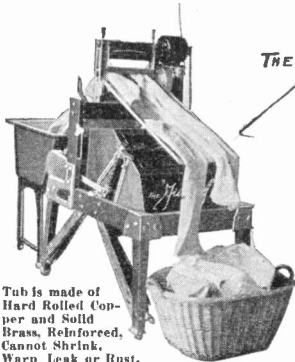

THE *Judd*

Won't Wear Out the Clothes

The Reason Why? It's Perfectly Smooth Inside

Blankets and finest fabrics are all the same to THE JUDD, for the water is forced through the clothes a hundred times per minute. Ten or fifteen minutes will thoroughly cleanse a tub full.

Two hours to do a family washing! The electricity from any light socket will do the work at a cost of about four cents.

The special motor operates the reversible wringer and washer at the same time. Let us show you how THE JUDD works. Descriptive literature for the asking.

JUDD LAUNDRY MACHINE COMPANY
Room 335 People's Gas Building, CHICAGO

Tub is made of Hard Rolled Copper and Solid Brass, Reinforced. Cannot Shrink, Warp, Leak or Rust.



Which Would You Rather Be?

If you were one of these two men would you change places with the other for a difference of half a cent an hour?

The comfort alone is worth many times that amount, to say nothing of the difference it makes with your disposition and the work you can do. The same thing is true of those who work for you and

Fort Wayne Electric Fans Are A Good Investment

because they increase the efficiency of your help.

They are the best means of supplying refreshing, cooling breezes during the hot sultry weather, and it costs only half as much to run one as a 16 candle power incandescent lamp.

We make a size and type for every use and there's enough difference in quality to make it well worth while asking for a "Fort Wayne" when you buy a fan. If your dealer does not carry them—write us.

FORT WAYNE ELECTRIC WORKS

OF GENERAL ELECTRIC COMPANY
1603 Broadway, Fort Wayne, Ind.
"WOOD" SYSTEMS
Branch offices most large cities



72

For our Mutual Advantage mention Popular Electricity when writing to Advertisers.

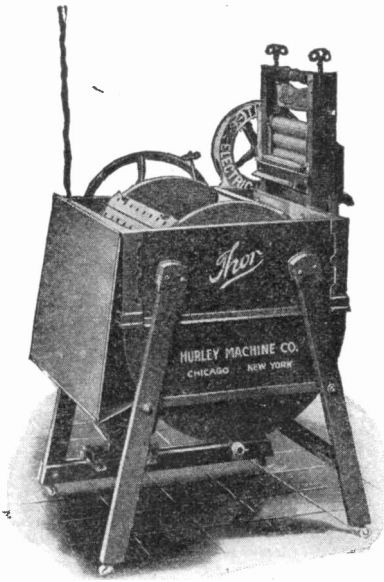

THOR ELECTRIC
Home Laundry Machine

THE HURLEY LINE

OF
ELECTRIC LAUNDRY MACHINES

29 Sizes and Styles
to Select From

\$50 to \$500

Think of it. Your entire week's washing and wringing done in 90 minutes, without any laborious work and at a cost of only 3 cents for electricity.

THE THOR

is used and appreciated in more than 36,000 homes. We gave them a two weeks'

FREE TRIAL

to prove its merits. Why cling to drudgery and excess expense in YOUR home. Don't be skeptical. Select the machine you want and try it. We pay all freight charges if you don't wish to keep it. Sold on easy payments.

Write today, now, for Free Catalog F and name of dealer in your city.

HURLEY MACHINE COMPANY

27 SOUTH CLINTON STREET, CHICAGO

NEW YORK: 1011 Flatiron Building

LOS ANGELES: Third and Main Streets



A 30 Day Free Trial

in your home will demonstrate to your satisfaction how necessary the

SIMPLEX IRONER

is for economical management.

It saves your strength, health, beauty, time and money. It irons five times as fast, better and makes it easier. Servants are better contented, more efficient. Heats by gas or electricity. Operates by hand or small motor at small expense. It really costs nothing because it saves its cost every six months. Write for booklet and "Ironing Hints." Both free.

AMERICAN IRONING MACHINE COMPANY
55 East Lake Street Chicago, Ill.

Would you prefer in your Electric Iron one that has

- ? The heat in the bottom only ?
- ? A cool, comfortable handle ?
- ? A permanent nickel finish ?
- ? A really practical stand ?
- ? A positive certainty of durability ?
- ? The lowest cost for running ?
- ? The Upside-down-rack ?

Then insist on the

SIMPLEX ELECTRIC IRON



Send for descriptive folder

Simplex Electric Heating Company
Cambridge, Mass.

Chicago, 15-21 S. Desplaines St.
New York, 25 W. 42d St.

San Francisco, 612 Howard St.
Belleville, Ont.



For our Mutual Advantage mention Popular Electricity when writing to Advertisers.

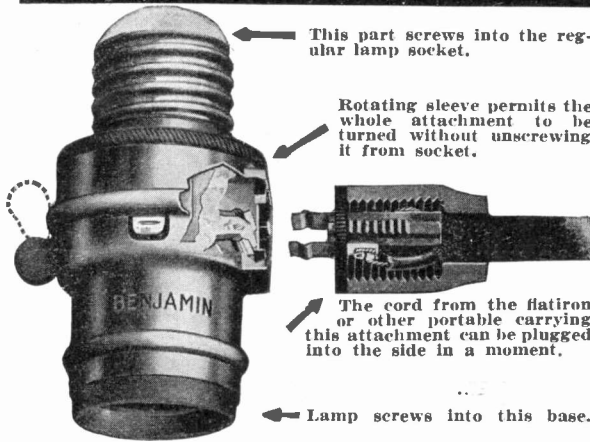

BENJAMIN PLUG CURRENT TAP

← This part screws into the regular lamp socket.

Rotating sleeve permits the whole attachment to be turned without unscrewing it from socket.

← The cord from the flatiron or other portable carrying this attachment can be plugged into the side in a moment.

← Lamp screws into this base.

THE Benjamin Plug Current Tap enables you easily to attach a portable device, such as a flatiron, electric curling iron, etc., to the electric circuit without bothering to take out the regular lamp. A special attachment on the end of cord from the portable carries two little spring clips which are thrust into an opening in the side of the plug making connection in an instant. A rotating sleeve permits the plug, with its attachment in any position without unscrewing it from the ordinary socket. The little switch on the side permits the operation of the lamp alone, the lamp and attached device together, or the attached device alone. Means are also provided to attach the lamp shade as on the ordinary socket.

If you desire to use a two to four candlepower lamp with an extension cord in connection with the ordinary lamp of the same voltage, the smaller lamp becomes a good night lamp and can be placed in any desired location. The Benjamin current tap permits this to be done without burning out the smaller lamp, which would happen if it were connected direct to the circuit.

This and other Benjamin specialties are no doubt carried by your electrical supply dealer. If not we will make you a special introductory price for a single sample. Write for descriptive folder.

BENJAMIN ELECTRIC MFG. CO., 126 S. Sangamon St., Chicago, Ill.

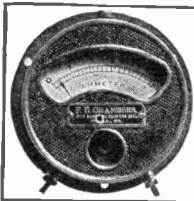

Hot Wire Ammeters

We are pleased to offer a hot wire ammeter at a lower price and of a quality equalled only in instruments selling for many times its price. The bearings are of Oriental sapphires; the rotating shaft of specially hardened steel. The mechanism mounted on a compensating plate made from carefully tested alloy. The case is non-reflecting black with raised parts nickelled, is 4 1/4 in. dia. and weighs 2 lbs. The scale is calibrated 0-3, 0-10, 0-25 as desired. Price, \$5, for a limited time. Send 2c stamp for Catalog. F. B. Chambers & Co., 217 N. 9th St., Phila., Pa.

DETECTORS

Perikon, Silicon and all other mineral and solid rectifier detectors, are covered by patents owned by this company, and all infringements will be prosecuted to the full extent of the law, including makers, users and sellers of such detectors, or supply and repair parts thereof.

WIRELESS SPECIALTY APPARATUS COMPANY
126 State Street, Boston, Mass.

VOLTAMP ELECTRICAL APPARATUS AND SUPPLIES

Are sold on their merits and under the Voltamp guarantee of quality. Write today for our complete, fully illustrated catalog of Voltamp Products, which includes everything for experimental and general electrical work—motors, dynamos, induction coils, transformers; telephone, telegraph and lighting equipment; miniature railways, tools, toys, etc. (Send 6c in stamps or coin for catalog, which will be refunded on your first order of 50c or over. No postals answered.)

Voltamp Electric Mfg. Co., Park Bldg., Baltimore, Md.

DROP US A POSTAL CARD

for our new book catalog and pamphlet, "18 Ways to Make Money." Do it now.

Popular Electricity—Book Dept.

ELECTRIC Goods for Everybody.

House Lighting
Plants, Lamps, Engines, Dynamos, Fan, Sewing Machine and Power Motors, Heating Pads, Laundry Irons, Toasters, Transformers, Meters, Telephones, Hand Lanterns, Submarine, Cap, Bicycle, Carriage, Automobile and Flash Lights, Storage and Primary Batteries, Belts, Bells, Books. Fortune for agents. Big Catalog, 4 cents.

OHIO ELECTRIC WORKS, Cleveland, Ohio

Electricians

are you up-to-date in house-wiring, if not, study our 75 genuine blue print drawings, of all up-to-date labor saving diagrams and connections for wiring bells, lights, annunciators, gas lights, burglar alarms, telephones, fire alarms, etc.—everything known in house-wiring to date, for saving time and material. These drawings are bound in the form of a flexible book (7x3) for convenience in using on the job. No one interested in house-wiring can afford to be without these drawings as they're a house-wiring education in themselves. Send for them, and if they don't make you more efficient as a wireman and save you a hundred times their cost as a contractor, return them and money will be refunded. 50 cents, Postpaid.

PATENT SPECIALTY COMPANY
462 Sanchez Street, San Francisco, Cal.

CALIDO

FOR
HEATING APPARATUS

ELECTRICAL ALLOY CO., Morristown, N. J.

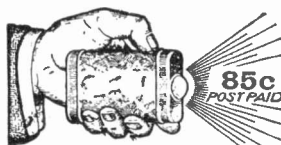

THIS TUNGSTEN FLASHLIGHT

can be used for a dozen different purposes about the house, garage, auto or launch without any danger whatever; and gives a very powerful light. Just the thing to slip under your pillow for immediate use during the night. Send for it Today, also Agent's Proposition.

Foreign Electrical Exchange
105 N. Wabash Ave., Dept. 1, Chicago

BIG ELECTRICAL CATALOG AND WIRELESS

250 PAGES THIS BIG 250-PAGE CATALOG is unquestionably the largest, most artistic, most elaborate and comprehensive catalog of its kind published.

Celebrated Ferron Detector, yet remains the peer of all Detectors licensed for private use. Price only \$5.00.



The Ferron Detector contains the same high grade crystal, and an adjustment equally as admirable as the Pyron Detector licensed for commercial use and which sells for \$65.00. Licensed for private use at a low price. A patron in Georgia writes: "Easily picked up several shipoff Norfolk and New Orleans, also land stations. Signals came in so loud I could hear them with telephones removed some distance from my ears."

MAILED FOR 6c in stamps or coin, which may be deducted on first order of \$1.00.

LOWEST PRICES ON EVERYTHING IN ELECTRICAL LINE

Attention is called to our very attractive prices on spark coils. These prices will last for a limited time only. Our spark coils are made by one of the foremost coil companies in the United States and our patrons should be quick to take advantage of the great opportunity offered to them to get these excellent spark coils at such attractive prices.



WIRELESS INSTRUMENTS

for commercial, private and experimental use.

WHAT THIS BIG CATALOG CONTAINS:

- 75 pp. Wireless Instruments
- 20 pp. Telegraph Instruments
- 30 pp. Motors and Dynamos
- 15 pp. Flashlights and Miniature Lamps
- 25 pp. Miniature Trains
- 70 pp. General Electrical Supplies
- 10 pp. Mirrorscopes (will project pictures of all sizes in natural colors greatly enlarged)
- 10 pp. Launch Lighting Outfits

Special low prices on our high grade wireless spark coils for this month only. Magazine must be mentioned when ordering at these reduced prices.

1-inch	\$ 3.85
2-inch	7.00
3-inch	14.00
4-inch	20.00

J. J. DUCK 428 ST. CLAIR ST. TOLEDO, - OHIO

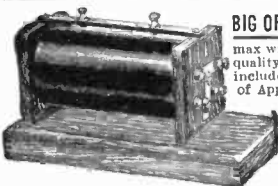

BIG OFFER ON SPARK COILS. We cap the climax with coils which stand alone in style, quality and price. As a special offer we will include Free with each coil a set of 12 pieces of Apparatus and directions with which many interesting experiments can be performed. These coils are specially adapted for wireless. 1/2-in. Spark Coil and 12 pieces of Apparatus, \$1.16; 3/4 in. Spark Coil and 12 pieces of Apparatus, \$1.75; 1-in. Spark Coil and 12 pieces of Apparatus, \$2.50.

Send 3c for catalog. Thomas M. St. John, 846-S 9th Ave., New York

Wireless Goods at Cut Prices

1-inch spark coil, \$3.75; 1 1/2-inch, \$5.75; 2-inch, \$7.75; 3-inch, \$14.75. 1000 ohm double pole receiver, \$1.25. High-grade telegraph set, \$1.25. Head band, 38c, etc. Send 3c stamp for catalog. No postals answered.

ETHERIC WIRELESS MFG. CO.
80 W. 124th Street, New York, N. Y.

Wireless Detector Stand, \$2.75
By Mail, 15c extra

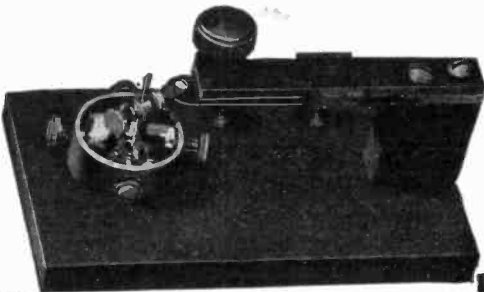

Just the Thing You Have Been Looking For

Not only is it equipped with our now justly famous Variable Tension Slide, but in addition to this the revolving mineral cup is designed to contain four different kinds of minerals, or four of the same kind as you please, each crystal being brought into position either by rotating the cup, or laterally moving the arm containing contact pin. This principle enables you to not only bring any desired mineral into the circuit, but any desired point of the mineral or minerals.

The pin is sterling silver or brass, as may be desired, and by soldering a very fine wire to the pin you secure conditions which are just right for the use of galena.

Base is vulcanized black fibre, 3"x5"x1/2", nicely finished as to be easily mistaken for polished hard rubber. If desired can furnish with Polished Hard Rubber Base for 50c extra.

Send 2c stamp for our Wireless Catalog
DAWSON & WINGER ELECTRIC CO.
727 So. Dearborn Street, Chicago, Ill.

THE BLITZEN Rotary Variable Condenser

Price \$5.00

Don't chase away the small amount of energy in an incoming signal with condensers which slide in grooves and provide a large leakage path on every edge of every plate.

Capacity is large (.0008) and by filling with castor oil may be increased five times to .004 M.F. Has 15 rotary and 16 stationary aluminum plates, nickel plated brass case and hard rubber top and handle (not composition).

Better send to stamps for our complete catalog—today.

GLAPP-EASTHAM CO., 141 MAIN ST., CAMBRIDGE, MASS.
Aylsworth Agencies Co., 143 2nd St., San Francisco, Cal.
Western Sales Agents
J. J. Duck, 430 St. Clair St., Toledo, Ohio
Central States Agent

Murdock Helix No. 422

\$4⁰⁰

\$4⁰⁰

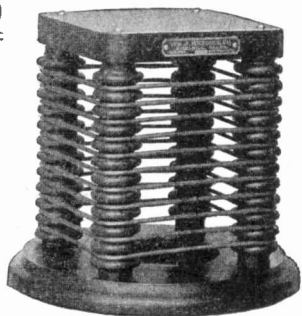

An instrument of merit, splendidly constructed and thoroughly efficient. Suitable for transmitting outputs of ¼ KW and under. Biggest, strongest, and best helix ever offered at the price.

We are also offering a new

Receiving Transformer No. 343 at \$8.00

an absolutely unparalleled value. Perfect tuning made possible; it works with professional precision. It is certainly the most efficient tuning device ever offered at any price under \$15. Investigate.

WM. J. MURDOCK COMPANY
50 Carter Street, CHELSEA, MASS.
162 MINNA ST., SAN FRANCISCO

Send for Our New Catalog E.26

It is pocket size, contains 200 pages, measures 4¼x8¼", can be carried in the pocket, and has a mine of information to impart in clear, concise, understandable language.

It Means Money Saved to You

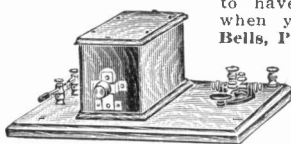

to have one to consult when you want to buy Bells, Push Buttons, Batteries, Telephones, and Telegraph Material, Electric Toys, Burglar and Fire Alarm Contrivances,

Electric Call Bells, Electric Alarm Clocks, Medical Batteries, Motor Boat Horns, Electrically Heated Apparatus, Battery Connectors, Switches, Battery Gauges, Wireless Telegraph Instruments, Ignition Supplies, etc. Do not wait until some other time, but sit down now and send your name and address, and get the best pocket edition electrical catalogue published. It costs you nothing.

Manhattan Electrical Supply Company
New York, 17 Park Place Chicago, 114 S. 5th Ave.

BRANDES SUPERIOR RECEIVERS

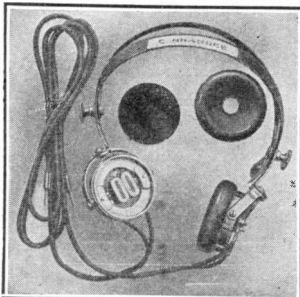

This testimonial is one of the many we receive regularly: "With an aerial 85 ft. high and 95 ft. long, I have heard the following stations: NPB Sitka, Alaska, 1800 miles, 11:00 P.M. NAX Colon, Panama, 3000 miles, 10:35 P.M. NAR Key West, Fla., 2500 miles, - 6:20 P.M. As my instruments are all of my own make I lay my good success to the 'phones.'" Santa Ana Cal. J. E. W.

Complete 2000 ohm set, \$5.00 If the receivers do not meet with your approval, you may return them, and your money will be refunded immediately.

C. BRANDES, Inc. 111-115 Broadway, New York
Agent for San Francisco, Ford King, 623 Balboa Bldg
Los Angeles, C. E. Cook Electric Co., 745 S. Spring St.

Special Key \$3.00

Designed for the experimenter who wants the best at a reasonable price. Has a carrying capacity suited for coils up to 4-inch or ¼ K. W. transformer. Points one-eighth inch diameter and of hardened alloy. Base of insulating material. Phosphor bronze lever; other parts finished in gold lacquer. Phosphor bronze spring riveted to lever and metal strip from anvil to other binding post provides ample carrying capacity. One-eighth inch hardened alloy points in removable holders can be renewed without sending key to factory. This key is remarkable both for beauty and efficiency.

Rotary variable.....\$3.00
Spark gaps.....75c to \$1.50
Helix ¼ K. W. 3 clips.....\$4.00
2,000 ohm head set.....\$5 to \$12.00
Loose coupler.....\$6, \$8 and \$15.00
Booklet H Free

J. ELLIOTT SHAW CO.
632 Arch Street Philadelphia

WIRELESS EXPERIMENTERS

Special prices in enamel wire for this month.
No. 22.....50c per lb. | No. 26.....60c per lb.
No. 24.....55c per lb. | No. 28.....70c per lb.
Send 2-cent stamp for our large wireless catalogue, including diagrams and other interesting information. We will also include our monthly aeroplane bargain sheet.

THE I. W. T. WIRELESS CO.
1038 Broadway, Brooklyn, N. Y.

"WIRELESS" "WIRELESS"

ABSOLUTELY BEST THE MARKET AFFORDS
SPARK COILS. ENAMELED WIRES
¼-inch\$ 2.00 8-14....Per Pound...\$.30
½-inch 3.00 14-22....Per Pound... .40
1-inch 4.00 24-26....Per Pound... .50
1½-inch 5.25 28-30....Per Pound... .70
2-inch 7.50 32-34....Per Pound... 1.25
3-inch 15.00 Aluminum Aerial or
4-inch 27.00 Helix Wire 6-14, lb. .50
½ K-W Trans- Galena, Iron Pyrites,
former..... 6.00 per ounce......10
Send 2-cent stamp (no postals answered) to Department "B" for big bargain Bulletin.
BROOKLYN WIRELESS & ELEC. NOV. CO.
766 Broadway, Brooklyn, N. Y. City.



Absolutely Free No Strings

Complete Course of Wireless Instruction in 20 Lessons—400 Illustrations.

This course embraces 20 lessons not only on wireless telegraphy but electricity in general. When you finish this course you will have an expert knowledge of wireless and general electricity. This course is not a gift—we owe it to you. It represents your discount for cash on future orders. Send today 4c postage mentioning this adv. and we will forward full information; also copy of our 196 page Electrical Encyclopedia No. 10, containing over 1,500 articles and 450 illustrations.

THE ELECTRO IMPORTING CO., 233 B Fulton Street, New York City

Sending and Receiving Wireless Outfits

COMPLETE

**IDEAL SETS FOR HOME, PICNICS,
CAMPING OR BOATING**

PORTABLE

No. 796—\$5.00 VALUE \$3.00

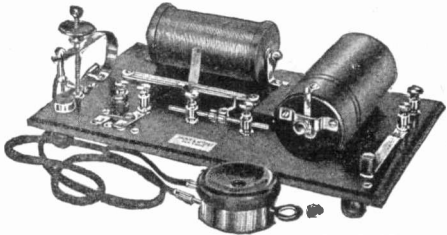

Mounted on solid oak base, size 7x12

Sends ½ to 1 Mile—Receives up to 500 Miles
This new, up-to-date, guaranteed, portable set, consisting of one ¼-inch spark coil, equal to the average ¾-inch coil, and high tension vibrator, one combination universal detector; one 75-ohm. nickeled case; exceptionally sensitive telephone receiver and cord; one large high efficient flat plate secondary condenser; one sending key; one condenser switch; one spark gap with lathe turned ¾-inch zinc spark ends; one tuner 4½x2 inches, latest type, wound with bare copper wire; one special primary condenser; 1-inch Wollaston wire; one double throw double pole aerial switch; 120 feet aluminum aerial wire; two insulators, complete directions, diagrams and code. The raw material alone would cost you this amount were you to build the set yourself. Operates on two batteries.

Price \$3.90
No. 798—Same as above, with ½-inch coll. Sending radius 1 to 2 miles. Price. \$5.00

No. 800—\$15.00 VALUE \$8.50

Sends 8 to 10 Miles—Receives 600 to 800 Miles
NEW — UP - TO - DATE — GUARANTEED

This set consists of a guaranteed 1-inch spark coil, the best type ever placed on the market for wireless; one sending key; special flat plate secondary condenser, extra large size; primary condenser; combination universal detector; very fine 1,000-ohm. silk copper wire wound receiver and flexible receiver cord; the newest type bare copper wire wound tuner, exceptionally large capacity; spark gap with lathe turned 3.8-in. zinc ends; one condenser switch; 120 feet aluminum aerial wire; double pole; double throw switch; two insulators; 1-inch Wollaston wire; proper capacity sending helix; diagrams 8 to 10 miles sending—600 to 800 miles receiving. Regular \$15 value. Operates on six batteries.

Price, complete \$8.50

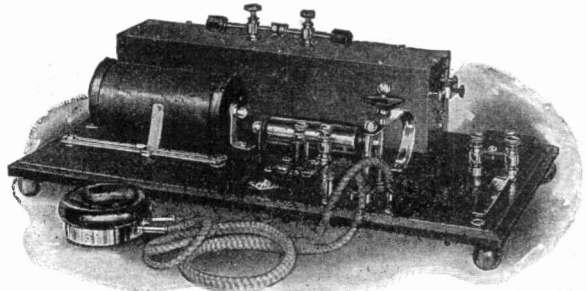

Mounted on solid oak base, size 8x14 inches

FOR THE BEGINNER

Mounted on Solid Oak Base
\$2.50 Value
Receives Up to 500 Miles
No. 797 \$1.75

This consists of a combination universal detector; 75-ohm. nickeled case; exceptionally sensitive receiver and telephone cord; tuner 4½x2-inch latest type, wound with bare copper wire; 1-inch Wollaston wire; two insulators; 65 feet aluminum aerial wire. Price \$1.75

By Mail 28c Extra

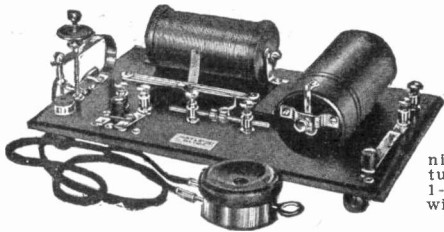

Don't Buy Before
Writing Us

Send at Once for
Circular P.

HUNT & McCREE

(The House of Wonderful Values)
NEW YORK

Laboratories
255 Washington St.

General Offices
92-94 Murray St.

Wireless Spark Coils

These coils are designed especially for Wireless Telegraphy and High Frequency Work. We believe our coils the most efficient made. A trial will convince you.

¼ inch \$2.00	2 inch \$7.75
⅜ inch 3.00	3 inch 15.50
¾ inch 3.65	4 inch 25.00
1 inch 3.95	6 inch 50.00
1½ inch 5.50	Not Mailable.

Complete catalog free on request

LEITCHER-STANLEY COMPANY
32 Frankfort Street, New York City



Human Safety
DEMANDS
RELIABLE

Wireless Receivers

WE MAKE THEM
Durably Built Yet Sensitive to the Slightest Vibration.

WRITE FOR CIRCULAR 20A2

THE HOLTZER-CABOT ELECTRIC CO.
BROOKLINE, MASS., and CHICAGO, ILLINOIS

Let This Electric Watchman Tend Your Furnace Next Winter

Prepare for the cold winds while summer breezes blow. The Utility Electric Thermostat is the simplest, most unique, efficient and durable heat regulator made. Utilizes house current. Mercury column of thermostat coming in contact with platinum wires, woven in glass tube, complete circuit—operates drafts and dampers without weights or other cumbersome mechanism. Highly sensitive and accurate. Operates on change of only 1-10 of a degree in temperature. Entire working apparatus contained in small steel box in basement. Thermometer elegantly finished to match woodwork.

THE UTILITY ELECTRIC THERMOSTAT is the best thermostat made and cheapest because it cannot get out of order. Will last a lifetime—and longer. Also furnished with clock attachment, if desired.

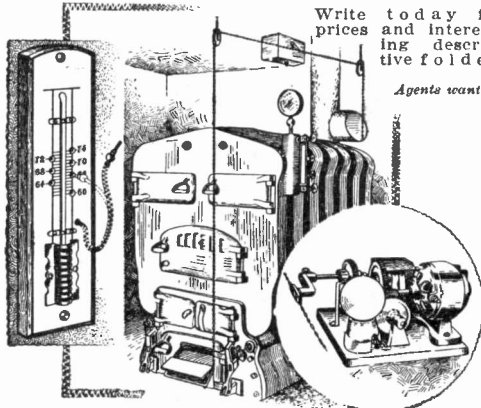

Write today for prices and interesting descriptive folder.

Agents wanted.

RAILWAY UTILITY CO., The Rookery, Chicago

OWN A BUSINESS

WE WILL HELP YOU.



"I made \$88.16 first three days," writes Mr. Reed, of Ohio. Mr. Woodward earns \$170 a month. Mr. M. L. Smith turned out \$301 in two weeks. Rev. Crawford made \$7.00 first day. See what others have done.

LET US START YOU.

in Gold, Silver, Nickel and metal plating. Prof. Gray's new electromachine plates on watches, jewelry, tableware and metal goods. Prof. Gray's new Royal Immersion Process latest method. Goods come out instantly with fine, brilliant, beautiful thick plate, guaranteed 3 to 10 yrs. No polishing or grinding. Every family, hotel and restaurant wants goods plated.

PLATERS HAVE ALL THEY CAN DO.

People bring it. You can hire boys to do the plating as we do. Men and women gather work for small per cent. Work is fine—no way to do it better. No experience required; we teach you. Recipes, Formulas, Trade Secrets Free. Outfits ready for work when received. Materials cost about ten cents to do \$1.00 worth of plating.

Our new plan, testimonials, circulars and SAMPLE FREE. Don't wait. Send us your address anyway. **GRAY & CO., PLATING WORKS.** 1164 Gray Building Cincinnati, Ohio



WOULD YOU

Show this wholly visible Typewriter to your friends and let them see wherein it excels any \$100 Typewriter made, if we would send one to you Free of One Cent of Cost for you to keep forever as your own? Then on a postal card, or in a letter to us, simply say: Mail particulars.

EMERSON TYPEWRITER CO., Box 67, Woodstock, Illinois.

TESTED APPARATUS

MEANS THE ELIMINATION OF FAULTS IN YOUR PRODUCT

Electrical and photometrical tests of every description. Checking electrical instruments of all kinds and classes. Inspecting and testing new electrical machinery, apparatus and material at factories and after installation. Tests on any electrical machinery and apparatus made anywhere. Arc and incandescent lamp tests, either electric, gas, acetylene or oil. Illumination tests made anywhere. Secondary standards of candle-power furnished. Facilities furnished to experimenters and investigators.

We have recently added to the above, Coal Testing, and are now prepared to make proximate analyses and calorific determinations on samples of coal, promptly and accurately.

ELECTRICAL TESTING LABORATORIES

80TH STREET AND EAST END AVENUE NEW YORK, N. Y.

How Tom The Onelegged Popcorn Man Got Rich

Send for the true story of how a man in a Michigan town got rich selling Popcorn

Size up your chances for doing the same. Big money is made in the popcorn business. Make \$2500 This Summer. New machine—just out—revolutionizes whole industry. New in design and operation. Corn comes from popper buttered and salted—bigger kernels—better flavor—less corn to bag—more profits. You never tasted such delicious, enticing corn.

White City Automatic Pop Corn and Candy Machine

Runs by electricity. Simple, easy to operate. Pops corn—makes candy. Candy kettle, cooler, candy hook, corn sieve, thermometer and paddle included in outfit. One of the greatest money making propositions ever offered for the investment. Get the big money this summer at fairs, parks, resorts, amusement pavilions, etc., on street corners in moving picture corridors, etc. Now is the time to start. Get ready for the rush. Anyhow, write for Tom's story—and big colored picture of machine.

C. E. DELLENBARGER COMPANY, 634 W. Jackson Blvd., Chicago, Illinois

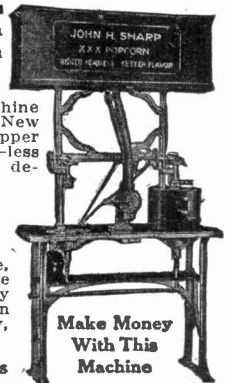

Make Money With This Machine

For our Mutual Advantage mention Popular Electricity when writing to Advertisers.

**PERFECTION MARINE ENGINE
100% RIGHT**

The big 1912 line of Caille Perfection Marine Engines from 2 to 30 H. P., give dollar for dollar more real service than most engines costing double their price—Perfection service is one hundred per cent right.

Without a Rival

For yachts, cruisers and ferry boats, a Perfection power plant is without a rival and simply thrives on hard, tough work. It works equally well in fresh or salt water, tide-water or stream, calm or storm. It embodies more refinements than any other engine on the market. The Igniter Equipment with the 6 H. P. and 8 H. P. insures a water-proof ignition and does away with batteries, coils, magneto and timer.

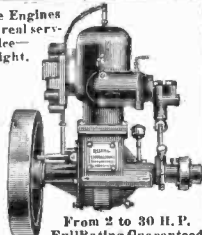

From 2 to 30 H. P.
Full Rating Guaranteed

Free Book of Engines—Our new 1912 Engine Prompt Book is free for the asking—refer to it any time for the true and correct meaning standard construction. Write today while you have the subject in mind. The Perfection owner could not buy a better engine. Caille Perfection Motor Co., 1208 Caille Street, Detroit, Mich.

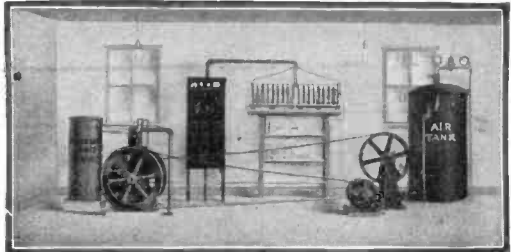

**BRILLIANT ELECTRIC LIGHT
WATER DIRECT FROM THE WELL**

Secure Them Both With a Single System

The two great conveniences of the city—electric light and running water—can now be secured for your country home with only one power plant. The

**Fairbanks-Morse
Electric Light & Water System**

will give you abundant light for your residence and other farm buildings, and also force water under constant uniform pressure to faucets anywhere on your place.

ONE ENGINE DOES ALL THE WORK

The Lighting Plant is our standard 50-light, 30-volt outfit and is complete, ready to run; nothing additional but the wiring being required. It gives 24-hour service.

The Fresh Water System pumps by compressed air; air from storage tank operates auto-pneumatic pumps located in as many sources of supply as you desire.

The entire outfit is simple, compact, easily installed and operated, and can be located wherever convenient.

Write for Catalog No. 1163ND and Prices.

FAIRBANKS, MORSE & CO.

900 S. Wabash Ave.,

Chicago, Ill.

NO MATTER

Where You Use It

A Temco Drill

is built for reliable
SERVICE

The lightest in weight,
most convenient in
shape.

A CATALOG ON REQUEST

**THE TEMCO
ELECTRIC MOTOR CO.**
88 Sugar Street
Leipsic, Ohio, U. S. A.



GRAY MOTORS FOR BOATS



Made in the Largest Plant in the World devoted to manufacturing 2-cycle marine gasoline engines.

3 H.P. with Complete Outfit ready to install \$55
ALSO 3/4 TO 36 H.P.

Guaranteed by a big responsible concern. Write for big catalog—tells and shows you all about these high grade motors and how they are made.

GRAY MOTOR CO., 651 U. S. Mejors Bldg., Detroit, Mich.

SEBCO EXPANSION BOLT



Write for Catalog No. 10

STAR EXPANSION BOLT COMPANY
147-149 CEDAR ST., NEW YORK

SMALL ENGINES

1/8 H. P. Up

Steam, Gas and Gasoline, for professional and amateur mechanic. Write for circulars. Big catalog listing mechanical and electrical devices. Small Power Machines and Individual

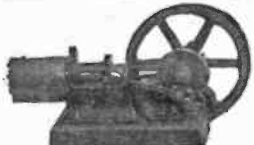

to 60 lights, 15c (coin preferred). Refunded on first order. No free list. Amateur Mechanics Supply Co. 860-A Monadnock Bldg., Chicago, Ill., U. S. A.

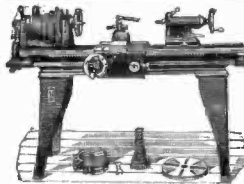

LATHES

\$75 Screw Cutting
Foot Power
9 to 13 inch

CATALOG FREE

SOUTH BEND MACHINE TOOL CO., 427 Madison St., South Bend, Ind.

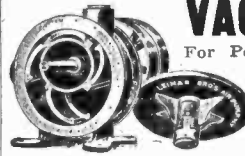

VACUUM PUMPS

For Powerful Portable and Stationary Vacuum Cleaning Plants. They take up their own wear. Powerful; Noiseless; can't get out of order.

GET CATALOG NO. 85

LEIMAN BROS., 62AD John St., NEW YORK

"BABY" GASOLINE MOTOR \$20 00

1/4 H. P., Self Contained, Self Cooling, complete, ready to run. Child can start it.

Will drive 200 watt dynamo, lathe, washing machine, or anything now turned by hand or foot power. Every one absolutely guaranteed.

Send stamp for circular.

ELGIN WHEEL & ENGINE CO., Elgin, Ill.



Magnificent Steel Launch \$96
Complete With Engine, Ready to Run



18-20-28 and 27 ft. boats at proportionate prices. All launches tested and fitted with Detroit two-cycle reversible engines with speed controlling lever—simplest engine made—starts without cranking—has only 3 moving parts—anyone can run it. The Safe Launch—absolutely non-sinkable—needs no bathhouse. All boats fitted with air-tight compartments—cannot sink, leak or rust. We are sole owners of the patents for the manufacture of rolled steel, lock-seamed steel boats. Orders filled the day they are received. Boats shipped to every part of the world. Free Catalog. Steel Rowboats, \$20. (83)

MICHIGAN STEEL BOAT CO., 1366 Jefferson Avenue, Detroit, Mich., U. S. A.

SPRINGS

Machine-made, coiled wire springs of all kinds and sizes to meet your requirements. Our method of manufacturing spring is absolutely correct and insures perfectly uniform size as well as tension.

Send us your specifications or requirements before purchasing, as we are sure our prices will be very pleasing, and at the same time a profitable saving. Very low prices for large quantities.

DON'T FORGET

C. E. DELLENBARGER CO., Electric Building, 617-631 W. Jackson Blvd., Chicago, Ill.

The Most Powerful 6 1/2" Nipper Made

Drop Forged Tool Steel—"Red Devil" Quality



One Sample Pair
75 Cents

No. 542, 6 1/2-inch.

HERE'S a diagonal side cutting nipper that should be in every telephone lineman's kit. It will cut anything in the wire line from the smallest to 3/0. For terminal work it has no equal. Your local dealer can supply you with it if you insist on "RED DEVIL" No. 542. If he can't, send us his name and 75 cents and one sample pair only will be sent you postpaid.

SMITH & HEMENWAY CO., 154 CHAMBERS ST., NEW YORK

Over 3,000 different kinds and sizes of tools bear the "RED DEVIL" trademark. Do you know them?

Hitch your Saw Frame to a Star Hack Saw Blade



and enjoy immunity from hack saw troubles

Star Blades Always make good.

Star blades with 14 teeth to the inch are suitable for every class of work except tubing less than 1/16". For this gauge, use Star Blade with 24 teeth to the inch. Our free book "Tool Practice" is worth while sending for.

Millers Falls Co., 28 Warren, St. New York City

LINEMEN'S and ELECTRICIAN'S TOOLS



Pliers, Splicing Clamps
Wire Grips
Pulley Blocks
Tool Belts
Tool Bags
Tool Kits

KLEIN'S MARK YOUR SECURITY

It brings testimonials like this:

I have been using your tools thirty years and I think they are good.

John A. Bothley, Chief Inspector
C. & M. V. Tel Co.
Carbondale, Ill.

MATHIAS KLEIN & SONS, Canal Station 3, Chicago, Ill.

SOLDER

DELICATE ELECTRICAL WORK

easily and reliably by using the modern combined solder and flux

"TINOL"

In wire or paste form. No special skill needed. The Tinol flux is non-corrosive, yet of highest cleansing power. Amateurs do work equal to experts. TINOL is largely used in Telephone and industrial work. Price of TINOL, Alcohol Torch and can of Tinol Paste, \$1.20. Illustrated folder free, showing many household and other uses of TINOL.

HESS & SON
Dept. M, 666 N. Broad St., Philadelphia, Pa.

Wonderful Sewing Awl



For mending harness, shoes, straps, canvas. Sews or mends anything; whole repair shop. Automatic natural tension reel, carrying waxed thread. Original perfect lock-stitch, diamond point grooved needle protects the thread, always ready.

\$1.00 only. Sample prepaid. Agents get busy. Bells on sight.

C.A. Myers Co., 6300-A Lexington Ave., Chicago, Ill.

LOOK!

IF YOU ARE IN THE MARKET FOR A **FORCE BLOWER** and the best is none too good. Get acquainted with the **GREY-HOUND** **\$25.00** Write us for pamphlets. **\$25.00**

THE ILLUMINATING SUPPLY COMPANY
2155 E. 9th St., Cleveland, Ohio

TOOL CASES

Every up-to-date mechanic should have a "Gerstner" Portable Tool Case to carry his tools and keep them orderly arranged. They are practical, neat, built right and they sell at the right prices. One of our many styles will please you—if not, we'll build a special to suit you. Write for further particulars.



Gerstner & Sons
Mfrs. of Mechanics' High Grade Tool Cases
800 Germantown Street. DAYTON, OHIO

Caille Perfection Motor

Simplest construction. Best material. Most economical—kerosene or gasoline.

\$48

1 1/2 HP—1 1/2 c—1 1/2 Hrs.
Write for Free Book and offer of 15 Days' Free Trial.

Caille Perfection Motor Co.
320 Second St.
Detroit, Mich.

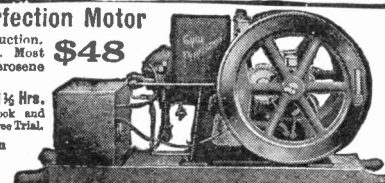

Complete Launch

With Engine Ready to Run **\$94.50**



16, 18, 20, 23, 27, 28 and 35 footers at proportionate prices. Including Family Launches, Speed Boats, Auto Boats and Hunting Cabin Cruisers. We are the world's largest Power Boat Manufacturers.

A NEW PROPOSITION TO DEMONSTRATING AGENTS

Sixty-four different models in all sizes ready to ship, equipped with the simplest motors made; start without cranking; only three moving parts; ten-year-old child can run them. Boats and engines fully guaranteed. 12,500 satisfied owners. Write today for large Free Illustrated Catalog.

DETROIT BOAT CO., 1155 Jefferson Ave., DETROIT, MICH.

Here's a new
"YANKEE" Spiral Ratchet Screw-driver
 (No. 130) that means easier, quicker and surer work.

"YANKEE" TOOLS
 Make Better Mechanics

A spring in the handle makes it the "Quick Return." All you have to do is push! The handle comes back of itself, ready for the next push. Great for working one-handed—the spring's pressure keeps the bit in place.

Ask Your Dealer for
"YANKEE" Quick Return Spiral Ratchet Screw-Driver
 No. 130 Price \$1.85

Supplied with three sizes of bits. Special attachments may be had for drilling and countersinking.

Get the "Yankee Tool Book" —sent FREE, on request.

NORTH BROS. MFG. CO., Philadelphia



REG. U. S. PAT. OFF.

P. S. & W.
 TRADE MARK
 GUARANTEED

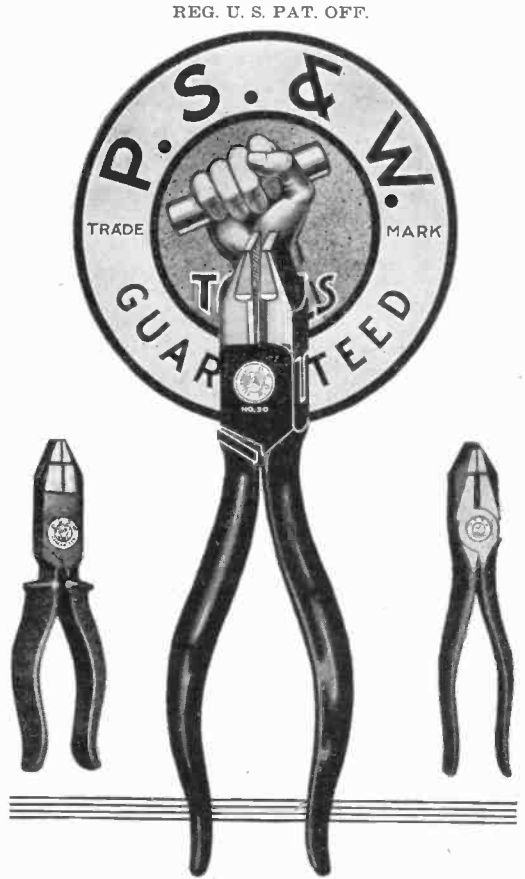

Box-Joint Pliers that made America the World's Leader in Plier Construction.

IN the P. S. & W. Box-Joint the great advantage is the fact that the jaws can't work loose—they must meet accurately as long as the pliers last.

This makes them the pliers par excellence for fine work—plus the good steel, careful forging and tempering, and fine finish guaranteed by The MARK of the MAKER.

Also a full line of highest-grade lap-joint pliers and splicing clamps

Write at once for our 170-page "Mechanics' Handy List." 35 pages of reference tables and useful information, and a complete catalog of over 200 tools for Electricians, Machinists, Tinsmiths and Carpenters sent free.

The Peck, Stow & Wilcox Company
MANUF'RS of the Largest Line of Mechanics' Hand Tools Offered by Any Maker
 Address Correspondence to 30 Murray St., N. Y. City
 Established 1819 Five Large Factories

Life Savers

MARBLE'S Safety Pocket Axes are large enough to fell a tree. Guard folds into 12 in. handle of steel or hickory. Weights, 16 to 27 oz. Guaranteed.

MARBLE'S WATERPROOF MATCHBOX is cheap life insurance to the man who is caught out in wet and cold weather. Size of a 10 gauge shell.

Free Catalog of Marble's Sixty Specialties and Game Getter Gun.

MARBLE ARMS & MFG. CO.
 579 Delta Avenue
 Gladstone, Mich.



RICHARDSON SLIDE RULE

Complete wire table. Gives diam., mils; area sq. in., and cir., mils. Res., and weight per 1000 feet.

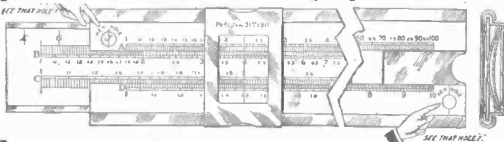

Electricians are frequently called upon to calculate the size of a motor to run a pump, change gears, and pulley problems, testing recording wattmeters, plotting curves, etc. The slide rule will do all this mechanically. The Richardson Direct Reading Slide Rule is especially adapted for those who wish to learn the use of this valuable instrument. It will multiply, divide, extract the square or cube roots of numbers, calculate interest and percentage. 5-inch rule in leather case \$2.50, 10-inch rule, \$2.50, including cardboard pocket case. Our new book "The Slide Rule Simplified" contains 70 full size illustrations of how to set rule, just off the press. Paper cover \$1.00, Cloth, \$1.50. Paper covered book free with either of above rules. **GEO. W. RICHARDSON, Late Artificer U. S. Navy 4214, 24th Place, Chicago**

Portable Stove COOKING AND HEATING

Right size. No flues nor chimneys. Light—pick it up, set anywhere. **COMBINED COOKING AND HEATING**. Quick meals, washing, ironing, canning fruit, camping. Summer and winter stove. Heats rooms, offices, stores, etc. Intense heat under control.



Not Dangerous Like Gasoline. No valves—no wicks. Nothing to get out of order. "The Radiator is a grand heater," Mrs. Kate Devlin, Pa. "Stove kept the rooms warm," John C. Hussey, N. Y. "Baked, cooked, washed, ironed; can do anything my range does," Mrs. M. E. King, Ky. "Only used half a gallon of oil last week for cooking, baking and ironing," E. N. Helwig, Ont. "Safe and clean as a lamp," Mrs. E. R. McClellan, Ill. **PORTABLE OIL GAS STOVE SAVES FUEL BILLS**, time, anxiety, expense. Get rid of kindling, wood, coal, dirt, ashes. Gives economy, genuine comfort and convenience. Simple, durable, lasts for years. Try it. Not sold in stores. Many thousands sent to families. Write for description.

AGENTS. "Was out one day, sold 11 stoves," B. L. Huested, Mich. "You have the best stove on the market; sold 9 in 2 hours," W. E. Beard, S. C. J. W. Hunter, Ala. secured 1—tested it—ordered 200 since. J. G. Gauthreaux, La., ordered 155 since.

THESE MEN MAKE MONEY—You have the same chance. Price low—\$3.25 up; any number of burners. Send no money. Write today, Agent's selling plan, etc. The World Mfg. Co., 1505 World Bldg., Cincinnati, O.

RANGER BICYCLES

Have imported roller chains, sprockets and pedals; New Departure Coaster-Brakes and Hubs; Puncture Proof Tires; highest grade equipment and many advanced features possessed by no other wheels. **Guaranteed 5 yrs.** **FACTORY PRICES**—Direct to you are less than others. Ask for cheap wheels. Other reliable models from \$12 up. A few good second-hand machines \$3 to \$8.



10 DAYS' FREE TRIAL—We ship on approval, freight prepaid, anywhere in U.S., without a cent in advance. **DO NOT BUY** a bicycle or a pair of tires from anyone at any price until you get our big new catalog and special prices and a marvelous new offer. A postal brings everything. Write it now. **TIRRS**, Coaster-Brake Rear Wheels, lamps, parts, sundries, half usual prices. **Rider Agents everywhere** are coining money selling our bicycles, tires and sundries. Write today. **MEAD CYCLE CO., Dept. C-109 CHICAGO**

"You and the Motorcycle"

is the title of the snappy little tale we have written for the man who loves the open country and the summer air. Just drop us a line and we'll send it **FREE**, together with our catalog illustrating the

EXCELSIOR AUTO-CYCLE

EXCELSIOR MOTOR, MFG. & SUPPLY COMPANY
Dept. E, 2214-2274 Union Street, Chicago

Guaranteed Non-Magnetic



This watch, a handsome stem wind and set, thin model, dust proof time piece, will positively withstand all magnetic attractions. Tested to 2000 Volts. Guaranteed accurate. Money back if not as represented. Approved by all electrical engineers. Price only \$5.00. Delivery FREE.

E. KIRCHBERG, Dept. A 132 NORTH STATE ST., CHICAGO.

WE SELL YOU AT WHOLESALE

Agents' Price One AMERICAN Motorcycle or Bicycle

\$139⁸⁵

\$18⁸⁵

Honest hand-made machines at factory cost. Write now for catalog. Say whether interested in Motorcycle or Bicycle.
AMERICAN MOTOR CYCLE CO., 116 American Bldg., CHICAGO

BUILD YOURSELF A BOAT

A RACING CAT OR SPEED LAUNCH
Send for Catalogue
Yacht and Boat Building Books
RUDDER PUBLISHING CO., 4 Hudson St., New York, N. Y.

150 KINDS IRON, WOOD, WIRE & STEEL PUZZLES

Sample with Catalog, 10 cents or 3 leaders for 25 cents.
WESTERN PUZZLE WORKS - E St. Paul, Minn.

CAMERA AND COMPLETE OUTFIT

25c Takes pictures 1 1/4 x 1 1/4 ins. a "little gem." Leatherette covered camera and complete outfit of plates, paper, chemicals, etc., together with full instructions so simple that a boy or girl can take photos of landscapes, buildings, etc. All mailed for only 25c, or 3 for 60c.

FUN MAKERS, Dept. 3, KEWANEE, ILL.

THE SAVAGE AUTOMATIC PISTOL

Special features embodied in this arm which will appeal to you:

Ten Shots—Double the number in an ordinary revolver and two more than other automatics.

Accuracy—The only automatic which locks at the breech, while the bullet traverses the barrel, insuring extreme accuracy, as well as freedom for fouling.

Simplicity—Fewer parts than other automatics. Completely dismounts by hand, without the aid of tools.

Safety—Breech automatically locked during time of discharge. Cannot be fired unless the trigger is pulled. Safety positively locks it against discharge.

Convenience—Length only 3 1/2 inches. Weighs but 19 ounces; full blued finish.

Coupon filled in with your name and address will bring you a beautifully illustrated gun catalog.

SAVAGE ARMS COMPANY
502 Savage Avenue, Utica, N. Y.

PATENTS AND PROFIT.

"A Talk to the Inventor"

FREE BOOK explains WHAT YOU SHOULD KNOW before applying for a Patent; WHAT TO INVENT; HOW TO SELL YOUR PATENT; WHAT NOT TO INVENT. Write for it today. Send sketch for advice.

H. L. WOODWARD, 726 9th ST., WASHINGTON, D. C.
BY PATENT OFFICE

PATENTS

THAT PROTECT AND PAY

Books, Advice, Search and List of Inventions Wanted} FREE

Send sketch or model for search. Highest References. Best Results. Promptness Assured.

WATSON E. COLEMAN, Patent Lawyer
622 F Street, N. W. Washington, D. C.

PATENTS

C. L. PARKER
Formerly Member Examining Corps, U. S. Patent Office.

PATENT LAWYERS
12 McGill Bldg., WASHINGTON, D. C.

PATENTS, TRADE MARKS, COPYRIGHTS, PATENT LITIGATION

Handbook for Inventors, "Protecting, Exploiting and Selling Inventions" sent free upon request.

COUPON

Savage Arms Co., Utica, N. Y.

Please send me, without cost, your gun catalog as advertised in Popular Electricity magazine.

Name

Address

For our Mutual Advantage mention Popular Electricity when writing to Advertisers.

PATENTS

TRADEMARKS AND COPYRIGHTS SECURED OR FEE RETURNED

Our New
\$150,000 Building
Opposite U.S. PATENT OFFICE
Washington, D.C.



Send model or sketch and description of your invention for free search of the U. S. Patent Office Record.

Our **FOUR BOOKS** mailed free to any address. Send for these books; the finest publications ever issued for free distribution.

HOW TO OBTAIN A PATENT. Our Illustrated 80 page Guide Book is an invaluable book of reference for inventor; and 100 mechanical movements illustrated and described.

FORTUNES IN PATENTS. Tells how to invent for profit and gives history of successful inventions.

WHAT TO INVENT. Contains a valuable list of inventions wanted and suggestions concerning profitable fields of invention. Also information regarding prizes offered for inventions, among which is a **Prize of One Million Dollars** offered for one invention and \$10,000 for others.

PATENTS THAT PAY. Contains letters from our clients who have built up profitable enterprises founded upon patents procured by us.

LIST OF PATENT BUYERS. Personal requests and letters from manufacturers and promoters for patents secured by us and suggestions of new ideas they wish to purchase.

We advertise our clients' inventions free in a list of Sunday newspapers with two million circulation and in the *World's Progress*. Sample copy free.

Electrical Cases a Specialty. We have secured many important electrical patents.

VICTOR J. EVANS & CO.

(Formerly Evans, Wilkins & Co.)

Victor Bldg., 724 9th St. N. W., WASHINGTON, D. C.

WANTED-IDEAS

Manufacturers are
constantly writing me for new ideas

PROTECTED BY OWEN PATENTS

FREE!

Send for the three finest patent books published and read their letters—see what they want! **"SUCCESSFUL PATENTS"**—tells how to proceed; **"STEPPING STONES"**—contains list of over 200 inventions wanted, the truth about prizes, etc.; **"PATENT PROMOTION"**—tells how to promote and sell your rights, chief causes of failure, etc. A simple request will bring you all three books absolutely free.

Personal Services. I help my clients sell their patents or dispose of their applications. Advice Free. No obligation incurred by writing me. Manufacturing facilities. I get you strong protection or receive no compensation.

VERY HIGHEST REFERENCES

Columbia National Bank, Washington, D. C.	Whitehead Hosiery Mills, Burlington, N. C.
American Loktile Co., Alexandria, Va.	Dickinson Mfg. Co., Des Moines, Iowa.
National Metal Tile Co., Washington, D. C.	The Fancher Drug Co., Bridgeport, Ill.
National Supply Co. Berlin, N. H.	The Starrett Mfg. Co., Shelbina, Mo.
Louden Machinery Co. Fairfield, Iowa.	The C. J. Loftus Co. Youngstown, O.
Antholene Mfg. Co. Hutchinson, Kans.	Lightening Gun and Cycle Works, Okla. City, Okla.

And an immense number of others whose letters are printed in my booklets.

RICHARD B. OWEN, 6 OWEN BUILDING, WASHINGTON, D. C.

Inventors submitting their invention to me are protected in a tangible manner until their applications are filed.

SPECIAL!

Send me a sketch or model of your invention and I will make a search of the U. S. Patent Office Records **FREE OF CHARGE** and report to you concerning patentability, practicability, etc.

“Forty years at hard labor”

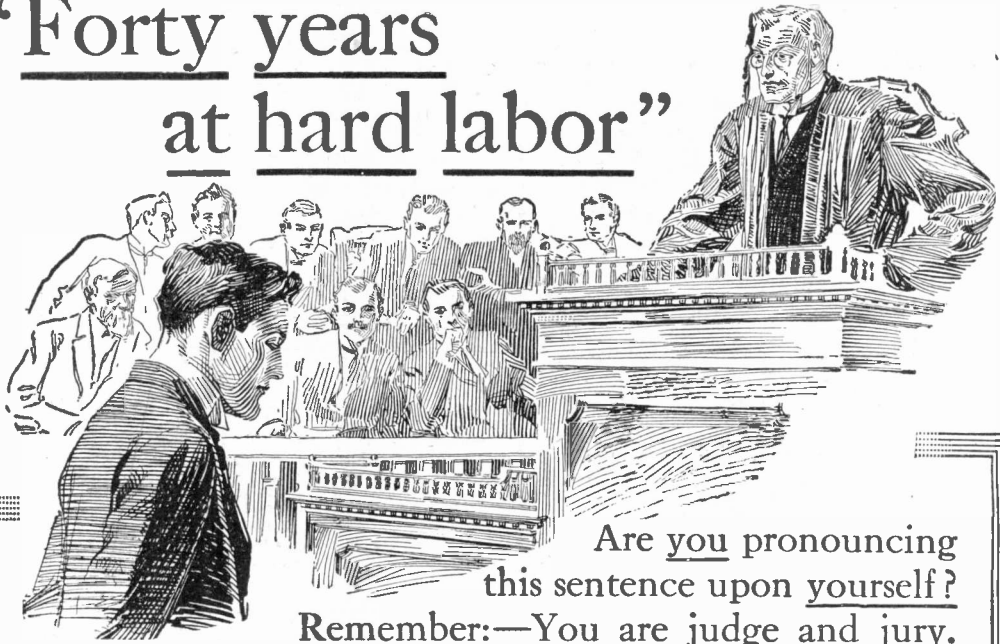

Are you pronouncing this sentence upon yourself? Remember:—You are judge and jury.

THE man who cheats himself out of his own opportunities is committing a crime, and the penalty is as sure as it is for breaking the law. Usually the penalty is more severe, for the young man who neglects his opportunities in youth will suffer the consequences all his life.

“Forty years at hard labor”—not inside prison walls, to be sure, but free to go and come only as the *requirements of your job and the necessity of holding it permit*—not so different from the rules and regulations of prison life after all.

“Forty years at hard labor.” And why? Because *you* failed to equip *yourself* mentally for something better—because you deliberately chose to be a *wage-laborer* with your hands and muscle instead of a well-paid, capable *brain-worker*—a trained man, competent to fill a good position.

“Forty years at hard labor.” Do you realize what it means? A mediocre existence through youth and maturity on a small, unsatisfactory salary—without hope of advancement or betterment—then an old age of poverty, dependence, and futile regrets. Does this sound attractive?

“Forty years at hard labor.” If *you* have passed that sentence upon *yourself*, take an appeal before it's too late. You can't do it too quickly. Make up your mind today—now—to become a *trained worker*. You will be surprised to find out how little *money, time, and effort* it will take.

Thousands of other young men with no more brains or natural ability than you have are doing this very thing *cheerfully, conscientiously, and successfully*—earning while they learn. Why can't *you*? Just stop and think about it a moment—seriously. Then check, fill in, and mail the coupon. That's all until we do our part.

The American School is one of the largest educational institutions in the world. Its reputation is founded upon fifteen years of successful teaching by mail, and thousands of graduates who are now earning more because they learned more. “Forty years at hard labor” did not appeal to them; they signed the coupon. Will you? The American School does not employ agents or collectors, so you will not be bothered in your home or at your work.

American School of Correspondence
Chicago, U. S. A.

Opportunity Coupon

American School of Correspondence, Chicago, U. S. A.

Please send me your Bulletin and advise me how I can qualify for the position marked “X.” Pop. Elec. 6-12

- | | |
|---------------------------------|---------------------------|
| Automobile Operator | Lawyer |
| Draftsman | Fire Ins. Engineer |
| Architect | Telephone Expert |
| Building Contractor | Moving Picture Op'r |
| Structural Engineer | Bookkeeper |
| Civil Engineer | Stenographer |
| Electrical Engineer | Accountant |
| Elec. Light & Power Supt. | Cost Accountant |
| Master Mechanic | Cert'd Public Acc't |
| Sanitary Engineer | Auditor |
| Steam Engineer | Business Manager |
| Reclamation Engineer | College Preparatory |

NAME.....

ADDRESS.....

OCCUPATION.....

For our Mutual Advantage mention Popular Electricity when writing to Advertisers.

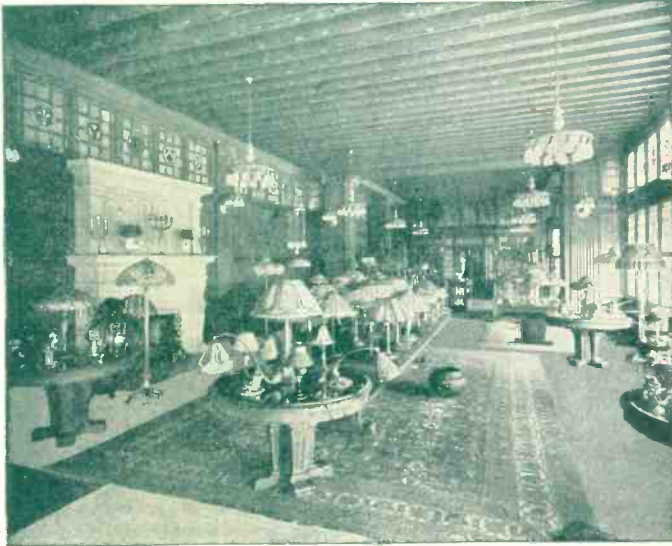

America's Finest Show Room of Things Electrical

Electric Shop, in Chicago, is the most elaborate electrical show room in the country. Here you will find the most complete line of electrical appliances for every possible purpose. Although magnificently furnished and equipped, and located in Chicago's most exclusive shopping district, Electric Shop is not exclusive in regard to price. Electrical articles of the highest quality can be had here at prices generally lower than elsewhere. Visitors are always welcome without obligation to purchase. A trip to Chicago is not complete unless you see Electric Shop.

Electrical Appliances for Every Purpose

Among the things electrical displayed are appliances for nearly every necessity of light, heat and power in the home. The following are some of the articles on sale, all operated by electricity:

Lamps for every use

Tea Kettles

Fans

Cigar Lighters

Heating Pads

Dining Room Domes

Chafing Dishes

Coffee Percolators

Toasters

Stoves

Water Heaters

Grills

Curling Irons

Flat Irons

Washing Machines

Foot Warmers

Luminous Radiators

Vacuum Cleaners

Out-of-town Patronage Solicited

Complete information will be furnished in answer to any inquiry concerning any sort of electrical appliance or equipment. Catalogues, booklets, etc., sent free on request. You will find it highly satisfactory to order your electrical appliances by mail from Electric Shop. Every courtesy and attention is given.

ELECTRIC SHOP - CHICAGO
MICHIGAN AND JACKSON BOULEVARD

Art Glass Electric Fixtures

Some beautiful, artistic designs in Art Glass Fixtures at inexpensive prices are shown below. They make home charming and more attractive; also suitable for public buildings, clubs, cafes and display windows. Made of metal in verde antique finish and fitted with green or amber art glass. these fixtures give the effect of leaded glass at a much lower cost.

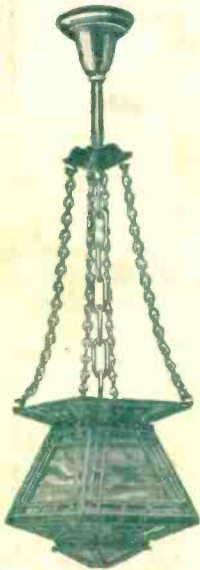

No. 1209

Prices do not include lamps or insulating joints.

No. 1209
This is an attractive, distinctive fixture, appropriate for a hall lamp or for ornamental purposes; hexagonal shade in leaded glass effect. Shade is 12 inches wide by 14 inches high; length of fixture, 36 inches. Wired complete, Each, \$22.85.

No. 1200
This handsome dining-room shade is full of elegance and exclusiveness. Throws a subdued, cheerful light. Supported by one heavy chain with four ornamental chains. Shade is 19 inches square; length of fixture over all, 36 inches. Each, \$31.40.

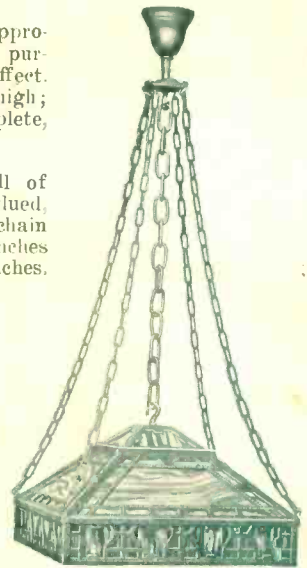

No. 1200

Green glass furnished unless otherwise specified.



No. 1205

Here is an unusual design in a table lamp; has hexagonal pedestal with ornamental feet and 16 inch hexagonal shade, 27 inch high. Each, \$33.60.



No. 1201

No. 1201
An ornamental wall bracket in inverted style is here shown. Shade is 5½ in. square, has closed top; 4 in. square wall canopy. Each, \$10.50.

No. 1202
This is another beautiful style in an inverted wall bracket. Has hexagonal shade 5 inches in diameter and 9 inches high, with closed top. Each, \$11.00.



No. 1202

Ask for Pocket Catalogue, No. M1450, of Fixtures and General Supplies
Liberal Discounts to Dealers. All Prices F. O. B. Chicago

FEDERAL SIGN SYSTEM (ELECTRIC)
Home Insurance Building, Chicago