

ICD08635

POPULAR COMMUNICATIONS

JUNE 1997

Pirate Radio

Tune in the Bad Boys

**See Broadcast
DXing Column (pg.68)
for the latest Expanded
AM Band Station List**

- Making Skywave Skip Work for You!
- Product Spotlight: Alpha Delta Variable Response Console
- CB Channel 9: Is Anyone Listening?

U.S. \$3.50 CAN/INTL \$4.00



*****3-DIGIT 641
02 00360028 FEB93 1706N AVZ

MR. DAVID C STEARNS
109 W 98 TER
KANSAS CITY MO 64114-4122

**...e New Probe 3.0, Product Parade,
...omputers, The Loose Connection,
...H MORE!**

Look to AOR for the BEST in Radio Equipment!

AR5000 Cyberscan

10kHz - 2600MHz*

The Professional Scanner

AOR has advanced the frontiers of performance providing strong signal handling, high sensitivity and the widest coverage on the market. Advanced wide band front end design provides high sensitivity with auto tuning pre-selector from 500kHz to 1000MHz, plus manual override to read signal and store setting in memory. Every function of the AR5000 is micro processor controlled and receives instructions direct through the front panel or via RS232. I.F. filtering is unique. Filter selection controls 2 banks of filters, one of 10.7 MHz the other at 455kHz. This cascade filtering effect produces excellent shape factors and ultimate out of band signal rejection. There are 6 filter bandwidth provided 3,6,15,30,110, 220kHz with a seventh position for optional 500Hz cw filter in the 455 kHz IF. There are 1000 memory channels in 20 banks plus 20 search banks and an of 2100 pass frequencies.



AR3000A

100kHz-2036MHz*

The Most Respected Scanner on the Market!

Compact, low cost wide band multi-mode reception. Small size has allowed the AR3000A to be used in many applications from battery powered brief case to multi-receiver rack-mounted installation to air born EWA systems. The AR3000A has proved itself as an easy to operate, rugged, low-cost and reliable contender for many requirements.

- Coverage: 100kHz-2036MHz*
- Memory: 400 CH 4 banks
- Sensitivity: NFM 2.5-1.800MHz .35NV
- Selectivity: 2.4, 12, 180 KHz
- Power: 13.8VDC<.5A AC Adapter included
- Size: 5.4 x 3.15 x 7.9", 2.4 lbs
- Modes: FM, FMW, AM, LSB, VSB, CW
- Scan Speed: up to 50 CH/Sec.
- Antenna: BNC 50 Ω



AR3030G

30kHz - 30MHz

Enhanced Coverage Receiver

A favorite of commercial and industrial applications. Same great features as the AR3030, but with these added features to further enhance your operation or special requirements.

FEATURES: The AR3030G boasts a wide frequency coverage from 30kHz to 30MHz and all mode reception "as standard": AM, S,AM (synchronous), NFM, USB, LSB, CW & FAX. There are 100 memory channels which allows data to retain frequency, mode, bandwidth, AGC, attenuator and tone etc. There are rear panel connections for low level audio output and tape recorder remote switching. I.F., output and AGC is also available through a rear panel connector. Computer control is possible through the RS232 rear panel port.



AR8000 - Still the Best!

500kHz - 1900MHz*

AOR made every effort to incorporate the latest technology into this scanner:

The Ultimate Handheld Receiver! "Welcome to the world of the AR8000"! It incorporates the latest PLL technology and offers a multitude of features including true carrier re-insertion SSB (CW) demodulation with 50Hz frequency steps. 4 level alpha numeric LCD indicates the frequency, signal strength, band scope and more.. Selectable squelch system, auto-mode, auto-band plan, serial communication port are all standard. Internal ferrite antenna offers high performance reception below 2MHz. When frequencies are entered, ALPHANUMERIC comments may be stored along with the frequency, mode & attenuator status simplifying the job or recalling and identifying memory channels.



- Frequency: 1 - 1900MHz*
- Modes: AM/NFM/WFM/USB/LSB/CW
- Stepsize: 50MHz to 999.995kHz
- Memories: 50ch x 20 banks=1000 total
- Size/Wt.: 6.1" x 2.6" x 1.5"/12.2oz. w/ NiCad

distributed by:

Electronic Distributors Corp.
Vienna, VA.

...See us at DAYTON!
Booth #'s 575 - 579!



AOR, LTD. 2-6-4 Misuji, Taito-Ku,
Tokyo 111 Japan (c) 1995 AOR, LTD.
Licensed under US. Pat. 4,270,217

CIRCLE 115 ON READER SERVICE CARD

* Cellular blocked; Unlocked OK to FCC approved users.



U.S. #1 RADIO OUTLET

OUR 25th YEAR!!!

JUNE '97



SCANNER SALE

AOR		
AR8000 ¹	BearCat	587.95
BC120XLT		139.95
SC150Y/B		169.95
BC230XLT		239.95
BC235XLT		289.95
BC3000XLT		369.95
BC9000XLT		379.95
BC890XLT		229.95
BCT12	800MHz NEW!	189.95
ICOM		
R10 ¹	NEW!	499.90

SHORTWAVE SALE

GRUNDIG		
YB400		179.95
YB305		129.95
Traveller II Digital		79.95
SANGEAN		
ATS 606P		169.95
ATS 808		139.95
ATS818		149.95
ATS909		249.95
SONY		
ICFSW40		149.95
ICFSW100S		359.95
ICFSW600		59.95
ICF2010		355.95
ICFSW7600G		179.95
AOR		
AR3030G		849.95
AR7030		1099
LOWE		
SRX100		259.95
HF150		499.94
HF250		1149
DRAKE		
SW1		279.95
SW2		499.95
SW8		689.95
R8A		1079

CB RADIO SALE

COBRA*		
HH70		96.95
2010GTL		339.95
CHEROKEE*		
AH27		119.95
CM5		99.95
AH100	NEW!	249.95
CBS1000	NEW!	279.95
MIDLAND*		
79-290		249.95
75-810		119.95
75-784		69.95

*Only partial listing...
CALL for other models and all accessories are discounted.

1. Cell blocked, no blocks OK for FCC qualified users

DAVIS WEATHER WIZARD II SUMMER SALE

The Weather Wizard II offers sophisticated, professional quality at a surprisingly affordable price. It monitors and stores data about the most essential weather conditions:

- Inside & outside temp (Hi/Lo)
- Wind speed (Hi/Lo)
- Wind chill (Lo)
- Wind Direction
- Wind speed
- Alarms for temperature, wind speed, wind chill, and time



DAVIS

#7425 **NOW \$159.95**

SALE ENDS 28 JUNE '97
JUNE '97 SALE

Yaesu FT50RD/41B Hottest Ham HT!



- up to 5 W
- Dual Band,
- Exceptional Wideband receive capability
- Airband & 800MHz¹
- Built in CTCSS & DCS Enc/Dec & Digital Voice Recorder.

Accessories:
EDC5B - Cig Lite Plug
RH1 - Rubber Holster
MH34B4B - Spkr. Mic
4 modes to choose from...Call for Special Price \$100

SAVE OVER \$100

JUNE '97 SALE

BAYGEN FREEPLAY RADIO Take Anywhere Radio!

The Baygen free play radio...battery FREE for life! The world's first clockwork radio. 60 turns of the crank provides approximately 40 minutes of playing time. AM/FM/SW (5.8 - 18MHz), large 3.5" speaker, power handcrank or AC adaptor (incl.), 13.5" x 8" x 5", weighs 6.75lbs.



SALE \$99.95

GE SUPERADIO II



Puts the fun back in the AM/FM DX'ing. Larger ferrite rod antenna, 6.5" woofer, 2" tweeter, 4 I.F. stages and wide/narrow filters for superior reception. Separate controls for bass and Treble. Uses 120VAC or 6 "D" cells (not included). Everyone needs this great sounding radio.

7-2887 **SALE \$59.95**

AOR AR5000

NOTHING LIKE IT IN IT'S CLASS

- 10kHz - 2600MHz*
- Superior Sensitivity
- Cascade I.F. filtering
- 6 Filter B.W. +1 Opt.
- Memory 1000 + 2100 pass ch.
- Built-in decoder DTMF
- Option CTCSS and Voice Inversion
- 2 Ant. ports, Opt. to 8 ports
- Scan/Search 25 & 45 ch/sec.
- RS232C of all functions
- Priced under \$2000. CALL!

Best Tested

* Cell BLOCKED. UNBLOCKED models OK for FCC approved users.



Call for FREE 4 page detailed flyer w/ R8500 comparison

NEW FAMILY RADIO

It's all in the family!

- NEW Family Radio Service (FRS).
- LICENSE FREE
- Push & Talk up to 2 miles.
- Crisp clear audio.
- No monthly fee!

Small walkie-talkies as low as \$109.95

MAXON FRS114	CALL
MIDLAND 75-510	\$149.95
MOTOROLA Sport7*	\$119.95
MOTOROLA Sport7X*	\$139.95

Buy 2 or more and save!

*Available in black, camo, green & blue



ICOM R8500

ICOM's Latest WideBand Receiver

- 100kHz - 2000MHz*
- Improved Audio
- 4 I.F. Filters
- 900 Memories
- CI-V Computer control

EEB Modification

- 30kHz - I.F. Filter
- MUX - Wideband Output
- AGC On/Off



* Cell BLOCKED. UNBLOCKED models OK for FCC approved users.

Priced under \$2000



323 Mill St.
Vienna, VA.
22180
FAX: 703 938 6911

Orders: 800 368 3270
INFO/Metro: 703 938 3350
WWW: www.access.digex.net/eeb
E-mail: eeb@access.digex.net

- Prices subject to change
- Prices do not include freight
- Returns subject up to 20% restock fee
- FREE 1997 Catalog, 3rd Class, U.S.



POPULAR COMMUNICATIONS

JUNE 1997

VOLUME 15, NUMBER 10



page 8

ON THE COVER: A rare look at the inside of a pirate radio station. This particular station is located in Belfast, New York. To get more information on tuning in those elusive pirate stations, take a look at Pat Murphy's feature "Murphy's Law of Pirate Listening" on page 12. (Photo by Larry Mulvehill)

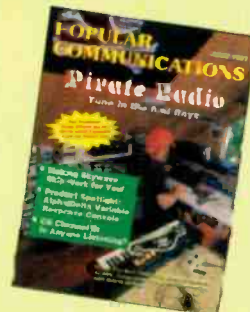

FEATURES

Making Skywave Skip Work for YOU!

8

When June 15 hits, stand by for incredible skywaves. See how far away you can pick up a station's location. Stand by for some exciting skywave Sporadic-E communications!

By Gordon West

Murphy's Law of Pirate Listening

12

Tuning in the "Bad Boys" of the bands requires a lot of patience and a few handy tips from someone who knows where to find 'em. Pat Murphy teaches you what it takes to catch a pirate.

By Pat Murphy

It Was America's Southernmost Broadcaster

16

WQAM—On the Move. Alice takes you on a trip through the history books of Miami radio station WQAM. Find out how they've changed through the years.

By Alice Brannigan

Product Spotlight

48

Alpha Delta's new VRC Variable Response Console fills a much-needed void in the communications speaker market. Get the scoop on this new product and see if it's for you.

By Ryan Gant

COLUMNS

The Radio Connection	20
Radio Resources	24
The Computer Corner	30
CB Scene	36
World Band Tuning Tips	40
Product Parade (Now Including "Books You'll Like")	42
Scanning The Globe	44
Clandestine Communiqué	46
Communications Confidential	50
The Listening Post	63
Broadcast DXing	68
The Pirate's Den	73
The ACARS Downlink	74
The Loose Connection	80

DEPARTMENTS

Tuning In	4
Pop'Comm P.O.	6
How I Got Started	34
Reader's Market	78



page 36

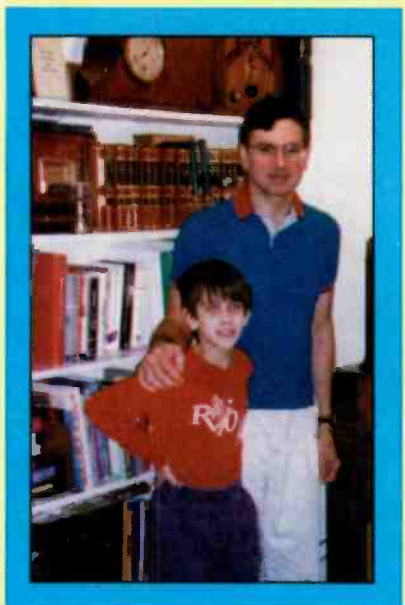

page 20

QUALITY COMMUNICATIONS EQUIPMENT SINCE 1942



Shortwave Receivers Past & Present is your guide to over 500 communications receivers made from 1945-1996. This huge 350 page Second Edition includes 80 chapters representing: Collins, Cubic, Dansk, Drake, Eddystone, Galaxy, Gonset, Hallicrafters, Hammarlund, Heathkit, Icom, JRC, Kenwood, Knight, Lowe, Mackay, McKay Dymek, Morrow, National, Plessey, Racal, RME, Rohde & Schwarz, Sony, Squires-Sanders, Ten-Tec, Vigilant, W-J, Yaesu and many more. Entry information includes: receiver type, date sold, photograph, size & weight, features, reviews, specifications, new & used values, variants, value rating and availability. Become an instant receiver expert! #0002 \$19.95 (+\$2)

RTTY AND FAX DECODERS

◆ Universal M-8000v7 Decoder

Designed primarily for the military or commercial user, the M-8000 can be used



by the hobbyist who requires professional capability. The color VGA output includes a spectral display & simulated tuning scope. Modes include: CW, Baudot, FAX, SITOR, ARQ-M2/4, ARQ-E/E3, ARQ6-90, ARQ-S, SWED-ARQ, FEC-A, FEC-S, POL-ARQ, GMDSS, ASCII, Packet, Factor, Piccolo, VFT, ACARS, POCSAG & GOLAY. Monitor & printer optional. #0087 \$1399.00 (+\$11)

◆ Universal M-450 Reader



The self-contained Universal M-450 reader decodes: Baudot, SITOR A & B, FEC-A, ASCII, SWED-ARQ, Weather FAX (to the printer port), ACARS aviation teletype, plus GOLAY and POCSAG (512/1200/2400) digital pager modes. Even off-the-air decoding of DTMF, CTCSS and DCS. Big two-line, 20 character LCD and bi-dir. parallel printer port. The M-450 runs from 12 VDC or with the supplied AC adapter. No computer or monitor is required. Now with serial port. #0450 \$399.95 (+\$8)

SPECIALTY



The **BayGen Freeplay** radio combines the ingenious Baylis generator with the latest in radio technology. Winding the crank handle for only 20 seconds provides 30 minutes of listening. Here is assured radio performance, day or night without the worry (and expense!) of batteries. Great for emergencies. The analog dial covers AM, FM and shortwave from 3000 to 12000 kHz. Made in South Africa. #3123 \$99.95 (+\$5)

HUGE FREE CATALOG

The 1997 **Universal Communications Catalog** covers everything for the shortwave, amateur and scanner enthusiasts. This informative 100 page catalog is **FREE** by bookrate or \$2 by First Class mail. Rising postage costs prevent us from sending this catalog out automatically so please **request your free copy today!**



Universal Radio, Inc.
6830 Americana Pkwy.
Reynoldsburg, Ohio
43068-4113 U.S.A.

☎ 800 431-3939 Orders & Prices
☎ 614 866-4267 Information
➔ 614 866-2339 FAX Line
✉ dx@universal-radio.com

**universal
radio inc.**

COMMUNICATIONS RECEIVERS

YAESU

KENWOOD

JRC

DRAKE



ICOM



Universal Radio carries an excellent selection of new and used communications receivers. The new **Japan Radio NRD-345** is shown above. Under \$1000.

The new American made **Drake SW-2** features SSB, Sync. Det., 100 mems., keypad and optional remote (shown).



COMMERCIAL RECEIVERS



The **Watkins-Johnson HF-1000** is the ultimate receiver! Advanced D.S.P. technology, 58 bandwidths, 1 Hz display. Under \$4000. Please contact us to receive a spec. sheet.

PORTABLE RECEIVERS

SANGEAN

SONY
ICOM

GRUNDIG



Universal offers over 40 portable receivers from \$50 to over \$500. Our free catalog fully describes & prices all models. The new deluxe **Sangean ATS-909** shown above is on sale for \$249.95 (+\$8). This includes the AC adapter and ANT-60.

COMMUNICATIONS BOOKS

- **Passport To Worldband Radio 1997** By L. Magne
Graphic presentation of all shortwave broadcast stations. Equipment reviews, too. #1000 \$19.95 (+\$2)
- **World Radio TV Handbook 1997**
All shortwave broadcast stations organized by country with schedules, addresses, power, etc. #2000 \$24.95 (+\$2)
- **Worldwide Aeronautical Frequency Dir.** By R. Evans
The definitive guide to commercial and military, HF and VHF-UHF aeronautical communications including ACARS. Huge Second Edition 260 p. #0042 \$19.95 (+\$2)
- **Guide to Utility Stations** By J. Klingenfuss
Clearly the best guide to non-broadcast HF stations. With 13,800 current frequencies. 585 p. #2019 \$39.95 (+\$2)
- **Discover DXing!** By J. Zondlo
An introduction to DXing AM, FM & TV. #0009 \$4.95 (+\$2)
- **Understanding ACARS** By E. Flynn
Learn the ACARS aviation format. #0012 \$9.95 (+\$2)

☛ Be sure to include \$2 per title for shipping.

VISIT UNIVERSAL RADIO ON THE INTERNET
<http://www.universal-radio.com>

- Visa
- MasterCard
- Discover
- Prices and specs. are subject to change.
- Returns subject to a 15% restocking fee.
- Used equipment list available on request.

Tuning In

AN EDITORIAL

BY HAROLD ORT, N2RLL, SSB-596

Internet Droppings

No doubt about it, computers and the internet are very powerful tools—when used properly by responsible, *thinking* people. Type in a “keyword” and the legwork is done for you. Using these search engines, as they’re called, you can find people, phone numbers, your long-lost Uncle Marty and research all kinds of things, many of which you could probably find at the county library, but the internet is faster and certainly more fun. After all, what could be better than having your own personal 24-hour-a-day research guru at your beckon call?

And what could be more fun than all those live online chat rooms? Probably our radio hobby, but that’s a topic we’ll save for another time. Then there’s the unending supply of newsgroups. You pick the topic from astronomy to zoology, and you’ll find a newsgroup where you can browse, read, and respond with your own two cents worth of wisdom to your topic of choice.

The other day I decided to see if the AOL folks had figured out how to deal with all those new customers overloading their system. After several tries—yawn—at connecting, I went to a couple of the radio related newsgroups.

Now if you’re the least bit squeamish or don’t like pre-adolescent bickering, I don’t recommend this adventure into cyberspace. Heaven help you if you’re a manufacturer, publisher or running any radio hobby business. You had better have the best darned radio, antenna or book ever built or printed, and be battle-hardened! Now I’m all for constructive criticism, but all too many of those indiscriminate postings and personal vendettas make me wonder what some of the folks making those “internet droppings” do for fun. Think about it for a moment. In five minutes a newcomer to the hobby can get the lowdown on everything radio; the companies are rip-off artists, the radios don’t work as advertised, the frequency books are outdated and inaccurate, hams are a bunch of losers, CBers with old 23-channel rigs from Topeka are going to take over the Pentagon, the radio

hobby is dead, and Alice Brannigan is really Hillary Clinton!

And some of the personal attacks on our fellow hobbyists would make Saddam Hussein cringe. Back and forth go the barbs like bullets on a battlefield! Now I’m not saying that there isn’t any good radio stuff on the newsgroups. There are lots of good, well-intentioned folks helping each other with a multitude of non-libelous, humane postings; frequencies, tips, tricks-of-the-trade and a fair exchange of ideas and opinions, but what *should* be disturbing to all of us is the other 50 percent that do nothing for the radio hobby except destroy it, posting by posting, until there’s nothing left except a few cranky, angry, overly-opinionated souls who seemingly delight in spitting into their own soup. Pity the newcomer checking out the hobby if we don’t change our attitudes—and the postings.

“... computers and the internet are very powerful tools—when used properly by responsible, thinking people.”

By the way, has anyone heard when the next Greyhound bus leaves Topeka for D.C.? I’ll only go if I can borrow someone’s laptop and get a photo of Hillary using an old Mark Sidewinder!

Welcome to Former U.S. Scanner News Subscribers

It’s good to see some new faces in the *PopComm* monitoring post! A hearty welcome to all of you who had time remaining on your subscriptions to this fine, but now defunct publication. If you have a question about your subscription, call our Subscriber Service Department at 516-681-2922 Monday through Friday between 9 a.m. and 5 p.m. ET; or you can fax us 24-hours-a-day at 516-681-2926.

We look forward to hearing from you with your comments and ideas about *your* magazine. Welcome aboard! ■

POPULAR COMMUNICATIONS

EDITORIAL STAFF

Harold Ort, N2RLL, SSB-596, Editor
(Internet e-mail: PopularCom@aol.com)
Tom Kneitel, K2AES/KNY2AB, Senior Editor
Nancy Barry, SSB-931, Associate Editor
(Internet e-mail: NancyPCmag@aol.com)
Richard S. Moseson, W2VU, Online Coordinator

CONTRIBUTING EDITORS

Richard “RD” Baker, Utility Communications
Ed Barnat, TCA-44, CB SSB
Peter J. Bertini, K1ZJH, Restoration/Electronics
Joe Carr, K4IPV, Antennas
Gerry L. Dexter, Shortwave Broadcast
Jock Elliott, SSB-734, Citizens Band
Bob Evans, ACARS
Ed Griffin, Computer-Aided Radio
Chuck Gysi, N2DUP, Scanning
Don Johnson, International Shortwave
Kirk Kleinschmidt, NT0Z, Amateur Radio
Tim Kridel, AM/FM Broadcasts
Chuck Mankin, Scanning
Bill Mauldin, WG4R, Radio Resources
Pat Murphy, Pirate Radio
Don Patrick, CB Restoration
Bill Price, N3AVY, Humor/Communications
Edward Teach, Pirate and Alternative Radio
Bonnie Zygmunt, Computer-Aided Radio

BUSINESS STAFF

Richard A. Ross, K2MGA, Publisher
Donald R. Allen, W9CW, Advertising Mgr.
Emily Kreutz, Sales Assistant
Frank V. Fuzia, Controller
Catherine Ross, Circulation Manager
Melissa Nitschke, Operations Manager
Jean Sawchuk, Data Processing
Denise Pyne, Customer Service

PRODUCTION STAFF

Elizabeth Ryan, Art Director
Barbara McGowan, Associate Art Director
Edmond Pesonen, Electronic Comp. Mgr.
Dorothy Kehrwieler, Production Manager
Emily Kreutz, Assistant Production Manager
Pat Le Blanc, Phototypographer
Hal Keith, Technical Illustrator
Larry Mulvehill, WB2ZPI, Photographer

A publication of



CQ Communications, Inc.
76 North Broadway
Hicksville, NY 11801-2953 USA

Offices: 76 North Broadway, Hicksville, NY 11801. Telephone (516) 681-2922. FAX (516) 681-2926. Popular Communications (ISSN-073-3315) is published monthly by CQ Communications, Inc. Periodical class postage paid at Hicksville, NY and additional offices. Subscription prices (payable in U.S. dollars): Domestic—one year \$22.95, two years \$41.00, three years \$60.00. Canada/Mexico—one year \$32.95, two years \$61.00, three years \$90.00. Foreign Air Post—one year \$40.95, two years \$77.00, three years \$114.00.

U.S. Government Agencies: Subscriptions to Popular Communications are available to agencies of the United States government, including military services, only on a cash with order basis. Requests for quotations, bids, contracts, etc. will be refused and will not be returned or processed.

Entire contents copyright © 1997 by CQ Communications, Inc. Popular Communications assumes no responsibility for unsolicited manuscripts, photographs, or drawings. Allow six weeks for change of address or delivery of first issue.

Printed in the United States of America.
Postmaster: Please send change of address to Popular Communications, 76 North Broadway, Hicksville, NY 11801.

the Best for Test

\$319. Save \$30

Take advantage of OPTOELECTRONICS' frequency counter SALEBRATION!!!

Antennas shown are optional accessories



Whether you are testing, calibrating, or aligning you need a good quality frequency counter. Optoelectronics the leader in frequency counters continues in its tradition of engineering the **highest quality test equipment**. Whatever your application may be, **OPTOELECTRONICS has a counter for you**. If you want the **BEST IN TEST**, look no further than **OPTOELECTRONICS**.

3000A+ MULTI-FUNCTION COUNTER

- 10Hz-3GHz frequency range
- 10 digit LCD display w/ bargraph and EL backlight
- Measures Period, Ratio, and Time Interval
- Built-in RS232 interface
- Patented Digital Filter and Auto Capture
- Fast 250 million counts per second
- +/- 1ppm accuracy w/ .2ppm option
- Dual high impedance amplifiers for ratio and time interval counting
- 5-6 hour battery life
- Built-in NiCads w/ charger
- Dual 50 Ohm and 1 Meg Ohm inputs



CUB MINI COUNTER

- 1MHz-2.8GHz frequency range
- 9 digit LCD display
- 8 selectable gate times
- High speed .0001 second gate
- Patented Digital Filter eliminates false counts
- Patented Auto Capture locks frequency display until cleared
- Direct and Pre-scaled ranges
- 50 Ohm input impedance
- 1ppm timebase
- 10 hour discharge time
- Built-in NiCads and charger included



M1 MICRO COUNTER

- 10Hz-2.8GHz frequency range
- 10 digit LCD display w/ bargraph and backlight
- Patented Digital Auto Filter and Auto Capture
- Digital Communications port for datalogging using optional OptoLinx and OptoLog software
- High speed 250MHz direct count with 1Hz per second resolution
- 1ppm timebase
- 1 meg Ohm and 50 Ohm inputs (switchable)
- NiCad batteries and charger included

SEE US AT DAYTON BOOTHS 70, 76, & 77



- 10Hz-3GHz frequency range
- 10 digit LCD display w/ bargraph and EL backlight
- Measures Period, Ratio, and Time Interval
- Built-in RS232 interface
- Patented Digital Filter and Auto Capture
- Fast 250 million counts per second
- +/- .05ppm ovenized timebase
- Internal clock output/External clock input
- Built-in low pass filter
- Built-in rapid-charge NiCads

FACTORY DIRECT ORDER LINE: 800-327-5912

OPTOELECTRONICS®

CIRCLE 151 ON READER SERVICE CARD

5821 NE 14th Avenue • Ft. Lauderdale, FL • 33334

Visa, Mastercard, C.O.D. • Prices and Specifications are subject to change without notice or obligation

Telephone (954) 771-2050 Fax (954) 771-2052

MADE IN THE U.S.A.

WWW.
optoelectronics.
com

Pop'Comm P.O.



LETTERS TO THE EDITOR

Each month we select representative reader letters for our Pop'Comm P.O. column. We reserve the right to condense lengthy letters for space reasons and to edit to conform to style. All letters submitted must be signed and show a return mailing address or valid e-mail address. Upon request, we will withhold a sender's name if the letter is used in Pop'Comm P.O. Address letters to: Harold Ort, N2RLL, SSB-596, Editor, *Popular Communications*, 76 N. Broadway, Hicksville, NY 11801-2909, or send e-mail via the Internet to <popular.com@aol.com>.

Summer School for Shakespeare?

Dear Editor:

I just wanted to drop you a line to let you know how much I enjoy reading your wonderful magazine. I wait for it like a little kid at Christmas every month. I've been reading it for the past three years now and have enjoyed every single issue. I hope to someday have my picture and story in the "How I Got Started" section. Three years ago I got my ham license when I was a senior in high school. You know, I studied that darn "Now You're Talking" book more than my school books? No lie, I felt that knowing all there is to know about ham radio was more important than Shakespeare! That's what summer school is for!

Your magazine has helped open up a world that otherwise would have been closed to me . . . it's amazing what short-wave has done to my life. Keep up the good work. There's one thing I'd like to see in your magazine—maybe some federal communications stuff—preferably in the HF spectrum.

73's,

Jason Bishop, KE4KZY
(via e-mail)

Dear Jason:

Look for federal comms in RD Baker's "Communications Confidential" column, where every month RD gives you the latest on listening to Uncle Sam and much more! The readers' loggings are a best bet for learning what's where in the utility HF spectrum.

I always thought summer school was

great for learning algebra; you don't want to be there and the teacher doesn't want to be there. What could be better?

Turnarounds Can Be Fun!

Dear Editor:

Peter Hunn's article on "Micro-Broadcasting Earns a Spot at NAB Convention" shared a good example of how to re-make a "dark" or poorly performing broadcast station into a local community asset.

I purchased a "financially challenged" one-kilowatt AM station on 1340 kHz in Clermont, FL in 1983. It had a staff of eight operating a 16-hour broadcast day, even though it was licensed for 24 hours. The studios and transmitter were located in a 400 square foot concrete shack that flooded when it rained. The tower was surrounded by five-foot weeds and trees and not surprisingly, the station was losing \$10,000 per month.

My partners and I rebuilt the building, cleared the field around the tower and installed a transmitter remote control to the local taxi service radio dispatch office. I installed an old Schaefer 800 relay automation controller to handle switching for a Satellite Music Network feed. The satellite receiver switched the automation by triggering the "panic button" featured on the 800 models! I hired one college student part-time to record the day's news, weather and commercial breaks each morning, while I sold and wrote commercials, covered city meetings and events and handled all business functions. An answering service took phone calls when I was out, and the station could and did operate for up to two days at a time unattended.

We broke even financially in the first six months while providing coverage of all major issues in our rural community. Turnarounds can be fun!

Sincerely,

Kenneth Peach
FL

Hang Together or Hang Separately!

Dear Editor:

I've been reading the exchange

between Mr. Ward and Waller in the past couple of issues. Both of them appear to be missing a larger view of the problem.

One by one, the government is taking away our rights. There could be as logical an argument made for not allowing listening to government or telephonic transmissions as there is for ownership of firearms, abortion, smoking, booze advertising or any of the dozens of other things the government regulates under the guise of protecting us from ourselves.

People must recognize that the abridgement of anyone's rights will ultimately result in the loss of rights to the people as a whole. Certainly not my quote, but "We hang together or we hang separately."

David Schoepf
FL

The Freeband Saga Continues

Dear Editor:

After reading *Popular Communications* for many years, I decided to drop a line. I've been involved in amateur radio for many years, worked in broadcasting since 1975, and also I'm an avid freebander. Only thing is, I don't call it that. It may be part of the 11 meter band, but certainly is not CB! I enjoy most all of the ham bands from DC to VHF, but better than 80 percent of the ham folks are primadonnas with a "little Napoleon" syndrome! If you are less than general class, you can forget any respect or connection to the fraternity. This behavior sure doesn't encourage newcomers or Techs to upgrade. I never supported the no-code license, but it's here and the snobs need to get over it . . . well, I've worked over 100 countries and encounter much more friendly and courteous operators than on the ham bands. Matter of fact, I hear more "10-4's" and "what's your 20" on 2 meters than anywhere "out of band"! It is very easy to stereotype an out-of-band operator as being a CBER. You would be surprised who operates out-of-band!! Hey, *Popular Communications*, keep up the good work. I look forward to the magazine every month.

Sincerely,

(name withheld, NC)

STOP BY AND SEE US AT DAYTON! BOOTH #s 575 - 579!



AR7030... "Superior by Design"

The introduction of the all new AOR AR7030 shortwave receiver is geared to the discerning and dedicated listener. The AR7030 is the result of a combined project between AOR and a UK designer. The AR7030 represents the very latest and best design, featuring exceptionally strong signal handling and bristling with enhanced features, with coverage from 0 - 32MHz. The AR7030 has been targeted to handle strong signals that are of prime concern of European listeners. It offers greater than +35dBm IP3 (Intercept Point 3) and greater than 100dBm dynamic range. The DMOS FET QUAD first mixer with NCO drive DDS offers the ultimate performance. All this and great sensitivity better than 0.5µV for 10dB S/N in AM mode and better than 0.3µV for 10dB S/N in SSB. Selectivity too is razor sharp offering greater than 90dB @ 10kHz SSB and greater than 100dB @ 20kHz. No other receiver "in the class" nor indeed at considerably higher price can match the sheer performance excellence of the AR7030.



AR8000... "Still the Best!"



The Ultimate Handheld Receiver! It incorporates the latest PLL technology and offers a multitude of features including true carrier re-insertion SSB (CW) demodulation with 50Hz frequency steps. 4 level alpha numeric LCD indicates the frequency, signal strength, band scope and more. Selectable squelch system, auto-mode, auto-band-plan, serial communication port are all standard. Internal ferrite antenna offers high performance reception below 2MHz..



When frequencies are entered, ALPHANUMERIC comments may be stored along with frequency, mode & attenuator status simplifying the job or recalling and identifying memory channels.

- Main Features.....**
- Frequency Coverage 500 kHz - 1900 MHz
 - All mode reception AM, NFM, WFM, USB, LSB & CW
 - True carrier reinsertion and specific SSB filter with non-offset frequency readout
 - 1000 memory channels, 20 banks
 - Priority channel
 - Step sizes programmable between 50 Hz & 999.995 kHz in 50 Hz increments
 - Signal strength meter
 - Attenuator

ICF8000

The ICF8000 now includes both the the RCSS Windows Software and the AR8000INF interface.

The RCSS8000, Windows '95 compatible Software significantly enhances the AOR AR8000 receiver's capabilities by providing automatic Personal Computer control over the receiver's scanning, logging and memory functions! These features and many more make this software a great choice for Windows!



AR3000A... "The Professional Communications Receiver"

Your listening horizons are truly extended with receiver coverage from 100kHz all the way up to 2036MHz.

The high level of performance is achieved by 15 band pass filters before the GaAs FET RF amplifiers. It will allow listening in any mode: NFM, WFM, AM, USB, LSB and CW. An RS232 port is provided enabling remote control via most computers. OFV Frequency, Receiver mode, Frequency steps, Writing to/from memory, Signal strength, RF attenuator, Memory bank change over and more, the LCD provides a multitude of information such as Search, Scan, Frequency, Memory and additional functions such as Memory bank and Second function. The display includes a real time clock for accurate log keeping; there is also a timer and tape output socket for unattended monitoring.



SPECIFICATIONS:
Receiver coverage:
Receiver mode:
Receiver circuitry:

Memory channels:
Scan rate:
Search rate:
Receiver selectivity:

Antenna connectors:
Audio output:

Power requirements:
Display:
Dimensions:
Weight:

- 100kHz - 2036MHz
- USB, LSB, CW, AM, NFM, WFM
- Triple (USB/LSB/CW/AM/NFM) & quadruple (WFM) conv. superheterodyne
- 400 (4 banks of 100 channels)
- 50 channels/second
- 50 steps/second
- 2.4kHz/ -6dB, 4.5kHz/ -60dB(USB/LSB/CW)
- 12kHz/ -6dB, 25kHz/ -70dB(AM/FM)
- 180kHz/ -6dB, 8000kHz/ -50dB(WFM)
- 50 ohm BNC
- 1.2 watts at 4 ohm load 10% distortion
- 0.7 watts at 8 ohm load 10% distortion
- 13.8 volts DC, approx. 500mA
- Illuminated Liquid crystal
- 5.52" w x 3.2" h x 8"
- 1.2kg



Electronic Distributors
325 Mill St.
Vienna, VA. 22180

Ph: 703.938.8105
FAX: 703.938.4525
www.elecdist.com

For more info
see your
favorite dealer.

Making Skywave Skip Work for YOU!

Get Ready for Some Fantastic DX—It's Just Around the Corner . . .

By Gordon West

Are you ready for June 15th? June 15 is six days away from the longest day of the year, and it is historically one of the most exciting days where an ionospheric phenomena called Sporadic-E skip takes place. The month of June has more Sporadic-E occurrences from dawn to hours after dusk than any other month of the year.

If you are looking for skip communications, June is your month. If skywave interference normally covers up your short-range base-to-mobile communications, chances are June will be the month that your squelch control won't take out the background interference.

Skip communications occur when radio waves refract off the ionosphere above us. That's right, *refract* as in bending, as opposed to simple reflections. This refraction of CB radio waves occurs during daylight and evening hours within one of three distinct ionospheric layers.

- **The D-layer**, closest to us, about 50 miles up, mainly absorbs skywave signals. No meaningful refraction here.
- The next layer up at about 75 miles is **the E-layer**, and this is where June skywaves are influenced the most. More about this layer in just a moment.
- **The F-1 and F-2 layers** are way out at 200 miles, and these two layers will not be participating in this summer's skywave excitement until we get closer to the peak of solar cycle 23 in the year 2000. When you get skip off of the ionosphere's F-layers, we are talking from East coast to Europe, and from Midwest and West coast to Japan and Australia. But for the next few years, forget about F-layer refraction because we are at the bottom of the current solar cycle.

The E-layer is where all of the summertime skywave excitement takes place for VHF operators. The E-layer is more influenced by the sun's proximity and position to earth than it is to the 11-year solar cycle. The E-layer "charges up"

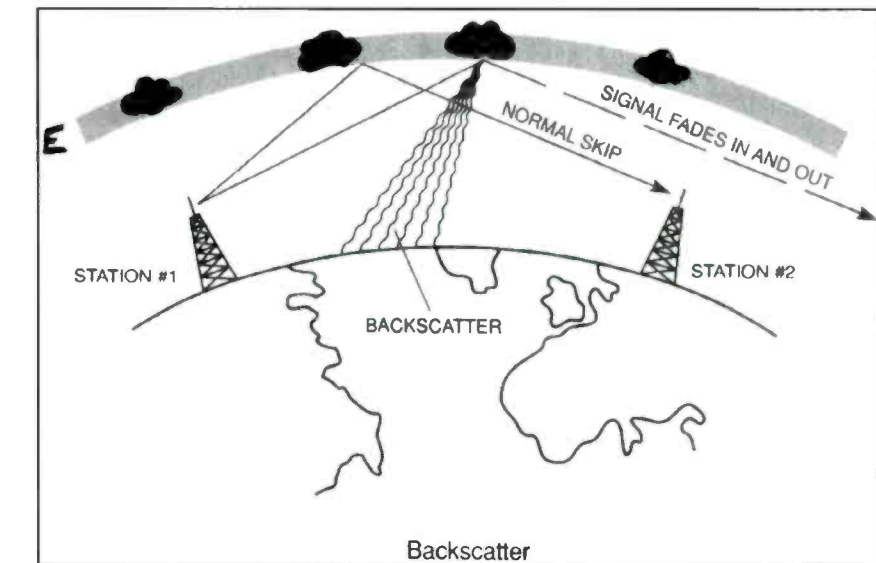

Sporadic-E layer clouds can create backscatter signals at 27 MHz. (Courtesy G. West Book, Master Publishing)

from ultraviolet radiation and charged particles bombarding it from the sun at around noon. Free electrons and ions bounce around within the E-layer, creating a density that causes incoming radio waves from 21 to 150 MHz to bend sharply back down toward earth. If there is enough ionization of the E-layer, the sharp bend will cause VHF signals to bounce back to earth approximately 1,500 miles away!

While skywave reception from a single E-hop can get your heart beating faster when someone acknowledges a call from your station thousands of miles away, it is Sporadic-E that may get your heart pounding when signals come in to your station 3,000 miles away!

Sporadic-E skip, abbreviated Es, occurs when intensely ionized patches of the E-layer break up, and travel at hundreds of miles per hour just above the jet stream. Each Sporadic-E invisible cloud may only be a few hundred feet thick, and only a mile or so across. This leads to

"spot skip circuits" where you might be working a station 1,800 miles away, and the other radio operators five miles down the road are really beginning to think you are making the whole thing up. Then, all of a sudden, your reception fades out, and the gang five miles down the way begins to hear and work that distant station thousands of miles away! Distant station contacts may last for a few minutes and sometimes off and on for a few hours.

This summertime Sporadic-E skip phenomena occurs every June and July without fail. This rules out influence from high or low sunspot numbers. Sporadic-E "super charged" clouds must then be getting their tremendous ionization from something else, other than just the sun.

Wind shears within a high-pressure system is one cause of Sporadic-E clouds that can refract radio waves for thousands of miles. Dry air and two surfaces rubbing together can lead to big build-ups of electron charges. We see this every summer when we walk across the carpet and

DRAKE PUTS THE WHOLE WORLD IN YOUR HANDS...



**SEE US
AT DAYTON
BOOTHS
127 & 128**

WITH THE SW2 SHORTWAVE RECEIVER.

Drake puts the whole world in your hands with the SW2 Shortwave Receiver. Tune in AM broadcast, amateur, CB or shortwave bands with continuous coverage from 100 kHz to 30,000 kHz. Single sideband operation and AM selectable sideband synchronous detection, brings the world closer to you. And with the optional infrared remote control, the world is in your hands even when the receiver is out of reach.

To find out how to get your hands on the world, call Drake at 1-800-937-2531.

CIRCLE 160 ON READER SERVICE CARD

DRAKE

230 Industrial Dr. Franklin, Ohio 45005
phone: 513-746-4556 fax: 513-743-4510
on-line: <http://www.rldrake.com>



**FREEPLAY...
...FREE POWER
NO BATTERIES REQUIRED**

BAYGEN is...The leader in personal power generation. **Just wind it up and turn it on!**

FREEPLAY RADIO



The World's *only* **completely battery-free**, wind up AM/FM and Shortwave radio!
The power source is an internal B-Motor carbon steel spring driving a generator that is powered by hand.
Put the power back in your hands and contact BayGen today.

Dealer inquiries welcome.

1 800 WIND 234

CIRCLE 63 ON READER SERVICE CARD

**WE HAVE IT ALL!
Surveillance**

- Infinity Transmitters
- FM Wireless Transmitter Kits
- Vehicle Tracking Systems
- Bug Detectors
- Caller I.D.
- Wired Mikes

- Telephone Register with Printer
 - Long-play Recorders
 - Shotgun Mikes
 - Telephone Recording Adapters
 - Alcohol Testers
 - Telephone Scramblers
 - Hidden Video Cameras
 - Telephone Tap Detectors
 - Drug Testers
- MUCH, MUCH, MUCH MORE.**

Our 27th Year!

Small catalog FREE.
Larger catalog send \$5.

Mail Order only. Visa, MasterCard and C.O.D. accepted for equipment only.

Inquire for dealers' prices.

A.M.C. SALES, INC.

193 Vaquero Dr. • Boulder, CO 80303
Mon.-Fri. 8 a.m.-5 p.m. Mtn. Time

800-926-2488

(303) 499-5405 • Fax (303) 494-4924

Internet: <http://www.siteleader.com/catalogdepot/AMCSC-home.html>

E-mail: amc-sales@siteleader.com

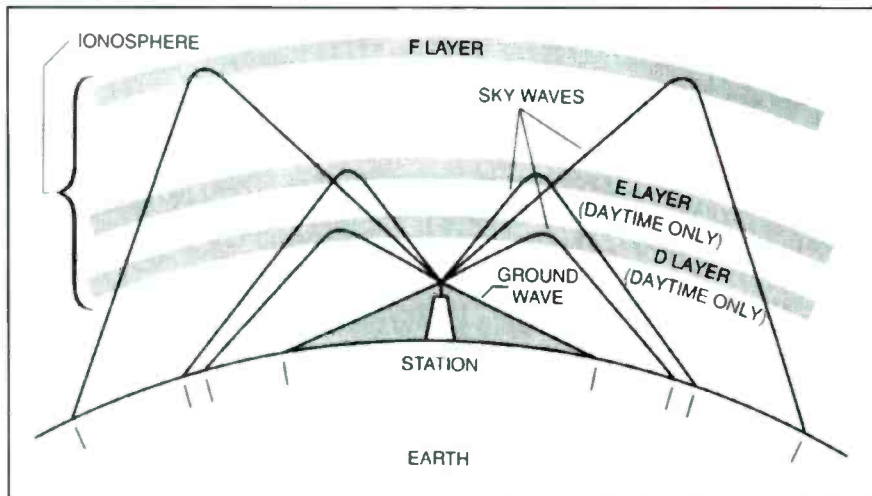

The ionosphere and how E-layer refracts 27 MHz radio waves in June. (Courtesy G. West Book, Master Publishing)

touch anything metal. Snap! Wind shears high above the jet stream seldom get an opportunity to go "snap," as in lightning, so this tremendous charge is carried in invisible E-clouds that offer enough mass to refract incoming radio waves back down to earth.

Thunderstorms Also Spawn Sporadic-E

Major thunderstorms moving from the West to the East coast will surely spawn Sporadic-E clouds. You can follow low-pressure disturbances across the country by simply watching weather maps on television and using your own United

States weather maps to keep track of the incoming storm. At the top of the thunderstorms which sometimes exceed 50,000 feet are major cloud formations where lightning is abundant and Sporadic-E skip almost guaranteed.

But since thunderstorms are not near as high as wind shears, your CB skip communications will be relatively short and intense. These weather conditions lead to "short skip" where the storm is in between you and the other station; typically distances of 500 to 700 miles are normal. Studies by Holzer and Watson suggest a refractivity index more than sufficient to bounce back signals between 25 and 30 MHz, based on atmospheric resistance of about 200 ohms, while the potential at the



Fire up the rig for some fantastic openings in mid-June!

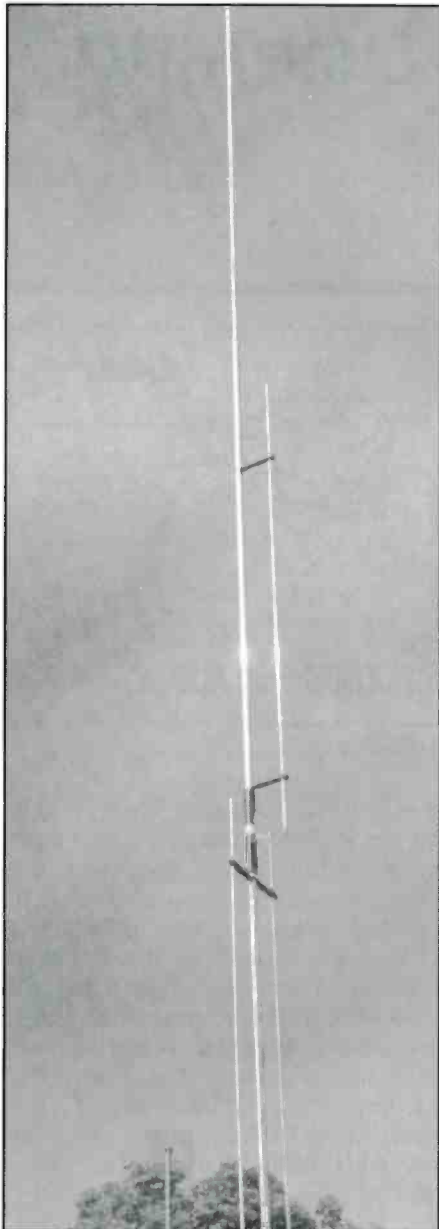

Make sure your antenna is up to par now and ready when you need it the most.

top of a major thunderhead is near 350,000 volts, creating a capacitor effect to give our CB signals a short-skip bounce.

SSB Phenomena!

A most interesting phenomena can be heard on a single-sideband 10 m or 6m or your CB tuned to an open frequency where all the operator hears is background static. Daybreak is the best time for this experiment, and a directional beam antenna is a big help, along with a regional weather map. Rotate the beam for an increase in random background noise, and see if this correlates with major distant thunderstorm activity. Now listen care-

"You may even get a double bounce within E-clouds, giving you reception out to 2,500 miles away."

fully and time the incoming snaps and pops that come over your SSB receiver.

The pops will increase in their repetition time from one per minute down to one every 10 or 15 seconds. When these bursts of snaps, zzzztttss, and pops increase to more than one or two occurrences every 10 seconds, start listening for signals from distant SSB operators to begin overriding the noise. In less than five minutes, you may find stations 700 to 1,200 miles distant come out of the noise from seemingly nowhere, and you'll hear extremely strong signals for several minutes, for up to an hour. Welcome to predicting short-skip openings!

Watch Television!

Another experiment is to watch television channel 2 using TV antenna on your roof. When your local station begins to receive interference of horizontal bands

moving from top to bottom of the screen, and sometimes a frequency offset vertical band on the left side of the screen, you are beginning to see skywave reception coming in at twice the frequency of 10m and 11m frequencies. When skywaves affect TV channel 2 on an outside antenna, they will always affect CB and 10 m.

Wind Shears

Finally, wind shears can sometimes be spotted way up in cirrus clouds, barely perceptible to the human eye. I have known several experienced radio operators who can scan the sky, and regularly predict band openings attributed to the formation of ultra-high clouds influenced by wind shears. I know it's hard to believe, but give it a try yourself.

When June 15 hits, stand by for incredible skywaves. See how far away you can pick up a station's location. You may even get a double bounce within E-clouds, giving you reception out to 2,500 miles away. It happened for three days last December, so it's bound to happen this June for some exciting skywave Sporadic-E communications! ■

The ZEIT by ARCRON RADIO-CONTROLLED CLOCK

- All World Time Zones with Precise Time
- Tell Time by the Atomic Clock that governs time for radio stations and space flights
- Sets Self By The NIST Radio Waves - WWVB Signal

DAYTON SPECIAL!
\$129.95

- Time, Hours, Minutes, Seconds
- Reception/Signal Strength
- Date or 2nd Time Zone
- BackLight Dial for Night
- US and World Time
- All World Time Zones
- ARC Program Symbol
- Dual Alarm Function



-YOU'LL NEVER HAVE TO SET THE TIME AGAIN

Keeping Exact Time HASN'T BEEN EASIER!!—Automatically sets accurate time, date and adjusts for the start and end of daylight savings time

- Receives Radio Signal from US Atomic Clock
- Superior Signal Sensitivity (Below 20µV/m)
- Continuous Oscillator Calibration
- Internal Quartz Oscillator
- Integrated Internal Ferrite Omnidirectional Antenna
- Battery Operated with Low Battery Indicator
- High Tech Design
- Warranted
- 2.60" x 5.30" x 4.45"

ORDER YOURS DIRECT FROM ARCRON ZEIT

CALL TOLL FREE 24 HOURS 1-800-985-TIME (8463)

630-472-9999 International
<http://www.arctime.com>

M/C • VISA • DISCOVER • AMEX 2ND DAY DELIVERY AVAILABLE

Wall Radio-Controlled Clocks
Also Available — Please Call!

Murphy's Law of Pirate Listening

How to Tune the Bad Boys of the Bands

By Pat Murphy

I've been DXing pirates for over a decade and the most often asked question is, "How do you hear them?" It's not like you can pick up a Passport to Pirate Broadcasting or a World Radio TV pirate handbook to check on schedules, because pirates don't maintain regular broadcast schedules and those that do don't last for very long. There are however, some patterns that develop and places to look that once the persistent DXer understands, tend to turn up these "bad boys of the bands" on a regular basis. Let me pass along my "Murphy's Law of Pirate Listening."

Disclaimer

Listening to pirates is *not* illegal. Being a pirate broadcaster may be illegal under certain federal codes. It has always been surprising to hear what some people think about the hobby of listening to pirates. One old coot at a hamfest was insistent that it was "illegal" to listen to pirates. It's no more illegal to listen to pirates than it is to listen to the VOA, BBC or the local AM broadcaster in your town. It is perfectly legal to listen to and report on pirate radio transmissions in the United States and around the globe. After the recent federal court ruling concerning Free Radio Berkeley, it may not be illegal for low power broadcasts, but until the federal courts finish their ruling on this case, it is not advisable to simply take to the airwaves with your own station. If you do, you may be faced with severe fines and long court procedures. The point is, *it is not illegal to listen to pirates.*

The First Step Toward Pirate DXing

Step one is *patience*. This is not like tuning in a BBC or VOA broadcast, which are using 500 kw transmitters. In fact, the recent trend in pirate stations has been to use low power; 10-50 watt transmitters. Pirates don't pop up during prime time; and while trying to get an audience for their transmissions, they aren't trying to draw a lot of attention to themselves by interfering with or bleeding over onto other frequencies. In my listening shack, I not only have my receiver, but several books as well as a computer for surfing the Internet, while I wait patiently for a pirate transmission to come on the air. Patience is the prime ingredient for the successful pirate listener. *Murphy's Law states that "if you've been listening for a pirate for three hours with no luck, two minutes after you turn off the radio, a pirate will begin broadcasting."*

Step Two in Pirate DXing

You must understand what the pirate broadcaster is considering when transmitting a signal. One is that they are violating the law, and as such will come on the air at unusual times, but

Abolish capitalism!
Abolish government!
Abolish religion!
Abolish war!
Abolish work!
Abolish clocks!
Abolish factories!
Abolish television!
Abolish locks!
Abolish cars!
Abolish landlord!
Abolish taxation!
Abolish the FCC!
Abolish commercial radio!

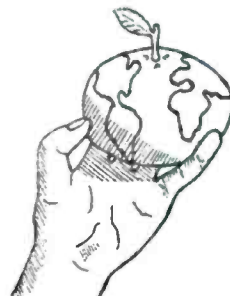

QSL

To _____

Date _____

GMT *Sample*

Freq. _____

Thanks for your report.

x *RR*

TANGERINE RADIO

Here's a QSL from Tangerine Radio.

still try to capture as big an audience as possible. There are only a few frequencies that pirates in North America use on a regular basis to broadcast on, so we'll check those frequencies on a regular basis as we look for a broadcast. European pirates, which can be heard in North America, use a number of different frequencies and we've included them in our list of frequencies as well. The single most popular frequency for pirates in the past 12 months has been **6955 kHz**. This can, and probably will change with time, as pirates move around, due to the big high-powered shortwave stations taking up residence on nearby frequencies. Four years ago, the most popular frequency was 7415 kHz, but when VOA squatted on 7405, the pirates moved to 6955 kHz. Always check 20 kHz up and down from the designated frequency, as pirates will move off the most popular frequency when it becomes crowded. A good example of this is Radio One, WREC, Radio Two and Radio Free Speech, showing up on 6950 kHz when 6955 kHz is busy, or Radio Bobs Communication Network (RBCN) on 6960 kHz. *Murphy's Law then states, "wherever you get used to hearing pirates, dictates how soon they move to another frequency."*

"One old coot at a hamfest was insistent that it was 'illegal' to listen to pirates."

What Frequencies Are Pirates Using Now?

Keeping in mind that this can, and will change with time, the most popular frequencies in use for North American pirates at this writing are: (in order of most use)

6955 kHz—AM, LSB & USB

6950 kHz—mainly being used in the AM mode

7415 kHz—AM & SSB, the old standby from the '70s & '80s

You may not know our name . . .

but our history gives us away!



While the name RELM Communications (formerly Regency Electronics) may not make you think of scanners, it soon will. We're re-entering the scanner market with top-quality, professional scanners. With that goal in mind, we're excited to introduce the HS 200 portable scanner. The HS 200 covers 13 bands including aircraft and 800 MHz. Other features include:

- 200 Channels, 10 Banks
- PL/CTCSS
- Fast Scan
- Bank Scan
- Priority Scan with Hierarchy
- Direct Channel Access
- Search Hold
- Birdie Lockout
- 10 Priority Channels
- DPL/DCS
- Scan Delay
- Weather Scan
- Priority
- Search
- Channel Lockout
- LCD Display

**Call for more information
on our complete line!
800-821-2900**



*Pictured Right:
The HX 1000 was a popular scanner
under the Regency Electronics name.*

RELMTM

COMMUNICATIONS

7505 Technology Drive
West Melbourne, FL 32904

407-984-1414

Fax: 407-984-0434

"Patience is the prime ingredient for the successful pirate listener."

Clandestine Radio Enthusiasts. For over 15 years they have published a monthly newsletter that has loggings of their members' catches of pirates, plus columns that focus on pirate radio trends. Contact the ACE at P.O. Box 12112, Norfolk, VA 23541. Another excellent publication is the Pirate Pages. Edited by well-known writer of pirate books, Andy Yoder, it is published several times a month and has extensive loggings that are very up to date. You can reach the Pirate Pages at P.O. Box 109, Blue Ridge Summit, PA 17214. On the Internet you'll find a couple of sources for good information about pirate listening. The Free Radio Weekly is a weekly e-mail source of great information. You can sign up by contacting Chris Lobdell at <piradio@usa1.com>. Chris also writes a column for the NASWA Newsletter and provides a valuable service for ardent pirate listeners. The <alt.pirate.radio>, newsgroup occasionally has information that actually has something to do with pirate broadcasting, but is not a reliable source since anyone can post anything they want on this newsgroup. The best source above all others is John Cruzan's, Free Radio Network. John has put together QSLs, audio clips, news and links to other pirate information sources. The ACE also has a Website that can be reached through the FRN. You can find the Free Radio Network and the link for the ACE websites at <www.frn.net/ace>. But regardless of all the information you obtain, *Murphy's Law of pirate information is: "No matter what information you have, it's outdated."*

What's In the Future for Pirate Broadcasting?

Let's look into our crystal ball and play the prediction game. With the FCC field office cutbacks and lack of enforcement, it would appear that there has never been a better time to try to hear a pirate radio station. Since the FCC shut down its field offices in June of 1996, pirate stations have proliferated beyond anyone's best guess. The loggings column in the Pirate's Den and other pirate publications have more than doubled over the past year. If you can't hear a pirate now, you are never going to hear a pirate. Patience, persistence and good equipment will render some of the most entertaining radio you have ever heard.

The level of quality among the pirate broadcasters has improved over the past 10 years and has in many cases become better than commercial broadcasters. One new high quality entry is "Up Your Radio" in which the operator, Woody B. Serious, edited a speech by Newt Gingrich that is some of the best comedy you will hear in any media, anywhere. Radio Free Speech took the Rush Limbaugh show and edited Rush's own words to have him saying all kinds of bizarre things. Radio USA did a special Olympic program during the summer Olympics. The list, and the number of different and unusual programs that pirates are offering on shortwave radio is endless.

The final Murphy's Law for pirate radio listening is: "When you've finally caught a pirate signal, a relative will call you

"If you want to really hear all the pirate stations that are on the air, you better have a really good receiver and a super antenna."

on the phone and bore you to death with the details of another relative's problems. By then the pirate will have stopped his transmission."

This is a great time for pirate listening as the propagation is picking up and there are more pirate stations on the air than at any other time in recent history. Pirate listening can be challenging and a lot of fun. After you've caught your first one, you'll understand the thrill of capturing and logging pirate radio! Have fun and good DX to you.

Next time I check in we'll be looking at pirate QSLs; how to get them and what to do with them once you do get them. ■

Murphy's Law of Pirate Listening

1. If you've been listening for a pirate for three hours with no luck, two minutes after you turn off the radio, a pirate will begin broadcasting.
2. Wherever you get used to hearing pirates, dictates how soon they move to another frequency.
3. Whatever frequency you are listening for a pirate is the wrong one.
4. No matter what direction you point your antenna for a pirate station, they will be transmitting from the opposite direction.
5. Murphy's Law of pirate information is: "No matter what information you have, it's outdated."
6. When you've finally caught a pirate signal, a relative will call you on the phone and bore you to death with the details of another relative's problems. By then the pirate will have stopped his transmission.

We don't make SCANNERS or the ICOM IC-R8500 RECEIVER - We make them better -

DELTACOMM I-8500 Communication Manager for the ICOM IC-R8500 communication receiver. With speed as a design goal DELTACOMM's QUICK LOG function will log signal level, frequency, mode, date, time and optional Global Positioning System (GPS) coordinates at speeds in excess of 2400 channels per minute. Here are a few examples of the many advanced features DELTACOMM I-8500 has to offer.

- Load 40 channels of information including ALPHA NUMERICS into one of the R8500's memory banks in 3 seconds.
- Separate volume level, resume scan delay and maximum monitor delay plus 40 character information field for each scan channel.
- Priority channel operation samples at 2.5 second intervals.
- Multi-receiver control will hand off active frequency to next receiver on line. Able to control up to 125 ICOM receivers (optional).
- Traditional scanning is a thing of the past with our CYBERSCAN feature, used to track systems employing frequency hopping.
- Activity log function automatically records and calculates total spectrum usage time.
- Unique search operation stores all frequencies found active and then automatically skips those frequencies during the remaining search cycles. This feature eliminates redundant logging.

Visit our Internet Web Page or Phone/FAX us for program features, new product releases and pricing schedule. DELTACOMM is available for ICOM R9000, R7100, R7000, R71, R72, IC-735 (features vary with type of radio). Also check out our DELTATONE 2.0 repeater programmer.

<http://www.execpc.com/~deltacom>



Delta Research



Box 13677 - Wauwatosa, WI 53213 - FAX/Phone (414) 353-4567

CIRCLE 65 ON READER SERVICE CARD

It Was America's Southernmost Broadcaster

WQAM—On the Move

By Alice Brannigan

In January of 1923, the Dept. of Commerce issued a broadcasting license to The Electrical Equipment Company, 42 North West 4th Street, Miami, FL. The auto and radio sales/service company was owned by W.W. Luce. His new station, WQAM, was authorized to operate with 250 watts on 833 kHz. WQAM was the southernmost broadcasting station in the U.S.

For whatever reason, within a few brief months, WQAM had cut its power back to 100 watts. In those days the government was driving stations crazy by constantly reorganizing their frequency assignments. This was the Dept. of Commerce's inept attempt at dealing with the rapidly expanding service, though regulations governing broadcasting were virtually non-existent. By early 1924, the government relocated WQAM to 1140 kHz, but by July they again ordered a move to 1000 kHz. By the end of 1924, the station had been told to shift to 1120 kHz, only to be sent back to 1140 kHz in July, 1925. By that time, WQAM was calling itself the "Pioneer Broadcast Station of Florida."

Stations were not universally pleased with their newly mandated frequency reassignments. During this period of no radio regulation, it was a common practice for stations to ignore federal assignments and simply use their own favorite channels. In November of 1925, WQAM reportedly "jumped" to the unauthorized frequency of 1050 kHz, using 1 kW, though still authorized for 1140 kHz with 100 watts. WQAM was still Miami's only year-round broadcaster because WIOD-WMBF shut down during the summer.

In the spring of 1927, the newly-formed Federal Radio Commission assigned WQAM to 930 kHz, permitting the station to operate with 750 watts. By November, WQAM was shifted to 780 kHz. In late 1928, WQAM was moved to 1240 kHz. By early 1929, the new licens-

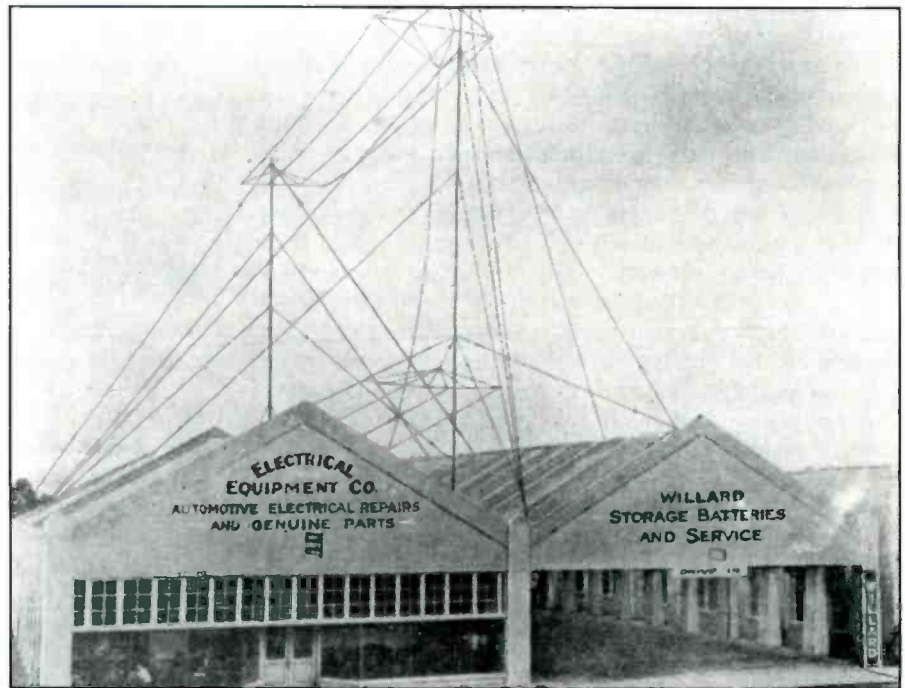

The original WQAM studio and transmitter site, about 1924 (National Archives collection via Jan Lowry, CA).

ee became the Miami Broadcasting Company. They increased the power to 1 kW and moved the studios to Miami's Postal Building, 327 North East First Avenue. The Western Electric transmitter was relocated to the fifteenth floor of the Realty Board Building, 600 Biscayne Blvd. When these changes were completed, WQAM shifted its dial position to 560 kHz.

In January of 1932, WQAM's transmitter was moved to the top of the Miami Daily News Building. In 1938, it was again moved to the water's edge at Biscayne Bay and 14th Street, where a new 224-foot self-supporting Blaw-Knox vertical was installed. The station's slogan became "The Voice of Tropical America."

In 1941, WQAM received a permit to increase its daytime power to 5 kW, and this was completed in November of 1943

with the addition of a Continental 315-B transmitter. In 1947, a new 380 foot tall Lehigh self-supported vertical radiating antenna tower was installed on a pier extending out into Biscayne Bay at 1425 North East Bayshore Ct., just south of the Venetian Causeway's Miami terminus.

In 1949, WQAM's studios were moved to Suite 1723, Alfred I. DuPont Building, in downtown Miami. In 1956, the station was sold to Todd Storz' Mid-Continent Broadcasting Co., later to become known as the Storz Broadcasting Co.

The studios and offices were moved in 1962 to the Mezzanine floor of Miami's McAllister Hotel. A permit was also issued that year to change the transmitter site. In 1965, the station's main studio was relocated to 767 41st Street, Miami Beach. The studios remained there until 1985, when they were relocated to 9881

to verify your reception of Oct 21st
 Paramount Publix Hour 10.30 to 11.00PM
 "WQAM" "WQAM"

It's Always June in Miami

YOUR reception report of WQAM's program is very much appreciated. WQAM is a 1000 Watt Western Electric crystal-controlled station, operating on a frequency of 560 K. C. Further report will be gratefully received.

MIAMI BROADCASTING COMPANY
 Most Southern Station in United States

This QSL from WQAM is from 1931 (PopComm archives).

Sheridan Street, Hollywood, FL. In early 1988, the transmitter was moved to a new site near Miami and commenced AM stereo operation. The old 5 kW Continental transmitter was put up for sale.

WQAM had been running a Country Music format, but in 1990, the station added Oldies and Sports Talk. The Country Music format was dropped (though was continued over the FM outlet, WKIS, at Boca Raton). The Oldies Music lasted until 1993 when the format was changed to all-sports, and the station became known as "Sportsradio 560."

In mid-1996 the station (along with WKIS) became the property of the Sunshine Wireless Co. As "Sportsradio 560," WQAM operates full time on 560 kHz, 5 kW days, 1 kW at night (non-directionally) from its studios in Hollywood. It is still licensed to nearby Miami.

Thanks to Broadcast Pro-File for per-

*"The station's slogan became
 'The Voice of Tropical
 America.'"*

mitting us to excerpt information from their lengthy report on WQAM. BP-F is a commercial research service that can provide highly detailed historic reports on all U.S. AM/FM stations, past/present. A reasonable fee is charged for their services. For their complete catalog, send \$1 to Broadcast Pro-File, 28243 Royal Road, Castaic, CA 91384-3028.

We always appreciate input from our readers in the form of old radio and wireless station photos, picture postcards, QSL cards and letters (originals or good copies), station lists, questions, anecdotes, memories, and ideas. See you on the road to Radioville! ■

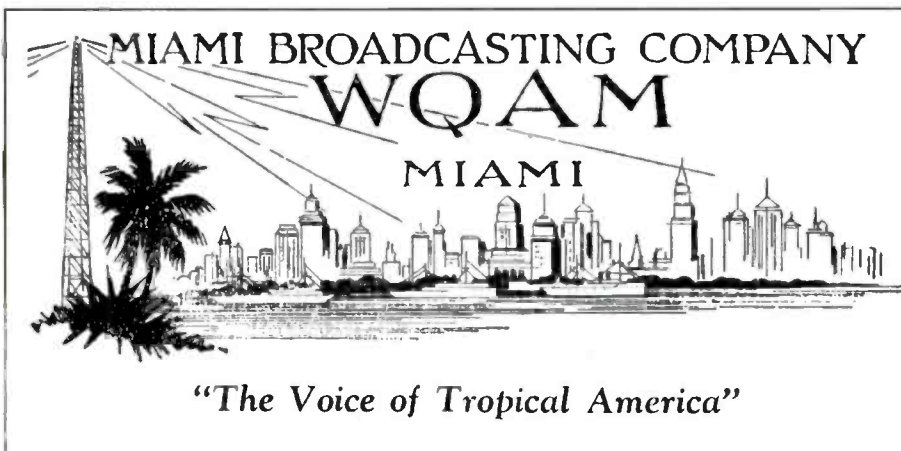

A 1930s WQAM logo (PopComm archives).



**Combination Antenna FM/CEL-1
 6db Gain Cellular-AM/FM-
 Weatherband Antenna Kit**

EVERHARDT ANTENNAS introduces its newest multi-purpose antenna design that combines 6db gain cellular, AM/FM and Weatherband on one antenna. This allows an installer to use one antenna, route one cable, and supply four different frequencies to a vehicle while using the existing cowl or roof mount AM/FM antenna hole. The supplied duplexer filters and separates the appropriate signals and has 3' of cable to route to the radio and transceiver. Features include 6db gain co-linear antenna for maximum performance, Weatherband "TRAP" for AM/FM radios with Weatherband feature, 90° low loss RG-58C/U from antenna base to duplexer box, adjustable mounting base from 1/8" to 3/4", 3-foot RG-62 AM/FM cable with male Motorola plug and 3-foot RG-58C/U cellular cable with TNC connector.

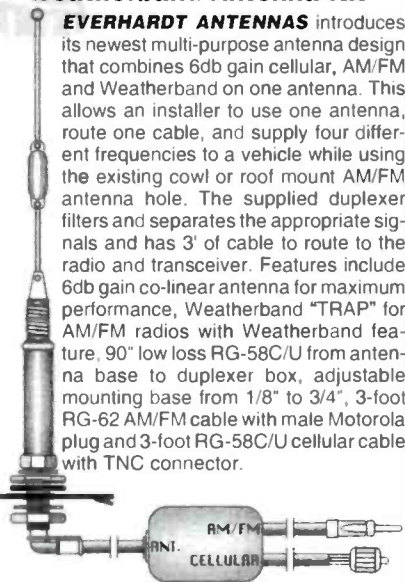

EVERHARDT ANTENNAS
 6000-D Old Hemphill Road
 Fort Worth, TX 76134
800-735-0176

CIRCLE 71 ON READER SERVICE CARD

Great Books!
Radio Monitoring

The How-To Guide T.J. "Skip" Arey
 NEW for 1997 WB2GHA

The complete hands-on guide to the world of communications, including mediumwave, shortwave, VHF/UHF scanning, and much more! Find out who's listening, how they do it, what equipment "works." The #1 book in scanning and monitoring today!

"...covers it all, from DC to daylight."

NEW! *World Scanner Report*

ISBN 1-56866-101-0 344 pages, \$19.95

ULTIMATE SCANNER Bill Cheek

Scanner modifications - THREE 240 pages, large format, \$29.95

Bill Cheek is the master of scanner modification, as Editor of the *World Scanner Report* and author of *Scanner Modification Manuals*.

SCANNERS & Secret Frequencies Henry Eisonson
 320 pages, \$19.95

"Must reading." *Electronics Now* "Useful, knowledgeable." *PopComm*
 "A giant undertaking, authoritative" *Monitoring Times* "You can't miss!" *ASG*
 "Absolutely the best..." *Norm Schrein* "A high point!" *RCMA*

Beyond Scanning!

Underground Database 100 pages, large format, \$23.75
 Everything that's sort of legal. "Fascinating" *ASG*

Television GRAY Market Henry Eisonson
 Cable & satellite chips, descramblers, etc. 160 pages, \$23.75

"Explores this shadowy fringe area in depth... good info" *PopComm*

www.electriciti.com/~ipgbooks

s/h \$4 1st book, then \$2 ea. CA add tax
INDEX Publishing Group, Inc. MO/check via mail, or
 3368 Governor Drive, Suite 273P MCard, Visa, Amex
 San Diego, CA 92122 **800-546-6707**

CIRCLE 68 ON READER SERVICE CARD

MAKE SURE TO STOP BY AND SEE US AT DAYTON!
BOOTH #'S 575 - 579

AR8000 - Still the Best!



All Mode Wide-Band World Band Radio Receiver

The Ultimate Handheld Receiver! The AR8000 incorporates the latest PLL technology and offers a multitude of features including true carrier re-insertion SSB (CW) demodulation with 50Hz frequency steps. 4 level alpha numeric LCD indicates the frequency, signal strength, band scope and more. Selectable squelch system, auto-mode, auto-band-plan, serial communication port are all standard. Internal ferrite antenna offers high performance reception below 2MHz..

Main Features • Frequency Coverage 500 kHz - 1900 MHz • All mode reception AM, NFM, WFM, USB, LSB & CW • 1000 memory channels. 20 search banks • Priority channel • Frequency pass • Step sizes programmable between 50 Hz & 999.995 kHz in 50 Hz increments • Scan & search speed up to 30 increments per second • Signal strength meter • Backlit LCD, Keypad & Side panel • Attenuator • Keypad lock • Password protected banks • Computer control

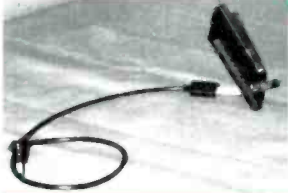

SAC8000 Adapter Cable

Once the SAC8000 is installed, the AR8000 can easily be connected to the OptoElectronics Scout™. Any frequency captured by the Scout™ instantly tunes the AR8000 receiver.

Supplied with: NiCads, AC Charger, Hand strap, Belt Clip, Semi-flexible antenna, DC lead with cigar plug, Comprehensive operating manual with over 50 LCD illustrations.

Options: SC8000 Soft Case, AR8000NF interface, SAC8000 (Scout Adaptor Cable), Desk stand, DS8000 (Speech Inversion descrambling chip), MA500 antenna, ScanCat GOLD Software, RCSS8000 Software, RCSI-SoftControl 2.0, LA320 active loop antenna, QS200 Mobile bracket

LOOK TO DAIWA FOR THE BEST IN HAM GEAR

Power Supplies

Daiwa's hi-tech, super efficient designs yield higher output capacity in rugged, compact packages.

MODEL	PS880	PS600	PS140ya
VOLTAGE	1-15VDC	1-15VDC	1-15VDC
CURRENT (max)	40A	56A	14A
CURRENT (CONT)	32A	50A	12A
SIZE (INCHES)	8.5x4.3x11.2	9.6x6.1x11.8	5.3x4.1x8.9
WEIGHT (LBS.)	18.7	37.4	11



Cross Needle Meters

From the originator of the cross needle meter, Daiwa offers models to suit every application, band and power level...

	CN101
Frequency Range (up to)	1.8-150MHz
Power Rating	15/150/1.5kW
CONN.	UHF
MIN SWR	<4W



Coaxial Switches

Professionally engineered cavity construction from the originator of the cavity type coaxial switch.

	C5201
Frequency Range (up to)	600MHz/1Ghz
Power Rating	2.5kW PEP - 1kW CW
VSWR	Below 0.12
Insertion Loss	Less than 0.2dB
Isolation	60dB, 600Mhz
Output Port	2



PSU101

Adjustable Desk Charger/ Power Supply 12VDC Version

This quality, custom-designed combination desk charger and regulated power supply unit is perfect for convenient 'Base Station' use of your handheld scanner at home or office!!

• Securely holds scanner in proper position
• Charges radio's internal NiCad w/out overcharging
• Powers radio from standard 117VAC house current



For: FIARMATE HP1000E/200E/HP2000
AOR AR1000XLT/AR1500/AR2000
YUPITERU MVT7000/MVT7100
UNIDEN BEARCAT BC50XL/BC55XLT/
BC70XLT/BC100XLT/
BC200XLT/BC205XLT
ALINCO DJX1
ICOM ICR1 Handheld
REALISTIC-TANDY-RADIO SHACK
PRO35/PRO38/PRO41



PSU101TA Desk Charger/Power Supply 9VDC Version

• 9 volt version for popular REALISTIC (RADIO SHACK) handheld scanners and others that require a 9 volt DC supply
• All the same quality & features of the PSU101 12 volt version above!

For: REALISTIC-TANDY-RADIO SHACK PRO34/PRO37/PRO43 and others.

WINRADIO

Your Window to the World

- Scan for exotic stations from faraway places
- Eavesdrop on aircraft and maritime communications
- Intercept clandestine stations
- Monitor emergency services
- Receive satellite and Space Shuttle signals
- Witness combat transmissions making history

Tune in the world from the monitor of your PC, with the latest receiver technology!

Just a mouse click or a keystroke can take you around the world to diverse cultures in hundreds of languages. PC screen shows entire receiver with all controls, including tuning dial for easy tuning and control. The WinRadio package includes the receiver card, software, handbook and indoor antenna. Microprocessor PC plug-in card is PLL synthesized with triple conversion superheterodyne and connectors for external antenna and speaker/headphone.



Features:

- 500kHz to 1.3GHz
- Tuning steps from 1kHz to 1MHz
- Up/down, direct entry or tuning dial via mouse or keys
- Modes are AM, FMW, FMN, SSB
- Long wire antenna included
- Requirements - 386 or higher, DOS 3.3 or Windows 3.1/Windows 95, 640kB Ram for DOS or 4 MB for windows use, and a vacant 16 bit card slot.



75-510

14 channel UHF FM FRS (Family Radio Service) transceiver.

- High quality UHF FM transmit and receive audio for clear, crisp and interference-free communication
- User selectable privacy codes for 38 separate lockouts per channel
- 14 computer controlled frequency selection
- Built-in modulation circuit adjusts to a wide variety of voice levels
- Supplied with rechargeable batteries and a charger
- Large, backlit LCD readout
- Maximum power for up to 2 miles range
- Automatic squelch eliminates noise between transmissions
- Quick up/down channel selector pads
- Scan mode to search for busy channels
- Busy channel delete to bypass unwanted conversations
- Automatic time-out timer turns off transmitter
- Automatic power save mode conserves power for longer battery life
- The "Y" versions of the LEP Professional Mic series by LOWE (SHOWN BELOW) are compatible with the MIDLAND 75-510



SCANCAT GOLD for WINDOWS!



SCANCAT presently supports:

- AOR3000/3000(A) & AOR2500, AOR-3030 HF receiver, AOR-AR8000 (Newest handheld) • Drake R-8
- MOST Icom Radios • Kenwoods including TS-440, TS-450, TS850 & R5000 • Most Yaesu including FRG-8800 & FRG-9600 Yaesu, plus FRG-100, FT-840 and more! • The NRD-525 & 535 JRC. • LOWE HF-150m • Watkins Johnson HF-1000
- Opto Electronics add-on boards for PRO series Radio Shack Radios

Scancat's basic features:

- Search between any 2 frequencies
- Search by ANY increment
- Create Disk files
- Import from most text formats to a working SCANCAT file
- Unattended Logging of frequencies to files while scanning.
- Scan Disk Files
- Spectrum Analysis to Screen OR Printer
- Supports PerCon & Mr. Scanner CD Roms

PLUS

- LINK up to 15 Disk files
- Scan VHF & HF Icom's Simultaneously
- Print to ANY printer or Disk file
- MULTIPLE search filters for Diskfile Scanning
- Search by CTCSS & DCS tones with OS456/535 or DC440 (ICOM only).
- Includes several large shortwave and VHF/UHF databases.
- NO MORE CONVERSION! Direct scanning of most DBASE, FOXPRO, ACCESS, BTRIEVE files WITHOUT "importing. Our Exclusive "AUTO-PLAN" even sets the mode and increment on the fly!
- UNIQUE database management system with moveable columns. Even SPLIT columns into doubles or triples for easy viewing of ALL important data on one screen.

Great for business and family uses, hunting, fishing, camping. No license required.



NEW PROFESSIONAL Microphones from LOWE



LEP300

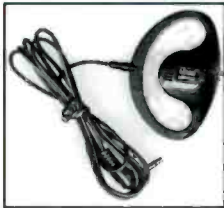

Extremely comfortable communications earpiece.

LEP 400 series

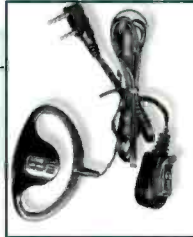

Earpiece with covert microphone and PTT switch.

LEP 500 series



Earpiece with lightweight boom microphone attached.

LEP 600 series



Single headband supported earpiece W/ boom mic & PTT

LEP 710



High quality speaker microphone with adjustable volume control

These Mics are available in either M, Y, or K versions for use with most popular brand name transceivers.

THE SRX100 RECEIVER

The new **LOWE SRX100** is an economy communications receiver intended for the newcomer to shortwave listening, or as a second receiver for the more experienced enthusiast. It sells for well under half the cost of our most popular receiver, the HF150, but nevertheless has an excellent specification for the price.



The SRX100 is extremely simple to operate, and can receive AM, CW and SSB signals. Some of the key features are shown below:

- Frequency range 30kHz to 30MHz
- 1kHz tuning steps
- Clarifier for SSB tuning ± 800 Hz
- 1 μ sensitivity
- 2 watt audio output
- Modes available: USB, LSB, AM
- Liquid crystal display
- Built in speaker
- Dual conversion superhet design
- Signal frequency readout to 1kHz
- Digital frequency readout to 1kHz
- British made
- 12VDC power adaptor supplied
- Dimensions: 7.3"W x 7.5"D x 2.5"H



The Hugger

"At your fingertips" convenience for handhelds and cellular phones. Quick, easy "no holes" mounting using your car air vents. Flexible gripper arms hug your radio yet allows quick, easy release.



Electronic Distributors
325 Mill St. • Vienna, VA. 22180
Ph: 703.938.8105
FAX: 703.938.4525
www.elecdist.com



For more information see your favorite dealer.

The Radio Connection

BY PETER J. BERTINI
<RadioConnection@juno.com>

A LOOK BEHIND THE DIALS

Summer Tag Sales and Summer Vacation

Summer is here! With summer comes vacations, and tag sales. I love tag sales; you just never know what vintage radio is lurking in some neighbor's garage or barn. Vacations are a great way to spend some time uncovering new treasures in far off antique shops. Reader George Gonzalez <grg@umn.edu> recounts a recent vacation experience.

"Our family went on a RV trip last summer through Wisconsin and Michigan. The plan was to enjoy the scenery, and maybe stop at an antique shop or two to find a few old radios.

"One day my wife was driving through the back-woods of northern Wisconsin. I'm sitting at the RV's table, dreamily watching mile-after-mile of pine trees and an occasional cabin pass by. The RV is shaking quite a bit over the bumpy roads—everything outside looks a bit jumpy and unreal. We come across a small town—nothing more than a few houses, water tower and post office. I happen to catch a glimpse of a sign in a shop window. Not really a proper sign, but more like whitewashed letters crudely dabbed on the inside of the window.

large shop with a lot of clutter, and through the dimness what could be some 1930s style radios. A sign tantalizes "more radios in next room." The room is out of sight. Radios in view, but no one to haggle with and no signs of life.

"The front door is locked and pad-locked. It looks as if it may have been closed for years. There is a garage door out back, leaning inward at a broken angle, with the bumper of a 1951 Chevy leaning against it. The place is overgrown and deserted. They may have been living quarters above the shop. I shout a few 'Hellos'. No one answers. So, I shout a few more times, even throwing in an 'I have moneeeey!', a fairly silly thing to do. We are now long overdue at our next campground, and must leave. As we drive off, I jot down the name and address of the place.

"Months later I call information and get a phone number for the shop. I call and call, but there is never an answer. I often consider travelling back and investigating further—but I think better of it. Perhaps it has more value as a mysteri-

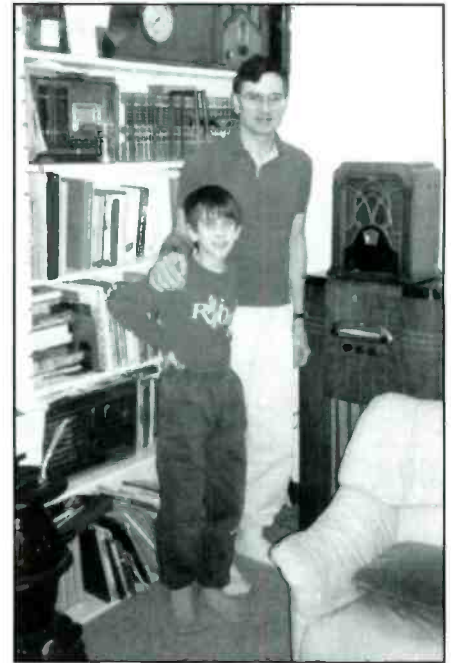

Reader Greg Gonzalez and son, 8-year old Eric, admiring part of Greg's collection. Shown is an early GE console, along with unidentified tombstone and cathedral radios.

Antique Radios For Sale

"It takes a few seconds to register. 'Whoa! Did I see this?' I must be seeing things. Twenty seconds pass and we are again well into the woods. Gathering my nerve I said 'Ah, dear, I saw something interesting back there.' After a few incredulous looks, we find a wide spot in the road and turn around.

"Vacations are a great way to spend some time uncovering new treasures in far-off antique shops."

"Sure enough, the building and sign are there. The place is some ancient storefront, barely standing. It is 6:30 on a Sunday evening, and the store and town are deserted. Peering through the stained and cracked glass window I make out a



More radios! This portion of Greg's collection includes some beautiful consoles from the 1930s and 1940s, along with some interesting table-top sets.

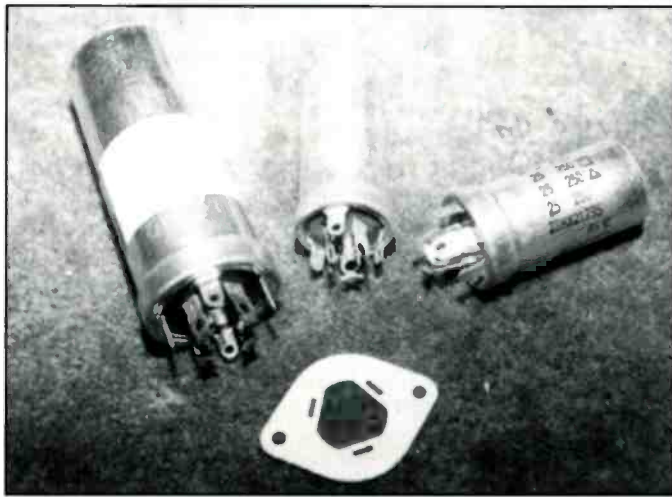

↑ "F" style capacitors use twist-tab mounting. Shown with an un-insulated mounting plate.

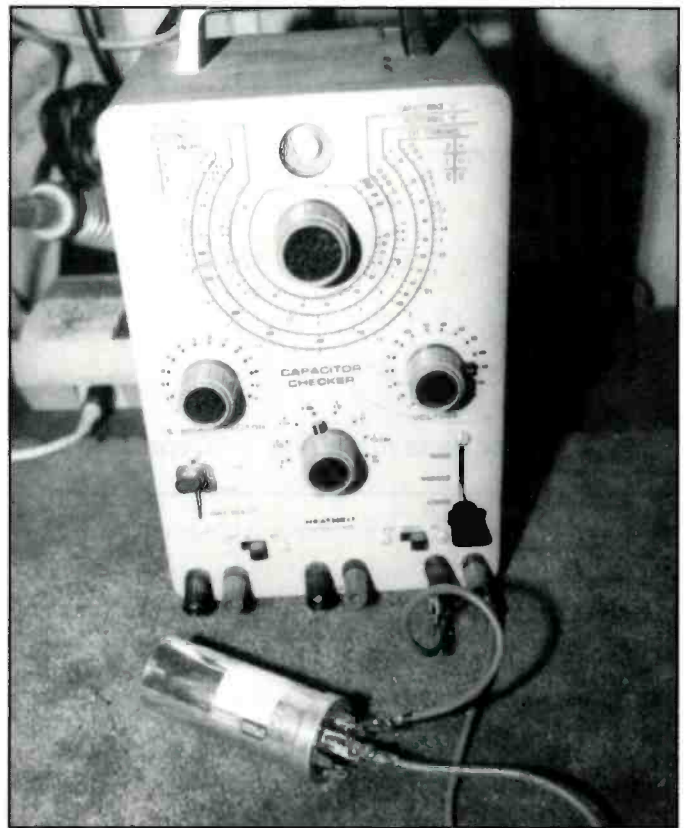

An electrolytic capacitor is checked for leakage while being "reformed" on the author's Heathkit IT-28 capacitance checker. The internal "eye" tube gives an indication of current being drawn by the capacitor. ▶

ous little place—visible, but untouchable. A big dusty mystery, where you can see just enough through the cracked glass window to let your imagination run free."

George also kindly shared some photos of his radio collection. His son Eric, age eight, isn't into collecting vintage radios, but did ask dad when he was six how he checked the tubes inside his tube checker. HmMMM.

More On Capacitors

Last month we talked a bit about mylar capacitors. I think it's time we took a harder look at filter capacitors. I advocate using new capacitors when ever possible, but, I would be hard-pressed to give you an exact date when a NOS or original capacitor has reached the end of its useful life. Obvious signs that a capacitor is due for a change are signs of leakage around the solder terminals or seals, or capacitors that are a "dead" short. Capacitors that show signs of heating should be immediately replaced! They may also "dry-out," and lose the ability to filter properly (loss of capacitance), and the radio will have a very loud hum. The earliest electrolytics used a liquid solution—even some of those early 1930 relics are still usable to this day! More than likely it will be found that the solution long since

has evaporated and the capacitor is no longer functional.

The FP Style Capacitor

Mallory introduced the "FP" style electrolytic can capacitor in the very late 1930s. This capacitor uses twist-lock mounting tabs. Usually either a metal plate or insulated phenolic plate is used for mounting the capacitor. The insulated mounting plates are used when the filter capacitor is not directly connected to the chassis ground. This is very common in vintage sets. Usually one of the two filter caps is insulated in those early sets. Earlier capacitors used either insulating washers, or cardboard sleeves to isolate the capacitor can from ground. If your set has the FP style capacitors, it was made after 1939.

Early capacitors housed only one capacitor in each assembly. With the FP style came the ability to offer multiple capacitors in one compact package.

For grounded cans, it is important to solder at least one of the twist mounting tabs to the metal mounting plate, and the mounting plate should be secured to the chassis by the use of star washers along with the nut and screw hardware to insure a good ground connection.

Many experienced restorers do not advocate indiscriminately replacing FP

style capacitors. If the capacitor shows no sign of leakage—usually noticed around the seals where the solder lugs emerge—they usually have many years of life left. Like many other electronic components, excessive heat leads to premature aging and failure. Before firing up a set using older FP style caps, you must first check the capacitors and reform them.

Identifying Capacitor Terminals

The photo of the "F" style caps and **Figure 1** illustrate the marking scheme used for identifying the terminals when more than one capacitor is housed in a single F style can housing. Up to four separate capacitors may be found in these cans. The normal marking scheme uses a square, triangle, rectangle or half semi-circle to indicate the correct terminal. The symbol is drawn on the label next to the capacitor value and voltage rating, and is etched in the phenolic base near the terminal associated with that capacitor value. Normally all capacitors use the can for a common negative ground return.

Reforming Capacitors

Newer "dry" electrolytics use a special paste that forms the dielectric during

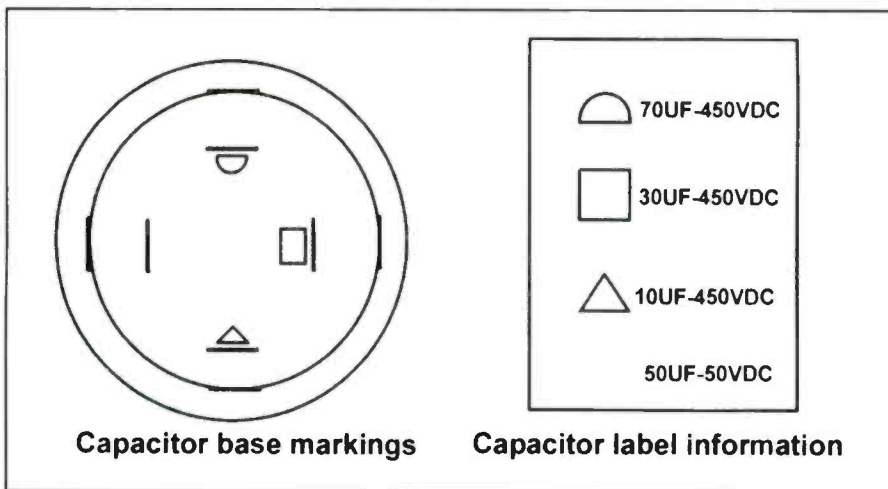

Figure 1. Capacitor terminals are identified by using symbols.

manufacture. Despite the name, they aren't really "dry," you just don't hear the electrolyte sloshing around in the can as in the olden days! And, they don't puddle all over your workbench (through the vent holes on top) when the chassis is inverted for service. Don't worry if one does this, the solution is boric acid and is not dangerous to handle.

Metal encased capacitors have safety vents to prevent explosive pressures from

building up inside the capacitor. The operating DC voltage applied to an electrolytic helps to maintain the insulating dielectric. A poor terminal or vent seal can allow this paste to dry out, making the capacitor no longer usable or recoverable. A dry electrolytic that has been in storage for many years may need "reforming" before being used. Reforming involves slowly increasing the DC voltage applied to the capacitor while measuring (or limiting) the current being drawn by the capacitor. While watching that the current remains low; under a few milliamperes the voltage is slowly increased over a period of several hours until the capacitor is being subjected to its rated voltage. This procedure allows the capacitor properly "reform" its dielectric in a nondestructive manner.

The Heathkit IT-28 Capacitor Tester

We will talk more about useful test equipment for your shop in future columns. One such instrument is the capacitor checker. My Heath IT-28 allows measuring most of the capacitor values used in vintage radios, including low value micas, coupling and by-pass capacitors and electrolytics. The IT-28, and many other testers, allow testing of the leakage current being drawn by a capacitor under voltage. This is done by an eye tube and a variable voltage output.

DC supply built in the IT-28. The unit will supply from one to 600 volts in several ranges, making it an ideal tool for reforming electrolytics. A internal 10,000 ohm power resistor is always in series with the capacitor under test and prevents a shorted capacitor from damaging the IT-

28 power supply. It also prevents a leaky capacitor from overheating, and possibly exploding! This resistor also serves to discharge the capacitor when the testing is finished.

I obtained my IT-28 at an amateur radio club's annual auction for five dollars! While capacitor testers have the gone the way of tube testers and Dodo birds, used ones are quite common, and finding a good used unit shouldn't be a problem. Check vintage radio publications, such as *Antique Radio Classified*, to locate a good used tester.

Floating-Ground Filters and Tube Biasing

We aren't ready to discuss how tubes work, or tube "biasing" in great detail at this point. But, it is important to understand that most radio circuits using tubes are operating in a "linear" mode. Linear means that the circuits amplify signals with minimum distortion. The operating mode for a tube is determined by a DC voltage bias level on it's control grid.

Radios use several methods to bias tubes. Some radios may employ more than one method, such as:

1. **The C cell.** C cells were popular in early battery sets, where a separate "C" battery was used for biasing.
2. **Cathode biasing.** Cathode biasing uses the voltage drop developed across the cathode resistor to self bias that tube.
3. **External bias voltage.** The power supply is used to develop a negative voltage for biasing the audio tubes into class A operation.
4. **Class C, self biasing.** Bias voltage is developed by grid cathode rectifier action when the grid is driven positive into conduction. Most commonly found in AM or CW transmitter power amplifier stages.

Earlier I mentioned that you may see an electrolytic can insulated from the chassis in some early sets. This is common in sets where the power supply also develops a negative bias voltage for the audio tubes. Regardless, always treat electrolytic capacitors with respect! Good ones can hold charges for hours, if not days. Always discharge the filter capacitors before working on a set.

Next month we will discuss this in detail, and we will learn that choosing voltage ratings for replacement caps in these sets can be trickier than it appears! Until then, happy hunting!

ANTIQUE ELECTRONIC SUPPLY
TUBES PARTS BOOKS SUPPLIES

CALL OR FAX TODAY
FOR OUR FREE 52 PAGE CATALOG
(602) 820.5411 • Fax (800) 706.6789

ANTIQUE ELECTRONIC SUPPLY™ LIMITED PARTNERSHIP
6221 S. Maple Avenue Tempe, AZ 85283
CIRCLE 6 ON READER SERVICE CARD

VIDEO SYNC GENERATOR

Restores Horizontal and Vertical Sync Lines from Distorted Analogue Video Formats

For Free Information Package on Completed Units and Pricing

• Call 219-236-5776 • VISA

R.C. Distributing • PO Box 552 • South Bend, IN 46624
CIRCLE 76 ON READER SERVICE CARD

KNOW the TONE

NEW



The all
New DC442
CTCSS,
DCS, and
DTMF
tone decoder!

Easy multi-function
POWER/MODE
button

ICOM R100 not sold or distributed by Optoelectronics

**SEE US
AT DAYTON
BOOTHS
70,76, & 77**

An asterisk appears next to an active tone, this ensures accurate tone decoding

You can't be without the **ALL NEW DC442 TONE**

DECODER. Use with any receiver for instant **CTCSS, DCS, and DTMF** decoding. The DC442 has the competition

beat with its **ALL MODE DECODE** function. Switching between functions is no longer necessary. With built-in RS232 and CI-5 receiver compatibility the DC442 becomes the ultimate instrument for computer controlled receiver applications. The DC442 is versatile enough for the bench and portable enough for the field. If you want to **KNOW THE TONE** you **NEED** an **OPTOELECTRONICS**

DC442 DECODER.....\$259.00

\$299.00 w/ NiCads



FEATURES

- Decodes 52 CTCSS tones, 106 DCS codes, and 16 DTMF digits
- Built-in RS232 / CI-5 compatible interface
- ALL MODE DECODE. Decode any CTCSS, DCS, or DTMF automatically without switching functions
- Two line LCD display with EL backlight
- DTMF Memory: 1,023 scrollable digits
- User adjustable CI-5 address and Baud Rate
- One button POWER/MODE control
- Compatible with any receiver or service monitor
- NiCad option for portable operation
- Size: 1.8"high x 4.5"wide x 4"deep

**FACTORY DIRECT ORDER LINE:
800 • 327 • 5912**

OPTOELECTRONICS®

5821 NE 14th Avenue • Ft. Lauderdale, FL • 33334

Telephone • 954-771-2050 Fax • 954-771-2052

Prices and Specifications are subject to change without notice or obligation

CIRCLE 150 ON READER SERVICE CARD

Radio Resources

BY BILL MAULDIN, WG4R
e-mail: 75750.1331@compuserve.com



INTERESTING THOUGHTS AND IDEAS FOR ENJOYING THE HOBBY

Computer Scanning

The first scanner I saw many years ago was made by Bearcat. The old Bearcat crystal controlled scanner contained eight crystals and eight channels. The frequencies, according to Bearcat instruction booklets, could be easily changed by simply changing the frequency controlling crystals. The row of eight flashing lights on the receiver indicated the channels as they were scanned. A new day for hobby radio listeners was born. I was hooked. I had to have one. That same scanner, my first, is still on my hobby shelf today along with my Police-Alert monitor and other listening tools of the '50s. As with all electronics, how things have changed!

One of the most exciting scanning tools that I have encountered recently has been the ultra fast programmable scanner. Although a very useful and enjoyable listening tool, the scanner that offers 400 plus channels, all scanned in the blink of an eye, can also have limitations. Many times, the scanner will search out a frequency that will catch your interest, but then as quickly as the transmission was captured, it is gone. What was that? Who was that? What frequency was that on? Where is my note pad? Believe me, this happens to all scanner buffs from the novice to the experienced. There is a solution to the problem. The answer is computerized scanning!

As you quickly glance through the pages of ads and articles in today's radio hobby magazines, you see many ads for ultra-fast scanners, scanning assist devices, and computer programs. The days of the old crystal-controlled Bearcat and the eight channels of excitement are truly far behind us. Companies such as Optoelectronics, Inc. Percon, Grove, RadioShack, EEB, Universal, AES, and DataFile are all offering products that would have cost thousands upon thousands of dollars a few years ago. Wait. What was that name? DataFile? Who is DataFile and what do they make?

DataFile is the company that makes, from my experience, the best computer program on the market today for com-

puter-assisted scanning. The program has been on the market for several years, and each version gets better, offers more features, and is easier to use. The program is named Probe, and version 3.0 is out! If you have a RadioShack scanner and a computer, you are already half way to becoming a computer-assisted scanning enthusiast. Let me tell you just a little about Probe and what computer assisted scanning is all about.

Initially, sometime back, when Probe 2.0 crossed my scanning desk, I objectively loaded the program in my computer. I have previewed many scanning programs over the years, but even with this early edition of Probe, I could tell immediately that I was dealing with a very different program. It really worked. That is the main thing about computer scanning programs that drives me crazy. Many don't work well, and others require an experienced computer person on the keys. Probe, even the early Probe 2.0, worked, and it worked well. The current version of Probe is 3.0, and it will blow you away if you are a serious scanner user. This especially applies to those of you who work in newsrooms or other serious scanning places.

Using Probe

To use Probe, you need three things. First, you need a computer that you can devote to scanner control, either briefly or during the periods when you don't need it for other purposes. Just a simple, much older 286 model will do. Used, older, slower laptops and desk computers are available just about everywhere for almost nothing these days. Next, you need a RadioShack scanner such as the older PRO-2005, PRO-2006, or the more current PRO-2035. Chances are if you are into scanning to any degree, you have a RadioShack scanner. DataFile can advise you if your model will work. My computer scanner is the older 2006 model. To date, Probe has only been written to work with the RadioShack scanners. You can bet if there is enough interest, Probe will

be produced for other scanners such as the advanced Bearcat and ICOM models. Finally, to complete your computer system, you need to get the special computer assist board from Optoelectronics, Inc. Opto ads are in most scanning hobby related computer magazines, and they have an easy to obtain 800 order number. The Opto board goes inside your scanner. Although it's small and easy for most technically oriented radio buffs to install, Opto does offer installation for a charge. You'll be without your scanner for a few days, but it will work well upon return. Consider this option if your ability to follow electronic instructions is limited.

"One of the most exciting scanning tools that I have encountered recently has been the ultra fast programmable scanner."

With the Opto board installed in your scanner, it will continue to work as a normal scanner when not used with your computer. You will notice no difference in the normal operation.

There is one additional item that will make your computer scanning system even more useful and much more enjoyable. Probe 3.0 has the ability to interface in a most useful manner with the Percon FCC database CD ROM. So, now you are asking, what will all of this software and software do for me that my scanner won't do now?

It is impossible to tell you about all of the features of the Probe 3.0 in this single article, but here are just a few of the highlights. Probe will take control of your scanner once the program starts. One of the menu selections is something called "SmartScan." When selected, "SmartScan" will allow you to select and load a group of frequencies and then place them in what I call a quiet bank. The frequencies are all there, loaded and ready. As you build the list, you select a "key" frequency or frequencies in the quiet bank.

Now, as you use your scanner to listen to your normal favorites, the quiet, "SmartScan" bank is there on standby. Then, suddenly, there is activity on one of your key frequencies. Immediately, "SmartScan" is aware that something is going on in the quiet frequency bank. With different methods of alerting you, the Probe takes control. The whole group of pre-loaded "SmartScan" frequencies is quickly opened and now you are not only scanning your normal interest listening channels, but you are now scanning the whole group of pre-loaded "SmartScan" frequencies. The bank is scanned until the activity dies down. Then, "SmartScan" detects the lack of activity and returns the full bank to the quiet, standby status.

How would a feature such as "SmartScan" be useful? Let me give you an example. Let's say your listening favorites are the normal police, fire, and ambulance channels. You know there is an accident in town. Fire rescue has been dispatched and has arrived at the scene, but you know little else. In one of your "SmartScan"

banks, you have the MED channels used in your coverage area. As the ambulance leaves the scene, the ambulance EMT calls the hospital on one of the MED channels with details on the patient and the related injuries. "SmartScan" knows there is activity, and in a blink of an eye, the MED channels are opened and scanned. You are in on the action. As soon as the activity on the MED channels stops, the MED channels are once again stored in standby by "SmartScan". This is a great feature when you are monitoring services such as airport fire alerts and interagency mutual aid channels. I'm sure you are already thinking of applications that would apply to your listening needs.

Hyperbanks

Probe 3.0 has another feature called "Hyperbanks". This is a very useful tool. Hyperbank allows you to customize your F-1 through F10 computer keys so that each F-key is a custom bank. The bank can have just about any specification that

"The days of the old crystal-controlled Bearcat and the eight channels of excitement are truly far behind us."

you need. These are not just added frequency lists, if used correctly. You can enter a description for each bank. This description will show at the bottom of your control screen. How does this work and how would it help improve your scanning? In my case, my F-1 bank is devoted to all of the fire and EMS dispatch channels in my town. I use F-2 for local and surrounding law enforcement agency channels. F-3 is used for the low band and VHF state highway patrol channels. F-4 contains the special interest channels. F-5 is devoted to the local airport aviation frequencies and airport fire rescue. F-6 is one that I use to store and monitor special catches that I discover during my frequency searches.

To me, Hyperbanks biggest plus is the use of the computer's function keys for searching. Since you can program any Hyperbank in just about any way, I use F-7, F-8, F-9, and F-10 for serious searching. Although I enjoy catching the local public safety action, I find searching perhaps the most interesting and enjoyable part of the scanning hobby. I have F-7 programmed to be my first Hyperbank search channel. It will search all frequencies between the upper and lower limits that I have established and do it in 10 kHz steps. F-8 is programmed to search between different upper and lower frequency limits in steps of 12.5 kHz steps. F-9 is programmed to search between my desired limits, and in this bank, it does it in 30 kHz steps. F-10 is used in the same manner, but both the steps and limits are changed often to fit my needs and desires. Using Probe Hyperbanks in this manner will give you the ultimate searching tool. It is extremely useful when searching out some of those new and completely unknown 800 MHz channels that are popping up in your area these days.

Although the RadioShack scanner has programmed scanning limits, especially on scanning speed and channel numbers, Probe can program your scanner to suit your personal needs. Getting an increased scanning rate is easy. Rates of 50 to 75 channels a second is a normal operation when using Probe controlling selections. Anyway you look at it, scanning at that

YOU AIN'T HEARD NOTHIN' YET

Since 1967, CRB Research has been the world's leading publisher and supplier of unique hobby and professional books and information including:

- Scanner Frequency Guides
- Shortwave Freq. Guides
- Military/ Federal Comm.
- Broadcast Station Registries
- Undercover Communications
- & Other Related Topics!

New titles are constantly being added to our exciting catalog. If it's interesting and unusual, we've got it.

YOU'LL SEE.

CRB RESEARCH
P.O. Box 56, Commack, NY 11725
Ph: (516) 543-9169 FAX: (516) 543-7486
e-mail: crbbooks@aol.com

Ask for our latest FREE catalog.

CIRCLE 11 ON READER SERVICE CARD

Get online with **POP'COMM** on Delphi!

DELPHI INTERNET™

To sign up dial **1-800-365-4636** with your computer & modem, and enter **ELECTRONIC** at the sign up password prompt! You can find **CQ VHF Magazine** in the **Radio & Electronics Forum (GO RADIO)**.

CIRCLE 67 ON READER SERVICE CARD

Rave Review Pop Comm April '96

SEE US ON THE WEB! www.vikingint.com

Professional 10 HOUR RECORDER "BUILT LIKE A BATTLESHIP"

- Heavy duty commercial recorder - NOT improvised from consumer models
- 12, 14, and 16 hour models also available
- BUILT-IN voice activation (add \$30)
- Applications information included
- Dimensions: 11.5 x 7.0 x 2.75"

SPECIAL Pop Comm Price... \$159

FREE SPECIAL EQUIPMENT WARRANTY

COO's OK Calif residents add tax Sorry, no credit cards Free catalog USA only, other countries \$5 .Includes UPS to 48 States

Viking International 150 Executive Park Blvd. #4600 San Francisco, CA 94134
Factory Direct Phone: (415) 468-2066 • Fax: (415) 468-2067 "Since 1971"

CIRCLE 82 ON READER SERVICE CARD

speed has definite advantages. Many of you live in lower activity areas where you probably listen to only 30 to 40 channels maximum. Just think of scanning every frequency on your listening list in less than a second.

There is another strong advantage in this Probe fast scanning feature. For those of you who scan in areas where you would like to monitor your priority favorite channel and yet scan many additional channels, here is a real plus. Probe treats the Priority Channel in an extended and improved light. For example, you can scan 99 channels at 60 channels a second. As you do this, you can also load the group of frequencies with several different "priority channels". As action takes place on any of your preprogrammed priority channels, the scanner will stop and let you in on the action. Then, when the transmission is over, normal 99 channel scanning resumes.

Additional Features

You can even take this "SmartScan/Priority" feature even further. Let's say you are scanning 100 channels. All of a sudden, there is action on one of your "priority channels". As the channel activates and the "priority channel" is opened for monitoring, Probe performs another computer controlled action! Remember, the "SmartScan" feature that opened up a preprogrammed bank when just one of the channels became active? Here we are scanning 100 channels at the rate of 60 channels a second, and now your local fire mutual aid channel has suddenly activated. By using "SmartScan", Probe will open your "fire alert" frequency bank and add this full list to the frequencies you've already been scanning! You are there and catching all of the action calls.

With the Probe "data handling" feature, you can control and completely manage your frequencies. By using "automark", you can scan while you are away from the computer. Probe will control the scanner. It will take care of your logging, noting, and marking of the frequencies that are active. You can throw away that frequency notebook that you have been using for years. Probe will allow you to print custom frequency lists for your records or your friends.

If you add a CD ROM to the computer hardware and the Percon FCC database, Probe will not only log the activity on a frequency catch, but will also note the frequency user from the local license

The Best* Just Got Better!

The Eavesdroppers™ now includes our new Zap Trapper™ Electronic Gas Tube Lightning Arrestors. Receive-only design shunts damaging transients to ground at only 1/7th the voltage buildup of the available 200 watt transmit-type arrestors, providing maximum solid state receiver protection.

Protect your investment - combine an excellent shortwave receiving antenna with the best receiver protection money can buy.



- Completely assembled and ready to use
- Only 42' overall length
- 8 trap circuits permit reception on all shortwave bands, 11-90 meters.
- All connections soldered and enclosed in ultrasonically-welded, hermetically-sealed trap covers
- Includes 50' of 450 lb. test nylon rope

- Model T includes 100' twinlead feedline
- Model C includes weatherproofed center connector for your coax & coax sealant
- Either model \$79.95
- UPS for lower 48 states \$6.00
- COD add \$4.75, IL add 8.25% sales tax
- Foreign shipping quoted

* "The best...built like an antenna should be." -Larry Magne in *World Radio TV Handbook*
 * "Our best seller." -EEB in their recent ads and catalogs
 * "Now in use in 45 countries." -Gilfer Shortwave in 1983

Antenna Supermarket

P.O. Box 563 Palatine, IL 60078 Tel (847) 359-7092 Fax (847) 359-8161

At your dealer or direct • Visa & Mastercard accepted

data, and it will give you the location of the transmitter site. The Percon CD is fantastic when used with Probe during travels. You can make quick frequency catches that are all entered in your capture log. The frequency, user, number of times captured, and transmitter location are all there for your logbook and data management later. By using the limits of the Percon "radius" search, you can control your listening coverage area. Try using that one with just a 5 mile listening radius for some really interesting data captures!

Probe offers several visual alarms and alerts that come in very handy too. If, for example, you are using a color screen, you can program Probe to display the catch or monitored channel in a special color; blue for police, red for fire, yellow for EMT, and it will alert you to the service of the catch and capture. You simply pick the colors.

Perry Joseph and the guys at DataFile initially had a great computer-assist program in Probe. Probe 2.0 was even better. Probe 3.0 totally blows away any other scanning assist computer programs

that I have used or tested. Several years ago, I worked as a member of the FCC Amateur Auxiliary Enforcement team. Part of my duties included working with the FCC Enforcement personnel at the monitoring stations. I had considerable knowledge of the receiving equipment used by government personnel. At that time, with all of the money that Uncle Sam devoted to enforcement monitoring tools, there was nothing in the FCC inventory that had the power of Probe. This outstanding computer program and the related hardware will give you a fantastic, versatile scanning tool that will greatly expand your enjoyment and knowledge of what is really out there! And, it can be yours for a reasonable price. If you have the scanner and a computer you are almost there now.

Information on DataFile's Probe and details about how to order your copy can be obtained by contacting DataFile, Inc., Post Office Box 20111, St. Louis, Missouri 63123. If you are in a hurry, send a stamped, self addressed business envelope. Happy scanning! ■

The Computer Corner

BY ED GRIFFIN and BONNIE ZYGUMNT

RECEIVER CONTROL, SOFTWARE AND MORE

Using The DELTACOMM I-8500

This edition of the Computer Corner begins with a review of a software control package from Delta Research named DELTACOMM I-8500. This software is a DOS program for use on an IBM compatible system with a 286 or better CPU, a minimum of 640k RAM, and is tailored for use with ICOM's I-8500 receiver.

The program requires a PC COM port for interfacing with the radio. A security key installs on the PC's printer port, allowing your printer to remain connected and be used normally. If the software is used without the key attached, you can still edit files, but not control the radio. The software comes on a 3.5" 1.44 Mb disk and a 31 page bound users manual is included. The product information says that scanning speeds in excess of 2400 channels a minute are possible.

Searching and scanning, as well as instant tuning to a frequency are possible using keyboard input. Keyboard control of volume level and other parameters is possible. The program uses files to store frequencies to be scanned, and these files can be exported, or an import function can be used to bring data from an outside source into the scan files. Exporting and importing ASCII delimited files for scan and search groups is supported.

Each of the 100 records in a scan file can have multiple parameters set. These settings allow you to tailor the volume, delay, maximum monitor, attenuator, lockout, hit counter, and 40 character alpha tag for each frequency you program. The program displays tuned frequency, signal strength, mode, date, and time on your computer's screen. It's possible to capture all of the information from a scanning or search session into log files for later analysis. Logs may be sent to the screen, printer, and/or disk.

Other Built-In Features

There are built-in features that can automatically calculate total spectrum usage time, or if monitoring a trunked system, record when the system is 100



Delta Research's DELTACOMM I-8500 enhances the features of the popular ICOM IC-R8500 receiver. (Courtesy ICOM America, Inc.)

percent loaded. One method of searching that's especially helpful for nailing down any active stations is a search where, as stations are found, they are logged, and the search continues with that frequency being locked out. This keeps a busy frequency from slowing down the search process, and other less active stations from being missed.

A feature of the search software allows for the recording of all of the receiver birdies, which will then be skipped whenever running any search feature. This is handy, and can keep you from spending hours of searching time sitting on a false signal instead of logging new activity. The number of search loops to perform, the start and stop frequency, and the stepping increment while searching are all user-specified.

Scanning and searching based on signal strength is supported. While scanning, a priority feature allows for checking a specified frequency every 2.5 seconds. This parameter may be customized to another value.

It's possible to lock out or update the frequency and/or mode of a channel while scanning, without having to exit to the editor. The editor allows you to quickly sort a scan or search file by frequency.

A feature named CYBERSCAN is available to allow for diversion scanning based upon channel activity. It's beyond the scope of this column to explain how it works and how it would be used. If you have a need to monitor frequency hopping systems, or to monitor a group of frequencies only after a certain one is active, it can be very handy.

User-Customized Features

Another nice feature that users of monochrome or gray scale displays may wish to note, is that the colors used to display various information on the screen are fully customizible. This program is very capable of running quickly, and allowing a user to customize the program and scanning or searching parameters to meet their needs. I like the fact that you can set the volume control for each channel, as some stations I monitor are louder than others: this helps even the sound level out. A single keystroke can mute the audio, making this feature handy when your phone rings. It can be run on modestly-equipped systems and it's easy to learn how to enter data into the program's screens.

Importing data requires you edit it to meet the format required by I-8500, but this isn't too difficult. There's a limit of 100 channels in a scan or search file which seems to be a drawback, but in practice, many folks may never scan that many frequencies at one time for fear of missing traffic on a lightly used channel. This package is also limited to controlling the I-8500, although scanning hand-off to other ICOM receivers is mentioned as an option.

Delta Research Support and Notes on the R8500

Support from Delta Research has, in my experience been very good, and they have been easy to reach with questions about their products. And, as a happy owner of an ICOM R7100 for many years, I'd like to point out some of the improvements ICOM has included in the newer R8500 that have been very obvious to me while using a loaned R8500. A nice feature of the ICOM R8500 when compared to older ICOM radios, is that it has a built-in serial port for its computer interface. No additional level converter is required. A simple serial cable between your PC's COM port and the radio is all that's required to allow software to control the radio. There's a provision for use of a CI-V interface so folks with multiple radio setups or reaction tune needs aren't left out. The R8500 is larger, and has a more rounded appearance to its front panel. The buttons and knobs are larger and easier to operate. It's still rather solidly constructed, and in my use has been very immune to intermod. It has additional coverage of HF bands below 30 MHz and because the power transformer is now outside the case, it doesn't get nearly as warm as the older ICOM's did. The ability to send audio out for data applications using the AGC connector after setting a jumper, and the addition of alpha tags to the memory channels, and faster scanning are welcome enhancements on the 8500.

On the other side of the fence, I don't like having the Rec. Remote and Rec. Out jacks moved to the front panel. I can see where that makes quick hook up easier, but since I always leave my recorder connected, the back panel approach looks neater and is out of the way. I also wish that the record-out jack was stereo, with the audio on one channel, and the UT-102 voice synthesized frequency readout on the other. A recording made with stereo

Motron 310 Garfield St Suite 4
PO Box 2748
Eugene, Oregon 97402
<http://www.motron.com>



SEE US
AT DAYTON
BOOTH 113

TM-16A DTMF & Rotary Decoder \$179.00 TM-16A Plus with RS-232 output \$249.00



S/H: \$8 USA, \$11 Canada, \$16 Foreign. Premium shipping available for an additional charge.
Visa, MasterCard, Discover & American Express Accepted. COD on Cash or Money Order basis only. \$5.

Orders: (800) 338-9058 Info: (541) 687-2118 Fax: (541) 687-2492

DTMF & ROTARY TEST DECODERS

TONE-MASTER™ TM-16A & TM-16A Plus

Decode and display DTMF from nearly any audio source; scanner, tape recorder, etc. And now decode and display either DTMF or Rotary digits from a telephone. TM-16A PLUS with RS-232 serial output includes Logger Software for optional automatic date/time/number logging using your IBM Compatible computer. Price and specifications subject to change without notice.



World's Most Powerful CB and Amateur Mobile Antenna*

Lockheed Corp. Test Shows
**Wilson 1000 CB Antenna Has
58% More Gain Than The
K40 Antenna (on channel 40).**

In tests conducted by Lockheed Corporation, one of the world's largest Aerospace Companies, at their Rye Canyon Laboratory and Antenna Test Range, the Wilson 1000 was found to have 58% more power gain than the K40 Electronics Company, K40 CB Antenna. This means that the Wilson 1000 gives you 58% more gain on both transmit and receive. Now you can instantly increase your operating range by using a Wilson 1000.

**Guaranteed To Transmit and Receive
Farther Than Any Other Mobile
CB Antenna or Your Money Back**
New Design**

The Wilson 1000 higher gain performance is a result of new design developments that bring you the most powerful CB base loaded antenna available.

Why Wilson 1000 Performs Better

Many CB antennas lose more than 50% of the power put into them. The power is wasted as heat loss in the plastic inside the coil form and not radiated as radio waves.

We have designed a new coil form which suspends the coil in air and still retains the rigidity needed for support. This new design eliminates 95% of the dielectric losses. We feel that this new design is so unique that we have filed a patent application on it.

In addition, we use 10 Ga. silver plated wire to reduce resistive losses to a minimum.

In order to handle higher power for amateur use, we used the more efficient direct coupling method of matching, rather than the lossy capacitor coupling. With this method the Wilson 1000 will handle 3000 watts of power.

The Best You Can Buy

So far you have read about why the Wilson 1000 performs better, but it is also one of the most rugged antennas you can buy. It is made from high impact thermoplastics with ultraviolet protection. The threaded body mount and coil threads are stainless steel; the whip is tapered 17-7 ph. stainless steel. All of these reasons are why it is the best CB antenna on the market today, and we guarantee to you that it will outperform any CB antenna (K40, Formula 1, you name it) or your money back!

*Inductively base loaded antennas
**Call for details.

Lockheed - California Company

A Division of Lockheed Corporation
Burbank, California 91520

Wilson Antenna Company Inc.
3 Sunset Way Unit A-10
Green Valley Commerce Center
Henderson, Nevada 89015

Subject: Comparative Gain Testing of Citizen's Band Antennas
Ref: Rye Canyon Antenna Lab File #870529

We have completed relative gain measurements of your model 1000 antenna using the K40 antenna as the reference. The test was conducted with the antennas mounted on a 16' ground plane with a separation of greater than 300' between the transmit and test antennas. The antennas were tuned by the standard VSWR method. The results of the test are tabulated below:

FREQUENCY (MHZ)	RELATIVE GAIN (dB)	RELATIVE POWER GAIN (%)
26.965	1.30	35
27.015	1.30	35
27.065	1.45	40
27.115	1.60	45
27.165	1.50	41
27.215	1.60	45
27.265	1.75	50
27.315	1.95	57
27.365	2.00	58
27.405	2.00	58

**58%
MORE
POWER GAIN
THAN THE
K40**

Individual test results may vary upon actual use.

CALL TODAY
TOLL FREE: 1-800-541-6116
FOR YOUR NEAREST DEALER
Wilson 1000

DEALERS Exclusive dealer areas still open

Roof Top Mount.....59⁹⁵ Little Wil.....29⁹⁵
Trunk Lip Mount.....69⁹⁵ Wilson 2000 Trucker .59⁹⁵
Magnetic Mount.....79⁹⁵ Wilson 5000 Trucker .79⁹⁵
500 Magnetic Mount .59⁹⁵ Call About Fiberglass!!!
Wilson 5000 BaseLoad — NOW AVAILABLE!

Wilson
ANTENNA INC.
1181 GRIER DR., STE. A
LAS VEGAS, NV 89119

New Internet Addresses Proposed

Now that most people who have tried the Internet are getting used to Web page addresses, there are plans to create even more address endings. There have been legal fights over domain names and as more people and businesses get involved, it has been harder and harder to find an Internet name that someone else hasn't already claimed.

Currently there are six different Internet addresses: .com for commercial businesses, .org for non-profit organizations, .net for networks, .edu for educational institutions, .gov for governmental bodies or .mil for the military. The International Ad Hoc Committee, made up of 11 representatives of Internet, legal and other international standards groups, has proposed that seven new endings be added. Before this plan can go into effect it must be approved by the Internet Society and the Internet Assigned Numbers Authority. These are both non-profit international organizations that help oversee the way the Net functions.

The new addresses would not affect the current Internet addresses. These changes may well be in place by the summer of 1997, so be on the lookout for these new address endings. Amaze and confound your friends by knowing what they stand for before they do.

CB Radio Resources on the 'Net

I was contacted by the Web designer of a page called "CB Radio Resources on the 'Net." He thought the readers of this column would find his collection of messages and links interesting. I must agree.

Mr. Rob Bellville has created a Web page with a wealth of information about the hobby of Citizens Band Radio. His main Web page featured a "Wintertime Tip," a sponsor's ad and links to other topics such as: What is CB Radio?, FCC Rules, CB-Related Web pages, CB WWWBoard, Miscellaneous, Add your link, and Sponsorship info.

Current Internet Addresses

.com—commercial businesses
.org—non-profit organizations
.net—networks
.edu—educational institutions
.gov—governmental bodies
.mil—the military

Proposed New Internet Addresses

.store—businesses offering goods
.info—information services
.nom—individuals who want personal sites
.firm—businesses or firms
.web—entities emphasizing the World Wide Web
.arts—cultural groups
.rec—recreational or entertainment activities

Under the "CB WWWBoard" there are non-commercial ads and a message posting area. Discussions on radio performance and requests for information about radios can be found here. Ads for selling and buying radio equipment are accepted if they are posted by individuals, but not by commercial groups.

For those who have commercial interests there is another section. It is the "CB-Related Web Pages." There, companies which sell radio equipment may be listed, along with Web pages created by other groups or individuals who are also interested in CB frequencies. Some listed there are: Astatic Microphones, Cobra Electronics, Copper Electronics, K40, and President CB.

There are also links to Web pages for international CB groups and individuals. Some of those listed are: Alfa Tango—Holland, Alfa Tango Venezuela, ALAN-Electronics—Germany, CB

equipment would make separating the synthesized voice from the recorded traffic easier via the use of two audio channels and balance control during playback.

Delta Research's Web site's URL is <<http://www.execpc.com/~deltacom>>. Their e-mail address is <deltacom@execpc.com>, and you can reach them via phone at 414-353-4567. Software updates for registered users of I-8500 will be available from their Web site. In addition to software for the I-8500, they also sell software products for the ICOM R7000, R7100, R9000 and other ICOM radios. I bought their I-7100 package when I first got my R7100, and still use it today. I'd like to thank Delta Research for the loan of a copy of I-8500, and ICOM America whose URL is <<http://www.icomamerica.com>> for loan of an I-8500, without which this review would not have been possible. Thanks are

also due for County Comm in Santa Clara, CA for providing me a very important right angle N type connector.

Precision Mapping 2.0 CD-ROM

I picked up a copy of Just SoftWorks Inc.'s Precision Mapping 2.0 CD-ROM at a recent ham swap meet. It runs on Windows 3.1 or better, 386 or higher PC's, and requires 4 Mb of memory, a CD-ROM drive, and a mouse. It's a complete detailed map of the entire continental U.S. on one disk that supports viewing, editing, printing, and searching the map data. Look-ups can be performed a number of ways including by zip code, city, and street name. It's pretty good for finding things, but it doesn't support importing items to be placed onto the maps. I'd say

most folks that have FCC license data with location information will want to skip this product for one that's more featured, but will also probably have to pay more than I did. If you just want a quick way to see where the local fire department is being dispatched, it should meet your needs just fine.

Networking

Using your computer to send e-mail, read newsgroups, participate in on-line chats or forums, and browse and publish Web sites is a very helpful way to add to your monitoring knowledge, or share it with others. There's a delay associated with printed materials like this magazine, and using other forms of media can help you get breaking news, and also have information sources between editions. Spending a little money on Internet and



Links include this one to K40 Electronics at <<http://www.k40.com/chindex.html>>.

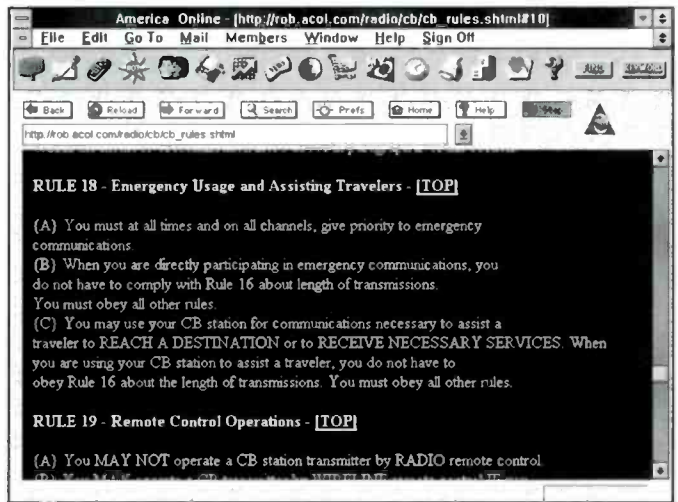

Looking for the current copy of the FCC CB Rules? Find them at <http://rob.acol.com/com/radio/cb/cb_rules.shtml>.

Frequencies from around the world, CB Packetradio (in Dutch), Christer's Home Page (Sweden), Euro CB Pro 101 (French), European Radio Club Echo Uniform, France CB (in French), Japan CB Radio, Liga Espanola de Asociaciones CB y R., Netherlands CB, Piraten News - in German, Radioamadorismo no Brasil, and UK CB Radio. I'm sure that if you have any interest in what's happening in other parts of the world in CB radio you can find it listed here somewhere.

Then there are some links with names that are just so unorthodox that they draw me to them. Such as: Ole Codgers SSB Club and CBs in Lava Caves. I'm not sure I'd qualify for the Ole Codgers club, but I know the name alone will make me go to their Web page to check them out.

Finally, it is good to see someone making the FCC rules for CB available on their Web page. I know some feel that FCC only stands for "Friendly to Commercial Companies" and many

"Mr. Rob Bellville has created a Web page with a wealth of information about the hobby of Citizens Band Radio."

chafe under rules of any kind, but sometimes they are necessary if large numbers of citizens all want to use the radio frequencies at the same time. Remember how Mom always said you had to share with your brothers and sisters <grin>? It's not a bad idea to re-read these CB rules once in a while, so that everyone can continue to enjoy this radio hobby.

If you get a chance to go to this Web page and any of the links from it, let me know if you enjoyed them. Also if you know of other radio-related Web pages you'd like to inform our readers about, let me know about them too.

Bonnie Zygmunt

"This program is very capable of running quickly, and allowing a user to customize the program and scanning or searching parameters to meet their needs."

on-line access can go a long way towards increasing the amount of information that flows your way. I read the <rec.radio.scanner> and <rec.radio.shortwave> USENET news groups every couple days. I'm subscribed to multiple mailing lists that send a daily assortment of scanning, military communications, HF utility, and other monitoring topic messages to my e-mail box. I read and create messages in the HamNet forum on CompuServe. And I try to connect with a weekly IRC chat. I have the e-mail addresses for many other folks whom I can send a message to asking them a question, or if they would please try and listen to something and report the results

back to me. I'm active in a local radio club, The Bay Area Scanner Enthusiasts; our monthly meetings are great, but the e-mail that passes among many of the members between meetings is just as helpful as attending the meeting, or reading the newsletters.

If you have an Internet account and are

"Support from Delta Research has, in my experience been very good, and they have been easy to reach with questions about their products."

already doing these things, then more power to you, but if not, why not consider some or all of them. I also would like to encourage those whose accounts offer them the ability to have a Web page to consider using some of that space for monitoring information. This is a way to contribute to our radio monitoring hobby and have some fun in the process. If you'd like some ideas, visit my Web site at <<http://ourworld.compuserve.com/homepages/griffined>>.

Coming in August

In our next column we'll take a look at the Hoka Code 3 Gold decoding product for PC's, and review the MacScan 8000 package from Design EQ for use with the AOR AR8000 and Macintosh systems. Until then, good listening!

Ed Griffin

ELECTRONIC COMPONENTS

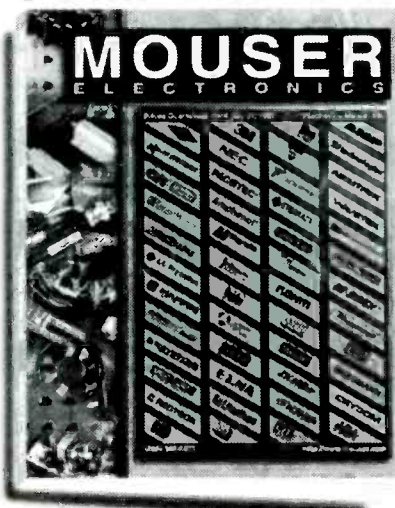

Call for your **FREE** 348 page catalog **TODAY!**

- 68,138 Products
- 128 Manufacturers
- All Orders Shlp Same Day
- No Minimum Order

800-992-9943

817-483-6828 FAX: 817-483-0931
<http://www.mouser.com> catalog@mouser.com

958 North Main St. Mansfield, TX 76063

CIRCLE 72 ON READER SERVICE CARD

SE SIGNAL ENGINEERING'S High Performance CB & 10 Meter Antennas

SUPERHAWK

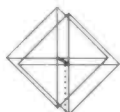

Goldenrod 45 Spyder A+
Broadband Hi powered MOBILE

WHITE LIGHTNING THE Four Element Antenna

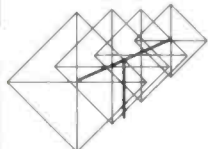

THUNDER 8
Hi Gain Bi-Directional OMNI Electronically Steerable

LIGHTNING 6

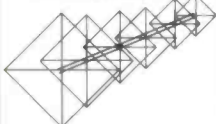

And, also, NEW QUAD LIGHTNING 8
THE most POWERFUL CB base in the world today!

ALL SE PATENTED rotary beams are true quads and OUTPERFORM their counterparts (quad/yagi types). SE's patented SFS matching system makes SE QUADS the most technologically advanced antennas in the world today.

If your dealer doesn't have SIGNAL ENGINEERING, write or call for full specs. DEALER inquiries invited. MasterCard, VISA, AMEX, Discover

SIGNAL ENGINEERING

1172 Aster Avenue, #E, Sunnyvale, CA 94086
 Phone: (408) 247-2300

How I Got Started

Catalog Shopping Leads to Bigger and Better Things . . .



Stefan's listening post is a RadioShack DX-360, DX-390, PRO-32 and a Bearcat Sportcat (with cellular) are used for scanning. A close look to the left shows a Ramsey FM-10A transmitter he's building.

Popular Communications invites you to submit in about 150 words how you got started in the communications hobby. Entries should be typewritten, or otherwise easily readable. If possible, your photo (no Polaroids, please) should be included.

Each month we'll select one entry and publish it here. Submit your entry only once; we'll keep it on file. All submissions become the property of *Popular Communications*, and none will be acknowledged or returned. Entries will be selected taking into consideration the story they relate, and if it is especially interesting, unusual or even humorous. We reserve the right to edit all submitted material for length and grammar, and to improve style.

The person whose entry is selected will receive a one-year gift subscription (or one-year subscription) to *Popular Communications*. Address all entries to: How I Got Started, *Popular Communications*, 76 North Broadway, Hicksville, NY 11801-2909 or e-mail your entry to <popularcom@aol.com>, letting us know if you're sending photos.

Our June Winner

When I was around 11 or 12 years old, I saw a shortwave receiver in the Fingerhut catalog. Remember Fingerhut? Only \$5.99 per month for 27 years, and it's yours! Anyway, I got mom to send for it and then fell in love with the world of radio. I still remember my first QSL card from station HCJB in Quito, Ecuador. Then came Radio Havana, Cuba. Then I discovered that you could listen to the cops talk on their radios (along with two shortwave bands, this Fingerhut special tuned the "public service band" 148-174 MHz) and this ultimately led to my becoming a police officer. I now have 14 years in the police service.

Nearly 25 years and one divorce later, I recently returned to my radio hobby. What a stress reliever! Divorce means budget, so for now I listen on a RadioShack DX-360, but the 23-foot wire antenna strung around the bedroom pulls in the signals. I even use an equalizer I got at a yard sale for \$5 to help filter the noise!

Two scanners and a computer make my post a home. ■

**INTRODUCING....
THE REVOLUTIONARY
CHEROKEE 6 METER
HT RADIO**

**Model
AH-50**



Cherokee, the new technology leader in wireless communications, is pleased to offer our new AH-50 HT, the smallest, easiest to use 6 meter radio in the world. Best of all, our unique design, when combined with the Cherokee "Mobil-Com" adapter, creates the world's smallest mobile 6 meter radio. A 6 meter HT that's also a mobile? Of course, and only from Cherokee! With a Cherokee radio, "Now You're Talking" sm

For More Information on the amazing AH-50 and where you can purchase it, call us at 1-800-259-0959, or visit us on the web at <http://www.wirelessmarketing.com>

CHEROKEE™

Cherokee is a trademark of the Wireless Marketing Corporation, Schaumburg, Illinois 60008

CIRCLE 12 ON READER SERVICE CARD

CB Scene

27 MHz COMMUNICATIONS ACTIVITIES

Is It Time for an Organization to Supplement REACT?

People keep forgetting. The reasons why aren't clear, but they keep forgetting the fact that our Citizens Band is the most popular radio service in the United States.

So let's for a moment review the statistics: Each year, several million CB radios are sold by the nation's retailers. The best guesstimates are that there is an installed base of some 40–50 million CBs out there. And that's just in the U.S. Cobra tells me that their sales are up 40 percent in the past few years, and they have introduced a number of new models. In the last year or so, Cherokee has fired up as a new brand name of high-quality CBs, and Midland has introduced a number of new rigs that are truly state-of-the-art.

So why mention the CB manufacturers? Well, even though the folks at Cobra, Cherokee and Midland are really good guys who genuinely believe in CB radio, they are also *business* people. That means they aren't going to invest in research and development to engineer new radios unless they believe that there really *is* a market for them.

Why Is CB So Popular?

The reasons for the popularity of CB aren't surprising—you don't have to apply for a license; you don't have to take a test; and you don't need to pay a fee. Walk into any RadioShack store in the country, plunk down 50 or 60 bucks, and you'll walk out with everything you need to equip your car or home to send and receive CB signals.

Now, compare this with some of the alternatives. To get the most popular ham radio license you have to pay a small fee and pass a test. Currently, there are roughly 660,000 licensed amateur radio operators in the country; that's a drop in the bucket compared to the number of Cbers.

To get a GMRS license, there's no test involved, but there is a fairly hefty license fee. There are only about 30,000 GMRS licensees in the U.S. As far as the new Family Radio Service (FRS) goes, the



+ ? = Improved Public Safety

radios themselves are designed for low power and fairly short range. So, even though there is no license required, the jury is still out on how popular this radio service will become.

Reasons To Be Proud

The point of all this is simply to say that, from my vantage point in 1997, Citizens Band is the King Kong of radio services. So it was great interest that a few days ago I received a newsletter from Crest REACT in Corona, CA. REACT stands for Radio Emergency Associated Communications Teams, and it was REACT International, along with several other organizations and individuals (including *Pop'Comm's* own Tom Kneitel), that was instrumental in finally getting the Federal Communications Commission to designate Channel 9 as the official emergency and traveler's assistance channel. On the cover, Crest REACT's newsletter said prominently, "34 Reasons To Be Proud." Number 1 was "Growth to the largest team in REACT." Wow, I thought, I can't wait to hear all the cool things the members of the world's largest REACT team are doing with CB Channel 9.

I called Bob Leef, editor of the Crest REACT newsletter and vice president of the team. He confirmed that Crest REACT has nearly 100 members. When I asked to interview him regarding how the team is using citizen's band radio, he said, "We aren't really using it. We have

a couple of members who monitor CB base stations, but mostly we use GMRS or ham radio."

I looked back at the other 33 "reasons to be proud" mentioned in the newsletter; none of them mentioned CB radio. Hmm... maybe I misunderstood something about the purposes of REACT. So I visited REACT International's Website on the Internet. "REACT An independent, incorporated, non-profit, tax-exempt, volunteer emergency communications public service civic organization," it said. So far, so good. "Radio Emergency Associated Communications Teams

"The reasons why aren't clear, but they keep forgetting that our Citizens Band is the most popular radio service in the United States."

are volunteers who are organized internationally, and use Citizens Band (CB) radios to provide public service communications for travelers and their local communities. REACT Teams use their radios to monitor Citizens Band Emergency Channel 9 in the interest of safety. REACT Teams also provide communications in response to emergencies and for community events. We utilize CB, UHF, VHF, amateur and other radio services," the website said. That sounded right to me.

So why wasn't Crest REACT deeply involved in CB? Was this an isolated case

“Perhaps the leadership of REACT feels that they must adapt and change according to the times.”

among REACT Teams? Then I remembered that about two years ago I had contact with a REACT team from Chicago that no longer monitors CB Channel 9 because of interference problems. So I called a friend of mine, a REACT insider (for the record, I, too, am a member of REACT). “What gives,” I said, “the largest REACT team in the world tells me they hardly use CB radio, and there is at least one other team that doesn’t use it at all.” He said, “You’ll find smaller, more rural teams rely heavily on CB, but as soon as a team starts to get really successful, they can afford to set up a GMRS repeater. Once they do that, pretty soon Channel 9 gets ignored. They figure they have better, more reliable, longer-range communications with GMRS.”

But wouldn’t ignoring Channel 9 be in conflict with the basic goals of REACT International? I went back to the Website and found a section that said, “REACT Objectives.” They are as follows:

1. To assist in any emergency by furnishing radio communications in cooperation with authorities and other volunteer organizations.

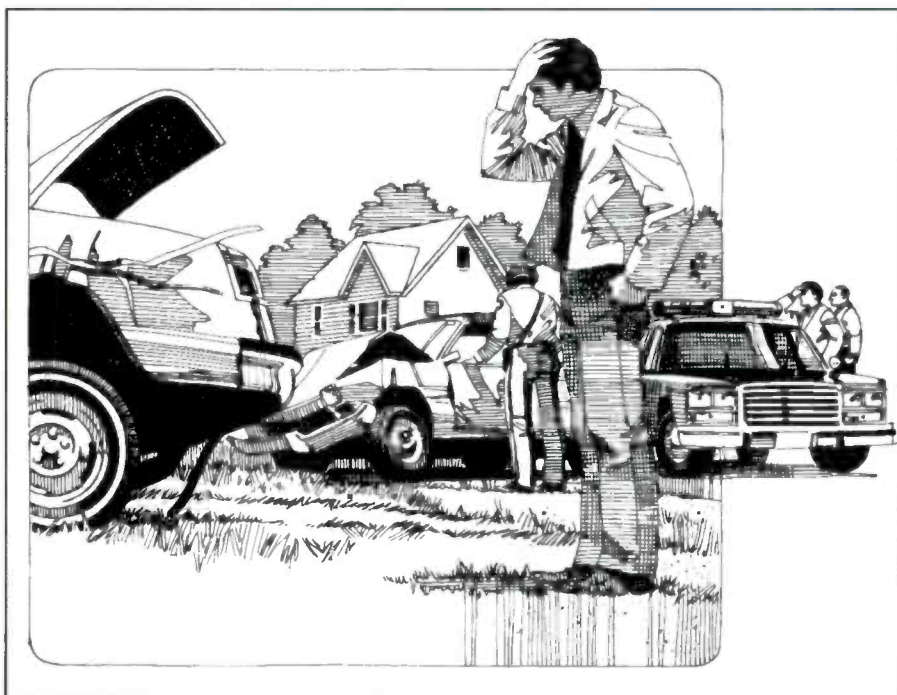

This could be you looking for highway assistance. Is anyone monitoring Channel 9 in your area?



4091 Viscount Street
Memphis, TN 38118
(901) 794-9494
Fax: (901) 366-5736

ANTENNAS • POWER SUPPLIES • CABLE ASSEMBLIES

HIGH PERFORMANCE and MADE IN U.S.A.

ALL MACO BASE STATION ANTENNAS are made of aircraft alloy 6063-T5 aluminum tubing—.050 wall. Elements are made of harder 6005 alloy.

NOTE! To prevent fatigue failure, no holes are made in any boom or element.

MACO
M105-HV



Dual Maximum Beam; 2 Beams on 1 Boom
10-11 METER VERTICAL/HORIZONTAL BEAMS

AVAILABLE IN 3-, 5-, 6-, 7-, AND 8-ELEMENT VERSIONS.

One part may be tuned for 10 meters
and the other for 11 meters.

M105-HV
Specifications:

Boom Length	26'
Boom OD	2"
Number Elements	10
Longest Radius	19'
Turn Radius	15'
Surface	
Area	8.47 (sq. ft.)
Wind Survival	90 mph
Tuning (MHz)	26.5-30
Gain	15.5 dB
VSWR	≤1.5
Power	
Multiplication	40X
Front-to-Back	
Separation	31 dB
Weight	40 lbs.

Call or write for free catalog and name of reseller near you.

CIRCLE 70 ON READER SERVICE CARD

2. To practice and encourage operation excellence through skilled communications techniques.

3. To maintain equipment at peak efficiency and operate in accordance with government regulations.

4. To advise the public in correct, effective use of CB Emergency Channel 9.

Now, these are all worthy objectives, but it seems odd that they do not include: “To monitor CB Channel 9 to provide assistance to the general public,” or something similar.

Then it occurred to me that there is a simple explanation. Perhaps REACT is evolving as an organization. I’ve been told that at the height of the CB boom during the 1970s, REACT had some 70,000 members worldwide. Now the membership has shrunk to somewhere between 7,000 and 10,000 members (depending on who is quoting the numbers).

Perhaps the leadership of REACT feels that they must adapt and change according to the times. After all, a few years ago, one of REACT’s board members wrote in the REACTer (REACT’s national newsletter) that, in essence, cellular phones would take over emergency calls on the highway and that there was no point in monitoring CB Channel 9.

There’s no doubt that many of the non-

“Volunteer help such as REACT is providing is one of the greatly under-appreciated assets of the nation.”

CB activities that REACT teams are undertaking are of great benefit to the public; providing auxiliary communications to the civil authorities when they are needed; assisting with communications at all kinds of special events; reporting traffic incidents through their GMRS and ham repeaters. REACT even has official “letters or memoranda of understanding” to provide communications for such organizations as the Red Cross and NOAA. These are all good activities that deserve a round of applause.

And some REACT members enjoy getting more involved in the “hands-on” aspect of handling emergencies. One REACT observer I spoke with said, “Many seem to be wannabees—wannabee cops, wannabee firemen, wannabee EMTs. They even want light bars for their vehicles.” Again, there is nothing wrong with wanting to plunge into the action to help. Volunteer help such as REACT is providing is one of the greatly under-appreciated assets of the nation.

Is Anyone Listening?

But where does that leave the general public? Mr., Mrs., or Ms. Public who can't afford the \$40 a month for a cell phone (real-world charges, not a theoretical budget plan) and who bought a CB

so they could get help “Just in case”? What happens when they press the priority button for “Emergency Channel 9,” call for help and there is no one listening?

Still there are voices within REACT calling for a renewed commitment to monitoring Channel 9. In the Jan./Feb. '97 issue of the REACTer, Ron McCracken, former President of REACT International, said, “REACT Teams have an important mandate to monitor CB Emergency Channel 9. It is the No. 1 priority. Our reputation was built on that pledge to the public. Millions of travelers continue to rely on REACT. Increasingly, REACT is their only link to help in emergencies. Is your CB on?”

“No one ever said monitoring CB 9 was going to be a picnic. Yet, Channel 9 is far better to monitor today than it has been in a decade or more. We have no excuse. If your REACT Team isn't monitoring Channel 9, it is misrepresenting itself to the public.”

And in that same issue, Bill Simpson, the Chairperson of the GMRS Committee, said, “It is time that we increase our time on Channel 9.” Is this to say that REACT isn't paying attention to Channel 9? There are many fine small teams and solo REACT operators steadfastly “standing watch” on Channel 9, and they are, it seems to me, the heart and soul of REACT. Last year, REACT International reported that in 1995, its members monitored CB Channel 9 and other frequencies a total of 3,631,668 hours. That's impressive, but when you divide the total number of hours monitored by 10,000 REACT members (including the teams that pay little or no

attention to Channel 9), it works out to only about an hour a day monitored by each member.

I know from personal experience that it's easy to rack up 30 hours a week monitoring Channel 9. Just turn on the CB, squelch out the noise, and go read a book, watch TV, or play with the dog. Monitoring doesn't mean you have to be glued to the CB—you simply have to be within earshot when a call comes through. So it makes me wonder why the average monitoring numbers aren't higher.

A Time For Choices

REACT International could, from the highest levels of its leadership, renew its commitment to CB Channel 9 and demand that all teams monitor 9 as a requirement for REACT membership. If not, perhaps the time has come for a new organization, one that would supplement the kind of organization that REACT appears to be evolving into. Maybe it is time for an organization that is single-minded in its purpose: To monitor the frequencies that are available to the general public—CB Channel 9, Marine VHF 156.8 calling and emergency frequency, 121.5 aircraft emergency, GMRS 462.675, and 146.52, the amateur two meter national calling frequency—and to relay the information to the appropriate authorities so they may respond.

Such an organization would not provide supplemental communications to the civil authorities, would not assist in communications for special events, and would not provide assistance beyond communications to people in trouble. There wouldn't be any need for light bars or uniforms. It would simply be ordinary citizens standing watch to listen for calls for help and passing the information to the professionals to respond.

As if to underscore the point, while I was working on this column, I took a call on Channel 9. It was from a trucker having trouble with his air brakes. He had pulled over to the side of the interstate and had called, “Is anyone monitoring Channel 9?” I took the information and turned it over to the state police. They said they would respond. When I told the trucker, he said, “Boy, I'm sure glad you're out there.”

It would be a shame to leave that trucker, and the millions of other Americans who have CBs in their vehicles, calling to a dead channel. I, for one, do not intend to forget. ■

MOVING?

If you're planning a move in the near future, don't risk missing an issue of Popular Communications. Please give us 6-8 weeks notice if you're planning a changing your address. Just write your new address and mail it, WITH YOUR SUBSCRIPTION MAILING LABEL, to:

POPULAR COMMUNICATIONS
76 North Broadway, Hicksville, NY 11801



We Have Scanners with 800MHz Coverage!

ICOM R9000, R8500, R10, R100
Yupiteru MVT-7100, MVT-8000, MVT-9000
AOR AR-8000, AR-5000, AR-3000A, Scout hookup's
WinRadio for PC-500Khz-1300Mhz continuous coverage

AR-8000 Wide Range Receiver
500KHz~1900MHz coverage AM/NFM/WFM/USB/LSB/CW
1000 Memory Channels (50 x 20) • Computer Interface
Ferrite Rod Antenna for below 2MHz • Selectable Step Size

ATLANTIC HAM RADIO Ltd.
(416) 636-3636 368 Wilson Ave
(416) 631-0747 fax Downsview, ON
<http://www.interlog.com/~ahr> Canada M3H 1S9

SEE US AT DAYTON BOOTH 488 BEHIND YAES USA



All U.S. Orders Shipped Air

Tap into secret Shortwave Signals

Turn mysterious signals into exciting text messages with this new MFJ MultiReader™



MFJ-462B Plug this self-contained MFJ MultiReader™ into your shortwave receiver's earphone jack.

\$169⁹⁵ Then watch mysterious chirps, whistles and buzzing sounds of RTTY, ASCII, CW and AMTOR(FEC) turn into exciting text messages as they scroll across your easy-to-read LCD display.

You'll read interesting commerial, military, diplomatic, weather, aeronautical, maritime and amateur traffic . . . traffic your friends can't read -- unless they have a decoder.

Eavesdrop on the World

Eavesdrop on the world's press agencies transmitting *unedited* late breaking news in English -- China News in Taiwan, Tanjug Press in Serbia, Iraqi News in Iraq -- all on RTTY.

Super Active Antenna

"World Radio TV Handbook" says MFJ-1024 is a "first rate easy-to-operate active antenna . . . quiet . . . excellent dynamic range . . . good gain . . . low noise . . . broad frequency coverage."

Mount it outdoors away from electrical noise for maximum signal, minimum noise. Covers 50 KHz to 30 MHz.

Receives strong, clear signals from all over the world. 20dB attenuator, gain control, ON LED. Switch two receivers and aux. or active antenna. 6x3x5 in. remote has 54 inch whip, 50 ft. coax.

\$129⁹⁵ MFJ-1024 MFJ-1312, \$12.95. **Indoor Active Antenna**

MFJ-1020B
\$79⁹⁵

Rival outside long wires with this *tuned* indoor active antenna. "World Radio TV Handbook" says MFJ-1020 is a "fine value . . . fair price . . . best offering to date . . . performs very well indeed."

Tuned circuitry minimizes intermod, improves selectivity, reduces noise outside tuned band. Use as preselector with external antenna. Covers 0.3-30 MHz. Has Tune, Band, Gain, On/Off/Bypass Controls. Detachable telescoping whip. 5x2x6 in. Use 9 volt battery, 9-18 VDC or 110 VAC with MFJ-1312, \$12.95.

Compact Active Antenna

MFJ-1022
\$39⁹⁵

Plug this new compact MFJ all band active antenna into your general coverage receiver and you'll hear strong clear signals from all over the world from 300 KHz to 200 MHz -- including low, medium, shortwave and VHF bands.

Also improves scanner radio reception on VHF high and low bands. Detachable 20 in. telescoping antenna. 9 volt battery or 110 VAC with MFJ-1312B, \$12.95. 3 1/4x1 1/4x4 in.

Copy RTTY weather stations from Antarctica, Mali, Congo and many others. Listen to military RTTY passing traffic from Panama, Cyprus, Peru, Capetown, London and others. Listen to hams, diplomatic, research, commercial and maritime RTTY.

Listen to maritime users, diplomats and amateurs send and receive error free messages using various forms of TOR (Telex-Over-Radio).

Monitor Morse code from hams, military, commercial, aeronautical, diplomatic, maritime -- from all over the world -- Australia, Russia, Hong Kong, Japan, Egypt, Norway, Israel, Africa.

Printer Monitors 24 Hours a Day

MFJ's exclusive *TelePrinterPort™* lets you monitor any station 24 hours a day by printing their transmissions your Epson compatible printer.

Printer cable, **MFJ-5412**, \$9.95.

MFJ MessageSaver™

You can save several pages of text in 8K of memory for re-reading or later review.

High Performance Modem

MFJ's high performance *phaselock loop* modem consistently gives you solid copy -- even with weak signals buried in noise. New threshold control minimizes noise interference -- greatly

improves copy on CW and other modes.

Easy to use, tune and read

It's easy to use -- just push a button to select modes and features from a menu.

It's easy to tune -- a precision tuning indicator makes tuning your receiver easy for best copy.

It's easy to read -- the 2 line 16 character LCD display with contrast adjustment is mounted on a sloped front panel for easy reading.

Copies most standard shifts and speeds. Has MFJ *AutoTrak™* Morse code speed tracking.

Use 12 VDC or use 110 VAC with MFJ-1312B AC adapter, \$12.95. 5 1/4x2 1/4x5 1/4 inches.

No Matter What Guarantee

You get MFJ's famous one year *No Matter What™* unconditional guarantee. That means we will repair or replace your MFJ MultiReader™ (at our option) *no matter what* for a full year.

Try it for 30 Days

Order an MFJ-462B MultiReader™ from MFJ and try it in your own setup -- compare it to any other product on the market regardless of price.

Then if you're not completely satisfied, simply return it within 30 days for a prompt and courteous refund (less shipping).

Order today and try it -- you'll be glad you did.

Receive Color News Photos, MFJ 12/24 Hour LCD Clocks, Weather Maps, RTTY, ASCII, Morse Code

MFJ-1214PC

\$149⁹⁵

Use your computer and radio to receive and display *brilliant full color* FAX news photos and incredible WeFAX weather maps with all 16 gray levels. Also RTTY, ASCII and Morse code.

Animate weather maps. Display 10 global pictures simultaneously. Zoom any part of picture or map. Frequency manager lists over 900 FAX stations. Automatic picture capture and save.

Includes interface, easy-to-use menu driven software, cables, power supply, comprehensive manual and Jump-Start™ guide. Requires 286 or better computer with VGA monitor.

Super Hi-Q Loop™ Antenna

The *Super Hi-Q Loop™* is a professional quality remotely tuned 10-30 MHz high-Q antenna.

It's very quiet and has a very narrow bandwidth that reduces receiver overloading and out-of-band interference.

High-Q Passive Preselector

MFJ-956
\$39⁹⁵

The MFJ-956 is a high-Q passive LC preselector that lets you boost your favorite stations while rejecting images, intermod and other phantom signals. Covers 1.5-30 MHz. Has preselector bypass and receiver grounded position. 2x3x4 in.

Mobile Scanner Ant.

Cellular MFJ-1824BB/BM
\$19⁹⁵
look-a-like. Covers 25-1300 MHz. Highest gain on 406-512 and 108-174 MHz. 19 in. Magnet mount. MFJ-1824BB has BNC/UHF plug; MFJ-1824BM has Motorola plug.

MFJ Antenna Matcher

MFJ-959B

\$99⁹⁵

Matches your antenna to your receiver so you get maximum signal and minimum loss.

Preamp with gain control boosts weak stations 10 times. 20 dB attenuator prevents overload. Pushbuttons let you select 2 antennas and 2 receivers. Cover 1.6-30 MHz. 9x2x6 inches. Use 9-18 VDC or 110 VAC with MFJ-1312, \$12.95.

High-Gain Preselector

MFJ-1045C

\$69⁹⁵

High-gain, high-Q receiver preselector covers 1.8-54 MHz. Boost weak signals 10 times with low noise dual gate MOSFET. Reject out-of-band signals and images with high-Q tuned circuits. Pushbuttons let you select 2 antennas and 2 receivers. Dual coax and phono connectors. Use 9-18VDC or 110 VAC with MFJ-1312, \$12.95.

Dual Tunable Audio Filter

MFJ-752C

\$99⁹⁵ Two separately tunable filters let you peak desired signals and notch out interference at the same time. You can peak, notch, low or high pass signals to eliminate heterodynes and interference. Plugs between radio and speaker or phones. 10x2x6 in.

Easy Up Antennas Book

How to build MFJ-38 and put up inexpensive, fully tested wire antennas using readily available parts that'll bring signals in like you've never heard before.

Covers receiving antennas from 100 KHz to almost 1000 KHz. Includes antennas for long, medium and shortwave, utility, marine and VHF/UHF services.

MFJ-107B

\$9⁹⁵

MFJ-108B **MFJ-105B**

\$19⁹⁵ **\$19⁹⁵**

MFJ-108B, dual clock displays 24 UTC and 12 hour local time *simultaneously*. **MFJ-107B**, single clock shows you 24 hour UTC time. *3 star rated by Passport to World Band Radio!*

MFJ-105B, accurate 24 hour UTC quartz wall clock with large 10 inch face.

MFJ Antenna Switches

MFJ-1704 **MFJ-1702B**
\$59⁹⁵ **\$21⁹⁵**

MFJ-1704 heavy duty antenna switch lets you select 4 antennas or ground them for static and lightning protection. Unused antennas automatically grounded. Replaceable lightning surge protection device. Good to 500 MHz. 60 dB isolation at 30 MHz. **MFJ-1702B** for 2 antennas.

World Band Radio Kit

MFJ-8100K
\$59⁹⁵ kit **MFJ-8100W**
\$79⁹⁵ wired

Build this *regenerative* shortwave receiver kit and listen to shortwave signals from all over the world with just a 10 foot wire antenna.

Has RF stage, vernier reduction drive, smooth regeneration, five bands.

Free MFJ Catalog

Write or Call tollfree . . . 800-647-1800

Nearest Dealer/Orders: 800-647-1800
Technical Help: 800-647-TECH(8324)

• 1 year unconditional guarantee • 30 day money back guarantee (less s/h) on orders from MFJ • FREE catalog

MFJ ENTERPRISES, INC.
Box 494, Miss. State, MS 39762
(601) 323-5869; 8-4:30 CST. Mon.-Fri.
FAX: (601) 323-6551; Add s/h

Internet: <http://www.mfjenterprises.com>

MFJ . . . making quality affordable

Prices and specifications subject to change ©MFJ Enterprises, Inc.

Pop'Comm's World Band Tuning Tips

June 1997

This listing is designed to help you hear more shortwave broadcasting stations. The list includes a variety of stations including international broadcasters beaming programs to North America, others to other parts of the world, as well as local and regional shortwave stations. Many of the transmissions listed here are not in English. Your ability to receive these stations will depend on time of day, time of year, your geographic location, highly variable propagation conditions and the receiving equipment used.

AA, FF, SS, GG, etc. are abbreviations for languages (Arabic, French, Spanish, German). Times given are in UTC, which is five hours ahead of EST, i.e. 0000 UT equals 7 pm EST, 6 pm CST, 4 pm PST.

UTC	Freq.	Station/Country	Notes	UTC	Freq.	Station/Country	Notes
0000	9705	R. Mexico Int'l	SS	0200	9735	R. Nacional Paraguay	SS
0030	4980	Ecos del Torbes, Venezuela	SS	0200	11710	RAE, Argentina	
0030	5965	R. Havana Cuba	SS	0200	11780	Radio Nacional/Radiobras, Brazil	
0030	7325	Austria Radio Int'l		0230	6140	Radio Tirana, Albania	
0030	9540	Radio Exterior Espana, Spain		0230	6200	Radio Sweden	
0030	11905	Radio Thailand		0230	7160	Radio Tirana, Albania	
0100	4805	Radiodifusora Amazonas, Brazil	PP	0243	7215	Qatar Broadcasting Service	AA, s/on
0100	4885	Radio Clube do Para, Brazil	PP	0250	6095	Vatican Radio	
0100	4919	Radio Quito, Ecuador	SS	0250	7200	Republic of Sudan Radio	AA
0100	5030	Adventist World Radio, Costa Rica	SS	0300	4910	Zambia National Broadcasting Corp.	unid
0100	5915	Radio Ukraine International		0300	4955	Radio Nacional, Colombia	SS
0100	6010	RAI, Italy		0300	4960	Voice of America relay, Sao Tome	
0100	6135	Swiss Radio Int'l		0300	5025	Radio Rebelde, Cuba	SS
0100	6190	Radio Budapest, Hungary		0300	9640	Radio Botswana	EE/local
0100	6260	Voice of Greece	GG/EE	0300	9690	China Radio International, via Spain	
0100	7105	Radio Tashkent, Uzbekistan		0300	9700	Radio Bulgaria	
0100	7115	Radio Yugoslavia		0330	4760	Trans World Radio, Swaziland	GG
0100	7180	Radio Ukraine		0400	3270	Namibian Broadcasting Corp.	
0100	7305	Slovak Radio, Slovakia		0400	3300	Radio Cultural, Guatemala	SS
0100	7345	R. Prague, Czech Republic	EE	0400	3330	Christian Voice, Zambia	
0100	9545	Deutsche Welle, Germany		0400	4775	Radil Liberal, Brazil	PP
0100	9650	Emisora Ciudad de Montevideo, Uruguay	SS	0400	4991	Radio Ancash, Peru	SS
0100	9675	RAI, Italy		0400	9730	China Radio Int'l, via French Guiana	
0100	9745	HCJB, Ecuador		0430	4770	R. Nigeria, Kaduna	sign on
0100	9835	Radio Budapest, Hungary		0430	6165	Radio Netherlands via Bonaire	
0100	15167	Radio Tahiti	FF	0430	9415	HCJB, Ecuador	GG
0130	7290	Radio Sweden		0500	3326	Radio Nigeria	
0200	2360	Radio Maya, Guatemala	SS	0500	4850	CRTV, Cameroon	FF
0200	3250	Radio Luz y Vida, Honduras	SS	0500	4904.5	Radiodiffusion National Tchadienne, Chad	FF
0200	4460	Radio Norandina, Peru	SS	0500	5550	Voice of the Tigray Revolution (clandestine)local	
0200	4755	Radio Edu. Rural, Brazil	PP	0500	6105	Radio Universidad, Costa Rica	SS
0200	4930	Radio Internacional, Honduras	SS	0500	6185	R. Educacion, Mexico	SS/EE
0200	4985	Radio Brazil Central, Brazil	PP	0500	7255	Voice of Nigeria	
0200	5077	Caracol Colombia	SS	0500	7480	R. Bulgaria	
0200	5930	Radio Slovakia International, Slovakia		0500	9475	Kol Israel	
0200	5990	Radio Exterior Espana, via Costa Rica	SS	0500	9485	Radio Bulgaria	EE
0200	6000	Radio Havana Cuba	EE	0500	9580	Africa No. One, Gabon	FF
0200	6025	Radio Amancer, Dominican Republic	SS	0530	4750	Voice of America relay, Sao Tome	FF
0200	6045	Deutsche Welle, Germany		0600	4815	RadioTV Burkina, Burkina Faso	FF
0200	6150	Adventist World Radio, Costa Rica	SS	0600	4870	ORTB, Benin	FF

UTC	Freq.	Station/Country	Notes	UTC	Freq.	Station/Country	Notes
0600	5004	Radio Nacional, Equitorial Guinea	SS	1330	11785	Broadcasting Svc of Kingdom of Saudi Arabia	AA
0600	6090	Caribbean Beacon, Anguilla		1330	13770	Radio Austria Int'l	
0600	7125	RTV Guineene, Guinea	FF	1400	13580	Radio Prague, Czech Republic	
0630	6015	R. Austria Int'l, via Canada		1400	15160	Radio Algiers Int'l, Algeria	
0700	4783	Radio TV Malienne, Mali	FF	1400	17560	Radio France Int'l, via Gabon	
0700	5860	HCJB, Ecuador		1400	17780	RAI, Italy	II
0700	5950	Voice of Guyana		1400	17830	Qatar Broadcasting Service	AA
0700	7155	RTV Malagasy	FF	1430	9485	Radio Sweden	
0700	11615	HCJB, Ecuador		1430	9535	Radio Japan NHK World	
0730	7265	Sudwestfunk, Germany	GG	1430	21515	Radio Portugal Int'l	
0800	5980	Radio Guaruja, Brazil	PP	1500	9785	China Radio Int'l	
0800	6070	Radio Japan-NHK World, via Fr. Guiana		1500	9910	All India Radio	
0800	6100	R. New Zealand Int'l		1500	11890	Radio Oman	AA
0800	9500	Trans World Radio, Swaziland	EE	1500	13635	Swiss Radio Int'l	
0900	3945	Radio Vanuatu		1500	17545	Reshet Bet, Israel	Hebrew
0900	6030	Radio Globo, Brazil	PP	1600	11690	Radio Jordan	
0900	6160	CKZU, Canada	PP	1600	11750	Qatar Broadcasting Service	AA
0900	9505	Radio Record, Brazil	PP	1600	11900	Channel Africa, South Africa	Swahili
0900	9885	Swiss Radio Int'l	II	1600	15160	Radio Algiers Int'l, Algeria	
0930	4895	Radio Bare, Brazil	PP	1600	15240	Channel Africa, South Africa	
0930	9665	Radio Marumby, Brazil	PP	1600	21560	Deutsche Welle, Germany	GG
1000	4780	Radio Oriental, Ecuador	SS	1630	15395	UAE Radio, Dubai	EE
1000	4790	Radio Atlantida, Peru	SS	1630	21700	R. Japan NHK World, via Gabon	JJ
1000	4996	Radio Andina, Peru	SS	1700	15715	WINB, Pennsylvania	
1000	6065	Colmundo, Colombia	SS	1800	11550	Monitor Radio, USA	
1000	6095	Radio Nacional, Peru	SS	1800	11850	Voice of the Great Homeland, Libya	AA
1000	6106	CKZN, Canada		1800	11975	VOA relay, Sao Tome	
1000	6155	Radio Fides, Bolivia	FF	1800	15265	Radiobras/Radio Nacional, Brazil	
1000	21605	UAE Radio, Dubai		1800	15450	RTT Tunisia	AA
1030	5020	Solomon Islands Broadcasting Corp.	EE	1830	11645	Voice of Greece	
1100	3380	Radio Chortis, Guatemala	SS/local	1830	11705	Radio France International	FF
1100	4890	NBC, Papua New Guinea	Pidgin	1830	11990	Radio Kuwait	
1100	6175	Faro del Caribe, Costa Rica	SS	1900	9870	BSKSA, Saudi Arabia	AA
1100	9580	R. Australia		1900	15345	RAE, Argentina	
1130	6120	R. Japan via Canada		1900	15540	HCJB, Ecuador	
1130	9650	R. Korea, S. Korea, via Canada		1900	17785	VOA via Morocco	
1130	9700	Radio New Zealand Int'l		1930	15313	Radio Netherlands via Bonaire	
1200	3205	Radio Sandaun, Papua New Guinea	Pidgin	1930	15505	Radio Kuwait	AA
1200	5975	Radio Tashkent, Uzbekistan		2000	12085	Radio Damascus, Syria	
1200	9805	Radio France International		2030	9525	Voice of Indonesia	
1200	13790	R. Bulgaria		2030	11960	HCJB, Ecuador	
1200	13800	Radio Norway		2030	12085	Radio Damascus, Syria	
1200	15075	All India Radio	Tamil	2100	9550	R. Havana Cuba	
1200	15115	HCJB, Ecuador		2100	13725	Radio Havana Cuba	U S B
1200	15400	R. Finland Int'l	Finnish	2200	7500	Radio Moldova Int'l, via Romania	
1200	15445	Radiobras, Brazil		2200	9445	Voice of Turkey	TT/EE
1230	11615	Radio France Int'l		2200	9570	R. Portugal	PP
1230	11735	Radio Finland Int'l		2200	17795	Radio Australia	
1230	12020	Voice of Vietnam		2230	5945	Radio Austria Int'l	
1230	12085	R. Ulaan Bataar, Mongolia		2230	9430	Radio Prague, Czech Republic	
1230	13610	R. Vlaanderen Int'l, Belgium		2230	9855	Radio Kuwait	AA
1230	15195	Radio France International		2300	5100	Radio Liberia	EE/FF
1300	7145	Radio Thailand	various	2300	7215	RTV Ivoirienne, Ivory Coast	FF
1300	7365	KNLS, Alaska		2300	7475	RTV Tunisienne, Tunisia	AA
1300	7405	China Radio International		2300	9755	Radio Canada Int'l	
1300	9440	Voice of Asia	unid	2300	9900	Radio Cairo, Egypt	
1300	9590	R. Norway	NN	2300	11795	UAE Radio, Dubai	AA
1300	9625	CBC Northern Service, Canada		2300	9275-		
1300	9985	KHBN, Palau		USB		Iceland National Broadcasting	Icelandic
1300	11815	Polish Radio		2330	7105	Radio Romania Int'l	
1300	15605	Radio Norway Int'l	NN/EE	2355	9925	R. Vlaanderen Int'l, Belgium	GG
1300	17745	R. Romania Int'l					
1320	21520	RAI, Italy	s/on; Sun.				
1330	11650	R. Sweden					

Product Parade

REVIEW OF NEW, INTERESTING AND USEFUL PRODUCTS

Two Super-Snoop Specials

Two new books by Tom Larsen should appeal to those with a penchant for surveillance and general snooping. The first of these is *Bench-Tested Circuits for Surveillance and Countersurveillance Technicians*. Here's a 128-page book filled with circuits and photos of simple, inexpensive, and practical designs. This isn't a book that you need to be a rocket scientist to use, because it isn't overly technical. You get rather clear and concise descriptions of the projects and their applications, plus a discussion of the circuit, and how and why it works.

Included are things like gizmos that allow you to turn a telephone into a live room bug while the handset is on the hook (takes only two components and a jumper wire); and a bug detector that out-per-

THE LAYMAN'S GUIDE TO

ELECTRONIC EAVESDROPPING

HOW IT'S
DONE AND
SIMPLE WAYS
TO PREVENT IT

TOM LARSEN

forms many top-selling units. Build a gadget that stops phone tapping, radio control circuits, an induction wiretap, and a VLF converter. There's also a carrier current transmitter detection circuit that triggers from all forms of modulation, including digital.

There are nearly 40 electronic snooping circuits described in this book. The majority of circuits require only a couple of components and go together in a snap.

Bench Tested Circuits for Surveillance and Countersurveillance Technicians is \$20. plus shipping and handling.

Tom Larsen's other new book is *The Layman's Guide to Electronic Eavesdropping: How It's Done and Simple Ways to Prevent It*. In this 112 page illustrated book, Larsen explains in detail how virtually all of the important details and

DEDICATED TO THE SCANNING AND SHORTWAVE ENTHUSIAST. WE'RE MORE THAN JUST SOFTWARE!

COPYCAT-PRO

The ONLY Commercially Available Computer Control Program for the Universal M-7000 & M-8000.

Also, AEA's PK-232 and the MFJ-1278.



COPYCAT-PRO FEATURES

- 32K incoming text buffer.
- Pull down menus.
- Mouse support (but not required).
- Runs on any 640K PC-Compatible.
- New improved online help.
- Control BOTH your TNC and radio simultaneously!
- Multiple pop-up windows for HELP, frequency files, and text editor.
- Supports ALL SCANCAT files.
- Easier, "Plain English" MACRO language for control of all radio and TNC functions.
- Supports most radios. Call for Info!

Discover our revolutionary COMPUTER CONTROL PROGRAM for the M-7000, M-8000, PK-232, and MFJ-1278. Let COPYCAT-PRO free you FOREVER from remembering all those buttons and keys. COPYCAT-PRO does it all! Simple "PULL-DOWN" menus control all functions. ALL commands are in plain English "PLUS" COPYCAT-PRO has a fully editable text buffer, with cut & paste. 20 PROGRAMMABLE macros and much more. COPYCAT-PRO supports ALL of the above units within ONE program.

COPYCAT-PRO \$79.95, UPGRADES \$24.95
S/H \$5.00 (\$7.50 Foreign)
Specially wired cable for the M-7000/8000 \$24.95

CAT-WHISKER

TIRED OF YOUR HANDHELD SCANNER ALWAYS FALLING OVER JUST TO KEEP THE ANTENNA "VERTICAL"?



Try our unique, swivel base, telescopic scanner antenna. Our new CAT-WHISKER lets you lay your handheld scanner on its back and still keep the antenna vertical!

- Swivels to ANY angle.
- Easily adjusts to any length AND frequency.
- Fits ANY scanner with a BNC antenna connector.
- Fits on BACK or TOP mount scanner antennas inputs.

CAT-WHISKER #1 (5 to 23 inches) **\$19.95**
CAT-WHISKER #2 (6 to 36 inches) **\$24.95**
(plus \$2.50 S & H)

HOKA CODE-3 USA Version

"The Standard Against Which All Future Decoders Will Be Compared"

Many radio amateurs and SWLs are puzzled! Just what are all those strange signals you can hear but not identify on the Short Wave Bands? A few of them such as CW, RTTY, Packet and Amort you'll know - but what about the many other signals?

There are some well known CW/RTTY Decoders but then there is CODE-3. It's up to you to make the choice, but it will be easy once you see CODE-3. CODE-3 has an exclusive auto-classification module that tells YOU what you're listening to AND automatically sets you up to start decoding. No other decoder can do this on ALL the modes listed below - and most more expensive decoders have no means of identifying ANY received signals! Why spend more money for other decoders with FEWER features? CODE-3 works on any IBM-compatible computer with MS-DOS with at least 640kb of RAM, and a CGA monitor. CODE-3 includes software, a complete audio to digital FSK converter with built-in 115V ac power supply, and a RS-232 cable, ready to use.

CODE-3 is the most sophisticated decoder available for ANY amount of money.

26 Modes Included in STANDARD package include:

- Morse
- RTTY/Baudot/Murray
- Sitor CCIR 625/476-4
- ARQ - Navtex
- AX25 Packet
- Facsimile all RPM (up to 16 gray shades at 1024 x 768 pixels)
- Autospec - Mk's I and II
- DUP-ARQ Artrac
- Twinplex
- ASCII
- ARQ6-90/98
- SI-ARQ/ARQ-S
- SWED-ARQ-ARQ-SWE
- ARQ-E/ARQ1000 Duplex Variant
- ARQ-N-ARQ1000 Duplex Variant
- ARQ-E3-CCIR519 Variant
- POL-ARQ 100 Baud Duplex ARQ
- TDM242/ARQ-M2/4-242
- TDM342/ARQ-M2/4
- FEC-A FEC100A/FEC101
- FEC-S • FEC1000 Simplex
- Sports Info 300 baud ASCII
- Hellsreiber-Synch/Asynch
- Sitor • RAW (Normal Sitor but without Synch.
- ARQ6-70
- Baudot F788N
- Pactor
- WEFAX

- All modes in typical baud rates with possibility of changing to any desired value of speed and shift.
- User can save incoming data to disk in either ASCII or raw bit form.

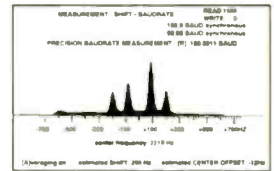

Simulated Speed Measurement Module

EXTRA OPTIONS

Piccolo	\$85.00
Coquelet	\$85.00
4 special ARQ & FEC systems:		
TORG-10/11		
ROU-FEC/ RUM-FEC		
HC-ARQ (ICRC) and HNG-FEC	\$115.00
SYNPG decoder	\$85.00

STANDARD CODE-3 DECODER

\$595.00 + S & H

Includes: ALL Modes, Plus Oscilloscope*, ASCII Storage, Auto Classify*, and FACTOR* Options

with ALL EXTRA OPTIONS \$795.00 + S & H

CODE 3 - GOLD VHF/SW DECODER

\$425.00 + S & H

includes POCSAG & ACARS Plus * Modes/Options

with ALL EXTRA MODES/OPTIONS \$595.00 + S & H

ALSO AVAILABLE - HOKA CODE-30 DSP-based Professional Decoder - CALL FOR PRICE

INTERNET WEB ADDRESS - <http://www.scancat.com> WEB E-MAIL - scancat@scancat.com

(S & H \$10 US, \$15 Foreign)

COMPUTER AIDED TECHNOLOGIES P.O. Box 18285 Shreveport, LA 71138

Phone: (318) 687-4444 FAX: (318) 686-0449

Live Tech Support (318) 687-2555 (9 am - 1 pm Central M-F) Nite-time BBS (SCANCAT File Area) (318) 631-3082 (7 pm - 6 am Cent)

Orders Only
888-SCANCAT
888-722-6228

stats of a person's life are transmitted over phone lines. Also, privacy can be invaded in many other ways, including room bugs, tracking devices, mini-video cameras, etc. Much of this equipment requires little or no tech savvy to use.

This book shows you all the many ways investigators, neighbors, spouses, even the government can use electronic eavesdropping to find out things about you. Learn about taps and bugs, and where they are readily obtained, how they are hidden, also which types are most often used by amateurs and pros.

Then, learn the simple steps you can take to keep snoops in the dark. This includes cheap, but effective encryption systems. Also, learn how to frustrate tappers and buggers with do-it-yourself countermeasures, and find out how to hire a competent professional countermeasures technician.

People can't get much more information about you than you are willing to let them casually walk off with. Larsen sets you straight on foiling the efforts of individuals and institutions that don't respect your privacy. *The Layman's Guide to Electronic Eavesdropping* is \$17, plus shipping and handling.

These books may be ordered from

Paladin Press, P.O. Box 1307, Boulder, CO 80306. Include \$5 per order for 4th Class Book Rate Mailing or \$7 for UPS ground shipping. VISA/MC/Discover accepted. Phone orders: 1-800-392-2400.

On The Right Track

Facts About Railroad Radio, by Vincent Reh, WA2AUY, is a new 208-page well-illustrated (67 photos) book that will interest scanner users.

Here's a book that's more than a computer printout of frequencies. Written for the hobby monitor, it's an examination of the history, types, and uses of communications aboard North American railroads. It examines railroads in general, then zeroes-in on specific carriers of interest. There are chapters on scanners and monitoring, improving scanner performance, and the future of railroad radio.

Included in the informative book is a directory of selected railroad frequencies, Assn. of American Railroad Channel Designators, a glossary of railroading terms, CTCSS (PL tone) chart, as well as other useful data.

This is a nicely done book that will provide you with all of the background information you need to get the most out

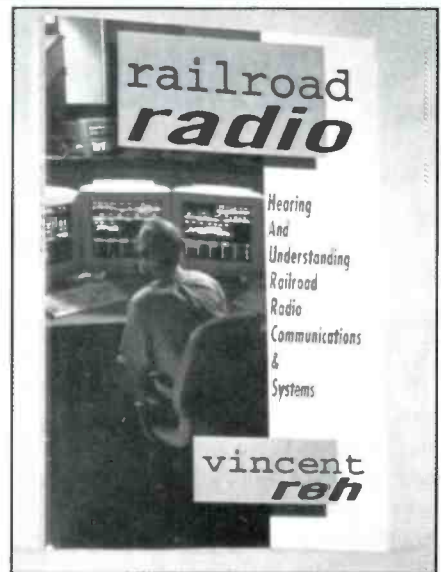

of monitoring railroad comms with your scanner. Train operations, railroad police, rail yards, track maintenance, and many other specialized activities are included.

Facts About Railroad Radio is available from selected dealers. It may also be obtained at \$19.95, plus \$3.50 s/h (to U.S./Canada), from Byron Hill Publishing Co., P.O. Box 197, Grand Isle, VT 05458. Vermont residents please add \$1 sales tax. Phone: 802-372-6557.

DEDICATED TO THE SCANNING AND SHORTWAVE ENTHUSIAST, WE'RE MORE THAN JUST SOFTWARE!

INTRODUCING . . . SCANCAT GOLD for Windows

Since 1989, The Recognized Leader in Computer Control

Once you use SCANCAT with YOUR radio, you'll NEVER use your radio again WITHOUT SCANCAT!

SCANCAT supports almost ALL computer controlled radios by: AOR, DRAKE, KENWOOD, ICOM, YAESU and JRC (NRD) Plus PRO-2005/6/35/42 (with OS456/535), Lowe HF-150, and Watkins-Johnson.

SCANCAT'S BASIC FEATURES

- Search between any 2 frequencies.
- Search by ANY increment.
- Create Disk files.
- Import from most text formats to a working SCANCAT file.
- Unattended Logging of frequencies to files while scanning.
- Scan Disk Files.
- Spectrum Analysis to Screen OR Printer.
- Supports PerCon & Mr. Scanner CD Roms.

PLUS

- LINK up to 15 Disk files.
- Scan VHF & HF Icom's Simultaneously.
- Print to ANY printer or Disk files.
- MULTIPLE search filters for Diskfile Scanning.
- Search by CTCSS & DCS tones with OS456/535 or DC440 (ICOM only).
- INCLUDES several large shortwave and VHF/UHF databases

POWERFUL COMMERCIAL FEATURES SUCH AS:

- Demographic search for frequency co-ordination and 2-way Usage Analysis.
- Detailed logging to ASCII type files with DATE, TIME, Sig Str, Air Time.
- UNLIMITED file sizes with our exclusive SCANCAT filing method.
- Exclusive "MACRO" control by frequency of Dwell, Hang, Resume, Sig. Threshold and even 6 separate programmable, audible alarms.
- Command line options for TIMED ON/OFF (Unattended) logging/searches.

NEW!
Windows Version
Supports AR5000
and IC-R8500

**SEE US
AT
DAYTON**

SCANCAT IS NOT COPY PROTECTED — USE ON AS MANY COMPUTERS AS YOU NEED * SCANCAT (DOS) will run on virtually ANY 640K computer, EVEN HP-100XLT PALMTOPI!

EXCLUSIVE WINDOWS FEATURES

All the features you EXPECT from a true Windows application such as:

- NO MORE CONVERSION! DIRECT scanning of most DBASE, FOXPRO, ACCESS, BTRIEVE files WITHOUT "importing". Our Exclusive "AUTO-PLAN" even sets the mode and increment on the fly!
- UNIQUE database management system with moveable columns. Even SPLIT columns into doubles or triples for easy viewing of ALL important data on one screen.
- VERSATILE "Functional" spectrum analysis. NOT just a "pretty face". Spectrum is held in memory for long term accumulation. Simply "mouse over" to read frequency of spectrum location, "CLICK" to immediately tune your receiver. You can even accumulate a spectrum from scanning DISKFILES of random frequencies!
- Exclusive "SLIDE RULE" tuner. Click or 'skate' your mouse over our Slide-Tuner to change frequencies effortlessly! OR use our graphical tuning knob.
- INTERACTIVELY have database, MAPS or Scanning functions on screen simultaneously.
- MAPS - Load virtually ANY map or GRAPHIC image in "BMP" format (several included with Scancat).
- Program 'hot spots' with your favorite frequencies. Up to 1000 frequencies per map. Click on Hotspot to immediately tune your receiver.
- A Complete Modem/Terminal with support for most current modems. Full X-Y-Zmodem download upload support up to 28,800.

SCANCAT GOLD FOR DOS.....\$94.95 + S & H* SCANCAT GOLD FOR WINDOWS.....\$99.95 + S & H* UPGRADE from any version.....\$29.95 + S & H* *\$5 U.S. \$7.50 FOREIGN

MAGIC for Windows

MAGIC takes any ASCII text file from virtually any source, and any format, and creates "frequency files" or ordered lists.

- Corrects inconsistent column alignment
- "Looks for" single or multiple frequencies embedded in ASCII text.
- Print to file or printer.
- Reads or writes to: SCANCAT, plain text, comma delimited, and dBase.

MAGIC for Windows
\$34.95
(plus \$5.00 S & H)

"UNIVERSAL" INTERFACE

- Supports ICOM, AR8000/2700, YAESU and SCOUT-40.
- Comes with 6 FOOT cable, and adapters to fit all units within a single package (Must Specify Yaesu)
- Unlike "single radio" adapters, can be used with ANY radio supported, simply change the adapter, then "Plug and Play."
- Expandable in future with a simple add on adapter.
- No external power required. Draws power from computer.
- "Reaction Tune" scout with NO modifications to radio.



NOW IN STOCK

CAT-232C "UNIVERSAL INTERFACE".....\$99.95 + s & h



DEALER INQUIRIES INVITED

INTERNET WEB ADDRESS - <http://www.scancat.com> WEB E-MAIL - scancat@scancat.com

Order direct or contact your favorite dealer

COMPUTER AIDED TECHNOLOGIES P.O. Box 18285 Shreveport, LA 71138

Phone: (318) 687-4444 FAX: (318) 686-0449

Live Tech Support (318) 687-2555 (9 am - 1 pm Central M-F) Nitetime BBS (SCANCAT File Area) (318) 631-3082 (7 pm - 6 am Cent)

Orders Only
888-SCANCAT
888-722-6228

Scanning The Globe

BY CHUCK GYSI, N2DUP

MONITORING THE 30 TO 900 MHz "ACTION" BANDS

Summer Scanning In Full Swing!

We're in the thick of the summer scanning season. This is the time of year when there is plenty to hear on your radios. The summer months mean more people are outside, and that means more two-way radios are in use, whether it's your local police departments on hot summer nights, or amusement parks with crowds bursting at the seams. It's doubtful you'll find the scanner bands quiet this time of year.

Catch-All Channel

A friend of mine recently bought a pair of handheld transceivers on 154.570 MHz that he uses for his small business. He says that it seems that almost everywhere he goes in a 100-mile radius he hears communications on the frequency. He asked me whether there was a list of licensed users on this frequency for his state. I told him that while I could print him out a list, it would be quite lengthy because there are so many users on this frequency. While power output on 154.570 is restricted to 2 watts for businesses, almost all who use the channel use it for walkie-talkies.

Usage in any given area might include store security, drive-through window order boards at fast-food eateries, surveyors, factories, tower climbers and construction crews. While licenses for this frequency would restrict the user to using the channel within a certain designated geographic area, it doesn't prevent a user from moving around. Thus, you can see that an inclusive list would be quite a task to assemble, let alone publish within the confines of this column. The best bet is to monitor the frequency and try to identify who you are hearing. Listen for locations and names. Sooner or later

"I've been around long enough to know that when one antenna works well for one person, it just may not work the same for someone else."

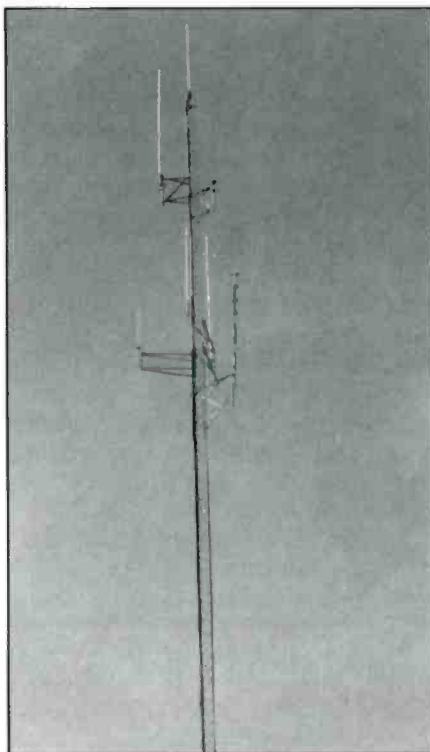

Stations some distance from your monitoring post using antenna sites such as this one may not be easily heard unless you have a good, properly installed antenna such as a discone or other appropriate antenna.

someone may say something that helps identify the user.

In addition to 154.570, the frequency of 154.600 is used in the exact same fashion. It's not unusual to find those licensed on 154.570 also licensed on 154.600, either for separate operations or alternate operations, such as to accommodate additional communications. I find both frequencies as "musts" to monitor because of the variety of communications that can pop up from time to time. And while we mentioned licensed users within the confines of this column so far, it also should be noted that there are plenty of unlicensed users using these two frequencies. Because of the cost of FCC licenses and frequency coordination, many businesses and individuals are using these two frequencies without the intent of obtaining

a necessary license. And unless they are causing interference to a licensed user who complains to the FCC, it is unlikely they will be caught, especially with the low-power nature of the two channels, which reduces interference potential. That's not to say I've heard higher-powered operations on these two channels. Some unscrupulous users have been heard using full-power mobile radios and even base stations on these channels. I once heard some teenagers playing phony police radio games on one of these channels, with one of the kids actually on a full-power base station radio. If he only knew how many low-power operations he probably was wiping out at the time!

Antenna Selection

Ryan J. McCarthy e-mailed some questions about scanner antennas. He says: "I was just going over your recent article, 'The Rule of Antenna Height,' in *Pop Comm*, and it has prompted me to ask a few questions. I would like to erect an outdoor scanner antenna. I need an antenna that covers 25 to 1300 MHz. I am interested in an omnidirectional antenna and have come down to the following antennas that I would like your opinion on: Diamond Discone, Antenna Specialists' MON-58 and the Scantenna. I will need an antenna that will hold up to the type of weather (snow, rain and strong, gusty winds) we get here on Long Island, NY, and judging by your callsign, I think you probably get the basic weather we do. I have heard that although one of the antennas is a great scanner antenna itself, it may not hold up to the type of weather that I mentioned. With the Diamond, I have heard that it doesn't have gain, but the antenna has an excellent reputation for its quality of manufacturing. There is so much out there that I am not sure what I want to do. That is why I have come to you. I trust you and your advice. What would your recommendation be? I am open to other antenna suggestions that you may have."

Well, in the years that I have penned

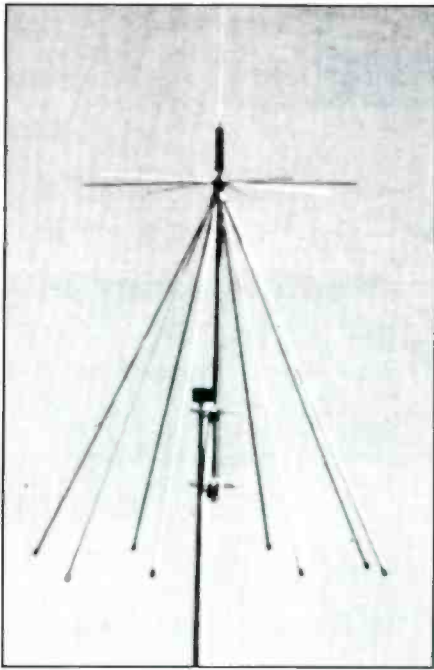

A discone antenna such as this Nevada discone typically have broadband coverage from 25–1300 MHz, but offer no gain. The tradeoff between gain and broadband coverage make them attractive to many scanner users.

this column, I have stayed away from endorsing one product over another. I've been around long enough to know that when one antenna works well for one person, it just may not work the same for someone else. There are so many factors that could affect equipment and accessory performance, that it's best sometimes to steer away. If it works good for me, it may not work good for you. I'll tell you how something works, but don't expect an outright endorsement!

First of all, Ryan, no, I don't live near you, even though I have a "2" in my call sign. I've been hibernating in the Midwest for quite a few years and retained my call sign here. Nowadays, especially with the new vanity call signs, it's not always a given as to where someone lives because of the numeral in their call. While the Diamond discone doesn't offer gain, the antenna offers much wider frequency coverage. Whereas most scanner antennas cover only the major scanner bands (i.e., 29–54, 108–174 and 406–512 MHz), the discone variety covers typically 40–900 MHz inclusively. Plus, if you are a ham, the antenna will cover transmitting on the major VHF and UHF ham bands, too (50–54, 144–148, 219–220, 222–225, 420–450 and 902–928 MHz). That versatility makes the antenna popular. It also offers cover-

age of the wide-ranging 225–400 MHz military aircraft and satellite communications band, and the antenna is popular with those who target those types of listening. And for those who want to get a little extra "oomph!" out of an antenna without gain, a friend of mine suggests using a TV antenna amplifier to boost the signals. Know what? It works! The TV antenna amplifiers are typically rated for 50–900 MHz coverage, which is exactly what the discone offers frequencywise. As long as you don't transmit on the cable, the amplifier works as a neat trick!

About the Scantenna and Antenna Specialists MON-58 antennas, ask other scanner listeners how their antennas work in your locale. See what works best for them. Look at the rooftops in the neighborhood for those who have scanner antennas mounted outside (there are more than you realize!). Compare warranties and band coverage. Compare all you can and let the dealer you patronize help, too. After all, if an antenna is a dog, any reputable dealer won't be selling it because they'd get tired of the complaints!

On His Tows

Richard Wolfe writes to say he has been a reader of my articles for some time. He says: "In regards to your article in *Pop Comm* (March 1997) "On your tows," yes, listening to tow trucks can be fun. I know: I have been doing it for 17 years, both listening and driving them. Our company is one of those on 800 MHz, and a lot of the auto clubs are going to 800 MHz also. AAA Oregon/Idaho is working on getting MDTs (mobile display terminals) into the trucks for dispatching, and getting away from voice dispatching. They are about a year away from that though. I will miss voices though, as I met my wife through the radio. She was an AAA dispatcher, and I drove for a contractor. I figured that she told me what to do eight hours a day and I was going to sleep eight hours, leaving eight hours to be with her!

"Well, keep up the good work, and let the information flow. And speaking of information, do you know of any frequency lists that are available online?"

You can check the search engines of most sites on the Internet such as Yahoo and Webcrawler and find frequency lists. Just type in enough words to get what you want, e.g.: "Montana frequency police scanner" and see what pops up! It amazes me what has been posted on the Internet.

Scanning Via the Web

Jim DeArment writes via e-mail from York, PA, saying: "I have been a scanner enthusiast and occasional CB nut for about two years. My wife and I recently bought a computer and started "surfing" the Internet. I wanted to pass on an interesting site I found: <<http://www.policescanner.com>>. It features LIVE scanning activity from Los Angeles and Dallas. Imagine, now you don't even need to buy a scanner to see if you like it—just listen in for a while to try it out!

With the way things are going, scanning via the Web is the wave of the future! It won't be long before we don't even need our radios—just a computer with the right components!

Write In

What are you listening to on your scanner. We welcome listening tips, questions, frequencies of interest, and photos of your listening posts or radio installations, towers, etc. Write to: Chuck Gysi, N2DUP, Scanning the Globe, *Popular Communications*, 76 N. Broadway, Hicksville, NY 11801-2909, or reach me via e-mail at <SCAN911@aol.com>. ■

HF-VHF Receiver Multicouplers

100 KHz to 1 GHz range

Are you using several HF radios or VHF/UHF scanners at your monitoring site??
Diversity Reception antenna systems??

...consider including a multicoupler.

Specially designed for demanding monitoring applications and for the dedicated hobbyist with multiple monitoring radios. Our 2 and 4 port couplers are 50 ohms units with better than 22 dB of port-to-port isolation. BNC connectors standard, type-N and SMA also available. Other port configurations on special order.

Please contact us for a Data Sheet and pricing \$70 to \$90 range - VISA/MC accepted

Stridsberg Engineering, Inc.
PO Box 5040, Shreveport, LA 71135-5040
(318) 861-0660 FAX: (318) 861-7068

CIRCLE 81 ON READER SERVICE CARD

FREE PRODUCT GUIDE NEW 1997 EDITION

NOTHING BUT FIRESTIK!
WE SPECIALIZE IN A VARIETY
OF ANTENNAS & ACCESSORIES
TO HANDLE BOTH COMMON &
UNIQUE CB APPLICATIONS.

CONTACT: FIRESTIK COMMUNICATIONS
2614 E ADAMS, PHOENIX, AZ 85034
TEL: 602-273-7151 FAX: 602-273-1836
WEB SITE: [HTTP://WWW.FIRESTIK.COM](http://www.firestik.com)

CIRCLE 66 ON READER SERVICE CARD

Clandestine Communique



TUNING IN TO ANTI-GOVERNMENT RADIO

Turning Up the Heat in Zaire

The Zaire station, **Radio Candip**, an educational broadcaster operating from Bunia on **5066**, is airing some of the broadcasts of the “**Voice of the People**,” which is the name of the local radio station taken over and now operated by the Zairian rebel alliance (Alliance of Democratic Forces for the Liberation of Congo-Zaire). Apparently this segment is aired from 1530 to 1600 and 0430 to 0500 in local languages and in French. The latter time slot is the only one North Americans would have any chance of hearing. Unfortunately, you will likely have to contend with extremely heavy interference from WWCN using 5065 at that time.

Although seldom reported by North American-based monitors, the “**Radio of the Provisional Government of National Union and National Salvation of Cambodia**” has been in operation for many years—using various variations of the current long-winded name. It is operated by the Khmer Rouge and broadcasts against the current Cambodian government. As noted, it’s not often heard in North America, even though its time and frequency pairing would indicate otherwise. Check for its broadcasts in the Khmer language on **5404** (over the years it has varied to as high as **5408**) between 1130 and 1330.

The anti-Beijing **Voice of Tibet** program is aired via a Russian government transmitter from around 1230 to shortly before 1300. It is being jammed by a station carrying one of the regular Chinese home services.

Radio Kuridat Nigeria, which opposes the current government of Nigeria, is still using **6205** and operating in English until some minutes past 2000.

On occasion a clandestine station “gets religion” and, thanks to the success of its political masters, becomes a legitimate station. One such station is **VORGAN (Voice of the Resistance of Galo Negro—“Black Cockerel”)** which speaks for Jonas Savambi’s UNITA party of Angola. The party is now recognized and so is its radio. VORGAN’s current schedule is from 0500 to 0900 on **9750**, 1100–1430 on **11830** and 1655 to 2100

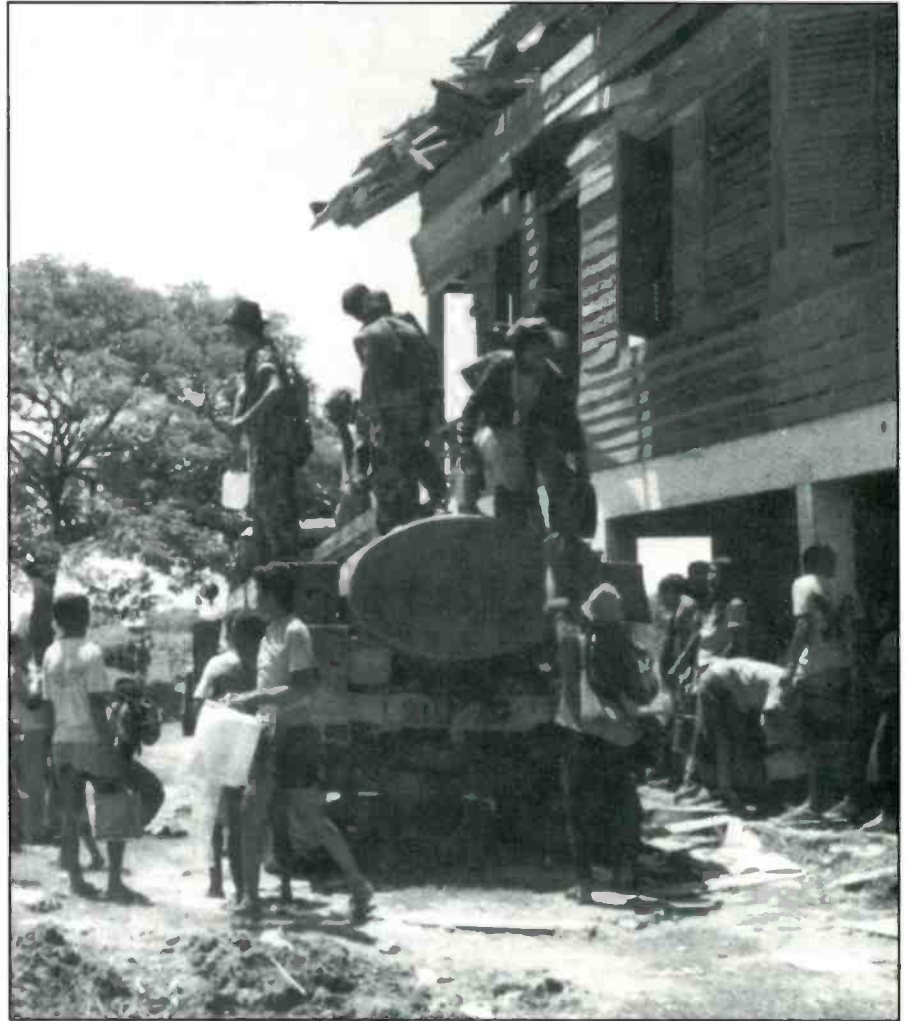

The Khmer Rouge, responsible for decades of devastation in Cambodia, operates its own station on 5404.

on **6095**. Your best shot is likely to be around 0500. The station is located in the town of Jamba Nigeria and broadcasts largely in Portuguese.

Another such station (with another neat name) is the **Voice of the Broad Masses of Eritrea**, now a legitimate voice of the Eritrean government. It broadcasts in Arabic and local languages Tigrigna, Tigre, Kunama and Afar and is often heard by North American clandestine hunters. Your best shots are at 0300 and 0500 in Tigrigna (0400 in Tigre) on **7085** (Monday-Friday), and at 0300 in Arabic on **7390** variable.

The **Voice of Oromo Liberation** is on

9930 Mondays, Wednesdays and Fridays from 1600 to 1700 sign off. This is a switch from its former **9870** frequency. The broadcasts come via a transmitter in the Ukraine.

A related clandestine station, is the **Voice of the Tigre Revolution**, which can be heard on 5500 around 0400, broadcasting in local languages.

The **Voice of Kashmir Freedom** (also known as the **Voice of Independent Kashmir**) apparently operates from Pakistan or from the Pakistan part of Kashmir. The station broadcasts in Urdu from 0230–0330 on **5300**, **5750** and **6300**. Also from 0830 to 0930 on **5300**

and 6300 and in Kashmiri from 1530 to 1730 on 4116, 5300 and 6300. Occasionally the broadcasts may be transmitted in sideband, rather than in AM. Also, at times the frequencies used don't always carry the same program. The station broadcasts against the Indian government and its control of part of Kashmir. It announces an address of P.O. Box 102, Muzaffarabad, Azad Kashmir, via Pakistan.

The Voice of Southern Azerbaijan's address is Vosa Ltd., Postfach 108, A-1193 Wien, Austria.

The Voice of the People of Kurdistan is scheduled at 0400 to 0500 on a frequency somewhere between 4100 and 4150 (often 4117 variable) and again from 1500 to 1600 in the same range. Programs are in Arabic and Kurdish.

The Voice of the Mojahed currently operates with this schedule: 0300 to 0700 on 3550, 3850, 4450, 4650, 5150, 5450, 6175, 7070, 7225 and 7550; 0700 to 0900 on 6175; 1500 to 1700 on 6175; 1700 to 2100 on 3550, 3850, 4450, 4650, 5150, 5450, 5750, 6175, 6450, 7070, 7225, and 7550. All programs are in Farsi. Don't take these frequencies too literally; they are extremely variable.

The New Star Broadcasting Station has again been noted with its 8300 transmissions, this time at around 1230.

The Democratic Voice of Burma broadcasts are now aired (via Radio Norway) from 1430 to 1500 on 9725.

The Voice of Sudan continues its broadcasts against the Sudanese government. It has been heard on 8000 and on 12008 around 1700 in local languages.

The U.S. government's Radio Free Asia service continues to expand its hours and languages. It has recently added broadcasts to Burma and Vietnam in those languages. Burmese is aired at 0030 to 0100 on 5940, 7455 and 7515 and 1500 to 1600 on 7490, 7540 and 9440. Vietnamese is carried at 1400 to 1500 on 5940, 7490 and 7520 and 2230 to 2330 on 5990 and 7415.

That covers things for this month. Remember that we always welcome your input on clandestine radio broadcasting, whether it's loggings of stations you've heard recently, background information on stations or the groups which back them which you may have run across in news articles, QSL and address information and other related items. Send your information to this column in care of Pop'Com headquarters, 76 N. Broadway Hicksville, NY 11801.

Until next month—good hunting! ■

PALADIN PRESS®

BENCH-TESTED CIRCUITS FOR SURVEILLANCE AND COUNTERSURVEILLANCE TECHNICIANS

by Tom Larsen

If you're hungry for updated, practical electronic circuits, this book is a beggar's banquet. There's no speculation here — the author makes his living as a countersurveillance tech, and he has bench-tested every one of these circuits. Not only do they actually do what they are supposed to, these ingenious designs — many never before published — are simple, inexpensive and fun. How about a hookswitch bypass that turns a telephone into a standing mic while on the hook, using only a resistor capacitor and a jumper wire? You've got it! Need a circuit that will stop most spousal phone tapping? It's in here too. So are some simple radio-control circuits, unique surreptitious entry alarms, field-tested firefly flasher circuits that can only be seen with night vision equipment, a carrier current transmitter detection circuit that will detect all modulation forms. Including digital (which is used by the feds) and much more. For academic study only. 5 1/2 x 8 1/2, softcover, photos, illus., 128 pp. **\$20.00**

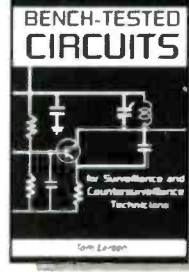

THE LAYMAN'S GUIDE TO ELECTRONIC EAVESDROPPING How It's Done and Simple Ways to Prevent It

by Tom Larsen

Phone lines, video cameras and room bugs are just a few of the tools nosy neighbors, angry spouses, private investigators and even the government can use to get the goods on you. This book will show you some simple, inexpensive ways to foil their efforts *right now!* 5 1/2 x 8 1/2, softcover, photos, 112 pp. **\$17.00**



THE HOME WORKSHOP SPY Spookware for the Serious Hobbyist

by Nick Chiarosuro

Here are all of the circuit-board patterns, parts lists and building tips needed to build a sneaky array of bugs, taps, mics and other forbidden spy toys. These simple designs are for "wire specialists" or anyone interested in knowing about the clandestine sciences. For academic study only. 8 1/2 x 11, softcover, photos, illus., 104 pp. **\$25.00**



THE WHOLE SPY CATALOG

by Lee Lapin

The *Whole Spy Catalog* shows you exactly how to hire an ex-KGB agent, order a photo of anyplace on earth anytime during the last 20 years, get an instant background check on anyone, open a door from 100 feet away, subscribe to an in-house FBI newsletter, order and install the latest electronic surveillance gear and many more tricks to trace, track, surveil and investigate anyone or anything. 8 1/2 x 11, softcover, photos, illus., 448 pp. **\$44.95**



SPYCOMM

Covert Communication Techniques of the Underground

by Lawrence W. Myers

Guerrillas, fugitives and other members of the "underground" must exploit existing resources to communicate secretly. This book tells you how they use improvised microfilm, steal phone service, create unbreakable codes and more. For information purposes only. 5 1/2 x 8 1/2, softcover, illus., 256 pp. **\$19.95**



SUPER PRIVACY

The Complete Guide to Personal Privacy and Financial Freedom in Tomorrow's Cashless Society

by Bob Hammond

Tomorrow's cashless society will allow anyone and everyone to get at your finances and transactions. This fascinating book will stop them cold and protect what's yours. From legal new ID to off-shore accounts, credit protection and trusts, now you can survive the coming cashless society. 5 1/2 x 8 1/2, softcover, 144 pp. **\$15.00**



HOW TO GET ANYTHING ON ANYBODY

by Lee Lapin

Get the goods on others with this encyclopedia of advanced investigative and surveillance techniques. Here are expert ways to secretly bug any target! Info on lock-pick technology, how polygraphs and voice lie detectors can be tricked and much more, including more than 100 sources for spy equipment. 8 1/2 x 11, softcover, illus., 272 pp. **\$30.00**



DON'T BUG ME The Latest High-Tech Spy Methods

by M.L. Shannon

This comprehensive study of spying devices shows you how to stop others from tapping into your privacy and violating your right to be left alone. It covers everything from inexpensive transmitters hidden in potted plants to the latest high-tech super-systems favored by governments and businesses. 8 1/2 x 11, softcover, photos, illus., 152 pp. **\$19.95**



SURVEILLANCE COUNTERMEASURES

A Serious Guide to Detecting, Evading, and Eluding Threats to Personal Privacy

by ACM IV Security Services

Learn to detect and evade surveillance efforts that threaten your personal security. These time-tested tactics of observation, detection and evasion are proven effective against the most sophisticated surveillance techniques used in the world. 5 1/2 x 8 1/2, softcover, illus., 192 pp. **\$20.00**



ORDER



PALADIN PRESS®
P.O. Box 1307-7PCO • Boulder, CO 80306
303-443-7250 • FAX 303-442-8741
E-MAIL: pala@rml.com



CREDIT CARD ORDERS CALL TOLL FREE

1-800-392-2400 USA and CANADA

Call 24 hours a day, 7 days a week. Send \$2.00 for 72-page catalog of over 750 titles (free with order).

RESPONSE CODE: 7PCO

VISA MASTERCARD DISCOVER CHECK / MONEY ORDER CARD # _____ EXP. DATE _____

NAME _____ ADDRESS _____ CITY _____ STATE _____ ZIP _____

NAME _____ ADDRESS _____ CITY _____ STATE _____ ZIP _____

MONEY-BACK GUARANTEE

VISIT OUR WEB SITE: www.paladin-press.com

Product Spotlight

POP'COMM REVIEWS PRODUCTS OF INTEREST

Alpha Delta Communications' VRC Variable Response Console Speaker

With the advent of advanced integrated circuits and surface mount technology, the physical size of today's communications receivers, scanners, and amateur radio transceivers is shrinking with each new model. While this may offer the operator greater operational convenience and performance, one design factor has suffered — the size, and resultant audio fidelity, of the internal speaker. Although many manufacturers offer optional external speaker systems, most are only inexpensive speakers housed in matching cabinets. Finally, a manufacturer has come to the rescue of those interested in quality audio from a communications receiver.

Alpha Delta Communications' new Model VRC Variable Response Console offers a "full range" Pioneer™ speaker housed in a carefully designed ducted port bass reflex cast aluminum enclosure with a built-in audio amplifier and a fully-adjustable "sampled data" SCAF (switched capacitor audio filter).

Initial Impressions

Upon unpacking the unit, I immediately noticed the weight of the VRC. Weighing in at slightly more than eight pounds, this is one speaker that will stay put at your operating location! The enclosure is a rugged cast aluminum structure finished with a tough baked on semi-gloss black powder coating for enhanced durability. Since the VRC is a ducted port bass reflex design, the speaker enclosure is only open through a tuned port at the front. With a color-matched perforated metal speaker grill occupying the upper-half of the front panel and the audio processing controls the lower-half, the VRC speaker exudes a quality and commercial-grade appearance. Overall, I was impressed with the VRC's rugged and quality construction.

Features

Alpha Delta's primary goal for the

Alpha Delta VRC Variable Response Console

Dimensions:	(HWD) 8.25" × 8.125" × 6.125"
Weight:	Approx. 8 lbs.
Suggested Retail Price:	\$249.95
For Info contact:	Alpha Delta Communications, Inc.
Phone:	(606) 598-2029
or fax:	(606) 598-4413.



The Alpha Delta VRC Variable Response Console.

VRC is "to make shortwave listening and radio communications listening more understandable and enjoyable." With a full complement of user-friendly features, it appears they have met this challenge. Here is a list of the VRC's most important features:

- ✓ A 4 inch wide-range Pioneer speaker enclosed in an acoustically designed ducted port bass reflex heavy-duty (3/16 inch thick) cast aluminum enclosure.
- ✓ A low harmonic distortion push-pull sold-state amplifier capable of a minimum of 2 watts R.M.S. audio output
- ✓ An adjustable sharp cut-off "sampled data" SCAF (Switched Capacitor Audio Filter) for optimum PEAK or NOTCH for AM, FM, SSB, CW, or data modes.

- ✓ An LED light bar readout displaying SCAF filter cut-off frequency from 500 Hz to 10 kHz.
- ✓ An adjustable 12dB bass boost or cut circuitry with LED bar readout in ± dB.
- ✓ Push-buttons for POWER, NORMAL, PEAK, and NOTCH operation.
- ✓ Rotary controls for LOW FREQ and HIGH FREQ bass cut-off and P/N FREQ and P/N BW for PEAK and NOTCH frequency and bandwidth adjustment.
- ✓ A front panel-mounted 1/4 inch phone jack for headphone operation.

Installation

The VRC is very simple to interface to your receiver. Alpha Delta includes a 6 foot length of shielded audio cable with a 3.5mm monaural plug on each end, a 1/4 inch phone plug to 3.5mm socket adapter (for use with the Drake SW-8's insulated phone jack), and a +12 Vdc @ 500 ma AC adapter for the system's power supply. Simply connect your receiver's audio output to the 3.5mm input jack on the back of the VRC with the supplied cable. Hookup the AC adapter to its jack on the VRC and plug into a 115 Vac wall outlet. It's that simple! All inputs are well marked on the VRC's back panel. *NOTE: The VRC can also be powered by any 12 to 16 Vdc source. Current requirement is 150ma at low volume and 500ma at maximum audio output.*

Operation

After turning the VRC on by pressing the red POWER switch, you must ini-

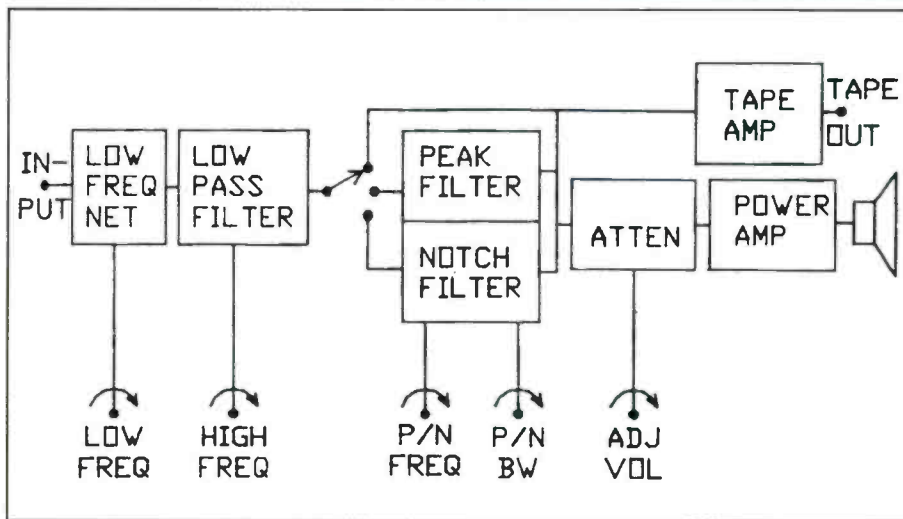

Block diagram of the VRC.

tially set the ADJ VOL control on the VRC—a “set once and forget” control. Since the audio output level is adjusted with your receiver’s volume control, the ADJ VOL control on the VRC is adjusted to match the normal listening level of your receiver’s audio output to the SAME level as the “before and after” insertion of the VRC in the audio output line.

For normal radio listening, you press the NORMAL push-button switch. This defeats the PEAK/NOTCH circuitry. LOW FREQ boost/cut and HIGH FREQ cut-off can be adjusted to one’s listening tastes. The LED bar graph with front-panel frequency reference points make this adjustment fast and easy! (Please note the well-written instructions describe in depth optimum adjustments for all listening modes.)

If the band starts to drop out or you should encounter weak and/or noisy signals, listening is enhanced by cutting the low frequencies with the LOW FREQ control and lowering the high frequency response with the HIGH FREQ control. If the audio response is still too broad, press the PEAK switch and adjust the P/N FREQ control (with the P/N BW control at WIDE) for best reception. Up to 20dB of peaking can be achieved in the PEAK mode. I also found the HIGH FREQ control to be useful in eliminating the “hiss” from the I.C. audio output stages of some receivers tested with the VRC. For SSB reception, you can set the high frequency cut-off to around 3 kHz, which is optimum for SSB reception.

Has your shortwave listening or amateur operating become a chore because of “heterodynes,” “whistles,” and “tuner uppers?” The VRC’s NOTCH mode offers a cure. Although you can use the

HIGH FREQ cut to reduce this frustrating problem, the SCAF NOTCH circuitry in the VRC eliminates it! Alpha Delta specifies the notch depth at 40dB; I measured a nominal 42dB notch depth from 400 Hz to 10 kHz. The NOTCH is adjusted by pressing the NOTCH push-button switch and adjusting the P/N FREQ and P/N BW control for the deepest notch.

Morse code (CW) or data operators can enhance their CW/data operation with the VRC’s peaking mode. Press the PEAK push-button and alternately adjust the P/N FREQ and P/N BW control. Since there is some interaction with these controls at narrow bandwidths, careful adjustment is necessary. No ringing was noted even at the most narrow CW and data bandwidths!

For those who enjoy recording broadcasts, the VRC offers a line-level audio output or TAPE OUT jack (approximately 0.5V) independent of the ADJ VOL control. This phono jack is located on the back panel of the enclosure next to the

+12 Vdc input.

Overall, the VRC was a pleasure to use. The Ducted Port Bass Reflex Speaker design used in the VRC improves overall audio fidelity, not only on the AM or FM bands, but for SSB and CW as well. The frequency and bandwidth controls work very smoothly, thereby allowing critical adjustments during the PEAK/NOTCH modes. The initial ADJ VOL adjustment is quite important, otherwise you can drive the VRC’s audio amplifier into distortion. Properly set-up, the audio from the VRC is clean and distortion free with reserve power to spare!

Fills A Much-Needed Void!

Alpha Delta’s new VRC Variable Response Console fills a much-needed void in the communications speaker market. The Pioneer™-built speaker is of high quality, and the rugged cast aluminum enclosure suffers no annoying resonance. Plus, the built-in audio amplifier and SCAF audio processing circuitry work wonders with the received signal. Many listeners may find it no longer necessary to use an outboard audio filter for normal broadcast listening.

Manufactured in the USA, the VRC is available from an Alpha Delta dealer or direct from the Alpha Delta. Price is \$249.95. Factory direct U.S. orders should add \$7 for shipping and handling.

If you don’t need the VRC’s built-in audio amplifier and SCAF audio processing circuitry, Alpha Delta also offers the Model VRC-2 Ducted Port Bass Reflex Speaker at \$99.95. For more information, contact Alpha Delta Communications, Inc., P.O. Box 620, Manchester, KY 40962. Phone (606) 598-2029; Fax (606) 598-4413 or call your authorized Alpha Delta dealer. ■



STOP MISSING YOUR FAVORITE RADIO PROGRAMS

Use ReelTalk™ radio timer-recorders... Like A VCR For Radio!

Includes: AM/FM Radio • Digital Tuner • Digital Clock
 • 4 Hour Timer Recorder (RT-101) or 1 Hour Timer Recorder (RT-201)
 • Mic. Input Jack • 6" x 6" x 13" • LCD Display • Headphone Jack
 • 20 Station Presets • And More.

ORDER NOW. CALL 1-800-723-4669.
30-DAY MONEY BACK GUARANTEE.

105 Rocket Ave., #101, Opelika, AL 36804
1-800-723-4669 FAX 334-704-0455
<http://www.realtalk.com>

\$129.95 plus S&H



CIRCLE 78 ON READER SERVICE CARD

Communications Confidential

YOUR GUIDE TO SHORTWAVE "UTILITY" STATIONS

Hurricane Season Monitoring Tips

June 1st is the start of the 1997 hurricane season, which runs to November 30th every year. We've provided you with a list of frequencies to watch. The original Hurricane Hunter frequencies, which were used by NOAA's National Hurricane Center (NHC), KJY74, "Miami Monitor" are listed. However, since 1994 I have noticed a lack of communications on these frequencies after NHC moved to its new facility at Coral Gables, FL. Except for some plane-to-plane traffic, most of the comms since then seem to have been on the USAF Global High Frequency System (GHFS) frequencies with the aircraft making phone patches to the NHC mostly via MacDill and Albrook. They often move to a discrete frequency after making contact on a GHFS primary. The NOAA NHC aircraft use call signs NOAA 42 and NOAA 43. These are WP-3D "Hurricane Hunter" aircraft from NOAA Aircraft Operations Center, P.O. Box 6829, MacDill AFB, FL 33608. Also heard are WC-130E/H aircraft from 53rd Weather Reconnaissance Squadron (AFRES), from Keesler AFB, MS. They use the call sign "TEAL xx". These aircraft also fly "hurricane hunter" missions, and generally alternate with the NOAA aircraft.

The 53rd WRS designation was activated and assigned to the Air Force Reserve's 403rd Airlift Wing, at Keesler AFB, Nov. 1, 1993. While they were being activated, their old unit designation, the 815th Weather Squadron, was inactivated. The 53rd WRS traces its roots to August 1944 when it was activated as the 3rd WRS at Presque Isle Army Airfield, Maine. The former active-duty unit was inactivated June 30, 1991, when the Air Force's entire WC-130 weather reconnaissance mission was transferred to the Reserve. Those of you who can surf the internet can try the following URL: <<http://cirrus.sprl.umich.edu/wxnet/tropical.html>>. This site provides the current schedule of USAF weather reconnaissance aircraft, hurri-



Photo of site of beacon JB on 201 kHz, located 22 km NW of Whitehorse, Yukon, Canada taken by Ron Tull.

cane imagery, and other useful information. Another useful site is NOAA's NHC URL at <<http://www.nhc.noaa.gov/>>. Let me know what you hear.

Lourdes Still in the News

Readers may have read recently where President Bill Clinton is still under pres-

sure by Congress to force the Russian signals intelligence (SIGINT) facility at Lourdes, Cuba (near Havana), to be closed. Russia's SIGINT effort at Lourdes is carried out by Russian military intelligence (GRU) and the Federal Agency for Government Communications (FAPSI). The FAPSI evolved in the early 1990's from the former KGB's SIGINT service.

The Russian Foreign Intelligence Service (SVR) also has a communications center at the facility for its agent network in North and South America, according to testimony before the U.S. Senates Select Committee On Intelligence in 1996 about Lourdes. The facility is the largest Russian SIGINT site abroad. Several readers sent a copy of an article which appeared in *The Sunday Times of London*, by Washington correspondent James Adams. He reported the site monitors U.S. civilian and military communications "using satellites and high-speed computers, they can pick up millions of microwave transmissions every day and communicate with Russian spies operating on the American continent." Sensitive U.S. government communications are encrypted to prevent this intercept, but most other unprotected telephone communications in the United States are systematically intercepted, and U.S. commercial satellites, and sensitive communications dealing with U.S. military, merchant shipping, and Florida-based NASA space programs are historically monitored, again according to U.S. Senate testimony. According to United States Department of State Publication 8347 - Background Notes Series, the Lourdes facility was established in the 1960s after Cuban-Soviet ties led to a direct confrontation between the United States and the Soviet Union in 1962 over the installation of nuclear-equipped missiles in Cuba. In what became known as the Cuban Missile Crisis, tensions eased only when Moscow agreed to the withdrawal of the missiles and other offensive weapons. Cuba's special relationship

ENHANCE YOUR ADVENTURE!



ALPHA DELTA MODEL VRC

Announcing the ALPHA DELTA Model VRC Variable Response Console. Finally, an advanced audio processing speaker system that offers studio level audio quality for music, voice, and CW/data for the communications enthusiast. The Model VRC enhances the reception capabilities of ANY receiver, transceiver or scanner— even the expensive ones using DSP! Our exclusive ducted port bass reflex speaker system offers state-of-the-art performance at an extremely reasonable price. Custom Designed for the Model VRC.

- Low distortion, low harmonic push-pull audio amplifier. Outperforms the typical single-ended types
- Adjustable 12 dB bass boost/cut circuitry enhances both voice and music. LED reads out in dB
- Adjustable sharp cut-off “Sampled Data Switched Capacitor Audio Filter” can be set for optimum interference reduction for any mode and any band condition. AM, FM, SSB, CW or data. LED light bar readout shows cut-off frequency and is calibrated in kHz
- Peaking circuitry (20 dB) allows CW/data signals to “pop” out of the background
- Continuously adjustable 40 dB deep notch circuitry effectively takes out interfering heterodynes

SEE US
AT DAYTON
BOOTHS
473 & 474

- At your Alpha Delta dealer. For direct U.S. orders add \$7.00 shipping and handling. Exports quoted.
- Alpha Delta Model VRC Variable Response Console\$ 249.95 ea
- Alpha Delta Model VRC-2 Ducted Port Bass Reflex Speaker-same as above but no amplifier/filter (a pair of these are great for your stereo or PC!).....\$ 99.95 ea

ALPHA DELTA COMMUNICATIONS, INC.



P.O. Box 620, Manchester, KY 40962 • 606-598-2029 • FAX 606-598-4413

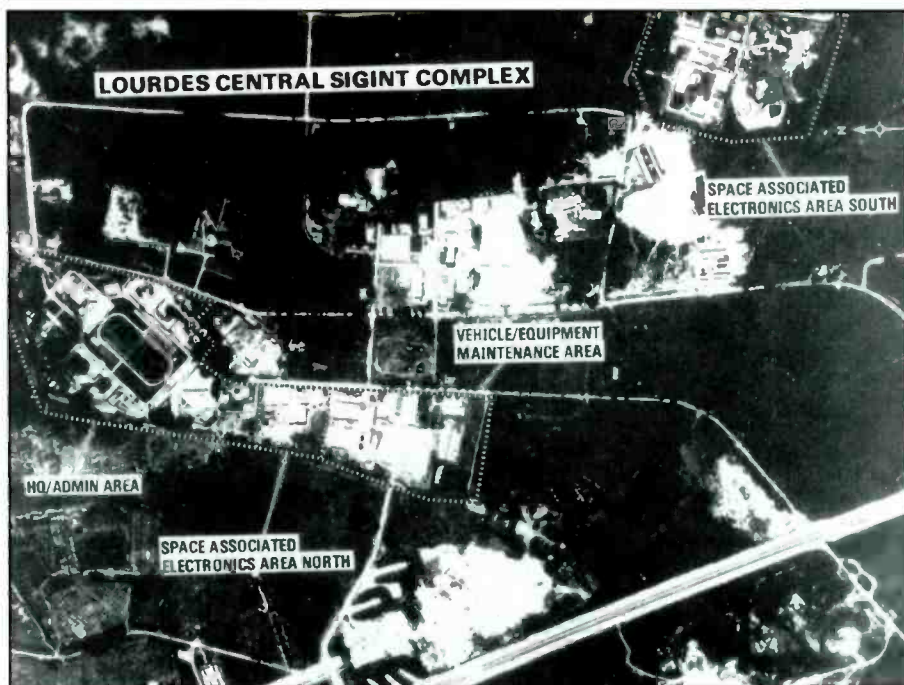

SR-71 surveillance photo of the Russian SIGINT facility, Lourdes, Cuba, taken circa mid-1980's. Department of Defense photo courtesy FAS (Federation of American Scientists) web site at <http://www.fas.org/>.

with the (then) Soviet Union began to disintegrate during perestroika. The Lourdes facility is indeed known as where numbers transmissions in several modes originate, then being transmitted from a remote site near-by.

Reader Mail

Jim Viele (W8JV), from right here in my hometown of Youngstown, Ohio, writes about a real oddity. Jim is part of a group of amateur radio folks who meet on 3840.0 kHz in the 75 meter ham band. The group has heard a phonetic numbers lady for years from time-to-time, which would be the Mossad "YHF" station. But on a Monday in December, the voice showed up at 0200 UTC and read for about five minutes. Jim explains "at the end of her transmission you could hear the shuffling of papers, a chair being pushed away and a moment later a door opening. We had always considered the 'numbers lady' to be a voice chip and were shocked to hear that these may be live, even more shocked that she seemed to walk away and leave the microphone on! For most of the next two hours we could hear sounds obviously coming from an adjacent room, occasional conversation between a male voice and a female voice that sounded just like the "numbers lady", occasional laughter and

general conversational speech patterns. Strangest of all was the sound of a TV set running in the distance. These two people were evidently watching TV and the language on the TV program was Spanish. The language was very clear and everybody in the QSO agreed it was Spanish. This went on for two hours non-stop. You could hear the transmitter blowers in the room and the constant Spanish chatter from the TV (or radio) in the distance. Finally at 0357 the sound of the TV went off and footprints approached again. Within a few seconds the mic was turned off leaving an open carrier. The open mic had apparently been discovered. At 0400 the 'numbers lady' appeared again with her normal routine of EE phonetics for about 5 minutes and off."

Although Jim is not 100 percent sure it was the same station they first heard, the Mossad stations are computerized transmissions sent out by computer control in a synthesized woman's voice. I checked with some other folks who have followed these transmissions for years, and they seem to agree it was not a Mossad station, but possibly a Cuban station riding the coat-tails of the Mossad broadcast. Although not frequent, these types of "blunders" made by the Cubans, have been heard before by the Cubans. Another possibility raised is that it was a South American pirate, who have also been

heard to leave their microphones open in such a manner. An interesting intercept to be sure.

Albert Hussein, FL writes that an active MINFAR (Ministerio de las Fuerzas Armadas Revolucionarias) military exercise took place in Cuba the end of February. One related RTTY transmitter appeared on 6593 in 75/500. Noted in the traffic sent were references to MIG-21's and MI-17's. Sites indicated were Matanzas and Holguin airport. "Jefatura ejercito central" or Central Army Headquarters was noted used as was "Regimiento aviacion caza", seemingly an aerial recon group. Chris Smolinski, MD checks in for the first time with some numbers stations logs. Chris runs the Spy Number Station Mailing List on the Internet. Those interested in Numbers Stations activities can join by sending e-mail to: cps@access.digex.net. Chris also has a real interesting Web site at <http://www.access.digex.net/~cps>.

Be sure to check out Dave Sabo's (South Korea) time/frequency matrix he came up with for the Lincolnshire Poacher and Cherry Ripe broadcasts as it's heard in his part of the world. There are still some holes in it; maybe other readers can fill in the blanks. Dave also did some research on the "New Star" transmissions. He discovered from actual monitoring that there are five discrete "New Star" frequencies as follows: 11430.0 New Star #1, 15388.0 New Star #2, 9725.0 New Star #3, 8300.0 New Star #4, and 13750.0 New Star #5. These stations seem to be up pretty much all day, at least in that one of them is bound to be active whenever he tunes it in.

Harold Abbott, NY sends his first utility log this month. Harold uses a Drake SW8 and a 60 foot random wire. OK Harold, you're in, now send more logs! Francis Donovan, MA sent his logs via the Internet and is using a NC300 receiver with a HD1420 VLF Converter and a 25 meter long wire antenna to log his beacons. His most distant confirmed log so far is ILS Beacon ML on 344, McAlester OK Municipal Airport. Beacon power is 35 watts there.

Kevin Scott sent me an e-mail about the Traveler Information Stations (TIS) at Dallas/Fort Worth International Airport used for American Airline arrivals and departures. Kevin called Airport Communications Services there and was told they had a few reports from California, Oregon, and a few other states. They are still fine tuning the stations, so they are not sure what the power

Abbreviations Used For Intercepts

AM	Amplitude Modulation mode
BC	Broadcast
CW	Morse Code mode
EE	English
GG	German
ID	Identification/led/location
LSB	Lower Sideband mode
OM	Male operator
PP	Portuguese
SS	Spanish
tfc	Traffic
USB	Upper Sideband mode
w/	With
wx	Weather report/forecast
YL	Female operator
4F	4-figure coded groups (i.e. 5739)
5F	5-figure coded groups
5L	5-letter coded groups (i.e. IGRXJ)

levels are, but 1640 is probably around 15 watts and 1680 is probably near 60 watts. After Kevin's e-mail I had several other tips on these stations, and it seems that they were widely heard and reported. Al Hemmalin, RI reports great conditions for beacon hunters during February and going into March. He was able to add new calls from Greenland and Guadeloupe as well as others.

Many readers are reporting the unidentified RTTY stations on 5747.0, 6350.0, 6797.0, 11006.0, and 14387.0 kHz. Hopefully we'll have some more details next month. Now on with the show . . .

**UTE Logging's SSB/CW/DIGITAL
All Times in UTC**

- 194:** NDB TUK, Nantucket, MA at 2110 w/voice-over aircraft WX. (FD)
- 201:** NDB U, Montreal, Canada at 0630, 510 miles. (AH)
- 206:** AY, NDB Waycross, GA at 0557 (DSB, new). (PC)
- 220:** NDB BX, Blanc Sablon, PQ herad at 0456. (WP)
- 221:** "RQM", NDB Ranglely, ME, at 0611 (DSB). (PC)
- 227:** TAN, NDB Taunton, MA at 2000. TOF, NDB Beverly Ma at 2100. (FD)
- 230:** NDB UCL, Cayo Largo del Sur, Cuba at 0923, 1,500 miles. (AH) NDB HSB Harrisonburg, IL, at 0510. (WP)
- 233:** NDB GRE, Greenville, IL at 0439. (RH)
- 244:** NDB "M", Manzanillo, Cuba at 0550, 1,508 miles. (AH)
- 245:** NDB JYL, Sylvania, GA, at 0434. (RH)
- 247:** NDB YLH, Landsdowne House, Ont, Canada at 0600, 1,072 miles. (AH)
- 266:** NDB AGO, Magnolia, AA at 0127. (RH)
- 272:** NDB "OLD", Old Town, MA at 0840, DSB? (PC) NDB CB Columbus, Oh, heard at 0333. (RH)

Lincolnshire Poacher and Cherry Ripe Time and Frequency Matrix (Courtesy Dave Sabo, South Korea) →

UTC	SUN	MON	TUE	WED	THU	FRI	SAT
1000 CR	10452	10452	10452	10452	10452
	17499	17499	17499	17499	17499
1000 LP	14487	14487	14487	14487
	15682	15682	15682	15682
	16084	16084	16084	16084
1100 CR	9263	9263	9263	9263	9263
	13866	13866	14469	13866
	14469	14469	14469
1100 LP	14487	14487	14487	14487	14487
	15682	15682	15682	15682	15682
	16084	16084	16084	16084	16084
1200 CR	8320	8320	8320	8320	8320
	13866	13866	13866	13866
1200 LP	14487	14487	14487	14487
	15682	15682	15682
	16084	16084
1300 CR	13866
1300 LP	15682	14487	15682
	16084	15682	16084
	16084
1400 CR	11580
1400 LP	10426	11545
1500 CR
1500 LP	11545	11545	7755	11545	11545	11545
	12603	8464	12603	12603
	13375	10426	13375	13375
1600 CR
1600 LP	8464	11545	6485	11545	11545
	10426	12603	7755	12603	12603
	11545	10426	13375	13375
1700 CR
1700 LP	11545	6959	11545	5422	11545
	12603	8464	12603	6485	12603
	13375	11545	13375	8464
1800 CR
1800 LP	7337	5746	6959	5422
	9251	6959	9251	6485
	9251	11545	8464
1900 CR
1900 LP	6959	7337	11545	8464
	9251	9251	13375
	12603
2000 CR
2000 LP	6959	6959	7337	6959	6959	10426
	9251	9251	9251	9251	9251
	11545	11545	11545	11545
2100 CR
2100 LP	6959	6959	6959
	10426	9251
2200 CR	9263
2200 LP	7337	6959
	9251	9251
	12603	11545
2300 CR	17499	17499	17499
	20474	20474	20474
2300 LP
0000 CR	19884	19884
0000 LP
0100 CR	19884	19884	19884
	21866	21866	21866
0100 LP

274.5: NDB RU, San Marcos (Municipal), TX at 0910. (WP) (we also have an "RU" as an unid on 274 same? -Ed.)

280: "IHM", NDB Mansfield, MA heard at 2115. (FD)

283: NDB UZG, Xaragoza, Cuba at 0906, 1,428 miles. (AH)

294: NDB ZIP, Zipaquirá, Columbia at 0723, 2,529 miles. (AH)

315: NDB UPI, Barranca De Upia, Colombia heard at 0840 (when sent, sounds like U A N I) 0923. (WP)

317: FTT, NDB Fulton, MO at 0220. (RH)

320: NDB FLA, Florencia, Columbia at 0445, 2,771 miles. (AH)

332: BE, NDB Bedford MA at 2130. (FD)

346: NDB THJ, Laurel, MS at 0425. (RH)

380: NDB COL, Barra del Colorado, Costa Rica at 0501, 2,247 miles. (AH)

382: NDB SJX, St James, MI at 0611, 768 miles. (AH)

390: VP, NDB Kuujuaq, PQ at 0932 (400 Hz). (PC)

391: DDP, NDB San Juan, Puerto Rico at 2140. (FD)

392: NDN BZE, Belize at 0603, 1,941 miles. NDB JN, Crawfordsville, IN at 0737, 738 miles. (AH)

394: NDB DTE, Dayton, TN at 0355. (RH)

399: NDB UP, Upernavik, Greenland at 0638, 2,216 miles. (AH)

407: BNW, NDB Boon, IA at 0736. (PC) NDB HAI, Three Rivers, Mi 0047. (RH)

414: IEB, NDB Lebanon, MO heard at 0752, DSB? (PC)

423: NDB CKP, Cherokee, IA at 0533. (WP)

424: NDB RVJ, Reidsville, GA at 0130. (RH)

427: NDB MMT, Columbia, SC at 0614, 739 miles. (AH)

430: NDB AYB, Auburn, NE at 0413. (RH)

476: WNU, Slidell Radio, LA at 0402 in CW w/WX bdest for Caribbean and Gulf of Mexico at 27 wpm. (DW)

1640: WQO767, TIS station Dallas/Ft. Worth Inter'l Airport for American Airline Departures, at 0447 in AM, YL/ann w/city info. (KS)

1680: WQO767 TIS station Dallas/Ft. Worth Inter'l Airport for American Airline Arrivals, at 0455 in AM, YL/ann w/city info. (KS)

2538: Labrador CG Radio, Canada, wkg M/V 'Venture' on split frequency (ship on 2142, shore on 2538) in USB. Venture is a 19,000 DWT bulk carrier owned by South African Marine Corp. (RK) (UTC? -Ed.)

2598: Gander CG Radio, Canada, hrd at 0108 in USB w/wx for Canadian maritime's, lots of gale warnings. (RK)

2998: Naha (Okinawa) Radio wkg Korean Air-685 in USB mode at 1430. After a/c passed posn report, Naha told him to contact Manila 8903 primary, 2998 secondary. ICAO CWP-2. (DS)

3023: Kinloss Rescue, Air Rescue Coordination Center Kinloss (ARCC), RAF

Kinloss, Scotland at 0640 in USB clg Coast Guard "OC", Bristows Seaking w/reg G-BDOC, no joy. (Ed.)

3250: Radio Pyongyang, North Korea, mid-night spy numbers broadcast kicks off at 1500 w/martial music until 1503, then YL w/ann of three messages: Number 3250 6119, Group Count 26; Number 3232, group count 53, due to start at 1508; and Number 7115, group count 72, due to start at 1520. Down at 1530. All AM mode. (DS)

3413: PACAF 01 at 0544 in USB wkg San Francisco. (AN)

3437.5: Unid stn 2RC8 Rptng "V 8L68 DE 2RC8" at 1435 in CW. (TY)

3441: Unid stn 6PXJ Rptng "V ABYZ DE 6PXJ" at 1345 in CW. (TY)

3458: Beijing Volmet, YL/EE strong, in USB mode at 1426. ID's at 1427 as "Beijing Meteorological Information for Aircraft in Flight." (DS)

3498: Unid stn G82X Rptng "V G82X K" at 1115 in hand-sent CW. (TY)

3624: Unid at 2356 in FEC with 242780, 96046B, 97042, 1713137 ... next scheduled ... then lost signal. (SW)

4026: Army MARS net being QRM'ed by Cuban CW cut# stn at 0300. (TS)

4028: YL/SS at 0200 in AM w/5FG. Heavy QRM from Hams. (SM)

4231: FUF, French Navy, Ft de France at 0118 w/75 baud RTTY test transmission w/ryry, kkkkk, 123456 etc. (SW)

4274: KFS, Palo Alto Radio, USA at 0945 in CW w/cq de kfs 4 6 12 16 MHz k. (EW)

4346: 9AR, Rijeka Radio, HRV at 2240 in CW w/VVV marker (AB)

4363: AT&T High Seas operator at 0300 in USB wkg vsf Eagle Eye 2 w/radiotelephone t/c to 0312. (HA) (WOM, AT&T Coastal Station Florida - Ed.)

4426: SVN24, Athens Radio, Greece at 0556 in USB YL/Greek w/voice frequency marker, ann of Hellenic Telecommunications Organization (OTE) services in Grk separated by door-bell like chime. (Ed.)

4510.7: North Central Civil Air Patrol Net at 0133 in PACKET 300/170 w/various units active including: NE0021, MO0940, MO0977, MO0920 and IA0043. (DW)

4515: USN MARS at 0139 in PACTOR 200/200 w/chat between unid stations. (DW)

4558: "C", Navy Moscow, Rus at 2234 w/CW channel marker. (AB)

4575: Argentine Nat'l Police net at 0336 in USB w/two-tone European siren like notes, then SS/OM w/app ann. Also see 9215.0 log. I'd be interested in any further info on this net. (Ed.)

4633: Unid heard at 2230 w/CW msg to 894, 5FGs. (AB)

4682.5: South Korean military comms in USB mode at 1218. OM/str w/tuning counts consisting of Korean 1-10 and NATO phonetics, plus some excited chatter about something or other. Repeated the same routine after a few minutes of quiet. (DS)

4721: EXECUTIVE ONE FOXTROT at 2303 in USB wkg Andrews. (AN) (a/c w/member of Presidents imm family on board - Ed.)

4855: NPM, USN Pearl Harbor at 0136 w/WEFAX w/polar view. (SW)

5000: YVTO: Caracas Time Station at 0150 in AM w/voice ann of station id. Also at 0151 and 0152. (DW)

5142.6: C6C, unid, prob USCG cutter, heard at 0241 in USB clg USCG Group Mayport, no joy. (Ed.)

5145.5: COBRA 62 at 0735 in USB wkg ABNORMAL 20 Duplex on 7706.5 kHz. (AN) (ABNORMAL 20 is reportedly the Operations Center, Western Space & Missile



Photo of reader Ronald Tull's (VY1RT) radio shack in Whitehorse, Yukon, Canada.

Center, Wheeler AFB, Hawaii - Ed.)

5180: BAA9, Beijing Meteo. China heard at 1202 in 50/850 RTTY w/RY ten count, wx info. (EW)

5238: The Counting Numbers station at 0200 w/YL/SS 3/2FG. (SM)

5374.7: FDX: Paris at 0104 in ARQ-M2 200/340 on ch. A & B idling. (SS)

5397.7: RFFP. MoD Paris. F at 2343 in ARQ-M2 200/342 w/non-protecte t/c on ch. A w/references to IFOR on circuit FDX. (Ed.) Same at 0053 idling on ch. A & B. (SS)

5405: JN2. Tokyo Meteo, Japan at 0929 w/120/576 FAX, wx map. (EW)

5517: Khartoum, Cairo, and Nairobi Radios hrd wkg various a/c and each other between 2109 and 2125. (DS) Port Sudan Radio, at 2252 wkg Cairo Radio re: AEL 522. (TO) Both in USB mode.

5628: Japanair 020 at 0826 in USB wkg Honolulu Radio, Hi w/ARP 43N160W 26. FL 370. (TO)

5655: Singapore 978 at 1847 w/Singapore @ "MEVAS" FL330, Singapore-Hiroshima, selcal "BF-ES". A310-300 w/reg 9V-STW. At 1702 Singapore 998 w/Manila @ "SEKSI" (12-16.2N/113-59.8E) FL330. selcal "DQ-BR", 747-400 reg 9V-SMZ. Both in USB. (JSM)

5673: "Guangzhou Meteorological Information for Aircraft in Flight." YL/EE USB mode at 1431. (DS)

5696: CG RESCUE 1718, USCG HC-130H, at 1946 wkg NMN, CAMSLANT Chesapeake declaring an IFE (In-Flight Emergency) att to make Nassau, cud not hear nature of distress; at 1956 landing Nassau. (Ed.) USCG 1712 wkg CAMSLANT Chesapeake at 0330 re search for raft. Dropped 'DMB's at 2312 and notified USCGAS Key West. (RK)

FARGO-801 (not positive on callword) at 0108 wkg CAMSPAC. Asked CAMSPAC to relay "flight ops normal" and current posn: 2536N 11400W to WESTERN SKY. I had this a/c up 7 hrs earlier on 8971 wkg WESTERN SKY. (DW) All in USB mode.

5700: COBRA 62 at 0721 in USB wkg ABNORMAL 10 & ABNORMAL 20. (AN) (ABNORMAL 10 is reportedly Vandenberg AFB, Western Test Range, Op's Center -Ed.) **5753.5:** Unid CW stn 4XML Rptng "V BFR7 DE 4XML" at 1435. (TY)

5819.5: P7X, unid Spook station in CW. 2255-2302. 11 wpm, 5LGs. ended w/STTR and then gone. At 1350 next day w/usual format 11 wpm 5LG training traffic. (AWH)

6216: Unid stn R5SA Rptng "V PV2S DE R5SA" at 1359 in CW. (TY)

6350: Unid at 0006 75bd RTTY //6797. Station xmits only foxes, no id. (AB) Same at 0934, foxes 10 count no id. (EW)

6507: VIM, Melbourne Radio, Australia at 0945 in USB w/wx forecast for Victorian coast. (EW)

6509.5: Royal Navy, UKMACCS Coastal Control at 0413 in USB w/2-tone availability beep. (Ed.)

6535: Aeroflot 353 at 0129 in USB wkg Canarias w/ARP GADUN 30. FL 350, ETA Sal 0220. (TO)

6559: Johannesburg Oceanic, S. Africa at 0320 in USB wkg MH202 told them to QSY 5565 due QRM here. (TO)

6602.1: Cuba?, Spook Babbler, heard at 1415 t/in w/strong carrier, hum/telco noise, then nothing until 1445 when SS/YL went into long counts. SS/OM came on w/"hola hola" not long after, right over her counts, like didn't know she was on, so maybe multiple command sites feeding one tx. Lousy audio. Gone 1730 recheck. (AWH)

6649: Ecuatoriana 801 at 2316 in USB wkg Panama w/selcal AE-CG. ARP DUXUN FL 350. (TO)

6683: SAM 60203 at 2056 in USB w/pp McConnell Metro via Andrews. (AN)

6692.5: Various Royal Navy Sea Cadet Corps stations. G at 1006 in USB. MFK62, MFP38, MFP34, MFJ22, MFP29, MFJ99 and MFQ40C. (AB)

6761: GASER 13 at 0111 in USB elg HAWK 84. (AN)(common air/air refueling freq - Ed)

6785: Unid CW w/5FG: s in USB. Heard on a SUN starting from 0903 to end of xmission at 0937. (KM)



WE'VE GOT THE FIELD COVERED!

JO GUNN Antennas

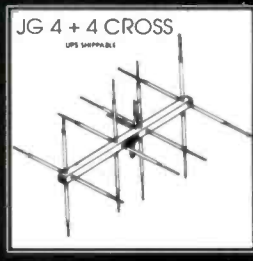

Route 1 Box 32C, Old Hwy 82.
Ethelsville, Alabama 35461
(205) 658-2229 fax (205) 658-2259

Hours: 9am - 5pm (CST) Tuesday - Friday

Other Models & Sizes Available in 10 or 11 Meters
Call or send \$2 for Complete Catalog and Pricing of Antenna
DEALER INQUIRIES, PLEASE CALL

6797: Unid at 0320 in 75/833 RTTY w/Foxes. (DW) Same at 0952 w/foxes/10-count/test + same tfc on 6350.0, 11006.0 (SS) Same at 0934 foxes 10 count no id. (EW) Same at 0716 //6350. (RH2) Same nightly, no ID at sign-down. (TS)
 6800: Unid in CW w/5FG's on a FRI at 0905. End of xmission at 0937. (KM)
 6802: The Counting Station at 0316 in AM, YL/SS w/5FGs (3/2). (DW)
 6855: SS/YL at 0314 in LSB w/5FG# Station (Fri).(AN) YL/SS 5FG @ 0300. (SM)
 6868: Bored Man Cuban spook station at 2004 in USB strong w/usual "R290" message. Regular Wednesday broadcast. (AWH)

6890.9: Tahiti, Papeete at 1220 in weird ARQ-M2 128.5/85. ch B running telexes from RFH-WWO w/SYNOP wx for RFHMMGW Murarora, ckt ID MOS. (AWH) (these 128.5 baud circuits all seem to involve Murarora, the French nuclear test site - Ed.)
 6956: 'Wolfpack Romeo', unid U.S. military, in USB at 0400 wkg '138' w/data burst xmissions. Op's must have had a hard time hearing each other as they were constantly yelling at each other. (TS) (USMC comms noted here before - Ed.)
 6959: Lincolnshire Poacher at 2130 in USB // 9251 // 11545 (CS)
 6983: Poss Cuban Spook station "Atencion

station" at 1113. SS/YL w/5FGs. (AWH) YL/SS w/5FG @0200. (SM)
 6993: SAM 60204 at 1215 in USB wkg Andrews. (AN)
 7039: F/C/S-Single Letter HF CW mkr at 1108. First time I've ever hrd three SLHFMs on this freq. (TY)
 7442: Cuban Spook station (ex-SOUD)in "Fast CW" at 1245. 5FGs 35 wpm. (AWH)
 7512: ZRO2, Pretoria Meteo at 1235 in 75/389 RTTY w/wx forecasts for African southern sub-continent. (RH2)
 7547: YL/EE in AM mode at 1203 repeats 1-0 counts and "872-872-872". Was passing 3/2F groups when checked back later at 1219. On another day. YL/EE in AM mode at 1337 with 3/2F groups. Strong, and //10529. (DS) YL/EE in AM at 1323 w/3+2FG's. //on 10529 kHz. (TY)
 7633.5: RADD 88: USAF a/c at 2107 in USB "over Louisiana" wkg Air Force MARS station AFA2XZ for pp tfc. (Ed.)
 7831.5: 5ST, ASECNA Antananarivo at 0332 in ARQ-E3 48/383 w/plain text wx. (DW)
 7948: F9S, French embassy Prague. CZE heard at 1136 in FEC-A 192bd w/plain text, and 5LGs. (AB)
 7982: Unid stn 7NKW Rptng "V CXT8 DE 7NKW" at 0735 in CW. (TY)
 8026: SAM 60204 at 2155 in USB wkg Andrews. (AN)
 8028: MFA Bucharest. ROU at 1121 in ROU-FEC 164bd w/encrypted msgs. (AB)
 8050.2: RFQP. FF Jibouti, DJI in ARQ-M2 200/340 a+b idling at 0126. (SS) Same at 0352 idling. (DW)
 8117: Spook station heard at 2305 to 2317 in CW w/12 wpm 5FGs 1x. "458" callup, long space between characters. sections ended w/BT, transmission ended with three long dashes. (AWH)
 8145: EIP, Shannon Air. IRL at 1118 in 50bd RTTY Meteo. (AB)
 8156: Bahamas. "FF" (boat) wkg "SS2" 1250, patrolling "GQ1852 area", also ops status to Coral Harbour in blind. (AWH) (Royal Bahamas Self Defense Forces here -Ed)
 8310: Spanish Navy training ship Juan Sebastian El Cano at 0100 in RTTY 100 baud w/msgs in SS/military format. "FM JECOM ELCANO." (WT) (nice catch, this is a mast-ed "tall-ship" - Ed.)
 8470: VTN9, Haiphong Radio. Vietnam at 1100 in cw w/de xvg qsx 500khz and 8/16 mHz.(EW)
 8495: SLHFB "C" in CW mode at 2046.(DS) (Russian Navy, Moscow -Ed.)
 8495.5: CLA, Havana Radio, Cuba at 1859 w/CW wheel, QRU C/12/7 CQCQCQ (SW)
 8604: DZJ, Bulacan Radio, Philippines. in CW mode at 1724 sends "CQ DE DZJ QSX 8 12 16 K". (DS)
 8764: 8PO, Barbados Radio heard at 2300 to 2301 in USB w/quick Carib marine wx. have been trying on and off for years to catch this one. (AWH)
 8779: JBO, Tokyo Radio, Japan at 0940 in USB making arrangements for phone call tomorrow at 1000 utc in EE. (EW)

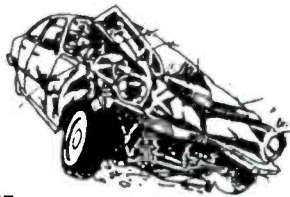

When seconds count, REACT® needs you...

...to summon help for an injured motorists, an elderly woman trapped in a fire, a trucker stranded in a blizzard, a drowning child!

As a REACT volunteer CB radio monitor you may be the only communications life-line for someone in serious trouble. You relay messages from those desperate for help to police or other emergency services.

Your REACT Team will also use CB and other radio services to provide safety communications for events like parades, marathons and even balloon races. The fellowship with other REACT members at Team meetings and annual conventions is an added bonus.

Volunteer. Join Today!

Add a New, Exciting Challenge to Your Life. Help Save Lives and Property!

REACT® International, Inc.

Tel (316) 263-2100
 FAX (316) 263-2118
 P.O. Box 998, Wichita, KS 67201



8825: Air Afrique 9974 at 2012 wkg Santa Maria, Azores w/selcal EM-BJ, ARP 2110N/3050W 2011, FL370, spd mach.80, enrt JFK-Dakar/B707F reg. 5X-JET. (TO)
8828: Hong Kong Volmet. YL/EE in USB mode from 2048-2049. (DS)
8867: LAN Chile 133 at 0745 in USB wkg Tahiti receiving Tahiti actual wx. (TO)
8872: Cuba? North Korean embassy, very strong so suspect La Habana, though traffic might indicate otherwise. 2320 ran across running RYs on 50/850, already into 5FG t/c by the time I woke up the Hoka. w/group counts at end of line every 10 lines, mostly several hundred line msgs but some shorter ones. Off at 2330 and into sloppy CW, mostly V's sent like H's. There was another similar sounding CW on 8873, but not sure if related, both xmitting over each other and never really QSO'd. Ran into it again in progress heard at 0010, had QSY'd down to 8867, more 5FG t/c but also some Korean plaintext w/ments of Pyongyang in the by-line, most datelined Lagos or Benin. (AWH)
8888: Forca Aerea Brasileira 2403 at 1946 in USB wkg Luanda ACC w/selcal ck LM-JK, ARP BOSN1 44, FL310, 5E 2005, 1VIGI 2010. (TO)
8891: New Zealand 1 at 2110 w/Baffin Radio @Coral Harbor (64-11N/83-21W), selcal JQ-EM, 747-400 w/reg ZK-NBT. Canadian 97 at 2115 w/Baffin Radio on polar track "E"

@80W, selcal DQ-CK, 767-300, reg. C-FCAJ. Both in USB. (JSM)
8936: VR-BK1 at 2011 in USB wkg Berne LDOC w/pp to Ops re: failing door seal. (TO)
8967: "S4JG" clg to Yokota for a radio check on one of the old. old GHFS freqs. Was USB mode heard at 0400. At 0403, the same guy, this time ID'ing as "Line Maintenance" came up on 11176 (another old freq) & called to "any station... on triple-one", at 0407, reverted to "S4JG" and started clg to Elmendorf. Failing that, called himself "Line Maintenance" again and put out a CQ call to "MAINSAIL... does anyone copy?" (DS) (app maint person who does not normally use the radio going from 'memory'. seems to confirm S4JG as a Navy 'test call' rather than a TACMO as some felt - Ed.)
8968: TEAL 37 (WC-130, 920th Weather Recon Group) wkg Gander in USB via Lajes, TEAL 37 is based at Keesler AFB. MS. (RK) (UTC? -Ed)
8980: CG RESCUE 2104, USCG HU-25A Falcon jet at 1724 in USB wkg CAMSLANT, w/pp D-7 (District 7), OAK GROVE (NORAD SE Air Defense Sector, Tyndall AFB, FL) reg origin of info re Cuban MiG's, also USCGC Monhegan (WPB-1305) is enrt to assist. (Ed.)
8983: At 1933, CG 2132 in USB passing to CAMSLANT results of a medevac enrt to hospital in Pensacola. Helo reported negative

vital signs on patient. (MF)
9016: At 1951, NIGHTWATCH 01 wkg NIGHTWATCH 03 in USB, "03" adv they where in the Gulf. (MF)
9023: At 2008, FOXTROT 7 VICTOR clg any station on this net. At 2046, SENTINEL clg OKIE SAM. Both in USB. (MF)
9090: NMC, USCG CAMSPAC, USA at 1000 w/120/576 FAX wx map.(EW)
9106: Unid station clg Rothera Base, Antarctica, at 0028 in USB, replied, both very weak. More activity next night 2340, no IDs readable, passing SYNOP wx by voice. (AWH) (I've also hrd these weak comms. Rothera is a British Antarctic Survey (BAS) station -Ed.)
9122.5: WUG, Army Corps of Engineers Vicksburg District at 1500 in USB w/Net Check-Ins. (AN)
9215: Policia Federal net. Argentina 0020 to 0030 in USB w/ distinct "eurosiren" interval signal, 0030 unreadable ID as "la red nacional de...". traffic list w/receiving stations (Junin, Mar del Plata, etc.), into radiogramas. Inn past at 0145. Also noted w/IS again at 1120. Ex-8050/4575/6920/etc. (AWH)
9226: RFPN, Lisbon Naval, Portugal at 0132 in RTTY 75/850 w/Rys, SGs, int zbz/pwx pwx de rpf/foxes/10-count (SS)
9251: Lincolnshire Poacher at 2230 in USB, // 6959 // 11545.(CS)
9263: MI-6 Cherry Ripe heard at 2208 in USB. (AWH)



LENTINI COMMUNICATIONS, INC.

Toll Free

1-800-666-0908

Deluxe Leather Cases w/Quick Disconnect Swivel Belt Loop for All Handheld Scanners - \$29.95

RELM HS 200

Multi-Band Programmable Scanner

- Multi-Band, Programmable Scanner, 13 Band Coverage From 26.000 MHz Thru 960.000 MHz.
- Includes 6 Meters and Aircraft.
- PL/CTCSS and DPL/DCS included!
- 200 Channels, 10 Banks, 10 Priority Channels.
- Birdie Lockout, Channel Lockout.
- Scan Speed Up To 100 Channels Per Second.
- HS200 Comes With A Metal Belt Clip, AC Adapter, Ear Piece, & Carrying Strap. (4 AA Batteries Not Included).
- Many Other Features.



\$249.95
UPS Included

GMRS 210+3 MAXON

Synthesized Scanning Mobiles UHF & VHF Versions Available

- 10 UHF Channels, CTCSS
- 2 Watts Output (5 watts at 12VDC)
- 25 Watts
- 4 Channels
- CTCSS/DCS

\$179.95 UPS incl.



Call on Maxom FRS Radios!
\$289.95
UPS inc.

YAESU FT-50R

Ultra Compact Dual Band Handheld

Receive: 76-200MHz, 300-540MHz
590-999MHz cellular blocked

Transmit: 144-148MHz
430-450MHz

- AM Aircraft Receive
- Digital Coded Squelch
- High Speed Scanning
- CTCSS Encode (Decode/w/FTT-12)
- 112 Memory Channels
- Much, Much More!



UNIDEN BC9000XLT

\$379.95 delivered



CALL FOR ALL UNIDEN BEARCAT

UNIDEN BC3000XLT

\$359.95 delivered



GRUNDIG Shortwave Yacht Boy 400

Advanced Compact AM/FM/SSB Shortwave

- Top Performance In A Portable Shortwave Receiver
- Yacht Boy 305 ALSO IN STOCK!

CALL FOR PRICING

CALL FOR DISCOUNT PRICES ON DRAKE AND SONY



SANGEAN ATS909

New From Sangean AM/FM/SSB Shortwave

- 306 Memories
- 28 SW Pages Preprogrammed
- Full RDS Reception

Loaded With Features

CALL FOR PRICING!



AR8000 AOR

CALL FOR PRICING



AR5000

IC-R10 ICOM

CALL FOR SPECIAL PRICING



IC-R8500

Conn Sales Infor. & Tech Help
860-666-6227

21 Garfield St. Newington, CT 06111
C.O.D.'s OK — SAME DAY SHIPPING

HOURS: M-F 10am - 6pm
SAT 10am-4pm
UPS Ground (48 states)

CIRCLE 69 ON READER SERVICE CARD

Frequencies of Interest for Hurricane Season

- 2182.0 International Maritime Distress.
- 2670.0 USCG ship working, SAR, weather broadcasts.
- 3130.0 SEALORD -USN FACSFAC (Fleet Area Control and Surveillance Facility) Jacksonville, FL
- 3357.0 NAA, U.S. Navy Cutler, Ma (weather fax 0000-1200 UTC).
- 3407.0 NHC Miami Monitor AAlpha@.
- 4317.9 NMG, USCG New Orleans weather FAX pictures.
- 4372.0 GIANT KILLER -USN FACSFAC, Virginia Capes Op's Area, Virginia Beach, Va. works assets out of Norfolk during Hurricane sorties.
- 4426.0 USCG CommSta's (ships/cutters QSX 4134.0)
- 4724.0 USAF GLOBAL HIGH FREQUENCY SYSTEM (GHFS) Andrews (H24), Elmendorf (Apr-Sep 1800-0800, Oct-Mar H24), McClellan (0400-1600), Thule (H24).
- 5211.0 FEMA - Night primary
- 5320.0 USCG Group Common, hrd as cutter coordination for hurricane sortie during Hurricane Felix.
- 5400.0 GANTSEC (USCG Greater Antilles Section, San Juan, PR) relaying posns. for cutters in Caribbean under hurricane sortie for 'Bertha'.
- 5550.0 New York ATC
- 5562.0 NHC Miami Monitor 'Bravo'.
- 5696.0 USCG Safety of Flight, Air/Ground, SAR op's, cutters.
- 5610.0 NHC Miami Monitor 'Charlie'.
- 6340.5 NMF, USCG Boston, weather FAX.
- 6501.0 USCG CommSta's (ships/cutters QSX 6200.0)
- 6586.0 New York ATC
- 6673.0 NHC Miami Monitor 'Delta'.
- 6712.0 USAF GLOBAL HIGH FREQUENCY SYSTEM (GHFS) Andrews (0001-1000), Bayonne (1300-2100).
- 6723.0 SEALORD -USN FACSFAC Jacksonville, FL (also 6742.0)
- 6739.0 USAF GLOBAL HIGH FREQUENCY SYSTEM (GHFS) Albrook (0001-1200), Andersen (0900-2000), Ascension (1800-0600), Elmendorf (Apr-Sep H24, Oct-Mar 0600-2000); Hickam (0400-1600), Lajes (H24), MacDill (2400-0900), McClellan (0400-1600), Offutt (2300-0800), Thule (H24)
- 6809.0 FEMA (F-21), Caribbean net during Hurricane Bertha.
- 7850.0 Caribbean Police Net.
- 7932.0 Florida Division of Emergency Management.
- 8080.0 NAA, U.S. Navy, Cutler, Me (as needed) weather fax.
- 8156.0 Bahamas Self Defense Force (SDF) -Coral Harbour.
- 8503.9 NMG, USCG CommSta New Orleans, 2300-1100 weather FAX.
- 8764.0 USCG CommSta's (ships/cutters QSX 8240.0)
- 8846.0 New York ATC
- 8876.0 NHC Miami Monitor 'Echo'.
- 8968.0 USAF GLOBAL HIGH FREQUENCY SYSTEM (GHFS) Andersen (H24), Andrews (H24), Elmendorf (H24), Hickam (H24), Lajes (H24), McClellan (H24), Offutt (H24), Thule (H24).
- 8983.0 USCG Safety of Flight, Air/Ground, SAR op's, cutters.
- 8992.0 USAF GLOBAL HIGH FREQUENCY SYSTEM (GHFS) Ascension (H24), MacDill (H24).
- 9016.0 MacDill GHFS discrete working TEAL flights.
- 9110.0 NMF: USCG Boston weather fax.
- 10015.0 NHC Miami Monitor 'Foxtrot'.
- 10493.0 FEMA Day Primary.
- 10865.0 NAA, U.S. Navy, Cutler, Me (1200-0000 UTC) weather fax.
- 11175.0 USAF GLOBAL HIGH FREQUENCY SYSTEM (GHFS) Albrook (H24), Andersen (H24), Andrews (H24), Ascension (H24), Bayonne (1300-2100), Elmendorf (H24), Hickam (H24), McClellan (H24), Offutt (H24)
- 11217.0 MacDill GHFS discrete, heard working TEAL flights.
- 11244.0 MacDill GHFS discrete, heard working TEAL flights.
- 11309.0 New York ATC
- 12750.0 NMF: USCG Boston weather fax.
- 12789.9 NMG, USCG New Orleans, weather FAX.
- 13089.0 USCG CommSta's (ships/cutters QSX 12242.0)
- 13200.0 USAF GLOBAL HIGH FREQUENCY SYSTEM (GHFS) Andersen (2000-0900), Elmendorf (Apr-Sep 1800-0800, Oct-Mar H24), Hickam (1600-0400), McClellan (1600-0400), Thule (H24).
- 13204.0 GHFS discrete.
- 13242.0 MacDill GHFS discrete.
- 13267.0 NHC Miami Monitor 'Gulf'.
- 13330.0 New York ATC
- 13354.0 New York ATC
- 14268.0 Amateur Radio, Radio Readiness Net, 4U1, UN Disaster Net.
- 14282.0 Amateur Radio, Caribbean Health & Welfare Net.
- 14325.0 Amateur Radio, Hurricane Nets. All hrd during Bertha.
- 15016.0 USAF GLOBAL HIGH FREQUENCY SYSTEM (GHFS) Albrook (1200-2400), Ascension (H24), Bayonne (1300-2100), Elmendorf (Apr-Sep H24, Oct-Mar 2000-0600), Lajes (H24), MacDill (0900-2400), McClellan (1600-0400).
- 17314.0 USCG CommSta's (ships/cutters QSX 16432.0)
- 17901.0 NHC Miami Monitor 'Hotel'.
- 17976.0 USAF GLOBAL HIGH FREQUENCY SYSTEM (GHFS) Andrews (1000-2400), Elmendorf (H24), McClellan (H24), Offutt (0800-2300).
- 21937.0 NHC Miami Monitor 'India'.

Also check the 75, 40, 20 and 15 meter amateur bands for additional nets.

9512: CMU967, Cuba at 1250 to 1540 on, quick CW, mostly VVV & clg RHO61 repeatedly, strong, crossband. At 1529 wkg RHO61 & sent QSX 11429 and later QSX 12446 but nothing ever hrd there or anywhere else. Supposedly Santiago Naval, but given the Russian connection have to wonder if it's really elsewhere, like Cienfuegos. (AWH)

9725: "New Star radio station #3" ("Xinxing Guangbo Dientai Di San Tai") signing on in AM mode at 0500 w/YL/CC announcer. Into 4FG's, each 2X, at 0504. Down at 0516. All New Star stations heard throughout the day, variously at h+00 and h+30. (DS)

9809: NIGHTWATCH 01 at 1752 in USB w/kg BACKPACK. (AN)

10018: Bombay Air, India at 1049 in USB clg Air India flt. (EW)

10078: Unid flight center at 2330 in LSB talking to a flt 801 about fuel quality. (SW) (Sue confirmed the LSB mode making this a real mystery - Ed.)

10091: Unid CW stn AMDL. (TY)

10223: YL/EE in AM mode at 1207 repeats 1-0 counts and "494-494-494". Noted with 3/2F groups at 1212. //7547. (DS) YL/EE in AM at 1250 w/3+2FG's. (TY)

10314: SNN299, MFA Warsaw, POL at 1110 in POL-ARQ 100bd msg to Madrid. (AB)

10830: Unid stn 4XML Rptng "V BFR7 DE 4XML" at 0925 in CW. (TY)

10873.7: RFVI, FF Le Port Reunion at 0105 in ARQ-E3 100/400 idling. (DW)

11006: Unid at 1758 in 75/850 RTTY w/Foxes. (DW) At 0900, same, w/foxes/10-count/test, //6797.0//6350.0 (SS)

11059: Air Force 2 at 1917 in USB wkg Andrews, departed Andrews "1410" Z, to arrive LaGuardia "1500" Z, evidently meant EST times. (AWH)

11173.3: Unid w/British accent at 1830 in USB "... Confidence level high, tracking 077 feet. 350, Yankee Yankee two. 1 fishing boat confidence level high, tracking 253 speed 9. 267 Yankee Yankee five. Tracking 088 speed 9, confidence high. 1 fishing boat confidence level low. Zero Yankee Yankee. Tracking one (sounds like) Lurge, confidence level medium tracking 093 speed 17...OUT". (BOZ) (interesting, poss UK MAFF - Ministry of Agriculture, Farms & Fisheries - Ed.)

11175: EXECUTIVE ONE FOXTROT at 2012 w/pp via Ascension. (AN) QUICK 63 at 2056 wkg Ascension for pp. (Strange c/s!) (BOZ) GHFS Yakota wkg a/c "EPIC-99" at 0614 w/pp to Yakota Metro. A/c was a C-130 enrt Singapore-Yakota, FL 230, posn 2106N 12238E (approaching Okinawa from the south), w/est time at Yakota of 1000Z. (DS) Ascension w/pp for NAVY 50496 at 2038 to Brunswick Ops. (VP-3A bureau #150496, the a/c of the Commander in Chief Atlantic, CinCLANT - Ed) At 1912, Offutt w/pp for NIGHTHAWK 12 to NIGHTHAWK Base. (MF) All in USB mode.

11181: SAM 60203 at 2126 in USB w/pp Andrews CP via Offutt. (AN)

11214: DRAGNET UNIFORM at 2023 w/pp EAGLE TWO via Trenton. (AN) SAM 27000,

SD-SAM C-137C tail 72-7000 at 1859 wkg SAM 682 re att to locate crewmember. (Ed.) Both in USB.

11220: SPAR 63 heard at 2029 in USB clg Andrews. (AN)

11265: CanForce 2104 at 2205 in USB w/pp via Trenton Military. (AN)

11300: Seychelles Radio at 2008 wkg Mauritius w/tfc rpt re: AF445. Sanaa Radio at 2120 wkg Mogadishu re: Air-India 205. Both in USB. (TO)

11306: American 912 heard at 0347 in USB wkg Flight Support Lima LDOC, Peru. (American Airlines) w/ARP ELASA? 43 FL310 93.7. (TO)

11430: YL/CC in AM mode at 0203 w/opening ann for numbers broadcast on "New Star Radio Station Number 1" ("Xinxing Guangbo Dientai Di Yi Tai"). Into 4FG's, ea 2X, at 0204. (DS)

11430: HMF55, KCNA Pyongyang, N. Korea heard at 0950 in 50/300 RTTY w/RYRY DE HMF. (EW)

11455.5: BRANDY clg FABULOUS at 1936 in USB. FABULOUS req switch to secondary then passes this msg H21 1935. (MF)

11518.2: RFFP, MOD PARIS, F at 1650 in ARQ-M2 200/400 a: idle b: idle. (SS)

11536: HMF49, KCNA Pyongyang at 0820 in 50/244 RTTY w/EE nx. (RH2)

11545: Lincolnshire Poacher at 1400 in USB //14487//15682. (CS)

12208: Slovakian Nx Agency Bratislava, heard at 1326 in 100/400 RTTY. Slavic-roman nx. (AWH)

12566: UUTU, RTMS Zvezda Sevastopolya at 1729 in 50/170 RTTY. Ukrainian-flagged Super Fishing Trawler/Super Freezer (Rybolovnyy Trauler Morilzhnyy -RTMS) wkg Kerch Radio w/admin msg from master KM Fisenko. (Ed.)

12603: Lincolnshire Poacher at 1800 in USB //9251. (CS)

12795: UCE5, Arkhangelsk Radio, CIS at 1129 in CW w/de uce5. (EW)

13200: NASA-717 wkg GHFS Andersen for pp to Andersen Metro and Andersen Base Ops Dispatch. A/c was enrt Bangkok-Guam. USB mode 0430-0441. (DS) (Douglas DC-8-72, N717NA -Ed.)

13206: DARKSTAR MIKE at 2012 w/pp Radar Maint via Trenton. (AN) PLANTATION Ops. 16th SOW, Hurlburt Field, FL at 1649 clg "any station", then "nothing hrd... out". (Ed.) Both in USB.

13242: EXECUTIVE ONE FOXTROT at 2015 in USB wkg Offutt. (AN)

13270: New York Volmet at 2110 in USB, ID "New York Radio". (BOZ)

13300: N387PA at 2021 in USB wkg Houston

"DON'T GET CAUGHT OFF GUARD!!"

Avoid death or injury due to severe weather with IMMEDIATE notification via alphanumeric pagers.

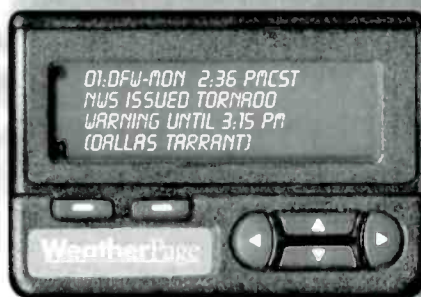

WeatherPage provides immediate severe weather watches and warnings, real-time storm movement and speed, severe weather statements, hurricane advisories, and even daily forecasts wherever you go. Any alphanumeric pager from any paging company will work with WeatherPage.

Find out what hundreds of emergency managers, television and radio stations, storm spotters, and weather enthusiasts already know... WeatherPage is the quickest and most efficient technique to receive life-threatening severe weather information. WWS developed the WeatherPage System to provide maximum flexibility and affordability to all users via alphanumeric pagers.

WeatherPage's flexibility allows you to determine your own customized county-specific coverage region. Not only can you choose the specific counties for notification, but you can also choose from our extensive list of over 25 severe weather products.

Know what its like to be notified immediately of severe weather wherever you are...
Know WeatherPage!!

Only From Widespread Weather Services

1-800-845-0383

<http://www.io.com/~weather/>

WORLDS SMALLEST TRANSMITTERS

XWB1000E-Z kit \$46.95

MICRO FM TRANSMITTER

Voice transmitter kit. Transmits 88 to 108MHz. Range up to 1/2 mile. Includes mic and battery. Uses surface mount components



XTL1000E-Z kit \$69.95

CRYSTAL CONTROLLED TRANSMITTER

Voice transmitter kit. Range up to 1/2 mile. Super sensitive mic. Transmits at 143.790MHz. Uses surface mount components



XTL3000E-Z kit \$99.95

LONG RANGE CRYSTAL CONTROLLED TRANSMITTER

Voice transmitter kit. Range up to 1 mile. Super sensitive mic. Transmits at 143.790MHz. Uses surface mount components



XLC900(C) \$49.95

SCANNER CONVERTER KIT

Uninterrupted coverage of the 800 to 950MHz band. Works with any 400 to 550MHz scanner.



XBD500E-Z KIT \$129.95

BUG DETECTOR

Professional quality. Covers 1MHz to 2GHz. Uses new microwave integrated circuit amplifier. Adjustable sensitivity. Earphone jack for quiet operation.



ASK ABOUT OUR CRYSTAL CONTROLLED TRACKING TRANSMITTER XTR300E-Z \$79.95

ORDER LINE
1-800-336-7389



CHECK, VISA, MC, MO,
or COD. S&H EXTRA

Call for FREE Catalog



XANDI ELECTRONICS, INC.
SATISFACTION GUARANTEED
SERVING THE PUBLIC SINCE 1981
1270 E. BROADWAY RD. # 113
TEMPE, AZ 85282

CIRCLE 85 ON READER SERVICE CARD

PAY TV AND SATELLITE DESCRAMBLING

all new information 1996 Edition VOLUME 7

Pay TV and Satellite Descrambling Volume 1-7 (all different). Satellite & DBS hacking, Wireless Cable Hacking, Complete Wizard, Buying Surplus, Seized & Distressed Goods, Cellular Phone Hacking, Computer & Phone Hacking, all new Hacker Video. \$15.95 each, any 3/\$34.95 or any 5/\$52.95. American Hacker Magazine \$29.95 includes BBS. Our Best Deal is everything listed here and lots more for only \$129.95. New product catalog \$1. Add \$6 for C.O. O's.

SCRAMBLING NEWS

3494 DELAWARE AVE. #123, BUFFALO, NY 14217-1230
Voice/FAX (716) 283-6910 BBS (716) 871-1915
<http://www.scramblingnews.com>

CIRCLE 79 ON READER SERVICE CARD

**FREE
SAMPLE
COPY!**

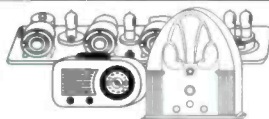

ANTIQUE RADIO CLASSIFIED

Antique Radio's Largest-Circulation
Monthly Magazine

Articles - Classifieds - Ads for Parts & Services

Also: Early TV, Ham Equip., Books,
Telegraph, 40's & 50's Radios & more...

Free 20-word ad each month. Don't miss out!

1-Year: \$38.95 (\$55.95 by 1st Class)
6-Month Trial - \$19.95. Foreign - Write.

A.R.C., P.O. Box 802-T12, Carlisle, MA 01741
Phone: (508) 371-0512; Fax: (508) 371-7129

Web: www.antiqueradio.com

LDOC. selcal AD-FH. w/pp for wx
GON/PVD/TEB. (TO)

13375: Lincolnshire Poacher at 1500 in
USB(no parallels).(CS)

13444.2: RFQP. French Forces Djibouti at
1125 in ARQ-E3 100/425 idling.(EW)

13585.9: CNM85/X11, MAP Rabat at 1605
in 50/386 RTTY nx in FF.(SS)

13750: Traditional Chinese music and YL
w/"New Star Radio Station #5" ID ("Xinxing
Guangbo Dientai Di Wu Tai"). Different YL
w/opening remarks, then into 4FG's, ea 2X,
at 1103. (DS)

13886.7: RFFA. MOD PARIS. F at 1431 in
ARQ-E3 192/425 idle.(SS)

13969.5: CLP1, Cuban Ministerio de las
Relaciones Exteriores (MINREX), Havana.
Cuba at 1934 in 75/486 RTTY w/embacuba
tfc & encryption. (Ed.)

14382.3: Unid at 1518 in 150/400 RTTY
Bulgarian text. (SS)

14383.5: MARS stn NNNORFH at 2250
wking NNNONXV in USB re: setting up a 75
baud RTTY link. Stns sent numerous RTTY
75/500 test xmissions to ea other. (TS)

14387: Unid. daytime. 75/850 RTTY running
the previously noted "a lazy dog
1234567890 test" tape continuously. today at
1800 noted mixing w/NAM WEFAX audio.

Same mixing also noted at night on 5157;
RTTY alone noted at nights also on 6797.
Slight milli-seconds delay between the usual
NAM freqs and these, not sure which way
though. (AWH) Same at 1828 w/Foxes. (DW)

Unid stn here in RTTY 75/850 on daytime freq
rptng "quick brown fox" test tape nonstop for
several hours. This is the same station as on
6797. (TS)

14487: Lincolnshire Poacher at 1300 in USB
//15682//16084.(CS)

14508: P6Z. MFA Paris F at 1108 in ARQ6-
90 200/170 w/5LG's to unid location. (EW)

14510.5: MKK. London heard at 1325 in
Piccolo-6, eng channel w/op chat to MTS
Stanley. (AWH)

15016: Albrook at 1941 w/pp for JASPEY
(sp) to Command Center. (MF)

15097: McClellan AFB at 2158 in USB wkg
MacDill AFB. (AN)

15388: YL/CC ann upcoming msg traffic on
"New Star Radio Station #2" ("Xinxing
Guangbo Dientai Di Er Tai") in AM mode at
2330, then into 4FG's, ea 2X. 8300, 9725, and
11430 were also active at this time, but non-
//. "Zaihui" ("good-bye") at 2141.(DS)

15448: BANGER at 1814 in USB wkg JER-
SEY. (AN)

15616: Lincolnshire Poacher nbr stn in USE
heard at 1015 w/5FG's in EE, also on 17499
kHz. (TY)

15946.5: Spanish Embassy. Managua,
Nicaragua at 1912 in TWINPLEX 100/170
w/SS tfc to EAE220. At 1615 Spanish
Embassy. Tegucigalpa, Honduras, in TWIN-
PLEX w/SS tfc to Madrid, also up here at
1750, then sends QSL, ID at 1810, off. (Ed.)

16125.3: RFQP, FF Jibouti at 1610 in ARQ-
M2 200/360 w/"CdeV". (RH2)

16357: OMZ, MFA Prague at 1209 in 100/425
RTTY w/CZECH nx.(RH2)

16799.4: EKRR, TH Terehovsk at 1020 in
50/170 RTTY, at Port Bissau, cargo & sailing
details to K'grad. (RH2)

16811: CBV, Valparaiso, Chile w/Sitor free
& CW ID at 2056.(WP)

17499: Lincolnshire Poacher nbr stn in USE
w/5FG's grps in EE, at 1015 //15616 kHz, and
at 1005 //10452 kHz. (TY)

17904: Air Mike-806 wkg Honolulu ARINC
in USB mode at 0206. A/c est waypoint
"KUCOO" (N17-18.9/E140-00.0, Saipan
area) at 0252.

selcal CM-BK. Honolulu adv 11384 sec-
ondary. (DS)

17976: NAVY RX693, C-9B Skytrain. VR-
57 (USNR)"Conquistadors". NAS North
Island, at 1704 in USB wkg McCellan GHFS
att pp Little Rock, QSY 11175. (Ed.)

18180.8: MFA Algiers (Tent ID) at 0800 in
COQ-8 w/crypto. (RH2)

18220: JMH5. Tokyo Meteo. Japan, at 0932
in 120/576 FAX w/wx map. (EW)

18220.9: CNM76X9, MAP Rabat. MRC at
1614 in 50/380 RTTY, nx in FF.(SS)

18320.7: RFTJ, French Forces, Dakar, SEN
at 1641 in ARQ-E3 192/393 w/control de voie
on circuit TJD, ltr w/non-protecte tfc. (Ed.)

18496.1: CNM80, MAP Rabat at 1620 in
50/441 RTTY w/Arabic nx. (RH2)

18560: BMF, Taipei Meteo, Taiwan, at 0916
in 120/576 FAX wx map. (EW)

18704.4: DFS70, PIAB Bonn at 0920 in FEC-
A 96/395 w/GG nx. (RH2)

20950: 6XM8. BND/Mossad station at 1309
in ARQ-E 192/170 w/crypto on screen. (RH2)

22565: XSW. Kaoshiung Radio, Taiwan, at
1058 in cw w/cq de de xsw. (EW)

This months contributors:(AB) Ary
Boender (The Netherlands); (AH) Al
Hemmalin (RI); (AN) Anonymous (Mid-
west USA); (AWH) Albert W. Hussein
(FL); (BOZ) Richard in Iceland; (CS)
Chris Smolinski (MD); (DS) Dave Sabo,
South Korea; (DW) Dave Wright (TX);
(EW) Eddy Waters (Australia); (FD)
Francis D. Donovan (MA); (HA) Harold
Abbott (NY); (JSM) Steve McDonald
(BC, Canada); (KM) Ken McWaters
(TX); (KS) Kevin Scott (GA); (MF) Mike
Fink (FL); (PC) Perry Crabill Jr. (VA);
(RH) Robert Hill (MI); (RH2) Robert
Hall (Capetown, S. Africa); (RK) Rich
Klingman (NY); (SM) Scott H. Miller
(TX); (SS) Stan Scalsky (MD); (SW) Sue
Wilden (IN); (TO) Tony Orr (VA); (TS)
Tom Severt (KS); (TY) Takashi
Yamaguchi (Nagasaki, Japan); (WP)
Walt Petersen, FL; (WT) Wade Taylor
(CA) and (Ed.) ye editor in Ohio. Another
nice turn out . . . thanks to all. ■

The Listening Post

BY GERRY L. DEXTER

WHAT'S HAPPENING: INTERNATIONAL SHORTWAVE BROADCASTING BANDS

Radio Australia on the Chopping Block and Radio Jordan Issuing QSLs?

At first many people assumed the stories about Radio Australia were nothing more than rumors; tea leaves in the bottom of the cup. Perhaps because the idea of Radio Australia no longer being on shortwave was too preposterous to be given any weight. Now we know the wallet crunchers in Canberra are actually serious! They want to see the overseas service closed down or sold off and the money saved (or raised) used to improve the domestic service. Richard Alston, who is Minister of Australian Communications and the Arts says the government has not made any decision regarding Radio Australia; that the ABC (the domestic side) will make

the decision. Fortunately, the opposition party doesn't agree with this and surely there will be a stink raised by Radio Australia's millions of listeners in Asia and the Pacific, as well as around the world. Your support letters should be sent to **Radio Australia, GPO Box 428G, Melbourne, Victoria 3001.** e-mail <roz@radioaus.org.au.> Their web site is at <<http://www.abc.net.au/ra/default.htm>>.

Tell you what: Radio Australia could rent unused transmitter time to stations looking to increase their coverage of Asia and the Pacific and those which can't seem to find a "home." Radio Free Asia, perhaps? HCJB has been nosing

around, considering the possibility of Australia as a site for a facility to better reach an Asian audience.)

We hear rumors that Mauritius, the Maldives Islands and Brunei are all planning shortwave comebacks. All three have been missing from the higher frequencies for (literally) decades. We also hear that Bahrain, gone for a couple of years now, is also planning to return. Even if only one or two of these countries came back, it would be terrific news. Australia may leave; four small countries may return. If that were a picture on the wall it wouldn't hang straight!

Also, long gone, but now returned is **Radio Bayrak** on the island of Cyprus.

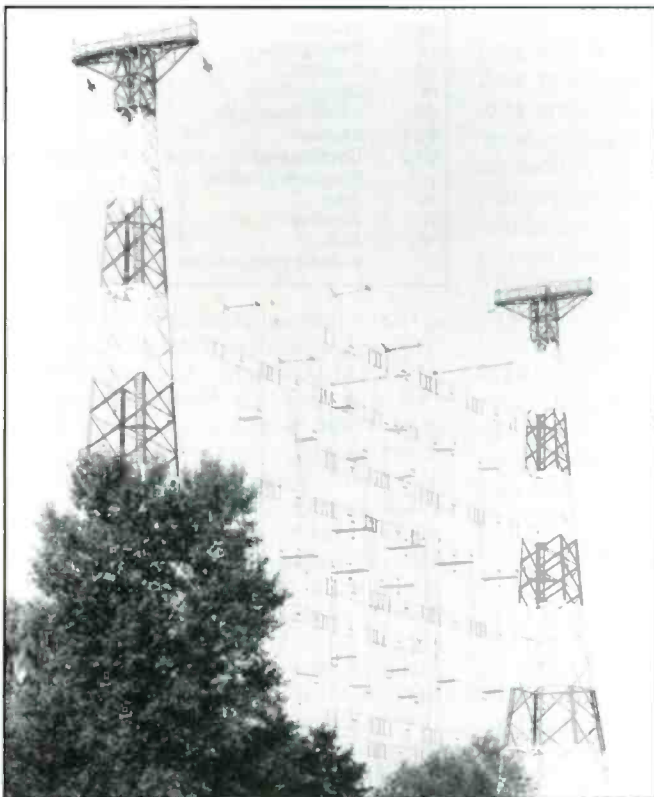

Transmitting towers at Radio Austria International's Moosbrunn transmitting site.

Ed Rausch got this nice reply from CRTV, Cameroon for his reception of the station at Yaounde on 4850. →

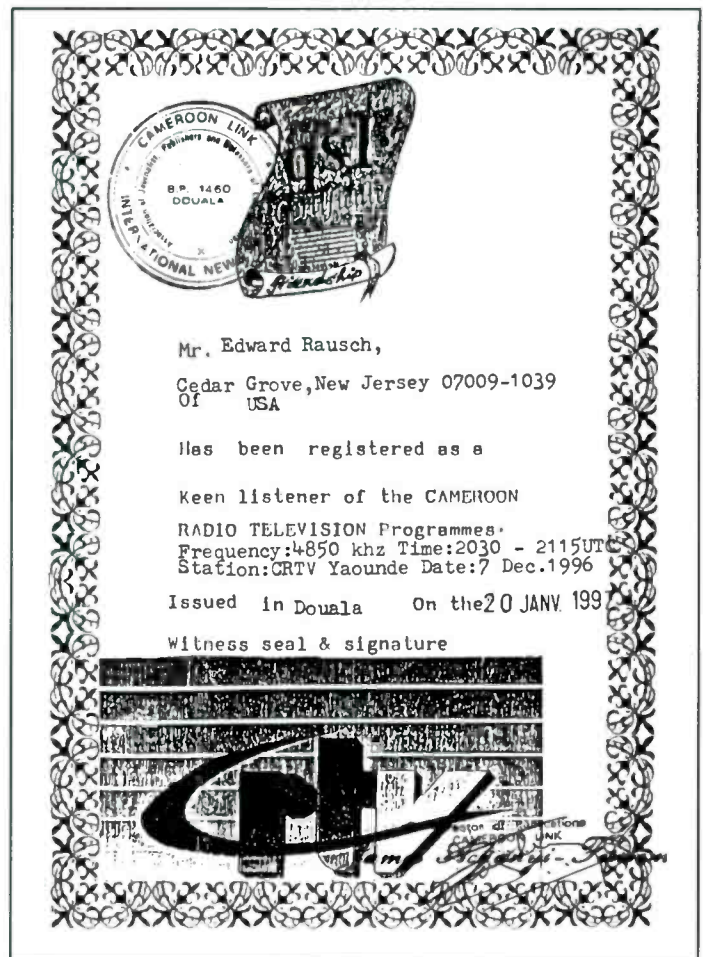



Here's the Editorial staff at Radio Romania International.



It is using **6150** (and sometimes **6159** or **6160**) to closing just after 2200. Most of us will have to wait until the return of shorter daytime hours in the fall in order to hear this one at that time.

Still another returnee is **Radio Guaira, Paraguay**, which has resumed broadcasting on **5975** (varies to **5976**), running until 0100 or so with programs in Spanish. The shortwave station relays their local FM outlet.

The big squeeze continues to haunt shortwave from Russia. Further budget cuts are forcing the Voice of Russia to make considerable cuts in its Russian language World Service programs from 18 hours per day down to just 10.

Radio Jordan, long known as a "bad guy" when it comes to issuing QSLs to listeners says it's going to do better from now on. According to an on-air announcement, they will now send a QSL card, a sticker and a program schedule in response to all correct reports received. If you need a reply from Radio Jordan, you should probably make a move now, while they're in the mood (assuming they're still in that state!). Check **11690** around 1200. The address is P.O. Box 909, Amman, Jordan. It might be a good idea to send your reception report to the attention of the "Mailbag" program.

The **BBC's new relay at Nakhon, Thailand**, is now in operation. The full schedule is much too long to include here. But here are the frequencies being used: **5965, 5975, 5990, 6085, 7180, 7225, 7235, 9510, 9580, 9600, 9750, 11750, 11955, 15310, 15380, 15405, 17790** and **21660**. Your best bet is probably one of the 41 meter band frequencies during our early morning hours. BBC Thailand is broadcasting in a number of Asian languages (Bengali, Mandarin, Hindi, Azeri,

Cantonese, Urdu, Farsi, Burmese, etc.)

WRMI, Miami has expanded its broadcasts and now operates Monday to Friday from 1045 to 1715 and 2000 to 0330 on **9955** (weekend hours are longer). They're also planning to add a second 50 kw transmitter so they can have English and Spanish programming on the air simultaneously.

Remember, your informational input is always welcome! Logs should be double-spaced, listed by country (don't bother to alphabetize them) and tagged with your last name and state abbreviation after each. We also need shack and station photos, station literature and schedules, spare QSL cards we can use as illustrations (as well as stickers and the like), information about station QSL policies, new addresses and so forth. Your continued interest and cooperation is greatly appreciated!

Here are this month's logs. All times are in UTC which is five hours ahead of EST, i.e. 0000 UTC equals 7 p.m. EST, 6 p.m. CST, 4 p.m. PST. Double letters such as FF, SS, PP, AA, RR are abbreviations for languages (French, Spanish, Portuguese, Arabic, Russian, etc.). If no such abbreviation appears the broadcast is assumed to have been in English.

ALBANIA—Radio Tirana, **7160** at 0228. (Miller, WA)

ANGUILLA—Presumed Caribbean Beacon, **11775** at 1300 with Dr. Gene Scott. Mentioned **6090**, too. (Hornstein, MI) (Correct, Hugh, 6090 is also Anguilla but that's only in use when 11775 is not. Editor)

ARGENTINA—RAE, **11710** at 0200 with multi-lingual ID, into news, music and cultural features. (Behrendt, NE)

ARMENIA—Radio Yerevan, **9965** at 2240 in Armenian with music, closing announcements and anthem. (Behrendt, NE)

ASCENSION ISLAND—BBC relay, **15105**

Abbreviations Used in Listening Post

AA	Arabic
BC	Broadcasting
CC	Chinese
EE	English
FF	French
GG	German
ID	Identification
IS	Interval Signal
JJ	Japanese
mx	Music
NA	North America
nx	News
OM	Male
pgm	Program
PP	Portuguese
RR	Russian
rx	Religion/ious
SA	South America/n
SS	Spanish
UTC	Coordinated Universal Time (ex-GMT)
v	Frequency varies
w/	With
WX	Weather
YL	Female
//	Parallel Frequencies

at 1900 with news. (Behrendt, NE) 1902 with "Ogagawa's Untellable Tales." (Jeffery, NY)

AUSTRALIA—Radio Australia, **9580** at 1521 with Australian Boy's Choir. (Miller, WA) **11800** heard at 1335 with news. (Northrup, MO)

AUSTRIA—Radio Austria Int'l, **6015** (via Canada) at 0639. (Tucker, AL)

AZERBAIJAN—Azerbaijani Radio, **4785** at 0645 in possible Azeri with male announcer playing music. (Behrendt, NE)

BENIN—Radiodiffusion du Benin, **4870** in FF and local African languages at 0715. (Behrendt, NE)

BOTSWANA—VOA relay, **12080** heard at 1845 with news and features to Africa. (Behrendt, NE)

BRAZIL—Radio Nacional Amazonas, **11780** at 1835 in PP with pop. (Behrendt, NE) 2317 in PP with music. (Miller, WA)

Radio Nacional, presumed, **11765** at 0513 in what appeared to be PP with a talk by a man, then music. Off at 0517, no ID. (Jeffery, NY) Radio Aparecida, **5035**, presumed, at 0504 in what appeared to be PP with music, man

announcer, talk by woman. No ID. (Jeffery, NY) **9630** at 0830 in PP. (Behrendt, NE)

Radio Brazil Central, Goiania, **4985** at 0720 in PP with Brazilian pop. (Behrendt, NE)

RadioBras, **15265** at 1900 in EE with music. (Behrendt, NE)

Radio Cultura do Para, Belem, **5045** in PP heard at 0245 with music and commercials. (Miller, WA)

Radio Anhanguera, Goiania, **4830** at 2343 in PP with news, commercials. (Miller, WA)

BULGARIA—Radio Bulgaria, **9700** at 2000 with news and "Topic of the Week." (Behrendt, NE)

BURKINA FASO—Radio Burkina, **4815** at 2240 in FF with music, man announcer. (Jeffery, NY) **0630** in FF and local languages. News at 0700. (Behrendt, NE)

CANADA—CFRX, **6070** at 1530 about banning pit bull dogs in Kitchner. ON. (Wallesen, IL) **2100** with commentary, weather report. (Jones, SD)

Deutsche Welle via Sackville, **13790** at 1530 in GG. (Jones, SD)

Radio Canada Int'l, **9755** at 0039 with CBC's "As It Happens." (Tucker, AL) **0043** "Quirks and Quarks." (Miller, WA) **9805** at 2107 with weather, sports. Parallel with **5925//11945//17820**. (Jones, SD) **11725** at 0200. (Garvin, MD) **11855** at 1345. (Northrup, MO); **11940** at 0001 with news. (Miller, WA)

CHILE—Radio Esperanza, Temuco, **6090** heard at 0336 in SS with evangelistic program. (Miller, WA)

CHINA—China Radio International, Xi'an, 2218 to 2228 close and 2230 to 2256 close. (Silvi, OH) **2219** in what seemed CC. Fade out at 2227. (Jeffery, NY) **15110** via Mali at 2053. (Hornstein, MI)

Voice of the Strait, **4900** at 1050 in CC with CC pop, unique Chinese regional stations* 5 + 1 time pips to ID and presumed news by woman at 1100. (Rausch, NJ)

COLOMBIA—Caracol Colombia, **5077** in SS at 0244 with news. (Miller, WA)

CROATIA—Croatian Radio, **5895** at 2300 with news headlines. (Behrendt, NE) **2301** news by woman. An e-mail report brought a QSL card. (Wilden, IN)

COSTA RICA—RFPI, **7385** heard at 0525. (Jones, SD)

TIFC/Faro del Caribe, **5055** in SS at 0800. (Behrendt, NE)

Adventist World Radio, **5030** at 1158 with religious program. (Hornstein, MI) **0227** in SS with religious message. (Miller, WA)

Radio Reloj, **4832** at 0715 in SS with music and time checks. (Behrendt, NE)

CUBA—Radio Havana Cuba, **6000** at 0204 with news. (Tucker, AL) **0300** with news. (Garvin, MD) **6005** at 0101; supposed to be on **6000**. (Wilden, IN) **6180** at 2230 with ID, news. (Jones, SD) **11760** at 1310 in SS. (Northrup, MO)

Radio Rebelde, **5025** at 1205 in SS with rapid talks. (Hornstein, MI)

DENMARK—Radio Denmark via Norway, **11735** heard at 1315 with sports, in DD. (Northrup, MO)

DOMINICAN REPUBLIC—Radio Cristal Int'l, **5012v**, 2340 in SS with many Ids as "Radio Cristal Internacional, la voz de la Republica Dominicana." (Silvi, OH)

ECUADOR—HCJB, **9745** at 0041 with mailbag. **15140** at 2336 in SS. (Miller, WA); **0400** with news with excellent coverage of the political crisis. (Silvi, OH); **0539** with music. (Tucker, AL) **12005** at 1340 and **15115** at 1355. (Northrup, MO).

Radio Jesus del Gran Poder, **5049** in SS at 0255. (Miller, WA)

Radio Quito, **4919** with animated talk in SS. (Miller, WA) **0456** with talk, music, ID: "Radio Quito, La Voz de la Capital." (Hornstein, MI) **0715**. (Behrendt, NE)

La Voz del Napo, **3280** at 1100. Man with SS talk and martial music at the top of the hour. (Hornstein, MI)

EGYPT—Radio Cairo, **12050** in AA at 1845 with commentary and music. (Behrendt, NE)

ENGLAND—BBC, **5975** (via Antigua) with sports at 0315 and **6175** (via WYFR) at 0100. (Garvin, MD) **5990** heard at 1540 with drama. (Miller, WA) **9590** (via WYFR) at 0314. (Clayton, MT) **12095** at 1330. (Northrup, MO)

FRANCE—Radio France Int'l, **15574** at 1720 in FF with reports by correspondents, discussion, ID. (Paszkiwicz, WI)

FRENCH GUIANA—Radio France Int'l relay **11995** at 0001 in PP with news. (Miller, WA) **13625** at 1350 in FF. (Northrup, MO)

GABON—RTV Gabonaise, **4777** at 2230 in FF with talk. (Jeffery, NY)

Africa Number One, **9580** at 2241 in FF with African music. (Miller, WA)

GERMANY—Deutsche Welle, **9945** at 1634 with frequencies, weather. (Miller, WA)

GHANA—Ghana Broadcasting Corp., **4915** at 0700 with news. (Tucker, AL) **0715** with news. (Behrendt, NE)

GUATEMALA—Adventist World Radio, **5981** heard at 1232 in SS with ID, IS, music. (Jeffery, NY)

Radio Buenas Nuevas, **4799.8** at 1130 in SS with religious music, ID. (Hornstein, MI) **0500** in SS with music, children singing. (Behrendt, NE)

Radio Cultural Coatan, San Sebastian, **4779**, **0219** in SS with Latin music. (Miller, WA)

Radio Tezulutlan, **4835** heard at 1158 with man in local Indian language, background music. ID in SS. (Hornstein, MI) **0228** in SS. (Miller, WA)

Radio Cultural, **3300** at 1100 with music in SS. (Hornstein, MI)

HAWAII—KWHR on **13625** at 1850 with DX program. (Behrendt, NE)

HONDURAS—Radio Internacional, San Pedro Sula, **4830** in SS with Latin music at 0309. (Miller, WA)

La Voz Evangelica, **4820** at 0223 with religious programming. (Miller, WA)

INDIA—All India Radio, Gorakhpur, **7250** at 0158 in Hindi. Music of India, news by read by man. **10330** at 0140 with music of India, Hindi. (Miller, WA) **9650** (Bangalore listed, Ed.) at 1900-1945 close. Parallel **11620**. (Silvi, OH)

C. CRANE COMPANY

COMMUNICATIONS EXCITEMENT



The Sangean ATS 909

- Sangean •Lowe •Drake •Uniden

The most powerful loop antennas for shortwave/MW and much more!
558-10TH ST. FORTUNA CA 95540
Free Catalog FAX 707-725-9060
website:www.ccrane.com

800-522-(TUNE) 8863

CIRCLE 64 ON READER SERVICE CARD



FREE SHIPPING!

Take advantage of the best price on the best handheld mic... Astatic's D104M6BI

QUEMENT COMMUNICATIONS
PHONE 800.998.8070
969 S. BASTION AVE. BARABEE, WI 53128

CIRCLE 75 ON READER SERVICE CARD

Scanner Buffs We've Got The Goods!

We have a great selection of full-coverage scanners including AOR, Radio Shack, Trident and Yupiter. We also carry scanner interfaces for the ultimate scanning experience!

- 1000 channels (20 banks of 50 channels)
- full coverage from 500KHz-1.9GHz AM-WFM-NFM-U/LSB-CW
- scans a maximum of 30 channels/sec.
- comes with rubber duck ant, nicods, charger, lighter plug, more

Send \$3.00 for our new 60 page catalog

AOR AR8000

Durham Radio Sales & Service, Inc.
350 Wentworth St. E., Oshawa, Ont. L1H 7R7
Ph: (905)436-2100 Fax: 436-3231
Web: durhamradio.ca e-mail: info@durhamradio.ca

PATENTS

PATENT AND TRADEMARK APPLICATIONS
PATENT SEARCHES • LITIGATION
LEGAL ADVICE ON INVENTIONS AND IDEAS

1-800-333-IDEA

STEPHEN D. CARVER (K5PT) WWW.ARKPATENT.COM
SUITE 800 P.V.C.C. 2024 ARKANSAS VALLEY DR. LITTLE ROCK, AR 72212-4139
FAX: (501) 224-8831

CIRCLE 87 ON READER SERVICE CARD

RadioMax Windows Scanning

SERIOUS RADIO & SCANNER CONTROL Win 3.1 / 95

Powerful, high speed scanning with more features! High res. graphics let you see what's happening in real time. Search, sort, scan, log, tape by frequency, comments, hit times, modes etc. PC can even speak the frequency and hit time! PerCon file support. Intelligent tape control and delays. Download free demo at: www.futuresscanning.com or call

RadioMax (includes 60 page manual) \$79.90 + \$6 S/H
CI-V Interface with Squelch Detect and Tape Control \$89.90 + S/H
VISA FUTURE SCANNING SYSTEMS M-C
6105 SE Nowata Road Unit 6, Bartlesville, OK 74008
TEL 918-335-3318 FAX 918-335-3328

Quality Microwave TV Systems

WIRELESS CABLE ITFS MMDs
ATV - INTERNATIONAL S-BAND
Amplifiers • Antennas • Books • Components
Filters • Systems • Video Products

- RF Frequency 1990 2700 MHz
- Cable Ready VHF - UHF Outputs
- SASE For "FREE" Catalog or Send \$1

PHILLIPS-TECH ELECTRONICS
PO Box 8533 • Scottsdale, AZ 85252

ORDER LINE 800-880-MMDS
CATALOG/INFO 602-947-7700
FAX LINE 602-947-7799

CHALLENGER SYSTEM
33 Channel 52db Gain
Complete Grid 52db
Five Year Warranty
FREE SHIPPING Visa • MC • Amx • Disc • COD's • Qty Pricing

CIRCLE 74 ON READER SERVICE CARD

INDONESIA—Radio Republik Indonesia, 9525 at 1811 with woman in GG. 15150 at 2330 in Indonesian. (Miller, WA)
ISRAEL—Kol Israel, 9365 at 2002 with Mid-east news. (Miller, WA) 11605 at 1520 with news, commentary, address, schedule, music and into Yiddish at 1530. (Jones, SD)
ITALY—RAI, 6010 at 0023 in II with classical music, talks. (Jeffery, NY) 6110 at 0140 with news. (Miller, WA)
KUWAIT—Radio Kuwait, 9855//9880 at 1950 in AA with Arabic music. 11990 at 1930 in EE. (Behrendt, NE) 11990 at 1809 with various stories, including Iraqi mines still causing problems. News at 1830. (Wilden, IN)
LIBERIA—Radio Liberia, 5100 at 0730 in EE with music and commentaries about the political and social situation in Liberia. (Behrendt, NE) (Mail isn't getting through to this station. Editor)
MADAGASCAR—Radio Netherlands relay, 9605 at 1816 with discussion of the effects of noise on people. (Miller, WA) 9895 at 1345 with letters and congrats on their 50th anniversary. (Hornstein, MI)
MALI—RTV Malienne, 4783 at 2235 in FF with talk. (Jeffery, NY)
 China Radio Int'l relay, 11715 at 2110 with news and comment. (Jones, SD)
MEXICO—Radio Mil, 6010 at 0800 in SS with smooth Latin pops. (Behrendt, NE)
 Radio Educacion, 6185 at 0830 in SS with marimbas. (Behrendt, NE)
 Radio Mexico Int'l, 9705 at 1950 in SS with

news, features, music. (Behrendt, NE) 2334 in SS with Mexican music. (Miller, WA)
MOLDOVA—Voice of Russia relay, 7125 at 2304 with music, ID at 2311. (Jones, SD)
NAMIBIA—Namibian Broadcasting Corp., 3270//3290 heard at 0315 with US pops, news at 0400. 3270 clear in AM mode; due to noise 3290 audible only in USB. (Silvi, OH)
NETHERLANDS—Radio Netherlands, 12005 (via Uzbekistan, Ed) at 1340 in EE. (Northrup, MO)
NETHERLANDS ANTILLES—Radio Netherlands via Bonaire, 5995 at 0625. (Miller, WA) 15315 at 1900 with news magazine. Parallel 17605. (Behrendt, NE)
NEW ZEALAND—Radio New Zealand Int'l, 15115 at 2324 with news. (Miller, WA)
NIGERIA—Voice of Nigeria, 7255 at 0729 with African folk music. (Miller, WA) Presumed. 15120, at 1815 to 1859 close down. African-sounding music, no announcements or IDs. (Silvi, OH)
 Radio Nigeria, Kaduna, 4770 at 2225 in unidentified language. ID. (Jeffery, NY) 0600 with "network service" news. (Behrendt, NE)
NORTHERN MARIANAS—KFBS, Saipan, 9465 at 1729 in RR with IS, announcement by man, religious program. (Miller, WA)
 KHBI, 9355 with Christian Science sermon to ID heard at 1400, then another sermon. (Hornstein, MI)
NORWAY—Radio Norway Int'l, 9590 at 1021 in NN. (Miller, WA) 11840 at 1310 in NN. (Northrup, MO)

PAPUA NEW GUINEA—NBC, Port Morseby, 4890 at 0800 with EE news and current events. (Behrendt, NE) 4930 at 1235 to 1305 with soft rock and several IDs as "Papua National Radio." Full ID at 1300, then news. (Hornstein, MI) (They've never used this channel before. Are you still hearing them here? Editor)
PARAGUAY—Radio Nacional, 9735 at 0038 in SS with Latin ballroom type music. (Miller, WA)
PERU—Radio Gotas del Oro, 4564.8, heard from 0320 to 0530 sign off with huaynos, frequent time checks, birthday greetings, ID, location. Chiclayo national anthem at sign off. (Rausch, NJ)
 Radio Union, 6115 at 0421 in SS with soccer. (Miller, WA)
PHILIPPINES—Voice of America relay, 6110 at 1242 with "Stateside." Off at 1259. (Jeffery, NY)
PORTUGAL—Radio Portugal, 17745 at 1930 with music and features in PP. (Behrendt, NE)
RUSSIA—Voice of Vietnam relay on 5905 heard at 0355 with commentary, ID. (Paszkievich, WI)
RWANDA—Deutsche Welle relay, 9615 at 2130 with "European Journal," Internet address, ID, music. (Jones, SD) 17860 in GG at 1930. (Behrendt, NE)
SAO TOME—VOA relay, 11975 at 1840 with news in special EE. (Behrendt, NE)
SAUDI ARABIA—Broadcasting Service of the Kingdom of Saudi Arabia, 9730 in AA at 1648 with call to prayer. (Miller, WA) 9870 in AA at 1950 with music, phone calls. (Behrendt, NE)
SEYCHELLES ISLANDS—Far East Broadcasting Assn, 9440 at 1730 in AA. Off suddenly at 1748. (Silvi, OH) 9820 at 1545. (Miller, WA)
SINGAPORE—Radio One, 6155 at 1629 with old time rock. (Miller, WA)
SLOVAKIA—Radio Slovakia, 5930 at 0112 with times and frequencies, "Slovakia Today." (Wilden, IN)
SOLOMON ISLANDS—Solomon Islands Broadcasting Corp., 5020 at 0730 in EE and local. Pacific and western pops, news at 0800. (Behrendt, NE)
SOUTH AFRICA—Channel Africa, 7185 at 0509 in unidentified language with what seemed to be news, then an ID. Also 11900 at 0507 in EE with news. (Jeffery, NY)
SPAIN—Radio Exterior Espana, 11775 heard at 2236 with Spanish classical music. (Wilden, IN) 15110 in SS heard at 1400 with ID. (Northrup, MO)
SWEDEN—Radio Sweden, 6005 at 0049 with news. Lost at 0100. (Wilden, IN) 11650 at 1448 with economic news. (Hornstein, MI)
TAIWAN—Voice of Free China, 5950 via WYFR, 0220; 0226; 0330. (Tucker, AL; Wilden, IN; Garvin, MD)
THAILAND—Radio Thailand, 7295 heard at 1945 in EE with feature on Thai holiday and spiritual celebrations, ID at 1957 sign off. (Rausch, NJ)
TOGO—Radio Lome, 5047 at 2225 in FF

ORGANIZE AND PROTECT YOUR COPIES OF POPULAR COMMUNICATIONS

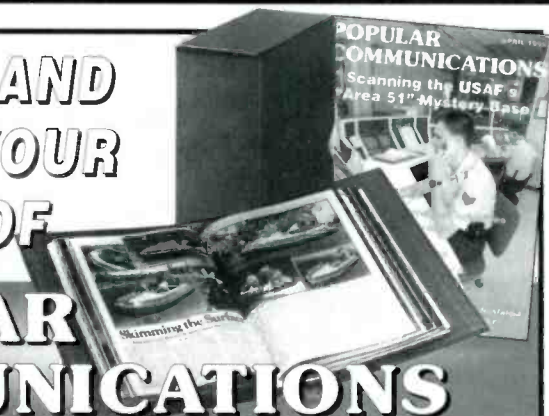

Now there's an easy way to organize and keep copies of your favorite magazine readily available for future reference.

Designed exclusively for PC by Jesse Jones Industries, these custom-made titled cases and binders provide the luxury look that makes them attractive additions to your bookshelf, desk or any location in your home or office.

Whether you choose cases or binders, you'll have a storage system that's durable and well organized to help protect your valuable copies from damage.

Quantity	Cases	Binders
One	\$ 8.95	\$11.25
Three	\$24.95	\$31.85
Six	\$45.95	\$60.75

Add \$1.50 per case/binder for postage and handling. Outside USA \$3.50 per case/binder. (U.S. funds only)

- Cases and binders designed to hold a year's issues (may vary with issue sizes).
- Constructed of reinforced board, covered with durable flat-blue leather-like material.
- Cases V-notched for easy access.
- Free personalization foil for indexing year.
- Binders have special spring mechanism to hold individual rods which easily snap in. This allows magazines to be fully opened for easy readability.
- Title hot - stamped in gold.

Call TOLL FREE 7 days, 24 hours

1-800-825-6690

Popular Communications Jesse Jones Industries, Dept. 95 PC
 499 East Erie Avenue, Philadelphia, PA 19134

11th ANNIVERSARY
 MARCH 8, 1987
ENGLISH SERVICE
 19, 31 mb
radio veritas asia

Radio Veritas Asia in the Philippines issued this bumper sticker to mark their 11th anniversary 10 years ago. That means they are 21 this year. (Do the math.)

with talk by a woman. (Jeffery, NY)

TURKEY—Voice of Turkey, 7100 at 0414 in EE with news, music. ID. (Jeffery, NY) 9445//9460 at 2245 in TT with Turkish music. (Behrendt, NE)

UGANDA—Radio Uganda, 4976 at 0413 with news about Africa. (Paszkiwicz, WI) 0420 with toothpaste commercial, death notices, African regional news at 0430. (Rausch, NJ)

UNITED ARAB EMIRATES—UAE Radio, Abu Dhabi, 9605 heard at 2345 with cultural program in EE. (Behrendt, NE) 9695 heard at 1645 in AA with Mid-east music. (Miller, WA)

UNITED STATES—WINB, Red Lion, PA,

11950 at 2351 with religious music. (Miller, WA) (Reactivated some months back. Editor) **UZBEKISTAN** —Radio Tashkent, presumed, 5975 at 1225 in EE with Mid-east music and announcer saying good-bye. Off at 1228. No ID. (Jeffery, NY)

VANUATU—tentative Radio Vanuatu, 3945 at 0730 to 0950 in EE/FF including a British/Australian-accented commercial for "healthy smile—healthy teeth." (Silvi, OH)

VATICAN—Vatican Radio, 9645 at 1940 to Africa in unidentified language. (Silvi, OH)

VENEZUELA—Radio Tachira, 4830 at 1130 in SS with ID. (Hornstein, MI) 0224 in SS with commercials, music. (Miller, WA)

YVTO Observatorio Nacional, 5000 at 0720

with SS time checks underneath WWV/WWVH. (Behrendt, NE)

Ecos del Torbes, 4980 at 1210 in SS with music. ID. (Hornstein, MI)

YEMEN REPUBLIC—Republic of Yemen Radio, 9780 at 1649 in AA with Mid-east music. (Miller, WA)

YUGOSLAVIA—Radio Yugoslavia, 7130 at 0214 with news. (Miller, WA)

ZAMBIA—Radio Zambia, presumed, 4910 at 0438 in unidentified language with talk by man and woman. (Jeffery, NY)

That's it! Bring up the best from the cellar and let's toast the following good folks who provided the great loggings this month:

Lee Silvi, Mentor, OH; L.W. Clayton, Great Falls, MT; Dave Jeffery, Niagara Falls, NY; Sheryl Paszkiewicz, Manitowoc, WI; Mark Northrup, Gladstone, MO; Hugh Hornstein, Muskegon, MI; Bill Garvin, Maryland; Mike Miller, Issaquah, WA; Ed Rausch, Cedar Grove, NJ; Michael Tucker, Cullman, AL; Stephen C. Behrendt, Lincoln, NE; Sue Wilden; Columbus, IN; Terry Jones, Plankinton, SD and Ernie Wallesen, LaGrange Park, IL. Thanks to each of you!

Until next month—good listening! ■

Tune In With



The **NEW** magazine for all ham radio operators who are active or interested in operating on the bands above 50 MHz!



In every issue you'll find...

- Operating articles
- Technical articles
- Product reviews
- Beginner's articles
- Projects you can build
- New things to try
- News and columns

All year long, each issue of **CQ VHF** guarantees to show you **WHAT, WHY** and **HOW** to do more above 50 MHz.

SUBSCRIBE TODAY!

US—one year \$21.95, two years \$39.95,
 Canada/Mexico—one year \$31.95, two years \$59.95,
 Foreign Air Post—one year \$39.95, two years \$74.95.

Phone 516-681-2922

FAX 516-681-2926

Mail orders to: **CQ VHF Magazine, 76 N. Broadway, Hicksville, New York 11801**

Get A New Image

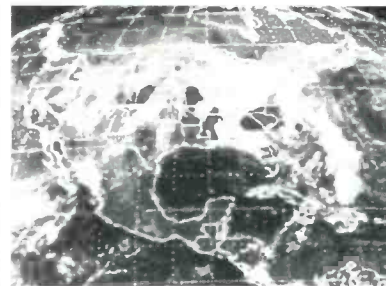

PC HF Fax Plus \$129

PC HF Fax Plus is a simple, yet comprehensive HF system that receives Fax, RTTY, CW, and AMTOR on an IBM PC or compatible. It includes an FSK demodulator, advanced signal processing software, tutorial audio cassette, and complete reference manual. Just plug the demodulator into a serial port, install the software and get text and vivid images on your PC.

PC SSTV \$149.95

PC Slow Scan Television is a complete system for sending and receiving full color amateur SSTV. The package includes an SSTV FSK modem, SSTV software, image capture utilities and reference manual. All popular formats are supported including Robot, Scottie, Martin and AVT. The system requires a 286, 386 or faster PC with VGA or super VGA display.



Have It All For Only \$199.95

For a limited time we are offering both software packages with a single FSK modem for under \$200. This combination offer will let you send and receive the popular HF image and text transmission modes.

Call or write for our free catalog. Visa and Mastercard welcomed.

Software Systems Consulting

615 S. El Camino Real, San Clemente, CA 92672

Tel. (714) 498-5784 Fax. (714) 498-0568

website: <http://www.sccc.com> e-mail: support@sccc.com

CIRCLE 80 ON READER SERVICE CARD

Broadcast DXing

DX, NEWS AND VIEWS OF AM AND FM BROADCASTING

WQO767: 'Round the World on 34 Watts

Dallas-Fort Worth International Airport is home of the newest travelers-information station (TIS) in the expanded AM band, and since its Feb. 24 debut, the 34-watt station has already been heard by DXers as far away as New Zealand. WQO767 actually uses two frequencies: The 1680 kHz outlet carries three-minute taped loops of arriving-flight gate information, while its counterpart on 1640 kHz carries similar information for departing flights.

Joe Blair, of the airport's Public Affairs Department, told *PopComm* the antennas are 44-foot VALCOM V147CL2-FT-THs, perched atop a five-foot tower, with a 40-foot copper rod as a ground plane. It's a setup that's been working extraordinarily well. Although the stations were designed to provide coverage within a 10-mile radius of the airport, Blair said they've received reports from as far away as New Zealand and Canada.

The two stations are owned by the airport and are located at its Administration Building, just east of East Airfield Drive. A PC takes all of the flight information data from the airport's computer system and with the aid of a WAV file, turns them into announcements in a female voice.

The Birmingham-campus station of the University of Alabama runs 32 kW (Courtesy Michael Tucker, Cullman, AL).

Information for American and American Eagle flights is currently running, although Blair said other airlines would soon be added.

WQO767 was born out of a \$25 million lawsuit by two men who were injured in a 1993 traffic accident on the airport's International Parkway, which featured signs displaying flight information. "The men claimed that a driver who stopped to

When is 5 kW more than 50 kW? Apparently when the folks at KTRS say so. "The strongest daytime signal in St. Louis" is a swipe at king-of-the-hill KMOX, which runs with 10 times the power of KTRS.

Seeking Permits to Construct New AM Stations

ID	Rupert	1340 kHz	1 kW
MN	Sauk Rapids	800 kHz	2.6 kW/850 watts
VA	Bayside	1450 kHz	1 kW

Seeking Permits to Construct New FM Stations

AL	Concord	88.1 MHz
AL	Troy	91.1 MHz
AR	Batesville	99.5 MHz
AR	Blytheville	88.1 MHz
AR	El Dorado	101.5 MHz
AR	Marvell	90.7 MHz
AR	Nashville	90.5 MHz
AZ	Oraibi	98.9 MHz
AZ	Tuba City	97.9 MHz
AZ	Williams	96.7 MHz (KVTE booster)
CA	Johannesburg	100.9 MHz
CA	Laytonville	90.1 MHz
CA	Newberry	103.7 MHz
CA	Tehachapi	100.1 MHz
CA	Temecula	103.3 MHz
CA	Ukiah	97.1 MHz
CO	Burlington	99.3 MHz

CO	Delta	103.3 MHz
CO	Hayden	107.3 MHz
CO	Julesburg	96.5 MHz
CO	Limon	93.7 MHz
CO	Wellington	94.3 MHz
FL	Bayshore	91.9 MHz
FL	Port Charlotte	91.7 MHz
GA	Elberton	105.1 MHz
GA	Savannah	88.1 MHz
HI	Keaau	105.1 MHz
HI	Princeville	98.9 MHz
IA	Hiawatha	89.9 MHz
IA	Keokuk	90.9 MHz
IA	Ottumwa	88.3 MHz
IA	Ottumwa	91.1 MHz
IA	St. Ansgar	95.5 MHz
IL	Duquoin	90.1 MHz
KS	Arkansas City	91.3 MHz
KS	Manhattan	88.7 MHz
LA	Many	89.7 MHz
MD	Ocean City	90.7 MHz
MI	Muskegon	91.7 MHz
MI	Negaunee	99.5 MHz
MI	Negaunee	101.9 MHz
MO	Hannibal	91.7 MHz
MO	Kirksville	88.7 MHz
MO	Kirksville	91.9 MHz
MO	Sunrise Beach	90.3 MHz

MO	Wheeling	105.9 MHz	
MS	State College	104.5 MHz	
MT	Shelby	97.9 MHz	
MT	Sidney	93.1 MHz	
NC	Fayetteville	91.1 MHz	
NC	Folkstone	89.9 MHz	
NC	Mt. Airy	90.3 MHz	
NC	Wade	91.1 MHz	
ND	Tioga	104.1 MHz	
ND	Williston	98.5 MHz	
NH	Nashua	88.3 MHz	
NM	Santa Rosa	95.9 MHz	
NV	Ely	96.7 MHz	
NY	Eagle Bridge	88.1 MHz	
NY	Hague	93.7 MHz	
NY	Old Forge	94.1 MHz	
OH	Cleveland	91.1 MHz	
OH	Zanesville	91.7 MHz	
OK	Ada	91.3 MHz	
OK	Ardmore	90.3 MHz	25 kW
OK	Seminole	89.1 MHz	
OK	Shawnee	91.3 MHz	
OK	Yukon	88.5 MHz	
SD	Redfield	97.7 MHz	
TN	Middleton	100.7 MHz	
TX	Big Lake	98.3 MHz	
TX	Hemphill	103.9 MHz	
TX	Lamesa	91.3 MHz	
TX	Lubbock	91.9 MHz	
TX	Markham	92.5 MHz	
TX	McCamey	95.3 MHz	
TX	McCook	91.5 MHz	
TX	Pampa	90.9 MHz	
TX	San Angelo	105.7 MHz	
VA	Danville	91.1 MHz	18 kW
VT	St. Johnsbury	88.5 MHz	
WA	Nile	88.1 MHz	200 watts

Granted Permits to Construct New FM Stations

AZ	Red Mesa	89.7 MHz	
CA	Fairfield	91.5 MHz	
KS	Salina	88.5 MHz	
OK	Poteau	91.7 MHz	3.25 kW
PA	Mansfield	92.3 MHz	800 watts
TN	Maynardville	88.3 MHz	

Canceled, Revoked or Otherwise Deleted

KFPS	Salem, MO	1440 kHz
WFRK	Coleman, FL	1320 kHz
WHIC	Hardinsburg, KY	1520 kHz

Reinstated

KAOE	Hilo, HI	92.7 MHz	Until 6/19/97
------	----------	----------	---------------

Sent Notices of Apparent Liability of Forfeiture

KSWB	Seaside, OR	\$10,000. Apparent unauth. transfer of control.
KFUO-AM/FM	Clayton, MO	\$25,000. Apparent misleading statements to FCC re EEO compliance.
KCIL/KJIN	Houma, LA	\$10,000. Apparent EEO rule violations.
KVKI-FM	Shreveport, LA	\$30,000. Apparent EEO rule violations.

Requesting Modified AM Facilities

KBBV	Big Bear Lake, CA	1050 kHz	Seeks move to Loma Linda
------	-------------------	----------	--------------------------

WDMV	Pocomoke City, MD	540 kHz	Seeks move to Damascus. 1 kW
WKCE	Maryville, TN	1120 kHz	Seeks move to Seymour, 1 kW
WSIV	E. Syracuse, NY	1540 kHz	Seeks changed freq., power.
WUNO	San Juan, PR	1320 kHz	Seeks change in night power

Changed AM Facilities

WREN	Topeka, KS	1250 kHz	Moved to Kansas City (KS). 15/3.7 kW
------	------------	----------	--------------------------------------

Changed FM Facilities

KONO-FM	Helotes, TX	101.1 MHz	Changed City
WXGC	Millidgeville, GA	91.9 MHz	Changed freq. to 94.9 MHz

Pending AM Call Letter Changes

New	Old	
KNEZ	KWTR	Georgetown, TX
WNWC	WMAD	Sun Prairie, WI

Changed AM Call Letters

New	Old	
KBKO	KSPE	Santa Barbara, CA
KIHM	KIRS	Sun Valley, NV
KMHI	KLVJ	Mountain Home, ID
KOOO	KDFX	Dallas, TX
KUZZ	KCWR	Bakersfield, CA
WEZU	WIMN	Stillwater, MN
WIOL	WUTK	Knoxville, TN
WMRE	WAQY	E. Longmeadow, MA
WOWW	WNWZ	Germantown, TN
WRCC	WWKN	Battle Creek, MI
WXP	WRJL	Hanceville, AL

New FM Call Letters Issued

KASD	Lamoni, IA
KASK	Bells, TX
KASV	Borger, TX
KASX	Pine Bluff, WY
KHYM	Copeland, KS
KIKD	Lake City, IA
KLVY	Fairmead, CA
KNLM	Marshfield, MO
KNMA	Reserve, NM
KQRV	Deer Lodge, MT
KRDR	Red River, NM
KXLV	Winchester, OR
KYCC	Livingston, CA
KYRM	Yuma, AZ
KZNX	Astoria, OR
WABX	Evansville, IN
WAKJ	DeFuniak Spgs., FL
WAQN	Crawfordsville, IN
WAQO	Vincennes, IN
WAQU	Selma, AL
WGRI	Flint, MI
WHLJ	Statesville, GA
WKOZ-FM	Durant, KS
WSUM	Madison, WI
WTGG	Amite, LA
WWCJ	Cape May, NJ
WZRQ	Biltmore Forest, NC

Changed FM Call Letters

New	Old	
KACO	KRXZ	Ardmore, OK

KANG	KMZN	Marion, AR	WFCG-FM	WXVE	Franklinton, LA
KARN-FM	KKRN	Cabot, AR	WFRY-FM	WCIZ-FM	Watertown, NY
KBYA	KTHX-FM	Carson City, NV	WFXN	WMLV	Ironton, OH
KCWR	KTIE	Bakersfield, CA	WGLN	WQLX	Galion, OH
KJFK	KUTZ	Lampasas, TX	WJBQ	WCOS	Portland, ME
KKST	KICR-FM	Oakdale, LA	WKBH-FM	WQJY	W. Salem, WI
KLIT	KRCI	Avalon, CA	WKIK-FM	WRFK	California, MD
KLOO-FM	KFAT	Corvallis, OR	WKLO	WKLR	Veedersburg, IN
KLTI-FM	KEZT	Ames, IA	WTPT	WFNQ	Forest City, NC
KRLG	KOJJE	Porterville, CA	WVCL	WLTY	Norfolk, VA
KSMJ-FM	KHIS-FM	Bakersfield, CA	WWKN	WRCC	Marshall, MI
KTPZ	KLVJ-FM	Mountain Home, ID	WWQZ	WQLW	Eutaw, AL
KWRD-FM	KEWS	Arlington, TX	WXRFP	WRJL	Hanceville, AL
KXEZ	KOOJ	Riverside, CA	WZAZ-FM	WLLD	Upper Arlington, OH
KXIL	KWSM	Sanger, TX			
KZHK	KVYS	St. George, UT			
WAMX	WFXN	Milton, WV			
WAVC	WCLX	Mio, MI	New	Old	
WAZU-FM	WAHC	Circleville, OH	KBZD	LKKR	Amarillo, TX
WCOG	WXVE	Galeton, PA	KLVD	KLWV	Julian, CA
WEEK-FM	WIVR	Eureka, IL	WIST-FM	WFAZ	Thomasville, NC
WFBZ	WKBH-FM	Trempealeu, WI	WXJY	WSCA	Georgetown, SC

Pending FM Call Letter Changes

Expanded AM Band Station List Released

Nearly one year after releasing its short-lived second allotment plan for the expanded AM band, the FCC in March announced its third, revised list of stations eligible to apply for licenses above 1600 kHz. Eighty-eight stations in the United States, Puerto Rico and the Virgin Islands were chosen to use the 10 new channels between 1605 and 1705 kHz. Eligible stations have until June 17 to apply for a license.

Each station's listing includes its current frequency and proposed expanded band frequency under the March 1997 allotment plan. This list uses the call letters each station had when it first applied for an expanded band assignment; several stations have changed their calls in the interim. See the September 1996 issue for the 1994 and 1996 allotment plans.

State	City	Call	Current	Proposed	State	City	Call	Current	Proposed
AL	Atmore	WGYY	1590	1620	MS	Biloxi	WVMV	570	1640
AL	Huntsville	WEUP	1600	1700	NC	Charlotte	WGIV	1600	1660
AL	Mobile	WKRK	710	1660	NC	Mount Airy	WSYD	1300	1640
AR	Fort Smith	KWHN	1320	1650	ND	Bismarck	KLXX	1270	1640
AZ	Tucson	KNST	790	1700	ND	Minot	KHRT	1320	1620
AZ	Tucson	KWFM	940	1630	ND	West Fargo	KQWB	1550	1660
AZ	Yuma	KBLU	560	1640	NE	Bellevue	KKAR	1180	1620
CA	Auburn	KAHI	950	1620	NH	Rochester	WZNN	930	1700
CA	Clovis	KOQO	790	1630	NM	Hobbs	KKEL	1480	1670
CA	Costa Mesa	KOJY	540	1650	NJ	Elizabeth	WJDM	1530	1660
CA	Fresno	KXEX	1550	1680	NJ	Princeton	WHWH	1350	1680
CA	Merced	KLOQ	1580	1660	NJ	Toms River	WJRZ	1550	1620
CA	Moreno Valley	KHPY	1530	1670	NY	Troy	WTRY	980	1640
CA	Redding	KHTE	600	1670	NM	Farmington	KENN	1390	1620
CA	Roseville	KRCX	1110	1690	OK	Enid	KCRC	1390	1640
CA	Soledad	KQKE	700	1700	OR	Astoria	KAST	1370	1700
CA	Vallejo	KNBA	1190	1640	OR	Lake Oswego	KPHP	1290	1640
CO	Arvada	KQXI	1550	1690	OR	Phoenix	KTMT	880	1650
CO	Grand Junction	KSTR	620	1680	OR	Salem	KSLM	1390	1660
CO	Denver	KRKS	990	1650	PR	Camuy	WCHQ	1360	1660
CO	Fort Collins	KCOL	1410	1670	SC	Myrtle Beach	WKZQ	1520	1620
FL	Marco Island	WMIB	1480	1660	SD	Rapid City	KKLS	920	1700
FL	Miami Springs	WCMQ	1210	1700	TN	Jonesborough	WKTP	1590	1680
FL	Winter Garden	WXTO	1600	1680	TX	Atlanta	KALT	900	1610
GA	Adel	WBIT	1470	1690	TX	Brownsville	KBOR	1600	1700
GA	Atlanta	WAOK	1380	1650	TX	College Station	WTAW	1150	1620
GA	Augusta	WRDW	1480	1630	TX	Denison-Sherman	KDSX	950	1700
GA	Warner Robins	WRCC	1600	1670	TX	Edinburg	KURV	710	1640
IA	Cedar Falls	KCFI	1250	1650	TX	El Paso	KBNA	920	1680
IA	Des Moines	KKSO	1390	1700	TX	El Paso	KSVL	1150	1650
IA	Estherville	KILR	1070	1690	TX	Fort Worth	KHVN	970	1630
IA	Iowa City	KCJJ	1560	1630	TX	Houston	KLAT	1010	1690
ID	Blackfoot	KECN	690	1620	TX	Waco	KRZI	1580	1660
IL	Johnston City	WDDD	810	1690	UT	Brigham City	KSOS	800	1660
IN	South Bend	WAMJ	1580	1620	UT	Sandy	KTKK	630	1640
KS	Junction City	KJCK	1420	1680	VA	Harrisonburg	WSVA	550	1700
KS	Topeka	WREN	1250	1660	VA	Portsmouth	WPMH	1010	1650
LA	Monroe	KMLB	1440	1680	VI	Charlotte Amalie	WGOD	1090	1690
MD	Lexington Park	WPTX	920	1690	VI	Frederiksted	WRRR	1290	1620
MD	Salisbury	WLVW	960	1670	WA	Renton	KRIZ	1420	1620
MI	Kalamazoo	WQSN	1470	1660	WA	Seattle	KZOK	1590	1680
MI	Muskegon	WSFN	1600	1680	WI	Madison	WTDY	1480	1670
MN	Fergus Falls	KBRF	1250	1680	WI	Sussex	WKSH	1370	1640
MO	Neosho	KBTN	1420	1670	WY	Fox Farm	KSHY	1530	1630

Channels 60-69 May Disappear From TV Dial

By Tim Kridel

United States TV channels 60-69 would eventually be taken out of service and sold to the highest bidder under a bill before Congress. Senator John McCain (R-AZ), Chairman of the Senate Committee on Commerce, Science, and Transportation, in February introduced the "Law Enforcement and Public Safety Telecommunication Empowerment Act." The bill would create four new radio channels in the spectrum between TV channels 60-69 for law enforcement and other public safety agencies.

The aim of the bill, according to a press release from McCain's office, is to relieve the crowded conditions in the bands currently allocated to police, fire departments and emergency medical services. "Our country's emergency communications capability is severely lacking," McCain said. "This legislation would provide law enforcement officers and public safety officials with the necessary means to fulfill their duty and ensure the safety of the American people is not jeopardized."

McCain isn't proposing that stations who currently use channels 60-69 be immediately uprooted and relocated to other parts of the TV dial. Instead, stations on those channels would be moved as they convert from analog to digital broadcasting. Under the FCC's proposed digital TV (DTV) plan, released last July, stations going digital would receive a new channel assignment anyway. And as TV makes the transition from analog to digital—beginning perhaps by the year 2000—the Commission appears set to phase out allocations for channels 60-69 as it issues DTV licenses.

The legislation also calls for remaining the six TV channels to be auctioned off to reduce the federal deficit, with 10 percent of the proceeds going to the states to fund public safety communications. Individual states also could sell or lease unused spectrum to provide still more money for public safety communications.

McCain isn't the only one calling for the reallocation of channels 60-69. The Association of Public Safety Communications Officials-International told the FCC last fall that public safety agencies at all levels are in dire need of more spectrum, calling channels 60-69 "a prime candidate for meeting a portion of those public safety needs." Motorola also endorsed the idea of keeping the number of TV stations on those channels to a minimum.

TV broadcasters, meanwhile, counter that potential auction revenues, which some estimates put as high as \$10 billion, shouldn't determine who can inhabit the spectrum. The Association for Maximum Service Television, a coalition of some 650 stations, told the FCC that taking channels 60-69 out of service would "mean less service to the public, more interference, more viewer disenfranchisement and much less flexibility to adjust our facilities to the new DTV environment." The Community Broadcasters Association, meanwhile, is concerned about the impact it says the reallocation would have on low-power TV stations, which were authorized by the FCC in 1979 to encourage local programming and minority ownership. "There is no reason summarily to destroy an entire industry of as many as 400 active, operating TV stations," the group told the FCC last December.

look at the signs caused the accident," Blair said.

The Public Affairs Department is verifying reception reports with a QSL card. Reports can go to Joe Blair, DFW International Airport, P.O. Drawer 619428, DFW Airport, Texas 75261.

Move Down, Power Up

The question of who would get the 1280 kHz channel serving Montreal was settled in February when the Canadian Radio-television Commission gave CFMB the green light to take over the vacant frequency. CFMB beat out a competing application by TAMM Communications to start a new, 10-kW, French-language station on 1280 kHz, with a country music format. The channel had been home to CMJS until it was shuttered in September 1994 following the merger

of Canadian radio giants Telemédia Communications and Radiomutuel.

As part of its ruling, the CRTC also gave CFMB approval to increase its day and nighttime powers from 10 kW to 50 kW after it moves from 1410 kHz, as well as to relocate its transmitter about 15 km southwest of the current site.

In its application, CFMB said moving the transmitter site would correct its distorted antenna pattern, which it blamed on a nearby electrical installation that re-radiated the stations signal. And powering up to 50 kW, CFMB said, would allow not only for a better signal into metropolitan Montreal, but also extend coverage into the city's growing suburbs.

AM: R.I.P.?

It's a depressing statistic, really: Of the 12,000 people, age 12 and older, surveyed

between November 1995 and October 1996 by Statistical Research Inc., only eight percent said that they listened exclusively to AM stations. Sixty percent, meanwhile, said that they tuned in only FM stations.

So is AM finally headed down for the count? Not just yet, if gross station revenues are any indicator. The top three cash cows in radio for 1996 were all AM: New York City's WFAN topped BIA Research's annual list at \$42.3 million, up 15 percent from 1995. Chicago's WGN came in second with \$37.9 million and New York City's WINS-racked up \$32.1 million for third place. In fact, half of the top-10 stations on BIA's list were AM.

In Brief

The world's first two-million-watt AM transmitter is on its way to the Mideast country of Qatar. Harris Corp.'s Broadcast Division built the DX 2000, which cranks out more than 40 times the maximum power for a U.S. AM station, at its Quincy, IL, plant. It's headed for the Qatar Broadcasting Service's Al-Arish facility, which currently uses 954 kHz.

Los Angeles KHS-AM rolled out its revamped sports format on March 10. The 5 kW station, now calling itself "XTRA Sports 1150 AM," recently inked a four-year deal to broadcast UCLA football and basketball and a five-year deal, beginning in 1998, to carry Dodgers baseball. ESPN's "Fabulous Sports Babe" also will join the lineup, from 9 a.m. to 1 p.m.

Thirteen people are out of work following the sale of Seattle's KIRO-AM/FM and KNWX-AM, according to the Seattle Times. The sale makes Philadelphia-based Entertainment Communications Seattle's largest owner of radio stations, with a stable that includes KBSG-AM/FM, KISW-FM, KMTT-FM and KNDD-FM.

Robert Sarnoff, eldest son of radio pioneer David Sarnoff, died Feb. 22. He was 78. While president of then RCA subsidiary NBC, he orchestrated the 1960 Kennedy-Nixon debate. He succeeded his father as head of RCA, a tenure that included the elimination of the famous "Nipper" trademark.

New York City's WINS-AM has a new antenna system in place, according to *PopComm* reader Mark Robinson, KA2UVI, of Pompton Plains, NJ. The four-tower, quarter-wavelength setup should put a better signal into New Jersey. A new transmitter is also on order.

Loose Connection

(from page 80)

Transmission Line

- a. The trail of parts visible behind your car the day the warranty expires.
- b. A small cord extending upward through the floor of a new vehicle, usually tagged with the words "Warning—do not pull!"
- c. Flat twin-lead, ladder-line or coaxial cable of a specific characteristic impedance that is used to carry a radio signal from the output of a transmitter to the transmitting antenna.
- d. "Oh, it looks pretty bad—probably need a new one—maybe you could get by with a rebuilt . . ."

Flip-Flop Circuit

- a. An electronic circuit which causes those trick cars at the mall toy stores to go back and forth endlessly on the display table.
- b. The secret circuit built into most televisions, designed to start your picture rolling after you've owned the set approximately eighteen months.
- c. A binary, sequential logic circuit with two stable states—form of bi-stable multivibrator designed to remain in one stable state until triggered to change (flip or flop) to the other stable state.
- d. A group of Washington, D.C. nightclubs frequented by certain politicians.

Parasitic Elements

- a. Insects who don't really *need* human blood to survive, but feel they owe it to nature to make your outdoor activities as unpleasant as possible.
- b. Insects which are resonant at citizens band and amateur frequencies, known to drain power from your antenna, leaving you to wonder where your signal is going.
- c. The non-driven elements (directors and reflector) on a Yagi antenna.
- d. Those friends your kids bring home with elephantine jeans and beaver-pelt haircuts, usually found in your kitchen.

To receive a list of correct answers, please send a genuine leather SASE with one troy ounce of .999 fine gold to me c/o The Loose Connection, *Popular Communications*, 76 North Broadway, Hicksville, NY 11801. (If you *really* need a list of answers, send an SASE (under an assumed name) to us and we'll get right back to you. ■



OFFICE PH: (07) 5538 1620 • FAX: (07) 5570 1621
P.O. BOX 609, NERANG QLD 4211



DEAR LISTENER.

Thanks so much for your recent reception report and your interest in our station.

I am happy to inform you that the station you received was indeed AUSTRALIAN DANCE RADIO 1620 AM.

Here's a little information on our station -

STATION FREQUENCY	1620 AM
BROADCASTING FROM	Gold Coast, Queensland, Australia.
BROADCAST CAPACITY	400 Watts.
FORMAT	Nightclub type Dance Music
BROADCAST TIMES	Fulltime, 24 hours per day.
ADDRESS	P.O. Box 609, Nerang, Queensland, Australia, 4211.
TELEPHONE	61 07 55381620
FAX	61 07 55701621
CONTACT	Station Manager.

If you have any further enquiries please feel free to contact us at any time.

I have enclosed a station bio and sticker for your enjoyment.

Regards,

Stephen Harvey,
Chairman.

Techno-popper Australian Dance Radio has been heard by many U.S. DXers, including Gary V. Jackson, of Sacramento, CA.

Kids have one less radio format to choose from following the demise of KidStar Radio in March. An inability to attract new investors did in the six-month-old syndicator of music and entertainment for pre-teens. Programming originated at Seattle's KKDZ-AM, with affiliates including San Diego's KSON-AM and San Francisco's KDFC-AM.

Quebec's CFJO-FM will boost its power from 16.6 kW to 100 kW and move from 103.3 MHz to 97.3 MHz, changes it says will improve its signal in its Thetford Mines and Victoriaville markets.

A fellow DXer needs your help: *Pop'Comm* reader Gary V. Jackson is looking

to ID a station he's been hearing on 1610 kHz. It runs an unusual format of a "computerized" male voice saying "ready" over and over, along with a series of test tones. Any clues to this station's identity should go to Gary at 7735 Center Pkwy., Sacramento, CA 95823.

Thanks

Your news clippings, bumper stickers, station and shack photos and QSLs are always welcome, as are your questions and comments. Send 'em to "Broadcast DXing" at *Pop'Comm's* Hicksville address. Until next month, 73. ■

The Pirate's Den

BY EDWARD TEACH

FOCUS ON FREE RADIO BROADCASTING

Indigestion, Colonel Billy Bob, and Station Pileups!

Let's get right into another round of logs! This month is no exception; the bizarre happenings and odd-ball stations just keep on coming. Don't forget to send me your pirate logs to <popularcom@aol.com> or mail them to the Hicksville address.

WSRR, 6955 USB heard at 1408 with some easy listening tunes and an ID. Another day at 1315 it was heard with a repeat of the previous program. Still another logging some days later it was caught at 1730 with what they said was the First Night Fellowship International broadcast from the church of the same name in Buffalo, NY with Pastor Tony W. Robertson. Another day WSRR was captured at 1625 with a repeat. I guess he did two shows—one IDing as WSRR and one as Solid Rock Radio. (Dick Pearce, VT)

Friday Radio, 6955 USB at 2130 with lots of "It's Frriiidaaaayyy" shouts, many comments about the drudgery of the workplace, and some rock tunes. This was a fast-paced, high energy program. (Pearce, VT)

RFS on 6955 heard at 1357 with parodies on songs. They offered a special RFS ruler in exchange for a tape of the program. (Pierce, VT)

Solid Rock Radio, 6955 USB at 1425 with interview with a female singer, then gospel-sounding music. They mentioned simulcasting on 6955 shortwave and 101.5 FM. (Pearce, VT)

The Gas Man on 6950.7 at 1458. Lost my notes on this one, but recall hearing a couple of unidentified tunes and the remark "the preceding was a parody production of the Fox." (Pearce, VT)

Office de Radio et TV du Quebec, 6955 LSB at 1550 in French with a number of tunes in French, then English. (Pearce, VT)

WGLR, 6955 USB at 1554 with another pirate underneath, talk about DC Comics, Willie Nelson-sounding music they said they recorded off an old juke box in the cellar. They also mentioned Neal Wolfish, whom they said was the only person to thank them for his QSL. Also heard with a repeat 1520 a few days later. (Pearce, VT)

FRIDAY OR BUST



HOPE YOUR WEEKEND
WAS A FINE ONE!

FRIDAY RADIO

6955 kHz USB

2237 - 2323 UTC

Friday

3 May, 1996

QSL VERIFICATION

Number -40

©MILLER

Friday Radio sent this QSL to Kenny Love for his reception a year ago.

WREC—6960 USB with parody songs. Closed with "Now it's time to say good-bye. Duuhh, where are we going?" Again at 2040 with the "Pirate's Life for Me" song and several song parodies. The warble **jammer on 6959** was strong enough to spill onto 6955. Also another day at 1550. Still another time at 1926 with a Sgt. Friday bit. (Pearce, VT)

Radio Free Brooklyn, 6955 at 1707 with songs by the Who, Hollies, Donovan, Monkees, Blue Tornadoes, and the Dave Clark Five. The host, "Tony," said he was new and that he'd like to write

to listeners if we "give our address to that guy who does Pop'Comm." (C'mon, folks. Give me a break! Ed)

Up Your Radio Shortwave—6955 USB at 1735 with lots of political satire. The announcer said the program was the Alan Sherman Project. "Before there was Weird Al Yankovich there was Weird Alan Sherman."

Radio City (tentative) on 6950 USB at 2015 with a number of commercial parodies including Dial a (calendar) date, Bowling for Burgers and real commercial

(Continued on page 77)

The ACARS Downlink

BY BOB EVANS

YOUR LINK TO DIGITAL AIRCRAFT COMMUNICATIONS

Aircraft Routing Messages

One of the more interesting facets of monitoring ACARS transmissions involves transatlantic routing messages, identifying the flight level and waypoints/coordinates that the aircraft will follow as it crosses the Atlantic Ocean. These downlink transmissions from the aircraft occur after the aircraft has become airborne after take-off. A considerable period of time may elapse between the first and second trans-

missions (up to one hour has been observed). It is important to catch the first destination message as it contains both the aircraft registration and carrier and flight number. Subsequent transmissions may only contain the registration number, with the aircraft flight number always appearing as "0000." To date, only American Airlines has been noted using this type of Routing message.

Message 1—Flight Destination (22:05:04 UTC)

This transmission from the aircraft occurs shortly after take-off. Its chief purpose appears to be to indicate the destination of the flight. It is the only transmission in the series that con-

tains both the aircraft's registration number as well as the flight number. Likewise, it seems to be the only message that contains the flight's destination.

**.N321AA 5Z6
5910AA038OS ZRH**

Here's an explanation of the message:

.N321AA	Address: Aircraft Registration Mark—American Airlines Boeing 767
5Z	Downlink Message Label: 5Z—Airline Designated Downlink
6	Downlink Block Identifier
5910	Message Sequence Number: 59 minutes, 10 seconds past the hour (21:59:10)
AA038	American Airlines flight # 38
OS	Other Supplementary (information)
ZRH	Destination: Zurich, Switzerland

Message 2—Flight Routing (22:49:30 UTC)

This transmission from the aircraft occurs after the aircraft has been airborne for some time. It has been observed as much as one hour after the original destination message. The majority of the message identifies the VORTAC navigational beacons and Waypoint names that the aircraft will follow on its flight to the destination airport.

Monitoring the same flight on different days often yields some interesting comparisons of differing flight routes to the same destination.

It's important to note that Waypoint and beacon names are often observed joined together. Beacon names are usually three characters in length, while Waypoints are generally five characters long. Aircraft positions over the Atlantic Ocean are normally given in degrees Latitude. Note the use of non-standard Message Sequence Numbers generated by the Optional Auxiliary Terminal. If the same longitudinal radial is being followed from the last land position, the Longitude co-ordinates are not usually given.

**.N321AA H10
F004AA0000#M1APWDA370YYZ VQC YUP YMX CEFOUYNA JUGARYAY 5350N5440N5430N54
20N5315NBURAKCRK TIVLILND NAKIDLIZADJSY SENEQCAN RBT BRY TRO RLP**

Here's an explanation of the message:

N321AA	Address: Aircraft Registration Mark: American Airlines Boeing 767
H1	Downlink Message Label: H1—Optional Auxiliary Terminal Message
0	Downlink Block Identifier
F004	Avionic Subsystem Downlink (Flight Management Computer)
AA0000	AA Flight Number always appears as 0000. You must catch previous message with registration and Flight Number to identify this transmission
#M1A	Flight Management Computer "A" originated downlink
PWDA	Predicted Wind Data Request for Flight Level and Positions as follows:

370	Flight Level 350 (35,000 feet)
YYZ	Position: Toronto, Ont
VQC	Position: Sterling, Ont VOR
YUP	Position: Uplands, Ont VOR
YMX	Position: Montreal, Que VOR
CEFOU	Position: Waypoint "CEFOU" (somewhere in Quebec)
YNA	Position: Natashquan, Que VOR
JUGAR	Position: Waypoint "JUGAR", Nfld
YAY	Position: St. Anthony, Nfld VOR
5350N	Position: 53:50 North
5440N	Position: 54:40 North
5430N	Position: 54:30 North
5420N	Position: 54:20 North
5315N	Position: 53:15 North
BURAK	Position: Waypoint "BURAK" off coast of United Kingdom
CRK	Position: Beacon at Cork, Ireland
TIVLI	Position: Waypoint "TIVLI"—southern coast of England
LND	Position: Beacon at Land's End, England
NAKID	Position: Waypoint "NAKID"
LIZAD	Position: Waypoint "LIZAD"
JSY	Position: Beacon at Jersey
SENEQ	Position: Waypoint "SENEQ"
CAN	Position: Beacon at Caen, France
RBT	Position: Beacon at Rambouillet, France
BRY	Position: Beacon at Bray, France
TRO	Position: Beacon at Troyes France
RLP	Position: Beacon at Rolampont, France

Message 3—Position Report (22:50:37 UTC)

This position report was transmitted approximately 45 minutes after the first destination report message. Current position, flight level, wind and outside air temperature are usually given. Time and flight level at the next position also appear.

.N321AA H11
F005AA0000#M1AAEPN433524W08021362250370M5729759YAY/0105/370

Here's an explanation of the message:

.N321AA	Address: Aircraft Registration Mark: American Airlines Boeing 767
H1	Downlink Message Label: H1—Optional Auxiliary Terminal Downlink Message
1	Downlink Block Identifier
F005	Avionic Subsystem Downlink (Flight Management Computer)
AA0000	AA Flight Number always appears as 0000. You must catch previous message with registration and Flight Number to identify this transmission
#M1A	Flight Management Computer "A" originated downlink
AEP	Fixed ICAO Format Position Report with Weather
N433524	Current North Position: 43:35.24 degrees
W0802136	Current West position: 80:21:36 degrees
2250	Time over current position 22 hours 50 minutes
370	Flight Level FL370
M57	Outside Air Temperature—Minus 57 Celsius
297	Wind Direction: Blowing from 297 degrees
59	Wind Speed in Knots: 59
YAY	Next Position : St. Anthony Nfld VOR
/0105	Time at next position (St. Anthony) 0105
/370	Flight level at next position (St. Anthony) FL370

Message 4—Engine Data Report (22:51:51 UTC)

This message, transmitted by the aircraft, contains information on aircraft engine performance. Content will vary depending on the type of aircraft. For now, the actual engine data is not decipherable.

.N321AA H11

D635AA0000#DFBEDA/E184,411,322,E3B,,61E621,5FE5FD,5FE5FD,58C585,2AE2AD,03C03F,2 B02E0,2192E8,2571BF,12401240,3E8,0E30E2,00C,001,0,6AD449,225146

Here's an explanation of the message:

.N321AA Address: Aircraft Registration Mark: American Airlines Boeing 767
H1 Downlink Message Label: H1—Optional Auxiliary Terminal Downlink Message
I Downlink Block Identifier
D635 Message Sequence Number from DFDAU Unit
AA0000 AA Flight Number always appears as 0000. You must catch previous message with registration and Flight Number to identify this transmission
#DFB Flight Data Recorder originated message
EDA Engine Performance Data follows: (Hexadecimal format)

The next example is from an Air Canada Boeing 767 flying from Toronto (YYZ to Zurich (ZRH).

The following abbreviations are used:

PSN = Position
 ETO = Estimated Time Over
 F/L = Flight Level
 ATO = Actual Time Over
 EFOB = Estimated Fuel On Board
 AFOB = Actual Fuel On Board

Refer to the explanation below for the Enroute AFPAC Waypoints.

.C-GDSU 4PE

PSN	AT PSN	ETO	F/L	ATO	F/L	EFOB	AFOB
YYZ1	*YYZ	0007	CLB			443	
YOW1	MSS	0042	330			393	
YFC1	MIILS	0124	330			357	
YJT1	FROSS	0154	330			331	
YQX1	YQX	0226	370			305	
YYT1	50N50W	0249	370			286	
	51N40W	0337	370			250	
	51N30W	0422	370			215	
	51N20W	0530	390			163	
SNN1	KENUK	0543	390			153	
BES1	RATKA	0602	370			139	
BES1	ODELO	0612	370			132	

Here's an explanation of the PSN and AT PSN codes:

PSN	AT PSN
YYZ1—Toronto T1	*YYZ—Toronto Beacon
YOW—Ottawa ONT	Massena VOR Beacon
YFC—Fredericton NB	Waypoint MIILS
YJT—Stephenville NFLD	Waypoint FROSS
YQX—Gander NFLD	Gander VOR Beacon
YYT—Saint John's NFLD	Aircraft now over Atlantic Ocean (Geographic Latitude and Long. Coordinates are now used)
SNN- Shannon IRELAND	Waypoint KENUK
BES—Brest FRANCE	Waypoint RATKA
BES—Brest FRANCE	Waypoint ODELO

This list of positions and waypoints identifies the route the aircraft will take from Toronto to Europe. The first position abbreviation represents the general area or Flight Information Region (FIR). The second code identifies the VOR beacon or waypoint name. ETO (Estimated Time Over) represents the UTC (GMT) time that the aircraft will be over the various positions. Flight Level (F/L) changes to be made at each of the positions are indicated. For example, at the Toronto position, the aircraft should be climbing (CLB). At Massena, the aircraft should be cruising at Flight Level 330 (33,000 feet. At waypoint FROSS, off the coast of Newfoundland, it should climb to FL 370 (37,000 feet) while crossing the open water of the North Atlantic Ocean. The flight routing in this example message only covers as far as

Brest France. I have copied other transmissions which include further European positions, including the destination. If a complete aircraft routing plan was shown here, you would see the code DSC (descend) for the flight's destination.

The Estimated Fuel on Board (EFOB) is also listed for each enroute position.

The Actual Time Over (ATO) and the Actual Fuel on Board (AFOB) for each enroute position is completed by the crew as they overfly each position during the flight. West Coast readers should be able to pick up similar flight routing information for Pacific Ocean flights.

Until next time, may all your flights be smooth, your skies blue, and your landings happy ones. ■

PSN	AT PSN	ETO	F/L	ATO	F/L	EFOB	AFOB
YYZ1	*YYZ	0007	CLB			443	
YOW1	MSS	0042	330			393	
BES1	ODELO	0612	370			132	
ZRH	ZRH	0735	DSC			84	(This is an example of how this line would appear)

Pirates Den *(from page 73)*

for Offshore Echoes magazine. "Television must be a medium, because it's never rare or well done." (Pearce, VT)

Radio Pepperland, tentative frequency **6955.15** at 1328, in one of the worst pileups I've ever heard. Heard a fairly clear ID that sounded like Radio Pepperland. (Pearce, VT)

RFS, 6955 at 1418 with various song parodies, songs by Steve Miller, Led Zeppelin, a country number. (Pearce, VT)

Cat in the Hat—6953 LSB at 1815, including a calypso tune and sign off giving the Providence address in rhyme. (Pearce, VT)

Radio Boston, 6955 at 1846 with lots of co-host chat and listener mail, even mentioning that mine (?) was on the way. Tune by "Third World" and another by "Culture." Claimed to run 1700 watts. (Pearce, VT)

Voice of Indigestion, 6955 at 1825 playing lots of artists being imitated by other artists. Also a tune with a lot of barnyard effects. (Pearce, VT)

The Talking Pirate—6955 USB at 2100 with lots of Jeff Fox worthy stuff and spoof of Clinton. (Pearce, VT)

WKND—6954.8 at 1445. Radio Animal with a religious program! Talking Heads tune, Iron Butterfly, Stones, Chicago. (Pearce, VT)

FHX, 6955.10 USB at 1950 talking of rejecting a reception report because the

writer heard them on 6954.999 when they were actually on 6954.99995. Claimed to be broadcasting with an ERP of 100 watts from south central North America. (Pearce, VT)

WBIG, 6955 at 1749 with Big Mike featuring "The Ministry." Offering QSL for a "detailed report and three un-licked stamps to WBIG, The BIG One, P.O. Box 1, Belfast, NY 14711. (Brandon Artman, PA) 1950 with FHX at the same time. "It's a green day on WBIG" and Belfast address. (Pearce, VT)

Radio Eclipse, 6955.1 USB at 1707 just at sign off saying lots of things planned for the year. Also at 1805 with host Steve Man and the "phone freak of the week. They said no drop yet but will confirm reports which appear in A*C*E. (Pearce, VT)

Voice of Bizarro World, 6955 LSB at 1618. "now going to play the Bizarro World's national anthem" "If you don't want to receive a shortwave listener's report from Exum then don't send a QSL to the Huntsville address." Commercial for DAMM—Drunk Drivers Against Mad Mothers. (Pearce, VT)

Radio Three, 6955 SSB at 2042 with rock music. The announcer stressed that the only way to get a QSL from Radio Three was to send a report to the A*C*E bulletin. (Dave Jeffery, NY)

Stereo Sound Radio, 6955 USB at

2159 with Colonel Billy-Bob playing rock and later contending with a heckler identifying himself as Slick Willy. Shortly after that started Stereo Sound left the air. (Jeffery, NY).

WARR, 6955 USB at 0112 with rock dedications, instructions for building a pirate TV station for under \$60 using RadioShack parts. (Artman, PA)

Radio Doomsday, tentative, **6955 LSB** at 1903 with someone repeating "That's Grrreat" over and over ad nauseum. Lots of barnyard sounds, "Radio Doomsday would love to hear from you." Not sure about ID because also mentioned Radio KIRK(?) so perhaps a relay? (Artman, PA)

We Love WLIS, 6955 USB at 1817. Only bits and pieces copied, commercial for "Main Event Movie," which featured a serial killer who killed all the popular cereal personalities like Tony the Tiger and Captain Crunch. The address given on the air was: P.O. Box 28413, Providence RI 02908. (Artman, PA)

WMPR, 6955 at 2300 with a digitized voice, birds chirping, female digitized voice saying 6955 and that they played a lot of music, most of it computer music but also some '50s. (Mark De Paepe, N5YEV—state unknown)

We're out of space for this month. Thanks, folks! And keep that good stuff coming my way! ■

Readers' Market

Advertising Rates: Non-commercial ads are 30 cents per word, including abbreviations and addresses; minimum charge \$6.00 per issue. Ads from firms offering commercial products or services are \$1.00 per word; minimum charge \$20.00 per issue. Boldface words are \$1.20 each (specify which words). Leading key words set in all caps at no additional charge. All ads *must be prepaid in full* at time of insertion; a 5% discount is offered for prepaid 6 time insertions. All ads must be typewritten double spaced.

Approval: All ad copy is subject to Publisher's approval and may be modified to eliminate references to equipment and practices which are either illegal or otherwise not within the spirit or coverage scope of the magazine.

Closing Date: The 10th day in the third month preceding date of publication. Because the advertisers and equipment contained in Readers' Market have not been investigated, the Publisher of *Popular Communications* cannot vouch for the merchandise listed therein. Direct all correspondence and ad copy to: PC Readers' Market, 76 N. Broadway, Hicksville, NY 11801, Attn: Nancy Barry.

TUNE In On Telephone Calls! New 3rd Edition, by Tom Kneitel. Latest freqs., info., and effective scanner accessories for serious recreational eavesdropping on cellular, 46 and 900 MHz cordless, air/ground phones, digital pagers and more. The original, official, controversial 160-page source book, now updated! Only \$16.95, plus \$5 s/h (\$6 to Canada). NY State residents add \$1.81 tax. Order from your favorite dealer or CRB Research Books, Inc., P.O. Box 56, Commack, NY 11725. MC/VISA accepted. Phone orders: (516) 543-9169.

"FORBIDDEN SECRETS OF THE LEGION OF DOOM HACKERS!" Big 224-page handbook. The infamous LOD's condemned programs and amazing techniques. From the LOD's now shut down in BBS. Hacking, phreaking, and more! Hard to locate information, now in this Limited edition. For reference and informational purposes only. \$20.95, plus \$5 s/h (Canada \$6). NYS add \$2.21 tax. VISA/MC okay. CRB Research Books Inc., Commack, NY 11725. Phone orders: (516) 543-9169.

SCANNER MODIFICATION HANDBOOK VOL.1 by Bill Cheek. The famous original 160-page book. Performance improvement modifications. Simple step-by-step instructions, many photos. Primarily PRO-2004 & PRO-2005, some for PRO-34, BC-200/205XLT, BC-705XLT, BC-705XLT. Restore blocked-out bands, speed up scanning rate, disable "beep," increase number of channels, improve squelch action, add an S-meter, interface with shortwave receivers, etc. Make the PRO-2004 & 2005 into a 6,400 channel scanner; put 3,200 channels into the PRO-34! Plus, cellular frequency charts, antenna info & mods, inside info on frequency management, operating hints, emergency power supplies, scanners & the law, lots more! Only \$18.95, plus \$5.00 s/h (Canada \$6). Residents of NY State add \$2.36 tax. Big 220 page **VOL. 2** with more mods for PRO-2004/5/6, PRO-34, PRO-2022, BC-760/950XL, BC200/205XL, also available. \$18.95 plus \$5.00 s/h (Canada \$6). NY State residents include \$2.36 tax. **NEW! The Ultimate Scanner, VOL. 3.** Giant 240-page edition. Many more mods! Picks up where the first two books ended. \$29.95 plus \$5 s/h (Canada \$6), residents of NYS add \$2.97 tax. Order from CRB Research Books, Inc., PO Box 56, Commack, NY 11725. Visa/MC welcome. Tel: (516) 543-9169.

RADIO SHACK SCANNERS LOWEST PRICES all catalog items. NEW-FRS 105 Family Radio Service 2-way HT reg. \$180—OUR PRICE \$150. Join our buying club and save. No tax. Call 1-800-848-3004 (orders only). **COTRONICS, Inc.**, 2250 S.E. Federal Hwy., Stuart, FL 34994.

MORSE CODE Got You Down? Why let a mental block stand between you and upgrading? Use Alternative Art's **CW Mental-Block Buster** to blast through those barriers. Just follow the instructions for 30 days—Results Guaranteed! Based on 40 years of research, the **CW Mental-Block Buster** uses guided meditation, dynamic visualizations, and powerful affirmations to blast through mental blocks. You can do code! That means new bands, more contacts, more fun! (This is not a CW practice tape.) The CW Mental-Block Buster audio cassette and practice booklet are only \$25.95 ppd. in the US. **Alternative Arts**, 4601 Rosemare Rd., Parkersburg, WV 26101. (304) 422-2767. MC/VISA, COD. Mail orders include signature. Office hours after 4:30 Eastern.

VHF AERO SCANNER GUIDE: Kneitel's Air-Scan, sixth edition. Great new edition of the new comprehensive and popular USA/Canada VHF aero band directory ever published: Civilian, Military, Private Airports, Heliports & Seaplane Bases, Control Towers, ARTCC, Weather, Approach/Departure, FSS, Ground Control, ATIS, Unicom, National & Air National Guard freqs., etc. Many listings for airport security, fire/rescue, airline ground services & more beyond the aero band. One "must have" guide to tens of thousands of aero related monitor frequencies! Only \$18.95, plus \$5 s/h (\$6 to Canada) from CRB Research, P.O. Box 56, Commack, NY 11725. VISA/MC accepted. Phone orders: (516) 543-9169. (NYS res. add \$2.04 tax.)

CB RADIO HACKER'S GUIDE! Big 151 page book: pictorials, diagrams, text. Complete guide to peaking, tweaking, & modifying 200+ CB radios for enhanced performance & more features. Which screws to turn, which wires to cut. AM & SSB radios: Cobra, Courier, GE, Midland, Radio Shack Realistic, SBE, Sears, Uniden/President. Get the most from your CB radio & operations. Only \$19.95, plus \$5.00 shipping (\$6.00 to Canada). NY State residents add \$2.12 tax. Order from CRB Research Books, Inc., PO Box 56, Commack, NY 11725. Visa/MC OK. Tel: (516) 543-9169.

TOMCAT'S BIG CB HANDBOOK, by Tom Kneitel. 221 large pages, fully illustrated. Complete guide to worldwide AM, SSB, Freeband, 27 MHz operations. Everything they never told you (legal & otherwise) from world's leading CB authority. Only \$15.95 plus \$5.00 s/h (Canada \$6.00) from CRB Research Books, Inc., PO Box 56, Commack, NY 11725. (NYS residents add \$1.78 sales tax). Visa/MC orders call: (516) 543-9169.

DX TOOLS for the serious radio listener. Quantum Loops, Q-Sticks, more. Stamp for catalog. Radio Plus+ Electronics, 3635 Chastain Way, Pensacola, FL 32504. (904) 434-3635.

WORLD'S MOST UNUSUAL Communications Books! A large selection of outstanding titles covering scanners, "confidential" frequency registries, bugging, wire tapping, electronic surveillance, covert communications, computers, espionage, monitoring, and more! New titles being added constantly! Ask for our big FREE catalog. CRB Research, BOX 56-PC, Commack, NY 11725.

MILITARY RADIOS: Easily made battery adapters for military radios & other electronics. Get **POWERUP!** Big new 96-page manual of instructions, diagrams. Use readily available commercial batteries in PRC-6, -8, -9, -10, -25, -28, -47, -74, -77, TRC-77, AN/PRC-9, AN/PRT-4, RT-77, URC-68, more; also mine detectors, night scopes, radiacs, field telephones, etc. Only \$14.95, plus \$5 s/h (\$6 Canada). NYS residents add \$1.53 tax. CRB Research Books, Box 56-PC, Commack, NY 11725. VISA/MC accepted. Phone (516) 543-9169.

CW Lite is the easiest Morse Code training method in the world, bar none! And it is the fastest, too. Just closed your eyes and relax. This powerful **hypnosis cassette tape** does the rest. Subliminals speed you along! Only \$15.95 ppd in US Order today! **Alternative Arts**, 4601 Rosemare Rd., Parkersburg, WV 26101. (304) 422-2767. MC/VISA, COD. Mail orders include signature. Office hours after 4:30 Eastern.

CB MODIFICATIONS! 10M, frequencies, sliders, FM, amplifiers, books, plans, kits, high-performance accessories. The best since 1976. Find out why! Catalog \$3. CBC INTERNATIONAL INC., Box 31500A, Phoenix, AZ 85046.

CABLE DESCRAMBLER! Build for \$12 with seven RadioShack parts. Instructions \$8. F.A.S.T., Box 369-U74, Ft. Salerno, FL 34992-0369.

CABLE DESCRAMBLERS—BELOW WHOLESALE PRICES ALL BRANDS, 30 DAY MONEY-BACK GUARANTEE ABSOLUTELY THE LOWEST PRICES—NOBODY BEATS US. THE CABLE STORE 1-800-390-1899.

CW? NO PROBLEM. You can increase your speed, no matter how many times you've failed before. **Results guaranteed** when you follow the instructions. Alternative Art's **CW Mental-Block Buster** program helps you **explode mental blocks** that hold you back. Based on 40 years of research, the **CW Mental-Block Buster** uses guided meditation, dynamic visualizations, and powerful affirmations to blast through mental blocks. You can do code! That means new bands, more contacts, more fun! (This is not a CW practice tape.) The CW Mental-Block Buster audio cassette and practice booklet are only \$29.95 ppd. in the US. (Quantity discounts available for classes.) **Alternative Arts**, 4601 Rosemare Rd., Parkersburg, WV 26101. (304) 422-2767. MC/VISA, COD. Mail orders include signature. Office hours after 4:30 Eastern.

WANTED: CB RADIO EQUIPMENT—I'm looking for all types of old/vintage CB radios, amps, manuals, magazines, mics, etc. **PLEASE CALL** anytime. **WALTER 818-297-7249.**

GE SUPERADIO III with up to four SCS bands is the DX'ers choice. AM modification included. Low as \$85. 800-944-0630.

CABLE DESCRAMBLERS FROM \$99.00. TEST DEVICES FROM \$15.00. CALL US WITH YOUR QUESTIONS. 1-800-449-9189. NO FLORIDA SALES. ANYONE IMPLYING THEFT OF SERVICE WILL BE DENIED ASSISTANCE.

MILITARY TECHNICAL MANUALS for sale. Basic Electricity. Basic Electronics. Antenna Theory and mechanical books. Write or call for listing: ART'S BOOK WORLD, INC., 6822 22nd Ave. N., Ste. 175, St. Petersburg, FL 33710; phone 813-525-4880; or TOLL-FREE 1-888-414-BOOK.

NEED HELP! Radio Shack can't repair/replace band switch and FET amp on analog geezer's like-new Realistic DX-200. Can anyone? Joseph Burgess, 407 Hiawatha, Frankfort, KY 40601, (502) 695-3016.

CABLE TV DESCRAMBLER. Build your own. Complete plans. Parts list. Diagrams. Circuit board. Schematics. Send \$9.95 to A. Gray, P.O. Box 1223-E Station 28, Route 6, Halifax, NS B3L-4P4.

CABLE TV DESCRAMBLER!! ANYONE CAN BUILD IN SEVEN EASY STEPS WITH RADIO SHACK PARTS. PLANS/KITS FROM \$5.00 PLUS FREE BONUS. 1-800-818-9103.

RADIO STUFF SALE: Books, magazines, club bulletins, radio station items, old time radio & more. \$1 for list. G. Dexter, 213 Forest St., Lake Geneva, WI 53147.

CABLE DESCRAMBLER anyone can build for under \$12 in 7 easy steps with Radio Shack parts! Plans \$10. R.L. International, 12917 Jefferson Ave., Suite H-162, Newport News, VA 23608.

WANTED: TUBE-TYPE audio equipment, speakers, 1930's-1960's. Microphones, amplifiers, mixers, etc. Western Electric, Macintosh, Marantz, Altec, J.B.L., etc. 1-800-251-5454.

LEARN MORSE CODE IN 4 HOURS! Taught the military method. Send \$9.95 to: J.L. Steiger, 375 Hillside, Seven Hills, OH 44131.

SERVICE AND MODIFICATION HANDBOOKS: Cobra, Uniden, RCI, Galaxy, Motorola. CB/HAM/MARINE/COMMERCIAL Radios, antennas, mics, meters, and accessories. Plus Night Scopes and Tons more stuff. 28 pg. Catalog \$3.00. MAX-TECH, Box 8086, New York, NY 10150 USA: 718-547-8244.

NOW YOU CAN DEAL DIRECT WITH THE 'SHED! We only deal with CB's—We have to be good! The CB Shed, P.O. Box 565, Chouteau, OK 74337: 918-476-8656.

NEW SCANNING USA. from the publishers of Scanning Illinois. Nationwide newsletter with Public Safety, Aircraft, Railroad, Shortwave, Federal/Military, Tech, more! Samples 3.00. Twelve issues for \$19.95. SASE checks to: 2054 Hawthorne, Joliet, IL 60435. Make checks payable to Alex Blaha.

WANTED: EARLY MILITARY RADARS. Aviation, marine, fire control, bombing, missile. Also parts, training courses, TM's. RADAR: Box 10215, Bloomfield, PA 15232.

WANTED: NORWOOD XLP 4-track tape recorder. Must be in good working condition. Contact R.L.N, P.O. Box 238, Chicopee, MA 01014-0238.

LEARN CODE BY HYPNOSIS—<http://www.qth.com/cweasy/>; or 1-800-425-2552.

RF TRANSISTORS, TUBES 2SC2879, 5AV17, 2SC1946A, MRF247, 2SC1969, MRF455, MB8719, MRF454, 2SC2312, 2SB754, SRF3749, 4CX250B, 572B, 3-500, ETC. WESTGATE 800-213-4563.

POOR RECEPTION ON YOUR AM RADIO? Our signal booster will help. Guaranteed! Version 1601 tunes 530-1600 kHz. \$39 + \$5.50 s/h. If not satisfied within 30 days, we'll refund your money, less s/h charge. FALA ELECTRONICS-5, P.O. Box 1376, Milwaukee, WI 53201-1376. 414-671-5203.

INTERNATIONAL SSB-CB CLUB—looking for members in Georgia, Mississippi, Missouri, and Tennessee. You get callsign, directory, member card, award program, contest program and club magazine. We issue separate QSL cards for each state/ country. Fee is \$20 money order mailed to A.S.A. DX-Group, P.O. Box 685, S-521 21 Falkoping, Sweden.

CB and 10 METER equipment: Ranger, Galaxy, Mirage, Super Star, and Much More! Send 3 stamps to EDS, P.O. Box 343, Howell, NJ 07731.

1997 CATALOG. SCANNERS, CB radios, microphones, power supplies, hard-to-find electronics, catalog \$1.00 (refundable). 10 yrs. in business. GALAXY, BOX 1202, Akron, OH 44309.

CB MODIFICATION SECRETS. big new 200-page guide by Kevin Ross, author of "CB Radio Hacker's Guide." More great easy-to-do Am/SSB CB equipment upgrades and enhancements applicable to Cobra. Realistic. Uniden. President, etc. Freq. expansion. VFO, clarifier unlock. VOX, Roger Beep, anti-theft device, receive signal preamp, much more. Only \$21.95, plus \$5 s/h (\$6 to Canada) from CRB Research Books, P.O. Box 56, Commack, NY 11725. NYS residents add \$2.22 tax. VISA/MC orders call: (516) 543-9169.

HAM location, beautiful all brick rancher. 4700 sq. ft. home includes home office, HAM shack (radio room), antennas, 3 tiled full baths, 3 or more bedrooms, 3 dens. The 3 car garage and smoking room are not included in the 4700 sq. ft. Sturdy quality construction. Type of heat is great for sinuses and very warm. Acre lot, back fully fenced and very quiet and private, secure gates, separate dog kennel, Olympic size well kept swimming pool. Located on mountain ridge, quiet prestigious neighborhood, nice homes all around, great schools. Located 55 miles from Baltimore and Washington, D.C. Ideal location to work in DC, with easy accessibility by train. House and property will be inspected, one year warranty. Pictures, property plot, layout, amenities list, and features in a booklet available to serious buyers for \$5 cash, check or money order. Contact W3BAG, Box 609, Braddock Heights, MD 21714, or call 301-473-5825.

RC-740X band expansion for **KENWOOD** 741/742 series. **ScannerWEAR WINDOWS** software for ICOM, AOR, Opto receivers see all at <http://www.radioscan.com>. **RADIO CONTROL SYSTEMS, INC.** 1-800-560-7234.

TUBE-TYPE CB RADIO COLLECTION sale! Free List. Ed Clink, WA9PFB, 1285 New Salem Church Rd., New Berlin, IL 62670.

1997 PICTURE CATALOG, CB RADIOS, SCANNERS, INCLUDING NEW TRUNKING UNITS, POWER SUPPLYS, METERS, MICROPHONES AND HARD TO FIND ELECTRONICS. \$1.00 (REFUNDABLE). GALAXY ELECTRONICS, BOX 1202, AKRON, OHIO 44309. (13 yrs. IN BUSINESS).

JAPAN RADIO Co. NRD 535D Receiver. Mint, original packing. \$900.00. Call Earl at 518-584-0762.

FOR SALE: ICOM R71A mint, manual, box, new lth. batt. 7-93. \$550.00 Plus shipping. George 207-965-8675.

Advertisers Index

A.M.C. Sales, Inc.	10
AOR, LTD.	Cov. II
Alpha Delta Communications, Inc.	51
Antenna Supermarket	29
Antique Electronic Supply	22
Antique Radio Classified	62
Arcron-Zeit	11
Atlantic Ham Radio	38
BayGen USA	10
C. Crane Company	65
CQ Books & Video	27
CQ VHF Magazine	67
CRB Research	28
Carver Patent Law Ltd.	65
Computer Aided Technologies	42,43
Delta Research	15
Delphi	28
Drake, R.L. Company	9
Durham Radio Sales & Service, Inc.	65
EDCO	7,18,19
Electronic Equipment Bank	1
Firestik Antenna Company	45
Future Scanning Systems	65
Index Publishing Group, Inc.	17
Jo Gunn Enterprises	57
Lentini Communications, Inc.	59
MACO Mfg. Div./Majestic Comm.	37
MFJ Enterprises, Inc.	39
Marvel Communications, Co.	17
MoTron Electronics	31
Mouser Electronics	34
Optoelectronics, Inc.	5,23,Cov. IV
Paladin Press	47
Phillips-Tech Electronics	65
Quement Communications	65
R.C. Distributing	22
REACT International, Inc.	58
REEL-Talk, Inc.	49
RELM Communications	13
Scrambling News	62
Signal Engineering, Inc.	34
Software Systems Consulting	67
Stridsberg Enginnering, Inc.	45
Universal Radio, Inc.	3
Viking International	28
Widespread Weather Services	61
Wilson Antenna, Inc.	31
Wireless Marketing Corp.	35
Xandi Electronics, Inc.	62
Yaesu U.S.A.	Cov. III

Reach this dynamic audience with your advertising message, contact Don Allen, W9CW at 217-344-8653, FAX 217-344-8656, or e-mail: PopComAds@aol.com

The Loose Connection

BY BILL PRICE, N3AVY

RADIO COMMUNICATIONS HUMOR

A "Serious" Test of Your Knowledge of the Hobby

Match wits with *Pop'Comm's* Wizard of Waveguide. Are you smarter than Bill? (If not, how did you ever fill out your subscription card?) Take this quick test to see if you really know your stuff! (Find how to get answers at end of article.)

Capture Effect

- The ability of some antennas to "grab" a signal and hold it.
- The basis of operation for all RF traps.
- A unique quality of FM receivers allowing only the loudest signal present on a frequency to be demodulated.
- A nauseated feeling arising from the sight of blue lights reflecting in a mirror.

Carrier

- A really big ship—often with airplanes on it.
- A frothing raccoon.
- An unmodulated AC (radio) wave radiating at a constant frequency from an AM radio transmitter.
- Typhoid Mary.

Citizens Band

- A new method of identification introduced in California, to be worn around the wrist.
- A group of well-meaning, tone-deaf, and often elderly musicians who perform during the warmer months at the gazebo in the town square, who deserve respect just for shamelessly making those noises in front of everyone.
- A portion of 26 and 27 MHz set aside for unlicensed, unregulated, and often annoying AM communication, limited to five watts input to the final stage of the transmitter unless you can think of a reason to use more.
- A bunch of people, usually in England, with a propensity for chasing werewolves, vampires, or even the dreaded Frankenstein monster through the moors or other damp area, with torches.

Compandoring

- The art of procuring certain favors for a compadre.
- Communicating with a panderer.
- Compressing speech at the transmitter and re-expanding it at the receiver.
- An involved navigation process using a compass and an o-ring.

DeForest, Lee

- What Liberace's brother, George, said to him upon reaching the edge of the woods near their boyhood home.
- The actor who played "Bones" on Star Trek, made famous by his line, "For God's sake, Jim—I'm a doctor, not a _____!"
- The Father of Radio—born 1873, an American Electrical Engineer who patented the triode electron tube in 1907, making possible the amplification and detection of radio waves. DeForest lived until 1961.
- Bruce Lee's less-famous brother, noted for using excessive amounts of agent-orange to clear wooded lots at his ranch in southern California.

Dip Meter

- A mechanical gauge to determine the effectiveness of shock absorbers.
- A secret electronic device carried to dances by high-school girls to protect them from the embarrassment of dancing with someone dorky.
- A piece of electronic test equipment; the meter "dips" in the presence of a component or circuit resonant at a predetermined frequency.
- A mechanical device used to assist in determining the winner of high school dance-contests.

Dipole

- A wooden stick used to stir clothing in a dyeing vat.
- A really nasty expression used by foot-soldiers invading Poland.
- A simple, classic wire or tubular anten-

na, probably the most frequently-used antenna in amateur radio; the basis for all Yagi antennas.

- A long wooden stick which Prince Charles wouldn't touch his wife with until someone explained that she was the empire's best hope to produce normal-looking children.

Direction Finder

- Some guy at a travel club who makes up those neat, personalized maps they send you.
- Your spouse.
- An apparatus (can you tell this is a definition from a government publication?) capable of receiving radio signals and taking bearings from those signals from which the true bearing and direction of the origination of those radio signals can be determined.
- The person who discovers that elusive slip of paper telling you how to get to Aunt Margie's in Paducah.

Distress

- Why L.A. Dodgers manager Tommy LaSorda ate antacids by the handful.
- A mythical town where damsels waited for knights to rescue them. Distress was often inhabited by dragons.
- An emergency where loss of life or the destruction of property is likely.
- How Rocky Balboa described a lock of Adrian's hair.

Dummy Load

- Charlie McCarthy, Danny O'Day, Mortimer Snerd, and Farfel, riding in the back of a pickup.
- Members of the (Democrat/Republican—pick one) party on a hayride.
- A non-reactive, resistive load, usually with 50 ohms characteristic impedance, to absorb the RF output of a transmitter for testing purposes.
- A hundred-pound bag of sand for you to carry across the desert.

(Continued on page 72)

Ultra Compact Dual Band Handheld FT-50RD

One tough little dual bander!

Features

- Frequency Coverage
 - Wide Band Receive
 - RX: 76-200 MHz, 300-540 MHz, 590-999 MHz*
 - TX: 144-148 MHz, 430-450 MHz
- AM Aircraft Receive
- MIL-STD 810 Rating
- Digital Coded Squelch (DCS)
- 112 Memory Channels
- 12V DC Direct Input
- High Speed Scanning
- Alphanumeric Display
- CTCSS Encode/Decode
- Auto Range Transpond System™ (ARTS™)
- Dual Watch
- Direct FM
- High Audio Output
- ADMS-1C Windows™ PC Programmable
- Four Battery Savers:
 - Automatic Power-Off (APO)
 - Receive Battery Saver (RBS)
 - Selectable Power Output (SPO)
 - Transmit Battery Saver (TBS)
- Time Out Timer (TOT)
- 2.5 and 5 Watt Versions Available
- Built-in Digital Voice Recording System (DVRS)
- Full line of accessories

NOW
WITH BUILT-IN
DELUXE
KEYPAD

"You notice how loud this HT's audio is?"

"Yeah, it's Mil Spec tough like a commercial HT."

"Easy to operate, small, great price!"

"Yaesu did it again!"



The foremost in top-performing, durable, dual band handhelds now includes the FT-50RD DTMF keypad with CTCSS enc/dec, DCS enc/dec, DVRS and paging/coded squelch. Manufactured to rigid commercial grade standards, the FT-50RD is the only amateur dual band HT to achieve a MIL-STD 810 rating. Already a winner: the deluxe keypad makes this stand-out HT even better! Water-resistant construction uses weather-proof gaskets to seal major internal components against the corrosive action of dust and moisture. And, the rugged FT-50RD withstands shock and vibration, so throw it in with your gear!

Exclusive features set the FT-50RD apart, too. Wide Band Receive includes 76-200 MHz (VHF), 300-540 (UHF), and 590-999 MHz*. Dual Watch checks sub-band activity while receiving on another frequency, then when a signal is detected, shifts operation to

that frequency. Digital Battery Voltage displays current operating battery voltage. Digital Coded Squelch (DCS) silently monitors busy channels. Auto Range Transpond System™ (ARTS™) uses DCS to allow two radios to track one another. And, the FT-50RD is ADMS-1C Windows™ PC programming compatible, too. To round out the FT-50RD, it has four battery savers, and super loud audio—remarkable in an HT this size.

A reliable companion where ever you go, the FT-50RD is one tough little dual bander with all the features you want!

YAESU

...leading the way SM

For the latest Yaesu news: hottest products, visit us on the Internet! <http://www.yaesu.com>



FT-10/40R
Ultra Compact Handhelds
VHF or UHF. Similar to FT-50RD including MIL-STD 810, and other exclusive features.

iCan

Reaction Tune Another Receiver

SEE US
AT DAYTON
BOOTHS
70, 76, & 77

Reaction Tune the
NEW
ICOM IC-R10

Use the OptoLinx
for computer controlling
the ICOM IC-R10
\$129.00



Computer Not Included

Another radio to tune, another reason to purchase the *Scout*.

Until now the AOR AR8000/2700 were the only hand held scanners to take advantage of the *Scout's* Patented Reaction Tune function. The *Scout* can now tune the new ICOM IC-R10 hand held scanner (shown below). Connection is easy: No modifications required - No custom cables to buy - Just plug and play.

Scanner hobbyists and communication professionals benefit from the *Scout's* unique functions. Whether you're searching for new frequencies in your neighborhood, or testing for interference, the *Scout* is the ultimate communications tool.

Armed with a 400 frequency memory register, the *Scout* does not record duplicate frequencies, instead it coordinates repeated frequencies into a hit register storing up to 255 hits per frequency. Attach it to your belt and begin your day, the *Scout* will alert you when a signal is received by its beeper or vibrator function.

You won't miss a thing with Reaction Tune. The *Scout's* CI-V compatible output allows it to interface to the AOR AR2700/AR8000, ICOM R7000, R7100, R8500, R9000 and now the new IC-R10 (shown opposite). The *Scout* captures the frequency, then sends the serial data to the receiver and tunes the scanner to the frequency for instant monitoring in less than one second. Recorded frequencies can be downloaded to a PC using the optional OptoLinx universal interface •

SPECIFICATIONS

- ▶ 10MHz - 1.4GHz frequency coverage
- ▶ Stores and records 400 frequencies in memory with 255 hits for each
- ▶ Interface to a PC for frequency download using optional OptoLinx PC interface
- ▶ Distinctive beeps indicate frequency hits, pager style vibrator for discreet recording
- ▶ Automatic EL backlight for night operation
- ▶ 16 segment RF signal strength bargraph
- ▶ Frequencies are automatically saved when unit is turned off
- ▶ Reaction Tune the ICOM R7000, R7100, R8500, R9000, IC-R10, and AOR AR2700, AR8000, and the Radio Shack Pro 2005/6 using the Optoelectronics OS456, Radio Shack Pro 2035/42 using the Optoelectronics OS535

U.S. Patent No. 5,471,408



\$449
Includes Scout, DB32 Antenna, CC30 Case, & Spectrum CD

Scout with ICOM IC-R10
Mono Cable required (shown)

Radio Not Included

FACTORY DIRECT ORDER LINE 800-327-5912

OPTOELECTRONICS®

INNOVATIVE PRODUCTS FOR A MODERN PLANET

5821 NE 14th Avenue • Ft. Lauderdale, FL • 33334

Telephone • (954) 771-2050 Fax • (954) 771-2052

CIRCLE 152 ON READER SERVICE CARD

Visa, Mastercard, C.O.D. Prices and specifications are subject to change without notice or obligation



The ICOM logo is a registered trademark of ICOM Inc. ICOM IC-R10 not distributed by OPTOELECTRONICS. contact ICOM for information and availability.