

SPRING EDITION

\$1.25

1974

POPULAR
ELECTRONICS

ELECTRONIC EXPERIMENTER'S HANDBOOK

HOW TO BUILD

Stereo Balance Meter
Electronic Thermometer
Guitar "Fuzz" Adapter
Optical Voice Transceiver
Sound-Activated Photoflash
Memory Logic Probe
Electrolytic Restorer
Bass-Reflex Enclosures
Electronic Coin Flipper
Voltage Monitor
Electronic Lock

COMPLETE PLANS

SCHEMATICS/PHOTOS

PC PATTERNS

PLUS...

Op Amp Course
PC Board Construction
Using Coax Connectors

SCIENCE FAIR BONUS!

Build the "Bouncing Ball"
ANALOG COMPUTER

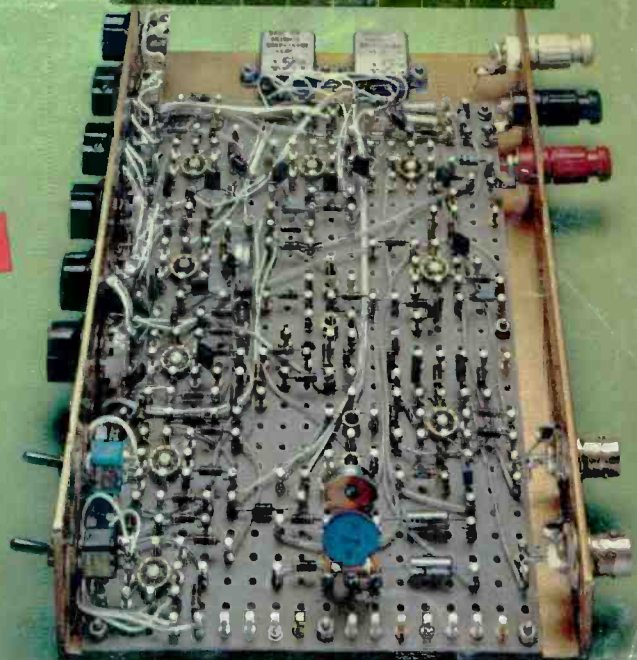
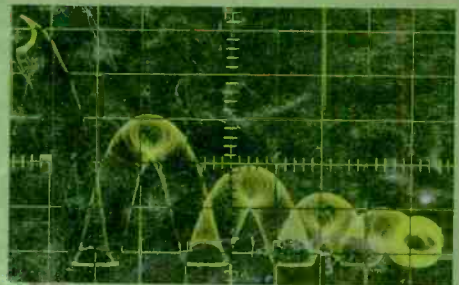

NEW! Build and test circuits as fast as you can think! No soldering or patch cords!

Plug in...wire...modify...build...test

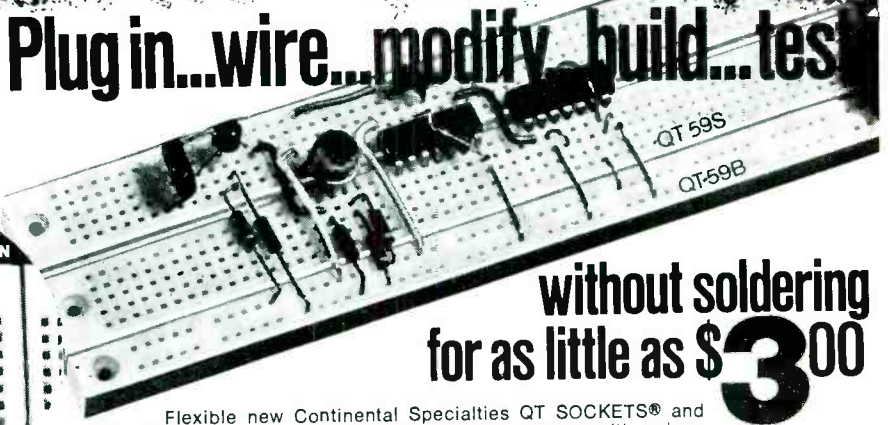

without soldering for as little as \$3.00

Flexible new Continental Specialties QT SOCKETS® and BUS STRIPS are a fast, easy breadboarding system with unique SNAP/LOCK that lets you add or remove as many QTs as you need instantly. Now you can test ICs, transistors, resistors, capacitors and more. Just plug in, and connect with solid #22 AWG hook up wire... no soldering is needed! No more shorts! No more burnt fingers! No special patch cords! And you can use QTs again and again! QTs come in different sizes, starting as low as \$3 for QT Sockets and \$2 for Bus Strips. Order yours today!

plus, four new completely assembled PROTO BOARDS...

PAT. PENDING

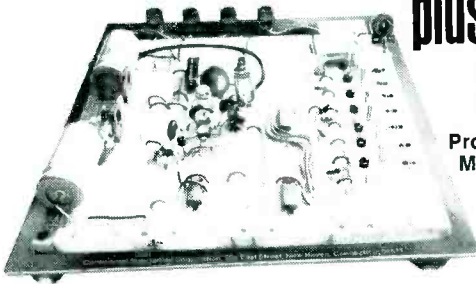

Proto Board Model No.	14 Pin DIP Capacity	Size (L" x W")	Price (U.S. only)
101	10	5.8" x 4.5"	\$29.95
102	12	7.0" x 4.5"	\$39.95
103	24	9.0" x 6.0"	\$59.95
104	32	9.5" x 8.0"	\$79.95

Four new Continental Specialties Proto Boards, made from combinations of QT Sockets and Bus Strips let you make all circuit and power interconnections with common solid #22 wire, while power distribution busses make wiring a snap. Aluminum base plates offer solid work surfaces and perfect ground plane. Rubber feet prevent scratching. Each Proto Board features one or more 5-way binding posts to tie into system or power supply ground. All are compatible with ICs (digital or linear), in TO5s, DIP packs and discrete components. Each is assembled and ready-to-use.

Order today — or send for free selection guide, with applications, photos, specs and more.



Continental Specialties Corp.
325 East St., Box 1942 *
New Haven, CT 06509
Telephone (203) 624-3103

CANADA: Available thru Len Finkler, Ltd., Downsview, Ontario

FREE METRIC TO ENGLISH SLIDE RULE

Convert lengths, area, weight, volume instantly. Yours FREE with each Proto Board order!

New square-cornered Sylvania picture tube

Handsome woodgrain cabinet, at no extra cost. (Offered only by NRI)

6-position detented UHF channel selector

Modular construction with plug-in circuit boards

Automatic color control

Automatic degaussing

Automatic tint control

100% solid state chassis

Automatic fine tuning



NOW... learn color TV servicing while building this NEW 25" DIAGONAL SOLID STATE SET created by NRI for home training

NRI wanted more than a hobby kit TV . . . so we built one from the circuits up, specifically for teaching advanced electronics. You can only get this superb set from NRI . . . it's exclusive with NRI Color TV Servicing Course.

NRI was first to supply home study students with custom-designed training kits to give practical hands-on experience as you learn. Now NRI scores another first . . . with the exclusive 25" diagonal picture tube, solid chassis, color TV set designed-for-learning. You build it yourself with NRI's TV-Radio Servicing Course.

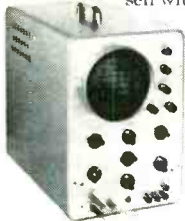

Kit for kit, dollar for dollar, you get more for your money from NRI.

The TV-Radio Servicing Course includes a wide-band service type oscilloscope and a color bar cross-hatch generator . . . along with

other valuable equipment you will use to perform experiments and make repairs on your own and other sets.



You'll soon find yourself earning \$5 to \$7 an hour, in your spare time . . . even before the course is completed.

Learning at home is easy . . . the simplified NRI way. Texts are "bite-size" and fully-illustrated, leading you step by step, stage by stage, to a thorough knowledge of electronics. You can introduce defects into circuits, perform experiments, and discover the how and why of circuitry and equipment operation.



Train with the Leader—NRI.

The same training innovations which have made NRI the leader in career training at home are now available to you. Mail the insert card for a free full-color catalog which spells out the NRI "discovery" method of learning. There's no obligation. **NO SALESMAN WILL CALL.**

APPROVED UNDER NEW GI BILL. If you have served since January 31, 1955, or are in service, check GI line on reply card.



NRI TRAINING
3939 Wisconsin Avenue, N.W.
Washington, D.C. 20016



1974 POPULAR ELECTRONICS **ELECTRONIC** **EXPERIMENTER'S** HANDBOOK

SPRING EDITION

COLOR CODES CHART		7
REACTANCE CHART		8
"BOUNCING BALL" ANALOG COMPUTER	Terry L. Mayhugh	9
<i>An ideal "Science Fair" project it displays any ball's behavior when dropped from a height. It does the calculations for a continuous display which would otherwise take hours of higher-math calculations.</i>		
TRANSMITTER FOR THE NEGLECTED BAND	Jim White, W5LET	14
"ELECTRIC EYE" IN-OUT ANNUNCIATOR	John S. Simonton, Jr.	22
VOLTAGE MONITOR	Jeffrey P. Hammes	28
SOUND-ACTIVATED PHOTOFLASH ATTACHMENT	Vic Leshkowitz	30
PHOTOCELL MOTOR CONTROL DEMONSTRATOR	Bob Koval	32
THE OPERATIONAL AMPLIFIER	Ralph Tenny	35
<i>The versatile linear IC opens up many new areas for the serious experimenter. This article tells you what it is, how it works, and covers some practical applications.</i>		
BUILD BASS REFLEX ENCLOSURES THE EASY WAY	David B. Weems	46
DIFFERENT RESISTANCE DECADE	James A. Fred	48
DECIBEL TABLE		51
BUILD A DISTORTIONLESS PREAMPLIFIER	James Bongiorno	52
<i>If you are into four-channel—or thinking of making a switch—this outboard phono preamp can salvage your present hi-fi set up and save it from premature obsolescence.</i>		
IMPROVED FOUR-WAY FLASHER	Donald R. Hicke	58
TUNER FOR THE NEGLECTED BAND	Jim White, W5LET	59
CONSTRUCTING PC BOARDS	Robert A. Sullivan & Robert S. Brodsky	62
SIGNAL DIFFERENCE STEREO BALANCE METER	J. R. Laughlin	66
ZENER DIODE SUBSTITUTION BOX	Stanley Sula	72

ELECTRONIC EXPERIMENTER'S HANDBOOK: Published semi-annually by Ziff-Davis Publishing Company at One Park Avenue, New York, New York 10016. William Ziff, President; Hershel B. Sarbin, Senior Vice President Secretary, and Treasurer; Philip Sine, Senior Vice President.
Copyright © 1974 by ZIFF-DAVIS PUBLISHING COMPANY. All rights reserved.

ONE SECOND METRONOME TIMER	A. A. Mangieri	74
LOW-COST LOGIC PROBE WITH MEMORY	H. H. Ross & T. R. Mueller	77
<i>This inexpensive, easy-to-build probe reveals TTL or DTL logic states as well as low-duty-cycle pulses . . . a handy addition to your test bench when troubleshooting digital circuits.</i>		
HEADS 'N' TAILS	Don Lancaster	81
CRYSTAL-CONTROLLED MUSICAL INSTRUMENT TUNER	Hank Olson	84
WHAT DO YOU KNOW ABOUT CAPACITORS?	Robert P. Balin	90
THE TOUCH-A-TONE	Charles D. Rakes	91
QUIZ ON AC CIRCUIT THEORY	Robert P. Balin	98
CARE AND HANDLING OF COAXIAL CONNECTORS	William I. Orr, W6SAI	99
TWO-TONE "WAVERLY" ALARM	Don Lancaster	102
THE OPTICOM	Forrest M. Mims, III & Henry E. Roberts	107
<i>Ensure the privacy of your communications with this invisible-light-beam transmitter/receiver which carries for 1500 feet.</i>		
BUILD AN IMPEDANCE METER	Charles D. Rakes	114
TACH-DWELL METER	Norman J. Olsen	118
SURF SYNTHESIZER	John S. Simonton, Jr.	119
ELECTRONIC CLINICAL THERMOMETER	J. R. Laughlin	123
BUILD A DIGI-VIEWER	Don Lancaster	127
BUILD THE TIME OUT	John Stayton	132
BUILD THE OPTIMUM FUZZ ADAPTER	Craig Anderton	136
BUILD A CRYPTO-LOCK	James G. Busse	142
SLOW TURN-ON PROTECTS POWER SUPPLY	Frank Tooker	146
BUILD AN ELECTROLYTIC RESTORER	George J. Plamondon	147
<i>You can laugh at parts shortages if you have electrolytics in your junk box . . . with this restorer you can salvage most of them.</i>		
BUILD AN AUDIO LEVEL METER	Samuel C. Milbourne	152
ADD COMPRESSION AMP TO YOUR ELECTRONIC ORGAN	J. E. Rohen	153
STOPPING ENGINE RUN-ON	Karl G. & Richard K. Johnsson	154
SQUAWK BOX TOY FOR \$3	Bennett A. Loftsgaard	155

Cover Photo: Conrad Studios
 For details on how to build the
 "Bouncing Ball" analog computer,
 see page 9.

EDGAR W. HOPPER, *Publisher*

ARTHUR P. SALSBERG, *Editorial Director* ● STANLEY NEUFELD, *Assoc. Publisher*

P. B. HOEFER, *Managing Editor* ● EDWARD I. BUNBAUM, *Art Director*

JOSEPH E. HALLORAN, *Adv. Director* ● JOHN J. CORTON, *Adv. Sales*

ANDRE DUZANT, *Technical Illustrator* ● MADELEINE LITTMAN, *Adv. Service Mgr.*

FURMAN H. HEBB, *Group Vice President, Electronics & Photographic*

Our terminal service kits, designed to your specifications, are indispensable for field service of data terminals and telecommunication units. For information, call or write.

ASK FOR OUR FREE CATALOG!

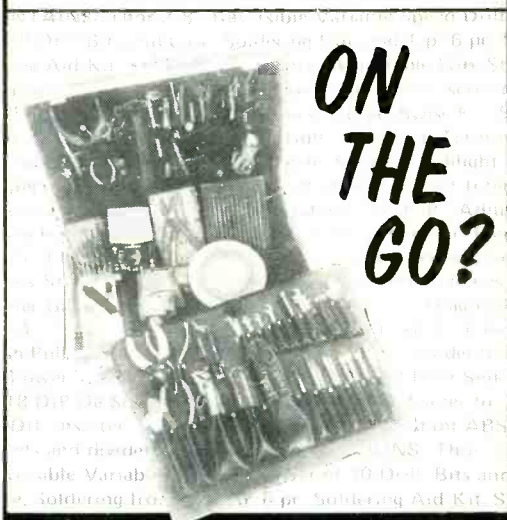

TECHNI-TOOL, INC.

5 Apollo Rd., Plymouth Meeting, Pa. 19462 825-4990

CIRCLE NO. 13 ON READER SERVICE CARD

**Now... the most enjoyable,
do-it-yourself project
of your life—a Schober
Electronic Organ!**

You'll never reap greater reward, more fun and proud accomplishment, more benefit for the **whole family** than by assembling your own Schober Electronic Organ.



You need no knowledge of electronics, woodwork or music. Schober's **complete** kits and crystal-clear instructions show you — whoever you are, whatever your skill (or lack of it) — how to turn the hundreds of quality parts into one of the world's most beautiful, most musical organs, worth up to twice the cost of the kit.

Five superb models, with kit prices from \$500 to around \$2,000, each an **authentic** musical instrument **actually superior to most you see in stores.**

Get the full story **FREE** by mailing the coupon **TODAY** for the big Schober color catalog, with all the fascinating details!

The *Schober Organ Corp.*, Dept. EH-8
43 West 61st Street, New York, N. Y. 10023

- Please send me Schober Organ Catalog.
- Enclosed please find \$1.00 for 12-inch L.P. record of Schober Organ music.

NAME _____

ADDRESS _____

CITY _____ STATE _____ ZIP _____

CIRCLE NO. 12 ON READER SERVICE CARD

1974
POPULAR
ELECTRONICS
**ELECTRONIC
EXPERIMENTER'S
HANDBOOK**

SPRING EDITION

Ziff-Davis Publishing Company
William Ziff
President

W. Bradford Briggs
Executive Vice President

Hershel B. Sarbin
Senior Vice President
Secretary and Treasurer

Philip Sine
Senior Vice President

Phillip T. Heffernan
Vice President, Marketing

Frank Pomerantz
Vice President, Creative Services

Arthur W. Butzow
Vice President, Production

Edward D. Muhlfeld
Vice President, Aviation Division

Irwin Robinson
Vice President, Travel Division

George Morrissey
Vice President

Sydney H. Rogers
Vice President

Sidney Holtz
Vice President

Lawrence Sporn
Vice President, Circulation

Jerry Schneider
Administrative Dir., Ziff-Davis Annuals

Ziff-Davis Publishing Company
Editorial, Circulation, and Executive Offices
One Park Avenue, New York, New York 10016
212 725-3500

Midwestern Office
The Pattis Group
4761 W. Touhy Ave., Lincolnwood, Ill. 60644
312 679-1100
Gerald E. Wolfe, George B. Mannion

Western Office
9025 Wilshire Blvd., Beverly Hills, Calif. 90211
213 273-8050, BR 2-1161
Western Adv. Manager, Bud Dean

Japan
James Yagi, Oji Palace Aoyama
6-25, Minami Aoyama 6-Chome, Minato-ku
Tokyo 407-1930/6821



1974 **ELECTRONIC EXPERIMENTER'S HANDBOOK** is published semi-annually by the Ziff-Davis Publishing Company, One Park Avenue, New York, N.Y. 10016. Also publishers of Stereo Review, Popular Electronics, Communications Handbook, Tape Recording & Buying Guide and Stereo Directory & Buying Guide

COLOR CODE CHARTS

COLOR BAND SYSTEM

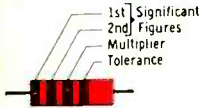

Resistors With Black Body Color Are Composition, Non-Insulated. Resistors With Colored Bodies Are Composition, Insulated. Wire-Wound Resistors Have The 1st Digit Color Band Double Width.

RESISTOR CODES (RESISTANCE GIVEN IN OHMS)

COLOR	DIGIT	MULTIPLIER	TOLERANCE
BLACK	0	1	+20%
BROWN	1	10	+1%
RED	2	100	+2%
ORANGE	3	1000	+3%
YELLOW	4	10000	GMV*
GREEN	5	100000	+5% (EIA Alternate)
BLUE	6	1000000	+6%
VIOLET	7	10000000	+12.12%
GRAY	8	01 (EIA Alternate)	+10%
WHITE	9	1 (EIA Alternate)	+10% (EIA Alternate)
GOLD			+5% (JAN and EIA Preferred)
SILVER			+10% (JAN and EIA Preferred)
NO COLOR			+20%

*GMV - guaranteed minimum value, or -0 - 100% tolerance.
 † 5, 12, 1, 2, and 3% are ASA 40, 20, 10, and 5 step tolerances.

BODY-END-DOT SYSTEM

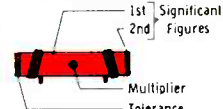

BODY-END BAND SYSTEM

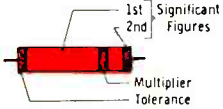

DISC CERAMICS (5-DOT SYSTEM)

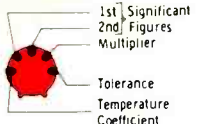

DISC CERAMICS (3-DOT SYSTEM)

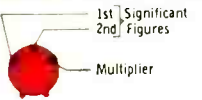

CERAMIC CAPACITOR CODES (CAPACITY GIVEN IN pF)

COLOR	DIGIT	MULTIPLIER	TOLERANCE		TEMPERATURE COEFFICIENT PPM/°C	EXTENDED RANGE	
			10 pF or LESS	0.1 10MM		SIGNIFICANT FIGURE	COEFF. MULTIPLIER
BLACK	0	1	+2.0 pF	+20%	0(NP0)	0.0	-1
BROWN	1	10	+0.1 pF	+1%	-33(N033)		-10
RED	2	100		+2%	-75(N075)	1.0	-100
ORANGE	3	1000		+2.5%	-150(N150)	1.5	-1000
YELLOW	4	10000			-220(N220)	2.2	-10000
GREEN	5		+0.5 pF	+5%	-330(N330)	3.3	-1
BLUE	6				-470(N470)	4.7	-10
VIOLET	7				-750(N750)	7.5	-100
GRAY	8	.01	+0.25 pF		-50(P030)		-1000
WHITE	9	.1	+1.0 pF	+10%	General Purpose Bypass & Coupling	+10 (P100, JAN)	-10000
SILVER							
GOLD							

Voltage ratings are standard 500 volts for some manufacturers, but 1000 volts for other companies.

HIGH CAPACITY TUBULAR CERAMIC INSULATED OR NON-INSULATED



TEMPERATURE COMPENSATING TUBULAR CERAMICS

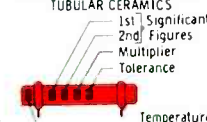

EXTENDED RANGE T.C. TUBULAR CERAMICS

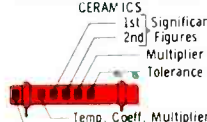

MOLDED-INSULATED AXIAL LEAD CERAMICS

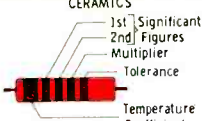

TYPOGRAPHICALLY MARKED CERAMICS

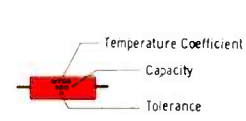

JAN LETTER	TOLERANCE
C	10 pF or LESS
D	+0.5 pF
F	+1.0 pF
G	+2.0 pF
J	+5%
K	+10%
M	+20%

MOLDED CERAMICS

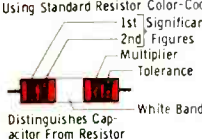

BUTTON CERAMICS

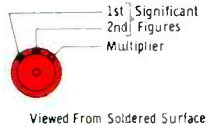

STAND-OFF CERAMICS

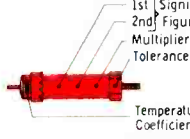

FEED-THRU CERAMICS

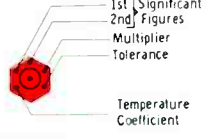

MOLDED MICA CAPACITOR CODES (Capacity Given In pF)

COLOR	DIGIT	MULTIPLIER	TOLERANCE	CLASS OR CHARACTERISTIC
BLACK	0	1	20%	A
BROWN	1	10	1%	B
RED	2	100	2%	C
ORANGE	3	1000	3%	D
YELLOW	4	10000	4%	E
GREEN	5		5% (EIA)	F(JAN)
BLUE	6			G(JAN)
VIOLET	7			H(EIA)
GRAY	8			I(EIA)
WHITE	9			J(EIA)
GOLD		.1	5% (JAN)	
SILVER		.01	10%	

Class or characteristic denotes specifications of design involving Q factors, temperature coefficients, and production test requirements. All axial lead mica capacitors have a voltage rating of 300, 500, or 1000 volts. *or ±1.8 pF whichever is greater.

MOLDED PAPER CAPACITOR CODES (Capacity Given In pF)

COLOR	DIGIT	MULTIPLIER	TOLERANCE
BLACK	0	1	20%
BROWN	1	10	
RED	2	100	
ORANGE	3	1000	
YELLOW	4	10000	5%
GREEN	5	100000	
BLUE	6	1000000	
VIOLET	7		
GRAY	8		10%
WHITE	9		5%
GOLD			10%
SILVER			20%
NO COLOR			

MOLDED PAPER TUBULAR

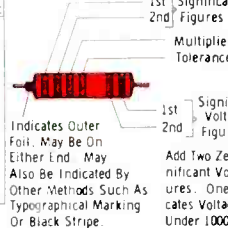

CURRENT STANDARD JAN AND EIA CODE

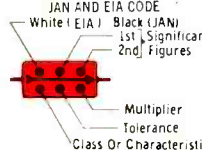

BUTTON SILVER MICA

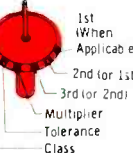

MOLDED FLAT PAPER CAPACITORS (COMMERCIAL CODE)

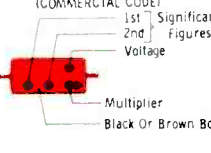

MOLDED FLAT PAPER CAPACITORS (JAN CODE)

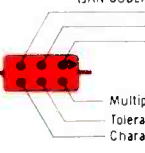

REACTANCE CHART

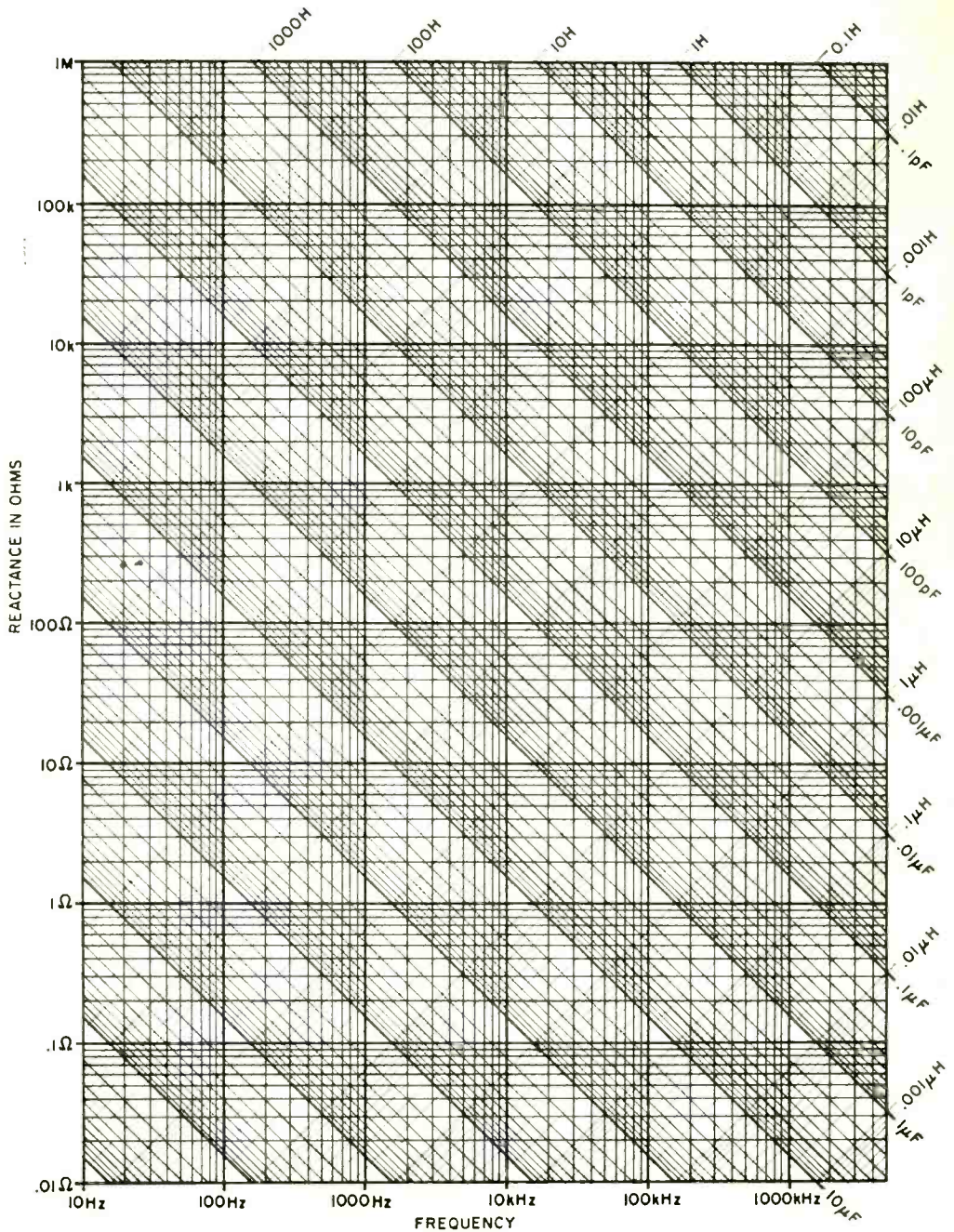

BUILD THE
"BOUNCING
BALL"
ANALOG
COMPUTER

*Displays any
ball's behavior
when dropped
from height . . .
Saves hours of
higher-math
calculations*

BY TERRY L. MAYHUGH

THIS Science Fair project demonstrates some principles of kinematics and how an analog computer works.

An analog computer may be likened to a

slide rule. Both provide instantaneous answers on a continuous scale without *absolute* accuracy. (In contrast, digital com-

(Text continues on page 12)

Front-panel view of the analog computer. The circuit was constructed on Vector board and mounted in an aluminum tray folded from sheet rock to provide panels.

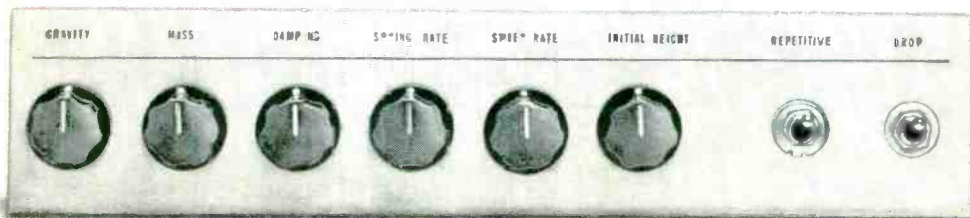

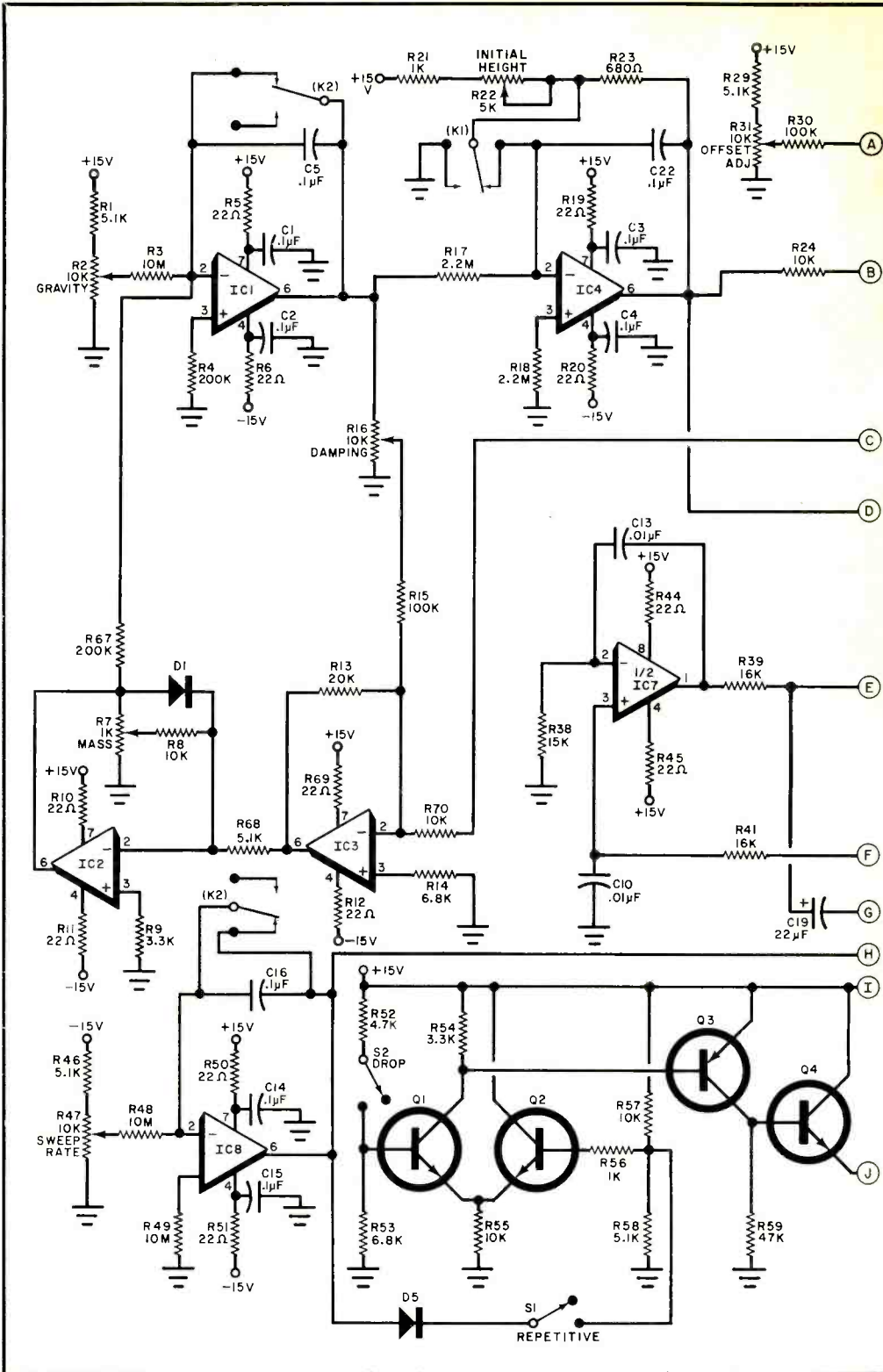

PARTS LIST

- R1, R25, R29, R46, R58, R68—5100 ohm, 1/4 W res. ±5%*
R2, R32, R47—10,000 ohm variable panel-mounted potentiometer
R3—10 megohm, 1/4 W res. ±5%
R4, R67—200,000 ohm, 1/4 W res. ±5%
R5, R6, R10, R11, R12, R19, R20, R26, R27, R34, R36, R44, R45, R50, R51, R63, R64, R69—22 ohm, 1/4 W res. ±5%
R7—1000 ohm variable panel-mounted potentiometer
R8, R24, R28, R33, R35, R37, R43, R55, R57, R61, R62, R65, R66, R70—10,000 ohm, 1/4 W res. ±5%
R9, R54—3300 ohm, 1/4 W res. ±5%
R13—20,000 ohm, 1/4 W res. ±5%
R14, R53—6800 ohm, 1/4 W res. ±5%
R15, R30—100,000 ohm, 1/4 W res. ±5%
R16—10,000 ohm potentiometer
R17, R18—2.2 megohm, 1/4 W res. ±5%
R21, R56—1000 ohm, 1/4 W res. ±5%
R22—5000 ohm variable panel-mounted potentiometer
R23—680 ohm, 1/4 W res. ±5%
R31—10,000 ohm variable PC-mount potentiometer
R38—15,000 ohm, 1/4 W res. ±5%
R39, R40, R41—16,000 ohm, 1/4 W res. ±5%
R42, R60—50,000 ohm variable PC-mount potentiometer
R48, R49—10 megohm, 1/4 W res. ±5%
R52—4700 ohm, 1/4 W res. ±5%
R59—47,000 ohm, 1/4 W res. ±5%
C1, C2, C3, C4, C6, C7, C8, C9, C14, C15, C17, C18—0.1 μF disc ceramic capacitor
C5, C16, C22—0.1 μF Mylar capacitor
C10, C12, C13—0.01 μF Mylar capacitor
C11, C19, C20, C21—22 μF tantalum capacitor
D1, D2, D5—1N914 (or equiv.) silicon diode
D3, D4—1N746
D6, D7, D8—1N4002 (or equiv.)
IC1, IC4, IC8—Intersil 8007 FET op-amp (or equiv. such as μA740 or NE536)
IC2, IC3, IC5, IC6, IC9—741 op-amp
IC7—558 op-amp (dual 741)
IC pin numbers shown for TO-5 package
S1, S2—Spst toggle switch
J1, J2—BNC jack
K1, K2—Relay (Babcock BR12-140B2 or equiv. dpdt with 12 V dc and approx. 100-ohm coil resistance)
Q1, Q2, Q4, Q5—2N718 (or equiv. npn with beta greater than 30)
Q3—2N3789 (or equiv. pnp with beta greater than 25)

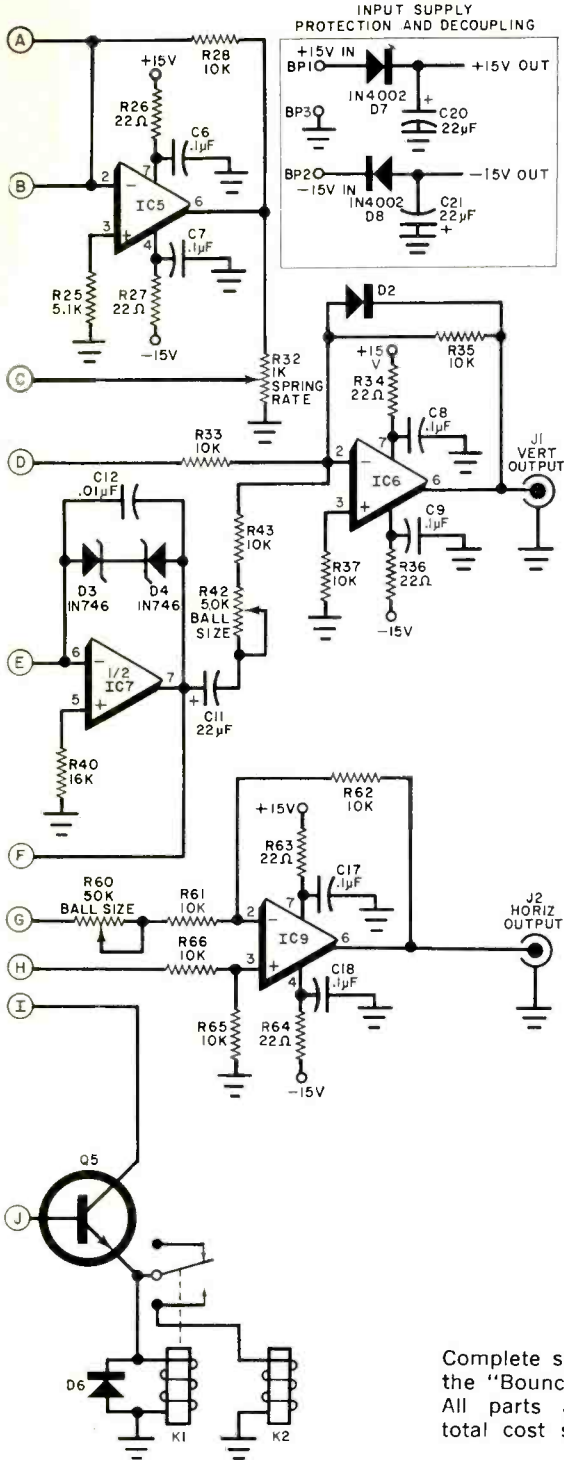

Complete schematic and parts list for the "Bouncing Ball" analog computer. All parts are readily available and total cost should not exceed \$30.00.

PHYSICAL PRINCIPLES INVOLVED

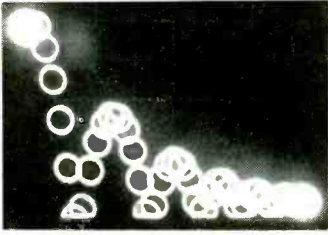

When the ball is lifted above the floor, potential energy is said to be stored in it due to the work done against the gravitational field while lifting it. When released in a uniform gravitational field it falls and the potential energy is converted into kinetic energy as the downward velocity increases.

Since the gravitational field is uniform over the distance concerned and, assuming zero air resistance, the ball is uniformly accelerated (at the rate of 32 ft/sec per sec on earth). The scope photo shows the effect of the uniformly accelerated motion. Since the sequence of shots represents equal increments of time (as the scope's blanking was strobed at a fixed PRT), the vertical velocity of the ball increases as the ball falls toward the surface, as expected. Theoretically, the change in the velocity is the same in each time interval. The value of Gravity can be varied to change the acceleration and therefore the time required to reach the floor. However, as Galileo observed, objects with different masses fall at the same rate; and this is seen from the fact that varying the mass has no effect on the fall time.

Although the acceleration is uniform if the air resistance is zero, in a practical situation the falling body will eventually attain a constant (terminal) velocity at a certain point where the drag offered to the ball becomes significant. (Drag increases with velocity.) This may be simulated by increasing the Damping which, in effect, increases the viscosity of the air, making it more "syrupy."

When the ball strikes the surface, a portion of its kinetic energy is absorbed (dissipated as heat), leaving the remainder to be converted back into kinetic energy during the rebound. The Spring Rate determines the amount that is left for rebound. Note, again from the photo, that the velocity decreases as the ball rebounds on any particular bounce. This, again, is due to the gravitational field acting to decelerate the motion of the ball. This time the kinetic energy is changed into potential energy by the gravitational field acting against the ball. At the peak of its rebound height, vertical velocity is zero and the cycle continues. This time the remaining potential energy is converted into kinetic energy by the gravitational field and again a percentage is dissipated at the floor and the rebound gets lower and lower.

puters are essentially fast arithmetic machines that solve one problem at a time with great accuracy.) Analog computers can simulate a variety of factors by substituting electrical models. The computer described in this project, for example, can be programmed to solve an interesting problem: Given the initial height of a ball of known mass above a hard surface, the force of gravity, the viscosity of the medium, and the spring constant of the ball, how does the ball behave when it is dropped?

The computer "paints" a ball on the screen of an oscilloscope and, when given the Drop command, computes and displays continuously the path of the ball as it falls, compresses at the hard surface, rebounds, and finally settles on the floor.

The machine quickly does the calculations for a continuous display which would take an engineer days to complete by hand and plot. The operator controls the parameters Gravity, Mass, Damping, Spring Constant, as well as the horizontal velocity across the screen. A repetitive mode is also provided for a repeating display.

Although analog computers cannot give the 15-decimal-place accuracy of their digital cousins, they are better suited for solving "real time" problems that would otherwise require a knowledge of differential calculus. More precise quantitative results than possible with the project's computer would require an expensive version of it with controlled offset errors, calibrated potentiometers, etc. Nonetheless, the unit described gives a fair approximation of what happens with a "bouncing ball."

Construction. Construction is relatively simple, as the layout is not critical. However, feedback elements should be placed near their associated op-amps. The prototype was constructed on a piece of Vector board and mounted in an aluminum tray folded from sheet stock, with front and rear panels for mounting the control pots, etc. All op-amps are of the 741 type with the exception of those used in the integrators. Here FET input amps with their low bias currents are necessary due to the high values of input resistors. Practically any FET op-amp may be used and a few suggestions are given in the parts list.

The entire project was built for less than \$30. All components are readily obtainable from local or mail-order electronics parts houses.

This optional tone generator sounds off each time the bouncing ball strikes the "ground." It consists of basic UJT oscillator triggered on by pulses from IC1. The UJT time constants can be modified to create any type of "bounce sound."

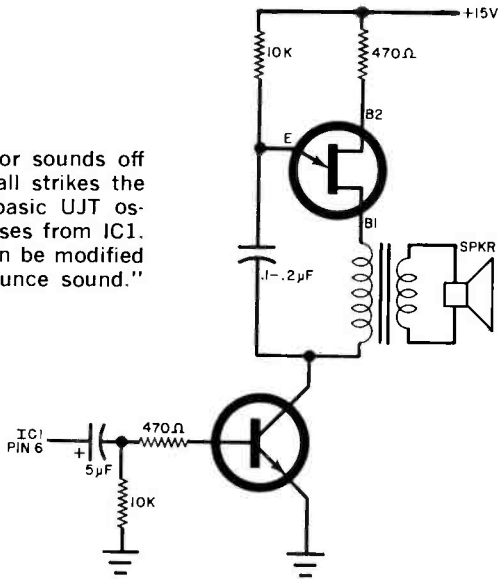

How It Works. IC7 is used as a sine/cosine generator to generate the circle. The two quadrature outputs of the oscillator are summed with the vertical and horizontal information generated by the computer in IC6 and IC9, respectively.

IC8 is used as a Miller integrator to generate the horizontal sweep. The rate is determined by R47 and the initial condition is set by one set of closed contacts of K2. Q1 and Q2 form a comparator to open the initial-condition contacts of K1 and K2 when the Drop switch is closed. When the Repetitive switch is closed, the relays momentarily reset the initial conditions when the sweep reaches about 9 volts, and the action repeats. One set of contacts on K1 is used to apply power to K2 to insure that the proper initial height is reset before the sweep begins again in the repetitive mode.

The actual computer arithmetic is done by IC1 through IC5 and their associated components. IC1 is an integrator whose rate of change of output is determined by the setting of the Gravity control (ignoring, for the moment, the second input from IC2). IC4 integrates IC1's output with initial condition set by the Initial Height control. Two feedback loops are used to control the Damping and Spring Rate of the loop. IC2 divides the sum of these two components and divides them by the Mass to complete the path back to IC1.

Operation. The computer requires ± 15 volts and a scope capable of X-Y mode operation (either a dual-trace scope with X-Y capability or a single-channel dc scope with access to the horizontal amp). Due to the low sweep speeds involved, it's necessary to d.c.-couple into the horizontal plates to get a repetitive display. Full-scale vertical and horizontal scale factors are about 10 V but they may be adjusted to anything less by using external voltage dividers.

With power applied, the controls set to their mid-positions, and the Drop switch "on," R42 and R60 are adjusted to give a symmetrical circle of convenient size for the display. R31 is then adjusted so that the ball just "sits" on the "floor" with little or no flattening. The Repetitive switch is then closed and the ball should return to the upper left corner and automatically drop. The Gravity and Damping controls may be adjusted to change the fall as well as the rebound. The Spring Rate changes the springiness of the ball, which controls the amount it flattens when it hits the floor, as well as its rebound characteristics. The Sweep Rate can be adjusted to control the horizontal velocity of the ball, or it can be turned down to zero.

Typical results are shown in the scope photo and on the front cover. The pictures were taken by strobing the scope's beam blanking repetitively during one sweep with the shutter held open. ◆

Transmitter for the Neglected Band

NO LICENSE IS REQUIRED
FOR THE 1750-METER (160-190 kHz) BAND

BY JIM WHITE, W5LET

AS LONG AGO as 1950, the Federal Communications Commission issued Part 15 of its Rules—an action we are all familiar with because it legalized the operation of unlicensed walkie-talkies of the 100-mW class in the 27-MHz (11-meter) CB band. The same action also set up a 30-kHz band between 160 and 190 kHz. This relatively unknown, unused band can be utilized for experimental, unlicensed operation provided certain technical requirements are met. The latter include: transmitter input power must be limited to 1 watt; antenna and feedline length must not exceed 50 feet; emissions outside the band must be down at least 20 dB below the unmodulated carrier; and operation must be on a non-interference basis. There is also the universal rule: no profane or illegal language!

You may wonder what can be done at these low frequencies with only one watt. Here, the ground wave is the thing. On a cold winter night, with an efficient antenna, you can work up to 100 miles. There are no restrictions on the type of emission that can be used; so you can experiment with radioteletype-writer, SSB, FM, conventional AM, or just plain CW—as long as you observe the band limits with your modulation and make sure that no commercial station is on the air in your location.

What do you do all this with? The gear described here is an easy-to-build, low-cost transmitter using only three tubes. (A companion tuner is described on page 59.) The r-f portion of the transmitter (Fig. 1) uses

a dual triode (V1), with one half used as the oscillator and the other half as the r-f amplifier. Crystals for this frequency are expensive and hard to find, but the oscillator circuit used here is very stable. Another dual triode (V2) is used as the speech amplifier with gain control between stages. These two stages provide ample gain for a ceramic or crystal mike. The speech amplifier drives V3, a class A modulator.

The power supply is a conventional half-wave rectifier with filter.

Construction. The prototype was assembled in a 7" × 9" × 2" aluminum chassis as shown in the photographs. Although the layout is not critical, it is suggested that the same general approach be used. Note that the transmitter coil L2-L3 is on a plug-in

EDITOR'S NOTE

Although the transmitter described here does not require a license for operation, strictly speaking it may need a certificate attached to it. The certificate may be executed by "a technician skilled in making and interpreting the measurements that are required to assure compliance" with Part 15 of the FCC Rules. The certificate should contain information on the operating conditions of the device, the antenna being used, a statement certifying that the device complies with the FCC Rules as described in this article, and the date of construction.

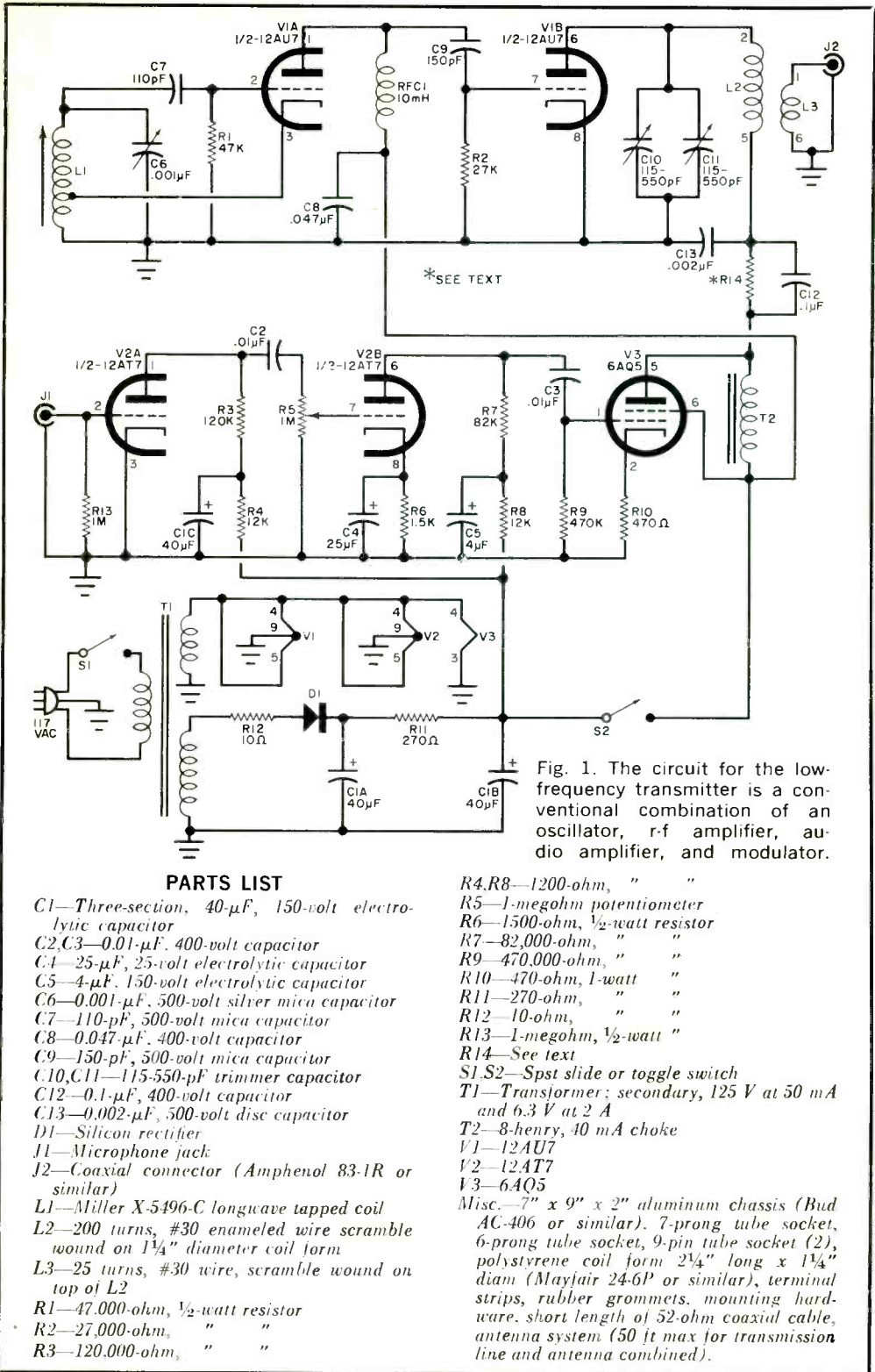
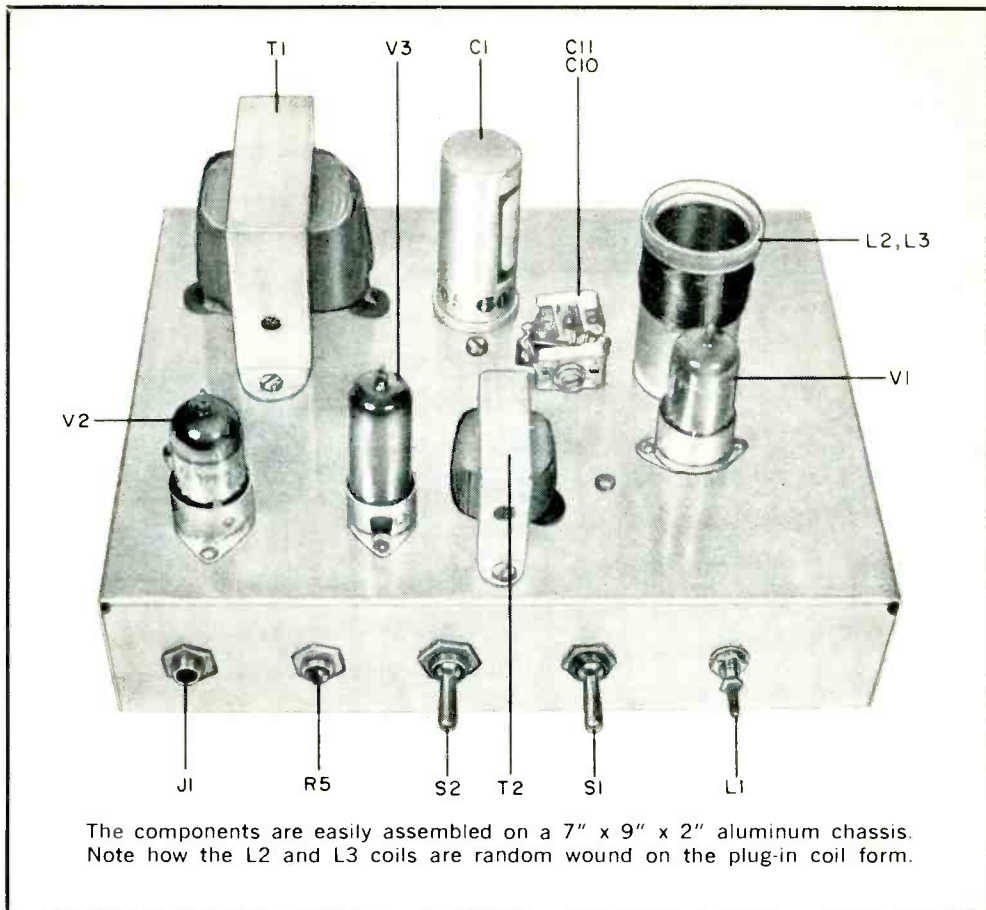

Fig. 1. The circuit for the low-frequency transmitter is a conventional combination of an oscillator, r-f amplifier, audio amplifier, and modulator.

PARTS LIST

- C1—Three-section, 40- μ F, 150-volt electrolytic capacitor
- C2, C3—0.01- μ F, 400-volt capacitor
- C4—25- μ F, 25-volt electrolytic capacitor
- C5—4- μ F, 150-volt electrolytic capacitor
- C6—0.001- μ F, 500-volt silver mica capacitor
- C7—110-pF, 500-volt mica capacitor
- C8—0.047- μ F, 400-volt capacitor
- C9—150-pF, 500-volt mica capacitor
- C10, C11—115-550-pF trimmer capacitor
- C12—0.1- μ F, 400-volt capacitor
- C13—0.002- μ F, 500-volt disc capacitor
- D1—Silicon rectifier
- J1—Microphone jack
- J2—Coaxial connector (Amphenol 83-1R or similar)
- L1—Miller X-5496-C longwave tapped coil
- L2—200 turns, #30 enameled wire scramble wound on 1 1/4" diameter coil form
- L3—25 turns, #30 wire, scramble wound on top of L2
- R1—47,000-ohm, 1/2-watt resistor
- R2—27,000-ohm, " "
- R3—120,000-ohm, " "

- R4, R8—1200-ohm, " "
 - R5—1-megohm potentiometer
 - R6—1500-ohm, 1/2-watt resistor
 - R7—82,000-ohm, " "
 - R9—470,000-ohm, " "
 - R10—470-ohm, 1-watt " "
 - R11—270-ohm, " "
 - R12—10-ohm, " "
 - R13—1-megohm, 1/2-watt "
 - R14—See text
 - S1, S2—Spst slide or toggle switch
 - T1—Transformer; secondary, 125 V at 50 mA and 6.3 V at 2 A
 - T2—8-henry, 40 mA choke
 - V1—12AU7
 - V2—12AT7
 - V3—6AQ5
- Misc.—7" x 9" x 2" aluminum chassis (Bud AC-406 or similar), 7-prong tube socket, 6-prong tube socket, 9-pin tube socket (2), polystyrene coil form 2 1/4" long x 1 1/4" diam (Mayjair 24-6P or similar), terminal strips, rubber grommets, mounting hardware, short length of 52-ohm coaxial cable, antenna system (50 ft max for transmission line and antenna combined).



The components are easily assembled on a 7" x 9" x 2" aluminum chassis. Note how the L2 and L3 coils are random wound on the plug-in coil form.

form, so a socket must be used for it. The coaxial antenna connector, *J2*, is mounted on the rear apron. The oscillator coil, *L1*, is mounted on the front apron, with the tuning slug screw available from the front. The lead from *L3* to the coaxial connector is made from a length of small-diameter coaxial cable.

To wind *L2* and *L3*, use the form called for in the Parts List and drill four small holes over the designated pins to pass the wire through the form. The plate coil, wound first, starts at pin 5 of the form and consists of 200 turns of #30 enameled wire, scramble-wound on the form. If you try to wind the coil neatly, you will soon run out of form, so scramble the windings to occupy about $\frac{3}{4}$ " of the form. Terminate *L2* at pin 2. Be sure to scrape the insulation off the wires before trying to solder them to the pins on the coil form.

Coupling coil *L3* is composed of 25 turns of #30 enameled wire scramble-wound on

top of *L2*. The winding begins at pin 1 and is in the same direction as *L2*. It ends at pin 6. Once the windings are complete, coat the assembly with coil dope to keep the turns from moving.

Testing. With power switch *S1* on and transmit switch *S2* off, note that the filaments of the three tubes glow. With *S2* on, check for high voltage at the tube plates. Take care when using the voltmeter—one hand holding the probe handle, the other off the chassis!

The best way to set the operating frequency is by using a frequency meter, remembering to include the sidebands and making sure that the entire signal is between 160 and 190 kHz. If you don't have a frequency meter, you can use an ordinary broadcast band radio. Select an operating frequency—say 185 kHz, which will have harmonics at 370, 555, 740, 925 kHz, etc. Choose a local station whose known frequency or its harmonic is the same as the

harmonic of your transmitter and adjust *L1* until the two beat against each other. To get enough signal injection, you may have to run the transmitter antenna lead close to the BCB radio antenna. Once the operating frequency has been located, the adjustment screw of *L1* can be secured with a drop of rubber cement or a jam nut.

You can use a field strength meter to adjust *C10* and *C11* for maximum output, or you can connect a milliammeter between *T2* and *L2* (for the moment, ignore *R14* and *C12* and tune *C10-C11* for a dip in plate current as the tuned circuit passes through resonance. With the antenna disconnected, this dip should be about 2 mA; and with an antenna connected, the current will be about 8 to 9 mA with *C10-C11* adjusted for minimum current.

To keep the operation legal, the power input to the final must be one watt or less. Measure the voltage at pin 5 of *L2*. If it is 120 volts, then you can run 8.3 mA final current ($120 \times 0.0083 = 1$ watt). If the

voltage is higher than 120, install *R14* bypassed by *C12* to reduce the voltage to 120. Resistor *R14* is determined (experimentally) by how much you have to lower the voltage.

Antenna. When you have only one watt of output power, the antenna becomes of paramount importance. A length of wire tossed out the window will not work. For best results, a vertical antenna should be used, with the total length of both transmission line and antenna not more than 50 feet. A good ground, preferably a series of long buried radials, must be used.

There are many all-wave receivers capable of tuning to the 160- to 190-kHz band. If you have one of these, you can use it in conjunction with the transmitter to form a complete station. If you don't have one, you will be interested in the receiver which is described on page 00—a fixed-tuned superhet tuner designed specifically to be used with this transmitter. ♦

View of bottom of chassis shows how connections are made point-to-point with a liberal use of multi-lug terminal strips to support the components.

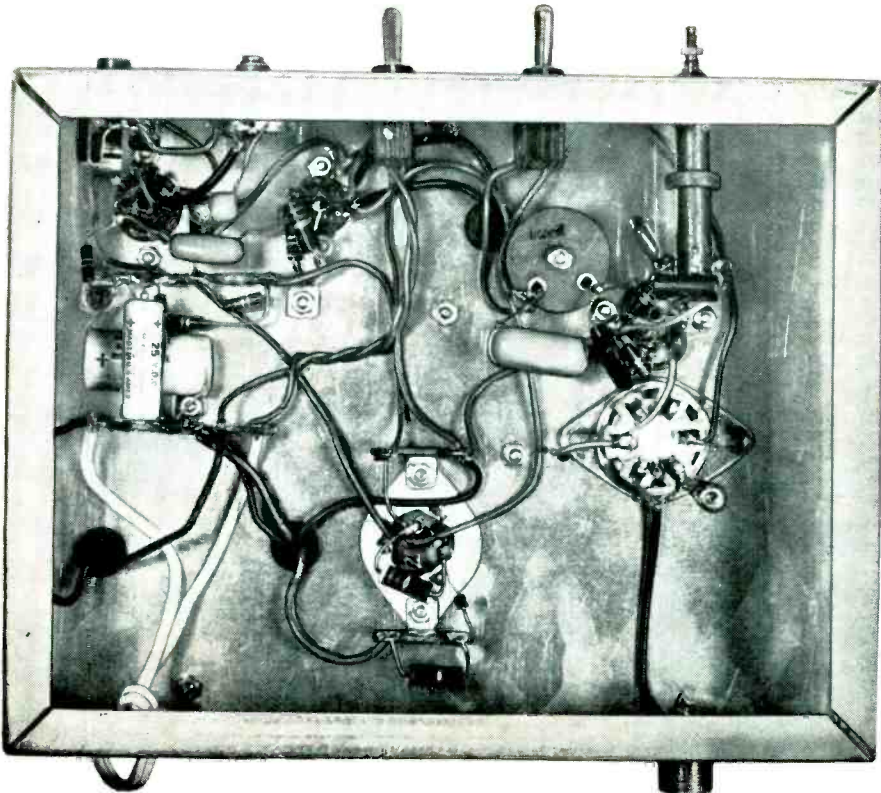

DIGITAL COLO

Bell & Howell Schools introduces an amazing new color TV featuring channel numbers and digital clock that flash on the screen and automatic channel selector!

Now you can build and keep a color television that's ahead of its time!

You've seen TV's that swivel, TV's with radios built in, TV's small enough to stuff in a suitcase and TV's that have remote control.

But now comes a color television with features you've *never* seen before. Features now possible as a result of the new technology of digital electronics... features that make Bell & Howell's new 25-inch diagonal digital color TV ahead of its time! Like...

Channel numbers that flash big and clear right on the screen. An on-screen digital clock that flashes the time in hours, minutes and seconds with just the push of a button. An automatic channel selector that you pre-set to skip over "dead" channels and go directly to the channels of your choice.



And, to insure highest quality performance, this new TV has all-electronic tuning, reliable integrated circuitry, and 100% solid-state chassis for a brighter, sharper picture with long life and dependability.

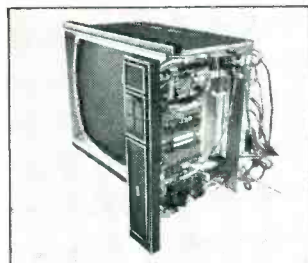

Perform fascinating experiments... test your new TV as you build it... with the exclusive Electro-Lab, electronics training system. It's yours to build and keep!

Designed exclusively for our students, this new Bell & Howell Electro-Lab features the most sophisticated and up-to-date "tools of the trade". In-

Simulated TV picture.

You build and keep this revolutionary new Bell & Howell 25" diagonal digital color TV! Mail the postage-free card today for complete details, free!

struments you can use professionally after you finish the program.

A *new digital multimeter* that measures voltage, current and resistance and displays its findings in big, clear numbers. Far more accurate and readable than conventional "needle pointer" meters that require guesswork and interpretation.



The *solid-state "triggered sweep" oscilloscope* is a "must" for accurate analysis of digital circuitry. With it you are able to make measurements of circuits in much the same way that heartbeats are measured on an electrocardiograph. Includes DC wide-band vertical amplifier and "triggered sweep" feature to lock in signals for easier observation.

The *design console* is a valuable device for setting up and examining circuits without soldering! Features patented modular connectors, AC power supply and transistorized dual range DC power supply.

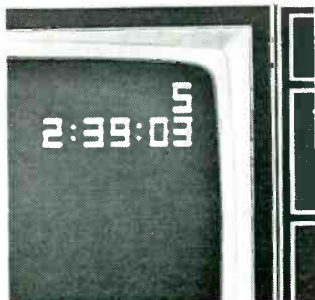

R TV IS HERE!

Build it yourself... the perfect way to learn all about the exciting new field of digital electronics!

It's a fascinating spare-time project you can enjoy at home!

Imagine spending your spare time actually building your own 25-inch diagonal digital color TV! It's a project you can enjoy working on right in your home. And you'll be amazed at the electronics knowledge you'll pick up in a relatively short period of time!

There's no travelling to classes, no lectures to attend, and you don't have to give up your job or paycheck just because you want to get ahead. When you finish this new Bell & Howell Schools program, you'll have the skills you need plus a great color TV to keep and enjoy for years!

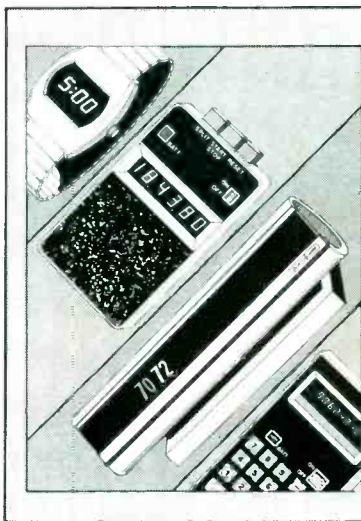

Digital electronics is changing our lives!

There's a lot more to digital electronics than just the numbers! True, that's what you see on more and more products like digital calculators, clocks and watches. But behind the numbers lies a fantastic new technology that's creating higher standards of accuracy and dependability. The versatility of digital electronics has begun another industrial revolution. Its growth and applications are limitless, giving us new and better ways of doing things and spectacular products like this new Bell & Howell digital color TV!

You don't have to be an electronics expert to build it... we help you every step of the way.

One of the beauties of this TV is that you don't need previous electronics experience to build it! With a few simple household tools, our step-by-step instructions and the exclusive Electro-Lab[®], you've got all the basics you need. Should you ever hit a 'snag', you're just a toll-free call away from one of our expert instructors who can help you solve it. You can also take advantage of our in-person "help

sessions" held in major cities throughout the year where you can enjoy "talking shop" with instructors and fellow students.

Pick up valuable skills in digital electronics that could lead to extra income full or part time... or a business of your own!

Once you have your new TV, cash in on all that you learned from building it! This new Bell & Howell program employing digital electronics will help you gain valuable new skills that could easily lead to extra income, part time. A service or repair business of your own? Why not! We even show you how to get started with a complete volume on the basics of setting up a TV servicing business. Get the complete story on this exciting, learn-at-home program... the world's first color TV course employing digital electronics technology!

Mail card today for full details, free!

Electro-Lab is a registered trademark of the Bell & Howell Company.

If card has been removed, write:

An Electronics Home Study School
DUNVARY INSTITUTE OF TECHNOLOGY

BELL & HOWELL SCHOOLS
414 - Belmont Chicago Illinois 60641

597



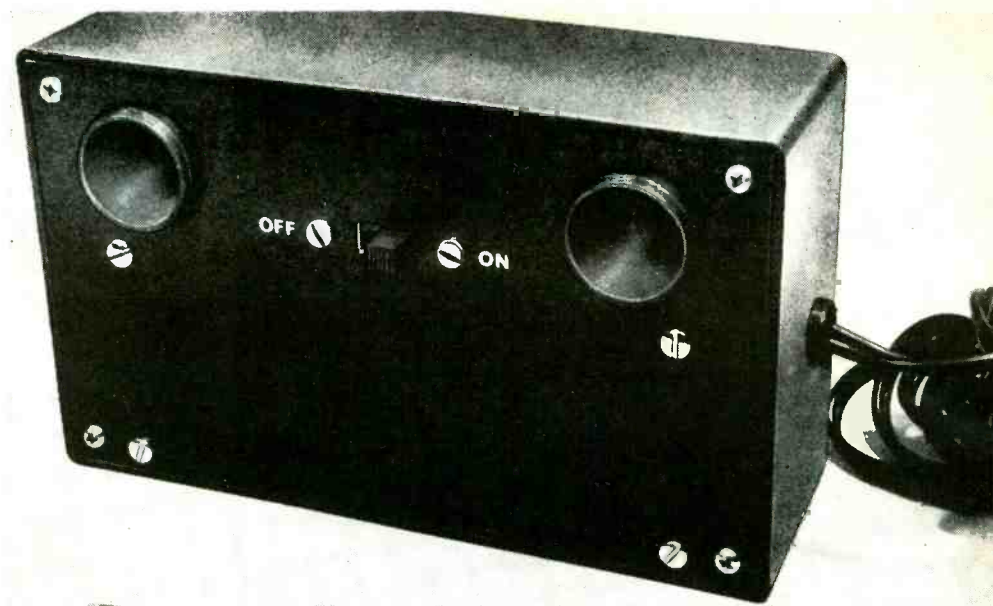

BUILD THE "ELECTRIC EYE" IN-OUT ANNUNCIATOR

SOPHISTICATED CIRCUIT REVEALS WHETHER
PERSON ENTERS OR LEAVES PASSAGEWAY

BY JOHN S. SIMONTON, JR.

THE ELECTRIC "EYE" has been a faithful, reliable workhorse in all sorts of burglar alarms and counting systems since before the word "electronics" was coined. Even today, it is extensively used in these applications. But too often it is used in circuits that are far from up-to-date.

The "In-Out Annunciator" described here is, in fact, an electric eye system—using a highly sophisticated circuit. Designed for the special case where it is not enough to

know simply that someone or something has interrupted the beam of light, the Annunciator tells you whether the person was entering or leaving the passage-way covered.

Uses of the Annunciator include monitoring one-way-only garage doors, operating automatic doorbells or chimes that do not sound when a visitor is leaving, guarding high-security areas, and discriminating sizes of objects. It also makes an interesting, attention-getting Science Fair project.

Two inexpensive resistor-transistor logic IC's are at the heart of the Annunciator, containing enough electronics to provide the amplification needed for good sensitivity in high ambient light areas and the logic necessary to distinguish between objects passing in either of two directions.

Theory of Circuit Design. Before going into a detailed examination of the operation of the Annunciator's circuit, it is useful to point out that gate pairs $G1/G3$ and $G2/G4$ in $IC1$, as shown in Fig. 1, are wired with regenerative feedback through resistors $R1$ and $R2$, respectively. This feedback arrangement adds hysteresis to the response of the circuit so that slight changes in ambient light level will not be misunderstood by the circuit and generate "false" counts. Capacitors $C3$ through $C6$, by rolling off the high-frequency response of $IC1$, reduce the sensitivity of the circuit to transients. Also, $G3$ and $G4$ are cross-coupled to form a set-reset latch.

The steady-state outputs of the NOR gates with both $LDR1$ and $LDR2$ fully illuminated are: $G1$ and $G2$, high; $G3$ and $G4$, low; $G5$ and $G6$, high; and $G7$ and $G8$, low.

Now, suppose the light source is interrupted first on $LDR1$ and then on $LDR2$. By darkening $LDR1$, its internal resistance increases and causes a high input to be presented to $G1$. In turn, the output of $G1$ goes to

low. Since both inputs to $G3$ are now low, the output of this gate goes to high and is then inverted by $G5$. The output of $G3$ is also applied to one of the inputs of $G4$ to guarantee that this gate's output will remain low.

Gate $G7$ now has one of its inputs at low and the input from $G2$ at high; so, its output is still low. When $LDR2$ is darkened, the output of $G2$ goes to low, applying a second input to $G7$ and causing the output of $G7$ to go to high. As a result, $Q1$ conducts and energizes $K1$. The state of $G4$ does not change because the output of this gate is held low by the high output of $G3$.

As the light again illuminates $LDR1$, the state of the circuit does not change by virtue of feedback from $G7$ which holds the output of $G1$ at low. When the light fully illuminates $LDR2$, the output of $G2$ goes to high and, consequently, the output of $G7$ goes to low, unlocking the loop formed by $G1$, $G3$, and $G5$.

Objects passing between the light source and the system so that $LDR2$ is darkened first, followed by the darkening of $LDR1$, generate a similar chain of events to energize $K2$.

Construction. Since integrated circuits are used in the Annunciator, printed circuit board construction is the only realiste approach to assembly. You can etch and drill your own circuit board by carefully following the actual size etching guide provided in Fig.

Text continued on page 26



All components except power transformer, on/off switch, and LDR's mount on printed circuit board. Spacers and 4-40 machine hardware fasten circuit board to case top.

Fig. 1. Two quad two-input gate digital IC's supply all functions for proper bidirectional operation of Annunciator system. Relays control counters and/or signaling devices.

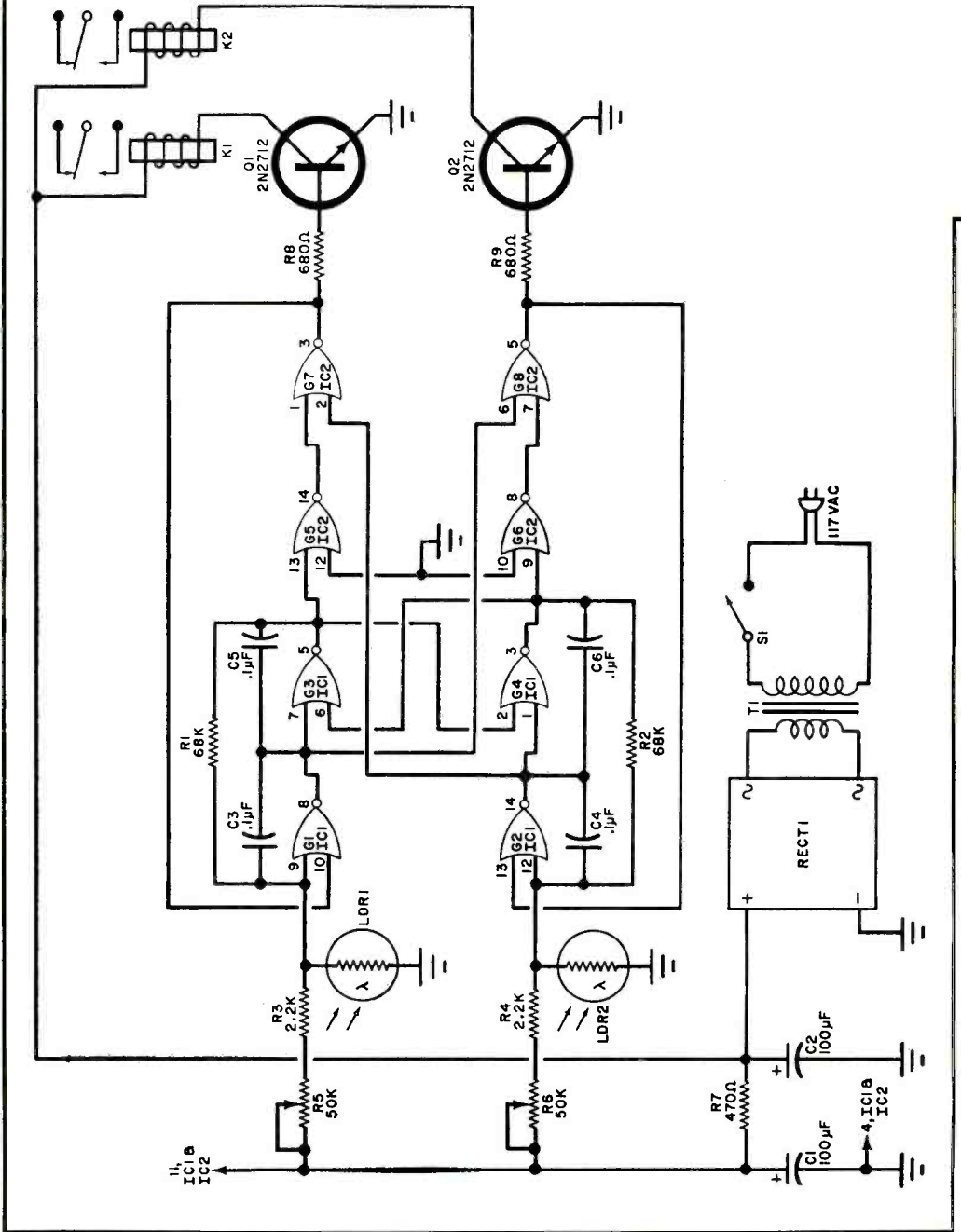

PARTS LIST

C1,C2—100- μ F, 15-volt electrolytic capacitor
 C3-C6—0.1- μ F disc capacitor
 IC1,IC2—Integrated circuit (Motorola MC-724P)
 K1,K2—12-volt, 1640-ohm relay (Sigma No. 65F1A-12Dc or similar)
 LDR1,LDR2—Light-dependent resistor (Clairex No. CL703L or similar)
 Q1,Q2—2N2712 transistor
 R1,R2—68,000-ohm
 R3,R4—2200-ohm
 R7—470-ohm
 R8,R9—680-ohm

All resistor, 1/2 watt,
 10% tolerance

R5,R6—50,000-ohm trimmer potentiometer
 RECT1—50 PIV, 1-ampere rectifier bridge assembly (Motorola MDA942A-1 or similar)
 S1—Spst switch
 T1—12.6-volt, 300-mA filament transformer
 Misc.—Printed circuit board, terminal strips (2), line cord and strain relief; 1/4"-long spacers; 6 3/4" \times 3 3/4" \times 2" plastic or Bakelite box; 5-dram pill containers (2); hook-up wire; 4-40 hardware; solder; etc.
 Note: The following item can be obtained from PAIA Electronics, Inc., P.O. Box 14359, Oklahoma City, OK 73114; etched and drilled circuit board No. 5701pc for \$3.50 postpaid.

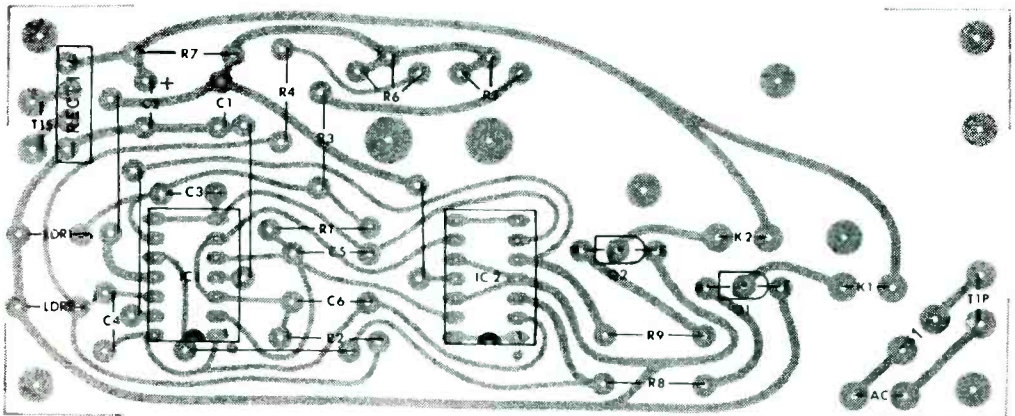
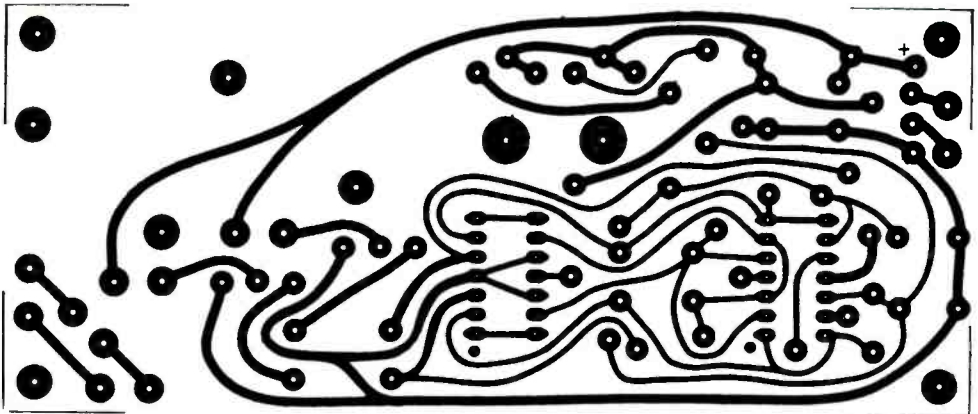
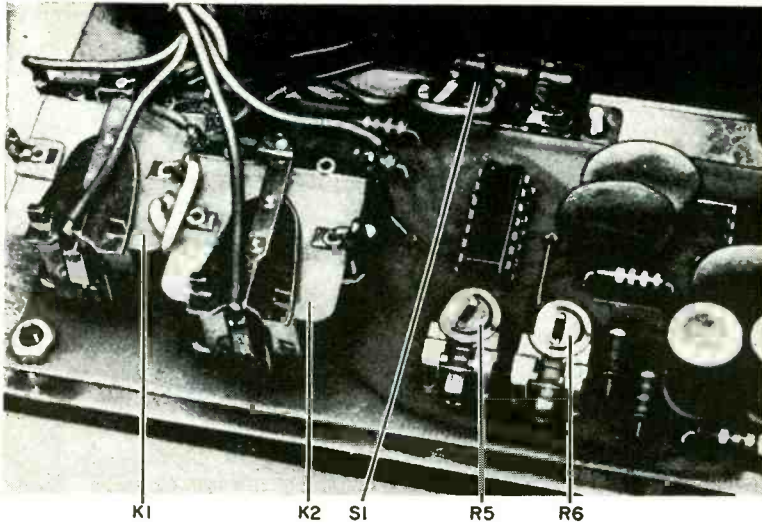

Fig. 2. At top is actual size etching and drilling guide for fabricating printed-circuit board. In component location and orientation guide (above) note particularly orientations of IC's.



Access to contacts on K1 and K2 is through solder lugs mounted on small phenolic boards which are on relay frames facing toward on/off switch S1 in photo.

2, or you can purchase a ready-to-use board from the source given in the Parts List.

Begin assembly by mounting the components on the board (see Fig. 2). Be careful to properly orient polarized components, and use heat from a 35-watt soldering iron sparingly. Also, as you solder, take pains to avoid solder bridges between closely spaced foil conductors—particularly around the IC solder pads.

Mount K1 and K2 on the circuit board with 4-40 machine hardware. Then use insulated jumper wires to connect the relay coils to the appropriate solder points on the foil pattern of the circuit board.

When mounting trimmer pots R5 and R6, bend their leads to position the adjustment slot directly over the $\frac{1}{16}$ "-diameter holes in the circuit board. This allows the system to be adjusted through access holes in the plastic cabinet once final assembly is complete.

A standard $6\frac{1}{4}'' \times 3\frac{3}{4}'' \times 2''$ Bakelite case makes for an exceptionally compact project. However, steps must be taken to keep components and assemblies from interfering with each other. The following general assembly sequence should be followed as closely as possible.

Begin mechanical assembly by drilling the mounting holes for transformer T1. Locate the transformer so that it is in contact with one of the long sides of the case. (Note that the same machine hardware used to fasten T1 in place is also used to anchor the terminal

strips which serve as tie points for the leads of the LDR's.)

Position the light shields (5-dram pill containers) at opposite ends of the transformer, and use a pencil or scoring tool to mark their outlines on the Bakelite case. Then remove and set aside the shields. Locate the centers of the light shield outlines and slowly and carefully drill a $\frac{1}{16}$ " hole, following it up with a $\frac{1}{8}$ " bit to enlarge the holes. At this point, you can use a multiple-drilling technique, a nibbling tool, or a chassis punch to enlarge the holes or cutouts so that they are slightly larger in diameter than the shields.

The mounting holes for power switch S1 and the circuit board, and the access holes for the slots of R5 and R6 trimmer pots can now be accurately located and drilled. Position the circuit board as close as possible to the front of the case to obviate any possibility of the lugs on S1 from contacting T1.

When all front-panel holes are drilled, paint and label the panel as desired. Allow sufficient time for the paint to dry; then drill a hole for and mount the line cord—via its strain relief—and the terminal block on the rear of the case.

Drill two #60 holes, about 30° apart and as close as possible to the bottom of each pill container. Then use flat black paint to coat the interior surfaces of both containers. When the paint dries, use a pin to clear the #60 holes of paint. Insert the leads of the LDR's through the holes, daub a drop of

epoxy cement on the undersides of the LDR's, and press the LDR's to the bottoms of the containers.

Slip the light shield assemblies into their respective cutouts, taking care not to tear off the LDR leads. Run a thin bead of epoxy cement around the lip of each shield; then seat the shields squarely in their cutoffs and allow the cement to set at least overnight.

Interconnect all components and assemblies as shown. Then mount the circuit board inside the case with 4-40 machine hardware and $\frac{1}{4}$ "-long spacers.

Setup and Use. Rotate *R5* and *R6* fully clockwise (viewed from the component side of the board). Point the LDR's at a relatively bright light source, plug the power cord into a convenient ac outlet, and close *S1*. Use a piece of opaque cardboard to completely cover *LDR1*; neither relay should be energized. With *LDR1* still covered, place another piece of cardboard over *LDR2*; now *K1* should immediately be energized.

Alternately exposing and covering *LDR2* should cause *K1* to open and close. Leaving *LDR2* covered, illuminate *LDR1*; *K1* should remain energized. Removing the cover from *LDR2* should cause *K1* to deenergize.

The reverse of this procedure to test *K2* is as follows: cover *LDR2* (*K1* and *K2* open); cover *LDR1* (*K2* closes); illuminate *LDR2*

(*K2* remains energized); illuminate *LDR1* (*K1* and *K2* open). While the system is operating properly, it should be impossible for both relays to energize simultaneously.

Although the system employs two LDR sensors, it is not necessary, in most cases, to use two light sources. A single light source and a flashlight reflector can be used to illuminate both LDR's satisfactorily if the distances are reasonable. Of course, if the distance between light source and Annunciator is excessive, a two-light source system would be required.

When you get ready to set up your system, orient it so that the maximum amount of ambient light reaches the LDR sensors. Avoid pointing the LDR's toward windows or bright room lighting, and do not set up the system so that an opening door will trigger it. Finally, when counting people passing by, it is a good idea to locate light sources and sensors about 54" from the floor so that swinging arms will not produce multiple counts.

Now, turn on the system and orient the setup for maximum illumination of the LDR's. If necessary, you can use mirrors to bend the light beam around corners so that more than one area can be surveyed.

Adjusting *R5* and *R6* is simple. Rotate both controls fully counterclockwise (viewed from the front of the case). Temporarily mask *LDR1* from the light source and rotate *R6* until *K1* pulls in; then back off until *K1* just opens. Interrupt the beam to *LDR2* once or twice with your hand to check that *K1* opens and closes properly.

Remove the mask from *LDR1* and place it in front of *LDR2*. Rotate *R5* until *K2* energizes; then back off until the relay just deenergizes. The controls are now set for maximum sensitivity.

The relay contacts can be used to activate a variety of alarms or counters. In simple one-way systems, use the normally open contacts of the appropriate relay to turn on the system. A slightly more elaborate system, using both relays and a dual door chime is shown in the wiring diagram in Fig. 3. People passing in one direction will cause the chime to sound once; people passing in the opposite direction will cause the chime to sound twice. This same basic arrangement can be used as a secure area monitor by substituting two counters. Anyone entering the area will be registered on one counter, while those leaving the area will be registered on the other counter. In this way, you can tell if someone has gone into the area and has not come out. ♦

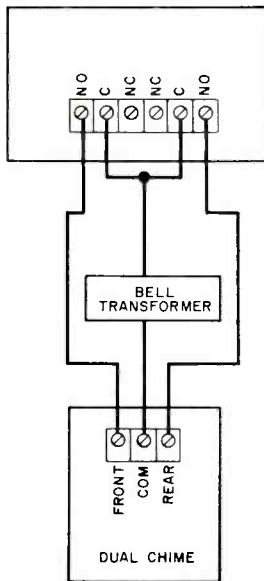

Fig. 3. When wiring dual chimes into system, use only normally open and common contacts on relays.

WHEN THE VOLTAGE
DROPS
A LIGHT COMES ON

BY JEFFREY P. HAMMES

VOLTAGE MONITOR

IN SOLID-STATE equipment, the dc supply voltage level is often quite critical. Many times, if the voltage drops below a specific level, the circuit does not operate properly. When a battery supply is used, it is highly desirable to have a means of checking on the voltage level.

Described here is a solid-state, voltage drop-out indicator that has in excess of 110 megohms input resistance so that it will not load the supply. When the supply

voltage drops below a preset level, it will turn on an indicator lamp. It can be built on a small printed circuit board, all parts costing about \$6. Although the indicator is designed to keep tabs on a 12-volt supply, a variety of voltages may be monitored by changing a few resistors.

The schematic is shown in Fig. 1. The circuit is essentially a five-stage dc amplifier using a FET input. When a sufficiently high negative voltage is applied

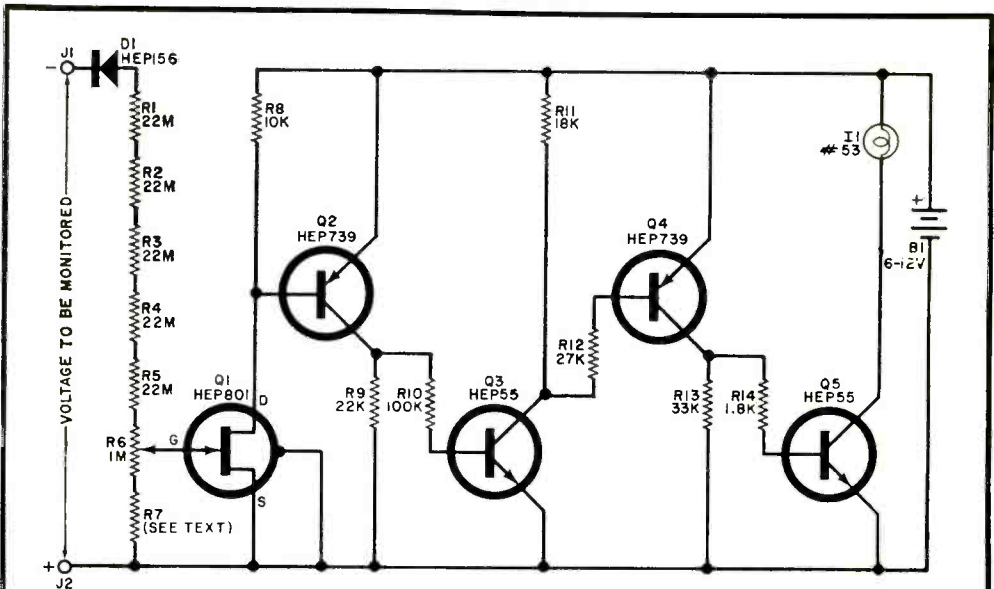

Fig. 1

PARTS LIST

B1—6-to-12-volt battery
D1—HEP156 diode
I1—#53 lamp (see text)
J1, J2—Five-way binding post (one red, one black)
Q1—HEP801 transistor
Q2, Q4—HEP739 transistor
Q3, Q5—HEP55 transistor
R1-R5—22-megohm, ½-watt resistor
R6—1-megohm, multi-turn potentiometer (Bourns 3068-P or similar)

R7—See text
R8—10,000-ohm, ½-watt resistor
R9—22,000-ohm, ½-watt resistor
R10—100,000-ohm, ½-watt resistor
R11—18,000-ohm, ½-watt resistor
R12—27,000-ohm, ½-watt resistor
R13—33,000-ohm, ½-watt resistor
R14—1800-ohm, ½-watt resistor
Misc.—Suitable chassis, lamp socket, hardware, wire, solder, etc.

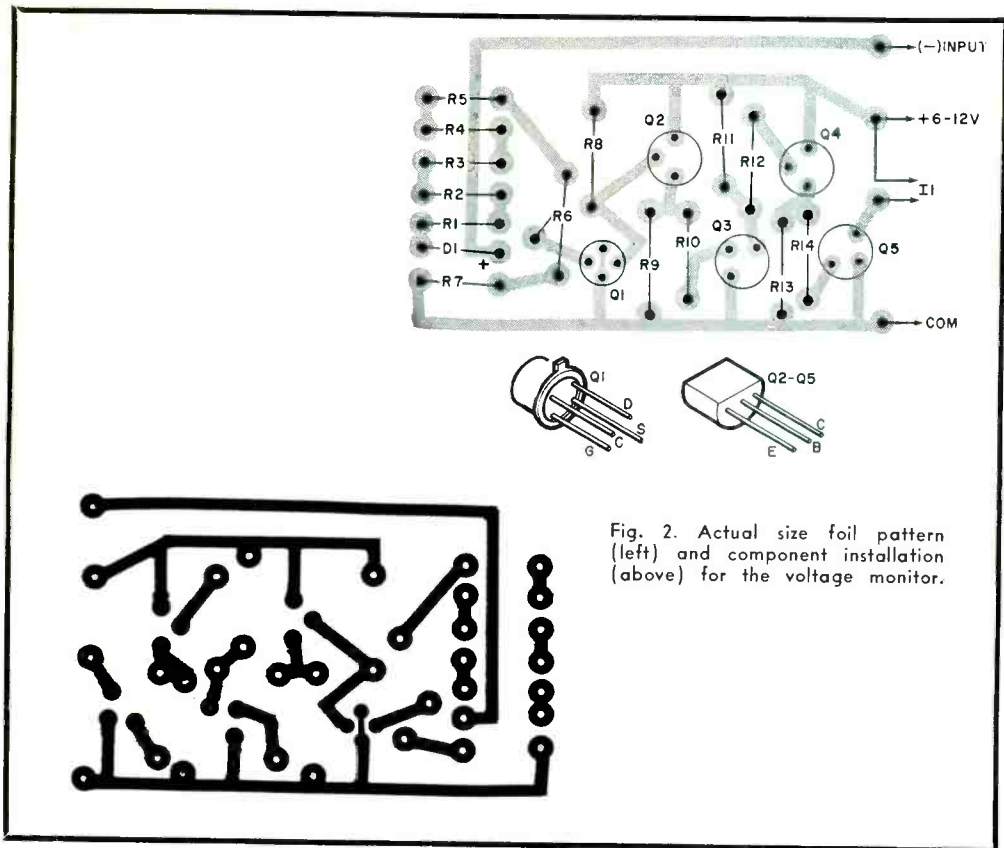

Fig. 2. Actual size foil pattern (left) and component installation (above) for the voltage monitor.

to the gate of the FET, the transistor has a very high resistance. In this case the remainder of the amplifier is cut off and the indicator light is off. When the gate voltage drops below a certain level, the FET turns on—as well as the amplifier and the indicator light.

The switching point (the monitored voltage level at which the circuit changes states) is determined by the voltage divider consisting of R1 through R7, with R6 being adjustable to set the voltage precisely. Diode D1 is a safety device which prevents damage to the FET in case the input voltage is accidentally reversed.

The resistance used for R7 depends on the voltage level to be monitored. With R6 set at the center of its rotation, select a value for R7 so that the indicator lamp can be turned off with just a small rotation of R6. If you are monitoring a voltage less than 10 volts, one or more of the five 22-megohm resistors may be omitted. For a relatively high voltage, you may have to introduce one or more additional 22-meg-

ohm resistors into the divider network. In any case, there should always be some point in the rotation of R6 that causes the indicator lamp to go out. Once R6 is preset so that the lamp just goes out, then any time the monitored voltage drops below the preset level, the indicator will go on.

Note that the monitoring circuit is isolated from the dc source being monitored. Therefore, when using a metal chassis, do not use the chassis as a common ground.

Any type of assembly may be used; and if desired, a PC board such as that shown in Fig. 2 may be used. This illustration also shows the component installation if you make the board. Use care in installing the semiconductors. The indicator lamp used is determined by the battery. The #53 lamp called for in the Parts List is good for a 12-volt battery, but any other low-power indicator lamp may be used as long as the rating of Q5 is not exceeded. ♦

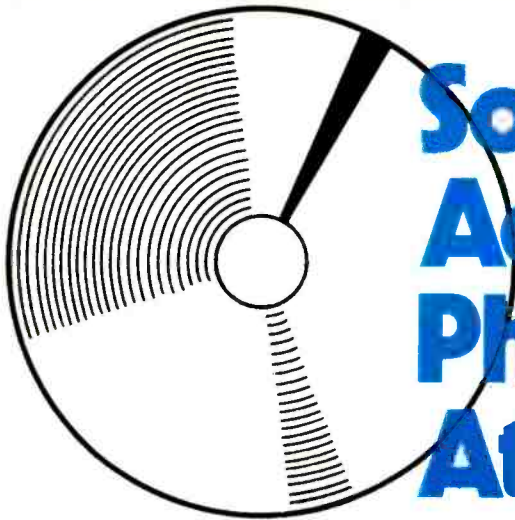

Sound-Activated Photoflash Attachment

FREEZE HIGH-SPEED MOTION USING THIS SIMPLE CIRCUIT

BY VIC LESHKOWITZ

HAVE you ever wondered how "frozen motion" photographs are made? Like the one that shows a balloon in the process of bursting as a needle penetrates the skin? They are easily made and you can do it yourself if you have a camera with a "bulb" or "time" position, an electronic photoflash (strobe), and the circuit shown below.

Theory of Operation. An electronic strobe uses the closing of a switch within the camera to energize the flashtube circuit. This occurs automatically when the camera shutter release is operated to take a picture. As shown below, an SCR can be used to simulate the camera switch. When the SCR is turned off, it has a very high resistance; when fired, its resistance is very low.

The microphone senses the sound pro-

duced by the action to be photographed; and this signal is amplified by the high-gain audio module. Transformer *T1* steps up the output signal and generates the trigger pulse for the SCR. Sensitivity potentiometer *R1* determines the sound level required to trip the SCR and thus determines the moment of firing of the electronic strobe.

Since sound travels at approximately 1000 ft/s, each foot between the microphone and the sound source represents about 1/1000 of a second in time delay. Thus the positioning of the microphone is very important if high-speed action is desired.

Construction. The physical size and power requirements of the circuit are determined by the audio amplifier module

PARTS LIST

B1—Battery suitable for audio module used
J1—Miniature phone jack

The SCR simulates camera flash switch and is triggered by the noise picked up by microphone.

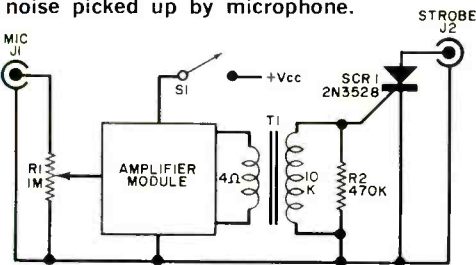

J2—Phono connector

R1—1-megohm potentiometer with *S1* attached

R2—170,000-ohm, ½-watt resistor

S1—Spst switch on *R1*

SCR1—Silicon controlled rectifier (2N3528, HEP621, or similar)

T1—Audio output transformer 4/10,000 ohms (Stancor A3822 or similar)

Mic.—Crystal microphone

Module—Any solid-state module capable of driving a speaker (Lafayette 19-55103 or similar)

Misc.—Electronic flash extension cable (Kaiser 1421 or similar), battery holder, phono plug, suitable chassis, multi-lug terminal strip, mounting hardware, wire, etc.

used. Although a low-cost Lafayette module (19-55103) was used in the prototype, almost any transistor or IC audio module capable of driving a 4- or 8-ohm speaker will suffice. These are usually battery powered.

Mount the audio module and battery in a chassis with the input (*J1*) and output (*J2*) connectors, the sensitivity control, and the on-off switch on the front panel. Transformer *T1* is mounted directly on the chassis bottom with a multi-lug terminal strip to hold the remainder of the components.

Secure an electronic flash extension cable from a camera supply house and remove the jack that goes to the camera. Strip the ends of the two leads and temporarily solder-tack the two leads to the connections on a conventional phono plug, which will be inserted in *J2*.

With the microphone connected to *J1* and the strobe attached to *J2*, make sure that the strobe is charged and ready to fire. (The little red light should be on.) Turn on the power to the module and adjust the sensitivity control until a sound activates the flash. If the flash does not occur, the connections to *J2* may be wrong. Unsolder the leads on the *J2* phono connector and reverse them. If the strobe still does not fire, check that there is an audio signal across *R2* with the sensitivity control up and some sounds in the room. If there is an audio signal, then the SCR may be at fault.

Operation. The sound-triggered flash pictures should be taken in a reasonably dark room. Total darkness is not essential as you will probably have to stop the camera down to the point where a little light will not register on the film. Place the shutter speed dial in the bulb position; and, using the guide index of the film in conjunction with the indicator on the strobe, set the lens opening for the flash-camera to subject distance. If you are using an SLR, a closeup lens may be used for a more dramatic effect. Try to keep the camera and flash about the same distance from the subject because the dial on the flash is calibrated for this type of use.

With power applied to the sound module and the strobe ready to fire, slowly turn up the sensitivity control and make a sound of about the same volume as the event to be photographed. Adjust the sensitivity control to fire the flash with this sound. Make a note of the sensitivity dial setting and turn the sensitivity down.

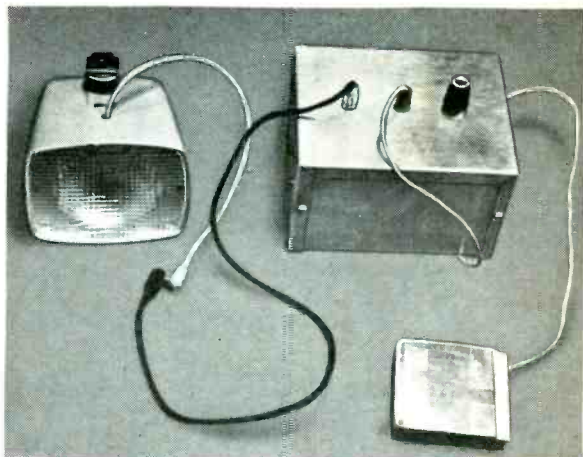

Strobe (upper left), circuit chassis, and mike are attached as shown here.

Allow time for the strobe to recharge, position the microphone near the target (but not within the photographed area), and focus the camera on the subject. Open the camera shutter by placing the shutter mechanism in the time or bulb position. Return the sensitivity control to its predetermined position, execute the event, and close the camera shutter. That's all there is to it.

Remember that the microphone-to-noise source distance represents the time delay between the action and the firing of the strobe. This can be adjusted to stop the action at almost any point. ♦

This photo was taken by dropping the sticks onto drum, triggering flash.



PHOTOCELL MOTOR CONTROL DEMONSTRATOR

*Great learning
and
teaching aid*

BY BOB KOVAL

THE MOST EFFECTIVE teaching aids and the most interesting science fair projects are working models of mechanical, electrical, or electromechanical devices. The photocell motor control demonstrator described here falls into this category. Unlike most such projects, however, it offers audience participation. Passersby are invited to turn on and off a motor themselves simply by shining a beam of light on a photocell.

By spreading out the circuit on a large $15\frac{1}{4}'' \times 24''$ piece of $\frac{1}{2}''$ -thick plywood and running the wires on the front surface of the board a twofold objective is achieved. First, the project has eye appeal (an important consideration at science fair judgments). Second, since there is no hidden circuitry on the rear of the board, it is more convenient to explain how the system operates.

How It Works. Photocell *PC1* (see Fig. 1) is connected across the emitter/base junction of transistor *Q1*. Then when light strikes *PC1*, a slight voltage is generated which causes *Q1* to conduct. This, in turn, causes relay *K1* to be energized and power is applied to the motor. Simultaneously,

K3 is energized and latched in since its circuit is completed through the contacts of *K2*. (If the light beam is removed from *PC1*, relay *K1* will drop out.) The entire sequence takes place in just a few milliseconds, so just a quick flash of light on *PC1* is enough to operate the circuit.

To turn off the motor, a beam of light must be directed at *PC2*, which generates a voltage that causes *Q2* to go into conduction. Now, *K2* is energized, opening its normally closed contacts and de-energizing *K3*. When *K3* drops out, the motor circuit is opened, and the motor stops operating.

Construction. Begin by selecting a $\frac{1}{2}''$ -thick piece of clear plywood measuring $15\frac{1}{4}'' \times 24''$ (or substitute a close-grained piece of particle board, cut to the same dimensions). If you use plywood, make sure the top lamination is birch so that there will be less of a tendency for the wood to crack after it has been painted. Sand the wood to obtain a smooth, flat finish, remove all wood dust, and apply a thin coat of sealer.

When the sealer has thoroughly dried, sand and clean once more. Now paint the

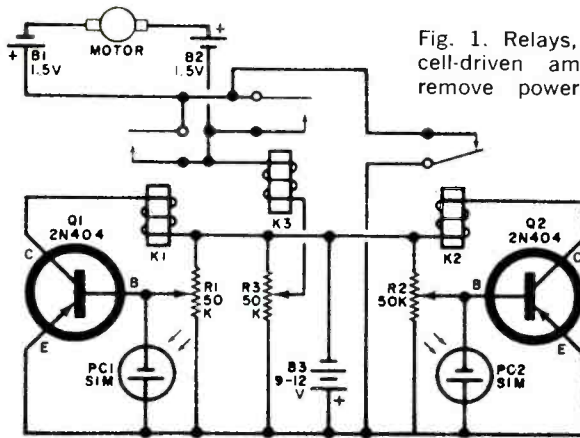

Fig. 1. Relays, operated by photo-cell-driven amplifiers, apply and remove power from the motor.

PARTS LIST

- B1, B2—1.5-volt D cell (see text)
- B3—9- or 12-volt power source (see text)
- K1-K3—1000-ohm, 7-mA spst relay (Sigma Type 11F-1000-G/SIL)
- PC1, PC2—Solar cell (International Rectifier Corp. S1M, or similar)
- Q1, Q2—2N404, 2N1191, or SK3006 transistor
- R1, R2—50,000-ohm, linear taper potentiometer

- R3—50,000-ohm miniature trimmer potentiometer
- 1—24" x 15 1/4" piece of 1/2" birch plywood or close-grained particle board
- 1—3-volt dc hobby motor
- Misc.—6-32 brass machine hardware; crimp-on solder lugs; #14 plastic-jacketed solid hook-up wire; sandpaper; sealer; white or light gray paint; battery connectors (2) for B1; etc.

board with thin coats of white or light gray enamel, using as many coats as necessary to give a hard reflective finish. Remember to sand and clean between each coat and allow sufficient time to dry.

Note that the board is painted before the holes are drilled. The reason for this is to prevent the screws from picking up paint when they are pushed through the holes.

Using the information provided in Fig. 2, drill 1/8" holes for parts mounting on the board. Drill through from the painted side so that as the drill point exits from the wood, any flaking or chipping will be on the unseen side of the board. (Note that holes for the relays are not dimensioned into the drawing since different types of relays require different mounting hole centers.)

Pass a 6-32 x 1" brass machine screw through each hole from the rear of the board, and fasten in place with machine nuts. Next, mount the motor in its appropriate location by any convenient method, and epoxy cement PC1 and PC2 in place. The size D flashlight batteries are soldered to #14 solid wire and connected to the appropriate screws with solder lugs, making a neat and sufficiently strong arrangement.

The potentiometers should be made self-

supporting by soldering their contacts to solder lugs (see Fig. 3) and fastening them to the screws. The leads of transistors Q1 and Q2 are simply connected to the screws directly or via solder lugs.

Wiring is best accomplished by cutting the leads to the appropriate sizes and attaching to each end a solder lug, after which the leads are simply bolted into place with machine nuts. Use #14 solid, plastic insulated wire to obtain the neatest layout and so it can be seen for a considerable distance. Remember, the bold appearance of the wire adds to the success of your project.

The power source for the transistors consists of two 9-volt batteries in parallel. No switch is provided, since the battery connector easily snaps on and off the batteries. (When the demonstrator is to be used for long periods, such as at Science Fairs, two heavy-duty 6-volt lantern batteries can be connected in series and hooked up to the circuit in place of the 9-volt batteries.) Mount the 9-volt batteries as shown, and route their wires behind the board. The dashed lines in Fig. 3 show where the battery leads terminate in the circuit.

No switch is provided in the motor power

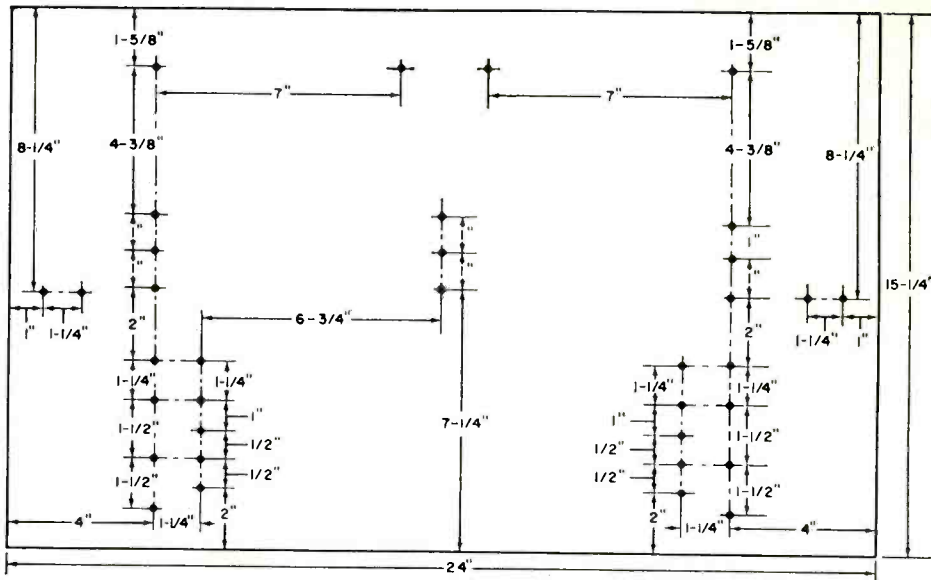

Fig. 2. Holes drilled through demonstrator board are for machine-hardware mounting screws and terminals.

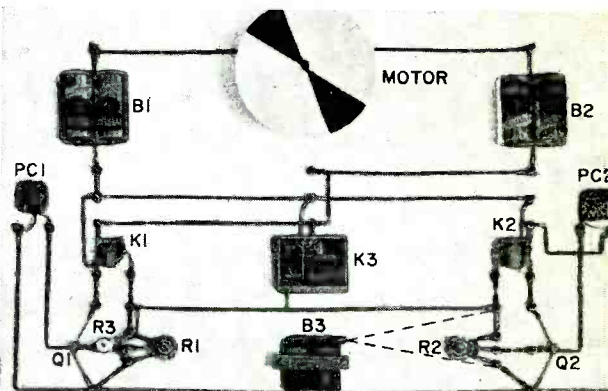

Fig. 3. Neat, symmetrical layout is accomplished with aid of heavy-gauge insulated wire and machine hardware.

supply since the D cells supply no power when the circuit is in standby. The D cells are in a series-parallel configuration to provide long life.

Adjustment and Use. After making a complete check of your wiring, cover *PC1* and *PC2*, and set *R1* and *R3* to their mid-range positions. Connect the 9- or 12-volt power source to the circuit, but do not install *B1* and *B2* yet.

Uncover *PC1* and from about 5' away, direct a light beam onto it and adjust *R1* so that *K1* is energized when the light strikes *PC1*. Move the beam away from *PC1*; *K1* should be immediately deenergized. Listen for the clicks.

Now, with *PC1* covered and *PC2* ex-

posed, again from about 5' away direct a beam of light onto *PC2*. Adjust *R2* so that when the beam strikes *PC2*, *K2* is energized. Then, when the beam is moved away from *PC2*, *K2* should immediately drop out.

Uncover both photocells. Now direct the flashlight beam onto *PC1*, and adjust *R3* until *K3* pulls in when the light strikes *PC1*. Check that *K3* remains locked in and is deenergized only when the light beam is directed at *PC2*.

Now install *B1* and *B2* and recheck the operation of the circuit.

Potentiometers *R1* and *R2* are sensitivity controls that can be adjusted for optimum circuit operation under whatever ambient light conditions exist in the vicinity of the demonstration setup. ♦

The Operational Amplifier

What it is
& How it works

THIS VERSATILE LINEAR IC OPENS UP MANY NEW AREAS FOR THE SERIOUS EXPERIMENTER

THE OPERATIONAL AMPLIFIER (usually shortened to op amp) is actually nothing more than a dc-coupled amplifier with extremely high gain and with external components connected to it to control its response characteristics. Although there was nothing new about the circuit, the term operational amplifier gained recognition in the early days of electronic computation when op amps were first used to perform certain specific mathematical operations.

Today's op amp (usually referring to an integrated circuit device) approaches in performance the elusive "perfect amplifier" which, if it existed, would have the following characteristics:

1. Infinite gain; a very small change in input should produce an infinite change in output.

2. Zero output for zero input.
3. Infinite input impedance; no power consumed from the driving source.
4. Zero output impedance; output voltage should remain the same even if load resistance drops to zero.
5. Infinite bandwidth; zero rise time.
6. Insensitivity to either power supply or temperature variations.

Although such a perfect amplifier has not yet been developed, modern semiconductor technology has produced an op amp whose characteristics come quite close to the perfect case.

What's in an Op Amp? A typical op amp consists of three basic parts as shown in Fig. 1: a high-impedance differential amplifier that has low drift and wide bandwidth; a high-gain stage; and an output



Fig. 1. The basic arrangement of a typical op amp. Such a circuit could contain up to a couple of dozen transistors and associated resistors, all on a very tiny silicon chip.

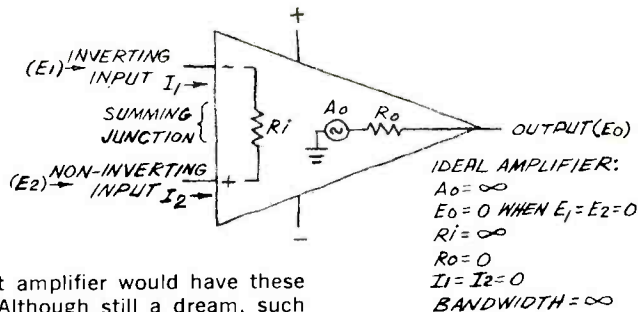

Fig. 2. A perfect amplifier would have these characteristics. Although still a dream, such a circuit may not be too far in the future.

stage that isolates the gain stage from the external load and provides the actual power output.

The conventional symbol for an op amp, together with the characteristics of a perfect amplifier are shown in Fig. 2. Note that both polarities of the supply voltage are used (with the common grounded). This is necessary for the op amp to be able to deliver both positive and negative (with respect to ground) signals at the output.

The schematic of a basic differential amplifier is shown in Fig. 3. The currents to the emitter-coupled transistors (Q1 and Q2) are supplied by the constant-current source (Q3). The characteristics of the differential pair and the associated resistors are closely matched in the manufacturing process. If the two input voltages are either zero or are similar in level and polarity, the amplifier is balanced because the collector currents are equal. Therefore, a zero voltage difference exists between the two collectors. The sum of the emitter currents is always equal to the current supplied by the constant-current source so that, if one transistor draws more current, the other must take less. Thus if the input to one transistor causes it to draw more current, the current in the other decreases and the voltage difference between the two collectors changes in a differential manner. The differential swing is greater than the simple variation that can be obtained from only one transistor.

To further understand the operation of the differential amplifier, consider the diagrams in Fig. 4. In A, a positive-going signal applied to the minus input produces a negative-going output. Thus the configuration at A is called an inverter and the minus input is called the inverting input. If the same signal is applied to the

positive (non-inverting) input, the output is positive-going and the configuration is called a follower. Because no feedback is used in Fig. 4, the amplifiers are operating "open loop" and a small input produces a large output.

Actually, operational amplifiers are usually used with some form of feedback (closed loop) as shown in Fig. 5. In this inverter arrangement, feedback resistor R2 is connected from the output back to the inverting input to produce a signal which works against the input to reduce its effect. Resistor R1 isolates the inverting input from the signal source and represents the circuit's input resistance. The non-inverting input is grounded in this case.

Assume that a 1-volt signal is applied to R1. Due to the high input impedance

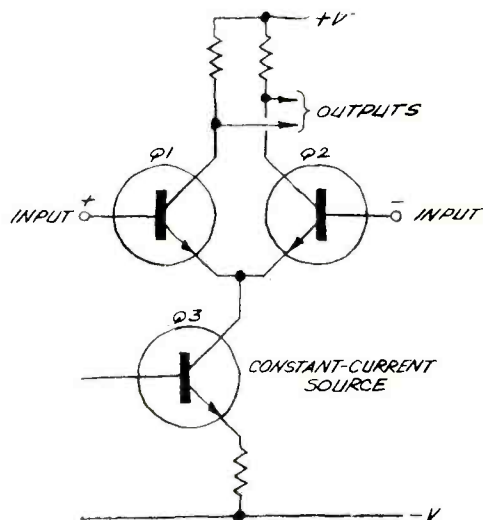

Fig. 3. This basic differential amplifier is found in op amps. The biasing of Q3 determines the amount of current flowing in Q1 and Q2. A differential pair produces greater output swing than single transistor.

of the op amp, essentially no current will flow into the input terminal (also called the summing junction), and there is a zero voltage drop between the two input terminals. The summing junction remains at zero potential. Since R_1 is 1000 ohms, the 1-volt input signal creates a current of 1 mA through R_1 and it flows also through R_2 to the output terminal. However, 1 mA of current through the 10,000-ohm resistor creates a voltage drop of 10 volts so the output terminal must go to -10 volts. Thus the configuration is a gain-of-10 inverter.

Frequency sensitive networks can be used with op amps to create oscillators and frequency selective amplifiers. With a capacitor in the feedback loop, the op amp acts as an integrator; and with a capacitor in the input, a differentiator is formed.

Feedback is not necessary in some op amp circuits. For example, if one input is connected to a reference voltage and the

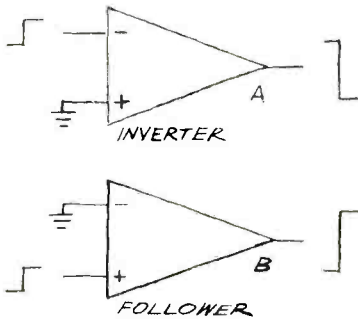

Fig. 4. The output of an op amp when a positive step is applied to the inverting and the non-inverting inputs.

other to a varying input signal (see Fig. 6), the open-loop amplifier will respond to the potential difference between the two inputs. Due to the high gain, the output level will swing widely (almost equal to the power supply voltages) as the varying voltage equals and exceeds the reference voltage. Note the input-output waveforms shown in Fig. 6. When the input signal is less than the reference, the op amp output is highly positive, and vice versa. If the two inputs were reversed, the phase relationships would also be reversed.

Other op amp circuits can be used as multi-signal summers, adders, or subtraction circuits. The second part of this ar-

article will illustrate a number of practical examples.

Compensation. Because high-gain op amps are usually used in a feedback mode, the feedback must be controlled to assure that the circuit is stable with frequency and will not oscillate if the input-output phase difference changes drastically. When no phase compensation is furnished, the gain of the feedback signal may be greater than unity when the phase angle approaches 180° . In this case, feedback that is nega-

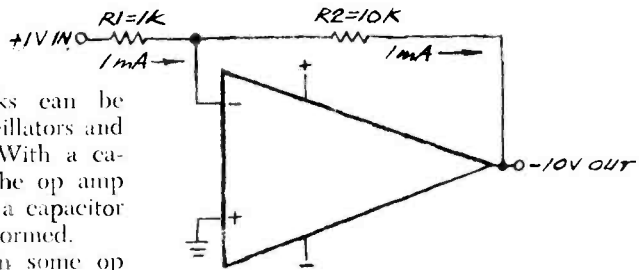

Fig. 5. Resistor R_2 is the feedback resistor while R_1 is an isolator and represents circuit input resistance.

tive at low frequencies, becomes positive at higher frequencies and unwanted oscillation may result.

To overcome this tendency toward unwanted oscillation, the frequency response and phase-shift characteristics of the op amp must be compensated—that is, out-

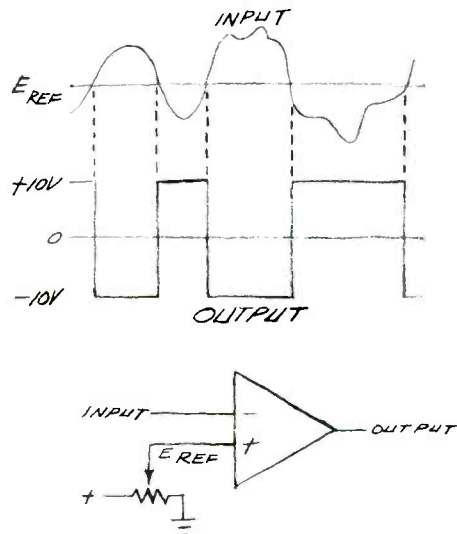

Fig. 6. When input exceeds reference, the output is negative and vice versa.

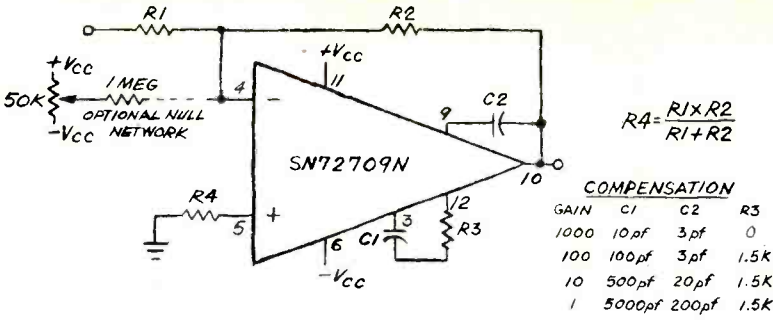

Fig. 7. Capacitors C1 and C2, and resistor R3 form the op amp compensation. Nulling can be via the optional resistor network.

board passive components (usually resistors and capacitors) are used to tailor the frequency response and phase-shift characteristics. One form of compensation uses a resistor and capacitor in series. In this case the amount of feedback increases as the frequency goes up and the reactance of the capacitor goes down; but the upper limit is determined by the resistor value which remains constant at the high frequencies.

Another popular form of compensation is called output limiting and can take the form of a low-value capacitor connected from the output back to the input. This output compensation is used to supplement the other compensation. The type of compensation used in any case is unique for the type of op amp and the application.

Sometimes compensation is obtained by bypassing the op amp to ground. If an op amp requires compensation, suitable terminals are provided on the package. There are some types that require no compensation and are so identified in the manufacturer's specifications.

A typical circuit with compensation is shown in Fig. 7. This circuit also has a null network which balances out the effect of offset voltage and current. This will be discussed later in more detail.

Each circuit using an op amp has certain closed-loop characteristics that must be taken into account by the circuit designer. For example, Fig. 8 shows the basic characteristics of a follower, an inverter, and a difference amplifier whose output is proportional to the difference between the two inputs.

Performance Limitations. Op amps have performance limitations—as do all electronic components. These limitations are

given in the specification sheets but for most purposes, the critical performance specs are power output, open-loop characteristics, bandwidth, input limitations, offset voltage, and offset current.

The most important specification is usually power output. The popular 709 IC op amp will develop ± 10 volts at 5 mA output, using a bipolar 15-volt power supply. Note that the 5 mA is the total output

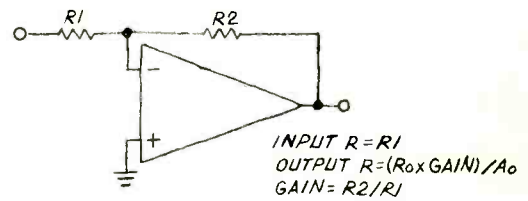

INVERTER

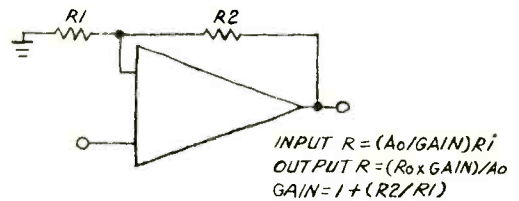

FOLLOWER

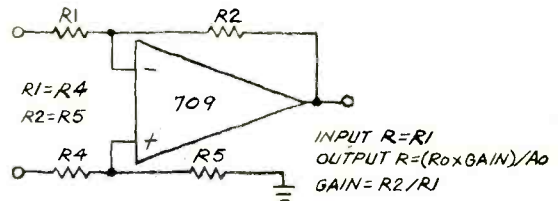

Fig. 8. Three typical op amp uses. Inverter (A) follower (B), and difference amplifier (C). Also shown are the basic equations for input, output, and gain. The difference amplifier output is proportional to voltage difference between two signal inputs.

current, including that used by the feedback network.

The effects of open loop gain and differential input resistance on final circuit performance are given in Fig. 9. To use the open loop gain graph, draw a vertical line at the open loop gain of the op amp being used. Where this line cuts the curve determined by the resistance values (R_2/R_1), read the percentage of ideal gain on the vertical axis. In the example in Fig. 9, the open loop gain was 10,000, R_2/R_1 was 1000 and the percentage was 90%, meaning that the gain is actually 900 (90% of R_2/R_1).

The lower graph of Fig. 9 shows the effect of the external resistors on open loop gain as a function of the open loop input resistance. It also demonstrates that the open loop input resistance should be as high as possible. For example, a typical 709 has an input resistance of 250,000 ohms. Draw a vertical line from this point on the horizontal axis. If R_1 is 100,000 ohms, the open loop gain would then be 77% of normal. In this case the specified open loop gain is 50,000, so the actual gain would be 38,000. This is the figure to be used in determining ideal gain from the upper graph in Fig. 9. For the same amplifier, if R_1 is reduced to 10,000 ohms, the open loop gain would be 95% of the

specified 50,000. For $R_1=1000$ ohms or less, the effect of open loop gain would be minimal. Of course, R_1 determines the input resistance so this factor must be taken into consideration.

Bandwidth and Slew Rate. Suppose a high-frequency, high-amplitude signal is fed into the op amp. Because the various elements within the op amp have some capacitor characteristics (mainly semiconductor junctions and strays due to proximity of conducting paths) a finite amount of time will be required to charge and discharge them. This prevents the output voltage from following the input signal instantaneously. Thus, these internal capacitances limit the rate at which the output voltage can change or slew. The maximum time rate of change of the output is identified as the slew rate and is specified as volts per microsecond. The slew rate of a feedback amplifier depends on a number of factors, including the value of the closed loop gain.

Bandwidth and slew rate are related in that slew rate limits the bandwidth. The latter is usually expressed as a large signal bandwidth or the highest frequency at which the amplifier will develop its rated output without distortion. A particular amplifier is capable of having a

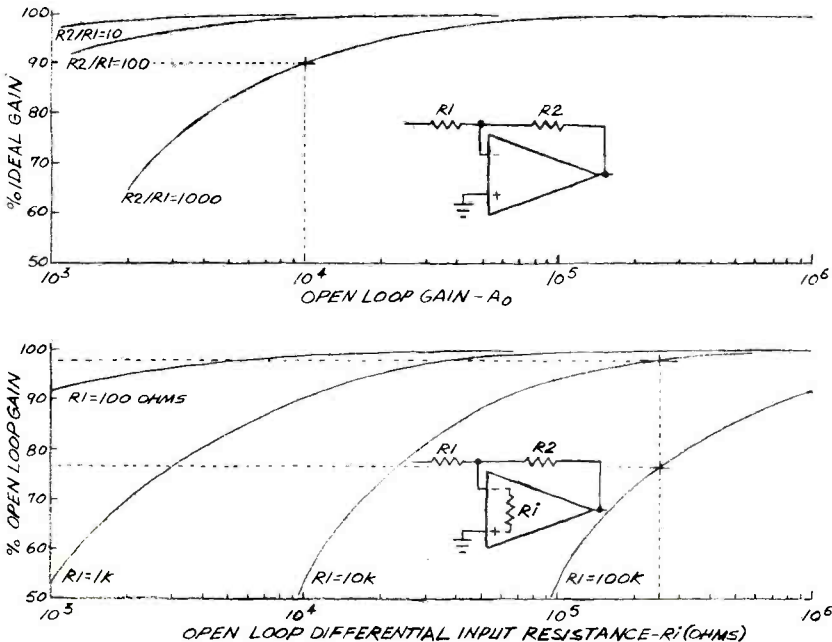

Fig. 9. Open-loop gain and differential input resistance vs performance.

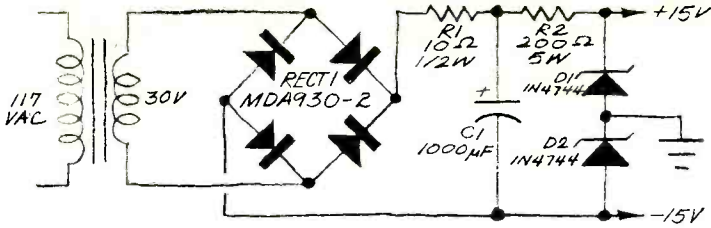

Fig. 10. Simple power supply for op amp experiments.

higher frequency response with a smaller output.

Offset Error. Even though extreme care is used in the fabrication of an op amp, a very slight mismatch may still occur between the internal components. The result of this mismatch prevents the amplifier from having a zero output for a zero input. This, of course, may be a problem when using the op amp in a dc circuit. Compensation for this offset voltage is made by using a nulling network such as that shown in Fig. 7, in which the nulling potentiometer is adjusted for zero output with zero input.

Common-Mode Error. Because it is very difficult to create a perfectly balanced system, the signal present at one input of a differential pair may affect the signal on the other input. The result is called common-mode error and it is smallest when the specification called "common-mode rejection ratio" is the highest.

Power Supply Considerations. Changes in the power supply of an op amp circuit often change the open loop gain, the common-mode input limits, and the input bias current. For example, the open loop gain of a typical 709 doubles when the power supply is changed from ± 10 to ± 15 volts. Input voltage limits change in proportion to the supply voltage and the bias current increases about 10% for a 50% increase in the supply voltage.

This sensitivity to power supply voltage seems to rule out batteries as a source but this need not be true. Circuits of moderate impedance having gains of 100 or less will not degrade appreciably if batteries with high current capacity are used and they are changed frequently. Mercury and rechargeable nickel-cadmium types have "flat" discharge curves and give good performance for a premium price. If battery power is a necessity, some manufacturers make discrete amplifiers for use with unregulated supplies.

Power supplies regulated by zener diodes furnish regulation close enough for most op amp applications. A typical supply of this type is shown in Fig. 10. Note that neither side of the filter capacitor is grounded since the supply develops both positive and negative voltages. The triangular ground symbol between the two diodes is an "instrumentation ground" and indicates that all ground connections within the system should be connected together but grounded to the chassis at one point only. This minimizes circulating ground currents. In extreme cases, the input connectors are also isolated from the metallic ground and connected to the instrumentation ground only.

The circuit of a single-battery, zener-controlled supply is shown in Fig. 11. The emitter resistor should be chosen so that the current through the zener diodes is about 50% above that required for the amplifier and associated load.

Critical op amp circuits require extremely close regulation—similar to that provided by a high-quality supply that uses one of the commercially available IC voltage regulators.

No matter what type of power supply you use, all op amp manufacturers suggest the use of a bypass capacitor close to the amplifier on the power supply leads. In fact this is mandatory if power supply leads are long. The recommended capacitor size is about $0.1 \mu\text{F}$.

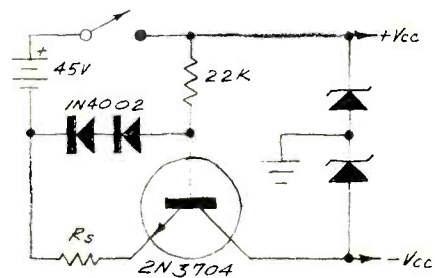
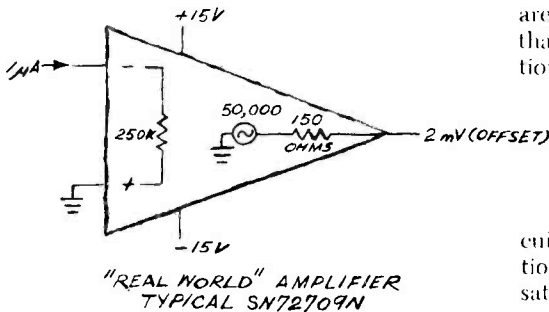

Fig. 11. Battery operated power supply delivers two polarity outputs.

PRACTICAL APPLICATIONS FOR THE VERSATILE OP AMP

IN THE FIRST PART of this article, we discussed the "perfect amplifier" and its characteristics. However, there is no such thing as a perfect amplifier and we must work with things that exist in the real world. So, how about applications for the real operational amplifier? Figure 1 shows the characteristics of one typical low-cost op amp (Texas Instruments SN72709N), which is a member of the famous 709 family.

This device has an open loop gain of 50,000, an input resistance of 250,000 ohms, an open loop output impedance of 150 ohms, and one microampere input



offset current with two millivolts offset voltage at the output. These are typical specifications for most 709 op amps, irrespective of manufacturer.

The best way to experiment with an integrated circuit of any kind without damaging it in soldering and desoldering is to make up a breadboard similar to that shown in Fig. 2. Suitable solder terminals are mounted on a piece of plastic and the IC is attached to the board with adhesive with its leads up. Each pin of the IC is then connected to one of the ter-

minals. Each terminal is identified as to pin number or function, and all external components and circuits are hooked up to the appropriate terminals.

Another approach is shown in Fig. 3. Here, a 14-pin dual in-line socket is mounted on a board, with a suitable number of terminals around the edge. The circuit can then be built up between the socket leads and the perimeter terminals. Figure 3 also shows how a round TO-99 case can be inserted in the socket, with the pins properly matched.

Typical Applications. Although only a few circuits will be described here, they are basic to all of the many variations that are found in this and other publications. Note that, although some of the cir-

Fig. 1. Characteristics of typical op amp. This has gain of 50,000, input impedance of 250,000 ohms, and 150-ohm output.

cuits shown here do not have compensation, it is always necessary to compensate a 709. This is not true, however, of some other op amps so the specifications should always be checked.

The two dc voltmeters shown in Fig. 4 illustrate some interesting points. In both circuits, the 5000-ohm output resistors can be changed to affect the basic circuit sensitivity. For example, making this resistor 1000 ohms gives both voltmeters full-scale ranges from 0.1 to 100 volts. Circuit A would then have an input sensitivity of 100,000 ohms per volt, but circuit B would retain its original 10-megohm input. Circuit B also has a null balance circuit since the typical offset

Fig. 2. This simple breadboard approach may be used to connect up an op amp. The layout, Fig. 3, shows the wired circuit.

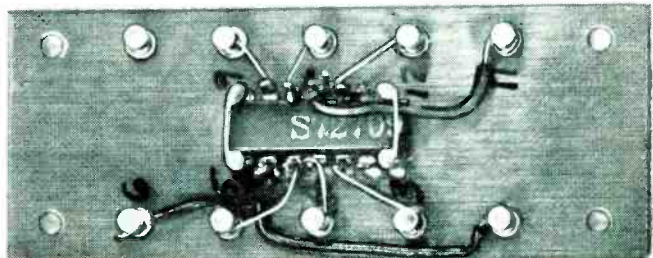

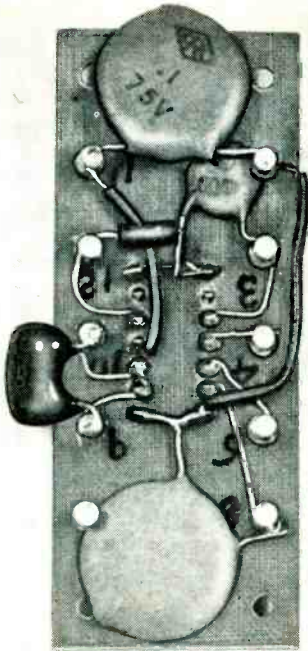

Fig. 3. If you mount a dual in-line socket on the breadboard, it can be used for both in-line and round IC's.

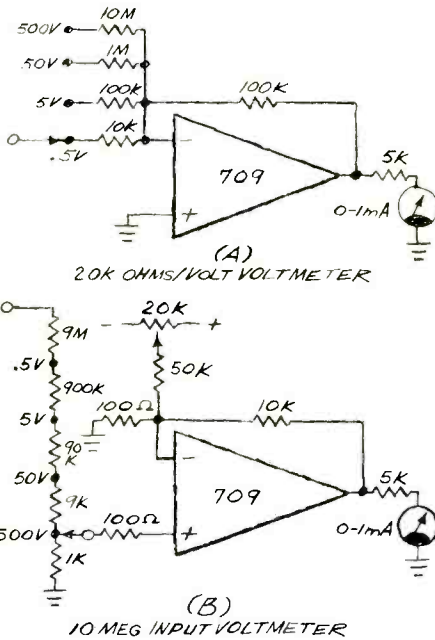
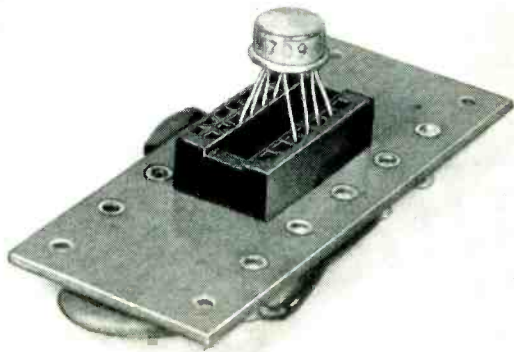

Fig. 4. A pair of dc voltmeters using an op amp. The circuit at (A) is 20,000 ohms per volt, while that at (B) is 10 megohms per volt. Text discusses design changes to improve this simple design. In both cases, the meter has a conventional 0.1 mA movement.

of a 709, multiplied by the gain of 100, would produce a significant zero offset on the meter. In this case, with the input shorted, the null offset potentiometer is adjusted to obtain a zero on the meter. Such a voltmeter would be ideal not only for solid-state testing (since it has the necessary low-voltage scale), but also for vacuum-tube circuits where the dc voltage could reach 500.

A very linear ac voltmeter is shown in

Fig. 5. In this circuit, diode nonlinearity is minimized by the high gain of the amplifier. Sensitivity is the same as that of the meter: that is, 1000 ohms per volt for a 1 mA meter. A higher input impedance can be attained by using an op amp buffer in front of this circuit.

The current-to-voltage transducer shown in Fig. 6 makes use of the current sensitivity of the op amp to measure very small currents. As shown, the circuit indicates 1 volt per microampere and is capable of 0.1-microampere sensitivity.

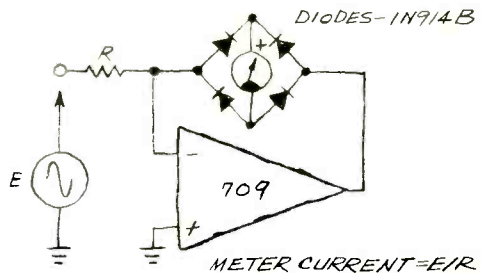

Fig. 5. Typical ac voltmeter basic circuit using an op amp. Although the input impedance is only 1000 ohms per volt, by adding an op amp buffer in front, impedance can be raised.

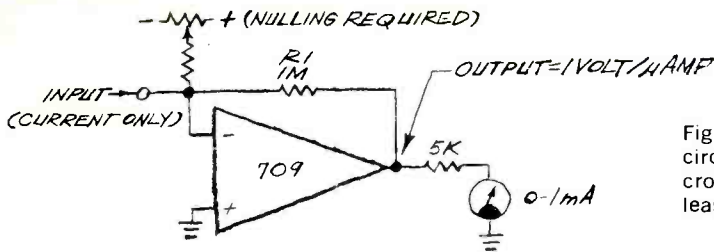

Fig. 6. This current-to-voltage circuit indicates 1 volt per microampere and is capable of at least 0.1-microamp sensitivity.

Resistance values for R_1 can be between 100,000 and 10,000,000 ohms to provide outputs from 10 μA per volt to 0.1 μA per volt.

The circuit shown in Fig. 7 is an example of just how far you can go in creating an ultra-high input impedance with an op amp. Developed by NASA, the circuit has an input impedance of several hundred megohms with an input capacitance of less than 1 picofarad. The high impedance is obtained by positive feedback through C_1 . The input capacitance plus the capacitance to ground can be cancelled by adding feedback capacitor C_2 and properly adjusting R_1 .

The low-frequency response is determined primarily by C_1 , for which an electrolytic capacitor may be used. High-

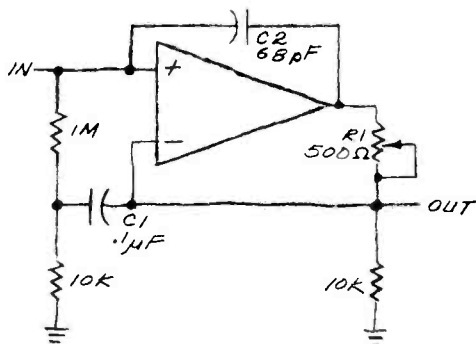

Fig. 7. This circuit, developed by NASA, has an input impedance of several hundred megohms with an input capacitance of less than 1 pF.

frequency response is limited by the op amp. With a square wave applied to the input, potentiometer R_1 is adjusted to obtain a square wave on the output (similar to making a scope attenuator adjustment). The circuit was designed to amplify a 5- μs pulse coupled through a 1-pF capacitor. The slew rate is approximately 0.5 volt per microsecond.

Two gain-control, or variable-attenu-

ator, stages are shown in Fig. 8. Note that two different input resistances are shown—one very high, the other low—and that the gain of either stage can be varied by changing the feedback circuit. A word of caution: when the feedback potentiometers are at their minimums, the effective load on the amplifier is 5000 ohms. Be sure that the feedback resistors do not "use up" all the available output current.

An interesting use of the op amp is in frequency-selective networks. With conventional discrete semiconductor circuits, it is usually necessary to use large inductors to perform this operation at low audio frequencies. In the circuit shown in Fig. 9, a twin-T filter (which has a resonance similar to its LC counterpart), is used in the feedback circuit. Figure 9 shows the method of calculating the element values for any frequency. Unfortunately, the Q of a twin-T filter is rather small—on the order of 0.25; but, when

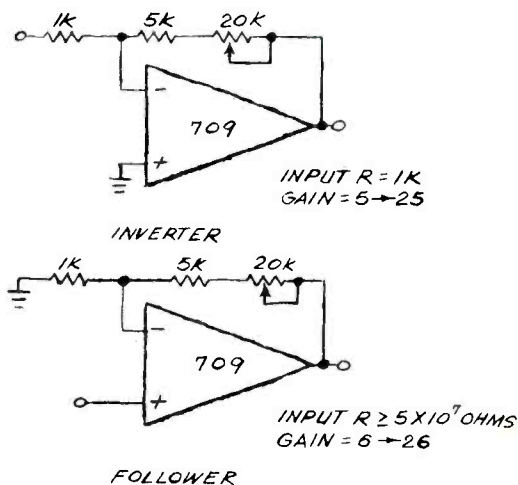
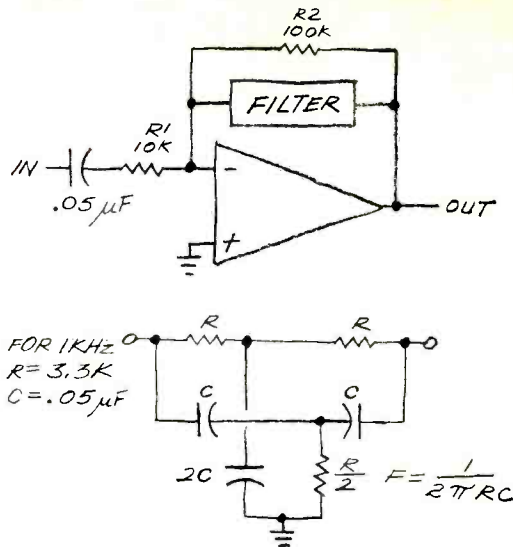

Fig. 8. A pair of variable attenuator circuits. The upper one has an input resistance of 1000 ohms, while bottom circuit has 50-megohm input. Gain is very similar.

Fig. 9. A frequency selective network in the feedback loop of an op amp can simulate an LC circuit having a high Q at audio frequencies. Both Q and center frequency can easily be changed by varying the RC values.



combined with the gain of the op amp, the Q is a reasonable value. Using an amplifier with a gain of 10, the Q is 2.5; and with a gain of 40, the Q is 10. Thus an op amp, with a few passive components, can be used to simulate a bulky, expensive inductor; and it has the advantages of a center frequency and Q that are easily controlled over a wide frequency range.

Another audio filter, this one generating a notch at the selected frequency and having a variable Q, is shown in Fig. 10. The input to the positive terminal of the op amp is combined with feedback through the bridge-T network. The other input is variable. When the signal levels at both inputs are equal, there is no output from the amplifier. System gain is still $R2/R1$. By adjusting the "SET" control, a small notch at the filter frequency is obtained. As the "Q ADJUST" control is brought near the filter end, the feedback increases, controlling the Q of the circuit. The frequency is determined by the values of the filter capacitors and the setting of the ganged potentiometers.

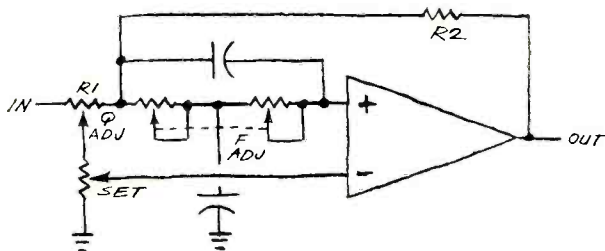

Fig. 10. This audio filter permits changing both Q and center frequency via pair of controls.

Performance Limitations. Input limitations are applicable primarily to follower configurations, provided, of course, that input overloads are avoided. The summing junction of an inverter remains at ground except when fast voltage spikes or extremely high voltages are applied. In the first case, feedback is too slow to protect the summing junction; while in the second case, the output stage saturates and is unable to divert the input current. In followers, the summing junction moves in step with the input voltage so that, in some circuits, the input must be restricted to 15 volts. In Fig. 4B, for example, the divider restricts the summing junction excursions until the output stage saturates. The amplifier has a gain of 100 (101 if the resistor values are exact), and an input in excess of 0.1 volt would saturate the amplifier at an output over 10 volts. If a 10-volt input were allowed, the summing junction would be driven so high that the input transistors in the op amp would probably be destroyed.

Performance limitations having to do

FAIRCHILD LINEAR INTEGRATED CIRCUITS μ A748

ELECTRICAL CHARACTERISTICS ($V_s = \pm 15$ V, $T_A = 25^\circ\text{C}$ unless otherwise specified)

PARAMETERS	CONDITIONS	709			UNITS
		MIN.	TYP.	MAX.	
Input Offset Voltage	$R_s \leq 10$ k Ω		1.0	<u>5.0</u> 10	mV
Input Offset Current			20	<u>200</u> 750	nA
Input Bias Current			80	<u>500</u> 2,000	nA
Input Resistance		<u>0.3</u>	2.0	<u>.05</u>	M Ω
Input Capacitance			1.4		pF
Large-Signal Voltage Gain	$R_L \geq 2$ k Ω , $V_{out} = \pm 10$ V	<u>50,000</u>	200,000	<u>12,000</u>	
Output Resistance			75	<u>150</u>	Ω
Output Short-Circuit Current			25		mA
Power Consumption			50	85	mW
Transient Response (unity gain)	$V_{in} = 20$ mV, $C_C = 30$ pF, $R_L = 2$ k Ω , $C_L \leq 100$ pF				
Risetime			0.3	<u>0.3</u>	μ s
Overshoot			5.0	<u>10</u>	%
Slew Rate	$R_L \geq 2$ k Ω		0.5		V/ μ s

GENERAL DESCRIPTION—The μ A748 is a high performance monolithic operational amplifier constructed on a single silicon chip, using the Fairchild Planar[®] epitaxial process. It is intended for a wide range of analog applications where tailoring of frequency characteristics is desirable. High common mode voltage range and absence of "latch-up" make the μ A748 ideal for use as a voltage follower. The high gain and wide range of operating voltages provide superior performance in integrator, summing amplifier, and general feedback applications. The μ A748 is short-circuit protected and has the same pin configuration as the popular μ A741 operational amplifier. Unity gain frequency compensation is achieved by means of a single 30 pF capacitor.

ABSOLUTE MAXIMUM RATINGS

	709	
Supply Voltage	<u>± 18 V</u>	± 22 V
Internal Power Dissipation (Note 1)		500 mW
Differential Input Voltage	<u>± 5 V</u>	± 30 V
Input Voltage (Note 2)	<u>± 10 V</u>	± 15 V
Storage Temperature Range		-65°C to $+150^\circ\text{C}$
Operating Temperature Range		-55°C to $+125^\circ\text{C}$
Lead Temperature (Soldering, 60 seconds)		300°C
Output Short-Circuit Duration (Note 3)	<u>5 sec.</u>	Indefinite

NOTES:

- (1) Rating applies for case temperatures to 125°C ; derate linearly at 6.5 mW/ $^\circ\text{C}$ for ambient temperatures above $+75^\circ\text{C}$.
- (2) For supply voltages less than ± 15 V, the absolute maximum input voltage is equal to the supply voltage.
- (3) Short circuit may be to ground or either supply. Rating applies to $+125^\circ\text{C}$ case temperature or $+75^\circ\text{C}$ ambient temperature.

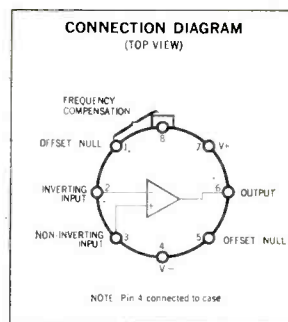

Fig. 11. This is portion of specifications sheet on the 748 op amp with "worst case" parameters underlined. Specs of typical 709 have been added for comparison purposes.

with offset voltage and current are large-ly inconvenience factors. External null circuits balance out offsets over a small range of ambient temperatures. Offset effects (as well as open loop gain and input resistance) vary with ambient temperature, so circuits that must operate in changing temperatures should be designed around amplifiers with low offset. Op amp circuits with low values of R_1 and R_2 are not bothered by offset currents, while circuits with low closed loop gain suffer little from offset voltage. For special applications, where extreme accuracy and/or stability is needed, it is important to consider not only the open loop characteristics of the amplifier, but also the accuracy and temperature stability of the external components.

In choosing an amplifier for a given application, the manufacturer's specification sheets should always be consulted. Unfortunately, these sheets often contain an amazing amount of information—

which may be confusing to the uninitiated. Figure 11, for instance, shows part of the information given on the Fairchild μ A748 op amp. Note the two columns headed "709" which have been added to the illustration for comparison purposes. Some of the performance figures have been underlined. These are "worst case" conditions and should be used in circuit design. Also note that some specifications are accompanied by "conditions" (such as a specified load resistor). When comparing amplifiers, these conditions must always be identical. All specifications are always for the open loop configuration unless otherwise noted on the sheets.

By now, you should have a pretty good idea what an operational amplifier is and how it is used. The next step is to keep your eyes open as you review the technical literature and be aware of the wide variety of op amp circuits available. Then put them to good use. \diamond

Build Bass Reflex Enclosures the Easy Way

SOME HINTS
ON SUCCESSFUL
DESIGN
AND CONSTRUCTION

BY DAVID B. WEEMS

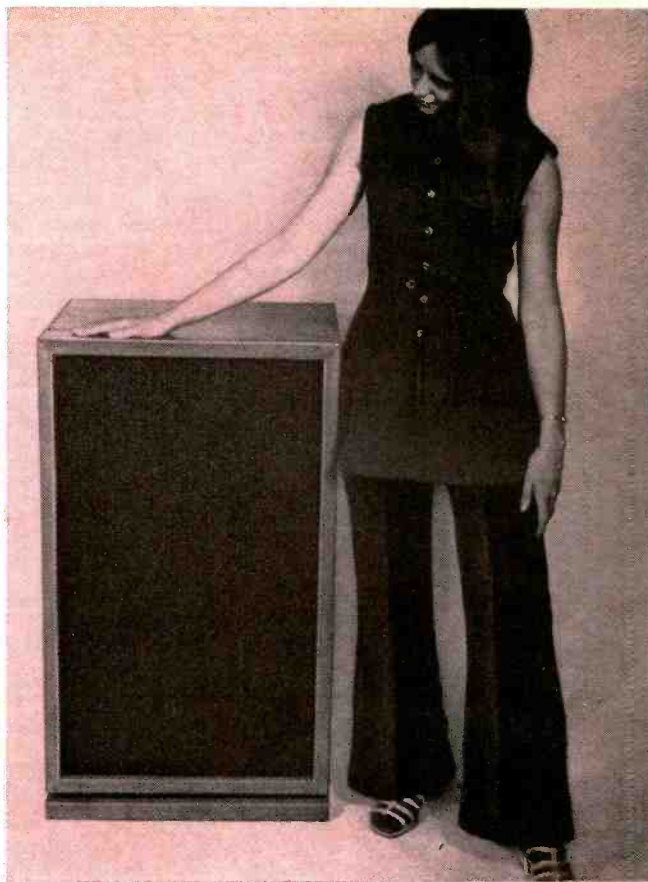

THE bass reflex speaker enclosure is a perennial favorite of home hi-fi builders. Perhaps one reason for its popularity is that most of the hi-fi component speakers sold are designed for bass reflex operation. But a ported enclosure also offers a more interesting project than does a simple box. Even the name of the system suggests something special in bass performance. This appeal sometimes inspires reckless application of reflex theory which can result in a mistuned "boom box."

It is not easy—but far from impossible—for the experimenter to successfully design his own bass reflex enclosure. First he must face a myriad of decisions. He must decide at the outset if he wants to emphasize bass output and range or concentrate on obtaining optimum transient response.

Of the questions he will most likely ask himself, one is should the box be tuned to control the cone at the speaker's free-air resonance or to some lower frequency to

minimize cone travel and distortion at the bottom of the reproduced frequency range? Then again, he might ponder whether or not to tune the box at the higher frequency of the speaker plus box (before porting) system resonance. Each of these methods of tuning is used by various manufacturers.

The experimenter with unusual tastes in sound can, by stressing the quality he desires, end up with a system that is not only more original but more satisfying to his ear than the typical commercial system. As one loudspeaker engineer points out, the amateur speaker system builder is sometimes a "strange bird." Perhaps his urge to be creative is stronger than the desire to obtain good sound.

Some Simple Do's. The home builder can obtain optimum performance from his loudspeaker, as defined by those who ought to know, by following the design booklets published by the manufacturer. Data sheets are packed right in the speaker's shipping

carton; so, one needs only to buy the speaker before beginning work on the enclosure.

Ports can be used with boxes of various sizes, but the principle is particularly useful for full-size systems. Typical of the kind of component speaker available for bass reflex operation is the Electro-Voice Model LT15, a 15" three-way loudspeaker for which the enclosure shown in the photos was designed.

Three-way speakers offer several advantages for the home builder. Most obvious is the simplified installation in a single speaker cutout. But, more important, the concentric mounting of all reproducing elements eliminates the problem of where to mount the midrange and/or tweeter reproducers for minimum phase distortion at the cross-over frequencies.

Our speaker system was put together without the need for cut-and-try efforts. Its very satisfactory performance can be described with one word—smooth. The enclosure dimensions chosen were the greatest of the three sets of figures given on the Electro-Voice data sheet that accompanied the speaker. This brings up a useful rule of thumb: Choose the largest possible enclosure

When installing speaker, do not overtighten hardware. Note duct behind the port which permits use of larger port.



Read information sheet packed in with speaker first. If size range is suggested, choose largest one possible.

size that is specifically recommended by the manufacturer to obtain the best results.

Here are some more construction hints that will help smooth the way. Use $\frac{3}{4}$ "-thick plywood with tight cores. Except for the removable rear panel, glue and screw together all joints. Use solid wood for glue blocks at the corners and for the cleats that hold the screws for the speaker and rear panels. Reinforce the panels, particularly the large ones, with braces. Mount the speaker off-center if possible to reduce standing waves in the enclosure. Install a 1"-or-greater thickness of fiberglass wool or other acoustical damping material on the rear panel and walls inside the enclosure to absorb the midrange and high-frequency sound and prevent its reflection through the speaker cone or the port. Guard against air leaks.

The only possible need for experimentation is in the amount of fiberglass to use. A fiberglass collar, stapled over the speaker, sometimes improves speaker damping.

The quality of a bass reflex enclosure depends upon proper design and sturdy construction. The loudspeaker manufacturer provides the design parameters. The audiophile who follows them need only concern himself with careful carpentry to prevent panel vibration and air leaks. A flair for originality can be expressed in external style and finish. ♦



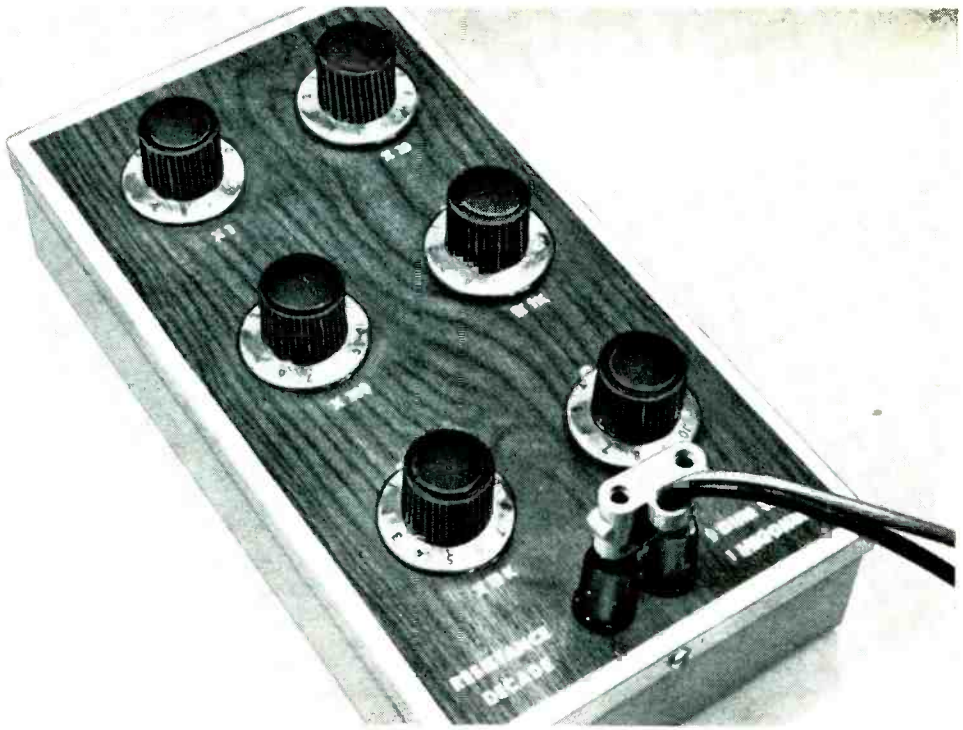

THE DIFFERENT **Resistance Decade**

Unusual, economical switching arrangement

BY JAMES A. FRED

THERE ARE several different approaches that can be taken to the design of a resistance decade box. One simply switches increasing values of resistors, while others use tricky switching arrangements that add four values of resistance (1,2,3, and 4) to make 10 units per switch.

All of these schemes have their drawbacks—from either a cost, production, or use standpoint. Take the case where four resistors are used to add up to 10. There are bound to be switching irregularities in this process since it is impossible to switch out

the one and two units and switch in the four units at the same time. The total resistance jumps during switching either a value below three or above four. Such a condition may not be important in many cases, but it may cause damage to a highly sensitive galvanometer or a delicate piece of electronic equipment.

Described here is a switching scheme for a resistance decade that solves many of the problems mentioned above and is simple and inexpensive to build. Six identical resistors are used in each decade to provide

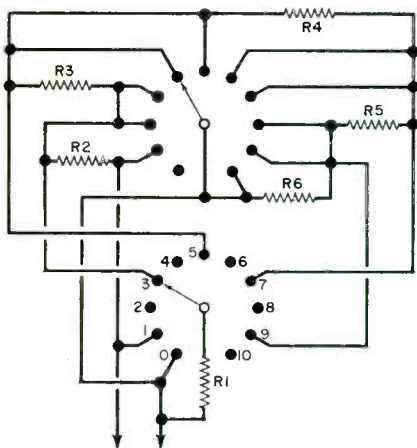

Fig. 1. Any number of decades can be made using this same circuit. Note that the two rotors are displaced one position apart.

PARTS LIST

For X1 decade:

R1-R6—2-ohm resistor (Mallory 3AE or Ohmite 995-3A)

For X10 decade:

R1-R6—20-ohm resistor (Mallory 3AE or Ohmite 995-3A)

For X100 decade:

R1-R6—200-ohm resistor (Mallory 3AE or Ohmite 995-3A)

For X1K decade:

R1-R6—2000-ohm resistor (Mallory 3AE or Ohmite 995-3A)

For X10K decade:

R1-R6—20,000-ohm resistor (Mallory 2MOL22k or Ohmite 995-5B)

For X100K decade:

R1-R6—200,000-ohm resistor (IRC RC2)

S1—Two-pole, 12-position rotary switch (one per decade)*

Misc.—Suitable chassis, knobs, five-way binding posts (2), wire, solder, etc.

* Available as JMSW1 from J & M Electronics, Rte 1, Box 28, Cutler, IN 46920 at \$4 each, \$3.00 each in lots of 6, postpaid. Indiana residents add 2% state sales tax.

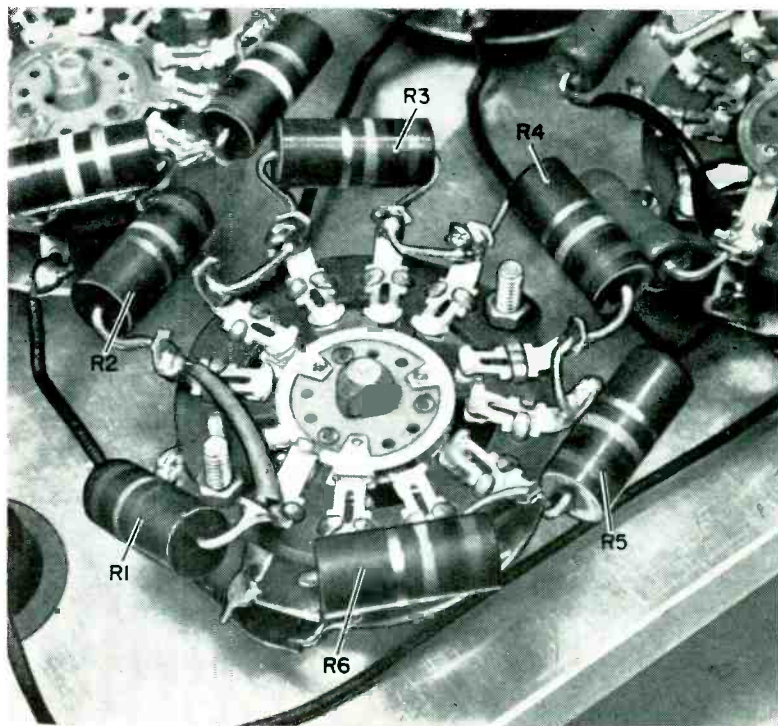

Typical switch showing how the associated resistors are mounted directly to the contacts. Make sure that each resistor is isolated from each of the others and from the chassis to insure against accidental shorts.

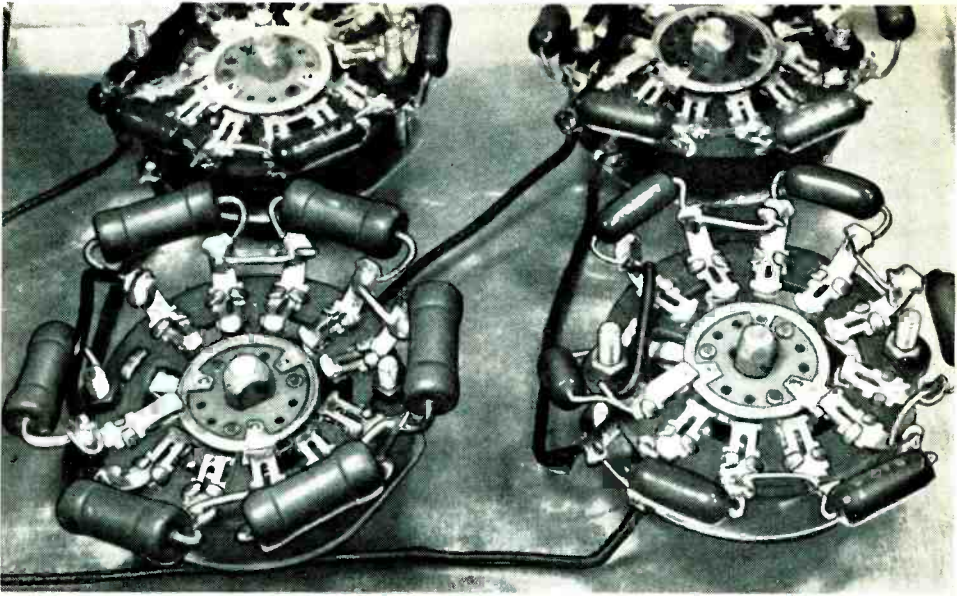

When building several decades, use resistors having same tolerance and wattage. Certain terminals on two wafers of each switch are stapled together. Note decade interconnections.

10 smooth equal steps. A schematic of one decade switch is shown in Fig. 1. The secret of the scheme is in the values of the resistors and in the switch arrangement. The rotors on the two wafers of the switch are offset by one place to provide smooth operation. The resistors are twice the value that would ordinarily be used for a particular decade. That is, for the $\times 1$ decade the resistors are all 2 ohms; for the $\times 10$ decade, they are 20 ohms; etc. To provide the even values (2, 4, 6, 8, and 10), the resistors are connected in series. To provide the odd values, the sixth resistor "floats" from one position to another so that it is in parallel with one of the other five, thus giving a resistance value equivalent to 1. Several factors must be taken into consideration when planning the decade box. First, the wattage of the resistors must be decided. This, of course, depends on where you are going to use the instrument. Then, the overall range of resistance must be determined. Six switches will produce resistance values in one-ohm steps from one ohm to one megohm. Eight switches will allow coverage from 0.1 ohm to 10 megohms.

The accuracy of the decade box must also be considered. Low-tolerance resistors cost more than higher tolerance types. However, 5% tolerance should prove adequate for general work.

Construction. The six-switch decade box shown in the photographs was constructed in a $5'' \times 9\frac{1}{2}'' \times 2''$ aluminum chassis having a removable top. The chassis size is not important as long as it can comfortably support the selected number of switches and the output five-way binding posts. Construction and operation will be greatly improved by the use of the special switch specified in the Parts List. This switch has its two sections staggered as required and has the proper terminals on each wafer stapled together to make the necessary electrical contact.

Wire the switches as shown in Fig. 1. Test each switch after completion with an ohmmeter. Connect the switch outputs in series. Make sure that resistors are not touching each other or the chassis. If high-wattage resistors are used, it is advisable to make several ventilation holes in the chassis. Mark the switch positions and the multiplication factor with press-on type. Once complete, use an ohmmeter to check the overall operation of the box.

To use, connect the decade box binding posts to the required external circuit and position the switches to obtain the total value of resistance required. The zero position of each switch forms a short across it, thus effectively removing it from the circuit. ♦

DECIBEL TABLE

Voltage Ratio (Equal Impedance)	Power Ratio	← - db + →	Voltage Ratio (Equal Impedance)	Power Ratio
1.000	1.000	0	1.000	1.000
0.989	0.977	0.1	1.012	1.023
0.977	0.955	0.2	1.023	1.047
0.966	0.933	0.3	1.035	1.072
0.955	0.912	0.4	1.047	1.096
0.944	0.891	0.5	1.059	1.122
0.933	0.871	0.6	1.072	1.148
0.923	0.851	0.7	1.084	1.175
0.912	0.832	0.8	1.096	1.202
0.902	0.813	0.9	1.109	1.230
0.891	0.794	1.0	1.122	1.259
0.841	0.708	1.5	1.189	1.413
0.794	0.631	2.0	1.259	1.585
0.750	0.562	2.5	1.334	1.778
0.708	0.501	3.0	1.413	1.995
0.668	0.447	3.5	1.496	2.239
0.631	0.398	4.0	1.585	2.512
0.596	0.355	4.5	1.679	2.818
0.562	0.316	5.0	1.778	3.162
0.531	0.282	5.5	1.884	3.548
0.501	0.251	6.0	1.995	3.981
0.473	0.224	6.5	2.113	4.467
0.447	0.200	7.0	2.239	5.012
0.422	0.178	7.5	2.371	5.623
0.398	0.159	8.0	2.512	6.310
0.376	0.141	8.5	2.661	7.079
0.355	0.126	9.0	2.818	7.943
0.335	0.112	9.5	2.985	8.913
0.316	0.100	10	3.162	10.00
0.282	0.0794	11	3.55	12.6
0.251	0.0631	12	3.98	15.9
0.224	0.0501	13	4.47	20.0
0.200	0.0398	14	5.01	25.1
0.178	0.0316	15	5.62	31.6
0.159	0.0251	16	6.31	39.8
0.141	0.0200	17	7.08	50.1
0.126	0.0159	18	7.94	63.1
0.112	0.0126	19	8.91	79.4
0.100	0.0100	20	10.00	100.0
3.16×10^{-2}	10^{-3}	30	3.16×10	10^3
10^{-2}	10^{-4}	40	10^2	10^4
3.16×10^{-3}	10^{-5}	50	3.16×10^2	10^5
10^{-3}	10^{-6}	60	10^3	10^6
3.16×10^{-4}	10^{-7}	70	3.16×10^3	10^7
10^{-4}	10^{-8}	80	10^4	10^8
3.16×10^{-5}	10^{-9}	90	3.16×10^4	10^9
10^{-5}	10^{-10}	100	10^5	10^{10}
3.16×10^{-6}	10^{-11}	110	3.16×10^5	10^{11}
10^{-6}	10^{-12}	120	10^6	10^{12}

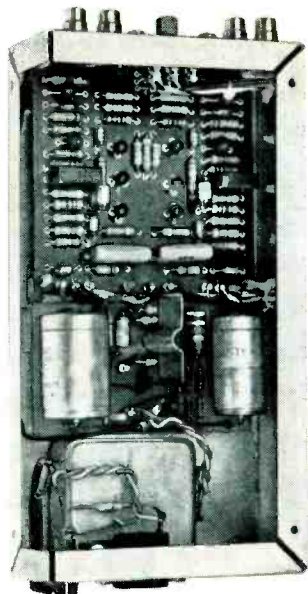

Build a Distortionless Preamplifier

PREPARING FOR FOUR CHANNEL?
YOU MAY WANT TO USE THIS PREAMP

BY JAMES BONGIORNO

THE ADVENT of four-channel stereo need not necessarily obsolete your present hi-fi system. Regardless of which four-channel system is finally agreed on as a standard, we feel that it's a safe bet that the conventional two-channel front end will remain and the four-channel decoding will take place after this stage. Therefore, it is more important than ever that the two-channel front end be of the best quality available. In essence, what you need is a noise-free, distortionless, nonoverloading amplifier that will follow the RIAA curve faithfully.

The phono preamplifier whose schematic is shown in Fig. 1 (only one channel is shown) comes as close to this "perfect" preamp as the state of the art permits. It is vir-

tually impossible to overload this unit with any cartridge presently available (at any frequency). The gain at 1 kHz is 42 dB (125 times) which means that even the most sensitive of cartridges may be used. But along with this high gain, the noise level is $0.7 \mu\text{V}$ referred to the input (63 dB below 1 mV). Since some audio measurements laboratories state noise as so many dB's below 10 mV, this unit has a figure of -83 dB below 10 mV, which makes it a very quiet operator.

The output level is about 12 volts rms; and below 4 volts output, the distortion is just about unmeasurable, rising to 0.1% at the 12-volt output. This high level of output is available across the audio band-

PARTS LIST PREAMPLIFIER

- Components common to both channels:
- C10—68- μ F, 3-volt 20% tantalum capacitor
 D1,D2—1N914 diode
 R18—43,000-ohm resistor
 S1—Dpdt slide switch
- Duplicate components in each channel:
- C1,C4—22- μ F, 60-volt, 20% tantalum capacitor
 C2—5 μ -pF, 5% polystyrene capacitor
 C3—33-pF, 5% polystyrene capacitor
 C5—0.47- μ F, 100-volt, 10% Mylar capacitor
 C6—330-pF, 5% polystyrene capacitor
 C7—5600-pF, 2% polystyrene capacitor
 C8—1650-pF, 2% polystyrene capacitor
 C9—47-pF, 5% polystyrene capacitor
 J1,J2—Phono jack
 Q1,Q3—2N4250 transistor
 Q2—2N5089 transistor
 R1,R14,R16—47,000-ohm, 2% resistor
 R2,R3—390-ohm, 10% resistor
 R4—1-megohm, 10% resistor
 R5—62,000-ohm, 5% resistor
 R6—Selected (see text)
 R7—22,000-ohm, 5% resistor
 R8,R17—470-ohm, 2% resistor
 R9—681,000-ohm, 1% resistor
 R10—3900-ohm, 5% resistor
 R11—2700-ohm, 5% resistor
 R12—1000-ohm, 10% resistor
 R13—2.2-megohm, 1% resistor
 R15—2200-ohm, 1% resistor
 (All resistors are $\frac{1}{2}$ watt.)

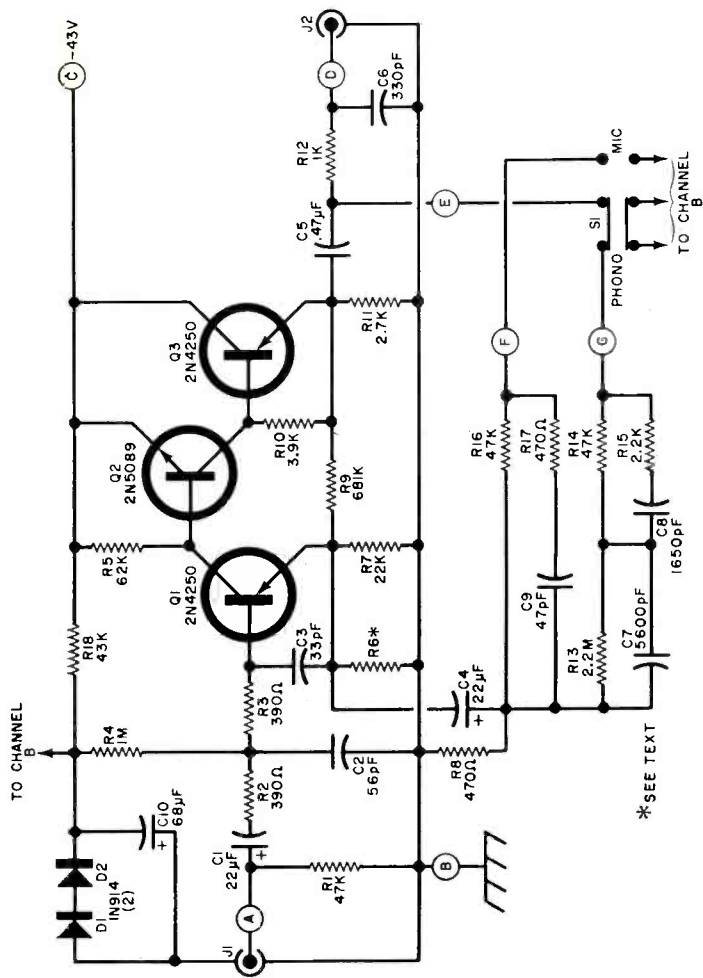

Fig. 1. This is the schematic for one channel of the preamp. Power supply, which is common to both, is shown in Fig. 3.

width of 20 to 20,000 Hz. The feedback loop maintains the frequency response flat to within ± 0.5 dB of the ideal RIAA curve. There is also a switch to change the feedback loop to provide a flat response for use with an optional microphone input.

Construction. The foil pattern shown in Fig. 2 covers both channels of a stereo pair. The component indications are the same for both channels, with *R18*, *C10*, *D1* and *D2*, and *S1* common to both channels.

The schematic of the power supply for the amplifier is shown in Fig. 3. It would appear at first glance to be somewhat elaborate but it is essential that the system be free of hum since the amplifier gain at 60 Hz is almost 60 dB. For the same reason, transformer *T1* is a fully shielded toroid. In addition to the -43 volts used in the amplifier, the supply also provides -47 volts for powering other circuits. The regulator will handle up to 100 mA. The foil pattern and component layout for the power supply are shown in Fig. 4 on page 56.

Fig. 2. Foil pattern shown below is for both channels of the preamp. Component layout is shown at right.

With only the power supply operating, connect a voltmeter between terminal K and ground. The indicated voltage should be -47 volts. If it is a little higher, connect a 40,000- to 60,000-ohm resistor across *R23* to bring the voltage down to -47 . If you have a sensitive millivoltmeter, check to see that the noise at this terminal is below 200 μ V. There should be no ripple at all when the output voltage of the supply is viewed on a scope.

Before mounting either the power supply

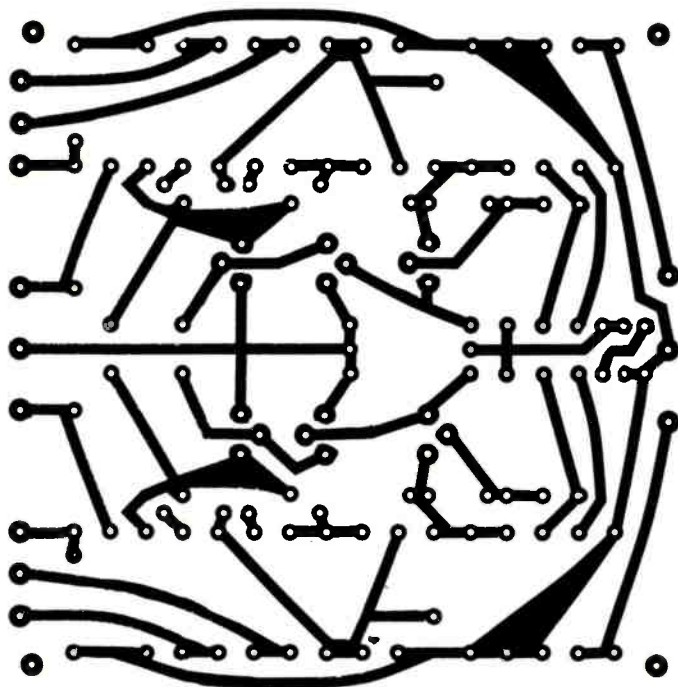
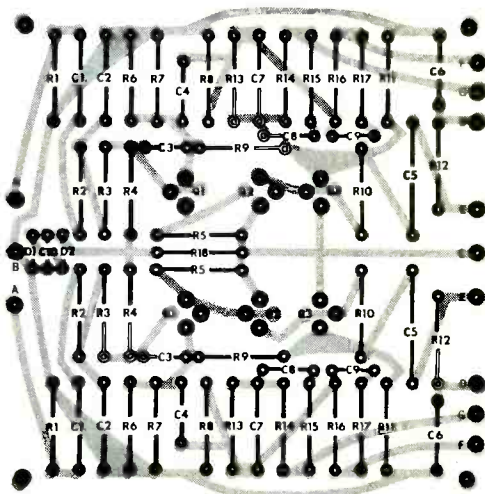

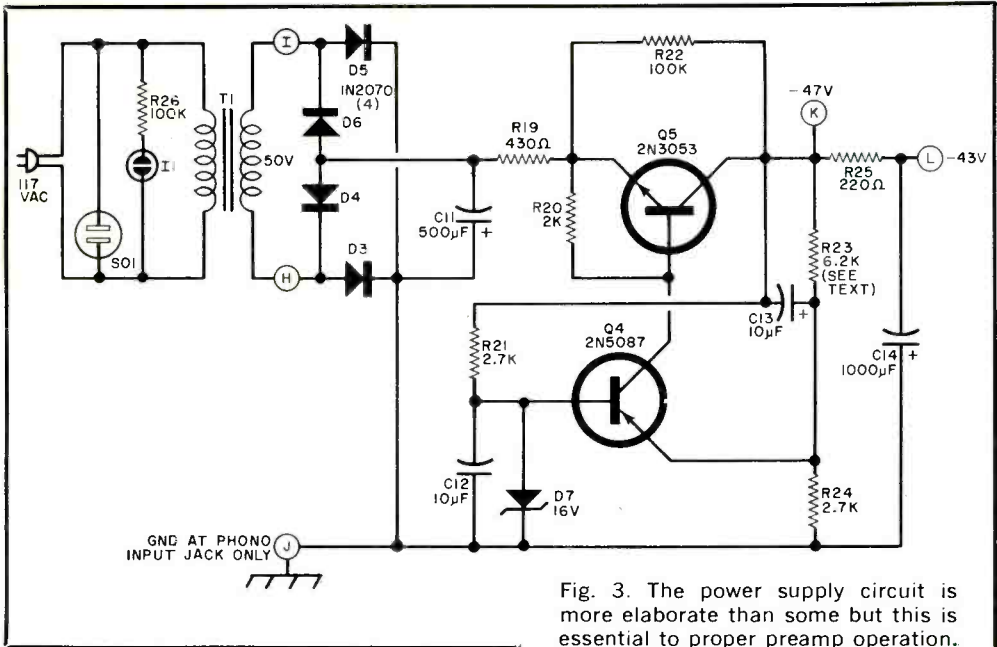
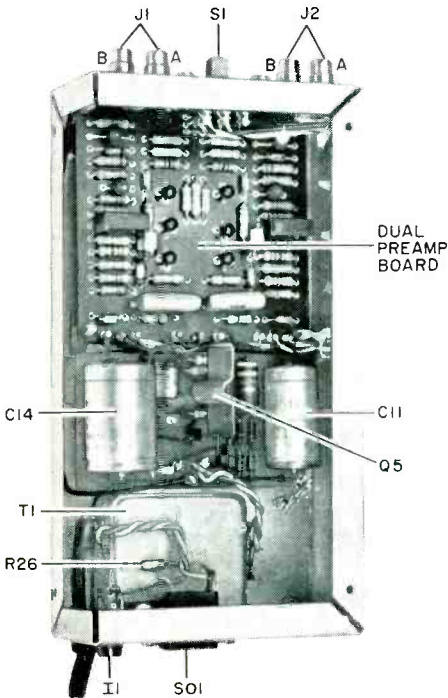

Fig. 3. The power supply circuit is more elaborate than some but this is essential to proper preamp operation.

PARTS LIST POWER SUPPLY

- C11—500-µF, 70-volt electrolytic capacitor*
- C12—10-µF, 16-volt tantalum capacitor*
- C13—10-µF, 35-volt electrolytic capacitor*
- C14—1000-µF, 50-volt electrolytic capacitor*
- D3-D6—1N2070 diode*
- D7—16-volt, 1-watt, 2% zener diode*
- I1—117-volt neon lamp*
- Q4—2N5087 transistor*
- Q5—2N3053 transistor*
- R19—430-ohm, 2-watt, 5% resistor*
- R20—2000-ohm, 10% resistor*
- R21,R24—2700-ohm, 5% resistor*
- R22,R26—100,000-ohm, 20% resistor*
- R23—6200-ohm resistor (see text)*
- R25—220-ohm resistor*
- S01—117-volt chassis mount receptacle*
- T1—Shielded toroid transformer; 50V at 100 mA*
- Misc.—Pilot lamp holder, line cord, rubber feet, (4), suitable chassis (Bud CU-482), heat sink for Q5 (Wakefield 296-4), terminal strip, mounting hardware, etc.*
- Note: Transformer T1 is available from James Bongiorno, c/o Bullock Magnetics, 2805 Metropolitan Place, Pomona, Calif. 91767 for \$14.50 plus postage for 1 lb.*



Preamp board and power supply should not be mounted in chassis before conducting the tests as described in text.

or the preamp in the chassis, interconnect the two boards, with terminal L of the supply to terminal C of the preamp, and terminal J of the supply to B on the preamp. Connect a dc voltmeter between the junction of C5 and R11 (negative) and ground (positive) in one channel. Turn on the

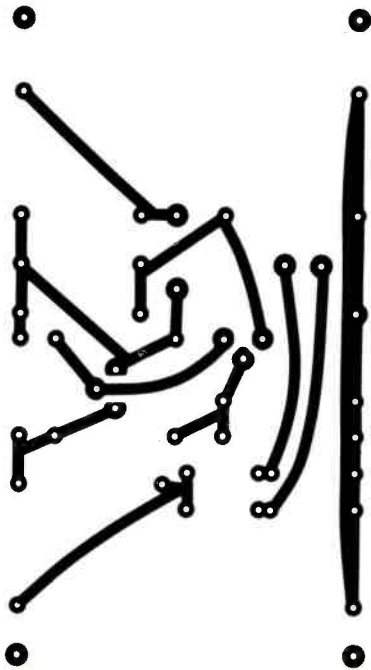

power and wait until the voltage being measured reaches a maximum—it will take a minute or more. Temporarily connect a fixed resistor (between 50,000 and 80,000 ohms) where $R6$ is supposed to be in this channel. The resistor should be such that the voltage being measured is as close as possible to -21.5 volts. Do the same for the other channel; then recheck the first channel as the two are slightly interactive. Once both channels have 21.5 volts at the junc-

PROJECT EVALUATION HIRSCH-HOUCK LABORATORIES

The preamplifier does just about what the designer claims for it. Gain measurements, in general, were within 0.5 dB of the author's claims and show a loss of only 1.4 dB at 20 Hz relative to the extrapolated RIAA curve. Phono overload occurs at a very safe 110 millivolts, and the clipping level from the output is 14.7 volts, something of a record in our experience.

Distortion is really negligible, typically 0.013 to 0.03% over most of the useful range of the amplifier (even up to 10 volts output). The measurement of 0.31% at 125 millivolts output was partly hum and partly noise, but both were extremely low. The combined hum/noise output was about 100 microvolts.

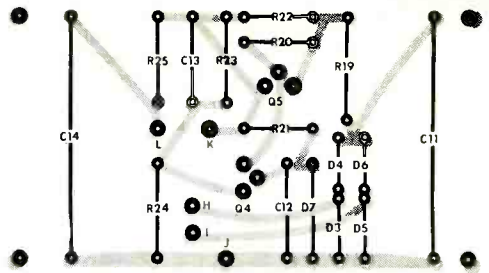

Fig. 4. Except for T1 and components in its primary, power supply is laid out (above) on the board (at the left).

tion of $C5$ and $R11$, solder in both $R6$'s. When installing the amplifier board, use one of the input jack chassis connections as the common ground, making this the only chassis connection. The ground wire to the pow-

TECHNICAL SPECIFICATIONS

Gain: 60 dB at 20 Hz, 42dB at 1kHz, 23 dB at 20 kHz; all within 0.5 dB of RIAA.

Gain with Microphone: within 0.5 dB from 20 to 20,000 Hz.

Sensitivity: 0.8 millivolt rms with 100 millivolts output.

Noise: 0.7 microvolt unweighted (RIAA bandwidth referred to shorted input).

Maximum Output before Clipping: 12 volts rms, 20 to 20,000 Hz.

Input Overload: 13 mV at 20 Hz, 100 mV at 1 kHz, 850 mV at 20 kHz.

Distortion: Unmeasurable at 1-volt output, increasing gradually to about 0.2% at clipping.

er supply should be removed and a ground wire run from the power supply point J to the selected input jack.

Mount the shielded transformer on the chassis, and place the heat sink on transistor Q5 of the power supply. The physical arrangement of the other chassis components and connectors is not critical.

Operation. To use the preamplifier in your present stereo system, simply plug the turntable signal cables into the input jacks (I1) and run the output jacks (J2) to the AUX inputs of your amplifier. Don't forget to phase all the ac plugs to get the lowest hum. If you find that you need a ground on the turntable chassis, run a wire from it to the mounting screw closest to the preamplifier input jack that was selected as the common ground. ♦

don't miss...

the next issue of the magazine that gives you the most exciting build-it-yourself projects anywhere.

ELECTRONIC EXPERIMENTER'S HANDBOOK

You can always count on ELECTRONIC EXPERIMENTER'S HANDBOOK. Published twice each year by the editors of Popular Electronics, it's the one publication that helps you get it together . . . with a score of build-it-yourself projects.

The next all-new edition, 1975 Winter, goes on sale nationally September 19, 1974.

It will again be packed with features and articles and complete lab-tested instructions that are sure to guarantee successful hours and months of mind absorbing projects for fun and practicality.

This offer is being made to readers of the HANDBOOK and POPULAR ELECTRONICS Magazines only.

Regular price is \$1.25; mail order price \$1.60. You can reserve your copy now at this special pre-publication price of only \$1 by completing the Reservation Form and returning it promptly along with your remittance. The 1975 Winter ELECTRONIC EXPERIMENTER'S HANDBOOK will be mailed to you on or before publication date from first-off-the-press copies.

YOU CAN RESERVE YOUR COPY NOW AT THE SPECIAL MONEY-SAVING PRE-PUBLICATION PRICE OF ONLY \$1.00 POSTPAID.

PRE-PUBLICATION RESERVATION FORM ▶

Electronic Experimenter's Handbook, Ziff-Davis Service Division, 595 Broadway, N.Y., N.Y. 10012.

Enclosed is \$1.00. Please reserve my copy of the 1975 Winter ELECTRONIC EXPERIMENTER'S HANDBOOK at this special pre-publication price, to be mailed to me from first-off-the-press copies on or before September 19, 1974.

Print Name _____

Address _____

City _____

State _____

Zip _____

PLEASE ENCLOSE PAYMENT WITH ORDER

AN IMPROVED FOUR-WAY FLASHER

AVOID THE PITFALLS OF MOST COMMERCIAL UNITS

BY DONALD R. HICKE

NOW THAT ALL NEW CARS are required to have emergency flashing-light systems, owners of older cars will want to add similar systems to their cars. There is a wide variety of do-it-yourself kits available for the purpose. Some are better than others, but nearly all of them have operational quirks that, for one reason or another, make them less than ideal.

For instance, one cheap kit consists of nothing more than a switch which is installed so that, when it is on, all four turn-signal lights flash in unison when the turn lever is moved to either position. This arrangement has two serious faults. First, the flasher mechanism in the car was designed to handle only two lamps, and the additional load imposed by the added pair shortens its life. This could eventually leave the driver with no flashing lights at all. Secondly, and

more important, flashing stops if the brakes are applied. This could have serious consequences during those first critical moments when the car is being positioned at the side of the road.

The better commercial kits are called "emergency flashers" and they contain a fuse, a heavy-duty flasher, and an indicator light. The flasher output is connected to all four turn-signal lamps to flash them together. The main disadvantage to this unit is that it also is inoperative when the brakes are applied. In another kit the indicator lamp is connected to one of the rear turn-signal lamps, which of course doubles as a brake light, and the "emergency" indicator comes on whenever the brakes are applied. This is very annoying for night driving.

An improved four-way flasher system is shown in the schematic. The main difference is in the manner of connecting the FLASH-OFF switch and indicator lamp. The switch connects the flasher to the stop light and to the front parking lights for emergency flashing. It also opens the normal circuits to these lights so that applying the brakes or turning on the parking lights does not stop the flashing. The indicator lamp monitors the parking lights instead of the brake lights and serves as a warning signal in case the parking lights are inadvertently left on.

The improved four-way flasher may be constructed in a small metal box and fastened under the dash. A much neater arrangement, however, is to mount the switch and indicator lamp right on the dash and locate the flasher and fuse out of sight. To avoid confusion with other indicator lights on the dashboard, be sure to use a different colored lens over the flasher indicator. ◆

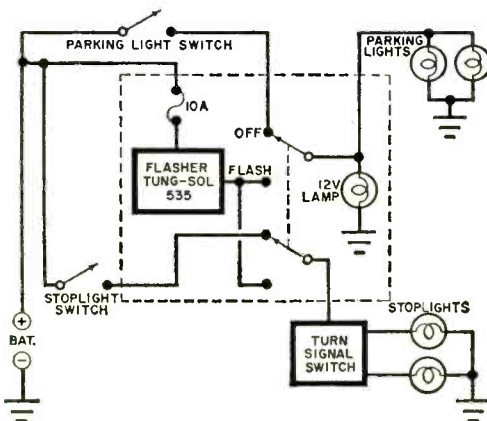

Components to be added to the standard automotive circuit shown inside dashed-line box.

Tuner for the Neglected Band

BUILD THIS COMPANION
TUNER FOR THE
LICENSE-FREE TRANSMITTER
DESCRIBED ON PAGE 14

BY JIM WHITE, W5LET

ON PAGE 14, we described a one-watt transmitter for the 160-190-kHz band. Now we will discuss a companion long-wave tuner.

The circuit, shown in Fig. 1, uses four conventional vacuum tubes and requires only an audio amplifier and antenna to make it a top-notch receiver. Headphones can be connected directly to the audio output if desired. Both *V1* and *V2* are r-f amplifiers and are adjusted to the same frequency as the transmitter you will be receiving.

The very low power of the transmitter makes it necessary to have a sensitive tuner, so two r-f stages are used. Also, two r-f stages provide a better rejection of strong BCB signals that can creep into a low-frequency converter. The use of two fixed tuned stages also eliminates the problem of tracking, with its increase in cost.

Following the two r-f stages is *V3*, a converter stage, where the input frequency is changed to 455 kHz. This is then amplified by *V4*. Diode *D1* is both the AM detector and a-gc device. The power supply is a conventional half-wave type.

The two r-f transformers, *T2* and *T3*, are conventional 262-kHz types with trimmer capacitors to bring their frequency down to the 160-190-kHz range. The antenna coil, *T1*, is a TV horizontal width coil with 30 turns of #28 enameled wire added as the coupling coil.

The tuner has three controls: *R15* for audio gain, *R18* for r-f gain, and *S2*, the standby switch. The ac control switch, *S1*, is mounted on *R15*.

Construction. The prototype of the tuner was built on a 7" × 9" × 2" aluminum chassis (the same as the transmitter) and the general layout is shown in Fig. 2. The large holes for tubes, transformers, etc. were made with chassis punches, while all the smaller holes were drilled. Mount the components so that interconnecting leads are as short as possible. A number of terminal strips were used below the chassis to support most of the components. The trimmer capacitors for *T2* and *T3* were soldered directly to the appropriate terminals on the transformers.

The 30 turns of #28 wire on *T1* are wound directly on top of the coil and in the same direction as the turns on the coil. When wiring *T6*, the oscillator coil, be sure to follow the manufacturer's recommended connections or the converter will not oscillate.

Adjustments. With the power turned on, make sure that all four filaments heat up, and carefully check for the presence of

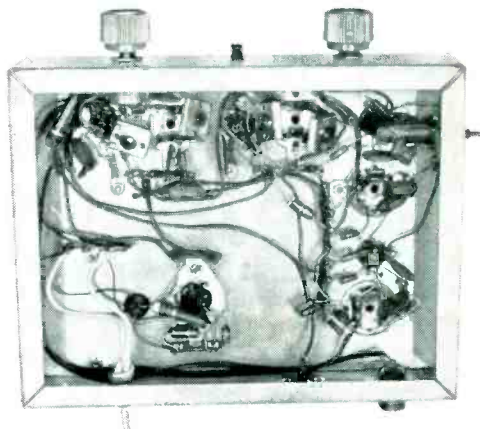

This bottom view of the tuner shows how point-to-point wiring was used. The adjustment for *T6*, the oscillator coil, is near the top right corner.

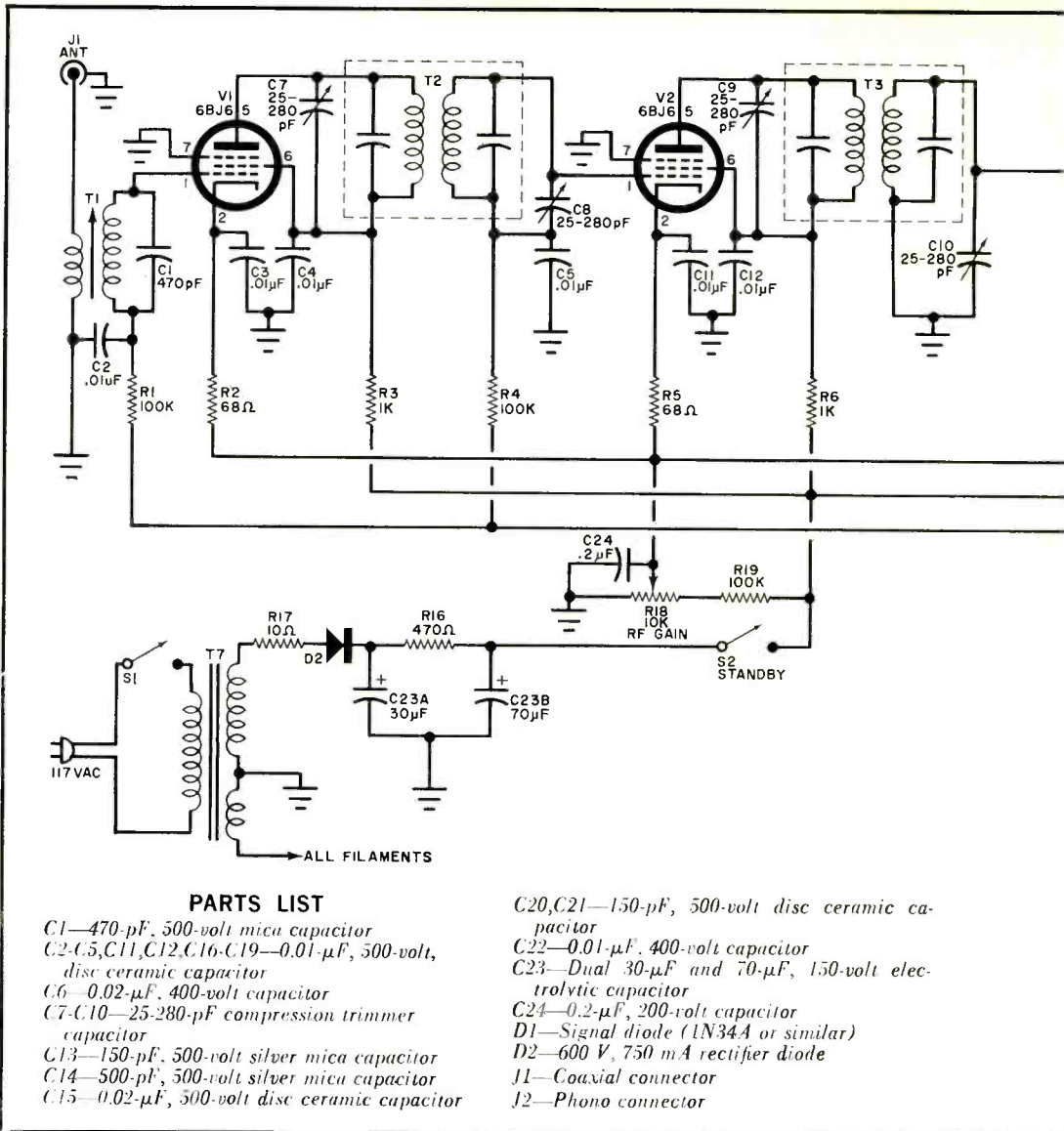

plate and screen voltage on the tubes. Connect an audio cable from J2 to an audio amplifier. The first adjustment is that of T6, the oscillator coil. This can be made by using a conventional BCB radio in close proximity to the receiver. Assume you want to tune to 175-kHz. Add this to the i-f frequency (455 kHz) and the result is 630 kHz. Tune the BCB radio to 630 kHz and slowly adjust the slug of T6 until you hear the signal from the oscillator. Lock the T6 slug with a jam nut or a drop of cement on the threads.

The other adjustments can be made in

one of two ways: if you have a well-calibrated oscillator that tunes to 160-190 kHz, things will be simplified; or if you have built the companion transmitter, you can use it. In either case, connect a VTVM across C6 (in the a-c line) with the negative lead to the line. Now with the appropriate long-wave signal injected into the antenna circuit, you should get some indication on the meter. Adjust C7, C8, C9, and C10 for a maximum indication. Then adjust the slugs of T1, T4, and T5 to further increase the meter indication. You may have to decrease the signal generator output or

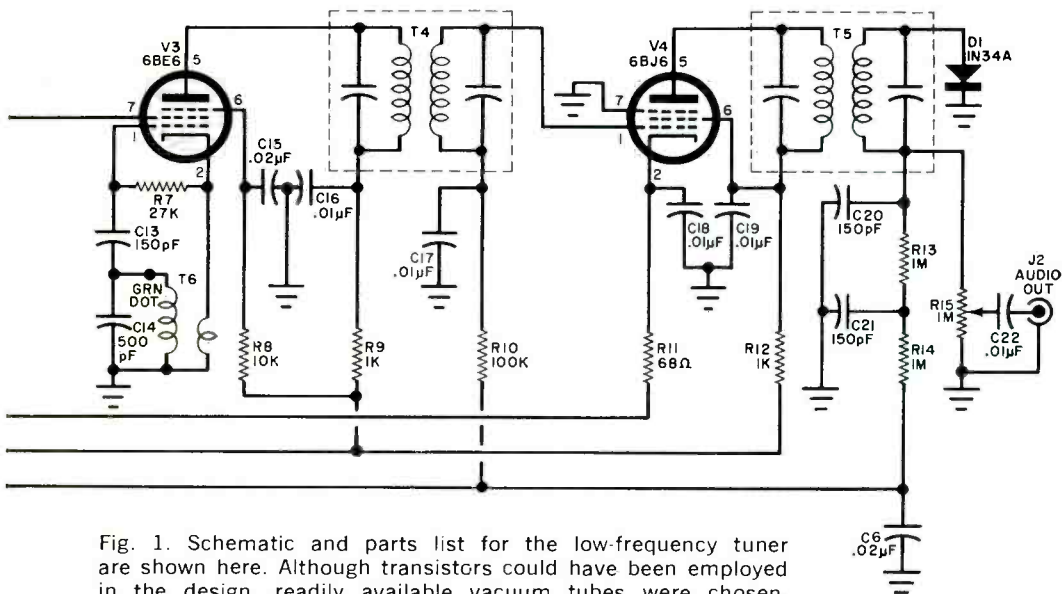

Fig. 1. Schematic and parts list for the low-frequency tuner are shown here. Although transistors could have been employed in the design, readily available vacuum tubes were chosen. Note that two r-f stages (V1 and V2) were used in design because the power of the transmitter requires a very sensitive tuner. The converter stage is V3, and V4 is the amplifier.

- R1, R4, R10—100,000-ohm, 1/2-watt resistor
 R2, R5, R11—68-ohm, 1/2-watt resistor
 R3, R6, R9, R12—1000-ohm, 1/2-watt resistor
 R7—27,000-ohm, 1/2-watt resistor
 R8—10,000-ohm, 1/2-watt resistor
 R13, R14—1-megohm, 1/2-watt resistor
 R15—1-megohm, audio taper potentiometer with switch S1
 R16—470-ohm, 2-watt resistor
 R17—10-ohm, 1-watt resistor
 R18—10,000-ohm, 2-watt linear taper potentiometer
 R19—100,000-ohm, 1-watt resistor
 S1—Spst switch on R15
 S2—Spst slide or toggle switch
 T1—TV width coil, 0.5-5 mH (Miller 6313 or similar)

- T2, T3—262-kHz miniature i-j transformer (Miller 12H1 or similar)
 T4, T5—455-kHz miniature i-j transformer (Miller 12C1 or similar)
 T6—Oscillator coil Meissner 14-1028 broadcast type
 T7—Transformer; secondaries: 125 V at 50 mA and 6.3 V at 2 A
 V1, V2, V4—6BJ6 tube
 V3—6BE6 tube
 Misc.—Chassis (Bud AC406 or similar), 7-pin miniature tube socket (4), knobs, terminal strips, ground lugs, rubber grommets, line cord, mounting hardware, short lengths of #28 enameled wire for T1, short length of thin coaxial cable for antenna connector.

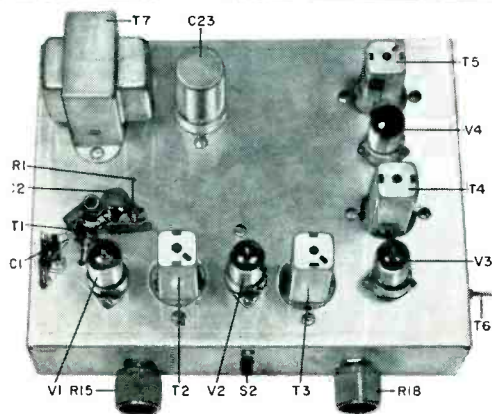

Fig. 2. This view of the top of the tuner shows how components were arranged on chassis for the prototype.

move the transmitter farther away to keep from overloading the receiver.

Operation. With the low-frequency tuner properly aligned and with a long antenna connected to it, adjust the audio gain (R15) for a comfortable level and operate the r-f gain control (R18) so that the received signal does not overload the receiver. To use the transmitter and tuner together, you can interlock the standby switches. ♦

CONSTRUCTING PC BOARDS

USEFUL TECHNIQUE TO MAKE PROFESSIONAL-LIKE PRINTED CIRCUITS

BY ROBERT A. SULLIVAN & ROBERT S. BRODSKY

MAKING your own printed circuit board has never been a particularly easy job; but the rewards of doing so are great. You save time and money; and you get a real feeling of satisfaction from having accomplished the task. Not, of course that it's all that difficult. A number of kits for making PC boards are available commercially—varying as to the degree of complexity involved in the technique and the quality of the final result.

It is not always necessary, however, to have a complicated layout to make a good PC board. Described here is a technique that combines many of the best features of different kit manufacturers. The non-camera photographic technique (generally agreed upon as the best approach) requires a minimum investment in equipment and is virtually "goof-proof."

The procedure involves five basic steps: laying out the etching guide, making a film positive of the layout, making a negative of the positive, printing the negative pattern on a sensitized PC board blank, and etching and drilling the board. The procedure is much less complicated than it sounds and you will be able to make a commercial-quality board on your first try.

Basic Materials Needed. Before you can begin making a printed circuit board, you must have on hand a few basic items. Table I lists the most important. In addition, not listed in Table I but a basic necessity is a

supply of sensitized PC board blanks (see Table II). There are three types available. Epoxy fiberglass has the best electrical and

Fig. 1. Reproduction of printed page shows how patterns are presented in magazine, making the first step easy.

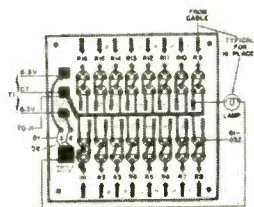
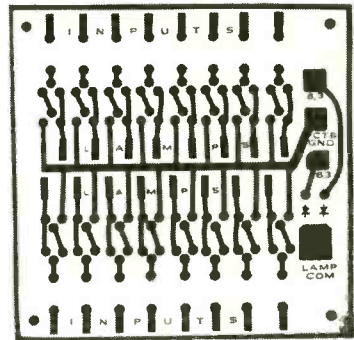

Fig. 2. Actual size foil pattern (above) and component installation (left) for a 15-terminal tester. If you need only 14 terminals, two end circuits are removed and two leads taken from 16-lead cable.

1/2" spacers with the two rows 15" apart. Drill the lamp holes just large enough for a screw fit with the lamp assembly. Determine which way the display is to be observed and make a conspicuously larger dot at the number 1 lamp (pin). You can also outline the lamps with an 18 layout, being sure to include the

notch between pin 1 and pin 14. Use permanent black ink.

With the lamps installed, solder one end of each lamp to the common ground solder pad on the foil pattern. Then, being very careful, solder the other leads to their respective solder pads that are connected to the transistors

mechanical properties, but it is also the most expensive by a wide margin. Polyester boards can yield electrical properties as good as the epoxy-fiberglass type, but they tend to warp—a difficulty which can be overcome by storing them flat. The phenolic board is the least expensive. It is adequate for all but the most critical projects. Its tendency to chip during drilling (which applies to the polyester board to a lesser degree) can be circumvented by careful and patient work.

For almost all projects, a $\frac{1}{16}$ "-thick board blank with 1-ounce copper cladding on one side will suffice. Buy fairly large board blanks, which cost less per square inch.

A photo reversing kit (such as the one from Kepro) is needed to make the film negative. The kit generates a total of 480 square inches of film negative for about \$7.00. Film and developer are available separately. (The developer supplied with the photo reversing kit is expensive, however 70% methyl—NOT propyl—alcohol works just as well and costs considerably less.) Very carefully read and follow all instructions which you will find on a sheet packed with the film.

You will also need a solution for developing the exposed PC board. Purchase this in gallon quantities if you plan on doing a lot of PC work.

Etchant is used to remove the unwanted copper from the developed board blank. This solution contains ferric chloride which permanently stains virtually anything it touches and corrodes most metals. Handle it with care. Again, buy by the gallon.

Layout materials come next. They include self-adhering black dots and black tape, dry-transfer decals which can be used to title and number component locations on the board (an option you can do without if you are on a tight budget), and sheet acetate for the layout base. For the latter, select clear, untreated acetate in a medium or heavy weight.

Kepro recommends that you use a No. 2 photoflood lamp for exposing the negative and board blank, but if you cannot find this item, a standard 150-watt reflector lamp, available at any drug store, can be substituted. Add to your shopping list two 9" × 5½" × 2" Pyrex dishes, to be used for developing and etching the board, and a small plastic funnel for replacing reusable chemicals in their containers.

Filter paper is an option which can pay for itself in the long run. Use it to periodically filter the accumulation of photoresist out of

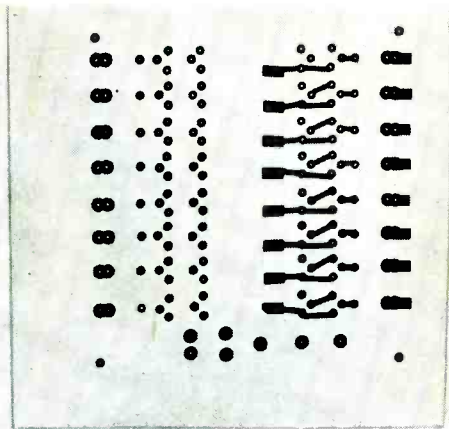

Fig. 2. Typical pattern on plastic sheet. Remaining lines must be added.

the developer. Cotton swabs with long wooden handles are a must. They are required for developing the film negative, and the handles can be used to lift the board out of the etchant.

A black ink designed for touching up photographic film can be used to correct layout errors on the film negative. And for errors caught before the board is etched, you should have on hand a supply of rub-on resist and a bottle of paint-on resist for corrections.

Finally, you will need No's. 60 and 67, $\frac{1}{16}$ ", and $\frac{1}{8}$ " drills, all of them high-speed types. The No. 67 drill is particularly useful for drilling IC lead holes.

Step-By-Step Procedure. You will most likely be interested, at least at first, in duplicating an actual size PC board from a magazine etching guide. In this case, the hard job of laying out the conductor pattern (see Fig. 1) has been done for you. Lay a piece of acetate sheet over the etching guide and fix it in place with masking tape or staples. You are now ready to make the film positive.

Begin your layout by pasting solder pads on the acetate, matching the dot sizes reasonably close as shown in Fig. 2. After all the pads are in place, put a piece of paper over the layout and use the back of a spoon to burnish them down.

Next, use the black crepe tape to interconnect the pads according to the published layout, again matching widths. It is also a good idea to make a border with the tape (see Fig. 3) to assist in trimming the board after it is etched. When positioning the tape strips, allow $\frac{1}{16}$ " of width for each 5 amperes of current they must handle and $\frac{1}{32}$ " minimum

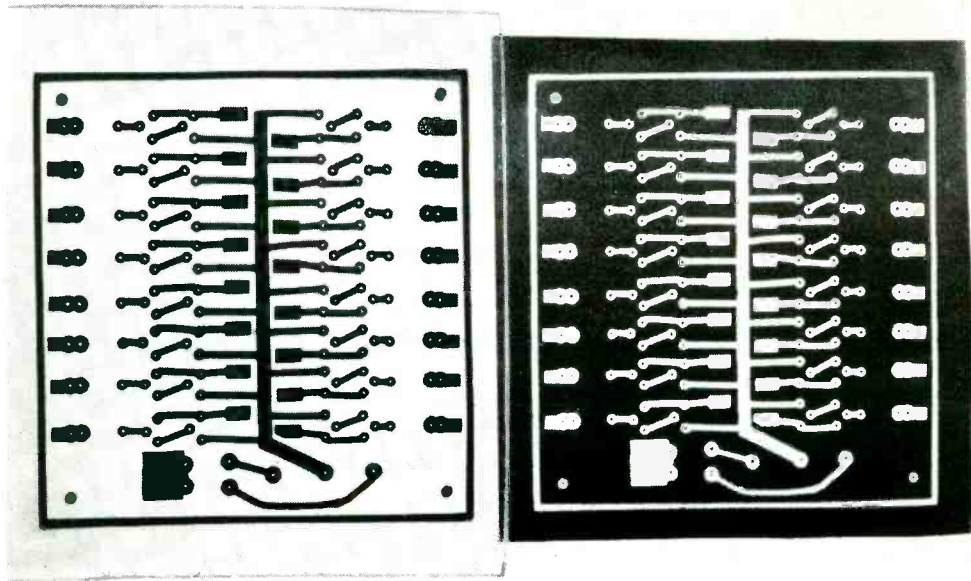

Fig. 3. At the left, the lines and border needed for Fig. 2 have been added to the plastic sheet. Then negative is made by photographic process (right).

spacing between strips. Burnish down the strips.

Remove the acetate positive from the layout and very carefully compare the two for accuracy. A mistake now is difficult to correct later. This done, turn off all fluorescent lighting, if any, in your work area. Place a lamp equipped with a 15-watt bulb and shade (to diffuse the light) 8 feet or more away from the work area. Turn on the lamp and extinguish all other lighting in the room. From now until you finish developing the board, this is the only lighting there should be in your work area.

Open the reversing film container and remove the instruction sheet packed inside. Carefully read the instructions provided. Then, remove the reversing film and cut off enough to make your negative. Immediately return the rest of the film to its light-tight container and seal the container with masking tape.

Place the reversing film, emulsion side down on a sheet of clear glass. Over this, place and center your positive. Complete the sandwich with another sheet of glass. If you are using the No. 2 photoflood lamp, expose the negative as instructed. But if your exposing medium is a 150-watt reflector lamp, exposure time will be about 3½ minutes at a distance of 12 inches.

After exposing the film for the recommended time, shut off the exposing lamp.

TABLE I—MATERIALS REQUIRED

Material	Cat. No.*	Price
PC Board Developer		
1 pint	D-1PT(K)	\$1.15
1 gallon	D-1G(K)	5.50
Etchant (Ferric Chloride)		
1 pint	E-1PT(K)	0.85
1 gallon	E-1G(K)	3.50
Resist Paint (Black)		
1 pint	R-1PT(K)	2.25
Photo Reversing Kit	FK-701(K)	7.20
Photo Reversing Film		
10" × 24"	RF-1024(K)	3.00
20" × 24"	RF-2024(K)	5.40
Reversing Film Developer		
1 pint	RFD-1PT(K)	2.25
Layout Pads		
250 (0.293 × 0.031)	D137(B)	3.00
250 (0.100 × 0.031)	D101(B)	3.00
250 (0.156 × 0.031)	D103(B)	2.00
IC Pads		
250 (14-pin DIP)	6014(B)	7.55
Black Tape		
20 yd (0.125" wide)	T201/.125(B)	0.75
20 yd (0.062" wide)	T201/.062(B)	0.75
20 yd (0.031" wide)	T201/.031(B)	0.75

*Catalog numbers followed by (K) are available from Kepro Circuit Systems, Inc., 3630 Scarlet Oak Blvd., St. Louis, MO 63122; those followed by (B) are available from Bishop Graphics Inc., 7300 Radford Ave., North Hollywood, CA 91605. Items are also available from distributors such as Allied Electronics and Newark Electronics.

TABLE II—BOARD BLANKS

Material	Cat. No.*	Price
Phenolic Base		
3" x 3"	S1-33	\$0.58
3" x 6"	S1-36	0.90
4" x 6"	S1-46	1.06
6" x 6"	S1-66	1.52
7" x 10"	S1-710	2.72
12" x 12"	S1-1212	5.36
Polyester Base		
3" x 3"	S1-33M	0.60
3" x 6"	S1-36M	0.94
4" x 6"	S1-46M	1.12
6" x 6"	S1-66M	1.62
7" x 10"	S1-710M	2.88
12" x 12"	S1-1212M	5.72
Epoxy Base		
3" x 3"	S1-33G	0.84
3" x 6"	S1-36G	1.44
4" x 6"	S1-46G	1.66
6" x 6"	S1-66G	2.58
7" x 10"	S1-710G	4.80
12" x 12"	S1-1212G	9.64

*Kepro Circuit Systems, Inc., 3630 Scarlet Oak Blvd., St. Louis, MO 63122.

Note: All are 1/16" thick, clad on one side only with 1-ounce copper with photosensitized resist coating.

Next, use a swab and the film developer to remove all unwanted emulsion as shown in Fig. 4. Move the swab back and forth, using enough developer to keep the film wet. In a few seconds, the unwanted green coating will begin to dissolve. Continue swabbing until all of the exposed emulsion has dissolved; wash and hang the negative up to dry.

If your board blank must be trimmed to size before being exposed, sandwich it between two sheets of heavy, opaque paper and seal the edges with masking tape. Then use a nibbling tool to trim the blank to size. Immediately seal with masking tape the ex-

Fig. 4. Remove the exposed emulsion with a swab and developer solution.

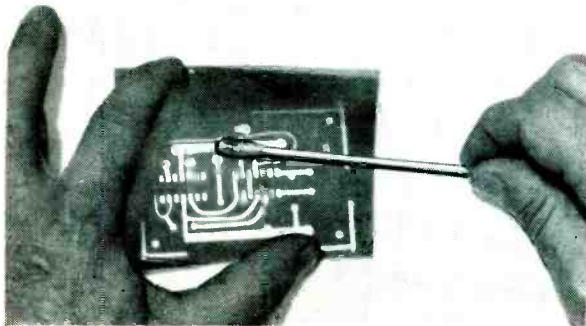

posed edges of the portion to be saved and return it to its light-tight envelope.

Now, sandwich the board (copper side up) and film negative between the two sheets of glass, and expose the board according to Kepro's instructions for the No. 2, or for 3½ minutes at 12" for the reflector lamp.

Pour board developer to a depth of ½" into both Pyrex dishes. Handling it carefully only by edges, place the board into the developer and gently rock the dish back and forth for 2 minutes. Still handling it by its edges, remove the board from the dish and lay it on a protected flat surface where the developer on it can evaporate undisturbed. Meanwhile, pour the used developer into a non-plastic (preferably glass) container labelled "used developer." Thoroughly rinse the dish.

When the board is completely dry, inspect it to see if the developer has done its work. You should be able to see clearly the photo-resist pattern on the copper. If necessary, place the board into the dish containing the clean developer and rock the dish for 45 seconds. Remove the board and again allow it to dry undisturbed. You can now turn on the regular lighting in the room. When it has dried completely, carefully inspect the board's resist pattern. Repair any messy or incomplete areas with rub-on or paint-on resist.

The board is now ready to be etched. To do this, pour etchant to a depth of ½" for small and ¾"-1" for medium to large boards into a Pyrex dish. Float the board, copper side down, in the resist. It will take about an hour for the etchant to completely remove the unwanted copper, but you should check the progress every 10 or 15 minutes. Do not rinse the board until the entire etching process is complete. When the etching process is complete, however, thoroughly rinse the etchant off under running water. Then remove the resist with fine steel wool and follow up with a cleaning in soapy water.

Do not try to economize on etchant. Once used, it should be discarded by pouring it in a slow, lazy stream down the drain with plenty of running water. Let the water continue to run for about 15 seconds after all the etchant is gone and the dish has been thoroughly cleaned.

The final steps in fabricating your PC board are drilling component lead and mounting holes and trimming to final size. If desired, you can rub onto the component side of the board dry-transfer legends to identify component locations. ♦

BUILD A SIGNAL DIFFERENCE STEREO BALANCE METER

EXACTLY BALANCES
OUTPUTS OF BOTH CHANNELS
FOR PERFECT STEREO
SOUND REPRODUCTION

BY J. R. LAUGHLIN



MOST audiophiles invest considerable effort and money into building their home stereo systems. Often, however, they are so concerned with wide frequency response, minimum distortion, and good channel separation, that proper amplitude balance of stereo channels is overlooked.

The "Signal Difference Stereo Balance Meter" described here, when connected to the stereo system's amplifier outputs, provides a means of quickly and accurately balancing stereo channels and gives a continuous readout of the various functions of the stereo signal. The Balance Meter is passive and requires no power supply.

The meter used here is a standard type commonly found in the broadcasting and recording industries. The face of the meter has two scales: one reading VU (volume units) from -20 to $+3$; the other showing voltage percentages from 0 to 100 , with 100% voltage coinciding with the 0 point on the VU scale. (An internal rectifier drives the dc meter movement.) The normal level for volume units is at 0 VU.

Volume units are numerically equal to the number of decibels above the reference level of 1 mW of power into a 600 -ohm load. The use of an uncalibrated level control and the omission of special circuits to compensate for loads other than 600 ohms great-

ly simplifies the hardware requirements of the Balance Meter. Of course, absolute power measurements are impossible without the aid of special calibration procedures; but, for any setting of the level control, accurate relative variations in audio amplitude will be displayed in dB on the meter scale.

Theory of Circuit Design. As shown in Fig. 1, $T1$ is a step-up transformer that boosts the input from the amplifier to provide a driving signal for $M1$. This gives the Balance Meter great sensitivity, even at low volume levels, without the need for active amplifiers. Level control $R1$, in series with $M1$, permits on-scale readings over a wide range of volume levels.

Function switch $S1$ connects the primary of $T1$ to the input circuit in the appropriate manner to provide four signal configurations for driving the meter movement. In the L and the R positions, the primary is simply connected to the input selected, while grounding the unwanted input.

The $L-R$ is obtained by connecting the primary of $T1$ to both "hot" lead outputs from the amplifier, without completing the circuit to ground. If the channels contain identical signals, there is no indication on $M1$. On the other hand, with a stereo

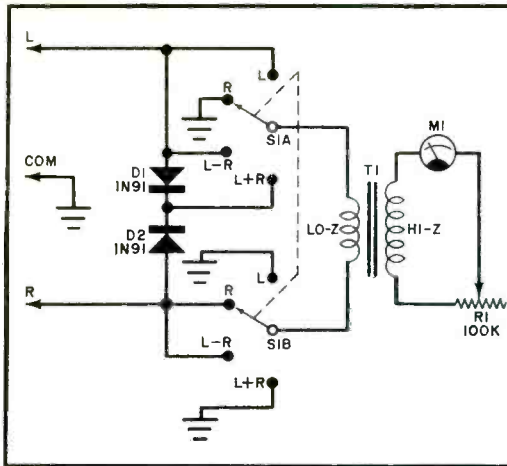

PARTS LIST

- D1, D2—1N91 diode (do not substitute)*
- M1—VU meter movement (Calestro No. D1-930 or similar)*
- R1—100,000-ohm, audio-taper potentiometer*
- S1—Double-pole, 4-position, nonshorting rotary switch*
- T1—Interstage transistor transformer with 5:1 impedance ratio (Triad T24X, Stancor TA35, or similar)*
- Misc.—Chassis box (LMB No. 453N or similar); three-conductor cable; control knobs (2); spade lugs (3); rubber feet; rubber grommet; panel and cabinet finishing materials; hook-up wire; solder; etc.*

Fig. 1. Circuit of the Balance Meter is basically a step-up system which drives meter. Diodes provide isolation.

signal, current will flow through *T1* in proportion to the *difference* signal.

The *L + R* function is derived by connecting the primary of *T1* to the "hot" outputs of both amplifier channels and completing a circuit to ground through *D1* and *D2*. Thus, the meter reads a *sum* signal.

Construction. Since the circuit (Fig. 1) of the Balance Meter is very simple, a circuit board and complicated wiring techniques are not needed.

Begin construction by machining the front panel of the cabinet to be used so that it will accommodate the meter movement, function switch, and level control. Then carefully finish the panel with a coat of paint or with adhesive-backed vinyl to complement your present system. This done, use a dry-transfer lettering kit to apply the legends for *S1* and *R1*; use black letters on light backgrounds and white letters on dark backgrounds. Then, to protect the lettering during use, spray a *thin* coat of clear Krylon over the entire front panel; allow to dry. Follow up with another coat or two of the Krylon. Note: Do *not* apply one heavy coat of the Krylon and let it go at that. A heavy coat will simply dissolve the lettering.

Now mount the meter movement, switch, and potentiometer in their respective cut-outs on the front panel. Referring to both Fig. 1 and Fig. 2, wire together all components and cables. When wiring *T1* into place, remember that the high-impedance side goes to the meter circuit. The polarities of *D1* and *D2* are not important as long as they are connected together either in an

anode-to-anode or a cathode-to-cathode configuration. Wiring up *S1* can be a bit tricky; so, be careful when working on the switch.

After passing the input cable through a rubber-grommet-lined hole in the rear panel of the chassis and connecting it at one end to the appropriate lugs on *S1*, connect and solder spade lugs to the free ends. The spade lugs facilitate easy and dependable connections to the amplifier.

As with the front panel, pains should also be taken to make the cover of the Balance Meter blend with the rest of your equipment. You can use contact cement to apply a cloth-backed vinyl upholstery material to the cover. Then finish up by assembling the cabinet and attaching rubber feet to the bottom of the chassis.

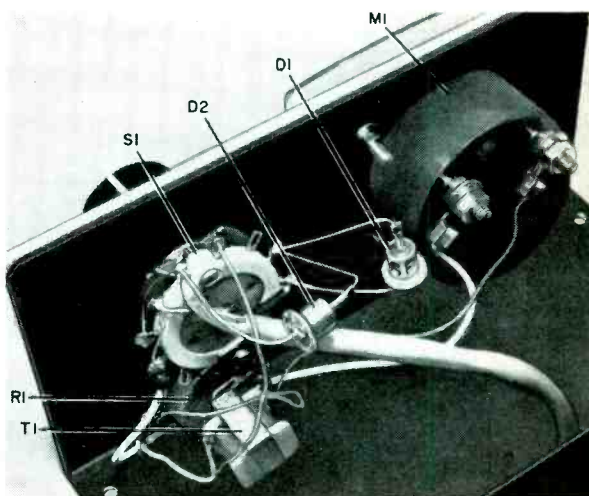

Fig. 2. Components are mounted on lugs of switch, potentiometer, and meter.

Setup and Use. Preliminary checkout is best accomplished with the aid of an audio generator. But if a generator is not available, you can use one channel of your stereo system for the tests.

First, place *SI* in the *L* position and connect the *L* and *COM* input leads to the generator's hot and ground outputs, respectively. With the generator turned on, the *VU* meter's pointer should deflect, and the deflection should change as you change the setting of the level control.

With *RI* fully clockwise, the most sensitive position, the signal level required for full-scale deflection of the meter pointer should be less than 0.4 volt rms. This signal should also be read on the *VU* meter with *SI* set to *L + R*. (It may be slightly less due to the drop across *D1*.)

Repeat the above procedure with the Balance Meter's *R* and *COM* inputs connected to the generator's hot and ground outputs and *SI* set to *R*. Check also to see that the signal is read in the *L + R* position of *SI*. Here, again, a slight reduction may be noticed as a result of the voltage drop across *D2*.

To check out the *L - R* function, place *SI* in the *L - R* position and ground the *R* input lead to *COM*. A reading should be obtained with the generator connected between the *L* and *COM* input leads. Likewise, the same reading should be obtained with the *L* input lead grounded to *COM* and the generator connected between the *R* and *COM* input leads. Now, tie the *L* and *R* input leads together, connect them to the

hot output of the generator, and connect the ground of the generator to the *COM* lead. If a zero reading is obtained on *MI* with this test and all previous checks are correct, the Balance Meter is ready to use.

Locate the Balance Meter close to the amplifier with which it is to be used and in a position where it can easily be observed. Then connect the input cable to the appropriate output terminals on the amplifier. (Note: In some amplifiers, especially those which provide speaker phase switching for one of the channels, use of the Balance Meter is not recommended. To determine whether or not it is safe to use the Balance Meter with your amplifier, study the amplifier's schematic diagram; if the outputs share a common reference line—and *only* if they do—it is safe to use this instrument.)

With the Balance Meter properly installed, readings should be obtained on *MI* with the function switch in the *L*, *R*, and *L + R* positions. A stereo signal will provide readings in the *L - R* position. To exactly balance the amplifier, switch to the mono mode so that identical program material is fed into each channel. Rotate the balance control on the amplifier to a position where the *VU* meter nulls to the left index of the scale.

Now, adjust *RI* fully clockwise to obtain maximum sensitivity. At maximum sensitivity, it might be difficult to obtain a perfect null, especially if the volume level is fairly high. Differences in bass or treble response in each channel will cause small deflections of *MI*. Some amplifiers incorporate separate clutched controls for bass and treble adjustments. In these amplifiers, adjust the controls to obtain the best possible null. If your amplifier has a switch to take the controls out of the system to provide a flat response, put the switch in the flat position.

When using a tape playback deck or record player with the amplifier, precise balance of the entire system can be obtained by use of a full-track prerecorded test tape or a test record that produces equal output amplitude on each channel. As the tape or record is being played, first switch the amplifier to mono and balance it as outlined above. Then switch to the stereo mode and adjust the tape recorder balance control for best possible null. This will balance the system from the tape heads or pickup cartridge forward. ♦

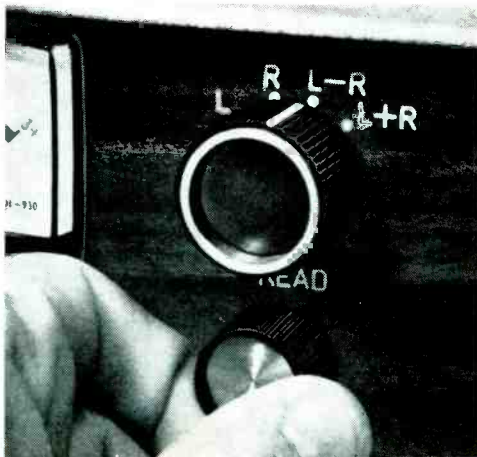

Mark *SI* positions to agree with circuit wiring. Finish front panel to coordinate with other system components.

Why a Sylvania home training program may be your best investment for a rewarding career in electronics

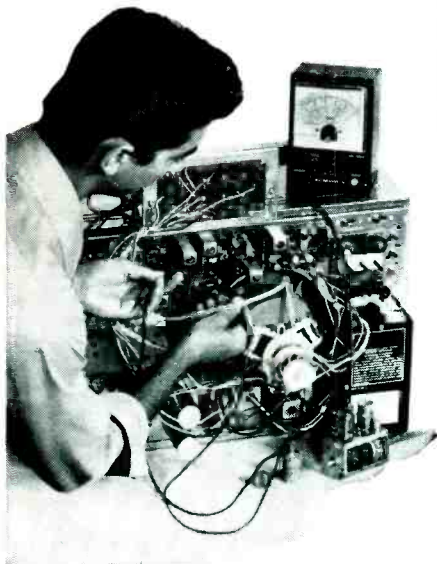

In the Master TV/Radio Servicing Program, you build and keep the all solid-state black and white TV set, the color TV set, the oscilloscope and multimeter shown above.

1 LEADER IN ELECTRONICS TRAINING

Over the years, Sylvania Resident Schools have trained thousands of men and women for key positions in the electronics field. Now, through Sylvania Home Training, you can receive the same high-quality career training at home. In your spare time. While you hold your present job.

2 AUTOTEXT TEACHES YOU ELECTRONICS RAPIDLY, EASILY.

AUTOTEXT, offered exclusively by Sylvania, is the proven step-by-step method of home training that can help you learn the basics of electronics quickly and easily.

3 CASSETTE SYSTEM

This innovative learning-by-hearing approach is a special option that adds an extra dimension to AUTOTEXT. It's almost like having an instructor in your own home. As you play the cassette tapes, you'll have an instructor guiding you through your AUTOTEXT lessons. Explaining the material as you read it. All in an easy-to-understand, conversational tone.

4 SPECIALIZED ADVANCED TRAINING

If you're already working in electronics or you have previous training, you can start on a higher level without wasting time on work you already know.

5 PERSONAL SUPERVISION THROUGHOUT

All during your program of home study, your exams are reviewed and your questions are answered by Sylvania instructors who become personally involved in your efforts and help you over any "rough spots" that may develop.

6 HANDS-ON TRAINING

To give practical application to your studies, a variety of valuable kits are included in many programs. In Sylvania's Master TV/Radio Servicing Program, you will actually build and keep an all solid-state black and white TV set, and a color TV set. You also construct an oscilloscope which is yours to keep and use on the job.

7 FCC LICENSE TRAINING MONEY BACK AGREEMENT

Take Sylvania's Communications Career Program — or enter with advanced standing and prepare immediately for your 1st, 2nd, or 3rd class FCC Radio Telephone License examinations. Our money-back agreement assures you of your money back if you take, and fail to pass, the FCC examination taken within 6 months after completing the course.

8 CONVENIENT PAYMENT PLANS

You get a selection of tuition plans. And, there are never any interest or finance charges.

SYLVANIA TECHNICAL SCHOOL

Sylvania Technical Systems, Inc.
Home Study
909 Third Avenue
New York, N.Y. 10022

Please send me FREE illustrated career catalog. I understand that I am under no obligation.

Name _____

Address _____

City _____

State _____ Zip _____

Age _____

Veterans Check here 222-402-01

GTE SYLVANIA

CIRCLE NO. 9 ON READER SERVICE CARD

BUILD A ZENER DIODE SUBSTITUTION BOX

SIMULATES A ZENER
DIODE FROM 1.2 TO
18 VOLTS WITH POWER DISSIPATION
TO SIX WATTS

BY STANLEY SULA

MOST experimenters are aware of the zener diode's usefulness and versatility. However, the fact that a single zener diode can provide only one value of zener voltage is a characteristic which may discourage experimentation with this very useful device. The trouble of buying a new diode every time a different voltage is required in an experimental circuit can be quite expensive and frustrating.

The Zener Diode Substitution Box described here is a very worthwhile project for those who experiment with circuits involving zener diodes. The substitution box provides a continuously variable zener breakdown from approximately 1.2 to 18 volts, with a power dissipation of up to six watts. Using all new parts, it can be constructed easily for less than \$10. The device's electrical characteristics are identical to those of a high-quality zener diode.

Construction. Due to the simplicity of the circuit (Fig. 1), point-to-point wiring can be used. Parts layout is not critical. The maximum power dissipation of the circuit varies from ½ watt to 6 watts, depending on whether or not Q1 is provided with a heat sink. With no heat sink, maximum dissipation is approximately ½ watt. With a "slip-on" fin-type heat sink, dissipation is about 1 watt; and for six watts, a heavy-duty heat sink is necessary.

If power dissipation is to be no more than 1 watt, the unit can be built in a 4" × 2 7/8" × 1 1/2" plastic enclosure. For a higher dissipation, a larger enclosure will be required.

Do not use a carbon-composition potentiometer for R2. Even the so-called "linear taper" potentiometers of this type can be grossly nonlinear and their use can lead to a

very nonlinear voltage scale. For reasonable linearity at low cost, a wirewound pot must be used. For a small enclosure, be sure to use the miniature VW-type Mallory potentiometer given in the Parts List to leave enough room for the battery.

Theory of Operation. The circuit is a high-gain Darlington amplifier, with a negative bias supply which normally keeps the transistors in their nonconducting state. The bias is varied by R2 from 1.2 to 18 volts. Note that one end of the bias supply (the wiper arm of R2) is connected to Q2's base, while the other end is connected to one of the input terminals. Thus, the voltage across the input terminals is bucked by the bias voltage so that, as long as the bias exceeds the input, the net voltage on Q2 is negative and the transistors do not conduct. However, as soon as the positive input exceeds the negative bias by 1.2 volts, the transistors turn on and present a very low resistance between the input terminals.

Transistors Q1 and Q2 will not conduct until a positive voltage of 0.6 appears across each of their emitter-base junctions. This sets the minimum of 1.2 volts for the lowest zener voltage attainable with this circuit.

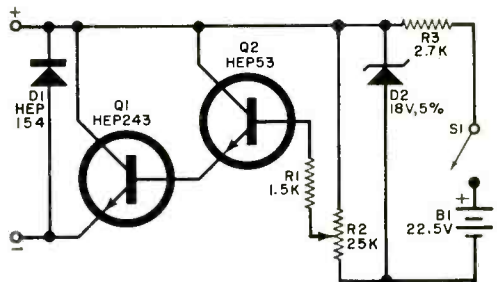

Fig. 1. Darlington amplifier switches on when voltage at the input bucks out preset bias. With proper heat sink on Q1, dissipation can be 6 watts.

PARTS LIST

- B1—22½-volt battery (Eveready #112)
- D1—1-A, 50-volt diode (HEP154)
- D2—18-volt zener diode (HEPZ2522)
- Q1—Transistor (HEP243)
- Q2—Transistor (HEP53)
- R1—1500-ohm, ½-watt resistor
- R2—25,000-ohm, 5-watt wirewound potentiometer (Mallory VW-25K)
- R3—2700-ohm, ½-watt resistor
- S1—Spst slide switch
- Misc.—Enclosure, 5-lug terminal strip, heat sink (see text), knob, battery holder (Keystone #177), hardware, etc.

Diode $D1$ simulates the forward characteristics of a zener diode and also protects $Q1$ and $Q2$ from reverse polarity voltages.

Calibration. The calibration circuit is shown in Fig. 2. The voltmeter should be capable of measuring down to one volt accurately. Turn the voltage-selector dial ($R2$) on the substitution box fully clockwise (minimum resistance). This should give a meter reading close to 1.2 volts. Slowly turn the dial until the meter reads 2 volts. Make a graduation mark on the dial at this point. Continue rotating the dial until the meter indicates 3 volts and make another dial marking. Continue until you reach the highest attainable voltage. This maximum voltage will be between 18 and 20 volts, depending on the exact value of $D2$. To complete the dial marking at the lower end, make a mark for 1 volt a distance below 2 volts that is approximately the average of the distance between other voltage markings.

Operation. Since the circuit of the substitution box duplicates the characteristics of a zener diode so closely, it is used exactly as you would use a regular zener diode. As

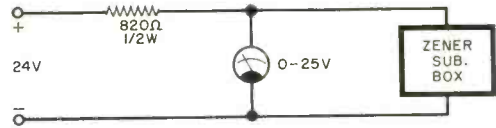

Fig. 2. To calibrate the dial on $R2$, use dc voltmeter capable of indicating down to about 1 volt accurately.

with any such diode, when connecting it into a circuit, always be sure that there is sufficient series resistance to prevent exceeding the power dissipation limits. This minimum series resistance can be calculated from the formula $R = E_z E_s / P$, where R is the minimum series resistance, E_z is the zener voltage, E_s is the difference between the zener voltage and the source voltage, and P is the maximum power dissipation in watts.

Needless to say, switch $S1$ should be turned off when the unit is not in use, though the battery drain is only about 2.5 mA. Incidentally, with $S1$ turned off, the device acts as a 1.2-volt zener regardless of the setting of the voltage dial. However, the zener voltage knee in this case is not as abrupt as it is with the switch on and the voltage dial set to 1.2 volts. ♦

The Mark Ten B Capacitive Discharge Ignition System keeps your car in tune ... and everyone knows that a well-tuned car gets better mileage, requires less maintenance, runs longer and better, and helps in the quest for cleaner air.



... Just ask Detroit

Order your Mark Ten B today! Please send me free literature.

Enclosed is \$ _____ Ship p.p.d. Ship C.O.D.
 Please send _____ Mark Ten B, assembled, @ \$59.95 p.p.d. _____ Mark Ten B Kit @ \$44.95 p.p.d.
 (12 Volt Negative Ground Only) • _____ Standard Mark Ten, assembled @ \$44.95 p.p.d.
 6 Volt: Neg. Ground Only _____ 12 Volt: Specify _____ Pos. Ground _____ Neg. Ground
 _____ Standard Mark Ten Deltakit* @ \$29.95 p.p.d. (12 Volt Positive or Negative Ground Only)
 Car Year _____ Make _____

DELTA PRODUCTS, INC.



Name _____ Zip _____
 Address _____
 City/State _____

Dept. ETH - P.O. Box 1147 - Grand Junction,
 Colo. 80501 (303) 242-9000

CIRCLE NO. 6 ON READER SERVICE CARD



One Second **METRONOME TIMER**

VISIBLE AND AUDIBLE INDICATIONS FOR YOUR DARKROOM

BY A. A. MANGIERI

ONE THOUSAND AND ONE . . . one thousand and two . . . one thousand and three . . . that's the familiar method of counting off the seconds for camera and enlarger exposures when a mechanical or electrical timer is not available. This method is not very accurate. For example, if you are in a big hurry, your count may speed up; or if you are tired, it may slow down. What you really need is a timer that is insensitive to emotions and fatigue.

The photographer's visual/audio One-Second Metronome Timer fills the bill. It paces your second count so that your film and paper exposures can be uniform. To

accomplish this, the timer provides an audible "click" and a simultaneous flash of light every second. All you do is count the number of clicks and/or flashes.

How it Works. Transistor *Q1*, in Fig. 1, is a Motorola HEP S9001 "programmable" unijunction transistor or PUT, a special type of SCR. The anode gate (AG) of *Q1* is at a voltage determined by voltage divider resistors *R4* and *R5*. When *S1* is closed, *Q1* is initially in the non-conducting state.

Voltage at anode A begins to build up as timing capacitor *C1* charges up through

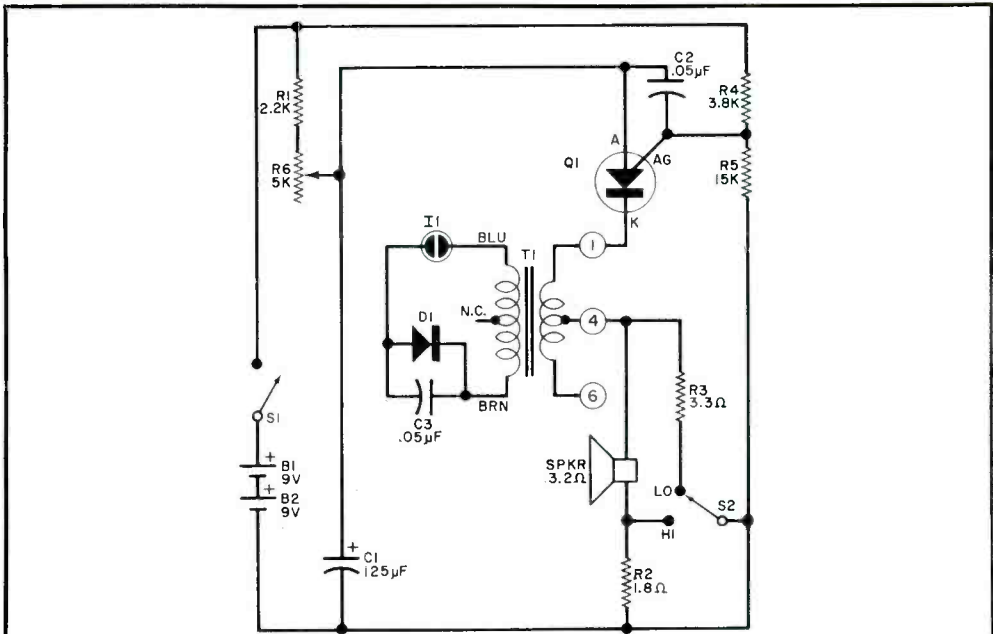

Fig. 1. Circuit is essentially a relaxation oscillator using a programmable UJT or PUT. The turns ratio between the low-impedance winding (connected to the UJT cathode lead) and the high-impedance winding (connected to neon lamp) of T1 causes lamp to flash with each audible "tick" of speaker.

PARTS LIST

B1,B2—9-volt battery
 C1—125- μ F, 35-volt electrolytic capacitor
 C2,C3—0.05- μ F disc capacitor
 D1—1-ampere, 200-volt silicon diode (Motorola HEP-156 or similar)
 I1—NE-51H high-intensity neon lamp
 Q1—PUT (HEP S9001 or similar)
 R1—2200-ohm
 R2—1.8-ohm
 R3—3.3-ohm
 R4—3800-ohm
 R5—15,000-ohm
 R6—5000-ohm potentiometer (Clarostat Type U39, or similar)

all resistors
 $\frac{1}{2}$ -watt

S1—Spst slide or toggle switch
 S2—Spdt slide or toggle switch
 SPKR—3.2-ohm, 2 $\frac{1}{2}$ "-square speaker
 T1—8-watt universal speaker transformer; 2000-14,000 ohm push-pull plate to voice coil (Allied Electronics 6W1511FL or similar)
 Misc.—Dialco No. 95-9110 lamp socket with red dome, less resistor for I1; 4 $\frac{1}{2}$ " x 3 $\frac{1}{4}$ " x 3" aluminum chassis box; perforated phenolic board and push-in solder terminals; rubber feet; hardware; hookup wire; solder; etc.

timing resistors R1 and R6. When the voltage at the anode builds up to slightly more than the voltage at AG, Q1 goes suddenly into conduction and allow C1 to discharge rapidly through T1 and the speaker's voice coil.

The sudden discharge of C1 through T1 generates a high-voltage spike across the secondary of the transformer, briefly lighting I1. Diode D1 and capacitor C3 enhance the brightness of the lamp's glow and the duration of the flash. The speaker produces an audible click simultaneously with the flash of I1.

As each click and flash occur, the volt-

age across C1 drops to a low level and Q1 ceases to conduct. The cycle then repeats itself as long as S1 is closed.

Resistors R4 and R5 set the Q1 stand-off ratio and valley current for high circuit efficiency. Capacitor C2 is an r.f. or noise bypass to prevent premature turn-on of Q1 by nearby electrical interference. Switch S2 provides HI and LO level audio selection.

Construction. It is imperative that a metal case be used to house the timer circuit to shield it thoroughly from electrical noise pickup. A 4 $\frac{1}{2}$ " x 3 $\frac{1}{4}$ " x 3"

aluminum chassis box easily accommodates all parts.

First perforate the front of the box with a $\frac{1}{8}$ " drill (or cut out a $2\frac{1}{4}$ " opening and use a screen grille) for the speaker. Then determine how and where you plan to mount each part and assembly, and machine the box accordingly. A suggested layout is shown in Figs. 2 and 3.

Start assembly by mounting *T1* and the battery clamp on the rear wall of the box. Then mount the components on a $2\frac{1}{2}$ " \times $2\frac{1}{4}$ " piece of perforated phenolic board with push-in terminals, and bolt the board in place.

Mount the lamp socket, switches, and speaker in their respective locations on the front of the box. Wire together all components, referring to Fig. 1. Make sure that the leads of *C3* and *D1* in the high-voltage secondary side of *T1* do not touch other wires or components. Lengths of plastic tubing slipped over these leads will prevent accidental short circuits.

When the circuit is completely assembled, set *R6* for about mid-range. Set *S1* to on and listen for the click and observe the brightness of the flashes, with *S2* set in the LO position. If the click is too loud or the flash level is too bright, you can omit battery *B2* and operate the circuit on only one 9-volt battery. In either position of *S2*, if the flash level is not bright enough, try reversing the diode. Use the connection that provides the brightest flash. Also, if you prefer an audio-off position, omit *R2*.

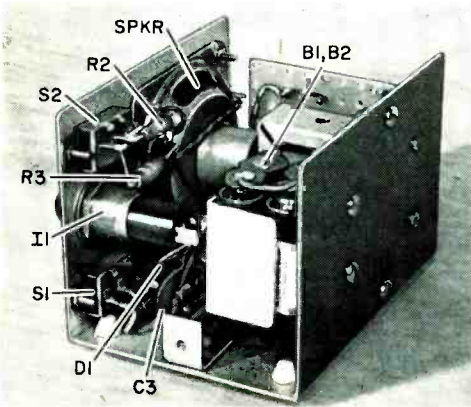

Fig. 2. If you arrange the components properly, they will easily fit within small chassis. Metal is used to prevent external noise from false triggering of UJT, causing timing errors.

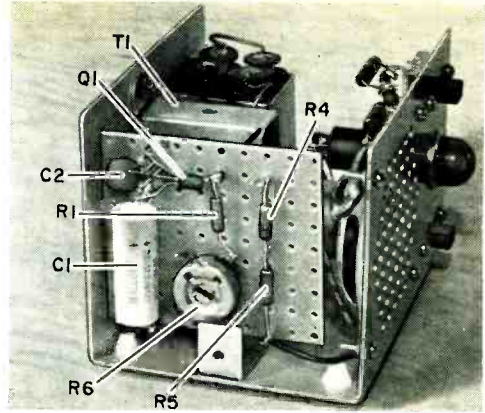

Fig. 3. Most of small components can be mounted on perf board.

Transistor *Q1* can be substituted by any 30- to 40-volt PUT rated at 150-200 mA forward current. Carefully identify the A, AG, and K leads. If the PUT refuses to fire, increase the value of *R4*. Transformer *T1* may be replaced by any universal 8-watt tube-type output transformer with secondary taps. Use the full secondary winding at first and shift to lower taps to increase audio output.

Calibration and Use. With the circuit operating, use an electric clock with a sweep second hand to adjust *R6* until you hear ten clicks and see ten flashes in exactly ten seconds. This is all there is to calibration, and you can now assemble the metal box.

Use the timer to pace your count for both timed camera and enlarger exposures. With a few practice runs, you will quickly acquire the knack of operating the camera cable release or enlarger switch at exactly the right moment.

If you incorporated the audio-off feature and have the timer set in this position when working in your darkroom, pace your count by lamp flashes, and rely on that pace because you might miss a lamp flash between eye blinks.

You can expect considerable battery life due to the low drain circuit of the metronome timer. As a rule of thumb, replace the batteries when either the audio or light output drops below your preferences; the count rate is affected very little by battery aging. Also, recheck the count rate occasionally and adjust *R6* if needed to compensate for any long-term change in *C1* ♦

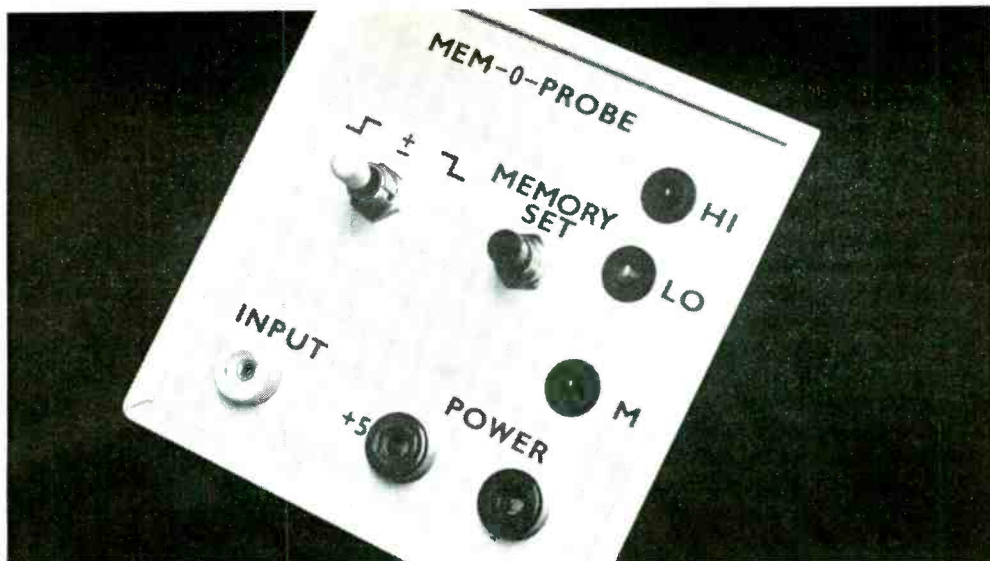

Build a **LOW-COST** **LOGIC PROBE WITH MEMORY***

REVEALS TTL OR DTL LOGIC STATES
AND LOW-DUTY-CYCLE PULSES

BY H. H. ROSS and T. R. MUELLER

Instrumentation and Advanced Methodology, Analytical Chemistry Div., Oak Ridge National Laboratory.

HOW OFTEN have you wished for a logic-level indicator that would not only reveal high and low TTL or DTL logic states, but would also capture those fleeting low-duty-cycle pulses that are difficult to see even with a high-quality scope? Would you also like your indicator to have a memory circuit that would tell you if a transition has occurred even in your absence? The MEM-0-PROBE shown in photo above will do all of this and more.

With only four inexpensive IC packages and a few other standard components, all of the following measurement modes can be implemented.

1. A circuit point can be checked for a high or low logic level.
2. A high or low going pulse will give a

clear indication of its presence even if the pulse width is as short as 10 nsec.

3. For every low-duty-cycle pulses, a memory can be activated that will indicate indefinitely that a level transition has occurred and this memory can be programmed to respond to only positive-going or negative-going pulses or both.

Comparable commercial logic-level indicators without the memory feature cost as much as \$100. However, for about 2 hours of time and \$6 worth of parts, you can construct a high-quality test instrument that will troubleshoot virtually any TTL or DTL circuit.

How It Works. The logic and wiring diagram for the probe is shown in Fig. 1. Main power for the probe is "stolen" from the device under test. Maximum load of the whole probe assembly is about 100 mA and most power supplies can stand this addition-

*Research on this project was sponsored by the U.S. Atomic Energy Commission under contract with Union Carbide Corp.

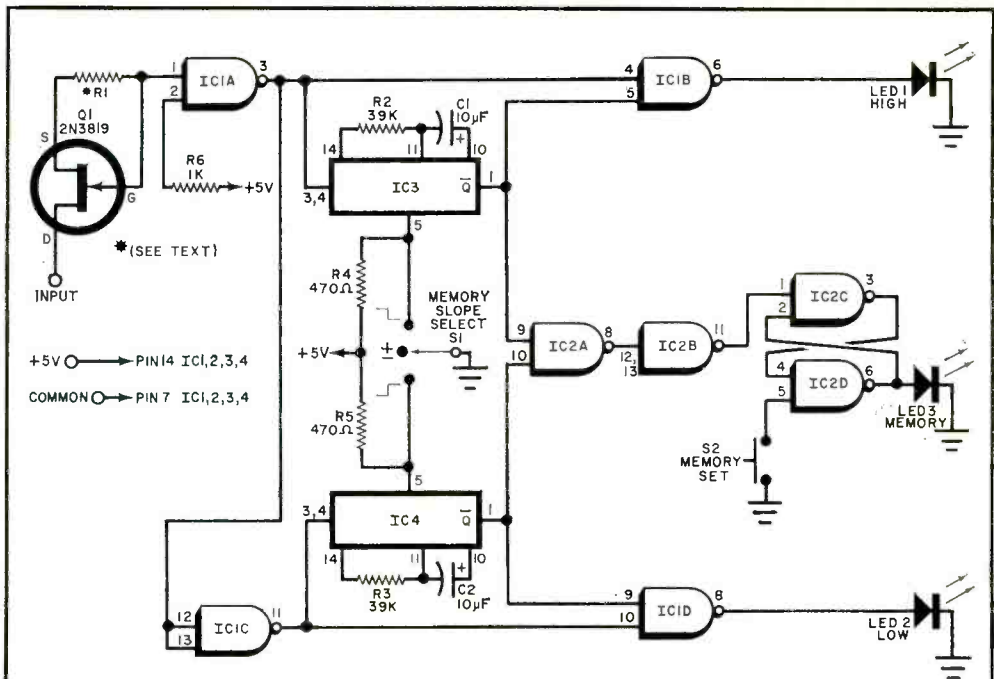

Fig. 1. Logic and wiring diagram for the "Mem-O-Probe." Use of four inexpensive IC's and standard parts makes this a real "bargain."

PARTS LIST

R1—Selected (see text)
 R2, R3—39,000 ohm, $\frac{1}{4}$ W res.
 R4, R5—470 ohm, $\frac{1}{4}$ W res.
 R6—1000 ohm, $\frac{1}{4}$ W res.
 C1, C2—10 μ F, 10 V electrolytic capacitor

S1—Spdt, center-off, switch
 S2—Spst, normally open push-button switch
 IC1, IC2—SN7400
 IC3, IC4—SN74121
 LED1, LED2, LED3—MV5023 (or equivalent)
 Q1—2N3819 (or equivalent)
 Misc. Perf board, terminal pin jacks, small case.

al drain. However, if loading is a problem, an external 5-volt supply can be used with common of the probe connected to common of the device under test. The probe test input represents only one TTL load to the point being checked. Q1 is an FET that is connected as a current limiter to the input of gate IC1A and provides over-voltage protection on the input of the gate of at least ± 30 volts. Gate IC1A serves as an input buffer for the probe and also gives an inverted level at the input of gate IC1C. IC3 and IC4 are monostable multivibrators. When not triggered, the Q outputs of these devices are high; upon receiving a *negative-going* trigger signal, the \bar{Q} output goes low for a time determined by R and C (in the case of the MEM-O-PROBE about 300 msec).

When the input is connected to a logic "1" (or left unconnected), pin 4 of gate

IC1B is low, the output of IC1B is high, and LED1 will be on, indicating a high level. Since the signal at gate IC1C is inverted, the output of IC1D will be low and LED2 will be off. When the probe is connected to a logic "0", the states of IC1 will be reversed and LED1 will be off and LED2 will be on.

For pulse observation, we must look at the operation of IC3 and IC4. Assume that the input is connected to a "low" and LED1 is off. The input to IC3 is high but will trigger if the input goes low (IC3 is enabled when switch S1 does not ground pin 5). When a high-going pulse occurs at the probe input, pins 3 and 4 of IC3 momentarily go low and triggering of the \bar{Q} output occurs. \bar{Q} stays low for 300 msec. When \bar{Q} is low, LED1, the high indicator, will light for 300 msec regardless of the state of the probe input or of how fast the input pulse occurs.

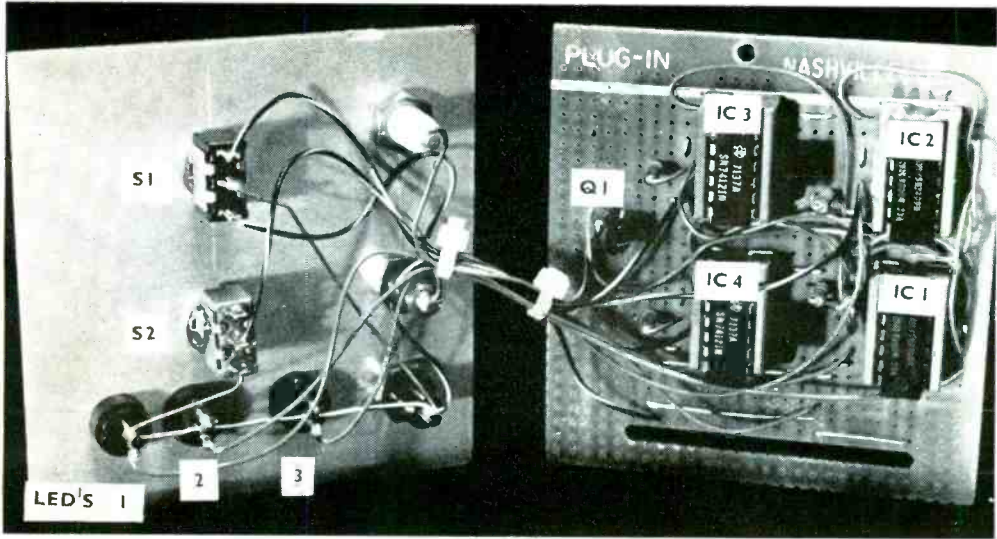

Interior view of the circuit board and interconnections to front panel. No PC board is required since the IC's can be interconnected directly.

When the probe input is originally high and a low-going pulse occurs, *IC4* will operate in a similar fashion to flash the low indicator for 300 msec. Thus, both high-and low-going pulses are easily seen. The outputs of *IC3* and *IC4* override any condition at the probe input for a fixed time.

Using only *IC1*, *IC3*, and *IC4*, one can detect both dc levels and very fast pulses at the probe input. However, for very low-duty-cycle pulses, it is somewhat tiresome to stare at the level indicators waiting for a 300-msec pulse, especially if the rep rate is on the order of 5 or 10 minutes! *IC2* is wired as a memory circuit that neatly circumvents this problem. When the memory switch, *S2*, is pushed, the R-S flip-flop (gates *IC2C* and *IC2D*) turns on *LED3*. If *S1* is in the "center-off" position, *IC3* and *IC4* are both enabled and a pulse of either polarity at the probe input will trigger one of the multi-

brators and cause the R-S flip-flop to reset and extinguish *LED3*. This indication will remain until *S2* is pushed again. *S1* is used to select the particular type of transition that you are looking for. The probe will respond to pulses of either polarity when *S1* is in the center position as noted above. If *S1* is moved so as to ground pin 5 of *IC3*, only *IC4* will be enabled and the memory will respond only to a low level going high. Conversely, grounding pin 5 of *IC4* causes only a high level going low to trigger the memory.

Construction Tips. No printed-circuit board has been laid out for this project since interconnection of the IC packages is relatively simple. A general-purpose board was used in our version. Lead dress and length are not critical. Power terminals, input terminal, switches *S1* and *S2*, and the LED's are mounted on the front panel of our probe (page 77) which is housed in a 3" × 3" × 1" aluminum box. An interior view of the circuit board and interconnections to the front panel are shown above. The ingenious experimenter will think of numerous other ways to conveniently package the probe.

The only component that requires selection in the MEM-O-PROBE is resistor *R1*; Fig. 2 illustrates how this is done. Connect the circuit as shown in the diagram making sure that the 5K pot is set for maximum resistance. Slowly adjust the pot until a reading of 2 mA is indicated on the meter. Remove

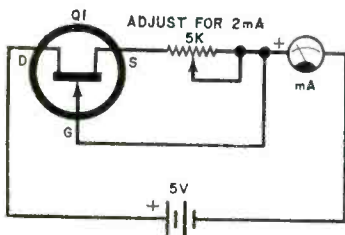

Fig. 2. Circuit for selecting resistor *R1*. Refer to text for the procedure.

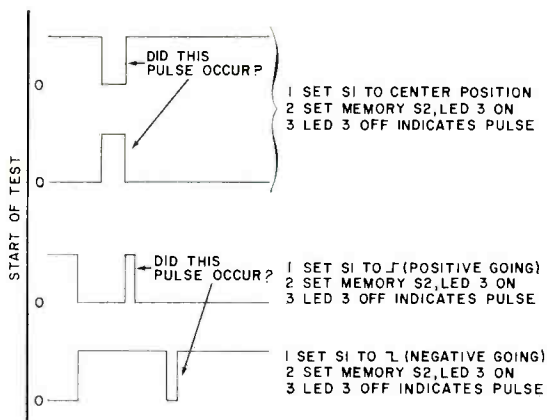

Fig. 3. Pulses reveal how probe's memory function is used. Refer to the article for complete details.

the pot and measure its resistance with an ohmmeter. Use the closest standard-value fixed resistor for $R1$ in your probe. (Note: if $Q1$ is ever changed, the value of $R1$ must be redetermined.) The exact value of $R1$ is not critical, however.

The use of LED indicators simplifies the design of the probe since drivers for incandescent lamps are not required. Anode and/or cathode markings on the LED's depend on the individual manufacturer. If you do not know the orientation of your particular units, there is a safe and easy way to check them. Take a VOM that uses a 1.5-V battery for the ohms circuit and set it for the $\times 10$ ohms position. Connect the LED to the VOM leads. The LED will glow when the anode is connected to the positive ohms lead. Make sure you know which probe lead is positive; configurations will vary among makes of VOM's. We used red emitting diodes in our prototype. However, yellow and green diodes are also available and may be used if desired.

Testing and Using Your Probe. After construction, check your solder connections and wiring against Fig. 1. If everything looks okay, perform the following tests. Leave the input disconnected and connect the power terminals to a +5-volt source. The high-level indicator should light. Connect the input to common; the low-level indicator should come on and the high indicator should extinguish. Put switch $S1$ into the center position and momentarily lift the input from common; the high indicator should flash for about 300 msec ($\frac{3}{10}$ sec) no matter how fast you break and make the connection. Disconnect the probe input—the "high" will come on and the "low" will go

out. Momentarily ground the input and observe the low indicator flash no matter how fast you ground the input. Push $S2$ and check to see that $LED3$ comes on. Ground the input to turn off $LED3$. If all of the above tests check out, your probe is working properly. If not, recheck your connections.

It's simple to use this probe. To check for a high or low logic level, simply touch the probe input to the point under test and observe the level indicators. When both indicators are on, the test point is switching between high and low levels continuously at a rate faster than 300 msec. The indicators will flash alternately when the switching rate is slower than 300 msec. By holding the probe on a point, the presence of any pulse will cause one of the indicators to flash if the pulse width is 10 nsec or longer.

Fig. 3 illustrates how to use the memory function. The pulses that occur in the top two waveforms have both positive-going and negative-going transitions. Thus, $S1$ can be in any position to register the pulses in the memory. In the lower waveforms we want to discriminate against the first level change but still detect the pulse. For the top one we set $S1$ to respond only to a low going high and for the lower a high going low. The status of the memory indicator will clearly reveal the presence or absence of the pulse in question. *One important note:* When you are not using the memory function, always place switch $S1$ in the center position. This will enable both multi-vibrators so that normal "pulse-catching" will occur for positive- and negative-going signals.

The MEM-O-PROBE can become a valuable addition to your test bench. You will come to rely on it more often than a scope when troubleshooting digital circuits. ♦

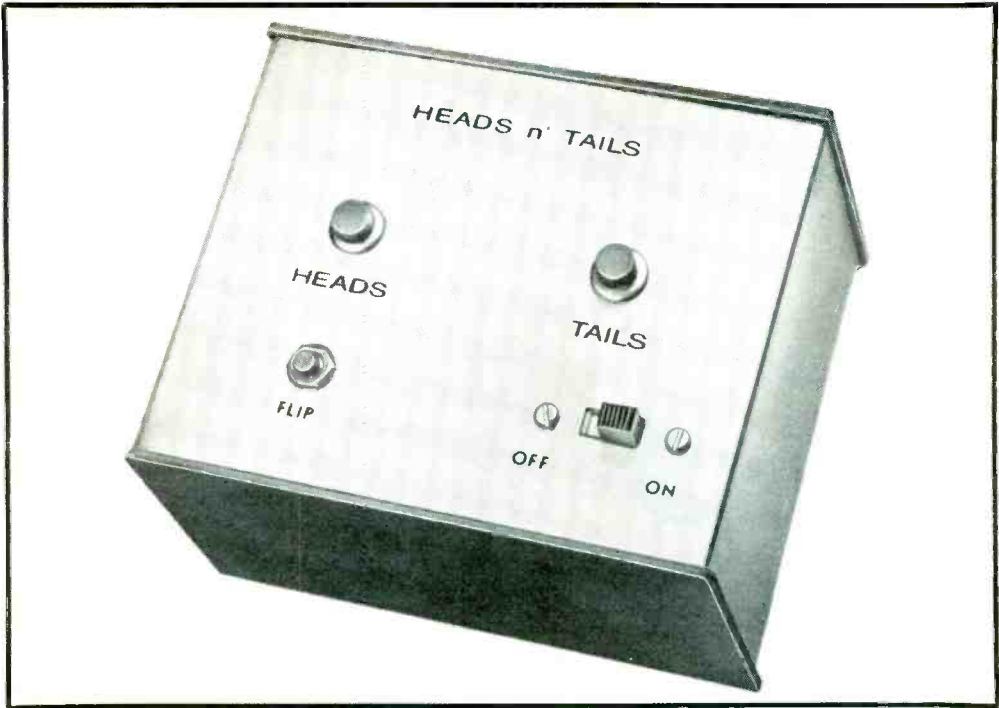

HEADS 'n' TAILS

ELECTRONIC COIN FLIPPER GIVES YOU A FAIR SHAKE

BY DON LANCASTER

MOST ELECTRONIC games that, in effect, flip a coin are designed to give "the house" an advantage—not so the "Heads 'n' Tails." It's strictly on the up-and-up with an exact 50-50 percentage, unless the circuit is tampered with. The project is ideal for school laboratories as a probability demonstrator or study aid. It is also good for a science fair project—or simply as a means of determining who buys on the next coffee break.

The simple circuit, shown in Fig. 1, uses a transistor-transistor-logic IC and four low-cost transistors. The visual readout of the second flip-flop indicates heads or tails.

Rather than using an astable, or some other potentially unsymmetrical "odds determinator," the Heads 'n' Tails counts the power line frequency so that both the length of time the pushbutton is held down and the phase of the power at the instant the pushbutton is depressed combine to

provide a truly random 50-50 long-term result.

In the first JK flip-flop only the direct inputs (clear and preset) are used so that the circuit squares up and follows the power line frequency as long as S2 is closed.

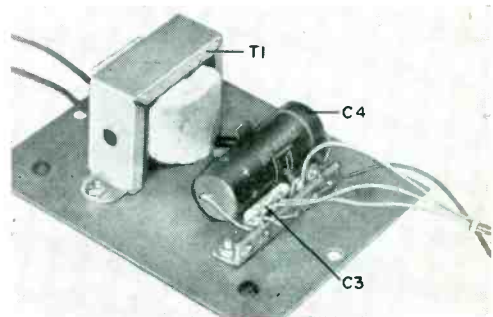

The power supply is a conventional two-diode, full-wave rectifier and filter mounted on the bottom plate.

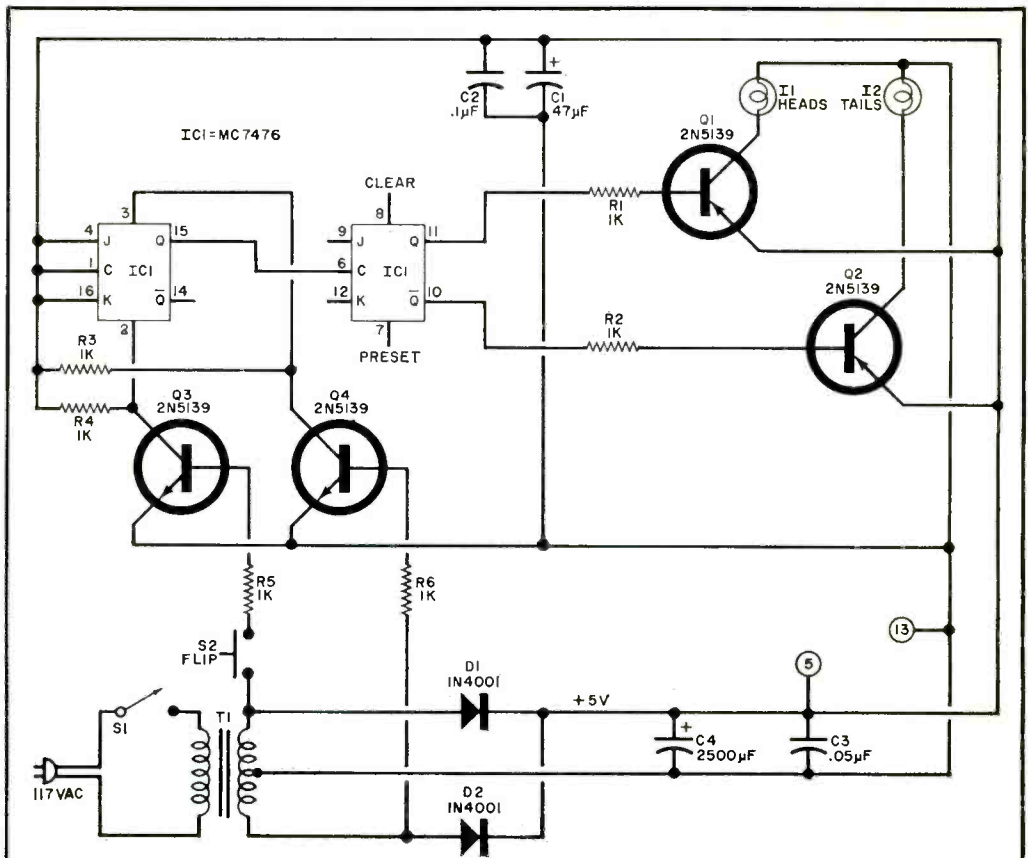

PARTS LIST

C1—47- μ F, 15-volt electrolytic capacitor
 C2—0.1- μ F, 10-volt disc ceramic capacitor
 C3—0.5- μ F, 10-volt disc ceramic capacitor
 C4—2500- μ F, 10-volt electrolytic capacitor
 D1, D2—1N4001 (or similar) rectifier diode
 IC1—Dual JK flip-flop (Motorola MC7476 or Texas Instruments SN7476)
 I1, I2—5-volt, 50-mA lamp (one green, one red)

Q1, Q2—2N5139 transistor
 Q3, Q4—2N5129 transistor
 R1-R6—1000-ohm, $\frac{1}{4}$ -watt resistor
 S1—Spst slide or toggle switch
 S2—Normally open spst pushbutton switch
 T1—Transformer; secondary: 6.3 to 8 VCT at 500 mA
 Misc.—Suitable chassis, line cord, strain relief, mounting hardware, etc.

Fig. 1. The flip-flops count the power-line frequency when S2 is held down. The state of the flip-flops is then indicated by the pilot lights.

Transistors Q3 and Q4 alternately set and reset the flip-flop immediately after each sequential power line zero crossing. The Q output of the first JK is a noise-free square wave when S2 is closed, and either a logic 1 or 0 when the switch is open.

The output of the first flip-flop is used to cycle the second JK which is connected as a binary divider. One of its outputs drives the "Heads" indicator lamp, and the other drives the "Tails" lamp. Transistors Q1 and Q2 provide sufficient power for the

flip-flop outputs to drive the lamps. When S2 is closed, both lamps cycle on and off 30 times a second—a speed much faster than the eye can follow, to discourage cheating.

Construction. Although any construction technique can be used, a printed circuit board such as that used in the prototype is recommended. A foil pattern and component layout are shown in Fig. 2. Note that one jumper is used on the component side

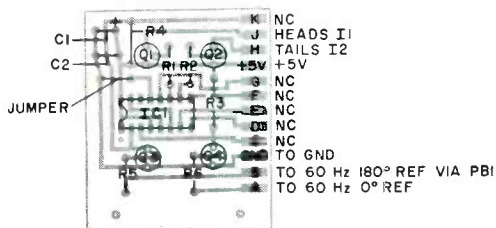
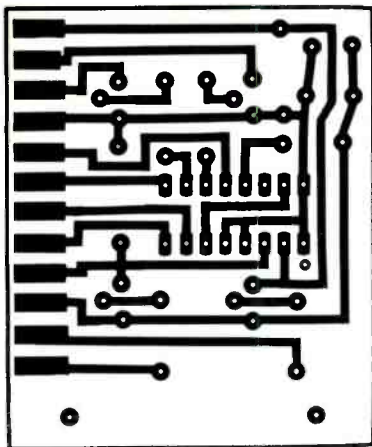

Fig. 2. Actual size foil pattern and component installation. The edge connector is used to facilitate removal.

of the board. When mounting the IC, observe the notch and dot code marks. Use a low-power soldering iron and fine solder.

The power supply, which can be used in other projects, is mounted on a separate board.

The project is very simple to use. With power applied, turn on *S1* and depress *S2* for as long as desired. Both lamps will glow. When *S2* is released, only one lamp will remain lit. ♦

The board mounts on a pair of angle brackets and doesn't take much room.

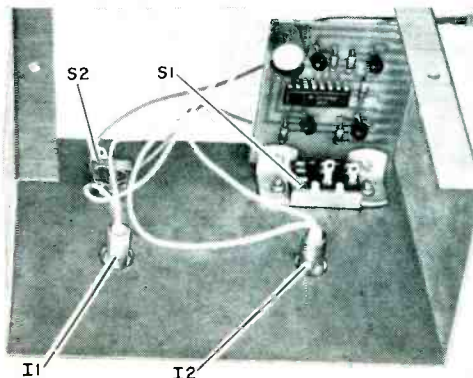

WHISTLE SWITCH

Solid-state, w/amplifier mike. Turns light on, radios, etc. by high-pitched sound from whistle. \$1.35.

MEMORY CORE FRAME

Ultra-small memory, wired 1024 cores, measures only 2x2 in. \$6.00 per frame or wired stack with 9 frames and diode matrix \$50.00. Made for RCA.

PANELESCENCE

Flat panel 3½ x ⅞ in. wide. Apply 117 VAC and it glows ghostly green, weird and unusual light of future. 3/\$1.00.

3 LED's for \$1.00

Light emitting diodes w/ memory cell for instant test.

UNDERWATER MIKE

Waterproof underwater mike from gov't contract. Listen to ships, fish, underwater noises, etc. \$6.50

CRYSTAL PHONE 25¢

Brand new, hearing aid type. Only 25¢ each in lots of 4/\$1.

COMPLETE MEMORY SYSTEM \$150

Measures 12 x 7 x 1 inches. Utilizes TTL IC's, 10204 memory cores, 9 installed sense amps, addressed as 1024 locations. I/O lines include 9 data-in, 9 data-out, 10 address-in, powering status and control. Only 40 systems on hand. Schematics included. —DCU \$150 pp

AUTOMOBILE REVERB \$7.00

Brand new fully assembled, ready to install in your car to give 3rd dimension concert hall effect. Complete with instructions, rear seat speaker, grill, wires, plugs. —05 \$7.00

8 TRACK STEREO TAPE DECK \$14.00

With built-in stereo pre-amp, 115 volt drive motor, channel indicator lamps. Unused, original boxed, less cabinet. Customize your stereo music center with one of these tape decks. #46 \$14.00

Please add postage for above.

JOHN MESHNA JR.

PO Box 62, E. LYNN, MASS. 01904
CIRCLE NO. 11 ON READER SERVICE CARD

ABOUT YOUR SUBSCRIPTION

Your subscription to POPULAR ELECTRONICS is maintained on one of the world's most modern, efficient computer systems, and if you're like 99% of our subscribers, you'll never have any reason to complain about your subscription service.

We have found that when complaints do arise, the majority of them occur because people have written their names or addresses differently at different times. For example, if your subscription were listed under "William Jones, Cedar Lane, Middletown, Arizona," and you were to renew it as "Bill Jones, Cedar Lane, Middletown, Arizona," our computer would think that two separate subscriptions were involved, and it would start sending you two copies of POPULAR ELECTRONICS each month. Other examples of combinations of names that would confuse the computer would include: John Henry Smith and Henry Smith; and Mrs. Joseph Jones and Mary Jones. Minor differences in addresses can also lead to difficulties. For example, to the computer, 100 Second St. is not the same as 100 2nd St.

So, please, when you write us about your subscription, be sure to enclose the mailing label from the cover of the magazine—or else copy your name and address exactly as they appear on the mailing label. This will greatly reduce any chance of error, and we will be able to service your request much more quickly.

Build a Crystal-Controlled Musical Instrument Tuner

AN ACCURATE SOURCE OF 440 Hz, A ABOVE MIDDLE C

BY HANK OLSON

MANY orchestras use the oboe as the instrument to which all of the others are tuned just before a performance. The oboe has been previously tuned to an accurate source of 440 Hz (A above middle C). Although there are many ways of generating the 440 Hz, the most accurate is an electronic system using a crystal-controlled oscillator. In this way, the pitch can be established within $\frac{1}{100}$ th of a hertz, which is far better than most other tune-up systems. In addition, the 440-Hz tone can be

Capacitor C5 is mounted on L1. Power supply components are under T1 and C2.

easily divided by two to obtain 220 Hz, which can be used to tune a bassoon.

Since 440-Hz crystals are hard to find, a crystal with a higher frequency and a suitable countdown circuit can be used. Such a circuit is shown in Fig. 1. The oscillator (*Q1*) operates at approximately 901 kHz. This frequency is used because there is usually available a surplus-type crystal (FT241) that will fill the bill. However, before starting this project, it is advisable to check on the availability of the crystal.

The oscillator operates in the 32-pF parallel-resonance mode and is quite stable. Between the crystal oscillator and the first digital divider (*IC2*), are two isolation stages (*Q2* and *Q3*) that drive a Schmitt trigger (*IC1*) to produce a clean toggle waveform.

The digital countdown circuit (*IC2* through *IC4*) needs no adjustment and is inherently stable. Total division is 2^{11} or 2048 which brings the crystal frequency down to within $\frac{1}{100}$ th of a hertz of 440 Hz. The oscillator frequency can be adjusted slightly by *C1* to make the final frequency even closer to 440 Hz. If a sharper or flatter A note is required, FT241 crystals are available every 1.042 kHz, making each step represent a change of about $\frac{1}{2}$ Hz in output frequency.

Construction. Although almost any type of construction can be used, an etched circuit board makes the work easier (see Fig. 2). A power supply circuit is shown in Fig.

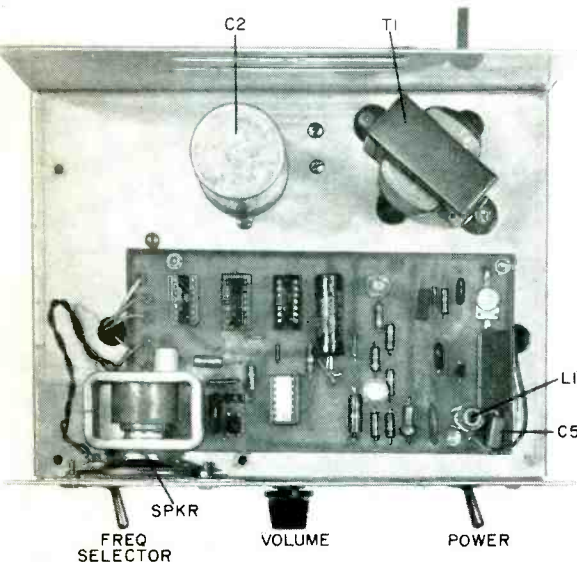

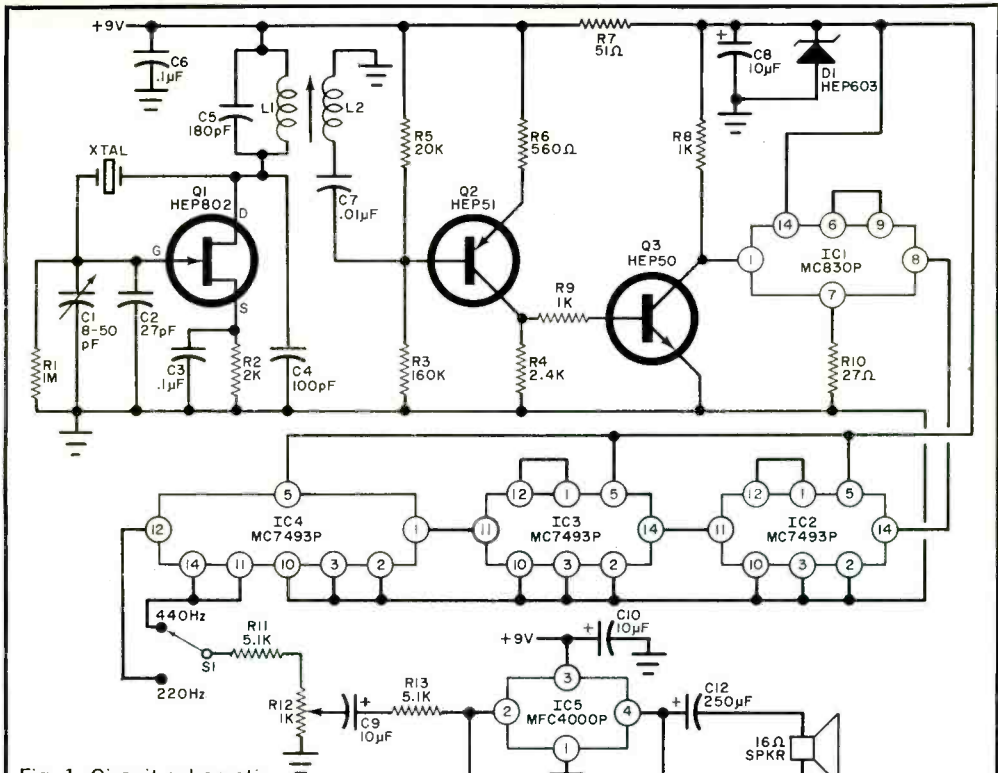
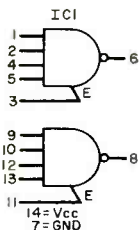

Fig. 1. Circuit schematic.



PARTS LIST

- C1—8-50-pF ceramic trimmer capacitor
- C2—27-pF silver-mica capacitor
- C3,C6—0.1- μ F, 50-volt Mylar capacitor
- C4—100-pF silver-mica capacitor
- C5—180-pF silver-mica capacitor
- C7—0.01- μ F, 50-volt Mylar capacitor
- C8-C10—10- μ F, 12-volt electrolytic capacitor
- C11—0.0033- μ F, 50-volt Mylar capacitor
- C12—250- μ F, 15-volt electrolytic capacitor
- C13—0.005- μ F, 100-volt Mylar capacitor
- D1—5.6-volt, 1-watt zener diode (1N4734A, HEP603)
- IC1—Dual 4-input gate (μ L930, MC830P, SN15830N, CD2300E/8.30, HEPC1030P)
- IC2-IC4—4-bit binary counter (SN7493N, MC7493P, or similar)
- IC5—Audio amp. (MFC1000P, HEPC6003)
- L1—120-243- μ H (CTC X2060-8)
- L2—10 turns #24 wire wound over L1
- Q1—FET (HEP802, MPF102, or similar)
- Q2—Transistor (HEP51, 2N3638, 2N5142)
- Q3—Transistor (HEP50, 2N3646, 2N708)

- R1—1-megohm, $\frac{1}{2}$ -watt resistor
- R2—2000-ohm, $\frac{1}{2}$ -watt resistor
- R3—160,000-ohm, $\frac{1}{2}$ -watt resistor
- R4—2400-ohm, $\frac{1}{2}$ -watt resistor
- R5—20,000-ohm, $\frac{1}{2}$ -watt resistor
- R6—560-ohm, $\frac{1}{2}$ -watt resistor
- R7—51-ohm, $\frac{1}{2}$ -watt resistor
- R8,R9—1000-ohm, $\frac{1}{2}$ -watt resistor
- R10—27-ohm, $\frac{1}{2}$ -watt resistor
- R11,R13—5100-ohm, $\frac{1}{2}$ -watt resistor
- R12—1000-ohm potentiometer with switch
- R14—4700-ohm, $\frac{1}{2}$ -watt resistor
- R15—10,000-ohm, $\frac{1}{2}$ -watt resistor
- S1—Spdt switch
- SPKR—16-ohm speaker

XTAL—901.042-kHz FT241 crystal (available from JAN Crystals, 2400 Crystal Dr., Ft. Myers, FL 33901)

Misc.—Suitable chassis, knob, line cord, rubber feet, mounting hardware, etc.

Note—An etched and drilled PC board is available from Eico, 283 Malta St., Brooklyn, NY 11207 for \$3.00.

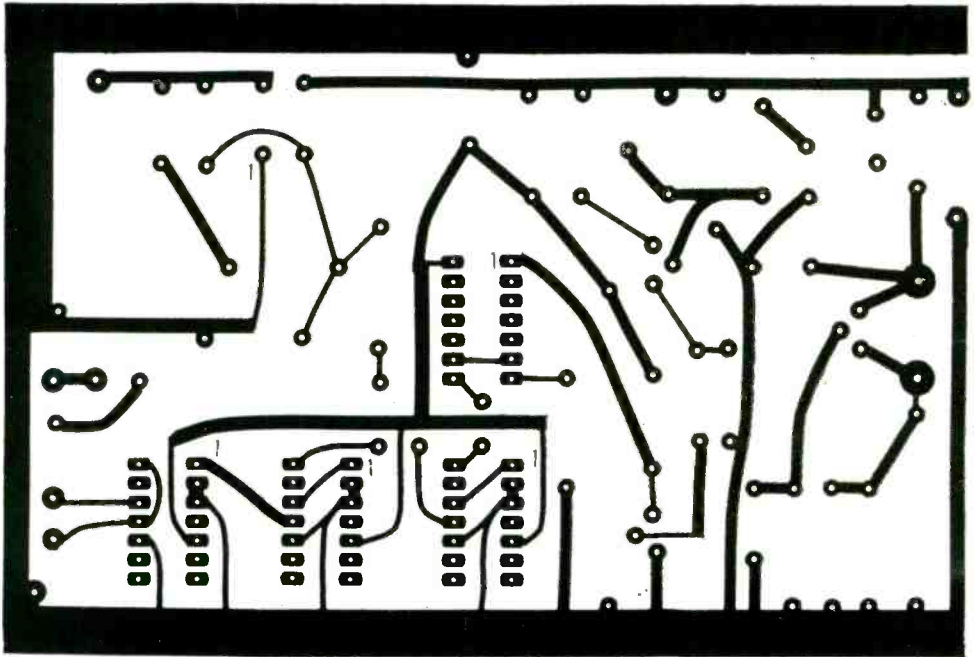
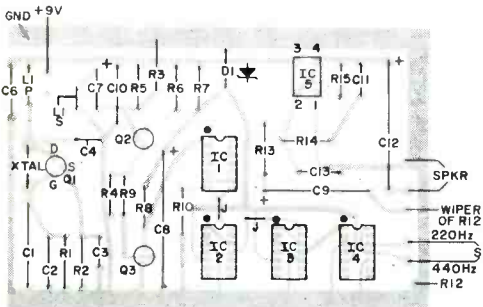

Fig. 2. Actual size foil pattern (above), component layout (below).



point, trimmer capacitor *C1* can be set to adjust the frequency as close as possible.

Operation consists simply of turning on the power, setting the frequency selector switch, and adjusting the volume. ♦

3. Although the photograph of the prototype shows the semiconductors and IC's mounted in sockets, they are optional and the devices may be mounted directly on the PC board.

The power supply transformer and filter capacitor are mounted in any available space on the chassis, with the other components mounted on a multi-lug terminal strip. The PC board is mounted in the chassis on insulated stand-offs. The power on-off switch, the 440/220-Hz selector switch, the volume control, and the speaker are mounted on the front panel.

Once the unit is assembled the frequency can be checked with a frequency counter or by generating Lissajous patterns with a suitable audio generator on a scope. At this

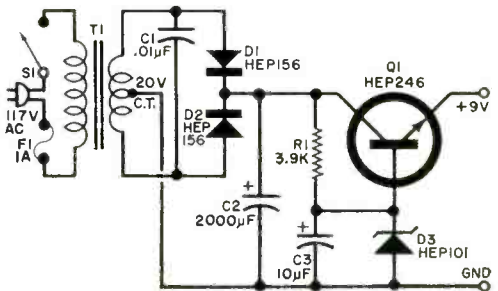

PARTS LIST

- C1*—0.01- μ F, 1-kV ceramic disc capacitor
- C2*—2000- μ F, 15-volt electrolytic capacitor
- C3*—10- μ F, 15-volt electrolytic capacitor
- D1, D2*—Diode (HEP156, 1N4002, or similar)
- D3*—10-volt, 1/4-watt zener diode (HEPZ0220, 1N4104, or similar)
- F1*—1-ampere, 3-AG fuse and holder
- Q1*—Transistor (HEP246, 2N5191, or similar)
- R1*—3900-ohm, 1/2-watt resistor
- S1*—Spst switch (on volume control)
- T1*—20-volt CT transformer (Triad F90X or similar)

Fig. 3. Power supply schematic and parts.

now-digital design color tv build this unique, all-new Heathkit Super Set

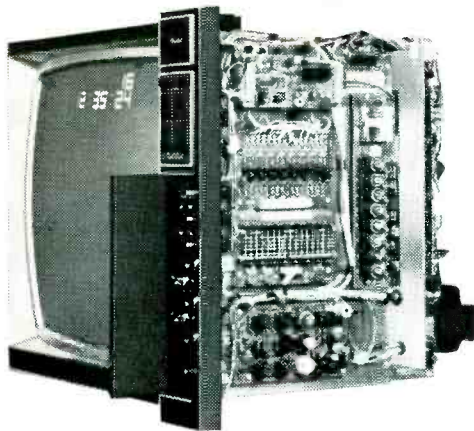

Three years ago, Heath began its most extensive engineering project — the development of a truly different color TV using digital and other design techniques unusual to the industry. The result is spectacular.

It features: ■ Programmable Digital Counter Channel Selector ■ On-Screen Digital Channel Identification ■ On-Screen Digital Clock Readout (optional) ■ Silent touch-tune electronic tuning ■ Combination VHF/UHF Varactor Tuner — DC voltage controlled ■ Exclusive Fixed-Filter IF — ideal bandpass shape for cleaner pictures and no instrument alignment ■ Digital True-Dot Generator — easier color convergence ■ 11-Function Remote Control (optional) ■ 100% Solid-State — the only tube is the picture ■ 19 integrated circuits (32 with remote) ■ 71 discrete transistors with sockets ■ Solid-State Tripler High Voltage Supply ■ Solid-State Low Voltage Supply — short-proof IC regulators ■ Solid-State Transformerless Vertical Sweep — better picture detail ■ Latest 25V Black (negative) Matrix picture tube — fully illuminated "black-surround" dots for brighter pictures — new etched face plate reduces glare and reflections ■ Front access slide-out Self-Service Drawer ■ 20 glass-epoxy circuit modules plus 12 prefabricated wiring harnesses with connectors for easier assembly.

The Heathkit Super Set is unlike any other color TV you've ever seen... it silently selects channels with digital-logic accuracy... it displays the channel numbers on the screen... it displays the time digits on the screen... it uses a fixed filter that never needs instrument alignment... it uses more integrated circuitry than any other set... it is easy to use... it is easy to look at... it is easier to build than any we've ever offered.

Pre-program any 16 channels into the digital counter. Touch a button (there isn't any tuning knob), and the counter silently sweeps up or down the stations, then locks in the Varactor Tuner to the station you choose. No mechanical contacts to clean, no turrets to make noise, no motors to hum.

The channel numbers are 1½" white digits on the screen — easy to see across the room, positionable anywhere on the screen. Add the clock module and time is displayed below the channel numbers — in 4 or 6 digits, 12 or 24 hour format. Digits remain on for any pre-set period up to 1½ minutes. Change channels or touch the "recall" button to make them re-appear.

Expanded self-service devices include a separate test meter, new vertical and horizontal centering, new top-bottom-sides pincushioning corrections, purity adjustments... and in the new slide-out service drawer are computer-like programming boards for channel selection, channel readout, clock readout, plus convergence circuit module.

Technically, the Heathkit Super Set is the most sophisticated TV we've ever offered. In addition to all the above features, it also has DC controlled contrast for less interference, an IC color amplifier for truer colors; an IC color oscillator and automatic phase control for more precise, reliable tints; an IC automatic gain control for improved sensitivity, stability, and noise immunity. In total, this digital Heathkit color TV sets new standards for state-of-the-art.

Heathkit Super Set...designed to change your mind about color TV.

Kit GR-2000, basic chassis and tube, 147 lbs. \$649.95*



Eleven-Function Touch-Tune Remote Control for the GR-2000... \$79.95*

This all solid-state ultrasonic system utilizes 13 integrated circuits, 28 transistors to give you wireless armchair control of on and off, volume, VHF/UHF channel selection, up or down color intensity, and tint. Plus, a touch of the volume button automatically recalls the digital readout to the screen. Kit includes receiver for in-chassis mounting and hand-held transmitter.

Kit GR-2000-6,
4 lbs. \$79.95*

Optional Digital Clock for your GR-2000... \$29.95*

In just a couple hours' time you can build the GRA-2000-1 Digital Clock Accessory. Everything mounts on one small board that plugs into the readout board in the GR-2000 service drawer. That's all there is to it. Clock circuit board has slow, fast and hold push-buttons for setting time, jumper wire for selecting 12 or 24-hour format. Order with your GR-2000, or add it on later, if you prefer.

Kit GRA-2000-1, Digital Clock Accy., 1 lb. \$29.95*

Custom install or use one of four new cabinets.

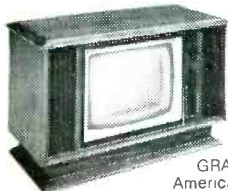

Like all Heathkit TV's the GR-2000 can be wall-mounted, or choose one of the striking new cabinet designs. The sophisticated Contemporary model GRA-2000-2 shown here, at \$139.95; the Mediterranean GRA-2000-4, \$139.95; the Mediterranean with doors, GRA-2000-5, \$179.95; or the Early American model GRA-200-3, \$139.95.

HEATHKIT ELECTRONIC CENTERS
Units of Schlumberger Products Corporation

ARIZ.: Phoenix; CALIF.: Anaheim, El Cerrito, Los Angeles, Pomona, Redwood City, San Diego (La Mesa), Woodland Hills; COLO.: Denver; CONN.: Hartford (Avon); FLA.: Miami (Hialeah), Tampa; GA.: Atlanta; ILL.: Chicago, Downers Grove; IND.: Indianapolis; KANSAS: Kansas City (Mission); KY.: Louisville; LA.: New Orleans (Kenner); MD.: Baltimore, Rockville; MASS.: Boston (Wellesley); MICH.: Detroit; MINN.: Minneapolis (Hopkins); MO.: St. Louis; NEB.: Omaha; N.J.: Fair Lawn; N.Y.: Buffalo (Amherst), New York City, Jericho, L.I., Rochester, White Plains; OHIO: Cincinnati (Woodlawn), Cleveland, Columbus; PA.: Philadelphia, Pittsburgh; R.I.: Providence (Warwick); TEXAS: Dallas, Houston; WASH.: Seattle, WIS.: Milwaukee

Send for FREE Heathkit Catalog.

HEATH	Schlumberger
HEATH COMPANY, Dept. 18-3 Benton Harbor, Michigan 49022	
<input type="checkbox"/> Please send FREE Heathkit Catalog.	
<input type="checkbox"/> Please send model(s) _____	
Enclosed is \$ _____ plus shipping.	
Name _____	
Address _____	
City _____ State _____ Zip _____	
*Mail order prices; F.O.B. factory. CL-495R	

CIRCLE NO. 5 ON READER SERVICE CARD

What Do You Know About Capacitors?

BY ROBERT P. BALIN

For the designer or builder of electronic circuits, capacitors can sometimes be the most baffling part of the project since they come in various shapes and sizes and

perform many different functions. Test your "capacitance" by filling in the blanks below.

(Answers are on page 156)

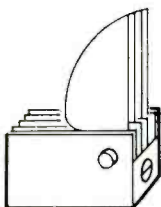

1. When a tuning capacitor in a receiver is wide open, is the receiver tuned to the low _____ or high _____ end of the band?

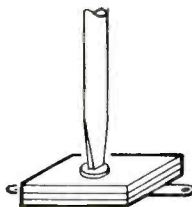

2. Does tightening the adjusting screw on a compression-type capacitor increase _____ or decrease _____ its capacitance?

What is the function of the capacitor, C, in each of the circuits shown below?

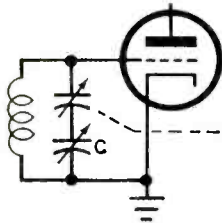

3. _____

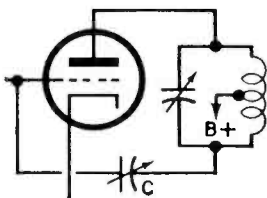

4. _____

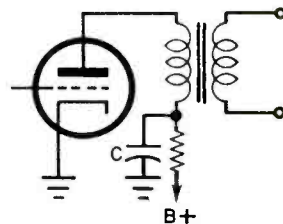

5. _____

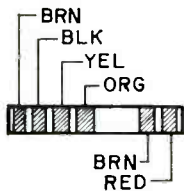

6. What does the color code on this molded tubular paper capacitor indicate about its value _____, tolerance _____, and voltage rating _____?

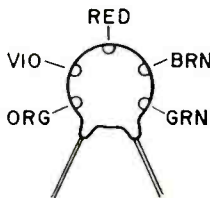

7. What are the value _____, tolerance _____, and temperature coefficient _____ of this ceramic disc capacitor as indicated by the color coding?

What is the total equivalent capacitance for each of the circuits shown here if all capacitors are identical and rated at 6 pF?

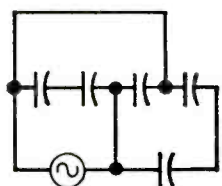

8. _____ pF

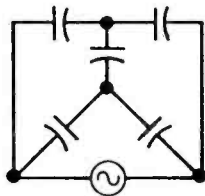

9. _____ pF

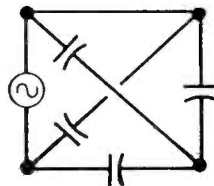

10. _____ pF



THE TOUCH-A-TONE

FOUR OCTAVES OF ORGAN-LIKE TONE

BY CHARLES D. RAKES

ONE OF THE biggest fads sweeping the rock music world is sound produced purely by electronic means. Electronic organs, drums, and castanets abound. The "Touch-A-Tone" resembles a banjo and is held in much the same manner, but there all similarity ends.

Capable of producing a range of four full octaves (one below and three above middle C) in organ-like tones, the Touch-A-Tone has eight note contacts and an easy-to-reach octave selector switch. It has a built-in speaker and battery supply and a variable-rate tremolo control (6 to 36 beats per second) to add color to the music. Optional features include a variable-depth control for the tremolo circuit and a headphone jack.

Playing the Touch-A-Tone is very simple. With one hand, the player selects any of the eight note contacts and also touches a metal strip (located on the rear of the neck of the instrument). He then uses the thumb of his free hand to touch or "pick" a third contact located at the base of the neck.

About the Circuit. The tremolo circuit is comprised of *Q1* and its associated components (see Fig. 1). This is a variable-rate, low-frequency generator, the output of which is coupled to the input of mixer-amplifier stage *Q3*. Potentiometer *R2* adjusts the rate of the generated signal at the player's discretion, and *S1* engages or disables the tremolo circuit.

Transistor *Q2* is the heart of the four-

octave tone generator. Capacitors *C3-C6* and resistors *R43-R50* comprise the generator's frequency determining network. Switch *S3* selects the desired octave range, and the player simultaneously touches the touch bar and one of the note keys (1-8) to activate the proper transistor touch switch for the note he wishes to play. Then, with his free hand, the player also contacts the thumb touch knob.

The output of *Q2* now feeds into the input of mixer-amplifier *Q3* where it mixes with the tremolo beat (if the tremolo circuit is active) and is amplified. The output of *Q3* is taken off the wiper contact of *R11* and is coupled to audio amplifier *Q7* via *C9*.

Transistor stages *Q4-Q6* operate as a touch switch; until it is switched open by touching the thumb touch knob, the gate of *Q3* is clamped to ground, allowing no output from the mixer-amplifier.

The eight direct-coupled touch switch circuits select the proper resistive value for the tone generator. Each circuit consists of a pair of transistor stages: *Q8/Q9*, *Q10/Q11*, etc., through *Q22/Q23*. Diodes *D1* through *D8* provide isolation for the touch switches.

The touch bar is used to supply *B+* to the inputs of each touch switch as it is selected. This positive voltage is applied through the body resistance of the player!

Construction. Since the physical layout of the Touch-A-Tone is not dictated by strings or critical dimensions, you can build

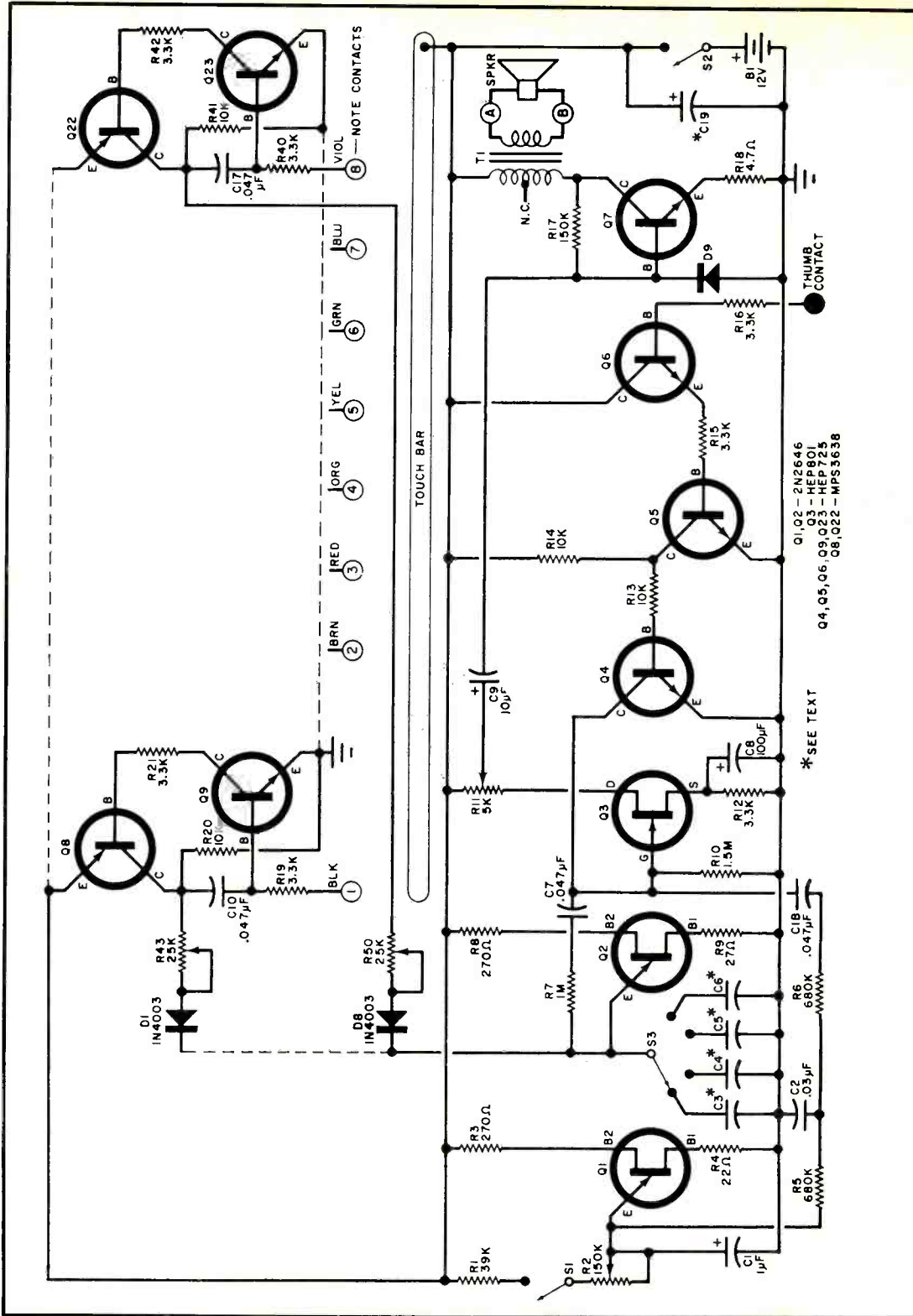

PARTS LIST

- B1—12-volt d.c. power source (eight 1.5 AA cells connected in series)
 C1—1- μ F Mylar or paper capacitor
 C2—0.03- μ F paper capacitor
 C3—0.377- μ F paper capacitor (see text)
 C4—0.19- μ F paper capacitor (see text)
 C5—0.1- μ F paper capacitor (see text)
 C6—0.057- μ F paper capacitor (see text)
 C7, C10-C18—0.17- μ F paper or Mylar capacitor
 C8—100- μ F, 15-volt electrolytic capacitor
 C9—10- μ F, 15-volt electrolytic capacitor
 C19—250-500- μ F, 15-volt electrolytic capacitor (see text)
 D1-D9—1N4003 or 1N4004 diode
 Q1, Q2—2N2646 unijunction transistor
 Q3—Field effect transistor (Motorola HEP-801)
 Q4-Q6, Q9, Q11, Q13, Q15, Q17, Q19, Q21, Q23—Bipolar transistor (Motorola HEP-725)
 Q7—2N2102 bipolar transistor
 Q8, Q10, Q12, Q14, Q16, Q18, Q20, Q22—Bipolar transistor (2N3638 or Motorola MPS3638)
 R1—39,000-ohm
 R3, R8—270-ohm
 R4—22-ohm
 R5—See text
 R6—680,000-ohm
 R7—1-megohm
 R9—27-ohm
 R10—1.5-megohm
 R12, R15, R16, R19, R21, R22, R24, R25, R27, R28, R30, R31, R33, R34, R36, R37, R39, R40, R42—3300-ohm
 R13, R14, R20, R23, R26, R29, R32, R35, R38, R41—10,000-ohm
 R17—150,000-ohm
 R18—4.7-ohm
 R2—150,000-ohm potentiometer
 R11—5000-ohm potentiometer
 R43-R50—PC-type miniature potentiometer (see text)
 S1, S2—Spst switch (for R2 and R11)
 S3—Sp 4-pos. rotary switch
 SPKR—3.2-ohm, 3" loudspeaker
 T1—400:4-ohm, 300-mW output transformer (Allied Radio Corp. No. 54A2367, or similar)
 1—1 1/2"-diameter x 3 1/2"-deep wood bowl
 8—1"-diameter chrome-plated drawer pulls
 1—Spoon-shaped, chrome-plated drawer pull
 1—Chrome-plated lever knob
 Misc.—Control knobs (2); 32" x 4" x 3/4" piece of redwood; hardboard panel; dual AA-cell battery holders (4); 9" x 4 1/2" perforated phenolic board with push-in solder terminals (or see text for printed circuit board); rubber cement; #6 hardware and solder lugs; spacers; aluminum or brass stock for touch bar; speaker grille; phone jack (optional); color-coded hookup wire; solder; etc.

All resistors 1/2-watt

Fig. 1. To simplify schematic diagram and save space, only first and last note touch switch circuits are shown. Circuits omitted are exactly same as those shown, including parts values.

the circuit into almost any housing that suits your taste. Just make sure that all touch contacts are within easy reach.

Although the circuit can be assembled on a piece of perforated phenolic board with push-in terminals for soldering, the use of a printed circuit board is recommended (see etching guide and component placement in Fig. 2). The PC board reduces assembly time and minimizes the chances of wiring errors.

Mount the components on the board in the following order: fixed resistors, capacitors, output transformer *T1*, and diodes and transistors (before installing *Q3*, cut off the case lead). The last components to be mounted should be the eight trimmer-type potentiometers for *R43-R50*.

When mounting the transistors and diodes, heat sink all leads whenever heat is applied. Also, leave about 1/4" of space between the bottoms of the transistors and the top of the circuit board. Then carefully check the polarities of the electrolytic capacitors, diodes, and transistors, and the orientation of *T1*. Flip over the circuit board and make sure that all leads are properly soldered to the foil; resolder any connections that appear "grainy." After making sure that no solder bridges exist between closely spaced foil conductors, set the board aside.

Now lay a piece of hardboard wall paneling face down on a flat surface. Set the wood bowl rim down on top of the paneling and strike a pencil line on the paneling around the circumference of the bowl. Remove the bowl and set it aside. Then, working carefully with a sabre saw or router, cut out the circular piece and sand the rough edges.

FREQUENCY IN HERTZ*

FIRST OCTAVE SECOND OCTAVE THIRD OCTAVE FOURTH OCTAVE

R43	2093	1047	523	262
R44	1976	988	494	247
R45	1760	880	440	220
R46	1568	784	392	196
R47	1397	698	349	175
R48	1319	659	329	165
R49	1117	587	294	147
R50	1047	523	262	131

*As observed from oscilloscope patterns or read from frequency counter.

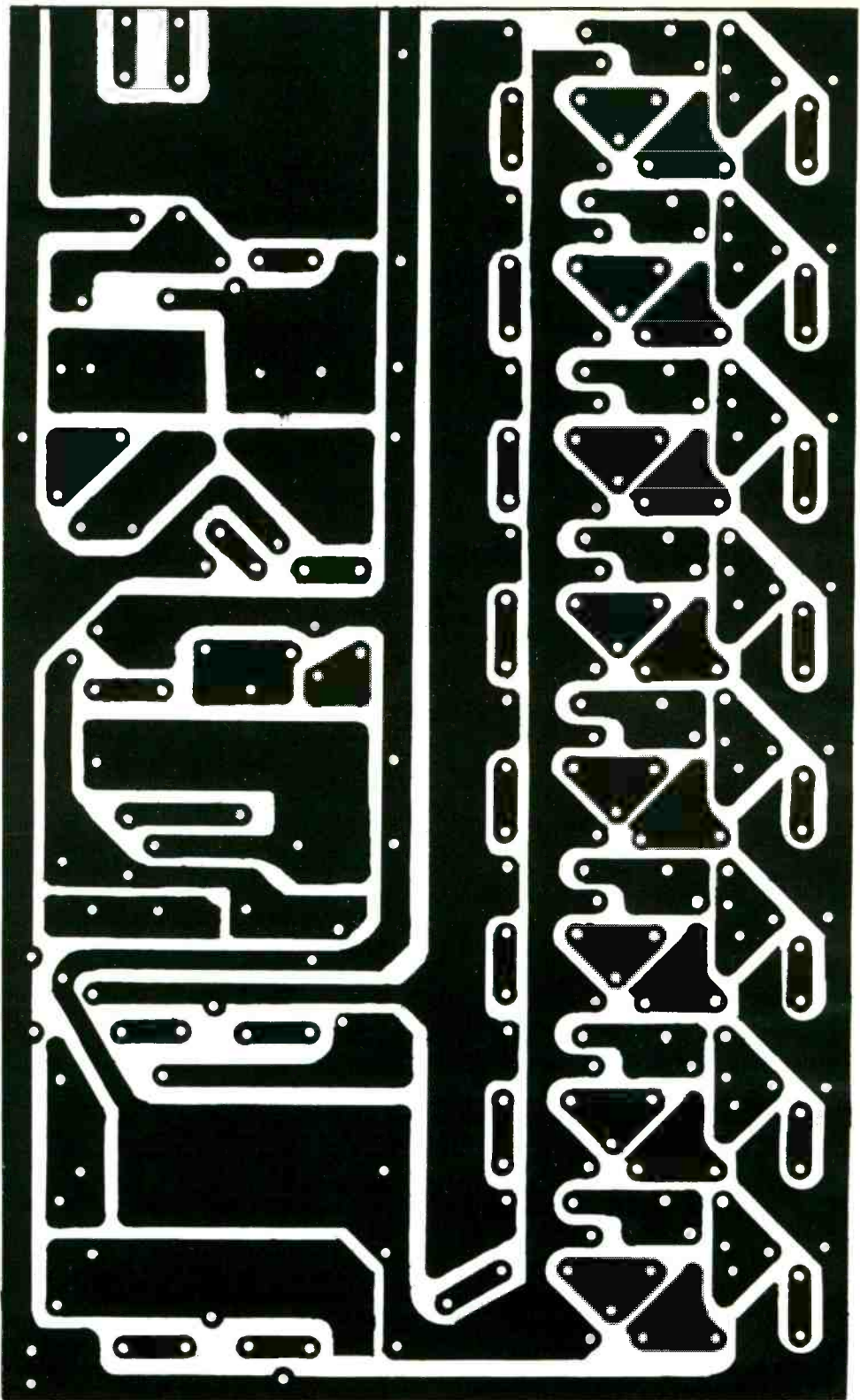

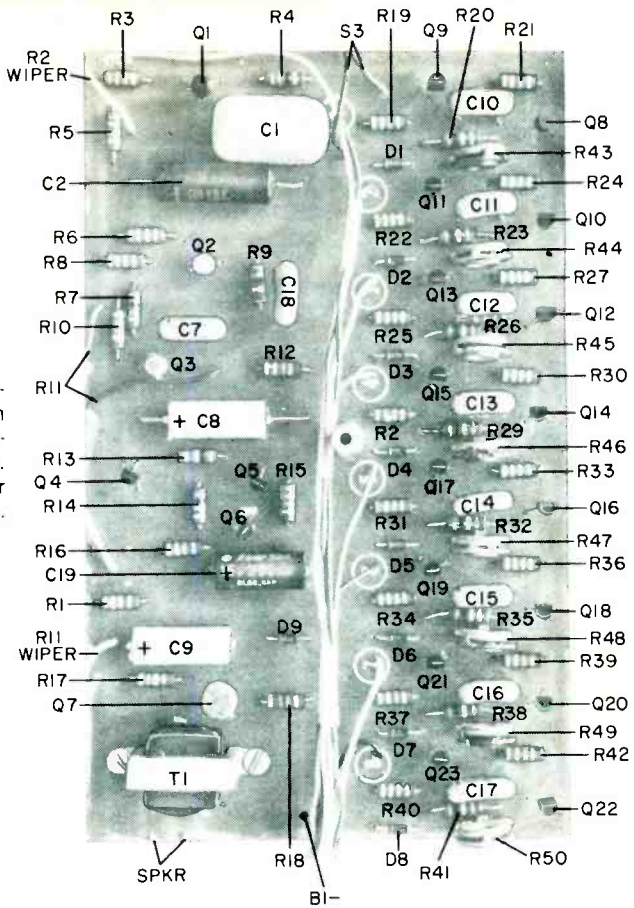

Fig. 2. Actual size printed circuit etching guide is shown on opposite page; component placement on board is shown at right. Refer to packages or cases for transistor lead identification.

This piece will serve as the front panel.

Now, referring to Fig. 3, finish fabricating the front panel according to the dimensions given. This done, set aside the front panel, and fashion the neck of the instrument from redwood or other decorative lumber. When the neck piece is cut to size with the desired outline, rout out a $\frac{3}{16}$ "-deep by $\frac{3}{8}$ "-wide groove down the center of the rear to provide a channel for the touch contact wires.

Drill eight equally spaced $\frac{1}{8}$ " holes through the center of the groove in the neck piece. Then place a #6 solder lug on each of the eight screws provided with the drawer-pull "touch contacts," and mount a drawer pull at each hole location.

Solder a length of hookup wire to each of the solder lugs (measure these wires from the solder lug to the base of the neck and add 8" to each length). If possible, use color-coded wire for easy contact lead identification. A good code to use is black, brown, red, orange, yellow, green, blue, and violet for contacts 1 through 8, respectively.

Mount a $16\frac{3}{4}$ "-long by $\frac{3}{8}$ "-wide (almost any thickness between 22 gauge and $\frac{1}{8}$ ") strip of aluminum about $\frac{1}{4}$ " to one side of the center groove (see Fig. 4), using $\frac{3}{8}$ " wood screws. Connect an 8" length of white hookup wire to the screw nearest the bowl end of the neck piece. Then carefully cut a shallow groove with a sharp knife between this last connection point to the center groove, and route the white wire through both grooves.

Anchor the neck to the front panel with three sets of 6-32 hardware. To do this, first center the spoon-shaped drawer pull at the base of the neck, and fasten it there with a screw equipped with a #6 solder lug to which a 6" length of gray hookup wire has been soldered.

Mount the speaker and grille, volume and tremolo controls, and octave selector switch in their respective holes (and the optional headphone jack, if used), as shown in Fig. 4. Pass a $1\frac{1}{2}$ " oval-head machine screw through the center hole on

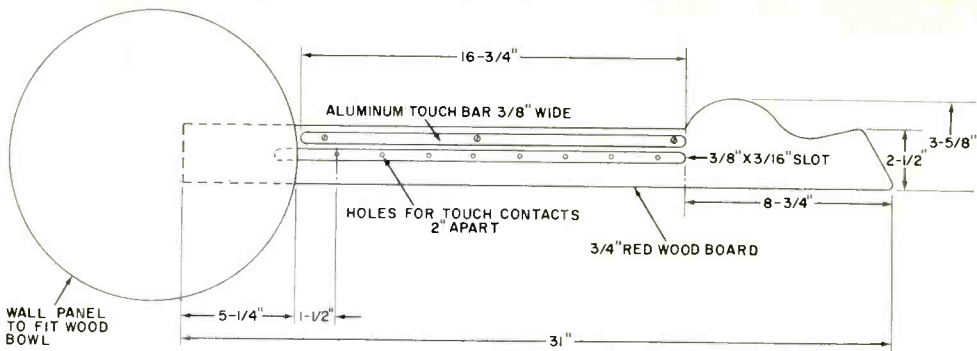

Fig. 3. Cut wall panel to fit outer circumference of bowl used. Locate holes for note touch contact mounting as shown, aluminum touch bar above groove.

the front panel, slide on a lockwasher, and screw all the way on a 1" threaded spacer. Slide on the circuit board, foil pattern down, follow with another lockwasher, and screw onto the threaded screw stub another 2 1/2" length of threaded spacer. (Note: If you cannot obtain the second spacer in the required length, try sandwiching a few flat washers between the board and a shorter spacer to obtain the proper final length. In this case, substitute a 2" oval-head screw to start with.)

Now referring to Figs. 1 and 2, interconnect all components and assemblies. If you are using the optional headphone jack, reroute the wiring from the output of the transformer through the jack as shown in Fig. 5, then to the speaker.

When connecting the color-coded wires from the various touch contacts to the circuit board, leave about 1" of slack and clip away any excess. Then to finish initial assembly, wire the battery holders for a series hookup, and connect the loose ends of the wires from the positive and negative holder contacts to the appropriate points in the circuit.

Tuning. To make the method of playing the Touch-A-Tone similar to that of a guitar, the instrument must be tuned so that the high-frequency notes are played by touching the contacts nearest the bowl. Each successive contact away from the bowl should diminish the frequency of the note generated.

The simplest method of tuning the instrument is to use a frequency counter. However, if a frequency counter is not available, you can use an audio generator and oscilloscope. In fact, if you are a musician and have a good ear for pitch and access to a properly tuned piano, you can even tune the instrument by ear.

To prepare for tuning by either of the electronic methods, make sure the tremolo is off. Take the output of the Touch-A-Tone from the speaker terminals. First, solder a 0.047- μ F capacitor (C6) in position 1 of octave selector switch S3. Then connect one clip lead between B1+ and the thumb touch contact, and another clip lead between B1+ and contact 1 on the neck of the instrument. If you are using the frequency counter, simply set R43 (see

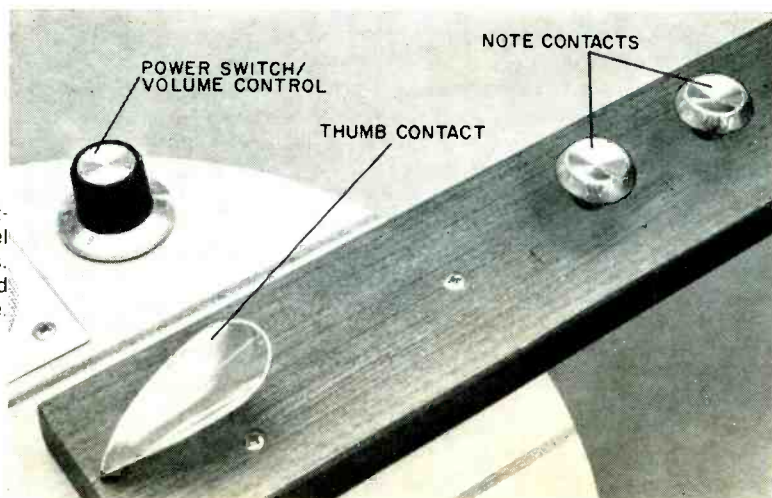

Fig. 4. Neck piece attaches to wall panel with three screws. Locate spoon-shaped drawer pull at base.

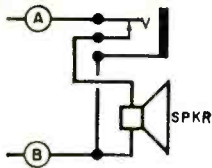

Fig. 5. Wire headphone jack as shown; connect to points A and B in schematic.

Fig. 2) for a reading of 2093 Hz on the frequency counter.

Now, move the second clip lead to contact 2, and set $R44$ for a reading of 1976 Hz. Continue moving the second clip lead and adjusting the proper trimmer potentiometers for the frequencies indicated under the "First Octave" column in the table on page 93.

To use the oscilloscope/signal generator method of tuning, set up the clip leads as described above. Then connect another pair of leads between the output of the Touch-A-Tone and the horizontal input and ground of the scope. Connect a final pair of leads between the output of the audio generator and vertical input and ground of the scope.

Now, first tune the audio generator to the frequency listed under the "First Octave" column in the Table, and adjust the setting of the proper trimmer potentiometer to obtain a circle on the screen of the scope. (Note: if you have a meter available, set the output signal level of the instrument to the same signal level of the generator.) The circle indicates that the Touch-A-Tone and audio generator are tuned to the same frequency. Also, remember that as you move from one trim pot

to another, you will have to move the appropriate clip lead from touch contact to touch contact.

When you are finished tuning the first octave, you can, if you desire, replace the trimmer potentiometers with fixed resistors of appropriate values to obviate periodic retuning. If you leave the pots in place, readjustment about twice a year will be sufficient.

Next, install a $0.1\text{-}\mu\text{F}$ capacitor ($C5$) in position 2 of $S3$. Parallel connect a $0.15\text{-}\mu\text{F}$ capacitor with a $0.04\text{-}\mu\text{F}$ capacitor to make the specified $0.19\text{-}\mu\text{F}$ value for $C4$; connect this assembly in position 3 of $S3$. In like manner, to make the $0.377\text{-}\mu\text{F}$ value specified for $C3$, parallel-connect a $0.33\text{-}\mu\text{F}$ capacitor with a $0.047\text{-}\mu\text{F}$ capacitor, and solder this assembly into position 4 of $S3$.

If you do not want the variable-depth control for the tremolo circuit, simply install and solder a 1.5-megohm resistor in the $R5$ position on the circuit board. For variable-depth, mount a 1.5-megohm potentiometer in a convenient location on the front panel of the Touch-A-Tone. Solder one end of a 680,000-ohm, $\frac{1}{2}$ -watt resistor to the wiper lug of this potentiometer. Then connect the free end of the resistor to one of the $R5$ holes in the board, and a length of hookup wire between the right lug of the pot (viewed from the rear) and the other $R5$ hole.

Assemble the instrument, and you are ready to play a tune. With a little practice, it will not be long before you are playing like an old pro. ♦

One suggested layout for controls and speaker on front panel is shown in photo below. If headphone jack and variable-depth tremolo are used, mount on rear near $R1$ and $R11$.

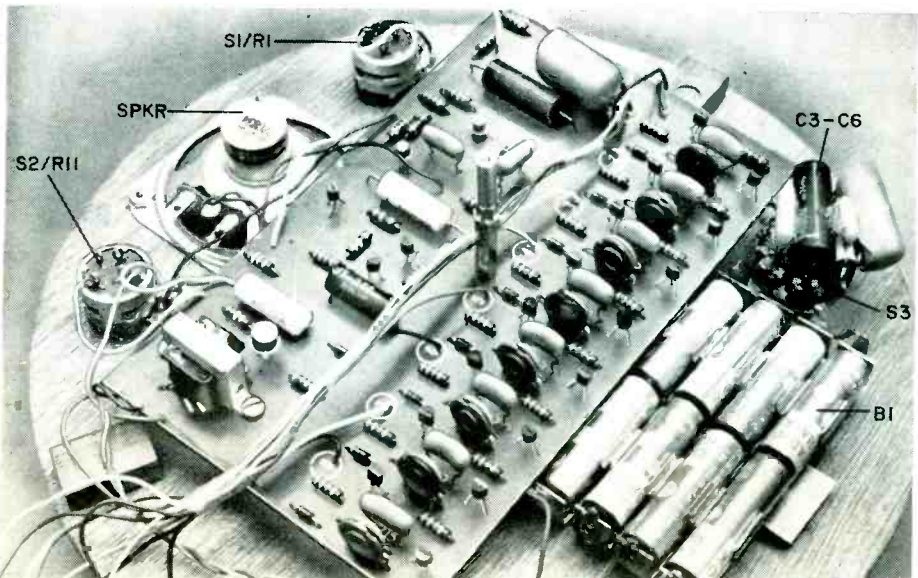

QUIZ ON AC CIRCUIT THEORY

BY ROBERT P. BALIN

Voltage measurements made in a series ac circuit seldom add up as simply as they do in a dc circuit. You may even find the voltage across a coil or capacitor to be greater than the supply voltage! Nevertheless, Ohm's Law and Kirchoff's Law do apply, and careful measurements will show that the supply voltage and the various voltage drops around a series ac circuit are related in an unusual way: the square of the supply voltage is equal to the square of the difference between the voltage on the coil and the voltage on the capacitor, plus the square of the voltage on the resistor.

This relationship, $(VT)^2 = (VL-VC)^2 + (VR)^2$, can be used to find any unknown voltage if all others are known.

In parallel ac circuits, the currents add up the same way as voltages do in a series ac circuit. Brush up on your ac theory and see if you can solve the missing voltage or current in the circuits below. Where necessary, the voltages and currents are related by the 3:4:5 ratio to provide easy, whole number answers. Only simple algebra is required. Vectors, phasors, and quadratic equations are not necessary to find the solutions.

(Answers are on page 156)

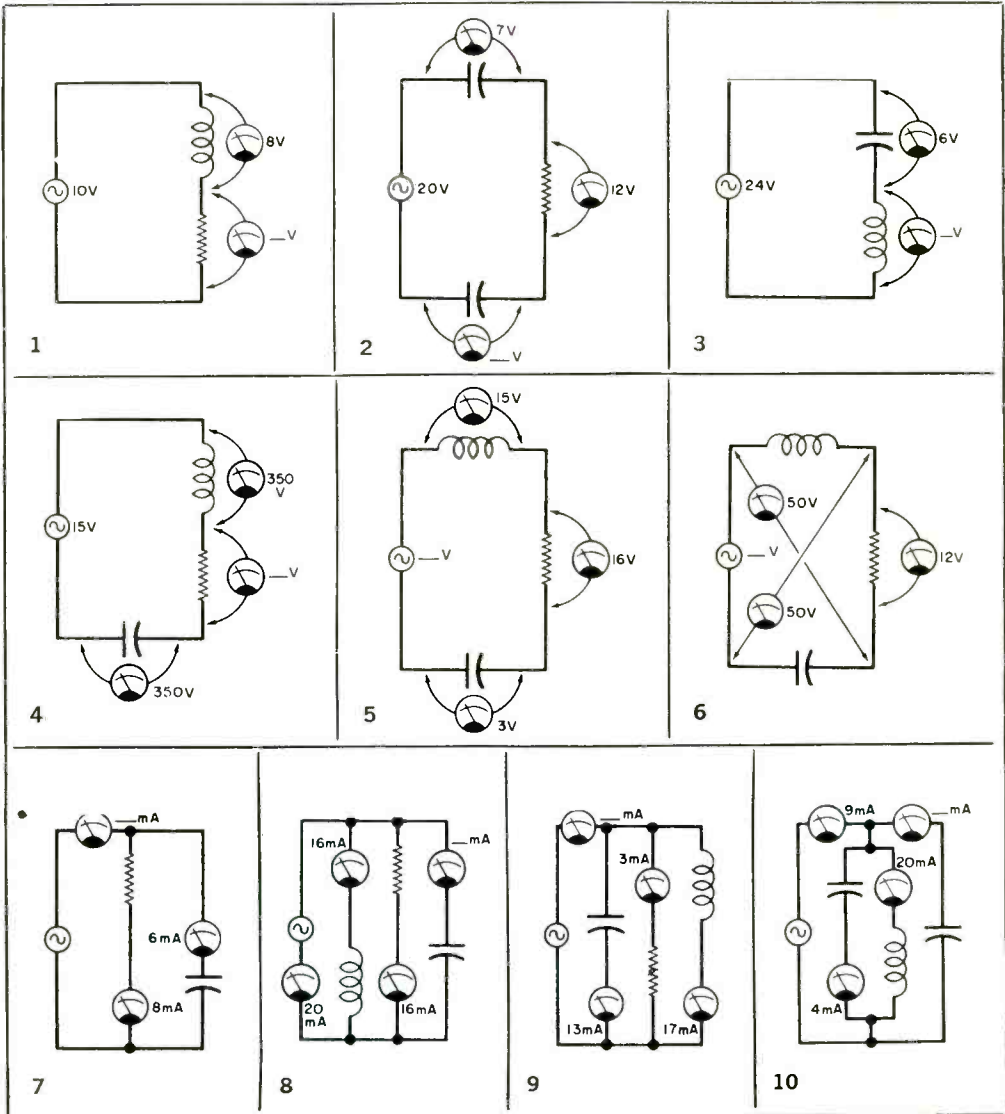

CARE AND HANDLING OF COAXIAL CONNECTORS THE QUICK, FOOLPROOF WAY



BY WILLIAM I. ORR, W6SAI



MANY of the so-called UHF connectors were developed during World War II for use with medium size coaxial r.f. cables (such as RG-8/U and RG-11/U). Now generally supplanted by the newer Series N connectors in commercial equipment, these inexpensive and readily available UHF connectors are still widely used on amateur, CB, and SWL equipment. The most common members of this family are the male plugs (PL-259, PL-259A, and UG-295/U) and the female receptacles (SO-239, UG-296/U).

The male plug, a beguilingly simple affair, has a non-constant impedance, is a non-waterproof device and (to many exasperated amateurs and CB'ers) is an in-

vention of the devil. A look at the PL-259 plug shows instantly how it *should* fit on the end of a piece of coax cable; the installation is self-evident! But, alas, getting the plug properly astride the cable end and soldered firmly in place is a frustrating and time-consuming task. In too many instances, the user simply gives up the battle, jams the connector on the end of the cable, and solders what he can, leaving whiskers of copper braid ready to short out the plug.

True, the plug manufacturers provide nifty little drawings showing how the plug should be placed on the cable; but these pieces of advertising art merely make the frustrating experience seem more bitter, since sooner or later most amateurs come

to the reluctant conclusion that the PL-259 plug was *never intended* to be placed on a coaxial cable by the hand of man!

I have battled the PL-259 plug problem for longer than I care to admit and I finally solved the dilemma by switching to the newer and better *type N* coaxial fittings, which were seemingly designed by a sane mind. However, time does not march on, and a large amount of gear in the W6SAI station is equipped with the PL-259's matching partner, the ubiquitous SO-239.

Finally, with the assistance of W6CYL, who had made his peace with the coaxial plug problem, it was decided to try a system approach that would solve the PL-259 question once and for all. Here is the solution.

Coaxial Connector Assembly. The mating cable must be properly prepared if the connector is expected to operate to its fullest capability. With a little care and some inexpensive tools, a well-engineered assembly may be made in a few minutes. In addition to a soldering iron or gun, you will need: a ruler, a sharp knife (the Stanley 99A Shop Knife is recommended), and a tubing cutter (the General Hardware #123 Midget Tubing Cutter is recommended). Oh yes, you'll need a pair of wire cutters to snip the cable to proper length, also.

Follow this procedure carefully:

Step 1. Slide the coupling ring of the PL-259 over the coaxial line. Next, take the shop knife and circumscribe a cut in the outer, black jacket of the cable about $1\frac{1}{2}$ " back from the end. Make the cut at right angles to the cable so that the end of the vinyl jacket will be square and ship-shape. Slit the free end of the jacket with the knife and peel it off.

Step 2. You now have part of the outer braided shield exposed. Using a hot solder-

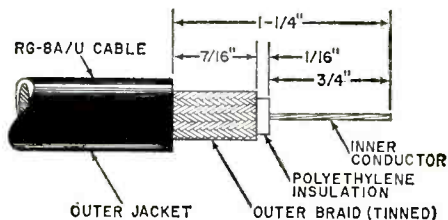

By the time you have finished step 4, the end of your RG-8A/U cable should look like this.

UHF CONNECTORS

For RG-8A/U and RG-58/U Cable

Plugs: PL-259, PL-259A, UG-295/U

Adapters for RG-58/U: UG-175/U, UG-410/U

Right-angle adapter: UG-297/U, UG-646/U, M-359

Adapter, straight (female-female): PL-258, UG-360/U, UG-299/U

Receptacle: SO-239, UG-296/U

Adapter, straight (male-male): Dow-Key F-2

Hybrid adapters:

UHF (female) to BNC (male): UG-255/U

UHF (male) to BNC (female): UG-273/U

UHF (female) to N (male): UG-146A/U

UHF (male) to N (female): UG-83B/U

UHF (female) to male phono connector:

Dow-Key A-210

UHF (male) to male phono connector:

Dow-Key A-211

UHF plug (solderless): Amphenol 83-851

(for RG-8A/U)

ing iron or gun, *quickly* and *smoothly* tin the braid, making the shield a solid entity. Do this quickly so as not to unduly overheat the inner polyethylene insulation of the cable. If you take too long, the inner insulation will melt and "squirt" out between the interstices of the braid. Don't worry; you'll obtain expertise in soldering the braid once you set your hand to it. Clean the left-over flux from the braid with paint thinner after the solder cools.

Step 3. Next, cut the soldered braid with the tubing cutter. You want to cut it so that $7/16"$ is left exposed. Using a soft pencil, make a mark on the braid exactly $7/16"$ out from the black jacket. Place the tubing cutter over the braid so that the cutter wheel falls on the pencil mark. Tighten the cutter a bit and slowly revolve it about the cable. Tighten the cutter wheel once or twice again and continue to revolve the cutter. Four or five revolutions, and the tubing cutter will neatly slice the solid braid. The unwanted braid end may be easily pulled off, using the wire cutters as snips.

Step 4. Trim the inner polyethylene insulation of the cable. It should be cut cleanly (using the utility knife) so that a collar about $1/16"$ wide is left at the end of the outer braid which was just trimmed. Go slowly, so that you do not nick the inner conductor. Once the slug of insulation is free, it may be removed from the cable by grasping it with your fingers and

slowly but firmly pulling and rotating it at the same time. When the slug is off, tin the inner conductor.

Step 5. You have now come to the moment of truth. The cable is ready for the PL-259 shell. It should be pushed on the cable end and rotated with the fingers so that the internal threads of the shell are screwed onto the outer vinyl jacket of the cable. As the plug is screwed onto the cable, you should see the tinned outer jacket appear through the four solder holes of the plug. Continue twisting the plug onto the cable until the braid is completely visible through all holes.

Step 6. The last step is to solder the braid through the solder holes of the plug and solder the center conductor to the center terminal of the plug. Use an iron or gun with a small point and make neat connections to the braid taking care that the solder does not run over the outer threads of the plug. With a little care, you'll have a work of art. When joints cool, examine your masterpiece and then slide the coupling ring down over the plug.

Sealing for Outdoor Use. The PL-259 is not waterproof and must be protected against moisture by an additional covering. If water does get into the plug, it can be very quickly sucked down the coaxial cable by capillary action. Soon the entire outer braid becomes corroded and line loss rises rapidly.

To seal the plug and line properly, the mating surface between the plug and the matching SO-239 receptacle should be packed with silicone grease. The connectors are then mated and the excess grease is forced out of the joint and wiped off. The next step is to wrap the coaxial joint thoroughly with pressure sensitive vinyl electrical tape. Several layers of tape should be used; and the wrappings should extend beyond each connector a minimum of four inches, making the total wrap about ten inches long. The tape should be put on under tension, with one layer overlapping the one beneath. As a final precaution, the cable run should be dressed so that water cannot run to a joint and stand there.

Use With Small Cables. The popular PL-259 UHF plug may be used with small-diameter coaxial cables (such as RG-58/U and RG-59/U) by adding a reduction adapter. For example, RG-58/U

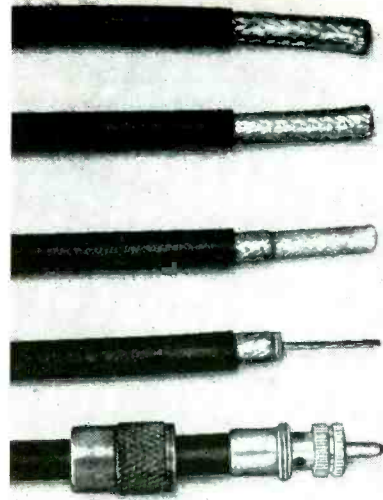

Photo shows, from top to bottom, the result of steps in preparing the cable.

(52-ohm cable) requires a UG-175/U adapter and RG-59/U (72-ohm cable) requires a UG176/U adapter. Follow much the same procedure detailed above with the exceptions noted below.

Step 1. Insert the cable end through the coupling ring and the adapter. Note that the knurled end of the ring and the narrow end of the adapter face the open end of the cable. Cut the end off $\frac{3}{8}$ " of the cable jacket with the utility knife.

Step 2. Fan the braid out slightly and fold it back over the outer jacket.

Step 3. Push the adapter forward under the braid and trim the braid with small, sharp scissors to a length of $\frac{3}{8}$ ". Next, using the utility knife, remove $\frac{3}{8}$ " of the insulation from the center conductor. Be careful not to nick the conductor. Tin the exposed conductor quickly with a small soldering iron.

Step 4. Carefully screw the plug assembly onto the adapter. The center conductor will pass through the center pin and the braid should appear through the side holes of the plug assembly. Using an iron with a small soldering tip, solder the braid through the plug assembly holes. Use just enough heat to bond the braid to the shell. After these have cooled, solder the center conductor to the tip of the plug. Finally, screw the coupling ring on the assembly.

Waterproofing and sealing are even more important when using either the RG-58/U or RG-59/U cable. ♦



BUILD THE **TWO-TONE “WAVERLY” ALARM**

AUDIBLE WARNING OF MANY USES

BY DON LANCASTER

HAVE YOU EVER needed an audio tone source that was really loud, absolutely distinctive, or even downright annoying? If so, the Two-Tone Alarm is for you.

The circuit of the Alarm automatically switches the audible output from 500 to 1000 Hz five times a second, producing a “*twee-dell, twee-dell*” sound that can’t be missed anywhere and positively can’t be ignored. By adding an optional potentiometer to the circuit, the sound level can be changed from a high tweet to a low growl.

The Alarm can be set to run continuously or it can be turned on with a local switch or a remotely operated contactor. There are two outputs; a low-level one which can be amplified in any audio amplifier and a high-level one that can be used to drive a conventional speaker directly.

You can use the Alarm as a panic button, a novelty audio device, an electronic doorbell, a selective call, a Science Fair multivibrator demonstrator, a burglar alarm, or as a signalling device for high-noise industrial environments.

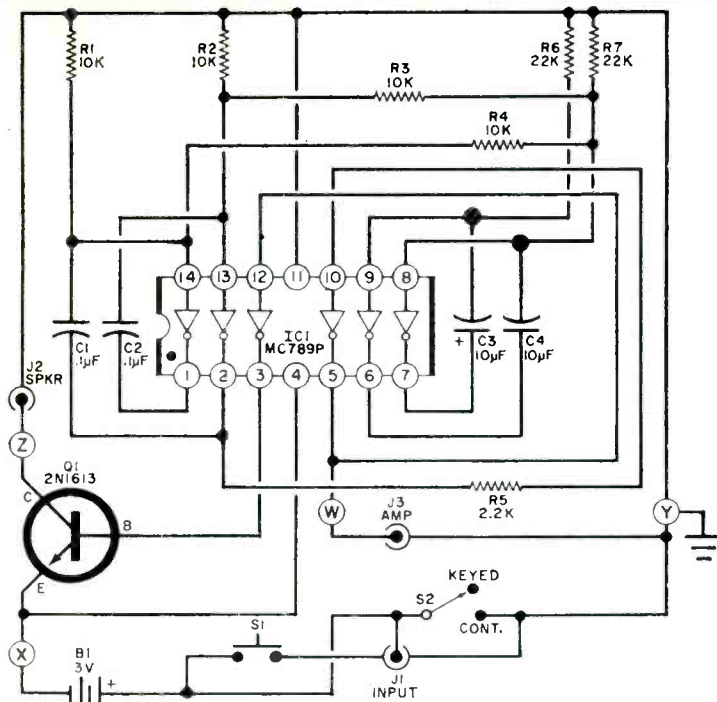

PARTS LIST

B1—D cell (2)
 C1,C2—0.1- μ F, 10-volt disc ceramic capacitor
 C3,C4—10- μ F, 10-volt electrolytic capacitor
 IC1—MRTL hex inverter (Motorola MC789P)
 J1-J3—Phono jack
 Q1—2N1613 npn medium-power transistor or similar)

R1-R4—10,000-ohm, $\frac{1}{4}$ -watt resistor
 R5—2200-ohm, $\frac{1}{4}$ -watt resistor
 R6,R7—22,000-ohm, $\frac{1}{4}$ -watt resistor
 S1—Spst normally open pushbutton switch
 S2—Spst slide switch
 Misc.—PC terminals (4), 3" x 4" x 5" case, mounting hardware, battery holder (Keystone 176), PM speaker and enclosure (optional), wire, solder, etc.

Fig. 1. The circuit is essentially a pair of audio oscillators that interact with each other to produce the strange sound. Note that the positive side of the battery is grounded to the chassis to ease wiring.

HOW IT WORKS

The integrated circuit used here is called a hex inverter and contains six separate inverting amplifier stages. Two of these stages are combined with R6, R7, C3, and C4 to form a 5-Hz astable multivibrator (square-wave oscillator). Two more inverters are combined with R1 through R4 and C1 and C2 to form a second astable multivibrator that can operate at either 500 or 1000 Hz, depending on the state of the 5-Hz multivibrator and feedback through R3 and R4.

The remaining inverters provide load isolation, while transistor Q1 provides enough drive to handle a permanent-magnet speaker.

Power for the Alarm is obtained from two D cells. Any other medium-current dc supply with a voltage from 1.5 to 6 volts can be used. Switches S1 and S2 and jack J1 are all in parallel to energize the Alarm. To simplify the assembly, the case is connected to the keyed positive supply level (PC terminal Y).

Construction. A schematic diagram of the Alarm is shown in Fig. 1. While it is not essential, a printed circuit board greatly simplifies the assembly. If you want to make your own, use the foil pattern and drilling details shown in Fig. 2. Mount the parts as shown in Fig. 3. The integrated circuit polarity is identified by a notch (between pins 1 and 14) and a dot. In the illustrations it is shown from the top. Be sure to orient it properly and use a small soldering iron and fine solder when installing it. Also, be careful about the polarities of electrolytic capacitors C3 and C4.

Assemble the Alarm in a 3" x 4" x 5" metal box. The battery holder is mounted on the bottom with pop rivets

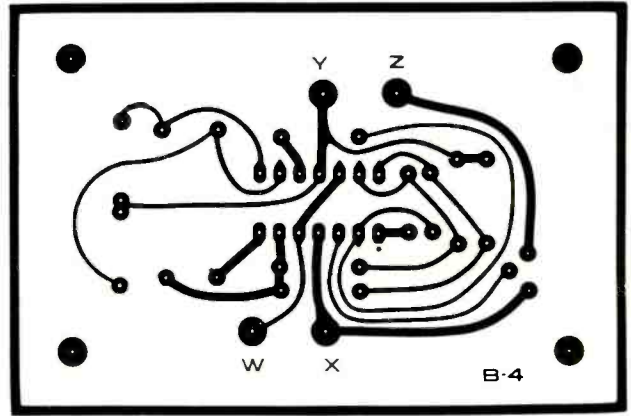
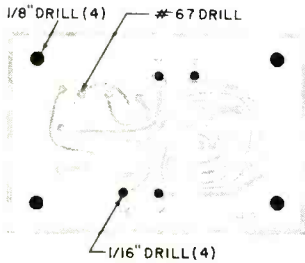

Fig. 2. Actual size foil pattern for the Two-Tone Generator. The IC is oriented so that pin 1 is adjacent to the small dot on the foil pattern. After fabrication, the board can be drilled as shown at left and PC terminals can be used at the four lettered locations. The board is supported by spacers at each corner. Fig. 3 shows parts location.

or #6 hardware, while the PC board goes on the top with suitable spacers or #6 hardware.

Operation: To test the Alarm, either connect the amplifier output (*J3*) to a suitable amplification system or attach a low-impedance (4-, 8-, or 16-ohm) speaker to the speaker jack (*J2*). The Alarm should operate immediately.

To vary the output sound, add a 500- or 1000-ohm potentiometer in series with *S1*.

Capacitors *C1* and *C2* determine the frequency of the lowest note, while *C3* and *C4* determine the switching rate. The difference between the highest and lowest notes is determined by *R3* and *R4*. You can experiment with any of these values to get different audio results.

Volume should be more than enough for most applications. If you want more, however, try using a higher supply voltage (up to 6 volts). You can also use an output matching transformer or a high-efficiency horn-type speaker. ♦

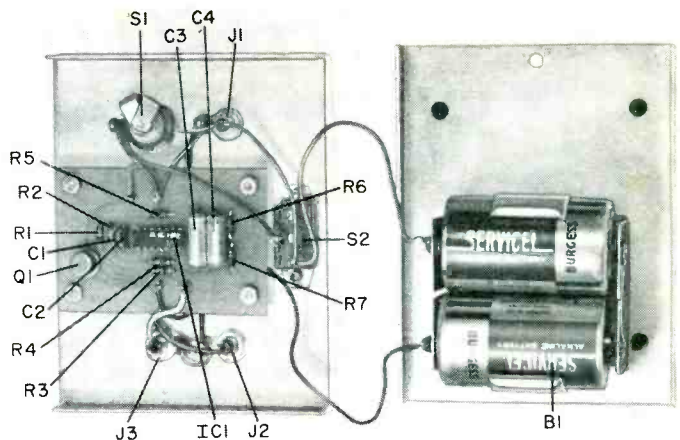
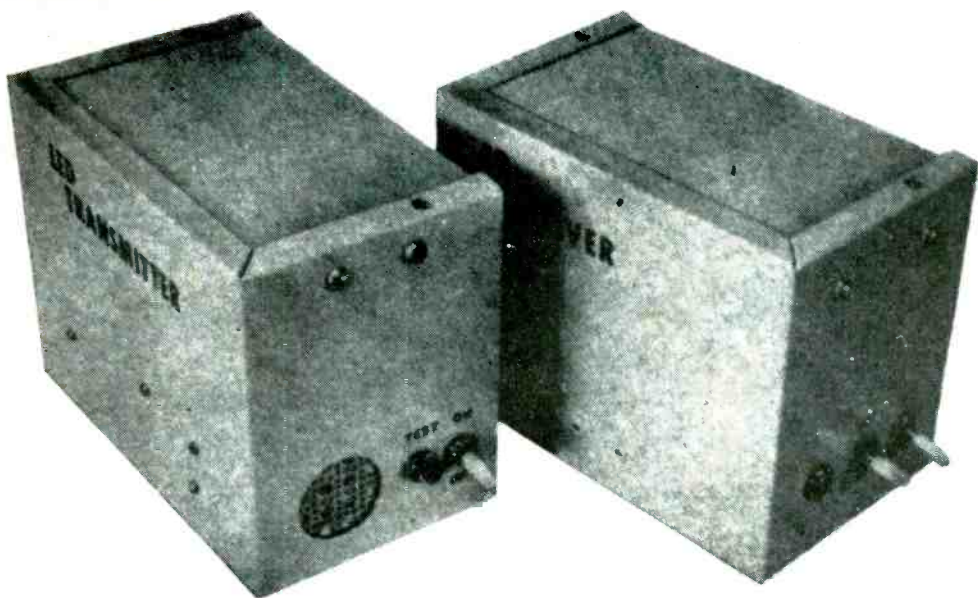

Fig. 3. Although the alarm can be built in almost any type of case, the prototype was built within a small metal enclosure. Install the components on the PC board as shown at left and mount batteries on other side.



ASSEMBLE AN LED COMMUNICATOR— THE OPTICOM

PRIVATE COMMUNICATIONS

VIA AN INVISIBLE LIGHT BEAM

BY FORREST M. MIMS, III AND HENRY E. ROBERTS

LOOKING for a totally private, jam-proof, interference-free communications system? Try the "Opticom."

Using a light-emitting diode in the transmitter and phototransistor in the receiver, the Opticom is a voice-modulated infrared optical communicator. It operates at 9400 angstroms and has a range of over 1500 feet in darkness. The range is considerably less in daylight; but, depending on sun angle and cloud cover, it can reach 100 feet without use of special filters or light shields.

The key to the amount of range obtainable is in the lenses used at the transmitter and receiver. In the prototype, simple, low-cost lenses were used. Employing a pair of binoculars or a low-cost telescope at each end would greatly increase the operating range.

Transmitter. The circuit of the transmitter is shown in Fig. 1. During voice operation, *Q1* and *Q2* provide amplification and impedance matching between the 20-mV signal from the crystal microphone and *Q3*. The amplifier formed by *Q1* and *Q2* is coupled to provide a low-frequency cutoff to minimize 60-Hz response. Darlington emitter follower *Q3* supplies bias current to the LED from *B2*. Potentiometer *R9* provides an unmodulated current-level adjustment for the LED and should be set so that ½ volt is read across *R11*. From Ohms law, ½ volt across 10 ohms indicates a current level of 50 milliamperes. This is well below the 100-mA capability of the SSL-55C LED without a heat sink.

Tone operation is provided by connecting

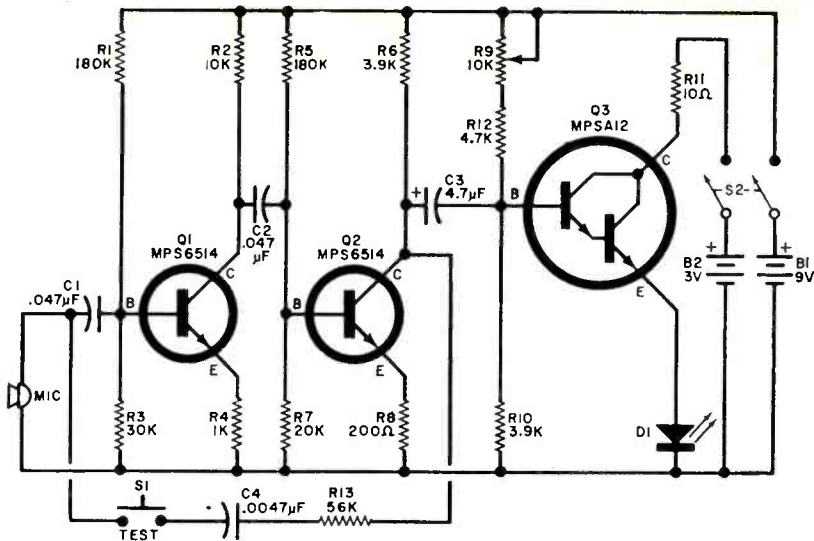

Fig. 1. The LED transmitter consists of a two-stage audio amplifier driving a Darlington modulator. When S1 is depressed, the audio amplifier is converted into an audio oscillator, used for making the original optical setup.

PARTS LIST TRANSMITTER

- B1—9-volt battery
 B2—Two 1½-volt C cells
 C1, C2—0.047- μ F, 10-volt capacitor
 C3—4.7- μ F, 10-volt electrolytic capacitor
 C4—0.0047- μ F, 10-volt capacitor
 D1—Light-emitting diode (GE SSL-55C)*
 R1, R5—180,000-ohm, ¼-watt resistor
 R2—10,000-ohm, ¼-watt resistor
 R3—30,000-ohm, ¼-watt resistor
 R4—1000-ohm, ¼-watt resistor
 R6, R10—3900-ohm, ¼-watt resistor
 R7—20,000-ohm, ¼-watt resistor
 R8—200-ohm, ¼-watt resistor
 R9—10,000-ohm, 1-watt potentiometer
 (Mallory MLC 11L or similar)
 R11—10-ohm, ½-watt resistor
 R12—4700-ohm, ¼-watt resistor

- R13—56,000-ohm, ¼-watt resistor
 S1—Normally open pushbutton switch
 S2—Dpst slide or toggle switch
 Q1, Q2—MPS6514 or HEP728 transistor
 Q3—Darlington transistor (Motorola MPSA12)

Misc.—Suitable chassis, miniature crystal microphone, lens, battery holders, battery clips, mounting hardware, cement, wire, solder, etc.

* Available from Miniature Lamp Department, General Electric Co., Nela Park, Cleveland, OH 44112, \$4.16, plus postage.

Note—The following are available from MITS, 6328 Linn. NE, Albuquerque, N. M. 87108: etched and drilled PC board, \$3.50; PC board and all electronic items except switches, microphone, batteries, and housing, \$13.50; all postpaid.

the feedback circuit comprised of R13 and C4 to the input of Q1 through S1. With S1 depressed, the amplifier formed by Q1 and Q2 oscillates at about 500 Hz and supplies 100% modulation to the LED.

The transmitter circuit is assembled on a printed circuit board as shown in Fig. 2. In installing the semiconductors, use care—particularly with the LED, whose leads should have a heat sink attached while soldering. Make sure that the window of the LED is parallel to the PC board.

Receiver. A schematic of the receiver circuit is shown in Fig. 3. Phototransistor Q1 passes a current proportional to the light in-

tensity at its active surface. In essence, light replaces Q1's base lead. Since Q1 is quite light sensitive, even a moderate level of ambient illumination will drive it into saturation. Transistors Q2 and Q3 provide a dynamic load for Q1, preventing saturation or cutoff and extending useful daylight receiving range. The FET, Q4, matches the high impedance of the detection circuit to the audio amplifier formed by Q5 and Q6. The complete receiver circuit provides a voltage gain of about 400.

A foil pattern and component layout for the receiver printed circuit board are shown in Fig. 4. Be very careful when installing phototransistor Q1 because it has a plastic

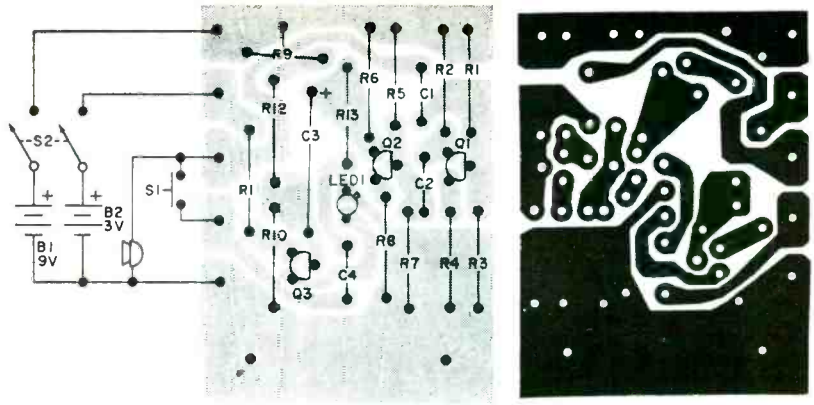
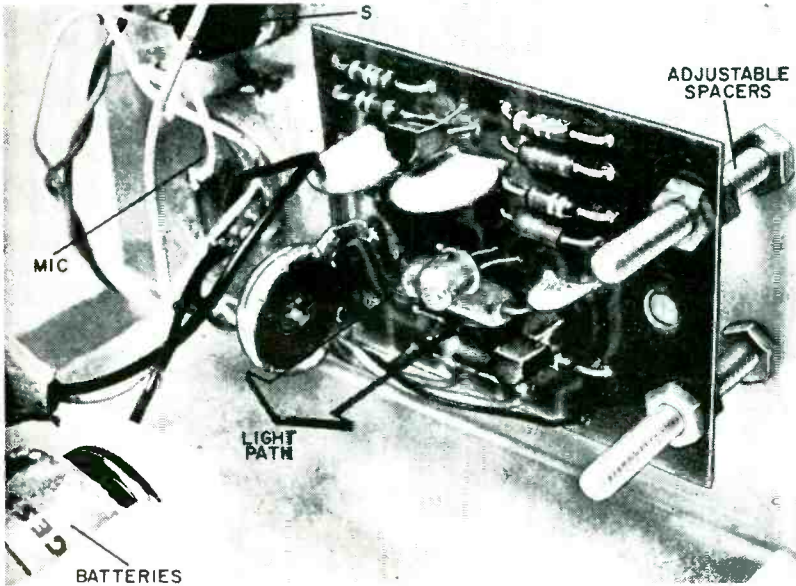
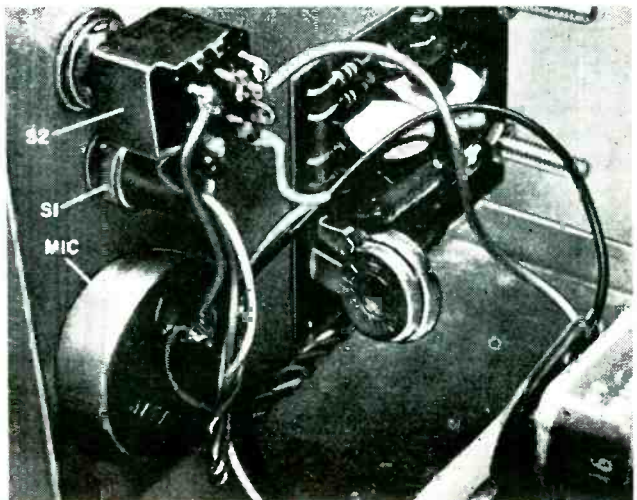
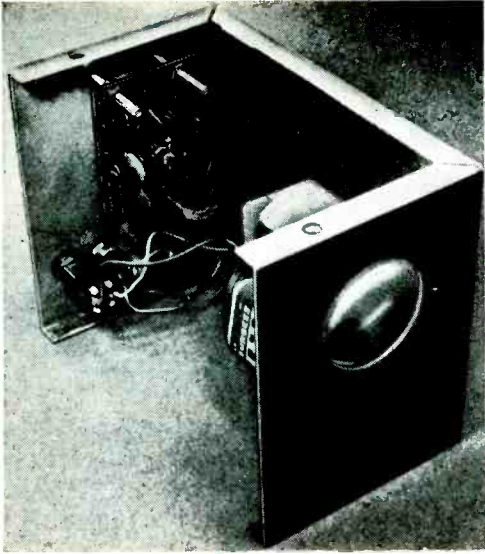

Fig. 2. The PC board foil pattern is shown actual size. When installing the components, use a heat sink on the LED (D1) and make sure that the window is facing the component side of the board. Make board larger than foil pattern to allow mounting holes.



Assemble transmitter on four adjustable spacers so that window of LED can be placed at focal point of lens. When assembling complete chassis be sure to mount the batteries so that they do not obstruct light path between LED and lens. Although the prototype has microphone on chassis, a remote mike can be used. Even S2 can be mike-mounted push-to-talk switch. Oscillator switch S1 is rarely used, so can remain on the chassis.





In assembling transmitter, arrange board and lens mounting so that LED window is on center line of lens. Text explains how to adjust board to make lens focus at window of light-emitting diode on the board.

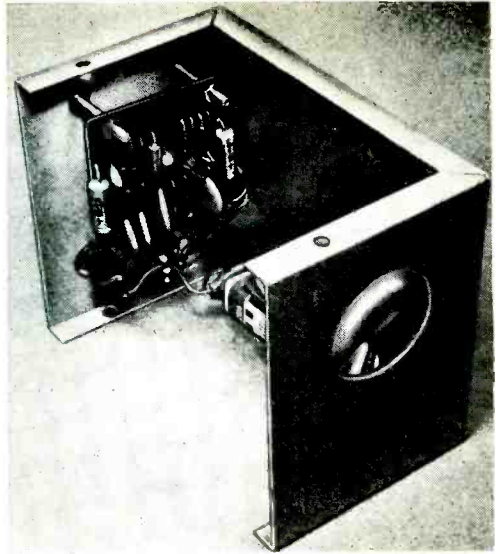

Receiver must be assembled in manner similar to transmitter, with window of Q1 at focal point of lens. In both receiver and transmitter, once focus is attained, drop of cement on screws holds settings.

package and the leads are fragile. The collector of this transistor is indicated by a small arrow on the bottom. Place the transistor through the 0.175" hole at the center of the receiver board (domed window to the component side), be sure the leads are properly oriented, and then solder them to the correct points. Use a clip-on heat sink when installing all semiconductors.

Assembly. Once both boards have been completed and checked for possible wiring errors, the system is ready for packaging. You can use the arrangement described here or you can strike out on your own. If, for example, you need only a 15-to-20-ft. range, an optical system is not required. All you have to do is aim the two boards at each other, depress the transmitter Test pushbutton, and align the two units. Then release the button and talk.

If you want a night range of up to 1500', you must use a lens at both transmitter and receiver. Obtain two low-cost magnifying lenses at least one inch in diameter and remove the lenses from their housing or frames. Measure the focal length of each lens by placing it in the beam of a fairly distant light source. The sun is ideal, but an overhead lamp, about 10 feet away will do. The focal length is determined by placing

the lens at a distance from a piece of white paper so that the smallest recognizable image is displayed on the paper. Measure the distance between the lens center and the paper—this is the focal length. The chassis to be used should be long enough so that, with the lens mounted at one end and the PC board carrying the LED or phototransistor at the other, the distance between the two can be adjusted to the focal length of the lens.

The chassis used must have a cover so that the interior is dark when the system is in use.

Drill four holes for mounting the PC board in one end of the chassis. Temporarily mount the chassis with four screws and nuts to allow for adjustments. Make measurements to determine the location of the center of the light-sensitive semiconductor with respect to its location on the chassis wall.

The center of the lens must be in the same position on the opposite end. Make the hole for the lens about $\frac{1}{4}$ " smaller in diameter than the lens.

The crystal microphone and two switches for the transmitter are mounted on the same end as the PC board on the transmitter chassis. Cut a clean hole for acoustic access to the microphone, which is cemented to the inside of the chassis. The battery clips are

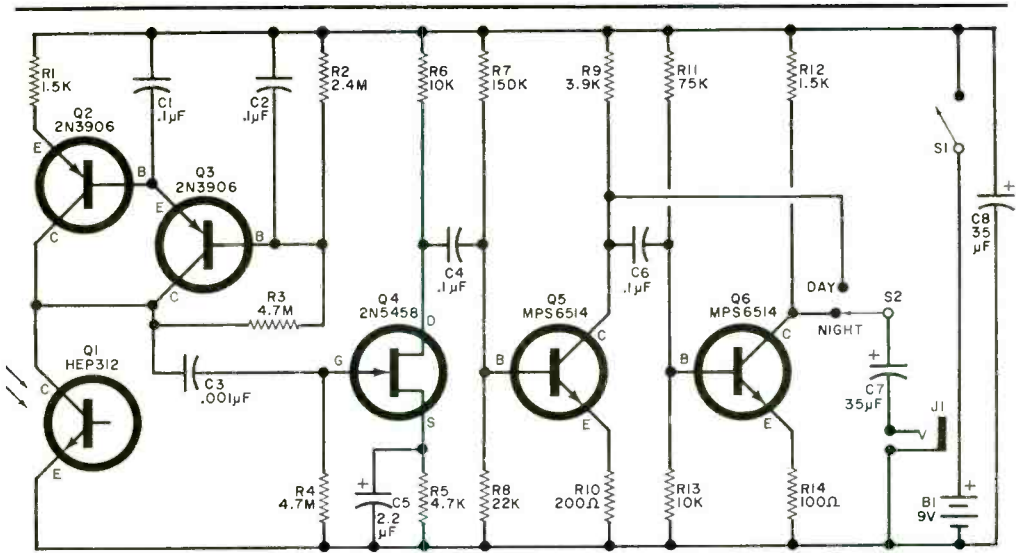

Fig. 3. Consisting of an audio amplifier driven by a phototransistor circuit, receiver can use either two or three audio stages for day or night operation. There is no actual base connection to Q1 as light from LED does job.

PARTS LIST RECEIVER

B1—9-volt battery
 C1,C2,C4,C6—0.1- μ F, 10-volt capacitor
 C3—0.001- μ F, 10-volt capacitor
 C5—2.2- μ F, 10-volt electrolytic capacitor
 C7,C8—35- μ F, 10-volt electrolytic capacitor
 J1—Earphone jack and plug
 Q1—HEP312 phototransistor
 Q2,Q3—2N3906 or HEP715 transistor
 Q4—2N5458 or HEP801 FET
 Q5, Q6—MPS6514 or HEP728 transistor
 R1,R12—1500-ohm, $\frac{1}{4}$ -watt resistor
 R2—2.4-megohm, $\frac{1}{4}$ -watt resistor
 R3,R4—4.7-megohm, $\frac{1}{4}$ -watt resistor
 R5—4700-ohm, $\frac{1}{4}$ -watt resistor
 R6,R13—10,000-ohm, $\frac{1}{4}$ -watt resistor

R7—150,000-ohm, $\frac{1}{4}$ -watt resistor
 R8—22,000-ohm, $\frac{1}{4}$ -watt resistor
 R9—3900-ohm, $\frac{1}{4}$ -watt resistor
 R10—200-ohm, $\frac{1}{4}$ -watt resistor
 R11—75,000-ohm, $\frac{1}{4}$ -watt resistor
 R14—100-ohm, $\frac{1}{4}$ -watt resistor
 S1—Spst slide or toggle switch
 S2—Spdt slide or toggle switch
 Misc.—Suitable chassis, lens, battery connectors, battery clips, mounting hardware, cement, earphone (250 ohms or more), solder, wire, etc.

Note—The following are available from MITS, 6328 Linn, NE, Albuquerque, N. M. 87108: etched and drilled PC board, \$3.75; PC board and all electronic items except switches, earphone, batteries, and housing, \$12.50; all postpaid.

mounted within the chassis, in a location where the batteries do not interfere with the light path from the lens to the LED.

On the receiver chassis use similar locations for the two switches and the earphone jack. Before mounting any components on the chassis, make sure that all mounting holes have been drilled and deburred; and, if desired, paint the chassis. Mount the PC boards with long screws to permit adjustment of focus. Put nuts on the screws on both sides of the boards to permit making the adjustment and locking the board in place.

When the wiring is complete and before mounting the lenses, test the units by aiming the active elements at each other. Turn on the transmitter and measure the voltage

Lens hole should be slightly smaller than lens. Use epoxy cement to mount lens to inside of chassis to prevent loosening.

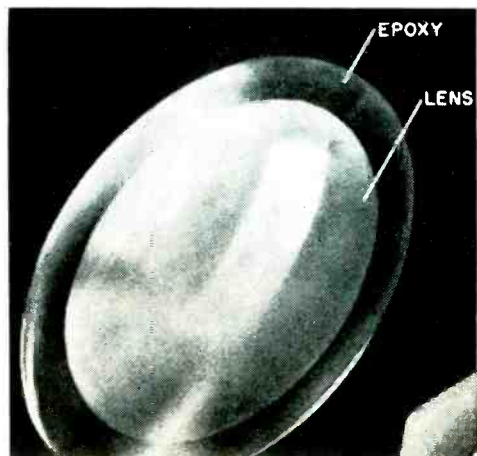

across *R11*. Adjust *R9* until this voltage is $\frac{1}{2}$ volt. With both units operating, depress the transmitter pushbutton *S1* and move the receiver slightly until a loud tone is heard in the earphone. If no tone is heard, test the receiver by aiming it at a 117-volt 60-Hz light. If the receiver is operating properly, you should hear a distinct 60- or 120-Hz hum. If you do not, troubleshoot the receiver. Once it is working, and you still get no signal from the transmitter, troubleshoot it.

With both units working, mount the lenses using a commercially available sealant. Mount them on the inside of the chassis so that they cover the holes and their centers are in line with the light-sensitive semiconductor elements on the PC boards.

Optical Alignment. Hold each unit in the beam path of a relatively distant light source. DON'T use the sun for this step—a common light bulb about 10 feet away will do. Align the chassis so that the light falls on the window of the active optical element. Move the PC board back and forth until the light comes to a sharp focus on the element window. Once this position has been located, lock the mounting screws; and, though it is not necessary, place a spot of cement on the screws to insure permanence. Once both units have been aligned optically, check that the batteries are firmly mounted and assemble the chassis covers.

You can simplify the optical alignment process by using a small phosphor screen

which glows orange when illuminated by the invisible infrared from the LED. Just activate the screen by placing it near a 100-watt lamp for a few seconds, turn off the room lights, and aim the transmitter at the screen from a few feet away. You can order an IR phosphor screen, called the Tell-Tale Card, from General Electric (Order #3-3361, Miniature Lamp Products Dept., Nela Park, Cleveland, Ohio 44112; price \$1.75).

Range Testing. Place the transmitter on a level mount and point it along a path unimpeded by obstacles for at least several hundred feet. With the Test pushbutton (*S1*) either depressed or temporarily shorted, walk about 10 or 15 feet away from the front of the transmitter carrying the receiver. Turn on the receiver and point it toward the transmitter, varying the aim until you hear the tone. You will notice the extreme directionality of the system. This is what makes it so private—you must be on the beam to get the signal. In daylight, the range will not be as great, but it can be improved by switching the receiver Day-Night switch (*S2*) to the Night position. If you find the tight beam too constraining, you can de-focus the receiver by moving the PC board slightly in toward the lens. One side effect of doing this is a reduction in range.

Operation. If you are using a pair of communicators as a network, the transmitter at one end should be aimed at the receiver of

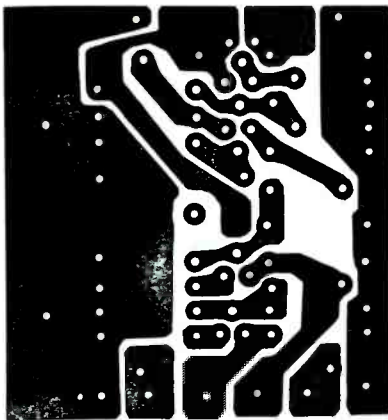
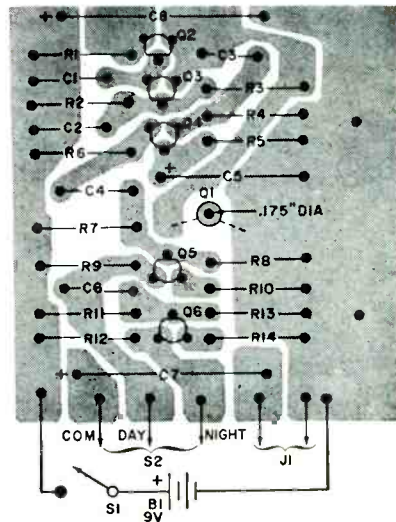
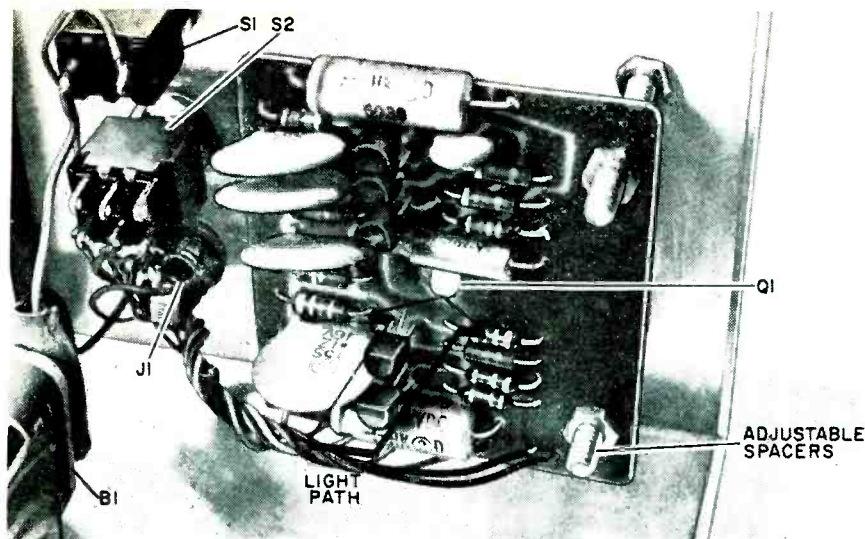

Fig. 4. When mounting *Q1* make sure window is facing component side of PC board. Connect collector to foil going to *R3* and *Q1*, emitter to common foil near *Q1* hole.





Like transmitter, assemble receiver board on four adjustable spacers so window of Q1 is at focus of lens. Be sure batteries do not obstruct light.

the other end and the transmitter Test button pushed to tone-modulate the transmitter. Both ends should be positioned until the tone at each end is heard loud and clear. Once the link has been established, the push-button is released and the microphone is used for speech communication. Manipulation of the receiver Day-Night switch (S2) will affect the range and volume.

Modifications. There are numerous modifications and variations that can be used with the Opticom. Telescopes or binoculars at either, or both ends greatly increase the range. Even low-cost plastic Fresnel lenses may be used. Since the light collecting area of a circular lens is proportional to the square of the diameter, a small increase in diameter results in a significant increase in the effective area. For example, a lens three inches in diameter has more than twice the light collecting area of a two-inch lens.

Since a diverging beam of light follows an inverse square law and produces a light energy density dependent on the square of the distance from the light source, doubling the lens light area will, in theory, double the range of the Opticom. Of course, operation in daylight or over paths having varied thermal conditions will limit the range. Longest ranges can be obtained on clear, cool nights, with a telescope at each end. A large variety of optical devices and components, ideal for use in improving the

Opticom's range, are available from Edmund Scientific Co. (150 Edscorp Bldg., Barrington, N.J. 08007).

The Opticom system may also be used as a short-distance rangefinder. Mount a bicycle reflector on the target and aim the tone-modulated transmitter at it. From a short distance away from the transmitter, aim the receiver at the reflector until the transmitter tone can be heard. The transmitter, target and receiver should form a triangle. Once the tone has been heard, simple geometry can be used to solve the triangle and calculate the distance.

One simple way to improve the night range of the Opticom is to mount a small filament of LED light source inside the receiver housing. By controlling the brightness of this light, the phototransistor can be externally biased into a better operating region, thus greatly increasing its sensitivity. To see how this works, shine a flashlight toward the receiver lens during a short-range test in darkness.

Daylight range can be improved if the interior of the receiver chassis is painted flat black. Also, a long focal plane lens can be used to narrow the field of view and reduce background illumination. This tightens the beam and makes more accurate alignment necessary. Also consider the use of a black interior tube or shield protruding from the lens to reduce ambient light to the phototransistor. ♦

Build an Impedance Meter

MEASURE IMPEDANCE
FROM ONE OHM
TO ONE MEGOHM

THE ubiquitous volt-ohmmeter (VOM) can be used to make all kinds of resistance measurements, but it is an abject failure when it comes to measuring impedances. In fact, most hobbyists and technicians reach a dead end when they have to measure an impedance. There is no way to determine the impedance of a speaker, a transformer, an RL or RC network, etc.

The Impedance Meter, whose schematic is shown in Fig. 1, includes five impedance ranges from zero to 100, 1000, 10,000, 100,000, and 1,000,000 ohms. The measurements are made at 1 kHz and the readout is a relatively large 0-100 linear-scale meter. The device is battery operated and costs about \$35.

The only restriction in using the meter is that the dc resistance path through the reactive component under test must be equal to or less than, the full-scale value of the range used to make the measurement. This restriction has never interfered with any impedance testing to date because, if a component is to be classified as reactive, it must have a higher impedance than the dc path.



BY CHARLES D. RAKES

The only component that cannot be tested is a capacitor.

Circuit Operation. Transistor *Q1* and its associated components form a simple 1-kHz phase-shift oscillator that is buffered by *Q2*. The output of *Q2* is taken from the level control, *R9*, and applied to the primary of *T1*. Transistor *Q3* is connected as a constant current source, and its output (collector) is coupled to *IC1*, an op amp circuit having a high input impedance and a gain of about 10. The next stage is *IC2*, connected as an ac voltmeter.

The output voltage of the constant current source depends on the values of the collector and emitter resistors. The base is held at a fixed voltage by zener diode *D1*. When an unknown resistance or reactance is connected to *J1* and *J2*, the amount of voltage developed across it is read on the ac voltmeter.

Construction. Any type of construction can be used; but if you want to use a printed circuit board (the best way), the foil pat-

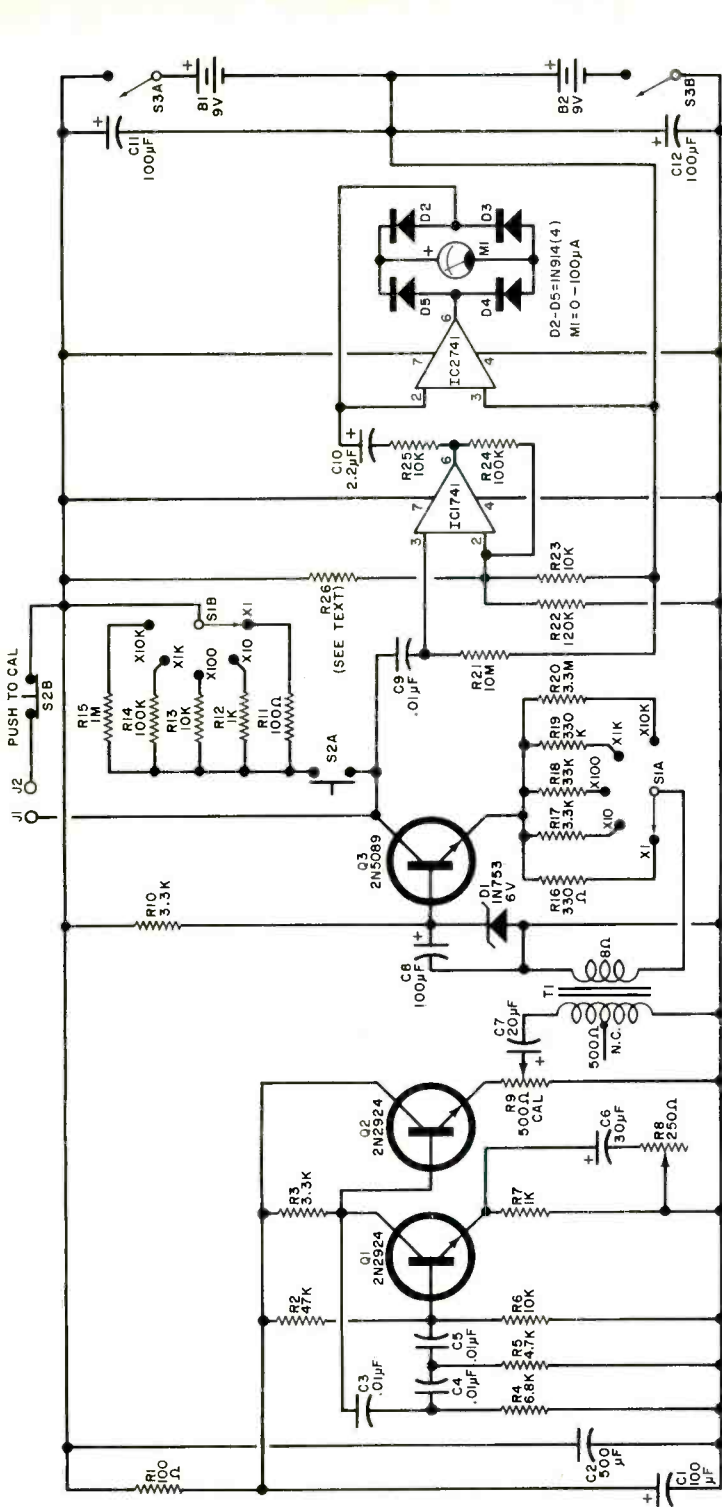

- B1, B2**—9-volt battery (six AA cells)
C1, C8, C11, C12—100- μ F, 25-volt electrolytic capacitor
C2—500- μ F, 25-volt electrolytic capacitor
C3, C5—0.01- μ F polystyrene capacitor
C6—30- μ F, 25-volt electrolytic capacitor
C7—20- μ F, 25-volt electrolytic capacitor
C9—0.01- μ F paper capacitor
C10—2.2- μ F, 50-volt polystyrene or Mylar capacitor
D1—6-volt zener diode (1N753)
D2, D5—Diode (1N914)
IC1, IC2—741 operational amplifier
J1, J2—Five-way binding post
M1—0-100- μ A meter with linear scale
R8—250-ohm, PC potentiometer
R9—500-ohm standard potentiometer
R11—100-ohm, 1% resistor
R12—1000-ohm, 1% resistor
R13—10,000-ohm, 1% resistor
R14—100,000-ohm, 1% resistor
R15—1-megohm, 1% resistor
R16—330-ohm resistor
R18—33,000-ohm resistor
R19—330,000-ohm resistor
R20—3.3-megohm resistor
R21—10-megohm resistor
R22—120,000-ohm resistor
R24—100,000-ohm resistor
R26—See text
S1—2-pole, 5-position non-shorting rotary switch
S2—Dpdt pushbutton switch
S3—Dpdt switch
T1—500:8 transformer output transformer
 Misc.—Suitable chassis, battery holders, mounting hardware, etc.

PARTS LIST

Fig. 1. The circuit is easily assembled using PC board.

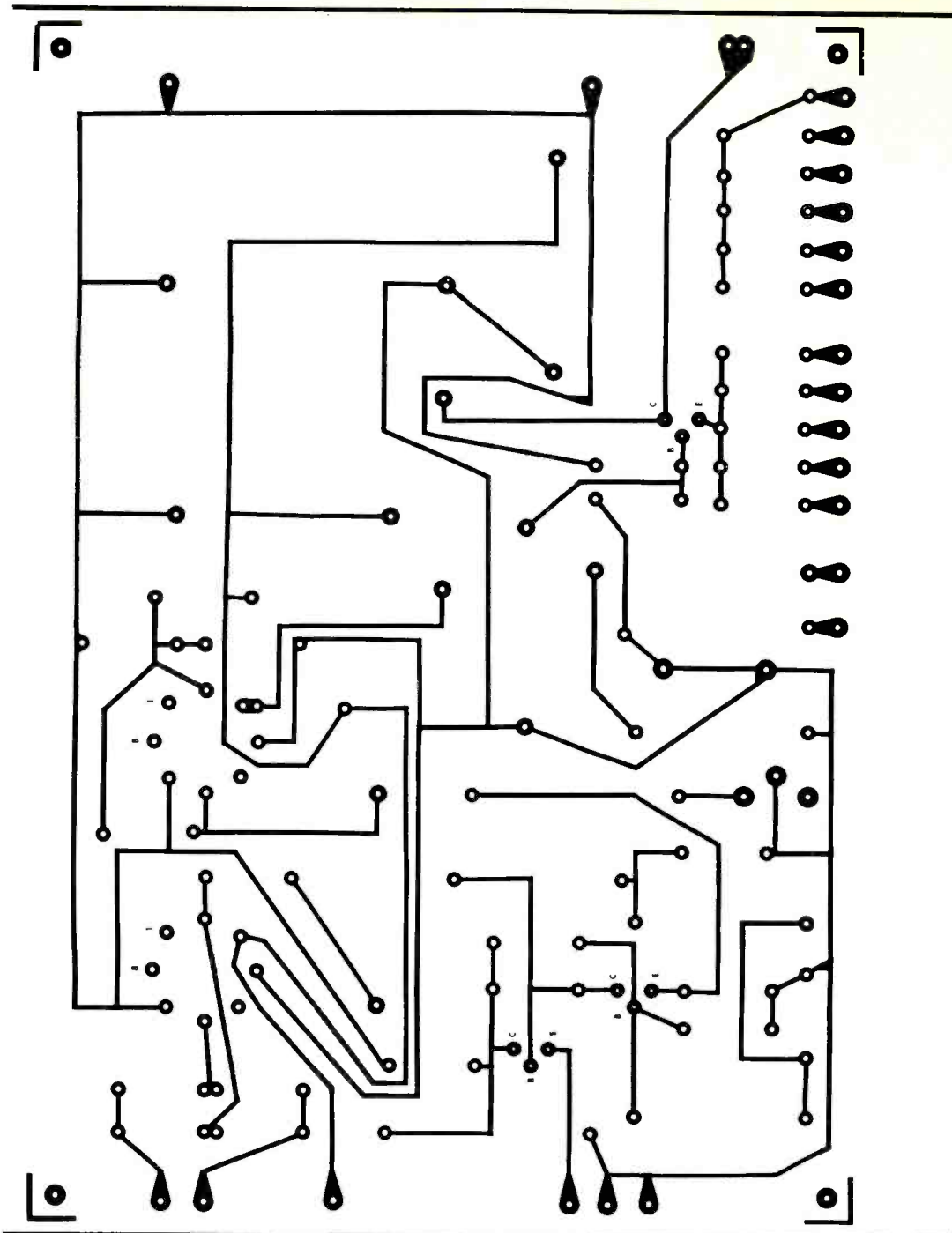

tern and component layout are shown in Fig. 2. The housing for the prototype is shown in the photo; but this is not essential. The meter, the range selector switch *S1*, the calibrate switch *S2*, control *R9*, the power

switch *S3*, and two connectors should be mounted on the front panel. Mount the circuit board on spacers and use appropriate holders for the batteries. The value of *R26* is selected in the calibration procedure.

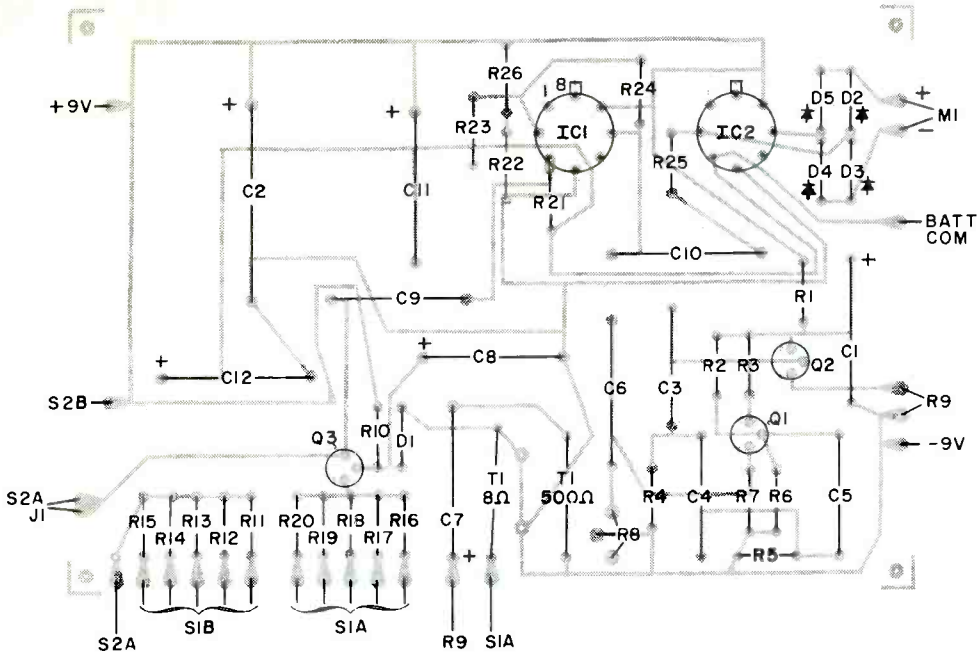

Fig. 2. The actual size foil pattern for a PC board is shown on facing page, while component layout is above. Perf board construction may also be employed.

Calibration. With all wiring checked, connect a 10-volt dc voltmeter between the common and pin 6 of IC1. With the power turned on, the meter can indicate either positive or negative at this point. Connect a resistance decade box between the R26 terminals on the board and start with a resistance of 100,000 ohms. Increase this value until the dc voltmeter indicates zero. Select a standard resistor nearest to the decade-box value, and use this for R26. The voltage at pin 6 should be less than 1 volt.

Connect a 10,000-ohm resistor between J1 and J2, and connect a scope in parallel with this resistor. Set R9 about $\frac{2}{3}$ of the way toward maximum and put the range switch on RX100. Adjust R8 (on the board) for the maximum peak-to-peak undistorted sine wave. Remove the scope and test resistor. Depress the calibration switch and adjust R9 for a full-scale meter indication. Check each range of S1 and note that a full-scale indication is obtained. If not, R8 may have to be re-adjusted.

Applications. Any value of precision resistor (up to one megohm) can be used to check the various ranges. A wirewound re-

sistor may provide false indications (not the same as the value marked on the resistor) because of the reactance of the windings.

To check speaker impedances, set S1 to the lowest range. Use the same range for headphones and switch to higher ranges if necessary.

When testing transformers, load the secondary with the required resistance (to simulate the load) and read the reflected impedance on the meter.

If you suspect a shorted turn in a choke, transformer, speaker coil, or motor winding, the impedance meter can be used to verify your suspicion since even one shorted turn can cause the impedance of a normally high impedance to show some low value—near the dc resistance.

Either RL or RC networks can be checked easily but make sure there are no series capacitors in the circuit.

The first four ranges can be made as accurate as you wish by calibration (taking into account the tolerance of the meter and of the calibration resistors). The upper range (one megohm) can have an error as large as 5% due to the input impedance of IC1. ♦

TACH-DWELL METER

ONE LOW-COST IC DOES DOUBLE DUTY

BY NORMAN J. OLSEN

USING only one low-cost digital IC, it is easy to construct a compact instrument that can measure both rpm and dwell angle of an internal combustion engine. Use of a simple equation then permits rpm calibration of almost any type of engine at any rpm.

As shown below, gates A and B are connected as a one-shot multivibrator with $R5$ and $C2$ used as the timing elements. As the engine operates, the distributor points open and close, causing the one-shot to generate fixed amplitude pulses with a repetition rate that is a function of the engine rpm. When $S1$ is in position 2 (tach), these pulses are applied to gate D (the meter driver). The large value of $C3$ integrates the pulsating voltage so that it is smooth with an amplitude proportional to the pulse frequency—or engine rpm.

When $S1$ is in position 3 (dwell), gate C is used as a conventional inverter with the pulses passed through $S1$ to gate D. The pulses are integrated by $C3$ and the resulting dc is read off on meter $M1$. The one-shot gates (A and B) are not used in this mode.

Calibration. To calibrate the dwell scale, Set $S1$ to position 3 and, with the two input leads shorted, adjust $R3$ for a full-scale deflection. This represents the angular distance between the lobes of the distributor cam shaft; i.e. 45° for an eight-cylinder engine (60° for six cylinders; 90° for four).

For the tachometer scale, determine the desired full-scale (in rpm) indication. By multiplying the rpm by the number of cylinders and dividing by 120, you will find the audio frequency required. For example, assume a speed of 1000 rpm for an 8-cylinder engine. The frequency is 66.67 Hz (about 10 volts output). Select a value for $R4$ so that, with 66.67 Hz as an input, the meter will indicate at the full-scale mark. The same relationship can be used to determine the audio frequency required for intermediate rpm indications—or for other than 8-cylinder engines.

Installation. Connect the ground lead to a suitable chassis ground on the vehicle. Use a length of insulated wire to connect the "dist" input to the non-grounded connector on the distributor points. Be sure that this lead is kept away from moving or high-temperature engine components. The meter itself can be mounted in any convenient, visible place. ♦

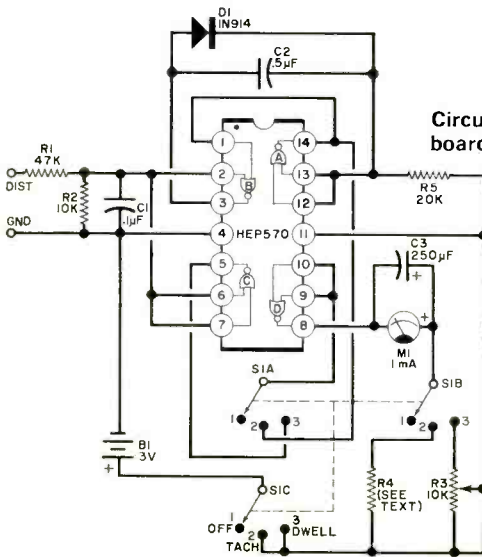

Circuit can be built on PC or perf board and enclosed in a plastic box.

PARTS LIST

- B1—Two 1.5-volt D cells
- C1—0.1- μ F, 400-volt capacitor
- C2—0.5- μ F, 50-volt capacitor
- C3—250- μ F, 10-volt electrolytic capacitor
- D1—Diode (HEP156 or 1N914)
- IC1—Integrated circuit (HEP570 or MC-724P)
- M1—0.1-mA meter
- R1—47,000-ohm, $\frac{1}{2}$ -watt resistor
- R2—10,000-ohm, $\frac{1}{2}$ -watt resistor
- R3—10,000-ohm potentiometer
- R4—See text
- R5—20,000-ohm, $\frac{1}{2}$ -watt resistor
- S1—Three-pole, three-position rotary switch
- Misc.—Suitable enclosure, battery holder, insulated cable for distributor connection.

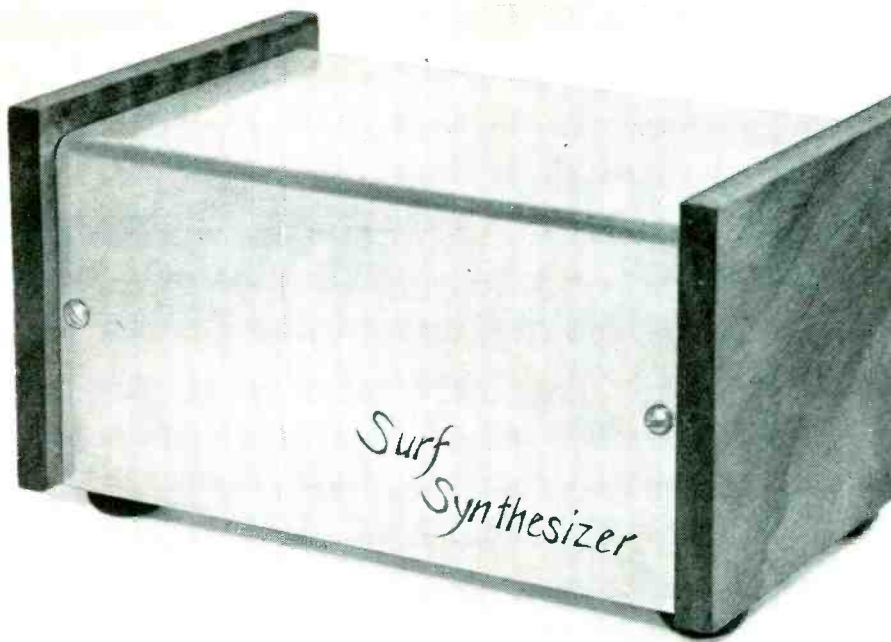

BUILD THE

SURF SYNTHESIZER

BY JOHN S. SIMONTON, JR.

REPRODUCE THE SOUND OF BREAKERS AGAINST THE SHORE

ONE of the most relaxing sounds imaginable is the roar of the surf. From Presidents on down, anyone who is close enough, and has the time, heads for the seashore when he wants to unwind. But what is really nice is to have the sound of the surf always available at the flick of a switch—and now you can. With a “Surf Synthesizer,” you can turn your home into an apartment at Malibu Beach.

The Surf Synthesizer is actually a special-purpose electronic music synthesis system which operates through your hi-fi amplifier. White noise is generated by an inexpensive silicon transistor and voiced by a voltage-controlled, low-pass filter and attenuator under the control of a random voltage generator.

Design Analysis. A complete schematic of the Surf Synthesizer is shown in Fig. 1, but it is convenient to break the unit down into blocks as shown in Fig. 2. These are a noise source; voltage-controlled, low pass filter

(VCF); voltage-controlled attenuator (VCA); and random voltage generator.

The noise source (Q7) is built around a reverse biased pn junction operating above its breakdown potential. The shot noise resulting from the avalanche breakdown mechanism is amplified by Q8.

Control voltage for the VCF and VCA originate in the random voltage generator which consists of three astable multi-vibrators (Q1-Q6) running at different rates and with different duty factors. The three outputs are summed and appear across R18. While the voltage across R18 is to a certain extent random, it is weighted by the different periods and duty factors of the astables and the different values of the summing resistor to approximate the “roll” of the ocean.

If there is a secret to the Surf Synthesizer, it is in the VCF (D1). When the VCA is disabled and only the VCF is operating, the sound is close to that of the surf even though there is no amplitude change. If, on the

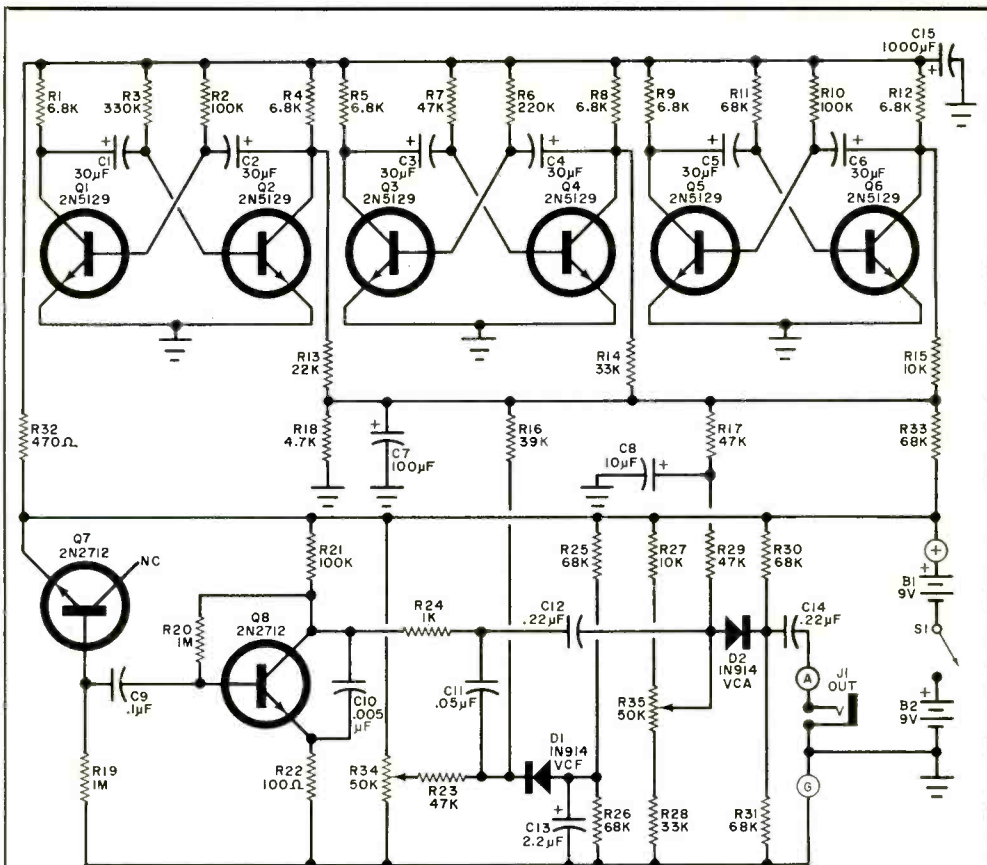

Fig. 1. The three astable multivibrators develop a composite voltage that controls both the voltage-controlled filter (VCF) and the voltage-controlled attenuator (VCA) to form the sound of the surf.

PARTS LIST

B1, B2—9-volt battery

C1, C6—30- μ F, 10-volt electrolytic capacitor

C7—100- μ F, 16-volt electrolytic capacitor

C8—10- μ F, 10-volt electrolytic capacitor

C9—0.1- μ F disc capacitor

C10—0.005- μ F disc capacitor

C11—0.05- μ F disc capacitor

C12, C14—0.22- μ F Mylar capacitor

C13—2.2- μ F, 16-volt electrolytic capacitor

C15—1000- μ F, 10-volt electrolytic capacitor

D1, D2—1N914 diode (or similar)

Q1-Q6—2N5129 transistor

Q7, Q8—2N2712 transistor

R1, R4, R5, R8, R9, R12—6800-ohm, $\frac{1}{2}$ -watt resistor

R2, R10, R21—100,000-ohm, $\frac{1}{2}$ -watt resistor

R3—330,000-ohm, $\frac{1}{2}$ -watt resistor*

R6—220,000-ohm, $\frac{1}{2}$ -watt resistor

R7, R17, R23, R29—17,000-ohm, $\frac{1}{2}$ -watt resistor

R11, R25, R26, R30, R31, R33—68,000-ohm, $\frac{1}{2}$ -watt resistor

R13—22,000-ohm, $\frac{1}{2}$ -watt resistor

R14, R28—33,000-ohm, $\frac{1}{2}$ -watt resistor*

R15, R27—10,000-ohm, $\frac{1}{2}$ -watt resistor*

R16—39,000-ohm, $\frac{1}{2}$ -watt resistor

R18—4700-ohm, $\frac{1}{2}$ -watt resistor

R19, R20—1-megohm, $\frac{1}{2}$ -watt resistor

R22—100-ohm, $\frac{1}{2}$ -watt resistor

R24—1000-ohm, $\frac{1}{2}$ -watt resistor

R32—470-ohm, $\frac{1}{2}$ -watt resistor

R34, R35—50,000-ohm trimmer potentiometer

S1—Spst switch

Misc—Case, battery connectors, battery clamps, output jack, wire, solder, hardware, etc.

Note—The following are available from P41A Electronics, P.O. Box 14359, Oklahoma City, OK 73116: etched circuit board #3711 pc at \$3.00 postpaid; kit of parts with circuit board and selected transistor for Q7, but less batteries and case #3711K at \$11.95 plus postage for 1 lb; case #3711C at \$2.50 with kit order.

*If the surf sound is not natural enough, try changing R3 to 270,000 ohms, R14 to 22,000 and R15 to 15,000.

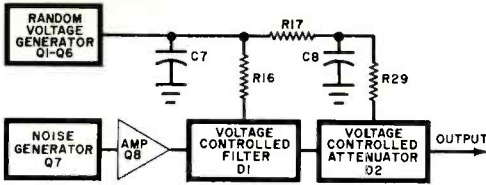

Fig. 2. Block diagram shows how random signal is filtered and level controlled by integrated random voltages from three sets of multivibrators.

other hand, the VCA is working alone, the result only sounds like interstation radio static fading in and out.

The VCF uses the nonlinear V-I characteristic of a conventional silicon diode as a voltage-controlled resistor. By proper adjustment of $R34$, diode $D1$ is ordinarily forward biased, resulting in a loss of high frequencies through $C11$, $D1$, and $C13$. As the control voltage of the VCF increases, it reverse biases $D1$ and allows less high-frequency loss to ground. The high frequencies not shunted to ground naturally become part of the output signal.

The operation of the VCA is similar to that of the VCF. Diode $D2$ is in series with the signal and is slightly reverse biased by $R35$. As the control voltage applied to the anode of $D2$ increases, its effective resistance becomes less, allowing more signal to pass.

Capacitor $C12$ blocks dc from the VCF and does not noticeably contribute to the overall frequency response.

Construction. Since there are no very high frequencies involved and parts placement is not critical, any method of construction may be used. An etched circuit board will make the job easier, however. If you decide to use a board, the foil pattern is given in Fig. 3. Component layout is also shown in Fig. 3. Leave transistors $Q7$ and $Q8$ till the last; their selection and installation are explained later. Be sure to get polarized components properly installed and use a heat sink on the semiconductor leads when soldering. In fact, it is good practice to save the installation of all semiconductors for last so that the heat from soldering adjacent components does not damage them.

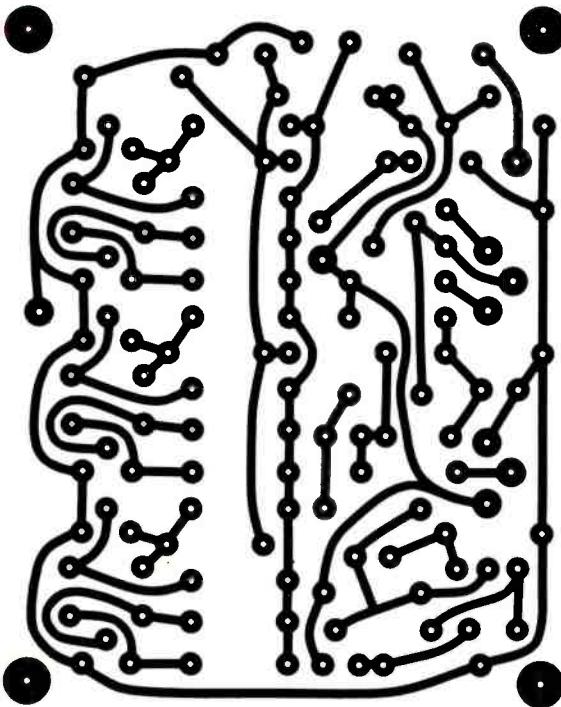
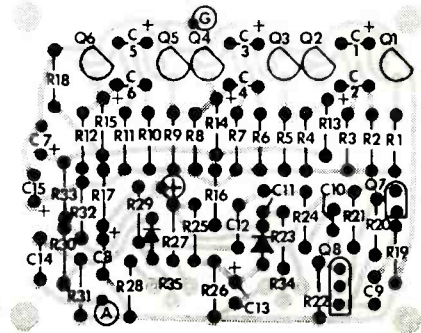
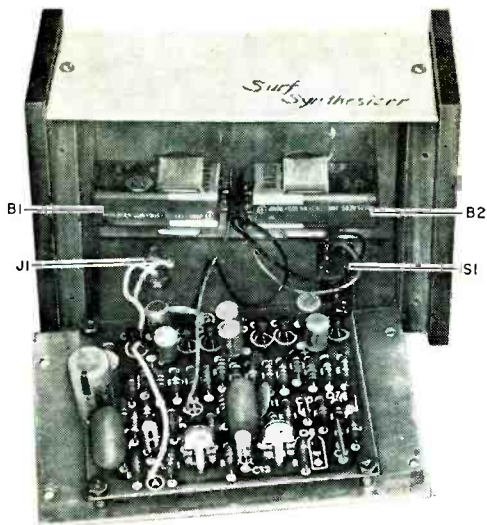

Fig. 3. Actual size foil pattern and component layout. Take care when installing semiconductors, diodes, etc. See text before installing $Q7$ and $Q8$.



When all of the components except Q7 and Q8 have been installed, connect the positive lead of one of the battery connectors to the circuit board point marked "+" and the negative lead of the other to point "G". Solder the remaining lead from each connector to either side of switch S7. Also connect the output jack to points "A" and "G" with wires that will be long enough to reach from the location



Interior view of author's prototype shows method of mounting boards and location of both of the 9-V batteries.

of the jack to the circuit board when it is installed in the case.

To select Q7 and Q8, remember that not every 2N2712 breaks down when its base-emitter junction is reverse biased with 18 volts. However a piece-by-piece survey of over 5000 transistors indicated that approximately 80% of them were suitable for use as a noise source. Since two of these transistors are used in the synthesizer, there's a good chance that one can be used for Q7. Arbitrarily select Q7 and Q8 and lightly solder them in place. Note that the collector of Q7 is not connected to any point in the circuit. Rotate R34 and R35 fully clockwise as viewed from the nearest edge of the board. Run a jumper from the output jack to the low-level input of a hi-fi or instrument amplifier and adjust the amplifier's gain about midway. Install two 9-volt batteries in the Synthesizer and turn on S1. You should hear a rushing sound

from the amplifier. If you don't, unsolder Q7 and Q8 (being careful to avoid overheating) and interchange them. When you are sure that Q7 has been properly selected, solder it and Q8 permanently in place.

This is a good time to check the voltages at the collectors of Q2, Q4, and Q6 to make sure that all three astables are operating. Use any VTVM set to a 20-to-25-volt scale. The voltage on the collector should go from about $\frac{1}{2}$ to 17 volts and have a period of several seconds.

The Surf Synthesizer may be housed in any convenient case. In the prototype, the case was made of sheet aluminum folded into a U measuring about $5'' \times 2\frac{1}{2}'' \times 3\frac{1}{4}''$. The ends of the U were sealed with walnut blocks having a rabbet cut around each edge. The ends are held in place by #4 wood screws through the aluminum. Holes were cut in the back of the case to provide clearance for the output jack and the power switch. The battery clips were glued to the top of the channel.

The circuit board was fastened to the aluminum bottom plate with 4-40 hardware and $\frac{1}{4}''$ standoffs. The bottom plate was fastened to the wooden ends with #4 screws.

Setup and Operation. The only adjustments to be made on the Surf Synthesizer are the settings of R34 and R35. While these settings are largely a matter of personal preference, a couple of tips will get you started.

Connect the Synthesizer to an amplifier and turn both on. With R35 set fully clockwise, adjust R34 for the widest and most natural sounding tone changes. When you are satisfied with the adjustment of the tone control, you can set R35 for volume changes. You will probably find that the most natural sound results when the Synthesizer is completely muted for short periods of time. There is little electrical interaction between, R35 and R34, but it will probably take some twiddling before you are completely satisfied with their adjustments.

Bear in mind that the quality of the amplifier used with the Synthesizer will greatly affect the final sound. Use an amplifier with the best bass response available so that the "roar" of the surf can be heard as well as the crescendo-like crash as the waves break. It will probably be necessary to advance the bass boost of the amplifier to achieve a really natural sound. ♦

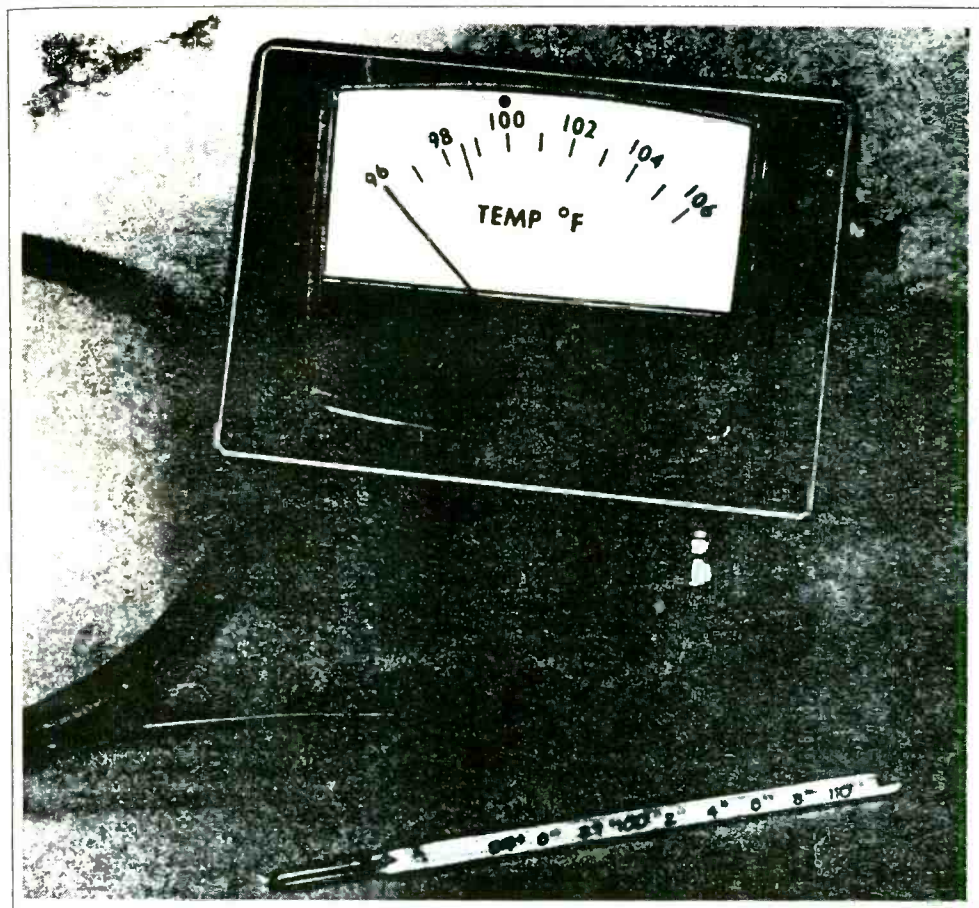

BUILD AN

Electronic Clinical Thermometer

BY J. R. LAUGHLIN

THE OLD mercury-glass thermometers that we have all used for so long have many disadvantages. They have to be shaken down before each use, they're hard to read, and they are all too easily broken. Modern electronic technology now permits us to build a small, portable, self-powered, electronic thermometer that provides a temperature indication in about 30 seconds, is easy to read, and is practically indestructible.

Temperature is sensed by a tiny precision thermistor mounted in a small metal enclosure and connected to the electronics and indicating unit through a length of very flexible cable. The diameter of the thermistor

probe is considerably less than that of a conventional glass clinical thermometer and is thus less uncomfortable for the patient. The probe is difficult to damage by accidentally biting. Its small size also allows it to respond rapidly to temperature changes and the low thermal mass of the housing does not affect the environment of the surroundings when temperature is being taken.

Thermistors generally have better long-term stability than thermocouples, and they tend to become more stable with age. In one test, thermistors varied in temperature indication by only 0.03°C per year, over a 12-year period. The resistance value, at any

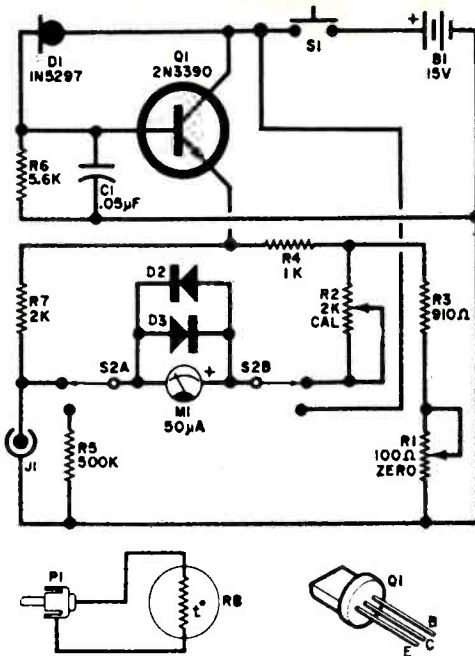

Fig. 1. Thermometer is essentially Wheatstone bridge powered by regulated battery power supply. Potentiometer R5 is used to set meter to full scale with a new battery.

PARTS LIST

- B1—15-volt battery (Eveready 411 or similar)
 C1—0.05- μ F, 20-volt ceramic capacitor
 D1—Constant-current diode (Motorola 1N-5297)
 D2,D3—Silicon rectifier diode (1N4001 or similar)
 J1—Phono jack
 M1—50- μ A meter (Calectro D1-910 or similar)
 P1—Plug to mate with J1
 Q1—2N3390 transistor
 R1—100-ohm, PC-type trimming potentiometer (Spectrol 34-3-8 or similar)
 R2—2000-ohm, PC-type trimming potentiometer (Spectrol 84-3-8 or similar)
 R3—910-ohm, 1% resistor
 R4—1000-ohm, 1% resistor
 R5—400,000-ohm, $\frac{1}{4}$ W, 5% resistor
 R6—5000-ohm, 5% resistor
 R7—2000-ohm, 1% resistor
 R8—3000-ohm at 25° C, 1% thermistor (Yellow Springs Instrument 44005 or similar)
 S1—Spst normally open pushbutton switch (Switchcraft 903 or similar)
 S2—Dpdt pushbutton switch (Switchcraft FF-1006 or similar)
 Misc.—Plastic case (4" x 3" x 1 $\frac{1}{2}$ ", Calectro J4-725 or similar), length of two-conductor cable (RG-174U, Belden 8216, or similar), press-on type, heat shrinkable tubing, spaghetti tubing, battery clip, wire, etc.

given temperature, for the thermistor used in the thermometer is accurate to less than 1%. This tolerance represents less than 0.18°F variation in temperature indication, which permits the use of any number of probes interchangeably.

Construction. A schematic of the ther-

monometer circuit is shown in Fig. 1. It can be constructed on a small PC board (see Fig. 2) and mounted directly on the meter terminals. The two large holes shown in the foil pattern should be drilled just to fit the meter terminals without sliding around.

Very carefully remove the cover of the meter to expose the scale. Place the meter

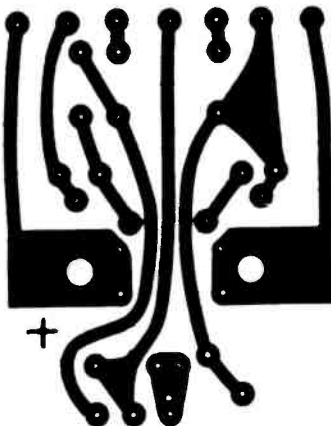
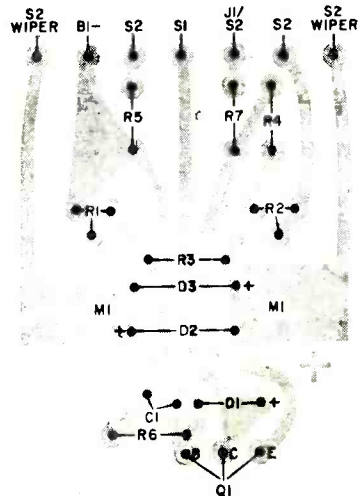
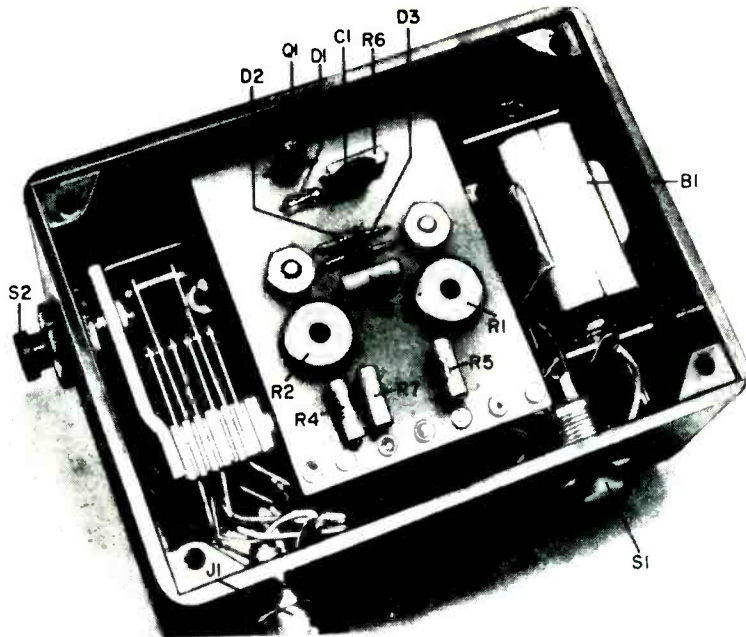

Fig. 2. Actual size foil pattern and component installation. Board mounts on meter terminals.





Completed thermometer fits in small plastic case, with battery. Note that meter is mounted in "bottom" of case to allow access when cover is lifted.

movement in a dust-free enclosure while modifying the scale. Using a light eraser, remove the numerals and the small division markers, leaving only the six large division markers. Using India ink and ruling equipment, add five matching division markers exactly between the six original markers. This results in ten equal divisions across the scale, each indicating one degree Fahrenheit. Using some form of press-on type, mark the left-hand marker 96. Number every other mark as shown in the photograph. Place a small dot over the 100 mark to indicate the battery cutoff voltage and draw a red line at 98.6 to indicate "normal" temperature. A "TEMP °F" notation can be added below the scale if desired. Reassemble the scale and meter, taking care that the zero screw engages the proper slot in the movement.

The thermometer can be assembled in a small plastic instrument case measuring 4" x 3" x 1½" with the meter mounted on the bottom of the case so that the rest of the assembly can be reached by removing the cover. You can dress up the unit by removing the feet on the bottom of the case and covering it with Contact paper. Once the meter is secured, fit the PC board in place and locate the holes for the two switches and probe jack. They must not

interfere with the circuit board. Also locate a suitable spot for the battery clip and mount it.

To make the probe, obtain approximately two feet of light, flexible two-conductor cable (RG-174U or similar) and terminate one end with a plug that matches the jack on the case. Cut a piece of slender aluminum tubing just large enough in diameter to allow the thermistor and connections to be inserted. The edges of the tube should

CAUTION

Great care must be exercised in fabricating the thermistor probe. A non-toxic epoxy must be used to keep the thermistor in place (particularly at the lead end of the thermistor); and the user must be cautioned not to bite or break the tube while it is in the mouth. Excessive strain should not be placed on the thermistor leads. Some people are allergic to the epoxy that covers the thermistor and can develop a rash when this chemical comes in contact with the sensitive areas within the mouth.

Cleanliness is as important in the use of this thermometer as it is with any other clinical instrument. Always sterilize the probe (with alcohol) before each use.

HOW IT WORKS

The circuit is essentially a Wheatstone Bridge powered by a well-regulated supply. The resistance values for the two legs of the bridge were selected to produce a linear output of desired amplitude for the temperature range covered.

Resistor *R7* is connected in series with the thermistor (*R8*) to form a voltage divider which is one arm of the bridge. The voltage at the junction of these two components is a function of the resistance value of the thermistor, which varies with the temperature. This voltage is applied to the negative terminal of the meter. The other arm of the bridge consists of resistors *R1*, *R3*, and *R4*, with the voltage at the junction of *R3* and *R4* capable of being set to equal exactly the voltage at the meter negative terminal when the thermistor probe is at 96°F. In this condition, no current flows through the meter and it indicates at the left end of the scale.

As the thermistor temperature increases, the voltage at the meter negative terminal goes down with respect to that at the positive terminal which is fixed by the resistor network. A probe temperature of 106°F produces a voltage difference sufficient to deflect the meter full scale. Precise adjustment is made with *R2*.

A well-regulated supply is mandatory for accuracy even though the battery voltage drops with use. The regulator circuit used is

superior to a zener regulator in two respects: regulation is better (especially as the battery voltage approaches the cutoff point) and it does not require a minimum current to function with a low dynamic resistance.

Operation of the regulator is based on the constant-current diode. The latter is actually a FET transistor with the gate connected internally to the source. It is carefully selected to obtain the most desirable characteristics. The constant-current diode functions in a manner just the opposite of the zener diode. Instead of maintaining a constant voltage drop, it maintains a constant current for a wide range of impressed voltages. A resistor connected in series with the diode (*R6*) then has a constant voltage across it. In the thermometer, this voltage is 5.6 volts, which is applied to *Q1*. The latter is connected as an emitter follower to supply power to the circuit. The circuit not only provides excellent regulation, but draws only about 1 milli-ampere. Capacitor *C1* insures that the transistor will not oscillate, which may be a problem with high-gain transistors.

Diodes *D2* and *D3* protect the meter from excessive voltages when the unit is operated without the probe or with a shorted probe. Voltage across the meter is limited to 0.6 volt.

Resistor *R5* is used to test the battery by causing a full-scale indication for 20 volts. The battery should be replaced when it falls to 8 volts.

be slightly rounded at each end. If you are using RG-174U cable, trim back the outer plastic cover and the braid for about two inches. The insulated center lead of the cable is connected to one thermistor lead (cut very short and insulated) while the other thermistor lead is brought down the outside and connected to the braid. Slide a length of spaghetti tubing down this pair until it contacts the braid. Use a small piece of heat-shrinkable tubing to secure the spaghetti in place. Insert the thermistor

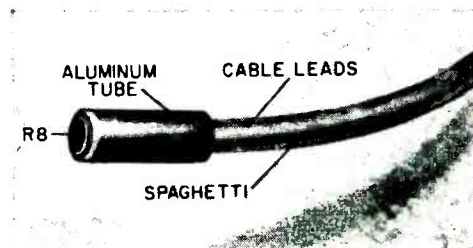

Care must be taken when making up probe. Use non-toxic glue to mount thermistor in aluminum tube. Note "Caution" on page 125.

and connections into the aluminum tubing with the aluminum just touching or slightly covering the spaghetti. Flow epoxy into the space between the thermistor and tubing and allow to harden. Use an abrasive paper to make the completed probe smooth.

Calibration. To calibrate the electronic thermometer, you will need an accurate bulb-type thermometer. Adjust the meter zero screw until the needle is directly on the 96 mark. Fill a large pot with water and heat to a temperature slightly over 96°F. Remove the heat, place the probe and bulb thermometer in the water, in close proximity, and stir the water continuously. When the water cools to exactly 96°F as indicated by the bulb thermometer, adjust *R1* so that the meter indicates exactly 96. Heat the water to slightly above 106°F, keep stirring and turn off the heat. When the water cools down to exactly 106, adjust *R2* to obtain this indication on the meter. As the water continues to cool, check the mid-scale marks. ♦

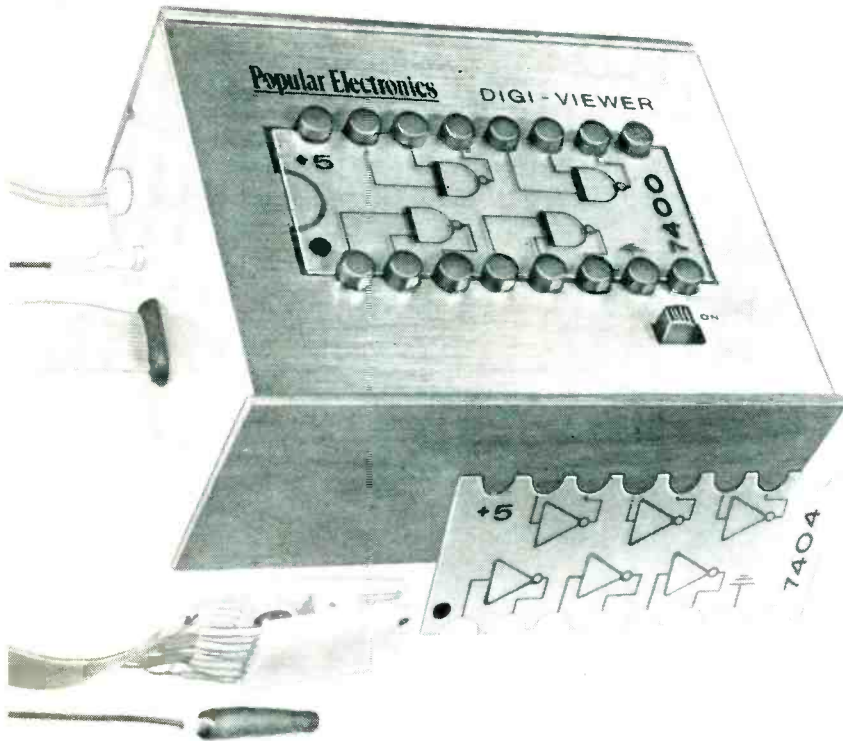

Build a DIGI-VIEWER

AUTOMATIC IN-OPERATION TESTING OF DIGITAL IC'S

BY DON LANCASTER

THAT OLD BUGABOO, testing in-circuit digital IC's, has finally been conquered for the experimenter/technician (assuming he's tired of one-lamp probes and can't afford a complex computer system). The Digi-Viewer, which can be built for under \$20, is a simple visual display that indicates immediately the state of every stage of an IC while it is operating in the circuit.

The Digi-Viewer consists of 16 indicator lamps driven by 16 Darlington pair transistor amplifiers. When these circuits are attached to the pins of an IC through a special clip-on connector, the lamps light or don't light depending on whether the potential on the respective pin is over or under 1.4 volts—thus indicating the "on" or "off" logic state. To identify which lights are which for specific IC's, a transparent overlay of the circuit arrangement is slipped between the rows of lights on the top of

the Digi-Viewer and the faulty circuit can be located at once.

The Digi-Viewer can be used on any 14- or 16-pin dual in-line package, including RTL, DTL, TTL, and most of the newer MOS types. Due to the extremely low loading factor, there is no need to worry about overloading the IC. By substituting an IC in a circuit that is known to be good (using a socket), you can perform use tests and find out if the IC is good or not.

Construction. The schematic of the Digi-Viewer is shown in Fig. 1. The diodes, resistors, and transistors are mounted on a printed circuit board as shown in Fig. 2. As shown, the Digi-Viewer is designed to handle 16-pin IC packages. If you have no need for the 16-pin version, two of the Darlington circuits (at one end) and their associated lamps may be omitted.

Any type of chassis may be used; the prototype was built in a 6" × 4½" × 2½" cabinet. The important thing is the placement of the lamps on the top surface. Space the lamps on ½" centers with the two rows 1¾" apart. Drill the lamp holes just large enough for a press fit with the lamp assembly. Determine which way the display is to be observed and make a conspicuously large dot at the number 1 lamp (pin).

can also outline the lamps with an IC layout, being sure to include the notch between pin 1 and pin 14. Use permanent black ink.

With the lamps installed, solder one end of each lamp to the common ground solder pad on the foil pattern. Then, being very careful, solder the other leads to their respective solder pads that are connected to the transistors. Looking down on the board,

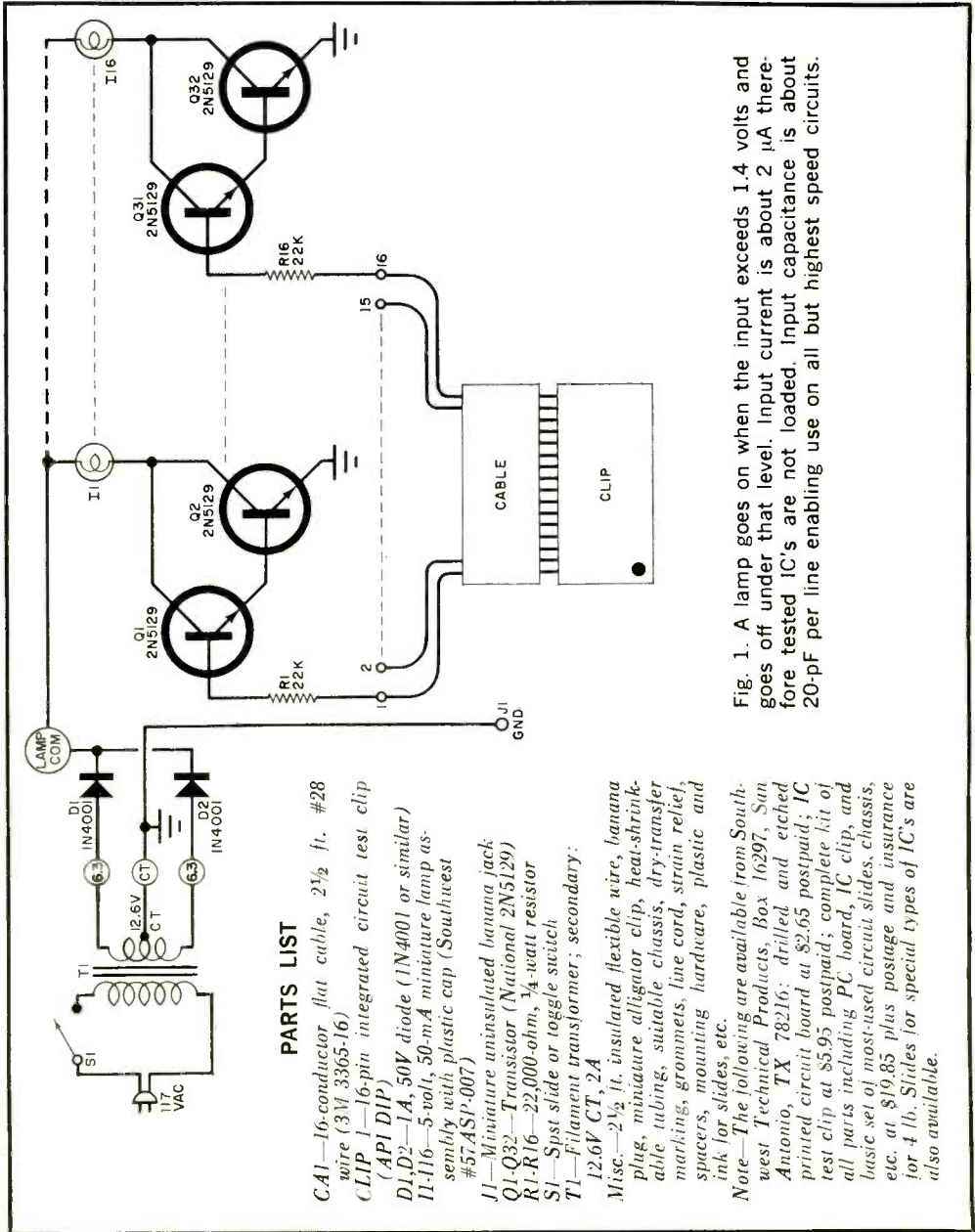
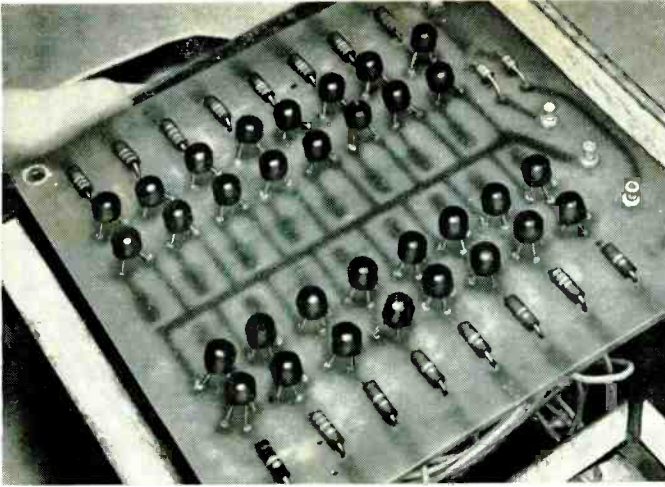

Fig. 1. A lamp goes on when the input exceeds 1.4 volts and goes off under that level. Input current is about 2 μ A therefore tested IC's are not loaded. Input capacitance is about 20-pF per line enabling use on all but highest speed circuits.

PARTS LIST

- CA1—16-conductor flat cable, 2½ ft. #28 wire (3M 3365-16)
 - CLIP 1—16-pin integrated circuit test clip (API DIP)
 - D1, D2—1A, 50V diode (1N4001 or similar)
 - I1, I2—5-volt, 50-mA miniature lamp assembly with plastic cap (Southwest #57ASP-007)
 - J1—Miniature uninsulated banana jack
 - Q1, Q2—Transistor (National 2N5129)
 - R1, R2—22,000-ohm, ¼-watt resistor
 - S1—Spst slide or toggle switch
 - T1—Filament transformer; secondary: 12.6V CT, 2A
- Misc.—2½ ft. insulated flexible wire, banana plug, miniature alligator clip, heat-shrinkable tubing, suitable chassis, dry-transfer markings, grommets, line cord, strain relief, spacers, mounting hardware, plastic and ink for slides, etc.

Note—The following are available from Southwest Technical Products, Box 16297, San Antonio, TX 78216; drilled and etched printed circuit board at \$2.65 postpaid; IC test clip at \$5.95 postpaid; complete kit of all parts including PC board, IC clip, and basic set of most-used circuit slides, chassis, etc. at \$19.85 plus postage and insurance for 4 lb. Slides for special types of IC's are also available.



Connection to each lamp driver is made on the foil side of the board. The use of PC board terminals is optional as leads can be soldered directly to the foil.

pins, two leads may be removed from the cable.) Drill a hole and fit it with a grommet to hold the flat cable. Draw the cable through the hole in the chassis and connect it to the test clip. Identify pin 1 with a wearproof mark. Use small lengths of heat-shrinkable tubing at the clip end to improve the looks, strengthen the cable termination, and remove the probability of short circuits.

For high-speed logic systems, including TTL, the multi-lead cable should be less than 2' long. Longer lengths are acceptable for RTL, DTL, and MOS circuits.

For the ground connection, use a conventional banana plug and jack with a piece of flexible wire 2 or 3 feet long. Terminate the other end in a miniature alligator clip. The ground jack (J1) is connected to both the metal case and the PC board ground.

Make up some plastic slides with cutouts for the lamps so that they fit between the two rows of lamps. Mark the plastic (with permanent ink or temporary grease pencil) with the logic of the circuit to be tested.

Checkout and Use. With power supplied to the unit, connect the ground clip to the negative end of a 1.5-volt cell. As the positive end of the cell is connected to each pin of the test clip (via a test lead), the appropriate lamp should come on. The bulbs must correspond to the clip terminals.

To use, snap the correct slide into place and connect the ground clip to the ground terminal of the circuit under test. Connect the large test clip to the IC being tested, making sure that the locator dot at pin one is correctly positioned on pin 1 of

the IC. Just open the test clip with a little pressure at the top end and fit it down over the IC. On a 14-pin inline IC, the two right-hand clip connectors will be off the right side of the IC away from the locator notch or dot code.

The first thing to note is that operating voltage is applied to the IC. This is indicated by the lighting of the lamp at the power supply pin. The ground lamp should not be lit. Now check that the input pins that could hold the IC at reset, zero or other state have the correct voltages on them to permit proper operation. Generally, RTL direct set, reset, and direct clear inputs are disabled by grounding, while their counterparts in TTL and DTL are made positive to disable. There are enough exceptions to this rule however that the appropriate data sheets should always be on hand to check any IC to be tested.

After checking the various conditions that

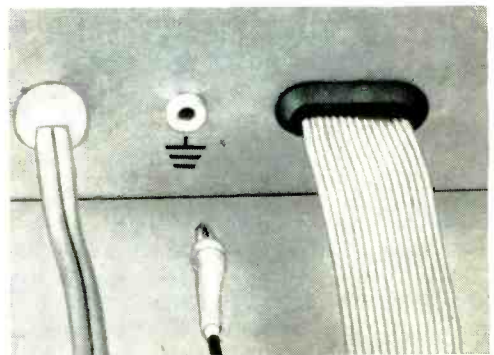

Both power line and 16-lead cable are passed through metal chassis via rubber grommets, ground jack (J1) is positioned at center.

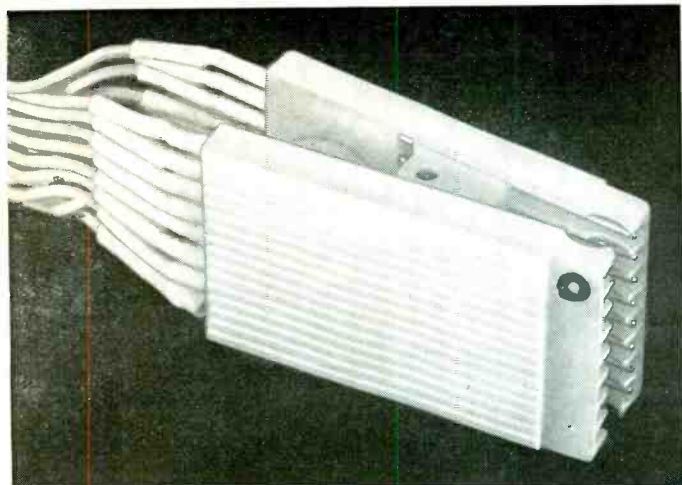

After wiring the 16-lead cable to the IC clamp, identify one end pin of the clamp with a dot to indicate pin 1. Make certain that each terminal of clamp corresponds with a similar terminal on PC board. Heat shrinkable tubing is used at cable-clamp interface for protection.

could cause difficulties. The logic rules for the IC should be verified. For example, on an inverter, when the input lamp is on (signifying a positive input), the output lamp should be off (signifying a grounded output), and vice versa. If both lamps are on, the IC is bad or there is an open ground. If both lamps are off, the IC is bad or the output is shorted. In the case of a flip-flop, the output lamps should turn on and off at half the rate of the input lamp. At high switching frequencies, the input and output lamps will all be on but with partial illumination due to the high switching speed. Proportional brightness can also be used as a relative indicator of the duty cycle of other "too fast to see" signals. The logic can be cycled at a slower

rate by using an external oscillator so that the indications become clear. A bounceless pushbutton may be used to "step" the logic manually, for a more detailed analysis. While you will not be able to see such things as a one-microsecond reset pulse, the indicator lamps connected to the flip-flop outputs will show the effect of such a pulse.

A few digital IC's have open collector circuits (readout drivers for example). An unused open collector in a system may never get to a high state and thus may show an off condition on its lamp even when the IC is perfectly good. If there is no connection to these outputs, then a pullup resistor of about 2200 ohms to the circuit positive may be used. ♦

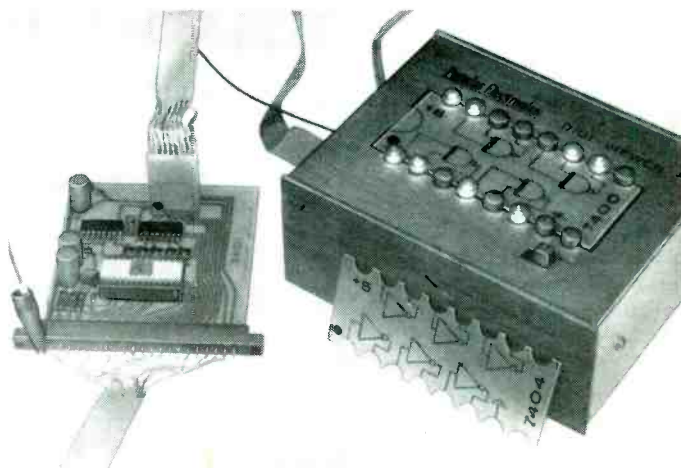

To use, simply affix the IC clamp to the IC under test making sure that pin 1 of clamp is contacting pin 1 of the IC. Also make sure that the tester ground lead is connected to the IC ground terminal.

BUILD THE Time Out



TURNS OFF CAR LIGHTS WHEN YOU'RE SAFELY INSIDE

BY JOHN STAYTON

THERE ARE FEW things more aggravating to the motorist than pulling into the driveway at night and having to stumble around in the dark driveway to find the key for the garage or front door. Not only is it inconvenient; it's unsafe if there is snow on the ground, or roller skates or bicycles lying around.

Wouldn't it be helpful if you could leave the headlights on for a while after getting out and not have to go back to turn them off? With a "Time Out" you can do just that. When you have this device installed in your car, the headlights stay on after the ignition is turned off and then go off automatically after a predetermined period of time—from a few seconds to a couple of minutes. If you always park in well-lighted areas at night, the Time Out comes in handy should you forget to turn off your lights.

The Time Out is easily constructed using readily obtainable parts and it is easy to install in your car.

Construction. There is nothing critical about the circuitry of the Time Out (see Fig. 1) and any method of construction may be used. A printed circuit board like the one used in the prototype helps to produce a sturdy compact unit and may be duplicated using Fig. 2 as a guide. When installing the semiconductors be sure you observe the proper polarities and heat sink their leads while soldering.

In the prototype, the circuit board and relay are housed in a $3\frac{3}{4}'' \times 3'' \times 2\frac{1}{2}''$ metal utility box. A barrier-type terminal strip mounted on one end of the box is used to make connections to the automobile wiring. The circuit board is mounted on short spacers and is in such a position that the delay adjusting potentiometer (*R9*) is accessible through a hole drilled in the case. Line this hole with a rubber grommet to prevent short circuits when making adjustments with a metal screwdriver.

When selecting a relay, don't scrimp on

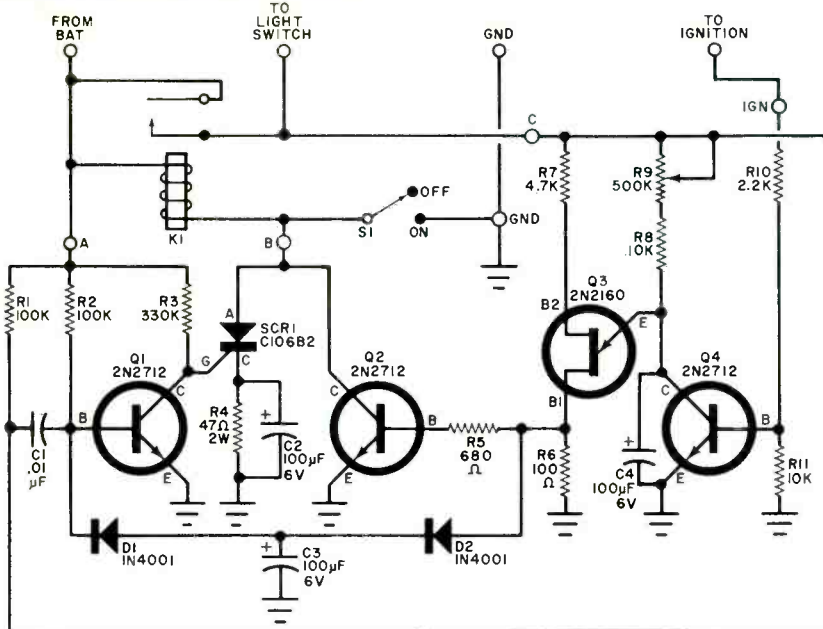

Fig. 1. The UJT turns off the lights by making Q2 appear as a momentary short circuit across SCR1. This causes the relay to open, removing power from lights and timer.

PARTS LIST

C1—0.01 μ F capacitor
 C2,C3,C4—100- μ F, 6-V electrolytic capacitor
 D1,D2—1N4001 diode
 K1—6-volt dpdt dc relay, 10-ampere contacts (see text)
 Q1,Q2,Q4—2N2712 bipolar transistor
 Q3—2N2160 unijunction transistor
 R1,R2—100,000-ohm
 R3—330,000-ohm
 R5—680-ohm
 R6—100-ohm
 R7—4700-ohm

All resistors
 1/2-watt, 10%

R8,R11,—10,000-ohm } 1/2-watt, 10%
 R10—2200-ohm
 R4—47-ohm, 2-watt resistor
 R9—500,000-ohm potentiometer (printed circuit board type)
 S1—Spst slide switch
 SCR1—Silicon controlled rectifier (GE C106B2)
 Misc.—Four-contact barrier strip, 3/4" x 3" x 2 1/8" metal utility box, rubber grommet, spacers, mounting hardware, chassis lettering, mounting hardware, etc.

HOW IT WORKS

When the circuit is in its normal, inoperative state, relay K1 is not energized and no power is applied to either the timing circuit or the headlights. Transistor Q1 conducts because of the forward bias through R2. This holds the gate of SCR1 near ground potential.

When the vehicle's headlight switch is closed the junction of R1 and C1 is grounded through the lights and the charge stored on C1 creates a negative pulse to turn off Q1 momentarily. With Q1 off, a voltage is applied to the gate of SCR1 turning it on and energizing the relay. Power is thus applied to the headlights and the rest of the timer circuit.

When the ignition switch is closed, the positive potential at the junction of R10 and R11 causes Q4 to conduct and disables the timing circuit by shorting to ground the emitter of unijunction transistor Q3. This

condition exists as long as the ignition switch is turned on. When it is turned off, Q4 stops conducting and a charge builds up on C4 through R8 and R9. When the charge on C4 is sufficiently high, Q3 starts to conduct and a pulse is created on the base of Q2, turning it on. With Q2 conducting, the anode of SCR1 is shorted to ground. Due to the charge built up on C2, SCR1 is then reverse biased and turns off. The relay is thus de-energized and the headlights are turned off.

When the relay's contacts open, the junction of R1 and C1 is once again grounded through the lights and a pulse is created which would begin the turn-on sequence again if it were not for the charge stored on C3 when Q3 was conducting. This charge neutralizes the pulse and keeps Q1 from turning off. Diodes D1 and D2 serve to keep the proper polarities in the circuit.

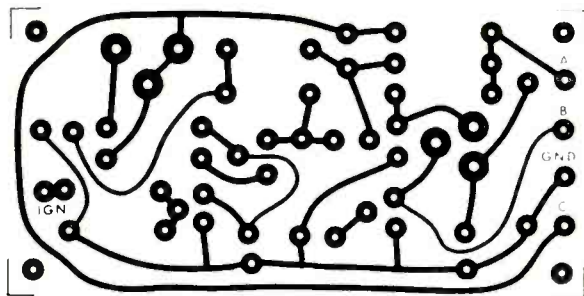
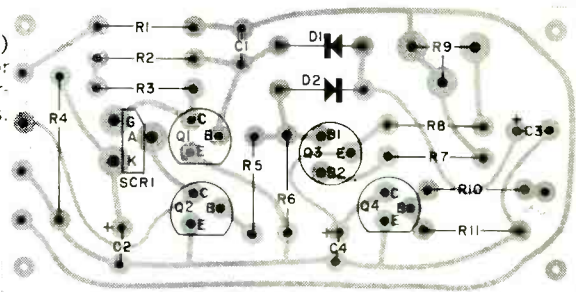

Fig. 2. Actual size foil pattern (above) and component installation (right) for the printed circuit board. Note polarities of semiconductors and capacitors.



the current rating of the contacts. In the prototype, both sets of 10-ampere contacts were wired in parallel just to be on the safe side. The same principle applies to the wire used to connect the relay contacts to the terminal strip—don't use anything smaller than #18 lamp cord or equivalent. The rest of the wiring can be standard #22 hook-up wire. Be sure to leave enough slack in the wires between the circuit and the terminal strip to remove the case.

Installation. In selecting a location for the Time Out in your car, bear in mind that you may want to be able to reach the override switch (S1) from time to time and that the time delay will have to be adjusted when you first set up the system.

Electrical connections to the car are shown in Fig. 3. Locate the lead from the car's light switch to the battery and cut it. After splicing lengths of lamp cord long enough to reach the Time Out, connect the line which

Relay K1 and override switch S1 are mounted on the metal chassis while the grommetted hole allows screwdriver adjustment of R9. Mount the PC board on four rubber shock absorbers to reduce vibration.

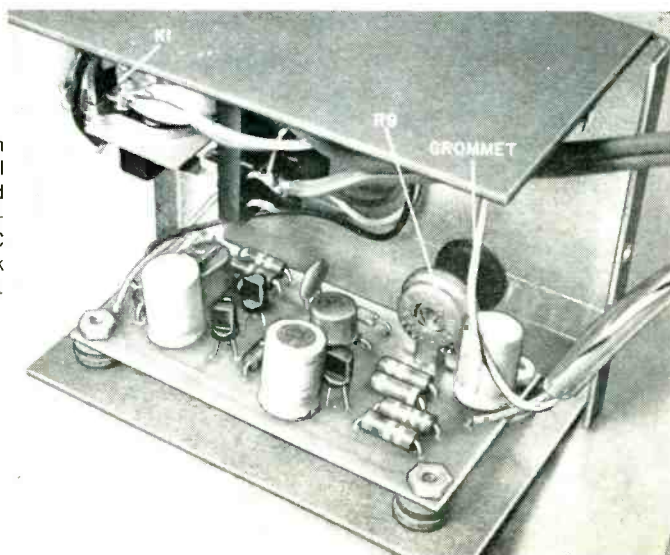

Fig. 3. Electrical connections for a typical car are shown at the right.

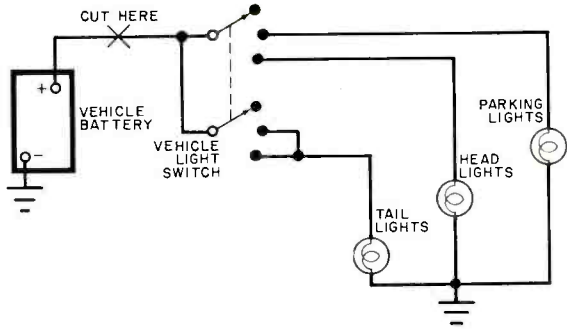
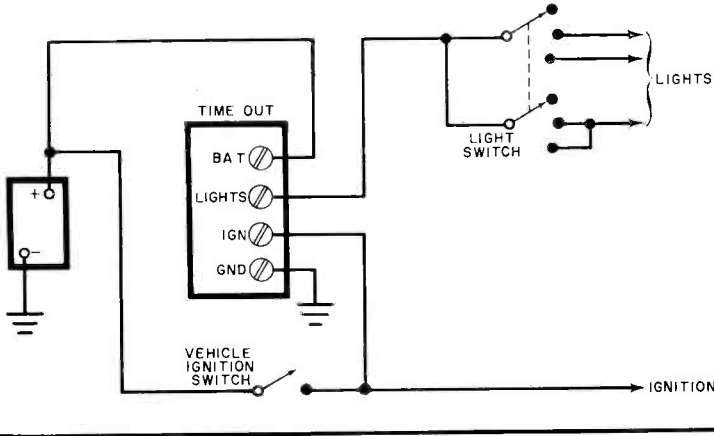
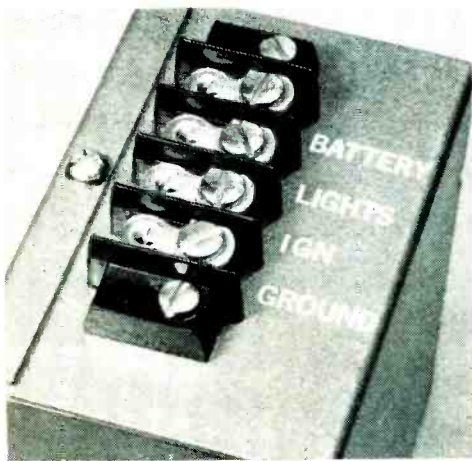

Fig. 4. When installed as shown in diagram below, Time Out has no effect on brake lights or turn signals.



goes to the light switch to the terminal marked LIGHTS on the timer. The wire that goes to the battery should be connected to the BATTERY terminal on the timer. The GROUND terminal of the Time Out is connected to any convenient ground

point such as under the head of an existing screw in the firewall or dashboard. The IGN terminal of the timer is connected to any convenient point which is live only when the ignition is on—such as the radio or heater fan motor. In most cases, the Time Out can be electrically connected at the vehicle fuse block.



Connections to vehicle wiring are made via four-terminal barrier strip. Clearly identify terminals to avoid wiring errors in installation.

Operation. The Time Out does not interfere with the vehicle's conventional lighting and ignition systems. The lights should work normally except that, when the light switch is left on and the ignition is turned off, the timer will hold the lights on for a length of time depending on the setting of the timer and then turn them off. Clockwise rotation of the timer control (*R9*) increases the time that the lights stay on.

When installed as shown in Fig. 4, the Time Out will control both parking and headlights but will not have any effect on the brake lights, turn signals, or emergency blinkers. For emergencies, turn *SI* on so that the headlights will remain lit indefinitely when the ignition is off. Be sure to turn *SI* off when override control is no longer needed. ♦

Build the Optimum Fuzz Adapter



THIS "TRIGGERED FUZZ" FOR YOUR GUITAR REPRESENTS A BRAND NEW APPROACH

BY CRAIG ANDERTON

FUZZ adapters for guitars and other electronic instruments have been around for quite a while—in a variety of forms. Unfortunately, when in use, some adapters suffer from impaired clipping, noise, and feedback problems that cause them to deliver a fuzz that is "dirtier" than desired.

The "Optimum Fuzz" eliminates these problems since it comes into operation only when triggered on by the electronic instrument; and it delivers an output that is almost a square wave, which sounds much fuzzier than the sound produced by conventional circuits.

As shown in Fig. 1, *IC1* is connected as a modified comparator that produces an output only when the signal applied to its inverting input ($-$) is above a certain level. Below this level, the comparator automatically switches off and there is no output. Provisions are made, through *S2*, to bypass the fuzz when desired.

Construction. The prototype was built on a small piece of perf board using flea clips to hold the components. Alternately, a printed circuit board could be designed to do the job. The board can be mounted in

PARTS LIST

- B1*—9-volt battery
- C1, C2*—0.1- μ F disc capacitor
- C3, C4*—15- μ F (or greater) electrolytic capacitor
- IC1*—741 compensated operational amplifier
- J1, J2*—Phono connector
- R1-R4*—10,000-ohm, $\frac{1}{4}$ -watt resistor
- R5*—500,000-ohm linear potentiometer
- R6*—5000-ohm linear potentiometer with spst switch attached
- S1*—Spst switch (part of *R6*)
- S2*—Dpdt push-on/push-off switch
- Misc.—Suitable chassis, battery connector, perf or printed circuit board, clips, etc.

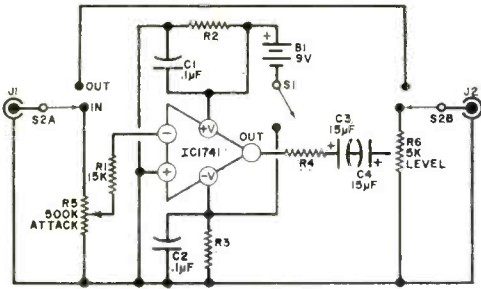

Fig. 1. Triggered square-wave output of op amp provides good fuzzy sounds.

any type of enclosure. The control switch (*S2*) should be a foot-operated device and must be enclosed in a sturdy housing. As shown in the photographs, the author put the entire circuit in a metal box.

Operation. Plug the instrument to be fuzzed into the input connector, *J1*, and connect the output terminal, *J2*, to the amplifier being used. Apply power to the fuzz by turning on *S1*. Turn level control *R6* and attack control *R5* about half-way up. Play the instrument, and operate the foot switch, *S2*, to make sure that you get both the straight and the fuzzed signals as the circuit is switched in and out. Should there be any problems with pickup of radio

signals, run a small (200 pF or so) capacitor from the (-) input of *IC1* to ground.

When using the adapter with an organ, connect the adapter between the organ and any volume pedals, or the action may be unpredictable. The attack control (*R5*), while not making too obvious a difference with stringed instruments, allows considerable variation of the output sounds when used with organs or other types of tone-generated instruments.

You will have to play the Optimum Fuzz for a while to get used to the somewhat abrupt decay. It is much faster than that of conventional fuzzes (due to the triggering action); but with a little practice, this problem is easily overcome. ♦

Photo of author's prototype shows method of construction. You could also install the electronics in one chassis and the foot-controlled switch in another sturdier one with a cable to connect the two units.

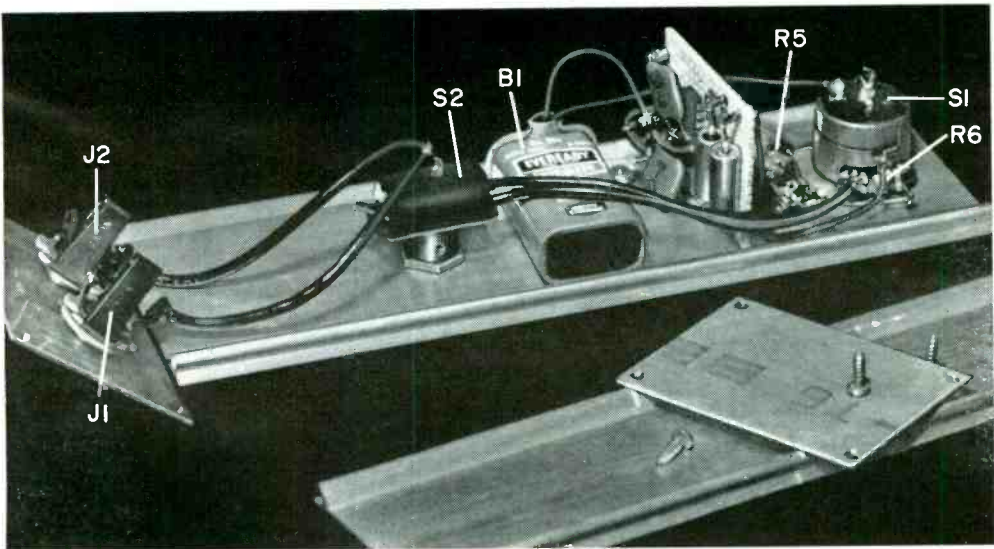

It's new! It's digital!

Build it

Bell & Howell Schools introduces a giant-screen color TV

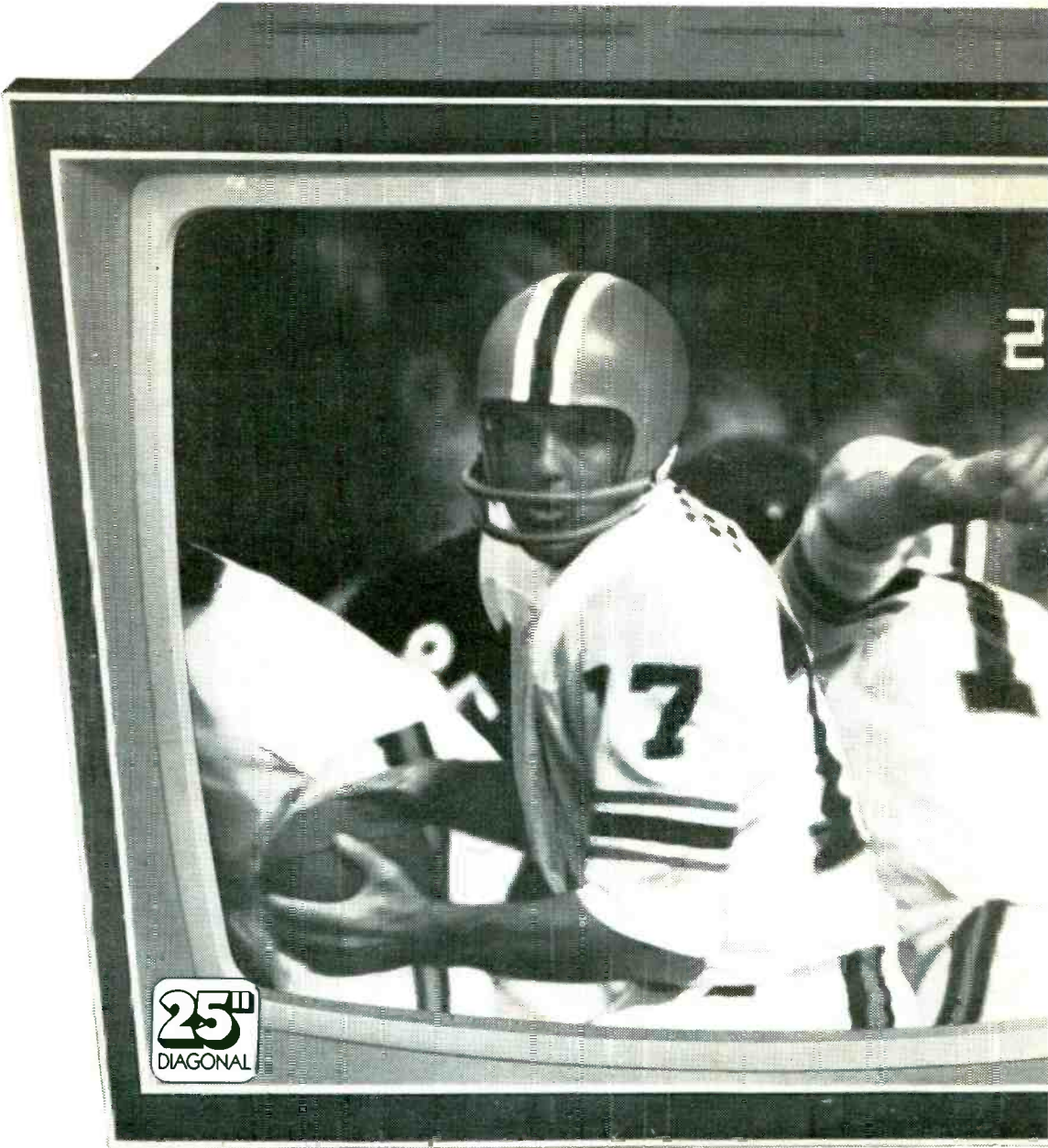

25"
DIAGONAL

yourself!

with these amazing features

Digital clock
that flashes on screen

Channel numbers
that flash on the screen

Automatic pre-set
channel selector

5 simulated TV picture

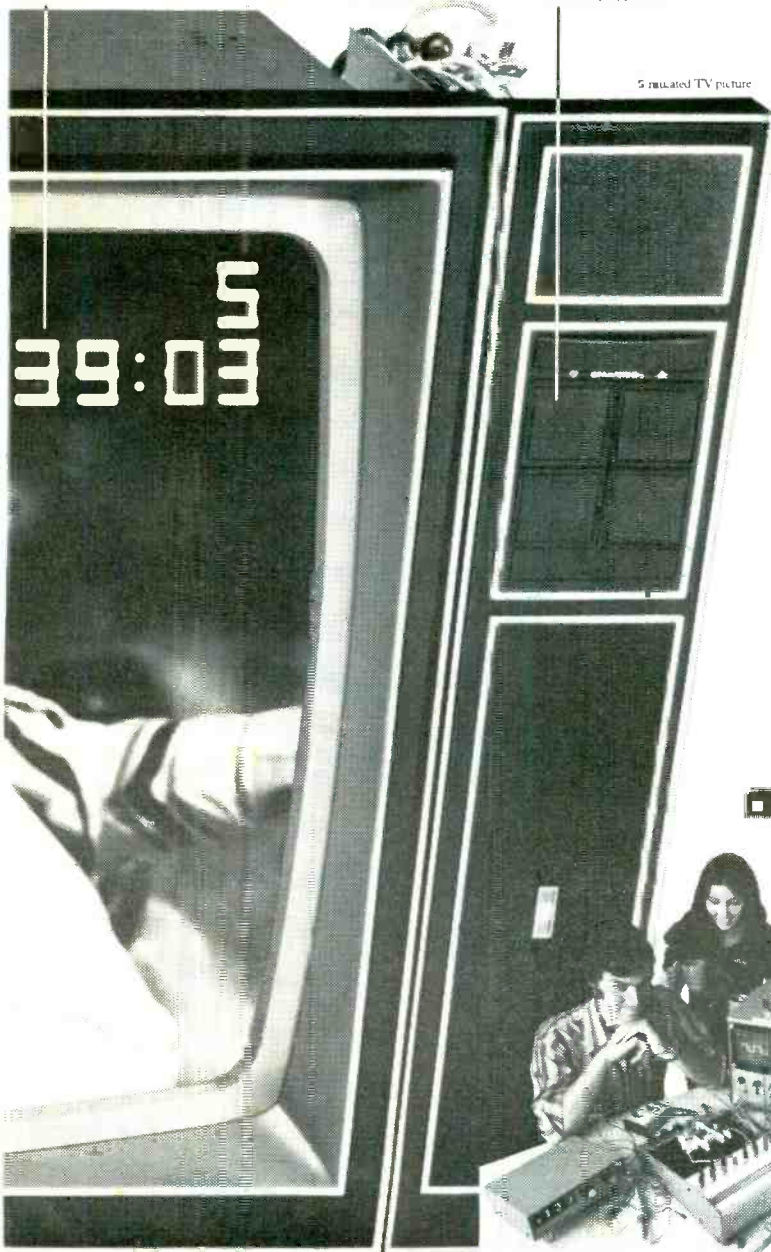

Do it for the fun!

What a thrill to spend your spare time actually building your own color TV! Especially one with features made possible by the new technology of digital electronics!

Like channel numbers that flash right on the screen! No more squinting to see which channel you're on or want to turn to.

An on-screen digital clock! Just a push of a button and your TV tells you the time of day in hours, minutes and seconds!

An automatic channel selector that you pre-set to skip over "dead" channels and go directly to the channels of your choice.

Plus... all-electronic tuning, reliable integrated circuitry and a 100% solid-state chassis for a bright, sharp picture with long life and dependability.

Do it for the money!

After you build your TV, cash in on all the new skills you've learned! This new Bell & Howell Schools at-home program gives you up-to-date skills in home entertainment electronics and digital circuitry that could lead to extra income, full or part time. We even include a complete volume on how to start your own TV service business!

Do it now!

Find out how you can build and keep this Bell & Howell 25-inch diagonal digital color TV — plus our exclusive Electro-Lab[®] electronics training system with new digital multimeter, solid-state "triggered sweep" oscilloscope and design console.

Find out, too, about the Lab Starter Kit that gives you "hands on" experience with your first lesson — and about the toll-free phone-in assistance and in-person "help sessions" to assist you every step of the way. Mail the card now.

Mail the postage-free card today for full details, free!

If card has been removed, write:
An Electronics Home Study School
DEVRY INSTITUTE OF TECHNOLOGY
ONE OF THE

 **BELL & HOWELL SCHOOLS**
4141 Belmont Chicago, Illinois 60641

"Electro-Lab" is a registered trademark of the Bell & Howell Company.

601



BUILD A

CRYPTO

-LOCK

ELECTRONIC SECURITY:

SMALL IN SIZE AND BURGLAR PROOF

BY JAMES G. BUSSE

THERE ARE almost as many varieties of electronic combination locks as there are combinations to operate them. Most are complex pieces of solid-state wizardry—often employing dozens of costly components in elaborate circuits to provide burglar-proof “one-chance-in-1,774,385” combinations.

By contrast, the “Cryptolock” is a simple device, that is inexpensive, easy to build, and small enough to give you electronic lock protection on such things as medicine cabinets, power tool chests, gun racks, desks, and even strong boxes. Or you can use it to safeguard the doors of your

home and garage as safely as the best mechanical lock.

The Cryptolock's three-digit combination is deceptive. Numerical grouping, two timing circuits and a penalty feature make "cracking" it a difficult task. Yet, when one knows the combination, it can be opened in less than two seconds. The Cryptolock can be powered by batteries or by a low-voltage dc power supply. Thus it is suitable for both fixed and portable installations.

On the "key" panel for the Cryptolock are six miniature, momentary-contact, push-button switches—each identified by number. The switches are connected to the

electronic circuit, which is housed in a small, molded-plastic box mounted inside the area to be protected.

The combination of the unit shown in Fig. 1 is 1/5-4. This means that, to open the lock, switches 1 and 5 must be pressed simultaneously, followed immediately by the pressing of switch 4. Most people find that it is quite easy to press the two initial switches at the same time with their index and middle fingers. Since these two switches are wired in series, they must be closed at the same time for a fraction of a second in order to enter the first part of the combination. Then when the 4 switch is

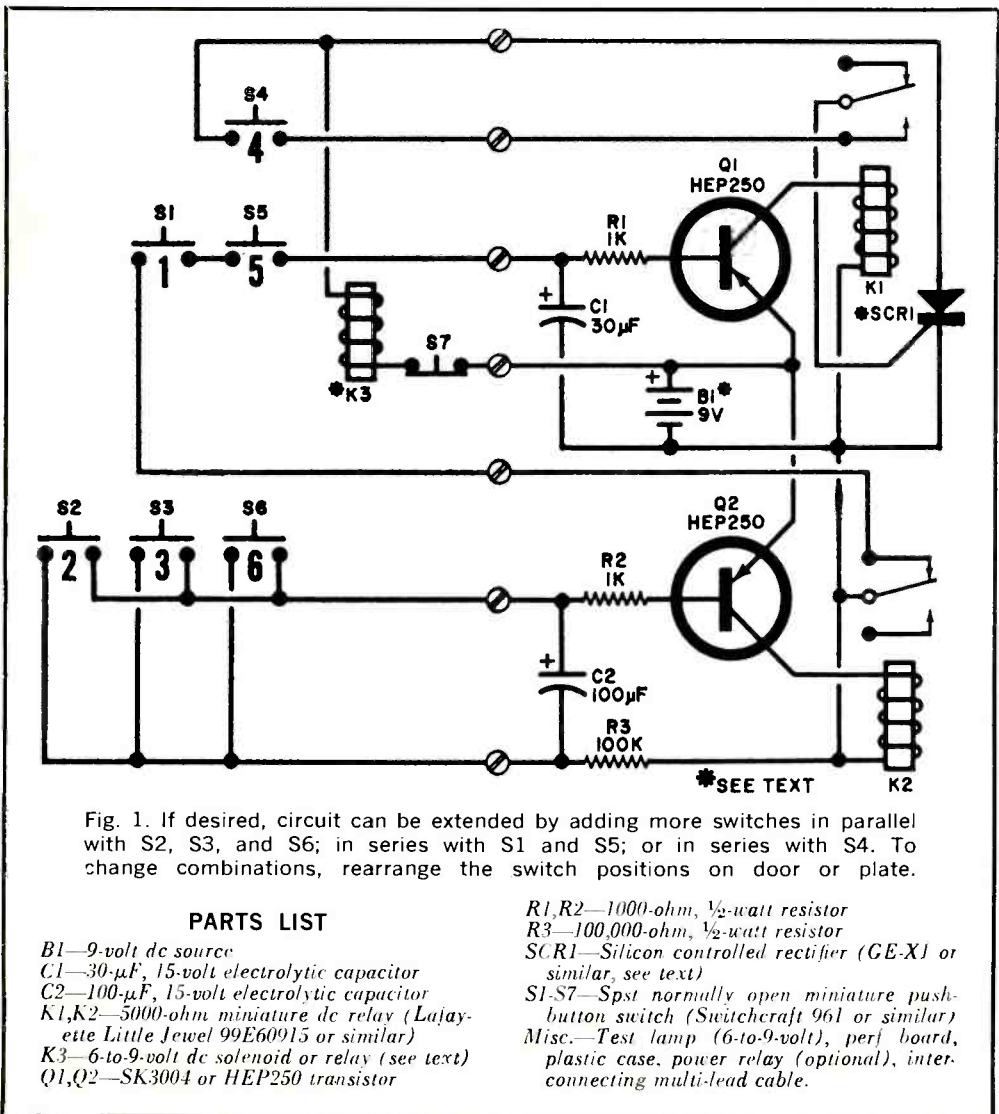
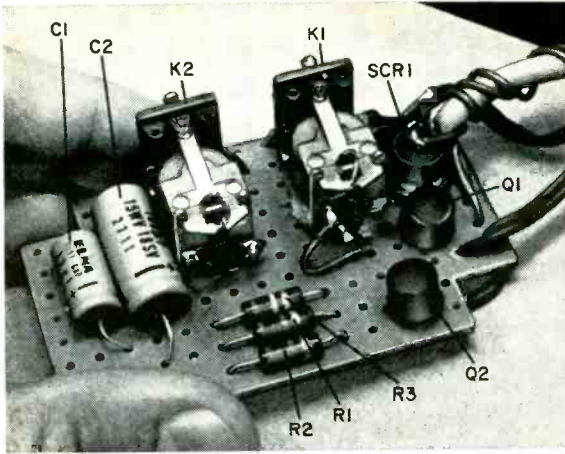

Fig. 1. If desired, circuit can be extended by adding more switches in parallel with S2, S3, and S6; in series with S1 and S5; or in series with S4. To change combinations, rearrange the switch positions on door or plate.

PARTS LIST

- B1—9-volt dc source
- C1—30-µF, 15-volt electrolytic capacitor
- C2—100-µF, 15-volt electrolytic capacitor
- K1, K2—5000-ohm miniature dc relay (Lafayette Little Jewel 99E60915 or similar)
- K3—6-to-9-volt dc solenoid or relay (see text)
- Q1, Q2—SK3004 or HEP250 transistor

- R1, R2—1000-ohm, ½-watt resistor
- R3—100,000-ohm, ½-watt resistor
- SCR1—Silicon controlled rectifier (GE-X1 or similar, see text)
- S1-S7—Spst normally open miniature push-button switch (Switchcraft 961 or similar)
- Misc.—Test lamp (6-to-9-volt), perf board, plastic case, power relay (optional), interconnecting multi-lead cable.



If you build lock on perf board, you can follow layouts used on the prototype.

pressed, the solenoid on the lock is energized.

That seems pretty simple, but there is a catch. After the first two numbers are pressed, you have only about one and one-half seconds to press the third. After that time, nothing happens when the third number is pressed. It is then necessary to start over with the first two numbers. This two-digit/one-digit combination is enough to confuse most would-be "safe-crackers" who expect to try no end of one-number-at-a-time combinations. That's not the end of the thief's problems, however. If, at any time after he has chanced to press 1 and 5 simultaneously, he chances to press 2, 3, or 6, the lock is automatically deactivated for about 25 seconds. Until the circuit comes to life again, even the correct combination won't open it. What's more, if 2, 3, or 6 is pressed again during this period, the waiting time is extended to the full 25 seconds. The fact that there is no way to tell when he has deactivated the circuit by pressing the wrong number is enough to discourage even the most persistent burglar.

Of course, the combination of the Cryptolock can be changed to any two-digit/one-digit code in a matter of minutes with a soldering iron. It can also be made more complicated by adding four or more switches in parallel with the penalty switches (2, 3, and 6). The combination—while sufficiently complex to foil most attempts to open it illegally—is still simple enough for a child to remember and use.

Construction. Using the circuit shown in Fig. 1, the prototype was built in a 2 $\frac{1}{2}$ " \times 3 $\frac{3}{4}$ " \times $\frac{1}{2}$ " molded plastic box. This makes

the unit as small as possible for use in a limited space. However, a larger enclosure can be used. The circuit can be located some distance away from the key panel and the solenoid latching mechanism.

The components were mounted on perf-board. Parts placement is not critical, as long as each component is isolated from the others and free movement of the relay armature is assured. Point-to-point wiring is acceptable if leads are kept short and neat. Use a needle-nose pliers or a clip-type heat sink to protect Q1 and Q2 when soldering. The SCR is bolted to the perf board by its threaded anode. Bolt or cement the two miniature relays to the perf board. They should be mounted so that they are upright and relatively level. Their performance will be affected if they are mounted on their sides or inverted.

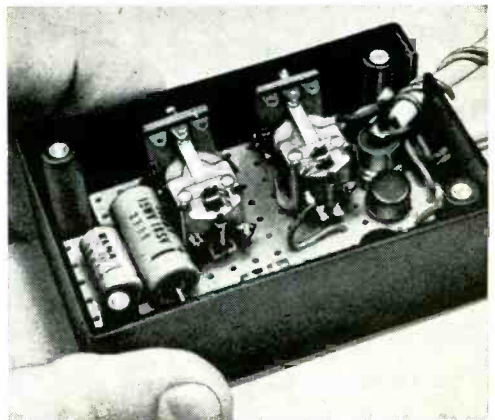

To protect relays, in prototype, unit was mounted in a plastic enclosure.

The components chosen for SCR1, K3 and the power source must be properly related. Start with the selection of solenoid K3. There are many low-current dc solenoids on the market, so select a 6- or 9-volt type that is spring-loaded to remain locked unless the coil is energized. Then choose an SCR that can carry the coil current and a power source that can handle this load. As another option, a 6-to-9-volt relay (with contacts rated to carry the load) can be used instead of K3 if you wish to activate some form of alarm. With dc applied to the SCR, once it is fired, it will remain on unless the supply is interrupted. This is the purpose of the normally closed pushbutton S7. When S7 is depressed, the SCR is cut off.

Checkout. When all components have been secured in place and wired in accordance with Fig. 1, substitute a 6-to-9-volt lamp for K3. Depress pushbutton switches 1 and 5 and note that relay K1 closes. If it does not, recheck all wiring, including the connections to the pushbuttons on the key panel. It's easy to wire them incorrectly since you are working from behind and they are in reverse order. Once assured that the wiring is correct, press 1 and 5 again, followed quickly by 4. The test lamp should light, indicating that SCR has been triggered and the lock is open. If not, use needle-nose pliers to bend the metal tab (carefully) to which the armature spring of K1 is attached. Bend it upward to decrease the tension on the spring. Try the combination again. An additional adjustment of K1's spring may be necessary.

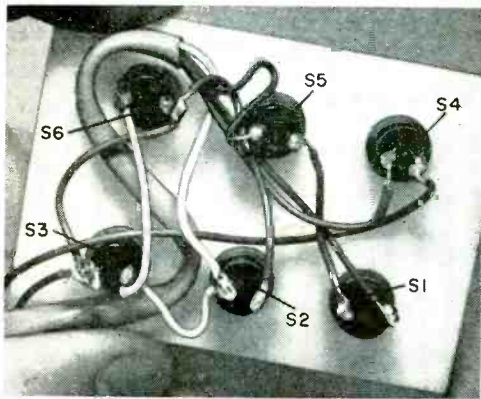

In finished version, six pushbuttons are mounted on door being protected.

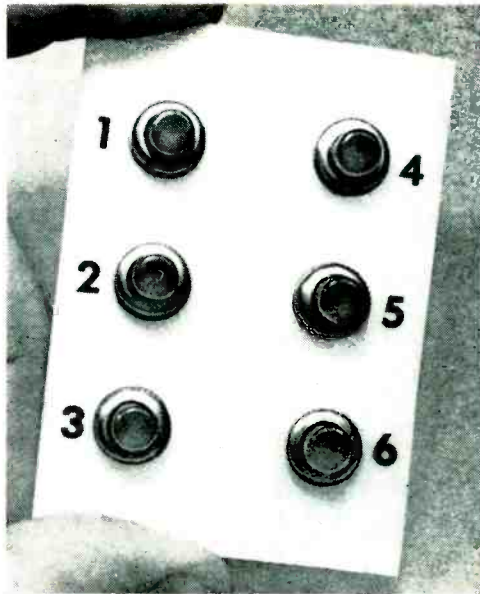

Six pushbuttons can be marked in any fashion with numbers, letters, symbols.

Switch S7 is used to de-activate the system.

Now press 2, 3, or 6 on the key panel. Relay K2 should close and remain closed for 20 to 30 seconds. During this time, it is impossible to activate K1. If K2 doesn't close, repeat the adjustment procedure specified for K1. Generally speaking, you won't have to adjust K2 because it closes with much more force than K1. There are a number of types of miniature, 5000-ohm dc relays on the market and their response times vary considerably so be prepared to switch relays if necessary. Once K1 and K2 are adjusted, no further adjustments should be necessary. Just be sure they remain in an upright position while the Cryptolock is being activated.

In the typical home or garage installation, it's a good idea to provide a key switch backup to the electronic locking system. Simply wire a spst key switch so that it bypasses the electronic lock and (when closed with a mechanical key) applies power directly to the solenoid latch to open the door. The key switch can be located some distance from the electronic key panel and concealed. This will enable you to open the door in the event the key panel is damaged as a result of an attempted burglary. Also remember to keep pushbutton S7 within the protected area. ♦

3-15 VOLT 0.1% REGULATORS ON A CIRCUIT BOARD



Board contains 3 15 volt regulators. 2 rated at 3 amps & 1 @ 6 amps, all @ 0.1%. At 5 & 10 amps, reg. is 0.5%. Comes with common +, easily isolated or changed to common -. Ideal for circuits requiring @ & - 15 volts. Board contains 5 2N5878, 150 watt silicon NPN transistors. 4 used in regulators & 1 spare.

2 regulators have electronic crowbar over voltage control, and all are short circuit protected. Precision resistors and capacitors used thruout. Best regulators we've seen, all for less than the price of the power transistors. With data sheet and circuit diagram.

6" x 6"
STOCK NO. Z5169 11.95 ea. 2/22.00

HONEYWELL 12"x4" COMPUTER BOARD



Loaded with components of all kinds, a parts bonanza.

STOCK NO. Z9121 3 diff boards 2.00
9/5.00 20/10.00

WE HAVE INEXPENSIVE POWER TRANSFORMERS FOR EVERY PROJECT IN THIS MAGAZINE. WRITE FOR CATALOG.

MINIMUM ORDER \$5.00. Include sufficient postage; excess refunded. Send for latest 56 page catalog with exciting values.



DELTA ELECTRONICS CO.

BOX 1, LYNN, MASSACHUSETTS 01903

CIRCLE NO. 4 ON READER SERVICE CARD

PRINTED CIRCUITS

FAST — EASY
with **DATAK's**

DIRECT ETCH SET

EASY—patterns rub down directly on the copper board and connect with rub-down lines or tapes supplied.

FAST—safe new etchants will etch a 2 oz. copper board in 30 minutes.

ACCURATE—±.002" print tolerance so parts and connectors mate with no errors.

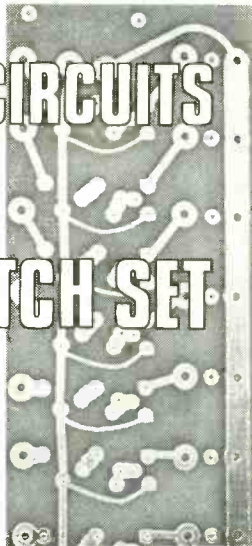

Circuit Made With ER-1

COMPLETE ER-1 SET contains hundreds of dry transfer DIP, flatpack, TO-5, IC, and transistor patterns; 1/4" and 1/2" etch resist tapes; 4 copper clad boards; 1/4 lb. dry etch; tray and instructions. \$5.95 ppd.

IN STOCK AT ALLIED AND OTHER DISTRIBUTORS
WRITE FOR FREE CATALOG listing this and many other dry transfer marking sets.

The **DATAK Corporation**

65 Seventy-first Street • Guttenberg, New Jersey 07093
CIRCLE NO. 2 ON READER SERVICE CARD

Slow Turn-On Protects Power Supply

BY FRANK TOOKER

ORDINARILY, when a power supply is switched on from a cold start, the instantaneous voltage drop across the filter capacitor is zero. Hence, at the instant of turn-on, the rectifier and power transformer "see" a short circuit. Not until the filter capacitor becomes charged does the power supply operate normally.

Although solid-state rectifiers can absorb a very high momentary current surge without breaking down, it would be better all around if the turn-on could be delayed to eliminate the instantaneous surge.

The schematic diagram shows how to add the simple delaying network to an existing power supply circuit. Notice that the delay network is installed between the rectifier and filter capacitor.

The operation of the network is simple and virtually foolproof. Capacitor *C1* has no voltage drop across it when no voltage is applied to the power supply. So, the voltage at the base of *Q1* is zero at the instant of turn-on. Now, when the power supply is switched on, *C1* begins to charge up through *R1*. The rate of charge depends on the values of *C1* and *R1*; the higher the values, the slower will be the charging rate.

As the voltage across *C1* increases, current begins to flow from *Q1*'s collector to its emitter, charging the supply's filter capacitor. The rate of charge for the filter follows the rate of charge on *C1* almost exactly. A charging rate of from 0.5 to 1.0 second, from zero to full charge, has been found to be more than adequate for most applications. ♦

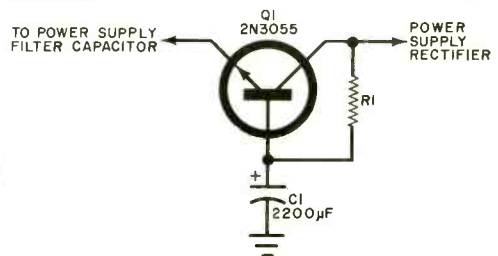



BUILD AN

Electrolytic Restorer

PREVENT HIGH-VOLTAGE CAPACITOR BREAKDOWN

BY GEORGE J. PLAMONDON

WHEN a high-voltage electrolytic capacitor has been unused for too long a time, it is customarily looked upon as a possible troublemaker. Too often, when power is applied to such units, the dielectric punctures, destroying the capacitor and probably the associated circuit. Unfortunately, many people have some of these capacitors in their junk boxes (they were quite common in power supplies for vacuum-tube circuits), but hesitate to use them. Since they are fairly expensive, it behooves the electronics experimenter or service man to salvage such

capacitors by restoring the dielectric so that there is no chance of its breaking down when put to use.

However, before finding out how to restore an electrolytic, let's be sure we know the exact nature of the trouble.

What Is an Electrolytic Capacitor? An electrolytic capacitor usually consists of two flexible sheets of aluminum foil separated by gauze impregnated with an electrolyte. Leads are connected to each foil section. The foil connected to the positive lead has an

oxide coating which serves as the capacitor's dielectric. It is the thickness of this coating that determines the working voltage of the capacitor.

While the capacitor is being used, the oxide coating is preserved by chemical processes resulting from the voltage impressed across the terminals. Unfortunately, when it

is in storage, time and ambient heat take their toll and the oxide deteriorates. When the full working voltage is applied to a capacitor whose oxide is weak, the latter breaks down and a short circuit is placed across the circuit.

Reforming the Dielectric. The dielectric

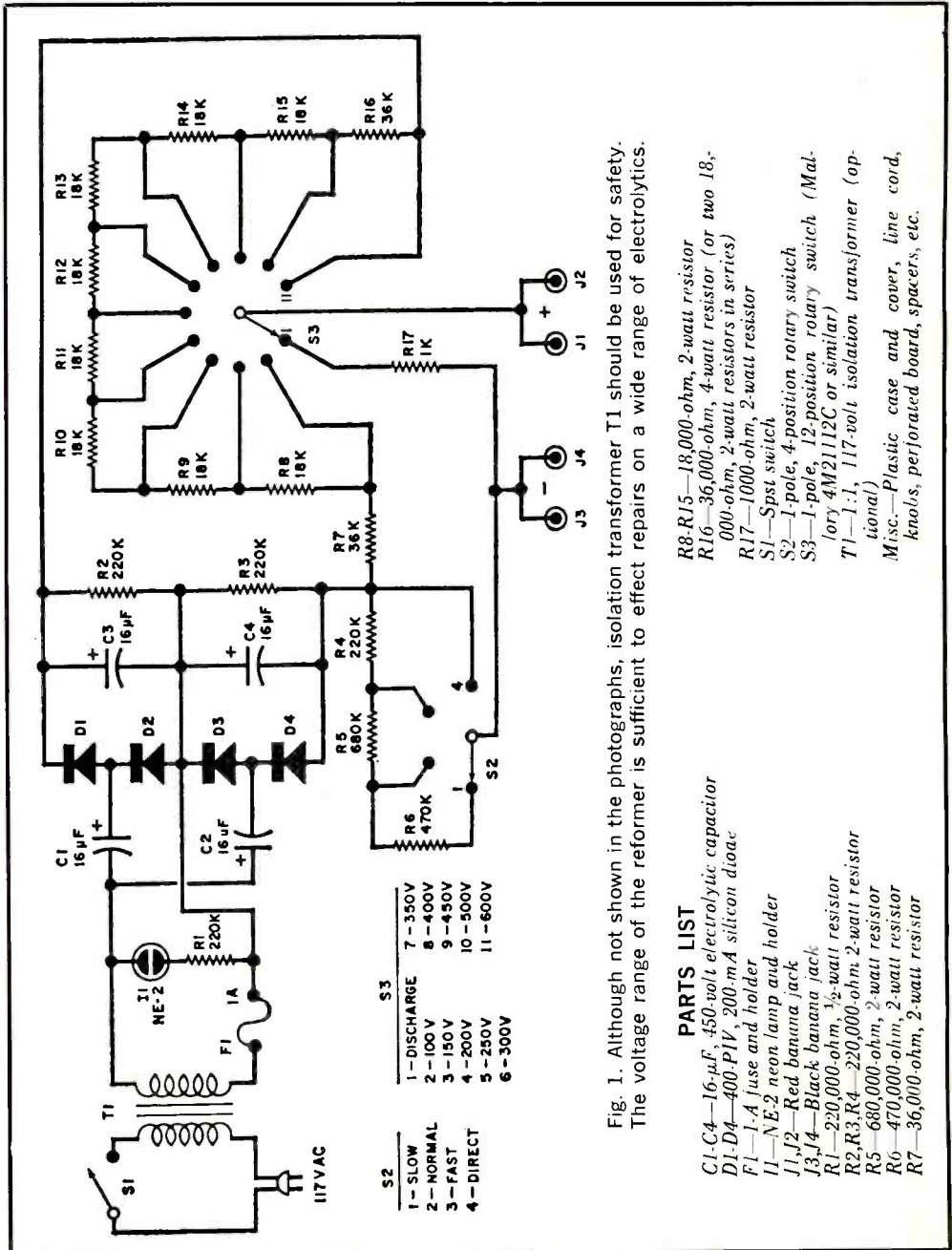
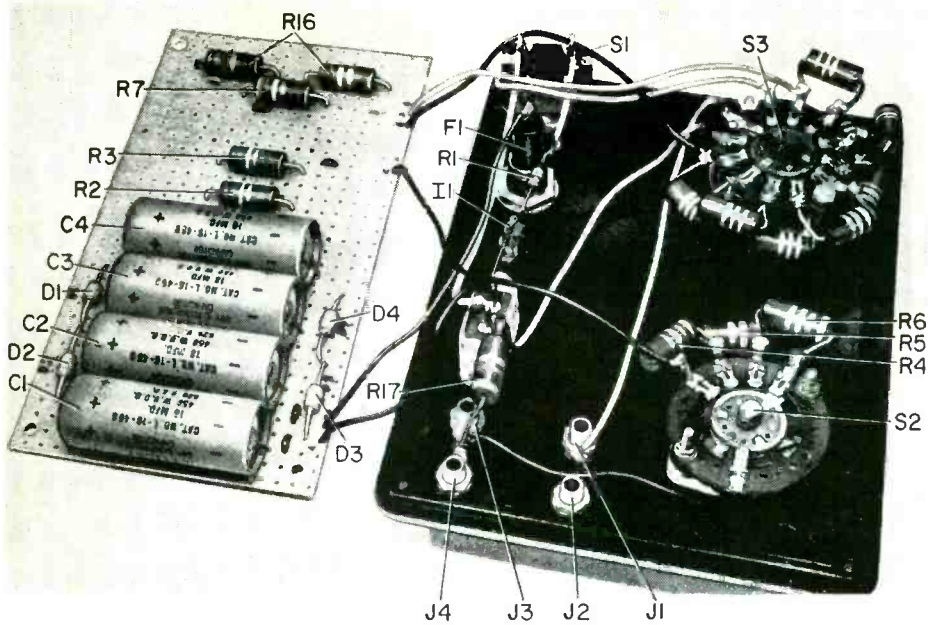
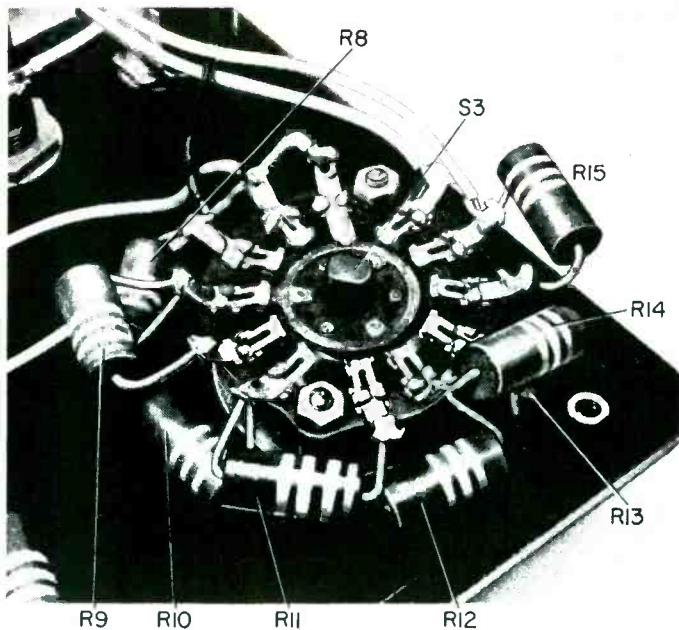

Fig. 1. Although not shown in the photographs, isolation transformer T1 should be used for safety. The voltage range of the reformer is sufficient to effect repairs on a wide range of electrolytics.



Perf board construction may be used with operating controls and jacks mounted on front panel of selected cabinet. A TV-type cheater connector is used to make the power connection. Mount perf board on suitable spacers and be sure that components on board do not make electrical contact with any front-panel elements.



of a suspect capacitor can be reformed by connecting a low dc voltage across the capacitor and slowly increasing the voltage until the rated value is reached. This must be done over a long period of time to allow the oxide to reform properly.

The "Electrolytic Restorer" described here does this job automatically, and requires only

an occasional look at a dc voltmeter to check progress. The cost of the project is about \$14 if all parts are bought new.

Construction. The prototype shown in the photos was housed in a conventional plastic case although any type of arrangement will suffice. The schematic of the circuit is shown

THEORY OF CIRCUIT DESIGN

Diodes *D1* through *D4* and capacitors *C1* through *C4* form a full-wave voltage quadruplar rectifier with a dc output of approximately 600 volts. Resistors *R7* through *R16* form a voltage divider network and *S3* selects the desired voltage and applies it to the parallel-connected positive output jacks *J1* and *J2*. The negative side of the power supply is connected through a switch-selected resistor network consisting of *R1* through *R6* to the parallel-connected negative jacks *J3* and *J4*. The use of *S2* determines the forming rate. The DIRECT position permits the unit to be used as a high-voltage, low-current power supply. This position can be eliminated if desired.

The DISCHARGE position of *S3* places *R17* across the output to discharge the formed capacitor, while resistors *R2* and *R3* keep a small load on the power supply and discharge the power supply capacitors.

During the forming process, the capacitor's resistance is low so most of the voltage is dropped across the limiting resistor. As the oxide coating in the capacitor is re-formed, less current flows through the capacitor, causing the voltage across it to increase. When this voltage equals the preset voltage on *S3*, the reformation is complete.

in Fig. 1. Exact placement of parts is not given since dimensions are not critical and the control locations can be changed depending on personal preferences.

Most of the circuit can be assembled on

perforated board. The front panel controls and jacks are mounted directly on the case cover, making sure that all leads are long enough to reach the electronics board. For safety, a 1:1 ac line isolation transformer should be used, though this is not shown in the prototype.

Operation. The electrolytic capacitor to be reformed is connected to the output jacks, making sure that the polarities are observed. The positive side of the capacitor is connected to either *J1* or *J2* and the negative side to either *J3* or *J4*. The dc voltmeter for checking the reforming action is connected to the remaining two jacks. Make sure that the polarity and voltage range are correct. The voltmeter can be disconnected and reconnected at any time without affecting the operation.

Place *S3* in the DISCHARGE position, plug the unit in, and turn on the power. Neon indicator lamp *I1* should glow. Set the desired forming rate on *S2* and then rotate *S3* to the working voltage of the capacitor. If the capacitor is unformed, the voltmeter will indicate a much lower voltage than that set on *S3*.

Note that the voltmeter indication starts to increase quickly at first, then slows down as the dielectric forms. The rate of increase is determined by the condition of the capacitor and the setting of *S2*. When the SLOW setting

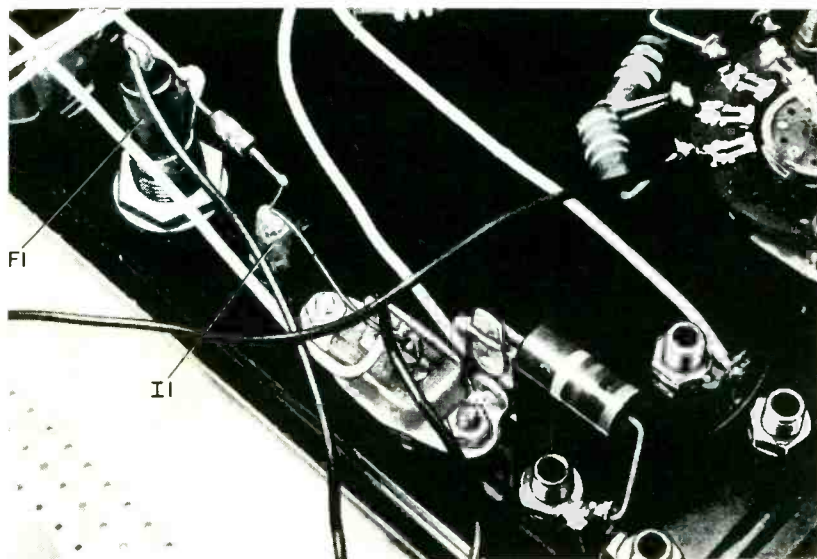

Be careful when drilling holes in the plastic front panel as it will chip easily. Neon indicator lamp is cemented in the hole, other components use hardware.

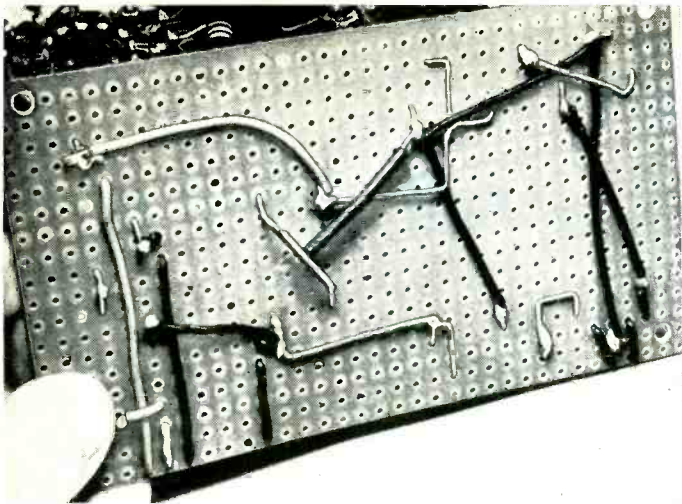

Insulated wiring is used to make interconnections. If metal case is used, make sure spacers keep connections from touching case.

is used, the operation takes longer but the oxide formed will be of better quality. The opposite is true for the FAST setting. Use the NORMAL position for most cases.

When the voltage across the capacitor is approximately equal to the set on S3, put the switch on DISCHARGE and remove the capacitor. No harm will be done if the capacitor is left connected longer than required, so it is not necessary to check progress constantly.

To use the unit as a high-voltage, low-cur-

rent power supply, set the forming rate switch (S2) to DIRECT. A current of 4 mA may be drawn continuously, and somewhat higher currents for a short period of time. (A load current of 10 mA causes a dissipation of 3 watts in the divider resistors.)

The Electrolytic Restorer can also be used for a quick go-no-go check of voltmeters. Comparison of voltage switch settings and voltmeter readings will reveal any gross inaccuracies. ♦

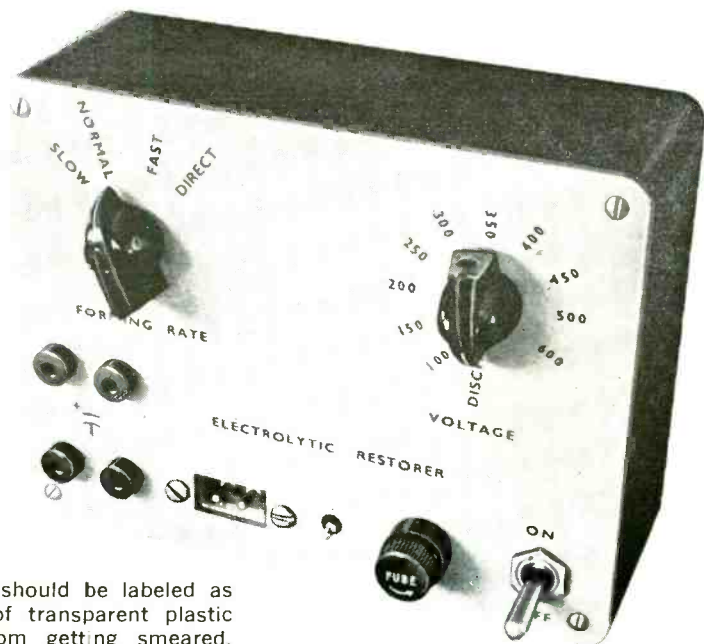

The finished front panel should be labeled as shown here. A coating of transparent plastic spray keeps lettering from getting smeared.

Build an Audio Level Meter

ADDING MULTI RANGES TO A LOW-COST DB METER

BY SAMUEL C. MILBOURNE

USERS of audio equipment often have a need to know the level of the audio signal at various points within a system. For this reason, many units come with built-in level (dB) meters. If your present system does not have a level meter, or if you need an extra one, here is your chance to construct one at low cost.

The actual meter used in the prototype is a low-cost panel meter having a $-10/0/+6$ dB scale, built-in rectifier, and series resistor for the basic range. (The meter is available from such surplus dealers as Fair Radio Sales, 1016 E. Eureka St., Lima, OH 45802, for about \$5.) It used 6 mW into a 600-ohm line as 0 dB; but information is supplied here for both 500-ohm and 1-mW circuits.

Calibration. The accompanying table shows the calibration voltages required to cause the meter to indicate at the 0-dB mark for ranges up to +32 dB.

Determine the highest range to which you will want to calibrate, pick a transformer having at least the necessary voltage output and build the circuit shown in Fig. 1. Set the voltage-adjustable transformer for minimum output and $R1$ for zero resistance. Only the 600 ohms of $R2$ (500 ohms if your meter requires it) should be in the circuit. For a 6-mW/600-ohm meter, the application of 1.90 volts (from $T2$) should cause the meter to indicate 0 dB. Raise the voltage to that required for +4 dB and adjust $R1$ until the meter reads 0 dB. Accurately measure and record the resistance of $R1$ for this setting.

Increase the voltage in the steps shown in the table, measuring and recording the resistance of $R1$ for each step. These values determine the final resistors that are used in the meter circuit shown in Fig. 2. The final accuracy of the meter depends on how

close you can set and read the ac voltage applied in Fig. 1 and how close you can come in selecting the final values of the fixed resistor.

In the prototype, we used the closest standard 5% resistors, obtaining reasonably accurate scale indications. Odd values of resistance can be made by combining two resistors. (For example, to get 51k, use 47k and 3.9k in series. Of course, paralleling can also be used.) Be careful not to overheat resistors when building up pairs as they may change value with heat.

The resistor network may be attached directly to the switch contacts or mounted on a piece of perf board. Use a pair of conventional banana jacks for the connectors.

When the meter is complete, re-run the voltage steps, changing the switch at each range, to check that the meter indicates at the 0-dB point at each switch position. If

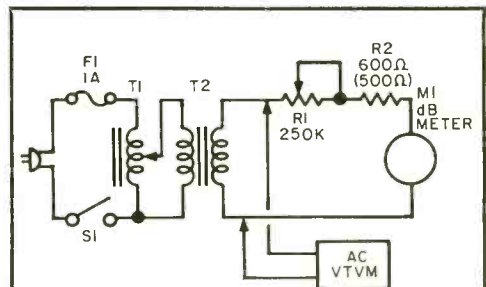

PARTS LIST

- F1*—1A fuse and holder
- M1*—dB meter being tested
- R1*—250,000-ohm potentiometer
- R2*—600-ohm, 2-watt resistor (see text)
- S1*—Spst slide or toggle switch
- T1*—Variable autotransformer
- T2*—Transformer with 117V primary; see text for secondary
- Misc.—Accurate ac vtvm, line cord.

Fig. 1. Circuit to determine resistances.

CALIBRATION VOLTAGES			
Range	6mW/600	6 mW/500	1 mW/600
	ohms	ohms	ohms
(dB)	(volts)	(volts)	(volts)
0	1.90	1.73	0.774
+4	3.01	2.75	1.228
+8	4.77	4.35	1.946
+12	7.55	6.90	3.084
+16	12.00	10.93	4.887
+20	19.00	17.32	7.746
+24	30.10	27.50	12.28
+28	47.70	43.50	19.46
+32	75.50	69.00	30.84

the meter does not indicate directly on the 0-dB mark, the value of resistance at that switch position will have to be adjusted. Lower the resistance if the meter indicates in the negative dB region; increase it if the meter is positive.

The finished level meter can be assembled in any type of case, plastic or metal, and each switch position should be marked in some manner.

Use. With a signal applied, set the range switch until the meter is as close to 0 dB as possible. The actual dB level is then the

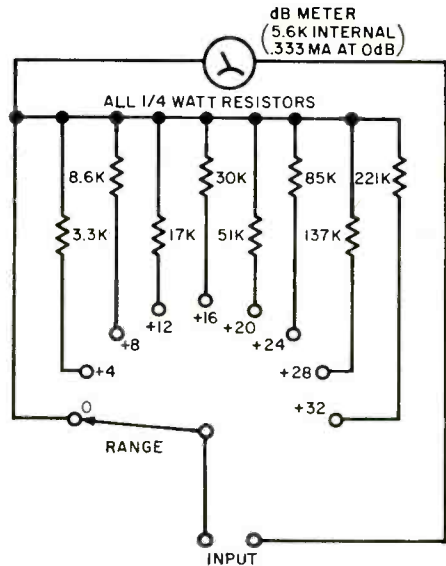

Fig. 2. Final circuit uses resistors as close as possible to test values.

sum of the meter reading and the switch setting. For example, assume the range switch is on +12 dB and the meter indicates -3 dB. The actual level is then +9 dB. ♦

ADD A COMPRESSION AMPLIFIER TO YOUR ELECTRONIC ORGAN

BY J. E. ROHEN

THE OUTPUT signal level of an electronic organ is dependent upon the setting of the foot-pedal volume control, the number of stops or voices switched in, and the number of keys depressed at a given moment. For a fixed volume setting and a fixed number of stops on line, the volume level heard will vary considerably, depending on how many keys are depressed simultaneously. Although the organist can compensate for the changes in volume by using the volume pedal, on a fast change of stops or a quick switch from solo to rhythm, the audio change is too fast for him to react, and a choppy audio burst results.

It is desirable to have a means for keeping the volume level constant when such rapid changes are made. To accomplish this, a compression amplifier like the Organ Leveler shown in the schematic can be used. Unlike compressors used for PA applications, the Organ Leveler can respond to the

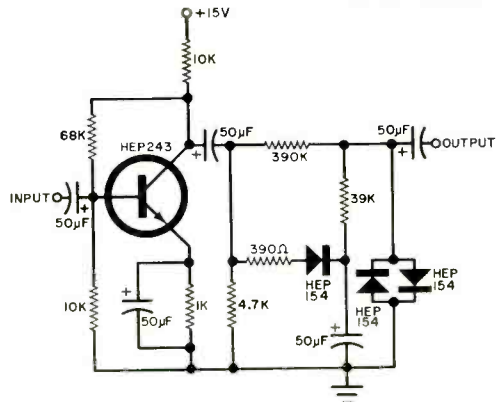

Leveling circuit does not affect volume or change the frequency response.

entire range of frequencies generated by the organ without adding coloring to the voices. It can handle large fluctuations in input signal without clipping. ♦

Stopping Engine Run-On

DOES YOUR CAR ENGINE KEEP RUNNING AFTER YOU TURN THE IGNITION OFF?

BY KARL O. AND RICHARD K. JOHNSON

ONE cause of run-on, or what is sometimes called "dieseling," in many modern cars may be the feeding of electrical power from the voltage regulator to the ignition coil after the ignition switch is turned off.

A portion of the charging circuit for many recent General Motors cars is shown in the diagram. When the ignition switch is turned on, 12 volts from the battery is applied to the ignition coil as well as to the alternator field through the alternator lamp (mounted on the dashboard) and a resistor located in the voltage regulator housing. This energizes the alternator field winding just enough for the alternator to start generating power when the engine runs. This initial flow of current also turns on the alternator lamp to provide a check on the lamp's condition and to indicate that the alternator is not producing power.

Addition of silicon diode to basic circuit (GM shown here) prevents the engine from running when key is off.

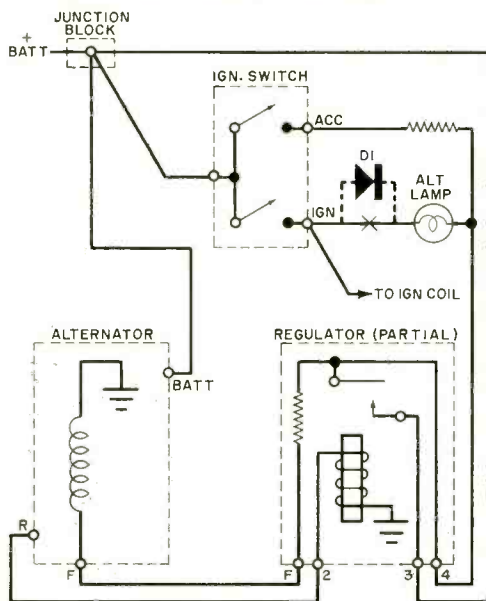

When the engine starts, the alternator produces enough power to energize the field relay in the voltage regulator to apply battery voltage directly to the field coil. With 12 volts on both sides of the lamp, it goes out, indicating that the alternator is operating.

When the ignition switch is turned off, inertia keeps the engine turning over for a couple of revolutions so that the alternator is still generating enough power to keep the field relay closed. Now, current (conventional) can flow from the battery through the closed field relay contacts and through the alternator lamp to the ignition coil. This current is limited by the resistance of the lamp (about $\frac{1}{2}$ ampere), and while it is not enough to produce a good spark from the coil, it may be sufficient to cause the engine to run roughly for some time after the ignition switch is off. With a transistor type of ignition system, this small current may be enough to keep the engine running for a considerable time.

One indication of this type of power feed-through is that the alternator lamp glows during the run-on. A simple way to determine if this is your problem is to remove the lamp from its socket. If the engine stops normally, with no run-on, then the cure is simple.

Locate the wire from the alternator lamp to the ignition switch and connect a 3-ampere, 50-PIV silicon rectifier diode (HEP-161 or similar) as shown in the diagram. Of course, you can connect the diode on the other side of the lamp if that lead is easier to get to.

Since you want current (conventional) to flow from the ignition switch to the regulator, but not backwards, the cathode end of the diode should be toward the voltage regulator. After cutting the correct wire, solder the diode in series and tape all exposed leads. This installation does not affect the normal operation of the ignition system, or the alternator lamp. ♦

Make a Squawk Box Toy for \$3

IT WILL ENTERTAIN AND EDUCATE YOUR CHILDREN

BY BENNETT A. LOFTSGAARD

TOYS are the best aids for keeping children occupied and out from under foot. The Squawk Box circuit shown in the diagram, when assembled, will emit squealing, squawking, and other strange sounds which should keep any child of eight years old and less absorbed for hours. It even has a built-in secret which the small fry will soon discover.

The parts needed for the Squawk Box are readily available. They include a cigar box, aluminum foil, a battery with holder, a code practice oscillator kit (available from most electronics outlets), and a small PM speaker. The whole thing should not cost you more than about \$3.

The first thing to do is cut a piece of aluminum foil to a size so that it covers the entire cigar box lid and overlaps the front and both sides by about $1\frac{1}{2}$ ". Rubber cement the foil to the lid, neatly tucking the foil around the edges of the lid and cementing it to the lid's inside surface. Use a sharp knife to remove a $\frac{1}{4}$ "-wide strip of the foil down the center of the lid, ending up with two electrically insulated foil panels. Insert a straight pin on a slant through each foil panel on the inside of the box lid. Solder an 8" length of hookup wire to each pin.

Using the circuit diagram which accompanies the code practice oscillator, locate and remove the feedback capacitor. Then wire the speaker and battery holder to the appropriate wires on the oscillator and the two wires coming from the straight pins to the points from which the feedback capacitor was removed. Mount the CPO, battery holder, and speaker to the floor of the cigar box. (Note: Before mounting the speaker, punch or drill a few holes through the bottom of the box so that the sound can get out.)

Insert a battery into the battery holder and close the cigar box, using a length of transparent or masking tape to keep the lid down. To test the Squawk Box, simply place one hand on each of the foil panels. In so doing, your body should complete the circuit and you should hear a "squawking" sound.

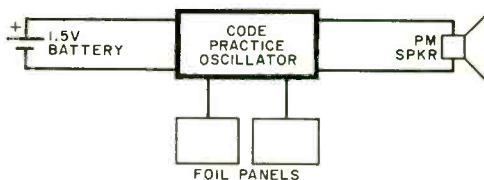

Parts necessary for the Squawk Box are a cigar box, aluminum foil, battery with holder, code practice kit, and small permanent magnet speaker. To assemble the Squawk Box, use the diagram that is provided with the CPO kit. The aluminum foil panels are substitutes for feedback capacitor.

Now, give the Squawk Box to the kids and let them figure out how it works. In a little while, they will learn that several of their friends can form a hand-holding chain to make it work. They will also find that the better the contact, the lower the tone. As a result, the toy tends to respond to the emotions of the person or persons playing with it.

The secret? Some ingenious child is sooner or later going to touch one panel with his hand and the other panel to a good earth ground (such as a water pipe), and—lo and behold—he is going to hear music or announcements. He will find that his Squawk Box is also an AM receiver capable of picking up nearby signals. ♦

SCIENCE · OPTICS · ELECTRONICS
UNUSUAL & HARD BARGAINS
 NEW PRODUCTS · NEW MATERIALS · NEW METHODS

KNOW YOUR ALPHA FROM THETA!



For greater relaxation, concentration, listen to your Alpha or Theta brainwaves. Ultra-sensitive electrode headband slips on off in seconds—eliminates need for messy creams, etc. Attached to amplifier, filters brainwaves, signals beep for ea. Alpha or Theta wave passed. Monitoring button stimulates Alpha or Theta audio & visual (d.E.D.) feedback. Reliable, easy-to-use unit—comparable to costlier models. Completely safe. Comprehensive instruction booklet.

No. 1635GD (8x3x4", 24 oz.) \$128.00 Ppd.
 LOW COST "STARTER" UNIT NO. 71.809GD \$49.95 Ppd.

130 EXPERIMENTS IN OPTICS . . .



and photography! Optix@Experiments Kit is a complete optical & photography lab for 130 exciting experiments. Lets you create the periscope, telescope, microscope, kaleidoscope! Build a 35mm radio camera with interchangeable lens system! Make a develop photographic film! Enjoy the fun and fascination of building your own optics lab. Fully illustrated 112-pg manual, 8 1/2 x 11", clearly explains usage of this stimulating kit's 114 precision engineering components.

Stock No. 71.646GD \$22.50 Ppd.
 AERONAUTICS FUN KIT (100 Experiments)
 Stock No. 71.840GD \$15.95 Ppd.

3-CHANNEL COLOR ORGAN KIT



Easy to build low-cost kit needs no technical knowledge. Completed unit has 3 bands of audio frequencies to modulate 3 independent strings of colored amps (i.e., "lows"-reds, "middles"-greens, "highs"-blues). Just connect hi-fi radio, power amp etc. & plug ea. lamp string into own channel (max. 100w ea.). Kit features 3 neon indicators, color intensity controls, controlled inductive SCR circuits, isolation transformer, custom plastic housing; instr.

Stock No. 41.831GD \$17.50 Ppd.

SPECIAL VISUAL EFFECTS PROJECTOR SET

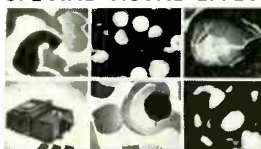

Dazzling, avant-garde visual effects. Fantastic variety. Incredibly beautiful special packages offer contains all necessary apparatus. Create floating, exploding, fiery bursts of color like "Symphony of Spheres", "Chromatic Starbursts", "Crystal Starburst". Features 35mm 100W fan cooled projector—produces big image at short distance. Spectacular 3 directional kaleidoscopic lens, 120 9" diam. wheels (kaleidoscope & Hexidoscope), 2 cylindrical accessories (Color Cloud & 5"

Hexidoscope w/ six internal mirrored walls). Instr.
DELUXE PROJECTOR W/ KALEIDOSCOPIE LENS \$ 99.50 Ppd.
 Stock No. 71.295GD
REMOTE CONTROL PROFESSIONAL MODEL \$119.95 Ppd.
 Stock No. 71.858GD

ACTUAL WORKING SOLAR HOME PLANS



Learn all about the most fascinating possible home of the future. It can be your "now" answer to today's energy crisis in housing. Expert Dr. Harry E. Thomason tells advantages, problems, savings, and more in this important 20-pg fact-filled booklet. Also includes 8-page oversize insert of basic, actual solar home plans, a valuable guide to you and your architect in fitting space requirements, design ideas, and local area building codes.

No. 9440GD (Solar House Plans) \$10.00 Ppd.



MAIL COUPON FOR GIANT FREE CATALOG!

180 PAGES · MORE THAN 4500 UNUSUAL BARGAINS!

Completely new 1974 edition. New items, categories, illustrations. 180 easy-to-read pages packed with 4000 unusual items. Dozens of electrical and electromagnetic parts, accessories. Enormous selections of astronomical Telescopes, Microscopes, Binoculars, Magnifiers, Magnets, Lenses, Lasers, Prisms. Many wear surplus items, for hobbyists, experimenters, workshops, factory. Write for catalog "GD."

EDMUND SCIENTIFIC CO., Barrington, N.J. 08007

NAME _____
 ADDRESS _____
 CITY _____ STATE _____ ZIP _____

EDMUND SCIENTIFIC CO. 300 EDSCORP BLDG. BARRINGTON, NEW JERSEY 08007
 CHECK BY STOCK NUMBER · SEND CHECK OR MONEY ORDER · MONEY-BACK GUARANTEE

CIRCLE NO. 8 ON READER SERVICE CARD

**ELECTRONIC
 EXPERIMENTER'S
 HANDBOOK
 SPRING 1974**

READER SERVICE NO.	ADVERTISER	PAGE NO.
	Bell & Howell Schools	18, 19, 20, 21, 138,
		139, 140, 141
3	Cleveland Institute of Electronics	155, 156, 3rd Cover
1	Continental Specialties Corporation	2nd Cover
2	Datak Corporation	146
4	Delta Electronics Co.	146
8	Edmund Scientific Corp.	156
9	GTE Sylvania	69, 70, 71
5	Heath Company	87, 88, 89
11	Meshna Jr., John	83
		1, 2, 3
10	RCA Electronics Components and Devices	4th Cover
12	Schober Organ Corp., The	6
13	Techni-Tool, Inc.	6

ANSWERS TO CAPACITOR QUIZ
 (Appearing on page 90)

1. High end
2. Increase
3. Padder
4. Neutralizing
5. Decoupling
6. 0.1 μF, ±3 percent, 1200 volts
7. 720 pF, ±5 percent, -150 PPM/°C
8. 12 pF
9. 6 pF
10. 10 pF

AC CIRCUIT THEORY QUIZ
 (Appearing on page 98)

1. $(10)^2 = (8)^2 + (VR)^2$; VR = 6 V
2. $(20)^2 = (7 + VC)^2 + (12)^2$; VC = 9 V
3. $(24)^2 = (VL - 6)^2$; VL = 30 V
4. $(15)^2 = (350 - 350)^2 + (VR)^2$; VR = 15 V
5. $(VT)^2 = (15 - 3)^2 + (16)^2$; VT = 20 V
6. $(50)^2 = (VL)^2 + (12)^2 = (VC)^2 + (12)^2$; VL + VC
 $(VT)^2 = (VL - VC)^2 + (12)^2$; VT = 12 V
7. $(IT)^2 = (6)^2 + (8)^2$; IT = 10 mA
8. $(20)^2 = (16 - IC)^2 + (16)^2$; IC = 4 mA or 28 mA
9. $(IT)^2 = (17 - 13)^2 + (3)^2$; IT = 5 mA
10. $(9)^2 = (20 - 4 - IC)^2$; IC = 7 mA or 25 mA

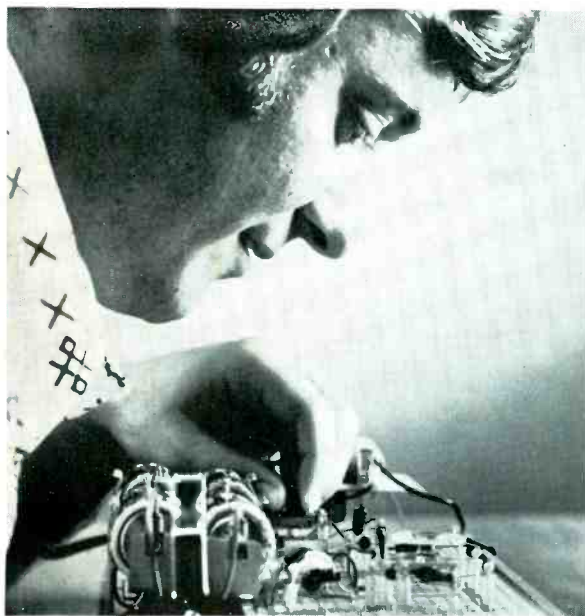

You Learn to Make Money ...with CIE's Electronics Laboratory!

Now you can learn Electronics by performing more than 200 practical, skill-producing experiments...with authentic industrial components...at home...in your spare time.

You learn by doing! This 161-piece Laboratory includes the up-to-date equipment you'll need — such things as an IC (integrated circuit), printed circuit board, FET (field effect transistor), photovoltaic cell, DC motor, microphone, multimeter, soldering iron and power supply.

You put theory into practice right in your own home... in your spare time...while you go right on pulling down your present pay. It's CIE's exciting space-age "Electronics Technology with Laboratory" program... a unique combination of CIE's special AUTO-PROGRAMMED® Lessons and laboratory equipment. It is the practical way to learn Electronics!

Prepare for a High-paying Career

You see, when you "learn by doing," you're ready to do...you're armed with the know-how to meet the challenges of a high-paying career in Electronics... prepared to go after an exciting, relevant job in a growing field such as medical technology, pollution control, radio and TV broadcasting, computers...just to name a few. Once you have some experience, you can make \$12,000 a year or more.

But that's not all! When you successfully complete your Electronics Laboratory course, you'll get a CIE Diploma. And, you'll be able to pass the Government FCC examination or be entitled to a full refund of all tuition paid! CIE's Money-Back Warranty is valid during the completion time allowed for your course.

Send today for CIE's 2 FREE BOOKS about opportunities in Electronics. For your convenience, we will try to have a representative call. Mail reply card or coupon to CIE...or write: Cleveland Institute of Electronics, Inc., 1776 E. 17th St., Cleveland, Ohio 44114.

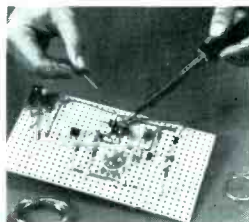

You learn how to construct circuits and connect them with a soldering iron, which is part of your CIE laboratory equipment. This "hands on" experience is extremely valuable.

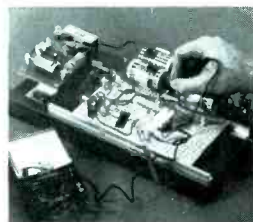

Testing and troubleshooting are an important part of your learning experience. Your laboratory has a precision multimeter to diagnose electronic troubles quickly and accurately.

APPROVED UNDER G.I. BILL

All CIE career courses are approved for educational benefits under the G.I. Bill. If you are a Veteran or in service now, check box for G.I. Bill information.

CIE Cleveland Institute of Electronics, Inc.

1776 East 17th Street, Cleveland, Ohio 44114
Accredited Member National Home Study Council

Please send me your 2 FREE BOOKS — The CIE school catalog, "Succeed in Electronics" and "How To Get a Commercial FCC License":



Name _____ (Please Print)

Address _____

City _____

State _____ Zip _____ Age _____

Veterans and Servicemen:

Check here for G.I. Bill information.

EH-15

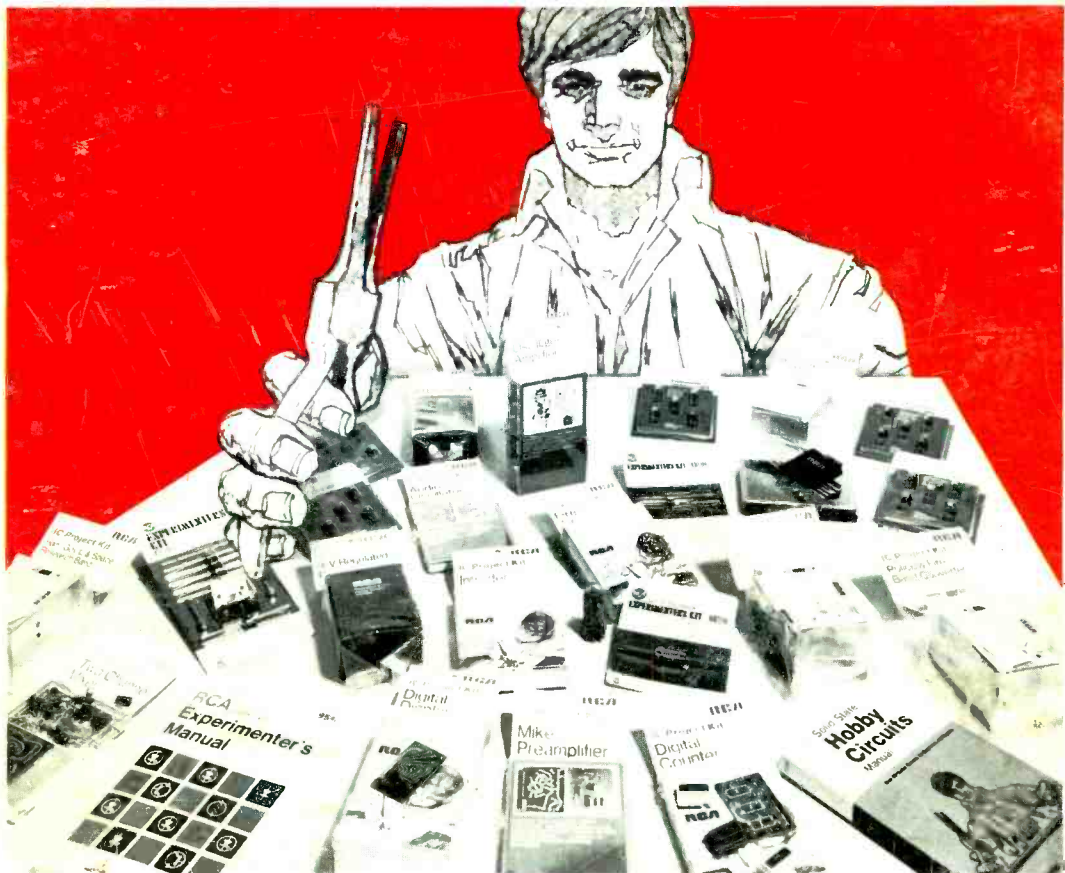

Get the whole kit and caboodle from RCA.

Now available from RCA... a wide variety of solid-state components in convenient kit form to build interesting and useful projects.

And you can further expand your solid-state experience with RCA's popular hobby and experimenter's manuals. For example, the 368-page RCA Solid-State Hobby Circuits Manual (HM-91) has over 60 interesting circuits you can build.

See your RCA Distributor to buy the RCA Kits and Manuals of your choice.

RCA | Solid State
Somerville, N.J. 08876

RCA

Solid State

RCA IC Project Kits, Experimenter Kits, and Devices

Type	Description	Type	Description
KC4000	I.C. Microphone Pre-Amplifier Kit	KD2100	Silicon Control Rectifier Assembly
KC4001	I.C. Two-Channel Mixer Kit	KD2105	SCR Experimenter Kit
KC4002	I.C. Audio Oscillator Kit	KD2106	Add on Light Sensor Kit
KC4003	I.C. Power Amplifier and Oscillator Kit	KD2110	Add on Heat Sensor Kit
KC4004	I.C. Regulated Power Supply Kit	KD2117	I.C. Experimenter Package Basic Kit Contains: 2-KD2114, 1-KD2115, 2-KD2116
KC4005	I.C. Intruder Alarm Kit	KD2118	NPN Silicon Variety Pack (5 Units)
KC4006	I.C. Fire Alarm Kit	KD2120	PNP Silicon Variety Pack (5 Units)
KC4007A	I.C. Converter Kit: 118-136MHz Aircraft Band	KD2123	PNP Germanium Variety Pack (5 Units)
KC4008A	I.C. Converter Kit: 134-150MHz Ham, Government, Space Research Band	KD2124	NPN Germanium Variety Pack (5 Units)
KC4009A	I.C. Converter Kit: 148-164MHz Maritime Mobile, Police, Fire Band	KD2131	70-Watt IC Power Module
KC4010A	I.C. Converter Kit: 160-174MHz Police, Fire Band	3N128DP	MOS/FET Device in Display (Blister) Pack
KC4011	Digital/Readout IC Kit	40214DP	18 Amp. ¼ in. Stud Silicon Rectifier Device in Display (Blister) Pack
KC4012	Digital/Counter IC Kit		
KC4014	Liquid Crystal Clock Kit		
KC4500	Kit Enclosure for use with KC4000, KC4001, KC4002, includes Input & Output Jacks, On-Off Switch and Hardware		