

Better Designs - Faster

With the Personal Design Solution

The Design Solution Includes: Electronics Workbench Personal Edition + EWB Layout

Electronics
Workbench[®]
Personal Edition

Full-featured schematic capture and SPICE 3F circuit simulation!

The world's best selling circuit design software. With analog, digital and mixed A/D SPICE simulation, a full suite of analyses and over 4000 devices. Imports netlists. Seamlessly integrated with EWB Layout or exports to other popular PCB programs. Still the standard for power and ease of use. Still the same effective price.

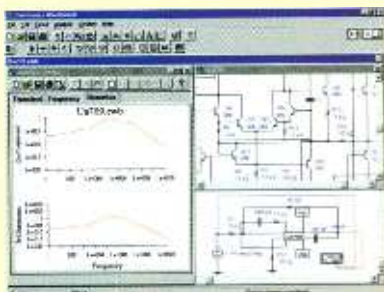

\$299
Version 5

HIGH-END FEATURES

TRUE MIXED ANALOG/DIGITAL	YES
FULLY INTERACTIVE SIMULATION	YES
PRO SCHEMATIC EDITOR	YES
HIERARCHICAL CIRCUITS	YES
VIRTUAL INSTRUMENTS	YES
ON-SCREEN GRAPHS	YES
ANALOG AND DIGITAL MODELS	OVER 4,000
FREE TECHNICAL SUPPORT	YES
DC OPERATING POINT	YES
AC FREQUENCY	YES
TRANSIENT	YES
FOURIER	YES
NOISE	YES
DISTORTION	YES

**30-DAY MONEY-BACK
GUARANTEE**

Electronics
Workbench **Layout**
Personal Edition

Power-packed PCB layout with autorouting and real-time DRC!

EWB Layout is a powerful board layout package for producing high-quality, multi-layer printed circuit boards. Offering tight integration with our schematic capture program, you can incorporate board layout and design and quickly bring well-designed boards to production.

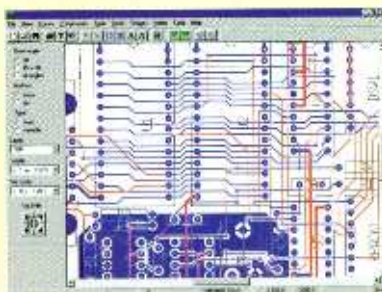

\$299
Version 5

POWER-PACKED FEATURES

AUTOROUTING	YES
REROUTE WHILE MOVE	YES
LAYERS	32 ROUTING LAYERS
BOARD SIZE	50" X 50"
LIBRARY SHAPES	OVER 3,500
BLIND AND BURIED VIAS	YES
EXTENSIVE OUTPUT	YES
SELECTIVE NET HIGHLIGHTING	YES
USER DEFINED PADS	YES
REAL TIME DESIGN RULE CHECK	YES
DENSITY HISTOGRAMS	YES
FREE TECHNICAL SUPPORT	YES

Join over 85,000 customers and find out why more circuit designers buy Electronics Workbench than any other circuit design tool.

**CALL FOR INFORMATION
AND PRICING ON OUR
PROFESSIONAL EDITION.**

ELECTRONICS WORKBENCH Personal Edition	\$299.00	BUY BOTH AND SAVE	PERSONAL DESIGN SOLUTION	\$598.00
EWB LAYOUT Personal Edition	\$299.00			\$548.00

CALL 800-263-5552

For a free demo, visit our website at <http://www.interactiv.com>

INTERACTIVE IMAGE TECHNOLOGIES LTD., 908 Niagara Falls Boulevard, #068, North Tonawanda, New York 14120-2060 / Telephone 416-977-5550.
TRADEMARKS ARE PROPERTY OF THEIR RESPECTIVE HOLDERS. OFFER IS IN U.S. DOLLARS AND VALID ONLY IN THE UNITED STATES AND CANADA. ALL ORDERS SUBJECT TO \$15 SHIPPING AND HANDLING CHARGE.
Fax: 416-977-1818 E-mail: ewb@interactiv.com
CompuServe: 71333,3435 / BBS:416-977-3540



CIRCLE 26 ON FREE INFORMATION CARD



A GERNSBACK
PUBLICATION

COVER STORY

31 Build the Millennium Clock

You can throw away your calendar when you need to keep track of how many days until a certain event happens. This is a great project to have as the entire planet counts the days until the new millennium!—*James E. Tarchinski, N8PTG*



Page 31

FEATURE

39 Getting Your Computer Up and Running

In this concluding article on building your own PC, we now install the major computer assemblies, configure the hardware, and load some basic software to get your PC off and running!—*Rafael Avila*



Page 39

PRODUCT REVIEWS

17 Hands-on Report

Sony PLL Synthesizer Scanning Receiver

22 Gizmo

PC Cinema DVD Player and Internet PC, Gekko Flat-Panel Speakers, Intensor Gaming Chair, Uniden Bearcat Trunk-Tracking Scanner



Page 22

POPULAR ELECTRONICS (ISSN 1042-170-X) Published monthly by Gernsback Publications, Inc. 500 Bi-County Boulevard, Farmingdale, NY 11735. Periodicals postage paid at Farmingdale, NY and at additional mailing offices. One-year, twelve issues, subscription rate U.S. and possessions \$24.99, Canada \$33.15 (includes G.S.T. Canadian Goods and Services Tax Registration No. R125166280), all other countries \$33.99. Subscription orders payable in U.S. funds only, International Postal Money Order or check drawn on a U.S. bank. U.S. single copy price \$4.99. Copyright 1998 by Gernsback Publications, Inc. All rights reserved. Hands-on Electronics and Gizmo trademarks are registered in U.S. and Canada by Gernsback Publications, Inc. Popular Electronics trademark is registered in U.S. and Canada by Electronics Technology Today, Inc. and is licensed to Gernsback Publications, Inc. Printed in U.S.A.

Postmaster: Please send address changes to Popular Electronics, Subscription Dept., P.O. Box 338, Mount Morris, IL 61054-9932

A stamped self-addressed envelope must accompany all submitted manuscripts and/or artwork or photographs if their return is desired should they be rejected. We disclaim any responsibility for the loss or damage of manuscripts and/or artwork or photographs while in our possession or otherwise.

As a service to readers, Popular Electronics publishes available plans or information relating to newsworthy products, techniques, and scientific and technological developments. Because of possible variances in the quality and condition of materials and workmanship used by readers, Popular Electronics disclaims any responsibility for the safe and proper functioning of reader-built projects based upon or from plans or information published in this magazine.

C O L U M N S

- 8 Net Watch**
Researching Online—*Konstantinos Karagiannis*
- 14 Scanner Scene**
A Racy Scanner—*Marc Saxon*
- 15 Antique Radio**
Recapping—The Broad-Spectrum Radio Repair—*Marc Ellis*
- 49 Multimedia Watch**
Fast CD Recording, New Graphics Cards, and New Software
—*Marc Spiwak*
- 54 DX Listening**
Broadcaster's Decisions—*Don Jensen*
- 56 Think Tank**
Get the LED Out!—*Alex Bie*
- 60 Ham Radio**
Getting Started in QRP—*Joseph J. Carr*
- 62 Circuit Circus**
Lights On With Photoelectronics—*Charles D. Rakes*

D E P A R T M E N T S

- 4 Editorial**
- 6 Letters**
- 66 Electronics Library**
- 67 New Products**
- 69 Popular Electronics Market Center**
- 96 Advertising Index**
- 96A Free Information Card**

Larry Steckler, EHF, CET,
editor-in-chief and publisher

EDITORIAL DEPARTMENT

Edward Whitman, managing editor
Robert Young, technical editor
Evelyn Rose, assistant editor
Teri Scaduto, assistant editor
Debbie Cybula, editorial assistant
Alex Bie, contributing editor
Joseph J. Carr, K4IPV,
 contributing editor
Marc Ellis, contributing editor
Jeffrey K. Holtzman,
 contributing editor
Don Jensen, contributing editor
Konstantinos Karagiannis,
 contributing editor
Charles D. Rakes, contributing editor
Marc Saxon, contributing editor
Marc Spiwak, contributing editor

PRODUCTION DEPARTMENT

Ruby M. Yee, production director
Ken Coren, desktop production director
Melissa Giordano, desktop production
Kathy Campbell, production assistant

ART DEPARTMENT

Andre Duzant, art director
Russell C. Truelson, illustrator

CIRCULATION DEPARTMENT

Theresa Lombardo,
 circulation manager
Gina L. Gallo, circulation assistant

REPRINT DEPARTMENT

Christina M. Estrada, Reprint Bookstore

BUSINESS AND EDITORIAL OFFICES

Gernsback Publications, Inc.
 500 Bi-County Blvd.
 Farmingdale, NY 11735
 516-293-3000
 FAX: 516-293-3115

President: **Larry Steckler**

Vice-President: **Adria Coren**

Vice-President: **Ken Coren**

**SUBSCRIPTION
 CUSTOMER SERVICE/
 ORDER ENTRY**

800-827-0383
 7:30 AM - 8:30 PM EST

**Advertising Sales Offices
 listed on page 94**

Composition by Mates Graphics
 Cover by Loewy Design

VISIT US ON THE INTERNET AT:
www.gernsback.com



Since some of the equipment and circuitry described in POPULAR ELECTRONICS may relate to or be covered by U.S. patents, POPULAR ELECTRONICS disclaims any liability for the infringement of such patents by the making, using, or selling of such equipment or circuitry, and suggests that anyone interested in such projects consult a patent attorney.

We're *the* shop for home shops.

39.99
3-amp regulated power supply powers DC devices from home AC. #22-504

1.99
Durable project box with aluminum and plastic lid. #270-1801

49.99
Auto-ranging digital multimeter. Simple push-button and slide-switch controls. #2-153

19.99
Soldering work station has dual-powered iron—just flip a switch to go from 20W to 40W. #64-2184

5.99
6-piece, precision anti-static screwdriver set. Durable alloy steel shafts. #64-1963

29.99
Pocket-size torch kit. Produces 5000°F in an adjustable pinpoint flame. #64-2165

2.29
Multicolor heat-shrink tubing. Red, white, blue and clear. Pkg. of 7. #278-1610

9.99
Ball-bearing type 12VDC blower fan. 2,600RPM, 180mA. #273-260

Solutions for all your projects and repairs.

There's a RadioShack in your neighborhood with the tools, parts and accessories to complete virtually any small electronics project or repair. You'll find the hottest gear for everything from making simple repairs and testing circuits to building speaker systems and designing your own electronic devices. Even hard-to-find parts and accessories that might not be on our shelves are available for fast delivery direct to your door—just ask a store associate about RadioShack Unlimited. For our store nearest you, call 1-800-THE SHACK (1-800-843-7422).



RadioShack®

You've got questions. We've got answers.®

Prices apply at participating RadioShack stores and dealers. Independent RadioShack dealers and franchisees may not be participating in this ad or stock or special-order every item advertised.

CIRCLE 32 ON FREE INFORMATION CARD

Accredited B.S. Degree in Computers or Electronics

by studying at Home

Grantham College of Engineering
offers 3 distance education programs:

- B.S.E.T. emphasis in Electronics
- B.S.E.T. emphasis in Computers
- B.S. in Computer Science

NEW! Electronics Workbench Professional 5.0
included in our B.S.E.T. curriculums
-Approved by more than 200 Companies,
VA and Dantes, (tuition assistance avail.)

For your free catalog of our programs dial
1-800-955-2527

<http://www.grantham.edu>

GCE

Your first step
to help yourself
better your future!



Grantham College of Engineering
34641 Grantham College Road
Slidell, LA 70460-6815

ANTIQUE RADIO CLASSIFIED Free Sample!

Antique Radio's
Largest Circulation Monthly.
Articles, Ads & Classifieds.



6-Month Trial: \$20.95. 1-Yr: \$40.95 (\$57.95-1st Class).
A.R.C., P.O. Box 802-L20, Carlisle, MA 01741
Phone:(978) 371-0512 VISA/MC Fax:(978) 371-7129

THE COLLECTED WORKS OF MOHAMMED ULYSES FIPS

#166—By Hugo Gernsback.
Here is a collection of 21 April
Fools Articles, reprinted from
the pages of the magazines
they appeared in, as a 74-
page, 8½ x 11-inch book. The
stories were written between
1933 and 1964. Some of the
devices actually exist today.



Others are just around the corner. All are fun and
almost possible. Stories include the Cordless
Radio Iron, The Visi-Talkie, Electronic Razor, 30-
Day LP Record, Teleyeglasses and even Elec-
tronic Brain Servicing. Get your copy today. Ask
for book #166 and include \$16.00 (includes ship-
ping and handling) in the US (First Class), Cana-
da and Overseas (surface mail), and order from
CLAGGK Inc., P.O. Box 4099, Farmingdale, NY
11735-0793. Payment in US funds by US bank
check or International Money Order. Allow 6-8
weeks for delivery. MA05

EDITORIAL

Ma Bell and Pa Cable— Rest in Peace

Several months ago I noticed a short article in the
business section of my local newspaper. The article
entitled "Cable Boxes for Sale" aroused my interest.
I read further. It appears that recent FCC action will
allow cable customers to *purchase* stand-alone
cable boxes, as well as TV sets, VCRs, and other
devices with built-in cable boxes from retail outlets
beginning July 1, 2000.

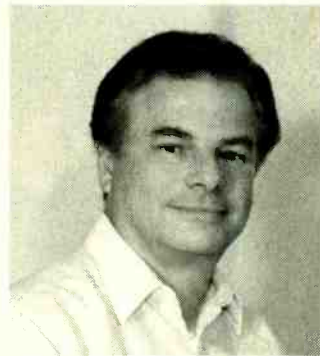

Deciding to pursue this matter further, I got a copy
of the "official" FCC decision (CS Docket 97-80).
Essentially the information I gleaned from all their
details was that this ruling allows consumers to
obtain "navigation devices"—meaning the set-top
boxes, remote-control units and other equipment—from commercial sources *other*
than their cable provider, and use this equipment to access video programming and
other services in their homes.

Obviously the cable industry does not like these provisions, since this will provide com-
petition by creating a major market for consumers to own their equipment. However, the
whole subject of "security," a.k.a. "descramblers," *etc.* seemed somewhat unclear. The
FCC action still prohibits the manufacture, sale, and distribution of equipment designed
to allow for *unauthorized* reception of service—guaranteeing the security of the cable
companies' systems and their programming. The newspaper article also indicated that
the consumer boxes could not contain security features. It implied that an external cryp-
to-device might be some type of electronic card, owned and controlled by the cable sys-
tem (which of course, the consumer would have to lease with a monthly fee from the
cable company) and inserted into the box to watch premium or scrambled programs.

In my opinion, this basic FCC decision was a ruling long overdue. I thought back about
30 years ago when Ma Bell would charge extra for every additional telephone that you
installed in your home. Many of the hobbyists in those days were easily able to purchase
additional telephones from catalogs, *etc.* The question was how to hook up these phones
and not be caught by the "Telephone Police." They learned that the bell-ringer wire, com-
monly the "yellow wire," was the ringer indicator that caused measurable current drain on
your line—which could be detected by sensitive equipment used by the Telephone Police
up on the pole. So these hobbyists would disconnect the bell wire, or install it through a
switch, or simply put the additional phone on a four-pin modular jack, which could be sim-
ply removed if the Telephone Police truck appeared in the neighborhood. Years later,
telephone deregulation against Ma Bell ended this fiasco. Future rulings, which unbun-
dled our telephone networks, have reaped benefits for consumers. Entrepreneurs with
new ideas and new products have found a way to enter and bring products to market.

I am of the school, perhaps legally incorrect, that once a telephone wire, coax cable, wire-
less signal, *etc.*—which you are legitimately paying for or leasing—gets into the confines
of your home, your "castle", it *belongs to you* to use or to experiment with, without the
fear of being caught by the Telephone or Cable Police. If the service in question prohibits
you from doing this, let them engineer the signal properly and apply security, *before* it
enters the confines of your home. Whether my opinion is right or wrong, I applaud this
new FCC decision as the first step in the demise of Pa Cable. What do you think?

Ed Whitman
Managing Editor

Buyers' Budget Books Better Buys

BP294-A Concise Introduction to Microsoft Works \$8.99. In the shortest and most effective way, you can use the word processor to advantage to type, edit, print and save documents. It goes on to explain how Works can be used to build up simple spreadsheet examples, edit them, save them, print them and retrieve them. It informs you how to create simple macros, and enables you to simplify long repetitive tasks and to customize the program to your own needs.

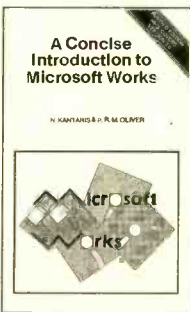

BP349-Practical Opto-Electronic Projects \$8.99. If you shun opto-electronic projects for lack of knowledge, this is the book for you. A bit of introductory theory comes first and then a number of practical projects which utilize a range of opto devices, from a filament bulb to modern infrared sensors and emitters.

BP350-Electronic Board Games \$8.99. Twenty novel electronic board games that you can build from the plans in this book. Whether you are interested in motor racing, searching for buried treasure on a barren island or for gold in Fort Knox, spinning the wheel of fortune, or doing a musical quiz—there is something for you to build and enjoy!

BP378-45-Simple Electronic Terminal Block Projects \$8.99. Contains 45 easy-to-build electronic projects that can be built by an absolute beginner. Projects are assembled on terminal blocks using only a screwdriver and other simple hand tools. No soldering is required.

BP432-Simple Sensor Terminal Block Projects \$8.99. This book is the next logical step from *45 Simple Electronic Terminal Block Projects* (BP378), by the same author. The former describes an easy method of constructing transistor circuits without the need for soldering. It is an *open sesame* to the practical world of electronics for youngsters or beginners.

BP428-MS-Word 97 Explained \$12.75. Without any previous knowledge of MS-Word, you can be up and running this evening using this basic text as a guide! Nothing is assumed! The hardware specification you need to run the package, and how to install it onto your system, are covered. You discover how to enter, edit and enhance text and how to become comfortable working with document page layouts, paragraph styles, document templates, textboxes and frames.

BP367-Electronic Projects for the Garden \$8.99. Electronics enters the Garden! New exciting book points out how gardeners can build simple gadgets to promote success where the elements work against you. Some of the projects are: over/under temperature monitoring, dusk/dawn switching, automatic plant watering, warming cables, etc.

BP368-Practical Electronics Musical Effect Units \$8.99. There is a constant hullabaloo for musical effects projects by the hobbyist community. This book provides practical circuits for several projects that range in complexity and are sure to work. All the circuits are easy to build and use readily-available parts.

BP429-MS-Excel 97 Explained \$8.99. 3D Excel 97 spreadsheet is here! Get a quick start with this exciting program in the shortest and most effective way. The book was written with both the newcomer to spreadsheets and the existing spreadsheet user in mind. After a brief period of reading the beginner will be able to build up simple spreadsheet examples, edit entries, format cells and ranges, and save and open worksheets. From there, you can generate and use 3-dimensional worksheets and to link them together.

BP385-Easy PC Interfacing \$8.99. The built-in ports in your PC provide an easy and hassle-free way of interfacing your circuits. This book provides useful PC add-on circuits including the following: Digital input/output ports; analog-to-digital and digital-to-analog converters; voltage and current measurement circuits; resistance and capacitance meters, temperature measurement interface, biofeedback monitor, and many other useful interfaces.



BP396-Electronic Hobbyists Data Book \$10.99. This book provides a wide range of data. If, for example, you require details of a modern five-band resistor code or an old color code for a ceramic capacitor, the formula for parallel resistance, or basic data on an NE5534AN operational amplifier, it is contained within these pages. The subjects covered are numerous and widespread to cover all hobbyist interests.

BP343-A Concise Introduction to Microsoft Works for Windows \$10.99. The book explains and details: How the Works for Windows package fits into the general Microsoft Windows environment; how to use the word processor to advantage; how to use Microsoft Draw to create and edit graphics and place them in your documents; how to build up simple spreadsheet examples; and how single, and multiple charts, or graphs, of different types can be generated. And there's much more!

BP282-Understanding PC Specifications \$8.95. This book explains PC specifications in detail, and the subjects covered include the following: Differences between types of PC (XT, AT, 80386, 80486, Pentium etc.); math co-processors; input devices (keyboards, mice, and digitizers); memory, including both expanded (EMS) and extended RAM; RAM disks and disk caches; floppy disk drive formats and compatibility; hard disk drives; and display adapters (CGA, Hercules, super VGA, etc.).

BP298-Concise Intro to the Macintosh System and Finder \$7.50. Although the Mac's WIMP user interface is designed to be easy to use, much of it only becomes clear when it is explained in simple terms. The book explains: The System and Finder, what they are and what they do; how to use the System and Finder to manipulate disks, files and folders; configuring and printing files from the Finder; getting the most from the system utility programs; and running MultiFinder.

BP88-How To Use OP Amps \$7.50. The Operational Amplifier is the most adaptable circuit module available to the circuit designer. It is possible to purchase a low-cost integrated circuit with several hundred components, very-high gain and predictable performance. This book has been written as a designer's guide for most Operational Amplifiers, serving both as a source book of circuits and a reference book for design calculations.

BP316-Practical Electric Design Data \$10.95. A builder's bargain book—a comprehensive ready-reference manual for electronic enthusiasts with over 150 practical circuits. It covers the main kinds of components (from pig-tail leads to surface mount), pin-outs, specs and type selection. Basic units are defined and most used formulae explained. Five additional sections are devoted to circuit design, covering analog, digital, display, radio and power supply circuits.

BP346-Programming in Visual Basic for Windows \$10.99. This book is a guide to programming. The reader is not expected to have any familiarity with the language as both the environment and statements are introduced and explained with the help of simple programs. The user is encouraged to build these, save them, and keep improving them as more complex language statements and commands are encountered.

BP341-MS-DOS 6 Explained \$12.25. The book covers: How the DOS operating system of your computer is structured so that you can understand what happens when you first switch on your computer; How directories and subdirectories can be employed to structure your hard disk for maximum efficiency; how to use the DOS Shell program, and much, much more.

BP345-Getting Started In Practical Electronics \$8.99. If you are looking into launching an exciting hobby activity, this text provides basic essentials for the builder and 30 easy-to-build fun projects with which every experimenter should toy. Printed-circuit designs are included to give your project the professional touch.

ELECTRONIC TECHNOLOGY TODAY INC.
P.O. BOX 240, Massapequa, NY 11762-0240

Name _____
Address _____
City _____ State _____ Zip _____

SHIPPING CHARGES IN USA AND CANADA

\$0.01 to \$10.00.....	\$3.00
\$10.01 to \$20.00.....	\$4.00
\$20.01 to \$30.00.....	\$5.00
\$30.01 to \$40.00.....	\$6.00
\$40.01 to \$50.00.....	\$7.00
\$50.01 and above.....	\$8.50

SORRY No orders accepted outside of USA & Canada

	No. of Books Ordered <input type="text"/>
Total price of books.....	\$ _____
Shipping (see chart).....	\$ _____
Subtotal.....	\$ _____
Sales Tax (NYS only).....	\$ _____
Amount Enclosed	\$ _____

All payments must be in U.S. funds!

NW1

Allow 6-8 weeks for delivery

LETTERS

AUTOMATIC BLOWER CONTROL CORRECTIONS

I noticed some errors in my article, "Automatic Blower Control," published in the September 1998 issue. In Fig. 8 on page 39, the contacts of the existing A/C blower relay are shown backwards. The correct wiring should show the normally-closed relay contact connected to MT1 of the triac. The normally open contact of the relay should be connected to the high-speed motor wire.

In the schematic diagram on page 32, terminals 3 and 6 of IC2 should be interchanged. Also, in Fig. 2, the anode and gate connections of Q3 are shown reversed.

In the Parts List, IC4 is shown as MOC3011; in the schematic diagram, it is shown as MOC3012. Either part number may be used in this circuit.

Note: Neither MOC3011 nor MOC3012 are zero-crossing optoisolators. Zero-crossing types may be used, but are not required.

Anthony J. Caristi
via e-mail

NOTCH-IT IMPROVEMENTS

In a letter in the August **Popular Electronics**, W.E. of Toronto asked for circuit changes needed to make a fourth-order filter for the harmonic distortion circuit of my "Build A Power Line Monitor" article. The excellent "Notch It" notch filter circuit article by Julian Kerr in the same issue is a great segue. I have also enclosed a notch filter application circuit published by *Analog Devices*, (see Fig. 1) built around their OPx84 precision single supply op-amp family (OP184 single, OP284 dual, OP484 quad), and designed to operate from +3 to +36 VDC. I see no reason why it could not be built with the more readily available AD712JN dual precision op-amp (from *Jameco* as p/n 115203).

Charles Hanson
Tinton Falls, NJ

THE 'AA' ALKALINE SHOWDOWN OF 1998

The television ads drove me to the above action. I'd had it with the pink bunny right up to my copper top! Who

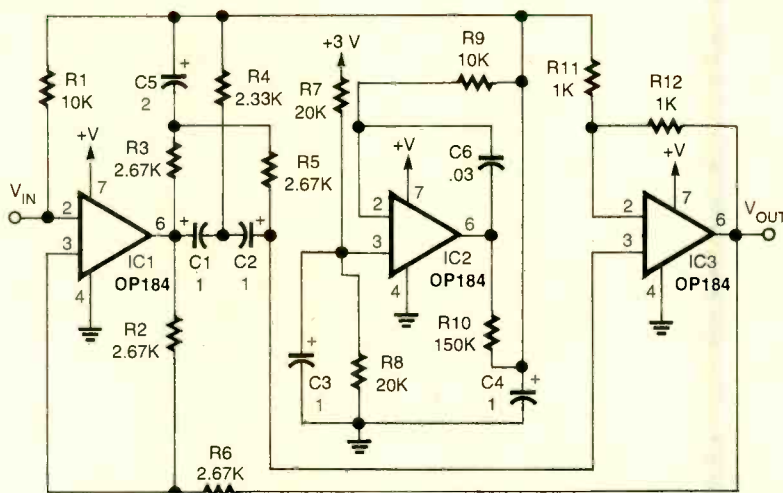

Fig. 1. A 3 volt, 60 Hz notch filter featuring ADC's precision op-amps.

does offer the best 'AA' primary cell? I decided to do my own comparison. (I leave the dollars-per-watt-hour up to you, since sales affect price greatly.)

Method: I used 'off-the-shelf' alkaline 'AA' cells commonly available in the midwest. All samples were well inside their shelf life. The batteries were tested in a circuit that stopped an analog clock at a repeatable 0.94 VDC level—and also applied an extremely heavy load to the CUT (Cell Under Test). In standard

applications, cell performance will be many times better—these results are for comparison only.

Test execution:

1. Record open terminal voltage.
2. Set clock.
3. Apply load to CUT.
4. Record voltage 10 minutes later.
5. When clock stops at 0.94 VDC, record time in decimal hours.

The final data is shown in Table 1. Results: The *Duracell* Ultra and *OSCO*

TABLE 1. 'AA' ALKALINE BATTERY SUMMARY

Battery type	V _{0dc}	V _{dc} @ 10 min.	Decimal hours	Calculated Miliamp hrs. @ 338.8 mA drain
<i>Duracell</i> Ultra Alkaline 'AA'	1.618	1.386	5.00	1944 mAh
<i>Duracell</i> Standard Alkaline 'AA'	1.600	1.335	4.45	1730 mAh
<i>Eveready</i> Energizer Alkaline 'AA'	1.537	1.322	4.65	1808 mAh
<i>OSCO</i> store brand Alkaline 'AA'	1.588	1.335	5.00	1944 mAh
<i>RadioShack</i> Alkaline 'AA'	1.577	1.272	2.66	1034 mAh
<i>Walgreen</i> store brand Alkaline 'AA'	1.598	1.348	2.38	925 mAh

drugstore alkalines tied at 5.00 hours. Standard *Duracell* Alkaline and *Eveready* Energizer showed no statistically significant difference with the little pink guy winning by a "hare." *RadioShack* and *Walgreen* battery results were not as good, although they would be a good buy at a deep discount. Keep in mind that even the worst results in battery life in my test were with a high load. At a more reasonable, but still high rate of 60 mA, continuous use yields more than 15.4 hours (26 hrs average). A 20 mA device (such as an AM pocket radio or DMM) that is kept on continuously, will work over 46.2 hours (78 average)! Even the clock I used sans the load resistor would last way over 9250 hours, or 1 year-20 days-4 hours and 14 minutes with the *RadioShack* 'AA'!

Well I am all "charged up" and "lon" my way! Don't just buy what they want to "cell" you.

Craig Fawcett
Downers Grove, IL

Not only has Craig done some interesting research, but he is also a comedian!—Editor

HAVE & NEEDS

I enjoyed the article on Audio Modules in **Popular Electronics** of August 1998.

Please help me with this problem: I have a manufacturer's amplifier from *Ford Motor Company* and would like it installed the conventional way in my Chevrolet. Amplifiers from other electronic stores have quick connectors for easy installation, but the manufacturer's amplifier carries too many wirings. The amplifier in question has the *Ford* part number E8VF-18T805-AA worked on its side. I also have the schematic from the service manual, but the extra wiring confuses me. Thank you for your help.

Tony Neiburg
352 Wacouta Street #208
St. Paul, MN 55101

Regarding the request by George Wroe, in the August *Haves & Needs* column, concerning a programmable radio/ tape that can be programmed like a VCR. I use an ordinary VCR to record radio programs with the VCR timer. Turn the radio on, tune in the station, and feed the audio from the radio to the audio input jack in the

rear of the VCR. Set the timer on the VCR and leave the radio on. This will work for one radio station only. You need another radio and VCR if you want to time-record another station.

When you play back the tape, you get the audio and a black picture on the TV set. With a hi-fi stereo VCR, you get excellent audio.

But you can also buy a product called "Reel Talk," which is an AM/FM digital radio with a built-in cassette recorder. Using a timer it records on a standard cassette at one-fourth nor-

mal speed. But it won't record music, switch stations, and record another program. *C. Crane Co.*, 558-10th Street, Fortuna, CA 95540, sells it for \$150. (Tel. 800-522-8673, Web: www.ccrane.com/reel_talk.htm).

I know this doesn't totally answer Mr. Wroe's question about switching stations and recording another. I am also looking for a way to switch radio stations and record another. Does any other reader have any thoughts on this matter?

Fred Lehmann, WAØPBL
e-mail: lehmann@design.com

Get our Freeware version
and you will know
why more and more PC-boards
are designed with EAGLE.



EAGLE 3.5

Schematic Capture • Board Layout
Autorouter

for Windows[®] 95/NT

Windows 95 and Windows NT are registered trademarks of Microsoft Corporation.

EAGLE Professional offers the full EAGLE power: 99 schematic sheets, pc-boards up to 64 x 64 inches, 16 signal layers.
With **EAGLE Standard** you can use 4 signal layers and place components on an area of 6.4 x 4 inches. **EAGLE Light** is limited to 1 schematic sheet (of any size) and to 2-layer boards. Components can be placed on an area of 4 x 3.2 inches. All other features are equivalent to EAGLE Professional and Standard.

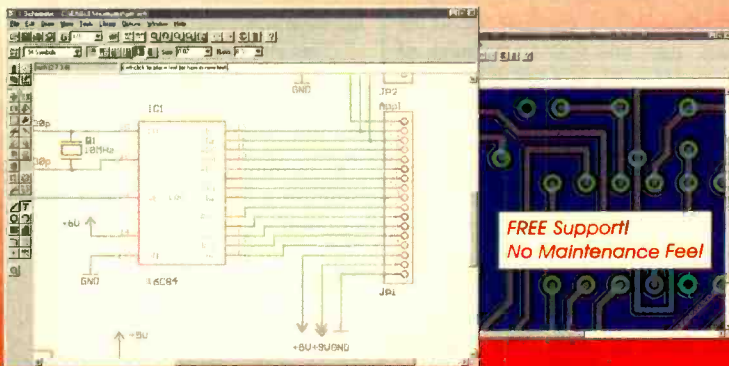

FREE Support!
No Maintenance Fee!

EAGLE 3.5 Light Is Freeware!



EAGLE Light is now available free for non-profit and evaluation use! Download it from our Internet Site or order our free CD. Registered users (49 \$ for the complete package) get the commercial license, the reference manual, and free hotline support.

<http://www.CadSoftUSA.com>

800-858-8355

CadSoft Computer, Inc., 801 S. Federal Highway, Delray Beach, FL 33483
Hotline (561) 274-8355, Fax (561) 274-8218, E-Mail: Info@cadsoftusa.com

Prices	Light	Standard	Professional
Layout		199\$	399\$
Layout + Schematic		398\$	798\$
Layout + Autorouter		398\$	798\$
Layout + Schematic + Autorouter	49\$	597\$	1197\$

Pay the difference for upgrades

CIRCLE 30 ON FREE INFORMATION CARD

NET WATCH

Researching Online

KONSTANTINOS KARAGIANNIS

Over the past few years the Internet has often been referred to synonymously as the Information Superhighway. While the latter term was actually created to describe a proposed larger mixing of the Net and other data-transfer media, it's safe to call the Web the core of this multilane road. But is it really filled with useful information? I mean, we've all come across our fair share of absurd sites on the Net, proving that just because something's online, it's not valid data.

A recent Superman story comes to mind (yes, some adults read comics). In it, Superman has apparently gone back in time and encounters a character named Prankster who, amid a string of bizarre ramblings, tells the Man of Steel that he envisions a future where everyone can publish information, regardless of whether it has any merit. He called it the World Wide Web.

But despite all the opinionated stuff floating out in cyberspace hard drives, real, useful data does exist online. Those of you writing papers for school or college, and even those of you searching for key data for that report for your boss, can still find something of merit on the Web. Researching online is not only possible, but time saving.

Just think, if you don't own an encyclopedia, how long would it take you to get to the library to check out a key fact? Or let's say you need to find an article about a recent or even not-so-recent event. Your trip to the library is only the beginning of your time consumption. Ever try using one of those microfilm machines? Lck!

Libraries are great, don't get me wrong. I visit them quite regularly, myself, and if you're a voracious reader you probably do, too. But it's much

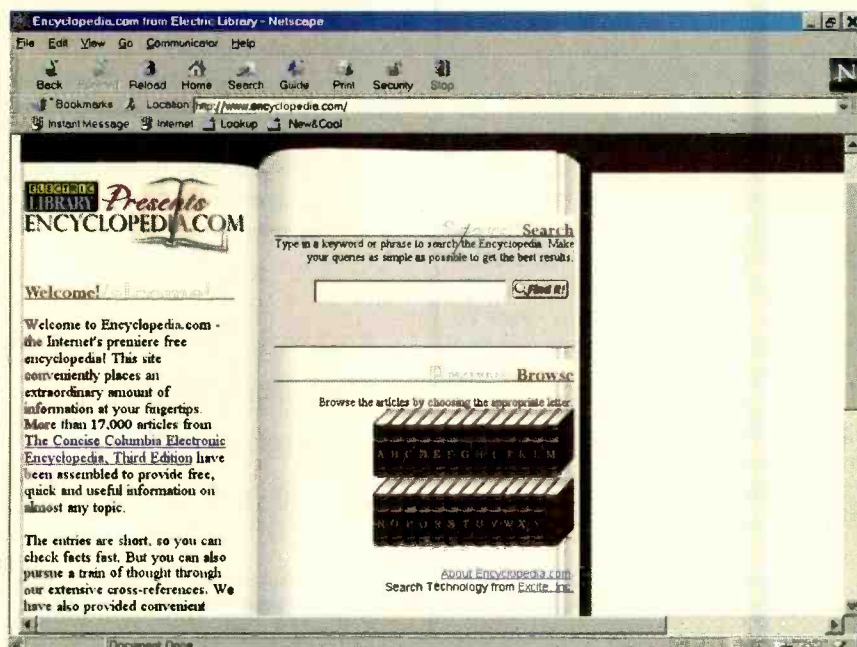

Encyclopedia.com is a free site that may contain some information that's valuable to you. Give its easy-to-use search engine a try and get a step closer to finishing up that latest project.

easier sometimes to fire up your Web browser and access that key piece of info, without heading outside on a chilly fall evening.

This month we'll take a look at a few sites that you'll just love when it comes time to finish that paper at two o'clock in the morning. Some are free and some you have to subscribe to, so give careful consideration to what your needs are before deciding to stick with either type.

TWO IN ONE

For reasons that will become obvious in a moment, we're about to cover two sites in one subheading. The first, Encyclopedia.com, proves that sometimes a name says it all. This site is quite impressive, considering it's absolutely free. It's a fully indexed site of 17,000 high-quality articles taken from *The Concise Columbia Electronic Encyclopedia, Third Edition*.

Like many CD-ROM encyclopedias, this site's articles are a bit on the short side. I wouldn't recommend using the data you get here to write a complete assignment. However, if all you really need is an important date, or the gen-

eral gist of what a certain something is, you've come to the right place.

Say you're reading a book and the author keeps mentioning a historical figure, without giving you the appropriate info for the guy or gal. Encyclopedia.com can easily dig up for you not only his or her birth and death dates, which usually should be included in a history paper, but a few key facts that may help this character come alive in your assignment.

The articles available fall into an impressive array of topics. Chances are that no matter what type of project you're working on, you'll find more than a couple of useful facts and anecdotes at Encyclopedia.com.

If you'd like to get more expanded information on a topic, each query you enter in the fast search engine results in a bunch of additional links. These links take you to images and articles stored at the Electric Library, which is the second site we alluded to earlier.

Electric Library is a pay site. The first 30 days of use are free, but after that you'll have to pay for access in one of two plans. The monthly fee is \$9.95,

HOT SITES

Electric Library
www.elibrary.com

Encyclopedia.com
www.encyclopedia.com

Encyclopaedia Britannica Online
www.eb.com

Computer Training That Pays for Itself

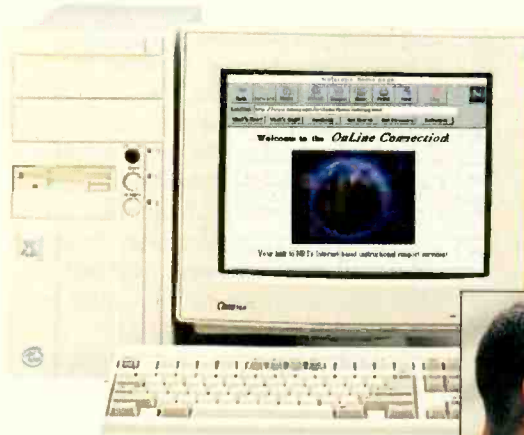

The training programs described below include a powerful computer and name-brand software. Each course includes Windows 95, with free upgrade to Windows 98, Netscape Navigator, access to NRI's Online Connection, 24-hour TeleGrading and TeleService, step-by-step lessons, and more!

Boost your earning power with NRI hands-on training

To compete in today's job market, you need state-of-the-art computer skills. Now, with NRI, you have a convenient, effective, and affordable way to keep your PC skills razor-sharp. A pioneer of hands-on computer training, NRI now features training programs geared to your special training needs ... from our updated PC Servicing course featuring ForeFront diagnostics to our enhanced course in Computer Programming that now allows you to specialize in one of three popular languages.

Choose the course that interests you, then send for your FREE catalog today!

Mastering Microsoft Office — Feel at ease with today's most popular business applications, including Word, Excel, Access, and PowerPoint. After learning Windows 95/98 and the Internet, you start training on your new PC!

Networking With Windows

NT — Learn how to set up and maintain LANs and WANs for today's busy offices. You cover every phase of the process, from analyzing system requirements to troubleshooting.



Multimedia Programming

— You create the kinds of contemporary multimedia programs that make everything—from shopping to education to business presentations—easier and more exciting. NRI's



innovative programming course helps you bring text and graphics to life with sound, animation, and photo-quality images. As you become skilled with the professional-level Asymetrix Toolbook authoring software included in your course, you'll be able to add drama and impact to all of your computer applications.

PC Servicing — Master PC architecture and operation, perform actual experiments with today's most sophisticated diagnostic tools, and experiment with NRI's exclusive labs: computer-aided electronics demonstrations, 8085 Microprocessor, and NRI Discovery Lab, a complete breadboarding system. With the active

NEW! NRI's PC Servicing and Computer Programming courses now feature a Pentium® II 300 PC with:

- MMX™ technology
- 32 meg RAM
- 5 gigabyte hard drive
- VGA color monitor
- 56,000 baud fax/modem
- 32X CD-ROM drive, and more!

support of helpful NRI instructors, this course will also help you prepare for the A+ certification exam, with updated lessons and interactive tutorial.

Computer Programming —

Whatever your previous experience, NRI's Computer Programming course gives you the hands-on training you need to compete in today's high-tech marketplace. Step by step, you acquire basic skills and master more complex programming design concepts and techniques, ultimately focusing in depth on your choice of languages: Visual Basic, C++, or Java.

**SEND COUPON OR CALL
1-800-321-4634, EXT. 3353**

FIND OUT MORE TODAY!

NRI Schools 4401 Connecticut Avenue, NW, Washington, DC 20008

Check one FREE catalog only:

- Mastering Microsoft Office
 Networking With Windows NT

- Multimedia Programming
 PC Servicing
 Computer Programming

Name _____ Age _____

Address _____

City/State/Zip _____

A Division of The McGraw-Hill Companies



Accredited Member, Distance
Education and Training Council

0018-1198

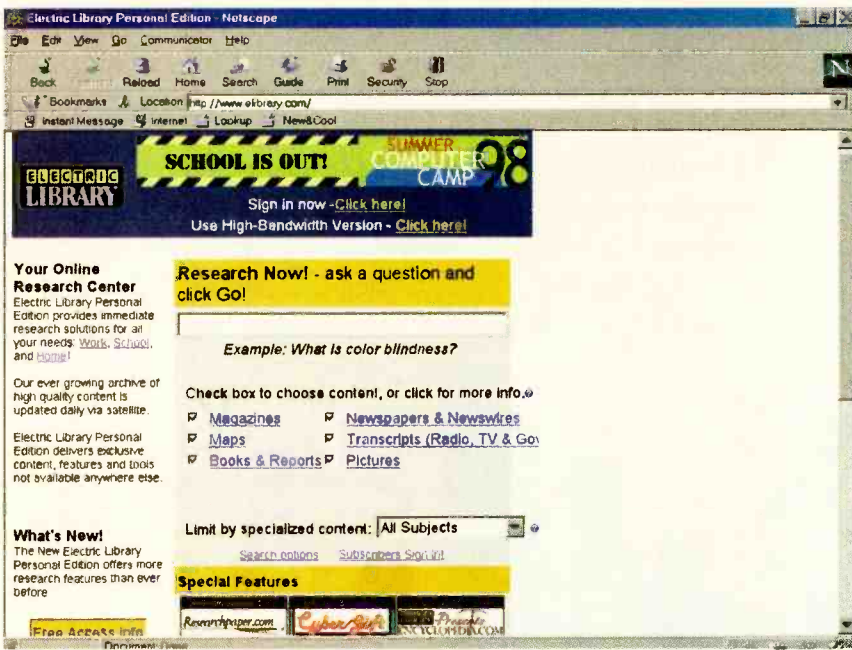

With Electric Library's advanced search parameters, you can find just about any type of data you need, even if you query the system in plain language. Don't forget to choose from the specialized-content groupings.

which does add up. If you really plan on using the service a lot, you may want to consider the yearly payment plan that allows you to pay only \$59.95 for 12 months of unlimited access.

What do you get for your cash? As mentioned, any searches you perform on Encyclopedia.com will provide you with plenty of links at Electric Library. However, once you're paying for the site, you might want to go directly to it and take advantage of its more advanced, selective search parameters.

Electric Library lets you search for something with a plain-language question like "What is a meteor shower?" You can pose your query to one or a number of different archive sources: Magazines, Maps, Books & Reports, Newspapers & Newswires, Transcripts (Radio, TV & Govt.), and Pictures. Simply check or uncheck the boxes next to the ones you want to search through or ignore (all boxes are checked by default).

You can further narrow your search by choosing from one of a couple-dozen specialized-content groupings like Automotive, Computers, Health, Literature, Science, and Women's Issues, to name a few. With all these precise options, you're less likely to have to weed through tons of garbage to get that critical data you need.

Unlike what you'd find through an Internet search engine, the content at Electric Library is from trusted, copy-

righted sources. Best of all, for those of you dealing with current topics, the information is updated daily.

There's a nice balance presented by this pair of sites. If you find that the free data at Encyclopedia.com is just fine for supplementing your research needs, stick to that site's core articles. If you need more, at least you know that it's out there waiting, for a price.

ENCYCLOPEDIA BRITANNICA ONLINE

Compared to Encyclopedia.com, the *Encyclopaedia Britannica* site offers a lot more than just an extra letter "A" in the word encyclopaedia. Featuring the complete content of the print version of *Britannica*, and several extra articles, the site provides researchers with fast access to over 72,000 articles and 12,000 images (illustrations, maps, flags, and other pictures). The text is full-length, and sure to fulfill most of your research needs.

Though Britannica Online editors are working with similar data as the fine print version, you'll still find tens of thousands of related Web links that help make this online version even better and more interactive. Further, current topics that an owner of the print version would miss out on are handled with new Web articles on a regular basis. Fantastic.

As you may have guessed, the Britannica Online site is not free. It costs a bit less per month than Electric Library, though you won't get as great a savings if you pay for Britannica by year. Monthly access is \$8.50, with a year in advance costing \$85.

To help you decide, Britannica Online has a sample search page that you can try out. Also, you can sign up for a free trial week of usage.

Members receive a Welcome Kit to

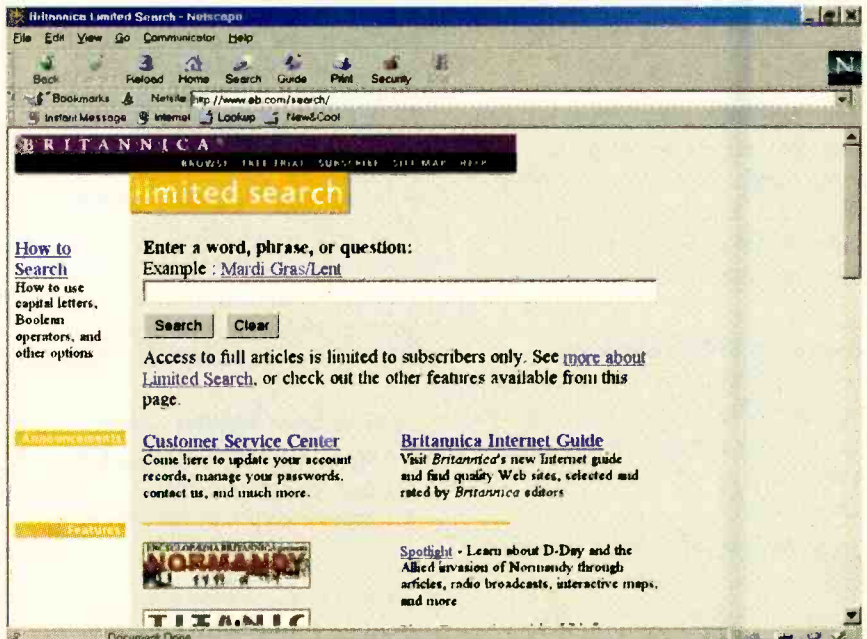

If the name Britannica isn't enough for you to decide on using this premiere pay service, give the system a try with a sample search. While the text data you'll receive is a limited sample of the full articles available, you should get an idea of the power of Britannica Online.

speed up orientation to the site's powerful features, quarterly newsletters to keep up to date, a Britannica Online mousepad, one-click access to the Britannica Internet Guide, periodic e-mail alerts about new features, and even online customer service.

Well, that's all the time we have this month. I hope one of these sites helps you finish that paper or report a little faster. If you've got a comment or question (besides one related to history), please feel free to e-mail me at netwatch@comports.com, or send a good-old USPS letter to **Net Watch, Popular Electronics**, 500 Bi-County Blvd., Farmingdale, NY 11735.

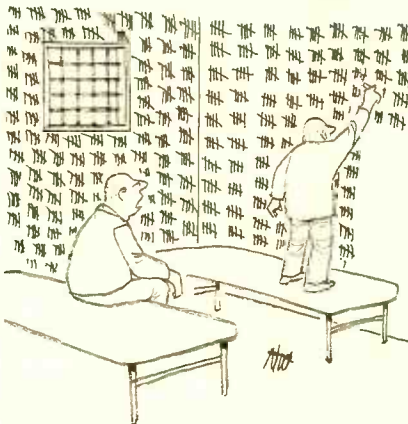

"No good to ignore it, Jake—how are we going to deal with the millennium problem?"



MULTIMEDIA on the PC!

What is Multimedia? What can it do for you? It can do lots of nice things! This 184-page book helps you create your own multimedia presentation.

Multimedia applications by people like you can revolutionize educational and business applications as well as bring more FUN, FUN, FUN into your leisure computer activities.

Mail coupon to:

Electronics Technology Today, Inc.
P.O. Box 240
Massapequa Park, NY 11762-0240

Please send me my copy of *Multimedia on the PC* (PCP120). I enclose a check or money order for **\$18.95** to cover the book's cost and shipping-and-handling expenses. NY state resident must add local sales tax.

Name _____

Address _____

City _____ State _____ Zip _____

All orders must be paid in U.S. funds only. Sorry, no orders accepted outside of USA and Canada. Please allow 6-8 weeks for delivery. MA02

NEW! ELECTRONICS CD ROM

The most effective way of learning electronics

Two Courses on one CD ROM!
Only \$56⁰⁰

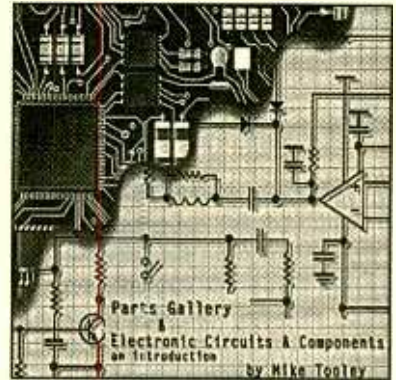

Electronic Circuits and Components

Discover the standards and application of common types of electronic components and how they are used to form complete circuits in **Electronic Circuits and Components**. Sections on the disk include: Fundamental Electronic Theory, Active Components, Passive Components, Analog Circuits and Digital Circuits. The CD ROM includes:

- Interactive laboratories • Supervisor notes
- Full audio commentary • Editable worksheets
- About 20 links to pre-designed Electronics Workbench circuits

The Parts Gallery

Many students have a good understanding of electronic theory but still have difficulty in recognizing the vast number of different types and makes of electronic components. **The Parts Gallery** has been designed to help overcome this problem; it will help students recognize common electronic components and their corresponding symbols in circuit diagrams. This CD ROM incorporates a quiz so that students can check their knowledge of electronic components and symbols. The CD ROM includes:

- Over 150 component and circuit photographs • Supervisors notes
- Self-test Component and Symbol quizzes • Hundreds of electronic symbols

To Be Released Soon!

A series of interactive CD ROMs provides a comprehensive and up-to-date introduction to the world of electronics. The series provides a sound understanding of the principles and behavior of electronic components and the circuits to which they are connected. Two new CD ROM disks are to be released in the very near future. They are **Analog Electronics** and **Digital Electronics**. As soon as they are released, information on their contents and availability will be published.

Claggk Inc., PO Box 4099
Farmingdale NY 11735-0792
e-mail: claggk@poptronix.com



Name _____ Phone _____

Address _____

City _____ State _____ Zip _____

Enclosed is \$56 for each Student version of **The Parts Gallery** and **Electronic Circuits & Components** on a single CD ROM, shipping included inside the U.S. Shipping costs to Canada an additional \$3.00. Overseas orders please contact CLAGGK, Inc. for shipping costs.

I am ordering (....) copies at \$56 each. NY State residents must include sales tax.

I have enclosed my check for \$ _____

Please charge my credit card for \$ _____

Visa MasterCard Discover Expiration Date: ___/___/___

Card Number _____ Signature _____

(Name on order and signature must be same as on Credit Card.)

SCANNER SCENE

A Racy Scanner

MARC SAXON

RadioShack's new PRO-74 handheld scanner is dubbed the *Race Scanner* because the company is specially pointing out its appeal to those who enjoy attending car races and air shows. As you may know, such events brim over with two-way communications. Monitoring adds enormously to the enjoyment and excitement of the sights and ambiance of being there.

The PRO-74 is well-suited to being a Race Scanner because it's lightweight, small, versatile, and covers the frequencies used at various types of racing events. Beyond the fact that it happens to be bred for a day at the races, it is otherwise a rather good basic handheld with excellent frequency coverage and features. You'd find it suited to your needs even if you're only into watching rocking chairs race.

Essentially, the PRO-74 has 100 programmable memory channels set up in 10 banks of 10 channels each. Each bank may be programmed with its own priority channel. The ample frequency range covers 29–54, 137–174, 406–512, 806–956 MHz (less the cellular bands), plus the 108–137-MHz VHF aeronautical band.

The Quic-Track memory feature lets you store a race car's number and any frequencies used by the driver's team into the scanner's memory. You can recall any of those frequencies by entering the car's number. Twelve service banks allow you to search preset frequencies in separate auto racing, marine, aeronautical, military, ham radio, federal, and other banks to make it easy to zero in on specific types of stations. The weather channels are also easily accessed.

The triple-conversion scanner operates at 50 channels/sec., but searches at 100 channels/sec. In Hyperscan mode, it searches at 300 channels/sec. Data Skip allows the unit to ignore non-modulated or data signals during searches, while Search Skip lets you select 20 unwanted frequencies to be skipped during searches.

You can power the PRO-74 by means of alkaline or rechargeable bat-

teries, an external (optional) power supply and charger, or an optional DC automobile adapter. Two antennas are supplied: a standard one for normal scanning and a stubby one for use at the track.



RadioShack's PRO-74 Race Scanner lets you store a race car's number and any frequencies used by the driver's team into the scanner's memory.

FEDERAL TIDBITS

Several readers have recently reported a lot of U.S. Customs activity in south Florida on 164.775 MHz, both scrambled and clear voice. This appears to be a new frequency, and I wonder if it's being monitored elsewhere, too.

For those who are fortunate enough to have a scanner capable of picking up the UHF military aeronautical band (225–400 MHz, AM mode), there are

quite a number of U.S. Customs air surveillance channels reported in use nationally. Here they are, along with their known, possible, or apparent code names: 234.6 (B-5), 238.4 (B-7), 254.2 (B-4), 260.8 (B-2), 282.4/282.425 (B-1), 303.825 (B-2), 336.6 (B-3), 350.45 (A-1G), 353.9 (B-3), 355.9 (B-?), 361.8 (B-9), 381.8 (B-6), and 387.8 MHz (B-8). Note that there is a bit of confusion concerning the code numbers. Also monitor 120.775, 132.95, and 139.70 MHz AM mode and 165.7375 (B-X2) FM mode.

DEA simplex and repeater output channels reported being used on a national basis include 418.615 (Chan. 1, repeaters), 418.90 (Chan. 2, repeaters), 418.75 (Chan. 3, simplex), 418.675 (Chan. 4, simplex), 418.825 (Chan. 5, repeaters), 418.95 (Chan. 6, repeaters), and 418.975 (Chan. 7, repeaters and Chan. 8, simplex). There are usually additional local optional channels in use, as well as special channels used in locations regarded as high-intensity drug-traffic areas. Generally, all DEA repeater outputs and simplex channels tend to lie within the range of 418.00–419.00 MHz.

Speaking of federal-band activity, many of us often tune the 138–144-MHz band. It has been rather active with military units using AM mode on channels established at 25 kHz steps (*i.e.*, 139.20, 139.225, 139.25, *etc.*, MHz).

It now appears that the various military services are re-channelizing and reshuffling this particular slice of the spectrum to reflect a more modern view of communications technology. Fact is, the entire federal band in this area runs from 138–150.8 MHz (except, of course, for the 2-meter amateur band, 144–148 MHz). The federal space is being re-channelized from 25 kHz steps to 12.5 kHz steps. Now, frequencies will be spaced 139.20, 139.2125, 139.225, 139.2375, *etc.*, MHz, just like the 162–174-MHz federal band. Ho boy!

Older 25-kHz capable tactical equipment presently installed in aircraft and ground vehicles will be accommodated

(Continued on page 18)

ANTIQUE Radio

Recapping— The Broad-Spectrum Radio Repair

MARC ELLIS

In the first two installments of "Radio Repair for Dummies," we reviewed the tools, supplies, and reference data that should be on your workbench, even if you are just starting out in radio restoration. We went on to discuss what to look for in carrying out a preliminary inspection of a vintage set, how to partially dismantle it for physical and electrical cleaning, and how to proceed with the cleaning. We looked at strategies for identifying and replacing tubes with burned-out filaments and, finally, made some suggestions for carrying out the initial "smoke test" on your long-disused vintage radio. This is the third and final installment of the series.

HOUSEKEEPING BATTERY SETS

Though our discussion was slanted towards AC (plug-in) sets, much of it also applies to the pre-electric battery radios. Physical and electrical cleaning are even more important in these early receivers, because they've had longer to pick up dirt and corrosion. Keep a special eye on the tube socket contacts. The bayonet-lock (push and turn) sockets are usually not too much of a problem, but some of the older "plug-in" designs don't have good spring tension and will make unreliable electrical connection even if just a little bit dirty. Filament rheostats, lacking the protective housings of more modern controls, are quite susceptible to grime and corrosion.

Pay careful attention to all of the set's headphone and speaker jacks, especially on those 5-tube "3-dialers." In addition to the audio-output contacts, you may find that a jack will incorporate a switch wired to energize the filament of the stage it serves (or de-energize the filament[s] of following stages) when a headphone or speaker is plugged in. This was a means of conserving filament battery power. If you fail to clean the switch contacts or to understand how they function, you may find your-

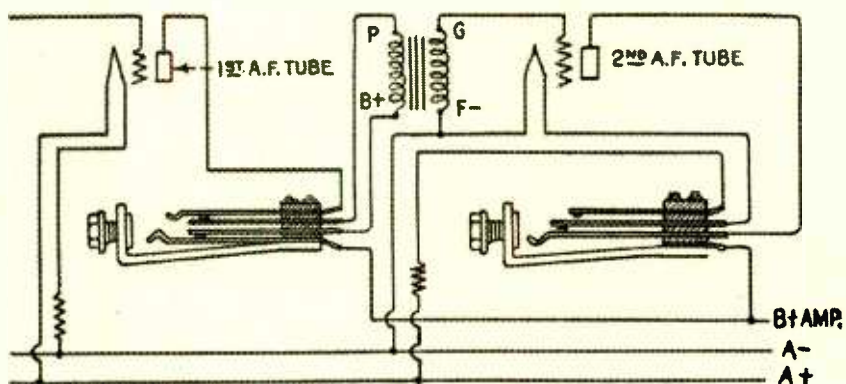

The audio jacks in battery sets often perform switching functions. Don't neglect to clean switch contacts!

self wondering why some of the tubes aren't lighting. Another switch section on the jack might open the primary of the audio transformer coupling to the following stage. Obviously, it too needs to be cleaned to avoid intermittent connections.

During your inspection and testing, pay special attention to the grid leak resistor (a clip-in unit made like a fuse), the audio transformers, and any large (usually 1 μ F) bypass capacitors. The latter are usually housed in flat metal cans. Measure the grid-leak with your multimeter. Chances are you will find that its actual resistance is nowhere near its labeled value. These units are very susceptible to the effects of age and humidity. If you are clever, you may be able to get the resistor apart without breaking the glass and replace the aged element inside with a modern 1/4-watt unit from *RadioShack*. I warn you, though, this is a little like trying to build a ship in a bottle. Most of us butterfingers dolts have to be satisfied with preserving the original unit for the historians and clipping in a "naked" modern resistor to replace it.

The 1- μ F (or whatever) bypass caps won't be any good either. Don't even bother to test them. It's easy to get the cans apart (a little prying with a screwdriver will suffice), clean out the old

insides, and wire in a modern "orange drop" or similar unit of the correct capacity and voltage. The new capacitor should fit easily inside the old case.

You'll also want to test the primary and secondary of all audio transformers for continuity (using the ohmmeter function of your multimeter). These are frequently found open because of corrosion of the fine wire windings or perhaps some past overload. Sometimes repair is possible, but that is beyond the scope of this discussion. Vintage audio transformers show up often in parts bins at radio meets. Just make sure your replacement has good continuity and the proper turns ratio (check the markings on your old unit).

CAPACITOR CONSIDERATIONS

The paper and electrolytic capacitors in a vintage radio are always suspect. The large cylindrical electrolytic caps generally used as power supply filters contain a liquid or paste electrolyte that forms a thin insulating barrier between the two capacitor "plates" (actually two sheets of foil rolled up together). The electrolyte was prone to dry out, even back when the sets were still in use, and cause the cap to open circuit (creating an ungodly hum in the speaker) or short circuit (burning out

other power-supply components). The radio repairmen of the time did a good business replacing them.

The electrolyte requires the presence of an electrical field in order to maintain its insulating qualities. In long-disused sets, the insulation is untrustworthy. That's why suddenly switching on such a set can destroy electrolytics that might otherwise be saved. See last month's column for suggestions for a gradual start-up that can restore ("reform") the electrolyte.

Paper capacitors (also cylindrical, but much smaller than the electrolytics) have a paper insulating barrier rather than an electrolyte and were much more permanent. However, these too are apt to become open or leaky in a generations-old set. The older style (wax seals at the ends and an overall wax coating) is particularly suspect. The later units in plastic housings are more reliable. Mica capacitors have mica insulation between the "plates." They can be identified by their small oblong plastic housings, usually coded with a series of colored dots to indicate capacity, etc. These almost never need replacement.

It is remarkable how well some of the old sets will function with their original caps. However, as I mentioned last month, you should strongly consider replacing all of the paper and electrolytic capacitors in a radio that you plan to use or demonstrate frequently. The capacitors will cost you a few dollars, and you'll have to put in some labor. But when you consider that a shorted capacitor can cause a current surge leading to the failure of hard-to-replace components such as power, IF, or output transformers, cap replacement is pretty cheap insurance. It will also automatically eliminate a lot of problems that a beginning radio restorer might find hard to diagnose.

RECAPPING

Recapping an old set might seem to be quite an ambitious project for a neophyte repair technician, but it is well within your capabilities as long as you are careful and have good soldering skills. The first task will be to acquire the replacement capacitors. Begin by making a list of the caps in your set, writing down the capacity and voltage you'll find marked on each unit. The electrolytic caps can be a special problem because you may find all of them

housed in a single paper or metal cylinder terminating in a spaghetti-like tangle of color-coded leads or a group of coded solder lugs. The capacities and voltages of the individual capacitors within will almost always be marked on the case. List each one separately.



Two styles of multi-section electrolytics. You'll be replacing such caps with equivalent individual units.

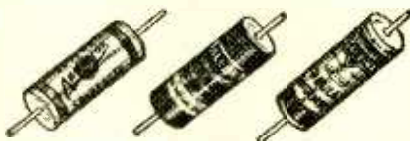

Typical wax-impregnated paper capacitors.

Replacement caps can be obtained from antique radio supply houses (such as *Antique Electronic Supply*, 6221 South Maple Ave., Tempe, AZ 85283) or surplus sources (the ads you find in this issue of **Popular Electronics** should give you some leads). You will not be able to get multi-section electrolytics very easily, at least not fresh stock (a **MUST**). Instead, purchase individual units having the required characteristics. Modern units are small enough that you'll have no trouble getting them all in. You may not be able to match specs exactly, just get the closest available size, making sure that the capacity and voltage ratings are at least as large as the original. I'd advise trying for voltage ratings no more than say 50% of the originals; proper voltage is needed to maintain capacity.

Similarly for the paper caps. Get the closest values you can, and don't be concerned if the capacity is 10 or 20 percent off. The voltage rating should obviously be at least as big as the original. But beyond that it makes no difference how big it is. The mica caps, which you won't be replacing, are usually the critical ones in the radio circuit.

With your new caps on hand, remove the old units one by one, replacing each one as you remove it. This will definitely eliminate confusion that could lead to wiring errors. We'll talk about the paper caps first.

The old ones will very likely have an end marked with a black band and/or labeled "outside foil." The "outside foil" lead was the one connected to the outermost foil of the rolled-up foil/paper "sandwich" comprising the capacitor. It was important to connect this foil to ground (or the circuit point closest to ground) for proper shielding of the capacitor, thus avoiding hum pickup and other undesirable coupling effects. With modern caps, this is a non-issue. Their construction is so compact that there really is no "outside foil" and little danger of coupling. If you find an "outside foil" band, connect it properly—but you probably won't.

A word about wiring. If you are a perfectionist (and many of us are into restoration because we are), you will be tempted to desolder the joints to which the old capacitor leads are connected so you can remove the leads completely and insert the new leads in their place. This practice will almost certainly lead to discolored unsightly joints and the burning or melting of the insulation on the other wires connected to them.

I recommend cutting the capacitor wires, leaving perhaps a quarter-inch stub at each joint. Cut and form the leads of the new capacitor so that they parallel and overlap the stubs when the capacitor is supported in position. If a new lead requires insulating spaghetti, slide that on before final forming. Now, using some means to properly support the cap, solder each lead to the stub that it parallels. (I know that conventional wisdom dictates that any joint be mechanically secure before solder is applied. However, this method produces splices that have more than the necessary strength and are very neat looking.)

Electrolytic capacitors have polarity. You must connect the positive side of a replacement cap to the circuit point where the old positive side was connected. If you are replacing a multi-section cap, you'll have to read the fine print on it very carefully. The can will likely have a couple of filter capacitors with their negative leads joined inside the case and brought out to a single wire or

(Continued on page 18)



Sony ICF-SC1PC Wavehawk PLL Synthesizer Scanning Receiver

Get the full impact of scanning 25–1300 MHz with a little bit of help from your personal computer!

The Sony Wavehawk radio scanner has gone high-tech. Police car chases, forest fires, air traffic, El Nino disturbances, and other calamities can now be tracked through your personal computer (PC) with the Wavehawk scanner. Sony entered the radio-frequency scanner market with a first: a turn-key package that provides controlled access of the airwaves with the click of a mouse. Yes, your computer is used to program the scanner. The Sony Wavehawk scanner eases operation and increases control by placing "search options" in front of your eyes in the form of icons on the computer screen.

The Sony Wavehawk phase-locked-loop synthesized scanning receiver allows users to tailor searches and create custom files for easy access to favorite listening areas. The supplied CD-ROM lists more than 3 million records of FCC-licensed radio frequencies in the United States, including public safety, aviation, marine frequencies, and more.

There are two Wavehawk hot features that this reviewer found invaluable: the 300-channel memory capability and the scanning of all possible frequencies from 25 to 1300 MHz, which are divided into nine bands. Other features of the Wavehawk scanner are easy access to police, air, weather, fire, emergency, marine, FM, and TV-audio; an intelligent, active-memory system; and AM, Narrow-FM, and Wide-FM detection modes.



The Sony ICF-SC1PC Wavehawk PLL Synthesizer Scanning Receiver provides coverage from 25 to 1300 MHz.

The Wavehawk scanner with PC tracking, Model ICF-SC1PC, includes the CD-ROM, interface cable, interface software, snap-on helical antenna, ear plug, and removable belt-holder for \$429.95 MSRP. The second scanner without PC interconnect, Model ICF-SC1, is available for \$329.95 MSRP.

Band Scanning. The receiver divides its frequency range (25.0 MHz to 1300.0 MHz) into 17 factory preset bands with no gaps except for the cellular-phone band, which supports AM, NFM, WFM detection modes in all frequencies. Select the band of frequencies that you want to monitor, adjust the VOLUME and SQUELCH controls, and hit the SCAN button. The band you select may be too broad for your monitoring needs. What you may desire is priority scanning—you select the two frequencies that determine the desired band.

Probably the best scanning selection for a new user are the nine pre-programmed public-service bands with service scanning available at the press of a button. I started with FIRE/EMG and pulled in the local firehouse within a minute. The WX (weather) band came in immediately. The other bands are Police, Marine, Air (VHF), Air (UHF), FM broadcast, TV (VHF sound) and TV (UHF sound). Provision is also made to scan preset frequencies (stations) that may become hot monitoring items for you.

The receiver has intelligent memory scanning, which permits the listener to track down the most active frequencies in a selected band. Up to 300 stations of your choice can be stored. The internal EEPROM retains stored information without backup batteries. Adjustable scanning pause time regulates the scanning period. There is a normal 2-second-delay mode and a 5-second-pause mode, both of which are adjustable. There is a priority scanning feature that checks every 5 seconds to "see" whether there is reception on the priority frequency that you've designated. And if you know the frequency of the station, it can be manually tuned by inputting the digits of the frequency from the numeric keypad as was done in the "old days."

Likewise, the receiver can be programmed to skip selected frequencies during scanning, thus eliminating RTTY, beacons, and undesirable frequencies.

PC Control. Welcome to the world of PC-controlled scanning reception. Your PC and a Sony CD-ROM controls the *ICF-SC1PC Wavehawk* scanning receiver. Through your PC, you can control all major functions of the receiver. Expanded data handling capability allows the user to set up 20 programmable scanning ranges. You can input as many *memory preference* files (300 channels per file) and *skip preference* files (100 frequencies per file) as you want. The import/export capability permits the computer to read data from the receiver to save as a file. Likewise, you can write data from a file of your choice to the receiver—programmable scanning range data, memory preference data, or the skip-frequency data.

If you plan to travel, search for frequencies using the supplied CD-ROM nationwide frequency database, which has over 3 million records. Preset the database search results in the preset memory and use them to scan or to tune. You can also save search results in a file.

The Wavehawk can operate up to 10 hours from a set of four AA alkaline batteries with the squelch open continuously for four hours a day. A low-battery symbol comes on the back-lighted LCD screen recommending battery replacement.

Wrap Up. It is difficult to conceive of additional features built into the Wavehawk scanning receiver. The unit with batteries installed and belt clip attached weighs only 13.5 ounces. The unit's optional accessories include an AC power adapter and car battery cord. Three manuals are supplied with the scanner. One is for receiver operation without a personal computer tie-in. The second covers operation with a personal computer. The last is a handbook listing stations throughout the United States. The latter serves as an excellent beginner's guide for finding frequencies with traffic. If you got the scratch, satisfy the itch by picking up a Wavehawk scanning receiver. Information can be obtained by circling no. 120 on the Free Information Card, or contacting Sony at 800-222-SONY; Web: www.sel.sony.com/sel/consumer/ss5/radioclockradio/scanners/index.html. ■

SCANNER SCENE

(continued from page 14)

to continue operating on new frequency assignments according to their existing capabilities. Two 1.5 MHz segments are being converted to non-governmental (FCC jurisdiction) purposes.

In the 138–144-MHz band, there will be established a 30-channel (60-frequency) trunking plan for the use of federal stations. Specific frequencies in the 138–150.9-MHz band will be designated for particular military missions, such as security, fire, commander, transportation, etc.

Certain frequencies will be designated nationwide for military emergency use (one repeater pair, plus one talk-around). Additional repeater pairs and simplex channels will be designated for intercommunication between military, FEMA, law enforcement (state, county, local), fire, and various other public service agencies during any nationwide emergency. These would be for mutual aid and assistance purposes only, and they would not be authorized for normal daily use.

MARS and CAP operations in this frequency range are (for the time being) not expected to be disrupted or modified. These anticipated changes will *not* affect the 144-MHz amateur band. As this plan progresses, we will watch for additional information.

HOLD THE HASH

Randy, from Nevada, asks about a common problem. He monitors his scanner a lot, but he finds that when he tries to use his computer simultaneously, the scanner locks-up on many frequencies. Despite FCC requirements that computers shouldn't generate RF, most transmit enough to mess up nearby scanners operating below about 400 MHz. Try moving the computer away from the scanner.

Keep in touch with us! Our e-mail address is: Sigintt@aol.com. Our snail mail address is *Scanner Scene*, Popular Electronics, 500 Bi-County Blvd., Farmingdale, NY 11735. ■

ANTIQUE RADIO

(continued from page 16)

terminal. The positive leads, however, will be brought out separately. It may also have an audio bypass unit with completely separate and independent positive and negative leads. Just be sure you know which wire or terminal is which and connect your replacement caps in the proper configuration.

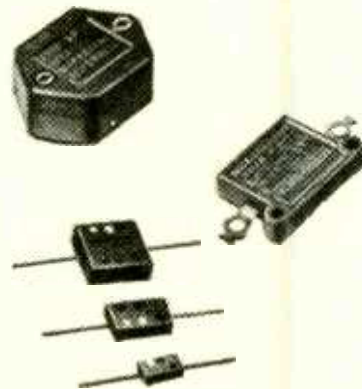

Mica caps like these rarely need replacement.

If you are replacing a multi-section can mounted on top of the chassis, you will want to leave it in place to preserve the original appearance after it is disconnected. You may need to install terminal strips under the chassis to support the individual electrolytics you are adding—but modern units are so small and light that this may not be necessary.

Speaking of preserving original appearance, many restorers like to melt out the insides of the old wax paper capacitors (easy, I understand, if you know how), slide in a replacement modern cap, and reseal the whole thing with new wax. I've never done this, but if someone will send me their favorite method I'll mention it in a future column. Even if you don't go that far, it would be a thoughtful touch to save the original caps in a plastic bag. Include a note indicating that this is the original set, and tape your "time capsule" somewhere inside the cabinet. That's it for this month. See you in the next issue! ■

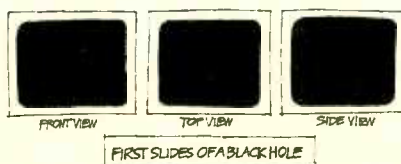

J. Page

Times Are Tough...



Today's headlines scream of the lack of qualified individuals to fill new and existing high-tech job openings. If you feel the robust economy is passing you by, there is something you can do about it. **Become CIE Qualified.** Since 1934, The Cleveland Institute of Electronics has been providing its students with the necessary technical and academic credentials employers are seeking. In fact, CIE was started in 1934 to fill a similar void in the radio/television industry.

Since then, CIE boasts of over 150,000 worldwide graduates who have benefited from a patented, independent-study program that lets the student complete a Career Course, Associate Degree program, or through our affiliate school

World College, a Bachelor Degree program.

If you are currently "under-employed" and want to increase your level of income, the most proven method is an education. With CIE's independent-study program you study when and where you wish with no time constraints on how quickly you can proceed. And though it is an independent-study program you have the full support of the faculty and staff at CIE's Cleveland Campus.

To discover all the Benefits, Career Courses and Degree Programs available from CIE send for your Free Course Catalog Today!

The Cleveland Institute of Electronics has been approved for the training of eligible veterans and active duty military service members, under the G.I. Bill.

Military tuition assistance (Up-Front and Basic) is also available under the DANTES Distance Learning Program.

...For Employers



BUSINESS NEWS
Employers Searching For
Qualified Candidates

F R E E C A T A L O G



Cleveland Institute of Electronics
1776 E. 17th Street
Cleveland, Ohio 44114-3679
Visit Our Web-Site: www.cie-wc.edu

*A School of Thousands.
A Class of One. Since 1934.*

YES! Please send me a catalog. AH128

Name: _____

Address: _____

City: _____ State: _____ Zip: _____

Phone Number: _____

Check Box for a Bulletin on Military Education Benefits:

VA Benefits DANTES Benefits

GIZMO

PC MOVIE MACHINE

PC CINEMA DVD PLAYER AND INTERNET PC. From TigerDirect, Inc., 8700 West Flagler Street, Miami, FL 33174; Tel. 888-762-5881; Web: www.pccinema.com. Prices: \$950 for 200-MHz processor with 2.5-GB hard drive, \$1100 for a 233-MHz processor with 4.33-GB hard drive, and \$1200 for 300-MHz processor with 4.33-GB hard drive.

Do you have to take a number to get a turn using the home computer that you bought to simplify home finances, check your e-mail, and catch up on office work? Do you have to wait while the kids research term papers, check their e-mail, and play games? While your wife catches up on her office work, checks her e-mail, and enters each family member's schedule into the PIM?

Could it actually be time to spring for a *second* home PC?

A lot of people are finding that to be the case. One computer just isn't enough to meet the demands of today's busy families—especially once they get a taste of surfing the 'Net.

If you think your family is nearing the two-PC point, there are a few questions to ask yourself before you go out and buy a new machine. Of course, there are the usual specs—processor power, memory, modem speed, and the like—to consider. But you might also want to ask where the second computer will go, how much interest your family has in DVD, and whether you've considered buying a set-top Internet access device such as WebTV.

DVD? WebTV? What do they have to do with anything?, you might ask. Actually, quite a bit. In fact, your answers to those DVD and WebTV questions might just decide what PC you'll buy and what room you'll put it in.

Anyone who is seriously considering the purchase of a second PC, and/or a set-top web-browsing device, and whose wish list includes a DVD player, too, should take a close look at the *PC Cinema* from Tiger Direct. Designed from the ground up as an "entertainment appliance" that belongs in the living room (or whatever room holds your TV and stereo gear), *not* in the

search, homework, banking, and other such tasks. But, they say, if you do need a second PC, make it a *PC Cinema*, and put it in your entertainment center, right between your TV and your stereo receiver. In one fell swoop, you'll have upgraded your home-theater setup to include DVD and provide full Internet access via your TV. Use *PC Cinema* to watch films, to play games using your TV as a monitor and your stereo to boost the sound, to play audio CDs, or to surf the 'Net with the whole family, checking out vacation destinations or any of the many family-oriented sites available.

PC Cinema doesn't resemble any other PC we've had the pleasure of knowing. Self-contained in a 16.75- × 16.75- × 6-inch matte-black case that should fit in most entertainment racks, it looks like an oversized audio or video component. The Airboard keyboard is a wireless affair that offers, in addition to the standard alphanumeric and function keys,



a row of "hot keys." Some can be programmed to launch your favorite *Windows 95* applications; others offer quick access to the *Windows 95* desktop, DVD, and Internet functions. The remaining ones are used to activate DVD/CD controls (play, pause, fast forward, etc.), adjust the volume of *Windows 95*-generated sounds, and access on-screen menus. The Airboard also has a pressure-sensitive joystick-like control with right and left buttons analogous to those on a standard mouse and a drag button that acts like a click-and-hold mouse button.

Ho, hum. We've heard all about these so-called convergence products before, and no one's buying. As far as the American consumer is concerned, the PC belongs in the study and the TV in the living room, and never the twain shall meet.

The people at *TigerDirect* agree wholeheartedly with the first part of that statement, and disagree just as vigorously with the latter. Yes, you should have a PC in your den, completely separate from your TV and stereo. You need it there for work, writing, re-

search, homework, banking, and other such tasks. But, they say, if you do need a second PC, make it a *PC Cinema*, and put it in your entertainment center, right between your TV and your stereo receiver. In one fell swoop, you'll have upgraded your home-theater setup to include DVD and provide full Internet access via your TV. Use *PC Cinema* to watch films, to play games using your TV as a monitor and your stereo to boost the sound, to play audio CDs, or to surf the 'Net with the whole family, checking out vacation destinations or any of the many family-oriented sites available.

The remote control that is also part of the *PC Cinema* package mimics the controls on the keyboard, right

GIZMO



The Airboard keyboard provides wireless remote control of PC, DVD, and Internet functions.

down to the user-programmable buttons. It is not a universal remote, however, and it can't be programmed to switch sources or control any other A/V devices.

No monitor is included, because you're supposed to connect the *PC Cinema* to your (preferably large-screen) TV via the rear-panel composite and S-video connectors. A VGA port allows you to hook up a computer monitor, if desired, in addition to the TV. Dual screens could come in handy if you wanted to indulge in an extended bout of 'Net surfing while others wanted to watch TV. It's also much easier to read computer text on an SVGA monitor than on an NTSC TV screen, and much more pleasant to watch a DVD film on a TV than on a computer monitor. During most of our tests, however, the TV image was acceptable. One nice feature offered by the *PC Cinema* is the ability to zoom in on any part of the screen, allowing you to read small text from across the room.

The manual offers a number of different setup scenarios, depending on the nature of your existing A/V and computer components. And the *PC Cinema* offers every imaginable input/output to accommodate them. Besides the S-video, composite video, and VGA outputs, there's an S/PDIF audio port for Dolby Digital surround sound; two serial ports; keyboard,

Gizmo is published by Gernsback Publications, Inc., 500 Bi-County Blvd., Farmingdale, NY 11735. Senior Writers: Christopher Scott and Teri Scaduto. Copyright 1998 by Gernsback Publications, Inc. Gizmo is a registered trademark. All rights reserved.

mouse, and joystick ports; a 25-pin printer port;

PC audio input; modem-and telephone-line jacks; one infrared port; and even two Universal Serial Bus (USB) ports. *Tiger-Direct* also included stereo audio, composite video, S-video, and digital coaxial cables, plus a game-port extension cable.

To allow for easy PC upgrades and to accommodate future technologies such as HDTV, the company took a piece-by-piece approach to assembling the *PC Cinema's* inner workings—the modem, sound card, MPEG-2 decoder, and video cards are separate entities. The Atx motherboard has 32 megabytes of EDO RAM, easily upgradable to 512 MB, and two expansion slots are available.

In keeping with its "entertainment appliance" description, the *PC Cinema* is so much easier to get to know than a typical PC—primarily because there's no need to familiarize yourself with the suite of software applications typically bundled with a PC or to connect all those peripherals. The *PC Cinema* comes with *Windows 95*, *Microsoft Explorer for Windows 95*, and DVD control software.

The complexity of your installation depends on how many PC peripherals and programs and A/V components you want to include. But we're going to examine the *PC Cinema* in its intended role, as DVD playback/web-browsing device. For that, you'll need to connect the *PC Cinema* to your TV and receiver. You'll get the most out of the unit by using a receiver that's equipped with a Dolby Digital decoder, and by using the SVGA/RGB output to hook up an LCD projector, but a standard TV and stereo will do. For Internet access, you'll need to connect the modem to a phone line,

and sign up with an Internet Service Provider (ISP).

The main *PC Cinema* menu offers three options: DVD, Internet, and Desktop (*Windows 95*). If a DVD disc is already loaded in the tray, selecting the DVD option (or clicking on the DVD icon on the *Windows 95* Desktop) automatically begins playback within an on-screen box, which changes to a full-screen display in a few seconds. Double-clicking anywhere within the playback area switches back and forth between box and full-screen display.

For the most part, you'll want to view a film in full-screen mode. But when you need to see the controls, moving the cursor to the bottom of the full-screen picture will bring them back. Those controls allow you to select specific chapters of a movie, increase or decrease the volume, pause or stop play, and access multiple soundtracks, subtitles, and camera angles, if available on the disc. Clicking on the keypad icon brings up a floating numeric keypad that can be used to directly access specific chapters of a movie.

The *PC Cinema* offers all of the special features you'd expect to see on a good DVD player. Segment play,

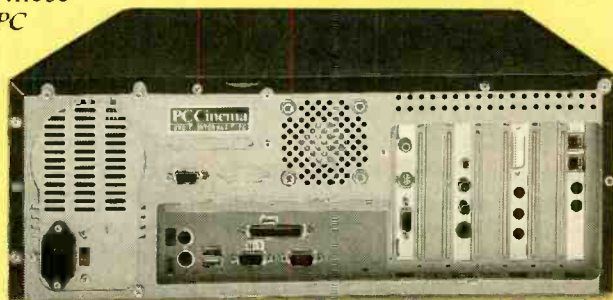

The *PC Cinema's* rear panel hosts a multitude of video, audio, and PC terminals.

for instance, allows you to replay repeatedly a favorite scene from a movie, while slow motion allows you to slow playback to 1/2 or 1/8 the normal speed.

There are also some PC-style features unique to the *PC Cinema*. Instead of relying on the typical on-screen menus to change audio and video settings, the *PC Cinema's* DVD Station Options screen, for instance, offers

Windows-style configuration settings. The Settings folder, for example, lets you enable Dolby Digital output (assuming your receiver has an AC3 decoder, that is), or disable it for stereo audio output. It's also used to display pop-up help tips, change the aspect ratio, enable and disable *Windows 95* AutoPlay, and to keep the movie window on top of all other windows. The DVD file contains additional setting options, including parental lockout, password, display mode, and default language.

Those PC-type screens might be a bit off-putting to the complete computer novice. And, like any other PC, the *PC Cinema* is subject to those annoying little glitches and mood changes—which can really throw you for a loop when all you want to do is watch a movie. Technophobes might be intimidated and would find a standard DVD player easier to use.

The wireless keyboard and remote control took a little getting used to. But once we got a handle on them, the only real drawback was that the remote control can't be used to adjust or mute the volume when Dolby Digital output is selected; the volume control does work with the stereo output, however.

We were unable to detect any difference in DVD video or audio quality between the *PC Cinema* and the standard DVD decks we've used—and that was without using the *PC Cinema*'s built-in line doubler, which requires the use of a VGA projector or a really big-screen VGA monitor. For computer applications, the S-video output was better than we expected. Although it's not something that we'd like to stare at for hours doing work, for browsing the web and reading or creating an occasional e-mail, it was just fine.

The DVD drive can also be used to play audio CDs and CD-ROM software—including PC games. There's a lot to be said for game playing on a large screen, with the soundtrack thumping through your stereo speakers, rather than little PC speakers. The *PC Cinema* can also play back DVD PC games, which should start appearing in stores later this year—perhaps by the time you read this.

We're not sure America is ready for convergence. But the *PC Cinema* proves that at least one manufacturer is ready with a product that really can meet a family's computing and entertainment needs. *PC Cinema* packs a lot of bang for the bucks, providing Internet access, DVD video, and a full-fledged PC for just about \$1000. It looks right at home in an entertainment center, and it's not at all intimidating to use if you have even a modicum of PC experience.

Just be forewarned: If your family already spends as much time arguing over what to watch on TV as they do over who gets to use the PC first, adding a *PC Cinema* to the mix might just exacerbate the problems!

The Art of Speakers

GEKKO FLAT-PANEL SPEAKERS. From NCT Audio Products, Inc., (a subsidiary of Noise Cancellation Technologies, Inc.), One Dock Street, Suite 300, Stamford, CT 06902; Tel. 800-278-3526 or 203-961-0500; Fax: 203-348-4106; Web: www.nct-active.com. Price: \$299 each.

There's an on-going battle in many of our friends' homes and, yes, it breaks down along gender lines. He wants big speakers in the living room; she doesn't want big boxes ruining the aesthetics of the carefully arranged room. We've seen many creative compromises over the years—ranging from speakers hidden in baskets of dried flowers to separate listening rooms set up in basements—and even more technological solutions, mostly in the form of ever-smaller enclosures and inside-the-wall speakers.

But the most innovative—both creatively and technologically—option we've seen is NCT's *Gekko* flat-panel speaker. It's only about two inches deep, and comes in standard picture

and poster sizes (9 × 11, 11 × 14, and 18 × 24 inches). That unique configuration makes it a good candidate for unobtrusive wall mounting. But you (and your spouse) will probably want this speaker to be seen as well as heard. That's because you can replace the plain black grille cloth with one of hundreds of printed replacement grilles that will be available in the "ArtGekko Collection." Next, frame your speaker art with your choice of custom picture frames, and your guests won't be able to guess where the music's coming from. (What? "Whistler's Mother" singing "Material Girl"?)

We tested the 11- × 14-inch speakers (model GK-1114), which were the only ones available when we went to press in early summer. Over the next few months (probably by the time you read this), 9- × 11- and 18- × 24-inch sizes will hit the market. Included for our viewing pleasure (though not normally part of the package) were two very different grille covers: a sepia-toned photo of the Beatles, and a Van Gogh painting titled "Cafe Terrace."

There is a print to meet just about every taste and style. They range from the corny (a tinted, vintage-look photo of children and flowers, a "photomosaic" picture of Princess Di) to the classic (Boticelli's "Venus on the Half Shell,"

Monet's "Waterlilies"), from nature photos of

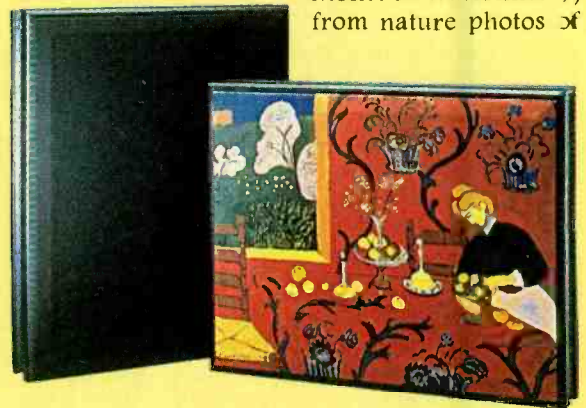

animals or flowers to campy conversation pieces (covers of pulp-fiction paperbacks like *Revolt of the Triffids* or *Fever Hot!*) from antique world maps to contemporary art posters. Although it wasn't up and running as we went to press, by now you should be able to browse the

GIZMO

ArtGekko Web gallery at www.artgekko.com.

There are 14 different colors and styles of frames available as well. Frame choices include simple polished wood in blond, natural, cherry, maple, oak, walnut, and black, along with more ornate styles finished in gold, pewter, and various wood stains. Pricing for the grille covers starts at about \$60, depending on the type of print and frame you choose.

The Gekko speaker is shown on the right in its natural state and on the left camouflaged as a Van Gogh print.

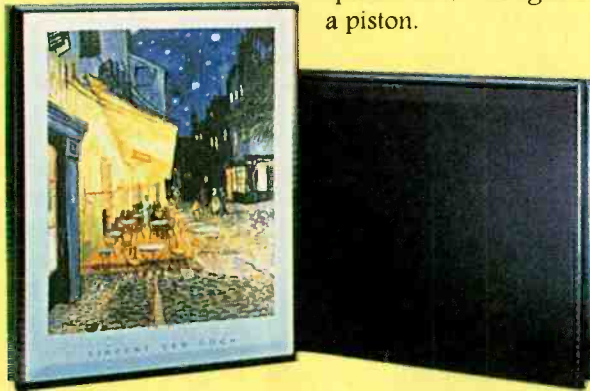

Of course, these are not oil paintings rendered on canvas, or photographs printed on high-quality paper. Printed on acoustically transparent fabric panels, the images will not be mistaken for originals (or even good reproductions) from up close. But they're made to hang in a living room, not a museum, and to be glanced at, not scrutinized. Hanging on a wall, attractively framed, they can make a nice visual addition to just about any room.

They also make a tremendous aural contribution. The *Gekko Flat-Panel* speakers are, first and foremost, meant to be heard. Their unusual configuration is not just a gimmick that allows them to be camouflaged with art prints. The *Gekko* speakers actually do represent some significant new technologies.

They use *Noise Cancellation Technologies'* proprietary "flat-panel transducer technology," consisting of a four-inch mid-range woofer that's fairly typical except for its extra-shallow basket, teamed with a high-frequency "tweeter" that actually puts the whole front baffle panel to work handling the upper frequencies (above 2500 Hz). Basic specifications include a handling capability of 50 watts rms, 150 watts peak; a bandwidth of 100 Hz to 15 kHz; and a nominal impedance of 4 ohms.

The computer-designed and tweak-

ed front baffle (the cabinet front) is a panel of resonant material that's about 1/8-inch thick. Its inner surface is home to several piezo-electric transducers that excite the panel, causing it to vibrate at dozens of different points (modal vibration), each of which resonates at a different frequency. Traditional speaker design, conversely, strives to avoid modal vibration at all costs, seeking instead to achieve coherent motion, with the speaker cone acting like a piston.

The uniquely styled *Gekko* driver delivers what *NCT* has dubbed "Sweet Space" dispersion. The antithesis of the "sweet spot" delivered by conventional speakers, Sweet Space refers to the *Gekko's* broad dispersion pattern, which evenly delivers the sound throughout a room. True enough, the *Gekko* speakers have a broad sonic image, because the flat panel "tweeter" doesn't radiate the same way that a cone driver does. Its output drops off linearly (rather than a factor of the inverse square of the distance). That means that the high-frequency output retains its loudness over a longer distance than that produced by ordinary speakers, and most stereo cues are found in the high-frequency signal.

The *Gekko* speakers come with an easy-to-use wall-mounting kit, including hardware (nails and rubber "feet") and a template for marking where the holes will go. The adhesive-backed feet, which should be attached to each corner of the back of the speaker frame, allow enough space to snake a wire up behind the frame and, supposedly (although it wasn't apparent to our ears), they improve the sound quality by preventing the speakers from rest-

ing flush against the wall. *NCT* offers a special, adhesive-backed, flat speaker wire as an option. Approximately 1 mm thick, it can be painted, spackled, or wall-papered. It comes in 16- and 30-foot lengths, with terminal blocks to attach it to conventional wire.

To add an ArtGekko print to the *Gekko* speakers, you simply pop off the original grille using a dull tool such as a butter knife or a nail file. Then press the replacement grille into place, where it will be held securely by magnets. The ArtGekko grille can be cleaned with a vacuum cleaner held a few inches from its surface.

We hung the two *Gekko* speakers in the living room. They both looked all right in our rather eclectically decorated room—good enough as to be virtually invisible!

Frankly, we expected the sound to be "invisible" too. Well, we were wrong. The *Gekko's* signature Sweet Space results in an exceptionally broad sound stage that added increased depth when listening to music with full, complex orchestrations. It would also be pleasing in home-theater applications, where the sense of spaciousness would enhance the surround-sound effect. Although supplied with just two *Gekko* speakers, we auditioned them in their stereo-listening mode. The speakers provided good definition, with none of the mid-bass boominess that we expected.

What was lacking, especially when listening to rock music (and, we'd imagine, action-film soundtracks), was bass output. The laws of physics being what they are, it's just not possible to get loud, deep bass out of a little woofer in a little enclosure. That shortcoming can be remedied, however, with the addition of the GK-SW10 subwoofer.

Available separately at a cost of about \$500, the subwoofer is acoustically matched to the *Gekko* flat speakers. No, it doesn't come with any artwork, but the approximately 12-inch square box can be easily tucked out of sight under a coffee table or behind a couch.

Add to the original two speakers and subwoofer three more *Gekkos* to serve as left, right, and center channels—the

smaller size would serve just fine—and you'll probably end up with a fine home-theater speaker system. True, you could undoubtedly buy a better performing system for the \$2000 it would cost. But if the way your home looks is as important to you as the way your music sounds, *Gekko* is the way to go. The *Gekko* is a chameleon at heart, changing itself to blend in with its—and your—surroundings.



ArtGekko prints snap easily into place. Behind the artful grille cloth, the mid-range woofer can be seen in the lower-left corner.



Rockin' Chair

INTENSOR GAMING CHAIR. From BSG Laboratories, Inc., 638 Harrison Avenue, 3rd Floor, Panama City, FL 32401; Tel. 800-BSG-LABS; Web: www.intensor.com. Price: \$300-\$600, depending upon optional accessories.

Serious gamers like to lose themselves in the action, to become one with their favorite video (or computer) game. But virtual reality is, for the most part, still a dream. The best we can do today is to connect our gaming consoles to a home-theater setup (or plug good speakers into our PCs), use a joystick that provides sensory feedback, and plant our chair directly in front of the PC or TV.

Or is that the best?

BSG Labs doesn't think so—unless that chair happens to be its *Intensor* video-gaming chair, with its built-in sound/tactile feedback system that shakes, rattles, and rolls the player. The chair is compatible with all video-

game systems past and current, including the *Sony PlayStation* and *Nintendo 64*, and with all PC games. It can also be used with home-theater gear, to enhance the user's enjoyment of music and video soundtracks.

The *Intensor* itself is a folding "chair shell" (think clamshell). In its closed position, it stands upright on tiny legs for space-saving storage. A handle on top makes it easier to lug the 20-pound unit around. The molded black plastic seat/seat back comes in one hinged piece, both parts cushioned in purple.

Five speakers are built into the *Intensor*. On the top of the seat back, just behind your head, is a rear

high-frequency transducer, said to "enhance psycho-acoustic effects by creating a unique sense of spatiality." In the center of the seat (between your legs when seated) is a full-frequency center channel speaker. Left and right mid-frequency transducers extend from either side of the seat. Hidden beneath the seat cushion is a low-frequency speaker that vibrates to let you feel the sound, even if you're listening through headphones (which can be plugged into a



jack on the side of the seat.) Control knobs located next to the center speaker allow you to adjust the volume and the tactile intensity.

The power unit is a separate affair, a 10¹/₂" × 11¹/₄" × 3¹/₂"-inch box with a 9-foot connector cord that plugs into the front of the *Intensor* seat. RCA cables are included for connecting the power unit to the audio output of a game console, PC sound card, VCR, DVD, CD player, or stereo receiver. The power unit also has a variable mono output for an external subwoofer, which is available as an option.

Another option is the chair base accessory kit, consisting of a heavy-duty attachment mechanism, unpadded molded-plastic arms, and "legs" (a five-spoke piece with casters) that extend from a center pedestal. The chair base turns the *Intensor* into a good quality office chair, complete with hydraulic height adjuster and an adjustable tilt mechanism.

The *Intensor* looks fine in front of a desk, but if you plan to use it in your living room, you will probably want to opt for its portable configuration. Unless you have a penchant for purple, this souped-up desk chair will surely clash with the rest of your furnishings.

What it lacks in style, the *Intensor* makes up in ergonomics, and that can be an important consideration if the game player is no longer a teen. All those hours spent sitting in one position, joystick clutched firmly in hand, can take a toll on all but the youngest, most limber spines. Of course, if you're not that limber, getting in and out of the legless *Intensor* could present a bit of a problem, too.

We first tried the *Intensor* in its no-frills configuration, without the subwoofer or chair-base accessories. We plugged it into our *Nintendo 64*, sat down, and picked up

GIZMO

the joystick. With our feet planted firmly on the ground, the *Intensor* tilted back at a nice angle for viewing, even though our TV is mounted 40 inches up from the floor. Comfortably ensconced, we turned up the volume, adjusted the tactile intensity, and started to get into a rip-roaring game of flight simulator. Surrounded by engine noise, feeling the plane shaking and rattling in response to our commands, we really got into it. When we pulled back hard on the joystick to pull the nose up out of a dive, we also leaned back far into the seat ... and toppled over, landing like a turtle on its back! We propped the *Intensor* up against a leg of the coffee table and had no more mishaps.

Next, we tried using the *Intensor* when watching a movie. Our home theater is equipped with Dolby Digital surround sound decoding and all the necessary speakers, so the *Intensor* really couldn't compete with the sound. In fact, we turned down the *Intensor's* volume completely, preferring our own speakers, and hoped to just enjoy the *Intensor's* tactile sensations while watching *Twister* on DVD. The body-thumping motion appears to be triggered by the ear-thumping sound and, at least on our pre-production test unit, cannot be used separately.

Adding the subwoofer further boosted the sound/sensation experience. The IGS 100 *Intensor* Multi-Media subwoofer is a cube measuring about 10 inches on each side; it's sized perfectly to serve as a pedestal for the power unit. The subwoofer and the chair's built-in speakers are sonically matched for optimal performance. The subwoofer features dual 5.25-inch bass drivers with a tuned-port enclosure, can handle 40 watts rms at 8 ohms, and offers level and variable cross-over controls.

Finally, we toted the entire *Intensor* upstairs to our office—a much more likely home for it. Here, we have a couple of PCs as well as a small TV (with built-in speakers) and a VCR. Add a *Nintendo 64*, subtract a PC, and we'd imagine it's pretty close to what you'd find in many a teenage boy's bedroom. In such a bare-bones setup,

the *Intensor* made a tremendous difference in the viewing experience for both games and movies. The sound envelops you, and the vibrations make you feel as if you're in the midst of the on-screen action. It's difficult to localize the sounds; you really do feel surrounded. You can feel a punch landing, a ship exploding, an engine throbbing. The same goes for movie-watching—feeling the action adds a whole new dimension to the video experience.

BSG claims that the *Intensor* “generates a new audio sound field—the open-air headphone—very different from stereo.” That's an apt description. Rather than directing the sound at you from a pair of speakers at the front of the room, the sound comes at you from all sides. It's also different from surround sound in that the sound is up close and personal, and is accompanied by those neat tactile sensations.

Finally, we added the arms and base so that we could use the *Intensor* at our desk. In its full-size chair configuration, the *Intensor* is quite comfortable for folks of average height or above. The seat is much deeper than that of a standard office chair, however, meaning that anyone under five-foot-three won't be able to bend their legs at the knees when seated! (The spread-leg position required to straddle the center speaker can be awkward for women in skirts, too.)

We used the *Intensor* not only for playing PC games—with the same live-action feel as with the Nintendo games—but also for listening to CDs. The *Intensor* represented a significant improvement over the desktop speakers we've been using, and had the added bonus of being a lot more comfortable during extended work (or game-playing, or Web surfing) sessions.

If your gaming and video viewing are confined to a dorm room or a room that's equipped with only a TV,

The fully-loaded *Intensor*, accessorized with optional subwoofer and chair-base.



VCR, and videogame console, the *Intensor* would be an excellent addition to your setup.

Of course, \$300 is pretty steep for a portable seat that delivers pseudo-surround sound and tactile sensations in game playing. But if you truly crave the ultimate in gaming, if nothing less than total sensory immersion will do, then treat yourself to the *Intensor*. You'll love it.

Complete Communications

UNIDEN BEARCAT BC235XLT TRUNK TRACKING SCANNER. Manufactured by Uniden America Corp., 4700 Amon Carter Blvd., Fort Worth, TX 76155. Tel. 800-297-1023; Web: www.uniden.com. List price: \$499.95. Street price: Under \$300.

When police departments and other government agencies, as well as

public-safety users, switched over to trunked radio systems, it seemed like a plot against scanner enthusiasts. It was no longer possible to hear complete conversations because every response could be on a new frequency. In reality, trunking was a "plot" against the limitations of finite spectrum.

Trunked radio systems work something like the cellular telephone system. A data channel sends information to all radios on the system so they know where to tune to hear the next transmission. With trunking, many more users can use the same number of frequencies. For example, it might be inefficient for your town's water department to have its own frequencies—its total communication time per day might be 30 minutes. But trunking allows the water department to share its frequencies with the county bus system and parks department—all without interference, and without even knowing that the frequencies are being "reused."

Uniden's BC235XLT is the first consumer scanner that can follow conversations in trunked radio systems. It works only on 800-MHz systems, and only those manufactured by Motorola. Even with those limitations, however, it's a major step forward.

The scanner measures about 6 inches tall, 2¼ inches wide, and 1½ inches deep. On the top are volume and squelch controls, an antenna connector, and a mini jack for headphones. The front face has the speaker, an LCD, and a 24-button keypad. The left side panel has a jack for connecting to external power. The rear panel of the scanner has a battery compartment and two threaded receptacles to accept a belt clip. The BC235XLT is supplied with an AC adapter/battery charger and two nickel-cadmium batteries.

Frequency coverage starts at 29 MHz and extends to 956 MHz in twelve bands. First is the 10-meter ham band from 29.0 to 29.7 MHz. Coverage is continuous up to 54 MHz, which includes the VHF low band and the 6-meter ham band (50 to 54 MHz). Coverage picks up again just above the FM band at 108 MHz and extends continuously up to 174 MHz.

That takes in aircraft frequencies (108 to 137 MHz), military frequencies (137 to 144 MHz), the 2-meter ham band (144 to 148 MHz), and the VHF high band (148-174 MHz). The scanner then jumps to cover 406 to 512 MHz continuously, taking in frequencies used by the federal government (406 to 420 MHz), the 70-cm ham band (420 to 450 MHz), the UHF band (450 to 470 MHz), and the T band (470 to 512 MHz). Finally, the scanner jumps to the 800-MHz band, covering from 806 to 956 MHz, excluding—as required by law—those frequencies used by cellular telephone systems.

The AM and NFM (narrow-band FM) reception modes are determined automatically by frequency and cannot be overridden. The size of the frequency step used when searching for new stations is also determined by frequency. A data-skip mode lets the scanner jump over data signals or constant tones.

The scanner features a memory of 300 frequencies, broken into 10 memory banks. In the normal scan mode, any number of banks can be active. Hitting one of the numerical keypad buttons (1 through 0) while in the scan mode toggles the associated bank between its active and inactive modes. Each numerical button has the associated memory locations printed on top of it. For example, the 1 key has "1-30" on top, the number 2 key has "31-60" printed on top, and so on.

In practice, this proved to be convenient. Quite a bit of our scanning was done during our daily commute on the Long Island Rail Road (LIRR) which took us through Nassau and Suffolk Counties on Long Island and into New York City. So we set one bank to cover frequencies used by the Suffolk County police and other emergency departments, another to cover Nassau

County's, and a third to cover frequencies used by the NYPD. Another bank was for frequencies used by the LIRR and by the New York City subway trains.

To many *Gizmo* readers, scanning might seem like an odd way to pass the time, especially since recent stories in the mass media have made a scannist seem like little more than an audio Peeping Tom. But in reality, scanning is an excellent way for citizens to learn how things work.

Typically, we set our scanner to receive the LIRR/transit frequencies and the police/fire/emergency frequencies of the county we were in. As we crossed county lines, we could include its scan bank in our listening with the touch of a button. Some days, when we were reading or not interested in hearing police activity, we could just keep the LIRR frequencies so we could be alerted to any potential problems that could occur during our commute.

So what did we hear and what did we learn? First example: We're on an express train heading into the city.

The train is, incidentally, two cars shorter than normal, so it's pretty crowded. By listening to the scanner, I understand that another train on another line is disabled, and our train is being ordered to make five unscheduled stops to pick up passengers. The conductor on our train knows that we're already reasonably crowded, and informs the control tower that we're running two cars short. No matter, we're going to make the stops.

I mutter something to the guy sitting next to me, and he says in astonishment, "How do you know?" "I'm listening to

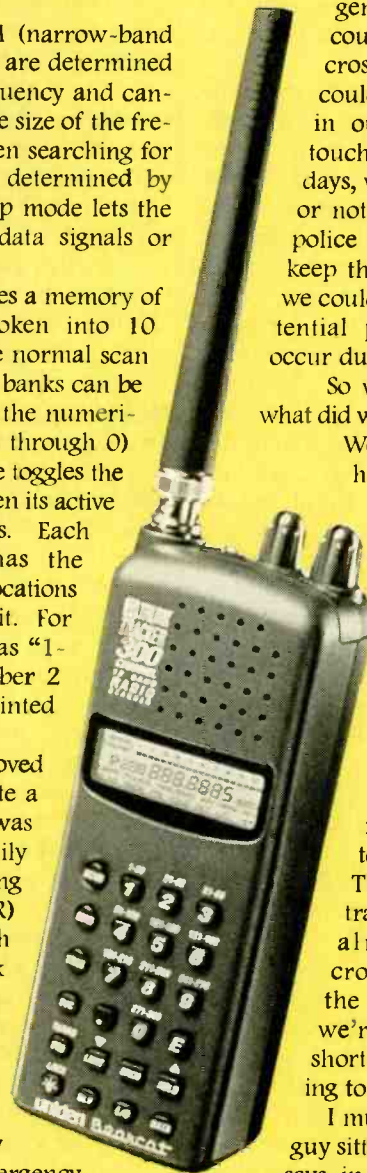



Give a Friend a Year of Electronics Fun this Christmas...

Does fighting the crowds at Christmas short-circuit your holiday fun? Don't blow a fuse this year...for the friend who shares your love of project-oriented electronics — or a youngster who may need only a spark to ignite a life-long interest — give a gift subscription to Popular Electronics.

Popular Electronics readers get the know how they need to build exciting, educational, and useful projects like these...a professional-quality home-security system...an autoranging frequency counter...a nine-band shortwave receiver...a radio-controlled car...a telephone scrambler...an aviation receiver...and even a robot!

PLUS...Gizmo, our honest and straight-shooting review of the latest consumer-electronics gear...Market Center, featuring mail-order merchants that are ready to help you in all your hobby activities...articles and columns covering every aspect of the electronics hobby — including antique radio, shortwave listening, ham radio, computers, scanners, circuit design, and more!

SAVE MONEY... A great gift to receive, Popular Electronics is also a great gift for *you* to give! The Special Holiday Rate saves you \$41.89* off the newsstand price on each gift. You can save another \$41.89* when you start or extend your own subscription at the same time. It's our "thank-you" for sharing Popular Electronics with a friend at Christmas.

Send no money, unless you prefer. We'll be glad to bill you in January, 1999. Just take a brief moment to go over your gift list and make sure you haven't forgotten anyone who might appreciate the many benefits of Popular Electronics. Then write the names on the attached Gift Certificate and mail it back in the postage-paid reply envelope...we'll take it from there!

Your friends will receive a handsome gift announcement card signed with your name just before Christmas. And all through the new year they'll remember and appreciate your thoughtful gift! So don't blow a fuse...take it easy and enjoy the holidays. Give Christmas gifts of Popular Electronics!

Popular Electronics[®]

*Basic sub rate — 1 yr/\$24.99

them—a Far Rockaway train is disabled,” I say. Two or three minutes later, the conductor gets on the PA to let everyone else know what’s going on. We make the five extra stops.

In another instance, I listened as our train came to a halt shortly after leaving the station. A train at the next station, as I learned from the scanner, had a “fire condition” in its last car. The powers that be decided that the best thing was for our train to head back past a switch, then switch to the other track, and head into New York. But rules are rules, and a train can’t just be told to head back and switch to the other track. Such an order has to be written out in military fashion. (For example, our train, No. 129, had to be written out as “train one two nine.”) After about 20 minutes of this, the order was rescinded. “All of that for nothing,” one crew member said. Few things are more frustrating than being stopped in a commuter train without knowing what’s going on. Because I knew, the delay was more palatable.

To make matters worse, while we were following the limping train ahead of us, I learned that another train had hit some debris outside of Penn Station, closing one of the two tunnels and sure to cause massive delays. (Our train trip, normally just over an hour, took more than 2½ hours that day.) Our scanner kept us better informed than anyone else on the train, and we were probably the only relaxed commuters that day.

OK, not everyone takes a commuter train every day, and, to be honest, conversations between train crew members could be pretty boring unless something directly affecting our commute was happening. So why else would a scanner be useful? Well, I found it fascinating to hear the police department preparing for Hillary Rodham Clinton’s arrival at the Waldorf Astoria hotel where she was having lunch with the President. (We hadn’t even realized that the First Family was visiting New York until we heard it on the scanner.) I found it gratifying that traffic accidents and potential traffic holdups were considered important, and people were

working hard to minimize their impact. And some transmissions, such as those after an ex-cop’s car was car-jacked, were, well, just plain exciting.

The ability to listen in on local amateur-radio meter repeaters was also a lot of fun. Even if you’re not a ham-radio operator, you might want to listen to the message traffic. (The Tuesday night swap-and-shop net on our local 2-meter repeater was one of our favorites.)

For a scanner to be useful, of course, it must be programmed with frequencies of interest. The BC235XLT comes with a starter frequency guide that includes frequencies of police, fire, and emergency services and more, broken down by state and city. It’s not a bad starter, but you’ll want to get more comprehensive guides available from, for example, *RadioShack*, or go on the Internet and get frequencies from other enthusiasts.

The Trunk Tracker, however, also offers a service (svc) button that switches the scanner between pre-programmed frequency sets for police, fire/emergency, air, marine, and weather services. The weather service was handy—we could tune to our local National Weather Service frequency with ease. The others were no substitute for having a list of actual frequencies used, but they could help a beginner to become familiar with the kind of traffic that can be heard.

As a standard scanner, the Bearcat BC235XLT was a pleasure to use—it was sensitive and scanned fast. Our biggest complaint was that its audio output was weak. In a car, for example, the audio had to be cranked up to full power to be effective—and even then it was less than ideal, distorted and not loud enough. On the other hand, we did most of our listening either through headphones or our multimedia computer speakers. The great thing here is that the headphone jack will accept a stereo jack and provide output to both channels even though the scanner itself is mono.

Birdies—signals generated by the scanner’s internal oscillators—were few and far between. Image rejection and freedom from intermodulation

distortion were excellent.

Of course, we haven’t even gotten to the sexy part—its trunk-tracking capabilities.

When you use trunk-tracking, only a single bank can be active at a time. That might sound limiting, and in some cases it is, but it’s important to remember that several services can use one trunked system. For example, in Suffolk County, the Police Department shares its 26 frequencies with county buses, the State Parks Police, the County Health Department, and others.

The scanner can follow *Motorola* Type I, Type II, and Hybrid trunked systems. For Type I and Hybrid systems, you’ll need someone else to tell you how to configure the “fleet maps” or you’ll have to go through a long, trial-and-error process. (A site on the Web, www.trunktracker.com, has been set up to share information.) The more modern Type II systems are easier to use because all you need are the frequencies.

Once you program the right frequencies into a trunked bank, the scanner searches for the data channel that has the control information for the radios using the system. Then, instead of frequencies, the display shows the “talk group” identifier. By themselves, the talk group numbers mean nothing. But by listening, you can figure out what they are. And that’s important, because you can set the scanner to ignore those that aren’t of interest. For example, we were perfectly happy to listen to the Suffolk County First-Precinct Dispatch (talk group 49776) but perfectly willing to ignore the county buses (240). The bottom line is that when you’re scanning trunked banks, forget about frequencies. Think instead about talk groups and fleets.

With trunked systems becoming more prevalent every day, we can’t think of a better portable scanner to recommend. We could quibble with a couple of ways that the scanner operates, but those quibbles would really get us away from the main point: *Uniden’s Bearcat Trunk Tracker BC235XLT* is a great scanner for newcomers and enthusiasts alike. ■

Build the

MILLENNIUM CLOCK

You can throw away your calendar when you need to keep track of how many days until a certain event happens. This is a great project to have as the entire planet counts the days until the new millennium!

JAMES E. TARCHINSKI, N8PTG

Something very rare is about to happen. It is so rare, in fact, that it has only happened once since the days of Christ. We are about to enter not just a new decade or even a new century—we are about to enter a new millennium. The last time the thousands digit of the year changed was for the zero-to-one transition. But in the year 1000 AD, communication was poor, and absolutely no one had any idea of the true scale of the world. This time around, however, things are different. For the first time in human history, the entire world is watching the calendar and counting down until the new millennium begins.

The *Millennium Clock* is designed to help keep track of the days until this historic event. Essentially, the Millennium Clock is a microprocessor-based circuit that displays a real-time clock. Every day at midnight it decrements a counter to indicate the number of days left until an event. Initially, it can be used to track the passage of time until the

big calendar flip, but after that it can be used to count down the days to other events, such as the start of the summer school break—or how about your retirement, a family vacation, or that final mortgage payment? Now there's something to look forward to!

Everything in Its Own Time. So when exactly does the new millennium begin? Well, there are really two answers to that question. For computers, the change will be most noticeable on January 1, 2000. As everyone should have heard by now, on that day, the current year variable in many computer systems will be simply "00," because many programs were written to just assume the "19" stuck out there on the left. When such a computer goes to calculate the time you've had your money in the bank since you opened an account in 1992, for example, you'll likely get 92 years of interest instead of just eight years. (You could possibly even be charged a *negative* 92

years of interest, meaning you might actually be shown to owe the bank money!) It looks like it'll be a real problem. Major corporations are now spending millions of dollars to modify their software to prevent total chaos in the year 2000. However, in spite of all the potential computer problems, January 1, 2000 is not the official start of the new millennium.

The new millennium officially begins on January 1, 2001. The reason for this is that our great ancestors decided to start the calendar with the year "one," and not the year "zero." So the first century ran from 1-100, the second from 101-200, and so on. The same for the first millennium, from 1-1000, and hence the second runs from 1001-2000. So the third millennium will begin on the first day of the year 2001 (hence the name of Arthur C. Clarke's most famous novel.)

No matter which definition you use, the Millennium Clock can help you keep track of the days until the much heralded event.

LISTING 1—A MICROSOFT EXCEL FUNCTION FOR CALCULATING THE NUMBER OF DAYS BETWEEN TWO DATES

	A	B	C	D	E
1	Date 1 =	1/1/00		Date 1 =	1/1/00
2	Date 2 =	9/1/97		Date 2 =	9/1/97
3	Days=	852		Days=	=abs(E1-E2)

Note: Both the left and right sides are the same function, but the one on the right shows the simple formula used.

support components are required to allow the 68HC705 to operate. For example, R2 and C1 are used to generate a suitable reset signal for IC1, allowing the microprocessor to power up correctly whenever voltage is applied. Components R1 and C2 work in conjunction with the microprocessor's internal oscillator circuit to generate the proper timing signal. While that signal is used by the microprocessor for its own internal timing, the timebase signal on the IRQ line is used to drive the microprocessor's time-keeping functions. (Again, that was done because the 60-Hz signal is very accurate and not nearly as susceptible to inaccuracies due to ambient temperature changes.)

Power for the project is derived from a 9-volt AC wall adapter. The 9-volt output of the adapter is rectified by BR1 and converted to a clean 5-volt DC supply by IC3, an LM78L05 5-volt, 1-amp fixed voltage regulator.

Assembly. The Millennium Clock was assembled on a single-sided printed-circuit board, measuring 1 7/16 by 3 3/16 inches. Figure 2 shows a full-size template of the author's single-sided, printed-circuit layout. A parts-placement diagram for the author's printed-circuit layout is shown in Fig. 3. Most of the components for the Millennium Clock, except for potentiometer R4 and the three input switches (S1-S3), are mounted to the board. The off-board components are connected to the board via PL1 and SO1—10-pin, male and female IDC connectors (respectively).

The board layout was dictated by the physical dimensions of DISP1, the DMC series liquid-crystal display—which is manufactured by a company called *Optrex*. There are several versions of the display unit—the one selected for the

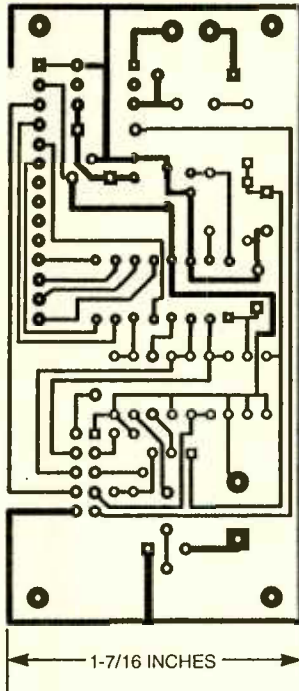

Fig. 2. The Millennium Clock was assembled on a single-sided printed-circuit board, measuring 1 7/16 by 3 3/16 inches. A full-size template of the author's printed-circuit layout is shown here.

Millennium Clock has 14 connection pins located in the upper left-hand corner when viewed from the front of its circuit board. Other similar display units, even those made by other manufacturers, can be substituted for the one specified. However, the replacement device should be controlled by a *Hitachi* 44780 integrated circuit. If you have another display with a different pin configuration in your parts' bin, the display can also be mounted off-board and connected to the main board using point-to-point wiring techniques.

Because the liquid-crystal display is mounted to the board and obscures on-board components, the display should be mounted to the board through a 14-pin SIP sock-

PARTS LIST FOR THE MILLENNIUM CLOCK

SEMICONDUCTORS

- BR1—DF06110M or equivalent full-wave bridge rectifier
- D1-D4—1N4001 1-amp, 50-PIV, silicon, rectifier diode
- DISP1—Optrex DMC series, 16 character × 2 line, liquid crystal display (see text)
- IC1—Programmed 68HC705K1 P micro processor, integrated circuit
- IC2—LM7805S positive 5-volt, 100-mA, fixed-voltage regulator, integrated circuit
- Q1—2N4403 general-purpose PNP silicon transistor

RESISTORS

- (All fixed resistors are 1/4-watt, 5% units, unless otherwise noted.)
- R1-R3, R5, R6, R8—10,000-ohm
- R4—10,000-ohm, single-turn, PC-mounted, trimmer potentiometer
- R7—1000-ohm
- R9—5600-ohm

CAPACITORS

- C1, C5, C6—1.0-μF, 16-WVDC, electrolytic
- C2—22-pF, ceramic disc
- C3—10-μF, 16-WVDC, electrolytic
- C4—0.1-μF, ceramic disc

ADDITIONAL PARTS AND MATERIALS

- BZ1—5-volt piezoelectric buzzer (*RadioShack* #273-074 or equivalent)
- F1—0.25-amp, PC-mount, Pico-fuse
- J1—Power jack
- PL1—Female, ribbon-cable mounted, 10-pin connector
- S1-S3—Normally-open pushbutton switch
- SO1—Male, PC-mount, 10-pin connector
- SO2—Optional, see text

Printed-circuit board materials, 8 to 11-volt DC power adapter, 14-pin SIP socket, 16-pin DIP socket, enclosure, spacers, wire, solder, hardware, etc.

Note: The following items are available from Aurora Software, PO Box 080133, Rochester, MI 48309-0133: a programmed 68HC05K1CP microcomputer (IC1) for \$12.99; a 1.44M, 3.5-inch floppy disk containing an S-record file (no source code) of the Millennium Clock software and the two programs shown in Listings 1 and 2 for \$6. Please add \$2 shipping and handling for all orders and (sorry) no Michigan orders accepted.

et. Mounting the display in a socket allows it to be easily removed from the board, should it ever become necessary to service the circuit. Fourteen-pin SIP sockets, although less common than the DIP type, are readily available—even your

LISTING 2—BASIC PROGRAM FOR CALCULATING THE NUMBER OF DAYS BETWEEN TWO DATES

```

100 ' DATE CALCULATIONS
110 ' (c) 1997 Aurora Software
120 '
160 WIDTH 80: KEY OFF: COLOR 7: CLS
410 Q$ = "PLEASE ENTER THE FIRST DATE: "
420 GOSUB 520: V1 = V
430 Q$ = "PLEASE ENTER THE SECOND DATE: "
440 GOSUB 520: V2 = V
450 PRINT : PRINT
460 PRINT "THERE ARE "; V2 - V1; " DAYS BETWEEN THESE": PRINT "TWO DATES.
    ("; (V2 - V1) / 365.25; " YEARS.)"
470 PRINT : PRINT
480 PRINT "PRESS ANY KEY...";
481 A$ = INKEY$: IF A$ = "" THEN 481
490 END
500 '
520 ' *** INPUT DATE ROUTINE ***
540 PRINT
550 COLOR 6: PRINT Q$: COLOR 7
560 PRINT
570 PRINT "USE THE FORM: MM,DD,YYYY": PRINT
580 INPUT "DATE: "; M, D, Y
590 FLAG = 0: PRINT
600 IF M < 0 OR M > 12 OR D < 0 THEN FLAG = 1
610 IF (M = 4 OR M = 6 OR M = 9 OR M = 11) AND D > 30 THEN FLAG = 1
620 IF (M = 1 OR M = 3 OR M = 5 OR M = 7 OR M = 8 OR M = 10 OR M = 12) AND
    D > 31 THEN FLAG = 1
630 IF M = 2 AND D > 29 THEN FLAG = 1
640 IF FLAG <> 0 THEN PRINT "INVALID MONTH/DAY SPECIFICATION.": GOTO 560
650 IF M = 2 AND D = 29 AND Y <> 4 * INT(Y / 4) THEN PRINT Y; " IS NOT A LEAP
    YEAR!": GOTO 560
660 IF Y < 1590 THEN PRINT "ALL DATES MUST BE AFTER THE YEAR 1590.": GOTO
    560
670 '
680 ' CALCULATE 'V'
700 IF M > 2 THEN GOTO 730
710 V = 365 * Y + D + 31 * (M - 1) + INT((Y - 1) / 4) - INT(.75 * (INT((Y - 1) / 100) + 1))
720 GOTO 740
730 V = 365 * Y + D + 31 * (M - 1) - INT(.4 * M + 2.3) + INT(Y / 4) - INT(.75 *
    (INT(Y / 100) + 1))
740 RETURN

```

local *RadioShack* carries them. With this connection system, the 14-pin connectors actually help hold the LCD board and the main boards together.

Another point worth mentioning is that the printed-circuit layout shown in Fig. 3 was used for all phases of developing the Millennium Clock. Because of that, the board contains component pads for parts that were used in the early stages of software development. In particular, SO1 was used as a tie point, allowing the builder to select an \overline{IRQ} signal coming from either the AC adapter or from off the board entirely. Resistor R8 was used as a pull-up for the external interrupt. That allowed for testing the interrupt's operation at a much slower

rate. The jumper and resistor can be eliminated from your unit; in doing so, don't forget to hard wire the \overline{IRQ} terminal (pin 4) of IC1 to the clock signal from the power supply section of the board.

Also on the board are about six extra pads, in addition to those for SO1 and resistor R8. Those pads were provided for components that were later found to be unnecessary in the final incarnation of the circuit.

Checkout. Once the printed-circuit board has been completely assembled, visually inspect the board for poor solder joints, solder bridges, missed joints, or even completely uninstalled components. **Caution:** Don't confuse the extra, unused board pads with those in which a

component should be installed. Inspecting the board may sound trivial, but misinstall a single component and then see just how "unnecessary" you view this step. Literally days can be lost debugging circuits with one or two minor flaws. Besides the time and frustration seemingly minuscule errors add to a construction project, it can also translate into some dollars if a major component should be damaged. Time invested in a visual inspection is generally time well spent.

Once the visual inspection is complete and you're satisfied that there are no obvious errors, it's time to do some active tests on the circuit. With the circuit completely wired, but without the LCD and microprocessor installed, apply power to the circuit by connecting a 9-volt AC adapter to J1. Check the voltage at the input and output of the 78L05 regulator; the input voltage readings should be about 8-11 volts and the output should be exactly 5 volts. Also check pins 1 and 13 (RESET and V_{DD} respectively) of IC1, which also should be at 5 volts.

There are two other simple circuit checks that should be performed. Using a wire jumper, short pin 6 to pin 4 of IC1's socket. Shorting those pins should cause buzzer BZ1 to sound. Once buzzer operation is confirmed, press each of the switches in turn and make certain that the appropriate pin(s) of the IC1 socket are pulled low. Pressing S1 or S2 should cause the voltage on pin 3 to drop to zero, while pressing S2 or S3 should cause pin 2 to drop to zero.

Finally, using an oscilloscope or a frequency counter (assuming either or both those devices are available), check the voltage and/or frequency of the signal at pin 4 of IC1. That's the pulse signal used by the microprocessor to keep track of real time. The signal should have a frequency of exactly 60.0 Hz, and an amplitude of less than 5.5 volts. If either of those parameters is exceeded, do not install IC1 until the problem has been corrected!

If all checks out OK, remove power from the circuit, and install both the microprocessor and the LCD module. Once again, apply power to the circuit; data similar to

that shown in Fig. 4A should appear in the display. If that display does not materialize, the first thing to check is

the adjustment of the LCD contrast control, R4. If R4 is incorrectly set, the screen appears blank.

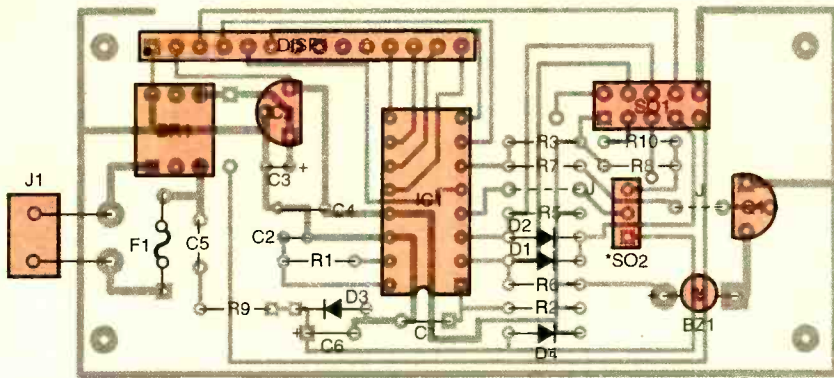

*SEE TEXT

Fig. 3. Most of the components for the Millennium Clock, except for potentiometer R4 and the three input switches (S1-S3), are mounted to the board. Potentiometer R4 and the switches connect to the circuit board through PL1. A parts-placement diagram for the author's printed-circuit layout is shown here.

At this point, you should see time incrementing on the display and you can give yourself a good pat on the back. Your clock is now standing on its own two legs, completely under the control of the project's software.

The Software. The Millennium Clock's microprocessor (IC1) must be programmed before the chip can be expected to do its job. For those capable of programming a 68HC705, the software—a file containing the S-record software—can be downloaded from the Gernsback Web site (as file "CDOWN.ZIP") or purchased from the supplier listed in the Parts List. If you do not have the equipment to program a 68HC705, a pre-programmed microprocessor is also available.

Three main sections of code dominate the Millennium Clock software, along with six or seven other smaller sections of code thrown in for good measure. The largest section is the one required to drive the liquid-crystal display. The reason it is so large is that the LCD is being run in 4-bit mode; hence, each byte of data sent to it must be broken down into two separate pieces (two nibbles). Each of the nibbles are then sent from the microprocessor to the LCD in succession. That brings us to a good point to remember if you plan on designing a LCD into one of your own projects: using the LCD in 4-bit mode saves 4 data lines, but it adds 3 or 4 times the software overhead. Like so many things in electronics, it's "pay me now or pay me later."

The two larger blocks of code are required to handle the switch inputs and to update the clock counters. The switch input section is fairly routine, constantly monitoring the switches, eliminating (via software) any key-bounce that is present, and finally transferring the switch settings to the rest of the program.

As for updating the clock counters, it turns out that memory-storage locations for the clock are very easy to update. Every time an IRQ signal is generated, the microprocessor automatically executes a specific section of code. In the code, a "tick" counter keeps track of how many times the microprocessor has entered the IRQ rou-

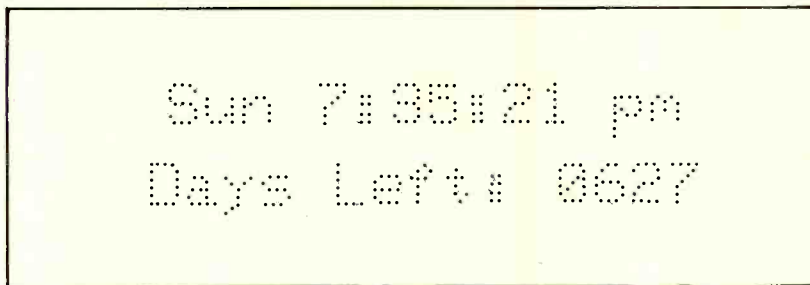

A

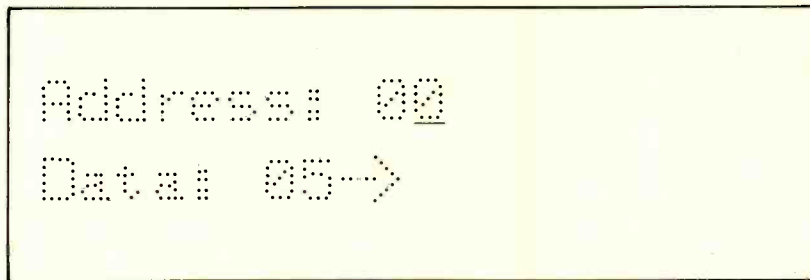

B

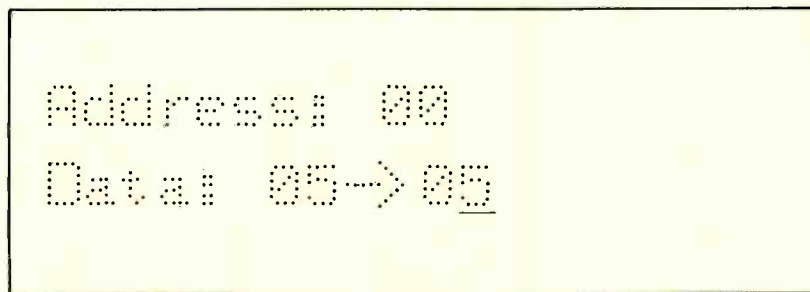

C

Fig. 4. When power is first applied to the unit, a "Time Display" screen similar to that illustrated in A appears. Pressing switch S1 once causes the display to change to that shown in B—the "Address Input" screen. After selecting the address to be modified, pressing S1 again brings up the "Data Input" screen shown in C.

TABLE 1—CONTENTS OF THE FIRST EIGHT (0-7) MEMORY LOCATIONS OF THE MILLENNIUM CLOCK.

Address	Name	Valid Range	Notes
0	DAYSHI	0-99	This is the thousands and hundreds digits of the Days Left variable.
1	DAYSLO	0-99	This is the tens and ones digits of the Days Left variable. For example, if you want to program the clock to count down 356 days, place 03 in memory location 0 and 56 in memory location 1.
2	TICKS	0-59	Current time: Tick counter. <i>This address updates too fast to be changed by the user.</i>
3	SEC	0-59	Current time: Seconds counter.
4	MIN	0-59	Current time: Minutes counter.
5	HRS	1-12	Current time: Hours counter.
6	AMPM	0-1	0 = AM 1 = PM
7	DAY	0-6	Current day of the week: 0 = Sunday 1 = Monday 2 = Tuesday 3 = Wednesday 4 = Thursday 5 = Friday 6 = Saturday

Note: These are the only locations that the user may change. The program does not perform error checking—if you enter a value outside of the valid range, strange things can happen.

time. After it sees 60 interrupts, it then zeros the tick counter and increments the "seconds" counter. Once the "seconds" get to 60, a minutes counter is updated, and so on. Finally, after the clock counters increment the "day" memory register, the software decrements the count-down register that contains the number of days remaining until the user's "event" is reached.

Setting the Clock. Setting the Millennium Clock is not so straightforward as it might have been, because of limited processor ROM space and limited processor input lines, which spawned the three-switch user interface. However, that should not be a problem for those who are adept at setting up modern electronic devices; it may be a bit more time consuming, but far from impossible for those who are not.

Start by applying power to the circuit. When power is first applied to the unit, the screen display illustrated in Fig. 4A should appear. That's

the clock's "Time Display," which gives the user's local time on the upper line and the "Days Left;" indication on the second line. At power-up, all RAM variables are initially set to zero, so the display defaults to SUN at 01:00:00 AM with 0 days left shown on the display.

Pressing switch S1 once causes the display to change to that shown in Fig. 4B—the "Address Input" screen. When that screen appears, pressing S3 allows you to select which of seven RAM locations you'd like to change (see Table 1 for a description of each RAM location). Each press of S3 increments the displayed address by one and automatically resets it to zero after address seven is displayed.

After selecting the address that you'd like to modify, pressing S1 again will bring up the "Data Input" screen, shown in Fig. 3C. That screen shows the current contents of the address selected, and also allows the value at that memory location to be altered. Switches S2 and S3

are both used on that screen, updating the displayed number by 10 and 1, respectively. Whenever the maximum value (99) is exceeded, the display automatically rolls over to zero.

Note that no error checking is performed on the variables entered. You could therefore enter a value of 34 for the "Day" variable even though that would not be correct. **Note:** You must perform your own error correction, based on the "Valid Range" column of Table 1. If you don't perform error correction, the project's display could exhibit fairly strange behavior. Error-checking routines could not be used for this section of the program due to the limited available program space.

After the new value is correctly displayed on the "Data Inputs" screen, pressing S1 a final time stores the new value in memory and also returns the readout to the "Time Display" screen. Think of pressing S1 the final time as being tantamount to pressing a computer's Return key—it locks your change into memory.

To completely set the clock, you need to loop through the three screens until all the required RAM addresses have been set to the desired values. Knowing what the correct values are for the standard time variables is as simple as looking at your watch, but getting values to enter for the two "Days Left" variables is a little more complicated.

Determining "Days Left." There are several ways to figure out how many days remain until a certain event happens. The obvious one is to pick up a calendar (or two) and count the days. It sounds simple, but that method is prone to error. A much better way is to let a computer figure it out. And finally, for those using the clock to count down until the new millennium, a simple alternative is shown in Table 2. To calculate the number of days until the new millennium, find the row corresponding to next month. That is, if the present month is November (11), the next month is December (12). Go to the 12/1/98 line, choose the appropriate "Days-Left" amount, and add to the Days-Left amount the number

(Continued on page 68)

GETTING YOUR COMPUTER UP AND RUNNING

In last month's article, *Putting Together Your Own Computer—from Atx to Zif*, we detailed the selection of many of the major components that are required in assembling your own computer. Hopefully, over the past few weeks you have made these selections, ordered the necessary items from the vendors, and have just gotten the packages in your eager hands. In this concluding article, we present a basic guide in setting up the major assemblies for the computer you intend to build. While it is beyond the scope of this article to explain every nuance and approach in setting up every conceivable system, it can be used as a general guide. But more importantly, it will take you step-by-step through the installation of the specific computer assemblies we have detailed, and it will also allow you to avoid many of the pitfalls encountered by amateur PC builders.

Ground Yourself Out! One cannot overstate the importance of adequately grounding yourself before and while handling computer hardware. Two common devices that are quite effective for this purpose are the ground strap, which straps to your wrist, and the ground mat, which lies on the floor beneath your feet. These devices prevent static electricity from building up on your

Special thanks to Benjamin Leidner, network engineer for *Gaspra Technologies*, a computer consulting firm in New York City. Mr. Leidner, who also teaches computer courses at *Computer Educational Services*, is A+ certified, a Microsoft NTPS, and a Novell CNE. He can be reached at ben@benyc.com.

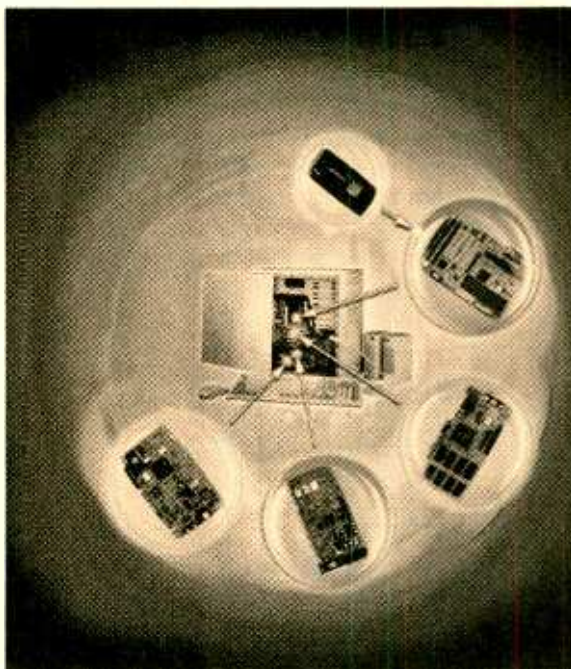

In this concluding article on building your own PC, we install the major computer assemblies, configure hardware, and load some basic software to get your PC off and running!

RAFAEL AVILA

body. When even small amounts of static electricity discharge through sensitive computer components, the components can become damaged or completely destroyed. So it is a good idea to always keep yourself grounded. In a pinch, if no grounding devices are available, many computer technicians will touch a metal surface of the computer case. In order to neutralize any potential that may have accumulated between themselves and the computer. However, this is *only* for emergency repairs and is no substitute for the proper grounding of devices.

After properly grounding yourself,

remove the outer cover to the PC case, either by unscrewing several screws that secure the cover to the rear panel of the case or by sliding the appropriate side panel backwards. Consult the manual to avoid unnecessary disassembly.

In putting together your PC, document all changes, switch settings, orientation of cards, wires, etc. as you go along. Also, record any brand names, model numbers (with notable revision letters), and serial numbers on the numerous assemblies you are installing—these may be invaluable for warranty and upgrade purposes at a future date.

Case and Power Supply. Because most case and power supply units are sold together, there is usually no need to assemble these two units. Power supply units are usually affixed to the case with screws and may be further

secured by a tab-and-slot or a bracket. Most of the newer ATX cases do not have tabs-and-slots or brackets.

When attached with screws, the rear surface of the power supply case should completely cover (from the inside) the square hole in the back panel of the PC case thus becoming part of case's rear panel. This panel should have a main power connector to which a power cord can supply current from the wall outlet. The panel should also have a voltage selector switch that can be set appropriately for your household current (for U.S. usually marked 115 VAC).

There is also a harness of wires with connector ends that extend from one of the surfaces of the



Your computer exposed! Here is a side view with panel removed showing the installed (ATX) motherboard.

power supply case. Be sure not to damage or accidentally obscure these wires, as you will need them to supply power to your motherboard and drives.

Motherboard. The installation of the motherboard is far simpler than expected. For those with tower cases, it may be preferable to lay the tower on its side, so that the motherboard can be installed horizontally.

The first thing to do is assess the proper orientation of the motherboard with respect to the case. Since the mounting holes in the motherboard are asymmetrical, there is only one possible orientation in which it can be installed—check with your owner's manual for your case. If you discover that your motherboard cannot be properly oriented, or will not fit the physical dimensions of the case when properly oriented, then you have acquired an incompatible case and motherboard. Contact the case/motherboard manufacturer(s) for further help. If you have followed the advice of last month's column, and you acquired the proper AT, baby-AT or ATX case, for a corresponding AT, baby-AT or ATX motherboard, finding the proper orientation is simple.

For our purposes, we will orient the motherboard and case so that the half of the motherboard that houses the mouse and keyboard ports is furthest away from us, and the half with the expansion slots on it is closest (see Fig. 1). We will call the farthest edge of the motherboard the "top" and the closest edge the "bottom" throughout this article.

Installing and Securing the Motherboard. Now that you have confirmed that your motherboard fits properly, the standoffs (nylon fasteners) which keep the motherboard elevated above the metal surfaces of the case can be inserted into the proper mounting holes. Most motherboards are mounted with four standoffs, one in each corner. The pointed ends of the standoffs, which look like arrows, should be inserted through the mounting holes from the underside of the motherboard. After they are inserted, and the motherboard falls into the correct position, the flat ends of the standoffs slide into standoff holes in the case. If the standoff holes do not line up with the

standoffs, your motherboard may not fit the case. Don't be discouraged too easily, though; sometimes it takes a little delicate shifting to allow the standoffs to fall into their proper holes. In addition, some motherboards can only be mounted with three standoffs and the non-useable standoff may get in the way. (This does not apply if both the motherboard and case are ATX).

After you have slid the motherboard and standoffs into the appropriate standoff holes in the motherboard, you must find the anchoring slots in the motherboard. There are usually two or three, situated precisely above the anchoring posts of the case. The motherboard must be secured

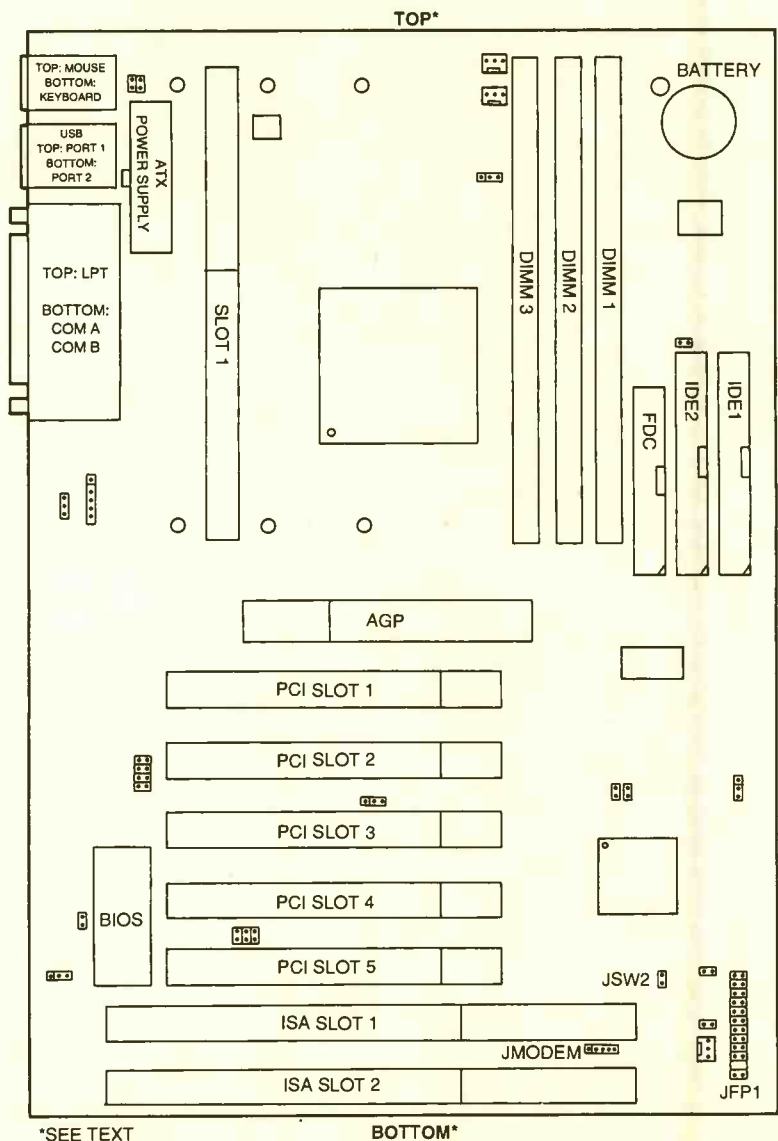

Fig. 1. Outline reference drawing of a typical ATX motherboard layout showing pertinent slots, connectors, and ports.

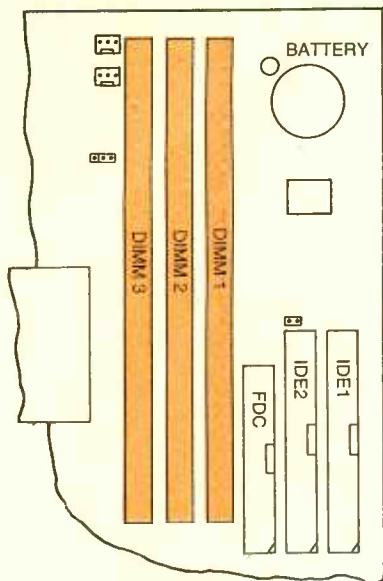

Fig. 2. Expanded view of slot locations on motherboard for insertion of RAM boards (only DIMM slots available for this board).

with screws, which go through the mounting holes and fasten into the mounting posts. With the motherboard secured properly, let's get into inserting the RAM boards.

Installing the RAM. Installing RAM requires consulting your owner's manual to identify the appropriate SIMM and/or DIMM ports (see Fig. 2). It is best to install RAM, starting from the first RAM slot and working your way up. So, if you are planning to install two DIMM RAM boards, you must identify DIMM Slot-1 and DIMM Slot-2 on the motherboard, and confirm this with owner's manual. Likewise, if you are planning to install two SIMM RAM boards, you must identify the SIMM Slot-1 and -2. You can tell the difference between DIMM and SIMM boards, or their corresponding slots, by the number of pins each type has. SIMM boards come in two varieties, 30 pins on older designs and 72 pins on newer ones. DIMM boards all have 168 pins.

Having identified the appropriate RAM slots, the RAM boards can be installed as follows. First, hold the RAM board by the top two corners, so that the pins are facing down. If you are installing DIMM boards, you will notice a pair of notches cut out of the edge of the board—where

pins would otherwise be. If, on the other hand, you are installing SIMM boards, you will notice that a single notch has been cut out of one of the bottom corners of the RAM board. Because of these notches, there is only one orientation in which either type of RAM board will fit into its corresponding slot.

Gently slide the RAM board into the slot at a 45-degree angle to the motherboard. If the RAM board does not easily fit into the slot, your orientation is incorrect, and you must flip the board over while keeping the pins facing downward. After sliding the RAM board into the slot, swing the top edge of the board upwards, using the bottom edge as a pivot, until the board is perpendicular to the motherboard. The RAM board should now snap into place; the two metal clips on either side of the slot securing it. Your RAM board has now been installed, and you can repeat this procedure for any additional RAM boards.

Installing the Hard Drive. Installing a UDMA, IDE or EIDE hard drive requires the identification of six items. They are the primary UDMA/IDE/EIDE port on the motherboard, the IDE/EIDE port on the hard drive itself, a forty-pin IDE ribbon cable, a power connector from the power-supply unit, the power-connector port on the hard drive, and an appropriately sized drive bay in the case.

The UDMA/IDE/EIDE ports can be identified as the only 40-pin ports on the motherboard. The connector is usually white, with two rows of 20 pins each standing straight up. If there are two or more UDMA/IDE/EIDE ports together, it is likely that the primary port is furthest to the right. However, you should consult the motherboard owner's manual to confirm this for your particular board. In addition to simply identifying the port, it is important to identify the number one pin of the port. Sometimes there is a "1" printed next to the number one pin, right on the motherboard. In the absence of such identification, it is useful to know that most UDMA/IDE/EIDE ports have a notch cut out at the center of the edge of the plastic connector wall, closest to the first row of pins. This notch allows

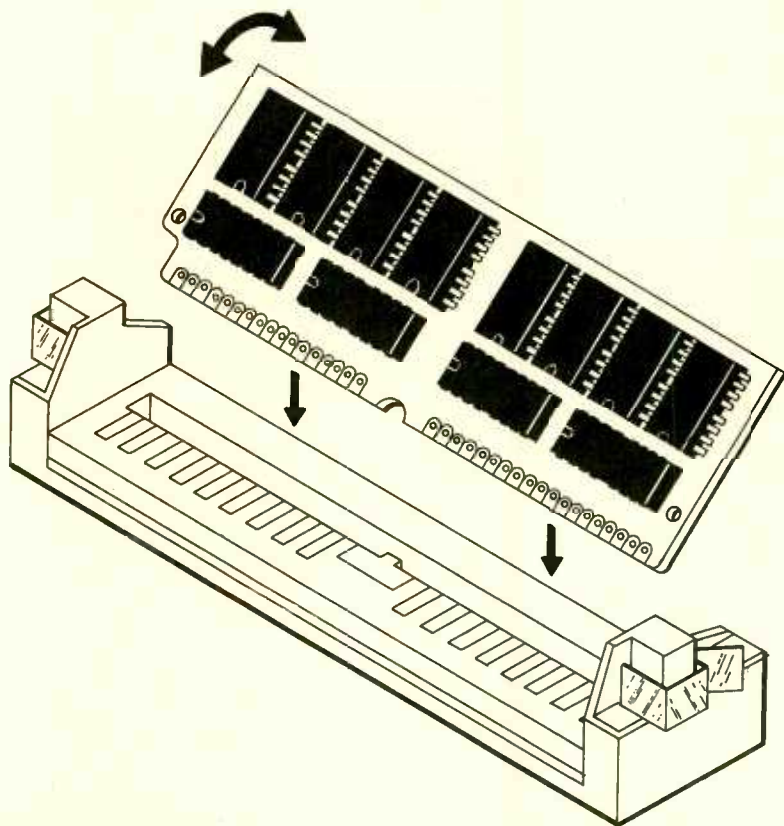

The proper technique in inserting a RAM board into a motherboard slot. Insert board into slot at a 45-degree angle and then swing the top edge of the board upwards.

for only one orientation in which most 40-pin IDE ribbon cables can be installed, as there is an appendage on the connectors that must fit into the notch, or the connector cannot be inserted. (Beware however, there are plenty of IDE cables being sold out there that do not have such an appendage on their connectors, and an appendage-less connector will fit into any port in the wrong configuration).

Once you have identified the number one pin of the UDMA/IDE/EIDE port on the motherboard (IDE1), insert the 40-pin IDE cable connector, making sure that the red wire of the cable is closest to the number one pin of the port. Leave the other end of the connector available to insert into the hard drive.

After unpacking the hard drive, consult the owner's manual to make sure that the jumper pins are set properly. You want to make sure that the jumpers are set in the "Primary" and "PnP" (Plug and Play) configuration—making this your primary hard drive. The next step is to insert the hard drive into the appropriate internal drive bay of your case. You will have the choice of using a 3.5 or a 5.25-inch bay in most cases. The mounting screws should align perfectly with the corresponding holes in the hard-drive casing. Leave these screws a little loose, until you are finished connecting the cables to the hard drive.

The power-supply cable for the hard drive is made up of four different colored wires, and emanates from the power-supply unit in the computer case. The connector is usually off-white in color, and always has two rounded corners so that it can only be inserted into a device's power-connector port in the correct orientation. Insert this power connector into the appropriate power-connector port of the hard drive. The fit will be tight, and there will be no snap indicating that it is in all the way, so be careful to stop when the connector and port casings are flush with one another.

The IDE ribbon cable must be connected to the UDMA/IDE/EIDE port of the hard drive. Once again, it is important to ensure that the

number one pin is aligned with the red wire of the cable. Just as with the IDE cable and port connection on the motherboard, if there is an appendage on the cable and a corresponding notch on the port, the correct orientation will be the only orientation in which the cable can be connected. Usually, but not always, the number one pin is closest to the power connector port on the hard drive. Sometimes there is a "1" label.

Gently insert the IDE ribbon cable into the port, ensuring that the red wire is closest to the number one pin. Also, be careful not to bend any of the pins in the port of the hard drive as you insert the cable connector. The hard drive is now connected, and you can now tighten the mounting screws, which hold the drive in its bay.

Installing the Floppy Drive. In searching for your 40-pin IDE cable for your hard drive, you may have also found a narrower 34-pin ribbon cable. This is the appropriate cable for the connection of your floppy drive to the motherboard. You will also have to identify the floppy-drive port on the motherboard (see Fig. 3), as well as that of the floppy drive itself, an appropriately sized external-facing drive bay, another power connector from the power-supply unit, and the power-supply port on the floppy drive.

To install a 3.5-inch floppy disk drive, a 3.5-inch external-facing bay, an appropriate mounting bracket must be made available. Without a mounting bracket, you are limited to a 3.5-inch external bay only. Simply pop the corresponding plastic external-facing bay cover out of the front of the case. Then slide the floppy drive or the floppy drive mounted on a bracket into the bay and secure it loosely with the mounting screws. Repeat this procedure with another floppy drive, if you intend to install a second floppy drive (drive B).

The 34-pin ribbon cable for the floppy drive is conspicuously designed with a twist in the cable between the connector in the middle of the cable, and the connector at the distant end of the cable. This twist separates the "floppy drive A"

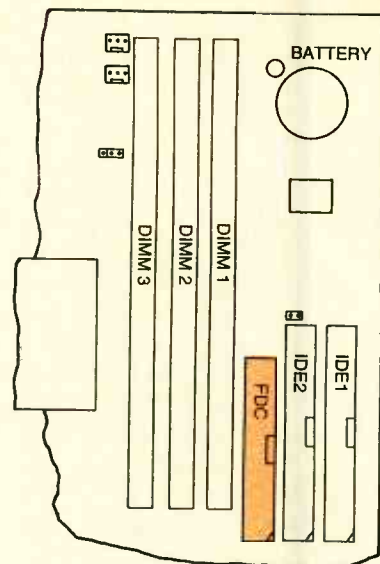

Fig. 3. Expanded view of the floppy-disk connector location on the motherboard.

connector from the "floppy drive B" connector. That is, the connector closest to the middle of the ribbon cable (before the twist) is designated as drive B and the one at the end of the cable (after the twist) is specified as drive A. Indeed, you only need this single cable to install two floppy drives. Like the IDE cable, this 34-pin ribbon cable also has either a red wire or red writing on one edge of the cable, indicating the side corresponding to pin number one. The floppy-drive connector must also be aligned so that the number one pin is closest to the "red edge" of the ribbon cable.

Having identified the correct orientation of the 34-pin ribbon cable and the floppy-drive port on the motherboard (FDC), gently insert the appropriate connector into the motherboard's floppy port. Do the same with floppy-drive-A and floppy-drive-B connectors—except insert these into the appropriate ports on the drives themselves. Finally, connect an available power-supply cable from the PC's power-supply to the power-supply port on each of the floppy drives. Recall that there is only one possible orientation in which these power-supply connectors can be inserted. After the ribbon cable and power supply have been connected, adjust the position of each drive so that when the cover to the case is reinstalled

the face plate of each drive is flush with the face of the case. Finally, tighten the mounting screws to lock the drive(s) into position.

Installing the CD-ROM. To install the IDE/EIDE CD-ROM disc drive, one can follow the basic installation procedure of the hard drive, with a few minor differences. The first difference is that the jumper pins on the drive must be configured to the "slave" setting. Consult the owner's manual to ensure the proper configuration of the jumper(s). Another major difference is that the CD-ROM drive must be installed into a 5 $\frac{1}{4}$ -inch external-facing drive bay. So, you will have to pop out one of the plastic external-facing drive bay covers in order to make room for the face of the CD-ROM drive.

As with the installation of the hard drive, you must connect an available power-supply cable to the power-supply port on the drive. In addition, you must connect an IDE ribbon cable so that its "red edge" is situated closest to the number one pin on the UDMA/IDE/EIDE port of the CD-ROM drive. Instead of connecting the other end of this IDE cable to the *primary* UDMA/IDE/EIDE port of the motherboard, you must connect it to the *secondary* IDE/EIDE port of the motherboard (IDE2).

Once the power and IDE cables have been connected, the position of the drive can be adjusted. Finally, the mounting screws can be tightened, locking the drive in place. Your CD-ROM is now physically installed in your computer.

Installing the Video/Graphics Accelerator Card. This is the first card you will want to install. In order to install it, identify the appropriate expansion slot(s). If you have purchased an AGP video card, it must be installed into the AGP slot of the motherboard, which is usually located above the other expansion slots on a Pentium II motherboard. The AGP slot appears somewhat recessed compared to other expansion slots. Next, remove the corresponding expansion slot bay plate, and insert the edge connector of the video card into the AGP slot. For PCI and ISA video cards, the same installation procedure must be carried out,

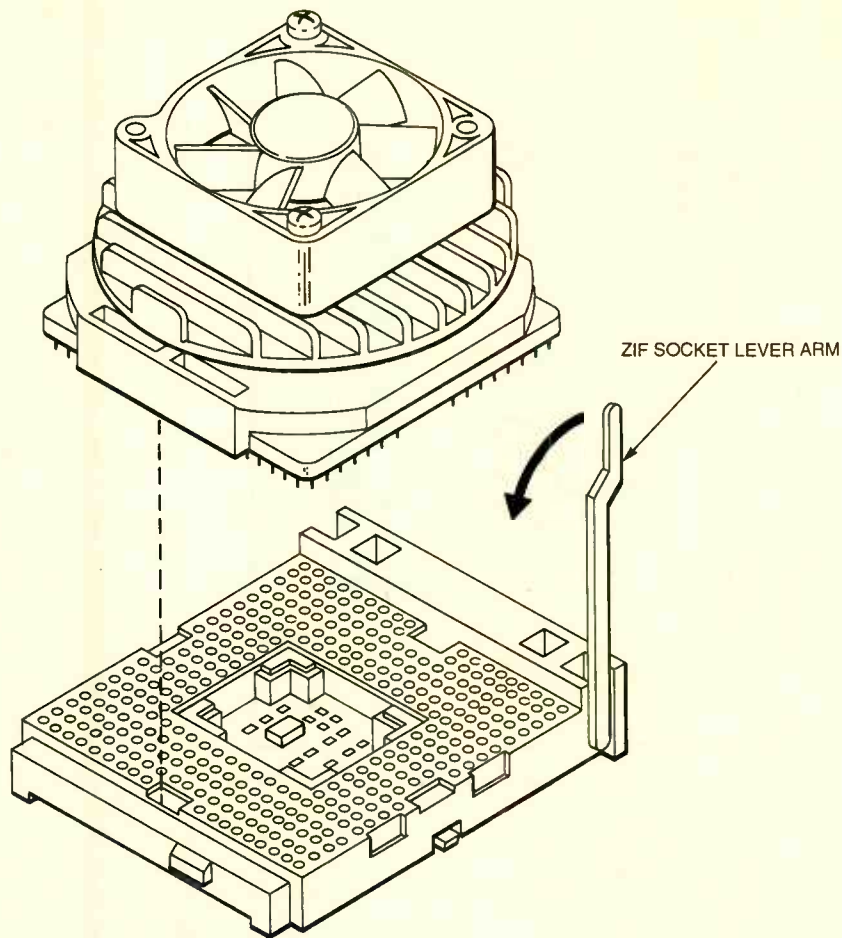

Installing a non-Pentium CPU is a snap. Locate your CPU socket on the motherboard, lift the lever of the ZIF socket, carefully insert the CPU into the socket, and then lower the lever.

except that a PCI card must be installed into a PCI expansion slot, and an ISA card must be installed into an ISA slot. PCI and ISA slots are different in that ISA slots are generally much larger, with wider contacts. Consult your motherboard owner's manual to confirm the types of slots and their locations.

Installing the Modem. The modem is installed in much the same way as the video card. If you have an external modem, installation is extremely simple. Connect it to your PC's 25-pin COM-port, through the appropriate cable, then attach the AC adapter to the modem and plug it into a power strip or common wall socket. Since there are no components to install inside the computer case, it is best to perform this procedure *after* you have finished installing all internal components and closed up the case cover.

In order to install an internal

modem, you must know the form of the card that it is on—ISA or PCI. Consult your modem owner's manual to make sure that the modem and the jumper settings are correct. For this initial installation, it is best to have the jumpers configured to plug and play (PnP). Even though this is almost always the factory default setting, occasionally a modem slips by in a different configuration.

Next, simply insert the card into the appropriate expansion slot, as you did with your video card. Secure its plate with a screw, and your modem installation is finished.

Installing the Sound Card. As with most ISA and PCI cards, the sound card is installed using the same methods as for the modem and the video card. Identify the form of the card, ISA or PCI; and then check the jumper settings, ensuring that the card is in the PnP configuration.

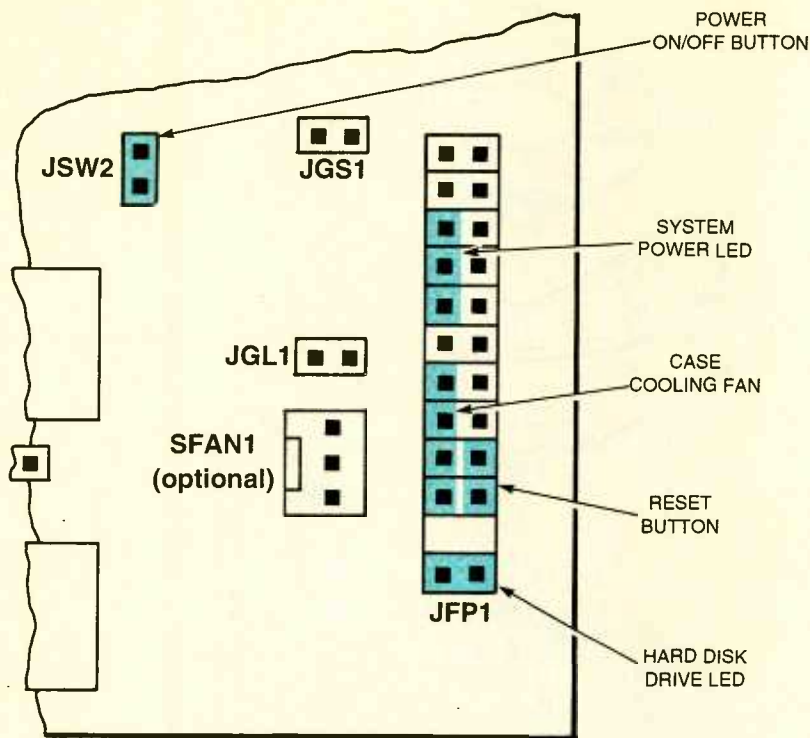

Fig. 4. Expanded view of several power-supply connectors on the motherboard.

Then simply insert the card into the appropriate expansion slot, and secure its plate with a screw.

CPU Installation. With the advent of the Pentium II processor, and its corresponding Slot 1 on the motherboard, CPU installation has become incredibly simple. There are four components that must be identified in order to successfully complete this installation. They are the Pentium II CPU, the Slot 1 location, the CPU cooling fan (if available), and an available power supply cable for the CPU cooling fan.

The Pentium II CPU is clearly marked with *Intel's* logo and the words "Pentium® II Processor." It may take you by surprise, as it is not the standard, flat mounting, square-shaped CPU that has dominated the industry for the past decade. The Pentium II is rectangular and mounted on a board with edge connector pins along its single exposed side. It is installed in the same way that RAM boards are installed. Holding it by its non-connector edge, simply find the only orientation in which the CPU will fit into the Slot-1 connector. Then slide it into Slot 1 at a 45-degree angle, and swing the board into the vertical position, using the pin-con-

necter edge within Slot-1 as a pivot.

If you have neither a Pentium II CPU nor a Pentium II processor (such as *Cyrix/IBM, AMD, Pentium MMX brand, etc.*), chances are that you are attempting to install your common CPU into a ZIF socket. This too is a simple task. The components are the CPU, the ZIF socket, an optional heatsink, and an optional cooling fan. The ZIF socket is easily identified as the only socket with female pinholes arranged in concentric squares. It is also the only socket that has a lever arm attached to one side. There should be an identifying number "1" printed on the socket, indicating where the corresponding "Pin 1" is supposed to go. The CPU has a single beveled edge, indicating the position of "Pin 1." Simply raise the lever arm to a vertical position (90-degrees), then place the CPU into the socket. It should require no force for the CPU to drop into place—pushing could damage the pins of the CPU. Once the CPU is in place, close the lever arm so that it is flush with the rest of the slot. Attach the cooling fan or heatsink (both optional), using the clips that are sold with either. If you have attached a cooling fan, you must connect the power to it. Your CPU is now installed.

Connecting the Power-Supply Cable.

The cable from the power supply to the motherboard requires the identification of two elements, the power-supply cable and the power-supply slot. The power-supply cable is one of the multi-wire cables that emanate from the power-supply. Newer power supplies are made with an ATX port at the end of the power-supply cable. Also, if you have a power supply and ATX case that were purchased together as a unit, the power-supply cable can easily be recognized because it will be the only 22-wire, multi-color cable, with a single connector at the end.

If you are lucky enough to have purchased an ATX power supply and an ATX case, you will find that there is only one orientation in which the power-supply cable can be inserted into the ATX power supply port. Consult your manual for location of your ATX power-supply slot.

If you have an older power supply, you will find one 12-wire, or two six-wire, multi-color cables that are different from all the other multi-color cables from the power supply. There are several differences, aside from the fact that the other cables have only four wires. These two cables will lead into narrower connectors, which are perfectly rectangular in shape and usually white. This is unlike the four-wire cables that connect to drives and other internal devices. (Note: If you have a pair of six-wire power-supply cables, you should consult the manuals that came with the case and the motherboard to determine this proper orientation. Although they are usually installed so that the two red wires are adjacent to one another, forming a line of 12 wires, some manufacturers may not follow conventional color-coding). *An improperly installed power supply can fry your motherboard and any components that are on it.*

Hooking Up the Power, Reset Buttons, and LEDs.

Most computer cases come with four handy little features that must be hooked up before you close up your case. These are the power on/off switch, the reset button, the system power LED, and the hard-disk-drive LED. If

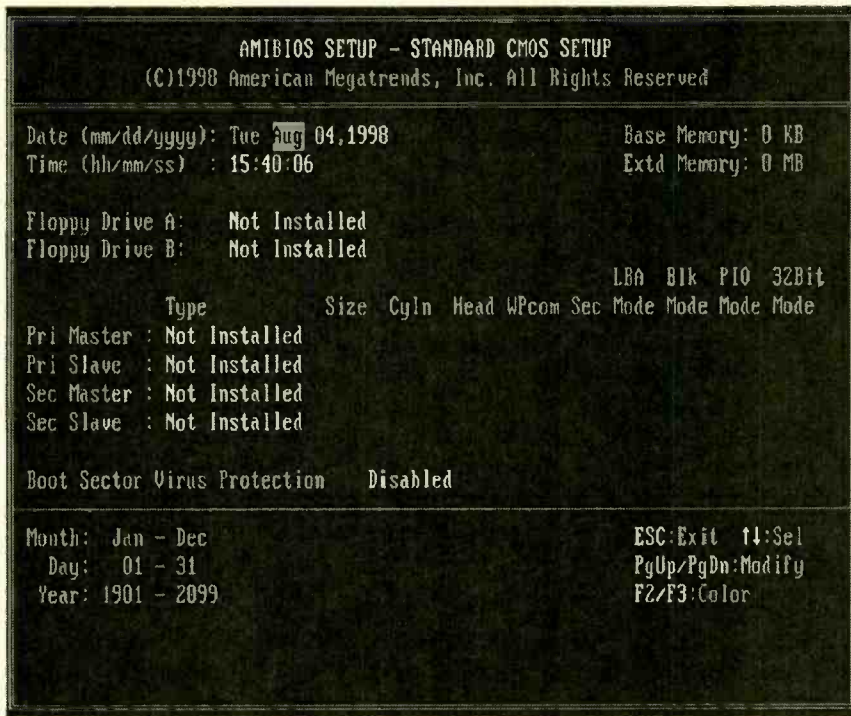

Typical items in a BIOS "Standard CMOS Setup Menu" are divided into a number of user-determined categories.

there is one area of PC setup information that cannot be generalized, it is the location of the connectors for these features. The best way to ensure that they are connected properly is to consult your motherboard owner's manual. See Fig.4 for the connections found in our system.

While I know of no generally accepted color code for such features, the following wire color legend may apply to your case:

- Power on/off button—white and blue
- Reset button—black and green
- Hard-disk-drive LED—white and red
- System-power LED—white and green
- Case fan—black and red

Connecting the Power Cables, Monitor, Speakers, Mouse and Keyboard, etc. As we approach the last part of the installation of the hardware items for your PC, we realize that you, our knowledgeable readers, are getting into a routine with these installation techniques. Hence, we will not bore you with the connection of the remaining required items, such as the keyboard, mouse, monitor, etc. Suffice to say

the hardware installation of these external assemblies can be gleaned from their respective owners' manuals. This step completes the physical assembly of the PC.

Buttoning Up the Cabinet. Closing up your case is a welcome task by now. But before you rush into replacing the panels/cover, double check the connections of the cables you have just installed and make sure your documentation is complete. It is very common to finish an installation or upgrade, only to find that your system is malfunctioning because of an accidentally loosened or disconnected cable. Since you may have to open up your case again, it may be a good idea to leave only a single screw holding your case closed until you are sure all the hardware/software settings match.

Blastoff and Back to Mission Control. So you've got all of the drives mounted in their bays. You've got the power supply connected properly and power cabling is distributed throughout the system. All of the cables are connected, and the CPU and RAM are in their sockets. The power cable is now plugged into a

fused AC outlet. Your trembling finger hesitates in front of the power button for a moment, you depress it and—Voila! The computer is alive! A light goes on and you hear some sweet noises from your baby. *But you are not done yet.* How does the CPU know how much SRAM & DRAM is available to it? How does the motherboard know what to do with the keyboard attached to it? This section concerns getting the hardware devices to communicate with one another so that you, the user, can control those devices.

What happens when you turn the computer on? There is a set of programs built in to the computer that automatically checks what devices are installed, and these programs also test those devices. This set of programs is called the BIOS, which stands for *Basic Input Output System*, and is stored on a special set of ROM (Read Only Memory) chips on the motherboard. The BIOS has two primary functions—inventory and initialization. To accomplish this, the BIOS performs a POST (Power On Self-Test). To configure your hardware devices in the BIOS, you enter the BIOS setup program (or CMOS setup—since the ROM is stored in Complementary Metal-Oxide Semiconductor material). This is accomplished by pressing a key or combination of keys on the keyboard when the system is first powered on. The key is usually the F1 function key or the (delete) key, depending on the type of BIOS you have. You will be prompted at the top or bottom of the screen—"Press <F1> to Enter Setup," but I have found that, whatever key you are prompted to enter, the key will usually work.

The BIOS is just as its name suggests—basic. In the BIOS, you configure those devices that the system requires for basic functionality. A computer will function without a printer, sound card, or Zip drive—but try using the PC without a CPU, or RAM, or a monitor—then you have a problem!

The BIOS configures the following Input/Output (I/O) devices:

- CPU
- RAM (SRAM and DRAM)
- Motherboard and Chipset
- Hard-Disk Drive (HDD)

- ATAPI CD-ROM drive
- Video
- Floppy-Disk Drive (FDD)
- Ports

The BIOS also configures some other startup options as well, and we will discuss them as necessary.

There are many screens with numerous options in the setup program. Different BIOS manufacturers have different interfaces and may vary in the options they provide and the means by which you navigate the different screens. All of the options that follow, however, are required for any BIOS, so if yours is different, you may just have to search a little to find them. There will always be instructions along the bottom of the screen or along the right margin that explain how to navigate through the BIOS.

DATE & TIME

The first two options in the AMI BIOS main setup screen allow you to configure the date and time. Although this is not required, as you can set the date and time through *Windows 95*, I would do it anyway.

FLOPPY OPTIONS

Today's PCs come standard with support for two floppy-disk drives. Generally, only one is installed—a 3.5-inch drive with a 1.44-MB capacity. This 3.5-inch drive should be configured as drive A. Availability of a second floppy drive provides support for another 3.5-inch drive, or an older 5¹/₄-inch, 1.2-MB drive that is rarely used anymore. Disable drive B if you do not intend to install a second floppy drive. Otherwise, choose the appropriate setting for your additional drive.

BOOT OPTIONS

Further down the main setup screen, you will find "Boot Options." Hit the <ENTER> key on the keyboard to get to the boot options screen, set the first boot device to "Floppy" and set the second boot device to "Hard Disk." Disable the third and fourth boot device, if those options are available, and ignore the rest of the options in this screen. Booting refers to how the computer searches for and loads an Operating System (OS). Here you are telling the BIOS to first search the floppy Drive A for an OS,

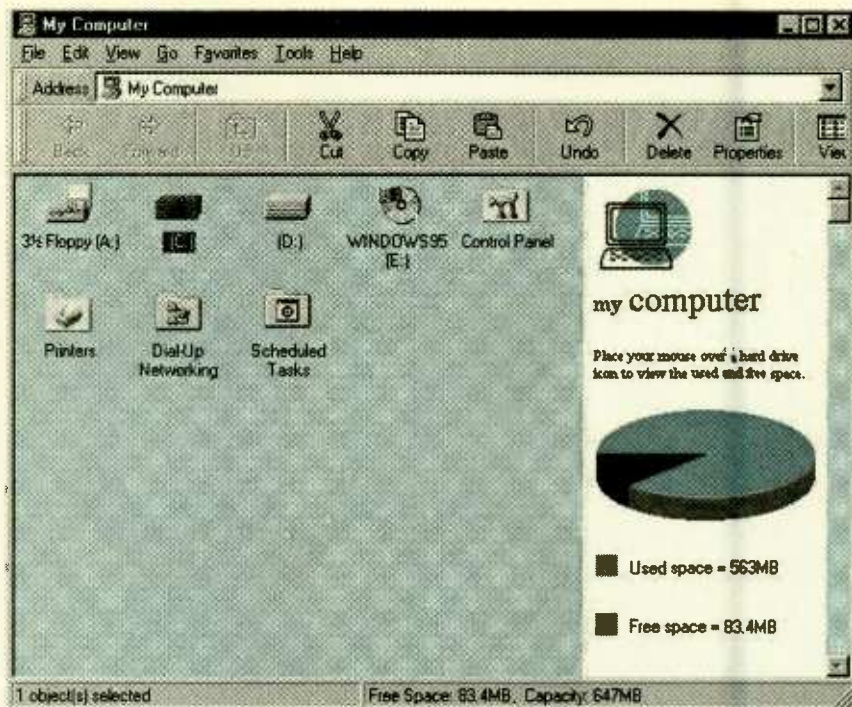

With Windows 98, the desktop operates like a Web browser, and you navigate the system using a feature called "My Computer."

and then the hard-disk drive. This is important for initial configuration of the hard disk, and it is also helpful in troubleshooting a malfunctioning hard drive. Apart from rare circumstances, booting to a floppy drive before the hard drive is an important safety precaution that *should not be changed*.

HDD CONFIGURATION

Back in the main setup screen, the next step is to configure the hard-disk drive. This is the first of many steps you will be performing in order to prepare the HDD to receive data, and here we are concerned with getting the drive recognized by the system.

All new BIOS programs have a utility that will autodetect a hard-disk drive for you. If your drive is anything but a SCSI drive (that is, an IDE, EIDE, UDMA, etc.), you need to set the Primary Master to "Autodetect." SCSI drives have their own BIOS and are not set up here in the main system BIOS. Press <Enter> on the Primary IDE Master and set the IDE device configuration to "Auto." The BIOS will then figure out the number of cylinders, heads, sectors, and the capacity of the drive. IDE translation is required because of early limitations on the size of a hard drive (for example,

the BIOS limit on the number of cylinders is 1024). For today's large capacity drives to be recognized by the system, IDE translation maps the actual, physical configuration of the drive to a logical configuration that the BIOS can control. Set IDE translation to "Autodetect" and make sure that the other parameters here (such as PIO modes) are also set to "Autodetect" as well.

ATAPI CD-ROM DRIVE

An ATAPI CD-ROM drive is controlled by the IDE controller. SCSI CD-ROM drives should not be configured in this setup program. If the CD-ROM drive is attached to the same cable as the hard-disk drive, then the CD-ROM drive is the Primary Slave. I have configured the CD-ROM drive on a different cable from the hard-disk drive, so I set the Secondary Slave to autodetect.

There are a few settings you may not be able to configure but should be aware of nonetheless. The video mode should be set to "EGA/VGA," base memory should always be 640K and extended memory (XMS) should be the amount of physical RAM you have installed, less the 640 kB of conventional memory. For example, I installed 64-MB of RAM in my system which equals 65,536 kbytes (65,536 less 640 kB of conven-

WINDOWS 98 CONSIDERATIONS

If you are up in the air about which Windows operating system to install on your system, *Windows 95* or *Windows 98*, you are not alone. Fortunately for those who are installing an OS onto a new system, this dilemma is easily resolved. If you have no OS, and must purchase a new one, there is no contest; *Windows 98* is by far the better buy, and will help you get the most out of your PC. However, if you already own a copy of *Windows 95* and are considering *Windows 98*, you may want to decide if buying the upgrade is worth it for you. According to *Microsoft Windows 98 Product Manager*, Kim Akers, there are many improved functions and capabilities in this new OS. Here are some of the more salient features:

1. *Set up in Windows 98 has been streamlined and simplified in comparison to Windows 95. Instead of having questions sprinkled throughout the installation process, as was the case in Windows 95, all the dialog boxes for Windows 98 are placed at the beginning.*

2. *"Maintenance Wizard"—This feature enables users to automatically maintain their machines. Just as a car needs an oil change on a regular basis, computers need to be "cleaned up" to maintain optimal performance—the "Maintenance Wizard" performs that task.*

3. *Faster start up, application load, Web page download, and shut-down performance—Windows 98 works to limit that wait time for users. For example, on the average, application programs start around 36 percent faster with Windows 98.*

4. *Support for USB hardware—makes adding hardware as easy as inserting bread into a toaster.*

5. *FAT32—Windows 98 enables a user to convert to the FAT32 File Allocation Table, which helps reclaim hard-disk space. In fact, on average, users can reclaim about 28 percent of their hard disk back by this conversion.*

If these features are important to you, you may find the cost of upgrading to *Windows 98* well worth it.

tional memory leaves 64,896 kbytes of XMS). The amount of memory is generally not user-defined but is automatically detected by the system. You should make sure that these numbers are accurate, however, or you may have installed the RAM incorrectly.

Main Setup Configured. Once the Main setup page has been configured, it's time to move on to the advanced settings. Check the processor type and processor speed and "cachesize" to make sure that these entries are accurate. Press <ENTER> to set the "peripheral configuration" and set the "Configuration Mode" to "Auto." Escape out of the "Peripheral Configuration" screen back into the "Advanced Setup."

Finally, you need to set the plug and play configuration to "Use CM," which enables the PnP configuration manager.

Now that the BIOS Setup is configured, press <F10> to save your changes and exit. The computer will store the settings you entered and restart the system. Don't worry that you will lose this information when the computer is turned off, the BIOS settings are kept alive by a battery on the motherboard, much like the clock in a car is directly attached to the car's battery. As the computer

restarts, you should see the POST in action.

First, you will see the BIOS date and version, and then the various devices will be inventoried and initialized. The numbers quickly spinning into the thousands represent your RAM being tested and counted. When the POST completes, you will hear a single beep telling you everything is okay with the hardware. Anything other than a single beep means there is something wrong with the hardware or its configuration. In fact, if you are ever having trouble with your computer, a quick way to determine whether the problem is hardware-related or software-related is to restart it. If you get a single beep, the POST performed properly, and you can be almost 100 percent assured that the problem lies with the software.

What is this error message on the screen? The hard-disk drive, while recognized by the BIOS, is not yet operable. The next two steps involve preparing the hard-disk drive to receive data, but it requires a little legwork on your part. Here is the problem—you have a CD-ROM with the *Windows 95* operating system on it, but you need to install the device driver for the CD-ROM drive to use the CD-ROM. A device driver is a software program that controls a

hardware device, and a device driver is required for every device in your system. How do you install the CD-ROM device driver onto the hard disk if the hard disk is currently inoperable?

What you need now is a bootable floppy diskette. A bootable floppy is a 3.5-inch diskette with an operating system on it. Remember, that we configured the BIOS to look for an operating system on the floppy drive before the hard drive. Now you know the reason—you must boot to a floppy and then copy the operating system from the floppy to the hard drive. In order to do this, you need to prepare a boot diskette. Find a PC with *Windows 95* already installed on it and double-click the "My Computer" icon (by default this icon is on the top-left of the screen). Put a blank floppy diskette in drive A, and right-click on the icon representing this drive. Select "Format" from the drop-down menu. Do a full format, just to be on the safe side, and make sure that the last option, "Copy System Files," is checked off. Then click "Start."

Once the format is finished, you need three more files on the diskette: "format.com," "fdisk.exe," and "sys.com." These files can be found in the c:\windows\command directory. Click each of these three files while holding down the control key (CTRL) on the keyboard, right-click on any one of the three highlighted files, and choose "Send To 3.5-inch Floppy (A)." This will copy those files to the floppy diskette. Now take this diskette and put it in the floppy drive of your computer and turn the computer on. After the POST, the PC should boot from the floppy drive. After pressing <ENTER> twice, to skip the date and time entries, you are left at a DOS prompt (A:\>) and a blinking cursor. Type <FDISK> to enter the partition utility. With the "FDISK" utility, you will partition the hard drive—that is, you determine if you want the entire drive to be available for one operating system, or you want to split the physical hard disk into multiple, smaller logical drives

Before "FDISK" begins, you may see a screen that warns you that large disk support may make this drive incompatible with other dri-

ves, namely those formatted with DOS, *Windows NT*, and even other versions of *Windows 95*.

For our purposes, however, go ahead and enable large disk support. Type <Y> and hit <ENTER>. Choose Option 1 to create a DOS partition, and then choose 1 to create a primary DOS partition. Use all of the free space available for this partition and, since there is no data on the drive, ignore the warnings that all of the data will be lost. Bear in mind though, that all data is lost when you "FDISK" a drive and do not attempt this on a drive with important information on it. There are third-party utilities available (such as *Partition Magic*, from *PowerQuest*) that enable you to repartition a drive without losing data, if you should need to in the future.

After the drive is partitioned, it must be formatted. Do this by typing <Format C:/s> at the (A:\>) prompt. This command will format the hard drive and the switch (/s) will put the operating system on the drive as well. This will take a fair amount of time, depending on the size of your hard drive. After the drive is formatted, remove the floppy diskette from the drive, and restart your computer. If all went well, you should be left off at a C prompt (C:\>).

Next, you need to install the CD-ROM driver. Use the utility diskette(s), and follow the instructions that came with your CD-ROM. The instructions for setting up my *Creative Lab's Soundblaster Vibra 24* are simple and straightforward. It took me about two minutes to get the CD-ROM recognized.

Windows 95. Now we must install *Windows 95* operating system (OS) for your PC. Put the *Windows 95* installation CD into the CD-ROM drive and type the letter of your CD, followed by a colon (for example D:). From the D: prompt, type <SETUP>. This launches the *Windows 95* setup program (in fact, typing <SETUP>, or <INSTALL> is usually how you add programs to your computer). Follow the instructions on the screen and enter any information as necessary (your name and the *95*-license number, for example). Installation is surprisingly simple and straightforward.

There are essentially three steps to the *Windows 95* installation: First, the program gathers information about the hardware and software installed in your system to make sure that they meet the minimum requirements to run the *Windows 95* operating system (minimum requirements are always written on the side of the box the software is packaged in). Second, *95* will copy files from the CD to your hard drive. Finally, *95* will restart your system and finish the installation process. Choose "Typical Installation," when the choice appears, and at one point you get to choose which components of *95* to install. Follow the instructions on-screen to select (or deselect) anything you may or may not want in *Windows 95*. For example, you may not want the games installed but you may want to install network support (if you are thinking of connecting many computers together). You may also want to select "System Monitor" for troubleshooting and benchmarking your system. The entire installation process should take about 20 minutes. When you see the "Welcome to Windows" screen on top of *Windows Explorer* (which is what *Microsoft* calls the *95* interface), you are finished.

Windows 95 will automatically detect any PnP devices, and when necessary, it will automatically assign an IRQ number and DMA setting to the devices. Occasionally, the OS will run into conflicts whereby two or more devices are set to the same IRQ number. This usually occurs if one of the devices is not PnP or if its jumper pins are not set to PnP. There are two ways to go about correcting the conflict. The first is to make sure that the device is set to PnP. The second is to go into *Windows 95* and open up the "Device Manager." This is done by clicking on "Start," then "Settings," then "Control Panel," then on the System icon, which looks like a monitor. A window labeled "System Properties" should appear. By clicking on the "Device Manager" tab, you will see all of the devices attached to your system. An exclamation mark identifies any devices that have conflicts. Double-clicking on the troubled device will bring up a window,

which gives information about the device. The "Resources Tab" displays any conflicts and may allow you to change the settings. It will give a list of alternatives if available. Keep in mind that if your device is not set to PnP, you may have no alternative setting choices. In such a situation, check to see if the settings of the device with which it is conflicting can be changed. In case you have to change several IRQs, here is a list of IRQ settings that are commonly applied:

- 0—System Timer
- 1—Keyboard
- 2—Programmable Interrupts
- 3—COM2/COM4 (Serial Port 1)
- 4—COM1/COM3 (Serial Port 2)
- 5—Hard-Disk Drive
- 6—Floppy-Disk Drive
- 7—LPT1, LPT2
- 8—CMOS Real-Time Clock
- 9—Re-directed to IRQ2
- 10—available
- 11—available
- 12—Mouse
- 13—Disk Drive
- 14—available

With a little perseverance, you should be able to find an IRQ setting for each of your components and resolve any conflicts.

Pat Yourself on the Back! Congratulations! You have just completed building a PC from scratch. From the case and power supply, up through the BIOS, and all the way into the operating system, you have created a PC tailored to your own specifications. Now you can customize the computer further by installing additional hardware, such as a printer, camera, or network card, and additional software, such as a word processor, Internet browser, database program, or games. Follow along in future **Popular Electronics** columns, such as *Multimedia Watch*, *Netwatch*, *Computer Bits*, etc. for reviews of multimedia and software packages.

As you have seen, the whole process requires some time and a fair amount of patience, but it is certainly not rocket science to assembling your own PC. With just a little skill, building your own computer is challenging, fun and educational. Now have fun with it! ■

MULTIMEDIA WATCH

Fast CD Recording, New Graphics Cards, and New Software

MARC SPIWAK

I pretty much take CD recording for granted now. I've had access to the drives for about three years, and every day it seems I find new ways to use CD-R. Of course all I really do is burn data onto blank discs, but for so many different reasons. Sometimes I simply need to copy a disc, and there's software that lets anyone capable of turning on a computer and working a mouse, make disc copies. I can make backup copies of music CDs, or even make my own custom audio CDs featuring various artists and only the tracks I want. Quite often I have to return a loaner computer system and before I do, I burn a disc of all its files just in case I need something for the next system.

When I'm at work, with a T1 connection to the Internet, it takes only minutes to download a 10 or 20 megabyte file or collection of files. Any chunk of data that size is hard to get from one PC to another without using a removable media drive—and then the drive usually has to travel with the data. When I burn data to CD, any system can read the disc.

Many times I'll download the installation software for a piece of hardware off the web. Then it's a simple matter to burn the data to a CD, which gives me a permanent installation disc for the hardware I'm working with. I could go on and on with the many uses I've found for CD-R, but you get the point. The blank discs cost about a buck apiece these days.

CD recorder technology hasn't changed much. The first CD-R drives recorded at 1×, or 150 kilobytes per second (kBps). The 1× drives were very expensive and slow. But then about two years ago, 2× drives appeared, which were quickly followed by a few 4× recorders. At the same time, prices for the drives plummeted to the sub-\$500 mark, which made them affordable.

Today you can get low-end recorders for \$200 to \$300, but 4×, or 600 kBps, is still the fastest. It seems



Teac's CD-R55S (internal) and CD-R55SE (external) can record CDs at 4× and read them at 12×.

that you can't burn data onto a CD any faster than 4× while still maintaining adequate tolerances—at least for now. Until recently, CD-R drives were also slow as readers, but not anymore. Teac's new CD-R55S records at 4× and reads at 12×.

Most CD recorders you'll come across are 2× recorders. It takes about half an hour to fill up a disc with one of them. With the CD-R55S, it takes just fifteen minutes to create a typical 650-MB CD. A 1-MB buffer helps avoid buffer underruns when recording. Its 12× read capability and 165 ms average access time are faster than other CD recorders. The CD-R55S is available as internal and external (CD-R55SE) models, but I tend to prefer external because it's easier to move from system to system. List prices for the drive are \$449 for internal and \$549 for external.

The CD-R55S has a SCSI interface so it's easy to connect to any system that has a SCSI adapter. It has a cad-yless power tray, which I much prefer

over the older CD-R drives that required the use of disc caddies. The CD-R55S supports all of the leading PC- and Macintosh-based CD-authoring programs and supports all standards including *Track At Once*, *Disk At Once*, *Multi-Session*, and so on.

ATI ALL-IN-WONDER PRO

It used to be that I always wanted the fastest possible graphics card I could get my hands on, and it used to really pay off by making the entire system that much faster. Faster graphics cards still make systems faster, but the new systems are so much faster than software needs them to be that it generally makes little difference what graphics card you have. Unless you're running software that requires a specific type of graphics accelerator, you should be happy with almost any 4-MB card. These often cost no more than \$50.

Now that it makes less of a difference what graphics card a system has, I tend to like a card that does a lot more

WHERE TO GET IT

ATI Technologies, Inc.

33 Commerce Valley Drive East
Thornhill, Ontario, Canada L3T 7N6
905-882-2600
www.atitech.com

**CIRCLE 60 ON FREE
INFORMATION CARD**

Cavedog Entertainment

3855 Monte Villa Parkway
Bothell, WA 98021
888-477-9369
www.cavedog.com

**CIRCLE 61 ON FREE
INFORMATION CARD**

Creative Labs

1901 McCarthy Blvd.
Milpitas, CA 95035
800-998-5227
www.creativelabs.com

**CIRCLE 62 ON FREE
INFORMATION CARD**

Expert Software, Inc.

800 Douglas Road
North Tower, Suite 600
Coral Gables, FL 33134
800-759-2562
www.expertsoftware.com

**CIRCLE 63 ON FREE
INFORMATION CARD**

Multimedia 2000

1100 Olive Way, Suite 1250
Seattle, WA 98101
206-622-5530
www.m-2k.com

**CIRCLE 64 ON FREE
INFORMATION CARD**

STB Systems, Inc.

1651 North Glenville
Richardson, TX 75081
800-234-4334
www.stb.com

**CIRCLE 65 ON FREE
INFORMATION CARD**

Teac America, Inc.

7733 Telegraph Road
Montebello, CA 90640
213-726-0303
www.teac.com

**CIRCLE 66 ON FREE
INFORMATION CARD**

than ordinary graphics cards. And if it's a fast graphics accelerator as well, then I'm all the more happy. Not slow by any means, the *ATI All-In-Wonder Pro* does a lot more than any other single-card solution.

I like the *All-In-Wonder Pro* because it occupies only a single PCI or AGP



The Core Commander from Total Annihilation: The Core Contingency is a pretty destructive dude.

slot, yet it does so many things. To begin with, it's a fast 2D/3D graphics accelerator, suitable for any entertainment/business PC. The card is based on *ATI's Rage Pro Turbo* 64-bit graphics accelerator. The AGP 2X *All-In-Wonder Pro* takes advantage of the *Pentium II* processor and AGP technology to deliver premium graphics performance.

It has a TV tuner built in, so I can hook it up to cable and have more tuner options than any TV set. It also has video in and out, so I can capture video from any source or output PC video to a large-screen TV for awesome game playing or record the output on VHS tape. The card accelerates video quite well and comes with a great player application that looks like a home entertainment system. *All-In-Wonder Pro* is a computer-based video production studio all in one.

Using the built in TV tuner, you can select your own close-ups or schedule your favorite shows to come on. A neat channel scanner scans through all available stations, placing multiple channel stills in a grid on the screen. If you see a program you like, you just click on the image and that channel is selected. An instant replay feature lets you catch scenes you missed.

All-In-Wonder Pro can receive closed captioning, so you can program the TV display to become active when key words you specify are detected, say the score in a ball game, the stock

quotes, or weather. You can even record transcripts of TV programs from the closed captioning information. Prices for *All-In-Wonder Pro* range between about \$250 and \$325 depending on whether you want PCI or AGP, and if you want four or eight megabytes of memory. I say it's money well spent.

3D BLASTER VOODOO2

New from *Creative Labs* comes the *3D Blaster Voodoo2*, a graphics accelerator card intended for gaming based on the *Voodoo2 Graphics* chipset from *3Dfx Interactive*. Both models feature high-speed, single-cycle DRAM and can process up to 3 million triangles per second, or 90 million dual-textured, bilinear-filtered, MIP-mapped, alpha-blended, Z-buffered pixels per second. In an SLI configuration where two cards are used in tandem, each processing half of the scan lines, the card can process 180 million pixels per second.

Designed for PC gamers looking for top performance, the *3D Blaster Voodoo2* works with an existing graphics card. It's compatible with any graphics card, including AGP, using video pass-through technology. You need at least a *Pentium 90* to use the *3D Blaster Voodoo2*. The *3D Blaster Voodoo2* comes in a 12-MB version for \$299 or an 8MB version for \$229.

VELOCITY 128

The *Velocity 128* from *STB* is a new
(Continued on page 68)

Take This Giant Circuit Library For Only \$4.95

when you join the
**Electronics
Engineers'
Book Club®**

"...includes schematics for the latest electronics
circuits from industry leaders..."
—Popular Electronics

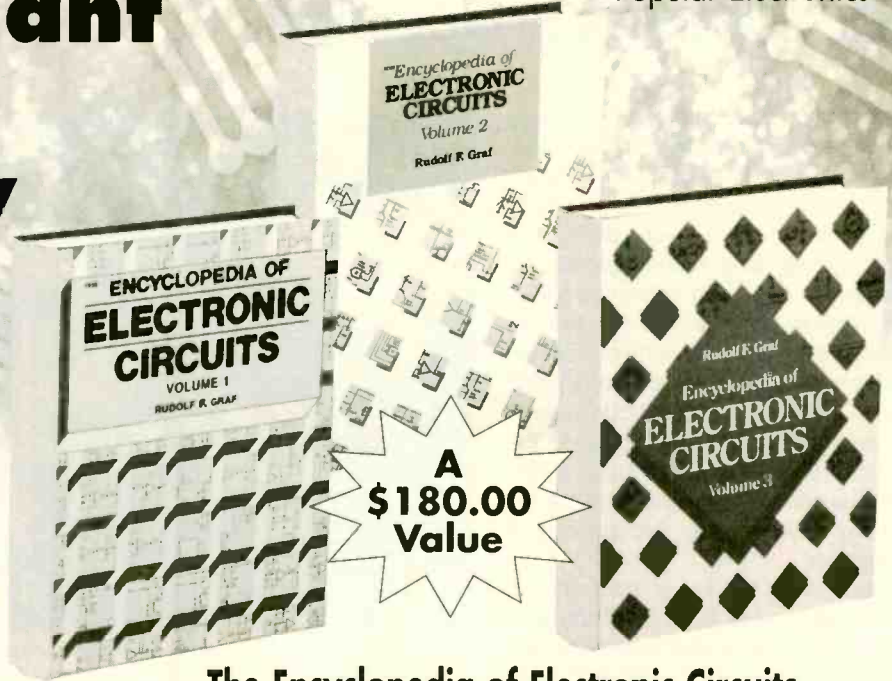

The Encyclopedia of Electronic Circuits
Volumes 1-3 by Rudolf F. Graf
2,344 total pages • 3,490 total illustrations

**Hundreds of circuit ideas alphabetically
arranged—from Alarm circuits to Zero
crossing detector circuits!**

Turn to this comprehensive circuit library for hundreds of project ideas...valuable troubleshooting and repair tips...and concise pinout diagrams and schematics. Each volume contains more than 700 electronic and integrated circuits and covers 100+ circuit categories.

As a member of the
Electronics Engineers' Book Club...

you'll enjoy receiving Club bulletins every 3-4 weeks containing exciting offers on the latest books in the field at savings of up to 50% off the regular publishers' prices. If you want the Main Selection, do nothing and it will be shipped automatically. If you want another book, or no book at all, simply return the reply form to us by the date specified. You'll have at least 10 days to decide. If you ever receive a book you don't want due to late delivery of the bulletin, you can return it at our expense. Your only obligation is to purchase 2 more books during the next 12 months, after which you may cancel your membership at any time. And you'll be eligible for FREE BOOKS through our Bonus Book Program.

Publisher's price shown. © 1998 EEBC

If coupon is missing, write to:

Electronics Engineers' Book Club®
A Division of The McGraw-Hill Companies
P.O. Box 549, Blacklick, OH 43004-0549

☎ **Phone:** 1-614-759-3666
(8:30 am to 5:00 pm EST Monday-Friday)

📠 **Fax:** 1-614-759-3749
(24 hours a day, 7 days a week)

🌐 **Internet:** www.bookclubs.mcgraw-hill.com

ELECTRONICS ENGINEERS' BOOK CLUB®

A Division of The McGraw-Hill Companies, P.O. Box 549, Blacklick, OH 43004-9918

YES! Please send me The Encyclopedia of Electronic Circuits-Vols. 1-3 (5857863), billing me just \$4.95, plus shipping/handling & tax. Enroll me as a member of the **Electronics Engineers' Book Club** according to the terms outlined in this ad. If not satisfied, I may return the books without obligation and have my membership cancelled.

Name _____

Signature _____
(Required on all orders)

Address/Apt.# _____

City _____ State _____

Zip _____ Phone _____

Valid for new members only, subject to acceptance by EEBC. Canada must remit in U.S. funds drawn on U.S. banks. Applicants outside the U.S. and Canada will receive special ordering instructions. A shipping/handling charge & sales tax will be added to all orders.

PIF1198A

DX LISTENING

Broadcaster's Decisions

DON JENSEN

It's November and that means many of the major international SW broadcasters again are changing frequencies, and sometimes program schedules as well. The four-times-a-year changes in station transmitting frequencies may be puzzling to beginning shortwave listeners. After all, their favorite AM and FM stations stay put on a certain assigned frequency year-round and year after year. TV stations don't bounce from channel to channel, depending on the season. But the big international SW broadcasters do, usually around the first Sunday in March, May, September, and November.

How does a major international broadcaster select its program schedule when it will broadcast to certain areas of the world? And how about frequency management? How are the shortwave frequencies selected, and why do they change several times a year?

First, the schedule selection is a relatively easy matter. To a great degree, the "when" is determined by the listening patterns of the intended audience. It would make no sense to schedule an English-language North American shortwave service at, say, 10 a.m., eastern time. Relatively few listeners will be around to tune in. Most US and Canadian listeners do their tuning during our evening hours. So you'll find that many big SW stations beam English language programs our way during the prime evening hours in North America, roughly between 0100 and 0600 UTC.

But the audience is only part of the scheduling equation. Propagation—how shortwave signals reach us—is the other.

Some years ago, Radio Thailand sought to reach an American audience with English-language shortwave pro-

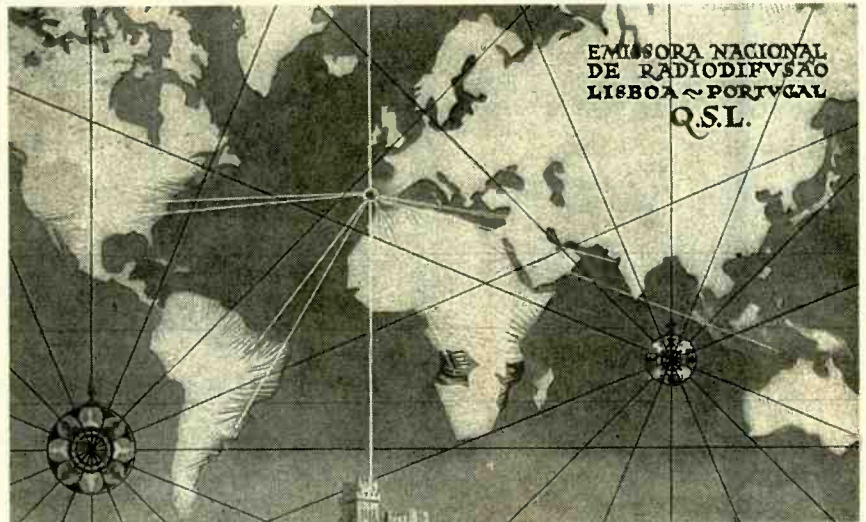

QSL card from earlier years when the Portuguese shortwave service broadcast in a half dozen major languages, including English, to a worldwide audience. Radio Portugal International earlier this year ended its foreign language programs.

gramming. Its so-called North American Service broadcast from 04:15 UTC—11:15 p.m. eastern time or 8:15 p.m. on the West Coast, prime listening time from the audience standpoint. But few if any US SWLs ever heard it because on the frequency chosen, transmissions from Thailand at that time of day were nearly impossible to hear. This points out why it is important that SW stations select both appropriate frequencies and times so that programs actually reach their intended audiences.

While some stations stick like glue to certain traditional frequencies—the BBC, for instance, has used 12095 kHz for years—the majority of the larger broadcast organizations make regular changes, dividing their year into four "seasons." They include two "long" seasons, the so-called "J" schedule (covering May through August) and "D" schedule (November through February). Also there are two short transitional schedules, "M" (March and April) and "S" (September and October).

The frequency choices for these periods are based on propagation factors that change season by season, based on such natural phenomena that affect signal propagation, including the

angle of the sun's rays and the number of hours of daily solar radiation.

SWLs, of course, know the vexing problem of having two, sometimes more, stations plopped down on the same or adjoining frequencies, causing a headache of mutual interference. With many stations vying for frequencies during the optimum evening hours in North America, what is surprising is that there isn't even more co-channel interference.

Attempting to coordinate this complex business of selecting shortwave frequencies is the International Frequency Registration Board (IFRB) of the International Telecommunications Union in Geneva, Switzerland. Since 1960, the IFRB has attempted, with some success, to reduce the chaos of seasonal frequency changes by broadcasters. Five months in advance of actual use SW stations are supposed to submit to the IFRB a list of frequencies they intend to use. The international agency compiles this data into a tentative schedule for the shortwave bands. Where it appears conflicts will occur, the IFRB recommends alternative frequencies.

But the IFRB has no real enforcement powers. So, while some broad-

CREDITS — Brian Alexander, PA; Albert Arnold, VA; Peter Costello, NJ; John Figliozzi, ONT; Bob Fraser, MA; Mark Humenyk, ONT; David Krause, OH; Harold Levison, PA; Jerry Lineback, KS; William McGuire, MD; Jay Novello, NC; Denis Pasquale, PA; Betsy Robinson, TN; John Wilson, DE; Robert Yajko, PA

GLOSSARY

BBC = British Broadcasting Corporation
DX, DXer = Listening to distant radio broadcasts; one who listens to DX.
ID = Station identification announcement.
kHz = kilohertz, unit of frequency measurement.
SW, SWL = Shortwave, one who listens to shortwave as a hobby.
UTC = Universal Coordinated Time, a time standard used by worldwide broadcasters and SWLs; UTC is five hours ahead of Eastern Standard Time, or CST+6 hours, MST+7 hours, PST+8 hours.

casting organizations scrupulously try to cooperate with the agency in providing advance frequency use information and following recommended changes, others simply go their own merry way.

It's not uncommon for broadcasters to indicate plans to use far more SW frequencies than they can possibly use to allow themselves some flexibility later in actual use. Other stations may jump from frequency to frequency, looking for a competitive advantage in delivering a signal with minimal interference with little consideration for the overall patterns of frequency use within a given SW band.

So when all is said and done, the shortwave station's actual choice of seasonal frequencies is a combination of technical planning and seat-of-the-pants guesswork.

During the next few weeks, chances are you'll find some of your favorite international shortwave stations operating on new frequencies. But then things should tend to stabilize until March, when again there will be more seasonal frequency changes.

BYE TO A LITTLE GUY

In past years, some of the most active and easily heard English language services belonged to SW stations in Europe's smaller nations. But as shortwave broadcasting costs escalated, many of them—including Luxembourg, Denmark, Belgium, Norway, and others—cut back operations or even disappeared entirely from the bands. Now another has joined them: Portugal.

In the 1960s and early 1970s, Portugal's English language external service was called the Voice of the West. The station, easily heard, broadcast in German, Spanish, Italian and French, as well as Portuguese and

English. It portrayed itself as a broadcasting bulwark against the Soviet Union's radio propaganda. Often heard was its defiant slogan: "The West must, and will win!"

At that time, the station's 45 minute English program was transmitted nine times daily to different parts of the world. The widely listened to Voice of the West even had its own DX club for SWLs. Following a revolutionary change of government in 1974, the SW station went off the air temporarily. It returned later but with a scaled back foreign SW service. In recent years, reception of the station has been somewhat difficult.

And on March 31, Radio Portugal International ceased English programming and other foreign language broadcasts. The station announced that it would continue on the air, however, but only with a limited schedule of Portuguese broadcasts.

A NEW VOICE

Dr. Adrian Peterson, longtime DX enthusiast and a spokesman for Adventist World Radio, announced earlier this year that AWR has purchased 133 acres of land near the small town of Argenta in northeastern Italy. This site will be the location of a new large SW broadcasting complex which is scheduled to open in July of the year 2000.

The site of the station originally was part of a 1930s reclamation project from the Adriatic Sea. The flat land with a high water table makes an ideal location for shortwave broadcasting, said Brook Powers, the station's engineering project director. Groundbreaking was scheduled for late this year. The transmitter building is to house four high-power SW transmitters, with space for adding two more eventually. The antenna field will contain six directional antennas.

The Italian government enacted special legislation several years ago to enable AWR to construct its powerful shortwave station in Italy. Programs will be aimed particularly to Central and Southern Asia, Africa and the Middle East, but certainly should also be audible in North America.

DOWN THE DIAL

Here are some stations being heard by SWLs. Give them a try.

ARMENIA—9965 kHz, Voice of Armenia, in English, was logged with English news at 2115 UTC.

AUSTRALIA—15635 kHz, Australian Defense Forces Radio, has English programming for Aussie troops serving in overseas peacekeeping assignments. This has been reported at 0350 UTC with news and rock and roll music.

BELGIUM—11680 kHz, Radio Vlaanderen signs on in English at 1700 UTC, followed by news and commentary, then the "Radio World" program.

BRAZIL—11804 kHz, Radio Globo identifies in Portuguese with an echo announcement, a shouted "Globooooo!" Listen for the samba-flavored Brazilian pops music and soccer sports news after 2015 UTC.

CHINA—9535 kHz, China Radio International, Beijing, has English programming at 1515 UTC. It was heard with political and economic talks and ID.

CUBA—6000 kHz, Radio Habana Cuba was noted from 0255 UTC with Cuban music, identification, and news in English.

FRENCH GUIANA—9800 kHz, Radio France International French language programs from Paris are relayed by shortwave transmitters in this corner of South America. Look for it around 0245 UTC.

INDIA—11620 kHz, All India Radio from Bangalore has English scheduled from 1800 to 1904 UTC. Programming includes news and Indian music.

IRAQ—11785 kHz, Radio Iraq International was heard here at 0410 UTC with English news and commentary, ID and frequencies, followed by Middle Eastern music. Interference from another station increases though at 1457 UTC.

JAPAN—13630 kHz, Radio Japan's "Japan Diary" feature in English was noted on this frequency at 0030 UTC.

SLOVAKIA—5930 kHz, Radio Slovakia English language programs, including news and a feature about trade with other countries, was noted after 0100 UTC, along with identification and frequency announcements.

SOUTH AFRICA—3320 kHz, South African Broadcasting Corp. home service shortwave has been logged here shortly after 0300 UTC with music.

SPAIN—6125 kHz, Radio Exterior de Espana, the Spanish overseas radio service, is heard in English at 2230 UTC with programs about Spanish history.

TURKEY—7300 kHz, Voice of Turkey in Ankara was noted as 2300 UTC with music and a Turkish folklore program in English. ■

Think Tank

Get the LED Out!

ALEX BIE

In this month's review of semiconductor components, we come across a common device that appears in at least some design circuit of every issue of *Popular Electronics*; namely, Light-Emitting Diodes (LEDs). They are used in a wide variety of applications from small indicator lamps to more complicated alphanumeric displays.

Although LEDs have been superseded in some areas by the much less current-hungry Liquid Crystal Display (LCD), they are nevertheless still used in vast quantities in many areas, with no sign of diminished use. This is proved by the fact that over 20-billion LEDs are produced each year. As indicator lamps, they have the distinct advantage in that, if they are used correctly, they have an almost indefinite lifetime. As a result, the small tungsten lamps, which were previously used as indicator displays, are now a thing of the past.

Brief History

Although LEDs are thought of as a product of today's high-technology semiconductor industry, their luminous effect was first noticed many years ago. One of Marconi's engineers, H. J. Round, also famous for many vacuum tube and radio developments, was the first to observe their illumination in 1907, when he was working with Marconi on point-contact crystal detectors. These discoveries were first reported in *Electrical World* in 1907.

The idea of the LED lay dormant for some years before it was observed again by the Russian scientist O.V. Losov in 1922. Losov lived in Leningrad, where, unfortunately he was killed during *World War II*. Although he published a total of four patents during the period between 1927 and 1942, his work was not discovered until after his death, and it is likely that many projects of his were destroyed in the war.

("What is A...?" series by Ian Poole, G3YWX, reprinted by permission from *Practical Wireless*, Arrowsmith Court, Station Approach, Broadstone, Dorset BH18 8PW, England.)

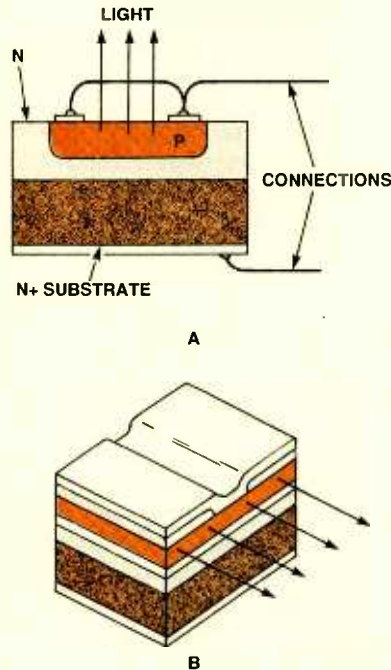

Fig. 1. In (A) is shown the structure of a surface-emitting diode, while (B) illustrates the structure of an edge-emitting diode.

The LED resurfaced in 1951 when a team of researchers led by K. Lehovec started to investigate the effect. The research continued with many companies and researchers including W. Shockley (father of the transistor). The LED was eventually refined sufficiently and started to be marketed in the late 1960s.

Specialized Junction

Light-emitting diodes are essentially a specialized form of a PN junction fabricated using a compound semiconductor. The most commonly used semiconductors, silicon and germanium, are simply elements and cannot be used for LEDs. However, compounds formed from two or more elements like gallium arsenide, gallium phosphide, and indium phosphide are widely used for LEDs. In the example of gallium arsenide, gallium has a valency of three and arsenic a valency of five, and as such they are known as group III-V semiconductors. Other compound semi-

conductors are also formed from group III-V materials.

In a forward-biased junction, holes from the P-type region and electrons from the N-type region enter the junction and recombine like a normal diode. In this way, current flows across the junction. When this occurs, energy is released, some of which is in the form of photons (light). It is found that more light is usually produced from the P-side of the junction, and this is kept closest to the surface of the device to ensure that the minimum amount of light is absorbed in the structure.

To produce light that can be seen, the junction must be optimized and the correct materials must be chosen. Pure gallium arsenide releases energy in the infrared portion of the spectrum. To bring the light emission into the visible red end of the spectrum, aluminum is added to the semiconductor to give aluminum gallium arsenide (AlGaAs). Phosphorus can also be added to give red light. For other colors, other materials are used. For example, gallium phosphide gives green light, and aluminum indium gallium phosphide is used for yellow and orange light. Most LEDs are based on gallium semiconductor material.

Two Main Structures

Two main structures are used for LEDs: the surface-emitting diode and the edge-emitting diode are shown in Figs. 1A and B, respectively. Of these, the surface-emitting diode is the most common, because it emits light over a wider angle, although there are a number of applications where a narrow angle is required.

Once the diode structure has been manufactured, it has to be packaged in a form that can be used and protected. Many of the small indicator LEDs are potted in an epoxy whose refractive index is between that of the semiconductor and the outside air (see Fig. 2). In this way, the diode can be protected, and the light transmitted to the outside world in the most efficient way.

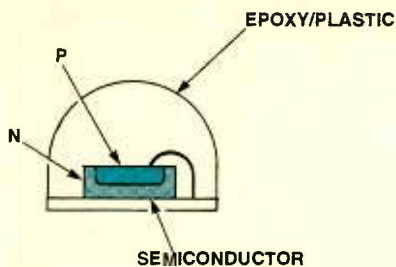

Fig. 2. The mounting of an LED.

Current Limiting

Like ordinary diodes, LEDs have no form of internal current limiting, and if placed directly across a battery, they would be destroyed. To prevent destruction, a resistor must be placed in circuit to limit the current. For most devices, a maximum current of around 20 mA can flow; if less current is drawn, the device's output illumination is dimmer.

As shown in Fig. 3, when calculating the amount of current drawn, the voltage across the LED itself may need to be taken into consideration. The voltage across an LED in its forward-biased condition is just over one volt, although the exact voltage is dependent upon the diode, and in particular its color. Typically a red-emitting LED has a forward voltage of just fewer than 2 volts, and it's around 2.5 volts for a green or yellow-emitting diode.

Great care must be taken not to allow a reverse bias to be applied to the diode. Usually they only have a reverse breakdown of a very few volts. If breakdown occurs, the LED will be destroyed. To prevent this happening, an ordinary silicon diode can be placed across the LED in the reverse direction (as shown in Fig. 4) to prevent any reverse bias being applied.

Typical LED colors are red, green, blue, amber, and yellow. Besides the standard individual panel-mount, LEDs are supplied in assemblies such as in

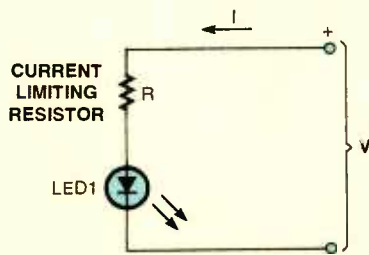

Fig. 3. Utilizing an LED in a circuit. The resistor must be chosen to ensure that the current through the diode does not exceed around 20 mA.

level meters, numeric displays, and dot-matrix configurations, just to name a few.

In next month's column, we will continue our "What is a ...?" series as we examine a semiconductor device, which is used to generate low-power microwave power—the Gunn diode. Now let's get to our readers' circuits.

THE "BAND-JO," A WEIRD MUSICAL INSTRUMENT

My 7-year-old son recently built a guitar with several household items, such as rubber bands for strings, a Kleenex-box resonator, and a paper towel roll neck. I followed this up by making an electronic version—that qualifies as being a very strange electric guitar.

To construct a "Band-Jo," take a typical 12-inch wooden ruler and stretch a rubber band around it the long way (see Fig. 5). Next, slip an ordinary piezo-disc element, 1-inch diameter or less, between the rubber band and ruler, about 1-1/2 inches up from the end of the ruler. Next, place a 1/2-inch spring-clip paper clip, with the two handles removed, between the piezo disc and rubber band. This "bridge" can be any roughly triangular-shaped hard object for transferring the mechanical wave of the rubber band to the piezo disc. In fact, experimenting with differ-

ent rubber bands, bridge shapes, and materials is half the fun of messing with the Band-Jo. Finally, connect the piezo output to an audio amplifier as shown. The amplifier's input impedance needs to be relatively high to match the piezo impedance, but all amps I have tried work fine as-is—from simple 200-mW test devices to 10-watt musical instrument systems. If you don't already have an amplifier, put together one of the simple designs using the LM386 IC, which frequently appear in *Popular Electronics*.

When you're all set up, turn on the amplifier and give the rubber band a light pluck. You'll hear a definite musical note with a fairly short decay and a very unique twangy bass-like sound that is reminiscent of jazz, or blues, or

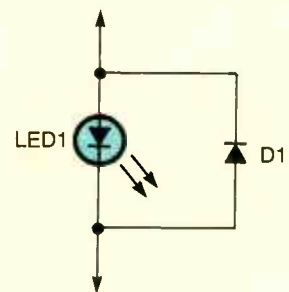

Fig. 4. A diode is placed across the LED to protect the LED from receiving any reverse bias voltages.

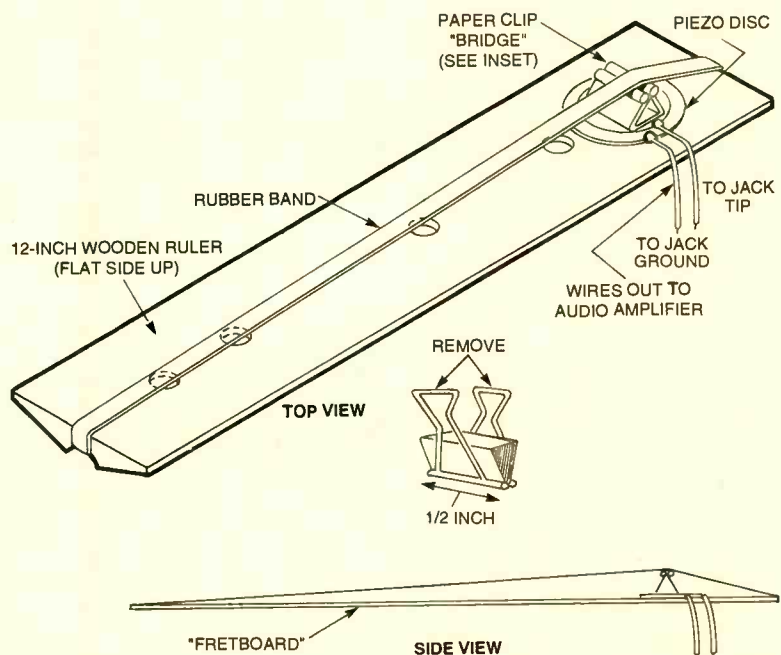

Fig. 5. This simple musical instrument is constructed with common household items.

60's surf music! And remember that's the natural sound—no effects boxes were needed! Next, get your fingers on the "fretboard," pinch the rubber band and try different notes. You'll be playing a respectable blues bass line in minutes! When you're satisfied with the sound, it is best to glue down the piezo disc and bridge with hot glue or epoxy.

My favorite party stunt is to hand someone the ruler, and ask for a guess as to what it is. (Your engineering types will mull it over for a good five minutes!) Note the facial expression when you state that it's an electric guitar. Then demonstrate it!—Nick Cinquino, *Schaumburg, IL*

Nice simple circuit, Nick. It is easy to build and very portable. I wonder how this would have sounded with a 1-yard stick fretboard and Elvis plunking away!

WIRELESS-BROADCASTER AMPLIFIER

The wireless-broadcaster-amplifier takes only a few hours to build, but has many uses in home entertainment. It can be connected to a record player or

microphone to broadcast programs out to any number of standard AM-band radios in the house. It also can be used as a complete preamplifier and amplifier with any record-player input.

As shown in the schematic of Fig. 6, one input jack takes a ceramic, or crystal cartridge, or high-Z microphone; the other input accepts a magnetic tape head, or low-Z microphone. A high gain pre-amplifier provides good amplification, even for the input from low-level magnetic cartridges. As a transmitter or broadcaster, this unit has many practical applications, since it can broadcast music from a single record player to as many radios as you like, located any place in the home. For party fun it's hard to beat—imagine the effect of a radio broadcast made in your own voice, with your own words! The wireless broadcaster can be tuned to come in at any desired clear frequency on your radio dial, from 600 kHz to 1500 kHz. Phone jack or terminals are provided for connecting a speaker directly to the amplifier, so the record or microphone can be heard at the unit itself. An inexpensive, binaural or pleasing dimensional effect can be achieved by

broadcasting music to the radio and playing it through the amplifier speaker at the same time. Practically any audio speaker can be used, since the amplifier matches most popular speaker impedances, from 3.2 to 16 ohms.

The wireless-broadcaster amplifier doubles as a phonograph oscillator and a miniature broadcasting station. The phono amplifier section consists of V1, the 12AV6 or 12AT6 (twin diode, high-mu triode) vacuum tube, and V2, the 35C5 beam-power pentode tube. This combination amplifies the very small signals coming from the record player cartridge or microphone, and results in making the signals strong enough to drive a speaker and produce audible sound. Ceramic crystal or magnetic cartridges are correctly loaded by input resistors R1 and R2. The preamplifier tube, a 12AV6, supplies the high gain needed for magnetic cartridges, with equalization supplied by a feedback loop made of components R6 and C4. Output from the preamplifier stage is fed into the 35C5 audio-output tube, which supplies ample power to drive a speaker and produce room-filling sound. The audio-output transformer,

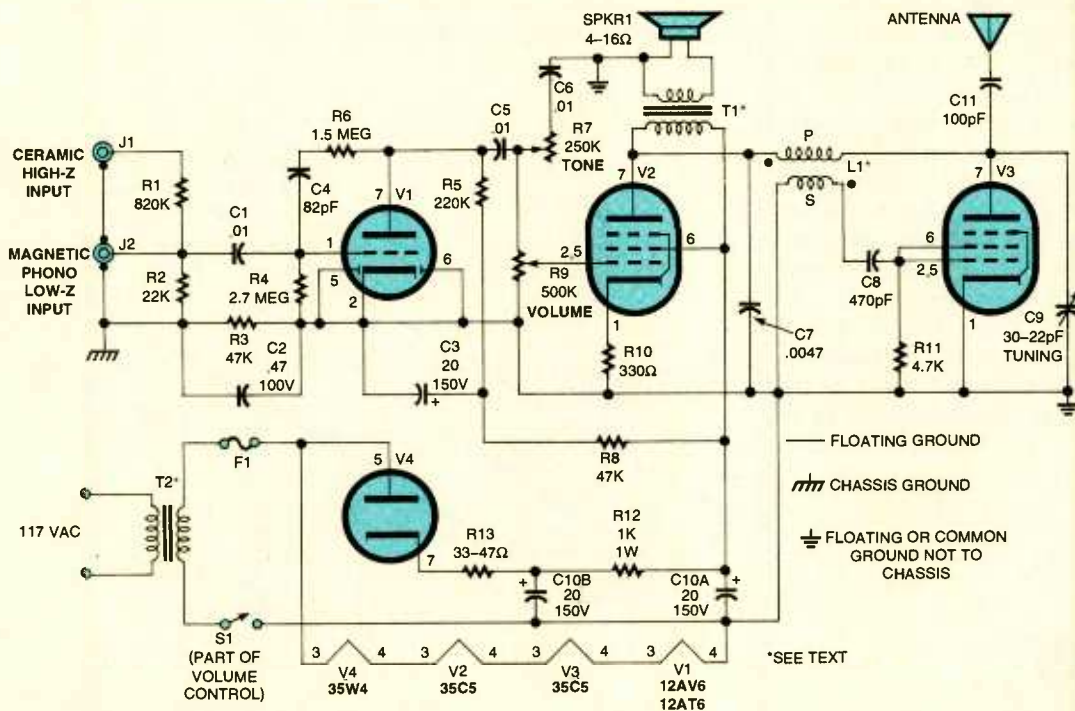

Fig. 6. The wireless-broadcaster amplifier, built with four vacuum tubes, can be used to broadcast through a standard AM-band radio. It also doubles as a stand-alone preamplifier/amplifier.

T1, matches 3.2-to-16-ohms on the secondary; the primary has an impedance of about 2500 to 3000 ohms.

The output level and modulation depth are adjusted by the 500k volume control, R9, which varies the signal voltage applied to the grid of the output-modulator tube, V3, another 35C5 beam power pentode. As a wireless broadcaster, this unit operates much like a regular broadcasting station. It transmits a signal between 600 kHz to 1500 kHz, which can be received by any standard AM-band radio. The carrier wave is produced by V3 and is broadcast at the antenna. Tube V3 oscillates because some of its output across L1 and C9 is fed back in the correct phase into the grid circuit of this tube. These oscillations, or waves, can be varied over the transmit-frequency range, by adjusting tuning capacitor C9. The sound (audio) signal is impressed on the carrier wave at the plate of V3. The plate voltage of V3 varies at an audio rate because it is tied to the plate of V2. Tube V2 doubles as an audio output and modulator tube, and it amplifies the audio voltage to effect a 75% modulation of the carrier wave. Clean modulation is assured by the use of degenerative feedback across resistor R10. The oscillator coil, L1, is made out of a tube-type radio IF transformer, modified by removing the internal padding capacitors on each side of the transformer.

The required DC voltages are developed in a standard power supply circuit using a 35C4 half-wave rectifier tube, V4, and filter circuitry. Power transformer T2 has a 1:1 turns-ratio and is rated at about 1 amp at 117 volts. It is not necessary to have a separate filament tap as the filaments of the four tubes add up in series to the 117-volt secondary-voltage supply.—Craig Kendrick Sellen, Waymart, PA

Fine circuit, Craig. The broadcaster should be a great unit for our would-be disc jockeys out there. I wonder what the transmitter range is and whether the signals will get into your neighbor's radios! As with any tube circuits—be very careful when handling the high voltages that may develop. By the way, most of the unusual parts for this circuit can be obtained from Antique Electronic Supply, 6221 South Maple Avenue, Tempe, AZ 85283; Tel. 800-706-6789; Web: www.tubesandmore.com.

MAILBAG

In the August column, I saw two responses to a letter from the May issue regarding old phones being used as intercoms. Many years ago I worked at the Turkey Point Nuclear Power Plant in South Florida. Since I was knowledgeable in electronics, I was given the task of setting up a communications link between several points when a large crew had a long pull of heavy electric cables. This was a different situation in that it didn't require signal devices to indicate a call was coming. We had a very simple pair of wires available at each end and at intervening points on the pull route.

At some central point I used a salvaged inductor (from an old phone) in series with a six-volt battery across the phone pair. This powered all phones that were then clipped onto that pair wherever it was needed. The handsets each had the microphone and earpiece wired in series with battery clips on the end of the cord, which then could be clipped to the line. We often had as many as six or seven phones at a time to join all points of the pull together. When you have a gang of men pulling four million MCM Cables through three or four manholes in one continuous pull, communication is vital, and this did it.

Any good choke (audio) and a power supply could be used, but on a construction job of this magnitude the battery and inductor were what was available. I don't think a drawing is needed as it is simply two wires strung to the various points needed with an inductor and voltage source across the pair at any point.

Dwight Eggleston
Union City, IN

I wanted to comment on the "Rechargeable Flashlight" circuit in the September column. It seems like a bad idea to have the flashlight on all the time while the batteries are charging, and it seems like inviting disaster to connect a nominal 6-volt battery (four rechargeable C-cells) directly to the 6-volt power source with no current-limiting resistor provided.

Kenneth E. Stone
Cherryvale, KS

That's about it for this month's column. Remember—this is **your** col-

umn—keep those circuits, solutions, and ideas coming in. For each of your circuits that appear, you'll receive a book from our library. Send in enough circuits to fill a whole column and you will get a nifty kit or electronics tool to make your construction easier. Write me—Alex Bie, *Think Tank*, **Popular Electronics**, 500 Bi-County Blvd., Farmingdale, NY 11735. ■



"I hate these older radar guns!"

POPTRONIX®

Online
Edition

We're on the web

FREE

We are starting up,
but you can watch us grow!

Projects for beginners
to experts!

New Product information!
Bookstore—discover
what's new!

<http://www.poptronix.com>

WE'RE WITH YOU EVERY DAY
24 HOURS A DAY! DROP IN!
WE'D LOVE TO HAVE YOU VISIT!



A public service of this magazine

HAM Radio

Getting Started in QRP

JOSEPH J. CARR, K4IPV

Although today I own a 2000-watt power amplifier, I've used low power (or QRP—as the ham's say) for most of my life. At first it was economics (a kid could easily get 25–100 watts on the air in the 1950s and 1960s), but now it's a matter of preference. I live in a crowded suburban neighborhood, so it's also a matter of practical “good-neighbor” relations to limit power. After all, even when a transmitter is properly grounded, shielded, and filtered, high RF levels can still afflict a certain number of consumer-electronic products with *ElectroMagnetic Interference* (EMI). While one could argue that “poor design of the consumer device” is not your problem, try telling that to a homeowners' association (or even a single ticked-off neighbor). QRP does have its advantages.

Another attraction of QRP operation is that it takes operator skill. Any “idiot” can blast through the QRM with a multi-kilowatt signal, but it takes a real operator to do it with less than ten watts! My QRP station—built using *Ramsey Electronics* (793 Canning Parkway, Victor, NY, 14564; Tel. 716-924-4560; Fax: 716-924-4555) kits—consists of a direct conversion receiver, transmitter, power amplifier, and an audio filter for improved receiver selectivity. The telegraph key was made for me by *Stillwell* in England. It is an expensive instrument, but it has the best “feel” of any straight key I've ever owned. It is patterned on the “North Atlantic” keys of a bygone era when radio operators really were in poorly heated (or unheated) “shacks” on the decks of ships.

Because of that situation, radio operators had to have large knob keys so they did not have to remove their gloves. The earphones are modern *RadioShack* \$8.95 specials.

This month we will take a look at the *Ramsey HR-30* receiver kit. Although I have two really good communications receivers (a *Drake R-8A* and the receiver section of my *Kenwood TS-130*), I decided to “go all the way” with the QRP station. It's unlikely, after all, that a reader who



My QRP station consists of four Ramsey kits—a direct-conversion receiver, a transmitter, a power amplifier, an audio filter—and a telegraph key (made by Stillwell in England). The earphones are modern RadioShack \$8.95 specials.

wanted to go portable or “mountain topping” would lug along a full-size receiver.

THE HR-30 RECEIVER

Ramsey makes kits for a number of bands. I selected 30-meters (10.1–10.15 MHz) for several reasons. One is that it is not too crowded, and another is that it is favored by a lot of QRP fans. Also, it is high enough to reduce interference from power-line harmonics and other local “trash” signals, and to provide some decent skip a good percentage of the time. Also, a 30-meter antenna is of manageable size.

The HR-30 has three basic controls—audio gain (or volume), RF gain, and tune—plus the on/off (power) switch. The audio gain sets the loudness (volume) of the output signal, while the RF-gain control sets the receiver sensitivity. Because it controls the gain of the RF input circuit, it also sets the output level, but it is used quite differently. While the audio gain is used to set a comfortable listening level, the RF gain is used for that purpose plus setting the sensitivity of the receiver. The idea is to reduce the sensitivity enough to eliminate interfering signals, while keeping

the desired signal. Also, if there are strong signals on adjacent channels, the RF-gain control can help to reduce the possibility of *InterModulation Distortion* (IMD) in the mixer stage.

There are not a lot of parts in the HR-30 receiver—that's the miracle of integrated circuit electronics. The front-end of the receiver (RF input and local oscillator) is comprised of part of *Signetics'* NE602 double-balanced mixer chip, while the audio output is provided by the LM386. Like several other Ramsey receiver kits, the HR-30 is a *Direct Conversion Receiver* (DCR) design. Like the superheterodyne, the DCR uses a *Local Oscillator* (LO) to mix with the incoming RF signal. In the superhet, the sum or difference between the LO and RF signals is the *Intermediate Frequency* (IF), at which most signal processing takes place. But in the DCR, the LO and RF signals are very close together (CW) or identical (AM). Because of that, the output of the mixer in a DCR is the base-band signal; that is, the audio signal in the case of AM or SSB reception, or an audio tone in the case of CW.

Given that 30-meters is a CW band, let's assume that mode first. Let's say

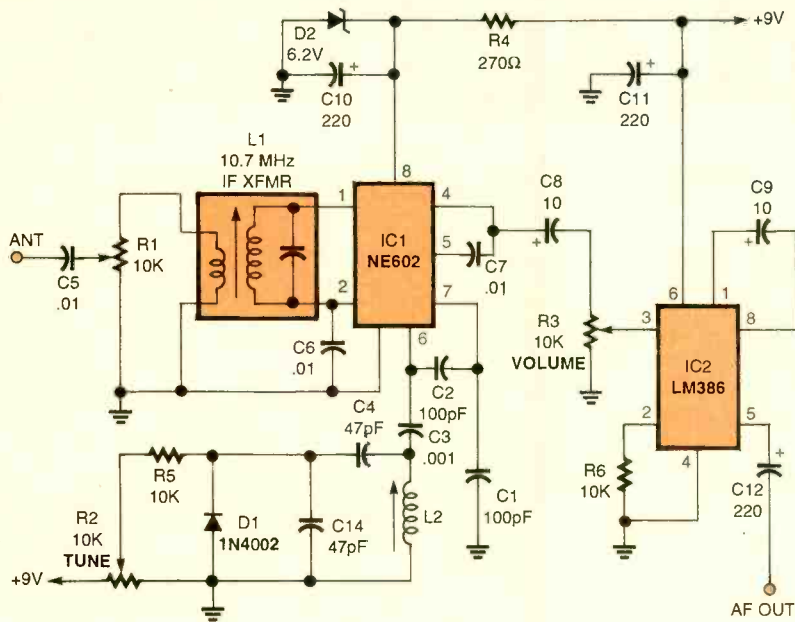
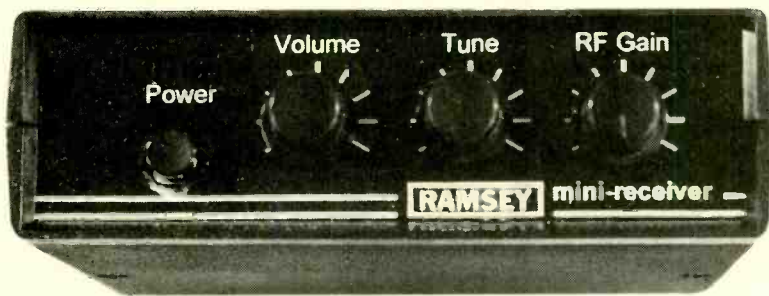

Fig. 1. The HR-30 is comprised of Signetics' NE602 double-balanced mixer (IC1), an LM386 low-voltage audio power amplifier (IC2), a pair of diodes, and a few additional support components.



The Ramsey HR-30 (a direct-conversion receiver) has three basic controls—audio gain (which is used to set the volume of the output signal), RF gain (to control receiver sensitivity), and tune—plus a power switch.

we have a signal at 10,127 kHz. If the LO is adjusted to that frequency (10,127 kHz), then it is zero beat with the RF, so the output frequency is zero. But if the LO is adjusted to 10,126 or 10,128 kHz, we'd hear the 1-kHz audio tone that many people prefer for CW reception. In both AM and SSB reception, the LO of the DCR is adjusted to the frequency of the RF signal's carrier, so the difference frequencies are the sidebands where the information is found.

A schematic diagram of the HR-30 receiver is shown in Fig. 1. Note that there are only two ICs in the circuit. The NE602 performs the RF input, mixer, and LO functions, while the LM386 performs the audio functions. The RF input to the NE602 is applied to pins 1 and 2, which are differential inputs. But, be-

cause C6 sets pin 2 to ground potential for RF signals, it is effectively a single-ended RF input.

RF input tuning is accomplished via inductor L1. Note that L1 looks like an IF transformer. That's because it is an IF transformer. For the 30-meter band, we can take advantage of the fact that the standard IF for FM broadcast-band receivers is 10.7 MHz. Slightly retuning the transformers puts them into the 30-meter ham band. In addition, because those transformers are designed for wideband FM Broadcast band signals (200 kHz), they can usually be used to cover the entire band without active tuning. Adding capacitance across the secondary of L1 can reduce its response frequency (to say 40-meters). For higher frequencies (e.g., 20-meters ham

ANTENNA NOTE

One of the keys to QRP operation is having a reasonably decent antenna. It would be nice to have a beam antenna, but that's not really necessary. Don Stoner, W6TNS, worked a South African (ZS1) station from his California home many years ago with one of the first transistor-based transmitter projects to appear in a magazine. The power level was 96 milliwatts, if I recall correctly. With the several watts worth of power that you will typically run in QRP operations, you ought to be able to work the Moon. Well, maybe some decent terrestrial DX.

Even if you don't have a beam antenna, I suggest that you have a decent, if low-cost, antenna. In some cases, you'll have to have a separate receive antenna, but if you use the Ramsey QRP-30 transmitter that we'll discuss in the December issue, then only one antenna is needed. The QRP-30 transmitter has a receiver output jack from the transmitter antenna circuitry. The dimensions for simple antennas for 30-meters are:

Dipole—46-feet overall (23-feet each side)

Vertical—23-feet high

I don't recommend using any sort of shortened or compensation antenna unless that is your only option. Install the antenna as high as you can; and if it is directional (e.g., the dipole), aim the main lobes to the area you want to work the most.

band or 15-MHz WWV), it is common to find people disconnecting the capacitor and replacing it with a smaller value. The way to "disconnect" the capacitors is a bit brutal: they are crushed with a screwdriver. Fortunately, on most small 10.7-MHz IF transformers the tuning capacitor is external—located in a recess in the plastic base of the device.

The RF-gain control is not really a "gain" control, but rather a 10k potentiometer (R1) that is used as a variable attenuator. The potentiometer is connected across the input of the transformer, with the antenna connected to the center wiper of the potentiometer. The LO is connected across pins 6 and 7 of the NE602. The circuit's feedback network is a capacitive voltage divider (C1/C2), so we know that it's a Colpitts oscillator. The oscillating frequency is controlled by inductor L2, plus the combined effects of C4, C14, and the reverse-bias junction capacitance of diode D1. That capacitance is, in turn, controlled by the tuning voltage applied through R5 and tuning control R2 (another 10k potentiometer).

(Continued on page 65)

Circuit Circus

Lights On With Photoelectronics

CHARLES D. RAKES

This visit, the Circus is going to spotlight circuits that sense and respond to light. Optoelectronics detectors—a category that covers a wide variety of photosensitive devices, which includes the photoresistor (also known as a light-dependent resistor and sometimes called a photocell), phototransistor, photodiode, and the solar cell—are the eyes of modern electronic circuits. All of our circuits this month will use an infrared transistor as the light-sensing device.

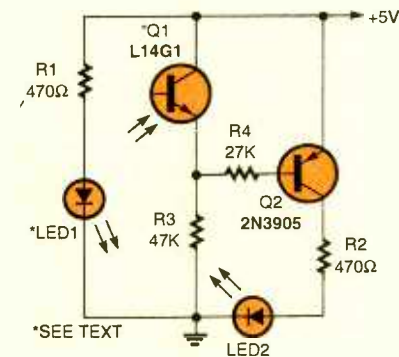

Fig. 1. The Light-Interruption Detector is designed to detect when an opaque object passes between the IR source and an IR detector.

PARTS LIST FOR THE LIGHT-INTERRUPTION DETECTOR (FIG. 1)

SEMICONDUCTORS

- *LED1—Infrared light-emitting diode, Mouser 512-QED223
- *LED2—Light-emitting diode, any color
- *Q1—Infrared-detector transistor, Mouser L14G1
- *Q2—2N3905 general-purpose PNP silicon transistor (NTE 130, SK3027, or equivalent)

RESISTORS

- (All resistors are 1/4-watt, 5% units.)
- R1, R2—470-ohm
 - *R3—47,000-ohm
 - *R4—27,000-ohm

ADDITIONAL PARTS AND MATERIALS

- Printed-circuit or perboard materials, wire, solder, hardware, etc.

LIGHT-INTERRUPTION DETECTOR

Our first IR sensor (see Fig. 1) is a simple circuit that's designed to detect the interruption of a light source when an opaque object passes between an IR source (an *InfraRed Diode* or IRD) and an IR detector (in this case a phototransistor). The IR emitter and detector (separated by a distance of several inches) are positioned so that they "look" at each other head-on. The maximum operating range between the emitter and detector is limited to the distance between the two that produces no less than 4.5-volts at the emitter of Q1. Under those circuit conditions, Q2 and LED2 are turned off. When an object moves between the emitter and detector the voltage at Q1's emitter goes low, turning Q2 on, and lighting LED2. If several sensor circuits are used along a path or track, the location of the blocking object can be tracked by monitoring the output LEDs.

In the Fig. 1 circuit, IR radiation from LED1 causes Q1 (the IR detector) to saturate, applying a positive voltage to the base of Q2 (a PNP transistor). The positive voltage holds Q2 at cutoff, so LED2 receives no forward bias, and is thus extinguished. But when the path between the emitter (LED1) and the detector (Q1) is blocked, Q1 turns off, removing the positive voltage from the base of Q2. The base of Q2 is now tied to ground through R3, forward biasing the transistor, thereby lighting LED2.

The circuit can be used to count or give an output as an object passes between the source and the detector. The circuit in Fig. 1 may seem too simple to be of any practical use; however, by replicating the circuit two or more times and placing the circuits in a configuration like that illustrated in Fig. 2, the Light-Interruption Detector of Fig. 1 can be used to follow the movement of an object as it proceeds down a track or path. By alternating the positions of the emitters and detectors, any number of sensor circuits can be used to track an object's movement over a long distance.

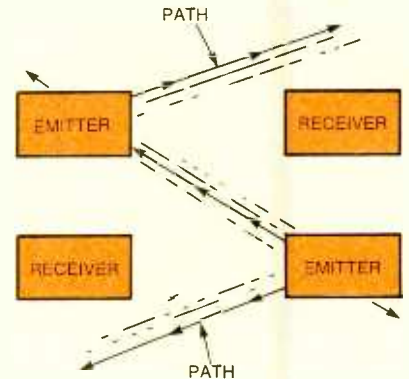

Fig. 2. By duplicating the circuit in Fig. 1 two or more times and placing the circuits in a configuration like that illustrated here, the Light-Interruption Detector can be used to follow the movement of an object as it proceeds down a track or path.

MODEL-TRAIN LOCATOR

Our next sensing circuit, see Fig. 3, is designed to track the movement of a model train and indicate the train's location via a string of LEDs. The number of circuits required depends on the length of the track and the sensor's spacing around the layout. The circuit (although only two sensor/detector subassemblies are shown—LED3-LED6, LED9-LED11, and Q3-Q6 omitted from figure for clarity) contains six sensors and six output LEDs. Determine the number of sensor locations required for a given layout, divide that number by six, and duplicate the circuit in Fig. 3 that many times.

A 4050 hex non-inverting buffer replaces the output transistors used in our previous circuit. Using a single IC to replace six transistors keeps the component count down, which makes for a cleaner looking circuit layout.

RAILROAD-CROSSING SIGNAL

The next entry, see Fig. 4, is a Railroad-Crossing Signal circuit. The circuit uses two sensors, one for each side of the crossing. With a clear track in front of both sensors the green LED is on; but when either sensor is blocked, the green and red LED flash

back and forth at a rate of about 1 Hz.

The circuit, operates in the following manner. With no blockage between either emitter/sensor pair, both inputs of IC1-a are high, producing a low output at pin 3. The output of IC1-a is fed to a

low-frequency oscillator, comprised of IC1-b and IC1-c. The oscillator only operates when pin 3 of IC1-a is high. With neither sensor blocked, LED2 (green) lights. When either sensor is blocked, the output of IC1-a goes high,

allowing the low-frequency oscillator to operate. The output of the oscillator causes the two LEDs to alternately switch on and off.

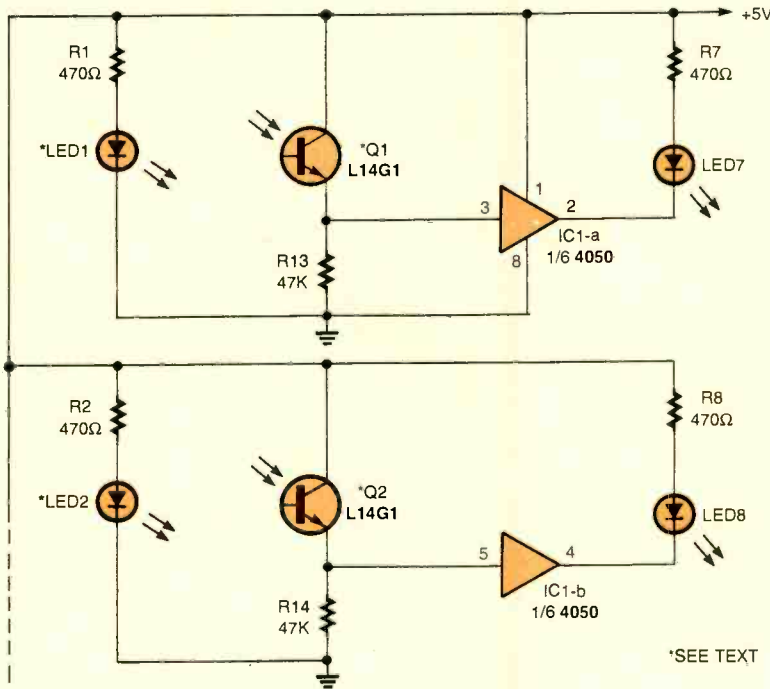

Fig. 3. The Model Train Locator can be used to track the movement of a model train and then indicate the train's whereabouts via a string of LEDs.

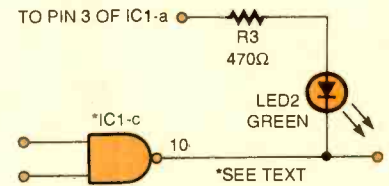

Fig. 5. The Crossing-Signal modification shown here changes the Fig. 4 circuit's operation, so that when either sensor is blocked LED2 flashes off and on.

PARTS LIST FOR THE MODEL-TRAIN LOCATOR (FIG. 3)

SEMICONDUCTORS

IC1—4050 CMOS non-inverting hex buffer, integrated circuit (NTE4050B, SK40506, or equivalent)
LED1–LED6—Infrared light-emitting diode, Mouser 512-QED223
LED7–LED12—Light-emitting diode, any color
Q1–Q6—Infrared-detector transistor, Mouser L14G1

RESISTORS

(All resistors are 1/4-watt, 5% units.)
R1–R12—470-ohm
R13–R18—47,000-ohm

ADDITIONAL PARTS AND MATERIALS

Printed-circuit or perfboard materials, wire, solder, hardware etc.

PARTS LIST FOR THE RAILROAD-CROSSING SIGNAL (FIG. 4)

SEMICONDUCTORS

IC1—4011 CMOS quad 2-input NAND gate, integrated circuit (NTE4011B, SK4011B, or equivalent)
LED1—Light-emitting diode, red
LED2—Light-emitting diode, green
LED3, LED4—Infrared light-emitting diode, Mouser 512-QED223
Q1, Q2—Infrared-detector transistor, Mouser L14G1

RESISTORS

(All resistors are 1/4-watt, 5% units.)
R1–R4—470-ohm
R5, R6—47,000-ohm
R7—1-megohm
R8—120,000-ohm

ADDITIONAL PARTS AND MATERIALS

C1—4.7-μF, 25-WVDC, electrolytic capacitor
Printed-circuit or perfboard materials, wire, solder, hardware, etc.

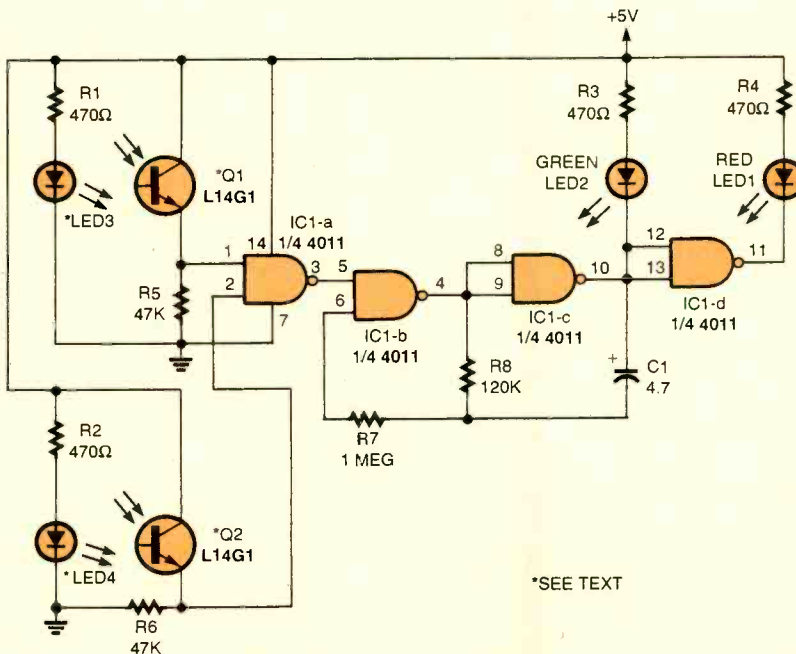
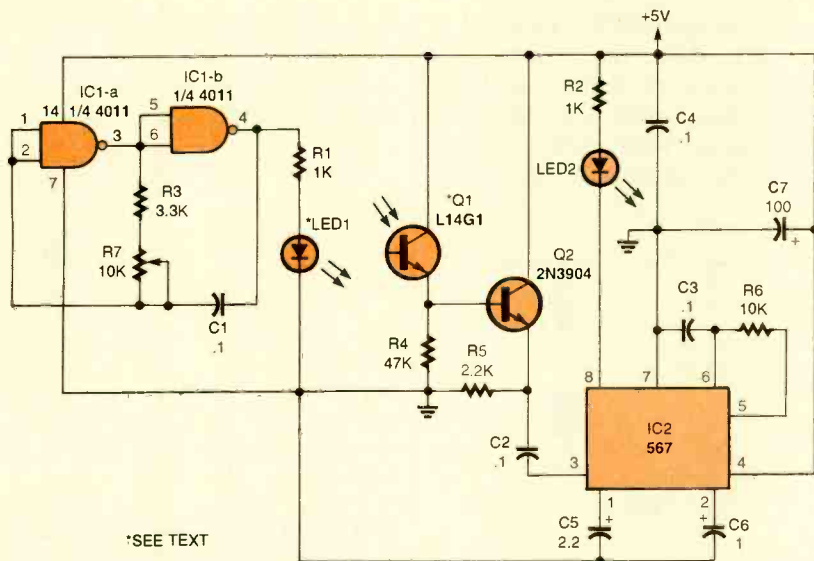

Fig. 4. The Railroad-Crossing Signal places a pair of sensors, one for each side of the crossing, in a circuit that detects whether that track in front of the sensors is clear or occupied.



*SEE TEXT

Fig. 6. Taking a slightly different approach to detecting the interruption of the IR light source, the Discriminating Sensor responds only to its IR emitter's output, making the circuit selective in what constitutes a valid trigger input.

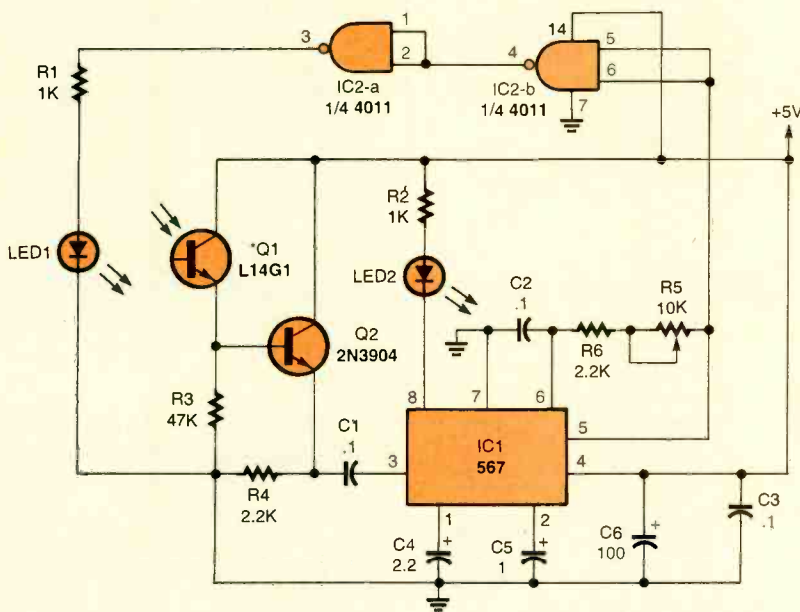

Fig. 7. The Self-Excited IR Sensor, unlike the previous circuit, uses a modulating signal (derived from the 567's internal oscillator) to drive the IR emitter through a pair of series-connected NAND gates.

If a standard dual, flashing red-light arrangement is desired, make the simple circuit change shown in Fig. 5. With this circuit modification, neither LED is on when the track is clear; but when either sensor is blocked, the two LEDs alternately flash on and off.

CROSSING-SIGNAL MODIFICATION

Using the modified circuit in Fig. 5 the circuit's operation is changed by tying the source for LED2 (green LED)

back to pin 3 of IC1-a. In the non-blocked state, pin 3 of IC1-a is low and can not supply a positive voltage for LED2, so the LED remains dark. When either sensor is blocked, pin 3 goes high, supplying a positive source for LED2, allowing it to flash on and on.

A DISCRIMINATING SENSOR

Our next sensor circuit, see Fig. 6, takes a slightly different approach to detecting the interruption of the IR light

PARTS LIST FOR THE DISCRIMINATING SENSOR (FIG. 6)

SEMICONDUCTORS

- IC1—4011 CMOS quad 2-input NAND gate, integrated circuit
- IC1—567 phase-locked loop, integrated circuit (NTE832, SK9089, or equivalent)
- LED1—Infrared light-emitting diode, Mouser 512-QED223
- LED2—Light-emitting diode, any color
- Q1—Infrared-detector transistor, Mouser L14G1
- Q2—2N3904 general purpose, NPN silicon transistor (NTE123AP, SK3854, or equivalent)

RESISTORS

- (All fixed resistors are 1/4-watt, 5% units.)
- R1, R2—1000-ohm
 - R3—3300-ohm
 - R4—47,000-ohm
 - R5—2200-ohm
 - R6—10,000-ohm
 - R7—10,000-ohm potentiometer

CAPACITORS

- C1—C4—0.1- μ F, ceramic-disc
- C5—2.2- μ F, 25-WVDC, electrolytic
- C6—1- μ F, 25-WVDC, electrolytic
- C7—100- μ F, 25-WVDC, electrolytic

ADDITIONAL PARTS AND MATERIALS

- Printed-circuit or perfboard materials, wire, solder, hardware etc.

source. In this case, the sensor responds only to its own emitter's IR output. The ability to discriminate between IR sources allows several sensors to be positioned in close proximity without the interference common to unmodulated sensor circuits.

In the Discriminating Sensor circuit, a pair of gates—IC1-a and IC1-b (half of a 4011 quad 2-input NAND gate)—are configured as a low-frequency oscillator with an operating frequency of around 1 kHz. The oscillator's output is used to drive LED1 (an infrared emitter). The modulated light produced by LED1 is focused on an IR detector (transistor Q1). The IR detector, in turn, switches on and off at a rate determined by the modulating frequency of the IC1-a/IC1-b oscillator, producing an alternating signal at the emitter of Q1. That signal is fed to the base of Q2 (which is configured as an emitter-follower buffer amplifier), causing it to toggle on and off at the same rate to produce a signal of equal frequency at its emitter. That signal is applied to the input of IC2 (a 567 phase-locked loop) at pin 3 through a

PARTS LIST FOR THE SELF-EXCITED IR SENSOR (FIG. 7)

SEMICONDUCTORS

- IC1—567 phase-locked loop, integrated circuit
 IC2—4011 CMOS quad 2-input NAND gate, integrated circuit
 LED1—Infrared light-emitting diode, Mouser 512-QED223
 LED2—Light-emitting diode, any color
 Q1—Infrared-detector transistor, Mouser L14G1
 Q2—2N3904 general-purpose, NPN silicon transistor

RESISTORS

- (All fixed resistors are 1/4-watt, 5% units.)
 R1, R2—1000-ohm
 R3—47,000-ohm
 R4, R6—2200-ohm
 R5—10,000-ohm potentiometer

CAPACITORS

- C1—C3—0.1- μ F, ceramic disc
 C4—2.2- μ F, 25-WVDC, electrolytic
 C5—1.0- μ F, 25-WVDC, electrolytic
 C6—100- μ F, 25-WVDC, electrolytic

ADDITIONAL PARTS AND MATERIALS

Printed-circuit or perfboard materials, wire, solder, hardware etc.

0.1- μ F capacitor (C2) for tone detection. The 567 PLL's tone-decoder bandwidth is about 15%.

Setting up the sensor is a simple chore. The sensor circuit as shown will easily operate over a range of several inches. The emitter should be aligned with the detector to achieve the maximum signal transfer. One method you can use in aligning the two IR devices is to connect a DC voltmeter to the top of R5 and adjust the position of the emitter LED for the maximum voltage. It is best to shield the detector from all other light sources, which could, if strong enough, saturate the input of the detector and keep it from sensing the desired input signal.

After completing the alignment, adjust R7 until LED2 just turns on, and note the potentiometer's position. Continue turning R7 in the same direction until the LED turns off, and note the potentiometer's new position. Set the potentiometer to the center of the two settings, and the circuit should be tuned and ready to operate.

SELF-EXCITED IR SENSOR

A Self-Excited IR Sensor circuit is shown in Fig. 7. Unlike the previous circuit, the modulating signal that drives

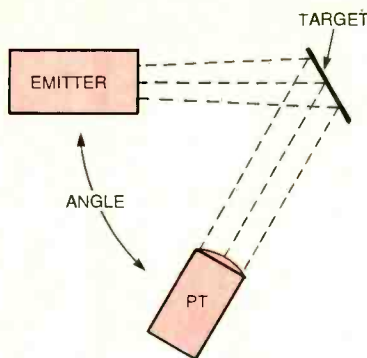

Fig. 8. With a little electronic "terpsichore"—rearranging the emitters and detector in a pattern similar to that illustrated here—all of this month's circuits can be operated in the reflective mode.

the IR emitter (LED1) in this circuit is derived from the 567's own internal oscillator. The 567's oscillator output at pin 5 is fed through a pair of series-connected NAND gates. The NAND gates, in turn, supply drive to LED1. The phase of the signal feeding LED1, must be in phase with the PLL's oscillator output, which is the reason that two NAND gates are required between the oscillator and LED1. The circuit's frequency range is slightly less than 1 kHz to above 10 kHz. Decreasing the value of C2 increases the oscillator frequency. If a lower operating frequency is desired, just increase the value of C2 or replace R5 (a 10k unit) with a 20k potentiometer. The circuit offers the same sensitivity and operating range as the previous sensor.

A LITTLE ELECTRONIC TERPSICHORE

All of the sensor circuits that we've looked at this month have been of the head-on (or non-reflective) type; i.e., in each circuit, the emitter LED was aimed directly at the input window of the detector. That arrangement gives the best possible signal-to-noise ratio. But by repositioning the emitter and detector, as shown in Fig. 8, all of the circuits can be operated in the reflective mode. The output LED indicator in all of the sensor circuits that we've covered will be in the reverse state. For example, LED2 in Fig. 2 will be off in the reflective mode and will only turn on when sufficient IR light is reflected from an object within target range of the phototransistor.

I hope that at least one of the IR sensor fills a void in a present or future project, and if that occurs we all will profit from the time spent here at the Circus. Until next month great circuitry! ■

HAM RADIO

(continued from page 61)

Notice something odd about the diode? Normally one would expect to see a variable capacitance diode (or varactor) in the position occupied by D1. But here we see a 1N4002, which is a power-supply rectifier. All diodes have at least some degree of reverse-bias junction capacitance, and the 1N400x series is well suited to use in tuning circuits.

The output of the NE602 is taken from pin 4 through a 10- μ F coupling capacitor (C8). That capacitor routes the recovered audio to the volume control (R3), yet another 10k potentiometer, which in turn feeds the signal to the audio stage (IC2, an LM386 low-voltage audio power amplifier).

ALIGNMENT

To align the circuit, some sort of reference-signal source is needed. If you already have a 30-meter transmitter, and it can be operated into a dummy load across the room, then you can use it. Alternatively, you can build the companion Ramsey QRP-30 transmitter and use its crystal to obtain a reference signal. Perhaps the best approach is to use a signal generator to create a signal between 10.1 MHz and 10.15 MHz.

Another approach is to seek "on-the-air" signals. In addition to the amateur signals between 10.1 and 10.15 MHz, there are also a lot of commercial radioteletype (RTTY) and CW signals present between 10.05 and 10.1 MHz. In addition, the 10 MHz WWV signal will be audible if the lower end of the band is set correctly. The receiver will accept any 250-kHz portion of the 30-meter band, so set the LO tuning coil (L2) such that WWV appears when the tune-control knob is set near the low end (counterclockwise, perhaps about "9:00 o'clock" on the scale). Once the LO is set, peak L1 to produce maximum signal level on some ham signal in the 10.1–10.15-MHz portion of the band.

NEXT MONTH

In the second installment of this QRP series, we'll take a look at building a QRP transmitter—the Ramsey QRP-30 30-meter transmitter, which is a companion to the HR-30 receiver discussed in this month's column. In the meantime, I can be reached by snail-mail at P.O. Box 1099, Falls Church, VA, 22041, or by e-mail at carrj@aol.com. ■

ELECTRONICS LIBRARY

E-MAIL ON THE INTERNET

by P.R.M. Oliver and N. Kantaris

If you want to become familiar with using e-mail, this book presents a clear, easy-to-understand introduction. Written for Windows 95 software, it is also useful for Mac and Unix-based systems.



The book explains the Internet and how e-mail fits into the Net. It introduces step-by-step methods to get e-mail up and running. Downloading and installing four of the main e-mail programs is explained: Pegasus Mail, Netscape Navigator Mail, Microsoft Explorer Mail, and Eudora Light for Windows 95. An appendix of keyboard shortcut commands for the four programs described is included, along with a glossary of Web and computer terms.

E-Mail on the Internet costs \$12.75 and is available from *Electronic Technology Today, Inc.*, P.O. Box 240, Massapequa, NY 11762-0240.

ELECTRONIC COMPONENTS AND COMPUTER CATALOG

from Jameco

Aimed at engineers, educators, and technicians, this 140-page catalog features thousands of ICs, components, tools, test equipment, and computer products. The items offered are divided into sections—each of which is color-coded for ease-of-use—ICs; discrete components; sockets and connectors; power components; kits and solder

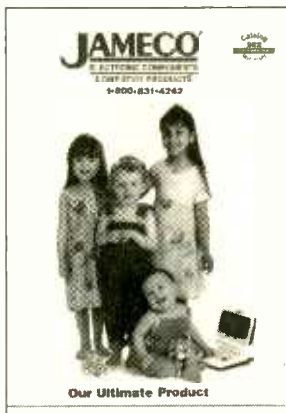

equipment; books; PCB, tools, and test equipment; and computer products.

If there is a limited supply of any item because it is being discontinued, this is noted in the catalog. Another feature is the FTP alert that accompanies products for which data sheets, manuals, and/or software is available at their FTP site: <ftp://ftp.jameco.com>.

There are 175 new products, including LEDs, serial LCD modules, solenoids, buzzers, batteries, power supplies, hobby kits, motherboards, digital cameras, graphics cards, and printers.

The Electronic Components and Computer Catalog is free upon request from Jameco, 1355 Shoreway Road, Belmont, CA 94002-4100; Tel. 800-831-4242 or 650-592-8097; Fax: 800-237-6948 or 650-592-2503; Web: www.jameco.com.

CIRCLE 90 ON FREE INFORMATION CARD

MODERN DICTIONARY OF ELECTRONICS: SIXTH EDITION

by Rudolf F. Graf

Since technological advances in electronics and closely related areas occur at a feverish pace, a modern dictionary must keep up. It has to reflect the ever-

expanding vocabulary generated in this field. Every new edition of this reference book confirms the impressive growth in electronics.

Completely updated, this compre-

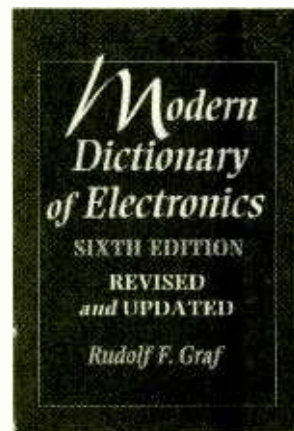

hensive dictionary contains over 25,000 electronic terms, accompanied by hundreds of illustrations. The previously published material has been revised and brought up to date, where necessary. Written in a style that is consistent with the complexity level of the terms being defined, all the definitions are clearly and simply presented. The author uses concrete, practical explanations, rather than abstract or mathematical ones.

With over 5000 new entries included, this dictionary is a valuable reference for professionals in the field, hobbyists, students, or anyone interested in the field of electronics. The sixth edition covers special topics, such as audio electronics, television and video, computers, fiber optics, microelectronics, communications, industrial processes, and medical electronics. Where appropriate, abbreviations and acronyms are included. There are also tables of SI units, schematic symbols, and of the Greek alphabet.

Modern Dictionary of Electronics, 6th Edition costs \$49.95, and is published by *Newnes, Butterworth-Heinemann, 225 Wildwood Avenue, Unit B, P.O. Box 4500, Woburn, MA 01801-2041; Tel. 781-904-2500; Fax: 800-446-6520 or 781-933-6333; Web: www.bb.com.*

CIRCLE 91 ON FREE INFORMATION CARD

BooksNow To order books in this magazine or, any book in print. Please call anytime day or night: (800) **BOOKS-NOW (266-5766)** or (801) 261-1187 ask for ext. 1456 or visit on the web at <http://www.BooksNow.com/popular-electronics.htm>.

Free catalogs are *not* available.

New Products

AMPLIFIED FM/AM ANTENNA

The *Recoton, Model 2417 Receptor*, an amplified FM/AM antenna, presents a high-tech, designer-styled appearance. It significantly improves the clarity of both FM and AM reception, increasing the number of stations pulled in.



Its tower body is topped by a spire that contains the antenna element. The Receptor can function in both omnidirectional and directional modes. When pointed upwards, the spire pulls in signals from anywhere around it, while the horizontal option allows users to aim the antenna element directly towards a favorite station's transmitter.

The Receptor also uses circuitry that increases coupling efficiency between antenna and tuner to reduce interference between FM and AM bands. It even includes sub-band accessory circuitry that pulls in sub-carrier signals with background music, weather, and traffic information (available in certain locations, when the antenna is linked to appropriate electronics). The antenna connects in seconds to any FM/AM receiver or tuner. It retails for \$44.99.

For more information, contact *Recoton*, 145 E. 57th St., New York, NY 10022; Tel. 800-732-6866; Web: www.recoton.com.

CIRCLE 80 ON FREE INFORMATION CARD

CIRCUIT-SIMULATION SOFTWARE

With this circuit-simulation package, designers create and analyze circuits quickly on their PCs. Click-and-drag component placement and online help makes it fast and easy to use.



ProtoLab 4.0 is designed to work as a simulated prototyping lab. Users insert components on a grid, similar to a breadboard. *ProtoLab's* prototyping grid is extensive and can handle a wide selection of active and passive components. They include wires, junctions, grounds, resistors, capacitors, inductors, voltage and current sources, diodes, transistors, and MOSFETs.

Circuit testing is done by placing probes at the nodes using the appropriate test instrument from the tool bar. Five virtual instruments provide circuit analysis; they are a voltmeter, ammeter, wattmeter, oscilloscope, and ohmmeter. An extensive library includes all types of oscillators, bridges, amplifiers, and tuned circuits, etc.

ProtoLab 4.0 has a list price of \$49.95. Contact *Global Specialties*, 70 Fulton Terrace, New Haven, CT 06512; Tel. 800-572-1028; Web: www.global-specialties.com.

CIRCLE 81 ON FREE INFORMATION CARD

CD PLAYER WITH ANTI-SKIP

Sanyo Fisher announced the release of the first personal CD player with a built-in 40-second Opti-Trac IV electronic anti-skip system. This is the longest shock buffer now available for personal CD listening, according to the manufacturer. The Opti-Trac system resists interruptions by storing CD music in a 16-MB, 40-second memory. Using a Fast-read Multi-Trace (FMT) system, musical data is read at twice normal speed and stored in memory before digital-to-analog conversion.



The compact *PCD-7950*, measuring approximately five inches by one inch by six inches and weighing just a little over eight ounces, can be taken anywhere. The CD player can be enjoyed without interruption while riding a bicycle; while exercising, walking or rollerblading, or while riding in a car over bumpy terrain.

Features of the *PCD-7950* include an AM/FM digital tuner with 20 presets, 22-track programmable CD, repeat/introscan functions, and three-beam laser tracking. Other features include automatic power-off, auto backlit LCD display, two rechargeable NiCD batteries, headphones, and an AC adapter/charger.

The *PCD-7950* has a suggested retail price of \$189.99. For more information, contact *Sanyo Fisher*, 21605 Plummer Street, Chatsworth, CA 91311; Tel. 818-998-7322; Fax: 818-701-4182; Web: audvidfisher.com.

CIRCLE 82 ON FREE INFORMATION CARD

MILLENNIUM CLOCK

(continued from page 36)

of days remaining in the present month to get the number of days left until the new millennium begins. Between the table and a calendar, it is fairly easy to determine the number of days until the new millennium (based on either of the above two definitions.)

Anyone with a computer, or at least access to one, can use it to determine the number of days between two dates. Any reasonably powerful spreadsheet program should be able to perform the calculation. For Microsoft Excel, one example of such a function is given in Listing 1.

Another alternative would be to use a dedicated program to perform the calculation, such as the BASIC program given in Listing 2. The program is available on the Gernsback Web site: www.gernsback.com and will also be given to

TABLE 2—DAYS LEFT

Date	Days Until:	
	1-Jan-2001	1-Jan-2000
11/1/98	792	426
12/1/98	762	396
1/1/99	731	365
2/1/99	700	334
3/1/99	672	306
4/1/99	641	275
5/1/99	611	245
6/1/99	580	214
7/1/99	550	184
8/1/99	519	153
9/1/99	488	122
10/1/99	458	92
11/1/99	427	61
12/1/99	397	31
1/1/00	366	0
2/1/00	335	--
3/1/00	306	--
4/1/00	275	--
5/1/00	245	--
6/1/00	214	--
7/1/00	184	--
8/1/00	153	--
9/1/00	122	--
10/1/00	92	--
11/1/00	61	--
12/1/00	31	--
1/1/01	0	--

anyone who purchases the S-record software for the Millennium Clock.

Closing Note. The small board size and component count of the Millennium Clock make it fairly simple to build and use. In fact, it should only take about three or four nights of your time to completely assemble and test the Millennium Clock. It is unfortunate that it is not up and running already. If it were, it could be used to track of the number of days required to complete the project! ■

MULTIMEDIA WATCH

(continued from page 50)

graphics accelerator that's not just for gaming. It's designed for business graphics and video acceleration, but also packs in 3D acceleration for gaming and such things as developing VRML Web content. Acceleration effects include gouraud shading, Z-buffering, bilinear and anisotropic filtering, MIP-mapping, alpha blending, perspective correction, video texture mapping, and more.

The *Velocity 128* is built around a 128-bit multimedia engine and includes 4MB of video memory. It is available with either a PCI or AGP bus and comes with drivers for *Windows 95* and *NT 4.0*. The *Velocity 128* has a suggested retail price of \$149.

NEW SOFTWARE

I think DVD is really starting to take off, because I'm starting to see a lot of DVD software titles, not to mention all the movies. For example, *Multimedia 2000* sent me two software titles that require either a computer with a DVD-ROM drive or a DVD player to run. In concept, the software is no different than related CD-ROM titles, but the main benefit to DVD publishing is having more room on the disc, which lends itself to storing better quality video that requires more storage space. *Multimedia 2000's Great Chefs—Great Cities* and *Warren Miller's Ski World* are two DVD titles that are loaded with multimedia and great video.

Great Chefs—Great Cities is a multimedia cookbook that lets you test out recipes from some of the country's most talented chefs—over 90 chefs from 17 cities. From appetizers to desserts, each recipe lists the neces-

sary ingredients and cooking techniques. You can watch the same video on DVD player or a DVD-ROM drive. But playing the disc on a PC with a DVD-ROM drive has its advantages. The software part of the disc contains hundreds of additional recipes. You can also add your own recipes, scale and collate ingredients from multiple recipes, print shopping lists, look over ingredient descriptions, and so on. *Great Chefs—Great Cities* has a suggested retail price of \$44.95.

Warren Miller's Ski World is the perfect title for people who can't ski often enough. It can also help you find the perfect ski destination according to the type of skiing you're looking for. The disc is loaded with videos of skiing and snowboarding. The disc helps beginners with video instruction, tips, tricks, and techniques from the experts. Again DVD-ROM users have more options. There's an interactive resort locator, filled with information on lodging, lifts, and more for over 700 worldwide ski resorts. You can even zoom in on trail maps of major resorts. There's also information on the history of skiing and a Windows screen saver. *Warren Miller's Ski World* has a suggested retail price of \$39.95.

I've got a few more titles from *Expert Software* this month. All of them cost only \$14.99. *Baby Album Deluxe* helps you preserve the precious moments of your child's life. From the minute you're expecting to the child's teenage years, *Baby Album Deluxe* records the process of a child's growing up. The disc helps you choose names, document medical history, record birthdays and special events, and so on. Other new titles from Expert include *Ultimate Game Collection* featuring over 500 different games and *Interactive Sailing* with over 30 minutes of sailing video, a simulated sailboat game, and more.

Total Annihilation from *Cavedog Entertainment*, the real-time combat game over land, sea and air, has some pretty loyal followers. Those folks will want to check out *Total Annihilation: The Core Contingency*, an add-on pack for *Total Annihilation*. *Total Annihilation: The Core Contingency* is the second chapter in the strategy saga. There are new worlds, strategies, amphibious assault vehicles, underwater bases, and fast-moving hovercrafts. This expansion pack has an estimated street price of \$24.99. ■

Market Center™

Paperback Books

GREAT BOOKS AT BUDGET PRICES

100 RADIO HOOKUPS
—#7—\$3.00

First published in May, 1923 this popular booklet went into reprint editions nine times. It is packed with circuits, theory, antenna installation and tips on consumer radio receivers that were popular in the early 1920's. Antique radio buffs and those inquisitive about the early days of radio will find this booklet an exciting, invaluable and excellent reference into the minds of early-day radio listeners. Sorry, we cannot honor the original 25-cent cover price.

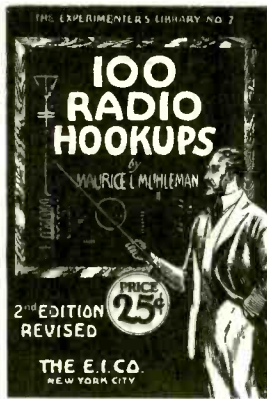

GUIDE TO THE WORLD'S RADIO STATIONS
—BP355—\$10.99

An easy-to-read guide for the casual listener and top notch QSL getter! The Guide is an essential reference work designed to steer the listener around the ever more complex radio bands. Listings cover world-wide shortwave stations with a special emphasis on international broadcasts in English. Medium and long-wave listings are also included for the US, Canada, European, Middle and Near East, and North Africa regions

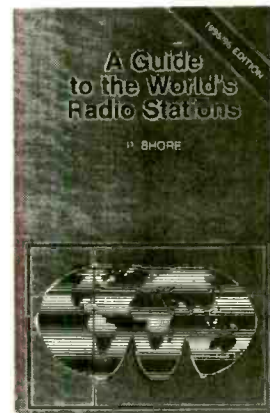

THE INTERNET AND WORLD WIDE WEB EXPLAINED —BP403—
\$10.99

Strip away the hype and mystery of the WWW and you'll be cruising on the information Superhighway! Understand the jargon used: ftp, protocols, TCP, hypertext, http, URL, home pages, threads, HTML, domains, FAQs, etc. Discover that e-mail is easy, fast and free! Learn how to guard against hackers and viruses. Develop friendships and "buddies" in Singapore, India, Cape Town, Peru—just about anywhere!

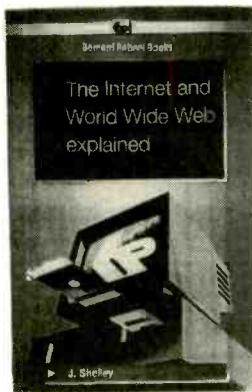

WIRELESS & ELECTRICAL CYCLOPEDIA
—ETT1—\$5.75

A slice of history. This early electronics catalog was issued in 1918. It consists of 176 pages that document the early history of electricity, radio and electronics. It was the "bible" of the electrical experimenter of the period. Take a look at history and see how far we have come. And by the way, don't try to order any of the radio parts and receivers shown, it's very unlikely that it will be available.

ELECTRONIC TECHNOLOGY TODAY INC.
P.O. BOX 240, Massapequa, NY 11762-0240

Name _____
Address _____
City _____ State _____ Zip _____

SHIPPING CHARGES IN USA AND CANADA

\$0.01 to \$5.00	\$2.00
\$5.01 to \$10.00	\$3.00
\$10.01 to 20.00	\$4.00
\$20.01 to 30.00	\$5.00
\$30.01 to 40.00	\$6.00
\$40.01 to 50.00	\$7.00
\$50.01 and above	\$8.50

SORRY No orders accepted outside of USA & Canada

Number of books ordered

Total price of merchandise	\$ _____
Shipping (see chart)	\$ _____
Subtotal	\$ _____
Sales Tax (NYS only)	\$ _____
Total Enclosed	\$ _____

All payments must be in U.S. funds!

ET01

November 1998, Popular Electronics

AMAZING PRODUCTS! INFORMATION

VISIT OUR 'ACTION' WEB SITE@
<http://www.amazing1.com>

UNLIMITED DEPT PE 0498
 BOX 716 AMHERST, N.H. 03031

ATTENTION!! RAILGUN EXPERIMENTERS HIGH ENERGY PULSER

RAIL GUN, COIL GUN, EXPLODING WATER, ANTIGRAVITY, MASS WARPING, LEVITATION, PLASMA PROPULSION, LATTICE SNAPPING, EMP etc

EXPERIMENTORS AND RESEARCHERS

- Lossless Energy Charging
- Programmable Voltage to 2 KV and Energy Control to 3 KJ
- Triggered Spark Switch (IKJ)
- Universal 12 VDC or 115 VAC
- 7.5 X 7.5 X 7" Light weight

HOTSHOT

UNIT IS SHOWN WITH OUR "DEFINITIVE ENERGY SOURCE" USED IN OUR GUN

HEP3 Plans High Energy Pulser/Ignitor.....\$15.00
 HEP3K Kit/ Plans (With 500 Joules Energy Storage).....\$349.50
 HEP30 Assembled (With 500 Joules Energy Storage).....\$449.50
 All Individual Parts and Subassemblies Available

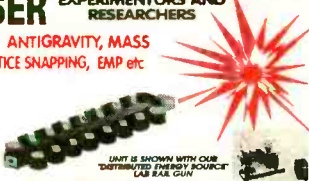

BURNING LASER RAY GUN

BLASTS THRU THE HARDEST OF METALS!

A FUTURISTIC CONCEPT!!

All Parts Available

LAGUN2 Plans.....\$20.00



BURNING CO2 BENCH LASER

HOTTER THAN MOST TORCHES!

All Parts Available

LC7 Plans.....\$20.00



ELECTRONIC HYPNOSIS AND MIND CONTROL

Generates Highly Effective Audible and Visual Stimuli With Bio-Feedback That Can Induce Hypnotic as Well as ALPHA Relaxed States of the Mind. Place Subjects "Under" Your Control. Enhances Hidden PSYCHIC Ability in Many People!

MIND Plans.....\$15.00
 MIND2K Kit and Plans.....\$49.50
 MIND20 Assembled.....\$89.50



TELEPHONE TAPING SYSTEM EXTENDED X4 PLAY

Tapes Phone Conversation 20 Mags Input 21 Check Level

TAP30X Ready to Use.....\$84.50
 BEEP10 Beeper Alert.....\$29.95



TRANSISTORIZED TESLA COIL

URNS A LIGHT BULB INTO A SPECTACULAR PLASMA DISPLAY

Transmits Wireless Energy Noiseless Operation Pyrotechnic Effect 12 VDC/5 Amps or Battery 115 VAC Optional Converter Adjustable Frequency Control For Effect

TCL5 Plans.....\$8.00
 TCL5K Kit/Plans.....\$59.50
 TCL50 Ready to Use.....\$109.50
 12DC/7 12VDC@7Amps.....\$39.50



JACOBS LADDER

Observe a pyrotechnical display of "traveling" fiery plasma. Starts off as 1/2" arc and expands to over 3" before evaporating into space. This is an excellent attention getting display as well as a winning science project!! With arc control.

JACK1 Plans.....\$8.00
 JACK1K Kit Minus Case.....\$129.50
 JACK10 Ready to Use.....\$249.50

12KVGEN20 Pwr Supply Only.....\$99.50
 12KVGENZ2K Kit of Pwr Supply.....\$79.50



ATTENTION! ANTI GRAVITY,

We Can Supply Low Cost HIGH VOLTAGE Current Producing Generators from 50 to 500 KV. Contact Factory For Details or Call 603 673 6493

MICRO MINI MITE TESLA COIL

LIGHTS UP A 4 FT FLUORESCENT TUBE WITHOUT CONTACT!! YET ONLY 3" TALL!

Super Magic Trick Low Cost Science Project 12 VDC/115 VAC Operation

MTC1K Kit/Plans.....\$19.50
 MTC10 Ready to Use.....\$34.50



PHASOR BLAST WAVE PISTOL

130 db of Directional Sonic Shock Waves Energy Handheld and Battery Operated

PPP1 Plans.....\$8.00
 PPP1K Kit/Plans.....\$49.50
 PPP10 Ready to Use.....\$79.50



HOVERBOARD PLANS

Kit Soon to be Available

28 Pages of "how to" build a magnetic force field capable of containing a column of ionized air up to several psi! Proven theory may require additional experiment

HOVER Plans.....\$25.00



3Mi FM VOICE TRANSMITTER

Safety Product Allows Listening to Children or Invalids in Hazardous Areas, Pools, Ponds etc. Great Security Intrusion Alert! Uses FM Table Top Radio.







FMV1K Kit/Plans.....\$39.50



1 800 221 1705 ORDERS ONLY! FAX 1 603 672 5406 INFO 9-5pm 1 603 673 4730 FREE CATALOG ON REQUEST
 Pay by MC, VISA, Cash, Chk, MO. COD. Please Add \$5.00 S&H plus \$5.00 if COD. Overseas Please Contact for PROFORMA

DATA ACQUISITION & CONTROL

AFFORDABLE PLUG-IN BOARDS FOR PC's ISA BUS

- | | |
|---|--|
| <p>ANA100 Analog I/O \$ 99</p>  <ul style="list-style-type: none"> * 8 Channel 8-Bit * 0 to 5 Volt Input * 14 TTL I/O lines * Analog Output * 400KHz Sampling | <p>DIG100 Digital I/O \$ 39</p>  <ul style="list-style-type: none"> * 82C55 PPI * 24 or 48 TTL I/O Lines option * Selectable Base Address |
| <p>ANA150 Analog/Counter... \$ 89</p>  <ul style="list-style-type: none"> * 8 Channel 8-Bit * 0 to 5 Volt Input * 3 16-Bit Counters * 400KHz Sampling | <p>DIG200 Counter I/O \$ 79</p>  <ul style="list-style-type: none"> * 3 16-Bit Counters * 8 TTL Input lines * 8 TTL Output lines * Selectable Clock Frequency Input |
| <p>ANA200 Analog I/O \$ 79</p>  <ul style="list-style-type: none"> * 1 Channel 12-Bit * 0 to 5 Volt Input optional bi-polar * 100KHz / 300KHz Sampling rate * 24 TTL I/O lines | <p>ANA201 Analog \$ 119</p>  <ul style="list-style-type: none"> * 8 Channel 12-Bit * x1, x5, x10, x50 Programmable Channel gain * 100KHz Sampling rate |

On-Line Product Catalog at Our Web Site
<http://www.Bsof.com>
 E-Mail: Sales@Bsof.com

BSOFT Software, Inc.

444 COLTON ROAD * COLUMBUS, OH 43207
 PHONE 614-491-0832 * FAX 614-497-9971

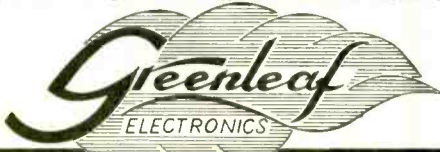

CABLE TV Converters & Descramblers

Compatible with
**Jerrold, Scientific Atlanta,
 Pioneer, Oak, & Hamlin
 Equipment**

BRAND NEW!

**6-MONTH GUARANTEE
 LOWEST PRICES**

Volume Control & Parental Lockout Available

Greenleaf Electronics
 1-800-742-2567

NO ILLINOIS SALES

It is not the intent of Greenleaf Electronics to defraud any pay television operator and we will not assist any company or individual in doing the same.

MCM ELECTRONICS

The Source For All Of Your Electronics Needs

When ordering, please provide this code: **SOURCE CODE: POP58**

Prices Effective Sept. 17 through Nov. 30, 1998

For over 20 years, MCM has been the leading supplier to the electronics service industry. Huge inventory, rapid delivery and competitive prices have made MCM the choice for:

- Hobbyists
- Service Technicians
- Educators
- Installers

Discover the MCM difference, call today for your free catalog.



ONLY \$7.95

Order #55-1240

MCM AUDIO SELECT™ 8" Clear Polypropylene Woofer

Great for home or autosound applications. Specifications: • 15 oz. magnet • 1½" voice coil • 45W/80W RMS/peak capacity • 32Hz-5KHz response • Polyfoam surround • 8ohm • Qts 0.74 • Vas 2.20cu. ft. • fs 37Hz • **Regular price \$13.50**



ONLY \$29.95

TENMA® DMM W/Logic Function

3½ digit DMM measures AC/DC voltage from 200mV-600V, resistance to 2000Mohm, capacitance to 20µF and transistor hFE gain. Includes protective holster. Requires 9V battery (#290-080) not included. **Regular price \$65.95**



ONLY \$59.95

Order #21-1590

TENMA® Digital Soldering Station

Adjustable temperature and a variety of available tips makes this perfect for most service applications. Digital display accurately displays operation temperature and setpoint. Adjustable from 340-875°F. **Regular price \$119.00**



ONLY \$19.95

30 Piece Security Screwdriver Set

Ideal for servicing items that utilize tamper proof security screws, including institutional equipment, computer monitors, cable boxes and more. Kit includes security hex and torx bits, spanners, tri wings and offset cross point type bits. **Regular price \$41.25**

Order #22-1475



ONLY \$3.99

Order #83-1320

DB-25 A/B Switch

Take advantage of this incredible price on a two position DB-25 switch. All pins are switched, all connectors female, metal housing. **Regular price \$9.95**



ONLY \$2.50

Order #58-3330

13.5VDC 1 Amp AC Adaptor

Great for powering projects! • Input voltage: 120VAC, 60Hz, 32W • Output voltage: 13.5VDC, 1A • Tip dimensions: 5.5mm (O.D.) x 2.1mm (I.D.), positive tip • UL, CSA • **Suggested list \$19.99 • Limited quantities**



FREE Catalog!

ONLY \$18.75

Hands Free Headset Telephone

Completely self contained phone includes lightweight headset for totally hands free operation. Two position belt clip allows horizontal or vertical attachment to belt. Features redial, tone/pulse operation, flash and hi/lo volume. **Regular price \$24.95**



Order #36-995

ONLY \$57.00

Order #22-1625

Adjustable Radius Blade Hole Cutter

Great for cutting speaker openings in wood up to 1¼" thick from 1¼"-7¼". Transparent cowl has metal frame to steady blade and catch debris when cutting in ceilings. **Regular \$103.00**



1-800-543-4330

www.mcmelectronics.com

Hours: M-F 7 a.m.-9 p.m., Sat. 9 a.m.-6 p.m., EST.

Same Day Shipping!

In stock orders received by 5:00 p.m. (YOUR TIME), are shipped the same day.



MCM ELECTRONICS®

650 CONGRESS PARK DR.
CENTERVILLE, OH 45459
A PREMIER FARNELL Company

SOURCE CODE: POP58

SEC Sun Equipment Corporation

P. O. Box 97903, Raleigh, NC 27624 E-mail: sunequipco@ipass.net
To request FREE CATALOG, please call, fax, write, or e-mail us.

Quality Test Equipment for Cost-Minded People

LODESTAR Lodestar Electronics Corp. Since 1979

One Year Warranty. 15 Day Money Back Guarantee. OEM WELCOME.

School purchase order accepted. Bids accepted.

SALES REP/DISTRIBUTORS/OEM WANTED.

1-800-870-1955 / (919)870-1955 Fax: (919)870-5720

VISA Mastercard
Discover, AmrExpr

DC POWER SUPPLY (CC/CV)

All models: protection of short ckt, overload, reverse polarity, over-voltage. Constant Current & Voltage (CC/CV) are fully adjustable. Regulation: $\leq 0.1\% + 3mV$ (line), $\leq 0.1\% + 3mV$ (load); $\leq 1mV$ ripple.

SINGLE OUTPUT

Analog Displays

- PS-303 \$159.00, 30V/3A
- PS-305 \$219.95, 30V/5A
- PS-1610S \$289.00, 16V/10A
- PS-2243 \$139.00, 12V/24V select, 3A
- PS-2245 \$159.00, 12V/24V select, 5A
- 8107 \$399.95, 30V/10A
- 8110 \$289.95, 60V/3A
- 8112 \$399.95, 60V/5A

Digital Voltmeter & Analog Ammeter

- 8200 (8201) \$179.95 (\$239.95), 30V/3A (5A)
- Digital Displays 8210/8300 \$199.95, 30V/3A
- 8211/8301 \$259.95, 30V/5A

DUAL OUTPUTS

Independent Tracking

Analog Displays

- 8108 \$549.95, 60V/3A
- 8109 \$699.95, 60V/5A

PS-303D \$314.95, 30V/3A

TRIPLE OUTPUTS, a fixed 5V/3A output, Independent Tracking

- Digital Displays 8202 (8203) \$499.95 (\$549.95), dual 30V/3A (5A)
- Analog Displays 8102 (8103) \$399.95 (\$489.95), dual 30V/3A (5A), with Parallel (30V/6A) and Series (60V/3A) Mode operation.

NTSC/PAL TV COLOR BAR GEN.

CPG-1366A \$159.95, VHF NTSC,

Freq.: 45.75, 175.25, 187.25 MHz

RF Output: 10mV

Impedance: 75 Ohm

Video Output: BNC, 1V_{p-p}

CPG-1367A \$159.95, VHF PAL



SWR/RF/mW POWER METER

310 \$89.95, 1.8-150MHz, RF Power: 0-4W/20W/200W 3 ranges; SWR Measurement: 1.0-∞, 4W minimum.

Accuracy: 5%-10%; Insert Loss: 3dB

Input/Output Imp.: 50Ω; SO-239 plug

320 \$89.95, 130-520MHz, Spec. 310

330 \$119.95, 1.8-520MHz, Spec. see 310.

SWR-3P \$26.95 1.7-150MHz,

RF Power: 0.5-10W, 0.5W-100W.

SWR-2P \$22.95, 1.7-30MHz, RF Power: 0.5-10W.

mW RF Power Meter \$40 \$219.00, 1.8-500MHz, RF

Power: 20mW/200mW/2W 3 ranges; Imped.: 50Ω; Accuracy:

±10% full scale. SWR <1.15; N-type connector; BNC type output.

FM STEREO MODULATOR

AG-2011A \$549.00

RF SECTION:

Carrier: 98MHz ±2MHz;

Output: 10mV, 1mV & 0.1mV

COMPOSITE SIGNALS:

Pilot: 19KHz ±2Hz, 0.8Vrms

INT. MODULATION: 400KHz,

1KHz ±1%, 1Vrms, distortion < .5%; L-R Separation: >50dB.

EXT. MODULATION: Freq.: 50Hz-15KHz

L-R Separation: >45dB 100Hz-3KHz; >35dB 50Hz-15KHz



WOW-FLUTTER METER

WF-3103A \$699.95 Freq. Range: 3KHz ±10% JIS/CCIR;

3.15KHz ±10% DIN.

Measurem.: .03/1/1.3/1.3% full scale.

Accuracy: ±5% of full scale.

WF-3105A \$799.95, digital display;

Function: LIN/WOW/Flutter/WTD.

Freq. Counter: 10Hz-9.99MHz

Indication: CCIR/DIN/JIS

TOOLKITS - ELECTRONIC/PC

9245 \$29.99 U.S. Patented, 45-pcs. Contents: IC inserter/extractor

with securers & bows, 3-prong part retriever, #0 Phillips screwdriver,

1/8" flat screwdriver, self-hold tweezers, metal tweezers, extra

parts tube, soldering iron, solder, crimping tool, long-nose plier,

cutting plier, zipper vinyl case. Bits include: Phillips: #0/#1/#2/#3;

Flar: 1/8"/3/16"/1/4"/19/32"; PZ1/PZ2; TB/T9/T10/T15/T20/T25/

T27/T30/T40/T45; Hex: 5/64"/3/32"/1/8"/5/32"/3/16"; Sockets:

3/16" (5mm)/7/32" (5.5mm)/1/4" (6mm)/9/32" (7mm)/5/16" (8mm).

8G23 \$34.99 23-pcs Contents: IC inserter/extractor with securer &

bows, 3-prong part retriever, 3/16"/1/4" nutdriver, 3/16"/1/8" slot-

ed screwdriver, #0/#1 Phillips, reversible T10/T15 bits, reversible

#2 Phillips 1/4" slotted bits, tweezers, long-nose plier, cutter, 6" adj.

wrench, soldering iron, solder, crimping tool, zipper case, manual.

Various packages available call/write/mail/fax for detail

RF SIGNAL GENERATOR

SG-4160B \$124.95, 100KHz-150MHz

up to 450MHz on 3rd harmonics in 6

ranges; AM modulation, Accuracy: ±5%

RF Output: 100mVrms to 35 MHz;

Modulation: Int. 1KHz (AM) =30%;

Ext. 50Hz-20KHz, at least 1V_{p-p} input.

Audio Output: 1KHz, 2V_{p-p} minimum

SG-4162AD (with Freq. Counter) \$229.95, Spec. see SG-4160B.

COUNTER SECTION: 10Hz-150MHz, Max. Input: ±3V effective

Gate Time: .1, 1sec. Input Sensitivity: 35mV, 10Hz-200MHz

Input Impedance: 1MΩ (HF), 50Ω (VHF). Display: 7-digit LEDs

AM/FM STD SIGNAL GEN.

SG-4110A \$1799.00, Freq. 0.1-110MHz, Display: 6-digit LED;

Resolution: 100Hz (0.1-34.999MHz), 1KHz (35MHz-110MHz).

Accuracy: $\pm 5 \times 10^{-1}$ count; Output: -19dBu-99dBu, 1dB steps

Impedance: 50Ω VSWR 1.2; 100 preset frequency & store functions

AUDIO GENERATOR

AG-2601A \$124.95, 10Hz-1MHz in 5

ranges; Output: sine wave 0-8V_{p-p}; square

10V_{p-p}. Output Imped.: 600 Ohm.

Distortion: <0.05% 500Hz-50KHz;

<0.5% 50KHz-500KHz.

AG-2603AD \$229.95, with 6-digit,

Int/Ext. Freq. Counter, 10Hz-150MHz.

Output Control: 0/-20/-40dB & Fine adjuster. Spec. see AG-2601A.

FUNCTION GENERATOR

FG-2100A \$169.95, 0.2Hz-2MHz in 7

ranges; sine, square, triangle, pulse &

Ramp; Output: 5mV_{p-p}-20V_{p-p}, 1%

distortion. VCP: 0-10V/freq. to 1000:1.

FG-2102AD \$229.95, with FG-2100A;

4-digit counter display, TTL & CMOS

outputs, 30ppm ±1 count accuracy.

FG-2020B \$159.00, 0.5Hz-500KHz, Sine, Square, Triangle.

FG-2103 \$329.95, Digital sweep generator, 0.5Hz-5MHz in 7

ranges. Operating Mode: sweep, AM, gated burst, VCO.

Freq. Counter: Int. 0.5Hz-5MHz, Ext. 5Hz-10MHz

FG-513 \$769.95, 13 MHz, Microprocessor embedded digital sweep;

Sine, Square, Triangle, Pulse, Ramp, TTL & DC; ±(0.1%+1dig).

Freq. Counter & TCXO: 5Hz-100MHz, 6.5 digits, x1/x20 attenuatn

AC MILLIVOLT METER

MV-3100A \$159.95 wide band

5Hz-1MHz, 3 scales, mV, dB & dBm;

300μV-100V in 12 ranges, 10μV

resolution: -70-40dB in 12 ranges,

0dB=1Vrms, 0dBm=0.775V; ±3%

accuracy; input impedance 10MΩ;

Noise <2%. MV-3201B \$309.95 dual

channels, simultaneous measurement.

OSCILLOSCOPES

OS-7305B \$249.00 DC-7MHz, 3"

CRT; Horiz: .25V/div; 10Hz-100KHz

in 4 ranges; Vert: 10mV/div, Int. &

Ext. Sync; Input: 1MΩ/35pF

OS-7010A \$299.95 10MHz, 5" CRT,

Horiz: 2V/div, Vert: 10mV-10V/div.

OS-622G \$389.95 20MHz, 2 CH/X-Y

Alt trigger, trigger lock, hold OFF, TV

syn., 8x10 div., 1mV/div., Horiz: 2μs-5μ/div; Vert: 1mV-5V/div.

OS-653G \$699.95 50MHz, 2 CH/delay sweep, Alt trigger, TV syn.

OS-6101G \$1499.95 100MHz, 4ch/8 traces, delay sweep, cursor

readout. 2 years warranty for OS-622G, OS-653G, & OS-6101G.

UHF ATTENUATORS

RT-8815U (50Ω) \$299.00 / RT-8817U (75Ω) \$299.00, 950MHz,

81dB, 0.5W max.; Steps: 1/2/3/5/10/20/20/20, 8 switches.

085E-2 (50Ω) \$399.00 / 087E-2 (75Ω) \$399.00, 950MHz, 81dB,

0.5W max.; Steps: 10dB+7.1dBx10. Electronic adjustment knob.

MICROPROCESSOR TRAINER

BCC-8088 \$699.00, learn

computer theory. Excellent

for school & individual

who want to learn about

ROM, RAM, I/O ports,

programming, & run a

8088 Microprocessor. An

easy to understand step-

by-step manual guides

you to achieve your goal

56-key keyboard, LCD

display, RS-232, UART.

GRID DIP METER

DM-4061 \$89.95 1.5-250MHz,

6 bands; 6 plug-in coils,

2 transistor, and 1 diode.

Modulation: = 2KHz Sinewave.

Crystal Oscillator: 1-15MHz.

Wave absorption meter. 9VDC battery.

FREQUENCY COUNTER

FC-5250C \$119.95 10Hz-220MHz

(HF) 10Hz-20MHz, (VHF) 10-200MHz.

Gate Time: .1, 1sec. Max. Input: 10V_{p-p}

Input Sensitivity: 35mV/10Hz-200MHz

Input Imped.: 1MΩ (HF), 50Ω (VHF).

Display: 7-digit LEDs; 9V adapter (\$6)

FC-5260A \$129.95

10Hz-600MHz, 7-digit LEDs.

FC-5270 \$149.95

10Hz-1.2GHz, 8-digit LEDs.

FC-5600B \$229.95

10Hz-600MHz, 10-digit LEDs.

FC-5700 \$299.95 10Hz-1.3GHz, 10-digit LEDs. Period measure

SIGNAL TRACER/INJECTOR

SE-6100 \$134.95

TRACER Gain 60dB maximum.

Attenuation: 0/20/40/60dB

Input Imped.: 100KΩ; Meter: Vu 100μA

Output Imped.: 600Ω; Speaker: 8 Ω.

INJECTOR: =1KHz Squarewave;

Output Level: Variable 0-4.5V_{p-p}, 9V battery or adapter (\$6.00)

LCR METERS

MIC-4070D \$179.95, Induct.: 0.1μ-200H, Capacit.: 0.1p-20mF,

Resist.: 1mΩ-20MΩ, 2Q range, Dissipation factor measurement,

Zero adjust; Surface mount device (SMD) test probe: LT-06 \$21.95

DIGITAL MULTIMETER

DMM-120 \$24.95, 3 1/2 digit, 600VDC, 2ADC

500VAC, 2MΩ, hFE/diode/continuity test, 1.2%

DMM-123+Capacitance \$44.95, 3 1/2 digit,

600VDC/600VAC, 10ADC/AC, 2GΩ, 20μF,

hFE/diode test, continuity beeper, 0.8% accuracy

DMM-124+Cap.+Temp.+Freq. \$69.95, 3 1/2 dig.

600VDC/500VAC, -58-752°F, 2GΩ, 20μF,

200KHz, 3φ phase/diode/continuity test; 1.2%

DMM-125 \$54.95, Autorange/Bargraph, 32MΩ,

600VDC/AC, 10ADC/AC, diode/continuity test

MIC-35 \$59.95, Autorange, 3 1/2 LCD, 20MΩ,

1000VDC/750VAC, 20ADC/AC, LCD, hold,

diode/continuity test, free holster, 0.5% accuracy

MIC-39 \$129.95, Autorange/Bargraph, True RMS, 3 1/2 LCD, 40μF,

40MΩ, 1000VDC/750VAC, 20ADC/AC, 600KHz freq. cntr, data

hold, sleep mode, memory, read functions, holster, 0.3% accuracy

POCKET

I DOUBLED MY INCOME...

WORK ONLY HALF THE HOURS!

I covered a lot of miles driving a cab for 13 years... but I sure didn't get anywhere! I mean the hours were long. The pay was short. My boss pushed, pushed, pushed all the time. In the meantime bills were piling up. Medical bills. House repairs. Charge cards. Just the everyday things. I was not just behind the wheel, I was behind the eight ball.

That's when I saw a magazine article that talked about the hottest big money-making career opportunities of the 90's. The one that interested me the most pertained to the **NEW explosive SATELLITE DISH/TV/ELECTRONICS field.**

I mailed the coupon for the FREE information kit they offered. I liked what I saw when the information packet came in the mail. What really caught my eye, however, was the idea I could gain all the knowledge I needed to make a success of this business studying in my spare time at home. **Foley-Belsaw's modern, practical hands on course combines simple step-by-step lessons with easy-to-follow video cassette guidance.** No special experience, education or electronics background is necessary. Just average mechanical aptitude to follow simple A-B-C repair procedures that are clearly outlined for you.

I decided to get in on the action... and just look at me now! Now I'm really in the driver's seat. I'm doing what I want to do. I'm my own boss. I set my own hours. I'm making more money than my wife and I ever dreamed possible. **Would you believe I'm making twice what I made driving a cab...and I work only half as many hours.**



Hottest career opportunity since invention of the VCR!

Get in the **FAST LANE** on the New "INFORMATION SUPERHIGHWAY" Everyone's Talking About!

It's exciting! It's gigantic! The technology of tomorrow is here today! You've been reading and hearing about the amazing INFORMATION SUPERHIGHWAY. **It's so NEW that few technicians are equipped to service this fast emerging field!** **Foley-Belsaw gives you SATELLITE DISH technology (including New MINI-DISH)...** along with the electronics expertise you need to make BIG MONEY servicing TVs and other electronics equipment.

Be Your Own Boss!

It's quick and easy to become an expert at home in your spare time. Earn really BIG money adjusting, installing, and repairing Satellite Dish Systems, TVs, Amplifiers, CD Players, AM/FM Tuners, Home Entertainment Centers. Every home, every business, every office in your area desperately needs your expertise!

Your Timing Couldn't Be Better!

Never before and probably never again will you have a ground-floor opportunity like this to get into a

booming business of your own, make really big money, be your own boss and enjoy financial freedom and security. The fact you're reading this message shows you're smart enough to realize this!

Learn In Spare Time At Home!

It's easy to learn in your spare time at home. And when you complete the course you will receive Foley-Belsaw's official diploma acknowledging your accomplishment

Send Coupon Today for FREE Kit. No Obligation.

Don't miss out on this once-in-a-lifetime opportunity. Send in the coupon NOW. Get all the facts and study them in the privacy of your own home. There's absolutely no obligation and no salesman will call on you. So don't delay. Mail the coupon today.

"Took in over \$3,200 in the past 10 days!"
H.H., Denver, CO

"Doubled my income within 6 weeks."
R.B., Bakersfield, CA

Mail for FREE Information Package

Foley-Belsaw Institute
6301 Equitable Road
Kansas City, MO 64120-1395



Please Check Only ONE of the Following:

- | | |
|---|---|
| <input type="checkbox"/> Satellite Dish, Dept. 31617 | <input type="checkbox"/> Locksmithing, Dept. 13145 |
| <input type="checkbox"/> Computer Repair, Dept. 64748 | <input type="checkbox"/> Small Engine Repair, Dept. 53019 |
| <input type="checkbox"/> Gunsmithing, Dept. 92651 | <input type="checkbox"/> Woodworking, Dept. 43883 |
| <input type="checkbox"/> PC Programming, Dept. 35564 | <input type="checkbox"/> Upholstery, Dept. 81555 |
| <input type="checkbox"/> VCR Repair, Dept. 62846 | <input type="checkbox"/> Saw & Tool Sharpening, Dept. 21951 |
| <input type="checkbox"/> Vinyl Repair, Dept. 71486 | |

Name

Address

City

State Zip



Call Toll-FREE **1-800-487-2100**

ALFA ELECTRONICS, INC.

HIGH QUALITY TEST EQUIPMENT PROVIDER

1-800-526-2532 (526-ALFA)

15 Days Money Back Guarantee!

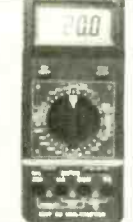
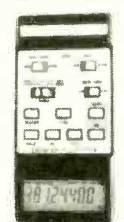
	<p align="center">DMM</p> <p>DMM-895 (\$179.00): true rms, AC/DC (V,A), Ω, bar graph, freq, capac., dBm, logic, diode</p> <p>DMM-885 (\$149.00): AC/DC (V,A), Ω, bar graph, freq, capac., logic, diode</p> <p>DMM-20 (\$74.95): AC/DC (V,A), Freq, cont., Capac, Induct., Ω, hFE, diode, duty cycle</p> <p>DMM-22 (\$89.95): 4000counts, bar graph, Freq, AC/DC (V,A), Ω, Capacitance, diode, contin.</p> <p>DMM-23T (\$99.95): 4 1/2 digit, true rms, high resol. (10μV, 10mA, 10mΩ), hFE, diode, contin.</p> <p>DMM-10 (\$19.95): 3 1/2 digit, DC/AC V, Ω, hFE, diode, signal output(+3V,-0.5Vsq.,.50% duty)</p>		<p align="center">LCR METER</p> <p>CAP-15 (\$49.95): 3 1/2 digit, 0.1pF-20mF, 9 Ranges, 0.1pF resolution zero adjustment</p> <p>LCR-24 (\$139.95): 0.1$\mu$H-200H, 0.1pF-2000$\mu$F, 0.01$\Omega$-20M$\Omega$, diode test. <i>New Model</i></p> <p>LCR-814 (\$189.95): 0.1$\mu$H-200H, 0.1pF-20mF, 1m$\Omega$-20M$\Omega$, Q, Factor, dissipation, zero adjust</p> <p>LCR-131D (\$229.95): autorange, 0.1$\mu$H-10kH, 0.1pF-10mF, 1m$\Omega$-10M$\Omega$, Q Factor, serial/parallel, 120Hz/1kHz testing mode.</p>	<p align="center">FREQ. COUNTER</p> <p>FC-1200 (\$129.95): 1.25GHz Handheld, 8 digits display, 10ppm accuracy, sensitivity 5mV (130-350MHz), 30mV (440MHz), 22mV (800MHz), batteries or 9V adapter.</p> <p>FC-2500 (\$179.95): 2.5GHz Handheld, 8 digits display, 4ppm accuracy, sensitivity <50mV, batteries or 9V adapter.</p> <p>FC-5270A (\$149.95): 1.2 GHz bench type, 8 digit, 10 ppm, 35mV sensitivity, 10V p-p max. input, power by 9V adapter.</p> <p>FC-5700 (\$329.95): 1.3GHz bench type, 8 digit, 1 ppm accuracy, 20mV sensitivity, period 0.1μs to 100ms. Ideal for test & repair of audio instrument.</p>																																
	<p>DMM-113 (\$24.95): Pocket Size, DC/ACV, Ω, diode, Continuity beeper</p> <p>DMM-120 (\$24.95): economy type, DCV, ACV, DCA, Ω, hFE, diode</p> <p>DMM-122 (\$59.95): DC/AC(V,A), Ω, hFE, diode, capacitance, freq, logic, continuity</p> <p>DMM-123 (\$44.95): DMM + capacitance, DC/AC(V,A), Ω, hFE, diode, continuity</p> <p>DMM-124 (\$69.95): Electrical+Temp, DC/ACV, Ω, capacitance, freq, 3 phase, diode, contin.</p> <p>DMM-125C (\$54.95): Autorange + bar graph, DC/ACV, Cap, Ω, diode, continuity beeper</p>		<p align="center">FLUKE DMM</p> <table border="1"> <tr> <th>HandHeld</th> <th>Scope Meter</th> </tr> <tr> <td>12B \$ 84.95</td> <td>92B-III \$1,445</td> </tr> <tr> <td>70-III \$ 85.00</td> <td>96B-III \$1,695</td> </tr> <tr> <td>73-III \$115.00</td> <td>99B-III \$2,095</td> </tr> <tr> <td>75-III \$139.00</td> <td>105B \$2,495</td> </tr> <tr> <td>77-III \$154.00</td> <td>123-III \$945</td> </tr> <tr> <td>79-III \$175.00</td> <td>863E \$475</td> </tr> <tr> <td>87 \$289.00</td> <td>867B \$650</td> </tr> <tr> <td>87-III \$309.00</td> <td></td> </tr> </table>	HandHeld	Scope Meter	12B \$ 84.95	92B-III \$1,445	70-III \$ 85.00	96B-III \$1,695	73-III \$115.00	99B-III \$2,095	75-III \$139.00	105B \$2,495	77-III \$154.00	123-III \$945	79-III \$175.00	863E \$475	87 \$289.00	867B \$650	87-III \$309.00		<p align="center">SPECIALTY METERS</p> <table border="1"> <tr> <td>• Sound meter \$169.95</td> <td>• Watt Meter \$129.95</td> </tr> <tr> <td>• EMF Tester \$69.95</td> <td>• High Voltage Probe \$59.95</td> </tr> <tr> <td>• Conductivity \$169.95</td> <td>• pH Meter \$79.95</td> </tr> <tr> <td>• Thermometer \$69.95-\$89.95</td> <td>• Light Meter \$80-\$90</td> </tr> <tr> <td>• Humid./Temp meter \$169.95</td> <td>• Light Adapter \$49.95</td> </tr> <tr> <td>• Press. meter \$299.95</td> <td>• Anemometer \$179.95</td> </tr> <tr> <td>• Electr. scale \$89.95</td> <td>• Anemometer adapter (And More) \$89.95</td> </tr> </table>	• Sound meter \$169.95	• Watt Meter \$129.95	• EMF Tester \$69.95	• High Voltage Probe \$59.95	• Conductivity \$169.95	• pH Meter \$79.95	• Thermometer \$69.95-\$89.95	• Light Meter \$80-\$90	• Humid./Temp meter \$169.95	• Light Adapter \$49.95	• Press. meter \$299.95	• Anemometer \$179.95	• Electr. scale \$89.95	• Anemometer adapter (And More) \$89.95
HandHeld	Scope Meter																																			
12B \$ 84.95	92B-III \$1,445																																			
70-III \$ 85.00	96B-III \$1,695																																			
73-III \$115.00	99B-III \$2,095																																			
75-III \$139.00	105B \$2,495																																			
77-III \$154.00	123-III \$945																																			
79-III \$175.00	863E \$475																																			
87 \$289.00	867B \$650																																			
87-III \$309.00																																				
• Sound meter \$169.95	• Watt Meter \$129.95																																			
• EMF Tester \$69.95	• High Voltage Probe \$59.95																																			
• Conductivity \$169.95	• pH Meter \$79.95																																			
• Thermometer \$69.95-\$89.95	• Light Meter \$80-\$90																																			
• Humid./Temp meter \$169.95	• Light Adapter \$49.95																																			
• Press. meter \$299.95	• Anemometer \$179.95																																			
• Electr. scale \$89.95	• Anemometer adapter (And More) \$89.95																																			

<p align="center">OSCILLOSCOPE</p> <p>Dual Trace, Component Test, 6" CRT, X-Y Operation, TV Sync, CH2 Output, Graticule Illum, 2 Probes(x1:x10)</p> <ul style="list-style-type: none"> • PS-200 20 MHz Dual Trace \$339.95 • PS-205 20 MHz Dual w/ Delay Sweep \$429.95 • PS-400 40 MHz Dual Trace \$494.95 • PS-405 40 MHz Dual w/ Delay Sweep \$569.95 • PS-605 60 MHz Dual w/ Delay Sweep \$769.95 • PS-1000 100MHz Dual Trace \$999.95 <p><u>Digital Scope:</u></p> <ul style="list-style-type: none"> • DS-303 30MHz Digital, 20 Samples/sec \$849.95 • DS-303P RS-232 interface, 30MHz \$1,049.95 <p><u>Scope Probe:</u></p> <ul style="list-style-type: none"> • HP-9060 (60MHz) \$15, HP-9150 (150MHz) \$22, • HP-9250 (250MHz)\$29, HP-9258 (250MHz,100:1)\$39 	<p align="center">AUDIO/R/F/FUNCT. GENERATOR</p> <p>RF Generator</p> <ul style="list-style-type: none"> • SG-4160 (\$124.95) 100kHz-150MHz sinewaves in 8 ranges, 100mV at 35MHz • SG-4162 (\$229.95): same as SG-4160, plus 6 digits int/ext freq. counter (150MHz). <p>Audio Generator</p> <ul style="list-style-type: none"> • AG-2601 (\$124.95) 10Hz-1MHz, 0-8Vpp sine, 0-10Vpp squarewave • AG-2603 (\$229.95): same as AG-2601, plus 6 digits int/ext freq. counter (150MHz). <p>Function Generator</p> <ul style="list-style-type: none"> • FG-2100A (\$169.95): 2Hz-2MHz, 5mV-20Vpp • FG-2102AD (\$229.95) same as FG-2100A, plus int. counter and TTL, CMOS output. • FG-2103 (\$329.95) Sweep 0.5Hz-5MHz, linear/log, VCG, GCV, 6 dig. int/ext counter
--	--

<p align="center">POWER SUPPLIES</p> <p align="center">Single Output DC Power Supplies</p> <ul style="list-style-type: none"> • Short Circuit and overload protected • Constant current, constant voltage mode • 0.02%+2mV line regulation; 0.02%+2mV load regulate <p><u>Analog Meters Display</u></p> <ul style="list-style-type: none"> PS-8200 (\$179.95) 30V/3A PS-305 (\$219.95) 30V/5A PS-8110 (\$289.95) 60V/3A PS-8112 (\$399.95) 60V/5A PS-1610 (\$289.00) 16V/10A PS-8107 (\$399.95) 30V/10A <p><u>Digital Voltage, Analog Current</u></p> <ul style="list-style-type: none"> PS-8201 (\$179.95) 30V/3A PS-8201 (\$239.95) 30V/5A <p><u>Digital Volt & Current Display</u></p> <ul style="list-style-type: none"> PS-8300 (\$199.95) 30V/3A PS-8301 (\$259.95) 30V/5A 	<p align="center">Dual Tracking</p> <ul style="list-style-type: none"> • Short Circuit & overload protected • Constant current & voltage mode • Independent or Tracking <p><u>Dual Tracking (Analog V & I Displays)</u></p> <ul style="list-style-type: none"> PS-303D (\$314.95) 30V/3A/30V/3A PS-305D (\$399.95) 30V/5A/30V/5A PS-8108 (\$549.95) 60V/3A/60V/3A PS-8109 (\$699.95) 60V/5A/60V/5A 	<p align="center">Triple Output</p> <ul style="list-style-type: none"> • One fixed 5VDC, 3 Amp output • Parallel to double current output (PS-8102 & PS-8103 only) <p><u>Triple Output (Analog displays)</u></p> <ul style="list-style-type: none"> PS-8102 (\$399.95) 30V/3A/30V/3A PS-8103 (\$489.95) 30V/5A/30V/5A <p><u>Digital Display</u></p> <ul style="list-style-type: none"> PS-8202 (\$499.95) 30V/3A/30V/3A PS-8203 (\$549.95) 30V/5A/30V/5A
---	--	---

<p align="center">GW/INSTEK® Test & Measuring Instrument ISO 9002 Cert. #934163 (2 Years Warranty)</p>						
<p align="center">OSCILLOSCOPE</p> <p>OS-65NG \$849.95 50MHz Curs on Readout</p> <p>OS-622C \$369.95 20MHz 100MHz scope</p>	<p align="center">DC POWER SUPPLIES</p> <p>Triple Output Single Output Programmable</p>			<p align="center">FUNCTION GENERATOR</p>	<p align="center">BENCHTOP DMM</p>	
<ul style="list-style-type: none"> • Dual CH / Delay sweep • Read-out & Cursor meas • Built-in delay line • Z-axis input, CH1 output • TV syn., trigger level lock • 2 probes (x1, x10) <p>OS-385 (\$229.95) - 5 MHz One Channel</p> <p>OS-310 (\$324.95) - 10 MHz One Channel</p>	<ul style="list-style-type: none"> • Dual CH/X-Y operation • 1 mV/div sensitivity • Z-axis input, CH1 output • TV syn., trigger level lock • 2 probes (x1, x10) <p>PC-3030 (\$499.95)</p> <p>PC-3030D (\$549.95)</p>	<ul style="list-style-type: none"> • 2 variable out 0-30V, 0-3A • One fixed 5V, 3A output • Auto track, serial, parallel • Const. volt, current mode • 4 analog or 2 digital display <p>PS-3030 (\$219.95) 30V/3A</p> <p>PS-6010 (\$209.95) 60V/10A</p>	<ul style="list-style-type: none"> • Const voltage, current mode • Voltage regulation \leq0.01% • Current regulation \leq0.2% • PS: 2 analog or 1 digital disp • PR: 2 analog or 2 digital disp <p><u>Analog Meters Display</u></p> <p>PR-1830 (\$209.95) 18V/3A</p> <p>PS-1850 (\$229.95) 18V/5A</p>	<ul style="list-style-type: none"> • High stability, low drift • One fixed 5V, 3A output • 100point program (PPS ser) • 50point program (PPT ser.) • Auto serial/parall. (PPT ser) • Auto track (PPT series), IEEE-488.2 and SCPI compatible command set (optional) <p>PFS-1860G (\$1,149.95)</p> <p>PPS-3635G (\$1,149.95)</p>	<ul style="list-style-type: none"> FG-8015G (\$179.95) Sweep 0.02Hz-2MHz, no counter • Sine/Squ/Tri/pulse/Ramp FG-8016G (\$239.95) • 0.02Hz-2MHz w/ counter • Pulse, function generator FG-8017G (\$249.95) Sweep 0.02Hz-2MHz w/counter • Sine/Tri/Squ/TTL/CMOS • dBm, auto, REL, min/max FG-8019 (\$399.95) Sweep 0.02Hz-2MHz w/counter • INT/EXT AM/FM mod FG-8020G (\$209.95) • 0.02Hz-2MHz FG-8050 (\$499.95) Sweep 0.05Hz-5MHz w/counter • INT/EXT AM/FM mod 	<ul style="list-style-type: none"> DM-8034 (\$179.95) 3 1/2 dgt • AC/DV (V,A), Ω, diode • 1000V, 20A, 0.5% accu. • ACV to 50kHz, true rms DM-8055 (\$649.95) 5 1/2 dgt • 0.006% basic accuracy • 1μV, 1mΩ, 1nA resolution • dBm, auto, REL, min/max DM-8055G (\$889.95) GPIB • Same funct. as DM-8055
<p align="center">Auto-set Cursor Read-out Oscilloscope</p> <p>100 MHz OS-6102 *NEW* \$1349.95</p>						
<ul style="list-style-type: none"> • Dual channels • Auto-set for parameter selection • Automatic Peak to Peak • Memory for 10 user-defined settings <p>RS-232 Remote control</p> <p>Triggering DC-250 MHz</p> <p>Alternate trigger</p> <p>Component tester</p>						

ALFA ELECTRONICS
P.O. BOX 8089
PRINCETON, NJ 08543

TEL: (800)526-ALFA(2532) / (609)897-1135
FAX: 609-897-0206
E-mail: alfa0168@aol.com

Call/Wrire/Fax/Email for FREE CATALOG
Visa, MC, AMEX, COD, PO Accepted OEM Welcome
1 Year Warranty (2 Years for GW/Instek)

Any waveform you want!



Starting at
\$795

Quantity 1

Money back
guarantee

- **Synthesized Signal Generator**
Clean sinewaves DC-20 MHz with .001% accuracy!
.1 Hz steps. DC Offset. RS232 remote control.
- **Arbitrary Waveform Generator**
40 Megasamples/Second. 32,768 points. 12 bit DAC
- **Function Generator**
Ramps, Triangles, Exponentials & more to 2 MHz!
- **Pulse Generator**
Digital waveforms with adjustable duty cycle

Telulex Inc. model SG-100

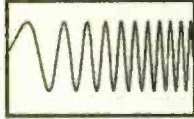

DC to 20 MHz linear
and log sweeps

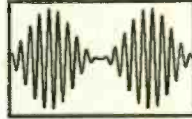

Int/Ext AM, SSB,
Dualtone Gen.

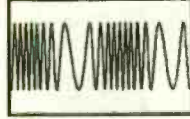

Int/Ext FM, PM,
BPSK, Burst

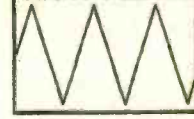

Ramps, Triangles,
Exponentials



Pulse Generator

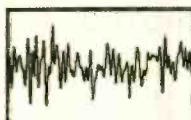

Noise

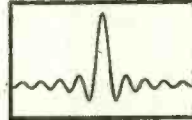

Arbitrary Waveforms

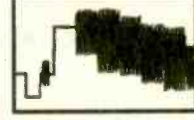

Unlimited Possibilities!

Telulex Inc.

2455 Old Middlefield Way S Tel (650) 938-0240 <http://www.Telulex.com>

Mountain View, CA 94043 Fax (650) 938-0241 Email: sales@Telulex.com

CIRCLE 137 ON FREE INFORMATION CARD

PANA VISE®

**Take Advantage of These Special
Prices on PanaVise Work
Positioning Systems!**



Model #201
Regular \$21.95
SALE \$20.85

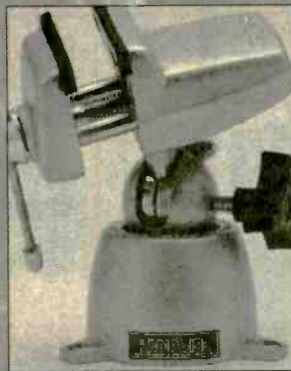

Model #301
Regular \$42.99
SALE \$40.85



Model #324
Regular \$76.99
SALE \$73.25



Model #381
Regular \$54.99
SALE \$52.25

PRINT™

Products International

8931 Brookville Rd * Silver Spring, MD, 20910

800-638-2020 * Fx 800-545-0058 * Fx 301-585-5402 * www.prodintl.com

Call, fax or email for your free
PANAVISE catalog and a copy of
our test and measurement
instrument catalog today!

CIRCLE 155 ON FREE INFORMATION CARD

CALL TOLL FREE
 (800) 292-7711 orders only
 Se Habla Español

C&S SALES
 EXCELLENCE IN SERVICE

LOOK FOR OTHER
MONTHLY SPECIALS
ON OUR WEBSITE

XK-700 Digital / Analog Trainer

Elenco's newest advanced designed Digital / Analog Trainer is specially designed for school projects. It is built on a single PC board for maximum reliability. It includes 5 built-in power supplies, a function generator with continuously sine, triangular and square wave-forms and a 1560 tie point breadboard area. Tools and meter shown optional. (Mounted in a professional tool case made of reinforced metal).

XK-700
Assembled and Tested
\$189.95

XK-700 - SEMI KIT
w/ Fully Assembled PC Board
\$174.95

XK-700K - Kit
\$159.95



Made in the USA

Digital Multimeter
Model M-1740

\$39.95

Free Holster

- 11 functions
- Freq to 20MHz
- Cap to 20m F
- AC/DC Voltage
- AC/DC Current
- Beeper
- Diode Test
- Transistor Test
- Meets UL-1244 safety specs



DIGITAL LCR METER
Model LCR-1810

\$99.95



- Capacitance .1pF to 20MF
- Inductance 1µH to 20H
- Resistance .01 to 2000M
- Temperature -20°C to 750°C
- DC Volts 0 - 20V
- Frequency up to 15MHz
- Diode/Audible Continuity Test
- Signal Output Function
- 3 1/2 Digit Display

15pc. VCR Service Tool Kit
Model TK-1400

- Inclined Base Screwdriver
- Eccentric Screwdriver
- 2mm & 3mm Fine Adjust Screwdriver
- VHS VCR Head Puller
- Retaining Ring Remover
- 3 Reversible Screwdrivers
- Spring Hook Tool
- Micro Screwdriver
- Hex Wrench Set

Special
\$24.95



Model M-6100

The M-6100 is Elenco's most sophisticated meter with almost every possible feature available. The M-6100 even has a computer interface for viewing and storing data on a personal computer. It comes complete with software, RS-232 cable, test leads and manual.

\$99.95

Model XP-581

4 Fully Regulated DC Power Supplies in One Unit
 4 DC voltages: 3 fixed - +5V @ 3A, +12V @ 1A, -12V @ 1A
 1 Variable - 2.5 - 20V @ 2A

\$89.95



Tektronix DMMs

For high performance digital multimeters that are accurate, reliable, and rugged, the DMM900 series extends the Tektronix line of already affordable DMMs. Twice the accuracy. Up to 10 times the resolution. And a full range of capabilities that span voltage, current, dual numeric display, 3 year warranty, and autoranging capability. All backed by the reliability of the Tektronix brand.



912 \$179
914 \$229
916 \$275

Power Supply Kit
Model XP-720K

3 fully reg. DC supplies
 1.5VDC - 15VDC @ 1A
 -1.5VDC to -15VDC
 5VDC @ 3A
Plus
 6.3VAC @ 1A and
 12.6VAC C.T. @1A

\$54.95



Available assembled Model XP-720 \$84.95

Sweep Function Generator
 with built-in Frequency counter
Model GF-8026

\$225

- Range .02Hz - 2MHz
- Sine, Square, Triangle, Pulse, Ramp
- Ext. counter 1Hz - 10MHz



Kit Corner
 over 100 kits available

AK-700

\$15.95

Phone kit with training course
 4 Flashing neon lights
 See thru case



RADIO CONTROL CAR KIT
MODEL AK-870

- 7 functions
- Remote control included

\$24.95



No Soldering Required

Digital Capacitance Meter
Model CM-1555

\$48.95



- Capacitors from .1pF to 20M m F
- 3 1/2 Digit LCD
- Zero adjust
- special insertion jack
- 1/2% basic accuracy
- Tilt stand

Digital Audio Generator
 with built-in Counter
SG-9300

- 10Hz - 1MHz
- Low Distortion
- Sine/Square waves
- Built-in 150MHz Frequency Counter

\$175



SG-9200 Analog/No counter \$119.95

Model AM/FM-108K
Transistor Radio Kit
 with training course

\$29.95



Free Stand

35mm Camera Kit
 Learn all about photography
AK-540

\$14.95



No Soldering Required

SATELLITE FINDER
Model SF-01

- Aligns Satellite Dishes
- Range 950-2050MHz
- Compact Size
- Self Power Check



\$39.95

RF Generator
 with Counter

Model SG-9500

\$225



- 100KHz - 150MHz
- Internal AM Mod of 1KHz
- RF Output 100MV - 35 MHz
- Audio Output 1KHz @ 1V rms

SG-9000 Analog/No counter \$119.95

WE WILL NOT BE UNDERSOLD C&S SALES, INC.

150 W. CARPENTER AVENUE
 WHEELING, IL 60090
 FAX: (847) 541-9904 (847) 541-0710
http://www.elenco.com/cs_sales/



15 DAY MONEY BACK
GUARANTEE
FULL FACTORY WARRANTY
 PRICES SUBJECT TO CHANGE WITHOUT NOTICE

**Same Day
Shipping**

C & S SALES
Your one stop source for
all your electronic needs!

CALL OR WRITE FOR OUR
NEW FREE 64 PAGE
CATALOG!
(800) 445-3201

Fluke Scopemeters



- 123.....NEW.....\$950
- 92B.....\$1445
- 96B.....\$1695
- 97.....\$1695
- 99B.....NEW.....\$2095
- 105B.....\$2495

**ALL FLUKE
PRODUCTS
ON SALE**

**B & K PRECISION
SCOPES**

20MHz DUAL-TRACE
Model 2120B - 2 Year Warranty
Special \$375

Model 2125A with delayed sweep
\$539.95



- 1mV/division sensitivity
- AUTO/NORM triggered sweep operation
- AC, TVH, TVV and fine coupling
- Calibrated 19 step time-base with x10 magnifier
- Compact low-profile design

**Affordable Spectrum
Analyzers by B&K**

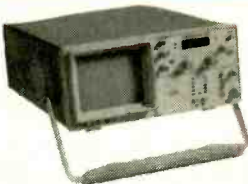

- 500MHz Series**
- BK2615A \$1250
 - BK2620A \$1675
 - 150KHz to 500MHz
 - Dynamic Range 80dB(113dB with attenuation)
 - +20dB maximum input
 - 12.5 and 400KHz resolution bandwidth
 - 150KHz/hour stability
 - Built-in tracking generator(Model 2620A)
- 1.05GHz Series**
- BK2625A \$1925
 - BK2630A \$2595
 - 150KHz to 1050MHz
 - Dynamic Range 80dB(113dB with attenuation)
 - AM & FM demod included
 - 20 and 400KHz resolution bandwidth
 - 150KHz/hour stability
 - Built-in tracking generator(Model 2630A)

PORTABLE SEMICONDUCTOR TESTER

**B&K 510
\$199.00**



- In or out-of-order circuit tests for transistor, FETs, SCRs and darlingtonts.

**20MHz Sweep / Function
Generator with Freq Counter**

B&K 4040

- 0.2Hz to 20MHz
- AM & FM modulation
- Burst Operation
- External Frequency counter to 30MHz
- Linear and Log sweep



\$399

10MHz B&K 4017 \$309
5MHz B&K 4011 \$239

Quality Scopes by Elenco

Lowest Prices of the Year!



60MHz

DS-603 \$995

- Analog / Digital Storage
- 20MS/s Sampling Rate
- RS232 Output

S-1360 \$749

- Analog with Delayed Sweep
- Component Tester

100MHz

S-1390 \$895

- Analog w/ delayed sweep
- Dual Time Base
- TV Sync

Includes
Free Dust
Cover and
Probes



25/30MHz

DS-303 30MHz \$895

- Analog / Digital Storage
- 20MS/s Sampling Rate
- RS232 Output

DS-203 20MHz \$695

- Analog / Digital Storage

S-1330 \$439

- 25MHz Analog
- Delayed Sweep

S-1325 \$325

- 25MHz Analog
- TV Sync
- 1mV Sensitivity

**2 Year
Warranty**

Fluke Multimeter Specials



F-73III

\$115

List \$129



F-75II

\$129

List \$149



F-79II

\$175

List \$199



F-87

\$289

List \$335

B&K Precision Multimeter Specials



- Accurately measures capacitance, resistance and inductance.
- Measures dissipation factor of capacitors and Q of inductors.
- Simultaneously displays measured value and Q or dissipation factor.
- Displays the difference between measures and reference values.

Model 878

\$219.95



- 50,000 count
- 0.025% DCV
- 0.07% ohms
- Min/Max/Avg
- True RMS, AC, or AC+DC
- 100kHz AC response
- Capacitance to 50,000pF
- Frequency, duty cycle, pulse width
- dB across 1 to 10k

Model 5390

\$295.00

MX-9300

Four Functions in One Instrument

Features:

- One instrument with four test and measuring systems:
 - 1.3GHz Frequency Counter
 - 2MHz Sweep Function Generator
 - Digital Multimeter
 - Digital Triple Power Supply
- 0-30V @ 3A, 15V @ 1A, 5V @ 2A



\$459.95

GUARANTEED LOWEST PRICES

C&S SALES, INC.

150 W. CARPENTER AVENUE
WHEELING, IL 60090

FAX: (847) 541-9904 (847) 541-0710

http://www.elenco.com/cs_sales/



**15 DAY MONEY BACK
GUARANTEE**

FULL FACTORY WARRANTY

PRICES SUBJECT TO CHANGE WITHOUT NOTICE

UPS SHIPPING: 48 STATES 5%
OTHERS CALL FOR DETAILS
IL Residents add 8.25% Sales Tax

CIRCLE 130 ON FREE INFORMATION CARD

EARN MORE MONEY!

Be an FCC LICENSED ELECTRONIC TECHNICIAN!



No costly school. No commuting to class. The Original Home-Study course prepares you for the "FCC Commercial Radiotelephone License." This valuable license is your professional "ticket" to thousands of exciting jobs in Communications, Radio-TV, Microwave, Maritime, Radar, Avionics and more...even start your own business! You don't need a college degree to qualify, but you do need an FCC License.

No Need to Quit Your Job or Go To School
This proven course is easy, fast and low cost! **GUARANTEED PASS**—You get your FCC License or money refunded. **Send for FREE facts now. MAIL COUPON TODAY!**

Or, Call 1-800-932-4268 Ext. 240

COMMAND PRODUCTIONS

FCC LICENSE TRAINING, Dept. 240
P.O. Box 2824, San Francisco, CA 94126
Please rush FREE details immediately!

NAME _____
ADDRESS _____
CITY _____ STATE _____ ZIP _____

CABLE T.V. EQUIPMENT

Friendly, Knowledgeable Service



**ORDERS CALL:
1-800-361-4586**



- All Equipment New
- Convertors & Descramblers
- 30 Day Money Back Guarantee
- 6 Month Warranty
- Visa, MC, C.O.D. Welcome

KDE ELECTRONICS, INC.

P.O. Box 1494

Addison, IL 60101

Info. 630-889-0281 HRS: Mon-Fri, 9-6 CST
Fax 630-889-0283 Sat, 10-2 CST

Low Cost CAD Software Now In Windows™ 95

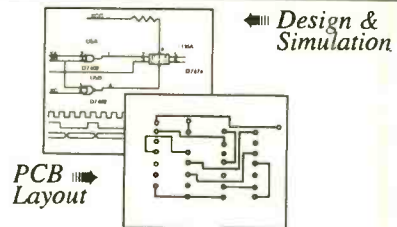

- Easy to use schematic entry program (**SuperCAD**) for circuit diagrams, only \$149. Includes netlisting, bill of materials, extensive parts libraries.
- Digital simulator (**SuperSIM**) allows you to check logic circuitry quickly before actually wiring it up. Works directly within SuperCAD and displays results in "logic analyzer" display window. Starting at \$149 this is the lowest cost simulator on the market. Library parts include TTL, and CMOS devices.
- Analog simulator (**mentalSPICE**) for \$199. Allows AC, DC and transient circuit analysis. Includes models of transistors, discretes, and op amps.
- Circuit board artwork editor and autorouter program (**SuperPCB**), starting at \$149. Produce high quality artwork directly on dot matrix or laser printers. You can do boards up to 16 layers including surface mount. Includes Gerber and Excellon file output. Autorouter accepts netlists and placement data directly from the SuperCAD schematic editor.
- **New!**—Complete electronic design package (**mentalMAX**) including schematic editor, analog and digital circuit simulation, and printed circuit board layout with autorouter for only \$549!

Write or call for free demo disks:
MENTAL AUTOMATION, INC.
5415 - 136th Place S.E.
Bellevue, WA 98006
(425) 641-2141
Internet: <http://www.mentala.com>

**OVER
30,000
ITEMS
IN STOCK**

**LARGE VARIETY
SAME DAY SHIPPING**

Minimum Orders \$20.-

Not Including Shipping & Handling

Dalbani®

The Ultimate Saving Source

SEMICONDUCTORS

Original #	Brand	Replaces
7805	Tesla	960
7806	Ank	962
7809	Ank	1910
7810	Samsung	1968
7812	Tesla	966
7815	Tesla	968
7818	Tesla	958
7824	Tesla	972
7905	Tesla	961
7906	Tesla	963
7908	Tesla	965
7912	Ank	967
7918	Tesla	959
7924	Tesla	971



YOUR CHOICE

45¢
each

**Dalco®
ECONOMICAL
SOLDER WICK**

5 Feet

Removes solder easy

- Length: 5 feet
- Width: 0.15"
- Safer Desoldering
- Fast Response

Item # 51-1050



\$1.10

SHIP UP TO 5lbs FOR ONLY

\$3.95



Plus handling & C.O.D. charge if it applies

**THE MOST POPULAR
VCR ALIGNMENT TOOL KIT**

\$24.99



- VCR Head pull
- Retaining ringremover
- Micro screwdriver
- Fitted vinyl Case
- 7 Assorted head & guide aligner
- Dimensions: 9 1/2"(W) X 12 1/4"(L)
- 3 Reverseable screwdrivers (Small-Flat-Phillips)
- Spring hook
- Hex key set
- Soft zippered case

Item # 50-888

POPULAR FUSE KIT 180 Piece Kit

Kit Contains 10 Pieces of each of these items:

- AGC Type : 0.5A, 1A, 1.5A, 2A, 2.5A, 3A, 4A, 5A, 6A, 10A, 15A
- Ceramic Type : 15A
- GMA Type : 1A, 1.5A, 2A, 3A, 4A, 5A

Item # 10-2050



\$13.95

TUN-O-WASH® (CFC Free)

Fast drying electronics grade cleaner for tuners, controls and PC boards.

- CFC and HCFC free
- Not for use on energized equipment
- Due to the chemical content, this product can be only shipped by UPS ground service.

Item # 30-0100
(12.5 Oz aerosol)



\$11.75

SOLDER ROLL

- 1 LB Spool
- 370° F melting point
- Fastest solder
- Alloy 60/40, tin lead, non corrosive flux, Diam. 1.0mm

Item # 51-1005



\$5.49

**DUAL
HELPING
HANDS**

- Hold Work in any Position to leave hands free for soldering

Item # 50-1325



\$3.45

SOLDERING IRON

- General Purpose Applications
- 117V AC, 30 Watts

Item # 51-1335



\$3.25

**WELLER WLC100
SOLDERING STATION**

Weller®

- Ideal for the professional, serious hobbyist
- Variable power control (5-40W)
- 40W pencil iron and ST# inter changeable tip
- Replaceable heating element
- Cushioned foam grip • Safety guard iron holder
- On/off switch with "power-on" indicator light

Item # 51-1505



\$38.90

**HEAVY DUTY COLOR
CODED LEADS**

- 10 Leads
- 11" Long Wire Lead
- Insulated 11/2" Alligator Clips
- 20 Gauge Wire Size
- Black, Green, Red, Yellow, White

Item # 56-500



\$2.95

**Dalco® SWING ARM
MAGNIFYING LAMP**

- Spring-Balanced 45" extension arm with 3 conductor cord 120V 60Hz
- Steel Shade supplied with a precise 3 diopter lens and a 22W fluorescent circline tube
- Comes with a lamp

Item # 54-0120



\$36.72

White Color

**DALCO DIGITAL
MULTIMETER**

- DC Voltage: 200m-1K
- AC Voltage: 200-750V
- DC Current: 20m-20
- Transistor and Diode Test
- Continuity Buzzer
- Polarity indicator appears on LCD
- Test Probes Included
- Dimensions: 4.96" x 2.76" x 9.4"
- Weight: 6 oz.
- 9V Battery Included

Item # 50-2895



\$9.95

**Free 400 Page Color Catalog
With your First Order**

Dalbani®

4225 NW 72ND AVE. MIAMI, FLORIDA 33166

TEL : (305) 716-1016 ----- FAX : (305) 594-6588

1-800-325-2264

CIRCLE 157 ON FREE INFORMATION CARD

CABLE TV EQUIPMENT

Converters, Test Cubes & Chips

**1 Year Warranty
30 Day Money
Back Guarantee**



**"ABSOLUTE LOWEST
WHOLESALE &
RETAIL PRICES"
CABLE U.S.A.
1-888-388-CUBE**

Filter Wiz v2.0

ACTIVE FILTER design software for Windows. Provides mastery of lowpass, highpass, bandpass and bandstop filters. Enhance critical signal components while controlling noise and other interference.

Meets the needs of both novice and professional designer. Standard (LE) version \$89, PRO version \$199.

Download: <http://www.schematica.com>
sales@schematica.com FAX:250-642-2644

Digital Entertainment GREAT VALUES ON:



SAVE Compare to Cable
30%-50%

MORE ENTERTAINMENT OPTIONS
ALL THE HOT ACCESSORIES
PAY LESS

Fax: 218-739-4879 1010 Frontier Dr.
Int'l: 18-739-5231 Fergus Falls, MN 56537

Call Now 800-500-9275
www.skyvision.com Skyvision

Quality Microwave TV Systems

WIRELESS CABLE - IFTS - MMDS
ATV - INTERNATIONAL - DIGITAL
Amplifiers - Antennas - Books - Components
• RF Frequency 2100-2700 MHz
• SASE For "FREE" Catalog or Send \$1

PHILLIPS-TECH ELECTRONICS
P.O. Box 13074 • Scottsdale, AZ 85267-3074
CATALOG/INFO: 602-947-7700
ORDER LINE: 800-880-MMDS

CHALLENGER SYSTEM
31 Channel Composites 214
Other Systems Available
5 Year Warranty
FREE SHIPPING

FAX LINE: 602-947-7799
WEBSITE: www.phillips-tech.com
E-MAIL: product@phillips-tech.com
Visa • MC • Amex • Discover • COD's • Quantity Pricing

Transfer System for **30-DAY**
Printed Circuit MONEY-BACK
Use with regular **GUARANTEED**
Household iron

Fax 305 538 3648
8-oz. \$30.00
+4.00 S&H average per transfer
Toll free 1 888 698 3648



1348 Washington av. Suite #189
Miami Beach Florida Fl 33139
www.starletsystems.com/elec/

Make circuits easy from your
Laser or Photocopy Machine

HACKING THE INTERNET

The latest tricks and methods being used on the Net to pirate software (warez) and the newest hacking websites. Includes examples, countermeasures, password defeats, UNIX, Sprintnet, brute force techs, lots of tips. *More!* \$29.

INTERNET TRACKING & TRACING: Scammers, spammers, stalkers, infectors, and others hide behind the Internet's anonymity to commit serious offenses. Learn from master hackers best methods to track & trace IDs and origins, and to protect your own privacy. *More!* \$29.

INTERNET CONS & SCAMS: Internet cons, scams and related frauds now rake in \$2+ Billion annually! Most are done anonymously with impunity. Details how they're done, how to ID them, how to protect yourself. *More!* \$25.

THE COOKIE TERMINATOR: When online, many websites track your every move! Browser cookie, history and cache files contain personal data readily accessible to Internet predators, scammers, spammers and snoopers. Your financial, medical, political, habits, lifestyle, future plans data is exposed to the world! Step-by-step how to remove and stop cookies from destroying your privacy. \$25.
Any 2 for \$49, 3 for \$64, all 4 for \$79!

PBX HACKING
PBXs hacking losses are at \$5-\$10 Billion annually! Details how PBXs are hacked, countermeasures. Author interview in Forbes! \$24



CONSUMERTRONICS

2430 Juan Tabo, NE, #259, ABQ, NM 87112
P.O. Box 23097 ABQ, NM 87192
Fax: 505-292-4078 (all hours, orders only) Voice: 505-237-2073 (10-5 M-F)

Full Catalog: www.tsc-global.com/consumer.html Adventure: www.tsc-global.com

Established in 1971. Featured on CBS "60 Minutes," Forbes, New York Times. Add \$5 total S/H (US Canada). Postal MO is fastest! VISA, MC OK. No CODs. Take 10% OFF all Orders over \$100, and Take \$2.00 OFF all New Orders over \$20 placed by Mail or Fax. Catalog \$1 w/order, \$3 w/o.

Sold for legal educational purposes only. See Catalog for LIMITED WARRANTY, SPECIAL PROJECTS and all other applicable policies.

CELLPHONE MODIF. GUIDE

How cellphones operate and are modified. Vulnerabilities to hack attack and countermeasures. Cloning details for NAMS, ESNs, etc. control data formats, computing encoded MINs, ESNs, SIDHs, Op Sys, PROMs, forcing ACK, test mode and resets, cable diagrams, scanning, tracking, scanner restorations, freq allocations, roaming, step-by-step to keypad-reprogram 100+ popular cellphones. One FREE database search. *More!* \$49.
PAGER (BEEPER) MANUAL: How Pagers work, different types and uses, freqs, advantages over and uses with cellphones, and tips and tricks. How Pagers are hacked/countermeasures. And plans for a Personal Pocket Paging System (xmitter and receiver). *More!* \$29.
Both for only \$69!

PHREAKING CALLER ID & ANI

How they work and dozens of ways of defeating Caller ID, ANI, *69, *57, Call Blocking, *67 etc. Describes ESS, SS7, CNA, CAMA, DNR, Diverters, Centrex - *more!* \$25.

HACKING FAX MACHINES

Details all known methods of hacking Faxes and countermeasures. Includes computer fax modems, crimes, interceptions, fax servers, fax-on-demand, protocols, parameters, compression, encryption, and fax surveillance-trace mods. *More!* \$29.

VOICE MAIL HACKING

VMSs are hacked to penetrate PBXs to make outgoing calls, get free VMB usage, secretly read/change/delete messages, or damage the VMS (or its PBX) itself. Step-by-step on how it's done, countermeasures. \$29.

STOPPING POWER METERS

As reported on "60 MINUTES"! New 6th Edition! Plans for devices that can slow down (even stop) watt-hour meters - while loads draw full power! Devices plug into one outlet and normal loads into other outlets. Describes meter creep, overload droop, pole meters, etc. \$29.

SPM THE VIDEO: Now its easier to learn about KW-HR Power Meters than ever before! This educational video shows you how they work and their anatomy. Demonstrates SPMEM device and external magnetic methods used to slow and stop meters! Hosted by a top expert in the field. From the novice to the pro, an excellent source of info on these exciting devices! Great in combo with our SPM related manuals! \$29.

THE I.G. MANUAL: External magnetic ways (applied to meter) to slow down and stop power meters while drawing full loads. Plans \$25.

KW-HR METERS: How watt-hour meters work, calibration, error modes (many), ANSI Standards, etc. Demand and Polyphase Meters. Experimental results to slow and stop meters by others. \$25.
Any 2 for \$49, 3 for \$64, all 4 for \$79!

COMPUTER PHREAKING

Describes in detail how computers penetrate each other, and how VIRUSES, TROJAN HORSES, WORMS are implemented. Dozens of computer crime and abuse methods and countermeasures. Includes disk filled with hacker text files and utilities, and the legendary FLUSHOT+ protection system. Internet advice, password defeats, glossary - much *more!* Manual + PC Disk! \$39.

THE HACKER FILES: 3 HD PC disks filled with choice raw, colorful and highly informative hacker, phreaker text files covering many topics! \$39.
Both for only \$69!

BEYOND VAN ECK PHREAKING

Plans for remote eavesdropping of TV video signals. Range up to 1 KM. Describes how van Eck systems work, and are also used in surveillance of computer systems. \$29. The van Eck Demo Tape is \$29. Both for only \$49!

MANY MORE TITLES!

- Beyond Phone Color Boxes - \$29
- Hacking Answer. Machines - \$19
- Casino Hacking - \$25
- Automatic Teller Machines - \$39
- Credit Card Scams - \$29
- Cons & Scams - \$29
- Social Engineering - \$29
- Polygraph Defeats - \$25
- By an Order of the Magnitude - \$49
- Ultimate Success Manual - \$19
- Stealth Technology - \$19
- Secret & Survival Radio - \$19
- High Voltage Devices - \$29
- Mind Control - \$29
- Under Attack! - \$29
- Radionics Manual - \$29
- Heal Thyself - \$19
- Secrets of Solderless BBS - \$24
- Secret & Alternate IDs - \$15
- Cryptanalysis Techniques - \$29
- Government Land Grab - \$15
- Rocket's Red Glare - \$29
- Survival Guns & Ammo - \$19
- The Ultimate Driver - \$19

THE DIRTY-2 DOZEN!

24+ Hot Hack/Phreak Disks!

See CATALOG!

SPECIAL PROJECTS

We will design & build just about anything electronic! Hardware done as SPECIAL PROJECTS only. See Catalog for details and SP Application Form, else: www.tsc-global.com/spaf-spp.html

5 Axis Robotic Arm \$195.00 Plus S&H



You can build this Robotic Arm

Impressive, fast, accurate, and repeatable motion. Any computer or micro capable of sending 2400 or 9600 baud serial data can control the arm. It can even be controlled from a Basic Stamp. This robot arm makes a great foundation for many AI and motion control experiments. Position the arm in an X, Y, Z, grid with a joystick or keyboard using the new RoboMotion for Windows. The kit includes the hardware, structural components, Hitec servos, pre-assembled SSC servo controller, DOS and Windows software, and an illustrated assembly manual. Camouflage paint not included.



We have many more cool robots, check out our web page or ask for our free catalog!

Lynxmotion, Inc.
104 Partridge Road
Pekin, IL 61554-1403
www.lynxmotion.com



Tel: 309-382-1816
Fax: 309-382-1254
sales@lynxmotion.com
tech@lynxmotion.com

The World's Largest Source for Home Automation

- The Best & Most Comprehensive Home Automation Catalog in the Industry.
- Best Customer Service & Technical Support



Thousands of hard-to-find automation, X-10 and wireless control products. Computer interfaces, software, development tools, lighting control, telephone systems, security systems, surveillance cameras, infrared audio/video control, home theater, touchscreen control, HVAC, pet care automation, wiring supplies, books and videos and much more!

World's Largest Selection!

Lowest Prices Guaranteed!

HOME AUTOMATION SYSTEMS, INC.

Questions: 714-708-0610 Fax: 714-708-0614
e-mail: catalog@smarthome.com
www.smarthome.com

Call for a **FREE** Catalog! 800-762-7846

800-SMART-HOME

Dealers/Resellers ask about our SmartHome Pro Dealer Program 800-949-6255



BUGGED??

EAVESDROPPING is unbelievably widespread! Electronic Devices with amazing capabilities can be monitoring your telephone and room conversations **RIGHT NOW!** Are you sure you're safe? **FREE CATALOG** tells you fast! Includes Free Bonus details on fantastic opportunities now open in Counter-Surveillance field. Exciting, immensely interesting and **EXTREMELY** profitable (up to \$250/hr) full/part-time come. Call Now! **1-800-732-5000**

Cable Television
Converters, equipment & test chips

Dealers wanted!!!
Best Prices and Service

30 Days Money Back 1 Year warranty!

1(800) 660-4180

Be a private investigator

Home study. Learn surveillance, interrogation, undercover skills. Solve crimes, earn great pay.
Free literature: 800-223-4542

Name: _____ Age: _____
Address: _____ Phone () _____
City/State: _____ Zip: _____

School of Private Investigation, Dept JRM341
6065 Roswell Rd., PCDI, Atlanta, Georgia 30328

BEST DEALER PRICING!

CABLE DIRECT
CONVERTERS • FILTERS
DESCRAMBLERS

IMPROVE YOUR IMAGE WITH
VIDEO STABILIZERS

FREE CABLE TV CATALOG!

100% MONEY BACK GUARANTEE!

Now you can tune-in your favorite cable TV programming and **SAVE \$100'S - EVEN \$1000'S** on premium CABLE TV EQUIPMENT.

30 DAY FREE TRIAL!

VISA MasterCard

MODERN ELECTRONICS
1-800-906-6664
2605 S. 156TH CIRCLE • OMAHA, NE 68130
http://www.modernelectronics.com

Free Catalog!

• The world's largest electronic surplus company • Liquidates excess inventory • Hobby items • Unique hard-to-find parts • Large quantities • Bargain prices • Huge items • Liquidation discounts • Unique and hard-to-find parts • Large quantities • Stock items • Save! Save! Save! Save!

If you are not getting this catalog you are missing out on some of the best deals in electronics today! We have thousands of items ranging from unique, hard-to-find parts to standard production components. Call, write, or fax today to start your free subscription to the most unique catalog in the industry, filled with super values on surplus electronic and hobbyist type items. If you have a friend who would like to receive our catalog, send us their name and address and we will gladly forward them a complementary 100 page catalog.

Why pay more? Call today.

MECI

340 East First Street Fax Order Line
Dayton, Ohio 45402 1-800-344-6324

Order Toll-Free
1-800-344-4465

CIRCLE 139 ON FREE INFORMATION CARD

ELECTRONIC COMPONENTS

MOUSER ELECTRONICS

Visit our web site!
www.mouser.com

FREE catalog is available on the internet, CD-ROM, or in paper!

- Over 72,500 Products
- More than 145 Suppliers
- Same Day Shipping
- No Minimum Order

800-992-9943
817-483-6828 Fax: 817-483-0931
catalog@mouser.com

958 North Main St., Mansfield, TX 76063

CIRCLE 160 ON FREE INFORMATION CARD

Turn Your Multimedia PC into a Powerful Real-Time Audio Spectrum Analyzer

Features

- 20 kHz real-time bandwidth
- Fast 32 bit executable
- Dual channel analysis
- High Resolution FFT
- Octave Analysis
- Distortion measurements
- Signal Generation
- Triggering, Decimation
- Transfer Functions, Coherence
- Time Series, Spectrum Phase, and 3-D Surface plots
- Real-Time Recording and Post-Processing modes

Applications

- Distortion Analysis
- Frequency Response Testing
- Acoustic Research

System Requirements

- 486 CPU or greater
- 8 MB RAM minimum
- Win. 95, NT, or Win. 3.1 + Win.32s
- Mouse and Math coprocessor

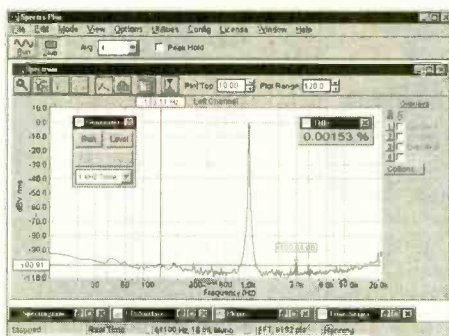

Priced from \$495

(U.S. sales only - not for export/resale)

DOWNLOAD FREE 30 DAY TRIAL!

www.spectraplus.com

PHS Pioneer Hill Software
24460 Mason Rd.
Poulsbo, WA 98370
a subsidiary of Sound Technology, Inc.



Spectra Plus
FFT Spectral Analysis System

Sales: (360) 697-3472

Fax: (360) 697-7717

e-mail: pioneer@telebyte.com

Call Today And **SAVE!** **Unbeatable PRICES!**

CABLE TV

**DESCRAMBLERS
CONVERTERS • FILTERS
VIDEO STABILIZERS**

FREE ➤ 30 Day Trial
FREE ➤ Product Catalog
FREE ➤ 1 Year Warranty

100% MONEY BACK GUARANTEE

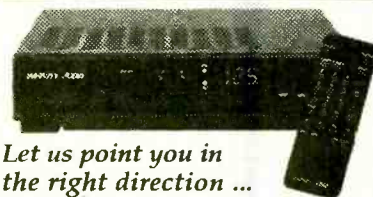

Let us point you in the right direction ...

Arrow Technologies
Omaha, Nebraska

**TOLL FREE
888-554-ARROW**

888-554-2776



Learn MICROCONTROLLERS EMBEDDED SYSTEMS and PROGRAMMING...

...with the AES learning system/
embedded control system.
Extensive manuals guide you
through your development
project. All programming and
hardware details explained.
Complete schematics. Learn to
program the LCD, keypad digital,
analog, and serial I/O. for your applications.

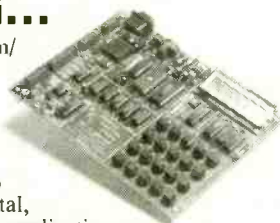

**THREE MODELS AVAILABLE. Choose from an
Intel 8051, Intel 8088, or Motorola 68HC11
based system. All models come with:**

- 32K Byte ROM, 32K Byte RAM • 2 by 16 Liquid Crystal Display • 4 by 5 Keypad • Digital, Analog, and Serial I/O • Interrupts, timers, chip-selects • 26 pin expansion connector • Built-in Logic Probe • Power Supply (can also be battery operated) • Powerful ROM MONITOR to help you program • Connects to your PC for programming or data logging (cable included) • Assembly, BASIC, and C programming (varies with model) • Program disks with Cross Assembler and many, well documented, program examples • User's Manuals: cover all details (over 500 pages) • Completely assembled and ready to use • Source code for all drivers and MONITOR • Optional Text Book

Everything you need. From \$279.
Money Back Guarantee

Call for Free Info Pack, or see
WEB at <http://www.aesmicro.com>
714-550-8094, FAX 714-550-9941

AES
Advanced Educational Systems

Call 1-800-730-3232

AES 575 ANTON BLVD., SUITE 300, COSTA MESA, CA 92626, USA

MICROTEST INC. CABLE TEST CHIPS FROM \$9.95

WE STOCK A COMPLETE LINE OF CHIPS
WE ALSO HAVE CRYSTAL 119.MHZ/117.MHZ

WARNING...
ANYONE IMPLYING ILLEGAL USE WILL BE
DENIED SALE. WE SELL PRODUCTS ONLY
TO TECHNICIAN OR REPAIR FACILITIES
ALL ORDERS SHIP VIA UPS/ECT
THE BEST PRICE IN THE MARKET
WE INCLUDE SWITCH & RESISTOR
MON-SAT 8 AM-7 PM EST. TECH SUPPORT
E-MAIL WWW.MICROTEST@AOL.COM

**FOR ORDERS
1-800-931-9440**

VIDEO SYNC GENERATOR



Restores Horizontal
and Vertical
Sync Lines from
Distorted Video



Lost Sync



Restored Sync
with VSG

For Free Information Package and Pricing

Call (219) 233-3053
www.south-bend.net/rcd

R.C. Distributing, P.O. Box 552, South Bend, IN 46624

Electronic Training Videos

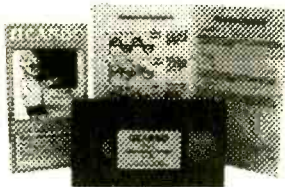

Learn electronics quickly and easily with UCANDO's computer-animated training videos. Students can learn at their own pace and professionals will find the UCANDO videos to be a valuable source of reference material. If these videos aren't the best learning tools you've ever seen, return them within 30 days for a

complete refund. These videos are being used by Tech-Schools, CET's, Military Branches, Ham Operators, Industries, and more, across the United States and around the world. Order today and see how UCANDO is ...

"Changing The Way The World Learns Electronics."

VCR Maintenance & Repair ... \$29.95 All others ... \$44.95 each
 • Intro to VCR Repair • Direct Current • Alternating Current •
 Semiconductors • Power Supplies • Amplifiers • Oscillators • Digital 1 •
 Digital 2 • Digital 3 • Digital 4 • Digital 5 • Digital 6 • AM Radio • FM
 Radio Part 1 • FM Radio Part 2 • TV Part 1 "Intro to TV" • TV Part 2
 "The Front End" • TV Part 3 "Audio" • Fiber Optics • Laser Technology •

SAVE!!! 6 videos for only \$240 or 12 videos for only \$450



1-800-678-6113

or mail check or money order to:

UCANDO Videos

P.O. Box 928

Greenville, OH 45331



FREE Shipping ... FREE Catalog

OSCILLOSCOPES from \$169 !!!

ATC O-Scope uses printer port to turn PC-AT into Digital Storage Oscilloscope, Spectrum Analyzer, Freq. Counter, Logger, DVM. DC-500KHz

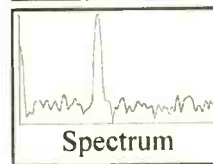
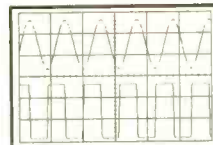

- Print, log to disk, or export data
- Accepts standard scope probes
- Uses standard printer port
- Small and portable
- Works with laptops
- Same day shipping
- Made in U.S.A.
- Single channel units from \$169
- Dual channel units from \$349

Options:

- Probe sets
- Automotive probes
- Battery packs

Order yours today.

800 980 9806

MC/Visa/Amex

Allison Technology Corporation

2006 Finney-Vallet, Rosenberg, TX 77471

PH: 281 239 8500, FAX: 281 239 8006

<http://www.atcweb.com>

JENSEN®

Supplement 98H

When you need the right tool... reach for the trusted name

A Tradition of Quality, Selection & Service Since 1954



Order Line: 800-426-1194 602-968-6231
 24 Hour FAX: 800-366-9662 602-438-1690
 24 Hour FaxBack®: 602-968-6241 x271
 Online Catalog: <http://www.jensentools.com>

Since 1954 ...

Electronic technicians have trusted the Jensen name for everything they need to build, troubleshoot and repair their electronic projects: Original JTK Tool Kits, specialty tools, test instruments, diagnostic equipment, PC & LAN accessories and more.

FREE Catalog
800-426-1194
Dept. 362

NEW
JTM



A full line of meters worthy of the Jensen name!

JENSEN TOOLS

7815 S. 46th Street, Phoenix, AZ 85044
 Tel: 800-426-1194 or 602-968-6231
 Fax: 800-366-9662 or 602-438-1690
 E-Mail: jensen@stanleyworks.com
 Online: <http://www.jensentools.com>

CIRCLE 159 ON FREE INFORMATION CARD

CABLE TV CONVERTERS

Equipment & Accessories
 Wholesalers Welcome

Call C&D ELECTRONICS
 1-888-615-5757 M-F 10a-6p

FCC License Preparation

Electronics Tech., Avionics, Marine & Radar
HOMESTUDY—Fast, Easy & Inexpensive
 Manuals, Audio, Video, PC disks, latest Q&As
 Free 1-800-800-7555 "Guaranteed Pass"
 See at <http://www.worldaccessnet.com>
 BusinessShowcase/wpt. 4701 NE 47th St.
 Vancouver, WA 98661 - WPT Publications

LEARN ELECTRONICS!



Home study. Make excellent money. Repair and install camcorders, TVs, VCRs, stereos, sound and lighting, alarm systems, and more!

FREE LITERATURE: 800-223-4342

Name _____ Age _____

Address _____ Phone () _____

City/State _____ Zip _____

School of Electronics, Dept. ELM341PCDI, 6065 Roswell Rd., Atlanta, GA 30328

Our Complete Catalog is now online  www.cir.com

Circuit Specialists Inc.

SINCE 1971

Check Out What We Have To Offer:

Fantastic DMM Offer!!!

Don't let the price fool you. This meter is a digital multimeter designed for engineers and hobbyists. Equipped with 5 functions and 19 ranges. Each test position is quickly and easily selected with a simple turn of the FUNCTION/RANGE selector rotary switch.

General Rubber Boot Included

Display: 3-1/2 Digit LCD, 21mm Figure Height with Automatic Polarity
Overrange Indication: 3 Least Significant Digits Blank
Temperature for Guaranteed Accuracy: 23°C±5°C RH<75%

Temperature Ranges:

Operating: 0°C to 40°C (32°F to 104°F)
Storage: -10°C to 50°C (14°F to 122°F)
Power: 9V Alkaline or Carbon-Zinc Battery (NEDA1604)

Low Battery Indication: BAT on Left of LCD Display

Dimensions: 188mm long x 87mm wide x 33mm thick
Net Weight: 400g

DC Voltage (DCV)

Range: Resolution: Accuracy:

200mV 100µV
2000mV 1mV ±(1.2%rdg+2dgts)
20V 10mV
200V 100mV
1000V 1V

Maximum Allowable Input: 1000V DC or Peak AC.

DC Current (DCA)

Range: Resolution: Accuracy:

200µA 100nA
2000µA 1µA ±(1.2%rdg+2dgts)
20mA 10µA
200mA 100µA ±(1.2%rdg+2dgts)
10A 10mA

Overload Protection: mA Input. 2A/250V fuse.



Our Best Offer Ever on a

High Quality Full Sized DMM

\$19.00 any qty

Resistance (Ω)

Range: Resolution: Accuracy:

200Ω 100mΩ
2000Ω 1Ω
20KΩ 10Ω ±(1.2%rdg+2dgts)
200KΩ 100Ω
2000KΩ 1KΩ
20MΩ 10KΩ ±(2%rdg+10dgts)

Maximum Open Circuit Voltage: 2.8V

Diode Test

Measures forward voltage drop of a semiconductor junction in mV test current of 1.5mA Max.

ohmTest

Measures transistor hFE.
Frequency Range: 45Hz-450Hz
Maximum Allowable Input: 750V rms
Response: Average Responding. Calibrated in rms of a Sine Wave.

AC Voltage (ACV)

Range: Resolution: Accuracy:

200V 100mV ±(1.2%rdg+10dgts)
750V 1V

CAT NO	DESCRIPTION	PRICE
9300G	Rugged High Quality DMM with Rubber Boot	\$19.00

Positive Photofabrication Kit Make your own PCB's

Kit includes the basic items needed to fabricate pre-sensitized printed circuit boards (does not include artwork). Also included is a basic process guide to assist the user in the basics of exposing, developing and etching a PCB. All items fit conveniently in the plastic development tray, and a tight fitting lid is included for handy storage. Additional recommended supplies for fabricating PCB's are: exposure bulb, etchant tank, eye protection, art-work, paper towels.

Kit Includes

- 1 each 3"x5" pre-sensitized single sided PCB
- 1 each 4"x6" pre-sensitized single sided PCB
- 1 each 6"x6" pre-sensitized single sided PCB
- 1 each 500ml developer liquid
- 1 each 500ml ferric chloride etching liquid
- 2 each foam brushes
- 1 each plastic development tray
- 1 each rubber gloves
- 1 each instruction sheet



new!

CAT NO	DESCRIPTION	PRICE
416-K	Photofabrication Kit	\$27.95

CIRCUIT SPECIALISTS, INC.

800-811-5203
602-464-2485

602-464-5824(FAX)

WE ACCEPT:



Positive Photo Resist Pre-Sensitized Printed Circuit Boards



These pre-sensitized printed circuit boards are ideal for small production runs. They provide high resolution and excellent line width control. High sensitive positive resist coated on 1oz. copper foil allows you to go direct from your computer plot or art work layout. No need to reverse art.

Single-Sided, 1oz. Copper Foil on Paper Phenolic Substrate

CAT NO	DESCRIPTION	1	10	50
PP101	100mm x 150mm/3.91" x 5.91"	\$2.55	\$1.90	\$1.70
PP114	114mm x 165mm/4.6" x 6.6"	2.98	2.45	1.98
PP152	150mm x 250mm/5.91" x 9.84"	5.40	3.98	3.60
PP153	150mm x 300mm/5.91" x 11.81"	6.15	4.48	4.10
PP1212	305mm x 305mm/12" x 12"	12.78	10.65	8.52

Single-Sided, 1oz. Copper Foil on Fiberglass Substrate

CAT NO	DESCRIPTION	1	10	50
GS101	100mm x 150mm/3.91" x 5.91"	\$ 3.90	\$2.98	\$2.60
GS114	114mm x 165mm/4.6" x 6.6"	4.80	3.49	3.20
GS152	150mm x 250mm/5.91" x 9.84"	8.69	5.98	5.78
GS153	150mm x 300mm/5.91" x 11.81"	10.20	7.20	6.80
GS1212	305mm x 305mm/12" x 12"	18.88	15.73	12.59

Double-Sided, 1oz. Copper Foil on Fiberglass Substrate

CAT NO	DESCRIPTION	1	10	50
GD101	100mm x 150mm/3.91" x 5.91"	\$ 5.07	\$3.68	\$3.38
GD114	114mm x 165mm/4.6" x 6.6"	5.95	4.29	3.99
GD152	150mm x 250mm/5.91" x 9.84"	10.47	7.39	6.98
GD153	150mm x 300mm/5.91" x 11.81"	11.95	8.69	8.30
GD1212	305mm x 305mm/12" x 12"	22.09	18.35	14.68

Exposure System

Just place your presensitized board and artwork centered under the exposure fixture. Place the convenient acrylic sheet over the board and artwork to hold everything in place. Turn on light. Voila! Exposure takes about 5 minutes. Kit includes one fluorescent tube, stand and acrylic weight.



new!

Features

- Exposes boards in about 5 minutes!
- Convenient acrylic sheet to hold board in place during exposure (12.5" x 8.5")
- Fluorescent light fixture with plastic cover designed to aid in proper light refractions for even exposure

CAT NO	DESCRIPTION	PRICE
416-X	Fluorescent Exposure System	\$31.95
416-B	Extra Replacement Fluorescent Tube	16.95



Etching Tank

This handy etching system will handle PC boards up to 8" x 9", two at a time. Ideal for etching your PCB's! System includes an air pump for etchant agitation, a thermostatically controlled heater for keeping etchant at optimum temperature and a tank that holds 1.35 gallons of etchant. A tight fitting lid is also supplied to prevent evaporation when system is not being used. Typical etching time is reduced to 4 minutes on 1oz. copper board!

REDUCES ETCHING TIME!	CAT NO	DESCRIPTION	PRICE
	12-700	Etch Tank System	\$37.95



Developer

This product is used as the developer on our positive photo-resist printed circuit boards. Includes instructions. 50 gram package, mixes with water, makes 1 quart.

CAT NO	DESCRIPTION	1	10	25
POSDEV	Positive Developer	\$.95	\$.80	\$.50

Etching Chemicals/Ferric Chloride

A dry concentrate that mixes with water to make 1 pint of etchant, enough to etch 400 sq. inches of 1oz board.

CAT NO	DESCRIPTION	1	5
ER-3	Makes 1 pint	\$3.50	\$2.75



RECEIVE OUR LATEST 132 PAGE CATALOG!

It's chock full of all types of electronic equipment and supplies. We've got I.C.'s, capacitors, resistors, pots, inductors, test equipment, breadboarding supplies, PC supplies, industrial computers, data acquisition products, personal computers and computer parts, plus much, much more. FAX us your name and address or call **800-811-5203, ext. 5**, to leave a message on our catalog request line.



Color Weather Proof Bullet Camera

1/3" CCD with removeable rotation capable mounting bracket

Specifications

Image Sensor:	Interline transfer CCD 1/3" format
Effective Pixel:	512(H)x492(V) pixels/NTSC 512(H)x582(V) pixels/PAL
Scanning System:	2 : 1 interlaced
Sync System:	Internal sync
Sync Pulse:	15.734KHz +1%(H)/15.625KHz +1%(H)
Resolution:	59.94Hz +1%(V)/ 50Hz +1%(V)
S/N Ratio:	Sub-Carrier 3.57 MHz +30ppm 400 TV lines (H)
Gamma Characteristics:	More than 46dB (typ)
Min. Illumination:	0.45
Video Out:	1 LUX (F1.2 10 IRE) Composite video signal : 1.0Vp-p
White Balance:	Auto white balance
Electronic Shutter:	1/60 - 1/100,000 SEC(N) 1/50 - 1/100,000 SEC (P)
Power Supply:	DC 12V +10%
Power Consumption:	240mA (typ)
Lens:	4mm (78 of 92 degree) F : 2.0
Ambient Operating Temp:	-5 deg. C +40 Deg. C
Ambient Storage Temp:	-10 Deg. C +50 Deg. C RH 95% MAX
Dimension:	2 1/8" (L) x 1 1/4" (C)
Weight:	3 oz.

new!

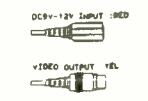
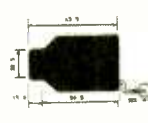

PRICE EACH
1 5
\$299.00 \$269.00

CAT NO	DESCRIPTION	1	5
WDB-6407S	Color Water Tight Bullet Camera	\$299.00	\$269.00

(water tight for outdoor use, not suitable for sustained underwater use)

CCD Bullet Cameras

Available with standard or pinhole lens. Virtually indestructible bullet shaped casing. This sleek B&W camera can be mounted on walls or ceilings along narrow corridors or virtually any location for virtually any surveillance application. 0.5 lux minimum illumination with 380 lines of resolution. Even includes a built-in electronic iris for automatic light compensation.

Features

- Extremely low power consumption
- No blooming, no burning
- 0.5 LUX minimum illumination
- CCD area image sensor for long camera life
- Ultra small size allows for simple application and installation
- Built-in electronic auto iris for automatic light compensation
- Ultra compact camera

Specifications

Image Pick-Up Device:	1/3" CCD area sensor
No. of Pixels:	EIA = 512(H) x 492(V)
Pixel Pitch:	EIA = 9.6UM(H) x 7.5UM
Scanning System:	EIA=525 lines, 60 field/sec
Sync System:	Internal sync
H. Resolution:	430 TU line
V. Resolution:	400 TU line
Usable Illumination:	0.5 Lux F1.6
S/N Ratio:	More than 48dB
Gamma Characteristic:	0.45
Video Output:	1.0 - 1.1 up-p 75 Ohm
Electronic Shutter Time:	EIA=1/60 - 1/50,000 sec
Lens F No. Focal Length:	STD : 1.6 Open / 4.3mm(78 deg) Pinhole: 4.3 fixed/ 2.8mm(91.4 deg)
Power Consumption:	DC 9V (8-10V), 110mA
Operational Temp.:	-10 deg - +50 deg C RH95% max
Storage Temp.:	-20 deg - +60 deg C RH95% max
Dimensions:	STD : 22mm(W) x 22mm(H) x 38mm(D) Pinhole: 22mm(W) x 22mm(H) x 30mm(D)
Weight:	35g max

new!

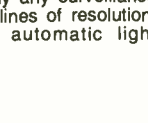

PRICE EACH
1 5
\$144.00 \$129.00

CAT NO	DESCRIPTION	1	5
WDB-07S	Standard Lens Version	\$144.00	\$129.00
WDB-07P	Pinhole Lens Version	144.00	129.00
WDP-07S/water	Standard Lens Weather Proof	169.00	152.00

ESD Safe Soldering Stations

- Auto-Temp 136ESD & Auto-Temp 137ESD
- Meets applicable military standards
- ESD safe featuring ceramic heating element and state of the art P.T.C. sensor to ensure accurate temperature performance

Features

Fine Tune Temperature from 150° C (300° F) through 450° C (850° F) without unnecessary tip or heating element changes.
Precision "Tip Temperature" accuracy is maintained to within ±3° C (6° F) using state of the art circuit technology and a built-in P.T.C. sensor located at the top of each ceramic heater shaft for fail safe accuracy.
Fast Heat Up & Recovery. A long life Japanese made ceramic heating element facilitates fast heat up, fast recovery and exacting temperature control with minimal overshoot. Heat-up time to working temperature is attained in about 45 seconds.
Spice Free Circuit. Zero voltage switching and fully grounded design meets military application standards for protection of electro-sensitive devices against line transience and voltage spikes. Tip leakage is less than 0.4 mv or 0.5 ohm resistance.
External Calibration Port. A calibration port is located on the face of the unit thus temperature adjustments are quick and convenient.
Lightweight Soldering Iron. Ergonomic mini handle that stays "cool". Handle assembly cord is made from silicone rubber that won't be damaged when coming into contact with high temperature irons.
Isolated Power Unit. The power unit is isolated from the AC line by a high quality



Standard Tip



136ESD



137ESD w/ Digital R/O

CAT NO	DESCRIPTION	1	5
136ESD	Electronic Temp Controlled ESD Safe Soldering Station	\$99.00	\$88.00
137ESD	Electronic Temp Controlled ESD Safe Soldering Station w/ Digital Readout	129.00	114.00

SEE OUR ON-LINE CATALOG AT
www.cir.com

CIRCUIT SPECIALISTS, INC. 800-811-5203
602-464-2485
SINCE 1971 602-464-5824(FAX)

CCD Dome Camera with Audio

B&W DOME camera with integrated microphone. Ideal security system application. 12 VDC operation.

Specifications

Image Device:	1/3" interline transfer CCD
Picture Elements:	EIA=542(H)x492(V)
Scanning System:	2:1 Interlace
Synchronization System:	Internal
Horizontal Resolution:	380 TV Lines
Sensitivity:	Under 0.3 LUX
Electronic Iris (linear):	EIA = 1/60 - 1/100,000 sec
Video Output:	1.0Vp-p, 75 ohm
S/N Ratio:	More than 50dB
Power Supply:	12V DC (±20%)
Gamma:	r=1
Power Consumption:	110 mA max
Operating Temp.:	-10°C ~ +50° C
Operating Humidity:	RH 95% Max
Weight:	100g
Applied Lens:	3.6mm -92°, 4.3mm -78°
AI/EE/Flicker Less/Mirror Image:	Jump soldering selection
Audio Pick-up Sensitivity:	-60dB (0dB=1V/ubar)
Audio Frequency Range:	20 Hz ~ 20 kHz
Audio S/N Ratio:	More than 40dB
Audio Output Level:	1Vp-p/600 ohm
Dimensions:	87 x 55.5mm

new!



CAT NO	DESCRIPTION	1	5
WDDB-6500	B&W Dome Camera	\$144.00	\$129.00

1/3" CCD Board Cameras

Available with **PINHOLE LENS with AUDIO**; **STANDARD LENS with AUDIO**; and **STANDARD LENS with INFRA-RED and AUDIO**. These are the world's smallest commercially available CCD board cameras!

World's Smallest B&W Board Cameras

Specifications

Image Pick-Up Device	1/3" CCD area Sensor
Picture Elements	EIA=512(H) x 492(V)
Pixel Pitch	EIA=9.6UM (H) x 7.5UM (V)
Scanning System	2 : 1 Interlace
Scanning Frequency	EIA=525 lines, 60 field/sec (II) 15.750 KHz x 60 HK
Resolution	430 Lines
Minimum Illumination	0.03LUX
S/N Ratio	45DB
Lens Mounting	4.3mm standard, 5mm pinhole
Video Output	1.0 VP-P/750OHM composite signal
Power Requirement	8-12 VDC (9VDC standard)
Power Consumption	100mA
Operating Temperature	-20C -- + 70 C RH 95% Max
Storage Temperature	-40C = 85 C RH 95% Max
Audio Pick-Up Sensitivity	-60 DB (0DB = 1B/UBAR. 1KNZ)
Audio Frequency Range	20 Hz to 20KHz
Audio S/N Ratio	More than 35DB
Audio Output Level	1VP-P/600 OHM

Dimensions

WDP-2000	30mm (H) x 30mm (W)
WDS-2005	30mm (H) x 30mm (W)
WDI-4000	44mm (H) x 30mm (W)

CAT NO	DESCRIPTION	1	5
WDP-2000	1/3" B&W Pinhole Lens with Audio	\$89.00	\$77.00
WDS-2005	1/3" B&W Standard Lens with Audio	89.00	77.00
WDI-4000	1/3" B&W Infra-RED with Audio	89.00	77.00
WDPH-55BW	Plastic Housing Option for B&W Board Cameras (WDP-2000 & WDS-2005 ONLY)	13.00	12.00



WDP-2000



WDS-2005



WDI-4000

PRICE EACH
1 5

transformer and only 24 Vac voltage is used to drive the heating element. **ESD Safe.** Exceeds all soldering equipment military specifications regarding electro static sensitive devices for critical applications. **Lock-Out Feature:** Constructed with a lock-out feature to allow supervisors only to set and lock specific soldering temperatures. Accomplished via a special sized allen head screw located on the front panel. **Superior High Insulation** ceramic heater provides insulation rated over 100Mohms at 750° F. **Optional SMD Tip Series** for re-work applications. **Range of interchangeable tips** available for maximum system flexibility.

SEE www.cir.com FOR OUR SELECTION OF REPLACEMENT TIPS, REPLACEMENT IRONS AND SMD TIPS.

LEADER

For Professionals Who Know The Difference

- Oscilloscopes
- Video Sync/Test Generators
- Waveform Monitors/Vectorscopes
- EFP/ENG Instruments
- RF Signal Level Meters
- Audio Generators & Meters
- Frequency Counters
- Meters & Bridges
- Power Supplies
- Function Generators
- RF Generators



Products International

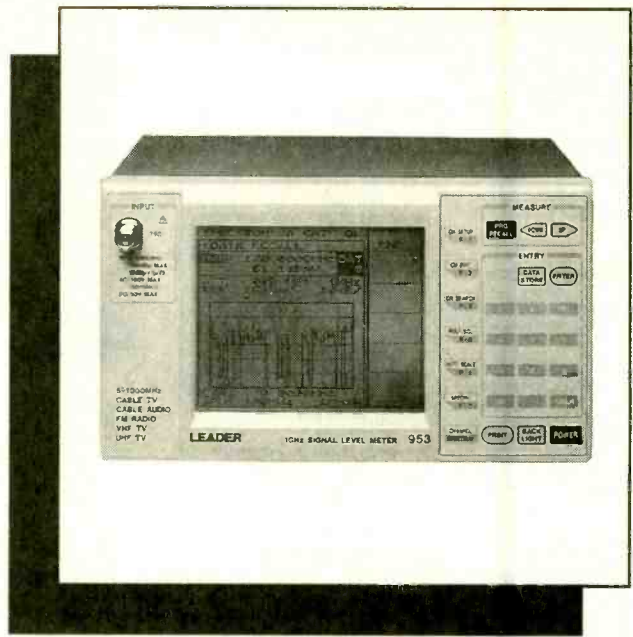

Call, fax or email for your free test and measurement instrument catalog today!
 800-638-2020 * Fax 800-545-0058
www.prodintl.com

Test Instruments, Equipment, Tools & Supplies For Electronic Production, Maintenance & Service
 8931 Brookville Road, Silver Spring, MD, 20910 * 800-638-2020 * Fax 800-545-0058

CIRCLE 47 ON FREE INFORMATION CARD

New and Pre-Owned Test Equipment

Goldstar

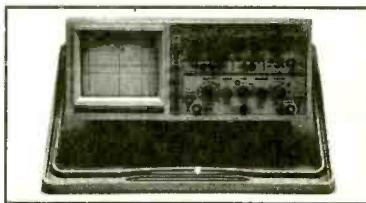

Model OS-9100P → **\$899.00**

Full 100 MHz Bandwidth!

- Dual-Channel, High Sensitivity
- TV Synchronization Trigger
- Calibrated Delayed Sweep
- Includes Two Probes, 2 Year Warranty

Spectrum Analyzer
 B+K Precision
 Model 2625

- 150kHz - 1050MHz
- 80dB Dynamic Range
- AM/FM demod Included

Only \$2,195.00!

We Buy Surplus Test Equipment

Leader CATV Signal Level Meter Model LF 941

- ✓ TV/CATV Coverage from 46 - 870 MHz
- ✓ Video/Audio Carrier Measurements **\$695.00!**

Just Released! → "Series III" Multimeters

Fluke Model 87III \$309.00 !!!

Pre-Owned Oscilloscope Specials

Tektronix 2213	60 MHz	\$549.00
Tektronix 2215	60 MHz	\$649.00
Tektronix 465	100 MHz	\$599.00
Tektronix 465B	100 MHz	\$729.00
Tektronix 475	200 MHz	\$829.00
Tektronix 475A	250 MHz	\$1,199.00

- Professionally Refurbished
- Aligned & Calibrated to Original Specifications
- The Industry Standard of Oscilloscopes
- **1 Year Warranty - The Longest Available!!!**

SIMMax Module Tester

- * Tests 72/30 pin SIMMs
- * Stand alone/portable
- * Identifies SIMM properties
- * 10 built-in tests identify most memory defects

Only \$599.00!

1-800-996-3837

See us on the Web!
www.fotronic.com

Test Equipment Depot

A FOTRONIC CORPORATION COMPANY
 99 Washington St. Melrose, MA 02176
 (781) 665-1400 • FAX (781) 665-0780

email: afoti@fotronic.com



TOLL FREE 1-800-99-METER

VARIAC

Excellent for controlling & testing various electronic products such as, Motor, Transformer,

Lighting Control,

School

Electronics Lab /

1000VA



\$69.89

Qty. 3+

DIGITAL MULTIMETER

Basic Digital Multimeter with

Transistor

"hfe" and

Continuity

Test.



Qty. 3+

\$8.50

1-888-456-4517

Associated Elec.

& Eng. Co./ AEEC

email: aeecpro1@aol.com

website: www.internet-web.net/aeec

PO Box 4766,

Santa Clara CA 95056

YOUR SUMMER SAVINGS

VIBRATING TRANSMITTER DETECTOR

DETECTS:

- Body Wires
- FM Wireless Mics
- AM Transmitters
- UHF Transmitters



Ai-2100...\$140.00

TRVD-900

DETECTS:

- Body Wires • Transmitters
- Tape Recorders • Video Equipment



TRVD-900...\$395

BLACK BOX COLOR CAMERA



BX-985...\$195

SMOKE DETECTOR COLOR CAMERA



SD-985...\$275

COVERT COLOR VIDEO LAMP

- 380 (H) TV Lines
- 2 Lux Sensitivity
- Undetectable Lens



VL-985...\$395

AI-5500 COMPLETE SAFETY SYSTEM

DETECTS:

- All Phone Taps
- All Body Wires
- All Transmitters

DISRUPTS:

ALL TRANSMITTERS & BODY WIRES WITH ITS BUILT-IN WHITE NOISE SIGNAL BREAKER



\$350

WSS-300 COLOR WIRELESS SURVEILLANCE SYSTEM

FEATURES:

- FCC Approved 2.4GHz Transmitter / Receiver
- Radio w/ Built-In Color Camera / Transmitter
- 380 (H) TVL Resolution • Super Low 2 Lux
- 4-Channel Receiver • 300' Transmission

Note: Cassette Player Non-Functioning \$595



All 985 Series Color Cameras Feature: Superior Resolution - Over 380(H) TV Lines Super Low 2 Lux Sensitivity, 3.7mm Wide-Angle Lens. Built-In Backlight Compensation.

Items May Be Purchased by Credit Card, Certified Check, Money Order or C.O.D.

Source Code 811PE

AMERICAN INNOVATIONS, INC.

119 ROCKLAND CENTER - SUITE 315 • NANUET, NY 10954

VOICE: (914) 735-6127 • FAX: (914) 735-3560

HTTP://WWW.SPYSITE.COM • E-MAIL: AMERICAN@SPYSITE.COM

Sale Ends 10/31/98

Weeder Technologies

Add \$4 Ship/Hand US & Canada

FREE CATALOG!



Pro-Kit

PO Box 2426, Ft. Walton Beach, FL 32549

850-863-5723

Stackable RS-232 Kits

Digital I/O - 12 I/O pins individually configurable for input or output. DIP switch addressable; stack up to 16 modules on same port for 192 I/O points. Turn on/off relays. Sense switch transistions, button presses, 4x4 matrix decoding using auto-debounce and repeat. **\$32**

Analog Input - 8 Input pins. 12-bit plus sign self-calibrating ADC. Returns results in 1mV steps from 0 to 4095. Software programmable alarm trip-points for each input. DIP switch addressable; stack up to 16 modules on same port for 128 single-ended or 64 differential inputs. **\$49**

Home Automation (X-10) - Connects between a TW523 and your serial port. Receive and transmit all X-10 commands with your home-brewed programs. Full collision detection and auto re-transmission. **\$39**

Caller ID - Decodes the caller ID data and sends it to your serial port in a pre-formatted ascii character string. Example: *12/31 08:45 850-863-5723 Weeder, Terry <CR>. Keep a log of all incoming calls. Block out unwanted callers to your BBS or other modem applications. **\$35**

Touch-Tone Input - Decodes DTMF tones used to dial telephones and sends them to your serial port. Keep a log of all outgoing calls. Use with the Caller ID kit for a complete in/out logging system. Send commands to the Home Automation or Digital I/O kits using a remote telephone. **\$34**

Telephone Call Restrictors

Two modes of operation; either prevent receiving or placing telephone calls (or call prefixes) which have been entered into memory, or prevent those calls (or call prefixes) which have "not" been entered.

Block out selected outgoing calls. Bypass at any time using your password. **\$35**

Block out selected incoming calls. Calls Identified using Caller ID data. **\$48**

Phone Line Transponder

7 individual output pins are controlled with buttons 1-7 on your touch-tone phone. Automatically answers telephone and waits for commands. Monitor room noises with built in mic. "Dial-Out" pin instructs unit to pick up phone and dial user entered number(s). Password protected. **\$48**

IR Remote Control Receiver

Learns and records the data patterns emitted by standard Infrared remote controls used by TVs, VCRs, Stereos, etc. Lets you control all your electronic projects with your TV remote. 7 individual output pins can be assigned to any button on your remote, and can be configured for either "toggle" or "momentary" action. **\$32**

DTMF Decoder/Logger

Keep track of all numbers dialed or entered from any phone on your line. Decodes all touch-tones and displays them on a 16 character LCD. Holds the last 240 digits in a non-volatile memory which can be scrolled through. Connect directly to radio receiver's speaker terminals for off-air decoding of repeater codes, or numbers dialed on a radio program. **\$55**

A WHOLE NEW WORLD IN SCIENCE KITS.

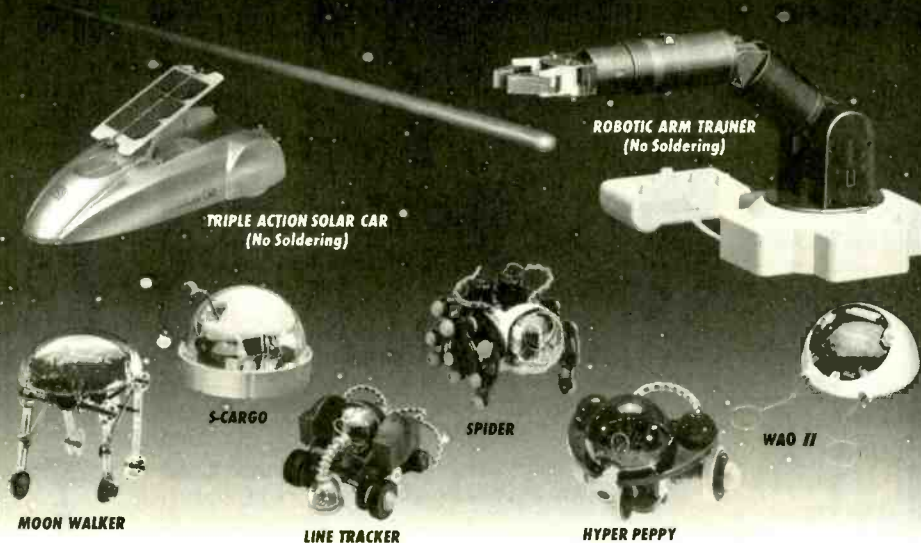

OWI's "Next Generation" of affordable, rugged Robot Kits challenge the enthusiast to solder circuit boards and / or mechanically assemble.

Each OWIKIT also incorporates the basic principles of robotic experiments, sensing and locomotion, guaranteeing an exciting, hands-on adventure of knowledge and fun!

But remember! OWI is the recognized founder and leader in Educational Robot Kits. ACCEPT NO IMITATIONS.

Visit our homepage
@ <http://www.owirobot.com>



ROBOTIC ARM TRAINER	OWI-007	5 Axis Control	Avail. Aug. '98	69.95
TRIPLE ACTION SOLAR CAR	OWI-685	Solar Sensor	28 pg. Book	39.95
S-CARGO	OWI-936K	Sound Sensor	47 Pg. Book	36.95
WAO II	OWI-961K	Programmable - Graphic	59 Pg. Book	69.95
SPIDER	OWI-962K	Infrared Sensor	49 Pg. Book	49.95
LINE TRACKER	OWI-963K	Infrared Sensor	48 Pg. Book	49.95
HYPER PEPPY	OWI-969K	Sound / Touch Sensor	46 Pg. Book	24.95
MOON WALKER	OWI-989K	Solar Sensor	10 Pg. Book	34.95

1160 Mahalo Place, Suite B
Rancho Dominguez, CA 90220-5443
(310) 638-7970
Fax: (310) 638-8347



Order M - F: 8a.m. - 4p.m. PST

Whaddya Say To A Guy Who's Had The Same Job For 50 Years, Has Never Called In Sick Or Showed Up Late, Never Taken A Vacation Or A Holiday, Never Asked For A Raise Or Griped About His Bonus And, Believe It Or Not, Has No Plans For Retirement?



Thanks.

Remember - only you can prevent forest fires.

CAD FILES TO CASH PILES



IMAGINE THE POSSIBILITIES!
ROUTE, MILL, DRILL, CARVE,
ENGRAVE, PAINT, ETC. . . .
IN WOOD, PLASTIC, VINYL,
PC BOARD, & LIGHT METALS.

THE **ROBOPRO X50**
CNC ROBOTIC MACHINING SYSTEM
YOUR WISH IS ITS COMMAND!



STARTING AT
\$895.00



3 AXIS UNITS FROM
12" X 12" TO 60" X 60"
MACHINING AREAS

Visit us at
www.uscyberlab.com

U. S. CYBERLAB, INC., 14786 SLATE GAP RD., WEST FORK, AR 72774
VOICE (501) 839-8293 / 24 HR. FAX BACK (501) 839-8293

EPROM+

The Professionals Choice!

A rugged device programming system for bench and field

Uses parallel printer port!

Supports all standard parts!

Excellent, easy-to-use software!



IMPROVED!
New features,
more devices

- FIRST GENERATION EPROMS 2708, TMS2716*, 25XX
- SECOND GENERATION EPROMS (24, 28, 32 PIN) 2716 - 27C080 (8 MEG) *ADAPTER REQUIRED (DIAGRAM INCLUDED)
- 16 BIT EPROMS* (40, 42 PIN) 27C1024 - 27C160 (16 MEG)
- FLASH EPROMS (28, 32 PIN) 28F, 29C, 29EE, 29F FAMILIES PLUS BOOT BLOCK DEVICES
- EEPROMS/NVRAMS (24, 28, 32 PIN) 28C04 - 28C010, X2210/12, ER5901, PLUS DALLAS 12XX
- SERIAL EEPROMS* (8, 14 PIN) 17XX, 24XX, 25XX, 35XXX, 59XX, 85XX, 93XX, 95XX+ER1400
- BIPOLAR PROMS* (16 - 24 PIN) 74SXXX AND 82SXXX FAMILIES
- MICROCONTROLLERS* (ALL FAMILIES) 874X, 875X, 87C5XX, 87C75X, 89CSX, 89CX051, 89SXXX, 90SXXX, 68705, 68711, PIC12CXXX - 16CXXX, 17C4X PLUS FLASH AND 14000

- READ, PROGRAM, COPY, COMPARE, FILE LOAD/SAVE (PLUS MUCH MORE!)
- FULL SCREEN EDITOR W/25 CMDS + BYTE/WORD MODES
- RUNS UNDER DOS, WIN3.1/95/98 AT ALL CPU SPEEDS
- SUPPORTS INTEL HEX, S-RECORD AND BINARY FILES
- MADE IN USA • 30 DAY MONEY BACK GUARANTEE







\$289

SYSTEM INCLUDES: PROGRAMMING UNIT, PRINTER \$5.00 SHIPPING + \$5.00 C.O.D.
PORT CABLE, POWER PACK, SOFTWARE & MANUAL VISA *MASTERCARD *AMEX

ANDROMEDA RESEARCH, P.O. BOX 222, MILFORD, OH 45150
(513) 831-9708 FAX (513) 831-7562 website - www.arlabs.com

CONTROL MEASURE INPUT

RELAYS • LIGHTS • MOTORS
TEMPERATURE • PRESSURE • LIGHT LEVELS • HUMIDITY
SWITCH POSITIONS • THERMOSTATS • LIQUID LEVELS

MODEL 30 \$79  <ul style="list-style-type: none"> • PLUGS INTO PC BUS • 24 LINES DIGITAL I/O • 8 CHANNEL • 8 BIT A/D IN • 12 BIT COUNTER • UP TO 14K SMP/SEC 	MODEL 45 \$189  <ul style="list-style-type: none"> • RS-232 INTERFACE • 8 DIGITAL I/O • 8 ANALOG INPUTS • 2 ANALOG OUTPUTS • 2 COUNTERS-24 BIT
MODEL 100 \$279  <ul style="list-style-type: none"> • 12 BIT 100 MHZ A/D • 4 ANALOG OUTPUTS • 3 TIMER COUNTERS • 24 DIGITAL I/O 	MODEL 150-02 \$179  <ul style="list-style-type: none"> • RS-232 INTERFACE • TRMS, 20 AMPS • 12 BIT A/D • OPTO-ISOLATED • COMPLETE DMM
MODEL 40 \$99  <ul style="list-style-type: none"> • RS-232 INTERFACE • 28 LINES DIGITAL I/O • 8 ANALOG INPUTS • PWM OUTPUT 	MODEL 70 \$239  <ul style="list-style-type: none"> • RS-232 INTERFACE • 15 BIT A/D • 5.5 DIGIT • UP TO 60 SMP/SEC

Prairie Digital, Inc.

PHONE 608-643-8599 • FAX 608-643-6754
846 SEVENTEENTH STREET • PRAIRIE DU SAC, WISCONSIN 53578

CIRCLE 48 ON FREE INFORMATION CARD

Help protect our nation's soil and water.
Call for your free action packet.

1-800-THE-SOIL

WE OWE IT TO OUR CHILDREN

United States Department of Agriculture
Soil Conservation Service

Projects, Design Ideas... DIY AUDIO BOOKS

AND MORE FROM OLD COLONY SOUND LAB



Loudspeaker Design Cookbook

by Vance Dickason

Fifth edition of the DIY loudspeaker "bible" includes information on home theater and car audio! Over 50,000 copies in print in six languages!

BKAA2-V \$34.95

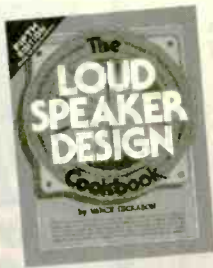

Beginner's Guide to Tube Audio Design

by Bruce Rozenblit

Terrific introduction to designing audio circuits with tubes, de-mystifies this old and new-again technology!

BKAA42 \$24.95



NEW! Testing Loudspeakers

by Joseph D'Appolito

Everything you need to know about loudspeaker testing from the why to the how. Covers the full range of measurement systems from analog to PC-based systems.

BKAA45 \$34.95

Call toll-free 1-888-924-9465

PEM98 Send me my FREE copy of the OLD COLONY SOUND LAB catalog!
• BOOKS • TEST CDS • SOFTWARE • PC BOARDS • KITS •

NAME _____

STREET & NO. _____

CITY _____ STATE _____ ZIP _____

AUDIO AMATEUR INC., PO BOX 876, PETERBOROUGH, NH 03458-0876 FAX TO 603-924-9467



Audio Amateur Inc., PO Box 876 Dept. PEM98, Peterborough, NH 03458-0876 USA Phone: 603-924-9464 Fax: 603-924-9467 E-mail: custserv@audioexpress.com VISIT OUR WEBSITE AT www.audioexpress.com

Kenwood CS-4125 Sale!!!

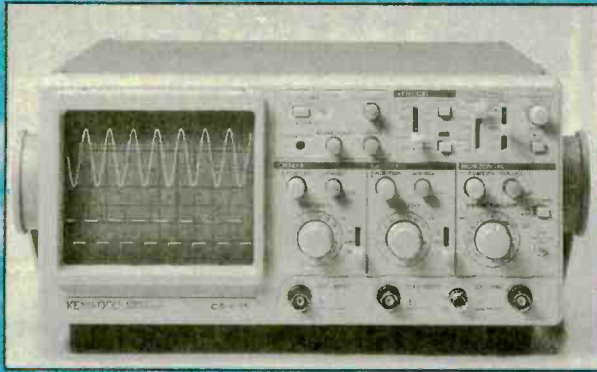

Free **KENWOOD** t-shirt
with purchase of
CS-4125 oscilloscope!!!

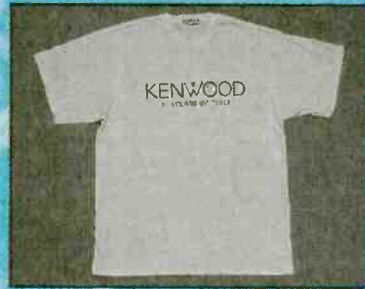

KENWOOD

MODEL CS-4125
20 MHz, 2 Channel, includes probes
Suggested Price \$595.00
SUPER SPECIAL \$389.00!!!

PRINT™ 
Products International

8931 Brookville Rd * Silver Spring, MD, 20910 * 800-638-2020 * Fx 800-545-0058
www.prodintl.com

SPARE SCOPE PROBE SPECIAL:

Kenwood PC-35 - 1D:1, DC to 50 MHz	
Regular \$62.00	SALE \$29.95
Kenwood PC-41 - 10:1/1:1, DC to 50 MHz	
Regular \$62.00	SALE \$29.95

Call today for your free 84 page test & measurement instrument catalog!

CIRCLE 46 ON FREE INFORMATION CARD

ATTENTION DEALERS: WHOLESALE ONLY!



**BEST PRICES!
FAST SERVICE
SAME DAY SHIPPING**

EXCLUSIVE:

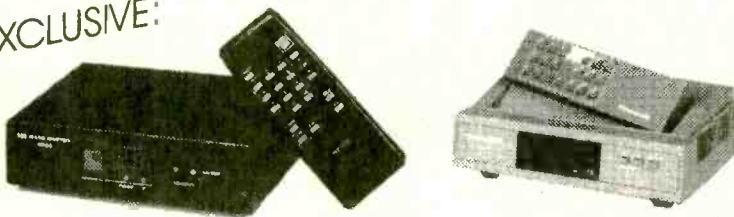

2 PIECE SETUPS: \$85⁰⁰

10 lot • 1 Year Warranty

Latest Technology • Universal Combo's - Ask For Details
CALL US LAST! LOWEST PRICES GUARANTEED!

**TOLL FREE:
800-322-9690**



**FAX:
516-246-5634**

CALLER ID SEEN ON YOUR TV



TVMessenger

**Only
\$89.95**

Never be interrupted by
unwanted calls again!

TVMessenger offers:

- Convenience
- Security
- Callers' log
- Visual call indicator



Modern Electronics
2609 S 156 Cir, Omaha, NE 68130
1-800-906-6664

ALL ELECTRONICS

C O R P O R A T I O N

QUALITY PARTS

FAST SHIPPING

DISCOUNT PRICING

CALL, WRITE, FAX
or E-MAIL For A
Free 96 Page
CATALOG.
Outside the U.S.A.
send \$3.00 postage.

Special Low Price! AA NICKEL-CADMIUM RECHARGEABLE BATTERY

Motorola
0.56" dia. X 1.97" long



CAT# NCB-AA

\$1.25
each

10 for \$11.00
100 for \$100.00

Incredible Deal !! METAL ENCLOSURE WITH POWER SUPPLY AND FAN

High-quality beige metal enclosure with built-in switching power supply, 60mm square fan (12 Vdc) and 2.25" speaker. Power supply outputs: +5V @ 6A, +12V @ 1A, -5V @ 0.1A, -12V @ 0.3A. On-off push switch, speaker and LEDs in front panel. Rear panel has IEC power receptacle and cutouts for other connectors. Exterior dimensions: 12" x 12" x 2.5". Front panel has a cutout for a 1/2 height drive. Vents in sides and rear. Plastic front panel with AT&T logo. Includes stick-on rubber feet and ribbon cable w/ 40 pin connectors.

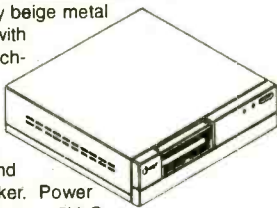

CAT # MB-68

\$11.00
each

Great Price! "EAR BUD" STEREO EARPHONES

Miniature "in-ear" ear-phones for use with most portable CD, radio and tape players. Gold-plated 3.5 mm stereo phone plug. 32 ohm impedance.



Large Quantity Available

CAT #HP-6

85¢ each

10 for \$7.50
100 for \$50.00

UV Blacklight

New black-light lamps designed by Avon Cosmetics to highlight dry skin. They have a built-in timer that shuts-off the lamp after approximately one minute. Ideal for lighting fluorescence in black-light posters, gemstones, hand stamps and US currency. 5" lamp, F4T5BLB, is housed in a light-weight plastic case. 7" x 3.25" x 2.3" high. Powered by a 12 Vdc, 500 ma wall transformer (included). Individually boxed.



CAT# UVL-1

\$10.00
each

F4T5-BLB. Replacement lamp for fixture above. CAT # BLB-5 \$3.00 ea.

HEAVY DUTY LIGHTER CORD

Cigarette lighter plug with replaceable 3AG fuse. 2.1 mm, center positive co-ax power plug on other end. 5' black SPT-2 cable. Good quality assembly. Large quantity available.



CAT# CLP-39

\$1.25
each

10 for \$9.00
500 for \$425.00 (85¢)
1000 for \$700.00 (70¢)

Filtered Modular Jack

Corcom # RJ11B-4L-B "Signal Sentry™" 4 pin, RJ-11 modular jack with built-in ferrite block for inductive filtering. Fits the same space as non-shielded jacks. 0.52" x 0.8" x 0.59" high. UL, CSA. Large quantity available.



CAT # MT-4F

\$1.25
each

10 for \$10.00 • 100 for \$85.00

RED Ultrabright LED

PAINFULLY BRIGHT RED LED
2500 to 4000 mcd @ 20 ma. These T 1 3/4 (5 mm diameter) red LEDs are significantly brighter than conventional LEDs. At close range, they are painful to look at. They are great for attention getting displays that can be seen from a distance. Water clear in off-state.



CAT # LED-42

2 for \$1.20

10 for \$5.00
100 for \$45.00
1000 for \$400.00

5 Vdc D.P.D.T. DIP RELAY

NAIS # DS2Y-S-DC5V 5 Vdc, 130 ohm coil. DPDT contacts rated 1 Amp @ 30 Vdc, 0.3 Amp @ 125 Vac. 0.79" x 0.4" x 0.4". UL, CSA.



CAT # RLY-338

\$1.00
each

100 for \$75.00
500 for \$300.00
1000 for \$500.00

1" SPEAKER WITH POLYPROPYLENE CONE

8 ohm, 0.1 watt speaker with clear polypropylene cone. Only 0.15" thick. Good sound quality for its size. Large quantity available.



CAT # SK-218

\$1.00
each

10 for \$8.50
100 for \$70.00
1000 for \$500.00

"Hi-8" Video Cassette

SONY Hi-8 Top quality, metal particle 120 minute video cassettes. Used for a short time, then bulk-erased. Each cassette has its own plastic storage box.

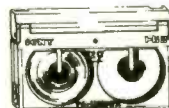

CAT # VCU-8

\$3.00
each

10 for \$28.00 • 100 for \$250.00

ORDER TOLL FREE

1-800-826-5432

MAIL ORDERS TO:
ALL ELECTRONICS CORP.
P.O. BOX 567
VAN NUYS, CA 91408-0567

FAX (818) 781-2653 • INFO (818) 904-0524
INTERNET <http://www.allcorp.com/>
E-MAIL allcorp@allcorp.com

NO MINIMUM ORDER • All Orders Can Be Charged to Visa, Mastercard, American Express or Discover • Checks and Money Orders Accepted by Mail • Orders Delivered in the State of California must include California State Sales Tax • NO C.O.D. • Shipping and Handling \$5.00 for the 48 Continental United States - ALL OTHERS including Alaska, Hawaii, P.R. and Canada Must Pay Full Shipping • Quantities Limited • Prices Subject to change without notice.

MANUFACTURERS - We Purchase EXCESS INVENTORIES... Call, Write, E-MAIL or Fax YOUR LIST.

CIRCLE 128 ON FREE INFORMATION CARD

www.americanradiohistory.com

Disco / Warning Strobe Light Kit

The best of all light effects.

The kit includes a xenon flash tube exactly like those

\$14.95
+S&H \$5

found on air-

planes, cameras, signal beacons and discos. The flash tube is rated for 2,000,000 flashes. Supply voltage: 120 VAC (use suitable box!) Strobe frequency: 0.3 to 3Hz. Includes all components, PCB and instructions. Money Back Guarantee. Pay by MC, VISA, MO or Check.

USA: Amazon Electronics, 14172 Eureka Rd, PO Box 21, Columbiana, OH 44408

AFRICA: Archimedes Products, Tel (012) 332-2356, PO Box 26603, Gezina, 0031, South Africa

Toll Free 1-888-549-3749 (USA & Canada)
We have lots of other electronic kits, books, science kits, components, enclosures, etc.
Request a **FREE** catalog.

www.electronics123.com

WINDOWS 95 —One Step at a Time

Don't know what to do when confronted with Microsoft's Windows 95 screen? Then you need a copy of **Windows 95—One Step at a Time**. Develop your expertise with the straight-forward presentation of the frequently-used features that make Windows 95 so valuable to the PC user.

To order Book BP399 send \$8.99 plus \$3.00 for shipping in the U.S. and Canada only to **Electronics Technology Today Inc., P.O. Box 240, Massapequa Park, NY 11762-0240**. Payment in U.S. funds by U.S. bank check or International Money Order. Please allow 6-8 weeks for delivery.



\$139* Laser LightShow

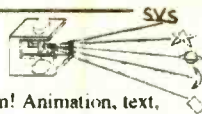

Draw with a laser beam! Animation, text, music & more! Includes galvos, mirrors, servo amp, demo software disk, analog and digital computer interface. Use an inexpensive pen pointer or high power gas laser.



Computerized Motors \$39*

Includes: 2 Stepper motors, 2 DC motors, computer interface, training manual, & demo software disk. Expandable! Up to 12 motors, up to 3 amps per phase.

Now with 4 Axis Linear Interpolation

* Add \$6 for shipping. Computer with parallel printer port & cable, assembly, power supply, & laser are required

FREE FLYER

Voice 510-582-6602 Fax 510-582-6603

SVS

1273 Industrial Pkwy West Bldg. 460
PO Box 55125 Hayward CA 94545-0125

ADAPT-11 68HC11 Modules for Solderless Breadboards

- miniature 2.0" by 2.8" module
- plugs vertically into solderless breadboard for easy development
- BOOT/RUN switch for easy programming via PC serial port
- all I/O lines on dual row connector

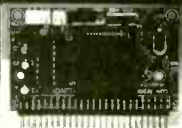

Complete modular prototyping system!
Expansion accessories available!

For just US\$74.95, our Starter Package (AD1ISP) provides everything you need to get going fast! Now you can harness the power of the popular 68HC11 in your projects! Includes ADAPT-11 with 68HC811E2, providing 2K EEPROM (re-programmable), 8 channel 8-bit Analog-to-Digital Converter (ADC), hardware timers, counters, interrupts, Serial Peripheral Interface (SPI), Serial Communications Interface (SCI), & more! On-board RS-232 interface (cable included), 5-volt regulator, 8MHz crystal, reset circuit, and convenient program/run switch. Comes with non-commercial versions of 'HC11 Assembler, BASIC, & C, as well as handy utilities & example code. Includes Motorola 68HC11 Pocket Programming Reference Guide and manual with schematic. All you need is a PC to write & program your software, a DC power supply, and a solderless breadboard (or proto-board) to build your application circuits on (or use our modular accessories).

Visa • MasterCard • American Express • Discover

TECHNOLOGICAL ARTS

309 Aragona Blvd., Suite 102, Box 418, Va. Beach, VA 23462
1644 Bayview Avenue, Box 1704, Toronto, ON M4G 3C2
voice/fax: (416) 963-8996 www.interlog.com/~techart

LASER MODULE



Auto Power Control
Collimated Laser
Compact Size
100,000 hr lifetime
No Electronics Required

Visible Laser Modules (635-670 nm)
TTL Modulated Laser Modules
Line Generator Laser Modules
Infrared Laser Modules (780-830 nm)

from
\$29 (US)

LASER POINTER



Focus Adjustable
Elegant Design
Solid Metal Body

Pen Style Laser Pointer (1500 ft visibility)
Key Chain Laser Pointer (1500 ft visibility)
Available in silver and, black finish.

\$19.95 (US)

World Star Tech.

Ask for free catalog

Tel: (416) 204 6298 Fax: (416) 596 7619

<http://www.worldstartech.com> e-mail: info@worldstartech.com

GALEP-III Pocket Multiprogrammer

This size
fits all!



• Programs 8-bit and 16-bit EPROMs, EEPROMs, Zero Power RAMs, Flash, serial EEPROMs • GAL, PALCE, ATF • 87xxx, 89xxx, PIC12/16/17Cxx • All DIL devices without adaptor • Lightning fast parallel data transfer (e.g. 27C512 read/compare 2 sec!) • Power supply independent due to rechargeable battery • Uses PC printer port • Hex, JEDec, and binary file formats • Hex and fusermap buffer editor • Split & shuffle for 8-bit, 16-bit and 32-bit targets • Runs under Win3.1, 95, 98 • 'Remote control' by DDE scripts • Designed for the future due to flexible pin driver technology - new devices will be added every month • Device list, demo software and lifetime free updates from our website www.conteck.com

GALEP-III Set with cable, battery, recharger \$389.00

PLCC Adaptor for 8-bit EPROMs / 16-bit EPROMs / GALs each \$149.00



1951 4th Ave, Ste 301 • San Diego, CA 92101
Tel: (619) 702-4420 • <http://www.conteck.com>

Notch Filters



Test Chips

Filter Kits
1 to 2 \$ 20 each
3 to 9 \$ 15 each
10 to 20 \$ 9 each
21 or more \$ 7 each

Adult Wholesale
Video's

\$ 379.00
Free Shipping

Video Media
P.O. Box 93/6025
Margate, FL 33093-6025
(954)-752-9202

www.nutnet.com



Timid about getting on the World Wide Web?

You've heard about the *Information Superhighway* and all the hype that goes with it! Sort of makes you feel timid about getting on the Web. Put your fears aside! A new book, *The Internet and World Wide Web Explained*, eliminates all the mystery and presents clear, concise information to build your confidence. The jargon used is explained in simple English. Once the tech-talk is understood, and with an hour or two of Web time under your belt, your friends will believe you are an Internet guru!

To order Book #BP403 send \$10.95 plus \$4.00 for shipping in the U.S. and Canada only to **Electronics Technology Today Inc., P.O. Box 240, Massapequa Park, NY 11762-0240**. Payment in U.S. funds by U.S. bank check or International Money Order. Please allow 6-8 weeks for delivery.

SURVEILLANCE HIDDEN CAMERAS DIRECT FROM MANUFACTURER - BEST PRICE IN THE MARKET!



Ultra miniature hidden camera, in dome, profile or rodent detector of min. 8W or Color. Wide view angle. Low light sensitivity & super sharp images, plus video and audio output. From \$150.00. Also 1/2" BW bead camera visible, only \$60.00 USD. Wireless hidden camera, start of only \$249.00 USD. Plus \$5.95 for SH. Wholesale/retail volume. CCD, Check Money Order or Visa/MC.

BOLIDE INTERNATIONAL CORPORATION

PH: (800) 355-0895 or (626) 575-8178

9660 Flair Drive #218, El Monte, CA 91731

<http://www.bolideinternational.com>

ULTIMATE HOME SHOP

Complete tools for metal & woodworking



Starting at
\$995

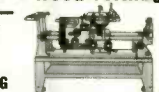

• Quality
• Easy to use
• Versatile
• Affordable

FREE CATALOG

Call 1-800-345-6342 or www.smithy.com Dept. PEC, PO Box 1917, Ann Arbor MI 48106-1917

CABLE TV CONVERTERS

Equipment & Accessories
Wholesalers Welcome

Call **C&D ELECTRONICS**

1-888-615-5757 M-F 10a-6p

CONSOLIDATED
1-800-543-3568

Free Catalog w/order

a \$5.00 value
1-800-543-3568

Includes Cross-Reference for:

- * Video Heads * Camcorder Batteries
- * Telephone Batteries * Flybacks
- * PLUS: "NEW" Semiconductor

Cross-Reference Information
CONSOLIDATED
ELECTRONICS
705 Watervliet Ave
PO Box 20070
Dayton, OH 45420-0070

Visit us on the WEB!
<http://www.ceitron.com>

Check our web site for greater savings.
Low pricing now on-line!
e-mail: cei@ceitron.com

PROGRAMMERS

OVER 50 MODELS

ADVANTECH EETOOLS NEEDHAMS DATA VO ICE TECHNOLOGY HILO SYSTEM GENERAL CHROMA MODULAR CIRCUIT TECHNOLOGY XELTEK

PROMAX EMP-20 MEGAMAX MEGAMAX4 SIMM/SIP-TESTER EMUPA

CALL ADVANTECH LABTOOL 599 EETOOLS SIMMAX
629 ICE TECH MICROW 795 CHROMA SIMM/SIP
650 EETOOLS ALLMAX + 359 MOD-MCT-EMUPA/R
409 EETOOLS MEGAMAX 279 MOD-MCT-EMUP/R
509 EETOOLS MEGAMAX4 49 EPROM 1G TO 512K
369 XELTEK SUPERPRO II 69 EPROM 1G TO 1MEG
409 XELTEK SUPERPRO II P 99 EPROM 4G TO 1MEG
249 XELTEK SUPERPRO L 199 EPROM 16G TO 1 MEG
165 XELTEK ROMMASTER II 89 EPROM 1G TO 8MEG
479 MOD-MCT-EMUPA 129 EPROM 4G TO 8MEG
739 STAG ORBIT-32 250 EPROM 8G TO 8MEG

LABTOOL48 MICROMASTER SUPERPRO ALLMAX PLUS ROMMASTER2

General Device Instruments

Sales 916-393-1655 Fax 916-393-4949 BBS 983-1234
Web www.generaldevice.com E-Mail icdevic@best.com

Cable T.V. Converters & Equipment

Lower Prices
Dealer Discounts
30-Day Money back
1-year warranty
MC, Visa, AE, COD

No Florida Sales
www.cable4you.com
1-(800) 888-5585

!!! BROADCAST FARTHER !!!

The model 220 is an 80-110 MHz RF amplifier that connects to mono or stereo FM transmitters and produces a powerful 2-15 watt signal which could broadcast up to 5 miles or more! Requires 50-150 mW drive.

Step by step plans complete with part source information and antenna designs... **ONLY \$14 PLUS \$2 S&H NO C.O.D.'s**

Progressive Concepts
BOX 586 S REAMWOOD, IL 60107
(C30)736-9822 FAX: 636-1736-0353

ELECTRONIC CLEANING CLOTH

ONLY \$12.95
NO C.O.D.'S
INC S&H

STOP USING SANDPAPER

- Removes Tarnish
- Reduces Impedance
- Cleans Electrical Contacts from Welding Leads to Circuit Boards
- No Harsh Abrasives

S SUPERSHYNE PRODUCTS L.L.C.
P.O. BOX 8352 Grand Rapids, MI 49503

Debco is a Kit Builders Paradise

Electronic Kits - Plans - Parts - Computers - Amateur Radio

Call Debco today for your **FREE** copy of
The Electronic Experimenter's Journal

1 800 423 - 4499

Debco Electronics 4025 Edwards Rd. Cincinnati, OH 45209

Do You Repair Electronics?

Repair Databases for TV, VCR, Monitor, UL Audio, FCC, and more.

- Over 76,000 records
- Private user forums
- Live on-line chat rooms

RepairWorld.com

Electronics Corp. 1 Herald Sq. Easton, OH 45324 (937) 878-9878

ATTENTION CABLE VIEWERS

CABLE VIEWERS... get back to your BASIC Cable Needs

Call 800-577-8775

For information regarding all of your BASIC cable needs.

- 5 GOOD REASONS TO BUY OUR FAR SUPERIOR PRODUCT
- ❖ PRICE
- ❖ EFFICIENT SALES AND SERVICE
- ❖ WE SPECIALIZE IN 5, 10 LOT PRICING
- ❖ ALL FUNCTIONS (COMPATIBLE WITH ALL MAJOR BRANDS)
- ❖ ANY SIZE ORDER FILLED WITH SAME DAY SHIPPING

We handle NEW equipment ONLY - Don't trust last year's OBSOLETE and UNSOLD stock!
COMPETITIVE PRICING—DEALERS WELCOME

HOURS: Monday-Saturday 9-5 C.S.T.

It is not the intent of B.E.S.W. to defraud any pay Television operator and we will not assist any company or individual in doing the same.
*Refer to sales personnel for specifications

BASIC ELECTRICAL SUPPLY & WAREHOUSING CORPORATION

P.O. Box 8180 ■ Bartlett, IL 60103 ■ 800-577-8775

CABLE TV CHANNELS

EQUIPMENT **Direct!**
GUARANTEED

FREE 30 DAY TRIAL

SAVE \$1000's
The Nationwide source for cable TV equipment.
"BUY WHERE THE DEALERS BUY."

FREE TV Cable Descramblers, Converters and Magic Box Catalog. Open Every Day!

FREE YOUR VCR TAPES CAN PLAY AS CLEAR AS DAY!
Eliminates copy protection on any tape.
UNJAM NOW WITH Video Decoder
• Copy any rental/bought tape
• Power Cord and RC Plugs Included

2 Year Warranty
CALL NOW!
Member Better Business Bureau

MEGA ELECTRONICS
1-800-676-6342 VISA • MC • COD

FREE 30 Day Trial!

The Pocket Programmer

\$129.95

The portable programmer that uses the printer port of your PC instead of an internal card.

Easy to use software that programs E(E)prom, Flash & Dallas Ram. 27(C)/28(C)(F)/29(C)(F)/25 series from 16K to 8 Megabit with a 32 pin socket. Adapters available for MCU's 874X, 875X, Pic, 40-Pin X 16 & Serial Eprom's, PLCC, 5-Gang and Eprom Emulator to 32K X 8.

Same Name, Address & Phone # for 13 Years.... Isn't it Amazing ?

Intronics, Inc.
Box 13723 / 612 Newton St.
Edwardsville, KS 66113 Add \$4.75 COD
Tel. (913) 422-2094 Add \$4.00 Shipping
Fax (913) 441-1623 Visa / Master Charge

Easy to use software that programs E(E)prom, Flash & Dallas Ram. 27(C)/28(C)(F)/29(C)(F)/25 series from 16K to 8 Megabit with a 32 pin socket. Adapters available for MCU's 874X, 875X, Pic, 40-Pin X 16 & Serial Eprom's, PLCC, 5-Gang and Eprom Emulator to 32K X 8.

SURVEILLANCE

The Latest High Tech Professional Electronic Devices

Our latest catalog offers a HUGE selection of surveillance, counter-surveillance/privacy devices: **pinhole camera \$129⁰⁰**, hidden video, **"realtime" 12-Hour telephone recorder \$139⁰⁰**, 12 hour VOX recorder phone call register, scanners, bug/phone tap detectors, voice disguisers, locksmithing tools, vehicle tracking, wireless video, and much more. Wholesale/retail.

We will not be undersold.

Catalog \$5.00 or
www.spyoutlet.com

SPY OUTLET
PO Box 337, Buffalo NY 14226
(716) 691-3476/(716) 695-8660

CLASSIFIED

BUSINESS OPPORTUNITIES

\$400 WEEKLY ASSEMBLING Electronic circuit boards/products from home. For free information send SASE: **Home Assembly-PE** Box 216 New Britain, CT 06050-0216.

THE MONEY MAKER!!! \$500 a DAY or MORE!!! As easy as mailing two letters that I provide. I will even tell you where to send them. \$20.00 + \$2 s/h check/money order to **Freedom Info Inc.** 610 W. Lockport St. Ste. A 164, Plainfield, IL 60544.

CABLE TV

CONFUSED?? Descramblers. Will explain all your options, all makes and models avl. Dealers are welcome. Open 6 days 9AM till 7PM EST, Toll Free# (888)238-0967. **ROYAL ENGINEERING INC.** Universal Box is here now.

CABLE TV Descramblers. One piece units. Scientific Atlanta, Jerrold, Pioneer, and others. Lowest prices around. **Precision Electronics** Houston, TX. Anytime. 1-888-691-4610.

WHOLESALE and volume pricing. **Boss** units and **Seemores** compatible with all systems. C.O.D. Call and compare prices 1-888-762-2253.

Bewildered about descramblers? Call for fast friendly explanation on your cable needs. Same day shipping or shipping is free. Tech. support with all orders. Call Toll free 1-888-221-8365. Global Electronics M-Sat. 9am-8pm.

CABLE TV EQUIPMENT & ACCESSORIES. Wholesalers Welcome! 30 Day Moneyback Guarantee! Free Catalog! **PROFORMANCE ELECTRONICS, INC.** 1-800-815-1512.

Free Cable Descramble Plans. For Details Write: Sierra Publishing, 909 E. Yorba Linda Blvd., Suite H-181, Dept PEU, Placentia, CA 92870.

CABLE TV Signal Eliminator - Powerful, user tunable filter for removing severe interference OR unwanted channels! Eight models, for channels (2-3)(4-6)(7-13)(14-17)(18-22)(23-29)(30-36)(95-99). Each \$30, add \$4 S/H. Quantity discounts. Money back guarantee. Visa, Mastercard or check. COD \$5 extra. Visit starcircuits.com. **Star Circuits**, PO Box 94917, Las Vegas, NV 89193. 1-800-433-6319.

FREE TV CABLE CATALOG. Revolutionary new products. Converters, Full viewing boxes, Gold or Silver, that do all boxes. Open 7 days a week. **1-800-676-6342.**

CABLEBOX descramblers, activators, testchips. Low prices. All questions welcome. Toll free (888) 295-6987. MC/Visa/COD. **E.B. INTERNATIONAL.**

ALL CABLE TV CONVERTERS & ACCESSORIES. LOWEST PRICES, 30 DAY TRIAL. 1 YEAR WARRANTY. 1-800-538-CABLE(2225).

Cube for Jerrold Model CFT_2200, 2014, 2024, 2254, Pioneer 6300-6310, Auto-Multimode, Zenith ST-1600, \$175.00. Lowest Price Call 800-822-8530.

CB-SCANNERS

CB Radio Modifications! Frequencies, kits, high-performance accessories, books, plans, repairs, amps, 10-Meter conversions. The best since 1976! Catalog \$3.00. **CBCI**, Box 52000PE, Pacific Grove, CA 93950.

COMPUTER HARDWARE

New Computers and parts at wholesale prices. www.techass.com Toll free 1-877-tec-hass. We will ship all parts and computers.

MISC. ELECTRONICS FOR SALE

RF TRANSISTORS AND TUBES. 2SC2879, MRF454, MRF422, 2SC1969, 2SB754, SD1446, 3-500ZG, 3CX3000A7, 4CX250B, **WESTGATE** 800-213-4563.

PLANS-KITS-SCHEMATICS

HEALTH COMPANY is selling photocopies of most Healthkit manuals. Only authorized source for copyright manuals. Phone: 616-925-5899, 8-4 ET.

ELECTRONIC PROJECT KITS: 49 McMichael St, Kingston, ON., K7M 1M8. \$3.00 catalog. www.qkits.com. **QUALITY KITS.**

MONITORS MADE SIMPLE. Learn to repair computer monitors! Case studies, illustrations, parts sources, manufacturers included! 136 pages, soft-cover, \$19.95 + \$2.50 shipping. Order today! Send check or money order to **Pikes Peak Press** 321 W. Henrietta Ave. P.O. Box 1801, Woodland Park, CO 80866. (719)687-1499.

CATALOG: Broadcasting/micro transmitters, amplifiers, antennas. Start your own radio station books. Audio, TV, Ham, CB, Surveillance, Science projects and more. www.panaxis.com **PAN-COM** Int'l, PO Box 130-11, Paradise, CA 95967.

DO IT YOURSELF KITS. WHY PAY HUNDREDS MORE!! Cable descrambler, TV projection display radar jammer, each kit \$12.95 + \$2 s/h check/money order to **Freedom Info Inc.** 610 W. Lockport St. Ste. A 164, Plainfield, IL 60544.

AWESOME KITS: Voice Changers, Levitators, Lasers, Gas Sensors and more! Catalog \$1.00. **LNS Technologies**, PO Box 67243, Scotts Valley, CA 95067 www.ccnets.com/~LNSTECH.

SATELLITE EQUIPMENT

FREE CATALOG - Satellite TV/GPS-DIY. Technical Books, Installation Videos, Computer Analysis Software www.baylin.com 800-843-2425.

SKYVISION! Your Satellite Home Entertainment Source. Best values: DBS and C/Ku-band equipment, including 4DTV. Most complete selection: Parts-Tools-Upgrades-Accessories! Free Discount Buyer's Guide. Call 800-543-3025. International 218-739-5231. www.skyvision.com.

SECURITY

SECURITY Systems and Surveillance Camera Equipment. Do it yourself and save. Camera's, Monitor's, VCR's, Motion and Glassbreak Detector's, Control Panel's, Siren's, more. www.a1security.com.

CALLER ID ON TV

NEW! CALLER-TV \$49.95 NO MORE INTERRUPTIONS! Know who's calling immediately. Secure internet ordering www.caller-tv.com, 520-544-4567.

BEST BY MAIL

Rates: Write National, Box 5, Sarasota, FL 34230

MONEY & FINANCE

MAKE A LOT of money distributing informative software. Only \$15.00. CARMEN PRODUCTIONS, 4766 Admiralty Way #9940, Marina Del Rey, CA 90292. <http://www/carmenproductions.com> 1-800-811-2141 Code 52505. Fax On Demand 415-273-6020; E-Mail: carmenpr@ps.net

HOMEWORKERS perform assembly, clerical and telemarketing work in your own home. Simple work, serious money. FREE info. 1-800-757-7335 Ext. B1111.

\$156,250.00 IN 6 MONTHS! For information Send \$1.00 and SASE to: EDB, Box 127, Rule, TX 79547.

INTEREST TO MEN

CHRISTIAN SINGLES CLUB, 6000 members, free information 1-800-437-1931.

FORMULA ONE - I Lost 7 Pounds in 10 Days. Send \$5.00 10-Day Supply. NEW YOU SYSTEM, Dept. #25, 278 H St., Lincoln, CA 95648.

EXOTIC FASHIONS. FREE SAMPLE CATALOG 1-800-927-0279.

DVD PLAYERS for a \$1.00. Send \$1.00 cash only non-refundable, plus 2 unused 32¢ stamps for more information to: D. Jimenez, P.O. Box 264, Yuma, AZ 85366.

HI-TECH SURVEILLANCE
 Pinhole Cameras, Recording Devices, Bug Detectors, Lasers, Lockpicks, Pen Knives, Tracking Devices, Wireless Mics, Books/Videos, plus much more!!!!
FOR CATALOG - SEND \$5.00 TO:
Spy Way
P.O. Box 61805, Jax, FL 32236

ATTENTION CABLE VIEWERS
Own Your Own Unit Today
Cable TV Converters & Descramblers
All Makes / All Models
Call 1-800-577-8775
Technical Info: 847-584-2099



COPY RENTAL TAPES

WITH OUR VIDEO STABILIZERS

BEFORE



AFTER



The clearest picture possible playing back movies. **GUARANTEED** to eliminate copy protection.

FREE CABLE TV CATALOG!

- No Rclls/Jitters/Flickers/Fading
- Works on all TV's, VCR's Beta & Cable
- Gold Video Connectors & Cables Included
- 1 Year Warranty
- Money Back Guarantee



VISION ELECTRONICS

1-800-562-2252

2609 S. 156TH CIRCLE • OMAHA, NE 68130
<http://www.modernelectronics.com>

MAY THE SOURCE BE WITH YOU

Don't let the dark forces of ignorance defeat you. Right in this galaxy you can tap into the source—the free Consumer Information Catalog. It lists free and low-cost federal publications on a variety of important topics.

So dispel the darkness and get the source. Call toll-free **1-888-8 PUEBLO** for your free Catalog. Or set your coordinates for the Consumer Information Center Web site:

www.pueblo.gsa.gov

NOW Find the Right Part for Your VCR!



The 172-page Eighth Edition of the VCR Cross Reference contains both model and part number cross references. Over 7,810 new parts and 1927 new models have been added.

VCR's are made in a few factories from which hundreds of different brand names and model numbers identify cosmetically-changed identical and near-identical manufactured units. Interchangeable parts are very common. An exact replacement part may be available only a few minutes away from you even though the original brand-name supplier is out of stock. Also, you may be able to cannibalize scrap units at no cost.

crosses of future models. The Seventh Edition can be printed on pages completely from the diskette.

The ISCET VCR Cross Reference, Eighth Edition, is on 8 1/2 x 11-in., pre-punched pages and sell for **\$38.00**. The 3 1/2 inch diskette sells for **\$69.95** and you can view listings from a monitor or printed page.

ONLY \$38.00 for pages
\$69.95 diskette
 Not including Shipping & Handling

Clagg Inc.
VCR CROSS REFERENCE OFFER
 P.O. Box 4099
 Farmingdale, New York 11735-0793

Name _____
 Business _____
 Address _____
 City _____
 State _____ Zip _____
 Phone _____

Enclosed \$38.00 for the ISCET VCR Cross Reference, Eighth Edition.
 Enclosed \$69.95 for the diskette containing the ISCET VCR Cross Reference, Ver. 7.0
 Include \$4.00 for shipping Version 8 pages within the United States. All other countries add \$5.00 (surface mail)
 Include \$3.00 for shipping Version 7 disk within the United States. All other countries add \$4.00 (surface mail).
 The total amount of my order is \$ _____

Check enclosed—do not send cash. US funds only.
 Visa MasterCard Exp. Date ____/____/____

Card No. _____
 Signature _____

New York State residents must add applicable local sales tax to total. Overseas Orders use US bank check or International Money Order. CB02

ADVERTISING INDEX

Popular Electronics does not assume any responsibility for errors that may appear in the index below.

Free Information Number	Page	Free Information Number	Page
— AES	82	159 Jensen Tools	83
— Alfa Electronics	74	— KDE Electronics	78
128 All Electronics	91	— Lynxmotion	81
— Allison Technology	83	161 MCM Electronics	71
— Amazon Electronics	92	— Mega Electronics	94
— American Innovations	87	139 Mendelson's	81
— Andromeda Research	89	— Mental Automation	78
— Arrow Electronics	82	35 MicroCode Engineering	CV4
— Associated Electrical & Eng.	87	— Micro Test	82
— Audio Amateur	89	— Modern Electronics	81, 90
— Basic Electrical Supply	93	160 Mouser	81
— Bsoft	70	— NRI Schools	11
130 C&S Sales, Inc.	76	— OWI	88
— Cable USA	80	— Pioneer Hill Software	82
30 Cadsoft	7	48 Prairie Digital Inc.	89
— Circuit Specialists	84	46 Print	90
— CLAGGK, Inc.	13, 95	47 Print	86
— Cleveland Inst. of Electronics	21	155 Print	75
— Command Productions	78	— Pro Planet	93
— Conitec	92	32 Radio Shack	3
— Consolidated Electronics	93	— Schematica Software	80
— Consumertronics	80	— Silicon Valley Surplus	92
157 Dalbani	79	— Skyvision Inc.	80
— EDE Spy Outlet	94	— Starlet Systems	80
— Electronic Tech. Today	5, 69	158 Sun Equipment	72
— Foley-Belsaw	73	— Tab Books	37, 53
— General Device Instruments	93	— Technological Arts	92
29 George Brown College	CV3	137 Telulex	75
— Grantham College of Eng.	4	— Test Equipment Depot	86
— Greenleaf Electronics Inc.	70	— UCANDO Videos	83
— Home Automation Systems	81	— US Cyberlab	88
— Information Unlimited	70	— Video Media	92
26 Interactive Image Technologies	CV2	— Vision Electronics	95
— Intronics, Inc.	94	— Weeder Technologies	87
— James Electronic Services	90	— World Star Technologies	92

ADVERTISING SALES OFFICES

Gernsback Publications, Inc.
500 Bi-County Blvd.
Farmingdale, NY 11735-3931
1-(516) 293-3000

Fax 1-(516) 293-3115

Larry Steckler, EHF/CET

President (ext. 201)

e-mail advertising@gernsback

Adria Coren

Vice-President (ext. 208)

Ken Coren

Vice-President (ext. 267)

Christina Estrada

Assistant to the President (ext. 209)

For Advertising ONLY

1-516-293-3000

Fax 1-516-293-3115

Larry Steckler

publisher

Arline Fishman

advertising director (ext. 206)

Marie Falcon

advertising assistant (ext. 211)

Adria Coren

credit manager (ext. 208)

Subscription/

Customer Service/

Order Entry

1-800-827-0383

7:30 AM - 8:30 PM EST

ADVERTISING SALES OFFICES

EAST/SOUTHEAST

Megan Mitchell

9072 Lawton Pine Avenue

Las Vegas, NV 89129

Phone 702-240-0184

Fax 702-838-6924

Lorri88@aol.com

MIDWEST/Texas/Arkansas/

Oklahoma, Colorado, Arizona

Ralph Bergen

Midwest Sales

One Northfield Plaza, Suite 300

Northfield, IL 60093-1214

1-847-559-0555

Fax 1-847-559-0562

bergenrj@aol.com

PACIFIC COAST/Mountain States

Anita Bartman

Hutch Looney & Assoc., Inc.

6310 San Vicente Blvd.

Suite 360

Los Angeles, CA 90048-5426

1-213-931-3444 (ext. 227)

Fax 1-213-931-7309

anita@hlooney.com

Study at home with the

Electronics Technician CD-ROM

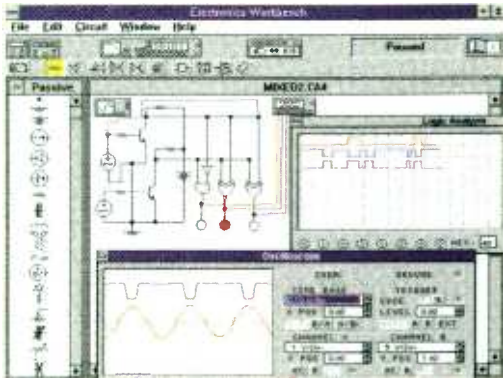

The only product of its kind

This unique CD-ROM based learning program includes 23 courses which are equivalent to a two-year Electronics Technician program and is recognized as the standard for Electronics Technician programs across North America.

Purchase the CD-ROM separately or earn College credits.

The choice is yours. Buy the CD-ROM and use it as the ultimate electronics reference tool to refresh your knowledge of electronics, or enroll in the program and earn College credits. The course material is delivered using video, text, 2-D and 3-D animations color photos, audio, and over 450 laboratory projects. Use the CD-ROM in the home, office, or shop as a troubleshooting/design tool and reference guide.

Industry Recognition

The course content for the CD-ROM was developed in association with some of the top corporate trainers in North America, and focuses on practical applications and troubleshooting techniques.

Best Price

The CD-ROM costs \$249 and comes with **ElectronicsWorkbench** (Student Edition), laboratory software simulation package. Complete all 23 courses on the CD-ROM and receive an Electronics Technician certificate.

Public Sector Standards

The CD-ROM was designed by George Brown College, one of the largest and most innovative community colleges in North America. Graduates of the program can continue their studies towards an undergraduate degree through the Minnesota University (Bemidji State) distance education program.

Easy at-home learning

All you need is the CD-ROM, no expensive books or lab equipment is required. Complete each course at your own pace, schedule the time that's best for you and decide how quickly you finish each course. The typical completion time is 48 weeks of part-time study, but there are no time limits.

Call now! Toll Free!

Call our 24-hour toll-free hotline to find out more about the Electronics Technician CD-ROM or the distance education program.

1-888-553-5333

George Brown College
160 Kendall Avenue
Toronto, Canada M5R 1M3
Fax: 416-415-4727
web site: <http://www.gbrownc.on.ca>

High-end features. Low-end price.

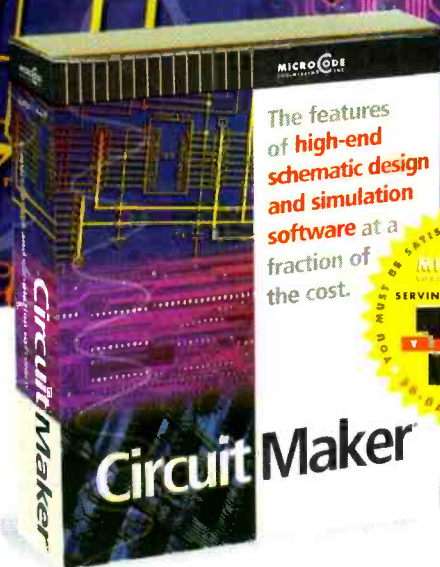

\$299

CircuitMaker 6:
Schematic design
and simulation
software



\$299

TraxMaker 3:
Printed circuit
board layout
software

CircuitMaker Version 6 and TraxMaker Version 3 give you the features of professional, high-end software at a fraction of the cost. Plus, with exceptional ease-of-use you'll spend less time learning to use the software and more time designing. Both applications are compatible with your existing software, and feature outstanding technical support. Call now for your free functional demo.

CircuitMaker 6 is a powerful schematic design and simulation program featuring:

- Professional schematic features including printout borders, title block and barred pin names
- Symbol editor and Macro feature for custom devices
- Fast, accurate SPICE3f5/XSPICE-based simulation
- Complete array of analysis types, including Fourier, AC, DC, Parameter sweep, Transient and more
- Virtual instruments including a digital oscilloscope, multimeter, Bode plotter, curve tracer and more
- Extensive library of over 4,000 models
- Tight integration with TraxMaker® for quick PCB layout
- Output PCB netlists in Protel®, Tango® and TraxMaker® formats for use in a variety of PCB layout programs
- Windows 3.1, 95 and NT

TraxMaker 3 is a powerful printed circuit board layout program featuring:

- Over 2,000 component footprints in a fully-documented, indexed library. Documentation shows footprints actual size
- Built-in autorouter and Design Rules Check
- Supports up to 6 signal layers plus power and ground planes, silk screen overlays and solder and paste masks
- Board sizes up to 32" x 32", with no pin limitations
- Intelligent manual routing with unrout capabilities
- Import any PCB netlist in CircuitMaker®, Protel® or Tango® format
- Output RS274X Gerber files, Excellon N/C drill files and Bill of Materials
- Print to any Windows-compatible printer or plotter
- Windows 3.1, 95 and NT

MICRO CODE
ENGINEERING INC

For free demo software, or to order, call 1-800-419-4242

927 West Center Street • Orem, UT 84057 • Phone (801) 226-4470 • Fax (801) 226-6532 • www.microcode.com