

# Popular Electronics®

WORLD'S LARGEST-SELLING ELECTRONICS MAGAZINE

JULY 1977 / \$1.25

## BATTERY MONEY-SAVER

### "Zap" New Life Into Dead NiCd Batteries

## AUDIO

### Tape Recorder Hygiene

#### HOW TO MAINTAIN RECORDERS IN PEAK CONDITION

### Build a Low-Cost Pink Noise Generator

#### A VALUABLE AUDIO TEST TOOL

## COMMUNICATIONS

### Deciphering Utility Code Broadcasts Without Knowing Morse Code!

## TEST REPORTS

### Radio Shack STA-2000 Stereo FM/AM Receiver

### Koss K-145 Stereo Headphones

### Cobra 29XLR 40-Channel AM CB Mobile Transceiver

## Two Fantastic Video Projects

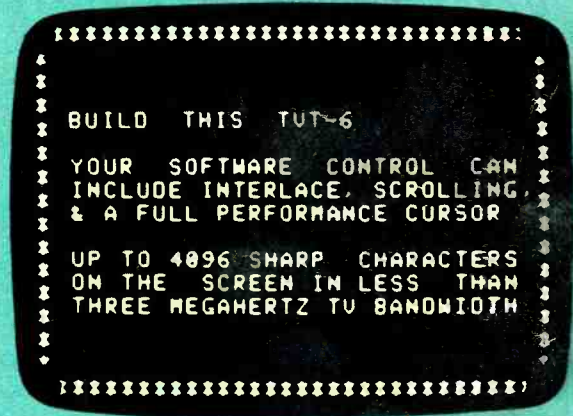

### BUILD DON LANCASTER'S LATEST "TV TYPEWRITER" It's a \$35 Interface Board



### COMES TO THE MICROCOMPUTER!

### This One's Less Than \$25



Popular Electronics

BRIAN ENCE  
168 APRICOT LN  
WRT PTRSN AFB OH 45433  
07  
614012 ECE 0160A094 141D JUL79

Introducing the mobile that can move you out of the world of the ordinary and into the world of the serious CB'er. The Cobra 138XLR Single Sideband. Sidebanding puts you in your own private world. A world where there's less congestion. More privacy. More time to talk.



It's all possible because instead of 40 channels you get your choice of 120 channels. Both AM and SSB. And instead of 4 watts of legal power you get 12 watts of legal power. So you get almost double the range of AM.

With the 138XLR Single Sideband there's less background noise and less interference. So there's cleaner, clearer reception. Because like all Cobras, the 138XLR SSB is engineered to punch through loud and clear. Even in crowded metropolitan areas.

And like all Cobras it comes equipped with such standard features as an easy-to-read LED channel indicator. Switchable noise blanking and limiting. An RF/signal strength meter. And Cobra's exclusive DynaMike gain control.

You'll find the 138XLR SSB wherever Cobras are sold. Which is almost everywhere. Because Cobra's got a nationwide network of dealers and Authorized Service Centers offering sales, installation, service and advice. So come on in. And move on up.



**Punches through loud and clear.**

Cobra Communications Products  
**DYNASCAN CORPORATION**  
 6460 W. Cortland St., Chicago, Illinois 60635

Write for color brochure  
 EXPORTERS: Empire • Plainview, N.Y. • CANADA: Atlas Electronics • Toronto

CIRCLE NO. 9 ON FREE INFORMATION CARD

# UPWARD MOBILITY.



# Revolutionary breakthrough in CB antenna design

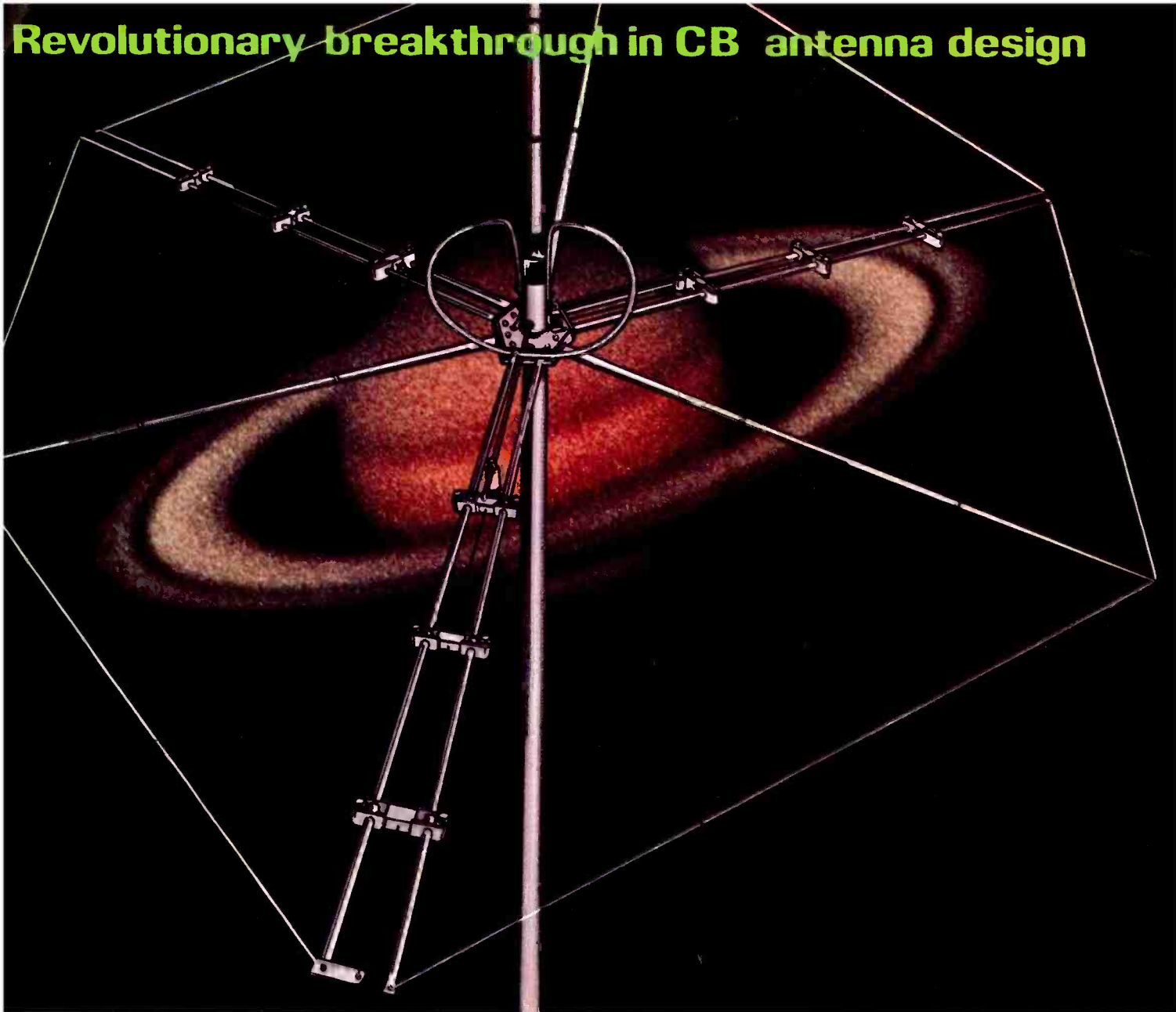

Photo courtesy of Edmund Scientific Co.

## AVANTI Invents the Saturn™ Base

The reason the "Saturn" is so revolutionary is that it is absolutely the only **combination vertical and horizontal omni-directional antenna**. That's right, it needs no rotor! You can pick up mobiles (which are vertical) or horizontal and vertical beams.

The "Saturn", invented after years of research by Avanti engineers, is the latest development using AVANTI's unique CO-INDUCTIVE principle to give you the performance of two antennas combined into one.

The "Saturn" not only works on both polarities, but pounds out signals like an air hammer and picks them up like a magnet. Both polarities offer high gain figures.

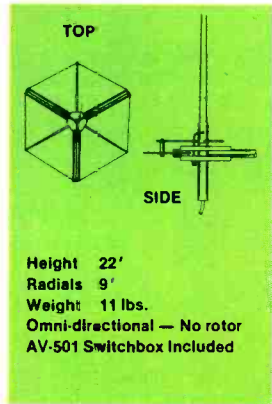

Patent Pending

Those of you who are worried about sun spots and "skip" can relax too. This antenna really helps. When the sun spots cause a signal shift, you can often change polarity (just like our P.D.L. or Moonraker) and still pick up the desired channel with no loss of transmission.

The P.D.L. and Moonraker made dual polarity famous as the only antennas to have during the last sun spot cycle, and this time around any serious C.B.'er will want to have the "Saturn."

In fact, having a "Saturn" and a "P.D.L." or "Moonraker" will put you in the elite group of C.B.'ers who "always seem to get out better."

Avanti makes a complete line of high performance base and mobile CB antennas from \$11.95 to \$404.00. Write for free Avanti catalog.



AVANTI RESEARCH AND DEVELOPMENT, INC.,  
340 Stewart Avenue, Addison, IL 60101

© Copyright 1977, All rights reserved

Creators of the famous



CIRCLE NO. 6 ON FREE INFORMATION CARD

www.americanradiohistory.com

# MIDLAND POWER

IT'S WHAT YOU GET WHEN YOU RUN WITH NUMBER 1. MIDLAND CB.

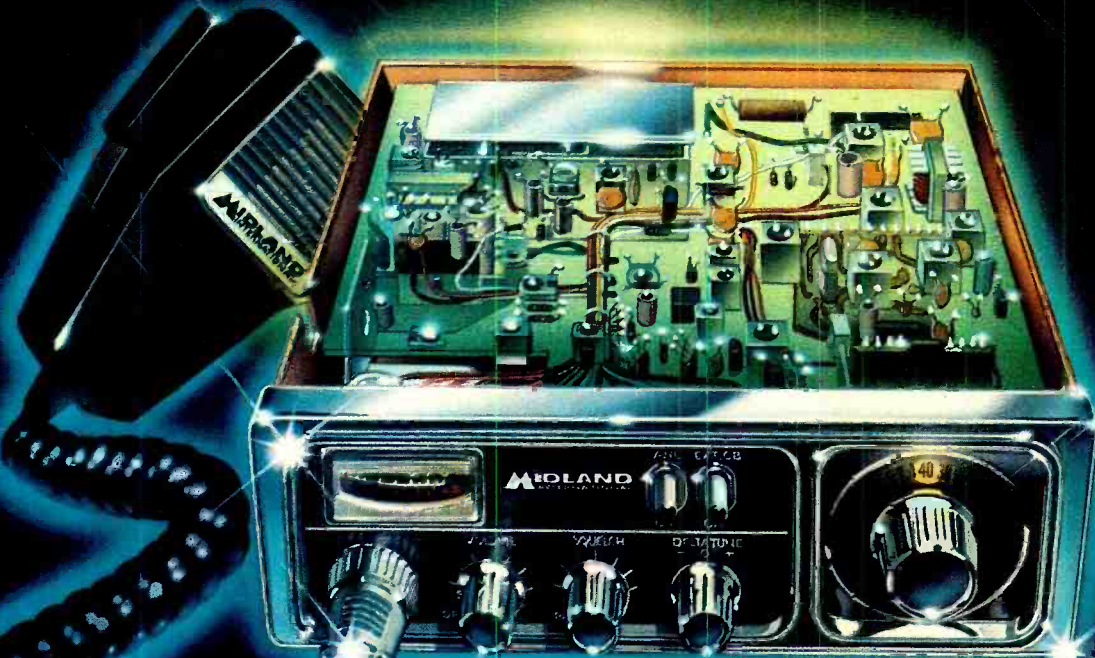

## WE GOT TO THE TOP ON PURE GUTS.

Consistency. If one word can sum up Midland's rise to Number 1 in CB, that's it.

We've got to know that the ten-thousandth Midland will

perform every watt and ohm as reliably as the first Midland off the line.

To make sure, we use computer technology throughout the manufacture of all our new 40-channel models.

In the assembly and integration of our state-of-the-art circuitry.

In the ultra-fine tuning of those circuits.

And in the final testing of your new 40-channel Midland CB, so you know it'll deliver,

right out of the box.

Add to that Midland's 15 years' experience in CB, Midland's warranty and convenient authorized service centers, coast to coast.

Pure guts. Pure reliability. Pure Midland Power. That's what you get when you run with Number 1.

For your free, full-color, 24-page 1977 Midland CB brochure, write: Midland International, P.O. Box 12737, North Kansas City, Mo. 64116

"RUN WITH NUMBER ONE"

*ewmreed*



### MIDLAND CB

A member of the Beneficial Corporation family.

Shop for these active living products from Midland International: Benchmark Tools • Goodwin Sporting Goods • Medalion Car-Sound Products • Midland Television • Young World Toys.

CIRCLE NO. 28 ON FREE INFORMATION CARD

# Popular Electronics®

WORLD'S LARGEST-SELLING ELECTRONICS MAGAZINE

## FEATURE ARTICLES

RC CIRCUIT QUIZ .....	Robert P. Balin	26
NOISE FILTERING FOR HI-FI .....	Julian D. Hirsch	32
PIXIE ANIMATION PROGRAM .....	Edward C. Deveaux	42
END THAT "UTILITY FUTILITY" .....	Harry L. Helms, Jr.	53
<i>DX'ing CW without knowing Morse code.</i>		
TAPE RECORDER HYGIENE .....	Craig Stark	56
<i>The importance of taking care of your machine and tapes.</i>		
AN INTRODUCTION TO GYRATOR THEORY .....	Bryan T. Morrison	58
"ZAP" NEW LIFE INTO DEAD NiCd BATTERIES .....	Douglas C. Myers	60
THE WORLD OF ELECTRONICS .....	Frank Bolle	67
AVERAGE, PEAK, AND RMS VALUES .....	Hector French	68
HOBBYIST COMPUTER CLUBS .....		91

## CONSTRUCTION ARTICLES

COSMAC ELF, PART IV .....	Joseph A. Weisbecker	41
<i>One added chip provides video interface and animated graphics.</i>		
ELECTRONIC "BELL" FOR A TVT-II .....	Denis J. Deutsch	46
BUILD THE TVT-6: A LOW-COST DIRECT VIDEO DISPLAY .....	Don Lancaster	47
<i>User-selectable line lengths; scrolling; and up to 4k on-screen characters.</i>		
BUILD A PINK NOISE GENERATOR FOR AUDIO TESTING .....	Dennis Bohn	66
BUILD A SOLAR CONTROLLER .....	Jerald M. Cogswell	69
PORTABLE 60-HZ "CLOCK" OSCILLATOR .....	Charles F. Smith	70
ONE-TOUCH DIODE TESTER .....	David Markegard	75

## COLUMNS

STEREO SCENE .....	Ralph Hodges	22
<i>Instruments I Have Miked.</i>		
SOLID STATE .....	Lou Garner	77
<i>IC's For Test Instruments.</i>		
EXPERIMENTER'S CORNER .....	Forrest M. Mims	82
<i>The 556 Timer.</i>		
HOBBY SCENE .....	John McVeigh	84
CB SCENE .....	Ray Newhall	88
<i>The Anatomy of CBRS.</i>		
COMPUTER BITS .....	Hal Chamberlin	89
<i>Assemblers.</i>		

## JULIAN HIRSCH AUDIO REPORTS

REALISTIC MODEL STA-2000 STEREO RECEIVER .....	33
KOSS MODEL K/145 STEREO HEADPHONES .....	36

## ELECTRONIC PRODUCT TEST REPORTS

COBRA MODEL 29 XLR MOBILE 40-CHANNEL CB TRANSCEIVER .....	85
WAHL MODELS 7700 AND 7800 CORDLESS SOLDERING IRONS .....	86

## DEPARTMENTS

EDITORIAL .....	Art Salsberg	4
<i>Solar Energy News Notes.</i>		
LETTERS .....		6
OUT OF TUNE .....		7
<i>"Bicycle Speedometer" (March 1977); "LED Racing Game" (March 1977); "Digistart Lock" (April 1977).</i>		
NEW PRODUCTS .....		12
NEW LITERATURE .....		16
NEWS HIGHLIGHTS .....		38
TIPS & TECHNIQUES .....		92
OPERATION ASSIST .....		93
ELECTRONICS LIBRARY .....		95

POPULAR ELECTRONICS, July 1977, Volume 12, Number 1, Published monthly at One Park Avenue, New York, NY 10016. One year subscription rate for U.S. and Possessions, \$12.00; Canada, \$15.00; all other countries, \$17.00 (cash orders only, payable in U.S. currency). Second Class postage paid at New York, NY and at additional mailing offices. Authorized as second class mail by the Post Office Department, Ottawa, Canada, and for payment of postage in cash.

POPULAR ELECTRONICS including ELECTRONICS WORLD, Trade Mark Registered. Indexed in the Reader's Guide to Periodical Literature.

COPYRIGHT © 1977 BY ZIFF-DAVIS PUBLISHING COMPANY. ALL RIGHTS RESERVED.

Ziff-Davis also publishes Boating, Car and Driver, Cycle, Flying, Modern Bride, Popular Photography, Skiing and Stereo Review.

Material in this publication may not be reproduced in any form without permission. Requests for permission should be directed to Jerry Schneider, Rights and Permissions, Ziff-Davis Publishing Co., One Park Ave., New York, NY 10016.

**Editorial correspondence:** POPULAR ELECTRONICS, 1 Park Ave., New York, NY 10016. Editorial contributions must be accompanied by return postage and will be handled with reasonable care; however, publisher assumes no responsibility for return or safety of manuscripts, art work, or models.

**Forms 3579 and all subscription correspondence:** POPULAR ELECTRONICS, Circulation Dept., P.O. Box 2774, Boulder, CO 80302. Please allow at least eight weeks for change of address. Include your old address, enclosing, if possible, an address label from a recent issue.

**EDGAR W. HOPPER**  
Publisher

**ARTHUR P. SALSBERG**  
Editorial Director

**LESLIE SOLOMON**  
Technical Editor

**JOHN R. RIGGS**  
Managing Editor

**IVAN BERGER**  
Senior Editor

**ALEXANDER W. BURAWA**  
Features Editor

**EDWARD I. BUXBAUM**  
Art Director

**JOHN McVEIGH**  
Associate Editor

**ANDRE DUZANT**  
Technical Illustrator

**PATRICIA GIRRIER-BROWN**  
Production Editor

Contributing Editors  
**HAL CHAMBERLIN, LOU GARNER**  
**GLENN HAUSER, JULIAN HIRSCH**  
**RALPH HODGES, FORREST MIMS**  
**RAY NEWHALL, WILFRED SCHERER**

**JOSEPH E. HALLORAN**  
Advertising Director

**JOHN J. CORTON**  
Advertising Sales

**LINDA BLUM**  
Advertising Service Manager

**PEGI McENEANEY**  
Executive Assistant

**STANLEY NEUFELD**  
Associate Publisher

ZIFF-DAVIS PUBLISHING COMPANY  
Popular Electronics  
Editorial and Executive Offices  
One Park Avenue New York, New York 10016  
212-725-3500

Hershel B. Sarbin, President  
Furman Hebb, Executive Vice President  
John R. Emery, Sr. Vice President, Finance and Treasurer  
Phillip T. Heffernan, Sr. Vice President  
Edward D. Muhfeld, Sr. Vice President, Sports Division  
Philip Sine, Sr. Vice President  
Frank Pomerantz, Vice President, Creative Services  
Arthur W. Butzow, Vice President, Production  
Lawrence Sporn, Vice President, Circulation  
George Morrissey, Vice President  
Sydney H. Rogers, Vice President  
Sidney Holtz, Vice President  
Albert S. Traina, Vice President  
Philip Korsant, Vice President  
Paul H. Chook, Vice President  
Edgar W. Hopper, Vice President  
Charles B. Seton, Secretary  
William Ziff, Chairman  
W. Bradford Briggs, Vice Chairman

Midwestern Office  
The Patis Group, 4761 West Touhy Ave.,  
Lincolnwood, Illinois 60466, 312 679-1100  
Thomas Hockney, Michael Neri, Gerald E. Wolfe  
Western Office  
9025 Wilshire Boulevard, Beverly Hills, CA 90211  
213-273-8050; BRadshaw 2-1161  
Western Advertising Manager: Bud Dean  
Japan: James Yagi  
Oji Palace Aoyama: 6-25, Minami Aoyama  
6 Chome, Minato-Ku, Tokyo 407-1930/6821,  
582-2851



The publisher has no knowledge of any proprietary rights which will be violated by the making or using of any items disclosed in this issue.



## Editorial

### SOLAR ENERGY NEWS NOTES

¶ A recent energy policy study by the MITRE Corp. concludes that nuclear power is the economical choice for at least the remainder of the century. . . . If other than economic considerations are counted, coal might eventually prove more attractive. . . . Solar energy for heating houses will be practical in the near future in favorable situations, but there's little prospect for competitively priced solar power in this century. (A Fusion Energy Foundation spokesman, however, says that the total study was justification to cut the Clinch River Tenn. fast-breeder reactor program.)

¶ In contrast, the latest paper from Worldwatch Institute (*Energy: The Solar Prospect*) concludes that subsidizing energy forms other than solar makes devices for the latter appear relatively costly. Removing subsidization would, according to the paper, make solar resources able to provide 40 percent of the world's energy needs by the end of the twentieth century. Researchers at the University of New Mexico, in a study prepared for the Joint Economic Committee of Congress, also claim that solar energy could compete with other energy sources (by 1990).

¶ President Carter asked Congress to downplay the future use of nuclear energy in his overall energy conservation/production proposals.

¶ At IBM Corp.'s Palo Alto facilities, powerful computers are exploring solutions to the problems of tapping the sun as a widespread and economical source of energy.

¶ Carl Pepper's amazing solar heating machine provides 55 percent of the heating needs in his 3200-square-foot home in Granton, Ontario, Canada. Cost is said to be \$1300, with projected savings in fuel oil of more than \$3000/year by 1996. The builder sells solar construction plans for \$10 and a differential thermostat for \$60, the latter said to be reversible for cooling the house in the summer. (See *Harrowsmith*, Jan./Feb. 1977 issue, \$1.00, published by Camden House Publishing, Camden East, Ontario, Canada, KOK-1J0.)

¶ An advertiser in *Newsday*, a Long Island, N. Y., newspaper, offers swimming-pool solar energy heaters for \$1900.

¶ A selection of texts on solar energy: *The Solar Energy Handbook*, Time-Wise Publications, P. O. Box 4140, Pasadena, CA 91106 (87 pages, soft cover, \$3.95, plus \$.50 handling); *Solar Energy Directory*, Centerline Corp., 401 S. 36th St., Phoenix, AZ 85034 (108 pages, soft cover, \$7.50); *Wind/Solar Energy*, by Edward Noll, Howard W. Sams & Co., Inc., Indianapolis, IN 46268 (208 pages, soft cover, \$7.95); *Solar Cells*, (IEEE Press Selected Reprints), John Wiley & Sons, Inc., 605 Third Ave., New York, NY 10016 (504 pages, \$29.95 cloth, \$8.95 soft cover).

Judging from the response to our annual tongue-in-cheek "April Hobby Scene," which included an implausible solar cell project, there's an extremely high level of interest in solar energy. Perhaps these serious observations will partially whet it. As an aside, I wonder what the new budget for energy research will be. Solar thermal research for fiscal-year 1976 was budgeted for only 89-million dollars; not much by any standard, and only some 4.5 percent of the total revised energy R & D budget. However, the Carter administration's new energy package seems to promise that solar devices will soon have their day in the sun.

*Art Salsberg*

# Do-it-yourself JBL.



Take the guts of what makes JBL JBL and adapt it to your own ideas of what a loudspeaker system should be.

Mix and match with forty-seven individual JBL components—horns, lenses, dividing networks, transducers, everything.

And when you've found your perfect sound, we'll help you find somewhere to put it: The JBL Enclosure Construction Kit, with complete plans for building your own loudspeaker enclosure from scratch.

See your authorized JBL Loudspeaker Components dealer for the start of a great new team in sound: You and JBL.





# Letters

## DOCTORS SAY NOT TO WORRY

No matter how "spacey" the rest of the world got, I could always depend on good ole PE to be swimming in the "real" world of parts specifications and product news. Then I saw April's "How to DX Earth Radio From Outer Space." I still talk to myself and my hands shake, but the doctors tell me not to worry. Just kidding. I can't begin to tell you how much I enjoy reading your magazine. —Michael Swaney, Erie, PA.

## ETC HAS ROM MONITOR

I read with interest the April 1977 Computer Bits column and was not pleased that the only remark about our product was an unfavorable comparison with a competitor, especially when this remark was based on misinformation. The Model ETC-1000 Basic System includes a 40-key keyboard that is operated by a monitor system that permits the user to effectively operate a minimum system or to initialize and perform other housekeeping operations in systems with terminal interfaces. Our terminal monitor version comes in two packages, the 8k and 16k configuration (the latter including an assembler), and disassembler, Basic, cassette I/O, Utilities, and a variety of other program packages. —E.S. Bjornsson, Electronic Tool Co., Hawthorne, CA.

*Our apologies for the erroneous description of the ETC-1000. The ROM monitor system indeed uses 40 buttons to allow calling routines from the monitor without need of a terminal. Debugging is simplified by using a built-in break-point routine, and included is a thorough memory diagnostic system.*

## "DIGISTART'S" COLLAPSING FIELD

After reading the "Digistart" (April 1977) article, I noticed a minor omission in the circuit that might cause operating problems. When the Q1 transistor cuts off, the collapsing field of the K1 coil could induce a large enough back emf to destroy the transistor. To remedy this, it is suggested that a diode be installed across the relay's coil in reverse bias. To be on the safe side, the rectifier diode should be rated at no less than 100 PIV at 1 ampere. —Alan Bradford, Derry, NH.

## "APRIL FOOL" IS 2-WAY STREET

We were intrigued with the high-efficiency solar cell described in the April Hobby Scene. Because the corresponding ketone (3,7-dimethylpentadecan-2-one) is available in

large quantities, at least in the midwest, by ether extraction from the saliva of pregnant sows, this seemed like the logical starting point. Reduction of this ketone with sodium borohydride gave the alcohol that, upon treatment with propionyl chloride in pyridine, gave the desired propionate ester in good yield.

The solar cell was then constructed pretty much as described, except that a glass spray bottle could not be used to apply the compound to the sand. This is because the chemical also reacts with the silica in the glass and the resulting deoxygenation process is violent. A plastic bottle, however, works quite well. The cell actually is more efficient than the one described, providing about 87% conversion. —Dr. C.T.C. Creedy and co-workers, Charles F. Kettering Research Laboratory, Yellow Springs, OH.

You stated that car-radio frequency drift was due to the Doppler effect and that the problem should be corrected with a phase-locked loop. My God, tell the fool to slow down! For an audible Doppler shift to occur in the commercial AM band (let's say 5 Hz, to be conservative), this person would have to be driving faster than 5000 mph. By helping him to keep his radio tuned, you are aiding and abetting this reckless and unlawful operation of a motor vehicle. —Walter Satre, Chairman, Electrical & Electronics Technology Dept., Vermont Technical College, Randolph Center, VT.

In discussing the well-known effect of radiation pressure from car stereo speakers in the April Hobby Scene, Marcia Swampfelder overlooked the most important application of them all: swinging the speakers forward to assist in braking. Such dynamic air braking does not wear down the tires and has been used effectively for years in fire engines. When close to the fire, the driver swings his siren around to hasten the stop. You can determine the precise moment when he does this from the change in pitch, caused by the Doppler effect, provided you are not close to the fire. —Harry E. Stockman, Arlington, MA.

## DX'ING EARTH ON CHANNEL 68

The statement that there is only one channel 68 in North America in "How to DX Earth Radio From Outer Space" (April 1977) is incorrect. Independent station WBTV in Newark, NJ operates on channel 68. —John J. Dynarski, Carteret, NJ

## FREQUENCY READOUT PROJECT A HIT

I wish to thank POPULAR ELECTRONICS and author David L. Mattis for the "Digital Frequency Readout for Shortwave Receivers" (February 1977). After connecting it to my receiver, it was surprisingly accurate and stable. I can set my receiver to a predetermined frequency and just wait for the signal to fade in. Also, the display is especially bright and clear and can be read from clear across the room.

Incidentally, the hookup point given in the

article is incorrect for my 1973 Lafayette Radio Model HA-600A receiver. The correct tie point is the junction of C31 and R16. The circuit board in the receiver is already drilled to permit such a connection. —Stephen E. Franklin, Ellicott City, MD

I built the "Digital Frequency Readout" project from a kit supplied by Mattis Electronics and am delighted with it. I was impressed by the fine kit of parts supplied. Everything was included and the project worked immediately upon completion. —D.C. Mead, Greensboro, NC

## AN ERROR IN SWITCHING

In "Build a Digital Bicycle Speedometer" (March 1977), it is stated that, to calibrate the project one must "depress S2 and adjust R2 until the display indicates the wheel's diameter." Since S2 is the power switch, the instructions should read: "depress S3 . . ." —Rick Stievenart, Carbon, IN.

## THANKS FOR THE "ELF"

My thanks to Joe Weisbecker for designing the "COSMAC Elf Microcomputer" (August 1976). I built my micro using slide switches, discrete LED's, and a 555 timer IC for economy. (In my project, the 555 timer can be placed in either of two positions in a 16-pin DIP socket to give me either a high or a low clock.)

The basic construction technique I used in assembling my Elf was Wire Wrap, with two bus strips for power distribution. My main problem during assembly was trying to find 22-pin Wire Wrap sockets. Since I couldn't find them anywhere, I had to build my own from Molex Scldercons, Vector J pins, and epoxy cement. My next project is to build my Elf with a hex keyboard and 1024 words of memory. —Charles J. Billwiller, Rancho Cordova, CA.

## SLIDE SYNCER STEERS MOTORBOAT

I enjoyed building "The 35-mm Slide Syncer" (November 1976). Found the circuit to be so stable that I plan to use two of them in a programmable steering system for my motorboat. The only "bug" in the system is that it will trigger from some momentary signals other than its center-frequency signal. This problem can be eliminated by increasing the value of C6 to 20 or 30  $\mu$ F.

I also found that the circuit refused to trigger at low signal levels. I discovered that by paralleling R2 with a 50,000-ohm potentiometer, this second problem could be eliminated. These modifications ensure excellent circuit operation. —Mark Irgang, New York, NY.

## MORE SOLAR VIEWING SAFETY

"Propagation Forecasts For Radio Communications" (November 1976) contains an error regarding the use of the Kodak #4 neu-



tral-density filter which could have serious consequences. The safest way to view the sun through binoculars or a telescope is by projection. If direct viewing is required, it should be done only through full-aperture filters of the deposited-metal-film type such as that shown on the telescope in Fig. 3 of the article. These filters effectively block all harmful radiation.

Another method is to use one or more layers of black and white (not color) film that has been exposed to direct sunlight and then developed. These are suitable for direct viewing but not photography because they degrade the image.

Another area of danger is in the use of the so-called "sun filters" supplied with many inexpensive telescopes. These filters are meant to be used on the eyepiece. Since they will be near the focal plane of the main objective lens or mirror, it is possible that sufficient heat could be built up in the filter to cause it to crack. The damage to the eye would occur before the observer could move away from the eyepiece.—John Hudak, Vice President, Hamilton Centre of the Royal Astronomical Society of Canada, Ontario, Canada.

#### ANOTHER CLASS OF AMPLIFIER

We read with interest "Classes of Audio Amplifiers" (March 1977) and noted that although the article covered classes A through G, it failed to mention the class K "reference

shift" amplifier. The class-K amp is similar to the class-A amp except that the average direct current to the power amplifier is controlled as a function of the audio level. Thus, no more power is consumed than is necessary to minimize distortion for a particular audio level. This makes its average efficiency appreciably higher than for the class-A amplifier. The principal virtue of the class-K amplifier is that it yields about twice the power output of a class-A system, using the same tube or transistor. Of course, the class-K system is not suitable for hi-fi without special refinements because of difficulties in handling transients. But it performs well in voice applications, such as in modulating communication equipment.—Dale Hileman, WB6NTR, Topanga, CA

## Out of Tune

In "Bicycle Speedometer" (March 1977), the segment-f pin of IC2 in Fig. 1 was incorrectly identified as pin 16; it should be pin 10.

In "LED Racing Game" (March 1977), pins 7 and 8 of IC13 in Fig. 4 are reversed. Also, pin 16 of IC6, IC7, and IC8 must be connected to the +5-volt bus (see Fig. 6). If you add a 4700-ohm, ¼-watt resistor to IC9 through

IC12 as shown here, the two unused 7411 gates can be used to block the clock pulse

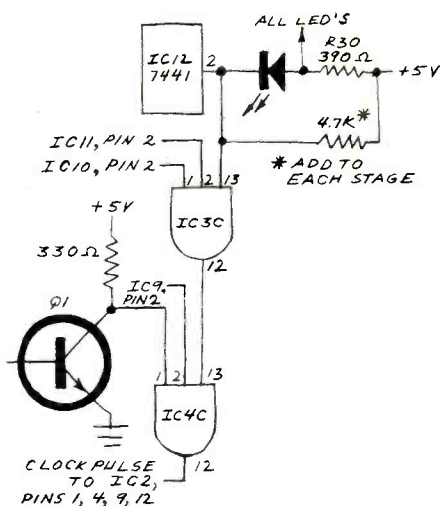

when any one of the four players reaches the finish first. This will eliminate any doubt as to the winner if all four players wish to race at the same time.

In the "Digistart Lock" (April 1977), contact bounce problems in flip-flop A can be reduced by connecting pin 1 (J) to +5V and pin 4 (K) to gnd. On IC5, the Q output is pin 1. For more stability in the one-shot multivibrator, change R6 to 39,000 ohms (¼-watt) and C1 to 120 μF.

# Great Jumpers are here!

State of the art flat cable connector assemblies . . . at affordable prices.

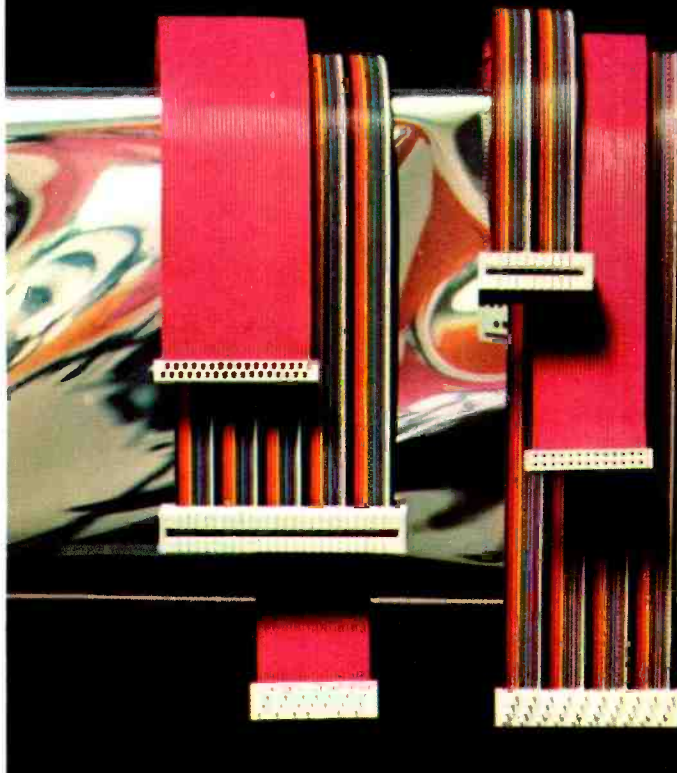

Great Jumpers come to you fully pre-assembled and fully pre-tested. Cable strain reliefs are integral to the molded-on connectors. And we've designed in complete line-by-line probeability with probe access ports behind each contact.

Our connectors are industry standard; two parallel rows of contacts, spaced every .1".

Great Jumpers come in five popular cable widths: 20, 26, 34, 40 and 50 lines wide, and in lengths ranging from 6" to 36".

Available now at the distributor near you who carries the A P Products Faster and Easier Line.

Our distributor list is growing daily. For the name of the distributor nearest you call Toll-Free 800-321-9668.

Send for our complete A P catalog, the Faster and Easier Book.

Faster and easier is what we're all about.



**A P PRODUCTS INCORPORATED**

Box 110-72 Corwin Drive, Painesville, Ohio 44077  
(216) 354-2101 TWX: 810-425-2250

# Learn to service Communications /CB equipment at home...with **NRI'S COMPLETE COMMUNICATIONS COURSE**

**Learn design, installation and maintenance of commercial, amateur, or CB communications equipment.**

The field of communications is bursting out all over. In Citizens Band alone, class D licenses grew from 1 to over 2.6 million in 1975, and the FCC projects about 15 million CB'ers in the U.S. by 1979. That means a lot of service and maintenance jobs . . . and NRI can train you at home to fill one of those openings. NRI's Complete Communications Course covers all types of two-way radio equipment (including CB), AM and FM



special instruction so you can go on the air.

The complete course includes 48 lessons, 9 special reference texts, and 10 training kits. Included are: your own electronics Discovery Lab, Antenna Applications Lab, CMOS Frequency Counter, and an Optical Transmission System. You'll learn at home, progressing at your own speed, to your FCC license and into the communications field of your choice.



Transmission and Reception, Television Broadcasting, Microwave Systems, Radar Principles, Marine Electronics, Mobile Communications, and Aircraft Electronics.

The course will also qualify you for a First Class Radio Telephone Commercial FCC License or you get your tuition back.

**Learn on your own 400-channel digitally-synthesized VHF transceiver.**

You will learn to service all types of communication equipment, with the one unit that is designed mechanically and electronically to train you for CB, Commercial and Amateur communications: a digitally-synthesized 400-channel VHF transceiver and AC power supply. This 2-meter unit gives you "Power-On" training. Then we help you get your FCC Amateur License with

## **NEW CB SPECIALIST COURSE NOW OFFERED**



NRI now offers a special course in CB Servicing. You get 37 lessons, 8 reference texts, your own CB Transceiver, AC power supply and multi-meter . . . for hands-on training. Also included are 14 coaching units to make it easy to get your commercial radio telephone FCC license—enabling you to test, install, and service communications equipment.

# NRI offers you five TV/Audio Servicing Courses

NRI can train you at home to service TV equipment and audio systems. You can choose from 5 courses, starting with a 48-lesson basic course, up to a Master Color TV/Audio Course, complete with designed-for-learning 25" diagonal solid state color TV and a 4-speaker SQ™ Quadrasonic Audio System. NRI gives you both TV and Audio servicing for hundreds of dollars less than the two courses as offered by another home study school.



™Trademark of CBS Inc.

All courses are available with low down payment and convenient monthly payments. All courses provide professional tools and "Power-On" equipment along with NRI kits engineered for training. With the Master Course, for instance, you build your own 5" wide-band triggered sweep solid state oscilloscope, digital color TV pattern generator, CMOS digital frequency counter, and NRI electronics Discovery Lab.

# NRI's complete computer electronics course gives you real digital training.

Digital electronics is the career area of the future . . . and the best way to learn is with NRI's Complete Computer Electronics Course. NRI's programmable digital computer goes far beyond any "logic trainer" in preparing you to become a computer or digital technician. With the IC's in its new Memory Kit, you get the only home training in machine language programming . . . experience essential to trouble shooting digital computers. And the NRI programmable computer is just one of ten kits you receive, including a TVOM and NRI's exclusive electronics lab. It's the quickest and best way to learn digital logic and computer operation.

**You pay less for NRI training and you get more for your money.**

NRI employs no salesmen, pays no commissions. We pass the savings on to you in reduced tuitions and extras in the way of professional equipment, testing instruments, etc. You can pay more, but you can't get better training.

**More than one million students have enrolled with NRI in 62 years.**

Mail the insert card and discover for yourself why NRI is the recognized leader in home training. No

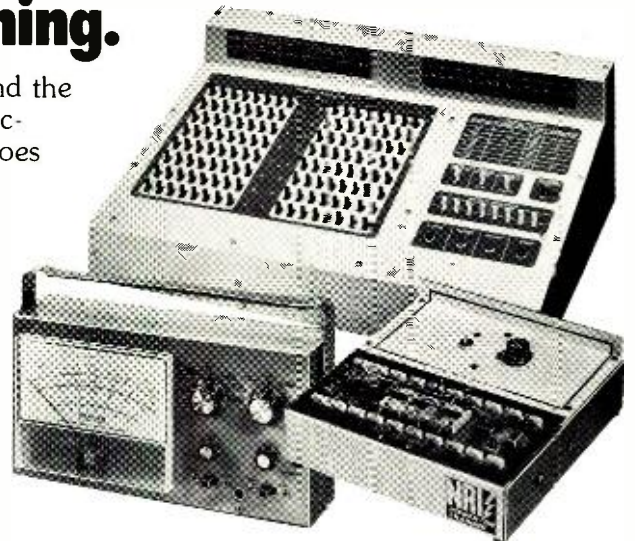

salesman will call. Do it today and get started on that new career.

**APPROVED UNDER GI BILL.**  
if taken for career purposes Check box on card for details.



**NRI SCHOOLS**  
McGraw-Hill Continuing Education Center  
3939 Wisconsin Avenue,  
Washington, D.C. 20016



# New Products

Additional information on new products covered in this section is available from the manufacturers. Either circle the item's code number on the Reader Service Card inside the back cover or write to the manufacturer at the address given.

## DYNACO INTEGRATED AMPLIFIER

The Model SCA-50 integrated amplifier is available from Dynaco/Dynakit either factory assembled or in kit form. It is rated at 25 watts/channel continuous average power with less than 0.5% THD with 8-ohm loads. The bass and treble control circuits are de-



signed to have little or no effect on the mid-range. The turnover in the bass control system is variable, while that in the treble system is fixed and has a hinge frequency that is higher than is usual. In the amplifier section, the output circuit is full complementary symmetry, and the bias supply thermally tracks the output transistors. A thump-suppression circuit (for turn-on/turn-off) is standard. In addition to the line fuse, protection includes separate fuses at each of the four power supply outputs, current limiting, and a thermal circuit breaker. \$149 kit; \$249 factory wired.

CIRCLE NO. 89 ON FREE INFORMATION CARD

## RAYMALEE CB MOBILE ANTENNA

The Solar Hot Rod, from Raymalee, is a power-gain CB antenna featuring a self-contained solar-powered device with built-in solar storage. It clamps to the user's present mobile or base-station antenna with no addi-



tional wiring required. The Solar Hot Rod is said to provide 14 dB of signal gain to the receiver with less than 2 dB of noise gain. The Solar Power Supply is claimed to be able to maintain a fully charged supply, enough to provide several months operation in total darkness. \$89.95.

CIRCLE NO. 91 ON FREE INFORMATION CARD

## AMCOMM 2-METER FM TRANSCEIVER

The Model S225 2-meter mobile FM transceiver from AMCOMM (American Communications Corp.) features a digital synthesizer that provides complete coverage of the 2-meter ham band in 5-kHz increments. Operating frequency is determined by three rotary



switches and is displayed to the nearest kilohertz on a six-digit LED display. Transmit offsets are switch selectable for +600 kHz, -600 kHz, +1 MHz and -1MHz. R-f output power is continuously variable from 2 to 25 watts, with spurious harmonic output at -60 dB. Receiver sensitivity is rated at 0.5  $\mu$ V for 20 dB quieting. Local oscillator frequency stability is claimed to be  $\pm 5$  ppm. Audio output power is rated at 4 watts into the built-in 8-ohm speaker with less than 10% distortion. The transmitter is phase modulated ( $\pm 5$  kHz with 100% modulation at 1000 Hz), and T/R switching is solid state. A Touch-Tone encoder is optional.

CIRCLE NO. 92 ON FREE INFORMATION CARD

## OPTONICA FRONT-LOAD CASSETTE DECK

Sharp Electronic Corp.'s Optonica Model RT-2050U is a two-motor, front-loaded cassette deck. Wow and flutter is rated at 0.045% weighted rms, and S/N ratio is 64 dB with its Dolby noise-reduction system switched in. An automatic program find sys-

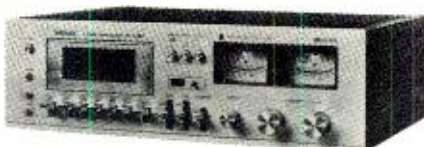

tem (APFS) enables the user to move to the next selection or to return to the start of the current selection simply by pushing a button. Among other features are: a space setter, peak level meters (respond to signals in 10 ms), electronic automatic stop, and three-position BIAS and EQUALIZER tape selection switches, pause switch, counter, stereo headphone jack, separate record level controls, and a ganged output control. \$299.95.

CIRCLE NO. 93 ON FREE INFORMATION CARD

## MOTOROLA CB RADIO CARRYING CASE

A Universal Carrying Case for mobile CB transceivers has been introduced by the Motorola Communications Group Parts Dept. The case permits easy removal of a CB radio so it can be carried by the owner from an unattended vehicle. Separate compartments



in the case hold microphones, the power cable, and a portable antenna. The case is designed so a mobile radio can be operated without removing it from the case. Openings at the top and bottom of the case allow the speakers to be heard, while a large opening at the back permits antenna and power connections. The front flap folds down so that the transceiver controls and microphone jack are readily accessible. Covered with Texion vinyl that simulates genuine leather and equipped with a heavy-duty handle, the case measures 12" x 9" x 3" (30.5 x 23 x 7.6 cm).

CIRCLE NO. 94 ON FREE INFORMATION CARD

## SENCORE AUDIO-VHF FREQUENCY COUNTER

Sencore's FC45 frequency counter offers continuous frequency check capability from audio through vhf (uhf-band coverage to 600 MHz with optional PR47 prescaler). A direct-reading eight-digit display with pushbutton



action makes the FC45 easy to use. Incorporates a crystal checker. Counter sensitivity is 25 mV average throughout the band; accuracy is 1 ppm, using a temperature-controlled oven. The basic unit comes with all testing leads at \$395. The PR47 prescaler is \$125.

CIRCLE NO. 95 ON FREE INFORMATION CARD

## NAKAMICHI FM TUNER/PREAMPLIFIER

The Model 630 FM tuner/preamplifier from Nakamichi is said to provide an extremely low-noise, low-distortion preamplifier section. Noise is rated at 80 dB below 1 mV, and distortion is claimed to be virtually impossible to measure. A phono overload of 250 mV and a switch-selectable phono input sensitivity ensure compatibility with a wide variety of cartridges. The preamp section also provides tone and contour controls, tape deck monitor

# Memories are made of this.

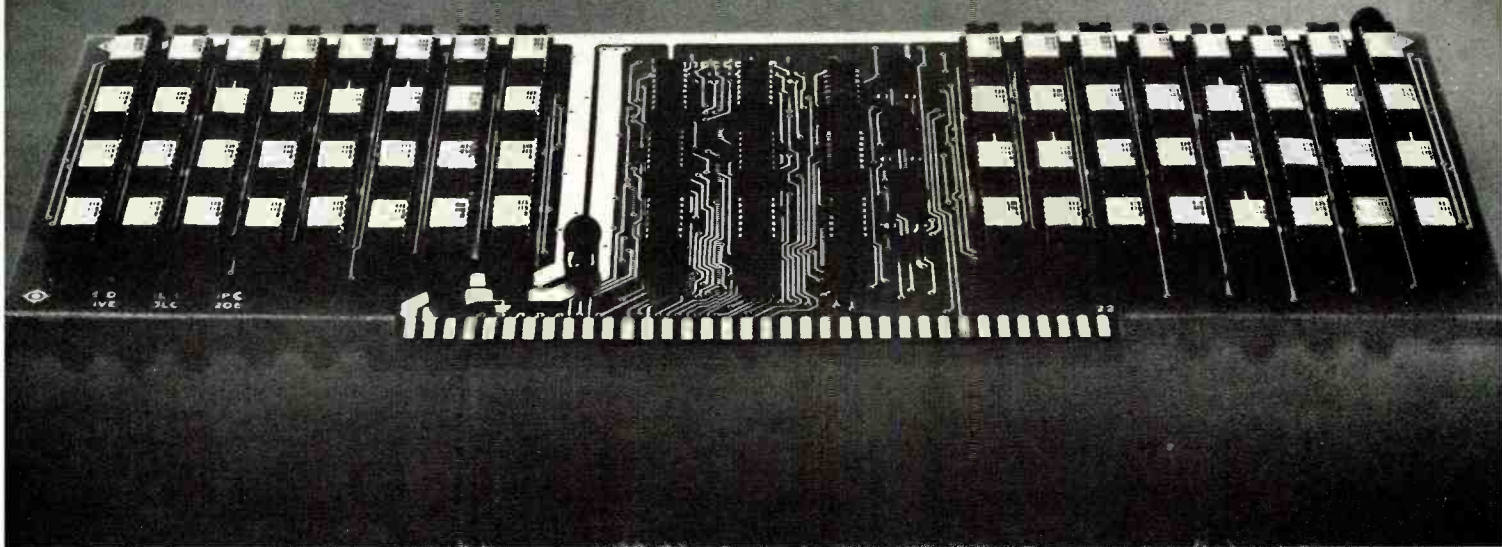

## 32K. One Card. One low price. Only from the Digital Group.

Now, on only one *fully static* card, the Digital Group has squeezed in a whopping 32K of memory. Which, with a little quick addition, means a full 64K architecture now requires only 2 boards instead of 8. That's a 4-to-1 space reduction ...and leaves one extra memory slot on the Digital Group's standard motherboard still available for future products.

All this and one low price, too. It just may be the best news of all. Our full static, assembled and tested 32K memory board is only \$995. Now that's worth remembering. It's substantially less than our equivalent assembled 8K board prices. (Please note: We're initially offering this 32K board assembled only, but kit versions will soon be available, too—at even lower prices.)

Here's what you get.

### Specifications:

- 32K on single card
- Speed—450ns. All of our current CPUs will operate at full-rated speed.
- Decoding—Lower or upper 32K bank
- Power—+5V only @ 4A
- Card size—12" x 5" (excluding connector fingers)

### Features:

- May be intermixed on Digital Group systems with our 8K memory cards

- All data and address lines are buffered
- *Fully static* memories—EMM 4801 (450ns) or equivalent

### Price:

32K board complete, assembled and tested \$995.00

For all the memorable details, just fill out the coupon below. (Then all you have to remember is to mail it in.)

the digital group

P.O. Box 6528  
Denver, Colorado 80206 (303) 777-7133

I promise to mail this in, so add me to your mailing list!

Name \_\_\_\_\_

Address \_\_\_\_\_

City/State/Zip \_\_\_\_\_

Remember me? I'm already on your mailing list, but I need the memory spec sheet desperately.



and copy facilities, and a high output head-phone amplifier. The FM tuner section features low-noise dual-gate MOSFETs, a six-element LC network, and a switch-selectable wide/narrow-band response. FM sensitivity is 8.75 dBf (1.5  $\mu$ V for 30 dB quieting), and a capture ratio of 1 dB. Incorporates a Dolby noise-reduction unit with 25- $\mu$ s deemphasis. \$600.00.

CIRCLE NO. 96 ON FREE INFORMATION CARD

### IMSAI SINGLE-BOARD COMPUTER

IMSAI's new 8048 control computer is a completely programmable computer and hardware control system on one 8½" x 10" board. It is powered by a 5-V supply or 6-V battery and allows standard electric tools, instruments, and appliances to be attached and controlled directly without requiring any intervening hardware other than wire. The 8048 8-bit CPU contains 1k words of program memory, and the system has cassette interface,

RS232 current loop, and five relays. The control computer incorporates the Intel 8048/8748 microcomputer chip, which will accommodate three separate and unique memory stages: program memory, internal register memory, and external RAM. Input a program through the onboard keyboard, attach the device, and immediate control of the

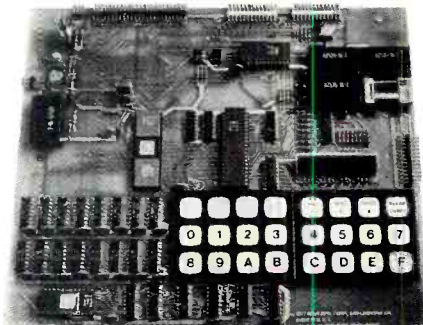

devices is said to be obtained. Both kit and assembled versions are available: ROM version (\$249, kit; \$299, assembled), EROM version (\$399, kit; \$499, assembled). A 5-V power supply is \$99.

CIRCLE NO. 97 ON FREE INFORMATION CARD

### CROWN ELECTRONIC CROSSOVER

The Crown Model VFX-2A is the successor to the Model VFX-2 electronic crossover. Internally, the VFX-2A uses six quad op amps in-



stead of the 10 dual op amps used in the earlier model to obtain better slew rates and handling of transients. Additionally, the new op amps are claimed to allow a greater range on the level control. One quad op amp operates as an isolation amplifier to eliminate impedance mismatching problems. Continuously variable filters—two per channel, can be used to perform either crossover or bandpass functions. Each filter in the dual-channel system is variable from 20 to 20,000 Hz with a fixed rolloff of 18 dB/octave. Output impedance is 300 ohms in both inverted and non-inverted modes, with greater than 6 volts maximum into 600 ohms. IM distortion and noise are rated at 0.01% and more than 100 dB below the rated output with 0 dB of gain, respectively. \$329 for VFX-2A, \$49.95 for optional walnut-veneer cabinet.

CIRCLE NO. 98 ON FREE INFORMATION CARD

### TRIPLETT PORTABLE DMM

A single switch provides five functions and 22 measurement ranges on the compact battery-powered Model 3000 digital multimeter from Triplett. The 3½-digit display features

# Aircommand 40-channel CB.



From the people who bring you Marantz—the world's finest stereo systems—comes the Aircommand CB-640—the finest in 40-channel CB. With Aircommand you get over 25 years experience in outstanding 2-way communications products.

**Full 6 Watts of audio power.** Provides plenty of punch so your speaker cuts through freeway noise.

**Dual-conversion superheterodyne receiver** with dual-cascaded ceramic filters. Together, both features provide the most complete rejection of unwanted signals, assuring you unsurpassed selectivity and sensitivity.

**4 big Watts of RF power.** Aircommand delivers the maximum power legally allowable to let you belt out the big sound.

**100% modulation capability.** Even when you talk softly into the mike, your message cuts through loud and clear, thanks to one of the most advanced mike preamp and compressor designs in CB today. With Aircommand, you don't have to spend an extra \$30 to \$40 on a "power mike." You can't buy better modulation than Aircommand.

**Specially tailored frequency response.**

**LED 40-channel selection display.** Easy-to-read, night or day.

**8-LED (light emitting diode) meter display.** Provides an easy-to-read display of SWR (standing wave ratio), modulation, and incoming or outgoing signal strength—instantly, accurately.

**Special emergency Channel 9 scan with exclusive Aircommand "beep" alert.** No matter what channel you're on, a special Aircommand CB-640 circuit continuously and silently monitors Emergency Channel 9. When someone starts transmitting on Channel 9, a unique "beep" alerts you, so you can tune yourself in and give assistance.

**Public address capability.** The versatile Aircommand CB-640 public address package lets you (1.) Talk into the CB mike and out an exterior public address speaker. (2.) Attach a tape recorder to the auxiliary jack on the



seven-segment LED's with blinking over-range, auto-zeroing, and autopolarity indication. All decimal points light up when the battery is low. Ranges include: 0 to 0.2, 2, 20, 200, and 600 on both ac and dc volts; 0 to 2, 20, and 200 mA on ac and dc; 0 to 200, 20k, and 2M ohms on low-power ohms; and 0 to 2k, 200k, and 20M ohms on conventional ohms. Typical ratings include 0.9% dc accuracy, 10-megohm input resistance on all voltage ranges, and 600-volt overload protection on all ranges. The DMM is powered by four Ni-Cd cells, for which a battery-charger/eliminator is provided. Size is 5 3/8" x 3" x 1 3/8" (13.7 x 7.6 x 3.5 cm) and weight is 10 oz (310 g). \$140.

CIRCLE NO. 99 ON FREE INFORMATION CARD

#### INFINITY ELECTROSTATIC HEADPHONES

Infinity System's ES-1 headphone system consists of headphones with a claimed fre-

quency response of 20-25,000 Hz  $\pm$ 2 dB and an adapter containing a power supply and matching transformers. Other specs include: less than 0.3% THD at 100 dB SPL, 50 watts at 1 kHz maximum input, and 118 dB SPL maximum output. The low-mass conductive diaphragms are made of an extremely light material called "Polyurethin." The power supply is housed in a walnut enclosure, which is connected between the amplifier and speakers. Front-panel switching allows head-

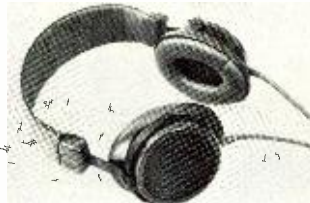

phones to remain connected whether they or the speaker systems are being used. The headset weighs 9 ounces. The complete system is \$275.

CIRCLE NO. 100 ON FREE INFORMATION CARD

#### ONE-HAND SOLDERING

The Kager KL-3000 is Minitool's answer to the problem of one-hand soldering on electronic circuits. The gun has adjustable, auto-

matic feed of preset amounts of solder. It accepts various diameters and brands of solder wire, interchangeable elements and tips (20-30-40-60-watt elements available), and has optional accessories for practically any type of soldering work. The standard kit is \$49.50 with interchangeable heating elements \$13 each; soldering tips, \$7.30; solder reels \$2.25 and \$5.95 depending on size. Address: Minitool, 15076 Dickens Ave., San Jose, CA 95124.

#### ROYAL MOBILE AMPLIFIER

Royal Sound has a new mobile stereo high-fidelity power amplifier module, the RS-55, that's normally driven by speaker output leads of an FM/AM radio with cassette player. The module increases amplifier output for car audio equipment by providing a power output of 15 watts/channel. Self-contained, the RS-55 is ruggedly constructed to withstand shock and vibration. It also has separ-



rate bass and treble controls, on/off switch, power indicator light, and quick-connect terminals, and can be mounted anywhere in a car or van. Operates on 12-volt dc negative-ground only. \$90.00

CIRCLE NO. 101 ON FREE INFORMATION CARD

# ...You never heard it so good!!!

CB-640 rear panel, and boom your tape out through the same external speaker. (3.) Mix your voice from the CB microphone with the program material on the tape recorder. Both voice and tape sound at the same time through the external speaker. (4.) Beam your **received signal** through the external speaker.

**Built-in standing wave ratio circuitry.** Measures the efficiency of the antenna system for optimum performance.

**Other outstanding features include:** Delta fine tuning control, digital synthesizer with phase-locked loop,

**automatic noise limiting switch, noise blanking switch, squelch control, RF gain control.**

Also available: Aircommand CB-140; Aircommand CB-340. All 3 units bring you state-of-art design, flawless craftsmanship and day-in, day-out reliability. Try them out now at your Superscope Aircommand dealer.

**TM Aircommand by SUPERSCOPE.**



© 1977 Superscope, Inc., 20525 Nordhoff St., Chatsworth, CA 91311. Prices and models subject to change without notice.

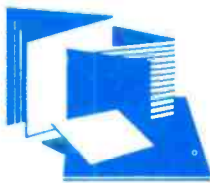

# New Literature

## HEATHKIT CATALOG

The new 96-page Heathkit Catalog describes over 400 electronic kits. Product categories include amateur radio, hi-fi components, col-

or TV, test instruments, digital clocks, radio control equipment and auto accessories. Among the new products introduced are a 3-way bookshelf speaker system, a battery monitor device for radio control modelers, a two-way freezer alarm and a touch-control light switch. A section of fully assembled brand-name 40-channel CB radios has also been included. Address: Heath Co., Dept. 350-11, Benton Harbor, MI 49022.

## EDMUND CATALOG

Edmund Scientific's 164-page Spring Catalog #772 contains over 4500 items for experimenters, students and hobbyists. Among the many items described are an AM/FM deluxe

wall radio; a storm alarm which is triggered by a signal from a local National Weather Service station; and a Sol-20 computer with Basic 5 language. Address: Edmund Scientific Co., 555 Edscorp Bldg., Barrington, NJ 08007.

## WINEGARD CB ANTENNA CATALOG

Winegard Industries offers its first CB Antenna Catalog #770. The catalog illustrates the company's line of 40-channel CB mobile antennas and accessories, providing technical information and specifications. A listing of available antenna replacement parts is also included. Address: Winegard Industries, Inc., 3002A Winegard Dr., Burlington, IA 52601.

## MOTOROLA HEP CATALOG

The new, 184-page edition of the HEP Semiconductor Cross Reference Guide and Catalog is offered by Motorola. Includes replacement HEP semiconductors for over 60,000 discrete devices and IC's, with 198 new products. Covers discrete silicon and germanium power transistors, thyristors, small-signal FET's and bipolar transistors, zeners, digital IC's, voltage regulator and op amps. The Educator II microcomputer power supply kits are also included. Address: HEP/MRO Operations Headquarters, Motorola Products, Inc., PO Box 20902, Phoenix, AZ 85036.

## ADWAR VIDEO EDITING GUIDE

Adwar Video's 8-page guide offers advice on editing with half-inch tape and video cassette equipment. It begins with basic tips on avoiding quality losses and editorial confusion, and goes on to deal with scene edits; search and review; insert editing; and quality-enhancing modifications to VTR's. New video processing and portable field editing are also highlighted. Address: Adwar Video Corp., 100 5th Ave., New York, NY 10011.

## SYNC TAPE RECORDERS & PLAYERS

A 4-page brochure from Audiotronics describes its line of SYNC Cassette tape recorders and players. The units, designed as aids for synchronized presentations of recorded audio tape to slide/filmstrip projectors, include Model 144S, which plays both superimposed and separate track synchronized cassette tapes. Another, Model 152-2, features an automatic stop program. The brochure illustrates each device and describes the different sync functions. A specification chart allows for easy comparison of models. Address: Audiotronics Corp., 7428 Bellaire Ave., N. Hollywood, CA 91605.

## SPERRY MULTI-TESTER BROCHURE

Bulletin SP-73 (Issue B) from a.w. Sperry describes its line of V-O-Ma-T multi-testers. The 7-page pocket-sized brochure provides detailed specifications, applications information, and a list of special features for each tester. Accessories are also described. Address: a.w. Sperry Instruments, Inc., 245 Marcus Blvd., Hauppauge, NY 11787.

# ARE YOU READY TO RECEIVE THE WORLD?

## ALL NEW fully synthesized DR22 Receiver general coverage receiver from McKAY DYMEK \$995.



### FEATURES

- Shortwave, CB, ham radio, ships at sea, overseas phone calls, etc.
- Hi Fi, SWL, commercial, industrial and government uses.
- High level RF front end for excellent inter-modulation rejection and sensitivity.
- Crystal filters in first and second IF amplifiers, ceramic filter in third IF.
- Quartz crystal tuning accuracy at all frequencies, no crystals to buy.
- Built in power supply for 110-120 or 220-240 VAC switchable, 50-60 Hz.
- Solid state, phase locked, digital synthesis tuning.
- Extreme ease of tuning at all frequencies.
- No mechanical tuning dial error or backlash.
- Switch selectable 4 or 8 kHz RF bandwidth.
- Built in monitor speaker with external speaker connectors.

### SPECIFICATIONS

Frequency coverage:	50 kHz to 29.7 MHz, continuous. Digital synthesis in 5 kHz steps, fine tune for $\pm 5$ kHz.			
Reception modes:	AM, upper sideband, lower sideband, CW.			
Sensitivity for 10 dB S + N/N:	100 kHz	200 kHz	300 kHz-20MHz	20-29.7 MHz
	CW, SSB AM	10 $\mu$ V 30 $\mu$ V	2.0 $\mu$ V 6.0 $\mu$ V	0.5 $\mu$ V 1.0 $\mu$ V
RF Bandwidth:	-3dB @ 4 kHz or 8 kHz, and -60dB @ 10 kHz or 14 kHz			
Dimensions & Wt.:	(W x D x H) 17.5 x 14.5 x 5.1 inches. Shpg. Wt. 19 lbs.			

## DR22 features and specifications unmatched under \$2900.



**McKay Dymek Co.**  
675 N. Park Ave.  
P.O. Box 2100  
Pomona, CA 91766

Order factory direct, call toll free today. Exclusive rent/own plan available.  
Nationwide  
800/854-7769  
California  
800/472-1783

In Canada:  
**Great Metropolitan Sound Co. Ltd.**  
120 Eglinton Avenue East  
Toronto, Canada M4P 1E2  
Tel. 416/484-0800



# We've just made the impossible... a professional 3½ digit DMM Kit for less than \$60.



The Sabtronics Model 2000 is an impossible \$59.95! And that price still includes phenomenal accuracy, range and professional features.

This all-new bench/portable multimeter, reading to  $\pm 1999$ , has a basic accuracy of  $0.1\% \pm 1$  digit, and has five functions giving 28 ranges, 100% overrange and overload protection. So you know it's no toy!

Besides, what toys are as automatic as the 2000? With automatic overrange indication, automatic polarity, even automatic zeroing!

Yet the 2000 is easy to assemble. We send you all the parts you need, even the high-impact case. We also send you clear, step-by-step assembly instructions.

So you end up with a professional quality 3½ digit DMM for the unheard-of price of less than \$60. From Sabtronics, specialists in digital technology. And manufacturers of the impossible.

Order yours today!

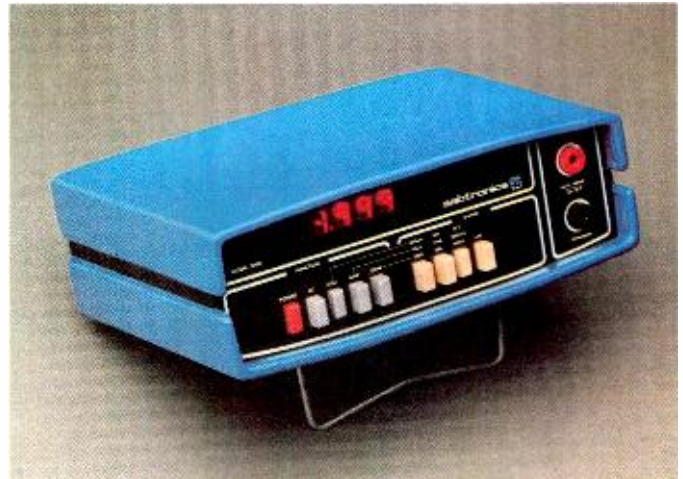

Made in U.S.A.

**sabtronics**   
INTERNATIONAL INC.

P.O. Box 64683 Dallas, Texas 75206 (214) 369-7310

## GUARANTEE:

Our guarantee to you; examine the 2000 DMM kit for 10 days. If you're not satisfied, return it unassembled for a full refund of purchase price.

## SPECIFICATIONS: (condensed)

DC volts in 5 ranges:  $100\mu\text{V}$  to 1000V.  
AC volts in 5 ranges:  $100\mu\text{V}$  to 1000V.  
DC current in 6 ranges: 10nA to 2A.  
AC current in 6 ranges: 10nA to 2A.  
Resistance in 6 ranges:  $1\Omega$  to  $20\text{M}\Omega$   
Input Impedance:  $10\text{M}\Omega$   
Display: 9mm (.36") LED.  
Power requirements: 4.5 VDC to 6.5 VDC  
(4 "C" cells - not included).  
Size: 8"W x 6.5"D x 3.0"H.  
(203W x 165D x 76H mm).

<b>To: Sabtronics International, Inc.</b>		PE7
P.O. Box 64683, Dallas, TX 75206		
Please send me _____ Sabtronics Model 2000 DMM kit(s) at \$59.95 each.	_____ subtotal	
Shipping and Handling, \$3.50 per unit*	_____ subtotal	
Texas Residents Add Sales Tax _____		
	<b>TOTAL enclosed</b> _____	
Name _____		
Street Address _____		
City _____		
State _____	Zip _____	
*USA only. Canada, \$4.50. All Other Countries, \$9.00		

CIRCLE NO. 45 ON FREE INFORMATION CARD

# Go after the best of everything.

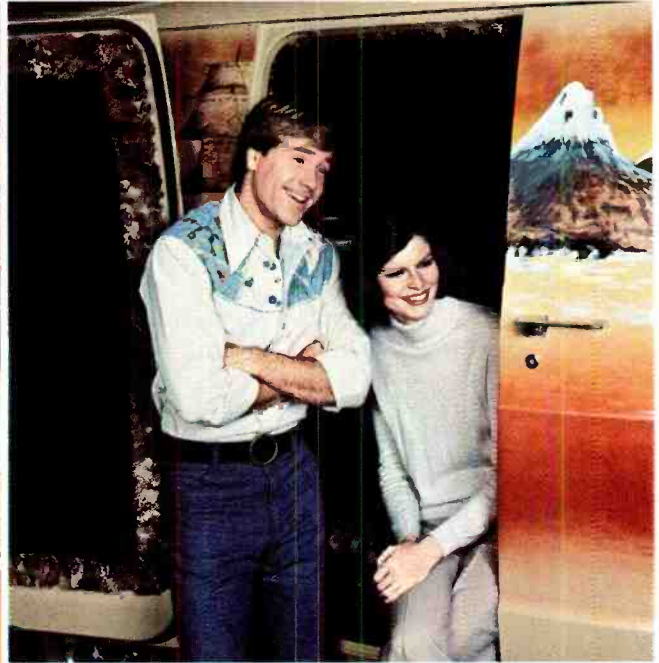

**Don't settle for less. Especially when it comes to electronics training... because everything else in your life may depend on it. That's why you ought to pick CIE!**

**You've probably seen advertisements from other electronics schools. Maybe you think they're all the same. They're not!**

**CIE is the largest independent home study school in the world that specializes exclusively in electronics.**

### Meet the Electronics Specialists.

When you pick an electronics school, you're getting ready to invest some time and money. And your whole future depends on the education you get in return.

That's why it makes so much sense to go with number one... with the specialists... with CIE!

### There's no such thing as bargain education.

If you talked with some of our graduates, chances are you'd find a lot of them shopped around for their training. Not for the lowest priced but for the best. They pretty much knew what was available when they picked CIE as number one.

We don't promise you the moon. We do promise you a proven way to build valuable career skills. The CIE faculty and staff are dedicated to that. When you graduate, your diploma shows employers you know what you're about. Today, it's pretty hard to put a price on that.

### Because we're specialists, we have to stay ahead.

At CIE, we've got a position of leadership to maintain. Here are some of the ways we hang onto it...

### Our step-by-step learning includes "hands-on" training.

At CIE, we believe theory is important. And our famous Auto-Programmed® Lessons teach you the principles in logical steps.

But professionals need more than theory. That's why some of our courses train you to use tools of the trade like a 5 MHz triggered-sweep, solid-state oscilloscope you build yourself—and use to practice troubleshooting. Or a beauty of a 19-inch diagonal Zenith solid-state color TV you use to perform actual service operations.

### Our specialists offer you personal attention.

Sometimes, you may even have a question about a specific lesson. Fine. Write it down and mail it in. Our experts will answer you promptly in writing. You may even get the specialized knowledge of all the CIE specialists. And the answer you get becomes a part of your permanent reference file. You may find this even better than having a classroom teacher.

JULY 1977

### Pick the pace that's right for you.

CIE understands people need to learn at their own pace. There's no pressure to keep up... no slow learners hold you back. If you're a beginner, you start with the basics. If you already know some electronics, you move ahead to your own level.

### Enjoy the promptness of CIE's "same day" grading cycle.

When we receive your lesson before noon Monday through Saturday, we grade it and mail it back—the same day. You find out quickly how well you're doing!

### CIE can prepare you for your FCC License.

For some electronics jobs, you must have your FCC License. For others, employers often consider it a mark in your favor. Either way, it's government-certified proof of your specific knowledge and skills!

More than half of CIE's courses prepare you to pass the government-administered exam. In continuing surveys, nearly 4 out of 5 CIE graduates who take the exam get their Licenses!

### For professionals only.

CIE training is not for the hobbyist. It's for people who are willing to roll up their sleeves and go to work... to build a career. The work can be hard, sure. But the benefits are worth it.

### Send for more details and a FREE school catalog.

Mail the card today. If it's gone, cut out and mail the coupon. You'll get a FREE school catalog plus complete information on independent home study. For your convenience, we'll try to have a CIE representative contact you to answer any questions you may have.

Mail the card or the coupon or write CIE (mentioning name and date of this magazine) at: 1776 East 17th Street, Cleveland, Ohio 44114.



Patterns shown on TV and oscilloscope screens are simulated.

## CIE Cleveland Institute of Electronics, Inc.

1776 East 17th Street, Cleveland, Ohio 44114  
Accredited Member National Home Study Council

**YES... I want the best of everything! Send me my FREE CIE school catalog — including details about troubleshooting courses — plus my FREE package of home study information.** PE-38

Print Name \_\_\_\_\_

Address \_\_\_\_\_ Apt. \_\_\_\_\_

City \_\_\_\_\_

State \_\_\_\_\_ Zip \_\_\_\_\_

Age \_\_\_\_\_ Phone (area code) \_\_\_\_\_

Check box for G.I. Bill information:  Veteran  Active Duty

**MAIL TODAY!**



# Stereo Scene

By Ralph Hodges

## INSTRUMENTS I HAVE MIKED

**I**'LL BE honest and admit I haven't actually made recordings of all the instruments to be mentioned here. Sometimes I have assisted others while they recorded them, or fulfilled the function of interested observer and general nuisance at a session. And in many cases, my experience with any given instrument is hardly what you'd call exhaustive. I have only recorded a large orchestra once, for example. (I found it rather easy; beginner's luck, no doubt.)

Every once in a while I pick up a piece of data about a particular instrument or recording situation that seems directly pertinent to the logistical problem of placing microphones. Sometimes this datum immediately suggests a solution to a miking situation; other times, after further examination, it proves totally irrelevant. In either case, the information is good to have.

The few really useful *general* guidelines for placing microphones—the various ways to achieve a good stereo pickup, the maintaining of acoustic separation between mikes when you're multi-tracking, etc.—are ably covered in the several good books on studio technique now available. The indispensable rules of mike placement—pulling the mikes back to increase the contribution of room reverberation, avoiding the close-up use of cardioid mikes because of various frequency-response errors it can introduce, and so on—are surely well known to anyone who has taken the slightest interest in live recording. However, approaching a specific instrument, or assemblage of specific instruments, gives almost everyone pause, I think.

How do you begin? What's the first logical move? Having a definite approach, whether it is vital to the proper capturing of the sound or not, is confidence-building for all of us, and that's what I mean to focus on here.

**Drums and Such.** The bass drum, surprisingly, is evidently a highly directional instrument. I first learned this when I happened on an unguarded bass drum in a rehearsal room at the New England Conservatory of Music. Ecstatic, I hefted the heavy lead-loaded mallet, poised it well to the side of the drum head, swung from the hips and shoulders, and . . . nothing! After a while I realized that the drum heads, apparently moving in tandem, were giving rise to an almost perfect acoustic cancellation around the periphery of the drum, and I was therefore standing in a huge node. Not so an innocent passerby outside, who met the enormous pressure wave as it swept up the corridor.

From time to time I've encountered audible evidence of this cancellation node at considerable distances from the drum itself. So if you're ever puzzled as to why your mike is missing the near-infrasonic throb you expect from a bass drum, try turning the drum so that one head faces the mike directly. Conversely, if you're getting too much throb, turn the drum so that you get a more edge-on perspective.

Tympani (kettledrums) present no comparable problems, although they have a well-known tendency to shake the stage floor and any microphone stands on it, which may cause vibration pickup. Sometimes a failure to get the sound you want from a kettledrum is attributable to the way in which it's played. Striking the drum in the exact center of its head produces a rather ridiculous, overdamped "boomp." As the mallet progresses out toward the edge, the drum acquires that characteristic baleful, almost metallic timbre. A light roll at the very edge produces almost a rustle. Tympani are played either with sponge (or perhaps a spongy synthetic) or felt mallets; the sonic results from each are quite different. Felt mallets are exceedingly rare nowadays, however. Some recordists apparently fear that it's impossible to properly balance the tympani with the rest of the orchestra unless they are recorded with a separate mike(s) and mixed in later. It's not.

Professional recordists take elaborate pains with a drum set (kick drum, tomtom, snare, and one or more cymbals), festooning it with microphones and stuffing towels in the kick drum. They all do it somewhat differently, so there are no general rules, except perhaps in the case of the cymbal. High-hat cymbals move considerably when they are played. If two differently placed microphones happen to be picking up the cymbal, and you intend to mix the outputs of these two mikes, you can wind up with a very weird Doppler effect that you may like, but which won't sound natural. (A two-mike pickup exaggerates the effect.) The best approach with a drum set is often a simple stereo pickup, balanced by ear.

**The Strings.** A celebrated concert violinist has said that a violin doesn't be-

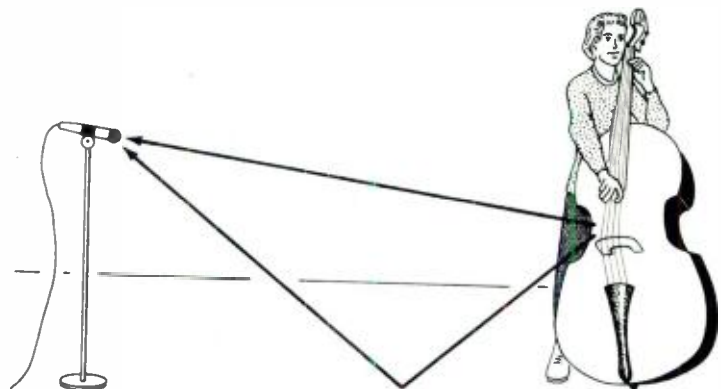

*Fig. 1. Phase differences between direct and reflected signals present a problem when miking a string bass or cello.*

# Go with Realistic<sup>®</sup> no matter how you go!

Realistic CB is for people on the move. Whether you're driving an unfamiliar road, hiking away from camp, or working in the field, reliability is a prime concern with your walkie-talkie or mobile set. So come to Radio Shack — leading the way in quality CB since 1959.



## walkin' and talkin'

Realistic's TRC-190 has exclusive range-boost: Grip the side-panels and your body adds extra signal power to the antenna system. Three watts input, with a high-low power switch to save on batteries during short-range use. Built-in automatic noise limiter, ceramic IF filter, IC audio circuitry — all for clean, low-interference sound. Adjustable squelch. Battery/RF meter. Built-in mike, speaker, plus a jack for optional push-to-talk mike. Power and antenna jacks so you can use the TRC-190 as a base or mobile station. Includes batteries, crystals for Channel 14, and you can add up to 5 more channels. Just 84.50\*.

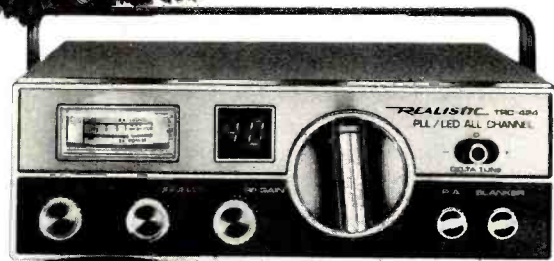

## ridin' and talkin'

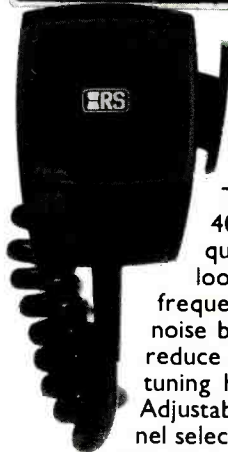

The TRC-424 is our finest 40-channel set, and the built-in quality is obvious. Phase-locked loop circuitry for ultra-precise frequency control. Switchable noise blander — the surest way to reduce pulse interference. Delta-tuning helps get off-channel signals. Adjustable RF gain and squelch. Channel selection is easier than ever with the large LED digital readout — one glance is all it takes. Add an external speaker and you've got a mobile public address system, too. with S/RF meter, dynamic plug-in mike, mounting bracket and power cables. First-class CB is even better when you can afford it! Get the new Realistic TRC-424. Just 169.95\*.



These two credit cards honored at most Radio Shacks.  
\*Prices may vary at individual stores and dealers.

SOLD ONLY WHERE YOU SEE THIS SIGN:

# Radio Shack<sup>®</sup>

A TANDY COMPANY • FORT WORTH, TEXAS 76107  
OVER 5000 LOCATIONS IN NINE COUNTRIES

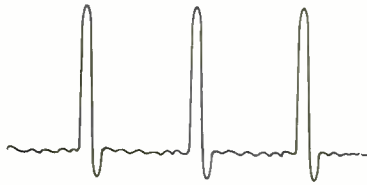

Fig. 2. Trumpet waveform miked on axis in anechoic chamber. From a Denon record made with pulse-code-modulation process.

gin to sound good until you're at least ten feet distant, so that the "garbage" has had a chance to fall away. Good miking advice too rarely taken. At their loudest, massed violins are never very loud compared with the real heavy-weights in a symphony orchestra. In their upper registers, however, they have a penetrating tone that will often rise above the most astounding ruckus. If one balances too much in favor of the violins (a fault of many commercial recordings), the aforementioned penetrating tone will give the feeling of going right in to your eardrums.

For a natural-sounding recording, restraint in the handling of violins is admirable. They should not *always* be audi-

bly strong, and they should have a certain fragility, even thinness, of tone. Where possible, give them a chance to balance naturally with the rest of the orchestra. And don't ride gain on them to any excess.

The string bass, when miked from any distance, encounters problems from reflecting surfaces. Figure 1 shows how the first reflection from the floor bounces up to the microphone, causing a complex pattern of reinforcements and cancellations, all wavelength-dependent. A solid wall behind the instrument will produce much the same thing. When you're miking several basses, as in an orchestra, the most productive approach is usually to ignore these complications and press on regardless, hoping the randomness factor will solve your problems for you. For a single bass, as in a jazz combo, it's a frequent practice to mike the instrument quite closely, which will tend to get rid of the room and, hence, the reflections. Electric basses are almost invariably miked closely (at the amplifier's speaker), or even fed directly into the recorder, bypassing the amp.

**Woodwinds.** It may be obvious, but the proper place to mike a woodwind is *not* at the bell of the instrument where you'd expect most of the sound to emerge. In general, the right place for the mike is directly in front of the musician, as if he were going to speak into it. Usually he will play so that the bell is pointing toward the floor (or, in the case of the bassoon, toward the ceiling). This is fine. Move the mike(s) closer or farther away as appropriate, but don't try to get too close.

**The Brass.** The trouble with the brass is eloquently demonstrated by Figure 2, a drawing of an oscilloscope trace made by a trumpet in full cry. The vicious spikiness of this waveform will never be revealed by any VU meter, and yet it has to be taken into account because any significant tampering with this crest will be audible. In jazz clubs you'll often see a trumpet played directly into a microphone. Apparently, the sound-reinforcement system can usually take this onslaught in stride. But it's murder on tape. I tried to record this trumpet waveform with a good cassette machine. Finally, I had to drop the recording level down to the point where the meters (peak reading) were barely stirring, and still the waveform peaks were appreciably abbreviated.

Your defense against the brass, which can easily overload microphone pream-

plifiers and the built-in preamps of condenser mikes as well as tape, is to get away and off-axis. Discourage brass players from pointing their instruments directly at the microphone or put the mike where they can't conveniently aim at it. Even then, a French horn, which projects rearward in line with the player's elbow, and which often has his fist stuck up into its bell, can cause trouble. Distance is your only recourse then, and here it usually sounds good.

**Piano.** Don't we wish we could make consistently good piano recordings. The trouble is, the instrument is too big to close-mike with one microphone, and when we try to mix the output of several microphones there is inevitable trouble with interference. Other complications intrude as well.

Presently, for grand piano, I favor the stereo pickup shown in Figure 3. Note that the two mikes (cardioids or omnidirectional, or a coincident pair embracing a moderate angle) are aimed down into the piano's case approximately in line with the instrument's lid. This theoretically avoids reflections from the lid



Fig. 3. This mike positioning for piano avoids pickup of direct reflections from bottom of lid.

(which I believe to be detrimental to clarity) from reaching the mikes directly. The mikes are brought forward or pulled back as necessary to provide that right touch of room reverberation.

There are many other ways of recording a piano that I'm itching to try as soon as I get the chance. Some of these are described in a Shure Brothers' publication, "The Music-Maker's Manual of Microphone Mastery." Although intended for sound reinforcement at live performances, you can extrapolate its advice into a recording situation with relative ease. It's free. (Shure Brothers, 222 Hartrey Ave., Evanston, IL 60204.)

**The Sound Field.** All of us are intrigued by the examples of recording

COMING UP IN  
THE AUGUST

## Popular Electronics®

BUILD THE "CABONGA"  
ELECTRONIC DRUMS  
SYNTHESIZER

MEASURE CAMERA SHUTTER  
SPEED DIGITALLY

HOW TO PROTECT  
MOS DEVICES  
DURING INSTALLATION AND  
SOLDERING

BUILD THE TVT-6: A LOW-COST  
DIRECT VIDEO  
DISPLAY—PART 2

### TEST REPORTS

Heath AR-1515 Digital-Readout  
Stereo FM/AM Receiver  
Thorens TD-126C Turntable  
President "Washington"  
40-Channel CB Base Station

professionals and hope to emulate their results in time. Here's a piece of advice offered by several recording professionals I have talked to: Forget it! A professional recording session costs multi-dollars with every tick of the clock. There is scarcely time for aesthetic considerations or lengthy consideration of microphone repositioning. Ideally, a professional recordist would like to capture every instrument in complete isolation and later mix all the instruments together (along with appropriate reverberation) at his leisure. Hence he turns to the multi-miking approach, which by-and-large sacrifices all the good things—depth, spaciousness, authentic perspective—of a simple stereo pickup. If you don't believe me, read John Woram's book, *The Recording Studio Handbook* (Saga-more Publishing Co., 1120 Old Country Road, Plainview, N.Y.) for some frank discussion of the subject.

If you're an amateur recordist, and time is not pressing, you have the luxury of being able to attempt a miking of the "sound field"—the whole musical event, balanced naturally, and presented to the ultimate listener with startling realism and an impressive stereo panorama. It will not sound like a professional mix on one of the big labels, but if you're famil-

iar with the sound of live music you'll appreciate that it sounds, in many respects, better. Above all, have a good time, and fulfill yourself while inching toward capturing the full realism of the music. Even if the final goal cannot be wholly reached, you'd be surprised at how forgiving the human ear is.

#### More on Decontaminating Discs.

Dr. Bruce Maier, president of Discwasher, has favored us with some comments on the recent "Decontamination Squad" column (May 1977) that I'd like to share.

He observes that "It has been our experience that once you begin wet-playing a record you can never, never play the record dry again. After two wet plays, playing the record dry will blow you out of the room with surface noise.

"The reason is fairly complex," says Dr. Maier, offering some research conclusions concerning wet playing of discs:

(1) Wet playing causes an intense disequilibrium in temperatures between the vinyl at the stylus pressure point and the liquid layer on the disc surface. This temperature differential causes (by actual electron microscopy investigation) disorientation or cracking or injury to the surface molecular structure, just as you

might fracture a glass cup if you heated it when it contained cold water.

(2) Wet playing allows an interface layer of liquid to extract tiny amounts of surface stabilizer into a slurry. When this slurry is allowed to dry back onto the surface, there is a concomitant lack of stabilizers in the right place plus little globules in the wrong places.

(3) Wet playing literally shorts out some cartridges by wicking up the cantilever and causing the generator assemblies of some cartridges to corrode very quickly.

Dr. Maier disagrees with my suggestion that record-cleaning substances and lubricants can be evaluated by treating just 180 degrees of a record side and then listening for any difference between the two halves. He points out (quite rightly, I suspect) that the transition points between the halves will always be audible. Had my description been more complete, it would have been clear that the evaluator should listen for any differences between the two halves *other* than the noise occurring at the actual transition points, of which there should be two per revolution. As I suggested, the slower the playing speed, the easier it will be to distinguish the transition points from the rest of the disc surface. ◇

## Treat yourself to a new direct reading DVM today.



### DVM35

POCKET PORTABLE  
ANALOG REPLACEMENT

3-digit, 1% DCV  
Battery or AC

Only \$134



### DVM36

LAB ACCURATE  
POCKET PORTABLE

3½ digit, .5% DCV  
Battery or AC

Only \$158



### DVM32

BENCH & FIELD MASTER

3½ digit, .5% DCV  
Battery or AC

Only \$198



### DVM38

"PRIME" STANDARD AT  
YOUR FINGERTIPS

3½ digit, .1% DCV  
Auto-Ranging

Only \$348

## A COMPLETE LINE OF DVMs TO FILL YOUR EVERY NEED OR WANT.

You can be sure more times in more circuits, under more adverse conditions, with greater versatility, accuracy, and meter protection than any other digital multimeters on the market today; and for less money, too. 10 Day Free Trial: Try any of these famous DVMs for 10 days. If the DVMs in use don't prove exactly what we say, return them to your Sencore FLPD Distributor.

# SENCORE

JULY 1977

CIRCLE NO. 46 ON FREE INFORMATION CARD

Want more information? We would like to tell you all about the Sencore DVMs by sending you a 24-page Sencore News, a six-page brochure, and the name of your nearest Sencore Distributor today . . . simply write or circle reader's service number.

3200 Sencore Drive, Sioux Falls, SD 57107

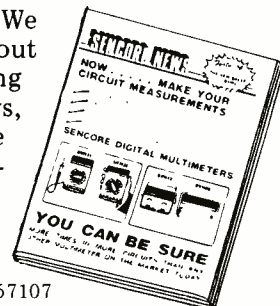

# RC CIRCUIT QUIZ

BY ROBERT P. BALIN

Resistance-capacitance circuits are not always as simple as they might seem. For example, in dc circuits, the charging time of the capacitor, as controlled by the resistance, is used to determine oscillator frequency.

In ac circuits, the RC combination is used as a frequency-sensitive voltage divider or filter. And, in circuits involving both dc and ac components, it is used to block the dc component. Other examples could be given.

However, whenever the RC circuit has a different application, it seems to acquire a different name for its function. To test your knowledge of RC circuits, see if you can match the circuits (A to J) with the functions (1 to 10).

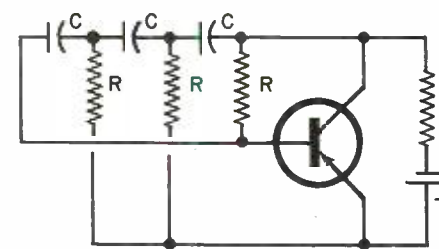
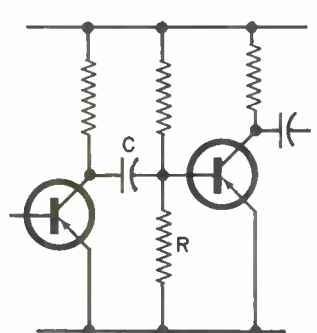
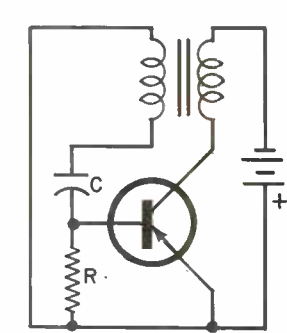
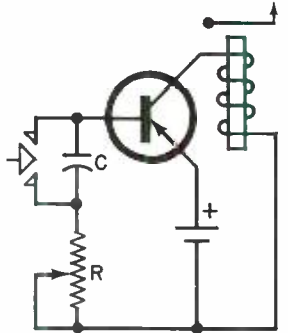
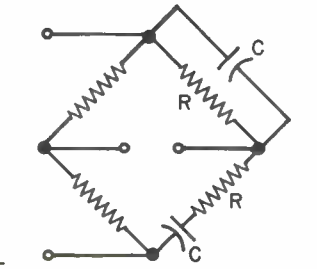
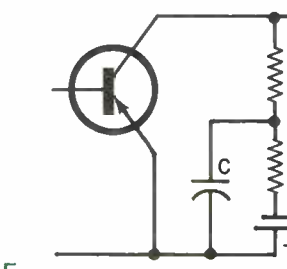
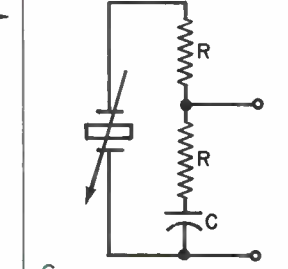
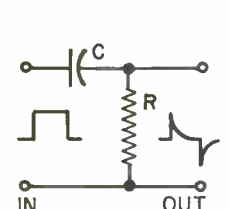
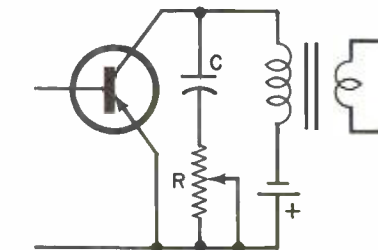
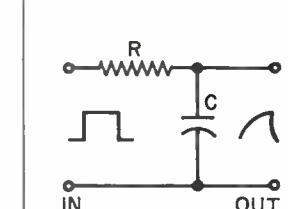
<ol style="list-style-type: none"> <li>1. Band Suppression Circuit _____</li> <li>2. Coupling Circuit _____</li> <li>3. Decoupling Circuit _____</li> <li>4. Differentiator _____</li> <li>5. Equalizer _____</li> <li>6. Frequency Control _____</li> <li>7. Integrator _____</li> <li>8. Phase Shifting Circuit _____</li> <li>9. Timing Control _____</li> <li>10. Tone Control _____</li> </ol>	 <p>A.</p>	
 <p>B.</p>	 <p>C.</p>	 <p>D.</p>
 <p>E.</p>	 <p>F.</p>	 <p>G.</p>
 <p>H.</p>	 <p>I.</p>	 <p>J.</p>

ANSWERS: 1-E, 2-B, 3-F, 4-J, 5-G, 6-C, 7-H, 8-A, 9-D, 10-I



# Ability.

## It Comes Naturally With The Altair™ 8800b

The Altair 8800b from MITS: the second generation design of the microcomputer that started it all. The mainframe that has the ability everyone is demanding from microcomputers today:

### Expand-ability:

The Altair 8800b power supply and one piece 18-slot motherboard allow efficient and easy expandability for memory and I/O options. All Altair PC boards are designed to give you maximum capability/lowest power usage possible per board. This means that for each slot used you get more features and require less power, than with any of the "off-brand" Altair-bus-compatible boards.

Whether you buy an entire system up front or choose to expand gradually, it's easy to get the configuration you need with the complete family of Altair peripheral equipment, including floppy disk, line printer, audio cassette record interface, A/D converter, PROM programmer, serial and parallel I/O boards,

choice of four different memory boards and many others.

### Reli-ability:

The unique design features of the Altair 8800b, which have set the standard for the microcomputer industry, make it the most reliable unit of its kind. The Altair 100-pin bus, the now-standard design used by many imitators, has been "standard" all along at MITS. The unique Front Panel Interface Board on the Altair 8800b isolates and filters front panel noise before it can be transmitted to the bus. The all-new CPU board utilizes the 8080A microprocessor, Intel 8224 clock generator and 8216 bus drivers.

### Flex-ability:

Meeting the diversified demands of an ever-increasing microprocessor market requires flexibility: not just hardware flexibility but

software flexibility as well. MITS software, including the innovative Altair BASIC language, allows the full potential of the Altair 8800b computer to be realized.

8K ALTAIR BASIC has facilities for variable length strings with LEFT\$, RIGHT\$, and MID\$ functions, a concatenation operator, and VAL AND STR\$ functions to convert between strings and numbers.

Extended ALTAIR BASIC allows integer single and double precision variables, automatic line numbering and renumbering, user-defined string functions, PRINT USING for formatted output and a powerful EDIT command for editing program files during or after entry. Extended statements and commands include IF . . . THEN . . . ELSE, LIST and DELETE program lines, SWAP variables and Trace On and Off for debugging.

Disk ALTAIR BASIC has all the features of Extended BASIC with the additional capability to maintain sequential and random access disk files. Utilities are provided for formatting disks and printing directories.

In all versions of ALTAIR BASIC you get the ease and efficiency of BASIC for the solution of real world problems.

Package II, an assembly language development system for the Altair 8800b, includes system monitor, text editor, assembler and debug.

### Afford-ability:

Prices for the Altair 8800b start at \$840.00 for a kit and \$1100.00 for an assembled unit (all documentation included).

For a complete listing of prices on all Altair products and a free brochure, contact:

MITS, Inc.  
2450 Alamo S.E.  
Albuquerque, N.M. 87106  
(505) 243-7821

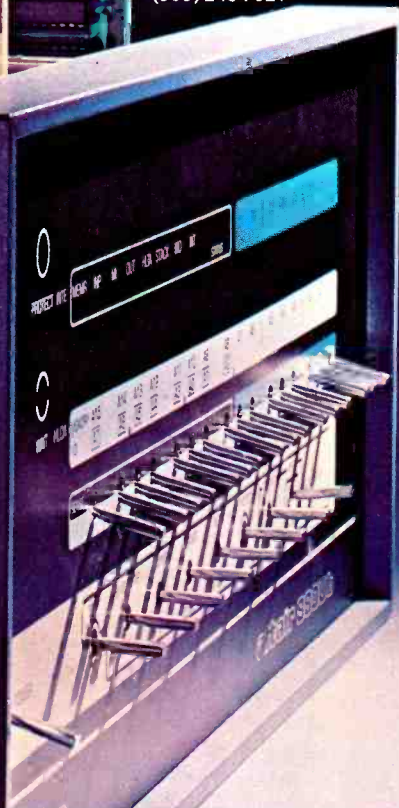
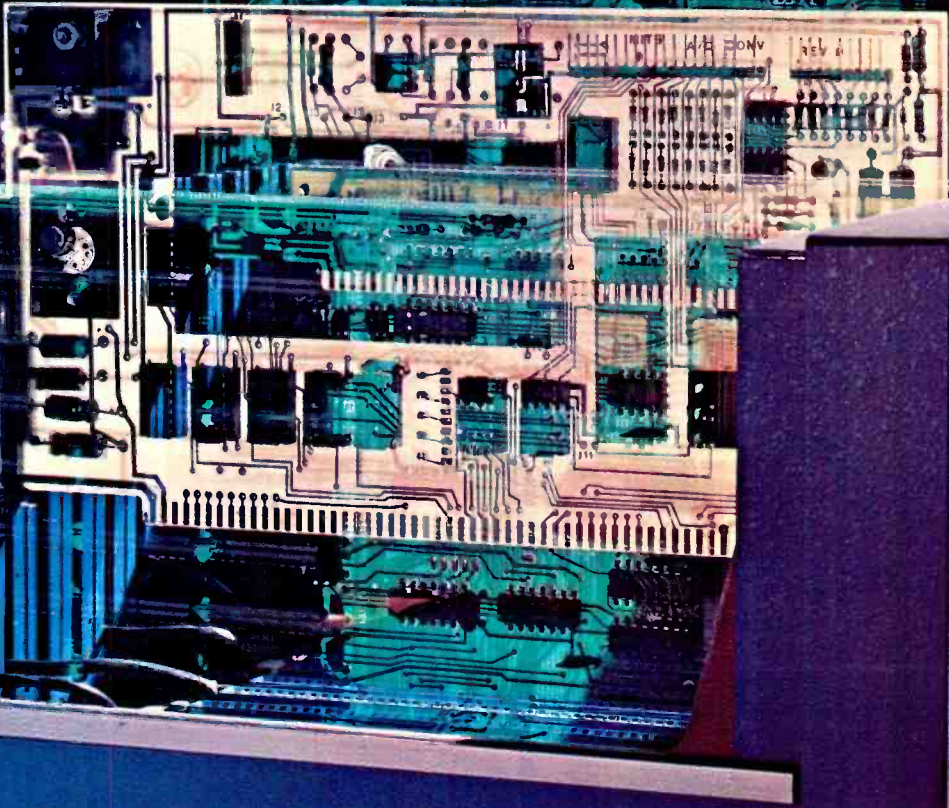
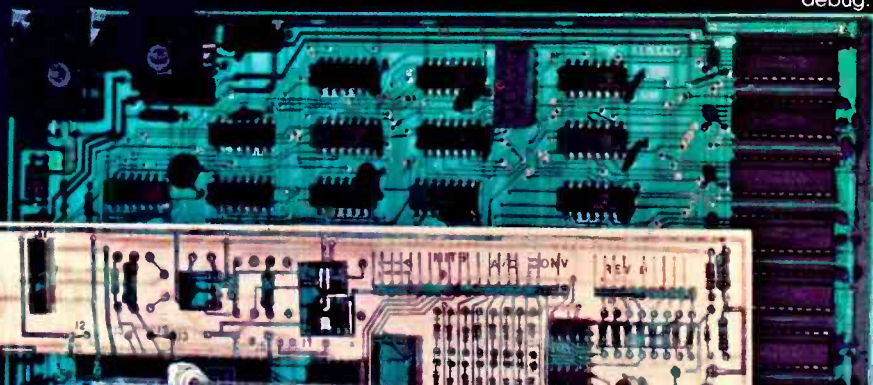

# If you can't go to college for your career in electronics -read this!

**CREI brings college-level training  
to you with eight educational  
advantages, including special  
arrangements for engineering degrees**

The best way to qualify for top positions and top pay in electronics is obviously with college-level training. The person with such training usually steps more quickly into an engineering level position and is paid considerably more than the average technician who has been on the job several years.

A regular college engineering program, however, means several years of full-time resident training—and it often means waiting several years before *you can even start your career*. This, of course, is difficult if you must work full time to support yourself and your family.

If your career in electronics is limited without college-level training, take a look at the advantages a CREI home study program can offer you.

## **1. Convenient Training**

CREI brings the college to you. Through the convenience of home study, you receive exactly the same level of training you will find in any college or university offering programs in electronic engineering technology. With CREI, however, you can “go to college” whenever you have spare time at home or on the job.

## **2. Specialized Programs**

With CREI, you enjoy the advantage of *specialized* training. That is, your program will include only those courses directly applicable to your career in electronics. We omit such courses as English, social studies and other subjects, which are usually required in resident schools. Therefore, with CREI, you move ahead faster to the more interesting and useful part of your training.

## **3. Practical Engineering**

CREI programs give you a *practical engineering* knowledge of electronics. That is, each part of your training is planned for your “use on the job.” By using your training, you reinforce the learning process. And by demonstrating your increased knowledge to your employer, you may qualify for faster career advancement.

## **4. Engineering Degrees**

CREI offers you a number of special arrangements for earning engineering degrees at recognized colleges and universities. You can earn college credit while you are taking your CREI program or apply later, whatever is best for your career plans.

## 5. Unique Laboratory

Only CREI offers you the unique Electronic Design Laboratory Program. This complete college laboratory makes learning advanced electronics easier and it gives you extensive practical experience in many areas of engineering, including design of electronic circuits. No other school offers this unique program. It is a better "Lab" than we have found in many colleges. And the professional equipment included in the program becomes yours to keep and use throughout your professional career.

## 6. Wide Program Choice

CREI gives you a choice of specialization in 14 areas of electronics. You can select exactly the area of electronics best for your career field. You can specialize in such areas as computer electronics, communications engineering, microwave, CATV, television (broadcast) engineering and many other areas of modern electronics.

## 7. Prepared by Experts

Experts in industry and technical organizations of government develop CREI programs. Each part of your training is developed by a recognized expert in that area of electronics. That means you get the most up-to-date and practical instruction for your career.

## 8. Industry Recognition

That CREI training is recognized by industry and government is evident from the fact CREI provides training to advanced technical personnel in over 1,700 technical organizations. Many subsidize the training of their employees with CREI. If there is any question about the advantages of CREI training for you, ask your employer or any engineer to evaluate the outline of a CREI program for you.

## Other Advantages

Of course, there are many other advantages to CREI training. For example, throughout your training, CREI's staff gives you personal instruction for each step of your program. And in many industrial areas, both in the U. S. and abroad, CREI Field Service Representatives provide a number of important personal services for your training and your career.

## FREE Book

There isn't room here to give you all of the facts about career opportunities in advanced electronics and how CREI prepares you for them. So we invite you to send for our free catalog (if you are qualified). This fully illustrated, 80 page catalog describes in detail the programs, equipment and services of CREI.

## Qualifications

You may be eligible to take a CREI college-level program in electronics if you are a high school graduate (or the true equivalent) and have previous training or experience in electronics. Program arrangements are available depending upon whether you have extensive or minimum experience in electronics.

Send for this **FREE Book** describing your opportunities and CREI college-level programs in electronics

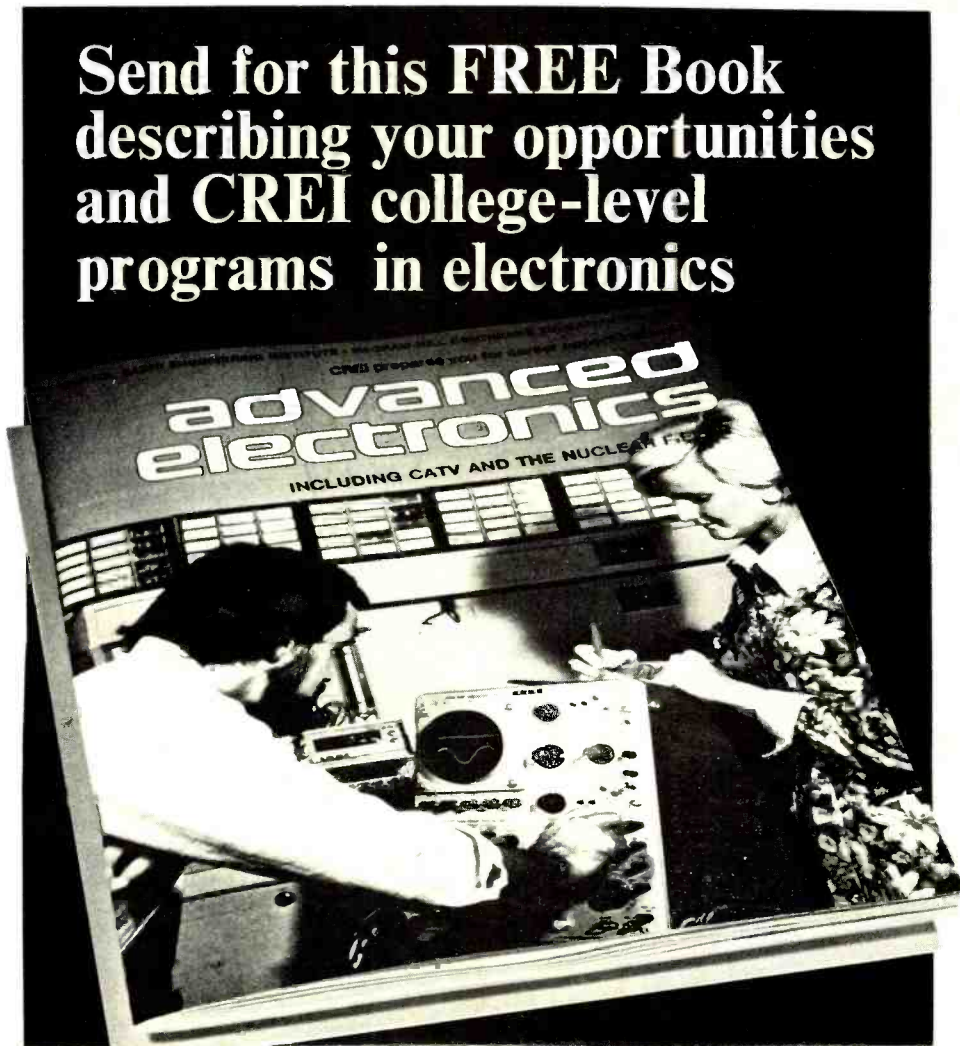

Mail card or write describing qualifications to

**CREI** **CAPITOL  
RADIO  
ENGINEERING  
INSTITUTE**

McGraw-Hill Continuing Education Center  
3939 Wisconsin Avenue Northwest  
Washington, D.C. 20016

Accredited Member National Home Study Council

## GI Bill

*CREI programs are approved for training of veterans and servicemen under the G.I. Bill.*



## Audio Reports

### NOISE FILTERING FOR HI-FI

From high fidelity's earliest days, audiophiles have faced the problem of dealing with the various effects that we lump together under the heading of "noise." Noise is defined in the current ANSI standard as "unwanted disturbances super-imposed upon a useful signal that tend to obscure its information content." In the case of sound reproduction systems, this is modified to exclude harmonic, subharmonic, and intermodulation distortion products, and flutter and wow.

For most hi-fi listeners, noise falls into two broad categories: high-frequency hiss or scratch and low-frequency noises, such as rumble or hum. All are essentially steady-state effects, though they are usually random in nature. Another category includes impulse noise, composed of discrete pulses that occur at regular or irregular intervals, such as automobile-ignition interference and record ticks or pops.

To some degree, all of these forms of noise are present at all times in reproduced music, and eliminating or reducing their objectionable qualities has been the goal of many talented engineers for decades. No panacea has yet been discovered for noise, but by attacking the problem on several fronts, it has been possible to greatly reduce its audible effects.

The basic problem is that the noise energy and the music program occupy the same frequency spectrum, often simultaneously. Noise may extend well beyond the program bandwidth or, as in the case of power line hum, may occupy a small discrete portion of the spectrum. The more successful noise-reduction systems operate by virtue of achieving a greater reduction of noise than of program content, though some sacrifice of the latter is unavoidable.

The simplest, oldest, and least-effective anti-noise technique is to use fixed low-pass or high-pass filters to attenuate noise energy outside the main spectrum of the program bandwidth. If bandwidth is limited (as in the case of 78-rpm records or AM radio) it is possible to cut off most of the hiss with little loss of program quality. The shellac-based 78-rpm phonograph records were noted for their high "scratch" level, and a fixed filter cutting off above 3000 or 4000 Hz could be very helpful. Since turntable rumble was concentrated at frequencies below 100 Hz, a filter cutting off at that frequency could clean up the bass reproduction without too much loss of content.

The wider bandwidth of LP records was fortunately (and not accidentally) combined with low-noise vinyl record materials so that the full frequency range could frequently be enjoyed without too much disturbance from noise. Nevertheless, even as records and playback systems were improved, one's enjoyment of a wide-range recording was increasingly likely to be marred by extraneous noises. The fixed filter, being by far the cheapest "cure," continued to be offered as a solution to this problem, although it usually solved nothing at all.

Unlike the situation with 78's, the recorded material on an LP disc usually had useful energy up to 10,000 Hz or higher. Cutting off the noise above 10,000 Hz was of no help, since the change could not be heard by most people. Cutting off an octave lower, at 5000 Hz, might produce a noticeable lowering of the hiss level, but would certainly dull the program to an undesirable degree. The low-frequency noise problem was much less severe. For one, most of it was under the listener's control, in the sense that using a better turntable would eliminate much of the rumble at its source. Since most speaker systems have considerably reduced output at very low frequencies, only the unfortunate combination of a poor turntable, good speaker system, and high listening level was likely to result in a disturbingly high rumble level.

We have been referring to filter action as "cutting off" at a certain frequency. If filters worked that way, they would be much more effective. Unfortunately, a real filter, the simple type used in home entertainment electronic products, attenuates the response gradually, on both sides of its cutoff frequency. Most filters used in hi-fi amplifiers or receivers have a cutoff slope of 6 dB/octave (which requires only a single resistor and capacitor, hence its popularity). The effect of the filter begins more than an octave below the cutoff frequency, at which point its response is down 3 dB. By the time the frequency has gone an octave or more above the cutoff point, the rate of attenuation approaches its ultimate value of 6 dB with each octave increase (doubling of frequency).

In fact, the typical filter response curve is virtually identical to the treble tone control response with the control set to minimum. The filter switch is thus a convenient substitute for the tone control—but it is

no more effective as a noise-reducing device! A similar situation exists at the low frequencies, with many rumble filters beginning to cut the frequency response as high as 150 or 200 Hz. Fortunately it is possible, by selecting a cutoff frequency between 50 and 100 Hz, to make a worthwhile reduction in rumble without undue loss of program content because most recorded music has little energy below 100 Hz.

For better results, filters can be made with a sharper cutoff action so that a greater proportion of noise can be removed without harmful effects on the program. It is not too expensive to build filters with a 12 dB/octave slope, and in some active filter configurations the cutoff "knee" can be made much sharper so that program material will be less affected. Some of the better amplifiers and receivers do have such filters, and if their cutoff frequencies are well chosen (and preferably selectable) they can be useful.

Nevertheless, no fixed filter, no matter how steep its attenuation slope or where its cutoff action begins, can do a really effective job of noise reduction without impairing program quality. A number of ingenious dynamic filters have been developed in which the attenuation and the frequency at which the filter becomes effective are controlled by the program itself. The psychoacoustic phenomenon of masking is used in the design of these filters. High-frequency hiss is audible only in the absence of high-frequency program content; when the music is loud or contains appreciable high-frequency energy, the hiss is masked and cannot be heard. Similarly at the low

end, rumble cannot be heard when the program is loud or contains strong low-frequency material.

It would seem logical to use a high-cut (low-pass) filter whose operating frequency and/or slope are controlled by the program so that its filtering action occurs only under conditions that allow the hiss to be heard. This logic is correct, but there is the problem of selecting the dynamic characteristics, including the basis for filter operation, its actual response characteristics, and the rate of attack and decay of the filtering. Failure to do this correctly will result in audible swishes and other clues that the filter is working; a noise reduction device whose action can be heard is not of much value.

There are a handful of add-on noise-reduction systems that truly do a fair-to-good job of minimizing noise without any noticeable effect on program material. A new NR accessory, announced by SAE recently, even claims to remove ticks and pops from record reproduction. But these are *accessories*.

As strongly implied, the fixed filters built into most receivers and amplifiers, especially those having 6-dB/octave slopes, are virtually worthless as noise-reduction devices. In spite of this, many receivers and amplifiers above the lowest price ranges include some sort of "filter," presumably because their designers feel that it is expected of them. Perhaps a counter-trend is under way, since we noted with interest that Radio Shack's deluxe Realistic Model STA-2000 receiver, reviewed in this issue, eschews *all* filters. We did not miss them for a moment. ◇



## REALISTIC MODEL STA-2000 STEREO RECEIVER

*Company's top-of-the-line, 75-W/channel receiver boasts notable features and smooth performance.*

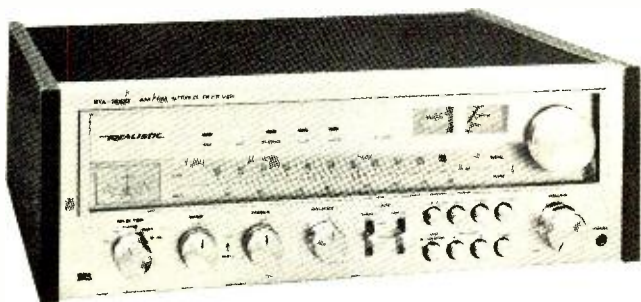

Radio Shack's Model STA-2000 heads the "Realistic" brand's list as its top AM/stereo FM receiver. Its amplifiers are rated to deliver 75 watts/channel into 8-ohm loads at less than 0.25% total harmonic distortion (THD) from 20 to 20,000 Hz. The front panel is satin-finished aluminum with matching control

knobs and switch buttons. A large clear glass window, behind which the dial scales are angled back for better visibility, dominates the upper two-thirds of the panel. All controls, except the large tuning knob, are located on the lower third of the panel. The single tuning meter indicates center-of-channel for FM and relative signal strength for AM.

The receiver measures 19"W × 16½"D × 6¾"H (48.3 × 41.9 × 17.5 cm)

and weighs 40 lb (18.2 kg). Supplied with genuine walnut-finished end plates, the receiver is catalog priced at \$499.95.

**General Description.** A row of colored indicator lights above the dial scales illuminate to identify the selected input (AM, FM, PHONO, AUX1, AUX2) and when a stereo FM station is being received. Two small meters above the dial scales monitor the output power of the audio channels. The meters are calibrated at decade intervals from 0.1 to 100 watts, based on 8-ohm loads.

In addition to the input SELECTOR switch, there are BASS and TREBLE tone controls with 21 detented positions, including a FLAT setting at the center, and a BALANCE control with a center detent. The volume control operates in steps with 41 detented positions. Tone controls are concentric, permitting individual channels to be adjusted.

Eight pushbutton switches are arranged in a two-row matrix. The upper

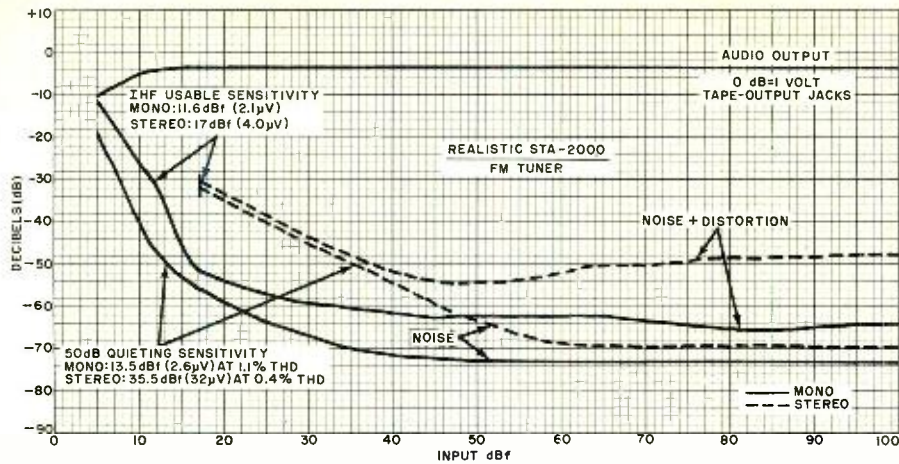

Noise and sensitivity curves for FM section of Realistic receiver.

row is for switching in and out an FM MPX FILTER (reduces noise in stereo reception by partially blending the channels at higher audio frequencies), FM MUTE circuit, MONO/STEREO mode, and LOUDNESS compensation. The lower row of switches contains switching for a 20-dB audio ATTENUATOR (for temporary interruption), A and B SPEAKERS selection, and POWER. Two lever switches are provided for controlling the tape recording functions for two tape decks. The DUBBING switch crossconnects the decks for copying a tape from either deck to the other or connects both decks for recording from the program source to which the SELECTOR switch is set. The MONITOR switch connects the playback from either deck or the selected source to the receiver's audio amplifiers.

On the rear apron of the receiver are insulated binding posts for the two pairs of speaker systems that can be accommodated. (The connectors are exceptionally easy to use and do not require the wire to be wrapped around the posts.) Their functions are duplicated by two pairs of phono jacks for speaker system cables equipped with phono plugs. The various signal input and output connectors are phono jacks, and the two sets of tape recorder connectors are duplicated in DIN sockets. Two sets of auxiliary outputs are also included. Preamplifier outputs and power amplifier inputs are brought out to separate phono jacks that are joined together by removable jumper links. There are antenna terminals for 75- and 300-ohm FM antennas as well as a wire-type AM antenna. There is also a fully hinged and pivoted AM ferrite rod antenna. The line cord has a capacitive coupling clip that can be connected to one of the 300-ohm FM antenna inputs so that the power line can be used as an antenna in strong sig-

nal areas. One of the two accessory outlets on the rear apron is switched.

**Laboratory Measurements.** During the one-hour preconditioning of the amplifier at one-third rated power, the metal cover above the output transistors became quite warm, but the receiver as a whole remained cool. The outputs of the amplifiers, when driving 8-ohm loads at 1000 Hz, clipped at 90 watts/channel. Into 4- and 16-ohm loads, the output was 106 and 55 watts, respectively.

The 1000-Hz THD was less than 0.01% from 0.1 to 20 watts. It increased very slowly to 0.05% at 80 watts. The IM distortion was between 0.03% and 0.1% from 0.1 to 80 watts. At outputs of a few milliwatts, the IM distortion increased to several tenths of a percent.

At the rated 75-watt output, the distortion was between 0.02% and 0.05% over most of the audible-frequency range and never exceeded 0.09%. It was much the same at lower output powers, measuring about 0.01% at middle frequencies and from 0.1% to 0.14% at 20,000 Hz. Through the Aux input, the amplifier's sensitivity was 50 mV for a reference 10-watt output with a 74-dB S/N ratio. The phono sensitivity was 0.83 mV with a 66-dB S/N ratio. The

phono input at 1000 Hz didn't overload until a very high 220 mV was reached.

The bass tone control had a variable turnover frequency. It provided a moderate boost or cut below 100 Hz at partial settings, with negligible effect at higher frequencies. The turnover frequency increased to about 500 Hz at the control's extremes. The treble control characteristics were hinged at about 3000 Hz. RIAA phono equalization was flat within  $\pm 0.5$  dB from 60 to 20,000 Hz, dropping slightly at lower frequencies to  $-2$  dB at 30 Hz. Because the phono preamplifier stage effectively isolates the cartridge from the feedback components, the phono response was completely unaffected by the cartridge inductance.

The loudness compensation boosted only the low frequencies as the volume control setting was reduced. The boost at normal listening levels was slight, avoiding the unnaturally heavy sound that is typical of most loudness-compensation systems. The power meters provided only a rough approximation of the actual output, with typical errors being 50% to 100%. They had a fairly slow response time and were well damped, following average program levels to our satisfaction.

The FM tuner section had an IHF sensitivity of 11.6 dBf (2.1  $\mu$ V) in mono and 17 dBf (4.0  $\mu$ V) in stereo. The steep limiting curve yielded 50 dB of noise quieting at only 13.5 dBf (2.6  $\mu$ V) in mono, with 1.1% THD, and 35.5 dBf (32  $\mu$ V) in stereo, with 0.4% THD. The 1000-Hz distortion was about 0.08% in mono and 0.32% in stereo at a 65-dBf (1000  $\mu$ V) input. The stereo THD, with L - R channel modulation, was 0.75% at 100 Hz, 0.1% at 1000 Hz, and 0.2% at 6000 Hz. The S/N was 72.5 dB in mono and 69 dB in stereo.

The FM frequency response had a slight dip in the midrange and high-frequency response, plus the usual drop at 15,000 Hz due to the multiplex pilot carrier filter. Overall, the response was still within  $\pm 1$  dB from 30 to 12,500 Hz,

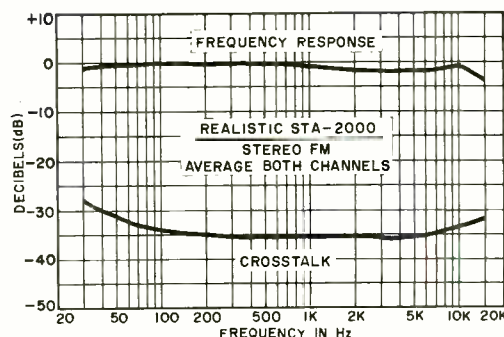

Frequency response and crosstalk averaged for both channels in stereo FM.

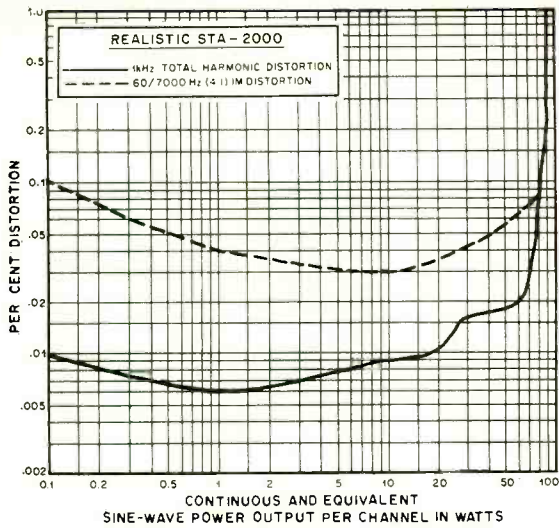

Total harmonic distortion and 60/7000-Hz distortion.

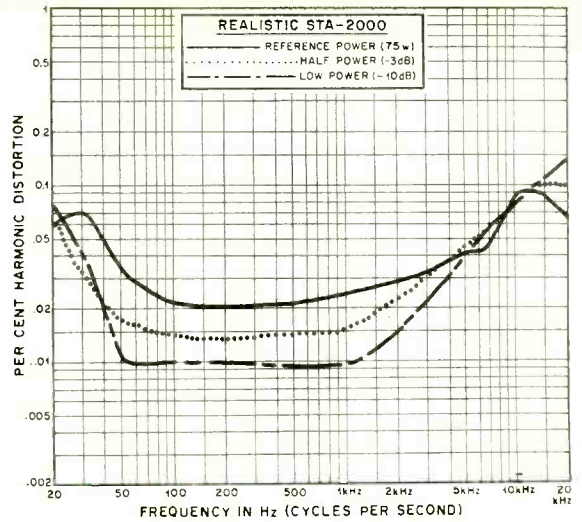

Harmonic distortion at three power levels.

down about 3.7 dB from midrange levels at 15,000 Hz. The stereo channel separation was very uniform, about 35 dB over most of the audio range. It was a very good 27.5 dB at 30 Hz and 31.5 dB at 15,000 Hz.

FM capture ratio was 1.75 dB at 65 dBf and 1.9 dB at 45 dBf (100  $\mu$ V) inputs. The AM rejection was an exceptional 83 dB. Image rejection also measured 83 dB. The alternate-channel se-

lectivity was 76 dB, and adjacent-channel selectivity was 4.6 dB. Muting and automatic stereo switching thresholds were identical at 17.2 dBf (4  $\mu$ V). The 19-kHz pilot carrier leakage into the audio outputs was -70 dB, and tuner hum was a very low -75 dB. The AM tuner section appeared to be relatively sensitive, with a notable freedom from buzzing noises, and a wider-than-usual frequency response that was down 6 dB at

4500 Hz and 3.5 dB at 20 Hz, from the midrange levels.

**User Comment.** There are some interesting in-use observations to be made concerning this receiver that don't show up by examining specifications. For example, unwanted noises and switching transients have been eliminated with notable success. This is accomplished by effecting a slight delay

# IN WIRE-WRAPPING HAS THE LINE...

**HOBBY-WRAP-30** WIRE-WRAPPING, STRIPPING, UNWRAPPING TOOL FOR AWG 30 (.025 SQUARE POST)

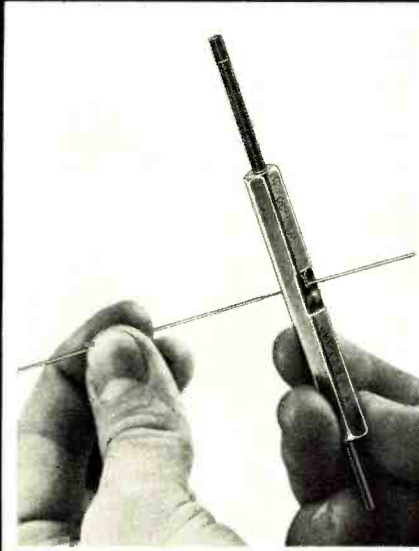

**STRIP**



**WRAP**



**UNWRAP**

**\$5.95**

SHIPPING CHARGE \$1.00  
NEW YORK STATE RESIDENTS ADD SALES TAX

**OK MACHINE & TOOL CORPORATION**

3455 CONNER STREET, BRONX, NEW YORK, N.Y. 10475 U.S.A. • PHONE (212) 894-8600

TELEX: 125091 TELEX: 232395

after power is applied, whereupon a relay connects the speakers to the output transistors. Furthermore, when the FM muting switch is activated, FM tuning action is completely free of transients and noise bursts.

The output transistors are protected against damage from overload, including short circuits, by a circuit that silences the receiver until it is reset by turning off the power for a few moments and then turning it on again. We verified the effectiveness of the overload protection by driving the receiver into shorted outputs, which immediately shut off the amplifiers without damaging them. It is also thermally protected against excessive operating temperatures, although we never reached such a condition.

Realistic has chosen to omit some "features" usually found in receivers of the Model STA-2000's price range that are of little value in any receiver such as low- and high-cut audio filters. Unless such filters have cutoff slopes of 12 dB/octave or more, they are useless for their intended purpose. However, the tape recorder dubbing connections, and the separate preamplifier outputs and power amplifier inputs that are indeed useful have been included. The same for its FM multiplex noise filter. We particularly like the large pushbutton switches as compared to rotary switches. They're most convenient to use. The 20-dB attenuator switch is a nice touch, permitting the user to lower volume temporarily without losing the

volume-setting place previously used.

Comparing the actual measured performance of this receiver to that of similar products we have evaluated, we find that the Model STA-2000 is at the least a competent performer in every respect and outstanding in many. It has the unmistakable "sound" of a good control amplifier, giving the sense of not having a device between the source and the speakers.

The physical smoothness and precision "feel" of the controls are consistent with the receiver's excellent performance. Though it is not a "super-power" receiver, the Model STA-2000 is more than powerful enough for the majority of users and is a very good value.

CIRCLE NO. 102 ON FREE INFORMATION CARD

## KOSS MODEL K/145 STEREO HEADPHONES

*Comfortable to wear with fine bass performance in moderate price range.*



Heading a new line of low-cost "Slimline" stereo headphones from Koss is the Model

K/145. This circumaural headphone features rectangular ear cushions that exclude most outside sounds. Each earcup contains a dynamic driver with a 38-mm polyester diaphragm. The frequency range of the phones is specified at 20 to 20,000 Hz. Impedance is rated at 90 ohms at 1000 Hz, while sensitivity is specified at 0.25 volt at 1000 Hz (or 0.11 volt rms with pink noise) for a 100-dB sound pressure level (SPL). Harmonic distortion is claimed to be less than 0.5% at 1000 Hz and 100 dB SPL.

The phones are finished in textured

brown vinyl and come with a matching padded headband. A separate knurled wheel protruding slightly from each earcup allows independent volume level adjustment in the left and right channels. The cords that attach to the earcups come down to form a Y joint about 2' (60 cm) from the earcups before joining to the coiled cord that goes to the driving amplifier. The total length of the cord is 10' (about 3 meters). The phones weigh 1 lb (454 g), less cord. Price is \$45.

**Laboratory Measurements.** We tested the phones on a modified ANSI headphone coupler, the type used by Koss for making in-plant measurements. The bass frequency response was very flat and smooth, confirming the effectiveness of the "Pneumalite" ear cushions in sealing the phones to the ears. The output varied by only  $\pm 1.5$  dB from 20 to 300 Hz.

At higher frequencies, the output dropped at about a 6-dB/octave rate, to -20 dB in the 3000-Hz range. The usual high-frequency response irregularities were visible above 4000 Hz in our chart plots, including peaks at 5500 and 14,000 Hz. These irregularities can be due, at least in some degree, to the coupler and cannot be definitely attributed to the headphones themselves.

With a 0.25-volt drive at 1000 Hz applied through a source resistance of 100 ohms, the phones delivered their rated 100-dB SPL output. The total harmonic distortion at this level was between 0.1% and 0.2% from 300 to 10,000 Hz, which is well below the rated 0.5%. At lower frequencies, the THD increased, due to

the larger excursions of the diaphragm, to between 0.6% and 0.9% in the 20-to-100-Hz range. We also measured the distortion with the drive level increased to 1 volt, which corresponds to a 112-dB output at 1000 Hz. The THD at this level, although far in excess of normal listening levels, was 0.3% to 0.8% at most frequencies above 100 hertz and 1.8% at 20 hertz.

The impedance of the phones was a constant 90 ohms from 20 to 20,000 Hz with the level controls set to maximum. At the center positions of the controls, the impedance increased to 700 ohms, while at the minimum settings, it was about 1000 ohms.

**User Comment.** In our use tests, we found these snug-fitting phones to be comfortable to wear, even over prolonged listening periods. We noted that the sound quality is pleasant and listenable throughout, though it lacks the brilliance or crispness exhibited by, say, electrostatic types. (The latter are much costlier, of course.) However, we observed no apparent loss in the high-frequency range. The bass and lower mid-range were strong and solid.

In an overall evaluation of performance, we find these new Koss phones to be fine performers, though sounding a bit "soft" for our personal tastes. But other listeners may indeed prefer it this way. Since headphones, like speaker systems, are best judged subjectively by the listener, we strongly recommend a personal audition of these comfortable, relatively inexpensive phones.

CIRCLE NO. 103 ON FREE INFORMATION CARD



# handic®



**FREE!**  
**FULL COLOR**  
**CATALOG OF**  
**handic**  
**EQUIPMENT**  
 Send today  
 for your free  
 copy.

## Now you can buy Europe's No.1 CB in the U.S.A.

The country that created superior steel, jet fighters, automobiles and cameras has also created the world's finest CB equipment.

handic, from Sweden, is the best selling, most popular CB in all Europe.

It is a true system. Base stations, mobiles, hand-helds and accessories interface with one another as a system should.

handic CBs have not only met but exceeded all FCC specifications at their time of introduction. Including the extraordinarily handsome new 40 channel line.

Ruggedly made for tough Swedish geography and extreme weather conditions, yet stunningly designed, handic has drawn rave reviews from CB publications in the U.S.



handic USA, Inc., 14560 N.W. 60th Ave., Miami Lakes, FL 33014

- A. handic 240 - in-dash 40 ch/5w Mobile CB/AM/FM Radio MPX (LED) - \$259.95
- B. handic 230 - under-dash 40 ch/5w Mobile CB (LED) - \$199.95
- C. handic 21 - 2 ch/1w Hand-held CB - \$59.95
- D. handic 32 - 3 ch/2w Hand-held CB - \$69.95
- E. handic 43C - 4 ch/3w Hand-held CB - \$89.95
- F. handic 65C - 6 ch/5w Hand-held CB - \$109.95
- G. UCB - Universal Cassette, Recharge/Power Holder for Hand-helds - \$19.95
- H. handic S-12 - Selective Call for Base & Mobile - \$79.95
- I. handic 305 - 3 ch/5w Mobile CB - \$79.95
- J. handic 4005 - 40 ch/5w Base CB w/Sub-receive (LED) - \$279.95
- K. handic 3605 - 40 ch/5w Base (LED) - \$249.95
- L. handic 007 - 8ch/hi-lo band Scanner w/FM Radio - \$239.95
- M. handic 006-H/L - 8ch/hi-lo band or UHF Scanner - \$149.95
- N. handic 004-U - 4ch/hi-lo band or UHF Pocket Scanner - \$139.95
- O. BK-305 - Power-pak for handic 305, 605, 006 - \$34.95
- P. handic 80 - Base Power Mike - \$49.95

PE-777.Lc

Please send the free handic color catalog and name of my nearest dealer.

Name \_\_\_\_\_

Address \_\_\_\_\_

City \_\_\_\_\_

State \_\_\_\_\_

Zip \_\_\_\_\_

**handic**  
USA Inc.

Telephone: (305) 558-1522 Telex: 519139  
Kennedy Building, 14560 N.W. 60th Ave.  
Miami Lakes Florida 33014 USA

# NEWS HIGHLIGHTS

## Automotive Developments

Ford Motor Company recently announced plans to use the resources of major semiconductor producers to help in the design of future automotive models. Specially designed large-scale integrated circuits and microcomputers will shortly control many engine functions. Two new concepts which will be pioneered by Ford in 1978 include an electronically controlled carburetor and an electronic engine control system for spark timing and exhaust gas recirculation. The new devices, to be installed on a limited volume of 1978 models, are intended to improve fuel economy, emissions and performance. Chrysler and General Motors have also announced plans to use microprocessors in some auto models.

## TV Color Organ

A new entertainment system developed by Atari, called "Video Music," electronically synchronizes images and colors to music from a stereo receiver. A cable which connects the Video Music to a stereo receiver and a switch box connected to the vhf antenna terminals of a television set allow the music signals to be conducted directly to the video screen. Five front-panel potentiometers and twelve pushbuttons on the Video Music enable the viewer to adjust the color, shape, brightness and size of the geometric image, producing an enormous number of possible picture combinations which pulse and beat to the rhythm of the music. Uses five IC's, two transistors and twelve diodes, and comes with an FCC-approved r-f switch box.

## RCA To Market 4-Hour VTR

RCA has announced plans to market a home video-tape recorder made by the Matsushita Electric Industrial Co. of Japan. The new video tape recorder, called "VHS," will have a mode switch for either 2- or 4-hour recording with the same cassette, vhf and uhf tuners, and a clock for automatic recording. Moreover, a company spokesman said that optional microphones and cameras will be made available to allow consumers to produce home movies on the video tape cassettes. Thus, a VTR war for consumers' hearts appears to be shaping up between the VHS models and Sony's Betamax models, the latter, a two-hour video recorder to be marketed by the Zenith Corp. Too bad that standards are dissimilar.

## An R-F People Finder

The Trakatron "Silent People Finder" by Interasonics Corp., New York, NY, is an electronic system that locates people in an office or plant without paging them. Each person has a transponder and is assigned a button on a console locator. A sensor is placed in certain desired areas. When the console's button is pressed, the proper signal goes throughout the covered areas. If the

person sought is in a room with a sensor, his or her transponder unit responds, whereupon a signal goes back to the console, giving the location and telephone extension (if any). The inquirer can then either go to the area indicated or call on the extension. Shades of 1984!

## Digital Watch Firsts

Intertime Corporation has introduced the latest in diving equipment, an *underwater* digital watch. Named "Maritime," the watch uses LED's to display month, week, date, hours, minutes and continuous counting seconds. Activation of a single button displays red numerals designed for easy underwater visibility, and a ratchet bezel graduated in minutes is provided for elapsed time reference. The housing is Swiss made, produced from a solid block of stainless steel. It's equipped with double "O" rings to prevent water leakage and fogging, and has been factory tested to a depth of 600 ft. \$250.00.

Another innovative digital watch to be introduced is the "programmable message" model from the Solid State Products Division of Hughes Aircraft Company. The watch module features a personalized five-word, five-letter-per-word message programmed by the wearer and displayed in an electronic readout. The message can be changed as desired by the user, a procedure which takes less than five minutes. The five standard functions of month, date, hour, minute and second are also included, with five LED's providing the letter, symbol and number readouts. A spokesman for the company suggests that the watch can be used for important appointment reminders or medical instructions, among other applications.

## Solar-Powered Calculator

"The Sun Man," a new solar battery-powered calculator recently introduced by Sharp Electronics, is believed to be the smallest such instrument on the market. With dimensions of 0.35" thin x 2.6" wide x 7.5" deep (9 mm x 66 mm x 109 mm), the solar-powered calculator is said to have a longer life span than the ordinary calculator battery, needing only two hours of window light to recharge. It performs six functions, and uses a liquid crystal display. \$99.95.

## Antique-Radio Manuals

To assist antique-radio collectors in the usually frustrating search for technical literature, Supreme Publications has formed a department which will buy and sell old technical data. Original Rider manuals and old Sams, Supreme, and many factory service manuals are on hand, some dating back to the 20's. For information write to Supreme Publications, 1760 Balsam Rd., Highland Park, IL 60035.

# HOW TO SAVE HUNDREDS OF DOLLARS ON PARTS. PAINLESSLY.

At CSC, we've developed a family of ingenious Design Mate™ test equipment that gives you professional quality and precision at very *un*professional prices. Each unit can save you money—and time—in a number of interesting ways. For more information on these, or any other CSC products, see your dealer or write for our catalog and distributor list.



## SAVE MONEY AND TIME WITH DESIGN MATE 1

This precision all-in-one unit combines a solderless plug-in breadboarding system with a built-in better-than-1%-regulated variable 5-15V supply and 0-15V voltmeter. Gives you everything you need to design and test circuits faster than you ever could before. Saves money by eliminating lead damage and heat damage to components. Lets you re-use parts over and over again, to save even more. All for just \$54.95\*

## STRETCH YOUR BUDGET FURTHER WITH DESIGN MATE 2

Precision function generator lets you test all kinds of equipment, with 1Hz-100kHz signals. Low-distortion sine waves, high-linearity triangle waves, fast-rise-time square waves. Five decade ranges, accurate to 5% of dial setting, with variable 100mV-10V P-P output and constant 600-ohm impedance. At \$69.95\*, it's a lot of signal for very little money.

## SAVE MORE MONEY AND TIME WITH DESIGN MATE 3

Accurate R/C bridge helps you use "bargain" components. Quickly and easily measures resistance 10 ohms—10 meg; capacitance 10pF-1μF—both in decade ranges to within 5% of dial setting. Simple, 2-control operation and positive LED indication make measurements in seconds. At \$59.95\*, it pays for itself in no time.

CONTINENTAL SPECIALTIES CORPORATION



EASY DOES IT

44 Kendall Street, Box 1942  
 New Haven, CT 06509 • 203-624-3103 TWX: 710-465-1227  
 West Coast office: Box 7809, San Francisco, CA  
 94119 • 415-421-8872 TWX: 910-372-7992  
 Canada: Len Finkler Ltd., Ontario  
 Mexico: ELPRO, S.A., Mexico City 5-23-30-04



The 9-inch screen of the CT-VM monitor (\$175) shown here with Southwest's new CT-64 illustrates the terminal's 64-character lines, switchable control character printing, and word highlighting. At just \$500 for both, these matching units provide a complete CRT terminal with full cursor control, 110-1200 Baud serial interface, and many other features.

## Now \$325 buys a 64-character terminal kit

Our new CT-64 terminal kit gives you scrolling, full cursor control, 128-character ASCII display (with both upper and lower case), and two 1K memory pages. It's usable with any 8-bit computer.

Add our optional fully assembled 12 MHz CT-VM monitor for another \$175 and you'll have the best CRT terminal buy offered anywhere.

The CT-64 gives you full cursor control, home-up and erase, erase to end of line or end of frame, cursor on/off, screen reversal, scroll or page, solid or blinking cursor, page selection, and end-of-page warning beeper.

The CT-64's features include:

- 64 or 32 characters per line (16 lines)
- Premium display with both upper and lower case letters, and descenders (g, j, etc.)
- Two 1K pages of 8-bit memory
- Scrolling or page mode operation
- 32 control character decoding
- Prints control characters (selectable)
- 128-character ASCII set
- 110 /220 Volt 50-60 Hz power supply
- Highlights words with reversed background
- Optional 9-inch monitor with matching cover available
- Complete with keyboard, power supply, 110-1200 Baud serial interface, and case

Okay, Southwest, I know a bargain when I see it.

- Enclosed is \$500 for the whole works (CT-64 terminal plus 12 MHz CT-VM monitor).
- Here's \$325 for the CT-64.
- Send only data for now.
- Send me your \$395 MP-68 computer kit.

or BAC # \_\_\_\_\_ Exp. Date \_\_\_\_\_

or MC # \_\_\_\_\_ Exp. Date \_\_\_\_\_

Name \_\_\_\_\_ Address \_\_\_\_\_

City \_\_\_\_\_ State \_\_\_\_\_ ZIP \_\_\_\_\_



**Southwest Technical Products Corp.**  
219 W. Rhapsody, San Antonio, Texas 78216

CIRCLE NO. 48 ON FREE INFORMATION CARD

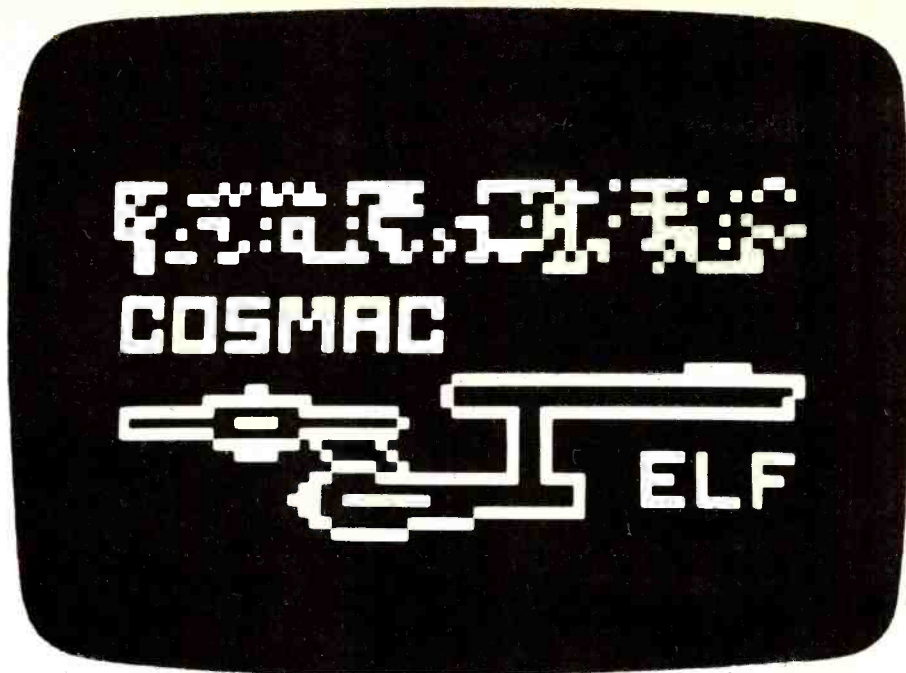

**BREAKTHROUGH  
PROJECT**

BY JOSEPH A. WEISBECKER

**PART IV:**

# Build the PIXIE Graphic Display

*Adding one chip to the Elf provides complete video interface and animated graphics capability for less than \$25.*

If you own an Elf microcomputer (see POPULAR ELECTRONICS August 1976) or are planning to build one soon, the addition of a single IC and a handful of support components, and a change in the crystal frequency, can give you Pixie graphics. The entire graphics system is built into the new CDP 1861 LSI chip that sells for less than \$20 from RCA

parts distributors. (A complete kit is available; see Parts List.) The two other IC's in the optional add-on system are for a crystal oscillator that allows the graphics IC to generate the correct TV horizontal and vertical sync pulses.

The photo at the top of this page illustrates what can be done with the original 256 bytes of memory in the Elf when the

Pixie graphics system is added. In this article, we will show you how to install and program the Pixie system to produce this type of graphics.

**Some Details.** The unique Pixie graphics system employs the direct memory access (DMA) capability built into the 1802 microprocessor in the Elf

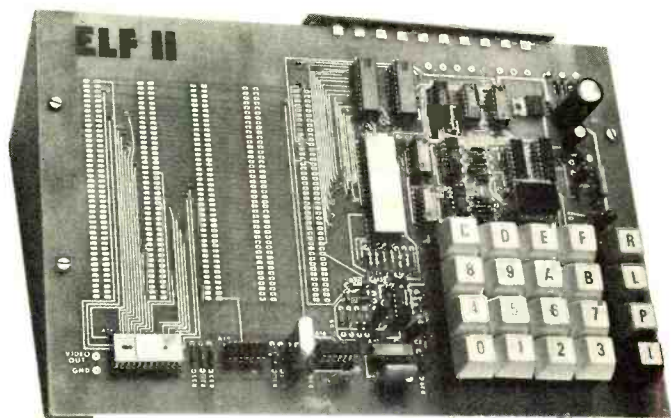
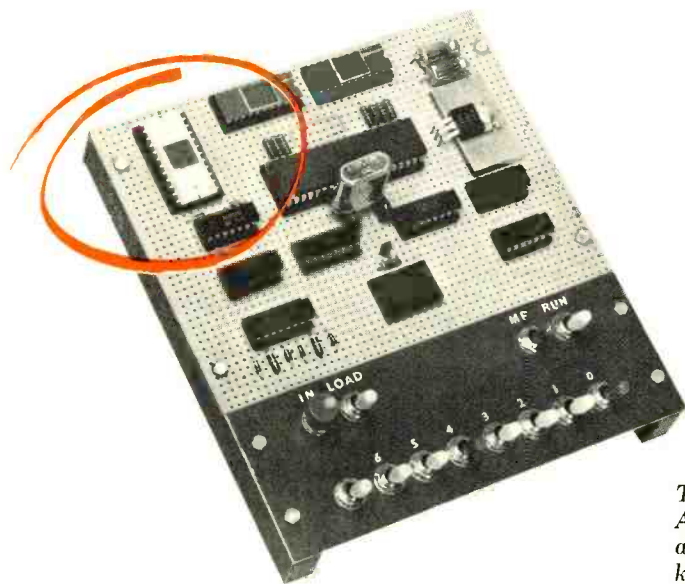

*The basic Elf project originally published in the August 1976 issue of POPULAR ELECTRONICS is shown at left with Pixie components added. Elf II is a complete kit including a pc board, hexadecimal keypad, Pixie graphics components and expansion bus (see Parts List).*

0000	0001	0002	0003	0004	0005	0006	0007
0008	0009	000A				000E	000F
0010	0011	0012				0016	0017
00F0	00F1	00F2				00F6	00F7
00F8	00F9	00FA	00FE	00FC	00FD	00FE	00FF

Fig. 1. Memory addresses of bytes mapped onto TV screen in sample program.

to work in conjunction with the new graphics IC. This allows you to display any 256-byte segment of memory on a CRT monitor or TV receiver. The output of the new chip is a 1-volt composite video/sync signal.

The selected segment of memory appears on-screen as an array of small squares that represent individual memory bits. If a memory bit is a 1, the appropriate square will be white, while if a bit is a 0, the square will be dark. Changing the bit pattern within the memory will change the pattern that appears on-screen. You can store several different bit patterns (pictures) in memory and,

TABLE I—TEST PROGRAM

Label	M	Bytes	Comments	
Start	0000	90 B1 B2	R1.1,R2.1=00	
	0003	B3 B4	R3.0,R4.0=00	
	0005	F8 2D A3	R3.0=(main)	
	0008	F8 3F A2	R2.0=(stack)	
	000B	F8 11 A1	R1.0=(interrupt)	
	000E	D3	P=3 (go to main)	
	Return	000F	72	restore D, R2+1
0010		70	restore XP,R2+1	
0011		22 78	R2-1, save XP @ M2	
Interrupt	0013	22 52	R2-1, save D @ M2	
	0015	C4 C4 C4	no-op (9 cycles)	
	0018	F8 00 B0		
	001B	F8 00 A0	R0=0000(refresh ptr)	
	Refresh	001E	80 E2	D=R0.0
				8 DMA cycles (R0+8)
		0020	E2 20 A0	R0-1,R0.0=D
			8 DMA cycles (R0+8)	
0023		E2 20 A0	R0-1,R0.0=D	
			8 DMA cycles (R0+8)	
0026		E2 20 A0	R0-1,R0.0=D	
Main			8 DMA cycles (R0+8)	
	0029	3C 1E	go to refresh (EF1=0)	
	002B	30 0F	go to return (EF1=1)	
	002D	E2 69	X=2, turn TV on	
	002F	3F 2F	wait for IN pressed	
	0031	6C A4	set MX,D,R4.0=toggles	
	0033	37 33	wait for IN released	
	0035	3F 35	wait for IN pressed	
	0037	6C	set MX,D=toggles	
	0038	54 14	set M4=D, R4+1	
003A	30 33	go to M33		

# PIXIE ANIMATION PROGRAM

BY EDWARD C. DEVEAUX

THE PROGRAM given here can be used with the Pixie version of the Elf microcomputer to create animation graphics using only the original 256 bytes of memory. The interrupt routine uses the same timing as described in previous Elf articles. However, a counter has been added to this routine, and we load the refresh address into R0 from R4. The main line of the program has been completely rewritten and contains shift, roll, and INPUT switch read routines.

The shift routine shifts 16 lines of the display to the right one bit at a time; bits shifted off the rightmost byte are shifted back onto the display in the

LOC	COSMAC CODE	LNNO	SOURCE LINE
		1	.. AN 1802 ANIMATION PROGRAM by E. DEVEAUX
		2	..
78		3	BEGSFT=#78 .. ADDRESS OF FIRST LINE SHIFTED.
		4	..
		5	.. THIS PROGRAM PROVIDES VARIABLE SPEED
		6	.. ANIMATION OF THE IMAGE LOCATED AT #78 to
		7	.. #F7 IN MEMORY.
		8	.. SPEED CONTROL IS PROVIDED BY INPUT SWITCHES.
00	90	9	GHI R0 ..ZERO HIGH ORDER OF
01	B1	10	PHI R1 ..R1 R2 R3.
02	B2	11	PHI R2
03	B3	12	PHI R3
04	B4	13	PHI R4 ..R4 POINTS TO REFRESH
05	A4	14	PLO R4 ADDRESS
06	F816	15	LDI A.0(INTRPT)
08	A1	16	PLO R1
09	F813	17	LDI A.0(STACK)
0B	A2	18	PLO R2
0C	F831	19	LDI A.0(MAIN)
0E	A3	20	PLO R3
0F	D3	21	SEP R3 ..GO TO MAIN_LINE
10	01020300	22	DC#01020300 ..STACK AREA
13		23	STACK =*-1
		24	..
		25	..THIS PROGRAM USES A MODIFIED VERSION
		26	..OF THE INTERRUPT ROUTINE THAT APPEARED
		27	..IN COSMAC ELF PART 4.
		28	..
		29	..A SHIFT ROUTINE HAS BEEN ADDED THAT MOVES THE
		30	.. STARSHIP FROM LEFT TO RIGHT ACROSS THE CRT.
		31	..
14	72	32	RETURN;LDXA
15	70	33	RET ..CYCLES
16	22	35	INTRPT;DEC R2 .. 2
17	78	36	SAV ..4 R5 COUNTS REFRESH
18	22	37	DEC R2 ..6 CYCLES, USED TO
19	52	38	STR R2 ..8 DETERMINE WHEN TO
1A	15	39	INC R5 ..10 SHIFT /ROLL.
1B	C4	40	NOP ..13
1C	94	41	GHI R4 ..15 R4 TO R0

using software, display them successively onscreen to produce animation effects. Low-resolution alphanumeric can also be created.

Since the basic Elf has only 256 bytes of memory, we will show how to display the entire memory on the screen. The memory is mapped as shown in Fig. 1, in an array of 64 spots wide (eight bytes with eight bits/byte) by 32 spots high to make a total of 256 bytes.

The byte at M(0000) is displayed at the upper-left of the screen; each row on the screen is equivalent to eight memory bytes. Byte M(00FF) appears at the bottom-right of the screen.

### Circuit Operation.

The entire schematic diagram for the Pixie graphics display system is shown in Fig. 2A. It consists of five components: the 1861 chip, a phono jack for the video output, and three resistors. The circuit shown in Fig. 2B may be used to replace the original crystal used in the Elf microcomputer. This is necessary because, to use the graphics display, the original crystal frequency must be changed to approximately 1.760640 MHz to generate the correct TV horizontal and vertical sync pulses. Crystals of this frequency may be expensive. The Fig. 2B circuit uses a

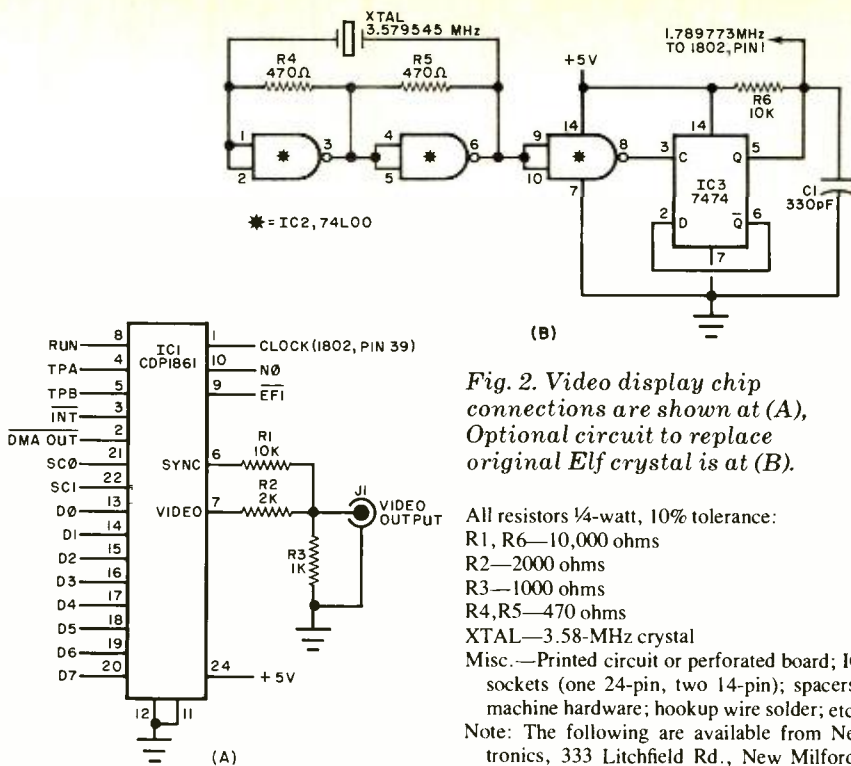

Fig. 2. Video display chip connections are shown at (A), Optional circuit to replace original Elf crystal is at (B).

All resistors 1/4-watt, 10% tolerance:  
 R1, R6—10,000 ohms  
 R2—2000 ohms  
 R3—1000 ohms  
 R4, R5—470 ohms  
 XTAL—3.58-MHz crystal  
 Misc.—Printed circuit or perforated board; IC sockets (one 24-pin, two 14-pin); spacers; machine hardware; hookup wire solder; etc.  
 Note: The following are available from Ne-  
 tronics, 333 Litchfield Rd., New Milford,  
 CN 06776: kit including all of above Pixie  
 components except those under "Misc." at  
 \$24.95; complete Elf II kit (basic Elf plus  
 Pixie components and hexadecimal key-  
 board), including pc board, keyboard sup-  
 port IC's and expansion bus at \$99.95, plus  
 \$3.00 shipping. Connecticut residents, add  
 7% sales tax.

### "PIXIE" PARTS LIST

- C1—330-pF disc capacitor
- IC1—CDP 1861 video IC (RCA)
- IC2—74L00 low-power quad 2-input NAND gate IC
- IC3—7474 dual-D flip-flop IC
- J1—Phono jack

high-order position of the first byte on the line.

The 32 lines of the display can be moved up one line by incrementing the starting refresh address by eight between refresh cycles. Decrementing register 4 (R4) allows the display to be rolled down. Hence, varying the frequency of shifts or rolls varies the animation speed of the displayed image.

Control of the speed is via the Elf's conventional INPUT switches. Setting all switches to zero and depressing the INPUT pushbutton causes a hex 00 to be read into location 13 (stack), in which case, there will be no movement of the displayed image. Loading any nonzero bit through the INPUT switches will animate the image. Any bits loaded are compared to the bits in the low-order byte of register 5 (R5). A shift or roll routine is initiated whenever there is a match between the bits of the low-order byte of R5 and the bits in the byte read into location 13. Register 5 is used to count the refresh cycles and is incremented by one every interrupt cycle.

1D	B0	42	PHI	R0	..17	REFRESH ADDRESS
1E	84	43	GLO	R4	..19	
1F	A0	44	PLO	R0	..21	
		45			..	
20	80	46	GLO	R0	..23	
21	80	47	GLO	R0	..25	
22	80	48	REFRESH;GLO	R0	.. 27	
23	E2	49	SEX	R2	.. 29	8 DMA CYCLES
		50			..	
24	E2	51	SEX	R2	..	
25	20	52	DEC	R0	..	
26	A0	53	PLO	R0	..	8 DMA CYCLES
		54			..	
27	E2	55	SEX	R2	..	
28	20	56	DEC	R0	..	
29	A0	57	PLO	R0	..	8 DMA CYCLES
		58			..	
2A	E2	59	SEX	R2	..	
2B	20	60	DEC	R0	..	
2C	A0	61	PLO	R0	..	8 DMA CYCLES
		62			..	
2D	3C22	63	BNI	REFRESH	.. ON EF1 REFRESH	
2F	3014	64	BR	RETURN	.. IS OVER.	
31	E2	65	MAIN;SEX	R2	.. RX=2	
32	69	66	INP	1	.. TELL 1861 TO	
		67			.. TURN ON CRT.	
		68	..SPREAD	READS INPUT SWITCHES	TO CONTROL	
		69	..SPEED	OF SHIFTS/ROLLS.		
		70	..INPUT	SWITCH IS STORED	AT STACK M(R2).	
		71	..			
		72	..INITIAL	VALUE OF STACK IS ZERO	AND THERE IS	
		73	..NO	MOVEMENT OF STAR SHIP	UNTIL A NON ZERO BIT	
		74	..IS	INPUT.		
33	3F38	75	SPREAD;BN4	CKSHIF	.. IF NO INPUT GO SEE	
35	3735	76	WTREAD;B4	WTREAD	.. IF TIME TO SHIFT.	
37	6C	77	INP	4	.. READ INTO STACK.	
		78	..		..	
38	85	79	CKSHIF;GLO	R5	.. GHI R5 VARY/SPEED	
39	F2	80	AND		.. OF STAR SHIP.	
3A	3233	81	BZ	SFREAD	.. SHIFT/ROLL BIT MATCH.	
3C	F800	82	LDI	A.1(BEGSPT)	..BR ROLL 3061	
3E	B9	83	PHI	R9	..ROLL NO SHIFT.	

readily available 3.58-MHz color-TV crystal and frequency divider to generate 1.789773 MHz, which is close enough for the 1861 chip to perform properly.

The 1861 chip uses the same clock as the 1802  $\mu$ P chip to trigger internal counters to provide the TV-like composite sync at pin 6. The graphics display is directly refreshed from the memory 60 times each second, accomplished by an interrupt request sent to the 1802 at the same rate.

When the 1802 receives the interrupt request, it temporarily stops the program it is executing and immediately branches to the interrupt routine previously stored in memory. This branch occurs when P is automatically set to 1 and X is set to 2. The interrupt routine program counter is always R1, which must be set to the address of the interrupt routine before the 1861 is activated and starts sending interrupts to the 1802. A pulse from NO is sent to pin 10 of the 1861, permitting this chip to start sending interrupts. A 69 instruction can be used to generate the 1861 activation pulse. The 1861 is always turned off

when the Elf is stopped with the RUN switch down.

In the program shown in Table I, R1 is set to the address of the interrupt routine at M(0011), R2 is set to the address of the work area (or stack) used subsequently for byte storage, R3 is set to the main program starting at M(002D), and setting P=3 causes a branch to M(002D) with R3 as the program counter. The main program permits entry of the bytes at any time via the Elf's toggle switches. This permits you to see what is happening to the CRT screen as memory bytes are changed. The program loops on itself until an interrupt signal is generated by the 1861, activated by the 69 instruction at M(002E).

Exactly 29 machine cycles after the initiation of the interrupt routine, the 1861 requests eight sequential memory bytes by pulling down the DMA-OUT (pin-2) request line for eight bytes (eight machine cycles). This automatically causes eight memory bytes, addressed by R0, to be sequentially fetched and transferred to the 1861 via the data bus. Note that the C4 instructions at M(0015) are special no-op instructions that re-

TABLE II—SPACESHIP PROGRAM

M	Byte Sequence
0040	00 00 00 00 00 00 00 00
0048	00 00 00 00 00 00 00 00
0050	7B DE DB DE 00 00 00 00
0058	4A 50 DA 52 00 00 00 00
0060	42 5E AB D0 00 00 00 00
0068	4A 42 8A 52 00 00 00 00
0070	7B DE 8A 5E 00 00 00 00
0078	00 00 00 00 00 00 00 00
0080	00 00 00 00 00 00 07 E0
0088	00 00 00 00 FF FF FF FF
0090	00 06 00 01 00 00 00 01
0098	00 7F E0 01 00 00 00 02
00A0	7F C0 3F E0 FC FF FF FE
00A8	40 0F 00 10 04 80 00 00
00B0	7F C0 3F E0 04 80 00 00
00B8	00 3F D0 40 04 80 00 00
00C0	00 0F 08 20 04 80 7A 1E
00C8	00 00 07 90 04 80 42 10
00D0	00 00 18 7F FC F0 72 1C
00D8	00 00 30 00 00 10 42 10
00E0	00 00 73 FC 00 10 7B D0
00E8	00 00 30 00 3F F0 00 00
00F0	00 00 18 0F C0 00 00 00
00F8	00 00 07 F0 00 00 00 00

```

3F F878      84      LDI  A.0(BEGSF7)
41 A9        85      PLO  R9          ..R9=FIRST LINE
42 F810      86      LDI  16          ..TO SHIFT.
44 A6        87      PLO  R6          ..SHIFT 16 LINES.
45 99        88      NXTLNE,GHI R9
46 BA        89      PHI  RA          ..SAVE ADDRESS OF 1st
47 89        90      GLO  R9          ..ON LINE IN RA
48 AA        91      PLO  RA
49 F807      92      LDI  7          ..R7=BYTES TO SHIFT-1.
4B A7        93      PLO  R7
4C 09        94      LDN  R9
4D B8        95      PHI  R8          ..SAVE 1ST BYTE ON
4E 76        96      SHRC          ..LINE IN R8.1
4F 19        97      NXTBYT:INC R9          ..POINT R9 TO NEXT BYTE.
50 09        98      LDN  R9          ..LOAD NEXT BYTE.
51 76        99      SHRC          ..SHIFT RIGHT.
52 59        100     STR  R9          ..STORE BYTE
53 27        101     DEC  R7
54 87        102     GLO  R7          ..CHECK IF ALL BYTES
55 3A4F      103     BNZ  NXTBYT      ..SHIFTED.
57 98        104     GHI  R8          ..PUT BIT 0 of 8TH
58 76        105     SHRC          ..BYT ON BIT 7 OF
59 5A        106     STR  RA          ..1ST BYT ON LINE.
5A 19        107     INC  R9          ..R9=BYTE 0 NXT LINE.
5B 26        108     DEC  R6
5C 86        109     GLO  R6          ..CHECK IF 16 LINES
5D 3A45      110     BNZ  NXTLNE      ..SHIFTED.
5F 3033      111     BR   SFREAD          ..SKP 38 ROLL AND SHIFT.
61 84        112     ROLL,GLO R4          ..INCREMENT R4 ONE LINE
62 FC08      113     ADI  8          ..ROLL SCREEN UP.
64 A4        114     PLO  R4
65 94        115     GHI  R4          ..CHANGE LNNO 116 TO
66 F800      116     LDI  00          ..ADCI 0 7C00 IF MORE
68 B4        117     PHI  R4          ..THAN 256 BYTES.
69 3233      118     BZ   SFREAD
6B 84        119     GLO  R4
6C B4        120     PHI  R4
6D 3033      121     BR   SFREAD
6F 00        122     DC   #00
123 ..ENTER IMAGE TO BE SHIFTED IN LOCATIONS
124 ..X'78' - x'F7'.
125      END

```

The numbers in the program flow chart (right) refer to the line numbers in the program. The program can be set up to shift or roll, or shift-and roll. The program is loaded into locations 78 through F7. (Try using the program for the starship shown in Table II of the Pixie article.) Only the data loaded into 78 through F7 is shifted, but the entire area from 00 through FF is rolled.

Loading the program exactly as it is listed here will enable the shift routine only. Loading a 38 (SKP instruction) in location 5F (line 111) will enable both shift and roll routines. Loading 30 61 (BR ROLL) in locations 3C and 3D (line 82) will enable only the roll routine.

After loading and running the program, animation of the display will begin after any nonzero byte is loaded via the INPUT switches and operation of the INPUT pushbutton. By varying the INPUT bit pattern, you can control the speed of the animation.

If you have never seen a stack in "motion" when a program is running, take a look at displayed location 13. Then vary the speed.  $\diamond$



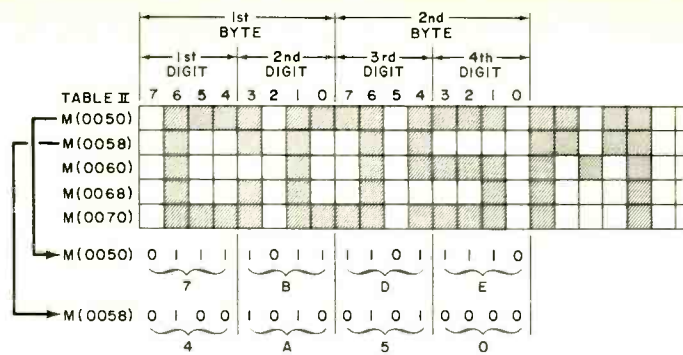

Fig. 3. Diagram showing how to create your own display. This one is for parts of five lines of Spaceship Program.

quire three cycles for each execution. These are used only to provide the delay required between the beginning of the interrupt routine and the first eight-byte DMA request generated by the 1861 display circuits.

Each of the eight display refresh bytes requested by the 1861 is internally converted to a bit serial form and used to provide the luminance (brightness) pulses that come out of the 1861 at pin 7. The actual raster display consists of 262 horizontal lines for each frame, and there are 60 frames per second. Each

display spot is four raster lines high, which means that each eight-byte display row must be repeated four times. With the interrupt routine, R0 is initially set to M(0000), which means that the first DMA request causes the eight bytes from M(0000) to M(0007) to be fetched and displayed. The time of each raster line is exactly 14 machine cycles to permit the transfer of eight bytes (eight cycles) plus the execution of three two-cycle instructions during each raster line time. Following the eight DMA cycles required to refresh the first eight bytes, R0

is restored to its original value so that it remains pointing at the same eight bytes.

The E2 20 A0 instructions at M(0020), M(0023), and M(0026) are used to occupy six machine cycles between the DMA requests and to restore R0 to its initial value before incrementing it by eight during the eight-byte DMA request. The 20 instruction decrements R0.1 back to its initial value if a 256-byte page boundary was crossed during the preceding eight DMA cycles.

After the first group of eight bytes has been displayed for four raster line times, R0 is permitted to advance to the next group of eight bytes to be displayed. This process is continued until 32 groups of eight bytes each (256 total) have been displayed. At this time, the circuits in the 1861 chip cause line EF1=1 (at pin 9) and the interrupt routine terminates.

**Other Considerations.** The raster refresh involves the display of 32 groups of eight bytes, and each row of eight bytes is repeated on four raster line scans. This means that the display refresh ties up the 1802  $\mu$ P for slightly more than 128 raster lines (32  $\times$  4). Since there are 262 raster lines per frame, the  $\mu$ P spends about 50% of its time performing the display-refresh function.

Since the 1802 and 1861 clocks must remain synchronized, none of the three-cycle instructions described in the 1802's user's manual should be used in programs that run concurrently with this display. The only exception is the use of the C4 instruction in the interrupt routine.

The sample program given in Table I was designed to run in expanded-memory systems as well as in the basic 256-byte Elf. In the expanded system, just change the bytes at M(0019) and M(001C) so that R0 initially points to any 256-byte segment of the memory you wish to display on the raster. You can write any other main program to run concurrently with this interrupt routine.

The 1861 chip can also be used to display any number of memory bytes from eight to 1024 by rewriting the interrupt routine. For example, change the byte at M(0024) from 20 to 80, and you will see 512 bytes displayed on the CRT screen as 64 spots horizontally by 64 spots vertically. If you have only 256 bytes of memory in your system, you will see the same 256 bytes repeated twice on the screen. When displaying 512 bytes, each spot represents half the

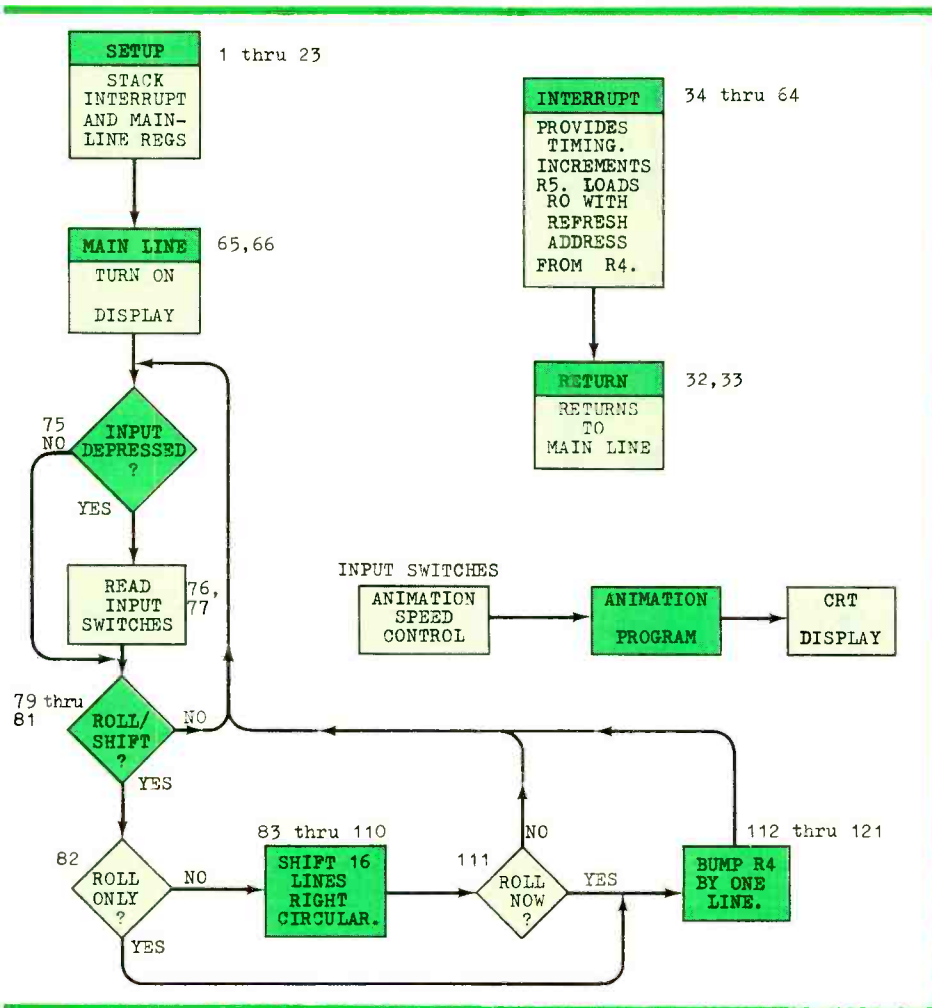

height of those displayed when 256 bytes are displayed.

One of the main advantages of mapping main memory directly into the monitor or TV raster is the ability to manipulate the display using the normal instruction set. In systems that employ an external frame buffer for refresh, specialized instructions are required to change buffer contents. The buffer memory also costs more money. With the refresh buffer approach toward animation, you must store two picture patterns in memory and alternately transfer them to the buffer memory. Using the Pixie graphics display described here, you store the same two-picture patterns in memory but you need only change the initial value of R0 to alternately display them. Not only do you save the cost of a refresh buffer, you can greatly simplify the programming.

**Construction.** The Pixie circuit can be mounted on the original Elf board by relocating the crystal and two capacitors to the center of the board. Now, the 1861 IC goes on the upper left of the board, the resistors on the bottom of the board, and the output jack on the rear apron of the chassis.

Remove the crystal from the Elf and wire the Fig. 2B frequency divider to pin 1 of the 1802  $\mu$ P. Then interconnect the two boards exactly as shown in Fig. 2A and B, including the power lines. Jack J1 can be mounted on a small metal bracket and secured to the add-on board with No. 4 machine hardware. Also, mount R1 and R2 on the add-on board via "flea" clips because they may have to be changed for different-value resistors to suit the modulation requirements of the particular monitor you are using.

**Sample Display Program.** To test the Pixie, load the program given in Table I, starting at location M(0000). When this program is run, a random spot pattern should be displayed on-screen. At this time, you may have to alter the values of R1 and R2 to produce a tight sync lock and the desired modulation level of the spots. These are only level-adjust resistors and play no role in the actual sync or video production. The displayed pattern represents whatever is stored in the Elf's memory. The top eight rows represent the program given in Table I.

You can familiarize yourself with the new graphics ability of your computer if you visualize a grid of 64 boxes wide by

32 boxes deep, assuming a 256-byte memory. Bear in mind that the operating program given in Table I occupies the top eight lines. Since the program ends at memory location M(003B), load 00 into memory location M(003F) to complete that line.

Now, to display the spacecraft shown in the lead photo, load the programs given in Tables I and II in that order, starting the Table II program at memory location M(0040). Reset and switch to RUN.

If you wish to create your own display, Fig. 3 illustrates how to arrive at the correct hex digits. (In this case, the example used is for a small area of the program in Table II.) Use graph paper to "draw" your picture, shading in the "spots" you want to be white on the CRT screen. Then transfer the line bit pattern into the eight hex bytes per line as shown in Fig. 3.

**Conclusion.** The Pixie system described here adds video graphics to your Elf microcomputer at very low cost. So far, we have described how the Pixie system can be used to put simple, stationary images on-screen. Accompanying this article is a program that will put the graphics in motion.  $\diamond$



## Electronic "Bell" for a TVT-II

*Lets you know when you are near the end of a line on a TV typewriter.*

BY DENNIS J. DEUTSCH

**H**ere is an add-on circuit for the computer hobbyist that will give his setup the effect of a bell ringing near the end of a line as it does on a typewriter. The circuit, as shown in the diagram, is for use with the Southwest Technical Products CT-1024 TVT-II terminal.

The CT-1024 produces 32 characters per line, for which access is required to bits 1, 2, 4, 8, and 16 on the CT-1024. These are located at IC35 and IC42.

The circuit as shown is set up to produce the tone on character 27. (Bit 4 is inverted in the 7404 IC so that it is "NOT"ed".) The character number trap consists of an 8-input NAND gate in the 7430 and the single inverter (which can be a single transistor if desired). If you want to stay at character 27, eliminate the inverter and bit 4.

Once the character is counted, the resulting pulse turns on the 74121 one-shot for a short period of time. The timing values of the one-shot can be altered by changing the circuit's time constant.

The one-shot triggers a 555 timer used as a tone generator to drive a small 8-ohm speaker. To alter the tone, change the value of the capacitor between pin 6 of the 555 and ground.  $\diamond$

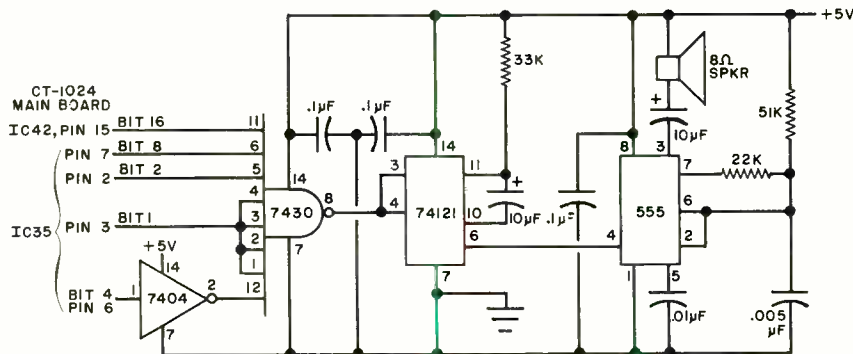

\*\*\*\*\*  
 \* BUILD THIS TVT-6 \*  
 \* YOUR SOFTWARE CONTROL CAN \*  
 \* INCLUDE INTERLACE, SCROLLING, \*  
 \* & A FULL PERFORMANCE CURSOR. \*  
 \* UP TO 4096 SHARP CHARACTERS \*  
 \* ON THE SCREEN IN LESS THAN \*  
 \* THREE MEGAHERTZ TV BANDWIDTH. \*  
 \*\*\*\*\*

# Build the TVT-6: A Low-Cost DIRECT VIDEO DISPLAY

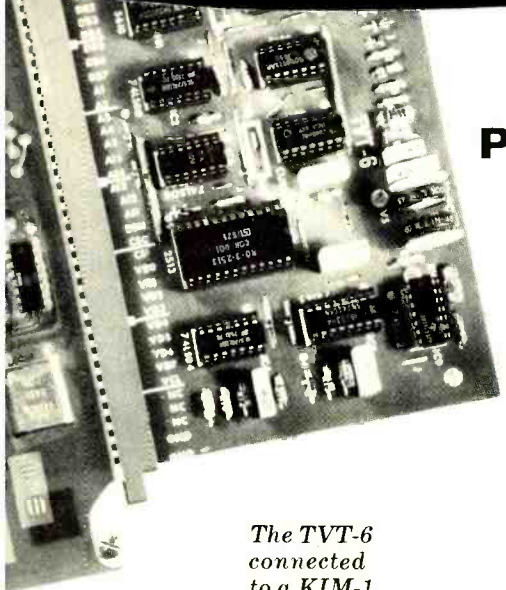

## PART I



The TVT-6 connected to a KIM-1.

\$35 microcomputer "add-on" provides:

- User-selectable line lengths
- Scrolling
- Up to 4k on-screen characters with only 3-MHz bandwidth

BY DON LANCASTER

Thanks to some software tricks, a simple and low-cost add-on circuit, and a new way to speed up a microprocessor, you can now build a video interface for your microcomputer for an investment of only \$20 to \$35. The TVT-6 video system described here permits the choice of virtually any format including 16/32 (16 lines of 32 characters), 16/64, or 32/64. It also features full editing capability and full-performance cursor.

In spite of its simplicity (10 low-cost IC's), the circuit employs a new approach to video processing that permits up to 4000 characters to be displayed on-screen within a 3-MHz bandwidth. Although the TVT-6 was designed for the 6502 microprocessor based KIM-1, software can be used to easily map into the JOLT, EBKA, or Ohio Scientific microcomputers. In addition, the TVT-6 can be adapted to other microprocessors, including the popular 6800, 8080, and Z80. It is easiest to use with 16-address-line systems that operate on a single 5-volt supply and 1- $\mu$ s cycle time.

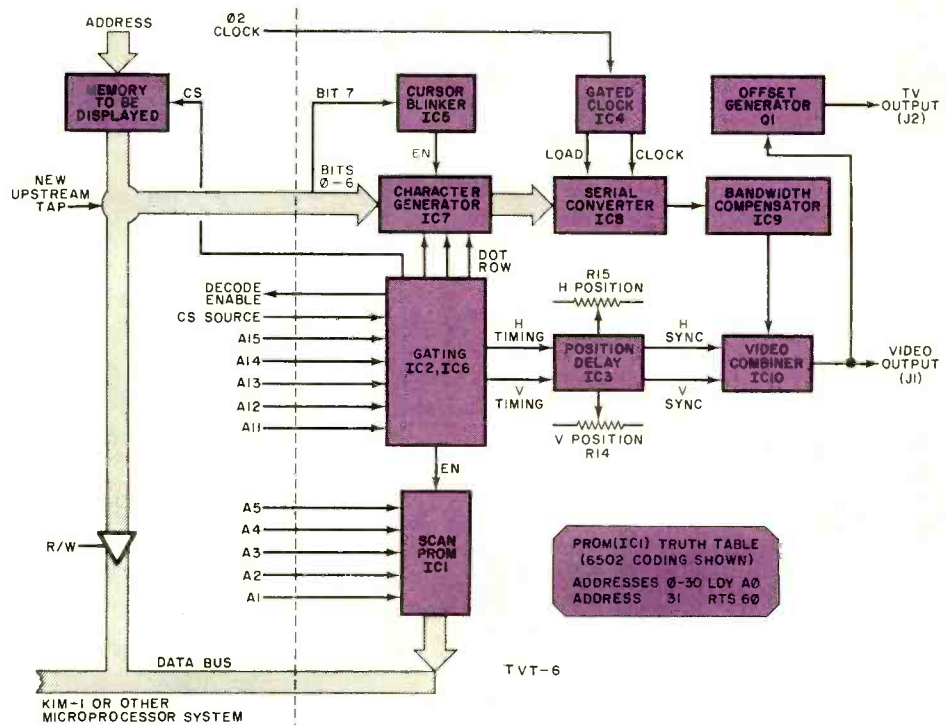

Fig. 1. TVT-6 block diagram and truth table for the PROM.

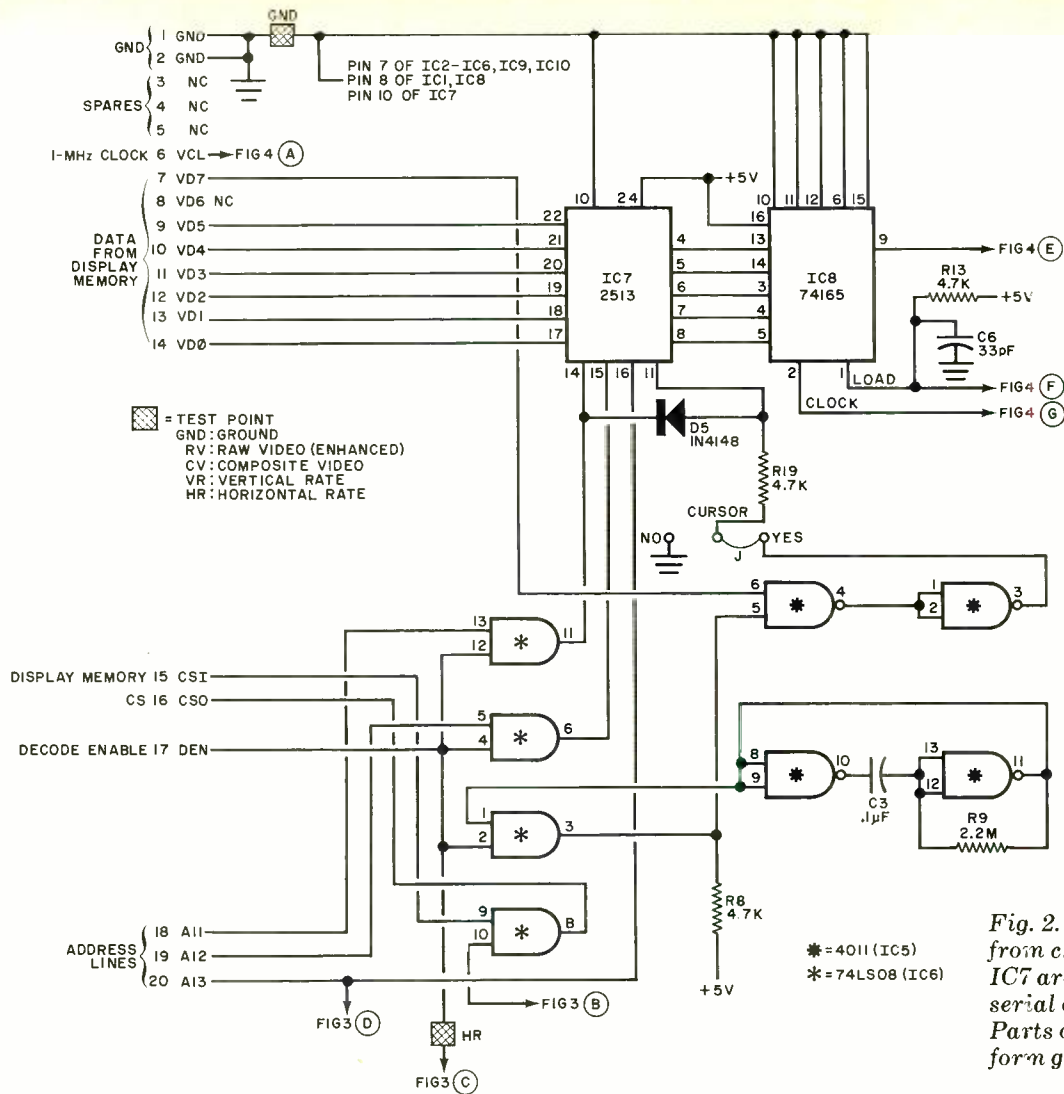

Fig. 2. Parallel outputs from character generator IC7 are converted into serial data in IC8. Parts of IC5 and IC6 form gating circuits.

Other systems will require software and microprogramming translation for their particular machine languages.

In this first of a two-part article, we will cover the hardware and construction details for the TVT-6. Next month, we will cover debugging, some useful software for the system, and provide instructions on how to couple the TVT-6 to other microprocessors.

**Circuit Operation.** A block diagram of the TVT-6, as used with the KIM-1 system, is shown in Fig. 1. The complete schematic diagram of the video system is shown in Figs. 2 through 4.

As shown in Fig. 1, bits 0 through 6 from the "upstream tap" on the KIM display memory drive character generator IC7 whose blanking and formatting are helped along by the AND gates in IC6. The cursor bit (bit 7) is stripped off the upstream tap and routed to cursor blinker IC5, which introduces a blinking cursor into the character generator's enable input.

The parallel outputs from IC7 go to

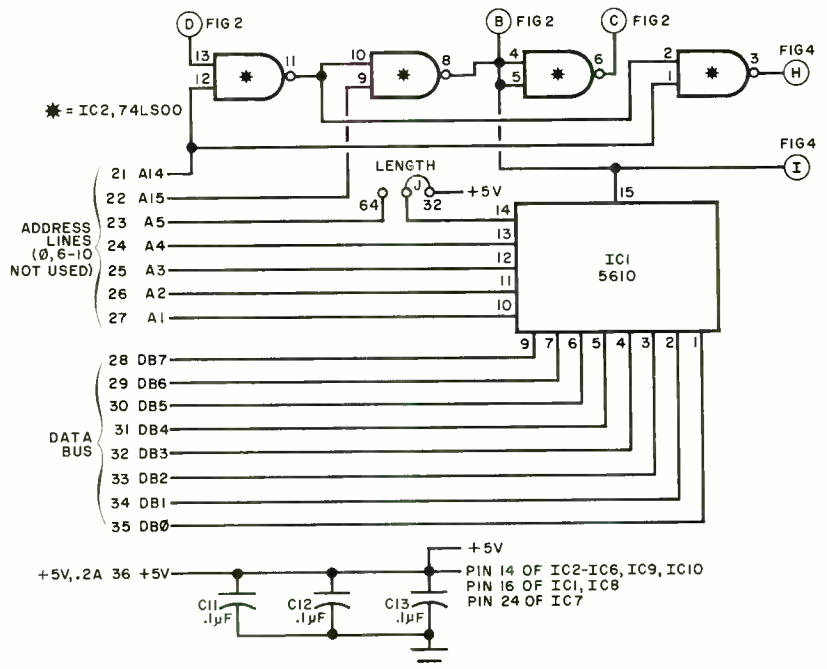

Fig. 3. New SCAN instruction uses PROM IC1, which also has the line length option in its circuit.

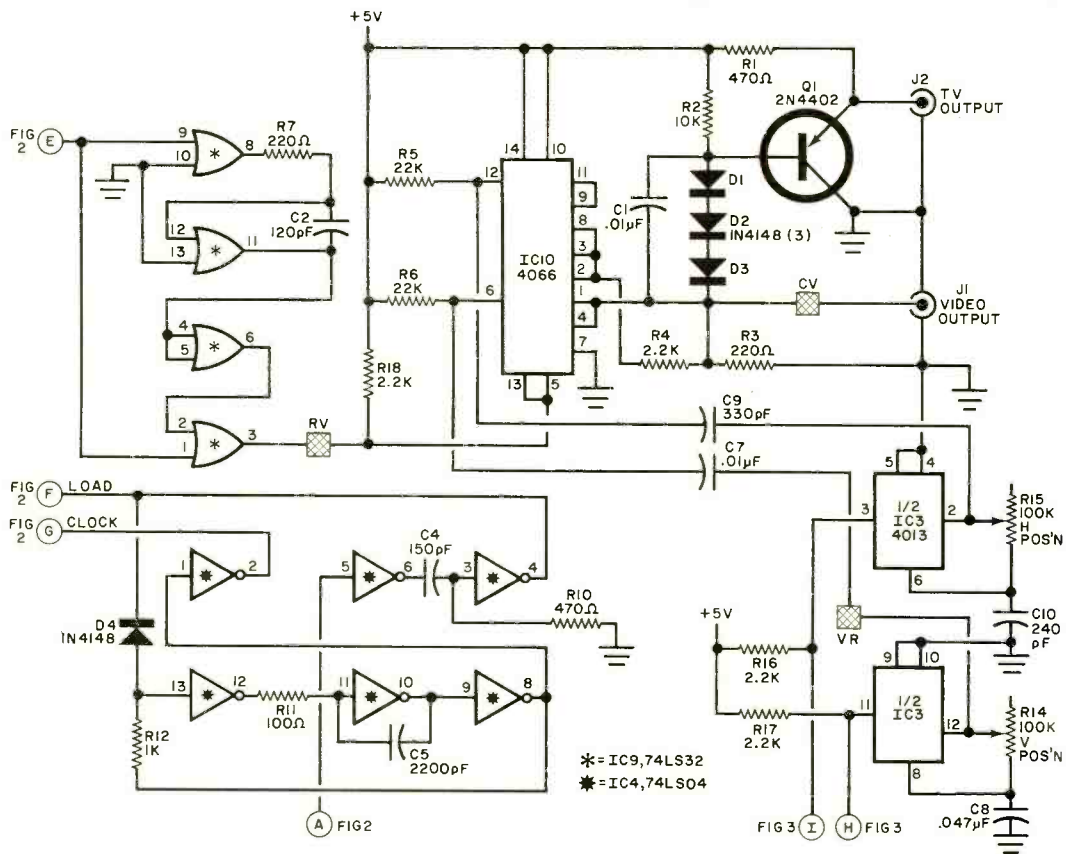

Fig. 4. Video combiner (IC10), offset generator (Q1) and sync delay circuits deliver video to TV. Gated clock (IC4) controls parallel-to-serial converter.

C1, C7—0.01- $\mu$ F Mylar capacitor  
 C2—120-pF polystyrene capacitor  
 C3, C11, C12, C13—0.1- $\mu$ F Mylar capacitor  
 C4—150-pF polystyrene capacitor  
 C5—2200-pF polystyrene or Mylar capacitor  
 C6—33-pF polystyrene capacitor  
 C8—0.047- $\mu$ F Mylar capacitor  
 C9—330-pF polystyrene capacitor  
 C10—240-pF polystyrene capacitor  
 D1 through D5—1N4148 silicon diode  
 IC1—IM5610 32 $\times$ 8 PROM (or similar)  
 IC2—74LS00 quad tri-state NAND gate IC  
 IC3—4013 dual-D flip-flop IC  
 IC4—74LS04 hex inverter IC  
 IC5—4011 quad NAND gate IC  
 IC6—74LS08 quad AND gate IC  
 IC7—2513 character generator (must be single-supply type, such as General Instruments No. RO-3-2513)

#### PARTS LIST

IC8—74165 PISO shift register  
 IC9—74LS32 quad OR gate IC  
 IC10—4066 quad analog switch IC  
 J1, J2—Pc-mount phono jack (Molex No. 15-24-2181 or similar)  
 Q1—2N4402 or MPS6523 (Motorola) transistor  
 The following resistors are  $\frac{1}{4}$  watt, 10% tolerance:  
 R1, R10—470 ohms  
 R2—10,000 ohms  
 R3, R7—220 ohms  
 R4, R16, R17, R18—2200 ohms  
 R5, R6—22,000 ohms  
 R8, R13, R19—4700 ohms  
 R9—2.2 megohms

R11—100 ohms  
 R12—1000 ohms  
 R14, R15—100,000-ohm pc-type (upright) potentiometer  
 Misc.—Sockets for IC's (seven 14-pin, two 16-pin, one 24-pin); 36-contact edge connector with 0.156" centers (Amphenol 225 or similar); solid hook-up wire for jumpers; insulated sleeving; test-point terminals (5); solder; etc.

Note: The following items are available from PAIA Electronics, Box 14359, Oklahoma City, OK 73114: No. PVI-1PC printed circuit board for \$5.95; complete kit of all parts, No. PVI-1K, for \$34.95 (specify blank or KIM-1 programmed IC1); KIM-1 coded cassette, with programs, No. PVI-1CC, for \$5.00. All prices postpaid.

shift register IC8, where they are converted into a serial video signal. The clock and load commands for IC8 come from gated oscillator IC4, which derives its signals from the microcomputer's clock. It is important that the correct clock phase be selected to permit the loading of IC8 to occur when the output of the character generator is valid and settled. This is phase 2 in the KIM-1. (If you are using a different  $\mu$ P based computer, check this detail.)

The serial video from IC8 goes to the TV Bandwidth Compensator in IC9, which predistorts the video by delaying the video output and OR'ing it against itself. This widens the vertical portions of all characters to generate clean and crisp characters that require minimum bandwidth. The amount of widening is determined by C2 (Fig. 4). The optimum value of C2 is obtained when the generated M or W in the video display just barely closes.

The vertical and horizontal timing signals from IC2 in the gating circuit are delayed by IC3. The display positioning can be varied by potentiometers R14 and R15. The vertical and horizontal sync signals are combined with the enhanced video from IC9 into video combiner IC10. The output from IC10, available at J1, is composite video, with the sync tips at ground, black at 0.4 volt, and white at 1.6 volts. This output can be used to drive conventional video moni-

tors and converted TV receivers. The video output from IC10 is also fed to Q1, which is offset to deliver a +4-volt output for the white level. This output, available at J2, can be connected directly to the first video amplifier of most transformer-powered solid-state TV receivers (see box for details) without requiring biasing, coupling, or translation circuits.

Two options are provided with the TVT-6, both of which are jumper selected. The LENGTH option allows a choice of either 32 or 64 characters/line. The CURSOR option gives the choice of either no cursor or allows the cursor to be displayed under software control.

**Construction.** The actual-size etching and drilling guide for the printed circuit board used in the TVT-6 is shown in Fig. 5, along with the component-installation diagram. Start assembly by installing and soldering into place the 21 jumpers and test points. (Note that insulated sleeving must be used on two of the long jumpers.) Install the IC sockets, resistors, capacitors, diodes, jacks, and position controls R14 and R15. Do not install the IC's at this time. The correct IC installation sequence and the waveforms to be observed will be discussed in Part 2 next month.

**Computer Interface.** Detailed in Table I are the requirements of each of the edge connector contacts on the TVT-6 and how to use each contact. Table I also contains the KIM-1 interface connection instructions. The interface consists of adding a new connector and making some add-on connections. One circuit board trace is cut on the KIM-1's pc board to permit an optional change-over switch (or jumper) to be added to the microcomputers. This permits KIM-1 to be used with or without the TVT-6.

**General Operation.** Since most of today's TVT circuits are used with a microprocessor or microcomputer, it is best to do as much of the display control as possible with the microprocessor and some software. What may not be obvious is that almost all of the timing in the system can also be done using the microprocessor. All this takes is a few dozen words of code.

The four key secrets of operation for the TVT-6 are:

1. Carefully choose how the address lines are defined for TVT operation.
2. Add a new instruction, which we call SCAN, to rapidly address 32 or 64 sequential memory locations.
3. Permanently connect an upstream

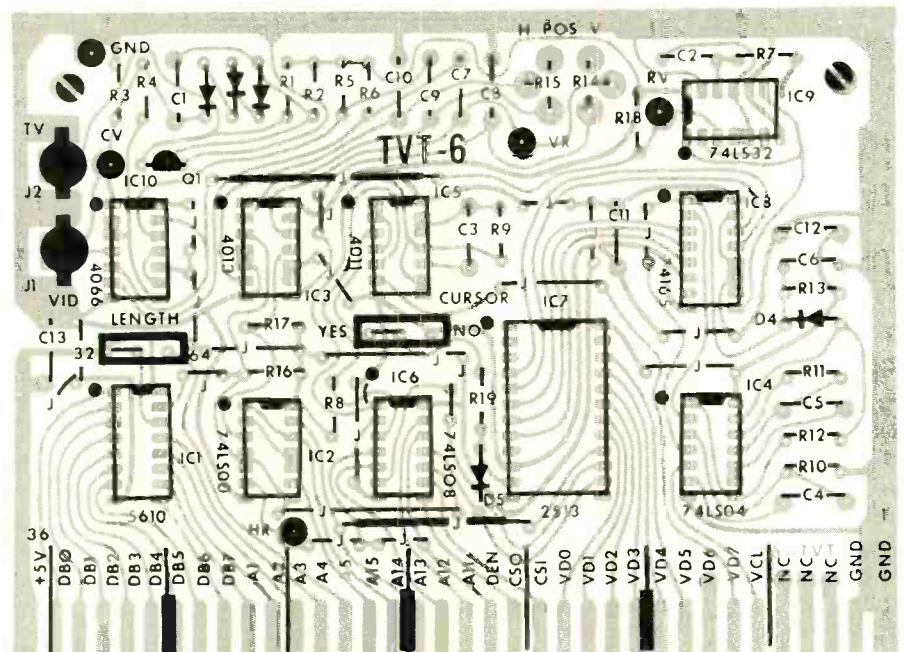
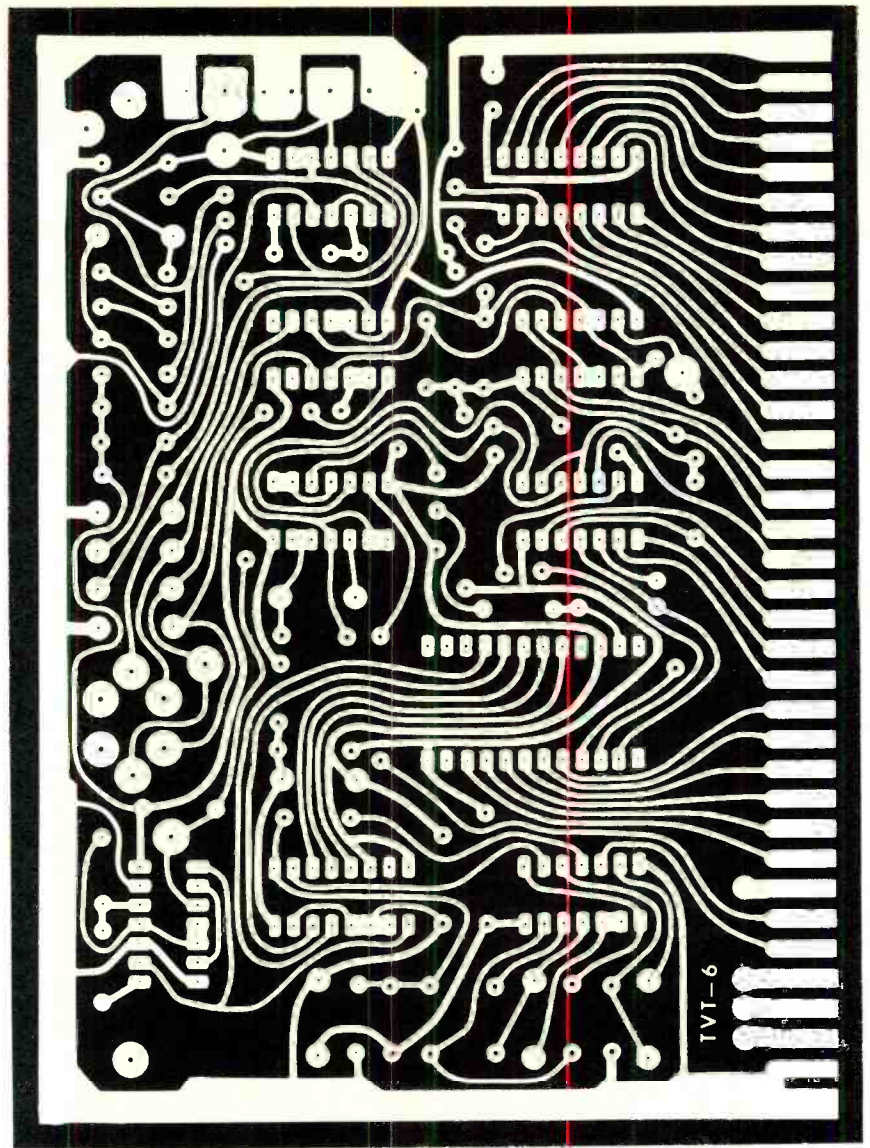

Fig. 5. Actual-size foil pattern (top) and component installation (below). Use sockets for all IC's. Edge connectors go to KIM-1.

**TABLE I**  
**TVT-6 PINOUT AND KIM-1 INTERFACE**

TVT-6 CONTACT	NAME	REMARKS			
1,2	GND	Heavy wire to expansion contact 22 or similar point in KIM-1	A4,	R (A13)	20
3, 4, 5	NC	Spares	A3,	S (A14)	21
6	VCL	1-MHz clock from expansion contact U(φ2). (In other systems clock phase must be selected so that load pulse arrives when CG is valid.)	A2,	T (A15)	22
7,8,9,10, 11,12,13, 14	VD7, VD6, VD5, VD4, VD3, VD2, VD1, VDφ	Data output from memory display; drives character generator. For KIM-1 to display any part of pages 00 through 03, connections must be made as follows: connections must be made as follows: TVT-6 contact: to pin 12 of KIM-1 IC:	A1	F (A5)	23
				E (A4)	24
			28, 29, 30, 31,32,33, 34, 35	D (A3)	25
				C (A2)	26
				B (A1)	27
				μP data bus; tri-state active high from IC1 during active scan, not used at other times.	
				Connections to KIM-1 expansion:	
				KIM-1 contact: to TVT-6 contact:	
				DB7, 8 (BD7)	28
				DB6, 9 (DB6)	29
				DB5, 10 (DB5)	30
				DB4, 11 (BD4)	31
				DB3, 12 (DB3)	32
				DB2, 13 (DB2)	33
				DB1, 14 (DB1)	34
				DBφ, 15 (DBφ)	35
			36	+5V	Regulated +5-volt (200-mA) power bus; should be heavy wire. From KIM-1 expansion contact 21 or similar point to contact 36 in TVT-6.
15	CSI	Display memory chip select from μP; negative logic OR combined with TVT-6 chip select. From pin 1 of U4 on KIM-1.			
16	CSO	Display memory chip select source; enables display memory when either TVT-6 is active or contact 15 is low. Goes to pin 13 of U5 through U12 in KIM-1 when displaying any part of pages 00 through 03. Existing Kφ connection in KIM-1 must be broken.			
17	DEN	Decode enable; goes low when μP is operated in normal mode, high when TVT-6 is doing an active scan. Goes to KIM-1 Applications contact K. Any external ground on applications contact K should be removed.			
18,19,20, 21,22,23, 24, 25, 26, 27	A11, A12, A13, A14, A15, A5,	Address inputs from μC, positive true. Addresses Aφ A6 through A10 not sent to TVT-6. Connections to KIM-1 expansion: KIM-1 contact: to TVT-6 contact: N (A11) 18 P (A12) 19			

Note: KIM-1 conversion consists of breaking one foil trace and adding a new 36-pin socket (Amphenol 127 or similar). Connection to be broken originates as Kφ (pin 1 of U4). Routing of Kφ that goes to memory chip select pin 13 of U5 through U12 should be broken. Other Kφ connections, such as that to pin 1 of U16 should remain intact. Any external ground connections to Application connector contact K (decode-enable) must be removed. All wiring should be made with a wiring pencil.

When KIM-1 is used *without* displaying video, it will behave normally and transparently as long as TVT-6 is plugged in and addresses 8000 through DFFF are not used. To restore KIM-1 operation with TVT-6 out of socket, or to use available addresses for other programs, jumper pin 15 to pin 16 and separately jumper pin 1 to pin 17 in the KIM-1. Note that this jumpering is to be done only when TVT-6 is out of its connector. If you wish, a dpdt changeover switch can be added to perform the jumpering. Switch positions should be changed only when power is off.

memory tap to the character generator and display circuit.

4. Create special software that will allow TVT-6 scanning.

All 16 address lines are used, assigned as shown in Fig. 6A for a 32-character/line system or as shown in Fig. 6B for a 64-character/line system. Address A15 is the horizontal sync pulse and the key to jumping to the new SCAN instruction. This pulse is followed in descending address order by the vertical sync (A14) and three lines (L4, L2, L1) that produce the "what row of dots do we want?" information for the character generator. The lower address lines are used to select a page of display memory and to select the character that goes into any particular horizontal and vertical location on the display.

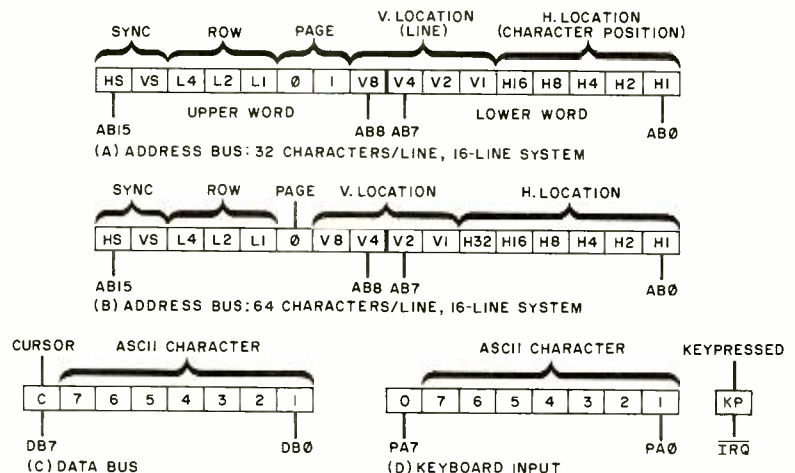
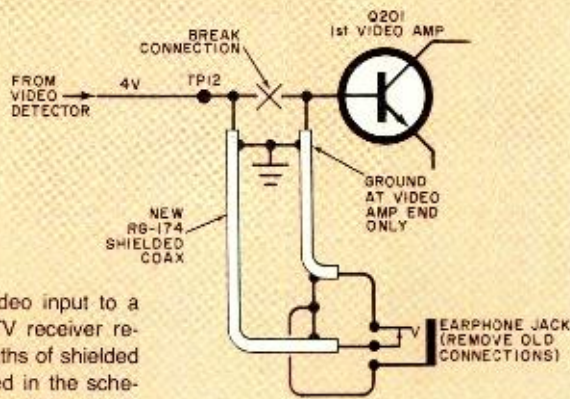

Fig. 6. Bus definitions as used with the TVT-6. All 16 address lines are used as described in text.

## DIRECT-VIDEO INPUT CONVERSION



Adding a TVT-6 direct-video input to a small-screen solid-state TV receiver requires only two short lengths of shielded coaxial cable, as illustrated in the schematic. (Important Note: *Do not use a hot-chassis TV receiver!* Make absolutely certain that the TV receiver you use is transformer powered from the ac line.) The conversion circuit shown here is for the Sears No. 562-50260500 (Sams Photo-fact No. 1565-1). Other TV receivers can be modified in a similar manner.

The earphone jack in the circuit provides automatic changeover from normal receiver performance to video access. Correct bias is provided by TV output of the TVT-6. As an option, you can defeat the sound trap in the Sears TV receiver by lifting one end of capacitor C201.

The data within the machine (see Fig. 6C) uses the lowest seven bits as ASCII character storage. This is arranged by putting the least-significant ASCII character bit in the least-significant data slot, and so on up through the more significant bits. The eighth data bit (DB7) is reserved for a cursor. If DB7 is a zero, a character is displayed, while if it is a one, a cursor box is optionally displayed.

The existing KIM-1 keypad can be used as an ASCII keyboard for many applications, particularly for setup and debugging. If you wish to add an external ASCII keyboard and encoder, connect it to the KIM-1's parallel interface A, following the assignments shown in Fig. 6D. The seven ASCII bits go to the seven low-order data lines, while PA7 is hard wired for a zero. The keypress, or strobe, signal from the keyboard must pull the IRQ (interrupt request line) to ground for 10  $\mu$ s to enter a character or machine command.

The truth table for PROM IC1 is shown in Fig. 1. This truth table stores the SCAN instruction, activated by addresses 8000 through DFFF. When IC1 is enabled, it causes the microprocessor's program counter to appear on the address lines for 32 or 64 consecutive scans that advance one count per microsecond. This automatically and sequentially addresses the display memory and produces exactly the data needed for a horizontal scan of TVT characters. The scan instruction runs at least twice as fast as the microprocessor normally moves, which is the key to TVT timing with a microprocessor.

To use the SCAN instruction, jump to a subroutine whose starting address is within the 8000 to DFFF range. For example, if you call JRS 8200, the SCAN instruction will deliver a horizontal sync pulse and initiate operation on the top row of characters, starting with the first character on page 2. After a selected 32

interrupt and reset vectors on the KIM-1 so that the operating system will work compatibly and properly with the new SCAN instruction.

There are many possible codings for the SCAN program with the limitation that the last address is a return-to-subroutine (RTS) instruction. The obvious choice of NOP or EA runs at only half speed and can't be used. Of the three dozen instructions that operate at full speed, the choice of LDY is the one that does not disturb the accumulator or its flags. This adds flexibility to other programs. The Y register can be viewed as a write-only memory in the SCAN software and we can think of the whole SCAN instruction as a group of double-speed fetch-but-don't-execute instructions. Theoretically, a 64-word PROM would be required for a 64-character line, but this can be overcome by ignoring address A $\phi$  and changing the PROM's address every second cycle of the machine.

**Upstream Tap.** The SCAN instruction will sequentially address 32 or 64 memory slots per horizontal scan line at a rate of one-per-clock cycle (1  $\mu$ s). These addresses are presented to the entire memory in the computer, including the memory to be displayed. However, during the display times, the SCAN instruc-

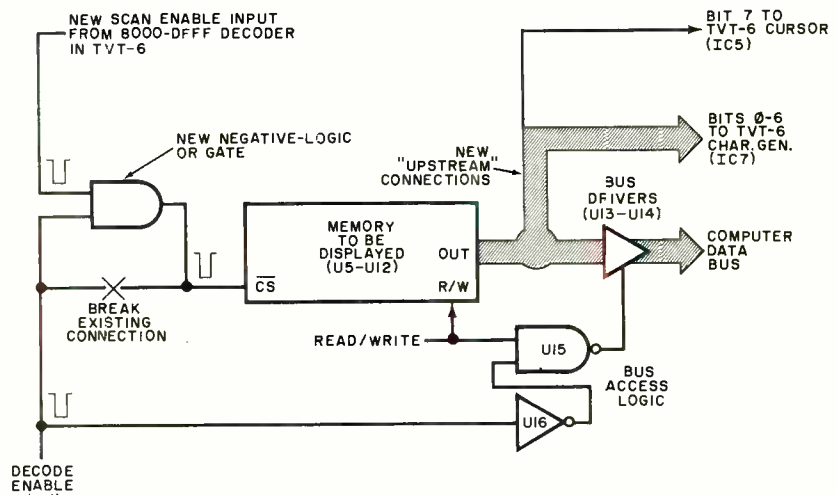

Fig. 7. Adding the upstream tap to the memory to be displayed.

or 64 characters, the SCAN instruction automatically jumps back to the main program.

The SCAN instruction can be viewed as a "portable subroutine" because it readily moves around to automatically output the correct page and character generator's row information, starting with an easily computed JSR address. Addresses above DFFF will not activate the SCAN instruction. This includes the

tion and its PROM have control of the data bus so that the display memory (or anything else) cannot output information to the data bus.

The upstream tap is added as shown in Fig. 7. This tap is always outputting information to the character generator in the TVT-6. The output information is present even (and especially) when the display memory data bus drivers have been inactive.  $\diamond$



From: Nagasaki Radio  
Nagasaki Japan  
OCT 20th 1975

To: Mr. Harry L. Helms, Jr.

Tnx for your QSL report  
Your details all confirmed!

**QSL**  
**NAGASAKI RADIO**  
JOS  
JOR  
JOU  
JDB

C. Iwashita  
C. Iwashita, radio operator of Nagasaki radio

**TABLE OF OPERATION HOUR ON HIGH FREQUENCY**

CALL SIGN	Power (KW)	FREQ. (KHz)	OPERATION HOUR (GMT)																							
			1	2	3	4	5	6	7	8	9	10	11	12	13	14	15	16	17	18	19	20	21	22	23	24
JOS	3	4.328	[Bar chart showing operation hours]																							
JOS	3	6.491.5	[Bar chart showing operation hours]																							
JOR	10	8.523.4	[Bar chart showing operation hours]																							
JOS	3	8.706	[Bar chart showing operation hours]																							
JOR	10	13.008	[Bar chart showing operation hours]																							
JDB	15	13.063	[Bar chart showing operation hours]																							
JOS	3	13.068.5	[Bar chart showing operation hours]																							
JOU	15	13.092	[Bar chart showing operation hours]																							
JOS	3	16.933.2	[Bar chart showing operation hours]																							
JOU	15	16.959.2	[Bar chart showing operation hours]																							
JOR	15	17.093.6	[Bar chart showing operation hours]																							
JDB	15	17.215	[Bar chart showing operation hours]																							
JOS	3	22.336	[Bar chart showing operation hours]																							
JOR	15	22.409	[Bar chart showing operation hours]																							
JOU	15	22.440	[Bar chart showing operation hours]																							
JOR	15	6.457.5	[Bar chart showing operation hours]																							

JOS, JOR, JOU, JDB (Nagasaki Radio) acknowledges reception with informal QSL which lists call signs, power (kW), frequency (kHz), and operating hours (GMT).

BY HARRY L. HELMS, JR.

# END THAT "UTILITY FUTILITY"

## DXing CW without knowing Morse code

If you're like a lot of SWL's, you're not getting full use of your shortwave receiver. You DX the international and tropical broadcasting bands for sure, and you probably eavesdrop on the amateurs, broadcast band, and international radiotelephone circuits from time to time. But what about those CW stations—Morse code. Tune outside the broadcasting bands and you'll find scads of those dit-dah stations dotting and dashing away around the clock. Have you ever tried your hand at DXing these stations?

Prime DX lurks in the CW utility bands! Countries such as Iceland, Bermuda, Barbados, and the Canal Zone are missing from many SWL logbooks because they are extremely difficult to hear on the broadcasting bands. But these countries and others are active. They're often heard on the CW utility bands, and they readily verify reports as well!

"But I don't know CW," you may protest. If that's all that has prevented you from DXing the dah-dit stations, relax. For the simple fact of the matter is that you don't have to know the code to DX and verify CW stations!

**Markers Make it Easy.** There's nothing magical about DXing CW stations if you don't know the code. CW stations offer a ready-made DX aid in the *marker transmission*, which is a repeated taped transmission used by a CW station to establish contact or to hold

onto a frequency while waiting for traffic.

Marker transmissions often follow this general format: the tape starts with a series of the letter "V" (VVV VVV VVV, etc.) or a series of CQs (CQ CQ CQ, etc.). This is almost certainly followed by "DE," which is French for "from." Next comes the station callsign, usually repeated three times. Thus, typical marker transmissions read something like this: "VVV VVV VVV DE WXX WXX WXX" or "CQ CQ CQ DE WXX WXX WXX." The marker often contains additional items, such as the Q-code abbreviations "QRU?" ("Do you have anything for me?") or "QSX" (I am listening on

\_\_\_\_\_). And often you will hear the letters "K," "SK," or "AR" sent at the end of a marker. All three are generally used to denote the end of the text of the marker. Thus you're likely to hear a marker running something like this: "VVV VVV VVV DE WXX WXX WXX QRU? QSX 6 8 12 MHZ AR." Translated, this means that station WXX is not busy at the moment and is asking listening stations if they have any traffic for WXX, and that WXX is listening on the 6, 8, and 12-MHz utility bands for a reply.

How can one translate those dits and dahs into readable letters if one doesn't know CW? The secret lies in the fact

### PRIME MARITIME CW DX BANDS

4231-4361 kHz	12689-13170.5 kHz
6345.5-6514 kHz	16917.5-17255 kHz
8459.5-8728.5 kHz	22374-22624.5 kHz

### CW MARKER ABBREVIATIONS & CODES

VVV	General opening for a marker; usually sent in a series of three
CQ	General call to any station, often used to start marker
DE	French for "from," precedes station callsign.
QRU?	Do you have any traffic for me?
QRX	I will call on the frequency of _____
QSX	I will be listening on the frequency of _____
QSY	I am changing frequency to _____
K	At end of marker, denotes end of message
AR	Same as K, meaning end of message
SK	Station work completed

## COMMONLY HEARD FOREIGN CW STATIONS

4352	NBA	Balboa, Canal Zone
6376	VPN	Nassau, Bahamas
6379	8PO	St. Philip, Barbados
6383	EAD	Madrid, Spain
6386	HKC	Buenaventura, Colombia
6393	ZLO	Waiouru, New Zealand
6439	OXZ	Lyngby, Denmark
6446	OXZ	Lyngby, Denmark
6463	HKB	Barranquilla, Colombia
6464	VIS	Sydney, Australia
6467	JCS	Choshi City, Japan
6470	IAR	Rome, Italy
6487	VRT	Bermuda
6491	PJC	Willemstad, Curacao
6491	JOS	Nagasaki, Japan
6512	TFA	Reykjavik, Iceland
8472	NMR	San Juan, Puerto Rico
8479	JCU	Choshi City, Japan
8481	VIS	Sydney, Australia
8483	DAN	Hamburg, West Germany
8511	DAL	Hamburg, West Germany
8521	VIS	Sydney, Australia
8523	JOR	Nagasaki, Japan
8530	IAR	Rome, Italy
8574	HKC	Buenaventura, Colombia
8598	OXZ	Lyngby, Denmark
8647	JDC	Choshi City, Japan
8666	OXZ	Lyngby, Denmark
8666	HKB	Barranquilla, Colombia
8666	HKC	Buenaventura, Colombia
8670	IAR	Rome, Italy
8682	EAD	Madrid, Spain
8686	JCT	Choshi City, Japan
8690	TFA	Reykjavik, Iceland
8694	PJC	Willemstad, Curacao
8710	VPN	Nassau, Bahamas
8718	8PO	St. Philip, Barbados
8718	VRT	Bermuda
8726	NMR	San Juan, Puerto Rico
12709	8PO	St. Philip, Barbados
12709	VRT	Bermuda
12718	NMR	San Juan, Puerto Rico
12832	DAF	Hamburg, West Germany
12943	ZLO	Waiouru, New Zealand
12952	VIS	Sydney, Australia
13065	EAD	Madrid, Spain
13069	TFA	Reykjavik, Iceland
17170	PJC	Willemstad, Curacao

that a marker is repeated for several minutes at a time, usually at a code speed considerably below that normally used, and the message is the same each time it is repeated. In fact, you may find some markers repeated for hours at a stretch. Thus, you need persistence and patience to bag CW DX, not code proficiency.

Your task will be greatly simplified if you have some form of tape recorder, either reel-to-reel or cassette. If you do, it helps to record several minutes of the marker. If you don't have a tape recorder, you can still log CW stations, but

The Overseas Telecommunications Commission (Australia) has pleasure in confirming your reception of the following transmission: —

**SERVICE: MARITIME MOBILE**  
**CALL SIGN: VIS 3**

EMMISSION: **A1**

TRANSMITTER POWER: **1 KW**

AERIAL TYPE: **DELTA MATCHED DIPOLE**

AERIAL BEARING: \_\_\_\_\_

FREQUENCY: **6464 KHz**

*A. H. 11723 TH 11*  
*11723 TH 11*  
*11723 TH 11*

O. T. C. is the Australian national body responsible for telecommunications services between Australia and other countries, and between Australia's external territories and shipping. Thank you for your report on its transmission and conveys our best wishes.

*R. F. J. [Signature]* Signed for O. T. C.

Your report of reception heard on **18/8/75**



*The Overseas Telecommunications Commission (Australia) sends this QSL with service, call sign, emission, transmitter power, antenna type, and frequency as part of the confirmation of one of its transmissions.*

you'll have to work quickly and accurately. With practice, you'll find that it will only take a couple of minutes, even without the aid of a tape recorder.

The Morse code is a language of sound, with only two sounds to learn: the dit (a short, staccato sound) and the dah (approximately three times as long as the dit and drawn out). Forget all about dots and dashes—those are relics left over from the days of landline telegraphy—and also forget any visual code table you may have memorized. On radio, CW is sound.

Learn to recognize the "V" or "CQ" series that open markers by their sound in CW. A "V" comes out as "didididah" and "CQ" sounds like "dahdidahdit dah-dahdidah." Memorize these sounds and practice them by repeating them to yourself or by whistling those sounds. Using this technique, you'll be able to recognize the "V" or "CQ" that indicates that you're hearing a marker. Listen carefully to the transmissions that follow the opening. Is it repeated over and over? If

so, turn on your tape recorder, get a pencil and paper, and grab the code table that accompanies this article. We are now going to end your utility futility!

The next thing you are likely to hear after the "V" or "CQ" series are the letters "DE," explained earlier. In CW, they make the sounds "dahdidit dit," and should be memorized along with "V" and "CQ." The call letters of the station are almost invariably next. Concentrate on getting the first letter. As soon as you hear it, look on our code sound table until you find the letter that matches the sound. As an example, suppose that the first sound you hear following "DE" is "didahdah." As soon as you hear it, concentrate on the sound, perhaps by repeating it to yourself—"didahdah, didahdah . . ."—until you locate it on our code table. In this case, you'll find that "didahdah" represents the letter "W." So you'll now have the first letter in the station's call. Repeat this process with the next letter, and the next, until you have the station's complete call sign.



Stamp

Thank you for your reception report of our signals on **8526 KHz** as reported by you on **3/2/75**

We appreciate your interest.

*Robert F. Kern*  
**Traffic Supervisor**

0411 (4-73)

**Mr. Harry Helms, Jr.**  
**115 West LeRoy Street**  
**Fort Mill, S.C. 29715**

*TRT Telecommunications Corporation acknowledges reception by confirming the transmitting frequency on the day and date.*

This may sound like a long and tedious process, and it may be so at first. But after a little practice you'll be able to copy the complete text of the marker within minutes. If you have trouble with the code sounds, try adjusting your receiver's beat frequency oscillator (BFO) for a different pitch.

**Verifications.** It's a snap to prove to the CW utility station that you heard them. Simply copy the complete text of the marker transmission and report in the usual manner. Normally it's a no-no under international law to repeat the details of a utility station transmission. Fortunately, markers are an exception. Include the date and time in GMT. Avoid using common reporting codes such as SINPO and SINFO. Plain English will do fine. Make particular note of any hum or frequency shifting of the signal.

Estimate the frequency as best you can. If you are one of those fortunate SWLs with direct-frequency readout receivers, this is no problem. But if you're like most of us and use a general cover-

### CW CHART BY SOUND

A	<i>didah</i>
B	<i>dahdididit</i>
C	<i>dahdidahdit</i>
D	<i>dahdidit</i>
E	<i>dit</i>
F	<i>dididahdit</i>
G	<i>dahdahdit</i>
H	<i>didididit</i>
I	<i>didit</i>
J	<i>didahdahdah</i>
K	<i>dahdidah</i>
L	<i>didahdidit</i>
M	<i>dahdah</i>
N	<i>dahdit</i>
O	<i>dahdahdah</i>
P	<i>didahdahdit</i>
Q	<i>dahdahdidah</i>
R	<i>didahdit</i>
S	<i>dididit</i>
T	<i>dah</i>
U	<i>dididah</i>
V	<i>didididah</i>
W	<i>didahdah</i>
X	<i>dahdididah</i>
Y	<i>dahdidahdah</i>
Z	<i>dahdahdidit</i>
1	<i>didahdahdahdah</i>
2	<i>dididahdahdah</i>
3	<i>didididahdah</i>
4	<i>dididididah</i>
5	<i>dididididit</i>
6	<i>dahdidididit</i>
7	<i>dahdahdididit</i>
8	<i>dahdahdahdidit</i>
9	<i>dahdahdahdahdit</i>
0	<i>dahdahdahdahdah</i>
?	<i>dididahdahdidit</i>
/	<i>dahdididahdit</i>
.	<i>didahdidahdidah</i>

### WHERE TO SEND CW DX RECEPTION REPORTS

KFS, ITT World Communications, Box 56, Half Moon Bay, Calif. 94019  
 KHK, RCA Global Communications, 223 S. King St., Honolulu, Hawaii 96804  
 KLB, ITT World Communications, 3620 Old Hiway 99, Marysville, Wash. 98270  
 KOK, ITT World Communications, 18500 S. Bloomfield Ave., Cerritos, Cal. 90701  
 KPH, RCA Global Communications, 135 Market St., San Francisco, Calif. 94105  
 WAX, TRT Telecommunications, Box 8876, Fort Lauderdale, Florida 33310  
 WCC, RCA Global Communications, Box 397, North Chatham, Mass. 02650  
 WLO, Mobile Marine Radio Inc., Box 743, Mobile, Alabama 33601  
 WMH, Dundalk Marine Terminal, 2700 Broening Highway, Baltimore, Maryland 21222  
 WNU, TRT Telecommunications, P. O. Drawer E, Pearl River, Louisiana 70452  
 WNY, RCA Communications Inc., 60 Broad St., New York, NY 10004  
 WOE, RCA Communications Inc., 8580 Lawrence Rd., Lake Worth, Florida 33460  
 WPA, RCA Global Communications, Box 1328, Port Arthur, Texas 77640  
 WSC, RCA Global Communications, Box 34, West Creek, New Jersey 08092  
 WSL, ITT World Communications, Mackay Marine Div., Amagansett, New York

### COMMONLY HEARD AMERICAN CW STATIONS

4247	KPH	San Francisco, Calif.
4274	KFS	Palo Alto, Calif.
4283	KOK	Cerritos, Calif.
4310	WNU	Slidell, Louisiana
4322	WPA	Port Arthur, Texas
4331	WSC	Tuckerton, New Jersey
4346	WMH	Baltimore, Maryland
4349	KLB	Marysville, Wash.
6376	WCC	Chatham, Mass.
6390	WAX	Ojus, Florida
6411	KLB	Marysville, Wash.
6411	WOE	Lantana, Florida
6435	WPA	Port Arthur, Texas
6463	KOK	Cerritos, Calif.
6477	KPH	San Francisco, Calif.
6495	WNU	Slidell, Louisiana
6502	WSC	Tuckerton, New Jersey
6519	WNY	New York, New York
8486	WOE	Lantana, Florida
8502	WMH	Baltimore, Maryland
8514	WSL	Amagansett, New York
8526	WAX	Ojus, Florida
8542	KHK	Honolulu, Hawaii
8558	KFS	Palo Alto, Calif.
8570	WNU	Slidell, Louisiana
8582	KLB	Marysville, Wash.
8586	WCC	Chatham, Mass.
8590	KOK	Cerritos, Calif.
8610	WSC	Tuckerton, New Jersey
8618	KPH	San Francisco, Calif.
8630	WCC	Chatham, Mass.
8642	KPH	San Francisco, Calif.
8658	KLB	Marysville, Wash.
8658	WSL	Amagansett, New York
8686	WMH	Baltimore, Maryland
8714	WLO	Mobile, Alabama
12808	KPH	San Francisco, Calif.
12844	KFS	Palo Alto, Calif.
12925	WCC	Chatham, Mass.
12993	KOK	Cerritos, Calif.
12997	WSL	Amagansett, New York

age receiver not calibrated so accurately, estimate the frequency to the best of your ability. If you get deeply involved with CW DXing, you may find an external frequency standard that puts out markers every 100 kHz will be a good investment. They often run around \$30 more or less.

It is always wise to include a prepared card with your report. Put the station call and location on the card, along with the date and time the station was heard. If you had to estimate the frequency, leave a space blank for the station operator to include the exact frequency. You might like to leave some space for the station operator to make some remarks, along with a line for a signature and station stamp. Frequently, a station will have its own QSL cards or will send a letter, but a prepared card is the best way to ensure a reply.

Included here is a list of the major CW utility bands. They're mainly used by coastal stations. Also presented is a list of commonly heard stations and the frequencies on which they have been active of late. More complete listings of CW stations can be obtained from Handler Enterprises, Box 253, Deerfield, Illinois 60015 and Gilfer Associates, Box 239, Park Ridge, NJ 07656. You might also be interested in joining a radio club that features coverage of CW DX. Three such clubs are American SWL Club, 16182 Ballad Lane, Huntington Beach, Calif., 92649; Newark News Radio Club, Box 539, Newark, New Jersey, 07101; and SPEEDX, Box E, Elsinore, Calif., 92330. Enclose a self-addressed stamped envelope with your requests for information to these clubs, and you might enclose \$1 if you want to examine a sample bulletin. ◇

# TAPE RECORDER HYGIENE

*How to maintain tape recorders and tapes  
in peak condition.*

BY CRAIG STARK

**A** PART from inquiries about specific product recommendations, the subject of most concern to readers is how to care for their recorders and tapes.

In addition to routine household dusting, recorders need two kinds of periodic cleaning: physical and magnetic. The tape has yet to be made that does not shed some of its oxide particles with every playing, and unfortunately these tend to accumulate on tape heads and guides, pressure pads, and the capstan/pressure-roller drive system. If not removed, this debris can cause slippage in the drive mechanism. The resulting wow and flutter is heard as inconstancy or "graininess" in pitch. In addition, the oxide accumulations on the heads cause momentary "drop-outs" in the signal and loss of treble response.

Happily, the solution is as near as a bottle of isopropyl or rubbing alcohol and an ordinary cotton-tipped swab. If the tape you use has a brown surface, the

chocolate-colored band that develops on the black pressure roller is an obvious warning that housekeeping is in order. If the tape you use has a black oxide, you will have to look more closely to see the shiny band that appears. In any case, the build-up of flaked-off oxide particles *must* be removed from *all* parts in the head assembly and anywhere the tape contacts the recorder.

**Magnetic Considerations.** Though unseen, residual magnetism induced in heads, guides, and capstan represents an even greater potential danger to your tape collection, and preventive or therapeutic treatment is indicated at least as often as physical cleaning. Professional studios "degauss" their machines daily (every 8 to 20 hours of operating time is the usual recommended rule of thumb) to guard against this insidious force. A magnetized component anywhere in the tape path will create some hiss and per-

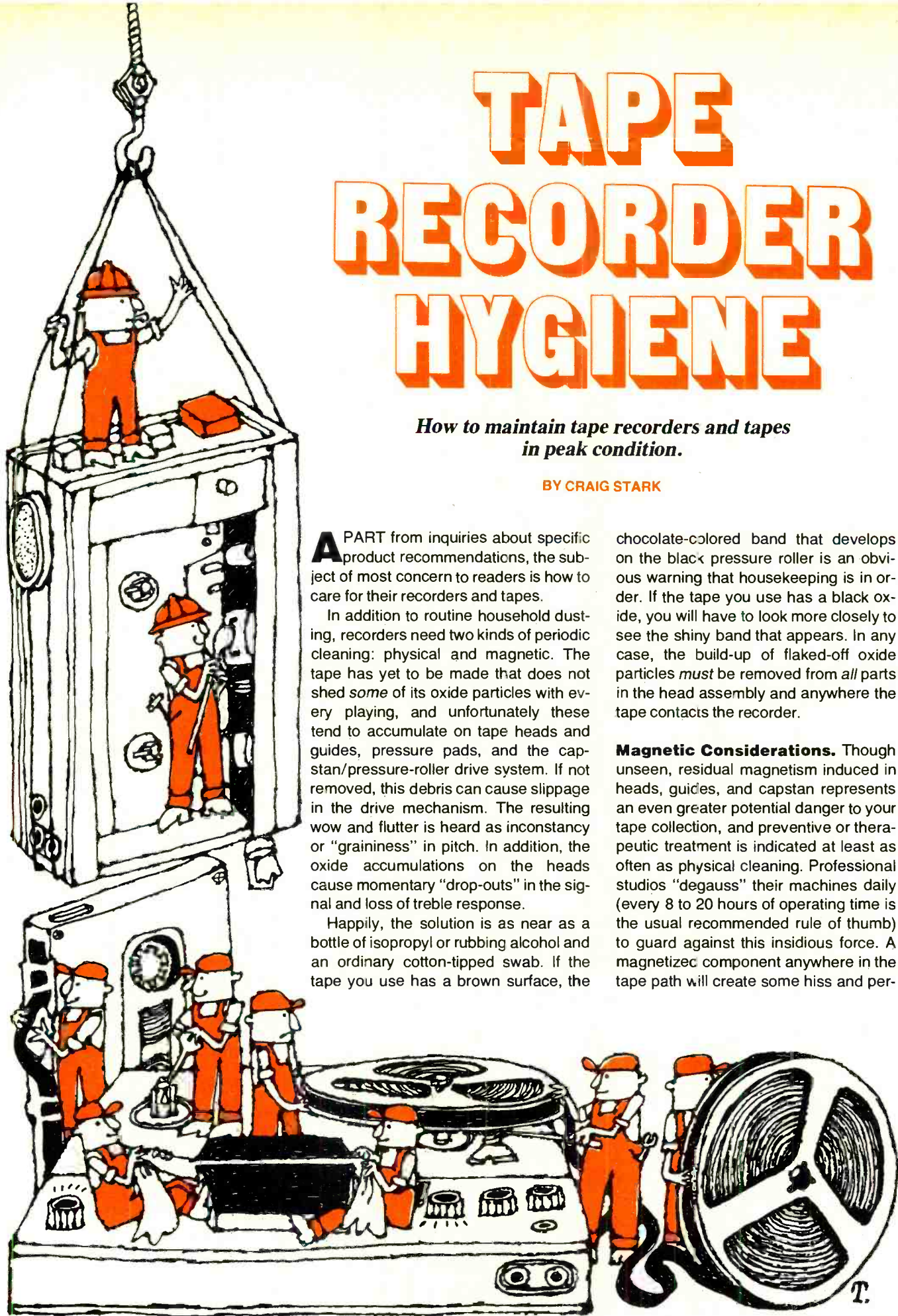

manent loss of high-frequency signal whether you're recording or simply playing back a tape.

Fortunately, head demagnetizers are inexpensive accessories available from all dealers, and using one properly takes less than a minute. Start by turning your recorder off and removing all tapes from the immediate vicinity. Remove the head covers (you should have done this already for the physical cleaning); and, holding the tape-head degausser at arm's length, plug it in, push its "on" button (if it has one), and bring it in close proximity to each of the surfaces that contact the flowing tape. Then, with the demagnetizer still on, withdraw it slowly and smoothly. Turn it off when it is at arm's length from the machine and the job is done. *Note:* to avoid any danger of scratching the tape heads, it is a good idea to put a piece of plastic tape over the tip(s) of the degausser. (Because of differences in physical design, it is not possible to get every tape-head demagnetizer to the heads of every recorder. Check with your dealer to make sure there will be no problem.)

For most audiophiles, lubrication of a recorder is best left to a yearly visit to the service technician. Too much is as great a danger as too little! Obviously, though, bearings and sliding and rotating surfaces must have lubricants. If you want to do the job yourself, follow the manufacturer's instructions carefully.

**Caring for Tape.** Tape care is no less important. Always keep tapes in their containers when not in use, and put tape reels on edge—not piled atop one another. I recommend the professional practice of leaving tapes in a *played*, not a *fast-wound* condition, for the latter tends not only to create an unevenly wound tape "pack," but also to put internal stresses on the tape layers that may cause damage. For the same reason, it's a good idea to play—not rewind—a tape at least twice a year. Avoid storing tapes next to a radiator, in the immediate vicinity (within 2 to 3 feet) of strong magnetic fields (loudspeakers, motors, or power transformers in hi-fi equipment), or in a car trunk during warm weather. Given proper care, your tapes should outlast their owner!

Accidental erasure, especially of the high frequencies, is something to worry about. I once ruined a \$35 test tape by using a screwdriver, that I didn't know was magnetized, for some head adjustments; and a friend once tearfully played for me a master tape on which his five-year-old had momentarily placed a mag-

net from the kitchen memo board, "to see if it would stick." The magnet didn't, but the once-around blip did.

To assess the potential dangers, I consulted several experts and found they agreed that most fears about accidental damage from magnetic fields—generated by radar, house wiring, home appliances, power transformers, and even loudspeakers—are exaggerated.

The reasons are two formidable-sounding but relatively straightforward factors: "tape coercivity" and "the inverse square law." Coercivity is simply an index of the amount of magnetic energy necessary to erase a tape and is measured in oersteds (Oe). Tapes generally have a coercivity in the 280- to 450-Oe range, but this value is a kind of an average (some oxide particles require more field, some less, for erasure). The consensus among the experts was: a good rule for general tape safety is to keep the absolute peak level of stray fields to less than 10 per cent of the tape coercivity. For ferric-oxide tapes, this amounts to 25 to 30 Oe, and for chromium-dioxide tapes, 45 Oe. One gentleman reported measuring a magnetic field of only 10 Oe at the case of an electric drill, so it surely would be safe to use in the vicinity of most tapes. (In fact, home-appliance motors aren't that different in principle from those used in tape decks.) However, for really critical tapes, it was suggested that external fields should be kept below about 10 and 15 Oe for iron and chrome tapes, respectively, since high frequencies tend to be more easily erased.

The other factor is a function of distance. Even a bulk tape eraser that may generate a powerful 1,000-Oe field measured at a distance of ½ inch measures only one fourth that field at one inch, and one sixteenth at two inches. That's the effect of the inverse square law, and it holds, generally, for magnetic recordings. Thus, even a few inches of separation from potentially damaging fields—magnetic latches on cabinets for example—can prevent signal damage.

You can measure *steady-state* or "permanent" fields (around a speaker cabinet or from magnetized tape heads, guides, and capstans) with an inexpensive (\$6.80) magnetometer from R. B. Annis, 1101 N. Delaware St., Indianapolis, Ind. 46202. Multiply your readings by ten or even a bit more on recorder parts that touch the tape directly. You'll find with speakers that the magnetic "leakage" field varies from model to model and, of course, the point on the cabinet at which it is measured. ◇

## Empire's Blueprint For Better Listening

No matter what system you own, a new Empire phono cartridge is certain to improve its performance.

The advantages of Empire are threefold.

One, your records will last longer. Unlike other magnetic cartridges, Empire's moving iron design allows our diamond stylus to float free of its magnets and coils. This imposes much less weight on the record surface and insures longer record life.

Two, you get better separation. The small, hollow iron armature we use allows for a tighter fit in its positioning among the poles. So, even the most minute movement is accurately reproduced to give you the space and depth of the original recording.

Three, Empire uses 4 poles, 4 coils, and 3 magnets (more than any other cartridge) for better balance and hum rejection.

The end result is great listening. Audition one for yourself or write for our free brochure, "How To Get The Most Out Of Your Records." After you compare our performance specifications we think you'll agree that, for the money, you can't do better than Empire.



# EMPIRE

Already your system sounds better.

Empire Scientific Corp.  
Garden City, New York 11530

# An Introduction to Gyrator Theory

*How inductors can be simulated using resistors, capacitors, and op amps.*

BY BRYAN T. MORRISON

**A** GYRATOR, believe it or not, is an inductor without any turns of wire. Although the theory behind this interesting circuit has been established for some time, only within the past few years have synthesized inductors been used on a wide scale. Before we examine the gyrator in detail, let's review some basic properties of inductors.

A pure inductance is a circuit element whose opposition to the flow of alternating current (*inductive reactance*) varies directly with frequency. At dc or zero hertz, the ideal inductor has zero ohms of resistance (a perfect conductor) and zero ohms of reactance. Therefore, we can say that it also has zero ohms of impedance—the vector sum of resistance and reactance. However, as we move into the realm of ac, the reactance of an inductor increases according to the formula  $X_L = 2\pi fL$ ; where  $X_L$  is measured in ohms;  $f$  (frequency) in hertz; and  $L$  (inductance) in henries. Its resistance remains zero ohms. At infinite frequency, the inductor has infinite reactance, and will permit no ac to flow.

So far we have been talking about an *ideal* inductor. Actually, every inductor has a certain amount of resistance and capacitance as well as inductance. As shown in Figs. 1A and 1B, an iron-core inductor can be modeled as an inductance in series with a resistance,  $R1$ ; and this combination is in parallel with a capacitance and series resistance,  $R2$ . An air-core inductor (Figs. 2A and 2B) behaves as an inductance and series resistance  $R1$  would. In both cases,  $L$  is the inductance of the coil, and  $R1$  is the resistance of the wire which comprises the coil. The iron-core inductor contains two additional elements,  $R2$  and  $C$ , which represent losses within the core. With dc, there are no core losses, and consequently, our model's  $C$  permits no current to flow through  $R2$ . At higher and higher frequencies, core losses increase. Thus, in our model, increased current flows through  $R2$  as the capacitor's reactance decreases.

**Synthesizing an Inductor.** By combining resistors and a capacitor with a

gain stage, we can create a circuit which appears to the "outside world" as a real inductor. To understand how, we will analyze the inductor models (Figs. 1B and 2B) in terms of "port admittance." A *port* is a point through which energy can enter or leave. In the case of an electrical circuit, it can consist of a pair of terminals to which a circuit element is connected. The inductors and their models in Figs. 1 and 2 are ports, and when a voltage source is connected across them, an input voltage ( $V_{IN}$ ) is applied and an input current ( $I_{IN}$ ) flows.

*Admittance*, measured in *mhos*, is the reciprocal of impedance. In other words, admittance is the ratio of current to voltage. If an element's admittance is zero mhos, no current will flow through it no matter how high the voltage is across it. Such an element is a perfect insulator or open circuit. On the other hand, an element with infinite admittance will conduct infinite current, even if a low voltage source is connected across it. It is a perfect conductor or a short circuit. Combining these two terms, port admittance is the ratio of the current flowing into the port ( $I_{IN}$ ) to the voltage across the port ( $V_{IN}$ ).

Referring to Fig. 1B, we can see that resistors  $R1$  and  $R2$  set the limits of port impedance at both very high and very low frequencies. At dc, the admittance of the inductor  $L$  is infinite (a short circuit), and only  $R1$  limits the current through it. Capacitor  $C$  behaves as an open circuit

with zero admittance, so  $R2$  is removed from the circuit. At an infinite frequency  $L$  is an open circuit and  $R1$  is removed from the circuit. However,  $C$  is a short circuit and current through it is limited only by  $R2$ . Between these frequency extremes,  $L$  will determine the port's admittance, because it is much larger than  $C$ .

The port admittance of the air-core coil at dc is simply the reciprocal of resistance  $R1$ , since  $L$  has infinite admittance. At an infinite frequency, the port admittance is zero, because the inductance acts as an open circuit, and no input current can flow.

**Analyzing the Gyrator.** Now let's apply these concepts to the gyrator circuits (Figs. 1C and 2C). As in the equivalent circuits,  $R1$  represents the ohmic resistance of the coil wire, and  $C$  and  $R2$  are core losses which increase in step with the applied frequency. However, something new has been added—a gain stage. Any active device can be used, but here we choose an op amp for its simplicity, high gain, almost infinite input impedance, and very low output impedance. The gyrator op amps are strapped for unity-gain, noninverting operation. So, within the frequency limits of the device (assume infinite bandwidth), the voltage at the output is exactly the same as that at the noninverting input.

If we apply a dc voltage across the input terminals of Fig. 1C, capacitor  $C$

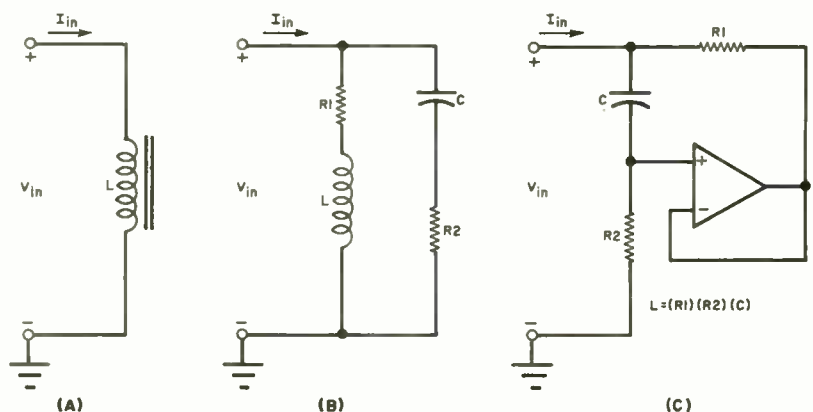

Fig. 1. Iron-core inductor (A) can be modeled as shown in (B) and simulated using the gyrator circuit in (C).

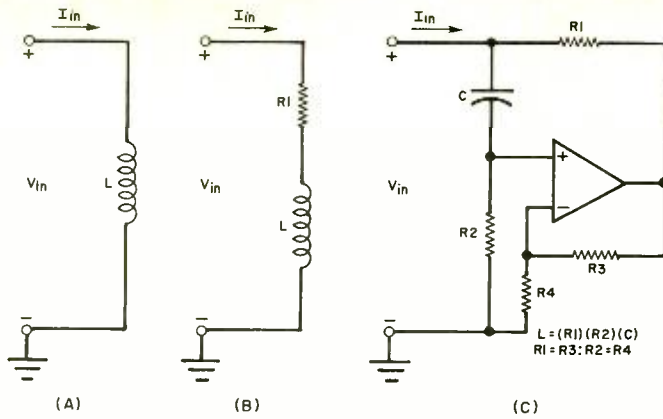

Fig. 2. An air-core coil (A) has an equivalent circuit shown in (B). Op amp gyrator (C) simulates the coil's behavior.

does not conduct, and the voltage at the noninverting input is zero. The output is also at ground potential, and because the op amp has very high output admittance (low output impedance), we can safely say that  $R1$  is connected across the port. So,  $I_{in}$  will flow only through  $R1$ . This agrees with the behaviour of the equivalent circuit of Fig. 1B. The port admittances are maximized at dc, limited only by the values of both  $R1$ 's (assumed to be equal).

At infinite frequency,  $C$  is a short circuit, and therefore the voltage at the op amp's noninverting input (as well as that at the output) is equal to  $V_{in}$ . Since there is no voltage drop across  $R1$ , it is effectively removed from the circuit. The only admittance path is through  $R2$  to

ground, which is the same behavior we noted in the equivalent circuit.

For frequencies between zero and infinity,  $C$  and  $R2$  act as a high-pass filter, causing less and less voltage drop across  $R1$  as frequency increases, and thus less port admittance until  $R2$ 's limiting effect comes into play. The reactive characteristics of the capacitor have successfully been inverted or gyrated so that the port behaves as an inductor. The equivalent inductance in henries is expressed by the formula  $L = (R1)(R2)(C)$  (C), with resistances in ohms and capacitance in farads.

With the addition of two resistors, an air-core inductor can be simulated. Air-core coils have essentially no "core" loss, and therefore have no parallel resistance in their equivalent circuits. Because of this the gyrator (Fig. 2C) uses the additional resistors to set the gain of the op amp. When the values are properly selected, they provide enough gain to compensate for  $R2$ 's losses at high frequencies. But the amount of gain must be carefully chosen—otherwise the circuit might oscillate! If  $R3$  equals  $R1$  and  $R4$  equals  $R2$ , the circuit will be stable and exhibit no parallel resistance. In practice, however, little is gained over the circuit of Fig. 1C as long as the ratio  $R2/R1$  is at least 90 to 100, because the effects of parallel resistance are negligible in most audio applications commonly encountered.

**Practical Design.** In synthesizing a useful "inductor," the same basic rules that govern the optimization of wound coils should be followed. For example, series resistance  $R1$  should be kept as small as possible and parallel resistance  $R2$  as large as possible. This corresponds to a coil wound from the heaviest wire practicable on the least lossy core available. For best performance,

$R1$  should be no lower than the op amp's minimum recommended load resistance, which falls between 100 and 2000 ohms for common op amp types. The largest acceptable value for  $R1$  is desirable, so as not to load the op amp too much, thus preventing high distortion and heating effects. To simulate a high-quality toroidally wound coil,  $R2$  should be at least 100 times greater than  $R1$ , but not so large as to become a major contributor to the op amp's input noise. As a rule of thumb, keep  $R1$  around 1000 ohms and  $R2$  between 10 kilohms and 1 megohm.

Once the values of  $R1$  and  $R2$  have been chosen, use the formula  $C = L / (R1)(R2)$  to find the required capacitance in farads. At least 100 pF should be used to avoid the detuning influences of stray capacitances.

It is important to keep the op amp functioning within acceptable circuit and signal parameters. If for any reason it begins to deviate from the role of a voltage follower, the "inductor" won't work properly. Input signals must lie within the operating bandwidth of the device, and their amplitudes must not cause the output stages to clip. In a gyrator, clipping in the gain stage is analogous to core saturation, which can cause high distortion levels.

However, this is not usually a problem with gyrators. Because they will most often be operated from the same power supplies that other audio stages use, they will not start to clip until the other amplifiers do. Unlike iron-core coils, whose saturation characteristics are functions of core material, size, number of turns, and applied current, the gyrator's saturation point is accurately predictable, and does not occur before the other active stages of the system also saturate or clip.

Using either of the gyrators we have examined will result in high-quality coils with inductances ranging from millihenries to hundreds or thousands of henries. Commonly available parts—including relatively small capacitors—can be employed. Added benefits include high magnetic field immunity and saturation characteristics, and (paradoxically) small amounts of required printed circuit board "real estate." However, there is one limitation. The gyrators we have described are single ended. That is, one side is grounded. To simulate "floating" inductors, neither side of which is connected to ground, more complex circuits using two op amps can be designed. But such gyrators are beyond the scope of this article. ◇

## PROPERTIES OF GYRATORS

### Advantages

1. Immunity to ambient magnetic fields; no coupling or crosstalk between "inductors."
2. Very small size required for large values of inductance.
3. Inexpensive, use readily available components.
4. Accurately predictable "saturation" levels.
5. Parameters can be fixed by choice of resistors.

### Disadvantages

1. Active device generates noise (can be held to low levels if proper devices are selected).
2. More complex circuits are required to simulate "floating" inductors.
3. Inductors with low series resistance and high current handling characteristics are difficult and impractical to simulate, as the circuits require high-power active devices.
4. Simulated inductors are frequency limited by their active devices' usable bandwidths and slew rates (not a problem at audio frequencies in most cases).

# "ZAP" NEW LIFE INTO DEAD Ni-Cd BATTERIES

*That dead cell may not be completely gone.  
A properly applied high current can often clear a  
fault, making the cell useful again.*

BY DOUGLAS C. MYERS

**T**HE NICKEL-CADMIUM cell is a paradox. Capable of being charged many hundreds to many thousands of times, it occasionally fails long before its claimed life cycle comes to an end. Most people simply replace a cell that has failed with a new cell. Considering that most Ni-Cd cell failures are reversible, this is a waste of money.

In this article, we will discuss the most common reason for early Ni-Cd cell failure and how the great majority of all failures can be reversed. The procedure described here will restore just about any dead Ni-Cd cell to provide its entire claimed useful life.

**Why Cells Fail.** In general, most devices powered by Ni-Cd cells employ more than a single cell. As the battery of

cells is discharged and recharged, the time available between recharges reduces. Almost invariably, this is due to the weakening of a single cell in the battery.

To understand the cause of such a failure—one cell "dead" while the others are still good—refer to Fig. 1, a schematic of a typical Ni-Cd power supply for small battery-powered devices. Without the charging source connected to the circuit, the 200-ohm load "sees" 5 volts and draws 25 mA from the battery of cells. Since each cell must pass the en-

tire 25 mA and each cell's potential is 1.25 volts, Ohm's Law tells us that each cell sees the equivalent load of 50 ohms. Ideally, the four cells deliver identical performance and, hence, share the load equally.

In practice, no four cells in a battery

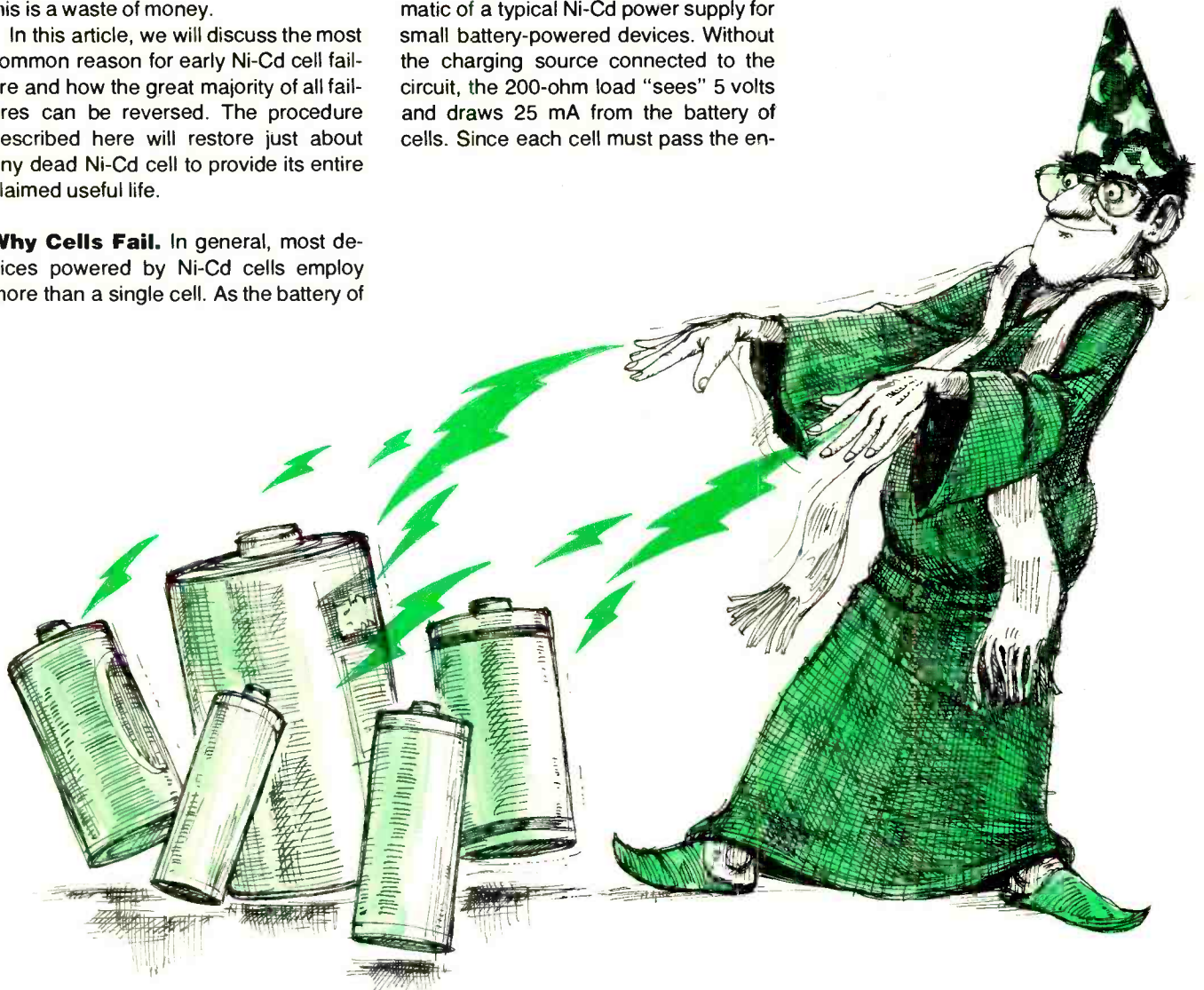



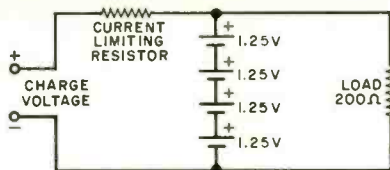

Fig. 1. Schematic of a typical NiCd supply for a small load.

ever exhibit exactly the same output voltage. Assume that one cell is delivering only 1.20 volts, while the other cells are delivering their rated 1.25 volts. Now, the 200-ohm load sees 4.95 volts and draws 24.75 mA. Since all four cells must pass the entire 24.75 mA, each of the strong cells at 1.25 volts sees an equivalent load of 50.5 ohms. This means that the weak cell sees only 48.5 ohms. While this does not seem to be too unequal a distribution, note that the weak cell is working into the heaviest load and, as a result, will discharge more rapidly than the other cells in the battery. Similarly, when the cells are recharged for only a short period of time, the weak cell, which has been working the hardest, is also the one that receives the least charging power.

This unequal loading and recharging is of little consequence in normal operation. The inequality is small for any given charge or discharge cycle, due to the relatively flat output voltage Ni-Cd cells exhibit over most of their range. And a good charge tends to equalize any energy differences between cells. However, during heavy usage, one is tempted to "quick charge" the battery just enough to restore service. A combination of shallow charges and deeper-than-normal discharges tends to exaggerate the energy difference between a weak cell and the other cells in the battery system. Operated continually in this manner, the weak cell inevitably reaches its "knee," the point at which its voltage decreases sharply, long before the other cells reach the same point.

At the knee, the picture changes dramatically. Suddenly, the weakest cell sees an increasingly heavy load, which causes its voltage to drop even faster. This avalanche continues until the cell is completely discharged, even as the other cells continue to force current to flow. The inevitable result is that the weak cell begins to charge in reverse, which eventually causes an internal short.

Once an internal short develops, recharging the cell at the normal rate is futile. The short simply bypasses current around the cell's active materials. (Even though the cell is apparently dead, most of its plate material is still intact.) If the

small amount of material that forms the short could be removed, the cell would be restored to virtually its original capacity once again.

**Clearing the Short.** Using the circuit shown in Fig. 2, the internal short can be burned away in a few seconds. In operation, energy stored in the capacitor is rapidly discharged through the dead cell to produce the high current necessary to clear the short. Current is then limited by the resistor to a safe charge rate for a small A cell.

Several applications of discharge current are usually necessary to clear a cell. During the "zapping" (restoration) process, it is a good idea to connect a voltmeter across the cell to monitor results. Momentarily close the normally open pushbutton switch several times to successively zap the cell, allowing sufficient time for the capacitor to charge up between zaps, until the voltage begins to rise. Then, with the toggle switch closed, watch as the potential across the cell climbs to 1.25 volts. If the potential

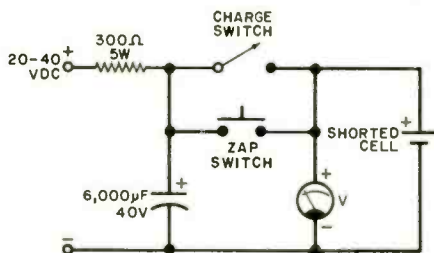

Fig. 2. Shorted cell is cleared by energy stored in capacitor.

stops before full voltage is reached, some residual short still remains and another series of zaps is in order. If you observe no effect whatsoever after several zaps and shorting out the cell and taking an ohmmeter measurement indicates a dead short, the cell is beyond redemption and should be replaced.

Once full cell potential is achieved, remove the charging current and monitor battery voltage. If the cell retains its charge, it can be returned to charge and eventually restored to service. But if the cell slowly discharges with no appreciable load, the residual slight short should be cleared. To do this, short circuit the cell for a few minutes to discharge it, zap again, and recharge it to full capacity.

Not all Ni-Cd cells can be restored by the method described here, but most can. After restoration, a cell's life expectancy will be roughly the same as that of the other cells taken from the same service application. ◇

For maximum  
CB performance,  
know you're  
exactly  
"on-channel" with  
B&K-PRECISION'S  
NEW FREQUENCY  
COUNTER!



Model 1827 \$120

For the serious CBer, the 1827 and accessory signal tap provide digital readout of transmit frequency, mobile or base on all 40 channels. For best range and signal clarity, your transmitter should be operating exactly on the assigned channels. The only way to accurately check this is with a frequency counter.

The new B&K-PRECISION Model 1827 is a full-feature battery portable frequency counter for only \$120.

- Typically reads to 50MHz with 1Hz resolution
- 6-digit display with switch allowing 8-digit accuracy
- Completely portable, use it in mobile or base
- Optional SA-10 signal tap available for constant output frequency measurements
- Full range of optional accessories available

Available for immediate delivery at your local distributor.

**BK PRECISION**

**DYNASCAN CORPORATION**

6460 West Cortland Avenue  
Chicago, Illinois 60635 • 312/889-9087  
In Canada: Atlas Electronics, Ontario  
Int'l. Sls. Empire Exp. 270 Newtown Rd., Plainville, LI, NY 11803

CIRCLE NO. 7 ON FREE INFORMATION CARD

# Heathkit®

SUMMER 1977

- New** High-Performance Frequency Counters with up to 1 GHz Range — See pages 68-69
- New** Budget-Priced Stereo FM-AM Receiver — See page 28
- New** Five-Function Aircraft Clock/Timer — See page 24
- New** Learn-at-home Courses in Electronic Circuits and Amateur Radio—See pages 93, 95

Plus programmable color TV, Digital Clocks and Weather Instruments, Amateur Radio Equipment, Test and Service Instruments, Hi-Fi Components and Speakers, Scanning Monitors, Marine and Auto Accessories, a complete selection of the latest electronics books, and lots more for your knowledge, fun and satisfaction.

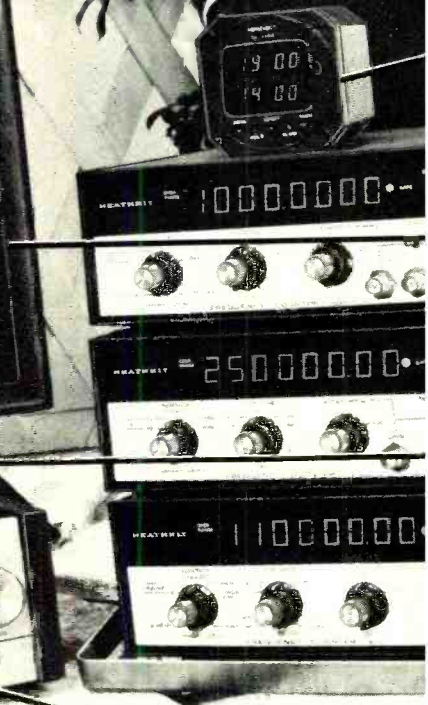
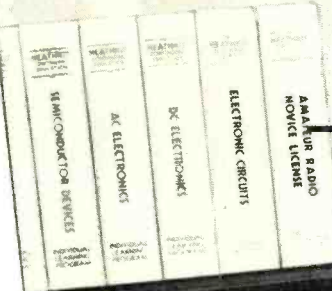

**HEATHKIT MAIL ORDER CATALOG**  
 "Heath" and "Heathkit" are registered trademarks of Heath Company

1977 Heath Company  
 See index on page 1

Heath Company, Dept. 10-31  
 Benton Harbor, Michigan 49022  
**POPULAR ELECTRONICS**

# FREE!

Some of the most exciting electronic kits ever to come along are described in this NEW Heathkit Catalog.

## NEW! Learn-at-home Electronics Courses

The famous Heathkit learn-at-home electronics courses are now in use by thousands and they've proven to be a really effective and low-cost way to learn about electronics for fun, for knowledge and for profit. Two new courses include the Electronics Circuits course which covers most basic circuits and an Amateur Radio Novice License course that's GUARANTEED to help you get your ticket fast and easy!

## NEW! Aircraft Clock Timer

The OI-1154 gives you everything you need for precise flight timing. Two bright red LED displays show GMT or ZULU time, and any one of four other functions: local time; 24-minute timer with minute and second display; 24-hour trip timer; and an alarm time for fuel management and check point notification. It's FAA/PMA approved and meets DO-160 environmental requirements.

## GR-2001 Digital "Programmable" Color TV

The color TV that gives you MORE convenience and versatility than EVER! Simply "program" it to change channels at times you select for an entire evening — then just sit back and relax. The GR-2001 automatically changes channels when you want it to, and you can even program it to rotate your outdoor antenna for the best possible reception on each channel.

## Complete Electronics Library

The new Heathkit catalog is your low-cost source for electronics books of every description. Our complete selection includes the latest books on microcomputers and microprocessors, digital devices, Amateur and Shortwave radio, television repair, test and service equipment, radio control, automotive, general reference and lots more.

## NEW! High-performance frequency counters

Our new "family" of frequency counters gives you the accuracy and flexibility you NEED for frequency measurements all the way to 1 GHz. All feature bright red LED 8-digit readouts, gate and overrange indicators. They also function as events counters, period and period averaging meters. The IM-4110 covers 5 Hz to 110 MHz; the IM-4120 covers 5 Hz to 250 MHz; and the IM-4130 covers 5 Hz to 1 GHz.

## NEW! Our "Budget-Priced" Stereo Receiver

The new AR-1219 AF-FM stereo receiver pulls in plenty of stations and gives you the power you want

for easy listening in most any room. 15 watts, minimum RMS, per channel into 8 ohms with less than 0.5% total harmonic distortion from 20-20,000 Hz. It's a quality receiver with smart new styling that's bound to please music lovers on a budget, and it's an easy and fun kitbuilding project, great for first-time builders.

PLUS nearly 400 other superb, easy-to-build, money-saving products. You'll find a complete line of digital electronic clocks and weather instruments, plus useful and unique items for your car, home or office.

There are many more exciting products to read about too! Home convenience items like a practical freezer alarm, a touch-control light switch, intercoms and a unique programmable doorbell. Automotive instruments and accessories, marine equipment, model aircraft Radio Control gear, security systems and more. Plus our world-famous Amateur Radio equipment and test and service instruments.

These are among the nearly 400 quality, fun-to-build kits described in this new Heathkit catalog. Kits for every interest. All with the world-famous Heathkit assembly manual — a step-by-step instruction guide that makes kitbuilding easy and leaves nothing to chance. And all backed by our "We won't let you fail" promise. Find out about the satisfaction, savings and FUN of kitbuilding.

Send for your  
**FREE copy today!**

HEATH <b>Schlumberger</b>	<b>Heath Company, Dept. 10-31 Benton Harbor, Michigan 49022</b>
Please send me my FREE Heathkit Catalog. I am not on your mailing list.	
Name _____	
Address _____	
City _____	State _____
CL-633	Zip _____

# Build a PINK NOISE GENERATOR for AUDIO TESTING

Uses a new MOS noise generator IC.

BY DENNIS BOHN

**A**N INCREASING number of audiophiles are incorporating graphic equalizers into their hi-fi music systems. The new component is most often used as a "super" tone control that offers a degree of frequency response compensation beyond the capabilities of bass and treble controls. However, adjusting 10 to 30 controls to compensate for acoustic deficiencies in the listening room can be challenging. This project—a pink noise generator—makes the job a little easier. It provides a reference signal for performing equalizer adjustments, and uses just one IC and a few passive components.

The IC, National Semiconductor's MM5837, is a digital pseudo-random sequence generator which will produce a broadband white noise signal for audio applications that's converted to pink noise by a passive filter. Unlike traditional semiconductor junction noise sources, the MM5837 provides uniform noise quality and output amplitude. Although it was originally developed with electronic organs and synthesizers in mind, it is equally suited to room equalization applications. A block diagram of the MM5837 is shown in Fig. 1.

**White vs. Pink Noise.** The output of the MM5837 is broadband white noise. Since pink noise is used in most audio work, it is helpful to understand the difference between the two.

White noise is a composite signal with contributions from all frequencies and a spectral density substantially independent of frequency (equal energy per constant bandwidth). It is characterized by a 3-dB increase in amplitude per octave of frequency change. In comparison, pink noise has a flat amplitude response per octave of frequency (equal energy per octave). Pink noise allows correlation between successive octave equalizer stages by insuring that the same amplitude of input signal is used for each as a reference.

The network required to convert white noise to pink noise is simply a -3-dB/octave low-pass filter; but it presents an interesting problem in circuit design. If capacitive reactance (and thus the response of a simple RC or first-order filter) varies at a rate of -6 dB/octave, how can a slope of less than -6 dB/

octave be obtained? The solution lies in cascading several stages of lag compensation so that the zeros of one stage partially cancel the poles of the next stage. Such a network, shown in Fig. 2, has a -3-dB/octave characteristic ( $\pm 1/4$  dB) from 10 to 40,000 Hz.

The complete pink noise generator in Fig. 3 gives a flat spectral distribution (per octave) over the audio band from 20 to 20,000 Hz. An 11.5-V p-p random pulse train appears at pin 3 of the IC, and is attenuated by the filter. The actual output across C5 is about 1 V p-p ac of pink noise riding on an 8.5-V dc level.

**Construction.** Since the circuit is fairly simple, it can be constructed on a small circuit board using printed circuit, point-to-point wiring, or Wire-Wrap techniques. Resistors in the filter network should have close tolerances. Premium-grade tantalum and polystyrene, ceramic, and film capacitors are recommended. Observe standard precautions in handling the MOS device, and use an IC socket or Molex Soldercons.  $\diamond$

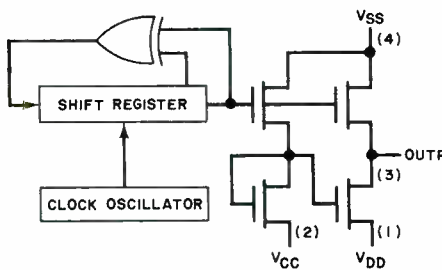

Fig. 1. Block diagram of the MM5837 noise source.

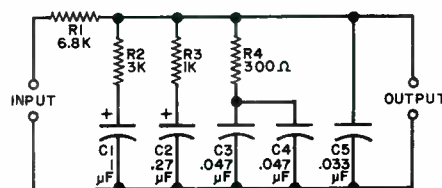

Fig. 2. Low-pass filter with -3-dB/octave response.

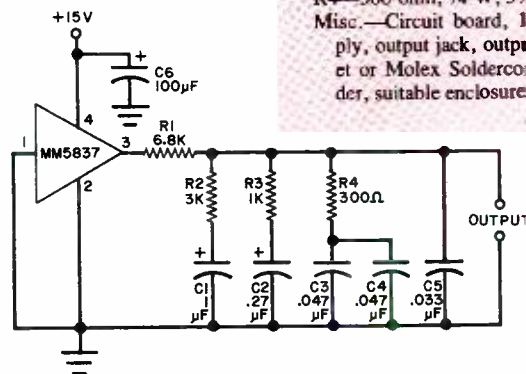

Fig. 3. Schematic diagram of the pink noise generator.

## PARTS LIST

- C1—1- $\mu$ F, 35-V tantalum capacitor
- C2—0.27- $\mu$ F, 35-V tantalum capacitor
- C3, C4—0.047- $\mu$ F capacitor
- C5—0.033- $\mu$ F capacitor
- C6—100- $\mu$ F, 35-V electrolytic capacitor
- IC4—MM5837 noise generator IC
- R1—6800-ohm, 1/4-W, 5% resistor
- R2—3000-ohm, 1/4-W, 5% resistor
- R3—1000-ohm, 1/4-W, 5% resistor
- R4—300-ohm, 1/4-W, 5% resistor

Misc.—Circuit board, 15-volt regulated supply, output jack, output connector, IC socket or Molex Soldercons, hookup wire, solder, suitable enclosure, etc.



"Breaker... breaker..."



# The World of Electronics

BY FRANK BOLLE

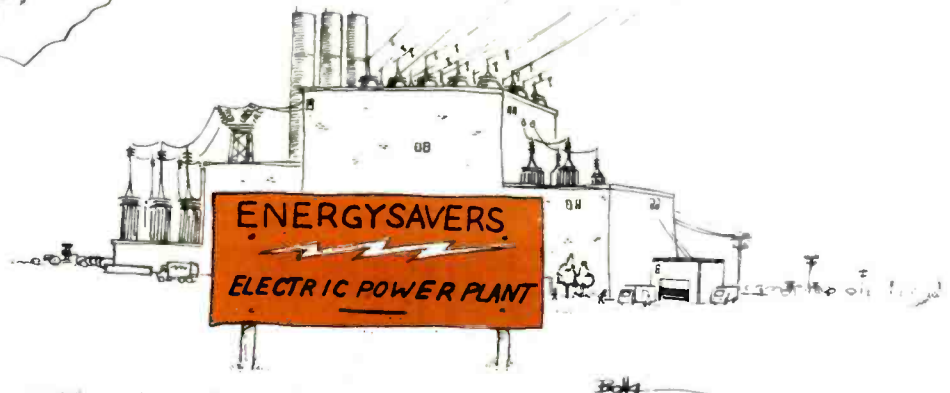
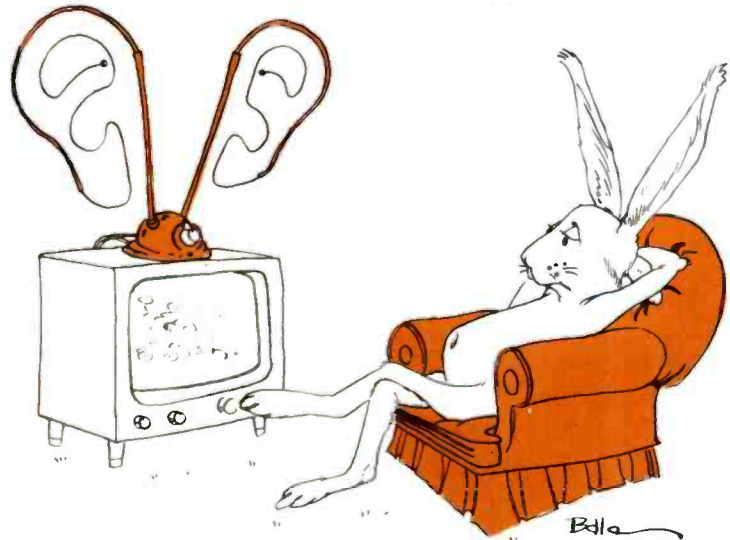

# AVERAGE, PEAK, AND RMS VALUES

*What is meant by the various ways of specifying ac potentials and currents.*

BY HECTOR FRENCH.

**W**HEN dealing with dc potentials, there is no ambiguity about what kind of voltage is meant. A dc volt is a dc volt. When it comes to ac voltage, however, the picture is very different and often confusing. For example, a potential specified as 100 volts ac has little or no meaning unless it is followed by an identifier like "peak," "rms," "average," or "effective," each of which has a different meaning from the others.

To illustrate what we mean, consider your common 117-volt ac power-line potential. This figure specifies the rms voltage of the power line. The peak potential is actually 164.66 volts, which is 39.8% greater than the rms potential. The average potential, at 11% lower than the rms potential, is 104.52 volts.

The peak voltage is the maximum potential of the entire waveform. This volt-

and capacitor are simply reversed.)

The average voltage is important for two different reasons. First, it is easy to find with simple circuits. Second, it is reliably close to the rms voltage with sine waves. The basic circuit for finding the average ac voltage is illustrated in Fig. 2.

In this case the output is a series of half-waves of the same polarity. (Again, to change the output voltage polarity, simply reverse the diodes.) A meter placed between the output point and ground provides the reading and is usually calibrated with a scale that is compressed just the right amount to give a relatively accurate rms reading with sine-wave signals. This is the type of circuit used in most ac voltmeters ranging from inexpensive portable to expensive laboratory instruments.

put in terms of rms with sine waves. What about nonsinusoidal waveforms? If we take a 117-volt sine wave and allow only one alternation in 10 to come through, the peak potential is still 164.66 volts. Since only a half wave out of every 10 cycles comes through, our average potential would be divided by 10 ( $104.52/10 = 10.452$  volts).

If we allow only one alternation in 10 cycles to come through for a 117-volt ac rms waveform, we cannot simply divide by 10 to find the new rms potential. First, we must square 117, which yields 13,689. Then, we find the average by dividing 13,689 by 10, yielding 1368.9. Finally, we must find the square root of 1368.9, which results in 37 volts rms. This last figure is a long way from the average reading of this one-in-10 waveform, even when the average scale is

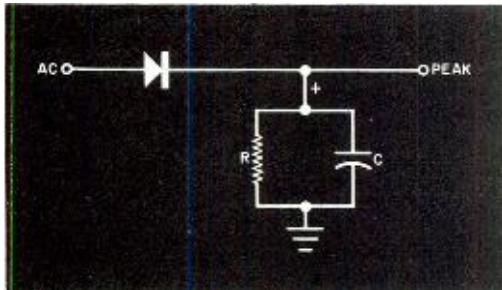

Fig. 1. Simple RC and diode circuit is used to find peak potential.

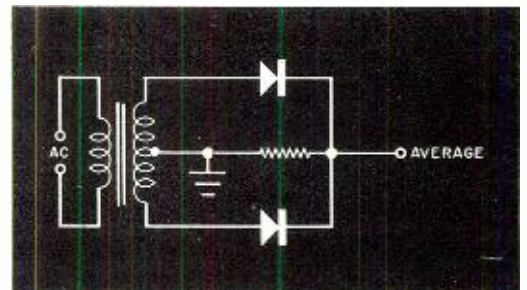

Fig. 2. Series of half waves is measured to find average value.

age is extremely important for designing the insulation of high-voltage ac circuits. An 11,500-volt (rms) line, for example, has a peak potential of  $11,500 + 4577 = 16,077$  volts. That difference of more than 4500 volts must be considered when specifying components.

The peak potential is easy to find with the circuit shown in Fig. 1.

The capacitor charges up to the peak voltage during the first positive alternation of the ac input. The charge then slowly drains off through the resistor until the next positive alternation comes along. (For a negative output, the diode

At this point, you are probably wondering where rms voltage comes into the picture. Well, the purpose of the rms measurement is to specify the dc voltage that has the same power capacity as the ac voltage it represents. "Rms" stands for "root mean squared," which is shorthand for saying that to find the rms voltage, you must square the ac waveform, find the average of the squared waveform, and find the square root of that average. About the only simple way of showing an rms detector system is as in Fig. 3.

The average-law circuit gives an out-

compressed to indicate in make-believe rms. Using the compressed scale, the indicated reading would be almost 70% low!

As you can see from the foregoing, when dealing with pure sinusoidal waveforms, you can use a peak-, average-, or rms-indicating circuit to convert from one type of ac voltage to another without introducing errors. But when you are dealing with nonsinusoidal waveforms, watch out. All your readings might be so grossly inaccurate as to be useless for anything other than to indicate the presence or absence of a potential. ◇

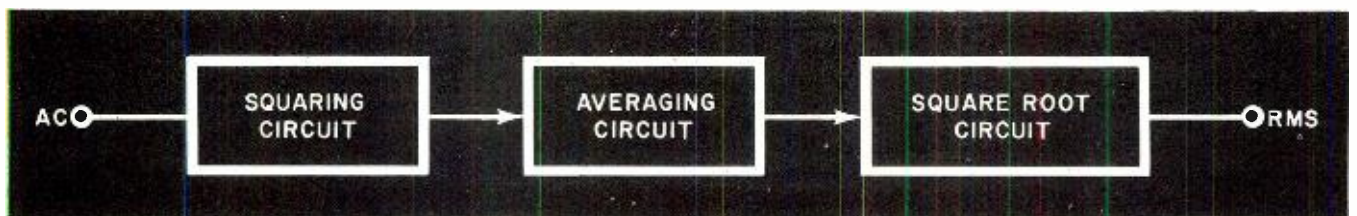

Fig. 3. Simple block diagram of an rms detector circuit.

# SOLAR CONTROLLER

## Electronic temperature comparator for solar energy systems or attic fans

BY JERALD M. COGSWELL

**T**HE SEARCH for new energy sources has encouraged amateurs as well as professional engineers to experiment with solar energy hardware as used in space heating. A typical solar heating system consists of three functional parts: solar energy collection, heat storage, and heat distribution. Automatic controls are required to operate the fans, blowers, pumps, etc. and coordi-

nate operation of the overall system.

Because the backyard (or rooftop) experimenter may be discouraged by the high cost or unavailability of suitable controls, the Solar Controller described here should come in very handy. It can be built for about \$35 and can be easily adapted to turn on attic fans when needed. It thus reduces the cooling load and prevents costly over-running of fans.

The Solar Controller is a temperature comparator that turns on a blower or pump when the air or fluid in the solar collector is at a sufficiently high temperature to justify a transfer to the storage medium. In the fan application, control is by the temperature difference between the attic and outside air (or between ceiling and floor of a large room).

**Circuit Operation.** The basic controller circuit is shown in Fig. 1. In IC1, a voltage comparator, the resistances of two temperature-dependent resistors (TDR1 and TDR2) are compared, with TDR1 placed in the storage medium and TDR2 in the solar collector. When TDR1 is warmer than TDR2, its resistance is higher and the higher voltage at the inverting (-) input to IC1 keeps its out-

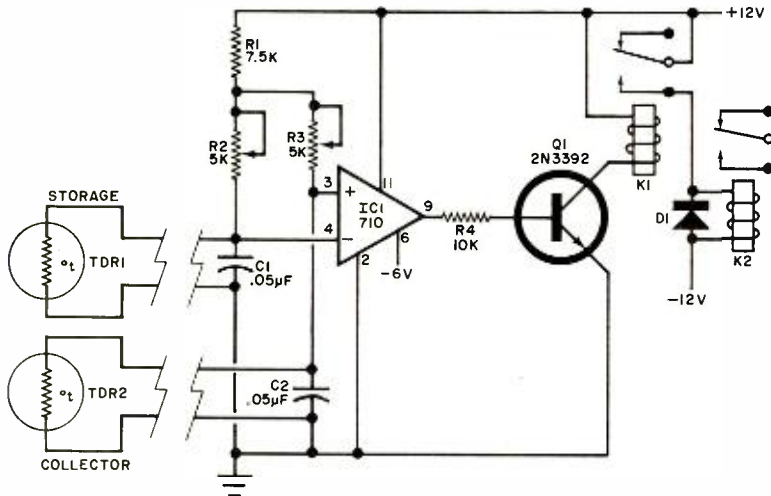

Fig. 1. Comparator IC1 turns on or off depending on resistances of TDR1 and TDR2. When IC1 is on, Q1 and the relays are energized.

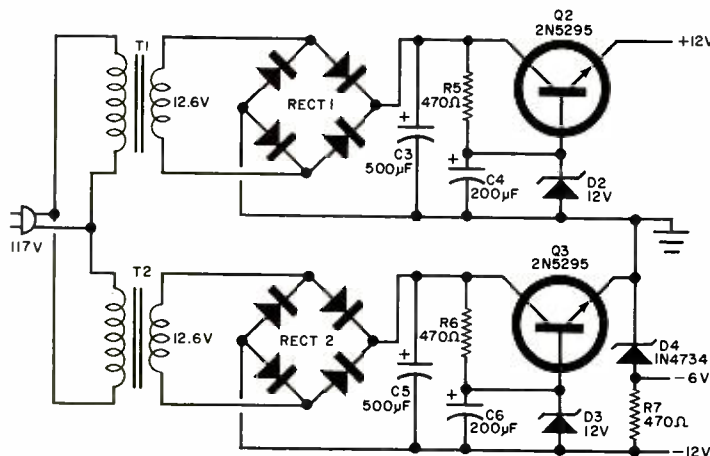

Fig. 2. The power supply for the solar controller is standard design and provides regulated positive and negative outputs.

### PARTS LIST

- C1, C2—0.05-µF, ceramic disc capacitor
  - C3, C5—500-µF, 25-V electrolytic capacitor
  - C4, C6—200-µF, 25-V electrolytic capacitor
  - D1—General-purpose silicon rectifier diode
  - D2, D3—12-V, 1-W zener diode (1N4742, or similar)
  - D4—6-V, 1-W zener diode (1N4734 or similar)
  - IC1—710 voltage comparator
  - K1—12-V, 600-ohm coil relay
  - K2—24-V, 10-ampere contacts relay
  - Q1—2N3392 transistor
  - Q2, Q3—2N5295 transistor (or similar)
  - R1—7500-ohm, ½-W resistor
  - R2, R3—5000-ohm multi-turn trimmer potentiometer
  - R4—10,000-ohm, ½-W resistor
  - R5, R6, R7—470-ohm, ½-W resistor
  - T1, T2—12.6-V, 300-mA transformer (Radio Shack 273-1385 or similar)
  - TDR1, TDR2—TG-1/8, 100-ohm, ±5% Sensor
  - Misc.—Suitable enclosure, perforated or pc board, socket for IC1, twin lead cable for sensors, heat sinks(2), power cord, mounting hardware.
- Note: The Sensors are available from Texas Instruments semiconductor dealers, or from Texas Instruments, 2916 Holmes St., Kansas City, MO 64109 at \$2.40 each.

# Portable 60-Hz "CLOCK" OSCILLATOR

*Crystal-controlled time base for field use.*

BY CHARLES F. SMITH

put in the low state. When *TDR2* gets warmer, the voltage across it gets higher and, when it is about 5 millivolts higher than the voltage across *TDR1*, the output of *IC1* goes high.

When this happens, transistor *Q1* is turned on and activates low-power relay *K1*. The latter, in turn, activates a 24-volt heavy-duty relay, *K2*, which handles the power requirements of the system.

Capacitors *C1* and *C2* prevent transients from affecting the inputs of *IC1*. Trimmer potentiometers *R2* and *R3* are used to preset the voltages on *IC1*. Diode *D1* is a general-purpose silicon rectifier used to protect the contact of *K1*. If desired, *Q1* can be replaced by a power transistor (such as RCA 40594) and one of the relays can be eliminated.

The power supply for the Solar Controller is shown in Fig. 2.

**Construction.** All components except the power transformer and relays can be mounted on a 3" x 6" piece of perforated board or pc board. Use small solder clips for connections to *TDR1*, *TDR2* and the relay. The entire system can be mounted in any type of enclosure. Use a heat sink for *Q2* and *Q3*.

The temperature sensors can be mounted at a distance from the rest of the circuit provided the resistance of the interconnecting leads does not exceed a few ohms. Use #14 wire or conventional slender twin leads. Solder the leads to the sensors carefully (and quickly) and anchor the soldered ends in silicone or epoxy. Be sure the bodies of the resistors are exposed to insure fast thermal response to temperature changes.

**Adjustment.** Set trimmer potentiometer *R2* at about its 3/4-resistance point. Then place the body of *TDR1* in a bowl of water that has been heated to the average temperature you expect in the storage medium. Place *TDR2* in another bowl of water that is between 5° and 10°F hotter than the first bowl. You will have to determine the exact temperature difference you want the circuit to detect.

Once both temperature sensitive devices are in their water bowls, and the water temperature difference is what you want, adjust trimmer *R3* until relay *K1* activates. The circuit can be made as sensitive as your needs demand. Note also that although the device appears passive when both probes are at room temperature, a gust of warm breath, or the touch of a finger on *TDR2*; or a drop of cool water on *TDR1*, will cause *K1* to be energized. ◇

**M**OST digital clocks and sports timers are energized by the ac line—not so much for power as for the 60-Hz frequency that is used as the time base. This means that such digital devices cannot be used in vehicles or boats or

**How It Works.** The integrated circuit used in this time base is an MM5369, a recently introduced 17-stage, mask-programmable oscillator/divider. Although masking options are available for use with almost any crystal frequency, the IC used operates with a low-cost, readily available 3.53-MHz color-TV crystal and delivers 60 Hz at its output pin. Trimmer capacitor *C2* allows for exact frequency adjusting, and a buffered 3.58-MHz output is available. Current drain is approximately 1.2 mA with a 10-volt supply.

**Construction.** Because of the high frequencies involved, a small pc board (or perforated board) such as that shown in Fig. 2 should be used. Figure 2 also shows component installation. Since the IC is a MOS type, take the usual precautions when installing.

**Adjustment.** If you have a frequency counter, or a calibrated oscilloscope, check for the presence of 3.579545 MHz at pin 7 of the IC. You can adjust trimmer capacitor *C2* for the correct value. If you do not have a frequency counter, use the Lissajous-figure approach with a scope, with the output of a conventional 6-volt transformer as the horizontal sweep and the output of *IC1* pin 1 for the vertical signal. Adjust *C2* until a very slow-moving square appears on the scope. If you have neither a counter nor a scope and are planning to use the clock with a portable timing device, use some form of accurate time signals such as those from WWV, CHU, etc., to start the timer at a one-minute "beep" and stop it at the next minute "beep." Adjust *C2* to obtain the correct time interval. ◇

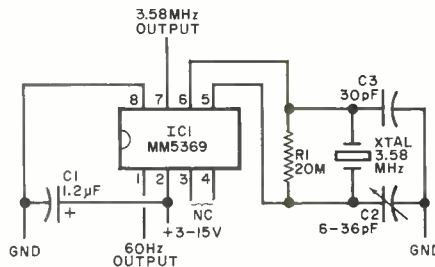

Fig. 1. Schematic of circuit.

## PARTS LIST

- C1—1.2- $\mu$ F, 35-V tantalum capacitor
  - C2—6-36-pF trimmer capacitor
  - C3—30-pF capacitor
  - IC1—MM5369 programmable oscillator/divider, for use with a 3.58-MHz crystal (National)
  - R1—20-megohm 1/4 watt resistor
  - XTAL—3.579545-MHz color-TV crystal
- Note: The following are available from Bill Godbout Electronics, Box 2355, Oakland Airport, CA 94614: etched and drilled pc board (068) at \$2.50; complete kit of parts, including board at \$5.95. California residents, please add 6% sales tax.

for timing outdoor events that are not near an ac power outlet.

The 60-Hz crystal-controlled time base described here (Fig. 1) can be powered by any dc supply between 3 and 15 volts. It has low power consumption, is stable within 2 parts per million and is small enough to fit inside the case of many digital clocks and timers.

Fig. 2. Actual-size etching and drilling guide (far right) and component layout. Components are mounted on nonfoil side.

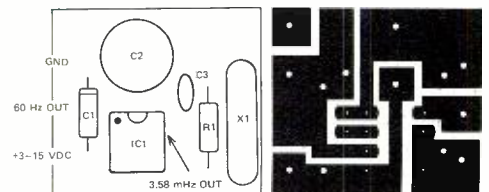





## STOP A COP. AND ASK TO SEE HIS RADIO.

Chances are, the name on his radio will be Motorola.<sup>®</sup>

The same Motorola that now makes a CB radio for your car.

Like our professional radios, a Motorola CB is exceptionally simple to operate.

It has features like gain control, audio compression, and noise limiting built in, fully automatic.

The result is truly outstanding talk/listen performance. Because the radio is in control. Rather than you.

A digital phase lock loop synthesizer makes tuning precise. Again, automatically.

A professional-quality 3½-inch top-fire speaker produces an audio fidelity that must be heard to be fully appreciated.

A Motorola CB is completely solid state and standardly equipped with a power mic that doesn't have batteries that can fail. That doesn't cost extra.

Of course, there's one feature a Motorola CB offers that's not in the specs. And that's reliability.

Police get it with the name Motorola.

So can you.

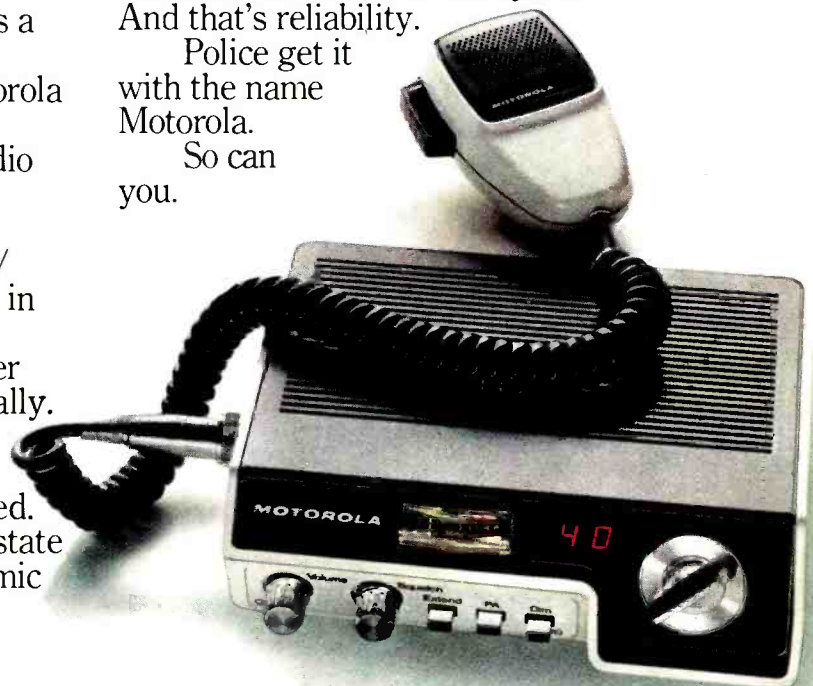

# Motorola CB

From the voice of experience in 2-way radio.

To find the dealer nearest you, write: Customer Relations Manager, Motorola Inc., Automotive Products Division, 1299 East Algonquin Rd., Schaumburg, Illinois 60196. Motorola is a registered trademark of Motorola Inc.

CIRCLE NO. 29 ON FREE INFORMATION CARD

[www.americanradiohistory.com](http://www.americanradiohistory.com)



# MAGAZINES AT DISCOUNT!

## You SAVE up to 50%

Here's your chance for a real bargain bonanza on your favorite magazines. You may select as many as five of these titles at the special introductory rates shown below—up to 50% off! To order, indicate the magazines you want by inserting their code numbers in the boxes on the attached order card. Or write to: MAGAZINES AT DISCOUNT, A Division of Ziff-Davis Publishing Co., P.O. Box 2703, Boulder, Colorado 80322.

### CODE NOS.

- (01) **BOATING** You pay only \$7.97  
Reg. Rate: 12 issues for \$12.00
- (02) **CAR & DRIVER** You pay only \$4.99  
Reg. Rate: 12 issues for \$9.98
- (76) **COUNTRY MUSIC** You pay only \$6.95  
Reg. Rate: 12 issues for \$8.95
- (03) **CYCLE** You pay only \$4.99  
Reg. Rate: 12 issues for \$9.98
- (04) **FLYING** You pay only \$7.99  
Reg. Rate: 12 issues for \$12.00
- (29) **MONEY** You pay only \$9.95  
Newsstand Rate: 10 issues for \$12.50
- (34) **PLAYBOY** You pay only \$12.00  
Newsstand Rate: 12 issues for \$19.00
- (06) **POPULAR ELECTRONICS** You pay only \$6.99  
Reg. Rate: 12 issues for \$12.00
- (45) **POPULAR MECHANICS** You pay only \$3.99  
Reg. Rate: 12 issues for \$7.97
- (07) **POPULAR PHOTOGRAPHY** You pay only \$4.99  
Reg. Rate: 12 issues for \$9.98
- (35) **POPULAR SCIENCE** You pay only \$4.50  
Newsstand Rate: 12 issues for \$9.00
- (08) **PSYCHOLOGY TODAY** You pay only \$6.97  
Reg. Rate: 12 issues for \$12.00
- (11) **STEREO REVIEW** You pay only \$3.99  
Reg. Rate: 12 issues for \$7.98
- (39) **TENNIS** You pay only \$4.75  
Reg. Rate: 12 issues for \$9.50
- (40) **TIME** You pay only \$12.50  
Newsstand Rate: 25 issues for \$25.00
- (41) **TV GUIDE** You pay only \$8.35  
Lowest Available Sub. Rate for 32 issues



# ONE-TOUCH DIODE TESTER

*Identifies good/bad diodes, and tells  
which end is anode/cathode.*

BY DAVID MARKEGARD

**M**OST electronics experimenters seem to have plenty of diodes in their junk boxes—either salvaged from old equipment or purchased at low bulk prices. The problem, usually, is to find out which ones are good, which are bad, and, in the case of the former, which end is which (cathode or anode). Of course, most diodes can be tested using a conventional ohmmeter. However, there are simpler ways, and one is to use the diode checker described here. Simply by touching a diode's leads to its binding posts (in either polarity), you can tell whether or not it is good and identify the anode and cathode.

**How It Works.** Op amp IC1 forms a simple square-wave oscillator whose output swings from almost full positive to full negative levels with respect to ground.

unknown diode lead connected to BP1 is easily identified.

**Construction.** The circuit can be assembled on a small piece of perforated board and mounted in small enclosure along with the batteries in holders. The two binding posts and the power on/off switch should be mounted about an inch apart on top of the enclosure. Put the two LED's in rubber grommets near BP1 and identify them properly.

Before installing the LED's, be sure they are of equal brightness. The values of R1, R2, R3, and C1 can be varied if the specified values are not available—as long as the circuit oscillates.

**Use.** Connect a diode to be tested between the two binding posts. If only one LED glows, the diode is good and the glowing LED will identify the cathode. If

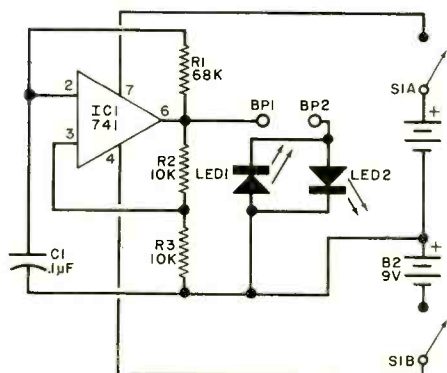

IC1 is square-wave oscillator. Tested diode turns on either LED.

If a good diode is connected between BP1 and BP2 with its cathode toward BP1, LED1 is forward biased and glows. LED2 remains dark because it is reverse biased. If the diode is reversed so that its anode is at BP1, LED2 glows and LED1 is dark. With the LED's properly identified and placed close to BP1, an

both LED's glow, the diode is shorted. If neither LED glows, the diode is open.

Transistor junctions can be tested by connecting the collector to BP1 and the base to BP2. If LED1 glows and is brighter than LED2, the transistor is npn. If LED2 glows, or is brighter than LED1, the transistor is pnp. ◇

## PARTS LIST

B1, B2—9-volt battery  
BP1, BP2—Five-way binding post  
C1—0.1- $\mu$ F capacitor  
IC1—741 op amp  
LED1, LED2—Red LED (about equal brightness)  
R1—68,000-ohm resistor  
R2, R3—10,000-ohm resistor  
S1—Dpst switch  
Misc.—Perforated board, socket for IC1, battery holder, suitable enclosure, grommets for LED's, mounting hardware, etc.

# SAVE!

MONEY • TIME • FREIGHT

- ♪ QUALITY STEREO EQUIPMENT AT LOWEST PRICES.
- ♪ YOUR REQUEST FOR QUOTATION RETURNED SAME DAY.
- ♪ FACTORY SEALED CARTONS—GUARANTEED AND INSURED.
- ♪ SAVE ON NAME BRANDS LIKE:
 

A.D.C.	KLH
A.R.	SHURE
DYNACO	KOSS
SONY	FISHER

PIONEER

AND MORE THAN 50 OTHERS  
BUY THE MODERN WAY  
BY MAIL—FROM

# ia illinois audio

Department 217S  
12 East Delaware  
Chicago, Illinois 60611  
312-664-0020

CIRCLE NO. 23 ON FREE INFORMATION CARD

# FREE catalog

of over  
**2000**  
small tools,  
measuring  
instruments,  
and supplies



**National Camera**  
2000 West Union Ave., Dept. 300  
Englewood, Colo., U.S.A. 80110

CIRCLE NO. 30 ON FREE INFORMATION CARD

Announcing the **NEW STANDARD** in Stereo Testing!

# Get the All-New Model SR12 STEREO TEST RECORD

The most complete...most sophisticated...most versatile  
Test Disc available today... **For Just \$6.95!**

## Who Needs the New Model SR12?

If you've read this far, you do. Whether you're an avid audiophile who'll settle for nothing but peak performance from his stereo components... a casual listener who'd like more insight into the challenging world of stereo reproduction... or a professional technician who needs precise standards for lab testing... the new MODEL SR12 will be the most important disc in your entire collection.

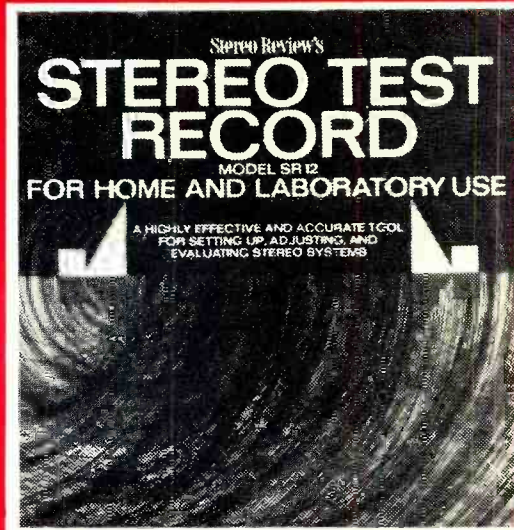

Like its predecessor Model 211, MODEL SR12 has been produced by Stereo Review Magazine (formerly HiFi/Stereo Review) as a labor of love — by music lovers... for music lovers who want immediate answers to questions about the performance of their stereo systems and how to get the best possible sound reproduction.

Now greatly expanded and updated with the most modern engineering techniques, MODEL SR12 is the most complete test record of its kind — containing the widest range of checks ever included on one test disc. An ear-opener for every serious listener!

## You'll make these important stereo checks BY EAR... (no test instruments of any kind required)

**Frequency response**—a direct warble-tone check of nineteen sections of the frequency spectrum, from 20 to 20,840 Hz, which will pinpoint any frequency response defects in your system.

**Separation**—an ingenious test which indicates whether you have adequate separation for good stereo.

**Cartridge tracking**—the most sophisticated tests ever devised for checking the performance of your cartridge, stylus and tone arm.

**Channel balance**—two broad-band, random-noise signals which permit you to eliminate any imbalances originating in cartridge, amplifier, speakers or room acoustics.

**Hum and rumble**—foolproof tests that help you evaluate the actual audible levels of rumble and hum in your system.

**Flutter**—a sensitive "musical" test to check whether your turntable's flutter is low, moderate, or high.

- Cartridge and Speaker Phasing
- Anti-Skating Adjustment
- "Gun Shot Test" for Stereo Spread
- Multi-purpose Musician's "A"
- Equal-tempered Chromatic Octave
- Guitar-tuning Tones

## Don't waste another minute on less-than-perfect stereo—Order Your Model SR12 Stereo Test Record NOW!

Consider the hundreds—even thousands—you've spent on your set-up and you'll agree \$6.95 is a small price to pay for the most valuable performance tool ever made. So to be sure your order is promptly filled from the supply available, mail the coupon at right with your remittance... today!

## AND, for the ultimate in stereo testing, 7 critical TEST EQUIPMENT checks...

Attention professionals: Stereo Review's new Model SR12 Stereo Test Record is also designed to be used as a highly efficient design and measurement tool. In the following tests, recorded levels, frequencies, etc. have been controlled to laboratory tolerances—affording accurate numerical evaluation when used with oscilloscope, chart recorder, output meter, intermodulation-distortion meter and flutter meter.

- 1,000-Hz square waves to test transient and high-frequency response of phono pickups.
- 500 to 20,000 Hz frequency-response sweep.
- Sine-wave tone-bursts to test transient response of pickup.
- Intermodulation test using simultaneous 400-Hz and 4,000-Hz signals.
- Intermodulation sweep to show distortion caused by excessive resonances in tone arm and cartridge.
- 1,000-Hz reference tones to determine groove velocity.
- 3,000-Hz tone for flutter and speed tests.

Sample waveforms—illustrating both accurate and faulty responses are provided in the Instruction Manual for comparison with the patterns appearing on your own oscilloscope screen.

## FREE Instruction Manual Includes Detailed Instructions, Charts, Tables and Diagrams.

Nothing is left to chance... or misinterpretation. Every segment of every band is fully, clearly, graphically explained. You'll know exactly what responses to listen for in each test. Which sounds and patterns indicate accurate performance... which ones spell trouble... as well as the cause of trouble and precise corrective measures to follow and help you pinpoint, analyze and cure your stereo headaches!

Ziff-Davis Service Division, Dept. R, 595 Broadway, New York, N.Y. 10012.

Please send the SR12 Stereo Test Record @ \$6.95, postpaid (\$8.95 outside U.S.A.). PE-77

Enclosed is \$\_\_\_\_\_ (Residents of Calif., Col., Fla., Ill., Mich., Mo., N.Y. State, D.C. and Tex. add applicable sales tax.)

CHARGE:  BankAmericard  Master Charge  
 American Express  Diners Club

Account # \_\_\_\_\_ Exp. Date \_\_\_\_\_

Master Charge Interbank # \_\_\_\_\_ (4 numbers over your name)

Signature \_\_\_\_\_

Print Name \_\_\_\_\_

Address \_\_\_\_\_

City \_\_\_\_\_ State \_\_\_\_\_ Zip \_\_\_\_\_



CHARGE YOUR ORDER TO YOUR AMERICAN EXPRESS, BANKAMERICARD, MASTER CHARGE OR DINERS CLUB ACCOUNT.



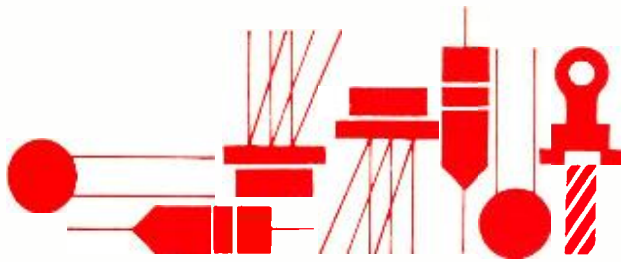

# Solid State

By Lou Garner

## IC's FOR TEST INSTRUMENTS

**S**URPRISING as it may seem, solid-state test instruments were manufactured and used long before the transistor itself was invented. Featuring crystal diode circuitry, the early units were relatively simple instruments—r-f test probes, square-wave clippers, oscilloscope calibrators, dc reference voltage sources, outboard signal generator modulators, etc. Historically, the transistor's first significant commercial use was in hearing aids. Shortly thereafter, however, the recently invented device found its way into pocket AM radio receivers and, almost simultaneously, into portable test instruments. With its small size and low voltage and current requirements, compared to the then standard vacuum tube, the new device was certainly ideal for such applications. Initially, its use was limited to such products as signal tracers, simple meter amplifiers, and limited-range signal generators. Later, as better transistor designs were developed and manufacturing techniques refined, transistors found their way into r-f signal generators, function generators, oscilloscopes, Q-meters, and even microwave gear. As time passed, other solid-state de-

automatic ranging, frequency synthesis, automatic unit conversion, and digital counting and display.

Introduced recently by the National Semiconductor Corporation (2900 Semiconductor Drive, Santa Clara, CA 95051), the LH0091 is one of the latest IC's developed primarily for test instrument applications. Suitable for use in digital voltmeters (DVM's) and digital multimeters (DMM's) as well as in noise, vibration, audio and power meters, the new device is designed to generate a dc output equal to the *true rms value* of any ac or composite ac/dc input signal from 0 Hz (dc) to 2 MHz. With an inherent accuracy of 0.5% of reading, the device can be adjusted using external trimming for accuracies down to 0.5%. In typical applications, it has an input impedance of 5000 ohms and an output impedance of 1 ohm. When operated with a dual  $\pm 15$ -volt dc power source, the LH0091

Fig. 1. Simplified schematic (A) and lead connections (B) for LH0091 rms converter IC.

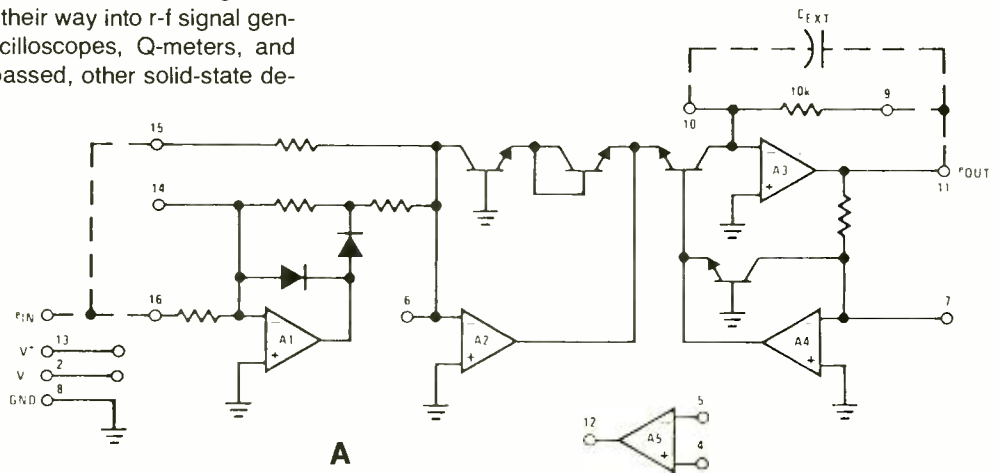

VICES were added to test instrument complements, including FET's, SCR's, triacs, diacs, and LED's, culminating in the use of integrated circuits. Today, almost all solid-state test instruments use at least one IC and many a dozen or more. There are, in fact, a number of special-purpose IC's designed specifically for test instrument applications.

For the experimenter and hobbyist, the evolution of integrated circuits and the ready availability of special purpose IC's has made possible the home assembly of inexpensive but sophisticated test instruments which would be both costly and prohibitively large if based on the use of either vacuum tube technology or discrete semiconductor devices. In addition, the development of complex IC's has permitted the efficient use of advanced design concepts and techniques in test equipment design, including phase-locked loops, gyrators,

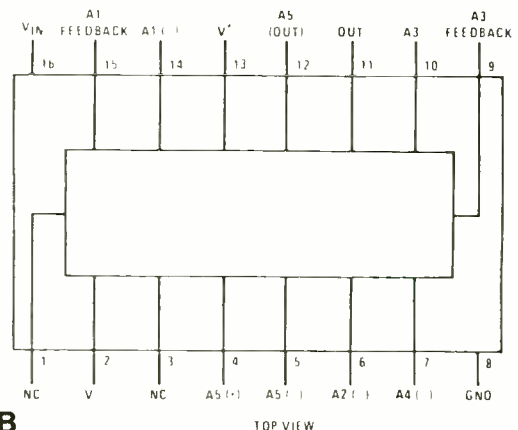

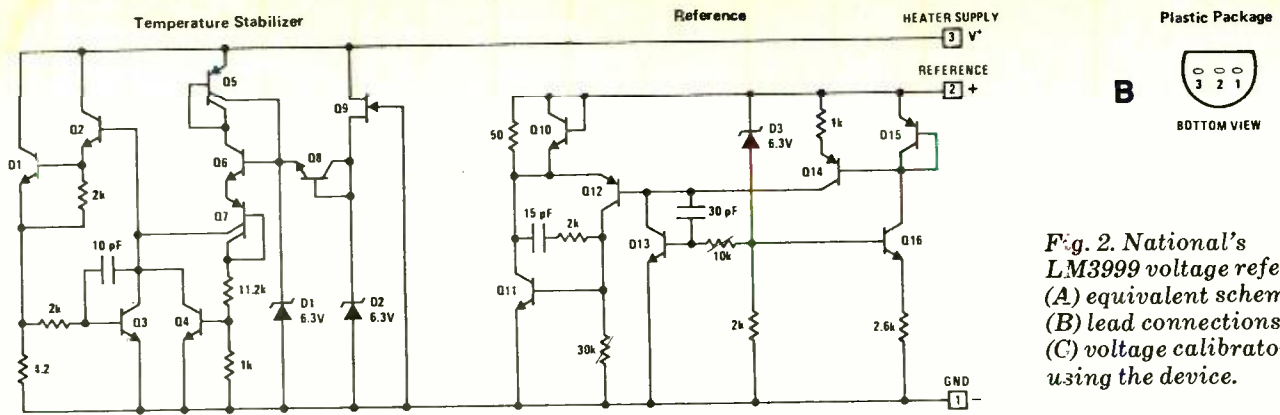

Fig. 2. National's LM3999 voltage reference: (A) equivalent schematic; (B) lead connections; (C) voltage calibrator using the device.

**A**

will accept input signals of up to  $\pm 15$  volts peak. As shown in the unit's simplified schematic diagram, Fig. 1A, the IC includes an uncommitted amplifier, A5, which may be used for filtering, to provide additional gain, or for other applications. Supplied in 16-pin DIP's, with lead connections as identified in Fig. 1B, the LH0091 is available in two versions—one in a metal case, for the standard military temperature range ( $-55^\circ$  to  $+125^\circ$  C) and the other for commercial operation ( $-25^\circ$  to  $+85^\circ$  C).

A unique device, the LH0091 is, of course, but one of a substantial number of IC's developed specifically for test instrument applications. Special, as well as general-purpose IC's useful in test equipment designs, are available not only from National Semiconductor but from virtually all other solid-state device manufacturers, including AMI, Exar, Fairchild, Intersil, Motorola, Plessey, RCA, Signetics, Siliconix, and Texas Instruments.

Suitable for power supply and general purpose as well as test instrument applications, another National Semiconductor IC, the LM3999, looks deceptively like an inexpensive transistor, for it is assembled in a three-lead, type TO-92 plastic package. Despite its simple external appearance, however, the unit is a monolithic precision voltage reference which combines a multi-device temperature stabilizing circuit with a zener controlled regulator, as shown in its equivalent schematic diagram, Fig. 2A. Its pin connections are identified in Fig. 2B. In operation, the LM3999 behaves as a highly stable 6.95-volt zener diode with a low dynamic impedance of only 0.5 ohm and an effective current range from 0.5 to 10 mA. Accepting dc inputs from 9 to 36 volts, the separately powered stabilization circuit permits operation from  $0^\circ$  to  $+70^\circ$  C with a temperature coefficient of  $0.0005\%/^\circ\text{C}$  and a long term stability of 20 ppm. The circuit for a portable voltage calibrator circuit, one of the many possible test equipment applications for the LM3999, is given in Fig. 2C. Here, the LM3999 is used in conjunction with an LM312 operational amplifier. Supplying a precise 10-volt output level for equipment calibration, the instrument requires a warm-up time of ten seconds, but may be used intermittently without degradation of long term stability.

If your instrument project plans include one or more digital meters, you'll want to investigate yet another new National Semiconductor device, the DM7700, a monolithic IC which contains all of the active circuitry, except for display, needed for a  $2\frac{1}{2}$ -digit meter. As illustrated by its simplified block diagram, Fig. 3A, the DM7700 comprises amplifier, reference voltage, voltage-to-frequency converter, clock, time-base, counter and latch circuits. Analog-to-digital conversion is

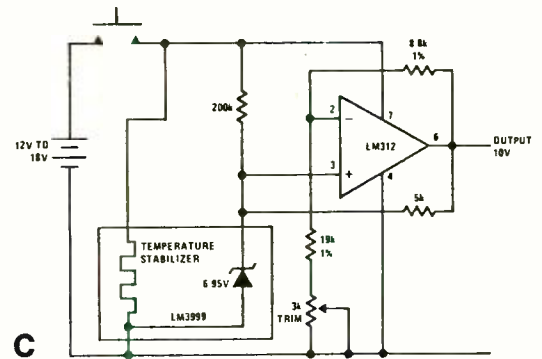

accomplished through the use of a dual voltage-to-frequency technique. One voltage-to-frequency converter generates a signal proportional to the input voltage while the other provides a sample window and determines the clock frequency for counting the output of the first. Requiring  $+5$ - and  $-15$ -volt dc sources for operation, the IC features a temperature compensated reference and both autopolarity and over-range output indicators. With an input impedance of 500,000 ohms, the device offers a full-scale analog range of  $\pm 1.99$  volts, a conversion time of 1 second, and an accuracy of  $\pm 1.0\%$ . Two versions of the IC are offered by the manufacturer, differing only in their temperature ratings. The standard DM7700 is specified for operation from  $-20^\circ$  to  $+95^\circ$  C, the less expensive DM8700 for operation from  $0^\circ$  to  $+50^\circ$  C. Both versions are supplied in standard 24-pin double-width DIP's, with pin connections as identified in Fig. 3B, and both can provide adequate current drive for standard LED numeric displays. A typical application circuit for the DM7700 (or DM8700) is given in Fig. 3C. Except for the IC, the NSN-33 LED readout, and the dc power supply, the only components needed for operation are three capacitors, three fixed resistors, and two potentiometers.

After the multimeter and the oscilloscope, many technicians feel that the basic signal tracer is the next most valuable of bench service instruments. Essentially a self-contained audio amplifier with integral loudspeaker, the signal tracer can be used with appropriate accessory probes for checking radio and TV receivers, CB transceivers, intercoms, PA systems, tape recorders, record players, hearing aids, and stereo installations. The medium power audio amplifier IC's offered by many semiconductor manufacturers are ideal for assembling signal tracers. A typical circuit is shown in Fig. 4. Abstracted from a Fairchild Semiconductor (464 Ellis St., Mountain View, CA 94042) data sheet, the design features a type TBA800 monolithic audio amplifier IC. Assembled in a 12-pin power

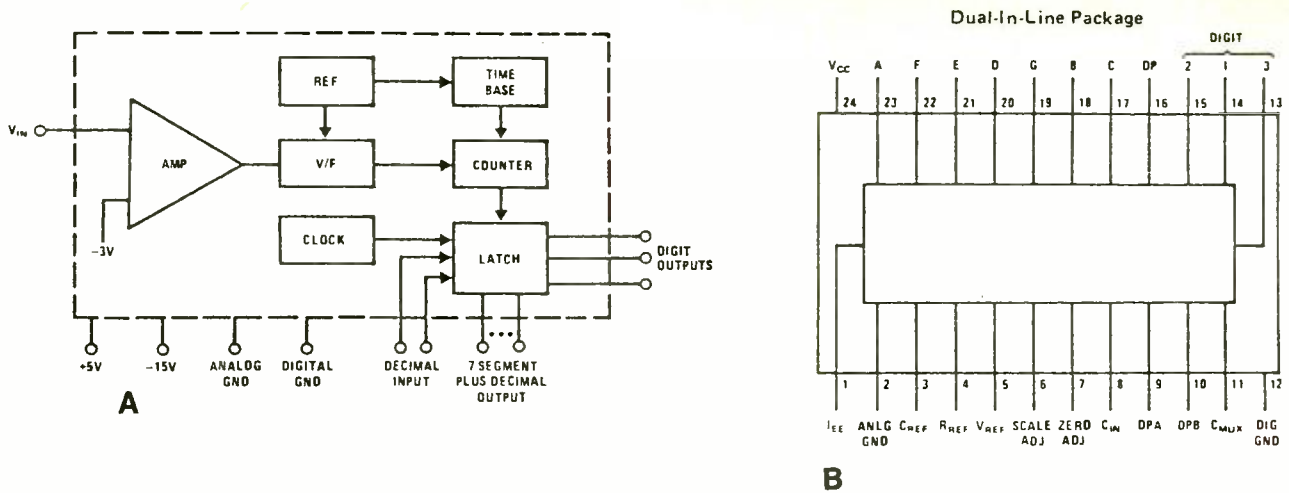

Fig. 3. Functional block diagram (A), lead connections (B), and typical application circuit (C) for DM7700 analog-to-digital meter converter integrated circuit.

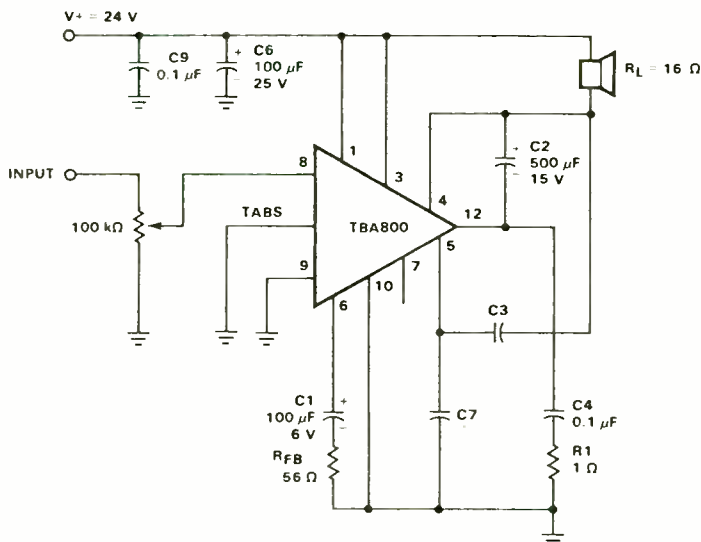
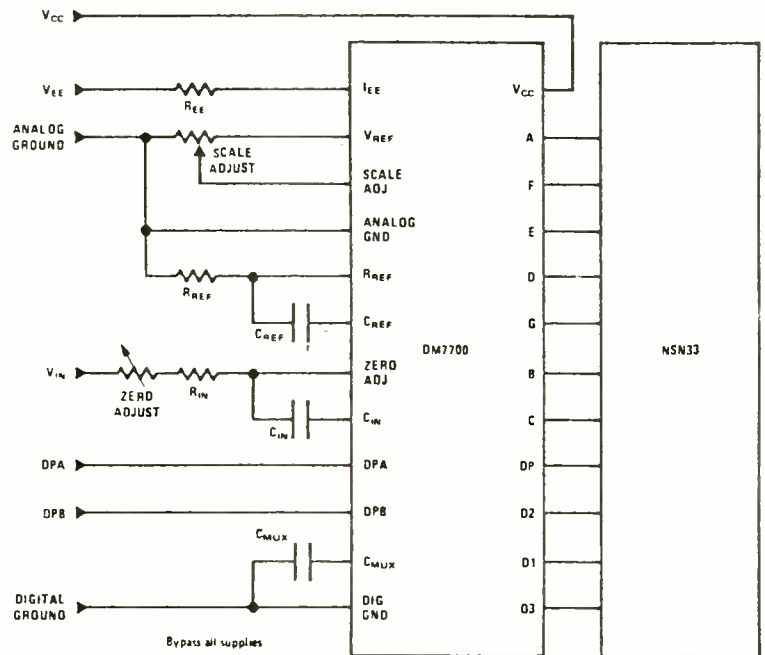

Fig. 4. With a TBA800 audio amplifier, this circuit can be used to make a basic signal tracer.

package with external cooling tabs, the TBA800 has a maximum voltage rating of 30 V and a maximum peak current capability of 2 A. With a modest heat sink, the device can deliver up to 5 watts to a 16-ohm load. At moderate output levels, the amplifier has a specified frequency response flat within 3-dB from 40 Hz to 20 kHz and an open-loop gain of 80 dB, with a typical total harmonic distortion of only 0.5%. Requiring but 80-mV input for full output, the IC's input resistance of 5.0 megohms permits it to accept all standard test probes. Properly matched to its load, the TBA800 is rated for 75.0% efficiency at full output. Referring to the schematic diagram, the circuit requires an external 24-V dc source for operation. This may be provided by batteries or by a well-filtered line-operated power supply, as preferred. All component values are specified except for  $C_3$  and  $C_7$ , which are part of the compensation network. These capacitor values are chosen to provide the overall frequency response needed for the circuit's application. Generally,  $C_7$  will be approximately five times as large as  $C_3$ . For most projects,  $C_3$  can be a 330-pF low-voltage ceramic capacitor and  $C_7$  a 1500-pF unit.

Although special-purpose IC's are ideal for instrument designs ranging from digital meters to multi-output function gen-

erators, operational amplifiers, as a broad class, are probably the most versatile of all IC's for general test equipment applications. Op amps may be used, typically, in sine-wave oscillators, pulse generators, oscilloscope preamps, active filters for signal analysis, bridge amplifiers, frequency meters, and staircase generators. Two representative examples of the many possible op amp test equipment circuits are given in Figs. 5 and 6. Both circuits were abstracted from application notes published by Intersil, Inc. (10900 N. Tantau Ave., Cu-

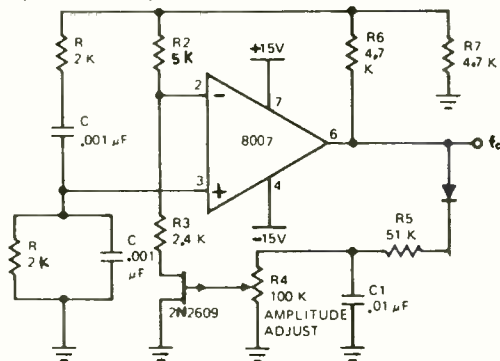

Fig. 5. Op amp Wein bridge oscillator described in an Intersil application note.

pertino, CA 95014), both feature FET-input op amps, and both are designed for operation on standard  $\pm 15$ -volt dual dc power sources.

Capable of delivering an output signal of 20 volts peak-to-peak, the Wein Bridge oscillator circuit shown in Fig. 5 may be used either alone as a test-tone source or as part of a complete audio-signal generator design. A type 8007 op amp serves as the basic oscillator, with a 2N2609 JFET used as a feedback element to provide amplitude control. In operation, the circuit's output frequency is determined by the values of the resistors and capacitors in the bridge feedback network and may be calculated from

$$f_0 = 1/2\pi RC,$$

where the frequency,  $f_0$ , is in Hz, R is in megohms and C in  $\mu$ F. Multiple output frequencies may be provided by using a number of different RC values, selected by means of a suitable multiposition switch. Continuous frequency coverage within a broad range can be obtained by replacing the two fixed resistors in the feedback network with a matched-pair gang potentiometer. The two techniques can be combined, of course, with switch selectable capacitors establishing different ranges and continuous coverage within each range provided by the ganged potentiometers.

Suitable for use in a variety of test equipment designs from counters to characteristics curve analyzers, the staircase generator circuit illustrated in Fig. 6 develops a cyclic stepped output signal waveform. Its active device complement includes a type 8043 dual op amp, a pair of low-leakage diodes, a type 1H5042 CMOS analog switch, and a type 311 voltage comparator. In operation, a high-frequency clock (square-wave) signal is applied to the first op amp, half of an 8043. Amplified, this signal drives the second op amp, which, in turn, charges a 0.02- $\mu$ F capacitor in small steps through a pair of low-leakage diodes. The capacitor's instantaneous voltage level is continuously compared to an externally applied dc reference by the 311 voltage comparator. When the capacitor voltage reaches the preestablished level, the comparator applies a signal to close the analog switch, discharging the capacitor to end the cycle and reset the circuit. The relative time width of

each step is determined by the initial clock frequency while the number of steps per cycle and hence the cyclic rate is established by the dc reference voltage applied to the 311 comparator.

Looking to the future, the next major evolutionary step in test instrument design probably will be the increased use of microprocessors and memory circuits. The use of these devices will permit the development of a whole family of automatic test instruments . . . units capable of performing a broad series of tests and, perhaps, of even changing the test procedures on the basis of initial results. More sophisticated future instruments may even provide aural outputs, telling the service technician where a circuit defect is located and which component or device should be replaced.

**Reader's Circuit.** Faced with frequent power interruptions in his area and having electrical equipment which required special start-up procedures if the ac power was removed for more than a few seconds, reader John M. King (1194 Idylberry Road, San Rafael, CA 94903) devised the protective control circuit shown in Fig. 7. The control is designed to maintain power-line contact with the protected equipment for short intervals in the event of a power failure, but to disconnect the equipment if the failure period exceeds a preset limit.

As shown in the schematic diagram, line power is applied to the external equipment connected to the dual outlet (SO1) through the contacts of relay K1 which, in turn, is controlled by a solid-state sensing circuit. Step-down transformer T1 in conjunction with bridge rectifier RECT1 and filter capacitor C1 form a dc power supply for the control circuit. Equipment operation is initiated when pushbutton S1 is depressed, turning on SCR1 and energizing K1. With SCR1 conducting, a dc charge is maintained on C2 by current flow through blocking diode D1. Should a momentary power failure occur, SCR1 will continue to conduct until C1 is discharged below the SCR's maintenance voltage, holding K1 closed and permitting the immediate reapplication of power to the external equipment. Thereafter, the SCR will switch to a high impedance state,

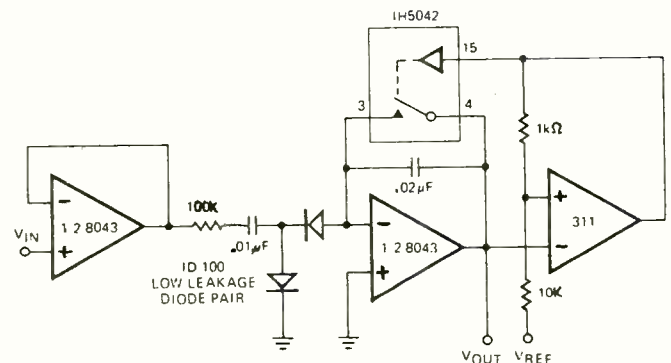

Fig. 6. Another Intersil circuit shown here is an op amp staircase generator.

opening the relay. However, a small gate voltage will be maintained on the SCR for a short while by the accumulated charge on C2. Thus, if ac line power is restored before C2 is discharged below the level needed to "fire" the SCR, circuit operation will be initiated automatically. If the power failure interval is longer than the time required for C1 and C2 to discharge, operation must be restarted manually by depressing S1, permitting the operator to carry out any necessary start-up procedures required by the protected equipment.

John used Motorola semiconductor devices in his design,



*Fig. 7. This circuit maintains power-line contact during short power outages but will disconnect the equipment if failure exceeds a preset simit.*

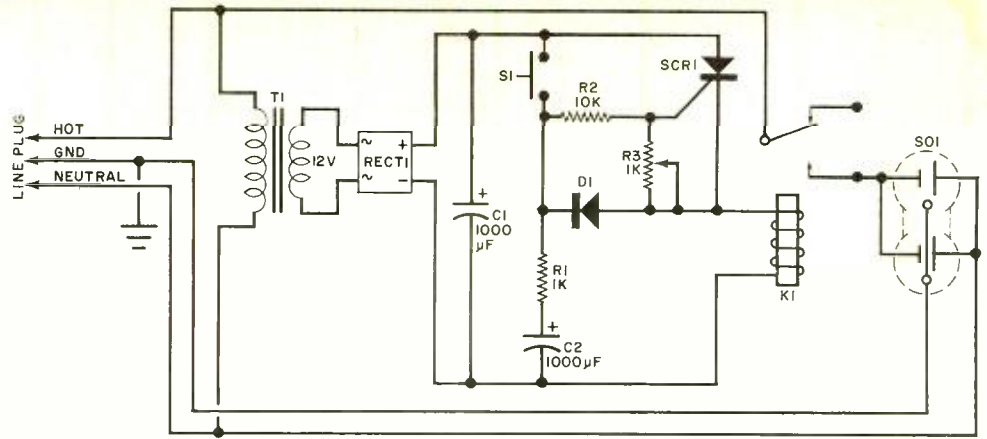

with the bridge rectifier a HEP type R0801, SCR1 a HEP type R1216, and diode D1 a HEP R0050. The step-down transformer may be any standard type with a 12-volt, 500-mA secondary. Resistors R1 and R2 are half-watt types. Capacitors C1 and C2 are 16-volt electrolytics. A 12-volt dc relay with a 95-ohm coil and contacts rated at 10 A is used for K1, while the control switch, S1, is a spst, momentary contact, NO pushbutton or lever type. Finally, the receptacle (SO1) is a familiar 3-wire dual wall outlet.

With neither layout nor lead dress critical, the circuit can be duplicated using any preferred construction technique but, for maximum safety, the wiring should be housed in a sturdy (and grounded) metal case or box. According to John, the time delay before manual resetting is required can be adjusted (by means of R3) between 1 and 12 seconds, which is more than adequate for most momentary power interruptions. If, for some reason, a longer delay is required, this may be achieved by increasing the values of C2, R2 and R3. Delays of up to a minute or two should be feasible with standard components.

**Device/Product News.** RCA's Solid State Division (Box 3200, Sommerville, NJ 08876) has added a new series of devices to its growing family of BiMOS (Bipolar/MOS) operational amplifiers, which feature MOSFET inputs and COS/MOS outputs. The new CA3160 series are frequency-compensated versions of the earlier CA3130 series op amps, and feature gate-protected p-channel MOSFET's in the input stage to provide input impedances of  $1.5 \times 10^{12}$  ohms (typical), very low input currents (5 pA typical at 15 V), and exceptional speed performance. In each, the output stage employs a complementary-symmetry MOS transistor pair capable of swinging the output voltage to within 10 mV of either supply voltage terminal, permitting direct interface with either CMOS or bipolar 7400 TTL series devices. Other features include wide bandwidth (15 MHz), high slew rate (10 V/ $\mu$ s unity-gain follower), and strobbing capability to reduce standby power consumption. Suitable for applications in sample-and-hold amplifiers, long duration timers, wideband amplifiers, voltage followers, voltage regulators, Wein Bridge oscillators, VCO's, and photo-diode sensor amplifiers, the devices are offered in both standard and dual-inline formed 8-lead TO-5 packages.

In addition to its special purpose test instrument IC's, National Semiconductor has announced a new family of positive regulators with several fixed output voltages in three temperature ranges. Identified as the LM140LA series, the new devices have a 2.0% output voltage specification, 0.04%/volt line regulation, a 0.01%/mA load regulation, and can deliver up to 100 mA with adequate heat sinking. Offered in metal

TO-39 and plastic TO-92 packages, the new regulators are available with outputs ranging from 5.0 to 24.0 volts. All of the devices are protected by internal current limiting and thermal shutdown circuitry.

International Rectifier's Semiconductor Division (233 Kansas St., El Segundo, CA 90245) has recently introduced a pair of 900-volt npn transistors with power dissipation ratings of 50 watts. Designated types IR 708 and 709, the new units are suited for applications in video deflection circuits, high-voltage switching power supplies, power controls, and switching regulators. Both offer continuous collector current ratings of 3 A with fall times of 1.5  $\mu$ s, and both are supplied in standard TO-3 metal cases.  $\diamond$



## Put more punch in your work.

With a Greenlee Chassis Punch you can punch clean, true holes in seconds. Round, square, key or D. In 16-ga. metal, hard rubber, plastic or epoxy. Available at radio and electronics parts dealers. Write for catalog E-730. Greenlee Tool Co, Rockford, Ill. 61101.

### GREENLEE TOOL CO

a subsidiary of

### Ex-Cell-O Corporation

CIRCLE NO. 21 ON FREE INFORMATION CARD

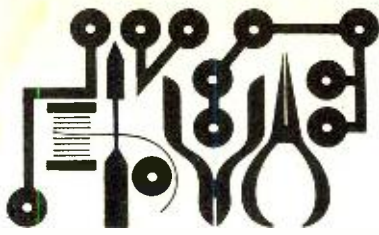

# Experimenter's Corner

By Forrest M. Mims

## THE 556 DUAL TIMER

IF THERE'S anything better than the popular 555 timer, it's the 556 dual timer. The 556 is two 555's on a single chip packaged in a 14-pin DIP. The pin outline of this versatile chip is shown in Fig. 1. Either or both halves of the 556 can be used for all the standard 555 applications. This month, we'll look at several that use two 555's and are therefore ideally suited for the 556.

generator. The tone continues until the one-shot's timing cycle is complete. The result is a tone burst which you can use for signaling, alarms, electronic music, and other effects.

You can experiment with the various timing and frequency-controlling components ( $R1$ ,  $C1$ ,  $R2$ ,  $R3$  and  $C4$ ) to produce different sound effects. Remember that you're looking for a tone which con-

tinues after  $S1$  is released, so adjust  $R1$  until this occurs.

tinues after  $S1$  is released, so adjust  $R1$  until this occurs. A timer using this principle is shown in Fig. 3 where  $R2$  and  $C1$  determine the time delay of the first timer and  $R3$  and  $C4$  determine the delay of the second timer. The output of the first timer is coupled to the input of the second by  $C5$ .

Operation of the circuit is straightforward, and you should easily be able to generate time delays of more than twenty minutes. Though Fig. 3 shows potentiometers for  $R2$  and  $R3$ , you can use fixed resistors if you prefer. The potentiometers, of course, are handy for altering the delay of each half of the timer.

You can also use a range of values for  $C1$  and  $C4$ . Naturally, large-value capacitors will give long time delays; but if you only need a delay of a few minutes or so, you can use less costly units.

Finally, though the main purpose of this circuit, which I've borrowed from Signetics, is to extend the time delay of a single 555, you might want to take advantage of the first timer's output, too. Lots of interesting sequencer applications are possible since each timer can be adjusted for a different timing period.

### Extra-Long Time-Delay Circuit. A

neat way to increase the time delay of a single 555 by a factor of ten is to connect a low-cost TTL decade counter like the 7490 to the basic timer circuit. This trick can provide time delays of up to a few hours—even more if you use a high-quality timing capacitor.

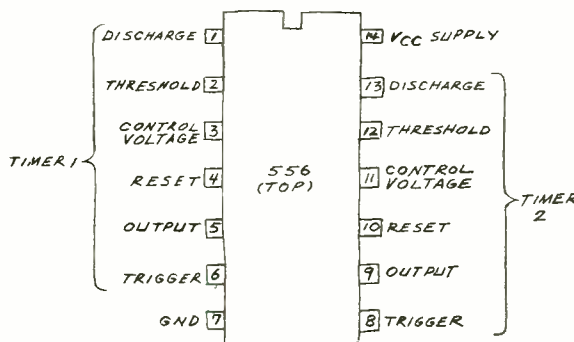

Fig. 1. Pin outline of the 556 timer.

**Tone-Burst Generator.** Figure 2 shows a circuit for a tone-burst generator using a single 556 dual timer. The first half of the 556 is connected as a monostable multivibrator (one-shot) whose timing period is controlled by  $R1$  and  $C1$ . The second half of the 556 is connected as an astable (free-running) multivibrator which produces an audio tone with a frequency governed by  $R2$ ,  $R3$  and  $C4$ .

Normally the speaker is quiet; but when pushbutton switch  $S1$  is pressed, the one-shot begins its timing cycle while simultaneously activating the tone

generator. The tone continues until the one-shot's timing cycle is complete. The result is a tone burst which you can use for signaling, alarms, electronic music, and other effects.

**Dual-Action Timer Circuit.** The maximum time delay of a single 555 timer is limited to ten or fifteen minutes unless you use an expensive low-leakage

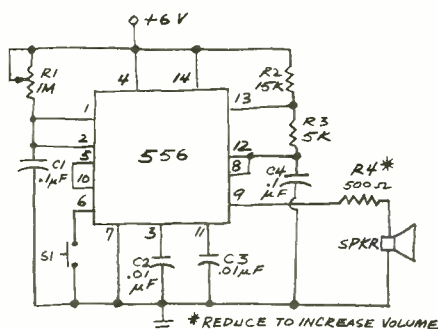

Fig. 2. Tone-burst generator.

generator. The tone continues until the one-shot's timing cycle is complete. The result is a tone burst which you can use for signaling, alarms, electronic music, and other effects.

**Dual-Action Timer Circuit.** The maximum time delay of a single 555 timer is limited to ten or fifteen minutes unless you use an expensive low-leakage

Fig. 3. Dual-action timer circuit using the 556 IC.

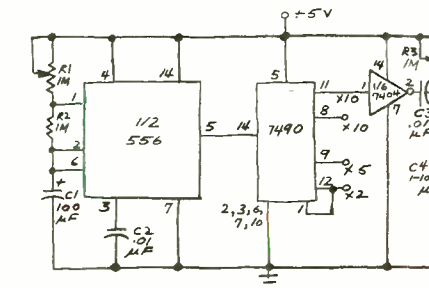
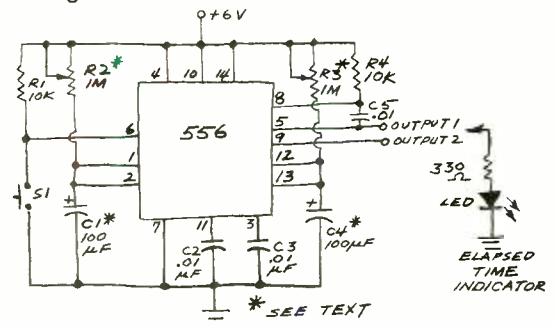

Fig. 4. Extra-long time delay circuit.

Operation of this circuit is made possible by the divide-by-ten operation of the 7490. The 7490 simply counts input pulses from the 555 until ten have been received. It then produces an output pulse of its own.

It's possible to connect the divide-by-ten output of the 7490 directly to an elapsed-time indicator such as an LED or audio oscillator. A better approach, however, is to connect a second 555 hooked up as a one-shot to the 7490. The one-shot is easy to adjust, and it will turn on the elapsed-time indicator for a fixed length of time. This is a handy feature if you want to use a bell or buzzer as an elapsed time indicator since the second 555 will trigger a quick burst of sound instead of a continuous noise.

Figure 4 shows how everything is connected together. A single 556 takes the place of the two 555 timers. One of the inverters in a 7404 hex inverter complements the output signal from the 7490 to provide the proper triggering potential. If you don't have a 7404 handy, use one of the gates in a 7400 quad NAND gate. Connect the two inputs of one gate together to form the inverter's input. (For example, connect pins 1 and 2 of the 7400 to pin 11 of the 7490. Connect pin 3 of the 7400 to pin 8 of the 556. Connect pins 14 and 7 of the 7400 to the positive and ground connections, respectively.)

The extra long timer circuit has several features you'll want to tinker with. First, note that potentiometer *R1* sets the delay time while potentiometer *R3* sets the on time of the elapsed time indicator. I used an LED for the elapsed-time indicator in the prototype circuit, but you can use a relay if you prefer (Radio Shack 275-004 or equivalent).

Second, note that the 7490 has four outputs. Both pins 11 and 8 will provide a time delay ten times that of the first 555 (one pulse out for every ten pulses in). Pin 9 will provide a time delay five times that from the 555. And pin 12 will provide twice the delay available from the 555.

Finally, if you want *really* long delays, you might consider connecting one or more additional 7490 decade counters in series with the first. Just connect pin 11 of the first 7490 to pin 14 of the second 7490. Pin 11 of the second 7490 goes to still another 7490 or to the inverter. Incidentally, note that this circuit is a repetitive, free-running timer. In other words, it begins a new timing cycle immediately upon completion of the first. Keep this in mind if you decide to tinker with super-long time delays. ◊

**FREE**

# McIntosh CATALOG and FM DIRECTORY

Get all the newest and latest information on the new McIntosh Solid State equipment in the McIntosh catalog. In addition you will receive an FM station directory that covers all of North America.



## MX 113

FM/FM STEREO - AM TUNER AND PREAMPLIFIER

**SEND TODAY!**

McIntosh Laboratory, Inc.  
East Side Station P.O. Box 96  
Binghamton, N.Y. 13904  
Dept. PE

NAME \_\_\_\_\_  
ADDRESS \_\_\_\_\_  
CITY \_\_\_\_\_ STATE \_\_\_\_\_ ZIP \_\_\_\_\_

If you are in a hurry for your catalog please send the coupon to McIntosh.  
For non rush service send the *Reader Service Card* to the magazine.

CIRCLE NO. 26 ON FREE INFORMATION CARD

### BUILD YOUR OWN

## BIG SCREEN COLOR TV!

- Sporting Events Are An Experience As Exciting as Being There!
- Movies Are Seen The Way They Were Meant To Be Seen!
- Ping And Other Video Games Are More Exciting Than Ever!
- Can Be Used With Video Tape Playback Equipment!

YOU ASKED FOR IT!

WE HAVE RECEIVED THOUSANDS OF INQUIRIES!

YOU REQUESTED PLANS FOR A BIG SCREEN TV THAT WOULD: utilize any portable TV as an image source — require a minimum of floor space — be a beautiful piece of furniture.

NOW — EXTRON IS HAPPY TO ANNOUNCE

THE ORIGINAL LIFESCREEN I

### THE NEW LIFESCREEN II

#### THE NEW LIFESCREEN II



The SELF-CONTAINED internal projection TV that will utilize any transistor portable TV (12" to 19") . . . requires only 2 x 4 feet of floor space — fits neatly against any wall . . . and lends its beauty to the decor of any room.

#### COMPLETE LIFESCREEN II PACKAGE:

- 1 set of LIFESCREEN II Plans  
1 Portable transistor Color TV (12" to 19")  
1 LIFESCREEN Lens  
2 LIFESCREEN Front Surface Mirrors — one 8" x 10" and one 14" x 20"  
1 EXTRON LS 50 Screen, 32" x 40" / 50" Diag.

**\$299**

THE EVERYTHING GUARANTEE  
EXTRON GUARANTEES EVERYTHING: THE PROFESSIONAL QUALITY, ACCURACY OF DESCRIPTION, AVAILABILITY AND PROMPT DELIVERY OF COMPONENTS DESCRIBED IN THIS AD. If, after building your LIFESCREEN PROJECTION SYSTEM, you are not satisfied for any reason, return all components to EXTRON, 8831 Sunset Boulevard, West Hollywood, California for instant refund of the purchase price.

- PLEASE RUSH ME ONE COMPLETE SET OF LIFESCREEN I PLANS . . . @ \$90.00  
 PLEASE RUSH ME ONE COMPLETE SET OF LIFESCREEN II PLANS . . . @ \$90.00

PLEASE ALSO SEND ME THE ITEMS CHECKED BELOW:

- LIFESCREEN LENS . . . @ \$150.00  
 LIFESCREEN FRONT SURFACE MIRROR, 8" x 10" . . . @ \$20.00  
 LIFESCREEN FRONT SURFACE MIRROR, 14" x 20" . . . @ \$30.00  
 EXTRON LS 50 SCREEN 32" x 40" / 50" Diagonal . . . @ \$90.00

- COMPLETE LIFESCREEN I PACKAGE . . . @ \$269.00  
 COMPLETE LIFESCREEN II PACKAGE . . . @ \$299.00

All Prices F.O.B. factory — Cal. residents add 6% sales tax. TOTAL: \$ \_\_\_\_\_

**\$269**

COMPLETE LIFESCREEN I PACKAGE:  
1 set of LIFESCREEN I Plans  
1 Sharp 13" Model 13A21 Color TV or Sony 15" Model KV 1541R Color TV  
1 LIFESCREEN Lens  
1 LIFESCREEN Front Surface Mirror, 8" x 10"  
1 EXTRON LS 50 Screen 32" x 40" / 50" Diagonal.

EXTRON LIFESCREEN® PROJECTION SYSTEM  
8831 Sunset Boulevard,  
West Hollywood, California 90069

Name \_\_\_\_\_  
Address \_\_\_\_\_  
City \_\_\_\_\_ State \_\_\_\_\_ Zip \_\_\_\_\_

CARD NUMBER \_\_\_\_\_ EXPR. DATE \_\_\_\_\_

INFO PAK — 50c

The INDEPENDENT projection system that can be used with ANY SIZE screen up to 80" Diagonal — one of the many reasons for its tremendous success.

LARGER SCREENS can be ordered through EXTRON 167" or 80" Diag.



**Q.** I have a TVI problem whenever I use my CB transceiver. My neighbors get very upset and tell me to turn off the radio. Is there anything I can do without going off the air? —Dwayne Edwards, Canton, NY.

By John McVeigh

### STATIC CRASHES

**Q.** Please advise how to eliminate unbearable noise that my school's heating system produces on my Hallcrafters SX62A shortwave receiver. A line filter was tried to no avail. The most deafening noise is heard for two or three seconds between 5 and 18 MHz.—Gerard Richard, Sherbrooke, Quebec, Canada.

**A.** It sounds like a thermostat or thermostat-controlled power relay is arcing and generating r-f crashes. If you can "sniff out" the source with a small field-strength meter or even a portable radio (the static should also affect the AM broadcast band), try placing a suitable bypass capacitor across the arcing thermostat or relay contacts. A 0.1- $\mu$ F, 1000-V ac disc ceramic capacitor should squelch the r-f. If you can't locate the source, try the "Ear Saver" circuit shown in the Hobby Scene column on p. 34 of the January 1977 issue.

### RESISTOR QUIZ

**Q.** Here's a problem which was posed by one of my professors. You have an infinite lattice of 1-ohm resistors as shown in the diagram. What's the effective resistance between points A and B?—Bryan Baker, Houston, TX.

**A.** Offhand, I think the effective resistance is zero ohms. There is an infinite number of resistors in parallel, and

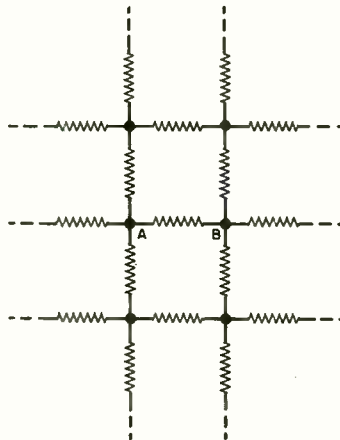

even though the further away from A and B the more series resistors you have in each parallel combination, it looks like the resistance will go to zero. The only other solution I could possibly see is a finite limit in the parallel combinations. But my tendency is to say zero ohms. Actually, the effective resistance of an ever-increasing number of parallel resistors will approach zero ohms, but will never reach it—just like the graph of a hyperbola or an exponentially decaying function. If any reader comes up with different solution, feel free to send it in!

### TRIGGERING THYRISTORS

**Q.** I would like to control 120-volt ac devices with TTL logic without using relays. Is there a way to do this using triacs or SCR's? They would only have to handle 1 or 2 amperes.—Dominick Testa, Skokie, IL.

**A.** The easiest way to trigger an SCR or triac from a TTL output is to use an optoisolator. It is essentially a LED, a cur-

rent limiting resistor, and a photocell. Of course, you can make your own optoisolator by enclosing the LED and CdS cell in a light-tight box. Connect the optoisolator as shown in the figure. An external current limiting resistor may be needed to keep the thyristor's gate current to a safe value. This depends on the lit resistance of the CdS cell. Using a 10,000-ohm, 1/4- or 1/2-watt series resistor will limit gate current to 17 mA peak.

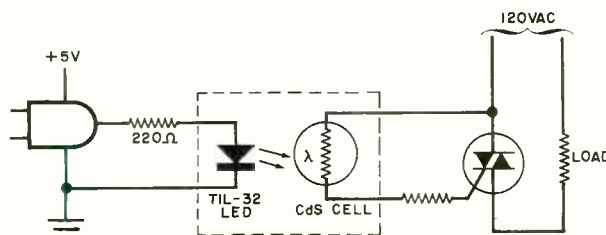

**A.** If your CB transceiver is a fairly recent vintage, type accepted, and used properly, it should not be generating TVI. Often, the interference is the result of overload within the TV receiver in the presence of a strong 27-MHz signal. The way to identify overloading is to determine the extent of the interference at the TV receiver. If TVI occurs on all channels, receiver overloading is the culprit. Visual interference can range from fine cross-hatching to a completely dark screen. When the sound portion of the program is also subject to interference, overloading is taking place.

The cure for this problem is to prevent the CB signal from reaching the TV. This can usually be done by attaching a high-pass filter such as the Drake TV-300-HP (for twinlead) or TV-75-HP (for RG-59-U coax) at the antenna terminals on the back of the receiver. In some cases, the filter will have to be installed at the tuner input inside the receiver's enclosure. When the CB signal is really strong, the use of the high-pass filter might have to be supplemented by more effectively shielding the receiver. Fine copper or brass screening or flashing carefully installed (beware of accidental shorts!) can be installed on the inside of the TV enclosure and grounded.

When visual interference occurs only on TV channels harmonically related to the 27-MHz Citizens Band (principally Channel 2 at 54 MHz and Channel 5 at 81 MHz), the transceiver is radiating undesired signals. This can occur when the transceiver circuitry is improperly adjusted or operated. Over-modulation from "power mikes" is a common cause of harmonic radiation. Don't overmodulate the transceiver and don't use a power amplifier. If the harmonic suppression of the transceiver must be improved, insert a low-pass filter in the coax transmission line close to the transceiver. Be sure you use a filter with a cut-off frequency around 40 MHz and attenuation of at least 60 dB at TV frequencies (Drake TV-42-LP or equivalent).

Have a problem or question on circuitry, components, parts availability, etc? Send it to the Hobby Scene Editor, POPULAR ELECTRONICS, One Park Ave., New York, N.Y. 10016. Though all letters can't be answered individually, those with wide interest will be published.



# Product Test Reports

## COBRA MODEL 29XLR MOBILE 40-CHANNEL CB TRANSCEIVER

*Digital readout AM rig provides strong transmission punch.*



**D**YNASCAN's Cobra Model 29XLR is a handsome 40-channel AM CB mobile transceiver that uses digital frequency synthesis and a red LED numerical display for channel identification. It incorporates such features as: display dimmer control, illuminated S/r-f/relative-power meter, LED transmit/modulation indicator, microphone and r-f gain controls, and switchable noise blanker (NB) and automatic noise limiter (anl). In addition, the transceiver has audio, squelch, and Delta tune controls; PA facilities; external-speaker jacks; automatic modulation control (amc); detachable dynamic microphone; bottom-facing speaker; line filter; and reverse-polarity protection. Operation is from a nominal 13.8-volt dc source with negative or positive ground.

The transceiver measures  $9\frac{1}{2}''\text{W} \times 7\frac{1}{4}''\text{D} \times 2\frac{1}{4}''\text{H}$  ( $24 \times 18.5 \times 5.6$  cm). Suggested list price is \$229.95.

**Technical Details.** The receiver employs double conversion, with frequency control provided by a phase-locked-loop (PLL) frequency synthesis system. A 10,695-kHz first i-f is obtained by heterodyning the CB signal with the PLL's voltage-controlled oscillator (vco) signal in the range of 37,660 to 38,100 kHz. The second conversion is to a 455-kHz i-f with a 10,240-kHz crystal oscillator, from which a 10-kHz standard reference for the PLL system is also derived through dividers. The 10-kHz vco comparison

signal is set up by combining the output of the vco with a 36,570-kHz crystal signal at a "down" converter (mixer). The difference frequencies are extracted and go to an IC divider that is controlled by the channel-selector switch.

Inductively coupled circuits at the input of the r-f amplifier and output of the second mixer, along with a bandpass-coupled circuit between the mixers, aid in good image and unwanted-signal rejection. This is augmented by a 10,695-kHz ceramic filter after the first mixer. The 455-kHz selectivity is also obtained with a ceramic filter.

Two i-f stages are followed by a diode detector and agc, the switchable anl, squelch system, and an IC audio section. The noise blanker employs an IC r-f amplifier/detector and three pulse amplifiers for gating the output of the second mixer. Electronic voltage regulation is supplied for all critical circuits.

The transmitter combines the output of the vco with a 10,695-kHz crystal oscillator signal, using the difference frequencies, at a dual-gate MOSFET transmitter mixer that is followed by bandpass coupling and the usual r-f stages. The multi-section output network includes a TVI trap. The SWR bridge is a trough-line type. The collectors of the driver and power amplifier stages are modulated by the receiver's audio output stage, providing the customary high- and low-level class-B modulation. Amc is obtained with a bootstrap setup

around an IC microphone amplifier. Transmit/receive transfer is conducted electronically.

It is interesting to note that the 29XLR utilizes ferrite beads at strategic points in place of wire-wound r-f chokes. These beads slip over a lead of the circuit to be isolated or stabilized. The beads save space, hold down circuit resistance, minimize resonance effects, and are highly effective in comparison to the wire-wound chokes.

**Test Results.** Receiver sensitivity of the Cobra 29XLR measured  $0.5 \mu\text{V}$  (with 30% modulation at 1000 Hz). Image and i-f signal rejection measured 80 dB minimum, while spurious response rejection of signals near the CB range was 45 dB. Adjacent-channel rejection and desensitization were nominally 60 dB. The overall 6-dB audio response was 240 to 2400 Hz. The maximum sine-wave output power measured 2.75 watts at 3% THD at 1000 Hz into 8 ohms at the onset of clipping. It measured 3 watts in the PA mode.

The agc held the audio output to within 10 dB with a 26-dB r-f input change at 0.5 to  $10 \mu\text{V}$  and to 13 dB with an 80-dB input change at 1 to  $10,000 \mu\text{V}$ . A nominal  $50\text{-}\mu\text{V}$  signal registered S9 on the signal meter. The threshold range of the squelch circuit was 0.3 to  $10,000 \mu\text{V}$ .

The transmitter put out a 4-watt carrier with operation from a 13.8-volt dc source. The modulation capabilities ran up to 100%. With the microphone input level raised 25 dB above the level required for 50% modulation, the THD was 7% at 1000 Hz, and the modulation held to just within the legal limit. The THD with a 400-Hz test tone was noticeably greater in both waveform observation and measurement, the latter varying between 10% and 20%, depending on the level of the amc.

We obtained high average modulation with voice inputs without overmodulation or adverse splatter. With voice input or 1000-Hz tone, the splatter at  $\pm 5000$  Hz from the carrier frequency was at least 60 dB down. Using a 2500-Hz tone input, it was 50 to 55 dB down. The overall 6-dB audio response of the transmitter was 400 to 2300 Hz. R-f frequency tolerance on any channel was within  $\pm 3$  Hz of  $-110$  Hz.

**User Comment.** This is a smartly styled mobile transceiver, set in a black case with brushed silver-colored front panel and chrome-trimmed knobs. The control knobs are located in a row along the lower half of the front panel.

Our one complaint about the control sequence arrangement is that the DYNA MIKE (microphone gain) control is located at the far left of the panel, where we automatically reach for the more-often used VOLUME control.

The channel selector control knob has a bar grip that makes it easy to manipulate. Other switching functions are handled by miniature toggle switches located in a line across the top of the front panel between the meter and numeric display. Two of these switches have three positions that do not have much lever swing, which sometimes makes it difficult to stop at the center position. A two-position switch, H.F./OFF, switches in and out a "hash" filter that is a fixed-setting tone control that drops the upper frequency response to minimize high-pitched noises.

The edgewise meter is easier to read than most other similar meters we have encountered. It is illuminated whenever the transceiver is turned on except when

in the PA function. Hence, instead of having the numeric readout display the letters PA, as is generally the case, the meter's light extinguishes to indicate that the transceiver is in the PA mode.

We determined that, when the transmitter is working into a nonreactive 50-ohm load (representing a 1:1 SWR), the actual r-f output was accurately indicated at any point on the meter's SWR scale. (This does not necessarily hold true for other loads or high SWR's.)

Use of the noise blanker allowed readability of weak signals in the presence of high impulse noise from our impulse-noise generator. It was similarly effective on ignition noise in a vehicle, where it almost entirely eliminated the noise (with a slight loss in signal level). The anl also performed well.

Although the speaker in this transceiver is bottom facing, its sound reproduction is clean and crisp without the usual muddyness associated with bottom-facing speakers. It provided good readabil-

ity in our on-the-road tests. It should be noted that the microphone must be plugged into its connector to permit the speaker to function.

On-the-air, we obtained a hefty punch from the amc system, which prevented overmodulation even when the microphone gain was fully advanced. We experimented with the DYNA MIKE control to determine its best setting. The cleanest sounding signal was obtained with the mike gain reduced to the point where the MOD indicator blinked only occasionally. At this point, we still obtained a high average modulation level without sacrificing intelligibility.

The excellent performance of the Cobra 29XLR transceiver far outweighs the minor criticisms noted here. It provides high sensitivity and fine selectivity, has a good transmitted signal without adverse splatter, and possesses effective noise-handling capabilities.

CIRCLE NO. 104 ON FREE INFORMATION CARD

## WAHL MODELS 7700 AND 7800 CORDLESS SOLDERING IRONS

*Battery-powered irons with recharging stands.*

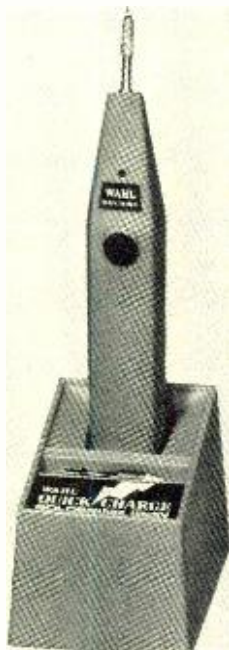

*Iso-Tip Quick-Charge Model 7700.*

When electrically powered cordless soldering irons first appeared, we lauded them because they gave us freedom from the ac line. Especially useful in the field, they also proved to be very practical on our workbench. We did, however, observe one shortcoming—we could not use the cordless iron for major project and kit building that required hundreds of connections to be soldered.

It was not that a fully charged iron provided just 100 to 150 soldered joints, but that it required up to 14 hours to recharge to full capacity. Now, however, there are "fast-charge" cordless soldering irons, as examined here.

The two fast-charge soldering irons from Wahl are the Iso-Tip "Quick Charge" Model 7700 that requires about four hours to recharge and the Iso-Tip 60 Model 7800 that comes up to full charge in about 60 minutes. Both irons come with their own recharger stand. The Model 7700 retails for \$24.95, the Model 7800 for \$34.95. Available as an option is the Model 6500 (\$10.95) printed circuit board drilling attachment that fits all Wahl cordless soldering irons.

**General Description.** The two soldering irons feature a couple of improvements that were not part of the original Wahl cordless soldering iron we tested five years ago. The first is that the header has been redesigned to hold tips firmly in place by friction instead of with the tiny Allen-type setscrews used on the original iron. This makes installation and removal of tips a simple plug-in/pull-out operation. Of course, the tip can still be semi-permanently fixed to the header by loosening the header screws, inserting the tip, and retightening the screws.

The second improvement is in the

power-on pushbutton switch. The button is rotatable so that its index can be set to either of two positions. To use the iron, the index must be set to the USE position before it can be depressed. Only in this position can the button be depressed far enough to close the switch contacts and allow power to be applied to the tip. Whenever the iron is not in use, the button is rotated until the index is pointing to the LOCK legend molded into the iron's housing. When the button is in the LOCK position, the iron cannot be accidentally turned on, which is a good safety feature on a bench or in a crowded toolbox.

The major improvement in the new irons is the fast-charging feature. The Model 7700 iron's average four-hour recharging cycle is roughly a third of that required by the original Wahl iron. For just \$10 more, the Model 7800 cuts the recharging time of the original iron to less than a tenth. Needless to say, with either iron, you can make many times more solder joints in a workday than was possible before. Hence, you can tackle a fairly large project or kit-building job without resorting to a line-powered iron.

Special nickel-cadium cells are used in the new irons. These cells, plus the newly designed charger stands, are responsible for the new fast-charge rates. In addition, the Model 7800 is equipped with a thermostat that automatically re-

duces the full fast-charge rate to a safe "trickle" once the cells have come up to full charge. When the cells are fully charged, and as long as the iron is still in its stand, a LED near the power switch comes on to indicate the full-charge status. A RESET switch on the left side of the iron must be pushed down to allow the iron to charge at the fast rate again.

Both irons are equipped with screw-in lamps that illuminate the work area near the tip when the power button is pressed. Also, both come with two tips, one a standard chisel and the other a fine configuration for IC soldering.

The new irons are equivalent to 50-watt line-powered soldering irons. The tips come up to soldering temperature within about five seconds after the power button is pressed, and each iron is rated to deliver approximately 160 twisted-tail solder connections, using 22-gauge wire, from full charge.

**User Comment.** The first test we performed on these new soldering irons was to fully charge them from the completely discharged states in which they arrived. The Model 7700 took almost exactly four hours to come up to full charge, the Model 7800 about 50 minutes. Both irons became warm to the touch, especially the Model 7800, which was quite warm when the full-charge LED came on.

Our next test was to determine approximately how many solder joints each iron would deliver from full charge. To do this, we did not replace the irons in their respective stands between solder operations as recommended by Wahl. We performed this test three times each for twisted-tail, solder-lug, and pc-board connections with both the chisel and fine points installed, recharging fully after each run. We obtained averages of 187 joints for 22-gauge twisted-tail wire connections, 131 for solder-lug connections, and 217 pc-board connections with the fine tip installed. Using the more massive chisel tip, the counts averaged 152, 114, and 180 connections, respectively. The averages were about the same for both irons.

As we were performing our solder-joint count test, we kept track of the times required for recharging to full capacity. Though the charging times did vary from charge to charge, they were well within 10% of the four-hour and 60-minute ratings specified by Wahl.

Our next test was to tackle two rather large construction projects, one a 4-k computer memory board and the other a computer I/O interface board, both of



*Iso-Tip 60 Model 7800.*

which required several hundred connections to be made. We found that intermittent operation of the Model 7800 iron, replacing it in its charging stand whenever it was not being used to solder a connection, allowed us to complete the entire memory board in two four-hour stints, which is about the amount of time one would normally spend on a project even with a line-powered iron. The Model 7700 iron provided enough soldering power in intermittent operation to allow

us to assemble completely the I/O port in three one-hour stints. Needless to say, we were favorably impressed by the performance we obtained from both irons, particularly the Model 7800.

In our final test, we used the irons to operate the optional pc-board drilling attachment. The attachment itself accepts a single size (No. 56) drill bit, which is good for just about all component-lead and IC-pin holes. The attachment snaps onto the tip-header end of the irons and snaps into place on the newer irons or is held in place by a small screw on the older Wahl irons. During our tests, the high-speed drill effortlessly drilled holes through paper-phenolic, polyester, and epoxy-fiberglass boards, both clad and unclad, with great accuracy and at a high-volume rate. We did not attempt to run down the power packs in the irons with the drilling attachment because, after drilling several hundred holes in each case, the irons were still going strong.

Using the irons in both field service work and on our bench, we found no faults in their performance. They are nicely contoured and light enough in weight to eliminate user fatigue. The built-in lamps accurately illuminate the work area and are very convenient when working in chassis with deep recesses. Also, the tips came up to operating temperature almost immediately.

In all, we consider either Wahl quick-charge cordless soldering iron an excellent tool for any hobbyist's workbench, the choice dictated by the amount of continuous soldering time generally needed. We also highly recommend the drilling attachment.

CIRCLE NO. 105 ON FREE INFORMATION CARD

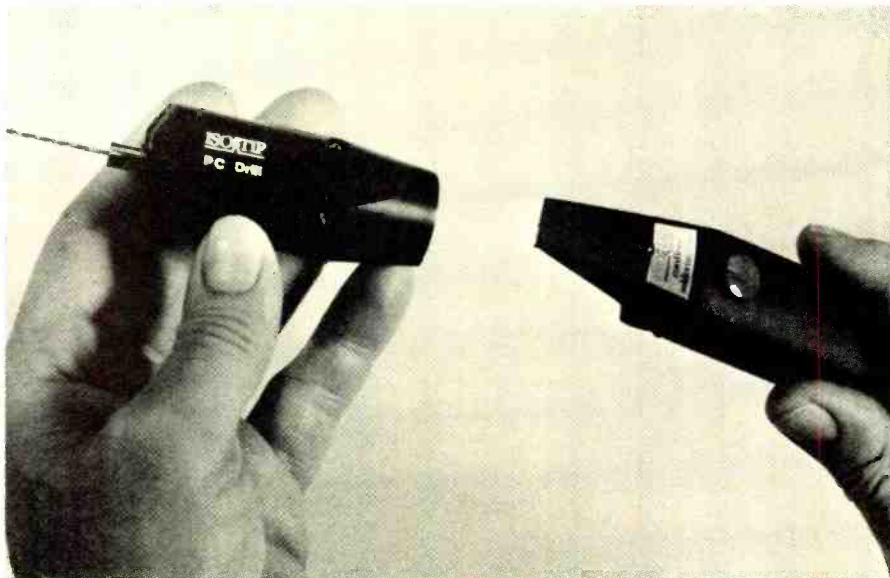

*The Model 6500 pc drilling attachment fits all Wahl cordless irons.*

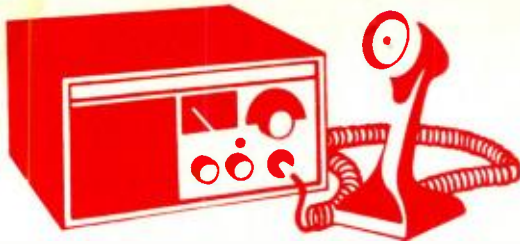

# CB Scene

By Ray Newhall, KWI6010

## THE ANATOMY OF CBRS

**A**LL OF US who have traveled the green stamp with wheels on our CB rigs (driven on turnpikes with mobile CB radios in our cars) know that CB makes driving safer, provides additional security in case of vehicle breakdown, and is *fun* to use. It keeps the driver awake and busy on the road and it makes the trip seem shorter. But does its usefulness to highway users account for the CB fever that has spread throughout America? Why have ten million people shelled-out \$100, \$200, or \$300 each for CB rigs during 1976? What prompted nearly a million new CB license applications to flood FCC offices during the single month of January 1977?

The sociologists who keep watch on the habits of the public are eyeing the CB syndrome and believe it is more than a fad which will soon pass on. They consider that it may signal an entirely new shift in sociological behavior. One Columbia University psychologist recently remarked to an FCC assemblage that the growth of CB may be one of the most healthy sociological events since the demise of the telephone party-line. For the first time in forty years there are extensive personal "one-to-one" communications occurring between people who are total strangers.

Oddly enough, this new form of personal communication we call CB has characteristics which are distinctly different from our more traditional communication forms. It is *not* "face-to-face" and projects an aspect of anonymity. Opinions exchanged through this media are apt to be more candid and open in nature because there is no fear of "peer disapproval" or reprisal. It is a medium in which the young and the old can communicate on common grounds and with similar interests; a far cry from the tragically common communication failures which occur between parents and their teenaged children.

Most CB'ers have given a great deal of thought to the selection of their CB handles. Handles serve a far greater purpose than to provide temporary iden-

tification between strangers on "the party line." They also serve a somewhat paradoxical purpose of revealing much of a CB'ers personality while concealing his true identity. I know several people who are making collections of the most unusual handles they hear. Some of the oddest ones are those "pairs" of handles used by a CB'er and his XYL or other members of his family.

The CB "lingo" is also unique. Although it is colorful and mystic to newcomers, it is concise and descriptive to those familiar with it, serving a true communication need. Its use gives CB'ers the feeling of belonging to a group, just as Hams are joined by their knowledge of Morse code. In fact, it is sometimes implied that one who doesn't bother to learn the CB language is not too welcome on the band.

The CB Radio Service as we see it today is a unique and useful "game" for young and old alike, and it serves the need of a mobile community. However, it is far from the type of personal radio service the FCC had in mind when the Citizen's Band was first authorized. CB was originally conceived as a two-way radio service for use by families and small businesses. Until recent years, there were only a few channels for communications between different station licensees. As the CBRS has developed today, it is not too effective for its original purpose in heavily populated areas. Yet, the need for such a service still remains!

**GMRS, The Other CB Service.** The CBRS (formerly the Class D service) is not the only personal radio service available to the general public. The General Mobile Radio Service (GMRS), formerly called Class A, was the first CB radio service. It was authorized in the early 1950s. Eight pairs of uhf frequencies were allocated above 460 MHz. The Class B service authorized low-power mobile two-way radio in the same frequency spectrum. Neither of these two CB services was used extensively because, until recently, we have not had

the radio technology to mass produce suitable transceivers at a price the personal user could afford. In fact, the Class B service was abandoned because it had not found any practical personal application.

However, the GMRS service is still available and has now become a high-quality, practical CB service for personal-use radio communications, although equipment cost is substantially higher than Class D gear. The new 460-MHz police communications equipment operates on assigned frequencies very close to the 462/467-MHz GMRS frequencies, and this equipment can be used. It is now feasible to mass-produce solid-state equipment to operate on uhf. On GMRS you may operate up to 50 watts input power and raise your antenna up to 200 feet in height. Line-of-sight FM transmission is most normally used. Repeaters and auto-patches are currently permitted, just as the Hams now use them on the 2-meter band.

In the Chicago, Cleveland and Dallas areas, to name but a few, GMRS "CBers" have banded together to set up community repeaters. They use 15-watt mobile units or 2½-watt hand-held transceivers to reach the repeaters for reliable rebroadcast to other stations as far as 25 to 40 miles away. In this way, they can contact their families or offices through the repeater, or they can dial direct landline calls to business associates by use of a touch-tone pad on the back of their mikes. Tone-encoded squelch circuits are said to work so well that these FM transceivers will be activated only by those calls intended specifically for them.

As a matter of fact, this columnist just mailed a Form 400 for a GMRS license to the FCC this morning. I have a standard CBRS AM unit in my car for use on the road, but it is not too practical to call my home (located in a densely populated Eastern Seaboard area) unless I'm rather close by. I operate a small consulting service and I intend to use GMRS radio to keep in touch with my customers from my car while I am within 25 miles of my home.

GMRS is not for everyone, but it does meet the needs of those who want high-grade personal and business communications. The cost is from two to five times as much as the current prices of CBRS equipment; more if you hang on all these accessories. But for many people it serves a practical purpose and in many cases may eliminate the need for telephone answering service or even a secretary. ◇





# Computer Bits

## ASSEMBLERS

By Hal Chamberlin

ACCORDING to a recent magazine survey, one of the most popular applications of personal computers is software development, or simply writing programs. As anyone who has been bitten by the programming bug undoubtedly knows, each new program is always bigger and fancier than the last. Beyond a certain point in program complexity, however, the use of an assembler program is almost mandatory to eliminate most of the drudgery associated with hand coding in octal or hex. This is particularly true when one wishes to make a "small improvement" to a hand-assembled program which otherwise requires it to be rewritten.

**Functions of an Assembler.** Using an assembler in machine language program development has three important advantages over hand coding. First, an assembler allows the programmer to use operation mnemonics such as "LDA" for the "load register A" operation rather than the octal code 072 (8080 microprocessor). When looking at a program you wrote several weeks ago or one written by somebody else, the LDA is much more meaningful than the 072, which in turn makes the program easier to understand.

The second and most important advantage is that the addresses of sections of code and data items can be given *symbolic names* and referred to by name. Again, a name like TAXTAB used to refer to a table of tax rate data is more meaningful than its address which might be 005:120. The most important benefit of symbolic names comes when a program is changed for some reason. With a hand-coded program, some of the addresses used in the program would probably have to change as sections of the program and data are shuffled around to make room for additions. Then, every reference to addresses that were changed would also have to be changed. The result is that, in a large program, a considerable number of changes may be necessary for what

would otherwise be a minor addition. With symbolic names, the assembler can do all of the address shuffling when the program is reassembled and the programmer need be concerned only with the additions. The concept is analogous to solving an equation in general using symbols and algebra and then substituting actual values into the *solution* rather than solving the equation for each set of values needed.

A third advantage is that the use of an assembler tends to develop good program documentation habits which adds to the value of a program. All assemblers allow the latter part of each statement to be used for comments. A well-written program has an English explanation of what the machine instructions are accomplishing as comments on nearly every statement. A neat assembly listing of a program is also much easier to reproduce and read than hand scrawls on coding sheets. Conversely, buying a machine language program without documentation in the form of commented assembly listings is like buying electronic equipment without a schematic.

Using the assembler program itself is generally quite simple. First the assembly language program which is called a *source* program is converted into machine readable form. Such a form may be ASCII characters on paper tape, audio or digital cassette records, floppy disk sector records, or even ASCII data in memory depending on the system and assembler used. Usually some kind of program editor is used to aid in entering and editing the source program. Next the assembler is loaded and ex-

ecuted. During execution, the assembler will scan the source program and produce a *listing* file containing a copy of the source program along with the octal machine codes and an *object* file containing only the machine codes.

The assembler may also flag some statements as having errors. Common errors that an assembler can catch include using non-existent instruction mnemonics and undefined symbols. The latter is the case when a reference is made to a symbolic address but an actual address is never assigned to the symbol. These and other errors detected by the assembler are usually caused by typing mistakes. After editing the source program to eliminate errors and reassembly, the object program is ready to be loaded into memory and executed.

**Types of Assemblers.** Although all assemblers perform basically the same function, there is considerable variety in the implementation and using details. Perhaps the most distinguishing characteristic is the number of scans or *passes* over the source code done by the assembler.

A classical assembler makes two passes over the source program. During the first pass, all symbol definitions are searched out and placed in a *symbol table* maintained by the assembler. During the second pass, the mnemonics are translated into their octal equivalents and the listing file and object file are generated. The two passes are needed because a reference to a symbolic address may occur in the program ahead of the definition of the symbol. This is called forward referencing. If the assembler is to know what octal address to substitute for the symbol, it will have to see the definition first.

Several attempts have been made at one-pass assemblers and a couple of these are available on hobbyist systems. The advantage of a one-pass assembler is increased assembly speed since the source file, which may be many thousands of characters in length, needs to be read only once. Often however the one-pass assembler imposes

```
.MACRO
*   MACRO DEFINITION FOR A DOUBLE PRECISION ADD FROM MEMORY
*   MACRO-INSTRUCTION
*   ADDS THE CONTENTS OF $ADDR AND $ADDR+1 TO REGISTERS B AND
*   C WITH THE RESULT IN B AND C, CONDITION FLAGS UNAFFECTED
$LBL  DPAD $ADDR           DOUBLE PRECISION ADD PROTOTYPE

      PUSH H              SAVE H AND L
      LHL $ADDR           GET TWO BYTES TO ADD IN H AND L
      DAD B               ADD THEM TO B AND C
      MOV B,H             COPY RESULT INTO B AND C
      MOV C,L
      POP H              RESTORE H AND L
      .MEND
```

Fig. 1. Example of macro definition.

restrictions on program organization and the free placement of symbols. This is due to the "look ahead" problem mentioned earlier. Sometimes a one-pass assembler is "faked" by a two-pass one. In this case the source file is read for the first pass and then saved in memory for the second pass which is invisible to the user. The difficulty with this approach is that a large amount of memory is needed to assemble a reasonably large program.

Occasionally a "three-pass" assembler is seen. These are really two-pass assemblers with the second pass split in two to accommodate a Teletype with built-in paper tape. These machines cannot punch the object file at the same time as printing the listing file so a separate pass is required for each function.

A *conversational* assembler is another variation. Basically a combination of a simple text editor and a conventional assembler, the conversational assembler is very convenient for experimentation and testing of short programs and sub-routines. Operation of a conversational assembler is much like most BASIC language systems. The program is typed in line-by-line and edited using line num-

bers and simple editing commands. When a RUN command is given, the program is quickly assembled directly into memory and executed. Program size is limited since the source program ASCII text, symbol table, and object program as well as the conversational assembler program itself must all fit into memory at once.

### Advanced Assembler Features.

As assembly language programming experience increases, some of the more sophisticated assembler features available will be appreciated. Although these features have been rare in hobbyist oriented systems, the assemblers being supplied with recently announced floppy disk systems generally have most of them.

One such feature is *macro-instruction* capability. A macro-instruction (often abbreviated as "macro") is one that may generate many machine language instructions when assembled. When writing a program, macro-instructions may

same dummy argument in the LHLD instruction as in the prototype. The .MEND signals the assembler that the macro definition is complete. The definition is then saved by the assembler in a special table in memory reserved for that purpose.

Figure 2 shows the use of this macro-instruction in a program (octal). In this example all of the instructions generated when the macro was expanded are shown on the listing with a preceding minus sign. Generally the assembler will have a command that would suppress printing of these expansion instructions if desired. With a good library of macro definitions, assembly language programming may become almost as easy as programming in a higher level language.

Another advanced feature is called "relocatable object code" capability. An assembler having this feature supplies additional information in the object file so that it may be later loaded into memory *anywhere* desired completely auto-

# SPEAKER KITS.



Money-saving, multi-element stereo speaker kits. Build them yourself to save up to half the retail cost of comparable ready-built systems. And get great sound in the bargain.

Send us your name and address and we'll mail you our free 44-page catalog of speaker kits, raw speakers, crossovers, enclosures and tips on design and construction. It's practically a manual on speaker building.

**Speakerlab®**  
Dept. PE-B, 5500 35th N.E., Seattle, WA 98105

```

      *      EXAMPLE PROGRAM SEGMENT ILLUSTRATING USE OF DPAD MACRO
001:100 116      MOV  C,M          LOAD ORIGINAL RAW VALUE (16 BITS)
001:101 043      INX  H
001:102 106      MOV  B,M
001:103          DPAD CORR      ADD IN CORRECTION FACTOR
001:103 345      -   PUSH H          SAVE H AND L
001:104 052 200 001 - LHLD CORR      GET TWO BYTES TO ADD IN H AND L
001:107 011      -   DAD  B          ADD THEM TO B AND C
001:110 104      -   MOV  B,H      COPY RESULT INTO B AND C
001:111 115      -   MOV  C,L
001:112 341      -   POP  H          RESTORE H AND L
001:113 160      MOV  M,B      UPDATE WITH CORRECTED VALUE
001:114 053      DCX  H
001:115 161      MOV  M,C
  
```

Fig. 2. Example of use of a macro-instruction.

be used just as if the microprocessor actually had them as real instructions in its repertoire.

Macros can be defined by the programmer at the beginning of his program according to his needs. Although exact details of macro definitions and usage differ among various assemblers, a typical macro definition is shown in Fig. 1. The .MACRO on the first line alerts the assembler that a macro definition follows rather than ordinary program instructions. The next line gives the macro *prototype* which defines how the macro-instruction would look in a source program. The symbols preceded by dollar marks are sometimes called "dummy arguments" because, when the macro-instruction is actually expanded by the assembler, they are effectively replaced by the actual symbols used in the macro-instruction. Following the prototype are the actual machine instructions that would be generated when the macro-instruction is used. Note the use of the

macro-instruction as in the prototype. The .MEND signals the assembler that the macro definition is complete. The definition is then saved by the assembler in a special table in memory reserved for that purpose.

Figure 2 shows the use of this macro-instruction in a program (octal). In this example all of the instructions generated when the macro was expanded are shown on the listing with a preceding minus sign. Generally the assembler will have a command that would suppress printing of these expansion instructions if desired. With a good library of macro definitions, assembly language programming may become almost as easy as programming in a higher level language.

Another advanced feature is called "relocatable object code" capability. An assembler having this feature supplies additional information in the object file so that it may be later loaded into memory *anywhere* desired completely auto-

With this little bit of background, the reader should be able to evaluate more fully the assembly language program development facilities of a particular system. ◇

# HOBBYIST COMPUTER CLUBS COMPILED BY Popular Electronics

(Additions to list published April 1977)

## CALIFORNIA

### Association for Educational Data Systems

c/o Dr. Jane D. Gawronski  
Dept. of Education  
6401 Linda Vista Rd.  
San Diego, CA 92111

### Inland Computer Society

c/o Tom Munnecke  
P.O. Box 55052  
Riverside, CA 92517

### Southern California Computer Society

P.O. Box 54751  
Los Angeles, CA 90054

## ILLINOIS

### SCCS 5063

c/o Roy Emerson  
14904 S. Calis Ave.  
Posen, IL 60469

### St. Louis Area Computer Club

c/o Lou Elkins  
Box 1143, St. Louis, MO 63188

## MASSACHUSETTS

### Boston Computer Society

c/o Donald Bradley  
123 Commonwealth Ave.  
Boston, MA 02116

### Greater Boston Computer Users Group

c/o Steven Hain  
40 Wilshire Dr. (Door 2)  
Sharon, MA 02067

## MINNESOTA

### Minnesota Computer Society

P.O. Box 35317  
Minneapolis, MN 55435

## MISSOURI

### St. Louis Area Computer Club

c/o Lou Elkins  
Box 1143, St. Louis, MO 63188

## NEBRASKA

### Mid-America Computer Hobbyists

c/o Lt. Tom Smith  
2708 Calhoun St.  
Bellevue, NB 68005

## NEVADA

### SCCS

Quentin C. West  
15 Ballerina  
Henderson, NV 89015

## NEW JERSEY

### SCCS

c/o William Staate  
Box 947, McGuire AFB, NJ 08641

## NEW MEXICO

### US Robotics Society

Box 26484, Albuquerque, NM

## NEW YORK

### Stony Brook Homebrew Computer Club

c/o Dr. Ludwig Braun  
College of Eng. and Applied Science  
State University of New York  
Stony Brook, NY 11794

## OHIO

### Dayton Microcomputer Association

Dayton Museum of Natural History  
2629 Ridge Avenue  
Dayton, OH 45414

## North Central Ohio Computer Club

c/o Bill Hicks  
618 Teakwood Court  
Galion, OH

## OKLAHOMA

### Tulsa Computer Society

P.O. Box 1133  
Tulsa, OK 74101

## PENNSYLVANIA

### Northeast Computer Association

834 Lawler Street  
Philadelphia, PA

### St. Thomas District HS Computer Club

1025 Braddock Avenue  
Braddock, PA 15104

### Wilkes College Computer Club

c/o Eric Jansen, Math Dept.  
Wilkes College  
Wilkes-Barre, PA 18703

## TEXAS

### Panhandle Computer Society

c/o Tex Everett  
2923 S. Spring  
Amarillo, TX 79103

### Theater Computer Users Group

Theater Sources Inc.  
4712 Northway Dr.  
Dallas, TX 75206

## VIRGINIA

### Roanoke Valley Computer Club

c/o Lee Yosafat  
2026 Wynmere Dr. S.W.  
Roanoke, VA

## WISCONSIN

### Durant Club

c/o James White  
901 S. 12th Street  
Watertown, WI 53094

## CANADA

### Montreal Micro-68 Computer Club

Case Postale al Succor Sale  
Montreal, Canada H4Y 1A2

### Ottawa Computer Group

P.O. Box 13218  
Kanata, Ontario, K2K 1X4

### Societe d'Informatique Amateur du Quebec

IRISCO du Quebec Inc.  
376 du Roi, Suite 304  
Quebec, Canada PQ 2W6

## ENGLAND

### Amateur Computer Club

7 Dordells  
Basildon, Essex, England

## JAPAN

### Japan Microcomputer Club

First Ohkura Building 4F 2-1  
Nihoubashi, Chuo-ku,  
Tokyo, Japan

## MEXICO

### Carlos de Leon

Avenue Chapultepec 318-603  
Mexico 7, DF, Mexico

If your club was not listed in the previous, or this coverage, please inform "Computer Bits," POPULAR ELECTRONICS, One Park Ave., New York, N.Y. 10016.

## FOR YOUR OWN PERSONAL COMPUTING POWER

Only \$169.95



### with MOTOROLA'S EDUCATOR II MICROCOMPUTER HEP KIT

- Motorola M6800 Technology
- Test-as-you-build in easy steps — normally one evening assembly
- Completely self-contained with all parts, cabinet and instructional manual

Learn MPU theory and programming as you build, and then get ready to expand your computing power with these new accessory kits that will be coming soon—

- Video Display Card
- Keyboard Kit
- Module Card Rack and Power Supply
- Memory Modules
- Application Programs on Cassettes

Also available...

### MOTOROLA HEP EDUCATOR II POWER SUPPLY KIT



\$29.95

- 5 V @ 1.0 Amps
- Designed specifically for Educator II Microcomputer Kit
- Complete Kit — all parts, cabinet and construction manual

Send today for more information about Educator II

Please print label clearly.

NAME \_\_\_\_\_

ADDRESS \_\_\_\_\_

CITY \_\_\_\_\_

STATE \_\_\_\_\_

ZIP \_\_\_\_\_



**MOTOROLA**  
Semiconductor Products Inc.

HEP/MRO OPERATIONS  
705 West 22nd Street — Tempe, AZ 85282



# Tips & Techniques

## BLOWN-FUSE INDICATOR

This simple circuit will enable you to tell at a glance whether you have blown a fuse—without removing the fuse from its holder. As long as the fuse is good, no

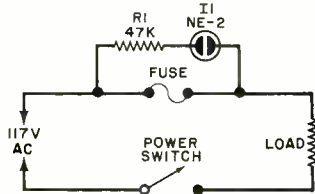

current will flow through *R1* and *I1*, an NE-2 neon bulb. If the fuse blows, the ac takes the alternate path through *R1* and *I1*. A 47,000-ohm, 1/2-watt resistor is used to limit current through *I1* to a safe value. Mount *I1* in any convenient (but visible) location.—*Ross Thompson, Lis-towell, Ontario, Can.*

## DESOLDERING BRAID

An inexpensive source of desoldering "wick" is the outer conductor of RG-58 and RG-59 coaxial cable. Cut your scrap into 8- to 10-inch (20.4- to 25.4-cm) lengths. Hold the braid and inner conductor firmly with pliers, and pull off the outer insulating jacket with your free hand. Then, push the two ends of the braid together to loosen it, and pull out the inner conductor and surrounding insulation.—*Arnold Irvine, Coopersburg, PA.*

## TEST JACK ADAPTER

Have you ever bought a new meter or other piece of test equipment only to discover that none of your standard 3/4-inch spaced test plugs will fit the jacks on it? If you can't or don't want to modify your new piece of gear by slotting the test jack mounting holes, consider this simple adapter you can make to rectify the situation. All you need are a pair of banana jacks, a pair of noninsulated banana jacks, and a 1 1/4-inch (3.81-cm) square piece of 1/8-inch (3.2-mm) thick plexiglass or bakelite. Round the corners of the plastic and drill two holes at opposite corners for the jacks, spaced 3/4-inch (1.9-cm) apart. Then carefully measure the spacing between the test jacks on the new equipment and drill holes for the plugs in the plastic square to match this spacing. Assemble and wire the plugs and jacks and you're all set.—*Donald R. Hicke, San Diego, CA.*

## PC DRILLING GUIDE

Here's a handy guide for drilling IC pin holes on a pc board. Epoxy a length of discarded Molex Soldercon holder strip to a block of wood as shown. Attach a few strips of double-faced adhesive tape (Scotch Nc. 666 or equivalent) to the

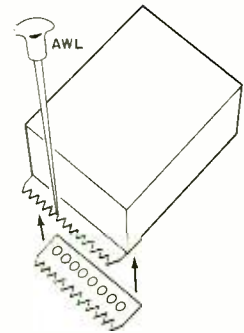

bottom of the block to prevent slippage. Hold the block on the pc board with one hand and make indentations with an awl at each "valley" along the holder strip. Then remove the block. You will find a line of depressions that can easily be drilled through the board, exactly 0.1" (2.54 mm) apart.—*Robert J. Murrell, Verona, PA.*

## INEXPENSIVE ELECTRIC EYE

Here's an electric eye that can be built from junkbox parts. It consists of a CdS photocell, a 7486 exclusive-OR gate IC, an npn switching transistor (2N3055 or similar) and a small electric bell. When no object interrupts the light path from a lamp to photocell *LDR1*, both inputs to the ex-OR gate are low. Thus the gate's output is low and the transistor is cut off. Interrupting the light beam causes the

gate output to go high and the transistor to conduct, energizing the bell. A 6-volt lantern battery can be used as a power source. All parts can be obtained for about \$3 from a surplus house. A simple pc board is used, and can accommodate up to four independent circuits, each using one gate in the quad ex-OR IC. The entire alarm can be mounted on a TO-3 heat sink.—*Kenneth B. Blois, APO SF 96286.*

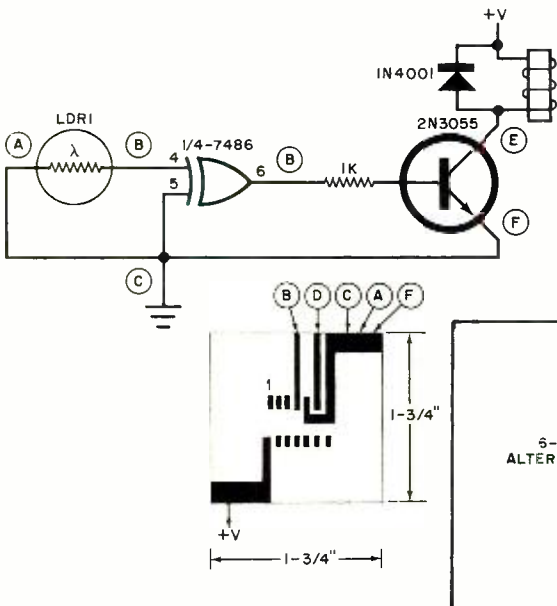

## IC SOLDERING AID

To prevent heat or static damage to an integrated circuit while soldering, push the pins of the device through a few sheets of aluminum foil measuring 2" x 2" (5.1 x 5.1 cm). Then mount the IC on the circuit board. The foil will dissipate heat and electrically tie all the pins together. When the IC is in place, tear away the foil. Check carefully for stray pieces of foil before powering the board. The foil will generally come away in a few pieces without leaving tiny scraps.—*Aart M. Olsen, Newark, DE.*

## BIKE LIGHT SAVER

I installed a Soubitez alternator to power the head and tail lights on my bicycle. Unfortunately, I found that the bulbs were burning out rather quickly when I was travelling at speeds greater than 15 mph. The problem was solved by installing two zener diodes back-to-back as shown in the figure. Before the modification, the alternator output was 6 volts rms at speeds greater than 6 mph. After the change, the voltage applied to the bulbs dropped to about 4.9 volts rms. Bulb life was considerably extended without significant reduction of light output. In the diagram, left, the miniature headlight (*I1*) is rated at 6 volts and 300 mA. The taillight (*I2*) is rated at 6 volts and 100 mA. The two zener diodes (*D1* and *D2*) are rated at 6 volts and 3 watts. Higher-powered zeners can be used.—*D.F. O'Connell, Palo Alto, CA.*

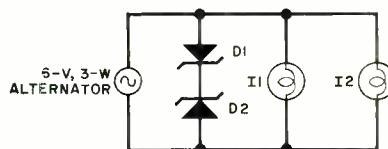

# Operation Assist

If you need information on outdated or rare equipment—a schematic, parts list, etc.—another reader might be able to assist. Simply send a postcard to Operation Assist, POPULAR ELECTRONICS, 1 Park Ave., New York, NY 10016. For those who can help readers, please respond directly to them. They'll appreciate it. (Only those items regarding equipment not available from normal sources are published.)

**American Scientific Development** TV-20 tube tester Schematic, operating manual, chart. Will buy or copy. Terry Nixon, RR 1, Box 182, Potosi, MO 63664.

**Sprague** TO-3 capacitor checker. Need 15-watt 50-ohm power rheostat. Ray Parsons Jr., Portsmouth Ave., Stratham, NH 03885.

**Kris** "Match Maker," serial 3302003. Schematic and/or specifications such as frequency, impedance, etc. Bob Dianetti, 80 Billington Rd., East Aurora, NY 14052.

**AGS** IC-RS-82 eight-track recorder/player. Schematic. Henry D. Mikkelsen, VA Hospital, Marion, IL 62959.

**Gran Sonic** GS-2 stereo receiver. Schematic, also need power transformer, marked SAT-260 OCM. John D. Gill, Rte. 5, Box 370, Blountville, TN 37617.

**RCA** WO-91B oscilloscope. Operating manual. Donald R. Anthony, 821 Lantana St., Corpus Christi, TX 78408.

**Allied Knight** 83Y102 Star Roamer radio. Schematic. Will buy or copy. Gerald Fox, Fox Electronics, Box 890, Rte. 3, New Holland, PA 17557.

**RCA** WP-23A regulated power supply. Schematic, operating instructions, or service manual. Ronald Gillen, Box 383, Hustisford, WI 53034.

**Cartrivision** video tape recorder. Source of tapes and spare parts. Donald Weber, 1333 N. Camino Alto, Apt. 245, Vallejo, CA 94590.

**Bell & Howell** 34 oscilloscope (DeVry Inst. of Tech.). Operating manual, schematic. R. Wood, 465 San Antonio, Palo Alto, CA 94306.

**Hickok** 640 oscilloscope. Schematic and/or service manual. Robert Zusman, 200 East Indian Spring Dr., Silver Spring, MD 20901.

**Lloyd** TM-988 AM/FM receiver. Schematic, operating manual and/or parts list. Peter B. Trippett, 581 Glen Rd., Sparta, NJ 07871.

**Friden** paper-tape readers, typewriters, Justwriters. Schematics, operating instructions. J.I. Taylor, Box 289, Salem, MA 01970.

**General Radiotelephone** MC-5 CB transceiver. Schematic, manual. Elliott Electronics, RR 2, Box 61, Effingham, IL 62401.

**Tektronix** 564 scope. Need 3B3 time base, 3A6 vertical plug-in. Ramesh B. Parikh, P.O. Box 17356, Bombay 400 058, India.

**Fisher** 400 receiver. Schematic and/or information on power transformer. **Magnavox** 9—295HH console. Schematic, power capabilities of 15" woofers that come with console. Thörn Filippeli, Rte. 1, Box 39-Z, Connie Lane, Shingle Springs, CA 95682.

**Radio City** 488 multimeter, circa 1942. Schematic and any other information. Joe H. Hibbs, 971-87 Borden Rd., San Marcos, CA 92069.

**Jackson Instrument** 641-A signal generator. Schematic, alignment procedure. J.M. Nightingale, 1675 Comox St., Vancouver, B.C. Canada V6G 1P4.

**Devtronics** SR-55 calculator. Owner's manual, source of case and keytops. Ivan Dzubak, 621 Spring St., Latrobe, PA 15650.

**Kaar** TR-505 uhf repeater. Schematic, owners manual or any info. V.C. Reed Jr., 1104 Abbot Ln., Park Forest South, IL 60466.

**Solid State Devices** Trigsweep, circa late 1960's. Instruction manual, pc artwork, parts list. John A. Harlan, 9720 Prospect Ave., Chicago, IL 60643.

**Superior Instruments** 707 or 707-A VOM multimeter. Schematic, instruction manual, parts list. Buy or copy. Arthur Kneller, 84 Bennett Ave., Neptune City, NJ 07753.

**Rutherford** B16R pulse generator, serial 171. Service manual and/or schematic. Vilson Silveira, 7708 Regent Ave. N., Brooklyn Park, MN 55443.

**Marlux** 407 reel-to-reel recorder. Schematic, service manual, or any info. T.K. Flanagan, U.S. Bluefish (SSN 675) FPO NY 09501.

**RCA** Berkshire, circa 1948. Literature and data, also speaker. Fabris, 3626 Morrie Dr., San Jose, CA 95127.

**Transcorder** TR300 reel-to-reel recorder. Need erase and record head. Erase head has 230-mH inductance, 1.5-V dc erase, dc bias. Play-record head has 380-mH inductance, 0.2 V bias. Curt Palme, 990 Wavertree Rd., North Vancouver, B.C., Canada V7R 1S5.

**Heathkit** 0-8 oscilloscope. Schematic and/or construction manual. Frido W. Buschmann, 3736 Pine Rd., Huntingdon Valley, PA 19006.

**Heathkit** 0-12 oscilloscope. Need power transformer. Kenneth Huffines, 356 O'Brian Dr., Stone Mountain, GA 30088.

**Crosley** 96 radio. Circa late '30's. Schematic, power transformer. Richard R. Nolette, RFD #1, River Rd., Kennebunkport, ME 04046.

**Mercury Electronics** 1101 tube tester. Manuals, any information. James B. Martin, 1708 Dave Dr., McAlester, OK 74501.

**Atwater Kent** 35 radio, serial 772713. Date of production, value. Kenneth J. Roberds, Box 367, Barling, AR 72923.

**Transcom** RCT 203 audio data terminal with strip printer. Schematic and/or manual. Will pay for copying. J. Bryan Loolbourrow, Box 1237, Mountaineer, NJ 07092.

**Century** VT-10 VTVM. Schematic, operating manual, probe. **Eico** 232 VTVM. Schematic, operating manual, probe. **Supreme** 542 multimeter. Schematic, operating manual. Allen C. Fryou, 3735 Fairmont Dr., New Orleans, LA 70122.

**Sharpe** HA-10A or other Sharpe headphones. Source. Dr. James P. Gaston, 45 East End Ave., Apt 5A, New York, NY 10028.

**Precision** 100 VOM. **Simpson** 311 VTVM. Schematics. Alan Norville, Rte. #2, Box 283, Forest City, NC 28043.

**Hallicrafter** S-38-E. Schematic, alignment manual, or any info. Steve L. Porter, 429 Balsam, Rogers City, MI 49779.

**Conar** 250 oscilloscope. **Motorola** FMTRU80D(A)1C2C mobile 2-meter transceiver. Schematics, operating manuals, any other info. David Eubank, Box 113, Greenup, IL 62428.

**Skycrafter** "VHF Superphone" AMT-9 transmitter, AMR-4 receiver. Schematics and any other info. Al Gwinn, 3321 Beverly Dr., Dallas, TX 75205.

**Radio Shack** 28-138 color organ kit. Schematics, parts list, or instruction manual. Gary Girzon, 4665 St. Kevin #3, Montreal, P.Q. Canada H3W 1N8.

**A.C. Cossor** 1434 preamplifier. Source of 120-V battery. **A.C. Cossor** 1049 MKII oscilloscope. Original camera, CRT. Claude Houde, 7427 Boyer St., Montreal, P.Q. H2R 2R9.

**Olson** AM-240 50-watt amplifier. Output transformers, 8-ohm output impedance. W.B. Wells, 172 Topsfield Rd., Pittsburgh, PA 15241.

**Erie Pacific** 720 frequency counter. Service manual, schematic, parts list, source for Elesta EZ10A and Burroughs 5031 tubes for counter. Gordon Wheatley, 9 Lynngrove Ave., Toronto, Ontario, Canada M8X 1M3.

**Collins** 32V2 transmitter. Instruction manual. Marvin E. Weber, Box 1261, Alamogordo, NM 88310.

**Realistic** 212 preamplifier, 210 ultra-linear amplifier. Any info. R. A. Rouge, Box 92, Hollywood, CA 90028.

**U.S. Govt.** RAO-2 Navy shortwave receiver (National type NC-120). Navy CNA-46187. Service manual and/or schematic. David L. Larson, 1301 1/2 S. First, Harlingen, TX 78550.

**Precision** EV10A VTVM. Schematic, manual. Willis J. Ball, 320 Bloxam Ave., London, Ontario, Canada N6J 3K6.

**Crosley Showbox**, circa early 1900's. Schematic, any rebuilding or service info. Kenneth Huffines, 356 O'Brian Dr., Stone Mountain, GA 30088.

**National** SW-3 receiver. Need series 10-20 coils, bandspread if possible. Martin Edelheit, 245-21 77 Crescent, Belterose, NY 11426.



## CITIZENS BAND HANDBOOK

The all-new 1977 edition, by the editors of POPULAR ELECTRONICS, has all the authoritative information you need on CB two-way radios to make an intelligent buying decision.

### It features a **COMPLETE BUYING GUIDE**

for the new 40-channel CB two-way radios, antennas and accessories—fully described with technical specifications, features, latest prices and photos. Other articles include the latest FCC Rules and Regulations changes in down-to-earth language • How to install a CB mobile system—and save money • How to operate and communicate with your first CB rig • Will sunspots affect CB range • CB language translation chart • How emergency CB associations can save your life • Manufacturers' specifications—"decoded" so that you will be able to read a "spec sheet" with ease • and much more information packed into one volume, all written by the experts.

### 1977 CITIZENS BAND HANDBOOK GOES ON SALE NATIONALLY JULY, 1977

### RESERVE YOUR COPY NOW AT THE SPECIAL PRE-PUBLICATION PRICE OF ONLY \$1.50

This offer is available to readers of POPULAR ELECTRONICS only. Regular price is \$1.95; mail order \$2.50. Save money and enjoy the convenience of having the 1977 CITIZENS BAND HANDBOOK mailed to you from first-off-the-press copies when published. Complete the Reservation Form and return it promptly with your remittance.

### PRE-PUBLICATION RESERVATION FORM

CITIZENS BAND HANDBOOK, PE-777  
Consumer Service Division,  
595 Broadway, New York, N.Y. 10012

Enclosed is \$1.50 (outside U.S.A. \$2.00) for the 1977 CITIZENS BAND HANDBOOK to be mailed to me in July, 1977 when published.

Residents of CA, CO, FL, IL, MI, MO, NY, STATE, DC and TX add applicable sales tax.

Print Name \_\_\_\_\_  
Address \_\_\_\_\_  
City \_\_\_\_\_  
State \_\_\_\_\_ Zip \_\_\_\_\_

**Signal Corps** BC-458-A transmitter. Schematic and/or operating manual. Dan Williams, Rte. 58, El Cerrito, CA 94530.

**Heathkit** W-3AM amplifier, with or without matching WA-P2 preamplifier. Source: David Hayes, 35 Cotton St., Gander, Nfld., Canada A1V 1E3.

**WW II Equipment.** Model RDO (Navy issue) receiver (circa 1945); Model AN/SPR-2 receiver; Model AN/APA-6A oscilloscope. Schematics and general manuals. John Andrews III, 11011 Waycroft Way, Rockville, MD 20852.

**Stephens** "Truphonic" midrange speaker systems. Circuitry and parts information. Frank J. Burris, 35640 Avenue F, Yucaipa, CA 92399.

**Bunker Ramo** Model 203-B-MON telegregister video display. Schematics and/or service manual. F. Ascolillo, Park Lane, North Windham, ME 04062.

**Microsystems International** DTMF receiver card. Schematics and manuals or any available information on touch-tone receiver cards. James Chochos, Jr., A-E 6107, San Luis Obispo, CA 93409.

**Philco** Model 41-608, Code 122 radio-phonograph combination. Schematic, parts list, tubes and parts source. R. Galligan, Box 326, Niantic, CT 06357.

**Leak** point-one stereo preamplifier and stereo-fifty power amplifier. **Altec Lansing** Model 445A stereo preamplifier. Schematics needed. Bill Rathyn, 19 Broadway, Bayonne, NJ 07002.

**Simpson** Model 330 tube checker. Schematics, operations manual and current tube sheet. Duane Schuh, 824 La Porte Dr., La Canada, CA 91011.

**Meissner** Analyst. Operating and service manual. John Graham, Box 186, Wurtsboro, NY 12790.

**Superior Instruments** Model 77 VTVM Schematic and/or service manual. Mr. Test, P.O. Box 9064, Newark, NJ 07104.

**Eldico** Model MT 2 2-meter AM transmitter. Schematics and operations manual. Francis H. Bailey, 541 Hill P.O., Dudley, MA 01570.

**Keppo Labs** Model 150 rack-mount variable power supply. Schematic, parts list and wiring diagram. Also, **Crystal Re-**

**search Products** Model 203 crystal checker. Schematic and any available information. Craig K. Sellen, Box 293, Carbondale, PA 18407.

**Micronta** Model 22-012 tube tester. Need tube chart. Charles A. Mizera, 3226 N. Kostner Ave., Chicago, IL 60641.

**Clough-Brengle** Model 111 frequency modulator. Operations manual or any available information. G.J. Kulp, 1115 Lillac Lane, West Lawn, PA 19609.

**Heathkit** Model 1G-62 color bar and dot generator. Schematic and/or service manual. Earl D. Kent, 810 E. 1st St., Emmett, ID 83617.

**Panasonic** Model RF-1006M AM/FM/MB radio. Schematic and operations manual. Bruce Stanley, 350 Beechwood O.T.S., Granbury, TX 76048.

**B&K** Model 1075 television analyst; Model A107 Dyna-Sweep circuit analyzer; Model 445 CRT tester. Service and operation manuals. Paul S. Panikowski, 5006 Edgewood Rd., College Park, MD 20740.

**Cartridge Television Inc.** Model MCA-0001 video camera. Schematic and service manual. Michael A. Lizzio, Apt. 8C, Clover Path, Spring Hill Apts., Maple Shade, NJ 08052.

**Reflector**, 18-in. parabolic. Need source. Albert Bhutapher, 5008 W. Pullerton Ave., Chicago, IL 60639.

**Jackson** Model TVG-2 TV/FM sweep alignment generator. Schematic and operation manual. Eden Rubin, 227-12 57th Ave., Bayside, NY 11364.

**Measurement Control Devices** Model 300 oscilloscope. Schematic and manual. Michael E. Headberg, 7760 NW 171 St., Hialeah, FL 33015.

**Automatic Radio** "Tom Boy" AM radio (circa late 1930's-early 40's). Parts list and/or schematic. C. Walker, 131 Bernard St., San Francisco, CA 94109.

**Precise** Model 305R triggered scope. Schematic, parts list and instruction manual. William H. Bragg, 1424 College, Des Moines, IA 50314.

**Transcom Electronics** Model SBT3 SSB transceiver. Alignment instructions, schematic and any other available information. Ari Procopio, QSL Bureau, P.O. Box 22 Labre, Sao Paulo SP 1000, Brazil.

**Solid State** Model ST-1000 TV camera. Any available information. Leigh Klotz, Jr., 119 Harmony St., McComb, MS 39648.

**Honeywell** Model TCM-31-C memory. Need PAC card layout. Joe Schram, Box 1818 Washington, DC 20013

**Hallcrafters** Model S38E shortwave receiver and **Precision** Model E-200 signal generator. Need schematics. S. Bergen Wilson, 1403 Lyttleton St., Camden, SC 29020.

**Hammarlund** Model FM50A outercorn and **Knightkit** Cat. No. 83Y146 oscilloscope. Schematics and manuals. James F. Reuter, 2595 Marlborough, Detroit, MI 48215.

**Radio Compass** Type R101/ARN6 receiver control box. Handbook and RX mounting rack needed. Lionel L. Sharp, 19 Kelso St., Cherside, Queensland, Australia 4032.

**American Concertone** Model 505 reel-to-reel tape recorder. Schematic and service information. Duncan Crawford, 206 Cedarwood, Flushing, MI 48433.

**Rockland** Model 5500 frequency synthesizer. Schematic needed. Thomas Barrett, 39 Lake Drive, Monroe, LA 71201.

**Superior Instrument** Model 800 allmeter. Schematic and operating manual. Robert E. Heitz, 317 Woodward Ave., Buffalo, NY 14214.

**Navy Surplus** oscilloscope type TS-34A/AP. Schematic and service manual. James W. Booker, 2808 W. Boyce Ave., Fort Worth, TX 76133.

**Magnavox** Model FM-16 AM/FM radio. Schematic. Robert J. Hewitt, 318 N. Greenbay Rd., Waukegan, IL 60085.

**Burroughs** 9350-2 (Friden #7311) computer terminal keyboard/printer. Control unit schematics and maintenance manual. Gary Alderman, 8615 Portsmouth Dr., Laurel, MD 20811.

**Grundig** Model M72 PX musical instrument. Schematic or tube list. Greg Binverse, 311 Monroe St., Valders, WI 54245.

**Advance Electronics** Model OS 15 oscilloscope. Schematic and any available information. Anil Rodrigues, Gilpin Ave., #1, Wilmington, DE 19806.

**Webster** wire recorder. Recording wire needed. A. Markowitz, 9 Henneberry Ln., Golf, IL 60029.

**EMC** Model 600 oscilloscope and Model 400 signal generator. Schematics and instruction manuals. J. Massing, 208 Dickens Dr., Toledo, OH 43607.

**Dumont** Type 241 oscillograph and **Hickok** Model RFO-5 oscillograph. Schematics and/or parts lists. A. Elliot, 221 N. 4th St., Tonawanda, PA 18848.

**Eico** Model 221 VTVM. Meter needed. Hervey C. Cain, Box 66, Coal Hill, AR 72832.

**Zenith** Model 6S532 2-band table radio. Operating manual, schematic, parts and alignment information. A. Hawk, 21 Rivercrest, Hanover, NH 03755.

**RCA** Model WT-130A electron-tube micromho-meter. Operation manual, schematic and tube chart. Danny Tovar, 4700 Rockmoor Ln, Fort Worth, TX 76116.

**Hallcrafters** Model CN-1 FM converter. Schematic needed. H.A. Wickert, 5 Deerview Ln, Asheville, NC 28804.

**Concert Company** Model 8003 "Emitor." Schematic and parts list for serv.cing. Bud Petersen, 801 Polynesian Dr., Long Beach, CA 90805.

**Canadian Marconi** Model C-2 frequency indicator (circa 1943). Schematic and operating instructions. M. Armstrong, 243 Howard, Sherbrooke, P.Q., Canada.

**McMurdo** Model 900 Silver Vomax. Schematic and operating manual. Don White, 109 Burns Street, Essexville, Michigan 48732.

**Miranda** "Nocturne" stereo tape recorder. Schematic or any available information. Walter Baker, 162 N. Queens Ave., N. Massapequa, NY 11758.

**Microsystems International** touch-tone receiver. Manual and/or schematic. J. Chochos, Box A-E 6107, San Luis Obispo, CA 93409.

**McIntosh** Model C-8 or C-8P. Looking for unit. B. Gerber, 8221 Streamwood Dr., Ba Ho., MD 21208.

**Hallcrafters** Model SX-100 receiver. Operator's manual, schematic or other information. Dale C. Vawter, 117 Altana St., San Rafael, CA 94901.

**Racom** Model 2174-610 selective voltmeter. R. Reed, 2054 Bradley, Ypsilanti, MI 48197.

**Hartman** "Hurricane" vhf-FM marine transceiver, 5-channel. Circuit diagram and manual. Paul Smith, 65 West St., New London, CT 06320.

**Dumont** Type 322 dual-beam oscillograph. Service or schematic. David Passeur, 6327 Everglades Dr., Alexandria, VA 22312.

**Military** radio receiver Model R-440 (XN-1) manufactured by RCA. Operating manual, service manual, schematics or any available information. Peter Z. Simpson, 18 University Dr., Natick, MA 01760.

**Knight** Model KG-2000 oscilloscope. Service and calibration data, power transformer data, and/or source. Ron Hunter, 308 Mertens Ave., Racine, WI 53405.

**APELCO** Model AE-31MA radiotelephone, **AMECO** Model CMA multiband converter and **B&K** Model 500 "Dyna-Quik" tube tester. Service manuals or any available information. Herb. Mitschan, 1688 Baywood Dr., Petaluma, CA 94952.

**Philco** Model 41-250 radio. Schematic, parts list and parts source. Charles M. Pache, Box 208, Marysville, KS 66508.

**Philco** Model 19 MK II wireless set with Model 3A MK II control unit. Built for Russian tanks during W.W. II. Need any available information. Cliff Holm, 1900 Grant Dr., Regina, Sask., Canada.

**Johnson** "Viking Ranger I" transmitter and **Drake** Model 2B receiver. Operation and service manuals. Paul Barbuto, Box 385, Genesee, ID 83832.

**DeVry Tech.** Model 1-15 5-inch oscilloscope. Builder's manual and calibration instructions. Andy Van Loenen 4684 Wakefield N.E., Cornstock Park, MI 49321.

**Muse** sequencer oscillator, **Western Electric** Model TP25-1 amplifier and **3-M** Model 78-9020 microphone. Schematics and parts source. James D. Craig, 511 Cedar St., Allentown, PA 18102.

**Crosley** Model Super 11 radio. Schematic and any available information. David P. Lesser, 82 Rolling Green, Amherst, MA 01002.

**Teletype Corp.** Model 15Y typing unit. Schematic and instruction manual. Martin H. Bunshaft, 29A Forest Acres Dr., Bradford, MA 01830.

## THE PAIA 8700 COMPUTER/CONTROLLER

An exceptional price on an applications oriented 6503 based micro-processor system



\$149.95

THE IDEAL, LOW COST SOLUTION TO IMPLEMENTING THOSE WILD COMPUTER BASED CONTROL SYSTEMS YOU'VE BEEN DREAMING OF!

PAIA software currently available or under development includes: Music synthesizer interface; Home applications package including: multi-zone fire/burglar alarm, real time clock, energy saving heat/air conditioning control, computer generated "door-bell"; Model railroad controller and more.....

**8700 COMPUTER/CONTROLLER KIT \$149.95**  
(requires 5v. @ 1.2A.; 12v. @ 150 ma.)

Shipped direct from PAIA (add \$3.00 postage)  
Also available at FULL LINE computer stores

DETAILS IN OUR FREE CATALOG

**PAIA** • DEPT. 7-P • 1020 W. Wilshire Blvd. • Oklahoma City, OK 73116



# Electronics Library

## ELECTRONIC TROUBLESHOOTING WITH SIMPLIFIED CIRCUIT ANALYSIS

by Leo Rozman

The author aims to familiarize the reader with a wide variety of circuits, how they operate, and how to localize trouble using symptom analysis, signal injection and/or tracing. Using simple circuits (mostly solid-state) as examples, the author covers troubleshooting via dc and ac measurements, the effects of passive components, identifying circuits, controls and adjustments, and symptom analysis. The stress is on practical, time-saving techniques in repairing radio and TV receivers.

Published by Parker Publishing Co., West Nyack, NY 10994. 240 pages. \$12.95 soft cover.

## MODERN ELECTRONICS MATH

by Jerrold R. Clifford and Martin Clifford

Immediate application is the keyword here, with electronics first brought into the picture on page 21, in a problem on adding series resistance. Arithmetic, algebra and trigonometry are thoroughly explored, with a multitude of examples taken from electronics. In the section on square root, the reader is shown how to calculate current, given power and resistance. In the chapter on trigonometry, phase angle and impedance calculations are introduced, among many other areas. A chapter on logarithms gets into decibels, power gain, etc. Four chapters are aimed at computer math: binary numbers, octal and hex numbers, other number systems, and Boolean algebra.

Published by Tab Books, Blue Ridge Summit, PA 17214. 684 pages. \$9.95 soft cover, \$12.95 hard cover.

## THE RADIO AMATEUR'S HANDBOOK (54TH ED.)

by the ARRL Headquarters Staff

The 1977 edition of the radio amateur's "bible" has been revised to reflect changes in both technology and amateur radio. An introductory chapter explains the basic characteristics of the amateur radio service, and is followed by chapters dealing with radio theory. The handbook is well illustrated and contains many graphs, formulae, and representative circuits. An expanded chapter on radio propagation, a section on radio and boating, and a frequency chart covering vlf to uhf are included. Among the new projects appearing in the handbook are an 80-to-10-Meter solid-state

transceiver with digital readout, a 2-kW 8877 linear amplifier, a 50-MHz frequency counter, and improved RFI filters. New amplifiers and a mobile antenna for 220 MHz are featured. An antenna coupler employing fixed capacitors and a homemade variable inductor helps beat the parts procurement problem.

Published by the American Radio Relay League, Inc., 225 Main Street, Newington, CT 06111. 704 pages. \$12.50 hard cover (\$13.50 in Canada, \$14.50 elsewhere), \$7.50 soft cover (\$8.50 in Canada, \$9.50 elsewhere).

## ELECTRONICS ONE-SEVEN, VOLS. 1 AND 2

These two volumes (one on electronics, one on electricity) are revised second editions of elementary self-teaching texts that first came out ten years ago. Each features one topic or concept per page, with at least one illustration on every page. Coverage is thorough, and very little math is used. Each volume is made up of seven parts. The electronics volume covers electronic signals, electronic building blocks, electron tubes, semiconductors, power supplies, oscillators, and auxiliary circuits. The electricity text covers "producing electricity," dc circuits, ac circuits, LCR circuits, test equipment, power sources, and electric motors.

Published by Hayden Book Co., 50 Essex St., Rochelle Park, NJ 07662. *Electronics*: 1,000 pages, \$21.95. *Electricity*: 992 pages, \$20.85. Hard cover.

## TV TYPEWRITER COOKBOOK

by Don Lancaster

As the "subtitle" indicates, this is a "complete guide to low-cost television display of alphanumeric and graphic data for microprocessor systems, computer hobbyists, ham RTTY, TV titling, word processing, and video games." The author, who has also written other electronic "cookbooks," covers TV typewriters in depth: IC's for TVT use, memory, timing, cursor and update circuits, keyboards and encoders, serial and TV interfaces, hard copy, and color graphics. Dozens of schematics provide information for building one's own TVT, or serve as background material for the hobbyist interested in knowing what's inside the kit or wired TVT he's bought.

Published by Howard W. Sams & Co., 4300 W. 62 St., Indianapolis, IN 46206. 256 pages. \$9.95 soft cover.

## ELECTRONIC SYSTEMS THEORY AND APPLICATIONS

by Henry Zanger

This text emphasizes how to use available IC's rather than how to design circuits, so the stress is on the system. There are chapters on system analysis, transducers, components, communications systems, instrumentation, control systems, and reliability and maintainability. The hardware ranges from op

# The "Click and Pop" machine

only by

# SAE



Ever since the invention of the recorded disc annoying "clicks" and "pops" caused by scratches, static and imperfections have consistently disturbed the listening pleasure of music lovers.

Now, SAE introduces the unique model 5000, an Impulse Noise Reduction System which eliminates those unwanted sounds with no adverse effect on the quality of the recorded material.

This breakthrough in electronic circuitry is so demonstrably effective that the SAE 5000 is destined to become an essential part of any sound system.

The SAE 5000 is compact and sleek, built to SAE's exacting standards, and ready to enhance the performance of any system, from the standard receiver/turntable combination, to the most sophisticated audiophile components.

SAE is proud to add the 5000 to their broad line of *Components for the Connoisseur*.

# SAE

Scientific Audio Electronics, Inc.  
P.O. Box 60271, Terminal Annex  
Los Angeles, Cal. 90060

Please send more information on the 5000.

Name \_\_\_\_\_

Address \_\_\_\_\_

City \_\_\_\_\_

State \_\_\_\_\_ Zip \_\_\_\_\_

PE-777

CIRCLE NO. 43 ON FREE INFORMATION CARD

Put Professional Knowledge and a  
**COLLEGE DEGREE**  
 in your Electronics Career through  
**HOME STUDY**

**Earn Your DEGREE**

by correspondence, while continuing your present job. No commuting to class. Study at your own pace. Learn from complete and explicit lesson materials, with additional assistance from our home-study instructors. Advance as fast as you wish, but take all the time you need to master each topic. Profit from, and enjoy, the advantages of directed but self-paced home study.

The Grantham electronics degree program begins with basics, leads first to the A.S.E.T. degree, and then to the B.S.E.E. degree. Our free bulletin gives complete details of the program itself, the degrees awarded, the requirements for each degree, and how to enroll. Write for *Bulletin E-77*.

**Grantham College of Engineering**  
 2000 Stoner Avenue  
 P. O. Box 25992  
 Los Angeles, CA 90025

Worldwide Career Training thru Home Study  
 CIRCLE NO. 20 ON FREE INFORMATION CARD

**FREE EICO CATALOG**

**358 Ways To Save On Instruments, CB, Burglar Alarms, Automotive & Hobby Electronics!**

The more you know about electronics, the more you'll appreciate EICO. Every EICO product is designed to provide you with the most pleasure and quality performance for your money. The fact that more than 3 million EICO products are in use attests to their quality and performance.

**"BUILD-IT-YOURSELF" and save up to 50% with our famous electronic kits.**

For the latest EICO Catalog and name of nearest EICO Distributor, check reader service card or send 50¢ for fast first class mail service.

**EICO—283 Malta Street, Brooklyn, N.Y. 11207**

Leadership in creative electronics since 1945.



CIRCLE NO. 13 ON FREE INFORMATION CARD

amps to plotters, the math from Laplace transforms to transfer function analysis, in this technical look at a wide range of systems.

Published by Prentice-Hall, Englewood Cliffs, NJ 07632. 352 pages. \$15.95 hard cover.

**COLOR TELEVISION TROUBLESHOOTING**

by Edward Bannon

Reflecting the rapid advances of electronic technology, this book presents the current status of color TV servicing. It is intended as a teaching tool for instructors, technicians, and technical-school or trade-school students. A fundamental knowledge of radio and TV theory is assumed. Troubleshooting is discussed as it relates to color reproduction problems in the black-and-white sections; bandpass amplifier; color-sync procedures; chroma demodulators; chroma and color matrices; systematic color circuits; color picture tube circuitry; modular procedures; and digital color TV circuitry.

Published by Reston Publishing Co., P.O. Box 547, Reston, VA 22090. 264 pages. \$14.95 hard cover.

**DIGITAL/LOGIC ELECTRONICS HANDBOOK**

by William L. Hunter

This handbook starts out with chapters on numbering systems (binary, octal, hex), basic arithmetic operations, and the laws of logic (Boolean algebra, Venn diagrams, truth tables) applied to digital circuits. The logic chapter also gets into DeMorgan's Theorem for simplifying Boolean equations. The next two chapters explore logic circuits such as flip-flops, counters, adders, converters and multiplexers, and basic digital circuits including multivibrators, gates, and the Schmitt trigger. Logic symbols are examined thoroughly, as is the 54/74 family of TTL IC's. The last chapter, on logic applications, looks at a digital-readout timer by Sprague, and four digital Heath Kits (multimeter, clock, calculator, thermometer).

Published by Tab Books, Blue Ridge Summit, PA 17214. 308 pages. \$6.95 soft cover, \$9.95 hard cover.

**A DICTIONARY OF MICROCOMPUTING**

by Philip E. Burton

If you are just getting into microcomputing or are just thinking about it, this is one book you might want to get at the start. It translates and defines the meanings of such things as ACIA, DMA, DCS, assembler, emulator, handshaking, iteration time, and a host of other terms and phrases used in computing. For example, it will make clear the difference between software, firmware, and hardware; JUMP and LOOP instructions; bit and byte; etc. Diagrams, drawings, and tables are provided to illustrate the text. The Appendix contains the complete listing of the full ASCII code; tables

of binary and hexadecimal numbers; and hexadecimal addition and multiplication tables.

Published by Garland Publishing, Inc., 545 Madison Ave., New York, NY 10022. Hard cover. 171 pages. \$12.50.

**SEMICONDUCTOR REFERENCE HANDBOOK**

Data on Radio Shack's line of Archer brand semiconductors is compiled in this new reference handbook that contains cross-reference data on more than 36,000 semiconductor devices. The handbook also has sections on the care and handling of transistors, soldering precautions, case styles and dimensions, testing of transistors, and a glossary of terms, symbols, and abbreviations used in electronics. The handbook is available from Radio Shack stores.

Published by Radio Shack, Forth Worth, TX 76102. Soft cover, 128 pages. \$1.95.

**HOW TO DESIGN & USE MULTIVIBRATORS**

by Courtney Hall

Various types of multivibrators are examined in this book at the introductory level. Astable, bistable, and monostable multivibrators as well as Schmitt trigger and half-shot circuits are discussed. Other chapters explain the design and applications of multivibrator circuits. The book also presents techniques for tailoring circuits to meet specific demands. A few of the projects covered are pulse generators, electronic counters, lamp flashers, tachometers, phase meters, voice-operated relays, and time-delay circuits.

Published by Howard W. Sams & Co., 4300 W. 62nd Street, Indianapolis, IN 46206. 96 pages. \$3.95 soft cover.

**RECORDING AND LISTENING GUIDES**

*Master Hi-Fi Installation* (151 pages), by Gordon J. King, describes in a straightforward manner the functions of the main components of a hi-fi system. It details the differences between mono, stereo, and quadraphonic sound and the effects of room acoustics. The guide is designed to help the reader select the right components for his audio system. *Master Stereo Cassette Recording* (112 pages), by I.R. Sinclair, covers just about everything you need to know to record and replay, and to maintain and improve your recording equipment for professional results. Coverage also includes noise-reduction equipment and special techniques and equipment for considerably boosting the quality of recordings. *Master Electronics In Music* (120 pages), by T.D. Towers, is a guide to the proper use and maintenance of such popular electronic instruments as electric guitars, electronic organs, amplifying systems for musical instruments, and other electronic musical equipment.

Distributed by Hayden Book Co., Inc., 50 Essex St., Rochelle Park, NJ 07662. Soft cover. \$5.45 per volume.



# ELECTRONICS MARKET PLACE

**REGULAR CLASSIFIED: COMMERCIAL RATE:** For firms or individuals offering commercial products or services, \$2.25 per word. Minimum order \$33.75. **EXPAND-AD CLASSIFIED RATE:** \$3.35 per word. Minimum order \$50.25. Frequency discount: 5% for 6 months; 10% for 12 months paid in advance. **READER RATE:** For individuals with a personal item to buy or sell, \$1.35 per word. No minimum! **DISPLAY CLASSIFIED:** 1" by 1 column (2-1/4" wide). \$260.00. 2" by 1 column. \$520.00. 3" by 1 column. \$780.00. Advertiser to supply film positives. For frequency rates, please inquire.

**GENERAL INFORMATION:** Payment must accompany copy except when ads are placed by accredited advertising agencies. First word in all ads set in caps. All copy subject to publisher's approval. All advertisers using Post Office Boxes in their addresses **MUST** supply publisher with permanent address and telephone number before ad can be run. Advertisements will not be published which advertise or promote the use of devices for the surreptitious interception of communications. Ads are not acknowledged. They will appear in first issue to go to press after closing date. Closing Date: 1st of the 2nd month preceding cover date (for example, March issue closes January 1st. Send order and remittance to **POPULAR ELECTRONICS**, One Park Avenue, New York, New York 10016. Attention: Hal Cymes

## FOR SALE

**FREE!** Bargain Catalog—I.C.'s, LED's, readouts, fiber optics, calculators parts & kits, semiconductors, parts. Poly Paks, Box 942PE, Lynnfield, Mass. 01940.

**GOVERNMENT** and industrial surplus receivers, transmitters, snooper scopes, electronic parts, Picture Catalog 25 cents. Meshna, Nahant, Mass. 01908.

**LOWEST Prices Electronic Parts.** Confidential Catalog Free. KNAPP, 3174 8th Ave. S.W., Largo, Fla. 33540.

**ELECTRONIC PARTS,** semiconductors, kits. **FREE FLYER.** Large catalog \$1.00 deposit. **BIGELOW ELECTRONICS,** Bluffton, Ohio 45817.

**RADIO—T.V. Tubes—**36 cents each. Send for free catalog. Cornell, 4213 University, San Diego, Calif. 92105.

**AMATEUR SCIENTISTS,** Electronics Experimenters, Science Fair Students. Construction plans—Complete, including drawings, schematics, parts list with prices and sources... Robot Man — Psychedelic shows — Lasers — Emotion/Lie Detector — Touch Tone Dial — Quadraphonic Adapter — Transistorized Ignition — Burglar Alarm — Sound Meter... over 60 items. Send 50 cents coin (no stamps) for complete catalog. Technical Writers Group, Box 5994, University Station, Raleigh, N.C. 27607.

**METERS—**Surplus, new, used, panel or portable. Send for list. Hanchett, Box 5577, Riverside, CA 92507.

**MECHANICAL, ELECTRONIC devices** catalog 10 cents. Greatest Values — Lowest Prices. Fertik's, 5249 "D", Philadelphia, Pa. 19120.

**POLICE/Fire scanners,** large stock scanner crystals, antennas. Also CBs. Harvey Park Radio, Box 19224, Denver, CO 80219.

**TELETYPE EQUIPMENT** for sale for beginners and experienced computer enthusiast. Teletype machines, parts, supplies. Catalogue \$1.00 to: ATLANTIC SALES, 3730 Nautilus Ave., Brooklyn, NY 11224. Tel: (212) 372-0349.

**ELECTRONIC ignition:** Capacitor-Discharge, pointless. Auburn Sparkplugs. Wheel Stabilizers Information 20 cents. Anderson Engineering, Epsom, N.H. 03234.

**WHOLESALE C.B.s.,** Scanners, Antennas. Catalog 25 cents. Crystals: Special cut. \$4.95. Monitor \$3.95. Send make, model, frequency. G. Enterprises, Box 461P, Clearfield, UT 84015.

**COMPUTER HOBBYISTS—**classified advertising newsletter. \$3.75/year. Free Sample. ON LINE, 24695 Santa Cruz Hwy., Los Gatos, CA 95030.

**SOUND SYNTHESIZER KITS—**Surf \$12.95. Wind \$12.95. Wind Chimes \$17.95. Electronic Songbird \$6.95. Musical Accessories, many more. Catalog free. PAIA Electronics, Box J14359, Oklahoma City, OK 73114.

**BUGGED???** New locator finds them fast. Write. Clifton, 11500-L N.W. 7th Avenue, Miami, Florida 33168.

**YOU WILL SAVE BIG MONEY!** Surplus. Clearouts. Bankruptcy. Inventory. Deals. Catalog \$1 (redeemable). ETCOA Electronics. Box 741, Montreal, H3C 2V2, U.S. Inquiries.

**HEAR POLICE/FIRE Dispatchers!** Catalog shows exclusive directories of "confidential" channels, scanners. Send postage stamp. Communications, Box 56-PE, Commack, N.Y. 11725.

**UNSCRAMBLERS:** Fits any scanner or monitor, easily adjusts to all scrambled frequencies. Only 4" square \$29.95, fully guaranteed. Dealer inquiries welcomed. PDQ Electronics, Box 841, North Little Rock, Arkansas 72115.

**RECONDITIONED Test Equipment.** \$0.50 for catalog. Walter's Test Equipment, 2697 Nickel, San Pablo, CA 94806.

**CB RADIOS,** monitors, crystals. CD ignitions. Southland, Box 3591-B, Baytown, Texas 77520.

**SURPRISES GALORE!** Projects: ham radio, music synthesizers, etc. IC's, pots, hardware, crystals, keyboards, resistors, etc. Send 13 cents stamp for catalogue. UTEP, Box 26231B, Salt Lake City, Utah 84125.

**NAME BRAND Digital/Analog Test Equipment.** Discount prices. Free catalog. Salen Electronics, Box 82, Skokie, Illinois 60076.



### ORGAN KITS KEYBOARDS

THE ULTIMATE IN DESIGN AND SOUND

Demo Record & Brochure \$1.00

Wurlitzer reproductions

**DEVTRONIX ORGAN PRODUCTS, Dept. C**  
5872 Amapola Dr. • San Jose, CA 95129



### SIX DIGIT 12/24 HR. CLOCK KIT

\$22.95

MODEL DC-5

The best looking, most complete kit on the market! Features include: time set pushbuttons, jumbo 4" readouts, Polaroid lens filter, line cord transformer, super quality PC boards and durable extruded aluminum case available in live different colors! All parts are included, there are no extras needed! Super instructions reduce assembly time to 1-2 hours. Fully guaranteed. Colors available: gold, silver, bronze, blue and black (specify).

Clock Kit, DC-5	\$22.95
Alarm Clock Version, DC-8	\$24.95
12/24 Hr Clock with 10-Minute ID Timer, DC-10	\$25.95

### VIDEO TERMINAL KIT \$149.95

A compact 5 x 10-inch PC card that requires only an ASCII keyboard and a TV set to become a complete interactive terminal for connection to your microprocessor asynchronous interface. Its many features are: single 5-volt supply, crystal controlled sync and baud rates (up to 9600 baud), 2 pages of 32 characters by 16 lines, read to and from memory, computer and keyboard-operated cursor and page control, parity error display and control, forward-on initialization, full 84 character ASCII display, block type size thru cursor, keyboard computer control backspaces, power-up space, line feeds, row line feeds, home, returns cursor. Also clears page, clears to end of line, selects page 1 or 2, reads from or to memory. The card requires 5 volts at approx. 800 ma and outputs standard 75 ohm composite video.

TH3216 Kit	\$149.95
TH3216, Assembled and Tested	\$239.95
VD-1, Video to RF Modulator Kit	\$ 6.95

### MINI-KITS

**FM WIRELESS MIKE KIT**  
FM-1 \$2.95  
Transfer up to 300' to any FM radio. Sensitive mike input requires 9v battery. crystal or ceramic mike. Runs on 3 to 9 volts.

**TONE DECODER KIT**  
A complete tone decoder on a single PC Board. Features: 400 to 5000 Hz adjustable frequency range, voltage regulation, 567 IC. Useful for tough tone decoding, tone burst detection, PSK demod, tone hunting, and many other uses. Use 3 for 12. Busbs, tone generator, decoding. Runs on 12 volts.  
Complete Kit, TD-1 \$4.95

**LED BLINKY KIT**  
A great attention getter, which alternately flashes a jumbo LED. Use for name badges, buttons, on-circuit type panel lights.  
Complete Kit, BL-1 \$2.95

**SUPER SNOOP AMPLIFIER**  
A super sensitive and downward well pick-up a pin drop at 15 feet! Great for monitoring a room or a car. Great for purpose test amplifier. Full 2 watts of output runs on 6 to 12 volts, uses any type of mike. Requires 8-45 ohm speaker.  
Complete Kit, BN-9 \$4.95

**MUSIC LIGHTS KIT**  
See music come alive! 3 different lights flicker with music on voice. One light for lows, one for the mid-range and one for the highs. Each channel individually adjustable, and drives up to 300 watts. Great for parties, band music, etc. and more.  
Complete Kit, ML-1 \$7.95

**SIREN KIT**  
Produces upward and downward wail characteristic of police siren. 200mw audio output, runs on 3-9 volts, uses 6-45 ohm speaker.  
Complete Kit, SM-3 \$2.95

### CAR CLOCK KIT

6-Digit 12/24 HR.

- High Accuracy (1 Min./Month)
- Big 4" high readout
- Special circuit suppresses all spikes and transients
- Same case as DC-5 above
- Displays blanks with ignition

Complete Kit, DC-7 \$25.95

### CALENDAR ALARM CLOCK KIT

6-Digit 12/24 Hour

Has every feature one could ever ask for. Kit includes all parts except case, build it into wall, station or even car! Uses the incredible 7001 chip. Features:

- 6-digit 5" high
- Calendar shows mo./day
- 24-Hour alarm with snooze
- 12- or 24-Hr Format
- Battery backup with on-chip time base

Complete Kit, less case, DC-9 \$34.95

### CAR CLOCK KIT \$27.95

12/24-Hour 12-Volt AC or DC

- High Accuracy (1 minute/month)
- 6 jumbo 4" LED readouts
- Easy, no-polarity hookup
- Display blanks with ignition
- Case, mounting bracket included
- Super instructions

Complete Kit, DC-11 \$27.95

**AUTO-DIMMER \$2.50**  
Automatically adjusts brightness of car clock display to suit conditions.

### 600 MHz Prescaler \$59.95



Fully assembled and tested. Extend the range of your counter to 10 times higher in frequency. Works with any counter. High sensitivity input with built-in on-chip pre-amp. PS-1B, 10 \$59.95

**741 OP-AMP**  
Factory prime mini-dip. House marked. **10 for \$2.00**

**MA-1003A CAR CLOCK MODULE** \$23.95  
**MA-1002A ALARM CLOCK MODULE** \$12.95  
Includes transformer and switches. Auto dimmer photocell for use with 1002 \$ 75

LINEAR REGULATOR		TRANSISTORS	
555 .50	309K .99	NPN 2N3904 type	10/\$1.00
556 .75	309H .99	PNP 2N3906 type	10/\$1.00
567 1.75	340K-12 .99	NPN Power Tab 40W	3/\$1.00
1458 .65	7805 .99	PNP Power Tab 40W	3/\$1.00
	7812 .99	FET MPF-102 type	3/\$2.00
	7815 .99	UJT 2N2646 type	3/\$2.00
	7818 .99	2N3055 NPN Power	.75
LED DRIVER			
75491 .50			
75492 .50			

**CODE OSCILLATOR KIT**  
Powerful 3 watt audio oscillator of appropriate frequency. Good for many uses. Great for warning alarm, battery checker, voltage indicator and code oscillator.  
Complete Kit, CPO-1 \$2.50

**POWER SUPPLY KIT**  
Complete triple regulated power supply provides variable 1 to 15 volts at 200ma and 5 volts at 1 amp. 50mw load regulation, good filtering and small size. Kit includes transformer. Requires 80w at 1 amp and 18 to 30VCT.  
Complete Kit, PS-3LT \$6.95

**ramsey electronics**

P.O. BOX 4072 ROCHESTER, N.Y. 14610 (716) 271-6487

Telephone Orders Welcome

BankAmericard, Master Charge, Discover, Visa

Satisfaction guaranteed or money refunded. C.O.D. orders add \$1.00. Orders under \$10.00 add \$75. N.Y. residents add 7% sales tax.

**DECADE COUNTER PARTS KIT**  
Includes 7420 31 Mhz counter, 7475 latch, 74x7 LED driver, LED readout, current limit resistor, hook up wires and instructions on how to build an easy low cost freq. counter.  
Kit of Parts, DCU-1 \$3.50

# PLANNING TO MOVE?

Let us know 8 weeks in advance so that you won't miss a single issue of **POPULAR ELECTRONICS**. Attach old label where indicated and print new address in space provided. Also include your mailing label whenever you write concerning your subscription. It helps us serve you promptly.

Write to: P.O. Box 2774, Boulder, CO 80322 giving the following information.

Change address only  Extend my subscription

### ENTER NEW SUBSCRIPTION

1 year \$12.00  Payment enclosed  
 Allow 30-60 days for delivery.  (1 extra BONUS issue)  
 Bill me later

AFFIX OLD LABEL  
If you have no label handy, print OLD address here.

Name \_\_\_\_\_ please print  
Address \_\_\_\_\_  
City \_\_\_\_\_ Zip \_\_\_\_\_  
State \_\_\_\_\_

NEW ADDRESS HERE 0208

Name \_\_\_\_\_ please print  
Address \_\_\_\_\_ Apt. \_\_\_\_\_  
City \_\_\_\_\_  
State \_\_\_\_\_ Zip \_\_\_\_\_

Additional postage on foreign orders: add \$3 a year for Canada, \$5 a year for all other countries outside the U.S. and its possessions. Cash only on foreign orders, payable in U.S. currency.

## BUILD YOUR OWN SPEAKERS AND SAVE UP TO 50%

Send for our free fact-packed 44-page catalog manual and learn how to assemble your own multi-  
element stereo speakers from scratch or from kits. Our catalog includes chapters on design, construction, X-overs, enclosures, midranges, woofers, tweeters and horns. Write us today.

**SPEAKERLAB**  
Dept. PE-A, 5500 35th N.E.  
Seattle, Washington 98105



**SURPLUS 'SMART' TERMINALS**, components, serious music synthesizer kits, plans, parts, and more. Send SASE for FREE INFO Package. CFR Associates, POBF, Newton, N.H. 03858.

**NON SEMI SURPLUS**. Monthly picture flyer. Quality. Low prices. Send 25 cents. U.S. only. Startronics, Box 683, McMinnville, OR 97128.

**BUILD AND SAVE TELEPHONES, TELEVISION, DETECTIVE, BROADCAST** Electronics. We sell construction plans with an Engineering Service. Speakerphones, Answering Machines, Carphones, Phonevision, Dialers, Color TV Converters, VTR, Games, \$25 TV Camera, Electron Microscope, Special Effects Generator, Time Base Corrector, Chroma Key, Engineering Courses in Telephone, Integrated Circuits, Detective Electronics. PLUS MUCH MORE. NEW Super Hobby Catalog PLUS year's subscription to Electronic News Letter, \$1.00. Don Britton Enterprises, 6200 Wilshire Blvd., Los Angeles, Calif. 90048.

**NAME BRAND Digital/Analog Test Equipment**. Discount prices. Free catalog. Salen Electronics, Box 82, Skokie, Illinois 60076.

**SURPLUS COMPONENTS**, Communication and test equipment. Illustrated catalog 25 cents. E. French, P.O. Box 249, Aurora, Illinois 60505.

### ANYONE CAN SOLDER WITH — DO-IT-YOURSELFERS!

Let Kester solder aid you in your home repairs or hobbies. A radio, TV, model train, jewelry, plumbing, etc. Save money — repair it yourself. Send self-addressed stamped envelope to Kester for a FREE Copy of "Soldering Simplified".

**KESTER SOLDER** / 4201 Wrightwood Ave. Chicago, Ill. 60639

## INTERNATIONAL ELECTRONICS UNLIMITED

### SPECIAL SUMMER SALE (GOOD THRU AUGUST)

#### DIGITAL

7400	\$ .09
7410	.13
7438	.17
7453	.14
74181	1.95
74123	.49
74153	.69
74154	.99
74C00	.13

#### SHIFT REGISTERS

2511	\$1.49
2527	1.95
2532	2.29

#### LINEAR

301 mDIP	\$ .23
311 mDIP	
or 14 pin .69	
340T 6V	1.09
723 DIP	.49
741 mDIP	.25
1458 mDIP	.53
75453 mDIP	.27

#### LED

RED LED .190"	\$ .10
WHITE LED (RED EMIT.)	
RL2-03 .160"	.14
DL 702 RED C.C.	
.30" LHD	.99

#### CALCULATOR CHIP

5738	1.95
------	------

#### KEYBOARD

20 KEYS  
2 SLIDE SW  
3 x 3 1/2"

**\$ .69**

#### UNIVERSAL BREADBOARD

Accommodates 8, 14, 16, 4, 28 & 40 pin IC's.  
2 triple rows of 27 holes for DIP IC's.  
Additional space for transistors, resistors & capacitors. Very versatile & simple to use. 1/16" phenolic with silver plated copper circuits. 3 1/2" x 5 1/4"

**\$ .89**

**2102** \$1.29  
1024X1 STATIC RAM 16 PIN

TTL	13	7451	17	74153	.89
461	.16	7453	17	74154	1.20
462	.15	7454	17	74155	.97
463	.15	7460	17	74156	.97
464	.16	7464	.35	74157	.99
465	.19	7465	.35	74158	1.79
466	.20	7470	.30	74160	1.23
467	.28	7472	.30	74161	.97
468	.18	7473	.35	74162	1.39
469	.19	7474	.28	74163	1.99
470	.16	7475	.49	74164	.99
471	.25	7476	.30	74165	.99
4713	.43	7481	.68	74166	1.25
4714	.65	7485	.88	74170	2.10
4716	.35	7486	.40	74173	1.49
4717	.35	7489	2.25	74174	1.23
4720	.16	7490	.43	74175	.97
4722	.30	7491	.75	74176	.89
4723	.29	7492	.48	74177	.84
4725	.27	7493	.48	74181	2.45
4726	.26	7494	.79	74181	2.45
4727	.29	7495	.79	74182	.79
4730	.20	7496	.79	74184	1.90
4732	.23	74100	.98	74175	2.20
4737	.25	74105	.64	74187	5.75
4748	.25	74107	.37	74190	1.15
7430	.15	74121	.38	74191	1.25
7441	.89	74122	.38	74192	.95
7442	.59	74123	.65	74193	.85
7443	.73	74125	.54	74194	1.25
7444	.73	74126	.58	74195	.74
7445	.73	74132	.89	74116	1.25
7446	.81	74141	1.04	74197	.73
7447	.79	74145	1.04	74198	1.73
7448	.79	74150	.97	74199	1.69
7450	.17	74151	.79	74200	5.45

#### LED S

DL10A	RED CA .27" LHD	\$1.89
DL707	RED CA .30" RHD	1.49
DL507	RED CA .50" RHD	1.49
FND359	RED CC .375" RHD	.89
DL702	RED CC .30" LHD	1.39
NSN74R	RED CC .30" RHD	1.49
DL500	RED CC .30" RHD	1.49
MAN5	GREEN CA .27" LHD	1.39
MAN8	YELLOW CA .27" LHD	1.39
MAN2	YELLOW CA .3" LHD	1.89
MAN66	RED CA .6" LHD	2.19
DL747	RED CA .6" LHD	2.39

#### SHIFT REGISTERS

2502	1024 bit MULT DYN	16 pin	\$3.75
2504	1024 bit MULT DYN	8 pin	3.75
2511	Tri-State Dual 50/100/200 bit		
STATIC 14 pin			2.95
2518	Hex 32-bit STATIC	16 pin	2.95
2519	Hex 40-bit STATIC	16 pin	2.95
2527	Dual 256 bit STATIC	8 pin	2.95
2532	Quad 80 bit STATIC	16 pin	3.95
5013	1024 bit accum. Dynamic	8 pin	1.75
5016	500/512 bit Dynamic	8 pin	1.59

#### SPECIAL DEVICES

372	AF-IF Strip Detector DIP	2.93
546	AM Radio Receiver Subsystem DIP	.75
1310	FM Stereo Demodulator DIP	2.90
1496	Balanced Modulator-Demodulator	.99
1800	Stereo Multiplexer DIP	2.48
ULN2206	FM Gain Block 34db (typ) mDIP	1.18
ULN2209	FM Gain Block 48db (typ) mDIP	1.35
2513	Character Generator 64x8x5 DIP-24	10.20
3046	Transistor Array DIP-14	.73

#### 74S200

256 BIT RAM TRI-STATE **\$3.25**

10% OFF WITH \$25 ORDER  
15% OFF WITH \$100 ORDER  
THESE DISCOUNTS APPLY TO TOTAL OF ORDER — SPECIALS INCLUDED

### Rohm

QUALITY RELIABILITY

Carbon film - 5%  
1/4 or 1/2 watt  
455 resistors, 44 values  
supplied in a 15 drawer,  
60 compartment storage  
cabinet — table or wall  
mount. Ready to use.

#### RESISTOR KIT

1/4 WATT 01255

1/2 WATT 01505

~~\$24.95~~ **\$19.95**

ADD SHIPPING CHGS

\$2.00  
RESISTOR ASSORTMENT  
R (OHMS)



R	QTY.	R	QTY.	R	QTY.	R	QTY.	R	QTY.
1.5	5	.68	5	2.2K	20	33K	20	330K	10
3.3	5	220	10	2.7K	10	39K	10	470K	10
6.8	5	270	5	3.3K	10	47K	10	680K	10
10	10	330	10	3.9K	10	68K	10	2.2M	5
15	5	470	20	4.7K	20	100K	20	3.3M	5
22	5	680	10	6.8K	10	150K	10	4.7M	5
33	5	1.0K	20	22K	10	220K	10		
47	10	1.5K	10	27K	10	270K	5		

#### FREE CATALOG AVAILABLE ON REQUEST

Satisfaction guaranteed. Shipment will be made postage prepaid within 3 days from receipt of order. Payment may be made with personal check, charge card (include number and exp. date), or money order. Phone Orders — Boi-A and M/C card or C.O.D. Add \$4.00 to cover shipping and handling if order is less than \$10.00. California residents add sales tax. Include shipping expense for orders shipped out of U.S. and Canada approx. 10% of order.

**INTERNATIONAL ELECTRONICS UNLIMITED**  
VILLAGE SQUARE, P.O. BOX 449  
CARMEL VALLEY, CA 93924 USA  
PHONE (408) 659-3171

**TELEPHONES UNLIMITED**, Equipment, Supplies, All types, Regular, Keyed, Modular. Catalog 50 cents. Box 1147E, San Diego, California 92112.

FREE CATALOG. Solar Cells, Nicads, Kits, Calculators, Digital Watch Modules, Ultrasonics, Strobes, LEDs, Transistors, IC's, Unique Components. Chaney's, Box 27038, Denver, Colorado 80227.

**POWERFUL, ADJUSTABLE, REGULATED, THREE OUTPUT POWER SUPPLY** and 900 easily removable parts in complete CARTRIVISION television recorder electronic assembly with documentation. Perfect for MICROPROCESSOR, IC, transistor, television, CB radio applications. \$21.45. Free brochure. MADISON ELECTRONICS, INCORPORATED, 369, D55, Madison, Alabama 35758. SATISFACTION GUARANTEED.

**CB RADIOS**—Police Scanners, Wholesale only!! Send letterhead for lowest prices anywhere. Four Wheeler, 10PE, New Scotland, Albany, N.Y. 12208.

LEDs, red with mounting clip 20 cents each, 10 for \$1.80 prime parts. 75 cents postage and handling. CA res. add 6% tax. Hooker Electronics, P.O. Box 386, Hanford, CA 93230.

#### PROMS PROGRAMMED

No. bits	256	1024	2048	4096
TTL	\$ 7 up	\$ 8 up	\$ 11 up	\$ 19 up
Schottky	10 up	11 up	19 up	25 up
MOS	—	—	33 up	45 up

Price depends on mfr. type. Send \$1.00 packet fee now, bits desired. Receive specs on all our PROMS, program sheets, PROM postage credit. Pencil in program sheets, remit balance of price. We will send new guaranteed programmed PROM. Send packet fee (check or money order only) to: RBH Enterprises, Box 12344, Wichita, KS 67277

**RADAR DETECTOR KIT**. Build a long range radar detector with over one mile range. Kit comes with complete documentation and drilled, etched and plated PC board. Only \$4.95. Thousands sold nationally. Satisfaction guaranteed. Same day shipment. J.B. Saunders Company, 3050 Valmont, Boulder, Colorado 80301.

**SEEKING JAPANESE TRANSISTORS** for CB Repair? Request list. Fuji-Svea Enterprise, Dept. P, Box 40325, Cincinnati, OH 45240.

**PROFESSIONAL UNSCRABLERS** — several models that fit any scanner. Free information. Capri Electronics, 8753T Windom, St. Louis, MO 63114.

**BREATHE Better Air With Negative Ion Generator** \$275.00. (Kit \$165.00.) Golden Enterprises, Box 1282PE, Glendale, Arizona 85311.

UNSCRAMBLE CODED MESSAGES from Police, Fire and Medical Channels. Same day service. Satisfaction guaranteed. Don Nobles Electronics, Inc., Rt. 7, Box 2658, Hot Springs, Arkansas 71901. (501) 623-6027.

UNSCRAMBLERS/DESCRAMBLERS: If you have tried the "cheapie" Squawk-Box unscramblers and have had nothing but squeals and frustration, then breathe new life into your scanner with our CODE-BREAKER. Tunes all scramble frequencies and operates with all scanners and monitors. Factory built and guaranteed. \$34.95. Catalog of many other descramblers and unusual electronic items. 25 cents. COD orders Tel. (501) 273-5340. CRYSTAL KITS, Box 445, Bentonville, Ark. 72712.

TELEPHONE technology. Recent Schematics, ads, manuals. 5,000 pages. \$9.95 Guaranteed. Automated, Box 1027, Issaquah, WA 98027.

ANYTHING ELECTRONIC — we've got it. Catalog \$1.00. Razoo, Box 1224, Cupertino, Calif.

SLEEP UNDISTURBED! Mask unwanted sound with soothing "pink noise". \$57.50. Golden Enterprises, Box 1282-PE, Glendale, Arizona 85311.

PENNY FORMULAS. Private collection. 1,000 easily prepared product formulas only \$10. Distributor, RTB68, Milton, Florida 32570.

C2708, 8K EPROM: \$35.00; C1702A: \$7.50. PROGRAMMING: C2708 — \$20.00; C1702A — \$5.00. HEX OR OCTAL LISTING. ELECTRONIC DISCOUNT SALES, 138 N. 81st Street, Mesa, Arizona 85207

DEAD BATTERY? Lights left on. Easily installed alarm alerts driver with pulsing tone. \$12.95 postpaid. CFL Enterprises, P.O. Box 415, Export, PA 15632.

MICROCOMPUTER HARD COPY. Attachment converts any electric typewriter. Free Brochure. Stout Microcomputer, Box 1573, Fremont, CA 94538.

FREE CATALOG of Goodies — Clock kits, power supplies, DVM kits, LED's, semis, all at lowest prices. DIAMONDBACK, Box 194P, Spring Valley, IL 61362.

TANK — TV GAME, Complete construction PLANS — \$10.00; P.C. BOARD — \$55.00; KITS — \$195.00; FREE information. ADVANCED ELECTRONICS, P.O. Box 133, Corvallis, OR 97330.

PRINTED CIRCUITS. Pint photo resist with aerosol \$15.25. Quart developer \$5.60. Four packs dry etchant \$5.56. Pint tin plating solution \$6.50. 8x10 auto lock exposure frame \$11.50. Ultraviolet lamp \$16. Shipping prepaid. CIRCOLEX, Box 198, Marcy, N.Y. 13403.

GAMES for HP-55: Lunar Lander, Racetrack, Blackjack, Tank, Submarine, Nim; \$66. McCabe Engineering, 8107 Winsford Ave., L.A., CA 90045.

CUT & STRIPPED 30 AWG Wire \$9.10 per 1000. Price list free. Electro Products, 6110 S. Pilgrim St., Seattle, Washington 98118.

ELECTROLYTIC CAPACITORS top quality, reasonable price, prompt delivery and free brochure. Ecom Parts Div., 3417 W. 8th St., L.A., CA 90005.

WIRE — Stranded and solid conductor — Wire — Wrap — Ribbon cable and connectors — MORE. Send 13 cents stamp for complete list. Ram Electronics, Box 336-P, Brookhaven, N.Y. 11719.

CARBON FILM RESISTORS 1/4W, 1/2W - 1.7 cents each. FREE sample / specifications. Other components. COM-PONENTS CENTER, Box 134P, New York, N.Y. 10038.

FREQUENCY ALLOCATION CHART 2Khz-200Ghz. Send \$2.00. Collins Chart Co., Box 1067, Coronado, CA 92118.

### TTL 7400N

SN7400N	.13	SN74125N	.40
SN7401N	.14	SN74126N	.59
SN7402N	.14	SN74128N	.59
SN7403N	.14	SN74132N	.69
SN7404N	.17	SN74136N	.59
SN7405N	.17	SN74141N	.88
SN7406N	.25	SN74142N	3.70
SN7407N	.25	SN74143N	3.98
SN7408N	.17	SN74144N	3.98
SN7409N	.17	SN74145N	.69
SN7410N	.14	SN74147N	1.58
SN7411N	.20	SN74148N	1.19
SN7412N	.21	SN74150N	.95
SN7413N	.39	SN74151N	.61
SN7414N	.64	SN74153N	.61
SN7416N	.24	SN74154N	.95
SN7417N	.29	SN74155N	.67
SN7420N	.14	SN74156N	1.64
SN7421N	.20	SN74157N	.59
SN7422N	.20	SN74159N	2.50
SN7423N	.25	SN74160N	.85
SN7425N	.25	SN74161N	.85
SN7426N	.22	SN74162N	.85
SN7427N	.25	SN74163N	.85
SN7428N	.28	SN74164N	.98
SN7430N	.14	SN74165N	.97
SN7432N	.23	SN74166N	1.09
SN7433N	.30	SN74167N	2.75
SN7437N	.21	SN74169N	1.69
SN7438N	.21	SN74172N	1.24
SN7440N	.14	SN74173N	1.24
SN7442N	.37	SN74174N	.94
SN7443N	.68	SN74175N	.84
SN7444N	.85	SN74176N	.77
SN7445N	.65	SN74177N	.76
SN7446AN	.70	SN74178N	1.19
SN7447AN	.67	SN74179N	1.49
SN7448N	.69	SN74180N	.67
SN7450N	.14	SN74181N	1.94
SN7451N	.14	SN74182N	.59
SN7453N	.14	SN74184N	1.75
SN7454N	.14	SN74185AN	6.95
SN7460N	.14	SN74186N	1.74
SN7470N	.26	SN74188N	2.98
SN7472N	.25	SN74190N	1.04
SN7473N	.29	SN74191N	1.04
SN7474N	.29	SN74192N	.84
SN7475N	.46	SN74193N	.84
SN7476N	.30	SN74194N	.89
SN7480N	.35	SN74195N	.54
SN7481AN	.95	SN74196N	.87
SN7482N	.55	SN74197N	.73
SN7483AN	.65	SN74198N	1.64
SN7484AN	1.50	SN74199N	1.14
SN7485N	.84	SN74221N	1.14
SN7486N	.30	SN74246N	1.95
SN7489N	1.85	SN74247N	1.70
SN7490AN	.43	SN74248N	1.75
SN7491AN	.59	SN74249N	1.75
SN7492AN	.44	SN74251N	1.05
SN7493AN	.44	SN74265N	.85
SS7494N	.69	SN74278N	1.99
SN7495AN	.67	SN74279N	.57
SN7496N	.65	SN74283N	1.39
SN7497N	2.50	SN74284N	4.50
SN74100N	.97	SN74285N	4.50
SN74104N	.42	SN74290N	.85
SN74105N	.42	SN74293N	.83
SN74107N	.28	SN74298N	1.64
SN74109N	.47	SN74351N	1.92
SN74110N	.52	SN74365N	.65
SN74111N	.69	SN74366N	.65
SN74116N	1.50	SN74367N	.65
SN74120N	1.40	SN74368N	.65
SN74121N	.34	SN74390N	1.40
SN74122N	.38	SN74393N	1.40
SN74123N	.48	SN74490N	1.90

### TTL LOW POWER SCHOTTKY

SN74LS00N	.23	SN74LS138N	1.25
SN74LS01N	.23	SN74LS139N	1.35
SN74LS02N	.23	SN74LS145N	1.19
SN74LS03N	.23	SN74LS151N	.99
SN74LS04N	.28	SN74LS153N	1.45
SN74LS05N	.28	SN74LS155N	1.45
SN74LS08N	.23	SN74LS156N	1.45
SN74LS09N	.23	SN74LS157N	.99
SN74LS10N	.23	SN74LS158N	1.10
SN74LS11N	.23	SN74LS160N	1.50
SN74LS12N	.25	SN74LS161N	1.50
SN74LS13N	.65	SN74LS162N	1.50
SN74LS14N	1.35	SN74LS163N	1.50
SN74LS15N	.23	SN74LS164N	1.60
SN74LS20N	.23	SN74LS168N	2.25
SN74LS21N	.23	SN74LS169N	2.25
SN74LS22N	.23	SN74LS170N	2.70
SN74LS26N	.37	SN74LS174N	1.25
SN74LS27N	.37	SN74LS175N	1.25
SN74LS28N	.30	SN74LS181N	3.30
SN74LS30N	.23	SN74LS190N	1.80
SN74LS32N	.33	SN74LS191N	1.80
SN74LS33N	.37	SN74LS192N	1.80
SN74LS37N	.37	SN74LS193N	1.80
SN74LS38N	.37	SN74LS194AN	1.30
SN74LS40N	.27	SN74LS195AN	1.30
SN74LS42N	.89	SN74LS196N	1.40
SN74LS47N	1.10	SN74LS197N	1.40
SN74LS48N	1.10	SN74LS221N	1.30
SN74LS49N	1.10	SN74LS240N	2.50
SN74LS51N	.23	SN74LS241N	2.40
SN74LS54N	.23	SN74LS242N	2.40
SN74LS55AN	.23	SN74LS243N	2.40
SN74LS563N	1.75	SN74LS244N	2.50
SN74LS573N	.45	SN74LS247N	1.30
SN74LS574N	.45	SN74LS248N	1.30
SN74LS575N	.65	SN74LS249N	1.30
SN74LS576N	.45	SN74LS251N	1.50
SN74LS578N	.45	SN74LS253N	1.50
SN74LS583AN	1.39	SN74LS257N	1.40
SN74LS585N	1.60	SN74LS258N	1.40
SN74LS586N	.89	SN74LS261N	2.95
SN74LS590N	1.15	SN74LS266N	.55
SN74LS592N	.85	SN74LS279N	1.35
SN74LS593AN	.85	SN74LS283N	.75
SN74LS595AN	1.50	SN74LS293N	1.30
SN74LS596N	1.65	SN74LS295AN	1.75
SN74LS107N	.45	SN74LS298AN	1.75
SN74LS109N	.50	SN74LS324AN	2.25
SN74LS112N	.45	SN74LS352AN	1.45
SN74LS113N	.45	SN74LS353AN	1.70
SN74LS114N	.45	SN74LS365AN	.69
SN74LS122N	.89	SN74LS366AN	.69
SN74LS123N	.99	SN74LS367AN	.69
SN74LS124N	.75	SN74LS368AN	.69
SN74LS125N	.75	SN74LS375AN	.75
SN74LS126N	.75	SN74LS386AN	.59
SN74LS132N	1.19	SN74LS395AN	1.95
SN74LS136N	.50	SN74LS670AN	2.75

### CMOS

CD4000BE	.09	CD4035BE	.99	CD4507BE	.52
CD4001BE	.18	CD4040BE	.99	CD4510BE	1.05
CD4002BE	.13	CD4041BE	.67	CD4511BE	1.25
CD4006BE	.99	CD4042BE	.63	CD4512BE	1.15
CD4007BE	.17	CD4043BE	.45	CD4514BE	2.50
CD4009BE	.80	CD4044BE	.45	CD4515BE	2.50
CD4009BE	.37	CD4046BE	2.45	CD4516BE	1.10
CD4010BE	.37	CD4047BE	2.45	CD4519BE	1.90
CD4011BE	.18	CD4049BE	.37	CD4519BE	.79
CD4012BE	.17	CD4050BE	.37	CD4520BE	.79
CD4013BE	.37	CD4051BE	1.15	CD4522BE	1.98
CD4014BE	.89	CD4052BE	1.15	CD4526BE	1.50
CD4015BE	.89	CD4053BE	1.19	CD4527BE	1.50
CD4016BE	.37	CD4055BE	1.29	CD4528BE	1.20
CD4017BE	.94	CD4060BE	1.40	CD4531BE	1.25
CD4018BE	.99	CD4066BE	.59	CD4539BE	1.20
CD4019BE	.42	CD4068BE	.24	CD4555BE	.75
CD4020BE	1.04	CD4069BE	.24	CD4556BE	.75
CD4021BE	.89	CD4070BE	.24	CD4585BE	1.80
CD4022BE	.89	CD4071BE	.29	74C85/40085PC	1.20
CD4023BE	.18	CD4072BE	.29	74C160/40160PC	1.50
CD4024BE	.67	CD4073BE	.29	74C161/40161PC	1.50
CD4025BE	.17	CD4075BE	.29	74C162/40162PC	1.50
CD4026BE	1.39	CD4076BE	1.05	74C163/40163PC	1.50
CD4027BE	.39	CD4078BE	.24	74C174/40174PC	1.40
CD4028BE	.39	CD4081BE	.24	74C175/40175PC	1.40
CD4029BE	.79	CD4082BE	.29	74C192/40192PC	1.50
CD4030BE	.37	CD4085BE	.75	74C193/40193PC	1.50
CD4033BE	1.60	CD4086BE	.75	74C195/40195PC	1.40
CD4034BE	2.95	CD4502BE	1.15		

### MOS AND BI-POLAR MEMORIES

P/N	Description	Price
C1702A	(1 Microsecond) 256 x 8 EPROM	8.95
C1702A	(1.5 Microsecond) 256 x 8 EPROM	5.95
C2708	1K x 8 EPROM (450 NS)	49.00
8080A	8 Bit MOS CPU (2 microseconds)	14.95
2102-1P	1K Static Ram 1024 x 1 (450 NS)	2.50
3342PC	Quad 64 Bit Static Shift Register	4.50
3347PC	Quad 80 Bit Static Shift Register	4.50
3411APC	4 x 64 MOS FIFO 1 Mhz Shift Register	4.50
TMS0117NC	Decimal Arithmetic Processor	10.00
LCM1001	Microprocessor Learning Module	149.95
TMS4024NC	64 x 9 FIFO	8.95
TMS4050NL	4K Dynamic RAM Plastic 300NS (18 Pin)	6.95
TMS4060NL	4K Dynamic RAM Plastic 300NS (22 Pin)	6.95
A55-1013P	8 Bit UART	6.95
SEMI 4804A	4K STATIC RAM 1024 x 4 (450 NS) single 5V supply	14.95
93415PC	1K RAM 40 NS Open Collector	11.00
AM2901DC	1K RAM 40 NS Tri-State	11.00
AM2902PC	4 Bit Bi-Polar Microprocessor slice	31.50
AM2905PC	Carry Look Ahead Circuit	3.18
AM2907PC	Quad 2 Input Bus Transceiver	8.10
	Quad Bus Transceiver with Tri-State Receiver and Parity	7.00
AM2909PC	4 Bit Cascadable Microprogram Sequencer	7.15
AM2918PC	Quad Deregister with Standard and Tri-State Outputs	4.32
F8 Kit	8 Bit Microprocessor Evaluation Kit with Software	185.00

### TEXAS INSTRUMENTS DATA BOOKS

LCC1011	Understanding Solid State Electronics	2.95
LCB1891	Software Design for Microprocessors	12.95
LCC4041	Power Data Book	3.95
LCC4112	TTL Data Book	4.95
LCC4131	Transistor and Diode Data Book	3.95
LCC4151	Linear and Interface I.C. Data Book	4.95
LCC4200	Semiconductor Memories Data Book	2.95
LCC4230	Optoelectronics Data Book	2.95
LCC4241	Linear Control Circuits Data Book	2.95

### FAIRCHILD DATA BOOKS

Power Data Book	3.00
Bi-Polar Memory Data Book	2.50
Linear Integrated Circuit Data Book	2.95
Low Power Schottky and Macrologic TTL Interface Data Book	1.75
Raytheon Linear Integrated Circuit Data Book	1.50
Sony State Scientific CMOS 'B' Series Data Book	2.50
Unitrode Semiconductor Data Book	4.95

### "ONLY MAJOR MANUFACTURERS SUPPLIED"

"This is a partial listing. Our complete catalogue lists many more device types & series which are available." "Our quality cannot be surpassed". "How can you beat the combination — the finest quality, current production, latest date code devices from the major manufacturers as Texas Instruments & Fairchild Semiconductor — At the lowest prices — Surely an unbeatable combination. Get the most value for your Dollar". Active Electronic provides the three essentials in Semiconductor Distribution —

1. QUALITY
2. INVENTORY
3. PRICE

We now offer the lowest mix pricing for major manufacturers devices only, with the largest variety of devices available from stock, from the source. We offer Rolls Royce quality at Volkswagen pricing.

### 1977 IC UPDATE MASTER MANUAL

Brand new. Complete integrated circuit data selector from all manufacturers. 1264 page master ref. guide to the latest IC's including microprocessors and consumer circuits. 17,000 cross references for easier sourcing of hard to get parts. \$29.95 with free update service.

New Fall 1977 Catalogue is now Available on Request

# Active Electronic Sales Corp.

P.O. BOX 1035 FRAMINGHAM, MASSACHUSETTS 01701  
Telephone Orders & Enquiries (617) 879-0077

NOW IN CANADA 5847 Ferrier st. 44 Faeken Dr-Unit 25  
2 Locations Montreal, Quebec Roxdale, Ontario  
Tel. (514) 735-6429 Tel. (416) 677-4287

MINIMUM ORDER \$10.00 \* ADD \$1.00 TO COVER POSTAGE & HANDLING \* Canadian customers add 30% for duty and handling. All federal and provincial taxes extra

CLASSIFIED ADVERTISING ORDER FORM

1	2	3
4	5	6
7	8	9
10	11	12
13	14	15
16	17	18
19	20	21
22	23	24
25	26	27
28	29	30
31	32	33
34	35	36

Please refer to heading on first page of this section for complete data concerning terms, frequency discounts, closing dates, etc. WORD COUNT: 15 WORD MINIMUM. Include name and address. Name of city (Des Moines) or of state (New York) counts as one word each. Zip Code not counted. Count each abbreviation, initial, single figure or group of figures or letters as a word. Symbols such as 35mm, COD, P.O., AC, etc., count as one word. Hyphenated words count as two words. Telephone numbers count as one word.

Words

\$2.25 (Commercial Rate)  
 \$1.35 (Reader Rate)  
 \$3.35 (Expand-Ad Rate)

Payment of \$ \_\_\_\_\_ enclosed for \_\_\_\_\_ insertions

AmEx  BAC

MC  Diners

CHARGE: for \_\_\_\_\_ insertions.  
 You will be billed monthly.



Account # \_\_\_\_\_ Expiration Date \_\_\_\_\_

Master Charge Interbank # (4 digits above name)

SIGNATURE MUST BE PROVIDED BELOW

PRINT NAME \_\_\_\_\_

ADDRESS \_\_\_\_\_

CITY \_\_\_\_\_ STATE \_\_\_\_\_ ZIP \_\_\_\_\_

SIGNATURE \_\_\_\_\_

PE-777

INSTRUCTION

LEARN ELECTRONIC ORGAN SERVICING at home all makes including transistor. Experimental kit—troubleshooting. Accredited NHSC, Free Booklet. NILES BRYANT SCHOOL, 3631 Stockton, Dept. A, Sacramento, Calif. 95820.

SCORE high on F.C.C. Exams... Over 300 questions and answers. Covers 3rd, 2nd, 1st and even Radar. Third and Second Test \$14.50; First Class Test, \$15.00. All tests, \$26.50. R.E.I., Inc., Box 806, Sarasota, Fla. 33577.

UNIVERSITY DEGREES BY MAIL! Bachelors, Masters, Ph.D's. Free revealing details. Counseling, Box 317-PE7, Tustin, California 92680.

SELF-STUDY CB RADIO REPAIR COURSE. THERE'S MONEY TO BE MADE REPAIRING CB RADIOS. This easy-to-learn course can prepare you for a career in electronics enabling you to earn as much as \$16.00 an hour in your spare time. For more information write: CB RADIO REPAIR COURSE, Dept. PE07, 531 N. Ann Arbor, Oklahoma City, Okla. 73127.

LEARN WHILE ASLEEP! HYPNOTIZE! Astonishing details, strange catalog free! Autosuggestion, Box 24-ZD, Olympia, Washington 98507.

GRANTHAM'S FCC LICENSE STUDY GUIDE — 377 pages, 1465 questions with answers/discussions — covering third, second, first radiotelephone examinations. \$13.45 postpaid. GSE, P.O. Box 25992, Los Angeles, California 90025.

INTENSIVE 5 week course for Broadcast Engineers. FCC First Class license. Student rooms at the school. Radio Engineering Inc., 61 N. Pineapple Ave., Sarasota, FL 33577 and 2402 Tidewater Trail, Fredericksburg, VA 22401.

LEARN BASIC Digital Troubleshooting by correspondence. Course includes text and demonstration modules. Educational Technologies, Box 224, Reynoldsburg, Ohio 43068.

HIGHLY EFFECTIVE Degree Program in Electronics Engineering. Advance rapidly! Our 31st Year. Free literature, Cook's Institute, Box 20345, Jackson, Miss. 39209

BURGLAR/FIRE ALARM EXPERTS NEEDED for cars, homes, industry. Learn high profit systems installation at home spare time. Simple, quick, complete. Free information by mail. No salesmen. Security Systems Management School (homestudy), Dept. 7373-077, Little Falls, N.J. 07424.

GET YOUR COMMERCIAL FCC License. New exams by author of successful published workbooks of FCC Practice Tests. 500 Questions Second Class, \$11.95; 200 First Class, \$7.95; 100 Radar, \$4.95; postpaid. Save, all three \$19.95. Complete mathematical solutions. Free counselling service. Victor Velay, P.O. Box 14, La Verne, Calif. 91750.

1977 TESTS-ANSWERS for FCC First Class License. Plus "Self-Study Ability Test." Proven! \$9.95. Moneyback Guarantee. "FREE" BROCHURE. Command, Box 26348-P, San Francisco 94126.

FCC License Preparation, Communications Electronics. Electronic Technology with Lab., Television Servicing. Free Catalog. Genn Tech., 5540 Hollywood Blvd., L.A., CA 90028.

For faster service

USE ZIP CODE

on all mail

**GODBOUT**  
 BILL GODBOUT ELECTRONICS  
 BOX 2355, OAKLAND AIRPORT, CA 94614

TERMS: Add \$0.00 orders under \$10. Allow up to \$5 for shipping, excess refunded. We require street address for COD. BankAmericard/Mastercharge\* (\$15 min) call 415-562-0636, 24h. CA res add tax.

**NEW 4K EconoROM \$265**  
 with editor, assembler, and monitor routines for the 8080

Improved listing, bigger and better...SP and PSW are now implemented for greater user facility. Very low power, quality board, sockets for all IC's, and so on...and out what moved Jay Bell, editor of Print-Out, to write

"Without a doubt, this board is the best buy I have made for my Altair 8800 out of the \$5000+ I've spent."

PRINT-OUT, September 1976

**CPU Power Supply \$45**

Gives 5V & 4A with crowbar overvoltage protection. +12V @ 1A, -12V @ 1A, and an adjustable 5-10V bias supply. Although intended for small computer systems, this is also a dandy little bench supply for digital experiments.

**CCc 8K EconoRAM II™ \$163.84**

Under \$6 per bit! Configured as two independent 4K blocks for maximum flexibility. Full buffering, tri-state outputs drive the S-100 bus or any bidirectional bus; low power Schottky support IC's plus selected RAMS give low power operation; chips along at 450 ns or better (use 1 wait state with C-80). Low profile sockets included for all IC's. Plate through, double-sided epoxy glass board.

**MM 10 Slot Motherboard \$ 85**

Includes 10 edge connectors, use as IMSAI add-on or for stand alone system. Active, regulated terminations minimize crosstalk, overshoot, and other bus problems. Epoxy glass board, quality parts, S-100 compatible, heavy power traces.

**RRR 18 Slot Motherboard \$ 118**

Same features as above, but with 18 slots + edge connectors.

**KKK Terminator Board \$ 29.50**

Add active terminations to your bus, and clean up the noise, crosstalk, ringing, and overshoot that can foul up data and crash programs. Plug into 1 slot of an S-100 compatible motherboard, and you are ready to go.

DEALER INQUIRIES INVITED



CIRCLE NO. 19 ON FREE INFORMATION CARD

**BULLET ELECTRONICS**  
 (214) 823-3740 P.O. BOX 19442P  
 DALLAS, TEXAS 75219

THE MK-05 MINI MOBILE is a compact 6 digit DC clock with a quartz xtal timebase and alarm capability. The readout is a magnified .125" LED calculator readout. Kit comes complete with all components, PC board and instructions. 12 hour format only. Do not be fooled by our low price, this is a quality time-piece with voltage and noise suppression. 2 1/2 x 2 1/2 x 1 1/2 \$12.95

Own the most unique electronic clock on the market! The MG-01 MINI GRANDFATHER has a swinging pendulum, matching tick-tock sound, and a pleasant bell-like chime that is adjustable in pitch, volume and sustain. The chime sounds and counts the hours (ie: 3 times for 3 o'clock). Kit comes complete with 2 plated and drilled PC boards (6.5"x4.5"). 7 CMOS integrated circuits and a 40 pin clock IC. Also included are switches, speaker, bright 4 digit .5" LED display with colon and all necessary electronic components. \$39.95 Kit (less case) Beautiful solid wood case over 8" tall custom cut for the MG-01 with ruby front filter and drilled rear panel. Available in WALNUT or ASH (please specify). \$18.95 finished, shipped un assembled

OUR CUSTOMERS WRITE ABOUT OUR CDI KIT:

"...great kit,"  
 "...unbeatable value", "...good design!"  
 "...fantastic kit and service. Send three more."  
 The CDI kit is all these things and more. Get in on a one-time deal. Complete electronics. \$9.95  
 Requires heatsink (not included) also works for voltage source for high intensity strobe.

MK-03 AIRCRAFT/CLOCK TIMER KIT.

You don't have to be a pilot to need the MK-03. If you want a mobile clock that offers: six 4" LED readouts, 24 hour real time readout, 24 elapsed-time readout, alarm, snooze, display blanking. Timer and clock share same set of readouts but are totally independent of each other. Timer has reset and freeze feature. Many other options are available. Sold less case and switches because of the various mountings and options available. \$26.95/complete electronics and boards less switches and case.

ULTRASONIC SENSER-RECEIVER KIT

A special buy on a high quality ultrasonic transducer allows us to offer this kit at a super price — but hurry, quantities are limited! You can build intrusion alarms, motion detectors, remote controls, echo ranging or liquid level measurement equipment. We supply the basic transmitter and receiver electronics including a drilled and plated PC board. The units work at 23KHZ with a range of 20 ft. and can be positioned opposite each other or side-by-side and bounced off a solid surface. The output will sink up to 300ma to drive a relay, alarm circuit, etc. ORDER US-01 \$19.95

AUTOMATIC TIME-OUT CIRCUIT for ultrasonic or mechanical switch alarms. Provides a five second entry delay. Sounds alarm for one minute, then re-arms itself. Requires 6-15VDC. \$3.95

TERMS: NO COD's \* Send check or M.O. \* Add 5% postage Tx. Residents add 5% sales tax \* Foreign add 10% (20% airmail) Orders under \$10. add 60c handling \* Repair service available Accepting phone orders on Master Charge and BankAmericard.

CIRCLE NO. 8 ON FREE INFORMATION CARD  
**POPULAR ELECTRONICS**

**DON'T FORGET OUR DISCOUNTS WHEN COMPARING PRICES**

**PRICE BREAKTHROUGH ON 74LS1'S**

74LS00	28	74LS30	28	74LS90	57	74LS157	75	74LS248	79
74LS01	28	74LS31	33	74LS92	57	74LS158	75	74LS249	79
74LS02	28	74LS32	33	74LS93	57	74LS160	102	74LS253	84
74LS03	28	74LS33	33	74LS94	57	74LS161	102	74LS257	75
74LS04	29	74LS34	28	74LS95	39	74LS162	102	74LS258	75
74LS05	29	74LS35	28	74LS96	39	74LS163	102	74LS259	75
74LS06	29	74LS36	28	74LS97	39	74LS164	102	74LS263	79
74LS09	29	74LS37	77	74LS114	39	74LS168	114	74LS290	65
74LS10	28	74LS38	28	74LS109	39	74LS169	114	74LS293	65
74LS11	28	74LS39	28	74LS112	39	74LS170	114	74LS296	65
74LS12	28	74LS40	28	74LS113	39	74LS174	134	74LS367	67
74LS13	47	74LS41	39	74LS114	39	74LS173	134	74LS368	67
74LS14	102	74LS42	67	74LS115	39	74LS174	134	74LS369	67
74LS20	28	74LS43	53	74LS116	75	74LS190	118	74LS386	39
74LS21	28	74LS44	39	74LS117	75	74LS191	118	74LS670	234
74LS22	28	74LS45	39	74LS118	75	74LS196	86	71LS95	77
74LS23	33	74LS46	39	74LS153	75	74LS197	79	71LS96	77
74LS27	33	74LS47	39	74LS154	75	74LS247	79	71LS97	77
74LS28	33	74LS48	39	74LS155	75	74LS247	79	71LS97	77

**INTEGRATED CIRCUITS - TTL, CMOS, LINEAR & MOS**

7400	21	7476	32	74181	215	4012	23	4520	114
7401	21	7480	70	74182	79	4013	40	4527	168
7402	21	7482	70	74184	219	4014	96	4528	88
7403	21	7483	70	74185	219	4015	96	4585	123
7404	21	7484	70	74186	350	2102-1	190	4586	123
7405	21	7486	28	74189	350	4017	105	8080A	70
7406	25	7489	219	74190	123	4018	105	CA3046	75
7407	25	7490	44	74191	123	4019	23	LM2111N	125
7408	21	7491	70	74192	88	4020	118	LM309K	180
7409	21	7492	44	74193	88	4021	114	LM324A	128
7410	21	7493	44	74194	88	4022	96	LM340T-5	125
7411	21	7494	44	74195	88	4023	23	LM340T-6	125
7412	21	7495	70	74196	88	4024	84	LM340T-7	125
7413	25	7496	70	74197	88	4025	23	LM340T-12	125
7414	89	74100	128	74198	149	4026	168	LM340T-15	125
7415	25	74101	30	74199	149	4027	40	LM340T-18	125
7416	25	74102	30	74201	149	4028	89	LM340T-24	125
7417	25	74103	33	74251	109	4029	114	LM3900N	88
7420	21	74121	35	74279	55	4030	23	LM3909N	69
7421	25	74122	44	74365	67	4031	51	MC1456W	100
7423	35	74123	61	74366	67	4032	114	MC1456V	100
7425	35	74125	40	74367	67	4034	50	MC1458V	53
7426	25	74126	40	74368	67	4035	114	MC1302P	115
7427	33	74132	70	8093	40	4040	114	NE536T	3.24
7428	28	74141	88	8094	40	4041	79	NE540L	2.04
7430	21	74145	70	9095	67	4042	79	NE555V	48
7432	25	74147	1.63	8096	67	4043	70	NE556A	48
7433	30	74148	1.30	8097	67	4044	70	NE560B	3.83
7437	25	74156	1.16	8098	67	4046	1.86	NE561B	3.83
7438	25	74157	1.16	75150	1.16	4049	40	NE562B	3.83
7440	21	74153	65	75430	88	4050	40	NE565A	1.25
7442	33	74154	63	75431	61	4051	26	NE566V	1.28
7443	33	74155	70	75432	61	4052	26	NE567V	1.36
7445	70	74156	63	75433	61	4053	1.26	uA709CV	44
7446	70	74157	70	75434	61	4060	1.58	uA710CA	44
7447	70	74160	88	75491	81	4066	79	uA711CA	53
7448	70	74161	88	75492	84	4071	23	uA722CA	60
7450	21	74162	88	75493	109	4072	23	uA733CA	75
7451	21	74163	88	75494	119	4073	23	uA741CV	44
7453	21	74164	88	82525	219	4075	23	uA747CA	70
7454	21	74165	115	4000	23	4081	23	uA748CV	49
7459	21	74166	126	4001	23	4082	23	uA7805CV	1.25
7460	21	74170	264	4002	23	4502	79	uA7806CV	1.25
7470	30	74173	1.42	4006	123	4510	114	uA788CV	1.25
7472	30	74174	98	4007	23	4511	105	uA7812CV	1.25
7473	30	74175	93	4008	79	4514	280	uA7815CV	1.25
7474	30	74176	79	4009	44	4515	280	uA7818CV	1.25
7475	49	74180	70	4011	23	4516	123	uA7824CV	1.25
				4012	23	4518	114		



**WIRE WRAPPING WIRE IN BULK**  
Red or Black 30 ga. Kynar

100'	\$2.00	500'	\$8.50	1000'	\$15.00
------	--------	------	--------	-------	---------

**SILICON DIODES**

1N4001	64/10	5.50/C	\$49/M
1N4002	66/10	5.60/C	\$51/M
1N4003	68/10	5.80/C	\$52/M
1N4004	70/10	5.95/C	\$54/M
1N4005	82/10	7.05/C	\$63/M
1N4006	90/10	7.75/C	\$69/M
1N4007	99/10	8.60/C	\$71/M
1N4148	40/10	3.50/C	\$29/M

**Double Digit Discounts Save You Even More!**

**1/2 WATT ZENER DIODES**

1N5228B	3.3v .15 111/C	1N5238B	7.5v .15 111/C
1N5227B	3.6v .15 111/C	1N5237B	8.2v .15 111/C
1N5228B	3.9v .15 111/C	1N5238B	8.7v .15 111/C
1N5229B	4.3v .15 111/C	1N5239B	9.1v .15 111/C
1N5230B	4.7v .15 111/C	1N5240B	10v .15 111/C
1N5231B	5.1v .15 111/C	1N5241B	11v .15 111/C
1N5232B	5.6v .15 111/C	1N5242B	12v .15 111/C
1N5233B	6.0v .15 111/C	1N5243B	13v .15 111/C
1N5234B	6.2v .15 111/C	1N5244B	14v .15 111/C
1N5235B	6.6v .15 111/C	1N5245B	15v .15 111/C

**BUY A-P PRODUCTS & BISHOP GRAPHICS FROM DIGI-KEY**

**SIGNETICS ANALOG MANUAL... \$9.95**

**PLESSEY SAMPLER**  
An Assortment of Metallized Polyester Capacitors

300 Caps 18 Values ..... \$26.00

**LED LAMPS**

NSLS053 T-1 1/4	.18	\$15/C
NSLS056 T-1 1/4	.18	\$15/C

**LED DUAL DIGITS**

**NEW!**

PRICED PER PAIR OF 2 DIGITS

NSN373 0.3"	CC	\$2.20/Pair
NSN374 0.3"	CA	\$2.20/Pair
NSN584 0.5"	CC	\$2.60/Pair
NSN584 0.5"	CA	\$2.60/Pair
NSN783 0.7"	CC	\$3.00/Pair
NSN784 0.7"	CA	\$3.00/Pair

ALL LEADS BROUGHT OUT FOR EASE OF APPLICATION



0.7" Digits Actual Size 1.25"x1.2"



0.3" Digits Actual Size 0.85"x0.8"



0.5" Digits Actual Size 1.05"x1.0"

**NEW! MA 1003 CAR CLOCK**

12 Hour Only  
12 Volt DC  
Crystal Time Base  
Bright Green Digits  
Assembled and Tested

**NEW - FOR CAR OR BOAT!**  
The MA1003 bright green fluorescent display offers a brilliance that cannot be achieved by LED displays, a feature that sold Detroit!

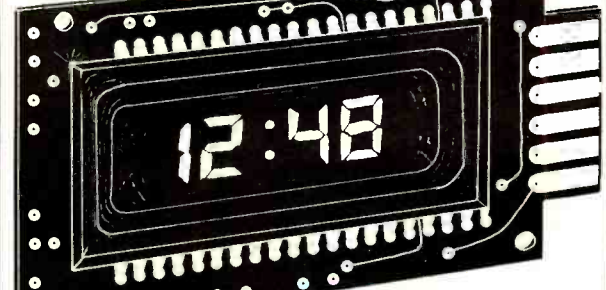

0.3" Digits Actual Size 1.75"x3.05" MA1003 \$24.95  
Includes 3 Push Button Switches

**MA1002 0.5" High Digits**

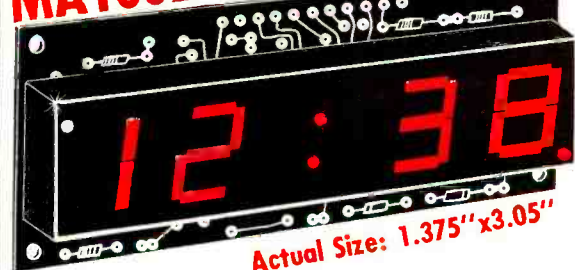

Actual Size: 1.375"x3.05"

MA1002A	12 Hour AM-PM	\$10.50
MA1002C	24 Hour	\$10.50
SPECIAL TRANSFORMER & SWITCHES ..... \$3.45		

**ABOUT OUR CLOCKS**

The MA1002 and MA1010 series clock modules by Mational Semiconductor are fully assembled and tested clocks using a 4 digit LED display and an MOS integrated circuit on the same board. Simply connect switches and our special transformer and you have a fully functioning clock.

The MA1003 clock module is a fully assembled and tested 12 hour clock using a high brilliance green fluorescent display and crystal time base making it perfect for car, boat or other portable use. It operates directly from 12 volts DC so no transformer is needed. Our price includes three push button switches for setting the time.

MA1002A	5" LED 12 Hour AM-PM Clock Module	\$10.50
MA1002A SET	Module with Transformer & Switches	\$13.95
MA1002C	5" LED 24 Hour Clock Module	\$10.50
MA1002C SET	Module with Transformer & Switches	\$13.95
MA1003	12 Volt Car Clock with Switches	\$24.95
MA1010A	3 1/2" LED 12 Hour AM-PM Clock Module	\$13.00
MA1010A SET	Module with Transformer & Switches	\$16.45
MA1010C	3 1/2" LED 24 Hour Clock Module	\$13.00
MA1010C SET	Module with Transformer & Switches	\$16.45

**MA1010 0.84" High Digits**



Actual size: 1.75"x3.75"

MA1010A	12 Hour AM-PM	\$13.00
MA1010C	24 Hour	\$13.00
SPECIAL TRANSFORMER & SWITCHES ..... \$3.45		

**SEND FOR OUR FREE CATALOG**  
WE STOCK A WIDE VARIETY OF PARTS NOT IN THIS AD PLUS MANY SPECIALLY PRICED BARGAINS!

**RADIAL ELECTROLYTICS**

47/50V .08	65/10	22/50V .12	100/10	330/25V .23	1.86/10
1/50V .08	65/10	100/6.3V .09	75/10	470/10V .21	1.71/10
2/250V .08	65/10	100/10V .10	77/10	470/16V .23	1.81/10
3/250V .08	65/10	100/16V .11	85/10	470/25V .29	2.35/10
4/735V .08	65/10	100/25V .13	110/10	1000/10V .24	1.96/10
4/750V .08	65/10	100/50V .21	171/10	1000/16V .29	2.35/10
10/16V .08	65/10	220/10V .13	108/10	1000/25V .42	3.33/10
10/25V .08	65/10	220/16V .15	116/10	2200/10V .42	3.33/10
10/50V .10	75/10	220/25V .21	171/10	2200/16V .54	4.30/10
22/16V .08	67/10	220/50V .29	235/10	2200/25V .58	4.67/10
22/25V .09	70/10	330/10V .15	116/10	3300/16V .89	7.14/10
		330/16V .21	116/10		

**AXIAL ELECTROLYTICS**

47/10V .11	90/10	33/25V .14	115/10	330/16V .29	2.35/10
1/30V .11	90/10	33/50V .19	152/10	330/25V .32	2.54/10
3.3/35V .12	95/10	47/16V .14	115/10	470/16V .23	2.55/10
47/25V .11	100/10	47/25V .17	126/10	470/25V .29	3.60/10
47/25V .11	90/10	47/50V .21	117/10	1000/10V .33	2.91/10
47/35V .12	95/10	100/10V .14	113/10	1000/16V .39	3.15/10
47/50V .12	100/10	100/16V .17	130/10	1000/25V .56	4.50/10
10/25V .12	100/10	100/			

**HIGH FIDELITY**

DIAMOND NEEDLES and Stereo Cartridges at Discount prices for Shure, Pickering, Stanton, Empire, Grado and ADC. Send for free catalog. LYLE CARTRIDGES, Dept. P, Box 69, Kensington Station, Brooklyn, New York 11218.

MUSIC GENERATOR—Real-time automatic composition and production of music. See Radio-Electronics, June, 1977 or write: Inner Space Electronics, Box 308, Berkeley, CA 94701.

**TUBES**

RADIO & T.V. Tubes—36 cents each. Send for free Catalog. Cornell, 4213 University, San Diego, Calif. 92105.

TUBES receiving, factory boxed, low prices, free price list. Transletronic, Inc., 1365 39th Street, Brooklyn, N.Y. 11218A, Telephone: 212-633-2800.

TUBES: "Oldies". Latest. Supplies, components, schematics. Catalog Free (stamp appreciated). Steinmetz, 7519-PE Maplewood, Hammond, Ind. 46324.

**BURGLAR ALARMS**

DIALING UNIT automatically calls police. \$29.95. Free security equipment catalog. S&S Systems, 5619-C St. John, Kansas City, MO 64123. (816) 483-4612.

**MUSICAL INSTRUMENTS**

UP TO 60% DISCOUNT. Name brand instruments catalog. Freepost Music, 114 G. Mahan St., W. Babylon, N.Y. 11704.

**SERVICES**

SWL's, CB's, HAM's. WDX will register your listening post and issue a certificate with call sign-type identification. Details for return postage from Monitor, P.O. Box 3333, Cherry Hill, N.J. 08034.

**GOVERNMENT SURPLUS**

MANUALS for Govt. Surplus radios, test sets, scopes. List 50 cents (coin). Books, 7218 Roanne Drive, Washington, D.C. 20021.

GOVERNMENT SURPLUS. Buy in your Area. How, where. Send \$2.00. Surplus, 30177-PE Headquarters Building, Washington, D.C. 20014.

JEEPS, TRUCKS, Typically from \$52.40 ... Automobiles, Boats, Motorcycles, Airplanes, Oscilloscopes. Tools, Clothing, Sports, Camping, Photographic, Electronics Equipment ... 200,000 Bid Bargains Nationwide Direct from Government ... Low as 2 cents on Dollar! Surplus Catalog and Sales Directory \$1.00 (refundable). National Surplus Center, 240 Eastcass-PEL, Joliet, Illinois 60432.

**WANTED**

GOLD, Silver, Platinum, Mercury wanted. Highest prices paid by refinery. Ores assayed. Free circular. Mercury Terminal, Norwood, MA 02062.

**Olson**

**ELECTRONIC PARTS AND ACCESSORIES**

**249 PH-331 REG. 2.99**

**Stereophones**  
• Comfortable, Light-weight  
• 25-18k Hz. Response  
• With 6-Ft. Cord & 1/4" Stereo Plug

**NICKEL CADMIUM "AA" Pen-Lite Cells**  
• Rechargeable  
For radios, calculators, etc. 1.2 Volt.

**BA-341 \$1 Ea.**

	Reg.	Sale
60 Min. Cassette, Pkg. of 3, TA-879	1.49	.87
2V. RED L.E.D., Pkg. of 5, PL-233	1.99	.59
40 Min. 8-Track Tape, TA-907	.69	.39
Elect. Cap. Kit, 50 Asst., CD-407	5.00	1.70
Black Light Bulb, XM-291	1.00	.49
CB Converter for Car, CB-417	14.99	9.99
Resistors 1/2-1 watt, Pkg. 100, RR-077	1.79	.79
Volume Controls, 12 Asstd. VC-274	1.00	.49
Empire 999 Mag. Phono Cart. PC-188	9.99	6.99
3-5V DC Hobby Motors, 5 Asstd. MO-333	2.00	.59
Solder Terminal Strips, 40 Asstd. XM-501	1.30	.50
Double Face Foam Tape 1/4"x52", TA-903	1.00	.80
1/4 RPM Timing Motor, 117 VAC, MO-277	.49	.30
Tape Mailers, 3" Pkg. 5, TA-936	.79	.39
Ceramic Disc Cap., 100 Asstd. CC-210	1.29	.80
Knob Kit, 25 Pcs. Asstd., KN-030	1.00	.69
3-Track Tape Deck Chassis, RA-383	17.00	12.99
7 Seg. L.E.D. Display Com. K., XM-414	2.00	1.00
Calculator Keys, 20 Asstd. XM-538	.75	.39
6V. 5A. Transformer TF-047	1.09	.49
2SB474 TO'66 Output Trans., TR-147	3.79	1.19

**Olson electronics**  
260 S. FORGE ST.  
DEPT. IZ AKRON, OHIO 44327

NAME \_\_\_\_\_  
ADDRESS \_\_\_\_\_  
CITY \_\_\_\_\_ STATE \_\_\_\_\_  
ZIP \_\_\_\_\_  Send Olson Cat.  
ENCLOSE POSTAGE AND SALES TAX

**EDLIE TUBE BONANZA**

**70% OFF LIST!**

1AD2	1.67	6AR5	.92
1B3	1.67	6AU4	2.07
1BC2	1.59	6AU5	2.54
1K3	1.67	6AU6	1.34
1S2A	1.04	6AU8	2.25
1U4	1.67	6AV6	1.16
1V2	1.02	6AW8	1.88
1X2B	1.64	6AX4	1.59
2AH2	1.67	6AY3	1.59
2AV2	1.32	6AZ8	3.37
2D21	1.95	6BA6	1.41
2GK5	1.65	6BA11	2.06
2HA5	1.43	6BC05	1.41
3AT2	1.65	6BE6	1.55
3BS2	1.79	6BH6	1.59
3CN3	1.74	6BH11	2.13
3CU3	2.06	6BJ6	1.74
3CY3	1.85	6BK4	3.14
3DJ3	1.79	6BK7	2.18
3GK5	1.62	6BL8	1.16
3HA5	1.61	6BM8	2.56
3HQ5	2.39	6BN6	1.07
3JC6	2.16	6BN8	1.73
3V4	2.30	6BN11	3.09
4AU6	1.67	6BQ5	1.65
4BZ6	1.49	6BQ7A	2.19
4CB6	1.16	6BR8A	2.24
4CD6	1.64	6BV11	2.48
4DE7	1.52	6BV6	1.56
4EJ7	1.58	6BZ6	1.32
4HS8	1.58	6C4	1.65
4JC6	2.15	6C5	3.28
4JD6	1.98	6CA4	1.70
4KE8	2.60	6CA7	2.34
4LJ8	1.91	6CB6	1.40
5AQ5	1.61	6CD6	2.98
5AR4	2.15	6CG3	1.65
5CG8	1.71	6CG7	1.28
5EW6	1.71	6CG8	1.82
5HG8	1.98	6CJ3	1.58
5GJ7	1.25	6CL3	1.70
5GS7	1.43	6CL6	1.18
5GX7	1.76	6CL8	2.04
5HZ6	1.26	6CM6	1.77
5JK6	1.77	6CM7	1.80
5JL6	2.10	6CS6	1.76
5KE8	2.60	6CUS	1.73
5LJ8	1.85	6CW4	4.17
5U4GB	1.31	6CW5	1.43
5Y3GT	1.38	6D6	2.39
5Y4GT	2.10	6DA6	2.10
6A8	4.70	6DJ8	2.50
6AB4	1.61	6DK6	1.55
6AC7	3.87	6DL4	2.39
6AC10	1.82	6DQ6	2.25
6AD10	3.86	6DT6	1.40
6AF4	2.31	6DW4	1.58
6AF9	2.39	6DX8	1.17
6AG7	4.53	6E5	3.90
6AH6	2.40	6EA8	1.65
6AJ8	2.10	6EB8	2.52
6AL3	1.28	6EH7	1.61
6AL5	1.37	6EJ7	1.50
6AM8	2.31	6EM7	2.37
6AN8	1.91	6EU7	1.70
6AQ5	1.43	6EW6	1.50
6AQ8	1.49	6EW7	2.51

**EDLIE TUBE BONANZA**

**BLY BRAND NEW MANUFACTURER'S BOXED TUBES** (Raytheon, Dumont, IEC Mullard, etc.) AT 70% OFF LIST!

**MONEY BACK GUARANTEE**

Terms: Minimum order \$10.00. Include postage. Either full payment with order or 30% deposit, balance C.O.D. F.O.B. Levittown, N.Y.

6FG6T	4.09	6JW8	1.41	7KY6	2.16
6FG6	1.43	6K6GT	1.71	7Y7	3.60
6FG7	2.40	6K7GT	2.40	8A8	1.13
6FM7	1.94	6K8	3.60	8AC9	2.43
6FQ7	1.28	6KA8	2.04	8AR11	3.12
6GE5	1.64	6KD6	3.54	8BA11	2.36
6GF7	2.24	6KE8	2.66	8BM11	3.39
6GH8	1.32	6KM6	3.54	8BQ11	2.49
6GJ7	1.25	6KT8	2.28	8BU11	2.42
6GK5	1.95	6KV6	2.81	8CB11	3.24
6GK5	1.47	6KZ8	1.71	8CG7	1.28
6GM6	1.76	6L6GB	2.57	8CW5	1.13
6GM8	3.30	6L6	4.50	8J8	1.13
6GS7	1.52	6L7	4.50	8J8	1.35
6GJ7	1.76	6LB6	3.38	8LT8	1.58
6GW8	1.47	6LE8	2.39	9AQ8	2.31
6GX5	1.46	6LF6	3.36	9H8	1.76
6CX7	1.92	6LF8	2.46	9JW8	1.32
6H6	3.33	6LH6	3.23	9KX6	2.16
6HA5	1.61	6LJ8	1.85	10CW5	1.43
6HB7	1.62	6LM8	2.04	10DX8	1.17
6HE5	2.01	6LN8	1.11	10GF7	2.18
6HF5	3.96	6LR6	3.23	10GK6	1.91
6HF8	2.28	6LT8	1.71	10GN8	2.01
6HQ5	2.13	6L8	2.01	10J78	2.16
6HS5	3.09	6LX8	1.11	10JH8	1.56
6HS6	2.66	6M11	3.30	10KR8	2.15
6HS8	2.00	6MB8	1.95	11AF9	2.39
6HV5	3.72	6MD8	2.46	11AR11	2.60
6HZ6	1.34	6MG8	1.41	11B8M	2.09
6J5GT	1.77	6SA7	3.74	11BT11	3.17
6J7	4.35	6SG7	3.95	11FY7	1.67
6J10	2.66	6SJ7GT	2.33	11KV8	2.31
6JB6	2.54	6SK7GT	2.40	11LQ8	2.27
6JC6A	1.88	6SL7GT	2.40	11MS8	1.71
6JD6	1.94	6SN7GT	1.59	12AB5	1.49
6JF6A	3.51	6SQ7GT	2.42	12AT6	1.19
6JF6	2.90	6T8A	2.01	12AT7	1.43
6JH6	1.50	6T10	2.36	12AU6	1.52
6JH8	2.64	6U8A	1.64	12A07	1.29
6JM6A	2.28	6U10	1.70	12AV6	1.08
6JM6	2.13	6V6	4.01	12AX7	1.32
6JSGC	3.12	6V6GT	1.92	12AZ7	1.83
6JTB	2.54	6X4	1.52	12B4	1.86
6JTB	2.01	6X5GT	1.55	12BA6	.22
6JUB	2.99	6X8	1.92	12BB6	1.28
6JUB	1.86	6X9	1.88	12BF11	2.49
6JY8	1.89	7F8	9.00	12BH7	1.67

**WRITE FOR FREE VALUE PACKED CATALOG**

**EDLIE DIGITAL COLOR CONVERGENCE GENERATOR BY SCIENCE WORK SHOP.** The miracle of Large Scale Integration (LSI) which made the low cost pocket calculator possible has now been applied to test equipment. A single monolithic P-channel MOS integrated circuit generates a composite video signal, complete with all sync and blanking pulses. Binary countdown from a single master clock oscillator (rather than 2 separate, unsynchronized oscillators) provides solid phase lock of all horizontal, vertical, and color signals. There are NO COUNTER ADJUSTMENTS! Using digital matrix switching techniques, 4 slide switches select any one of 16 patterns. A unique oscillator/modulator stage provides both RF and VIDEO output for troubleshooting circuits by signal injection. Also primarily intended for servicing Color TV sets, these compact (1 3/4" x 2 1/4" x 4") generators are excellent for amateur TV, computer terminals, closed circuit TV, video tape equipment, TV broadcast subsystems and cable TV work. TV station type sync. No counter adjustments. Crystal controlled chroma osc. Epoxy glass PC Boards. 2 year warranty video & RF output 3 color patterns. Model DB-12 (16 patterns) wired only \$64.95 Model DB12K in Kit form \$49.95 Model DB11 (13 patterns) wired only \$48.95 Model DB11K (13 Patterns) in Kit Form \$39.95 2 YEAR WARRANTY ON BOTH TYPES

**7400 TTL**

7400	.21	7442	1.08	74121	55
7401	.21	7443	1.15	74122	49
7402	.21	7450	2.50	74123	05
7404	.21	7451	27	74125	60
7405	.24	7453	27	74126	81
7406	.45	7454	41	74132	30
7407	.45	7460	22	74131	115
7408	.25	7472	39	74150	111
7409	.25	7473	45	74151	125
7410	.20	7474	45	74153	135
7411	.30	7475	80	74154	125
7413	.65	7482	175	74155	121
7416	.43	7483	115	74157	130
7417	.43	7485	112	74161	131
7420	.21	7486	45	74164	165
7422	1.50	7489	2.49	74165	165
7425	.43	7490	69	74166	170
7427	.37	7491	1.20	74174	95
7428	.33	7492	82	74175	95
7430	.26	7493	82	74180	105
7432	.31	7494	91	74181	355
7437	.47	7495	91	74191	1.50
7438	.40	7496	91	74195	1.00
7440	.21	74100	1.25	74197	1.00
7441	1.10	74107	49	74298	1.30

**5400 SERIES**

5400	1.00	5475	1.50
5404	1.25	5486	1.90
5410	1.00	5493	2.00
5426	1.25	54100	1.80
5473	1.50	54LS04	1.00

**MOTOROLA CIRCUITS**

MC725P	1.50	MC1741CG	98
MC740L	1.55	MC1804P	98
MC790P	1.50	MC1806P	98
MC832P	1.48	MC1810P	98
MC1004L	1.25	MC2053L	45
MC1008L	1.25	MC3004L	1.32
MC1010L	1.25	MC3006P	1.44
MC1011L	1.25	MC3007P	1.32
MC1036L	12.50	MC3021P	2.15
MC1037L	12.50	MC3021P	2.15
MC1352P	1.05	MC3062L	3.00
MC1406CP	3.95	MC4024P	2.20
MC1468L	2.90	MC14501CP	3.1
MC1469R	2.50	MC14502CP	1.18
MC1510G	8.00	MC14507CP	92
MC1514L	4.50	MC14510CP	2.40
MC1550G	1.50	MC14511CP	2.75
MC1558	4.37	MC14512CP	1.92
MC1595L	6.25	MC14519CG	94
MC1596G	3.31	MC14528CP	1.74
MC1723CG	1.25	MC4044P	4.80

**C MOS**

4001AE	29	4022AE	1.20
4002AE	29	4023AE	1.50
4007AE	29	4024AE	2.50
4009AE	58	4025AE	3.50
4010AE	58	4026AE	1.49
4011AE	29	4028AE	1.60
4012AE	29	4029AE	2.90
4013AE	52	4030AE	65
4015AE	125	4037AE	4.50
4016AE	65	4040AE	2.74
4018AE	110	4044AE	1.50
4019AE	65	4047AE	2.75
4020AE	1.75	4049AE	7.5
4021AE	1.50	4050AE	7.5

**MISC CIRCUITS**

BC184L	60	LM309K	1.95	SN15844N	55
CA3001	75	LM351AN	70	SN15946	65
CA3005	80	LM41CP	40	SN158097N	60
CA3006	110	LM1458M	65	SN72560P	4.50
CA3018	1.60	MFC9020	115	SN727410N	4.50
CA3018A	1.60	MRR95A	1.05	SN72741C	4.5
CA3026	2.15	MSC9967P1	50	SN72748P	.49
CA3035	2.45	N5558	55	UA703C	.95
CA3039	1.35	N8598B	5.00	UA709C	.40
CA3058	1.90	NE555V	4.5	USF7733393	2.40
CK707P	.45	PA771131	45	998979	6.50
CS134J	1.15	PL994551	45	998079	12.50
CS135J	1.20	RC14370B	35	998979	9.00
CS136E	1.25	SC9982P	70	936-5D	1.15
IC3(GE)	1.50	SC9986P	1.25	9313DC	1.20
LM301AN	.35	SN15830N	50	93L28DC	2.75

**POSITIVE VOLTAGE REGULATORS**

LM340K-5	1.95
LM340K-6	1.95
LM340K-8	1.95
LM340K-12	1.95
LM340K-15	1.95
LM340K-18	1.95
LM340K-24	1.95
LM340T0-5	1.75
LM340T0-6	1.75
LM340T0-8	1.75
LM340T0-12	1.75
LM340T0-15	1.75
LM340T0-18	1.75
LM340T0-24	1.75

**Negative REGULATORS AVAILABLE****JAPANESE CIRCUITS**

AN136	2.90	HA1312	4.05	STK056	11.35	TA7201P	6.40
AN203	3.75	HA1322	5.20	STK145	11.50	TA7203P	7.00
AN208	4.75	HA1339	5.20	TA7045M	3.50	TA7204P	6.50
AN210	3.10	LA1201	4.25	TA7054P	3.05	TA7205P	6.50
AN211	3.30	LA1364	4.70	TA7055P	5.50	TA78005M	2.50
AN214	4.90	LA1366	6.00	TA7060P	1.85	TA78005P	1.95
AN217	3.30	LA1367	5.90	TA7061P	2.25	TA78012M	2.50
AN229	6.35	LA3301	4.85	TA7149P	1.85	TA78012P	1.95
AN234	5.75	LA4030	4.85	TA7063P	2.25	TA78015M	2.50
AN239	6.50	LA4031P	3.50	TA7074P	4.90	TA78015P	1.95
AN241	3.20	LA4051P	4.65	TA7075P	4.90	TC9100P	12.00
AN245	6.50	T8A8105	3.50	TA7076P	4.55	UPC16C	2.50
AN274	3.95	LD3080	4.00	TA7089P	2.90	UPC20C	5.00
AN277B	3.40	LD3120	3.10	TA7102	5.15	UPC41C	3.95
AN288	4.80	LD3141	2.40	TA7106P	3.25	UPC48C	3.95
AN328	4.05	M5112	5.40	TA7120P	2.20	UPC554C	3.90
AN343	3.90	M5115PR	4.80	TA7120P-C	2.20	UPC563H2	8.00
BA511	3.50	M5155	2.85	TA7122AP	2.30	UPC566H	2.25
BA521	3.95	SG613	5.40	TA7124P	1.85	UPC575C	4.10
HA1158	6.30	STK011	10.50	TA7146P	4.10	UPC1001H2	5.15
HA1159	6.60	STK015	6.50	TA7150P	4.55	UPC1020H	5.50
HA1202	3.10	STK025	12.50	TA7153P	6.90	UPC1025	5.50
HA1306W	5.20	STK032	14.20	TA7200P	6.25		

**74L SERIES TTL**

74L00	33	74LS04	45	74LS113	98
74L10	33	74LS10	39	74LS138	1.99
74L30	33	74LS20	39	74LS174	2.50
74L42	1.50	74LS51	39	74LS366	5.30
74L86	69	74LS74	65	74LS153	2.25
74LS00	39	74LS112	65	74S387	1.95

**74H00 TTL**

74H00	33	74H11	33	74H53	39
74H01	33	74H20	33	74H55	39
74H04	33	74H21	33	74H73	59
74H05	35	74H30	33	74H74	59
74H10	33	74H40	33	74H76	60

**ELECTROLYTIC CAPACITORS**

2.2MF50	AXIAL LEADS	15
3.3MF10	AXIAL LEADS	15
3.3MF10	NO POLARITY	15
10MF25	AXIAL LEADS	15
10MF50	AXIAL LEADS	15
10MF150	AXIAL LEADS	20
25MF35	AXIAL LEADS	20
30MF25	AXIAL LEADS	15
47MF25	RADIAL LEADS	15
47MF50	RADIAL LEADS	20
100MF16	RADIAL LEADS	15
100MF25	RADIAL LEADS	20
500MF50	AXIAL LEADS	60
1000MF35	AXIAL LEADS	65

**CARBON RESISTORS**

Minimum 5 Pcs Per Value

QUANTITY	5-25	30-95	100-495
1/4w5%	.06	.05	.04
1/2w5%	.08	.07	.06
STANDARD RESISTANCE VALUES			
OHMS			
	270	820	4.7K 27K
	300	910	5.1K 33K
	330	1.0K	6.8K 47K
	51	470	1.5K 7.5K 100K
	100	510	2.2K 8.2K 330K
	150	560	2.7K 10K 1.0M
	220	680	3.3K 15K
	240	750	3.9K 22K

**JAPANESE TRANSISTORS \* CB. AUDIO. INDUSTRIAL**

2SA52	60	2SC206	1.00	2SC774	1.75	2SC1173	95	2SD777	1.00
2SA316	75	2SC240	1.10	2SC775	2.75	2SC1175	65	2SD81	3.25
2SA473	75	2SC291	65	2SC776	3.00	2SC1209	55	2SD88	1.50
2SA489	1.95	2SC292	3.00	2SC777	4.00	2SC1213	75	2SD118	3.25
2SA489	80	2SC320	75	2SC778	4.00	2SC1226A	1.25	2SD130	1.25
2SA490	70	2SC352	75	2SC781	3.00	2SC1237	4.50	2SD141	2.25
2SA505	70	2SC353	75	2SC783	1.00	2SC1239	4.00	2SD151	2.25
2SA564	50	2SC371	70	2SC784	70	2SC1243	5.50	2SD170	2.00
2SA628	65	2SC372	70	2SC785	1.00	2SC1293	85	2SD180	2.75
2SA643	85	2SC394	70	2SC789	1.50	2SC1306	4.75	2SD201	1.95
2SA647	2.75	2SC458	70	2SC793	2.00	2SC1307	5.75	2SD218	4.75
2SA673	85	2SC460	70	2SC796	3.15	2SC1308	4.75	2SD235	1.00
2SA679	3.75	2SC478	80	2SC797	2.50	2SC1317	60	2SD300	2.50
2SA682	85	2SC481	1.85	2SC798	3.10	2SC1318	70	2SD313	1.10
2SA699	1.30	2SC482	1.75	2SC799	4.25	2SC1325	4.95	2SD315	7.5
2SA699A	1.45	2SC491	2.50	2SC802	3.75	2SC1327	70	2SD316	2.50
2SA705	55	2SC495	1.10	2SC803	4.00	2SC1338	1.75	2SD317	1.25
2SA815	85	2SC497	1.60	2SC815	75	2SC1346	80	2SD318	9.5
2SA816	85	2SC502	1.50	2SC828	75	2SC1347	80	2SD325	1.25
		2SC515	80	2SC829	75	2SC1364	1.50	2SD341	9.5
2SB22	65	2SC517	4.25	2SC830	1.60	2SC1377	5.50	2SD350	3.25
2SB54	70	2SC535	75	2SC838	70	2SC1383	75	2SD352	8.0
2SB56	70	2SC536	65	2SC839	85	2SC1384	85	2SD380	5.70
2SB77	70	2SC537	70	2SC922	55	2SC1409	1.25	2SD389	7.5
2SB128	2.25	2SC563	2.50	2SC929	70	2SC1410	1.25	2SD390	7.5
2SB152	4.50	2SC662	65	2SC930	65	2SC1447	1.25		
2SB173	5.5	2SC614	3.80	2SC938	85	2SC1448	1.5	2SF8	3.00
2SB175	5.5	2SC615	3.90	2SC943	1.50	2SC1449	1.30	2SFC8	3.50
2SB178	1.00	2SC616	4.15	2SC945	65	2SC1475	1.50	2SFC6	1.25
2SB186	60	2SC617	4.25	2SC959	3.15	2SC1507	1.25	HEP53001	3.25
2SB187	60	2SC620	80	2SC960	2.75	2SC1509	1.25	JSP7001	7.5
2SB235	7.00	2SC627	1.75	2SC984	1.50	2SC1569	1.25	MRF8004	3.00
2SB303	5.5	2SC642	3.50	2SC996	4.90	2SC1674	1.75	MPS8000	1.25
2SB324	1.00	2SC643	3.75	2SC1010	80	2SC1675	1.75	MPS8001	1.25
2SB337	2.10	2SC644	70	2SC1012	80	2SC1679	4.75	MPSU02	5.0
2SB367	1.60	2SC681	2.50	2SC1013					

TREASURE FINDERS

SERICUS COIN SHOOTERS - Semtech's solid-state METL-SENSOR pin-points ALL metal objects...

TAPE AND RECORDERS

RENT 4-Track open reel tapes-free brochure. Stereo-Parti, P.O. Box 7, Fulton, CA 95401.

WE WILL BEAT any price sheet in America. Featuring TDK, MAXELL, and others. Tape World International...

8-TRACK AND CASSETTE BELTS - money back guarantee. Long wearing. Free Catalog - \$3 minimum order.

LP's, TAPES, Current, Cutout, Imports, Catalogs \$1; Beatles LP-Tape Sale. NERT, Box 268-PE, Lawrence, Mass 01842.

HOME ENTERTAINMENT FILMS

MIDSUMMER FILM SALE - Ali vs. Inoki (The Boxer vs. the Wrestler or Karate vs. Ali) Super 8 B&W SPECIAL \$6.95 ea PPD...

PERSONALS

MAKE FRIENDS WORLDWIDE through international correspondence. Illustrated brochure free. Hermes-Verlag, Box 110660-G, D-1000 Berlin 11, Germany.

WARTS. Vergo Cream is painless, safe, easy, gentle. Buy Vergo at better pharmacies.

INVENTIONS WANTED

INVENTORS: Manufacturers Need New Products. Free "Recommended Procedure," by a creative fee-based invention service company.

INVENTORS

RECOGNITION... FINANCIAL REWARD... OR CREDIT FOR "INVENTING IT FIRST" MAY BE YOURS!

If you have an idea for a new product, or a way to make an old product better, contact us. "The idea people" will develop your idea...

Write now without cost or obligation for free information. Fees are charged only for contracted services. So send for your FREE "Inventor's Kit..."

RAYMOND LEE ORGANIZATION 230 Park Avenue North, New York, NY 10017 At no cost or obligation, please rush my FREE "Inventor's Kit No. A-112"

Name, Address, City, State, Zip, Phone No., Area Code

BUSINESS OPPORTUNITIES

I MADE \$40,000.00 Year by Mailorder! Helped others make money! Free Proof. Torrey, Box 318-NN, Ypsilanti, Michigan 48197.

FREE CATALOGS. Repair air conditioning, refrigeration. Tools, supplies, full instructions. Doolin, 2016 Canton, Dallas, Texas 75201.

MAILORDER MILLIONAIRE helps beginners make \$500 weekly. Free report reveals secret plan! Executive (1K7), 333 North Michigan, Chicago 60601.

GET RICH with Secret Law that smashes debts and brings you \$500 to \$5 Million cash. Free report! Credit 4K7, 333 North Michigan, Chicago 60601.

HIGHLY SPECIALIZED ONE-MAN ELECTRONIC FACTORY Investment unnecessary, knowledge not required, sales handled by professionals.

P.O. Box 4430C Santa Clara, CA 95054 (408) 988-1640

Same day shipment. First line parts only. Factory tested. Guaranteed money back. Quality IC's and other components at factory prices.

INTEGRATED CIRCUITS

Table listing various integrated circuits with part numbers, quantities, and prices.

INTERFACES

Table listing various interface components with part numbers, quantities, and prices.

QUEST ELECTRONICS

Table listing various electronic components with part numbers, quantities, and prices.

Not a Cheap Clock Kit \$17.45 Includes everything except case. 2-PC boards, 6-50' LED Displays, 5314 clock chip, transformer, all components and full instructions.

Plexiglas Cases Black or white with red bezel in clock sizes. \$5.95

Digital Temperature Meter Kit Indoor and outdoor. Automatically switches back and forth. Beautiful. 50' LED readouts. Nothing like it available.

Variable Power Supply Kit 0-12 VDC @ 1/2 A, 7.1% line, load regulation. Remote sense capability. Constant voltage/circuit limit can be modified for other V/I ranges.

1977 IC Update Master Manual Brand new. Complete integrated circuit data selector from all manufacturers. 1234 page master ref guide to the latest IC's including microprocessors and consumer circuits.

TERMS: \$5.00 min. order U.S. Funds. Calif residents add 6% tax. BankAmericard and Master Charge accepted. Shipping charges will be added.

Function Module Card Kit Converts any frequency counter into 3 1/2 digit DVM, digital thermometer, pulse & square generator from 10 Hz to 100 kHz. Complete kit minus power supply. \$25.00

VOLUME SPECIALS MM5562 2K RAM Divder 1.00 2102-1 500 MS 1K RAM 1.80 303113 150 MS 4K RAM 6.00 Momentary Pushbutton Switch 50 .29

30 Mhz Frequency Counter Kit Crystal time base. Covers audio, amateur and CB band. 6.5" digits, prescalable with PC board and full instructions. \$55.00 Fully wired and tested. \$75.00

Stopwatch Kit \$26.95 Full six digit battery operated. 2-5 volts. 3.2768 Mhz crystal accuracy. Times to 59 minutes, 59 seconds, 99 1/100 hrs. Times standard, split and Taylor. 7205 chip, all components minus case. Full instructions. White or black plexiglass case. \$55.00

COSMAC 'ELF' RCA CMOS Microcomputer CDP1802 CD \$29.50 Users Manual \$7.50 Complete kit of parts to build the "ELF" including CDP1802 and users manual as listed in August '76 Pop. Elect. minus power supply and board. \$92.00

Hobbyist Electronics Course Beginning course in practical electronics, no theory. Lab experiment format. 12 lessons, can be purchased one at a time. \$10.00 per lesson

60 Hz Crystal Time Base Kit \$4.75 Converts digital clocks from AC line frequency to crystal time base. Outstanding accuracy. Kit includes: PC board, MM5369, crystal, resistors, capacitors and trimmer.

Volt/ohm Probe Batt. oper. AC/DC to 125 V, 2 pos. volt, and 2 neg. volt, plus continuity. Stainless steel, pocket size comp. assem. \$34.95

Digital Thermometer \$65.00 General purpose or medical 32-230°F. Disposable probe cover ±.2° accuracy. Completely assembled w/compact case.

2.5 Mhz Frequency Counter Kit As low as 10 Hz 6-50" digits with PC board and full instructions. \$40.00

Auto Clock Kit \$15.95 DC clock with 4-50" displays. Uses National MA1012 module with alarm option. Crystal time base PC boards and full instructions. Add \$3.95 for a beautiful dark gray case ready to install. This is the best value available anywhere!

HOW TO MAKE \$2,000 WEEKLY at home using other people's money. Guaranteed. Free Details. Richieu, Box 25357, Dept. F7, Houston 77005.

NEW LUXURY Car Without Cost. Free Details! Codex-ZZ, Box 6073, Toledo, Ohio 43614.

MAKE BIG MONEY in spare time selling: Tubes, Antennas, Speakers, Test Equipment, Lite Bulbs, Hi-Fi, etc. No investment. Free information: Allied Sales, Pimento, IN 47866. (812) 495-6555.

MECHANICALLY inclined individuals desiring financial independence operating Small Electronics Manufacturing Business without investment. Write: Marks, 92-K7 Brighton 11th, Brooklyn, New York 11235.

\$500.00 WEEKLY! IMMEDIATE, GUARANTEED income stuffing envelopes. FREE Supplies! Interested? Send 25 cents stamp. Profis, B725-PE7, Belen, N.M. 87002.

FREE REPORT: Big Money In Mail! Transworld-9K, Box 6226, Toledo, Ohio 43614.

HOW TO BORROW \$25,000 interest-free!...Indefinitely! Free Report: Executive-PE7, Box 368, Buford, Georgia 30518.

MAGNETS All types. Specials-20 disc, or 10 bar, or 2 stick or 8 assorted magnets. \$1.00. Magnets, Box 192-H Randallstown, Maryland 21133.



# Radio Hut

Money back guarantee. NO COD'S. Texas residents add 5% sales tax. Add 5% of order for postage and handling. Orders under \$15.00 add 75 cents. Foreign orders add 10% for postage.

For your convenience, call your BankAmericard or Master Charge orders in on our Toll Free Watts Line: 1-800-527-2304. Texas residents call collect: 1-214-271-8423.



P. O. Box 64783P  
Dallas, Texas 75206



Memorex computer boards with IC's, diodes, transistor, etc. 5 Boards containing 100 - 200 IC's  
**ONLY \$4.25**

BRIDGE RECTIFIERS		
6 Amp	50V	1.10
10 Amp	50V	1.25
25 Amp	50V	1.39

### RESISTORS

Over 50,000,000 in stock

*330 ohm	22K ohm
470 ohm	27K ohm
*680 ohm	33K ohm
1K ohm	39K ohm
1.2K ohm	43K ohm
2.2K ohm	47K ohm
3.3K ohm	82K ohm
4.7K ohm	100K ohm
6.8K ohm	150K ohm
10K ohm	220K ohm
20K ohm	

\*1/8 W only  
\*1/2 W only

All resistors are P.C. Lead but are not pull offs.  
100 min order for each value

NO MIX 100/99

**MK 5005**  
4 digit counter/latch decoder; 7 segment output only. 24 pin dip with specs.  
**\$ 8.00 EACH**

**UNSCRAMBLER KIT**  
for all Scanners

- Tunes easily
- Full instructions included
- Easy to install
- 3 1/2" x 3 1/2" x 1 1/2"

**Only \$19.95**

### PLASMA DISPLAY KIT

Kit Includes: 12 digit display .4" Character Power supply for display above Complete specs for hookup.

Line cord Not Included. **ONLY \$ 3.95**



### SPECIAL DEVICES

82S23	2.19
2513	10.00
MK4102-1	.99

### PROJECT CASES

Small	Med.	Large
\$1.50	\$2.00	\$2.75
D 2 1/2"	D-2"	D-2-1/2"
W-4 3/4"	W-4 7/8"	W-7"
H 1 7/8"	H 3 1/2"	H-4"

All cases have a sloped front, white with black wrinkle finish.

### REGULATORS

7805	7818
7806	7824
7808	7905
7812	7912
7815	7915

**Your Choice \$ .95**

### READOUTS

**Best Value!**

FND70 .4"C.C. .59  
FND800 .8"C.C. 1.69  
TI 6 digit array C.C. 3/1.00  
MAN 8 .3"CA Yellow .89  
LT767 .7" C.C. 4 digit stick **\$ 3.95**

### WATERGATE SPECIAL

Telephone Relay automatically starts and stops tape recorder. No batteries required. Kit complete with drilled P.C. Board.  
**Parts and Case ONLY \$ 10.95**



### CLOCK KIT

Kit includes  
- LT701 clock module  
• Power Supply  
• Punched Case  
• 12 or 24 hour operation

Complete except for line cord

LT701E	12 hour clock
LT701G	24 hour clock

**ONLY \$ 14.95**



### VARIABLE POWER SUPPLY KIT NO. 1

\*Continuously variable from 5V to 20V  
\*Excellent regulation up to 500 mil.  
\*4400 Mfd of filtering  
\*Drilled fiberglass PC Board  
\*One hour assembly  
\*Kit includes all components  
\*Case Included **ONLY \$10.95**

### VARIABLE POWER SUPPLY KIT NO. 2

Same as above but with 1 amp output, also with case. **ONLY \$13.95**

### BATTERY CLIPS

Standard 9V battery clip with 4-1/2" tinned leads. **25/\$1.00**

### TRANSISTORS - DIODES

*MJE1103	3/1.00
MJ3001	1.30
2N2222	6/1.00
2N2169	6/1.00
*2N2905	4/1.00
*2N2907	15/1.00
*2N3906	6/1.00
*2N4300	6/1.00
*2N4433 SCR	3/1.00
1N4004	15/1.00
1N4007	10/1.00
1N4148 (1N914) 20/1.00	
3N201 VHF Pre amp .50	
D40C1 Power Darl - 8/1.00	

\*House numbered and P.C. Lead

### PC BOARDS

4 digit PCB for FND800 or 807	2.50
6 digit PCB for FND800 or 807	3.50
4 digit PCB for DL707	1.50
6 digit PCB for DL707	2.00
4 digit PCB for FND503 or 510	2.00
6 digit PCB for FND503 or 510	3.00
4 digit PCB for DL747	2.50
6 digit PCB for DL747	3.00
4 digit PCB for DL727 or 728	2.00
6 digit PCB for DL727 or 728	3.00
4 digit PCB for FND359 or 70	1.75

NOTE: All PC Boards are multiplexed for adding additional digits.

### HARDWARE

New, includes 2-56, 4-40, 6-32 and 8-32 screws and nuts. A very usable selection.  
1/2 pound \$1.50  
1 pound \$2.60

### L S

74LS00	.25
74LS02	.25
74LS04	.30
74LS08	.25
74LS10	.25
74LS11	.32
74LS20	.31
74LS21	.33
74LS22	.33
74LS27	.30
74LS30	.31
74LS32	.33
74LS37	.40
74LS38	.35
74LS74	.49
74LS90	.85
74LS132	.90
74LS138	.89
74LS139	.89
74LS155	.90
74LS157	1.00
74LS162	1.39
74LS163	1.39
74LS175	1.09
74LS193	1.09
74LS258	1.09
74LS367	.70
74LS368	.70

### CMOS SALE

4020	.85	4046	.90
CD4000	.16	CD4040	1.00
CD4001	.16	CD4041	.69
CD4002	.16	CD4042	.59
CD4007	.16	CD4043	.60
CD4009	.45	CD4044	.59
CD4010	.45	CD4047	.59
CD4011	.16	CD4049	.35
CD4012	.16	CD4050	.35
CD4013	.29	CD4051	.90
CD4014	.75	CD4053	.90
CD4015	.75	CD4056	1.00
CD4016	.29	CD4058	.90
CD4017	.80	CD4060	1.00
CD4018	.80	CD4066	.69
CD4019	.39	CD4069	.30
CD4021	.90	CD4071	.16
CD4022	.90	CD4076	.99
CD4024	.70	74C04	.29
CD4025	.19	74C107	.29
CD4027	.39	CD4116	.39
CD4028	.75	CD4507	.40
CD4029	.99	CD4512	.50
CD4030	.16	CD4516	.85
CD4034	2.30	CD4518	.85
CD4035	.99	CD4520	.85

### T T L

7400	.17	7473	.21
7401	.17	7474	.35
7402	.17	7475	.55
7403	.17	7476	.35
74H04	.25	7480	.45
7404	.17	7483	.76
7406	.25	7485	.89
7408	.17	7486	.35
7409	.17	7490	.71
7410	.17	7491	.71
7411	.25	7492	.71
7413	.45	7493	.67
7420	.17	7494	.90
7421	.17	7495	.71
7423	.35	7496	.85
7425	.27	74100	.96
7426	.25	74121	.31
7427	.17	74123	.61
7430	.25	74125	.44
7432	.30	74141	.71
7437	.35	74145	.97
7438	.35	74151	.71
7440	.17	74153	.81
7442	.60	74154	.97
7443	.60	74161	.91
7444	.65	74163	1.05
7446	.85	74164	1.05
7447	.81	74174	.91
7448	.81	74175	1.40
7450	.20	74180	.76
7451	.17	74181	2.25
7453	.17	74191	1.20
7454	.17	74192	1.20
7470	.35	74193	.95
7472	.21	74195	.65

### LINEARS

LM301	.30
LM307	.30
LM309K	.95
LM311	.85
LM377	1.85
LM380 (8 pin)	.75
LM3900	.30
LM710	.25
LM711	.25
LM723	.40
LM741	.25
LM748	.25
NE553	1.95
NE555	.40
NE556	.95
NE565	.95
NE566	.95
NE567	1.10
1458	.49
RCA3043	.75
75491	.30
75492	.30

### 60 Hz L(•)(•)K

**Crystal Time Base Kit** - Kit enables a MOS clock circuit to operate from a DC power source. Ideal for car, camper, van, boat, etc.  
60Hz output with an accuracy of .005% (typ.) Low power consumption 2.5 ma (typ.). Small size will fit most any enclosure. Single MOS IC oscillator/divider chip 5-15 volts DC operation.  
**ONLY \$ 5.95**  
**2 for \$10.00**

### RADIO HUT GUARANTEE

If you are not satisfied with any of our products **NO MATTER WHAT THE REASON** we offer you a full money back guarantee if the product or products are returned within 14 days after you receive them.

**ORDER BY PHONE.** Charge your order to BankAmericard or Master Charge.  
**USE OUR TOLL FREE WATTS**  
**1-800-527-2304**



# Poly Pak's EXCLUSIVE SURE-FIRE WAY TO FIGHT BARREL KITS



Test 'em yourself 'n save! Includes 100% material, too! **INFLATION!** Each kit carries a money-back guarantee.

<b>BARREL KIT #239 SHIELDED CABLE</b> 50-ft. <b>\$1.98</b> For mikes, stereos, 1-cond. plus shield, 22 ga. vinyl jacket. Wt. 1 lb. 7E3577	<b>BARREL KIT #230 HALF INCH READDUTS</b> 7E3629 <b>15 for \$1.98</b> From factory to you! Includes Fairchild PND-500 & 607's.	<b>BARREL KIT #225 SOUND TRIGGERS</b> 3 for <b>\$1.98</b> "Hand clamp" sensitive crystal mike amplifier, trigger. SCR. Cat. No. 7E3625	<b>BARREL KIT #221 IC SOCKETS</b> 8 for <b>\$1.98</b> hobby Mfr. untested! Four 14-pin, four 18-pin. Solder tail, up-profile. No. 7E3621	<b>MIXED READDUTS</b> 15 for <b>\$1.98</b> KIT #219 Barrels of untested 177, 367, 600, 603, MAN-3's. Put a buy! No. 7E3619	<b>BARREL KIT #205 MINI BLDCK CAPACITORS</b> <b>50 for \$1.98</b> Unbelievable! Worth \$50. High precision submini caps for all applications. Wt. 1 lb. Cat. No. 7E3628	<b>BARREL KIT #203 CALCULATOR KEYBOARDS</b> <b>10 for \$1.98</b> It's true! 20-key, 4 function keyboards at ridiculous give-away. Wt. 12 ozs Cat. No. 7E3524
<b>BARREL KIT #210 A/GLOWIN' PANELS</b> 3 for <b>\$1.98</b> 4" x 1" panels that glow blue-green with 110VAC. Use for nit. lites, indicators, etc. Cat. No. 7E3550	<b>100 for KIT #198</b> <b>\$1.98</b> #202 <b>PLUGS, SOCKETS.</b> Distributor unload! Includes AC, DC, RF, audio, 1/8 in. all kinds. Wt. 1 lb. Cat. No. 7E3527	<b>BARREL KIT #201 6V INDICATORS</b> w/leads <b>15 for \$1.98</b> Test lamp manufacturer dumps inventory! Worth 60¢ ea. Like grain-o-wheat. Cat. No. 7E3526 hobby	<b>BARREL KIT #200 9 DIGIT READDUT MODULES</b> <b>5 for \$1.98</b> with calculator driver chips beneath epoxy Cat. No. 7E3515	<b>BARREL KIT #198 TRANSISTORS &amp; DARLINGTONS</b> <b>50 for \$1.98</b> Motorola premium 1,000,000 TO-220 in barrels. NPNs & PNP's. Cat. No. 7E3533	<b>BARREL KIT #191 CARBOFILM RESISTORS</b> <b>800* for \$1.98</b> 1/2 pound, approx. 1/8, 1/4 watters. Ass't. values. Unmarked. Cat. No. 7E3545	<b>BARREL KIT #188 400 Parts \$1.98</b> Includes resistors, caps, transformers, rectifiers, diodes, etc. Preformed, dumped into barrels by factory. 100% Cat. No. 7E3401
<b>BARREL KIT #187 AUDIO IC'S</b> <b>30 for \$1.98</b> National & Sprague, 2 to 4 watters, LM-380, LM-377, 2277, etc. DIPs, some with heat sinks. Untested. Cat. No. 7E3392	<b>BARREL KIT #185 400 parts \$1.98</b> parts: 60 transistors, 50 capacitors, diodes, etc. Cat. No. 7E3388	<b>BARREL KIT #184 1/4-WATT METAL FILM</b> <b>150 for \$1.98</b> 100% metal film resistors. Long leads. 7E3413	<b>BARREL KIT #182 JUMBO RED LEOS</b> <b>15 for \$1.98</b> 100% material, user cancellation from factory dumps. 3V 10 mils. For 100's of projects, red lens. Cat. No. 7E3369	<b>BARREL KIT #163 MINI TRIM POTS</b> <b>30 for \$1.98</b> Asst. values 100 to 1 meg. What a buy. Single turn. 1/4 Wt. 6 oz. 7E3345	<b>BARREL KIT #161 POP PLASTIC TRANSISTORS</b> <b>25 for \$1.98</b> 2N series with same 2N3906's of 100% material. TO-92. Preformed. Cat. No. 7E3343 1 oz.	<b>BARREL KIT #160 V. REGULATORS</b> <b>10 for \$1.98</b> No. 7E3330 LM309KC TO-3 V.R.'s barreled. Bot by the pound.
<b>BARREL KIT #159 MODULAR SWITCHES</b> <b>25 for \$1.98</b> Centralab switches, TV-makers extra. Dpdt. 6pdt. etc. Brand new. Cat. No. 7E3150	<b>BARREL KIT #158 MAGNIFIO MAN-3's</b> <b>20 for \$1.98</b> MAN-3's 7-seg readout, with built-on magnifier. Factory discontinued line. 100% material. Cat. No. 7E3325 1 oz.	<b>BARREL KIT #155 MOLDED CAPACITORS</b> <b>75 for \$1.98</b> 7E3311 Asst. size voltage, red, green, yellow, blue plastic cases, axial leads. 1 lb.	<b>BARREL KIT #154 CLOCK CHIPS</b> <b>20 for \$1.98</b> hobby We gathered an assortment of clock chip, alarm, calendar, beepers, who knows, all mixed. Cat. No. 7E3308	<b>BARREL KIT #145 MINI TRANSFORMER</b> <b>15 for \$1.98</b> outputs, inter-stage, and audio. 1/2 to 1000 VA. Sq. Wt. 2 lbs. 7E3294	<b>BARREL KIT #144 RCA PHONO PLUGS</b> <b>40 for \$1.98</b> 1,000,000 RCA phono plugs for this one. You hi-fiers know what they are. 100% material. 7E3293	<b>BARREL KIT #138 PANEL SWITCHES</b> <b>30 for \$1.98</b> Did you hear of OAK? Another eqpt maker barreled all types of rotary, electric, slider, etc. 7E3268
<b>BARREL KIT #135 MICRO MINI LAMPS</b> <b>20 for \$1.98</b> 1 oz. Imaginal Micro size (1/4 x 1/4) with wire leads in tin. 5 VDC. 40 mils. 7E3259	<b>BARREL KIT #128 MINI DIP IC'S</b> <b>100 for \$1.98</b> Large mfr dumped 100's of lbs into barrels. Includes 741's, LM-380-8, 703, 667, 555, 558—but who knows? Wt. 1 lb. 7E3245 hobby.	<b>BARREL KIT #127 AXIAL ELECTROS</b> <b>40 for \$1.98</b> Asst. capacities and voltages. Cat. No. 7E3227	<b>BARREL KIT #126 UPRIGHT ELECTROS</b> <b>40 for \$1.98</b> 1mf to 300mf in mixture of voltages. 100% marked n good. 7E3226	<b>BARREL KIT #118 MINI SCRS</b> <b>50 for \$1.98</b> UNBELIEVABLE! TO-92 plastic SCRS in barrels. Rise from factory. Includes all voltages up thru 200 pvt. 7E3135	<b>BARREL KIT #117 20-MIL OPTICAL FIBERS</b> <b>200 FT. \$1.98</b> Fiber optic factory bankruptcy purchase! High quality. Most-commonly used size (20-mil). CLEAR.	<b>BARREL KIT #115 100% GOOD SOCKETS</b> <b>200 for \$1.98</b> Cat. No. 7E3142 Calculator maker dump! We got a zillion of 'em.
<b>BARREL KIT #112 MICRO MINI LEDS</b> <b>40 for \$1.98</b> Hobby All the tiny leds, axial, upright of Monsanto, Litronix, variety of colors. Yield 80% or better. 7E3138	<b>BARREL KIT #108 TERMINAL STRIPS</b> <b>100 for \$1.98</b> Wide asst. of terminal strip connectors, from 1 contact curved line. 100% material. Strip manufacturers barrel dump is your gain. Wt. 1 lb. Cat. No. 7E3136	<b>BARREL KIT #108 PLASTIC TRANSISTORS</b> <b>40 for \$1.98</b> Includes PNP, NPN, 2N-3048, 2N3641, 2N5000 series, etc. Untested.	<b>BARREL KIT #104 SLIDE VOLUME CONTROLS</b> <b>10 for \$1.98</b> Cat. No. 7E3057	<b>BARREL KIT #101 RESISTOR SPECIAL</b> <b>200 for \$1.98</b> Includes: 1/8, 1/4, 1/2, 1, 2-watt, carbon, 8 oz. 100% good. 7E3054	<b>BARREL KIT #99 PHOTO ELECTRIC CELLS</b> <b>10 for \$1.98</b> Asst. GE types, CDS types. Mixed by factory. Big job for us to separate. 100% good. Cat. No. 7E3052	<b>BARREL KIT #93 HALF WATTERS</b> <b>200 for \$1.98</b> Resistor factory tried to fool us by mixing 100% color-coded resistors in bins. Double bin, there's there. 4 oz. 7E3046 Untested
<b>BARREL #91 SILVER MICAS</b> <b>100 for \$1.98</b> Axial, red case, variety of physical sizes & values. Cat. No. 7E3018	<b>BARREL KIT #88 LITRONICS LED READDUTS</b> <b>10 for \$1.98</b> Hobby singles, triplicates, etc. 33 to 0.6. Hot from factory. All mixed have fun! No. 7E2861	<b>BARREL KIT #87 NATIONAL IC BONANZA</b> <b>100 for \$1.98</b> Types: 5000, 7400 series, TTLs, ROMs, registers, clock & calc. chips, linears, etc. Cat. No. 7E2860 Untested.	<b>BARREL KIT #86 HOBBY LEDS</b> <b>40 for \$1.98</b> Untested 747's, 727's, singles, triplicates, etc. 33 to 0.6. Hot from factory. All mixed. Have fun! 7E2859	<b>BARREL KIT #83 LM-340T VOLT REG</b> <b>15 for \$1.98</b> Factory rejected item for length of leads. May include 5, 6, 7, 8, 12, 15, 18, 24 volt-power tab. Cat. 7E2635	<b>BARREL KIT #81 SUBMINI RESISTORS</b> <b>200 for \$1.98</b> PC, upright type, color coded, 1/4 watt. Asst. values. Want to use in a barrel. Cat. No. 7E2746 100% good.	<b>BARREL KIT #78 1-WATT ZENERS</b> <b>100 for \$1.98</b> Factory same as 400-mw's. Never-to-see-again offer. 6, 8, 10, 12, 15V. Under glass. Double bin, there's there. 4 oz. 7E2741 Untested

## Digital Clocks BASIC KIT!

Designed for the economy-minded. Includes: all components except for transformer, case & line cord.

### 4 DIGIT FLOURESCENT

□ \$9.95  
.57" Bright Blue Digits

The brightest clock made! Uses 7 segment GE tube readouts. Includes famous MM5316 clock perfect for the new hobbyist! 12 hour display, (24 hour cycle), AM-PM indicator. Options include clock radio timer, 60 minute sleep timer, and snooze. PC board not included. Easy to breadboard, with instructions. Requires 12 V transformer, see our 92UC3412. Cat. No. 7E3791 4 Digit Fluorescent Basic Kit \$9.95 Cat. No. 7E3792 Components for Alarm Option 2.95

Same famous design as our **KRONOS BEEPIN' TIME MACHINES!**

### 6 DIGIT BEEPER ALARM

□ \$12.95 .35" LED RED DIGITS

Easy and fun to build! 6 digit display time in hours, minutes and seconds, 12 hour format, 24 hour cycle. 7 minute snooze. Uses famous MM5375AB and a minimum of components. Controls for slow and fast set, and reset to zero. Includes all necessary components except for case, line cord, PC board, 12V Transformer, see our Catalog #92UC3412. PC boards available, write or call for information. Wt. 8 ozs. Cat. No. 7E3793 6 Digit LED alarm clock basic kit.

COMPLETE KIT: includes case, transformer and line cord. Cat. No. 7E3505... □ \$19.95

### 4 DIGIT \$12.95

Same as our 6 DIGIT LED ALARM CLOCK BASIC, except with .57" digits, displays hours and minutes, blinking colours indicate seconds. Wt. 8 ozs. Cat. No. 7E3794

COMPLETE KIT: includes case, transformer, and line cord. Cat. No. 7E3507... □ \$19.95

<b>BARREL KIT #73 TRANSISTOR ELECTROS</b> <b>50 for \$1.98</b> We don't wish to separate wide asst voltages & values up to 300 mf. Cat. 7E2747	<b>BARREL KIT #71 CAPACITOR SPECIAL</b> <b>100 pcs. \$1.98</b> micas, moldeds, plastics, ceramic discs, etc. Many 100% good Cat. No. 7E2738	<b>BARREL KIT #88 2 WATTERS</b> <b>100 for \$1.98</b> 100% good. Suppliers throw 'em in the barrel. It's a 10¢ gold mine. All marked. Cat. No. 7E2735	<b>BARREL KIT #65 MIXED READDUTS</b> <b>10 for \$1.98</b> factory returns such numbers as MAN-4's, MAN-7's, MAN-3's, 11 barrels & no time to separate. Hobby Cat. No. 7E2733 Untested.	<b>BARREL KIT #61 POLYSTYRENE CAPS</b> <b>100 for \$1.98</b> Finest caps made. As a gamble we bought 10 barrels from factory, mixed values, all good. Cat. No. 7E2729
<b>BARREL KIT #58 SLIDE SWITCHES</b> <b>30 for \$1.98</b> 17 All shapes, sizes, spst, npdt, etc. Transistors, etc. Tremendous shop pak for 100's of switching projects. Cat. No. 7E2726 100% good	<b>BARREL KIT #56 POWERS! POWERS!</b> <b>100 for \$1.98</b> Cat. 7E2724 Large distributor cleaned house. Barrels of power resistors 3 to 7 watts.	<b>BARREL KIT #55 8 DIGIT READDUTS</b> <b>10 for \$1.98</b> Bargain of a lifetime! All we got was 1 barrel—the "blissful digit" types. Multiplexed. Cat. No. 7E2722	<b>BARREL KIT #40 2N3007 HIGH POWER TRANSISTORS</b> <b>20 for \$1.98</b> Hobby Popular germanium TO-3 case 7E2618 100% good	<b>BARREL KIT #39 15 WATT ZENERS</b> <b>100 for \$1.98</b> Fallouts of the famous 2N3055. 7E2617 100%
<b>BARREL KIT #37 1 AMP "BULLET" RECTIFIERS</b> Untested <b>100 for \$1.98</b> Famous style, asst. voltages, silicon, axial includes all types of voltages to JKV. Cat. No. 7E2615	<b>BARREL KIT #36 GERMANIUM DIODES</b> Untested <b>200 for \$1.98</b> Cat. No. 7E2614 Famous maker, popular item. Never grows old.	<b>BARREL KIT #35 NEON LAMPS</b> <b>30 for \$1.98</b> 100% good. Famous NE-2's. All prime, but factory made millions and barreled 'em. Your advantage. Cat. No. 7E2613	<b>BARREL KIT #31 METALLIC FILM RESISTORS</b> <b>100 for \$1.98</b> Made mostly by Corning, the finest resistor made. Mostly 1/2 watters, 1% to 5% tolerance & bare. Cat. No. 7E2609	<b>BARREL KIT #30 PREFORMED RESISTORS</b> <b>200 for \$1.98</b> We got barrels of 1/4 and 1/2 watters for no use. 100% 1/4, 100% 1/2 watters. No. 7E2608 100% good
<b>BARREL KIT #27 PREFORMED DISCS</b> <b>150 for \$1.98</b> Hi-Fi mfr's shelf inventory but he dumped 'em in barrels. Preformed for PC use. Mixed values too! 7E2605	<b>KIT #26 PLASTIC TRANSISTORS</b> <b>100 for \$1.98</b> Hobby Untested. Type TO-92 (TO-18), all parameters, variety of 2N's. Cat. No. 7E2604	<b>BARREL KIT #25 METAL CAN TRANSISTORS</b> <b>100 for \$1.98</b> Includes TO-5's, TO-18, 18, etc., assorted 2N num. be-headers, etc. Cat. No. 7E2603 Untested.	<b>BARREL KIT #20 LONG LEAD DISCS</b> <b>100 for \$1.98</b> "Aurion" sale! Prime, marked only. Long leads. Cat. No. 7E2598 100% good	<b>BARREL KIT #19 DIPPED MYLARS</b> <b>60 for \$1.98</b> Finest capacitors made, shiny finish. Imagine factory dumping 'em in barrels. Cat. No. 7E2597 100% good
<b>BARREL KIT #17 HOBBY &amp; 7400 DIPS</b> <b>100 for \$1.98</b> \$1.98 Hobby Untested Marked and unmarked, internal numbers of raw factory stock. Cat. No. 7E2431	<b>BARREL KIT #15 HOBBY &amp; 7400 TRANSISTORS</b> <b>60 for \$1.98</b> All 4 leaders. TO-18 case, includes duals, variety of values, types, big ones, small ones. Cat. No. 7E2421	<b>BARREL KIT #14 PRECISION RESISTORS</b> <b>200 for \$1.98</b> Marked and unmarked 1/4, 1/2, 2 watts No. 7E2428	<b>BARREL KIT #11 POWER TAB TRANSISTORS</b> <b>40 for \$1.98</b> NPN, plastic TO220 type. Assorted 2N numbers. No. 7E2425 Untested.	<b>BARREL KIT #10 R0MS-REGISTERS</b> <b>75 for \$1.98</b> Untested Hobby 2w to 10 pin devices, marked, internal factory numbers, etc. Cat. No. 7E2424
<b>BARREL KIT #8 SUBMINIATURE IF TRANSFORMERS</b> <b>75 for \$1.98</b> Amazing, includes 455Kcs, osc, antenna, who knows? Cat. No. 7E2422 100% good	<b>BARREL KIT #7 01 LINEAR CONTROL</b> <b>30 for \$1.98</b> 100% good Includes duals, variety of values, styles, big ones, small ones. Cat. No. 7E2421	<b>BARREL KIT #5 SCRS, TRIACS, QUADRACS</b> <b>40 for \$1.98</b> Raw factory stock! All the 10 amp types. All marked. Cat. No. 7E2419 Untested.	<b>BARREL KIT #4 "4000" RECTIFIERS</b> <b>100 for \$1.98</b> 1N1000 series. May include 2C, 50, 100, 200, 400, 600, 800 and 1000 volters. 7E2417	<b>BARREL KIT #3 1N148/914 SWITCHING DIODES</b> <b>100 for \$1.98</b> Imagine famous switching diodes at these prices. Cat. No. 7E2418 Untested.

Terms: Add postage Rated: net 30  
Phone: Wakefield, Mass. (617) 245-3829  
Retail: 16-18 Del Carmine St., Wakefield.

# POLY PAKS

P.O. BOX 942E LYNNFIELD, MA. 01940

SALE  
Send for FREE SUMMER CATALOG  
C.O.D.'S MAY BE PHONED

### 7400N TTL

SN7400N	16	SN7458A	25	SN74154N	100
SN7401N	16	SN7400N	45	SN74155N	99
SN7402N	16	SN7412N	39	SN74156N	99
SN7404N	18	SN7473N	37	SN74157N	99
SN7405N	24	SN7474N	32	SN74160N	1.25
SN7406N	20	SN7475N	30	SN74161N	99
SN7407N	20	SN7476N	32	SN74162N	99
SN7408N	25	SN7479N	5.00	SN74164N	1.10
SN7409N	25	SN7480N	5.00	SN74165N	1.10
SN7410N	18	SN7482N	98	SN74166N	1.25
SN7411N	30	SN7483N	70	SN74167N	5.50
SN7412N	33	SN7485N	69	SN74170N	9.95
SN7413N	40	SN7486N	89	SN74172N	8.95
SN7414N	70	SN7488N	3.50	SN74173N	1.50
SN7414N	35	SN7489N	2.49	SN74174N	1.25
SN7417N	35	SN7490N	45	SN74175N	99
SN7420N	21	SN7491N	75	SN74176N	90
SN7421N	33	SN7492N	49	SN74177N	90
SN7422N	49	SN7493N	49	SN74180N	99
SN7423N	37	SN7494N	79	SN74181N	2.49
SN7425N	29	SN7495N	79	SN74182N	95
SN7426N	29	SN7496N	89	SN74184N	1.95
SN7427N	37	SN7497N	4.00	SN74185N	2.20
SN7429N	42	SN74100N	1.00	SN74186N	15.00
SN7430N	39	SN74101N	39	SN74187N	6.00
SN7432N	31	SN74121N	39	SN74188N	3.85
SN7433N	27	SN74122N	39	SN74190N	1.19
SN7436N	27	SN74123N	50	SN74191N	1.25
SN7436N	25	SN74125N	60	SN74192N	89
SN7440N	15	SN74126N	2.00	SN74193N	2.00
SN7441N	89	SN74132N	1.09	SN74194N	1.25
SN7442N	95	SN74136N	95	SN74195N	75
SN7443N	75	SN74141N	1.15	SN74196N	1.25
SN7444N	45	SN74142N	7.15	SN74197N	7.15
SN7445N	75	SN74143N	4.50	SN74198N	1.75
SN7446N	81	SN74144N	4.50	SN74199N	1.75
SN7447N	69	SN74145N	2.15	SN74200N	5.59
SN7448N	79	SN74147N	2.35	SN74202N	99
SN7449N	26	SN74148N	1.00	SN74203N	2.00
SN7451N	27	SN74150N	7.00	SN74284N	6.00
SN7453N	27	SN74151N	79	SN74285N	6.00
SN7454N	20	SN74153N	89	SN74367N	75

MANY OTHERS AVAILABLE ON REQUEST  
20% Discount for 100 Combined 7400's

CD4000	25	74CD04N	75
CD4001	25	74CD05N	65
CD4002	25	74CD06N	65
CD4003	25	74CD09N	65
CD4007	25	74CD12N	2.15
CD4009	59	74CD21N	1.50
CD4010	59	74CD24	1.15
CD4011	25	74CD27	3.00
CD4012	25	74CD28	3.00
CD4013	47	74CD29	1.25
CD4016	56	74CD31	2.90
CD4017	1.35	74CD32	4.00
CD4019	55	74CD33	2.15
CD4020	1.49	74CD36	3.25
CD4022	1.25	74CD37	3.25
CD4023	25	74CD38	3.00
CD4024	1.50	74CD41	3.25
CD4025	25	74CD42	2.60
CD4027	69	74CD45	2.75
CD4028	1.65	74CD46	2.75
CD4029	2.90	74CD49	4.30
CD4032	65	74CD52	6.50
LM309	80	LM331N	1.65
LM301N	35	LM344AN	1.75
LM301CN	75	LM4580C	65
LM303H	1.00	LM496N	95
LM305A	95	LM555	95
LM307CN	35	LM593N	1.95
LM308	1.00	LM593CN	69
LM308CN	1.00	LM596N	55
LM309	1.10	LM708N	60
LM309CN	99	LM708CN	1.25
LM310CN	1.15	LM709N	1.25
LM311H	90	LM709CN	1.25
LM311N	90	LM725N	1.25
LM315CN	1.50	LM725CN	4.95
LM319N	1.30	NE555	39
LM320K-5	1.35	NE555B	5.00
LM320K-5.2	1.35	NE555C	5.00
LM320K-12	1.35	NE555D	5.00
LM320K-15	1.35	NE555E	5.00
LM320T-5	1.75	NE555F	1.25
LM320T-5.2	1.75	NE555G	1.25
LM320T-12	1.75	NE555H	1.25
LM320T-15	1.75	NE555I	1.50
LM320T-18	1.75	LM703CN	45
LM320T-24	1.75	LM709N	29
LM320K-5	9.95	LM709CN	29
LM324N	1.80	LM710N	75
LM339N	1.70	LM711N	39
LM340K-5	1.95	LM723N	55
LM340K-15	1.95	LM723CN	3.25
LM340K-18	1.95	LM723N	95
LM340K-12	1.95	LM739N	1.00
LM340K-15	1.95	LM741D	35
LM340K-18	1.95	LM741E	35
LM340T-5	1.75	LM747H	79
LM340T-6	1.75	LM747N	79
LM340T-12	1.75	LM748H	39
LM340T-15	1.75	LM748N	39
LM340T-18	1.75	LM1304N	90
LM340T-24	1.75	LM1305A	1.40
LM350N	1.00	LM1307N	85
LM501CN	65	LM1308N	2.95

### LINEAR

74LS00	29	74LS139	1.95
74LS02	29	74LS151	1.55
74LS03	29	74LS153	1.89
74LS04	35	74LS157	1.55
74LS05	35	74LS162	2.25
74LS08	29	74LS163	2.25
74LS10	29	74LS164	1.95
74LS13	69	74LS175	1.95
74LS14	75	74LS181	3.69
74LS20	29	74LS192	8.85
74LS22	29	74LS191	2.85
74LS27	39	74LS192	2.85
74LS28	39	74LS193	2.85
74LS30	29	74LS194	2.85
74LS32	39	74LS195	2.85
74LS40	39	74LS257	7.75
74LS51	29	74LS260	5.50
74LS55	29	74LS279	7.75
74LS73	49	74LS270	3.95

### GLOCK CHIPS

MMS309	6 Digit BCD Outputs	Resist PW	\$9.95
MMS311	8 Digit BCD Outputs	12 or 24 Hour	4.95
MMS312	4 Digit BCD Outputs	1 PPS Output	4.95
MMS314	6 Digit 12 or 24 Hour	50 or 60 Hz	6.95
MMS316	4 Digit Alarm	1 PPS Output	6.95
MMS316	Video Drop	Free With (MMS314 - \$9.95)	9.95
CT7001	6 Digit Calendar	Alarm, 12 or 24 Hour	9.95

### DATA HANDBOOKS

7400	Pin-out & Description of 7400/7400 ICs	\$2.95
CMOS	Pin-out & Description of 4000 Series ICs	\$2.95
Linear	Pin-out & Functional Description of ALL THREE HANDBOOKS	\$6.95

### Timeband by FAIRCHILD

#### Watches

Men's & Ladies

- Solid State
- Displays hour, minute, second, month & day
- Snap-out battery replacement
- Free set of replacement batteries
- Choose LED or LCD styles
- One year factory warranty



### CHANNEL F

Freeze Action • Speed Option • Automatic time and scorekeeping • Battery-free AC operation • Dual controls with 8-way action • Built-in Pro Hockey and Tennis games • Easy hook-up on any B/W or Color TV • Factory warranty

**\$159.95**

Channel F — additional cartridges — \$19.95 ea.

- #8112 - Desert Fox/Shooting Gallery
- #8113 - Blackjack (1 or 2 players)
- #8114 - Spitfire (1 or 2 players)
- #8115 - Space War
- #8111 - Tic-Tac-Toe/Shooting Gallery/Doodle/Quadra-Doodle

#### DISCRETE LEADS

XC209	125" dia.	10 S1	XC111	190" dia.	10 S1
XC209	Green	4 S1	XC111	Green	4 S1
XC209	Orange	4 S1	XC111	Yellow	4 S1
XC209	Yellow	4 S1	XC111	Orange	4 S1

Special — XC556 Red 100/\$8.00 1000/\$60.00

#### ATARI GAME BOARDS

Deluxe Board B — 11 1/2" x 1 1/2" Over 100 each reusable IC's

**\$9.95 ea.**

HP 5082-7300 Multi-Digit Series

- 1/2" Ht. • Common Cathode • Dip Package
- 3 to 5 volts @ 5 mils per segment
- 7 segment Monolithic • Red Display

2 Digit \$ .79  
3 Digit \$ .89  
4 Digit \$ .99  
5 Digit \$ 1.19

#### IC SOLDERTAIL — LOW PROFILE (TIN) SOCKETS

8 pin	1.24	25	49	50-100	24 pin	1.24	25	49	50-100
14 pin	20	19	18	18	28 pin	45	44	44	43
16 pin	22	21	20	20	36 pin	60	59	58	58
18 pin	29	28	27	27	40 pin	63	62	61	61

#### SOLDERTAIL STANDARD (TIN)

14 pin	27	25	24	24	28 pin	5.99	30	81
16 pin	30	27	25	25	36 pin	1.39	1.26	1.15
18 pin	35	32	30	30	40 pin	1.59	1.45	1.30

#### SOLDERTAIL STANDARD (GOLD)

8 pin	3.00	27	24	24	24 pin	5.70	6.3	5.7
14 pin	35	32	29	29	36 pin	1.10	1.00	90
16 pin	38	35	32	32	36 pin	1.75	1.40	1.26
18 pin	52	47	43	43	40 pin	1.75	1.59	1.45

#### WIRE WRAP SOCKETS (GOLD) LEVEL #3

10 pin	\$45	41	37	37	24 pin	\$1.05	95	85
14 pin	38	38	37	37	36 pin	1.40	1.25	1.10
16 pin	43	42	41	41	36 pin	1.59	1.45	1.30
18 pin	75	68	62	62	40 pin	1.75	1.55	1.40

#### 50 PCS. RESISTOR ASSORTMENTS \$1.25 PER ASST.

ASST. 1	5 ea.	1C 0HM	12 0HM	15 0HM	18 0HM	22 0HM	1/4 WATT 5% — 50 PCS.
ASST. 2	5 ea.	68 0HM	82 0HM	100 0HM	120 0HM	150 0HM	1/4 WATT 5% — 50 PCS.
ASST. 3	5 ea.	1.2K	1.5K	1.8K	2.2K	2.7K	1/4 WATT 5% — 50 PCS.
ASST. 4	5 ea.	8.2K	10K	12K	15K	8K	1/4 WATT 5% — 50 PCS.
ASST. 5	5 ea.	56K	68K	82K	100K	100K	1/4 WATT 5% — 50 PCS.
ASST. 6	5 ea.	390K	470K	550K	680K	820K	1/4 WATT 5% — 50 PCS.
ASST. 7	5 ea.	1M	1.2M	1.5M	1.8M	2.2M	1/4 WATT 5% — 50 PCS.
ASST. 8R	Includes Resistor Assortments 1-7 (350 PCS.)						<b>\$7.49 ea.</b>

\$5.00 Minimum Order — U.S. Funds Only Spec Sheets - 25¢ — Send 35¢ Stamp for 1977A Catalog California Residents — Add 6% Sales Tax Dealer Discount Available — Request Pricing

## James ELECTRONICS

1021-A HOWARD AVE. SAN CARLOS, CA. 94070  
PHONE ORDERS WELCOME — (415) 592-8097  
All Advertised Prices Good Thru July

### WIRE WRAP CENTER

#### HOBBY-WRAP TOOL-BW-630

Battery Operated (Size C)  
Weights ONLY 11 Ounces  
Wraps 30 AWG Wire onto Standard DIP Sockets (.025 inch)  
Complete with built-in and sleeve

**\$34.95**  
(batteries not included)

#### WIRE-WRAP KIT — WK-2-W

WRAP • STRIP • UNWRAP

- Tool for 30 AWG Wire
- Roll of 50 Ft. White or Blue 30 AWG Wire
- 50 pcs. each 1", 2", 3" & 4" lengths — pre-stripped wire.

**\$11.95**

#### WIRE WRAP TOOL WSU-3

WRAP • STRIP • UNWRAP • \$5.95

#### WIRE WRAP WIRE — 30 AWG

25 Ft. min. S1 25 50 Ft. \$1.95 100 Ft. \$2.95 1000 Ft. \$15.00  
SPC. FINISH COLOR — White - Yellow - Red - Green - Blue - Black

#### Plastic Push Button Switch

- 18 AWG Solid Wire - 5' Long
- 50 (wide) X 60 (high) 2x2 Thread
- 8 AMP @ 14 Volt - 1 AMP @ .10 Volt

J-188-1 Push On-Push Off .59 49  
J-188-2 Normally Open .59 49  
J-188-3 Normally Closed .59 49

#### DIP SWITCHES

SPST Slide Action

- #206-4 (8 pin dip) 4 switch unit \$1.75 ea.
- #206-7 (14 pin dip) 7 switch unit \$1.95 ea.
- #206-8 (16 pin dip) 8 switch unit \$2.25 ea.

#### TV GAME CHIP — \$18.50

Includes AY-38500-1 chip and 2 010 mhz crystal — if purchased separately would cost \$21.90

#### ZENERS — DIODES — RECTIFIERS

TYPE	VOLTS V	4000V	PRICE	TYP	VOLTS V	AMP	PRICE
1N746	3.3	400mm	41.00	1N4005	500 PIV	1 AMP	10.10
1N751	5.1	400m	41.00	1N4006	800 PIV	1 AMP	10.10
1N752	5.6	400m	41.00	1N4007	1000 PIV	1 AMP	10.10
1N753	6.2	400m	41.00	1N4000	50	200m	61.00
1N754	6.8	400m	41.00	1N4148	75	10m	15.10
1N559	6.2	400m	81.00	1N4154	35	10m	12.10
1N558	7.5	400m	41.00	1N4185	75	25m	20.10
1N532	5.6	500m	28	1N4736	6	1w	28
1N5234	6.2	500m	28	1N4735	6.2	1w	28
1N5235	6.8	500m	28	1N4736	6.8	1w	28
1N5236	7.5	500m	28	1N4738	8.2	1w	28
1N458	25	40m	61.00	1N4743	12	1w	28
1N458	150	7m	61.00				

## CRYSTALS

THESE FREQUENCIES ONLY

Part #	Frequency	Case Style	Price
CY1A	1 000 MHz	HC33 U	\$5.95
CY2A	2 000 MHz	HC33 U	\$5.95
CY3A	4 000 MHz	HC18 U	\$4.95
CY7A	5 000 MHz	HC18 U	\$4.95
CY22A	10 000 MHz	HC18 U	\$4.95
CY14A	14 318.18 MHz	HC18 U	\$4.95
CY19A	18 000 MHz	HC18 U	\$4.95
CY22A	20 000 MHz	HC18 U	\$4.95
CY30B	32 000 MHz	HC18 U	\$4.95

XR-2206KB Kit \$29.95 Special XR-2206KA Kit \$19.95

WAVEFORM GENERATORS	EXAR	TIMERS
XR-205 \$8.40	XR 2210P \$6.70	XR-555CP 3.99
XR-2206CP 4.49	MISCELLANEOUS	XR-320P 1.55
XR-2207CP 3.85	XR 4136 1.85	XR-555CP 3.20
		XR-2240CP 3.25
		XR-555CP 1.85
		XR-356CP 3.20
		XR-2240CP 3.25
		XR-210 5.20
		XR-215 6.00
		XR-567C1 1.95
		XR-567C1 1.70

## CONNECTORS

### PRINTED CIRCUIT EDGE-CARD

156 Spacing-Tin-Double Read-Out

Bifurcated Contacts — Fits 054 to 070 P.C. Cards

15/30 PINS (Solder Eyelet)	\$1.95
18/36 PINS (Solder Eyelet)	\$2.49
22/44 PINS (Solder Eyelet)	\$2.95
50/100 (100 Spacing) PINS (Solder Eyelet)	\$6.95

### 25 PIN-D SUBMINATURE

DB25P PLUG	\$3.25
DB25S SOCKET	\$4.95

## IMC 3 1/2 DIGIT DVM KIT



This 0-2 VDC 0.5 per cent digital voltmeter features the Motorola 3 1/2 digit DVM chip set. It has a 4-LED display and operates from a single -5V power supply. The unit is provided complete with an injection-molded black plastic case complete with Bezel. An optional power supply is available which fits into the same case as the 0-2V DVM allowing 117 VAC operation.

A. 0-2V DVM with Case \$49.95  
B. 5V Power Supply \$14.95

Etching Kits	Vector	Price
27 X A-1 P.C. Etch Materials Kit enough for 5 circuit boards		\$29.95 ea.
32 X A-1 Etched Circuit Kit Complete kit — only add water		\$ 9.95 ea.
3662 6.5 X 1.5 X 1.16 Epoxy glass P-Pattern L.P.C. 135-socket 156		\$ 6.95 ea.
8800V Universal Microcomputer Processor plugboards — Epoxy Glass — complete with heatsink and mounting hardware 5.313 X 10 X 1.16 copper clad		\$19.95 ea.

1/16 VECTOR BOARD		P-Pattern		Price	
0-1 Hole Spacing Part No.	L	W	1	2	Use
PHENOLIC 64P4-062xXP	4.50	6.50	1.12	1.54	
169P4-028xXP	4.50	1.00	3.69	3.32	
EPOXY GLASS 64P4-062	4.50	6.50	2.07	1.86	
169P4-028	4.50	1.00	5.04	4.5	
169P4-062	4.50	1.00	9.23	8.76	
EPOXY GLASS COPPER CLAD 169P4-062C1	4.50	1.00	6.80	6.12	

## HEAT SINKS

205-CB Beryllium Copper Heat Sink with Black Finish for TO 5	\$ 25
291-36H Aluminum Heat Sink for TO 220 Transistors & Regulators	\$ 25
680-75A Black Anodized Aluminum	\$1.60

## HEXADECIMAL ENCODER 19-KEY PAD



\$10.95 each

## 63 KEY KEYBOARD



\$19.95

## JOYSTICK



Special \*5K Pots \$4.95  
\*100K Pots \$7.95

## MICROPROCESSOR COMPONENTS

8080A CPU	\$19.95	8228 System Controller - Bus Driver	\$10.95
8212 8 Bit Input/Output	4.95	MC6800L 8 Bit MPU	35.00
8214 Priority Interrupt Control	15.95	MC6820L Periph. Interface Adapter	15.00
8216 Bi-Directional Bus Driver	6.95	MC6810AP1 128 x 8 Static RAM	6.00
8224 Clock Generator/Driver	10.95	MC6830L7 1024 x 8 Bit ROM	18.00
CDP1802 - with user manual	39.95	280 CPU	49.95

## PARATRONICS

Featured on February's Front Cover of Popular Electronics

### Logic Analyzer Kit MODEL 100A \$189.00/Kit

- Analyzes any type of digital system
- Checks data rates in excess of 8 million words per second
- Trouble shoot TTL, CMOS, DTL, RTL, Schottky and MOS families
- Displays 16 logic states up to 8 digits wide
- See ones and zeros displayed on your CRT, octal or hexadecimal format
- Tests circuits under actual operating conditions
- Easy to assemble — comes with step-by-step construction manual which includes 80 pages on logic analyzer operation.

### BUGBOOK Continuing Education Series

- BUGBOOK I & II - Basic concepts of TTL Logic — over 90 experiments \$17.00/set
- BUGBOOK IIa - introduces UART — recommended for RTTY enthusiast \$5.00/book
- BUGBOOK III - Explores 8080 chip — introduces Mark 80 Microcomputer \$15.00/book

555 TIMER APPLICATIONS SOURCEBOOK WITH EXPERIMENTS — over 100 design techniques \$6.95/book

CMOS-M-DESIGNERS PRIMER AND HANDBOOK a complete CMOS instruction manual \$6.00

## CONTINENTAL SPECIALTIES

PROTO BOARD 6	Other CS Proto Boards	PROTO CLIPS
\$15.95 (6" long X 4" wide)	PB100 - 4.5" x 6" \$ 19.95	14 PIN \$4.50
	PB101 - 5.8" x 4.5" 29.95	16 PIN 4.75
	PB102 - 7" x 4.5" 39.95	24 PIN 8.50
	PB103 - 9" x 6" 59.95	
	PB104 - 9.5" x 8" 79.95	
	PB203 - 9.75 x 6 1/2 x 2 1/2 75.00	
	PB203A - 9.75 x 6 1/2 x 2 1/2 120.00 (includes power supply)	

QT PROTO STRIPS	QT type	holes	price
OT-59S	OT-59S	590	12.50
OT-59B	OT-59B	bus strip	2.50
OT-47S	OT-47S	470	10.00
OT-47B	OT-47B	bus strip	2.25
OT-35S	OT-35S	350	8.50
OT-35B	OT-35B	bus strip	2.00
OT-18S	OT-18S	180	4.75
OT-12S	OT-12S	120	3.75
OT-8S	OT-8S	80	3.25
OT-7S	OT-7S	70	3.00

\$5.00 Minimum Order — U.S. Funds Only  
California Residents — Add 8% Sales Tax

## James ELECTRONICS

1021-A HOWARD AVE., SAN CARLOS, CA. 94070  
PHONE ORDERS WELCOME — (415) 592-8097  
All Advertisers Prices Good Thru July

## Timeband Digital Alarm Clocks

- 24-hour alarm
- Doze Button
- 100% Solid State
- Large Red Led Display
- 1.8" high
- AM PM Indicator
- Seconds display at touch of button
- Power failure indicator
- One year factory warranty

C-500 Ivory Case \$16.95  
C-500R Ebony Case \$19.95

## DIGITAL AUTO INSTRUMENT SEVEN DIFFERENT INSTRUMENTS! MEETS OR EXCEEDS ORIGINAL AUTOMOTIVE SPECS.

Please specify which one of the seven models you want when ordering — these do not all come in one unit. Each model must be bought separately.

TACHOMETER 10 9900 RPM 4.6 or 8 Cyclic riders	4 SPEEDOMETER 0-99 MPH
2 WATER TEMP 100-250° F	5 OIL PRESSURE 0-80 PSI
3 FUEL LEVEL Percentage Low Fuel Indicator	6 OIL TEMP 200-350° F
	7 BATTERY MONITOR 1 Volts From 11-15 VDC

BRIGHT YELLOW ORANGE LED DISPLAY!  
Kit includes case bracket and all components — complete Nothing else to buy! 12 Volt NEG GND.  
DIMENSIONS 4 1/2" x 4 1/2" KIT: \$49.95  
Add \$10.00 for required speed transducer. ASSEMBLED: \$59.95

## DIGITAL STOPWATCH

- Bright 6 Digit LED Display
- Times to 59 minutes 59 seconds
- Crystal Controlled Time Base
- Three Stopwatches in One
- Times Single Event — Split & Taylor
- Size 4.5" x 2.15" x .90" (4 1/2 ounces)
- Uses 3 Penrite Cells

Kit — \$39.95  
Assembled — \$49.95  
Heavy Duty Carry Case \$5.95

Stop Watch Chip Only (7205) \$19.95

## ELECTRONIC 'PENDULUM' CLOCK

- Swing Pendulum
- 7" Hours and Minutes Display
- 12 or 24 Hour Mode
- Time Set Push Buttons
- Alarm Feature

Kit-unfinished \$59.95 (case unassembled)  
Assembled \$69.95 (case assembled)

## QUARTZ DIGITAL AUTO CLOCK OR ELAPSED TIMER!

Elapsed Timer: Hrs, Mins and Secs  
12 or 24 Hr Capacity  
Simple Reset - Start Pushbutton Control

Complete kit includes mounting bracket, case and all components, nothing else to buy. Features MMS314 chip. Large 4-LED S. Accuracy better than .1 min. per mo. internal battery backup. 12 volt wall polar operation.

Kit: \$29.95  
Assembled: \$39.95

## JE700 CLOCK

The JE700 is a low cost digital clock but is a very high quality unit. The unit features a simulated walnut case with dimensions of 6" x 2 1/2" x 1 1/2". It utilizes a Max272 high brightness red- and the MMS314 clock chip.

12 or 24 Hour  
115 VAC  
\$17.95

## DIGITAL CLOCK KIT — 3 1/2 INCH DIGITS

4 DIGIT KIT \$49.95  
6 DIGIT KIT \$69.95

4 DIGIT ASSEMBLED \$59.95  
6 DIGIT ASSEMBLED \$79.95

This clock features big 3 1/2" high digits for viewing in offices, auditoriums, etc. Each digit is formed by 31 bright 0.2" LEDs. The clock operates from 117 VAC, has either 12 or 24 hr. operation. The 6 digit version is 27" x 3 3/4" x 1 1/2" and the 4 digit is 18" x 3 3/4" x 1 1/2". Kits come complete with all components, case and transformer.  
Specify 12 or 24 Hour When Ordering

## JE803 PROBE

The Logic Probe is a unit which is for the most part indispensable in trouble shooting logic families TTL, DTL, RTL, CMOS. It derives the power it needs to operate directly off of the circuit under test, drawing a scant 10 mA max. It uses a MAX680 readout to indicate any of the following states by these Symbols: (H) 1 (LOW) 0 (PULSE) P. The Probe can detect high frequency pulses to 45 MHz. It can't be used on MOS levels or circuit damage will result.

\$9.95 Per Kit  
printed circuit board

T'L 5V 1A Supply  
This is a standard TTL power supply using the well known LM309K regulator IC to provide a solid 1 AMP of current at 5 volts. We try to make things easy for you by providing everything you need in one package, including the hardware for only \$9.95 Per Kit

**REAL ESTATE**

BIG...FREE...CATALOG! Over 2,500 top values coast to coast! UNITED FARM AGENCY, 612-EP, West 47th, Kansas City, MO 64112.

**RUBBER STAMPS**

RUBBER STAMPS, BUSINESS CARDS. Many new products. Catalog, Jackson's, Dept. K, Brownsville Rd., Mt. Vernon, Ill. 62864.

**DO-IT-YOURSELF**

MODULAR TELEPHONES now available. Sets and components, compatible with Western Electric concept. Catalog 50 cents. Box 1147W, San Diego, California 92112.

MODE 8 — 8 channels TTL on ANY scope plus triggered memory logic probe. Kit \$52.50; plans \$5.00. BASIX, 1067 Seneca, Bethlehem, PA 18015.

TAPE-SLIDE SYNCHRONIZER, lap-dissolve, multiprojector audiovisual plans \$8.50. Free Catalog, Millers, 1896 Maywood, South Euclid, OH 44121.

BUILD ELECTRONICS DEVICES in your home. Get started in your spare time. Big Profits — Experience not necessary. Write for free literature telling how. Electronics Develop Lab., Dept. D, Box 1535, Pinellas Park, Fla. 33565.

**PLANS AND KITS**

POCKET COLOR/BAR GENERATOR kit, 16 patterns, \$49.95. Plans, \$4.95. Workshop, Box 393PC, Bethpage, New York 11714.

FIVE OCTAVE Touch Sensitive Electronic PIANO Kit. Components \$245 airmail U.S.A., Canada. Clef Products, 31 Mountfield Road, Bramhall, Cheshire, England.

CONVERTER KIT: Two meters to AM Broadcast, \$8.95 ppd. Send stamp for flyer. Electronics Hobbies, 3421 Hawthorne Rd., Gainesville, FL 32601.

FORTY CHANNEL CONVERSION Kit fits all 23 channel AM rigs. 40 Plus, 11301 Melody 308, Northglenn, Colorado 80234.

**AMAZING ELECTRONIC PRODUCTS**

LASERS SUPER POWERED, RIFLE, PISTOL, POCKET - SEE IN DARK - PYRO. TECHNICAL DE-BUGGING. UNCRAWLERS - GIANT TESLA. STUNWAND - TV DISRUPTER - ENERGY PRODUCING. SCIENTIFIC DETECTION, ELECTRIFYING, CHEMICAL, ULTRASONIC, CB, AERO, AUTO AND MECH DEVICES, HUNDREDS MORE - ALL NEW PLUS INFO UNLIMITED PARTS SERVICE.

**INFORMATION unlimited**  
 CATALOG \$1 Box 626 Lord Jeffery PZ • Amherst, N.H. 03031

MIXERS — Preamps — Speakers. Top Quality Kits — Plans — Parts. Send 25 cents for catalog. Audio Design & Engineering Co., P.O. Box 154, Lee, Mass. 01238. (413) 243-1333.

**TIGER SST SIMPLI-KIT**

FOR THE DO-IT-YOURSEFER NOW! a high quality CD Electronic Ignition System in kit form.

Contains all components and solder to build complete Solid-State Electronic CD Ignition System for your car. Assembly requires less than 3 hours.

- Increases MFG 15%
- Increases horsepower 15%
- Eliminates 4 of 5 tune-ups
- Instant starting, any weather
- Plugs and Points last 50,000 mile.
- Dual system switch

Fits only 12 volt neg. ground... Only \$21.95 postpaid

**Tri-Star Corporation**  
 P.O. Box 1727 Grand Junction, Colorado 81501

FREE KIT Catalog contains Test and Experimenters' Equipment. Dage Scientific Instruments, Box 1054P, Livermore, CA 94550.

**WEERSI KITS**

Organs, Pianos, Strings Rhythms, PA Systems

**104-page catalog \$2**

WEERSI electronics, Inc.  
 Dept. A2, Box 5318, Lancaster, PA 17601

**EMPLOYMENT OPPORTUNITIES**

ELECTRONICS/AVIONICS EMPLOYMENT OPPORTUNITIES. Report on jobs now open. Details FREE. Aviation Employment Information Service, Box 240E, Northport, New York 1176E.

OVERSEAS JOBS — FANTASTIC PAY! All Occupations. Computerized Reports — \$2.00. TRANSWORLD, International Airport, Box 90802-N, Los Angeles, Calif. 90009.

ROCKY MOUNTAIN JOBS!! Colorado — Idaho — Montana — Wyoming!! Free details. Intermountain-S7, 300 Dundee, Boise, Idaho 83706.

**MISCELLANEOUS**

WINEMAKERS. Free illustrated catalog yeasts, equipment. Semplex, Box 12276P, Minneapolis, Minn. 55412.

**1977 COMMUNICATIONS HANDBOOK**

Everything you want to know—about CB, Ham Radio, SW Listening, Police-Fire Monitoring, Marine Radio. Features, specifications, latest prices and photographs of equipment on the market are at your fingertips. Order your copy from Communications Handbook, Consumer Service Division, 595 Broadway, New York, N.Y. 10012. Enclose \$2.50 (\$1.95 plus 55c for postage and handling). Outside U.S.A. \$3.00, postpaid. Residents of CA, CO, FL, IL, MI, MO, NY STATE, DC and TX add applicable sales tax. Postage and handling charges non-taxable.

**AUTO BURGLAR ALARM KIT**  
 KIT #ALR-1 \$9.95  
 #ALR-1WT WIRED & TESTED \$19.95

AN EASY TO ASSEMBLE AND EASY TO INSTALL ALARM PROVIDING MANY FEATURES NOT NORMALLY FOUND. KEYLESS ALARM HAS PROVISION FOR ROS & GROUNDING SWITCHES OR SENSORS. WILL PULSE HORN RELAY AT 1/2 RATE OR DRIVE SIREN. KIT PROVIDES PROGRAMMABLE TIME DELAYS FOR EXIT ENTRY & ALARM PERIOD. UNIT MOUNTS UNDER DASH - REMOTE SWITCH CAN BE MOUNTED WHERE DESIRED. CMOS RELIABILITY RESISTS FALSE ALARMS & PROVIDES FOR ULTRA DEPENDABLE ALARM. DO NOT BE FOOLED BY LOW PRICES! THIS IS A TOP QUALITY COMPLETE KIT WITH ALL PARTS INCLUDING DETAILED DRAWINGS AND INSTRUCTIONS OR AVAILABLE WIRED AND TESTED

**MOBILE LED CLOCK**  
 12 OR 24-HOUR OPERATION MODEL #2001  
 12 VOLT AC or DC POWERED  
 SIX LARGE 4" DIGITS

115 VAC Power Pack #A31 \$2.00  
 KIT #2001 COMPLETE KIT (Less 9V Battery) 29.95 EA 3 OR MORE \$27.95 EA  
 ASSEMBLED UNITS WIRED & TESTED \$39.95 3 OR MORE \$37.95 EA  
 ORDER # 2001 WT (LESS 9V BATTERY) WIRED FOR 12 HR. OP. IF NOT SPECIFIED OTHERWISE

MEMORY	PRIME 450 NS LOW POWER	OP AMPS	DIODES
1-24	\$1.95	3/1.00	1A, 100 PIV 12/\$1.00
25-99	1.75	301 TO-5	1A, 600 PIV 11/\$1.00
100-199	1.80	709 DIP	IN 4007 1A, 1000 PIV 10/\$1.00
200-499	1.45	709 TO 5	IN 4007 2.5A, 1000 PIV 4/\$1.00
Over 500	1.40	741 DIP	IN 914 SIL SIGNAL 20/\$1.00
		741 M-DIP	IN 4148 SIL SIGNAL 20/\$1.00
		741 TO-5	DYAC 28V 4/\$1.00
		747 TO 5	

PROM  
 1702 E Prom \$8.95  
 5203 E Prom \$8.95

**JUMBO DIGIT CLOCK KIT**  
 A complete Kit (less Cabinet) featuring: six 5" digits, MM5314 IC, 12/24 Hr. time, 50/60 HZ., Plug-Transformer, Line Cord, Switches, and all Parts. (Ideal Fit in Cabinet II) Kit # 5314-5 \$19.95 ea 2/\$38. WITH PC Boards

**JUMBO DIGIT CONVERSION KIT** \$9.95 ea.  
 Convert small digit LED clock to large 5" displays. Kit includes 6 - 5" LED's, Multiplex PC Board & easy hook-up info.  
 Kit # JD-1CC for common Cathode  
 Kit # JD-1CA for common Anode

**DISCRETE LED'S**  
 JUMBO RED  
 10 FOR \$1.00  
 100 FOR \$9.50

**DIGITAL CLOCK IC's**  
 MM5312 4.95  
 MM5314 3.95  
 MM5375 AB 3.95  
 CT-7001 7.95  
 CT-7002 13.95  
 MM5369 2.50 4/\$3.00

**PC TRIM POTS**  
 25K 6/\$1.00  
 47K 6/\$1.00  
 SPECTROL 10K 10/TURN 95c  
 4/\$3.00

**PLEXIGLAS CABINETS**  
 Great for Clocks or any LED Digital project. Clear-Red Chassis serves as Bezel to increase contrast of digital displays.  
 Black, White or Clear Cover

CABINET I 3"H, 6 1/4"W, 5 1/2"D \$6.50 ea.  
 CABINET II 2 1/2"H, 5"W, 4"D

**60 HZ. XTAL TIME BASE**  
 Will enable Digital Clock Kits or Clock-Calendar Kits to operate from 12V DC.  
 1" x 2" PC Board  
 Power Req: 5-15V (2.5 MA TYP.)  
 Easy 3 wire hook up  
 Accuracy: ± 2PPM  
 #TB-1 (Adjustable)  
 Complete Kit \$4.95 ea  
 Wir & Cal \$9.95

**VARIABLE REGULATED 1 AMP POWER SUPPLY KIT**  
 • VARIABLE FROM 4 to 14V  
 • SHORT CIRCUIT PROOF  
 • 723 IC REGULATOR  
 • 2N3055 PASS TRANSISTOR  
 • CURRENT LIMITING AT 1 AMP  
 KIT IS COMPLETE INCLUDING DRILLED & SOLDER PLATED FIBERGLASS PC BOARD AND ALL PARTS (Less TRANSFORMER) KIT #PS-01 \$8.95  
 TRANSFORMER 24V CT will provide 300MA at 12V and 1 Amp at 5V with #PS-01 \$3.50

**NEW LSI TECHNOLOGY**  
**FREQUENCY COUNTER KIT**  
 8 LARGE .4" RED LED DIGITS

• ONLY 8 IC's! • XTAL TIME BASE components throughout.  
 A truly "State of the Art" counter using quality components throughout.  
 KIT INCLUDES: DETAILED INSTRUCTIONS, XTAL, TOP QUALITY FIBERGLASS DOUBLE SIDED PC BOARD, IC'S WITH SOCKETS AND ALL PARTS LESS POWER SUPPLY AND CABINET.

50 MHZ COUNTER KIT #FC-50 \$69.95  
 5 VOLT REGULATED 1 AMP POWER SUPPLY KIT #PS-02 \$9.95  
 350 MHZ PRESCALER KIT #PSL-350 23.95  
 650 MHZ PRESCALER KIT #PSL-650 \$29.95  
 CABINET & MTG HARDWARE #CAB III \$19.95  
 [CABINET WILL HOUSE #FC-50, #PS-02, AND A PRESCALER]

DELIVERIES TO START IN MAY, 1977

SET OF 6 FND-359 WITH MULTIPLEX PC BOARD 6.95  
 Fairchild Super Digit FND-359  
 4" Char. Ht. 7 segment LED RED Com. Cath. Direct pin replacement for popular FND-70.  
 95¢ ea, 10/\$8.50 100/\$79.00

25 AMP BRIDGE \$1.95 ea. 3/\$5.00 100 PIV

NYLON WIRE TIES  
 8" TIE-WRAP 100/\$1.95  
 4" TIE-WRAP 100/\$1.75

IC SOCKETS  
 PINS 1-24 25 100  
 8 5 25 \$22 \$ 20  
 14 25 \$22 \$ 20  
 16 28 25 23  
 18 31 28 26  
 24 50 45 40  
 28 60 55 50  
 40 75 70 65

MOLEX PINS  
 Form Inexpensive Sockets  
 100 for \$1.25  
 Reel of 1000 - \$8.50

ORDER BY PHONE OR MAIL COD ORDERS WELCOME Orders Under \$15 Add \$1.00 Handling Fla. Res. Please Add 4% Sales Tax.

**OPTOELECTRONICS, INC.**  
 BOX 219 • HOLLYWOOD, FLA. 33022 • (305) 921-2056

WE PAY ALL SHIPPING IN CONTINENTAL USA — OTHERS ADD 5% [10% FOR AIRMAIL] CIRCLE NO. 35 ON FREE INFORMATION CARD

# SOLVE YOUR TEST CONNECTION PROBLEMS WITH EZ-HOOK

E-Z Hooks have been designed and field tested throughout the industry to save time and money in commercial electronic production and servicing. The spring-loaded hook attaches firmly, yet so gently it will not damage component — frees hands while testing. Durably constructed and fully insulated to a single contact point assuring true readings. Meets exacting laboratory and space age computer technology requirements. AVAILABLE IN 10 RETMA COLORS: Red, black, blue, green, orange, yellow, white, violet, brown or gray.

**Jumper with X-100W Mini Hooks**  
 Order No. Length Price  
 204-12W\* 12" \$1.60  
 204-24W\* 24" 1.60

Specify color



**Jumper with XM Micro Hooks**  
 Order No. Length Price  
 204XM-12\* 12" \$1.70  
 204XM-24\* 24" 1.70

Specify color



## EXTRA LONG MINI HOOK

XL-1 Mini Hook (5.0" long) combines all the proven features of the X100W with an extra long body. It will make safe, short-free test connections in card racks and through deep wiring nest up to 4".  
**\$1.25 ea.** ORDER Pin XL-1

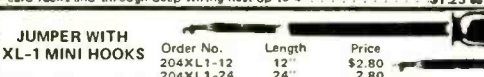

**JUMPER WITH XL-1 MINI HOOKS**

Order No. Length Price  
 204XL1-12 12" \$2.80  
 204XL1-24 24" 2.80

**JUMPER, XL-1 MINI HOOK TO STACKING BANANA PLUG**

Order No. Length Price  
 201XL-1\* 32" \$1.95

\*Specify color \*\*Square hole tip for hooking laterally to leads or vertically over square wire-wrap pins.

**Jumper with X-100W Mini Hook**  
 Order No. Length Price  
 201XW\* 32" \$1.40

**Jumper X-100W Mini Hook\*\***  
 to Stacking Banana Plug

Order No. Length Price  
 201W\* 32" \$1.35



**MICRO HOOK**

**XM Micro Hook (1.75" long, < 1 gram)** for difficult IC testing. Permits hookups to delicate wires where weight and pressure may damage component. \$.80 ea. Specify color. ORDER P/N XM

**MINI HOOK**

**X100W Mini Hook (2.25" long)** combines rugged construction, miniature size and Finger-eze Hypo Action for all the best test connections. Hook is large enough for component leads, yet small enough to get into tight places. \$.75 ea. Specify color. ORDER P/N X100W

# EZ-HOOK

**ORDER YOUR XM-S MICRO HOOK SET TODAY!** (Includes 1 ea. red, black, blue, green, orange, yellow, white, brown, violet and gray Micro Hook). At this low price you can afford more than one set.  
**COMPLETE SET (10) MICRO HOOKS — \$9.95**

## CONTINENTAL SPECIALTIES CORP.

### SOCKETS & BUS STRIPS

Plug-in, wire, test, modify or expand without patch cords or solder. Snap together to form breadboard needed.

PN/Description	Terminals	Price
QT59S Socket	118	\$12.50
QT59B Bus	20	2.50
QT47S Socket	94	10.00
QT47B Bus	16	2.25
QT35S Socket	70	8.50
QT35B Bus	12	2.00
QT18S Socket	36	4.75
QT12S Socket	24	3.75
QT8S Socket	16	3.25
QT7S Socket	14	3.00

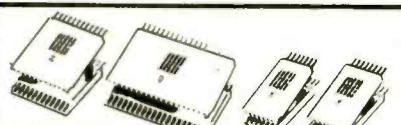

### PROTO-CLIP

For power-on/hands off signal tracing. Bring IC leads up from PCB surface for fast troubleshooting.

PC14	14-pin	\$ 4.50
PC16	16-pin	4.75
PC24	24-pin	8.50
PC40	40-pin	13.75

### CARBON FILM RESISTORS (5%)

Only in Multiples of 100 pcs per value (ohms)  
 \*W . . . \$1.89 per 100  
 \*W . . . \$1.79 per 100

10	100	1.0K	10K	100K	1.0M
11	110	1.1K	11K	110K	1.1M
12	120	1.2K	12K	120K	1.2M
13	130	1.3K	13K	130K	1.3M
15	150	1.5K	15K	150K	1.5M
16	160	1.6K	16K	160K	1.6M
18	180	1.8K	18K	180K	1.8M
20	200	2.0K	20K	200K	2.0M
22	220	2.2K	22K	220K	2.2M
24	240	2.4K	24K	240K	2.4M
27	270	2.7K	27K	270K	2.7M
30	300	3.0K	30K	300K	3.0M
33	330	3.3K	33K	330K	3.3M
36	360	3.6K	36K	360K	3.6M
39	390	3.9K	39K	390K	3.9M
43	430	4.3K	43K	430K	4.3M
47	470	4.7K	47K	470K	4.7M
51	510	5.1K	51K	510K	5.1M
56	560	5.6K	56K	560K	5.6M
62	620	6.2K	62K	620K	6.2M
68	680	6.8K	68K	680K	6.8M
75	750	7.5K	75K	750K	7.5M
82	820	8.2K	82K	820K	8.2M
91	910	9.1K	91K	910K	9.1M

### RESISTOR KITS

**5% CARBON FILM RESISTORS**

COMPLETE WITH STORAGE BIN  
 1/4 WATT KIT  
 42 Different Values (68Ω to 4.7 MΩ)  
 20 Each Value

1/2 WATT KIT  
 42 Different Values (68Ω to 4.7 MΩ)  
 20 Each Value

### RESISTOR ASSORTMENTS

Each assortment contains 5 pcs each of 10 different values. Values included are shown in (Ohms)  
 \*W.5% (50 pcs total) . . . \$1.75 / \*W.5% (50 pcs total) . . . \$1.85  
 Ass.1: 10, 12, 15, 18, 22, 27, 33, 39, 47, 56 ohm  
 Ass.2: 68, 82, 100, 120, 150, 180, 220, 270, 330, 390 ohm  
 Ass.3: 470, 560, 680, 820 ohm, 1K, 1.2K, 1.5K, 1.8K, 2.2K, 2.7K  
 Ass.4: 3.3K, 3.9K, 4.7K, 5.6K, 6.8K, 8.2K, 10K, 12K, 15K, 18K  
 Ass.5: 22K, 27K, 33K, 39K, 47K, 56K, 68K, 82K, 100K, 120K  
 Ass.6: 150K, 180K, 220K, 270K, 330K, 390K, 470K, 560K, 680K, 820K  
 Ass.7: 1M, 1.2M, 1.5M, 1.8M, 2.2M, 2.7M, 3.3M, 3.9M, 4.7M, 5.6M, (5% Assortment No. 7 doesn't include 5.6M)  
 Ass.8R: (All seven assortments above)  
 \*W.5% 350 pcs total: \$10.95 \*W.5% 350 pcs total: \$11.55

### PROTO-BOARD UNITS The Solderless Breadboarding System That Saves You Hours On Every Project

Like our QT system, Proto-Board units let you assemble, test and modify circuits literally as fast as you can think. Rugged, heavy duty construction for use in engineering laboratories, in educational institutions, on production lines, etc.

**PROTO-BOARD 6 KIT—Complete.** List Price . . . \$15.95  
 One preassembled QT-47S socket, two preassembled QT-47B bus strips, four four 5-way binding posts and all hardware.

**PROTO-BOARD 100 KIT—Complete.** List Price . . . \$19.95  
 Two preassembled QT-35S sockets, one preassembled QT-35B bus strip, two 5-way binding posts and all hardware.

**PROTO-BOARD 101—Complete.** List Price . . . \$29.95  
 Fully assembled breadboard contains two QT-35S sockets and four QT-35B bus strips mounted on metal ground/base plate with non-marring feet. Excellent for audio and small digital projects.

**PROTO-BOARD 102—Complete.** List Price . . . \$39.95  
 Fully assembled breadboard contains two QT-47S sockets, three QT-47B bus strips and one QT-35B bus strip. Excellent for intermediate digital needs.

**PROTO-BOARD 103—Complete.** List Price . . . \$59.95  
 Fully assembled breadboard contains three QT-59S sockets, four QT-59B bus one QT-47B bus strips, plus four 5-way binding posts. Build calculators, interfaces, networks, etc.

**PROTO-BOARD 104—Complete.** List Price . . . \$79.95  
 Fully assembled breadboard contains four QT-59S sockets, seven QT-59B bus strips and four 5-way binding posts. Build a CPU, encoder, complex display, etc.

**PROTO-BOARD 203—Complete.** List Price . . . \$75.00  
 Proto-Board flexibility plus built-in 1% regulated 5 VDC, 1A supply, 2250 All the features of the PB-203 plus additional power supply flexibility: provides 1% regulated 5 VDC supply; regulated separate +15 VDC and -15 VDC supplies; 5A supplies; each with internally and independently adjustable output voltage; ripple and noise of + and -15V supplies, 10 mV at 0.25A. solderless tie-points, twenty-four 14-pin dip capacity.

**PROTO-BOARD 203A—Complete.** List Price . . . \$120.00

### MATSUO DIPPED TANTALUM CAPACITORS

MF	V	MF	V	\$
.1	.35	.33	6.8	16 .40
.15	.35	.33	6.8	35 .45
.22	.35	.33	10.0	16 .42
.33	.35	.33	10.0	25 .45
.47	.35	.33	10.0	35 .90
.68	.35	.33	15.0	20 .45
1.0	.35	.33	15.0	35 1.32
1.5	.35	.33	20.0	20 .45
2.2	.20	.33	33.0	20 1.30
2.2	.35	.40	47.0	20 1.53
3.3	.35	.42	68.0	16 1.62
4.7	.35	.45		

### PLESSEY POLYESTER (CAPACITOR)

MF	V	MF	V	\$
.001	1000	.14	.039	250 .15
.0012	1000	.14	.047	250 .15
.0015	1000	.14	.056	250 .15
.0018	1000	.14	.068	250 .15
.0022	1000	.14	.082	250 .17
.0027	1000	.14	.1	100 .17
.0033	1000	.14	.12	100 .18
.0039	630	.14	.15	100 .19
.0047	630	.14	.18	100 .21
.0056	630	.14	.22	100 .23
.0068	630	.14	.27	100 .26
.0082	630	.14	.33	100 .30
.01	630	.14	.39	100 .33
.012	630	.14	.47	100 .36
.015	400	.15	.56	100 .44
.018	400	.15	.68	100 .47
.022	400	.15	.82	100 .54
.027	400	.15	1.0	100 .60
.033	250	.15		

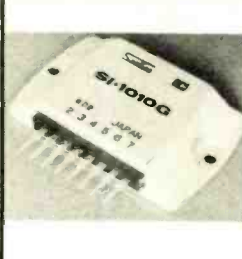

### SANKEN Series SI-1000G amplifiers

are self-contained power hybrid amplifiers designed for Hi-Fi, stereo, musical instruments, public address systems and other audio applications. The amplifiers have quasi-complementary class B output. The circuit employs flip-chip transistors with high reliability and passivated chip power transistors with excellent secondary breakdown strength. Built-in current limiting is provided for SI-1050G and all devices can be operated from a single or split power supply.  
 SI-1010G (10W output) . . . \$ 6.90  
 SI-1020G (20W output) . . . \$13.95  
 SI-1050G (50W output) . . . \$26.80  
 Data Sheet with Application Notes — \$0.50

### LOGIC MONITOR 1

Simultaneously displays static dynamic logic states of DTL, TTL, HTL or CMOS DIP ICs. Pocket size . . . \$74.95

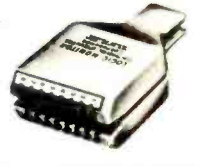

### LOGIC MONITOR 2

Displays static and dynamic states of digital ICs such as CMOS, HTL, TTL, DTL & RTL. Selectable threshold control . . . \$124.95



### LOGIC PROBE LP-1

Compact, circuit-powered multifunction logic probe. Multi-family compatibility, DTL/TTL/HTL/CMOS. Traces logic levels and pulses through digital circuitry . . . \$44.95

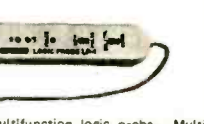

### SANKEN HYBRID AUDIO POWER AMPLIFIERS

- Multi-purpose linear amplifiers for commercial and industrial applications.
- Less than 0.5% harmonic distortion at full power level.
- 1/2 dB response from 20 to 100,000 Hz.
- Single or split (dual) power supply.
- Rugged, compact and lightweight packages.
- Built-in current limiting for SI-1050G and efficient heat radiating construction.

### TYPICAL CONNECTIONS

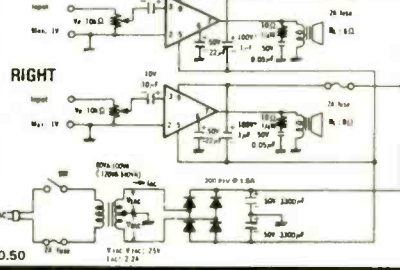

## ANCRONA

<b>CALIFORNIA ANCRONA</b> No. 101 11080 Jefferson Blvd. Culver City, CA 90230 (213) 390-3595	<b>CALIFORNIA ANCRONA</b> 1300 E. Edinger Ave. Santa Ana, CA 92705 (714) 547-8424	<b>ARIZONA ANCRONA</b> 4518 E. Broadway Tucson, AZ 85711 (602) 881-2348	<b>OREGON ANCRONA</b> 1125 N.E. 82nd Ave. Portland, OR 97220 (503) 254-5541	<b>GEORGIA ANCRONA</b> 3330 Piedmont Rd., NE Atlanta, GA 30305 (404) 261-7100	<b>TEXAS ANCRONA</b> 2649 Richmond Houston, TX 77098 (713) 529-3489	<b>CANADA, B.C. ANCRONA</b> Vancouver Vancouver
--	--	--	--	--	--	---

# S. D. SALES CO.

P.O. BOX 28810 - D  
DALLAS, TEXAS 75228

## JUMBO LED CAR CLOCK

**\$16.95 KIT**

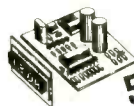

**50,000 Satisfied Clock Kit Customers Can't Be Wrong!**

ALARM OPTION - \$1.50  
AC XFMR - \$1.50

*The Hottest Selling Kit We Ever Produced!*

You requested it! Our first D.C. operatec clock kit. Professionally engineered from scratch. Not a makeshift kluge as sold by others.

Features:

- A. Bowmar Jumbo. 5 inch LED array.
- B. MOSTEK - 50250 - Super Clock Chip
- C. On board precision crystal time base.
- D. 12 or 24 hour Real Time Format.
- E. Perfect for cars, boats, vans, etc.
- F. P.C. Board and all parts (less case) included.

### Specials!

3.579545  
MHZ Time  
Base Crystal  
\$1.25

39 MFD  
16V Mallory  
Electrolytic  
15 for \$1.

28 PIN IC  
Sockets  
3/\$1.00  
11,000 MFD  
50WVDC  
Computer  
Grade  
Cap - \$3.

**60HZ Crystal  
Time Base  
\$5.95**

### 1702A 2K EPROM

We tell it like it is! We could have said these were factory new, but here is the straight scoop. We bought a load of new computer gear that contained a quantity of 1701 A's in sockets. We carefully removed the parts, verified their quality, and are offering them on one heck of a deal. First come, first served. Satisfaction Guaranteed! U. V. Erasable. (2.3 US access time.) **NEW PRICE!**

**\$2.95 each**

2/\$10.

### UP YOUR COMPUTER!

**21L02-1 1K LOW POWER 500 NS STATIC RAM**  
*Time is of the essence!*

And so is power. Not only are our RAM's faster than a speeding bullet but they are now very low power. We are pleased to offer prime new 21L02 -1 low power and super fast RAM's. Allows you to STRETCH your power supply farther and at the same time keep the wait light off!

**8 for \$12.95**

#### FEATURES:

- A. 60HZ output with accuracy comparable to a digital watch.
- B. Directly interfaces with all MOS clock chips.
- C. Super low power consumption (1.5MA typ.)
- D. Uses latest MOS 17 stage divider IC.
- E. Eliminates forever the problem of AC line glitches.
- F. Perfect for cars, boats, campers, or even for portable clocks at ham field days.
- G. Small size; can be used in existing enclosures.

Kit includes Crystal, Driver IC, PC board, plus all necessary parts and specs. At last count - over 20,000 sold!

**S.D. Sales Exclusive!**

**\$12.95 S. D. Sales Exclusive! \$12.95**

#### MOS 6 DIGIT UP-DOWN COUNTER

40 PIN DIP. Everything you ever wanted in a counter chip. Features: Direct LED segment drive, single power supply (12 VDC TYPE), six decades up/down, pre-loadable counter, separate pre-loadable compare register with compare output, BCD and seven segment outputs, internal scan oscillator, CMOS compatible, leading zero blanking, 1MHZ. count input frequency. Very limited quantity!

### IC's from XEROX

7400 - 9c	7430 - 9c	7493 - 26c	1402A-Shift Regulator-50c
7402 - 3c	7440 - 9c	74121 - 22c	MH0025CN - 55c
7404 - 9c	7437 - 10c	74123 - 32c	
7406 - 11c	7438 - 10c	74151 - 22c	IC'S REMOVED FROM
7407 - 11c	7451 - 9c	74155 - 22c	PC BOARDS
7410 - 9c	7474 - 16c	74193 - 35c	ALL TESTED:
7416 - 13c	7475 - 24c	8233 - 35c	FULL SPEC.
7420 - 9c	7486 - 16c	Intel - 1302 - 45c	

**1000 MFD**  
Filter Caps  
Rated 35 WVDC Up-  
right style with PC  
leads. Most popular val-  
ue for hobbyists. Com-  
pare at up to \$1.19 ea.  
from franchise type e-  
lectronic parts stores.

**4/\$1.00**

#### SLIDE SWITCH Assortment

Our best seller. Includes miniature and standard sizes; single and multi-position units. All new, first name brand. Try one package and you'll reorder more! Special!

**12/\$1.00**

**POWER RESISTOR**  
15 OHM  
25W  
BY  
CLAROSTAT

**75¢ ea.**

**RESISTOR ASSORTMENT**  
¼W 5% & 10%. PC leads. A good mix of values.

**200/\$2.**

**P.C. LEAD DIODES**  
1N4148/1N914  
100/\$2.00  
1N4002 - 1A  
100 PIV

**40/\$1.**

#### Transistor Grab Bag no. 1

Just received a good mixed lot of National TO92 plastic transistors. PNP & NPN, even a few FET's. 40 to 50% Yield. Untested. Ass't.

**500/\$3.**

**DISC CAP ASSORTMENT**  
PC leads. At least 10 different values. Includes: .001, .01, .05 plus other standard values.

**60/\$1.00**

**\$9.95 KIT**

P.C. Board - \$3.00  
AC XFMR - \$1.50

*Do not confuse with Non-Alarm kits sold by our competition! Eliminate the hassle - avoid the 5314!*

### SIX DIGIT ALARM CLOCK KIT

WE MADE A FANTASTIC KIT EVEN BETTER. REDESIGNED TO TAKE ADVANTAGE OF THE LATEST ADVANCES IN I.C. CLOCK TECHNOLOGY. FEATURES: LITRONIX DUAL ½" DISPLAYS, MOSTEK 50250 SUPER CLOCK CHIP, SINGLE I.C. SEGMENT DRIVER, SCR DIGIT DRIVERS. GREATLY SIMPLIFIED CONSTRUCTION. MORE RELIABLE AND EASIER TO BUILD. KIT INCLUDES ALL NECESSARY PARTS (except case). P.C.B. OR XFMR OPTIONAL. **NEW! WITH JUMBO LED READOUTS!**

**MOTOROLA SCR**  
2N4443. 8 AMP 400 PIV.  
P.C. Leads. \$3/\$1.00  
**FAIRCHILD - TBA 641**  
4W. Audio power Amp. Just out! In special heat sink DIP. One super audio IC. \$1.50 with data  
**AC LINE FILTER**  
Rated 3 AMPS - 115/230V  
50 to 400 HZ.  
Noise Proof Your Computer  
**\$3.00 each**

**GRAB BAG NUMBER 2**  
Mixed Motorola TO-18 case metal transistors. About 60% yield. PNP & NPN. Untested. A good assortment! 100 for \$3.00  
**PRICES SHOWN SUBJECT TO CHANGE WITHOUT NOTICE.**

*Price Cut!* ~~\$15.95~~  
**\$12.**

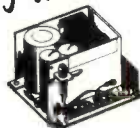

### COMPUTER POWER SUPPLY

A very fortunate purchase. One of the best industrial quality REGULATED supplies we have seen. High performance, small size. Input is 120VAC 60HZ. Has the following regulated outputs: -5VDC@800MA; -15VDC@1.25AMP; -25VDC@180MA. Sold at a fraction of original cost. Do yourself a favor and order NOW.

AMD - 1702A

Factory Prime Units - Brand New - 1.5 Micro-seconds Access Time. - \$4.95 each  
**HUGE FACTORY DIRECT PURCHASE!**

#### TERMS:

**MONEY BACK GUARANTEE. NO COD'S. TEXAS RESIDENTS ADD 5% SALES TAX. ADD 5% OF ORDER FOR POSTAGE & HANDLING. ORDERS UNDER \$10.00 ADD 75c. FOREIGN ORDERS: U. S. FUNDS ONLY!**

Call your BankAmericard or Master Charge order in on our continental United States toll free Watts:

**1-800-527-3460**

Texas Residents Call Collect:

**214/271-0022**

**CHEAP DC SUPPLY**  
Actually an AC adapter for calculators.  
3VDC no load. 6VDC@200MA.  
4VDC@375MA

**\$2. ea.**

S.D. SALES CO.  
P.O. BOX 28810 - D  
DALLAS, TEXAS 75228

**Orders over \$15. - Choose \$1. FREE MERCHANDISE!**





**AMAZING & HARD-TO-FIND  
SCIENCE BUYS!  
ALTERNATE ENERGY  
SPACE AGE • HOBBIES**

**SUPER POWER FOR ANY AM RADIO**



Antenna assist has pulled in stations up to 1000 miles' off! No wires, clips, grounding. Solid state—no elec., batts., tubes.  
No. 72,095 AV \$19.95 Ppd.  
**ULTRA SELECT-A-TENNA (OVER 1000\* MILES)**  
No. 72,147 AV .....\$24.95  
SUBJ. TO LOCAL COND.

**SAVE 50%! 8 x 20 MONOCULAR**



Top quality Spy Scope, a \$30 value, now \$14.95! Special purchase saves you 50%. 100% coated optics; 393 ft. field of view. Only 2 oz.—stores in pocket, purse, glove box.  
No. 1568 AV .. \$14.95 Ppd.

**GIANT MAGNET. LITTLE PRICE!**



Tie a line to our over-150 lb. -lift ceramic magnet and haul up treasure from the sea. 4 ceramic magnets, in series, between steel plates. A 1-lb. "giant"!

No. 42,318AV (1 x 1 1/4 x 4 3/4") ..... \$11.95 Ppd.

**NASA-CHOSEN FOR APOLLO/SOYUZ**



The Astronauts used this Super 20X60 binocular (modified) to view Earth! Big 60 mm objective lenses; 173-ft. field of view at 1000 yds. Relative brightness, 9.0. Fully coated optics, more!

No. 1556AV .....(9 1/4 x 8 1/2"; 47.5 oz) \$99.95 Ppd.

**MEASURE WIND SPEED ANYWHERE**



Hold handy (16 oz.!) low cost Anemometer into the wind, quickly read wind speed on its big dial—from 5 to 70mph. Acc. to ±3% of full scale (2.1 mph); no batts., adjustments, recalibration req.!! (7 1/2" HIGH)  
No. 42,428AV...\$19.95 Ppd.

**WORLD'S LARGEST SOLAR CELL...**

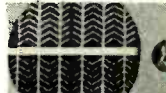

the most powerful silicon, cheapest dollar per watt! 4" dia. giant can put out 1 full watt, over 2 amps of current at .45v. Rated 100mW/Cm<sup>2</sup> light intens. at .45v.

No. 42,314AV...(TAB LEADS).....\$29.95 Ppd.  
No. 42,270AV...(1 AMP 1/2 W 3" DIA.).....\$17.95 Ppd.

**DELUX HI-TEMP SOLAR FURNACE**



Oversized Fresnel lens enables unit you screw together to attain temperatures over 2000F at prime focus! Use to temper small parts; fire enamel on jewelry, more! 6 parts easily assembled w/instrs.

No. 80,257AV(8 1/2 lb., 34" H) .....\$59.95 Ppd

**ELECTRONIC COUNT-DOWN STOPWATCH**



Hand-held 5-oz digital stopwatch counts up, down, sounds alarm—w/full range LED display (9 hrs., 59 mins., 59 secs.). Has start/stop (time-out/reset) buttons. Accurate alarm clock! 3 AA batts.

No. 1692AV (2.8 x 4.3 x 1.1").....\$49.95 Ppd.

**ELECTRONIC SOUND COLLECTOR**



Tune in a whisper at 20 ft., normal conversations up to 100 ft., birdcalls & high freq. sounds at almost 200 ft. Nearly twice as far over water! Check on baby birds! 18" refl. disc, mike, etc.  
No. 80,176AV \$32.25 Ppd.

**QUALITY DETECTOR UNDER \$40**



Our fully transistorized BFO unit can locate a quarter at 18". Powerful 6 trans.-oscillator-amplifier circuit. Comp. to others priced 50% more! Aluminum, just 2 lb.  
No. 80,222AV \$39.95 Ppd.

**EDMUND SCIENTIFIC CO.**

300 Edscorp Bldg., Barrington, N.J. 08007 • (609) 547-3488  
America's Greatest Science • Optics • Hobby Center



Patent Pending

**THERE IS NO OTHER TELESCOPE LIKE IT!  
THE NEW EDMUND 4 1/4", f/4  
NEWTONIAN WIDE FIELD  
REFLECTOR TELESCOPE**

Clear, bright, spectacular wide angle views of stars, moon, comets... easy to use... portable!

**IN SECONDS, YOU'RE SCANNING THE ASTOUNDING UNIVERSE,** able to see and study the breath-taking cosmos as perhaps you never have before... awesome vastness, unbelievable orderliness, stark silent beauty. All the fascinating heavenly mysteries are yours to enter and explore. This new reflector telescope makes it easy for everyone to span a thousand light-years to space-age enjoyment of the heavens and outdoors. No complicated set up! Just insert the eyepiece, focus, and its big 3 1/2" field of view gives you more stars in a single view than any other type of telescope. Bright, crisp, finely resolved images to capture your interest and imagination. It's probably the easiest to use telescope ever... over your shoulder, in your lap on a tripod. Or just rotate the spherical base on its own mount for use on a table, car hood. Take it anywhere (only 17" 10 lb.). Top quality optical system: 4 1/4", f/4 parabolic primary mirror (1/4 wave, 17" F.L.); prealigned 1/4 wave diagonal on a coated optical window seals optics from moisture and dust; 28mm Kellner eyepiece (figures 15X, higher without other eyepiece or Barlow). Fast focusing (25" to infinity). Bright Scharfman red (doesn't impair night vision); adj. carrying strap. A "first" scope must be an ideal second scope!

There is no other telescope like it. NO. 2001AV \$149.95 Ppd.

**The Edmund BIOSONE II  
turns brainwaves into an audible or visual signal. \$149.95  
KNOW YOUR ALPHA FROM YOUR THETA!**

For greater relaxation, concentration... monitor your alpha/theta brainwaves.

**Features Normally Found Only In Units Selling For More Than \$200.00—And 3 Feedback Modes.**

The portable, professional quality Edmund Biosone II boasts 3 feedback modes—LED FM tone, threshold tone, a test mode to check overall system of operation. Easy to use, this beautiful 4-pound, simulated walnut unit (9 1/2 x 5 1/2 x 4 1/4") can be operated at home, in office or clinic. It gives you outputs to allow further monitoring of logic signal, raw EEG, filter output, meter, and FM. Total brainwave monitoring capability, incl. filter select feedback, with wide range calibration sensitivity control (5-100 microvolts). Completely safe, the Edmund Biosone II is similar to an electroencephalograph (EEG), enabling you to identify the electrochemical activity that exists at all times in the human brain. In addition to letting you know when you're most relaxed, Biosone II is a great conversation piece. Included at its low price are a set of electrodes, an earphone jack for private use. Uses latest advances in linear circuitry, runs on two 9v transistor batteries (not included).

STOCK NO. 1668AV ..... Just \$149.95 ppd.  
LOW COST STARTERS' UNIT, No. 71,809AV ..... \$59.95 ppd.

**"SEE" MUSIC IN PULSATING COLOR**



ASSEMBLED \$18.50 Ppd.  
NO. 42,309AV

UNASSEMBLED, IN KIT FORM \$15.95 Ppd.  
NO. 42,336AV ONLY

**The Edmund 3-Channel Color Organ \$18.50**

COMPLETELY ASSEMBLED! LESS THAN HALF THE PRICE OF OTHER MODELS!

Create your own audio "light show", add a new dimension to your music listening pleasure with the bargain-priced Edmund 3-Channel Sound To Light Control. Lets you modulate 3 independent strings of colored lamps with the intensity of your music. They flash and vary in brightness related to the music's rhythm, pitch and volume—a pulsating light performance to music! You get volume and frequency sensitivity to a peak rating of 300 watts per channel. Just plug in your favorite colored flood or spot-light, and turn on! Great price, too. This high quality, fully assembled unit in metal housing, with 3 individually controlled circuits, is priced at less than half that of others. Complete instructions are included with this terrific value.

**GIANT FREE  
164 PG. CATALOG**



4000 UNUSUAL BARAINS FOR HOBBYISTS SCHOOLS, INDUSTRY

**COMPLETE AND MAIL COUPON NOW**

EDMUND SCIENTIFIC CO. 300 Edscorp Bldg., Barrington, N. J. 08007

Send me the following:  
Stock No. Quantity Price Ea.

Stock No.	Quantity	Price Ea.

☐ SEND FREE 164 PG. CATALOG "AV"

Charge my ☐ American Exp. ☐ BankAmericard ☐ Master Chg.

Interbank No. \_\_\_\_\_ Add handling charge \$ 1.00

Card No. \_\_\_\_\_ Enclosed is \_\_\_\_\_ check, \_\_\_\_\_ M.O. in amount of \$ \_\_\_\_\_

Expiration Date \_\_\_\_\_ Signature \_\_\_\_\_

30-DAY MONEY-BACK GUARANTEE. You must be satisfied or return any purchase in 30 days for full refund. Address \_\_\_\_\_

City, State, Zip \_\_\_\_\_

# The source of perfection in stereo sound... Pickering's new XSV/3000



## The reviewers applaud as never before!

"... we don't see how you can do better at any price."  
Hirsch-Houck Laboratories. Stereo Review. February 1977

"The new unit offers the stereo performance of the XUV/  
4500Q (or perhaps a little better than that) at a lower  
price. It seems hard to go wrong with such a combina-  
tion."

CBS Technology Center. High Fidelity. February 1977

"Congratulations to all concerned on a fine contender  
amongst the world's best stereo pick-ups."

John Borwick. Gramophone. United Kingdom 1977

Pickering's new XSV/3000 is a remarkable develop-  
ment. It possesses a totally new and different design that  
makes it the precursor of a whole new generation of so-  
phisticated, advanced stereo cartridges.

This has been made possible by technological advances  
in two areas. **First**, it has an unusually tiny, samarium  
cobalt (rare earth) magnet of remarkably high power that

permits extremely low mass, and also offers high output. **Second**, this cartridge features the new Stereohedron™ stylus tip, a Pickering first! This extraordinary shape has a far larger bearing radius, which provides increased contact area in the record groove. This assures gentler treatment of the record groove, longer record life, and also, far longer stylus life.

This cartridge provides remarkably smooth and flat fre-  
quency response; its channel separation is exceptional, its  
transient response possesses superb definition.

Truly, Pickering's XSV/3000 represents a whole new  
concept of excellence in stereo cartridges... the true  
**Source** of perfection in stereo sound.

For further information write to  
Pickering & Co., Inc. Dept. PE,  
101 Sunnyside Blvd., Plainview,  
New York 11803



"for those who can hear the difference"

PICKERING & CO., INC., COPYRIGHT 1977

CIRCLE NO 38 ON FREE INFORMATION CARD



**When you've got a Pace CB radio,**



**you've got the world by the ears.**

There are millions out there with their ears on waiting to talk to you Pace to Pace.

And with a Pace CB two-way radio you've got every bit of power the law allows. And features to cut through interference and "bleeders" from other channels.

What's more, it's assembled with computerized circuitry and it's 100% solid state, so it's as trouble-free as a CB can be.

It all adds up to your voice getting out

there clearer and with less distortion, and the other guy's voice coming back just as clear.

To learn more, drop into a Pace place near you. The dealer will tell you just how economical and easy-to-install a Pace is. He'll help you choose the one that's just right for you, too.

Ask him for the world by the ears. He'll know which CB you're talking about.



**pace**  
 PACE CB / PACE TWO-WAY RADIO PRODUCTS  
 BY PATHCOM INC., HARBOR CITY, CA 90710

CIRCLE NO. 37 ON FREE INFORMATION CARD