

BUILD TELEMETRY REMOTE CONTROL

# POPULAR ELECTRONICS

JULY 1967

50 CENTS

How To Use Digital Indicators

BUILD

Princess Hi-Fi Speaker System

FET Adapter Improves VOM

Review Your Soldering Habits

BUILD

QRP Midget Transmitter

You CAN Recharge Dry Cells

BUILD

a "Beachcomber" Coin & Metal Locator for under \$4

(see page 4)

E0970 3901365TE9131MD027  
D STEVENS  
9131 MANSFIELD AV  
MORTON GROVE IL 60052



# EXPERIENCE IS STILL YOUR BEST TEACHER

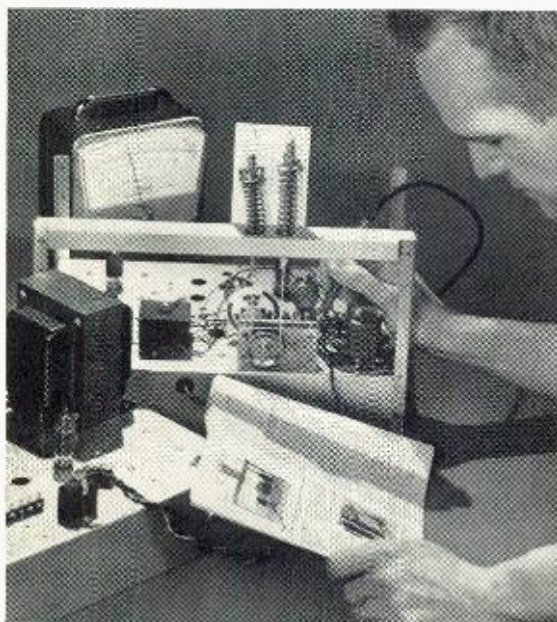

That is why NRI has invested more in Professional Lab Equipment than all other home-study schools combined. It makes train-

ing at home in Electronics fast and fascinating. Your hands are trained as well as your head.



**OLDEST AND LARGEST  
SCHOOL OF ITS KIND**

Accredited by the Accrediting Commission of the National Home Study Council



## You get more for your money from NRI

—more value, more solid experience so essential to careers in Electronics. NRI's pioneering "discovery" method is the result of more than half a century of simplifying, organizing, dramatizing subject matter. In each of NRI's major courses you learn by doing. You demonstrate theory you read in "bite-size" texts programmed with NRI designed-for-learning professional lab equipment. Electronics comes alive in a unique, fascinating way. You'll take pleasure in evidence you can feel and touch of increasing skills in Electronics, as you introduce defects into circuits you build, perform experiments, discover the "why" of circuitry and equipment operation.

Almost without realizing it, the NRI discovery method gives you the professional's most valuable tool—practical experience. You learn maintenance, installation, construction and trouble-shooting of Electronic circuits of any description. Whether your chosen field is Industrial Electronics, Communications or TV-Radio Servicing, NRI prepares you quickly to be employable in this booming field or to earn extra money in your spare time or have your own full-time business. And you start out with training equivalent to months—even years—of on-the-job training.

## NRI Has Trained More Men for Electronics Than Any Other School

—By actual count, the number of individuals who have enrolled for Electronics with NRI could easily populate a city the size of New Orleans or Indianapolis. Over three-quarters of a million have enrolled with NRI since 1914. How well NRI training has proved its value is evident from the thousands of letters we receive from graduates. Letters like those excerpted below. Take the first step to a rewarding new career today. Mail the postage-free card. No obligation. No salesman will call. NATIONAL RADIO INSTITUTE, Electronics Division, Washington, D.C. 20016.



L. V. Lynch, Louisville, Ky., was a factory worker with American Tobacco Co., now he's an Elec-

tronics Technician with the same firm. "I don't see how the NRI way of teaching could be improved."



Don House, Lubbock, Tex., went into his own Servicing business six months after completing NRI training. This former clothes salesman just bought a new house and reports, "I look forward to making twice as much money as I would have in my former work."

**APPROVED UNDER NEW GI BILL.** If you served since January 31, 1955, or are in service, check GI line on postage-free card.



G. L. Roberts, Champaign, Ill., is Senior Technician at the U. of Illinois Coordinated Science

Laboratory. In two years he received five pay raises. Says Roberts, "I attribute my present position to NRI training."



Ronald L. Ritter of Eatontown, N.J., received a promotion before finishing the NRI Communication course, scoring one of the highest grades in Army proficiency tests. He works with the U.S. Army Electronics Lab, Ft. Monmouth, N.J. "Through NRI, I know I can handle a job of responsibility."

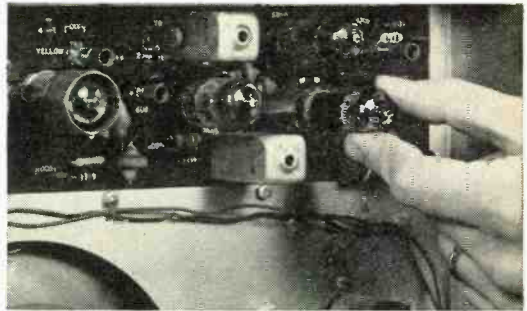

## COLOR TV CIRCUITRY COMES ALIVE

as you build, stage-by-stage, the only custom Color-TV engineered for training. You grasp a professional understanding of all color circuits through logical demonstrations never before presented. The TV-Radio Servicing course includes your choice of black and white or color training equipment.

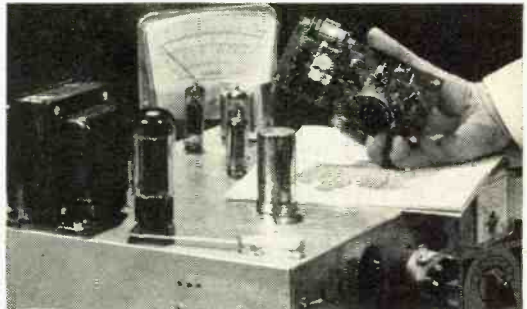

## COMMUNICATIONS EXPERIENCE

comparable to many months on the job is yours as you build and use a VTVM with solid-state power supply, perform experiments on transmission line and antenna systems and build and work with an operating, phone-cw, 30-watt transmitter suitable for use on the 80-meter amateur band. Again, no other home-study school offers this equipment. You pass your FCC exams—or get your money back.

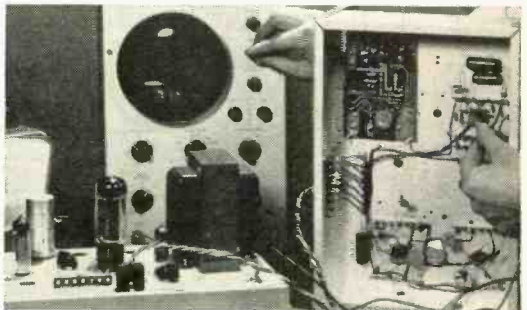

## COMPETENT TECHNICAL ABILITY

can be instantly demonstrated by you on completing the NRI course in Industrial Electronics. As you learn, you actually build and use your own motor control circuits, telemetering devices and even digital computer circuits which you program to solve simple problems. All major NRI courses include use of transistors, solid-state devices, printed circuits.

# POPULAR ELECTRONICS

WORLD'S LARGEST-SELLING ELECTRONICS MAGAZINE

VOLUME 27

JULY, 1967

NUMBER 1

## SPECIAL CONSTRUCTION FEATURE

- DANIEL MEYER **27** **THE "BEACHCOMBER"**  
*Metal locator for treasure hunters*

## FEATURE ARTICLES

- ELDEN C. MAYNARD, K6SAI **33** **PULSE COMMAND RESPONDER**  
*Single-channel remote control has multi-channel capability*
- DAVID B. WEEMS **38** **"PRINCESS CINDERELLA"**  
*Small size, big sound, for less than \$15*
- FRED SHUNAMAN **41** **CAN DRY CELLS BE RECHARGED?**  
*You can get more life out of your battery*
- ROBERT P. BALIN **46** **INTERNATIONAL ELECTRONICS QUIZ**
- 47** **ACOUSTECH "ADD-A-KIT" SOLID-STATE INTEGRATED HI-FI AMPLIFIER**
- JOHN L. BEISWENGER **49** **SENSITIVE LOW-COST INDICATORS**  
*Add a transistor to a pilot light*
- JIM WHITE, W5LET **51** **QRP MIDGET**  
*80-, 40-, 20-meter transmitter fits in palm of your hand*
- JOHN MC NARNEY **53** **ELECTRONIC SOLDERING**  
*Something no project can be without*
- JAMES RANDALL **57** **VOM + FET = TVM**  
*Give your VOM a 10-megohm front end*
- GARY MC CLELLAN **60** **AAH-CHOO! NOT ANOTHER PEPPER?**  
*Booster puts distant stations on your AM car radio*
- 62** **180 SQUARE INCHES OF COLOR TV**
- CHARLES J. SCHAUERS, W6QLV **64** **INFORMATION CENTRAL**
- HANK BENNETT, W2PNA **67** **SHORT-WAVE LISTENING**  
*"Sound recording—do not X-ray"*
- ROBERT LEGGE **72** **ENGLISH-LANGUAGE BROADCASTS TO NORTH AMERICA**
- HERB S. BRIER, W9EGQ **73** **AMATEUR RADIO**  
*FCC action on incentive licensing—when?*
- LOU GARNER **75** **SOLID STATE**
- MATT P. SPINELLO, KHC2060 **78** **ON THE CITIZENS BAND**  
*CB equipment flashback*
- 97** **SHORT-WAVE MONITOR CERTIFICATE APPLICATION**



Radio/wire telemetry receiver **33**

## DEPARTMENTS

- 8** **LETTERS FROM OUR READERS**
- 15** **READER SERVICE PAGE**
- 16** **TIPS & TECHNIQUES**
- 22** **NEW PRODUCTS**
- 80** **ELECTRONICS LIBRARY**
- 84** **NEW LITERATURE**



Speaker works as good as she looks **38**

POPULAR ELECTRONICS is indexed  
in the Readers' Guide  
to Periodical Literature

Copyright © 1967 by ZIFF-DAVIS PUBLISHING COMPANY. All rights reserved.

POPULAR ELECTRONICS, July 1967, Volume 27, Number 1. Published monthly at 307 North Michigan Avenue, Chicago, Illinois 60601. One year subscription rate for U.S., U.S. Possessions and Canada, \$5.00; all other countries, \$6.00. Second class postage paid at Chicago, Illinois and at additional mailing offices. Authorized as second class mail by the Post Office Department, Ottawa, Canada and for payment of postage in cash. Subscription Service: Portland Place, Boulder, Colorado 80302.

This month's cover photo by  
Conrad Studios, Inc.



# SEE WHY so many DeVry-trained Men Step Into Electronics Jobs the Day after Graduation!

## EVERY GRADUATE CAN ALSO RECEIVE EMPLOYMENT HELP THROUGH HIS ENTIRE CAREER, AT NO ADDED COST

DeVry's greatest claim to fame is the progress of its graduates. Our aim is to prepare a man so thoroughly that we can recommend him to employers . . . ready to step into a job the day after graduation. If we expect to continue to help employers, our graduates have to be good! That is why we provide top quality instruction—followed by career-long employment service at no added cost.

DeVry's educational programs are designed to prepare men 17-45 in their spare time at home or in any of our three well-equipped, modern resident schools in Chicago, Phoenix or Canada. Why not fill in and mail coupon for free facts today?

*Approved for Veterans.*

### For FREE Information

Lack of technical experience is no barrier to the man who wants to prepare for a career in ELECTRONICS. Send coupon for two FREE booklets and find out why.



### DeVRY INSTITUTE of TECHNOLOGY 4141 Belmont Avenue, Chicago, Ill. 60641, Dept. PE-7-X

Please give me your two free booklets, "Pockets Guide to Real Earnings," and Electronics in Space Travel"; also include details on how to prepare for a career in Electronics. I am interested in the following opportunity fields (check one or more):

- |  |   |
|--|---|
| <input type="checkbox"/> Space & Missile Electronics | <input type="checkbox"/> Communications         |
| <input type="checkbox"/> Television and Radio        | <input type="checkbox"/> Computers              |
| <input type="checkbox"/> Microwaves                  | <input type="checkbox"/> Broadcasting           |
| <input type="checkbox"/> Radar                       | <input type="checkbox"/> Industrial Electronics |
| <input type="checkbox"/> Automation Electronics      | <input type="checkbox"/> Electronic Control     |

Name \_\_\_\_\_ Age \_\_\_\_\_

Address \_\_\_\_\_ Apt. \_\_\_\_\_

City \_\_\_\_\_ State or Province \_\_\_\_\_ Zone or Zip Code \_\_\_\_\_

Check here if you are under 16 years of age.

**HOME STUDY AND RESIDENT SCHOOL PROGRAMS  
AVAILABLE IN CANADA. SEND FOR DETAILS.**

2106

Accredited Member of National Home Study Council

**DeVRY INSTITUTE OF TECHNOLOGY**

4141 BELMONT AVENUE, CHICAGO, ILLINOIS 60641



Powerful, rugged, sleek Northrop F5-A "Freedom Fighter" is helping to keep the peace for the U. S. and 14 allied nations.

**Powerful.  
Rugged.  
Sleek.  
Lightweight.  
Goes anywhere.**

## New CB-21 "REACTOR II"

8-channel Solid State Transceiver



**only \$13995**

All solid state circuitry with AGC to soften signal variation, built-in noise limiter, squelch control. 17 transistors and 6 diodes with audio output in excess of 4.0 watts. Dual conversion receiver. Provision for PA or hailing. Low battery drain, receive  $\pm 1 - 3$  amp., transmit .6 amp.

The new ideas  
in communications  
are born at . . .



# hallicrafters

A Subsidiary of Northrop Corporation  
5th & Kostner Aves., Chicago, Ill. 60624

Export: International Div., Canada, Gould Sales Co.  
**CIRCLE NO. 11 ON READER SERVICE PAGE**

# POPULAR ELECTRONICS

**PHILLIP T. HEFFERNAN**  
*Publisher*

**OLIVER P. FERRELL**  
*Editor*

**ROBERT CORNELL, WA2HDQ**  
*Managing Editor*

**WILLIAM GALBREATH**  
*Art Director*

**MARGARET MAGNA**  
*Associate Editor*

**ALEXANDER W. BURAWA**  
*Assistant Editor*

**ANDRE DUZANT**  
*Technical Illustrator*

**NINA KALAWSKY**  
**PATTI MORGAN**  
*Editorial Assistants*

**H. BENNETT, W2PNA**  
**H. S. BRIER W9EQG**

**L. E. GARNER, JR.**

**CHARLES J. SCHAUERS, W6QLV**  
**M. P. SPINELLO, KHG2060**  
*Contributing Editors*

**LAWRENCE SPORN**  
*Advertising Sales Manager*

**ARDYS C. MORAN**  
*Advertising Service Manager*

## ZIFF-DAVIS PUBLISHING COMPANY

Editorial and Executive Offices  
One Park Avenue, New York, New York 10016  
212 679-7200

Eastern Advertising Manager, RICHARD J. HALPERN

Midwestern Office  
307 North Michigan Avenue, Chicago, Illinois 60601  
312 726-0892

Midwestern Advertising Manager, JAMES WEAKLEY

Western Office  
9025 Wilshire Boulevard, Beverly Hills, California 90211  
213 CRestview 4-0265; BRadshaw 2-1161  
Western Advertising Manager, BUD DEAN

Japan: James Yagi  
Ishikawa Mansion  
#4, Sakuragaoka  
Shibuya-ku, Tokyo  
462-2911-3

Circulation Office  
Portland Place  
Boulder, Colorado 80302

William B. Ziff, Chairman of the Board (1946-1953)  
William Ziff, President

W. Bradford Briggs, Executive Vice President  
Hershel B. Sarbin, Senior Vice President

Philip Sine, Financial Vice President

Walter S. Mills, Jr., Vice President, Circulation

Stanley R. Greenfield, Vice President, Marketing

Phillip T. Heffernan, Vice President, Electronics Division

Frank Pomerantz, Vice President, Creative Services

Arthur W. Butzow, Vice President, Production

Edward D. Muhlfeld, Vice President, Aviation Division

Irwin Robinson, Vice President, Travel Division

Ziff-Davis also publishes Airline Management and Marketing, Boating, Business & Commercial Aviation, Car and Driver, Cycle, Electronics World, Flying, Hi-Fi/Stereo Review, Modern Bride, Popular Aviation, Popular Photography, Skiing, Skiing Area News, and Skiing Trade News. (Travel Weekly is published by Robinson Publications, Inc., a subsidiary of Ziff-Davis Publishing Company.)

All subscription correspondence should be addressed to POPULAR ELECTRONICS, Circulation Department, Portland Place, Boulder, Colorado 80302. Please allow at least six weeks for change of address. Include your old address, as well as new-enclosing if possible an address label from a recent issue.

EDITORIAL CONTRIBUTIONS must be accompanied by return postage and will be handled with reasonable care; however, publisher assumes no responsibility for return or safety of art work, photographs or manuscripts.



Member Audit Bureau  
of Circulations

POPULAR ELECTRONICS

**NEW!**  
**MASTER COURSE**  
**IN COLOR TV...**

**WITH NTS COLOR KITS**

Big 25" Color TV kits included in new Master Color TV Home Study program. Learn Color TV; keep the new 25" color TV receiver you build with exciting kits we send you. 10 million homes in this country will have color TV by the end of 1967. This industry needs technicians as never before, and NTS-trained men can move quickly into the big money.

**COLOR TV SERVICING BRINGS HIGH PROFITS**

New color sets need careful installation, precision tuning and skilled servicing. NTS home training can put you in this profit picture—prepare you for big pay, security, or start a business of your own.

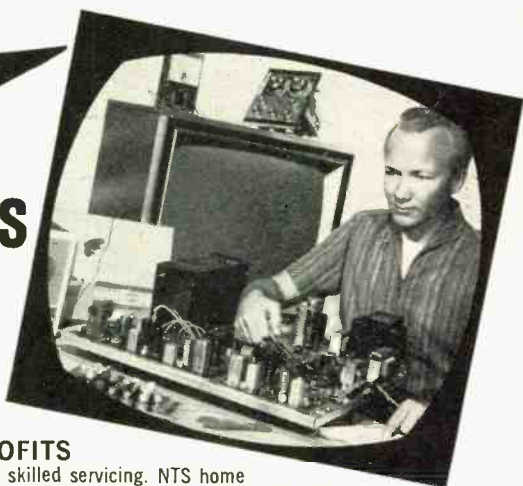

**LIFT OFF...TO**  
**A "SPACE AGE"**  
**CAREER IN**  
**ELECTRONICS**

This is the "space age". It offers new opportunities in communications, industrial electronics, computer technology, and many others. Automation has increased the need for skilled electronics technicians in thousands of manufacturing plants. Only the well trained man makes it big. Industry wants and demands this kind of man... the NTS man. Pick your field. Let an NTS Project Method Program help you toward a well-paid career in Electronics wherever you travel.

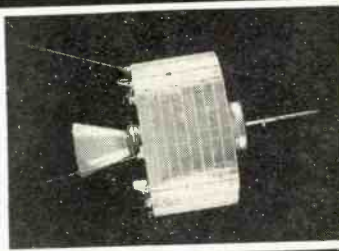

**NEW CAREER KIT... FAST, EASY START TO NTS HOME TRAINING**

The exclusive Project Method Career Kit helps you move quickly into your training program. Earn while you learn as you progress with your shop-tested Project Method lessons and kits.

Send for the New illustrated NTS Color Catalog. It shows the equipment and kits you work with and keep. Describes in detail the advantages of NTS Project Method Home Training. Tells you everything you need to know about starting your career in electronics.



**HIGH SCHOOL AT HOME**

National offers accredited high school programs. Take only subjects you need. Study at your own pace. Everything included at one low tuition. Check special High School box in coupon for full information & FREE catalog.

**CLASSROOM TRAINING AT LOS ANGELES**

You can take Classroom Training at Los Angeles in Sunny Southern California. NTS occupies a city block with over a million dollars in facilities devoted exclusively to technical training.

**MAIL REPLY CARD OR COUPON FOR NEW, FREE COLOR CATALOG AND SAMPLE LESSON.**



**NATIONAL TECHNICAL SCHOOLS**

World Wide Training Since 1905  
 4000 S. Figueroa St., Los Angeles, Calif. 90037

You enroll by mail

We have no salesmen: This means lower tuition for you.  
 Accredited Member National Home Study Council  
 Member: National Association of Trade & Technical Schools

**NATIONAL TECHNICAL SCHOOLS**

4000 S. Figueroa St., Los Angeles, California 90037

APPROVED FOR VETERANS

Please rush Free Color Catalog and Sample Lesson, plus detailed information on field checked below. No obligation. Dept. 205-77

- MASTER COURSE IN COLOR TELEVISION
- COLOR TV SERVICING
- MASTER COURSE IN ELECTRONICS-TV-RADIO plus ADVANCED TV and INDUSTRIAL ELECTRONICS
- ELECTRONICS-TV-RADIO SERVICING AND COMMUNICATIONS
- FCC LICENSE COURSE
- RADIO SERVICING (AM-FM-TRANSISTORS)
- TELEVISION SERVICING (including color lessons)
- STEREO, HI-FI and SOUND SYSTEMS
- BASIC ELECTRONICS
- ELECTRONICS MATH  HIGH SCHOOL AT HOME

Name \_\_\_\_\_ Age \_\_\_\_\_

Address \_\_\_\_\_

City \_\_\_\_\_ State \_\_\_\_\_ Zip \_\_\_\_\_

- Check if interested in Veteran Training under new G.I. Bill.
- Check if interested ONLY in Classroom Training at Los Angeles.

# FREE!

**BIGGER... BETTER  
THAN EVER!**



**40th ANNIVERSARY  
1967 CATALOG**

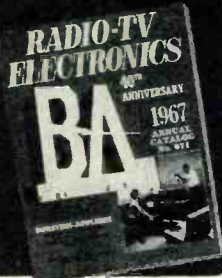

**YOUR BUYING GUIDE FOR:**

- Stereo & Hi-Fi Systems & Components.
- Tape Recorders.
- Electronics Parts, Tubes, Tools.
- Phonos & Records.
- Ham Gear.
- Test Instruments & Kits.
- Cameras & Film.
- P.A. • Citizens Band.
- Radio & TV Sets.
- Musical Instruments.

**SEND FOR  
YOURS TODAY!**

## BURSTEIN-APPLEBEE CO.

Dept. PE 1012 McGee, Kansas City, Mo. 64106  
 Rush me the FREE 1967 B-A Catalog.

Name.....

Address.....

City..... State..... Zip Code.....

**CIRCLE NO. 5 ON READER SERVICE PAGE**

**IT ONLY COSTS  
1/100 OF 1¢ MORE  
PER SOLDER JOINT  
TO KNOW YOU ARE USING THE  
WORLD'S FINEST CORED SOLDER**



New Easy  
Dispenser  
Pat.  
60/40  
18 S.W.G.



Latest PC  
(Printed)  
Circuit Pak  
60/40 Extra Thin  
22 S.W.G.—.028"

each only 69¢ per package at your dealer

ERSIN **Multicore**  
FIVE-CORE  
SOLDER

MULTICORE SALES CORP., WESTBURY, N.Y. 11590  
**CIRCLE NO. 20 ON READER SERVICE PAGE**

# LETTERS

FROM OUR READERS

Address correspondence for this department to:  
Letters Editor, POPULAR ELECTRONICS  
One Park Avenue, New York, N. Y. 10016

## THE MULE IS A JEWEL

We developed, designed, and have manufactured the "Jewel Box" since late 1964. This is an outboard r.f. amplifier similar to your "Mule Box" (March 1967, p. 45). It is often said that you should be flattered if someone thinks enough of your work to copy it. We are flattered.

RICHARD MARESH  
Wawasee Electronics Company  
Syracuse, Ind.

*As with innumerable electronic circuits, there are similarities between the "Jewel Box" and the "Mule Box," but the "Jewel Box" was not designed for operation with Class D CB equipment. And although the method of reducing carrier amplitude is similar, there are at least a dozen other distinct differences between these two circuits.*

## TUNER TAMER

Being a Tuner Tamer myself for several years, I was happy to see the article called "Taming Your TV Tuner" (March, 1967). But I would like to add a P.S. to this fine article. On a recent safari into my Heathkit color TV tuner for its annual taming, I noticed a fair



amount of wear on the contact strips, and it seemed to me that this wear could be greatly reduced if the unused channel strips were removed. In our area only six channels are used, so I removed seven strips. The results were as expected: the wear was reduced in proportion to the number of strips removed. I eliminated  $\frac{7}{8}$  of the normal wear. Now my annual safari has become a biennial affair.

JERRY WALTER  
N. Palm Beach, Fla.

## PUBLIC COMMENDATION

I took my Weller Model 8200-PK soldering gun back to the store to be sent to the factory

POPULAR ELECTRONICS





# Crisp Bacon in 90 Seconds

with **INTERNATIONAL'S  
MICROWAVE OVEN**

The culinary wonder of space age cooking moves to your kitchen with this new International countertop oven that cooks with radar-spawned microwave power.

People on the go will welcome an oven that makes cooking chores a pleasure. Imagine a "piping hot" TV dinner (frozen) in 3½ minutes\* instead of 20 to 50 minutes. Bake a potato in 5 minutes instead of 60 minutes. Warm a chilled baby bottle in 60 seconds. Fry crisp bacon in 90 seconds on a paper plate. Great for those leftovers.

International Microwave Oven is truly remarkable. No more waiting for the oven to reach cooking temperature.

Countertop designed for the home, mobile home, or the galley on your boat. No special wiring required. Works on 115 vac house circuit. Comes in baked vinyl white with attractive trim. **\$545.00**

Available direct from International or through your local appliance dealer.

*\*Times listed are approximate and vary with size of item.*



Write for folder.



**CRYSTAL MFG. CO., INC.**

10 NO. LEE • OKLA. CITY, OKLA. 73102

**CIRCLE NO. 13 ON READER SERVICE PAGE**

July, 1967

9

# NOW FROM

A Complete Automotive and Ignition Tune-Up System



## MARK TEN

Capacitive Discharge Ignition System

\$44<sup>95</sup> Assembled

\$29<sup>95</sup> Kit Form

Get mileage you never dreamed of! 3 to 10 times spark plug life. Instant starts in all weather. Installs in only 10 minutes. Up to 20% gas savings. Dramatic increase in engine performance and acceleration.

## 2 NEW AUTO TUNE UP INSTRUMENTS



**DWELL METER**  
\$12.95 Ppd.



**TACH METER**  
\$14.95 Ppd.

These two new cousins to the world famous proven MARK TEN now give you the capability to tune your own car inexpensively, easily, with remarkable precision. These separate instruments are low cost, portable and the easiest to read you've ever seen.

- Delta's famous printed circuit design
- Superior in precision, quality and performance to instruments selling for FIVE TIMES as much
- Large dial, high quality jewel D'Arsonval meters
- Operates with standard, transistor or capacitive discharge systems as well as magnetos
- Instant readings — no confusing scales

Send Your Order Today



## DELTA PRODUCTS, INC.

P.O. Box 1147 PE • Grand Junction, Colo. 81501

Enclosed is \$\_\_\_\_\_. Ship prepaid.

Ship C.O.D.

Please send:

Dwell Meters @ \$12.95

Tach Meters @ \$14.95

Mark Tens (Assembled) @ \$44.95

Mark Tens (Delta Kit) @ \$29.95

(12 volt positive or negative ground only)

SPECIFY —  Positive  Negative

6 or  12 Volt

Car Year \_\_\_\_\_ Make \_\_\_\_\_

Name \_\_\_\_\_

Address \_\_\_\_\_

City/State \_\_\_\_\_ Zip \_\_\_\_\_

CIRCLE NO. 28 ON READER SERVICE PAGE

## LETTERS

(Continued from page 8)

because of a faulty switch. The gun came back, promptly, not just fixed, but polished, with a set of tools, three new tips, and a guarantee to boot. I would like to commend the Weller Electric Corp. for this fine service.

DOUG WEARY  
Carlisle, Pa.

## PARTS SUBSTITUTIONS—AGAIN!

Why-oh-why do your authors always use parts and components that I can't buy? They keep calling out parts that stores in my city don't sell, or have never heard of. Are you and the authors in some other business—like selling radio parts?

HAROLD HAGENS  
Waterloo, Iowa

*Generally, an author recommends a particular part for a project because it's the one he used and he knows that the project works*



*with it. Neither the author nor the magazine can get every possible substitution and try it out. To be on the safe side, we always tell you what the author used. It is often possible to substitute a different manufacturer's part, but such substitution must be made at the builder's discretion.*

## "ETERNAL VTVM 'C' CELL"

Incorporating the "Eternal VTVM 'C' Cell" (May, 1966) in my Heathkit IM-13 VTVM was easy, but it takes a little doing on the IM-11 with its printed circuit board. I made up a package of the resistor, rectifier, and a nickel-cadmium battery the size of a penlight cell (C450 or N46, Allied 55 U 629) wrapped with tape and padded out to the size of a "C" cell. The a.c. lead was connected to the hot side of the pilot lamp. I put a piece of insulating tape over the "plus" end with a hole for the contact, and wrapped the connecting wire around the contact—NO SOLDER. In case of trouble, this package can be easily removed and the regular "C" battery restored.

HENRY C. MCCARTY  
Sun City, Calif.

## ASSISTING OPERATION ASSIST

To Philco owners who want schematics: I have obtained schematics and specifications  
(Continued on page 14)

# LOOK!

## A New Electronics Slide Rule with Instruction Course

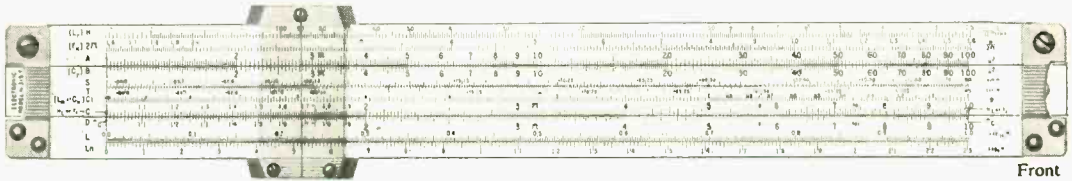

Front



Back

This amazing new "computer in a case" will save you time the very first day. CIE's patented, all-metal 10" electronics slide rule was designed *specifically* for electronic engineers, technicians, students, radio-TV servicemen and hobbyists. It features special scales for solving reactance, resonance, inductance and AC-DC circuitry problems... an exclusive "fast-finder" decimal point locator... widely-used formulas and conversion factors for instant reference. And there's all the standard scales you need to do multiplication, division, square roots, logs, etc.

Best of all, the new CIE Slide Rule comes with an Instruction Course of four **AUTO-PROGRAMMED** lessons. It includes hundreds of illustrations, diagrams and practice problems. You'll learn ingenious short cuts... whip through exacting electronics problems quickly and accurately. This course alone is worth far more than the price of the entire package!

Electronics Slide Rule, Instruction Course, and handsome, top-grain leather carrying case... a \$50 value for less than \$25. Send coupon for **FREE** illustrated booklet and **FREE** heavy vinyl Pocket Electronics Data Guide. Cleveland Institute of Electronics, 1776 E. 17th St., Dept. PE-134, Cleveland, Ohio 44114.

\*TRADEMARK

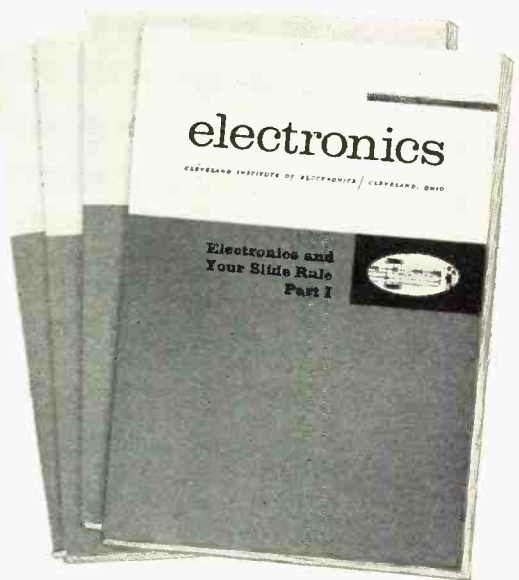

**GET BOTH FREE!**



**Send coupon today →**

### Cleveland Institute of Electronics

1776 E. 17th St., Dept. PE-134, Cleveland, Ohio 44114

Please send **FREE** Illustrated Booklet describing your Electronics Slide Rule and Instruction Course.

**SPECIAL BONUS!** Mail coupon promptly... get **FREE** Pocket Electronics Data Guide too!

Name \_\_\_\_\_ (PLEASE PRINT)

Address \_\_\_\_\_ County \_\_\_\_\_

City \_\_\_\_\_ State \_\_\_\_\_ Zip \_\_\_\_\_

A leader in Electronics Training... since 1934.

CIRCLE NO. 6 ON READER SERVICE PAGE



# Now Available For Immediate Delivery... Deluxe Heathkit Rectangular Color TV



Kit GR-295

**\$479<sup>95</sup>\***

(295 sq. inch viewing area)

### Exclusive Features That Can't Be Bought In Ready-Made Sets At Any Price!

All color TV sets require periodic convergence and color purity adjustments. Both Heathkit Color TV's have exclusive built-in servicing aids, so you can perform these adjustments anytime . . . without calling in a TV serviceman . . . without any special skills or knowledge. Just flip a switch on the built-in dot generator and a dot pattern appears on the screen. Simple-to-follow instructions and detailed color photos in the manual show you exactly what to look for, what to do and how to do it. Results? Beautifully clean and sharp color pictures day in and day out . . . and up to \$200 savings in servicing calls throughout the life of your set.

**Exclusive Heath Magna-Shield** . . . surrounds the entire tube to keep out stray magnetic fields and improve color purity. In addition, **Automatic De-gaussing** demagnetizes and "cleans" the picture everytime you turn the set on from a "cold" start. **Choice Of Installation** . . . Another Exclusive! Both color TV's are designed for mounting in a wall or your own custom cabinet. Or you can install either set in a choice of factory assembled and finished Heath contemporary walnut or Early American cabinets.

**From Parts To Programs In Just 25 Hours.** All critical circuits are preassembled, aligned and tested at the factory. The assembly manual guides you the rest



Kit GR-180

**\$379<sup>95</sup>\*\***

(180 sq. inch viewing area)

of the way with simple, non-technical instructions **Plus A Host Of Advanced Features** . . . a hi-fi rectangular picture tube with "rare earth" phosphors for brighter, livelier colors and sharper definition . . . **Automatic Color Control and Gated Automatic Gain Control** to reduce color fading and insure jitter-free pictures at all times . . . deluxe **VHF Turret Tuner** with "memory" fine tuning . . . **2-Speed Transistor UHF Tuner** . . . **Two Hi-Fi Sound Outputs** for play through your hi-fi system or connection to the special limited-field speaker . . . **Two VHF Antenna Inputs** — 300 ohm balanced and 75 ohm coax . . . **1-Year Warranty** on the picture tube, 90 days on all other parts . . . plus many more deluxe features. For full details, mail coupon for **FREE** Heathkit catalog.

\***Kit GR-295**, everything except cabinet, 131 lbs. . . . . **\$479.95**

**GRA-295-1**, walnut cabinet (shown above) 56 lbs. . . 19" D. x 31" H. x 34 1/2" W. . . . . **\$62.95**

Deluxe contemporary walnut & Early American cabinets also available at \$94.50 & \$99.95

\*\***Kit GR-180**, everything except cabinet, 102 lbs. . . . . **\$379.95**

**GRA-180-1**, walnut cabinet (shown above) 41 lbs. . . 18 1/4" D. x 28 1/4" W. x 29" H. . . . . **\$49.95**

Early American cabinet available at \$75.00

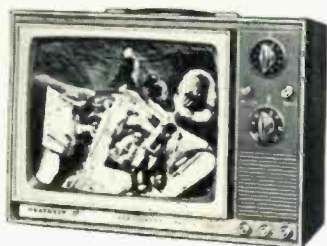

Kit GR-104

**\$119<sup>95</sup>**

### Deluxe 12" Solid-State B & W Portable TV

Unusually sensitive performance. Plays anywhere runs on household 117 v. AC, any 12 v. battery, or optional rechargeable battery pack (\$39.95); receives all channels; new integrated sound circuit replaces 39 components; pre-assembled, prealigned tuners; high gain IF strip; Gated AGC for steady, jitter-free pictures; front-panel mounted speaker; assembles in only 10 hours. Rugged high impact plastic cabinet measures a compact 11 1/2" H x 15 3/4" W x 9 3/4" D. 27 lbs.

# Build Your Own Heathkit® Electronics!

**60-Watt Solid-State Guitar Amplifier . . . All The Features Guitarists Want Most!**



Kit TA-16  
**\$129<sup>95</sup>**

**Worth \$300!** Two channels, 4 inputs handle accordion, guitars, organ or mike. Variable tremolo & reverb. Two foot switches. Two 12" speakers. Line bypass reversing switch for hum reduction. Leather-textured vinyl cabinet of ¾" stock. 28" W x 9" D x 19" H. Build in 12 hours. 52 lbs.

**NEW Heathkit 150-Watt Solid-State AM /FM Stereo Receiver**



Kit AR-15 **\$329<sup>95</sup>** (less cab.)

**World's Most Advanced Stereo Receiver . . .** with features like integrated circuits and crystal filters in the IF amplifier section; preassembled & aligned field effect transistor FM tuner for superior cross modulation index and image rejection; positive circuit protection; all silicon transistors; 2 tuning meters; and much more for the finest in stereo listening. See Julian Hirsch's review in the May issue of *Hi-Fi/Stereo Review*. 34 lbs.

Optional walnut wrap-around cabinet @ \$19.95

**NEW Solid-State Stereo 4-Speed Portable Phonograph**



Kit GD-107  
**\$49<sup>95</sup>**

**Go "Mod"! Go Stereo!** Features two 4" x 6" speakers and special "in-depth" cabinet design for a robust sound others can't match; automatic stereo or mono play of any size, any speed record; ceramic cartridge with dual diamond/sapphire styli; volume, stereo balance and tone controls; preassembled, fold-up changer and handle for suitcase portability; 3 watts music power; 45 rpm spindle; preassembled cabinet; 120 v. 60 Hz operation. Build in 3 to 4 hours. 24 lbs.

**NEW Amateur Radio Novice CW Transceiver**

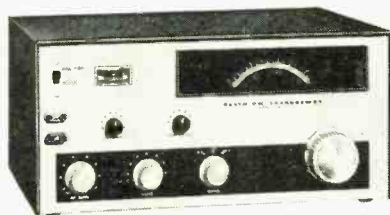

Kit HW-16  
**\$99<sup>50</sup>**

**Who Said Getting Started In Amateur Radio Is Expensive?** Check this new low cost Heathkit CW transceiver. Covers 80, 40 and 15 meter CW bands only. Features full break-in operation, provision for using HG-10B VFO; 50 to 90 watt adjustable power input; grid block keying; highly stable crystal controlled heterodyne receiver with RF stage; crystal lattice filter for 500 Hz selectivity; outputs for speaker or headphones; handsome gray-green cabinet. 23 lbs.

**FREE**

**World's Largest Electronic Kit Catalog!**

Describes these and over 250 kits for stereo/hi-fi, color TV, amateur radio, shortwave, test, CB, marine, educational, home and hobby. Save up to 50% by doing the easy assembly yourself. Mail coupon or write Heath Company, Benton Harbor, Michigan 49022



**HEATH COMPANY, Dept. 10-7**  
Benton Harbor, Michigan 49022  
In Canada, Daystrom Ltd.

Enclosed is \$ \_\_\_\_\_, plus shipping.

Please send model (s) \_\_\_\_\_

Please send FREE 1967 Heathkit Catalog.

Name \_\_\_\_\_

Address \_\_\_\_\_

City \_\_\_\_\_

State \_\_\_\_\_

Zip \_\_\_\_\_

Prices & specifications subject to change without notice.

CL-291

**CIRCLE NO. 12 ON READER SERVICE PAGE**

**Ask for  
Turner's M+2/U...**



## the LONG DISTANCE OPERATOR

The Turner M+2/U, a modified version of the famous Turner M+2, is here . . . and it gives you clear, distinct communication over distances which used to require a telephone!

The M+2/U uses a self-contained pre-amp and fingertip output control to let you dial the modulation you need . . . and it operates with any transceiver, tube or transistor! Wires quickly, easily . . . no matter what brand transceiver you have!

If you want new life for your old transceiver (or an unbelievable performance boost for a new one!) . . . ask for the new Turner M+2/U. It's the Long Distance Operator that's always on duty.



In Canada: Tri-Tel Associates, Ltd. Export: Ad Auriema, Inc., 85 Broad Street, New York, N.Y. 10004

**CIRCLE NO. 26 ON READER SERVICE PAGE**

## LETTERS (Continued from page 10)

from the Broome Distributing Company, 100 Tully St., Syracuse, N.Y., an address I received from the Philco home office. I obtained information on Models 40-180, 40-185, 40-190, 40-195, 40-200, 40-201, code 121-122; and Models 41-250, 41-255, 41-256, 41-246, code 121. They might well have other "old set" information.

ED YATES  
Wyalusing, Pa.

We note many requests for circuit diagrams and service notes for pre-1935 radios in "Operation Assist." We have, in fairly good condition, several sets of RCA service notes covering the RCA "Superette," Radiola R-11, R-50, R-55, R-14-15, R-35, R-39, Re-57, #17, 42, 44, 46, 48, 8-, 86, portable "Victrola" 2-65, "Radiolette" R-5, etc. We would be happy to place these service notes with some responsible

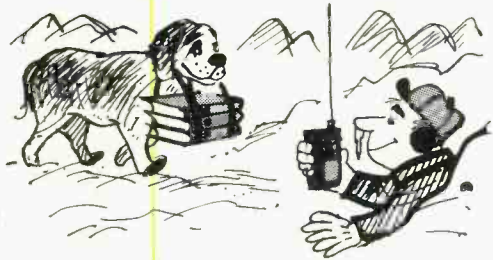

group that would make the information available by photostat or otherwise to those interested. However, we would hesitate to turn them over to just any private individual for his personal use.

CHARLES W. SMALLWOOD  
Charlotte Hardware  
P.O. Box 368  
Charlotte, Mich.

I have books on the Philco Models 3 to 511, all Philco models for 1939, 1941, and 1942, home and auto radios, which I no longer need. The books are complete, however—I would not want to tear out pages.

ERNEST PIPPO  
848 Summit St.  
Hancock, Mich.

### "HOW-TO" ELECTRONICS LIBRARY

The last item in "Electronics Library" (page 16, February, 1967) covers ten books which constitute a "How-To" electronics library. Would you be kind enough to give me an address that I can use to order these books by mail?

LARRY THOMAS  
Franklin, La.

*Since these books are distributed by the International Resistance Company through its electronic parts distributors, we suggest that you write to the company, which is located at 401 N. Broad St., Philadelphia, Pa. 19108, and let them take it from there.*

—30—



# POPULAR ELECTRONICS

## READER SERVICE PAGE

**You can get  
additional information promptly  
concerning  
products advertised or mentioned  
editorially  
in this issue**

1

Circle the number on the coupon below which corresponds to the key number at the bottom of the advertisement or is incorporated in the editorial mention that interests you.

2

Mail the coupon to the address indicated below.

3

Please use this address only for Product Service requests.

**POPULAR ELECTRONICS  
P. O. BOX 8391  
PHILADELPHIA, PA. 19101**

*Please send me additional information about the products whose code numbers I have circled*

1 2 3 4 5 6 7 8 9 10 11 12 13 14 15 16 17 18 19 20 21 22 23 24 25  
26 27 28 29 30 31 32 33 34 35 36 37 38 39 40 41 42 43 44 45 46 47 48 49 50  
51 52 53 54 55 56 57 58 59 60 61 62 63 64 65 66 67 68 69 70 71 72 73 74 75  
76 77 78 79 80 81 82 83 84 85 86 87 88 89 90 91 92 93 94 95 96 97 98 99 100

NAME (Print clearly) \_\_\_\_\_

ADDRESS \_\_\_\_\_

CITY \_\_\_\_\_ STATE \_\_\_\_\_ ZIP CODE \_\_\_\_\_

**VOID AFTER AUGUST 31, 1967**

7

Live Better Electronically With

# LAFAYETTE RADIO ELECTRONICS

1967 Catalog 670 **FREE!**



**BETTER THAN EVER  
512 Pages**

Stereo Hi-Fi • Citizens Band • Ham Gear • Tape Recorders • Test Equipment • TV and Radio Tubes and Parts • Cameras • Auto Accessories • Musical Instruments • Tools • Books

Featuring Everything in Electronics for  
• HOME • INDUSTRY • LABORATORY  
from the "World's Hi-Fi & Electronics Center"

LAFAYETTE Radio ELECTRONICS  
Dept. IG-7 P.O. Box 10  
Syosset, L.I., N.Y. 11791

Send me the FREE 1967 LAFAYETTE Catalog 670 IG-7

Name .....

Address .....

City ..... State .....

Zip .....

(Please Give Your Zip Code No.)

CIRCLE NO. 16 ON READER SERVICE PAGE

## AM/FM VHF RECEIVERS

**POLICE • FIRE • AIRCRAFT  
AMATEUR • GENERAL COVERAGE**

The new 364C is a self contained highly sensitive receiver offering the user continuous AM/FM coverage from 26 to 54 and 88 to 174 MC in eight bands plus one band covering 15 meters. Features: superhet circuitry, full vision calibrated dial with vernier drive, speaker, power transformer, ready to use for 110/120 V AC.



364C

**\$59.95**



377A

**\$22.50**

377A Low cost tuneable transistor converter self contained battery for car use. Three types—low or high band police and fire or aircraft. Also complete line of crystal controlled converters and squelch units for monitoring police, fire, aircraft, etc. signals.

372B Level limiting is a necessity in recording. The 372B features low distortion and adequate dynamic range for any situation. Write for full details of this and other audio equipment.



372B

**\$99.95**

## KUHN ELECTRONICS

20 GLENWOOD CINCINNATI 17, OHIO

CIRCLE NO. 15 ON READER SERVICE PAGE



# TIPS & TECHNIQUES

## CLOCK MOTOR COIL DOUBLES AS TELEPHONE PICKUP

You can use the motor windings from an old electric clock as an inductive coupling coil to pick up telephone conversations and feed them into an amplifier for group or conference work. Remove the clock case and check the coil to see that it isn't open-circuited or otherwise defective. Then carefully remove the coil and connect it to one end of a shielded cable. Wrap the cable par-

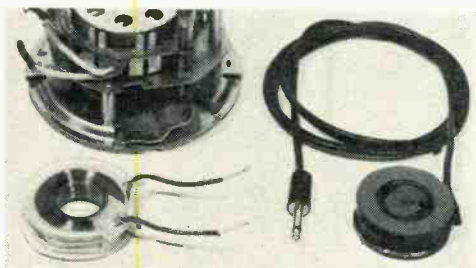

tially around the coil to act as a strain relief and secure it in place with several layers of electrical tape. Now connect the other end of the cable to a suitable jack to fit the input of your amplifier. Place the coil on the underside of the telephone cradle or in whatever position gives you maximum pickup.

—William Welch

## "HOME-BREW" QUICKIE SOLDERING GUN TIPS

If your soldering gun tip breaks and you have no spares, you can improvise a new tip with a piece of No. 10 or 12 AWG solid copper wire. You can quickly fashion the wire to almost any shape you wish. Simply cut it to the correct length (3 1/2" to 4 1/2"), strip off the insulation, if any, and bend the wire to shape. Such a soldering tip might not last as long as the store-bought kind, but will tide you over until you have a chance to get a new supply of tips.

—Jack R. Kiser

## GET 2, 4, 6, 8, 10 AND 12 VOLTS FROM YOUR CAR BATTERY

Car batteries are made up of a series of interconnected 2-volt cells, each of which can be tapped to provide a different potential up to 12 volts (6 volts with 6-volt batteries). To make the potential of each cell easily avail-

(Continued on page 82)

POPULAR ELECTRONICS

# If General Custer had used a Messenger 300

... things might have happened differently that day along the Little Big Horn River.

There's really no need to fight a battle every time you want to go on the air. The Johnson Messenger 300 protects your flanks at all times from adjacent channel interference with a precision crystal filter. Your voice carries authority thanks to the Messenger 300's speech compression circuit. It gives you more audio without splatter or overmodulation.

On the front lines the Messenger 300 operates up to 8 hours on the rechargeable Power Pack. At the command post, plug in the accessory AC power supply. You can even signal the troops with Tone Alert selective calling. It eliminates the need for constant monitoring and lets you concentrate on more important matters. FCC type accepted and DOT approved.

Don't win a price battle and get scalped on quality. Put yourself in command with a Johnson Messenger 300. Send for details today.



*Johnson's Messenger 1, TWO, III, 100 and 300 are FCC type accepted and DOT approved. No other manufacturer gives you this assurance of quality and performance.*



**E. F. JOHNSON COMPANY**

2424 Tenth Ave. S. W., Waseca, Minn. 56093

Providing nearly a half-century of communications leadership

**CIRCLE NO. 14 ON READER SERVICE PAGE**

Please send me information on the Messenger 300 and the complete Johnson CB line.

Name \_\_\_\_\_

Address \_\_\_\_\_

City \_\_\_\_\_ State \_\_\_\_\_ Zip \_\_\_\_\_



# SOMEONE SHOULD DEVELOP AN EASY WAY TO LEARN ELECTRONICS AT HOME

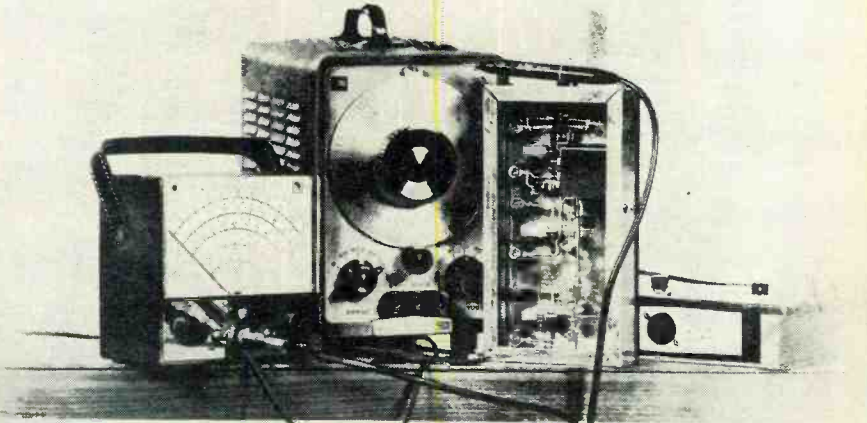

## RCA INSTITUTES DID!

Here is a whole new approach to learning electronics at home! RCA Institutes, one of the nations' largest schools devoted to electronics, has developed a faster, easier way for you to gain the skills and the knowledge you need for the career of your choice. Here for the first time, is a student-proved, scientifically designed way to learn. If you have had any doubts in the past about home training in electronics—if you have hesitated because you thought you might not be able to keep up—or that electronics was too complicated to learn—here is your answer! Read how RCA Institutes has revolutionized its entire home training ideas!

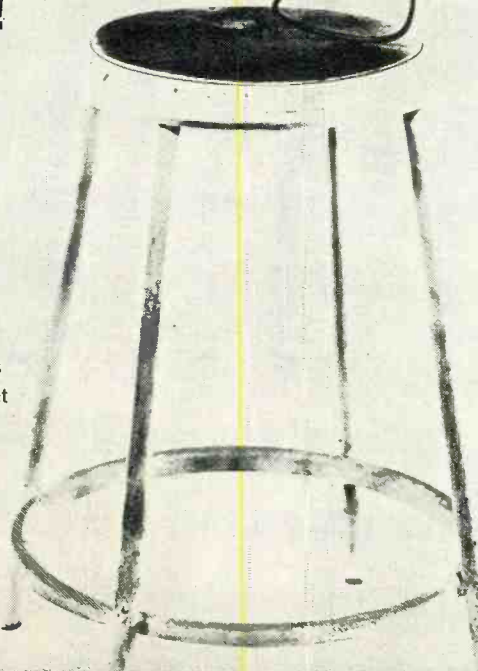

## NEW CAREER PROGRAMS BEGIN WITH "AUTOTEXT" INSTRUCTION METHOD!

**Start to learn the field of your choice immediately!**

**No previous training or experience in electronics needed!**

With this new revolutionized method of home training you pick the career of your choice—and RCA Institutes trains you for it. RCA's Career Programs assure you that everything you learn will help you go directly to the field that you have chosen! No wasted time learning things you'll never use on the job! The Career Program you choose is especially designed to get you into that career in the fastest, easiest possible way!

And each Career Program starts with the amazing "AUTOTEXT" Programmed Instruction Method—the new, faster way to learn that's almost automatic! "AUTOTEXT" helps even those who have had trouble with conventional home training methods in the past. This is the "Space Age" way to learn everything you need to know with the least amount of time and effort.

### **CHOOSE A CAREER PROGRAM NOW**

Your next stop may be the job of your choice. Each one of these RCA Institutes Career Programs is a complete unit. It contains the know-how you need to step into a profitable career. Here are the names of the programs and the kinds of jobs they train you for. Which one is for you?

**Television Servicing.** Prepares you for a career as a TV Technician/Serviceman; Master Antenna Systems Technician; TV Laboratory Technician; Educational TV Technician.

**FCC License Preparation.** For those who want to become TV Station Engineers, Communications Laboratory Technicians, or Field Engineers.

**Automation Electronics.** Gets you ready to be an Automation Electronics Technician; Manufacturer's Representative; Industrial Electronics Technician.

**Automatic Controls.** Prepares you to be an Automatic Controls Electronics Technician; Industrial Laboratory Technician; Maintenance Technician; Field Engineer.

**Digital Techniques.** For a career as a Digital Techniques Electronics Technician; Industrial Electronics Technician; Industrial Laboratory Technician.

**Telecommunications.** For a job as TV Station Engineer, Mobile Communications Technician, Marine Radio Technician.

**Industrial Electronics.** For jobs as Industrial Electronics Technicians; Field Engineers; Maintenance Technicians; Industrial Laboratory Technicians.

**Nuclear Instrumentation.** For those who want careers as Nuclear Instrumentation Electronics Technicians; Industrial Laboratory Technicians; Industrial Electronics Technicians.

**Solid State Electronics.** Become a specialist in the Semiconductor Field.

**Electronics Drafting.** Junior Draftsman, Junior Technical Illustrator; Parts Inspector; Design Draftsman Trainee Chartist.

### **SEPARATE COURSES**

In addition, in order to meet specific needs, RCA Institutes offers a wide variety of separate courses which may be taken independently of the Career Programs, on all subjects from Electronics Fundamentals to Computer Programming. Complete information will be sent with your other materials.

### **LIBERAL TUITION PLAN**

RCA offers you a unique Liberal Tuition Plan—your most economical way to learn. You pay for lessons only as you order them. No long term contracts. If you wish to stop your training for any reason, you may do so and not owe one cent until you resume the course.

### **VALUABLE EQUIPMENT**

You receive valuable equipment to keep and use on the job—and you never have to take apart one piece to build another. **New—Programmed Electronics Breadboard.** You now will receive a scientifically programmed electronic bread-

board with your study material. This breadboard provides limitless experimentation with basic electrical and electronic circuits involving vacuum tubes and transistors and includes the construction of a working signal generator and superheterodyne AM Receiver.

**Bonus From RCA—Multimeter and Oscilloscope Kits.** At no additional cost, you will receive with every RCA Institutes Career Program the instruments and kit material you need to build a multimeter and oscilloscope. The inclusion of both these kits is an RCA extra.

### **CLASSROOM TRAINING ALSO AVAILABLE**

RCA Institutes maintains one of the largest schools of its kind in New York City where classroom and laboratory training is available in day or evening sessions. You may be admitted without any previous technical training; preparatory courses are available if you haven't completed high school. Coeducational classes start four times a year.

### **FREE PLACEMENT SERVICE**

In recent years, 9 out of 10 Resident School students who used the Free Placement Service had their jobs waiting for them when they graduated. And many of these jobs were with top companies in the field—such as IBM, Bell Telephone Labs, General Electric, RCA, and radio and TV stations and other communications systems throughout the world.

**SEND ATTACHED POSTAGE PAID CARD FOR COMPLETE INFORMATION, NO OBLIGATION. NO SALESMAN WILL CALL.**

**ALL RCA INSTITUTES COURSES  
AVAILABLE UNDER NEW GI BILL.**

**RCA INSTITUTES, Inc., Dept. PE-77**  
A Service of Radio Corporation of America  
350 West 4th St., New York, N.Y. 10014



**The Most Trusted Name In Electronics**



# NEW PRODUCTS

Additional information on products covered in this section is available from the manufacturers. Each new product is identified by a code number. To obtain further details on any of them, simply fill in and mail the coupon on page 15.

## AM/VHF-AIR BAND PORTABLE

You can monitor aircraft in flight, tower transmissions, and weather reports with the low-cost "Jetstream" AM/VHF-air band portable receiver announced by *Radio Shack*. Measuring only 6" x 3½" x 1½", the unit weighs about a pound. Like the "Patrolman," a new AM/VHF-police band portable, the pocket-size "Jetstream" carries *Radio Shack's* "Realistic" brand label. An a.c. adapter is available.



Circle No. 75 on Reader Service Page 15

## PORTABLE TRANSISTOR ANALYZER

Providing accurate analysis of both power and signal transistors, without setup, the *Seco Electronics* Model 260 solid-state transistor analyzer is said to be fast, easy to operate, and completely safe. The dynamic "in-circuit" go-no-go test also lets you immediately identify *nnp* and *ppp* types as well as lead connections. The d.c. analysis is made

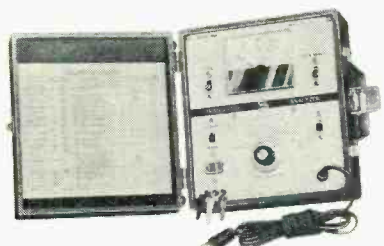

"out of circuit"; the *Beta* test position provides a direct meter reading of d.c. gain, the *Icco* and *Icbo* test positions read both collector-to-emitter and collector-to-base leakage. Completely self-contained, the Model 260 is mounted in a durable vinyl-covered carrying case.

Circle No. 76 on Reader Service Page 15

## 12-VOLT SOLDERING IRON

*Weller Electric Corporation's* new soldering iron, Model TCP-12, operates from any 12-volt battery or 12-14 volt a.c./d.c. power supply, and incorporates *Weller's* exclusive "temperature control" system for minimal battery source power drain, long tool and tip life, and rapid recovery for maximum efficiency and performance.

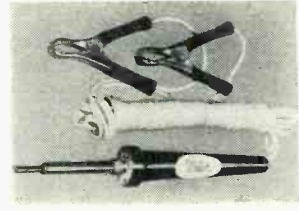

The light-weight pencil-style tool has a 12' power cord with battery clips, and a 700°F, ⅜" screwdriver tip. Tips of other configurations and temperature ranges are available, however, as is a similar soldering iron for 24-28 volt operation.

Circle No. 77 on Reader Service Page 15

## AUTOMATIC TURNTABLE

The new "Dual" Model 1015 automatic turntable announced by *United Audio Products, Inc.*, is the lowest-priced in the Dual Auto/Professional Series but shares with the more expensive models a dynamically balanced tone arm, direct-dial anti-skating, and a



versatile cueing system that can be used with either manual or automatic start. The low-mass, low-friction-bearing tone arm of the 1015 tracks as low as ½ gram, and accuracy of the tracking force is within 0.1 gram. Like all Duals, the 1015 is a fully automatic and manual single-play turntable, convertible to a record changer by interchanging the short single-play spindle with an "Elevator-Action" changer spindle.

Circle No. 78 on Reader Service Page 15

## CB TRANSCEIVER/P.A. SYSTEM

Mobile operating convenience and safety features are emphasized for the 5-watt solid-state CB transceiver/p.a. system introduced by *Hallcrafters*: concentric volume and squelch controls, illuminated channel selector, and an easily operated rocker switch which quickly converts the transceiver into a public address system with 4 watts of low-distortion audio output. Designated as the Model CB-21, the unit contains a 17-transis-



---

**what do you expect for \$99.95, miracles?**

---

# YES



*New Cobra V, 5 watt solid state CB. Created to perform miracles in performance.*

---

Just what you'd expect from B&K, the people who developed and built the famous Cobra CAM 88: new standards of performance in selectivity, in sensitivity, in miniaturization. Talk power? Dependability? Beauty? This one you've got to see and hear . . . to believe. Cobra V, the neatest little package of punch, power and performance to hit the CB industry yet. 5 channels, 100% modulation . . . it's a miracle for only \$99.95. You can hear it demonstrated at your B&K Distributor.



**A DIVISION OF DYNASCAN CORPORATION**

1801 W. Belle Plaine, Chicago, Illinois 60613

WHERE ELECTRONIC INNOVATION IS A WAY OF LIFE

Canada: Atlas Radio Corp., Ltd., Ontario  
Export: Empire Exporters, Inc., 123 Grand Street, New York, N.Y. 10013  
**CIRCLE NO. 4 ON READER SERVICE PAGE**

## PRODUCTS (Continued from page 22)

tor, 8-channel transceiver with a dual-conversion receiver. Typical sensitivity of the receiver section is 0.4  $\mu$ V for a signal with 30% modulation by a 1000-Hz tone. A special a.g.c. circuit compensates for variations in signal strengths and prevents "blasting" by nearby stations.

Circle No. 79 on Reader Service Page 15

### MOTOR CAPACITOR ANALYZER

Motor capacitors can be checked faster and easier with the Model M-3 "Mike-o-Meter" capacitor analyzer introduced by *Sprague Products Company*—it eliminates the need for ammeters, voltmeters, wattmeters, and complicated charts to interpret meter readings. A twist of a dial tells you whether capacitors are good or bad, and gives direct readings of actual capacitance and power factor measurements by the Wien bridge method. Mounted in a steel case (9" x 6" x 5 $\frac{1}{4}$ "), with a folding carrying handle, the unit weighs only six pounds. Model M-3 is designed for 110-125 volt a.c., 50-60 Hz applications. Also available is a Model M-3S for use on 110-125 or 220-230 volt a.c. (50-60 Hz) lines.

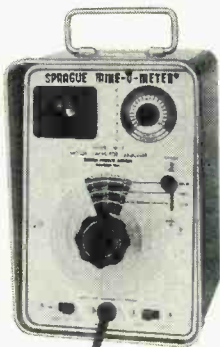

Circle No. 80 on Reader Service Page 15

### SEMI-AUTOMATIC ANTENNA ROTATOR

Featured in *Channel Master's* complete "Colorotor" line is the semi-automatic Model 9513 antenna rotator—said to be the first of its kind. The Model 9513 incorporates a motor instead of a meter in the control console; this motor, driving the position indicator dial, is synchronized with the exterior drive unit motor to provide more precise aiming and relocation of stations than is possible with manual meter indicators. Hookup is simplified through the use of three-conductor wire. The other rotators in the "Colorotor" line—Model 9503 (manual), Model 9512 (automatic), and Model 9516A (automatic, with de luxe wood cabinet)—have all been restyled and given increased torque to handle the heaviest fringe area color antennas and stacked arrays.

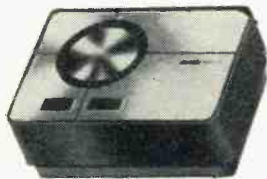

Circle No. 81 on Reader Service Page 15

### PORTABLE (CORDLESS) P.A. SYSTEM

Compact and lightweight (7" high, 4 $\frac{3}{4}$  pounds), the "Mark 7" p.a. system available from *AudioWave, Inc.*, can be carried virtually anywhere for hours on end with its shoulder-carrying strap, much as you would carry a camera. Features include solid-state and printed circuitry, battery operation, and a press-to-talk high-impedance dynamic microphone (frequency response, 70 to 15,000 hertz). Virtually unbreakable and impervious to weather, the Mark 7 has facilities for auxiliary speakers and microphones. Rechargeable batteries and a recharger are also available.



Circle No. 82 on Reader Service Page 15

### SOLID-STATE PORTABLE TAPE RECORDER

An improved model of *Lafayette Radio Electronics'* RK-142 series of monophonic tape recorders, the RK-142V operates vertically as well as horizontally. It provides more than



four hours of recording time with a long-play  $\frac{1}{2}$ -mil, 2400-foot tape reel. Features include: a separate push button to prevent accidental erasures! a lever-type switch for fast forward, rewind, play/record, and pause; instant speed selection switch (3 $\frac{3}{4}$ " or 7 $\frac{1}{2}$  in/s); a recording level meter; a 4" x 6" full-range hi-fi speaker and capstan drive; output jack and two input jacks. The RK-142V is furnished complete with microphone and alligator clip patch cord.

Circle No. 83 on Reader Service Page 15

### 3-WATT CB WALKIE-TALKIE

Latest in the *Polytronics* line of "Duo-Comm" walkie-talkies is the "123," a 3-watt, 2-channel hand-held CB unit. As in the previous four "Duo-Comm" units, rugged construction and a dual-conversion superheterodyne receiver circuit are featured. All solid-state, the "123" has 11 transistors, and is powered by rechargeable nickel-cadmium batteries. The sealed speaker/mike transducer is impervious to weather and to humidity.



Circle No. 84 on Reader Service Page 15

CIRCLE NO. 8 ON READER SERVICE PAGE →

*A new dimension  
in solid-state CB*

# COURIER CLASSIC

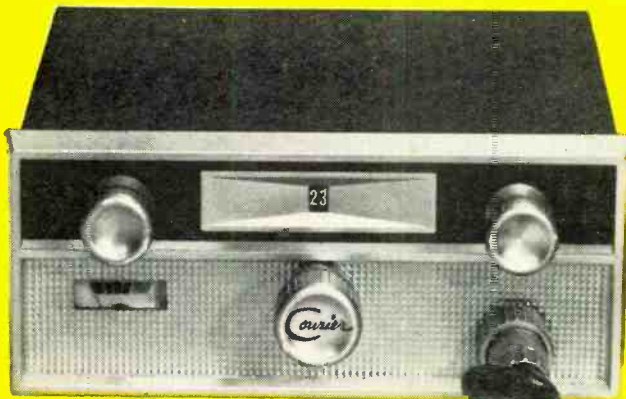

You are looking at the incomparable 23-channel Courier Classic—two years in development. Designed and engineered for total reliability, with years-ahead styling that sets a new standard of comparison. So advanced in performance, it required the creation of several new components by America's leading component manufacturers. With illuminated S meter. Illuminated channel selector. PA system. Auxiliary speaker jack. Single-knob tuning. Modulation indicator. DC cord. Exclusive Courier "Safety Circuit" to protect against mismatched antenna, incorrect polarity, and overload. The first transistor rig designed to help pierce "skip." Every known feature that could be built into a CB rig, in a compact 6½" W x 8½" D x 2½" H. Plus the industry's biggest guarantee—**10 full years!**

Just **\$189**  
Complete with crystals  
for all 23 channels.

**COURIER COMMUNICATIONS, INC.**  
56 Hamilton Avenue, White Plains, New York

Yes! Tell me all about the new Courier Classic.

Name \_\_\_\_\_

Address \_\_\_\_\_

City \_\_\_\_\_ County \_\_\_\_\_

State \_\_\_\_\_ Zip \_\_\_\_\_





## CLOSE THE TRACKABILITY GAP (AND YOU'LL HEAR THE DIFFERENCE)

The photomicrograph above portrays an errant, hard-to-track castanet sound in an otherwise conservatively modulated recording. The somewhat more heavily modulated grooves shown below are an exhilarating combination of flutes and maracas with a low frequency rhythm complement from a recording cut at sufficiently high velocity to deliver precise and definitive intonation, full dynamic range, and optimum signal-to-noise ratio. Neither situation is a rarity, far from it. They are the very essence of today's highest fidelity recordings. But when played with an ordinary "good" quality cartridge, the stylus invariably loses contact with these demanding grooves—the casta-

nets sound raspy, while the flute and maracas sound fuzzy, leaden, and "torn apart." Increasing tracking weight to force the stylus to stay in the groove will literally shave off the groove walls. Only the High Trackability V-15 Type II Super-Track® cartridge will consistently and effectively track all the grooves in today's recordings at record-saving less-than-one-gram pressure... even with cymbals, orchestral bells, and other difficult to track instruments. It will preserve the fidelity and reduce distortion from all your records, old and new. Not so surprisingly, every independent expert and authority who tested the Super Track agrees.

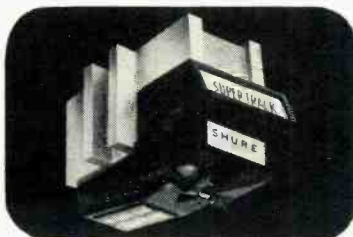
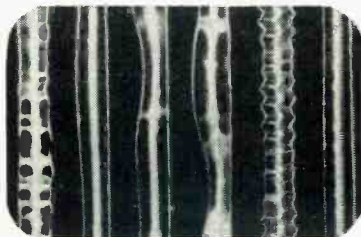

# SHURE V-15 TYPE II

**SUPER TRACKABILITY PHONO CARTRIDGE**

At \$67.50, your best investment in upgrading your entire music system.

Send for a list of Difficult-to-Track records, and detailed Trackability story: Shure Brothers, Inc., 222 Hartrey Ave., Evanston, Illinois 60204

© 1967 Shure Brothers Inc.



## BUILD THE "BEACHCOMBER"

COVER STORY

By DANIEL MEYER

THE ALTER EGO OF OUR DEEP SEARCH "IC-67" LOCATOR WILL FIND THOSE SMALL METALLIC OBJECTS AND COINS

**P**ROBABLY EVERY one of us has at one time or another had the urge to go searching for buried treasure. The "treasure" could be really valuable—a pot of gold coins buried during the Civil War, or a platinum locket lost on the beach—or it could be just a few cents dropped in some weeds or an old coffee can lid. A "treasure finder" or metal locator tells you where to dig.

Metal detectors come in two basic types. The one best suited to your needs will depend on just what you are searching for. The bulkier and more expensive transmit-receive detectors can find large

objects at greater depths, but do not detect small objects easily. A simple single-loop beat-frequency locator, like the "Beachcomber," will detect objects at a depth of only about 2 feet maximum (depending on size) but can readily find small objects only 1 or 2 inches in diameter.

The Beachcomber can be a lot of fun to have along on a trip to the coast, or to an old battlefield to search for relics. It is lightweight, and operates 6 to 8 hours on an ordinary transistor radio battery. Its speaker is built in, so there are no headsets or wires to get in the way or get lost. And it only costs about \$15 to build.

**How It Works.** The simple circuit (Fig. 1) consists of two r.f. oscillators—operating around 400 to 500 kHz, a detector, and an audio amplifier. The oscillators are identical, except for the coils used to tune them. One coil, *L1*, is tuned to make this oscillator's frequency slightly

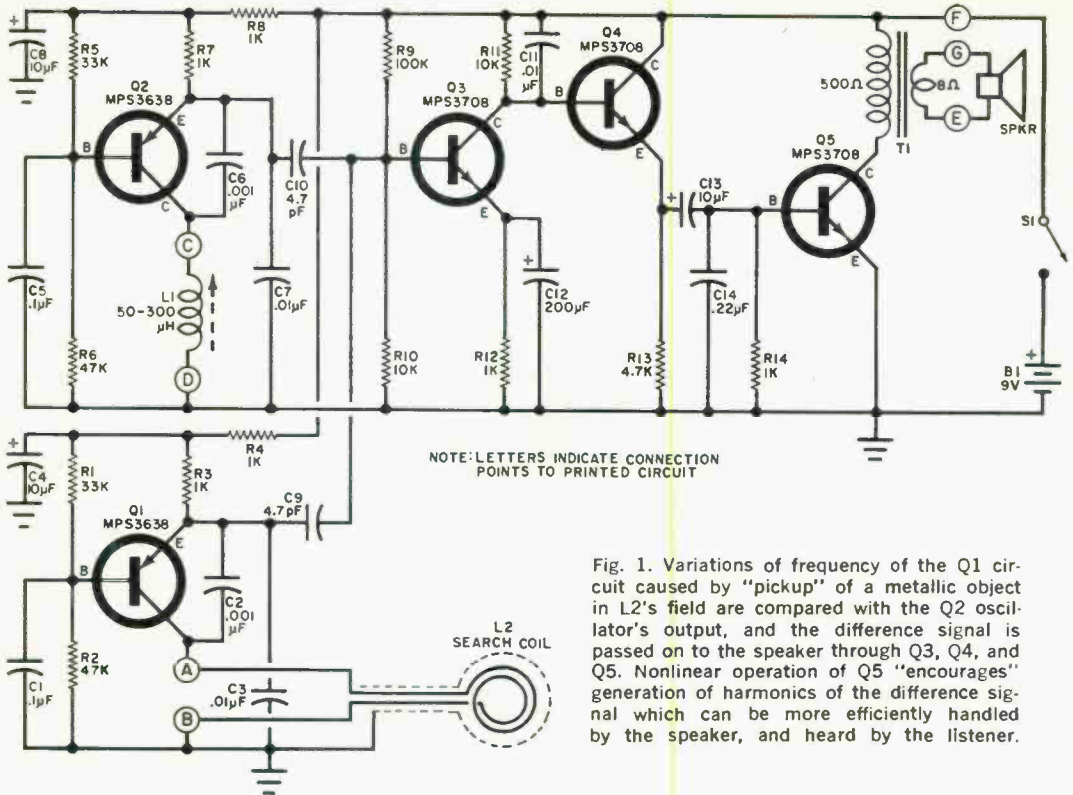

Fig. 1. Variations of frequency of the Q1 circuit caused by "pickup" of a metallic object in L2's field are compared with the Q2 oscillator's output, and the difference signal is passed on to the speaker through Q3, Q4, and Q5. Nonlinear operation of Q5 "encourages" generation of harmonics of the difference signal which can be more efficiently handled by the speaker, and heard by the listener.

higher or lower than that of the search coil oscillator. The two signals are combined in detector stage Q3, whose output is the audible difference between the two frequencies. This signal is fed to emitter follower Q4 and output stage Q5, and finally to the speaker.

The search coil oscillator frequency changes slightly whenever the conductance of the material in the field of the loop changes. This means that if the coil passes over a metal object, the oscillator frequency will change slightly, and the pitch of the audio beat note you hear from your speaker will also change. It is easier to hear a small frequency change in a low-pitched sound than an equal change in a higher frequency tone.

To get the best results from the Beachcomber, set the oscillators as near the same frequency as possible. *Both oscillators must be very stable.* Good sturdy construction with no loose parts is a must. The circuit must also be so laid out as to reduce coupling between the two oscillators to the minimum. Other-

### PARTS LIST

- B1—9-volt battery
- C1, C5—0.1- $\mu$ F, low-voltage disc ceramic capacitor
- C2, C6—0.001- $\mu$ F polystyrene capacitor
- C3, C7—0.01- $\mu$ F polystyrene capacitor
- C4, C8, C13—10- $\mu$ F, 15-volt electrolytic capacitor
- C9, C10—4.7-pF ceramic disc capacitor
- C11—0.01- $\mu$ F, low-voltage disc ceramic capacitor
- C12—200- $\mu$ F, 6-volt electrolytic capacitor
- C14—0.22- $\mu$ F low-voltage disc ceramic capacitor
- L1—50-300- $\mu$ H variable inductor (Thordarson WC-11, J. W. Miller #6196, or similar)
- L2—Search coil—see text
- Q1, Q2—MPS3638 transistor (Motorola)
- Q3, Q4, Q5—MPS3708 transistor (Motorola)
- R1, R5—33,000 ohms
- R2, R6—47,000 ohms
- R3, R4, R7, R8, R12, R14 } All resistors
- 1000 ohms }  $\frac{1}{2}$  watt
- R9—100,000 ohms
- R10, R11—10,000 ohms
- R13—4700 ohms
- S1—S.p.s.t. slide switch
- T1—Transistor output transformer: primary, 500 ohms CT (do not use CT); secondary; 8 ohms, 150 mW.
- Misc.—Miniature speaker, chassis box, battery clip, enameled wire, spacers, solder, etc.

NOTE: Printed circuit board for this project is available for \$2.50 from DEMCO, 219 West Rhapsody, San Antonio, Texas 78216. A complete kit (excluding the coil form, chassis and rod) is also available for \$15 postpaid.



wise, the oscillators will “pull”—suddenly lock together every time the beat frequency is brought down to a low pitch. That is why both oscillators are decoupled from the battery supply and from each other (through *R4-C4* and *R8-C8*) and why such small value capacitors are used for *C9* and *C10*.

The output stage is purposely designed to produce “distortion,” so that the low-frequency beat notes can be heard from the small speaker. If the audio circuit were designed for linear operation and little distortion, the speaker would produce little or no output below 150 to 200 hertz. In this circuit the audio output stage is not biased “on” at all. When it is driven with an audio signal from emitter follower *Q4*, transistor *Q5* conducts and produces an output on each positive half cycle. The signal to the speaker is therefore a series of pulses at the frequency of the beat signal. Since the pulses contain many harmonics, they can be heard down to a few hertz.

**Construction.** The electronic portion of the metal detector is easy to assemble, and there is no chance of coupling problems or shifting parts if the printed circuit board construction shown is used. The board (Fig. 2) serves as a template to locate the holes for *L1*, the mounting spacers, and the speaker.

Cut a  $\frac{7}{16}$ "-diameter hole for *L1* and another of the correct diameter for your

speaker. Then mount the small parts by simply inserting them in the positions indicated by the parts numbers on the top side of the board, turning the board over, and soldering them in place.

File the switch hole in the cabinet to fit the type of switch used. Mount the switch, speaker, battery clip, and *L1* as shown in the photograph (Fig. 3). Wire the switch and battery clip as shown. The lead from the positive terminal of the battery goes to one switch contact, and a short lead should be soldered to the other contact—to go to point *F* on the board. A doughnut cut from plastic foam is placed around the rear of the speaker; the board compresses the foam when it is mounted, and thus holds the speaker snugly.

Now connect the battery and speaker wires to the underside of the board at the points indicated on the schematic diagram. Mount the completed circuit

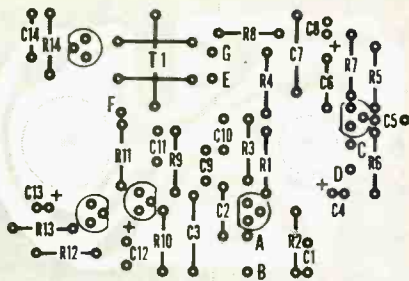

Fig. 2. Actual size drawing of foil side of printed circuit (left) will help you make your own board. Parts are installed on the plain side of the board as shown above. Figure 4 shows parts assembled on board.

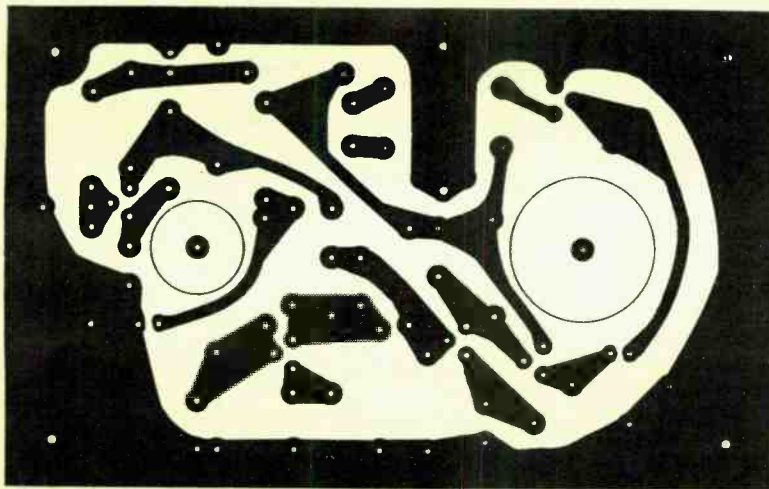

Fig. 3. Part of the speaker and coil L1 pass through the circuit board and must be carefully positioned to fit properly. The speaker is not bolted and can be shifted.

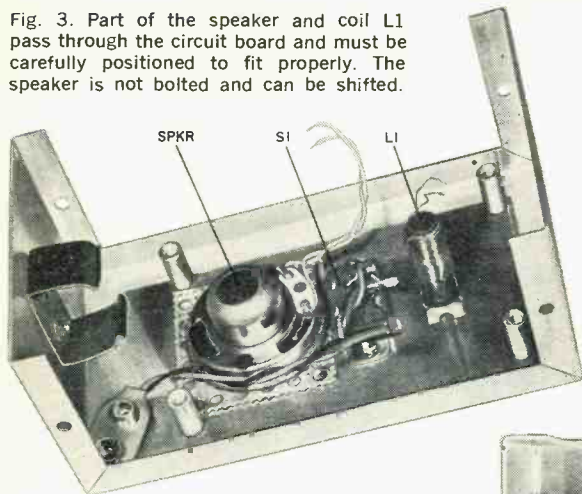

Fig. 5. Clean, firm assembly of internal as well as external components and other hardware means clean operation. Any variations due to movement of parts can cause false readings.

board (Fig. 5) and connect L1 to the eyelets at points C and D on top of the board.

**The Search Loop.** This important part of the locator can be made in several ways. Of the two presented here, the copper tubing search coil shown in Fig. 6 is more rugged, but the plastic tubing loop will work well and is much easier to build.

To make the copper coil, obtain a piece of  $\frac{1}{4}$ " soft copper tubing 42 inches long and bend it into as smooth a circle as possible. (Be sure it is straight when you buy it—and bend it around a cylindrical object a little less than a foot in diameter.) Leave a quarter-inch gap between the ends. Drill a  $\frac{1}{8}$ "-hole on the inside of the circle opposite the gap.

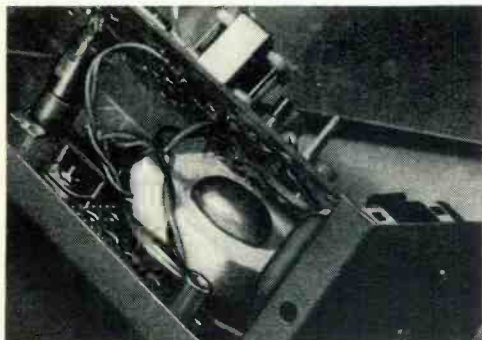
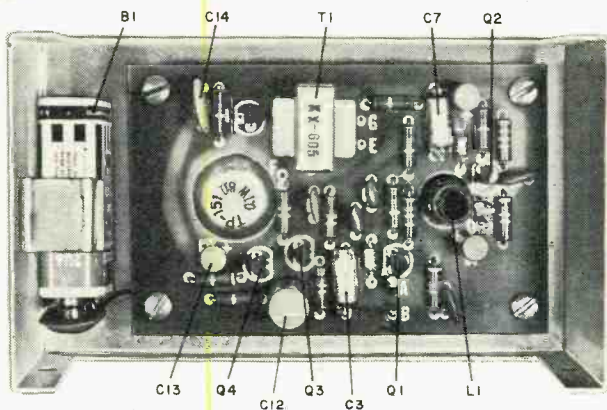

Fig. 4. A "doughnut" of foam rubber or plastic placed around the speaker holds it securely in its correct position when circuit board is installed.



Then take a hacksaw and split the tubing around its outside wall. (Cut through the outside wall only, not completely through the tube.) The edges of the cut can be smoothed with a small file. Solder about 6 inches of insulated hookup wire to one end of a 50' length of No. 24 enameled magnet wire, and slip a piece of insulating tubing over the connection. Thread the insulated wire through the  $\frac{1}{8}$ "-hole in the tubing from the outside (through the slot) and leave about an inch or two of insulated wire inside the split loop.

Now wind 14 turns of wire inside the copper tube through the saw slot, being careful not to pull the  $\frac{1}{4}$ " end gap together. Cut the magnet wire and solder another piece of hookup wire to that end. Insulate the connection and thread the hookup wire through the hole in the tubing. Finally, paint the coil of wire inside the copper shield with coil dope or white glue.

You can make the plastic loop (Fig. 6) in much the same way. Slip a 2" length of  $\frac{3}{8}$ " plastic tubing over the ends of the

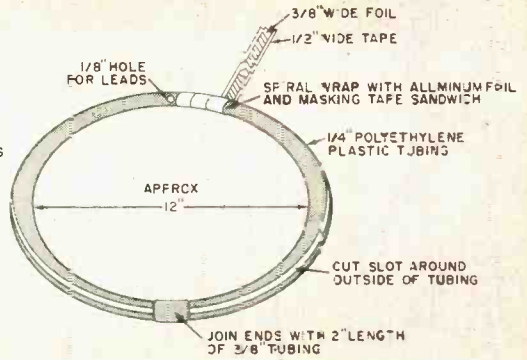
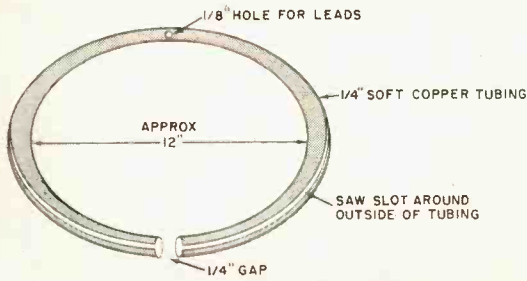

Fig. 6. Loop housing made of copper is shown above, and plastic tubing at right, above. If plastic is used, a metal outer covering can be made from aluminum foil. In either case, there must be a gap.

$\frac{1}{4}$ " plastic tubing to hold the ends in place. Then cut or drill a hole on the inside of the loop opposite the gap, and split the outside of the loop with a knife. Cut out a  $\frac{1}{16}$ " strip all the way around the outside.

Make up the magnet wire as described for the copper loop and wind the search loop with 14 turns. Cement the turns together. Since the plastic loop does not shield the coil—as does the copper loop—it must be shielded before mounting.

You shield the plastic loop by cutting a piece about  $\frac{3}{8}$ " wide from the end of a roll of aluminum foil. Stick the foil to a piece of  $\frac{1}{2}$ " plastic masking tape, leaving a border on each side. Then strip the insulation off of about half of a 6" piece of *stranded* hookup wire, and place the bare portion between the foil and

tape at the beginning of the spiral roll.

Now, starting at the point where the connections come out of the loop, spiral-wrap the tape-foil sandwich around the coil form. When you have gone all the way round, tear the foil off and go round

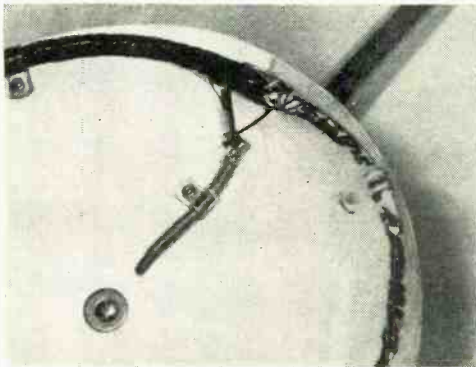
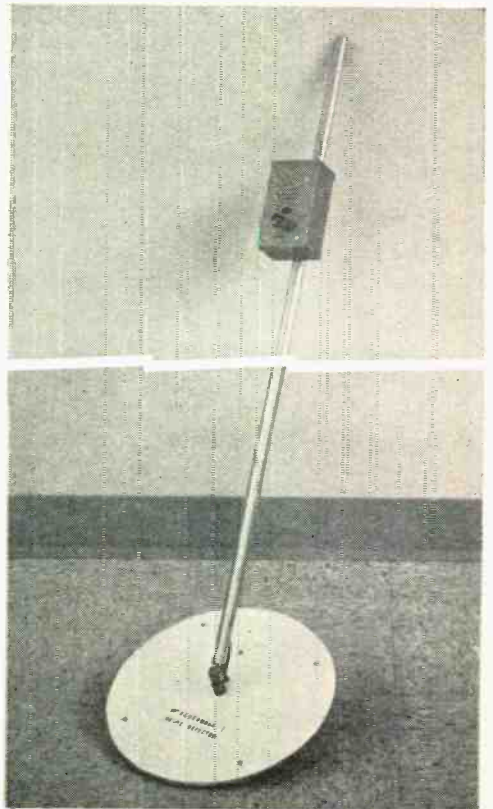
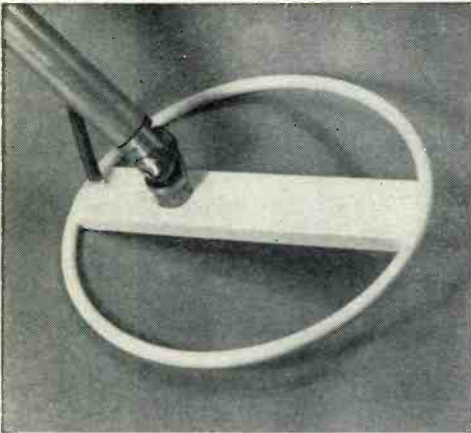

Fig. 7. Plastic-covered loop must be securely positioned. Use plastic cable clamps and putty or cement to hold the entire loop on the plywood board.



Completed "Beachcomber" is ready to "look for" buried treasure. Adjust loop so it is parallel to the ground while you hold unit at comfortable angle.





The copper tubing loop assembly is rigid enough to permit the use of a small wood brace for assembly. Some weight reduction can be gained in this manner.

again with the masking tape only, to hold everything firmly in place. *Note that the foil must not form a continuous loop.* Do not let the end of the foil—where you stop—touch the beginning of the winding.

The finished loop is mounted with plastic cable clamps to a  $\frac{1}{4}$ " plywood base (see Fig. 7). Use at least four clamps. The plastic loop must be potted in place on the plywood base with water putty to make sure it won't move or bend.

**Finishing Touches.** The handle on the Beachcomber can be any convenient length of  $\frac{3}{4}$ " aluminum tubing, and it can be fastened to the plywood base with a universal elbow made for  $\frac{3}{4}$ " tubing. (These items were obtained by the author off a "do-it-yourself" rack in a local hardware store. If you have trouble finding them, the handle can be made of wood. Even an old hoe handle will do.)

Connect the two ends of the loop to the two wires and the shield to the shield braid of a two-conductor shielded cable long enough to run up the handle to the control box. Screw the bottom of the box to the handle and bring the cable through a hole in the bottom of the box to a three-lug terminal strip, which can be mounted with one of the screws that hold the box to the handle.

Connect circuit board points *A* and *B* to the loop wires at the terminal strip with about 3 to 4 inches of hookup wire twisted together. Clip in the battery, put the box together, and you're ready to go.

**Using the Detector.** The Beachcomber is simple to use and—with a little practice—you should be able to find buried metal easily. The first thing to do is to set the tuning control to produce a beat note. Since the adjustment range of the coil is very wide, you should be able to get a beat note even if your search coil is not identical to the one shown.

If you are not sure whether the circuit is operating, hold a transistor radio near the detector while you turn the tuning control. You should be able to get a strong signal near the low end of the broadcast band somewhere in the tuning control's range.

Place the search loop flat on the ground and adjust the tuning to give a low beat note. Raising the loop 4 to 6 inches

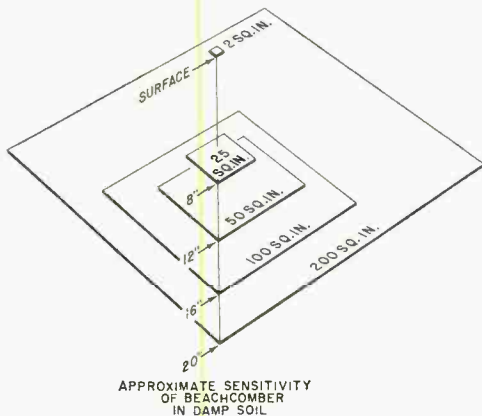

Fig. 8. When loop is on ground surface, you can pinpoint an object within 2 square inches. As loop is raised above ground, it will cover a wider area: about 50 square inches at a height of 12 inches, 100 square inches at a height of 16 inches, etc.

above ground should not change the beat note very much. To search, you simply hold the coil near the ground and swing it from side to side, parallel to the ground. If you hear a change in the pitch of the beat note, move the coil slowly around the area to get an idea of the exact location and size of your find.

The change in beat note will depend on the size of the buried object and its area as seen from straight above. Thus, while you can easily find a coffee can lid buried flat, you might miss it if it were buried on edge. Figure 8 should give you a good idea of the results you can expect with the detector.

(Continued on page 84)

# BUILD THE PULSE COMMAND RESPONDER

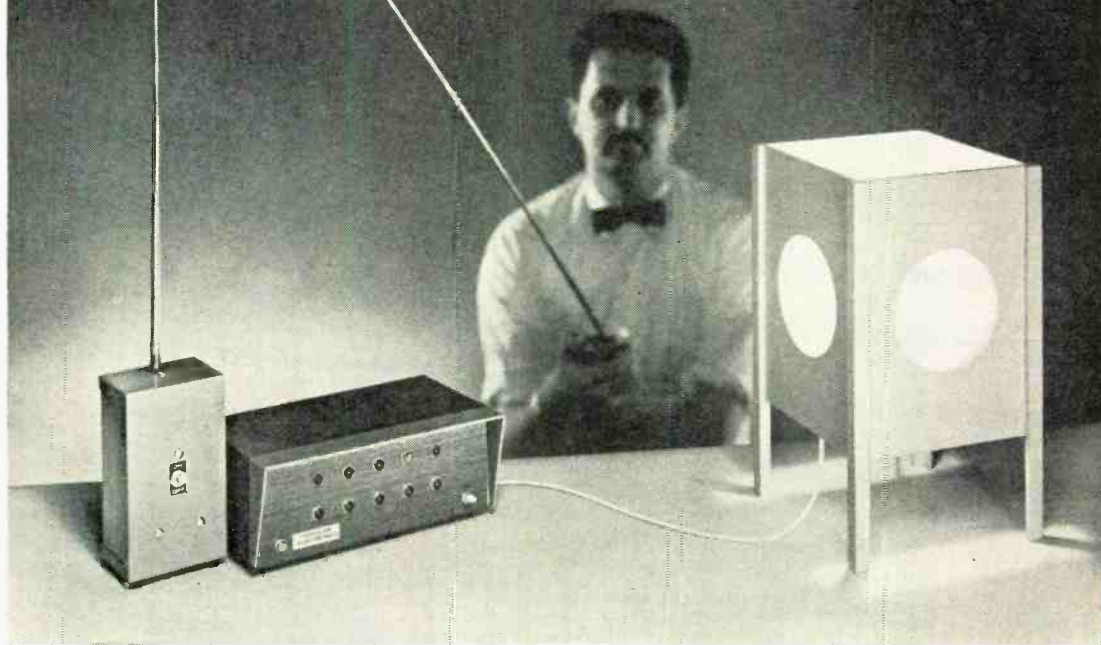

YOU CAN CONTROL ALMOST ANY NUMBER OF  
ELECTRICAL DEVICES FROM ALMOST ANYWHERE

By **ELDEN C. MAYNARD**, K6SAI

**T**HE "Pulse Command Responder" is perhaps one of the most versatile selective multifunction types of remote control centers you are likely to find anywhere. With just the touch of a single button, you can control many different electrical circuits individually and at any time. You can turn your TV set, lamps, motors, and just about any other electrical device on and off from one or more locations, and at distances of up to several hundred feet.

The Responder can be operated by radio control (R/C), carrier-current remote control, or direct "on-line" switching. For R/C operation, a transmitter and a receiver—of the types for controlling model airplanes—are suitable. The carrier-current remote control also has a transmitter and a receiver; but instead of the signal radiating from the transmitter into space, it is coupled to the

receiver by way of your house wiring. (Construction of a "Carrier Current Remote Control System" was described on page 50 of the January 1967 issue of *POPULAR ELECTRONICS*.) The "on-line" switching technique calls for a 3-wire hookup going from the Responder to one or more strategically-located pushbutton switches. A complete R/C system is illustrated in Fig. 1.

Regardless of the type of control employed, operation of the Responder remains the same: a number of pulses are used to trigger an electronic switching circuit, which in turn controls a stepping-type relay. Except for the first two steps, each step on the relay is connected to a different device to be controlled.

Unlike certain sequential or stepping relay control devices no unwanted circuit or device is energized even momentarily while the stepping relay "finds" a

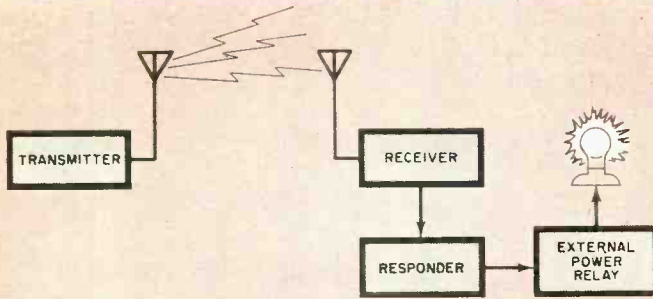

Fig. 1. The Responder can be radio-controlled if it is connected as shown. Details for constructing an R/C system for operating the Responder will appear in a coming issue.

wanted position. For example, you can start a motor in step 5, without affecting anything connected to steps 3, 4, 6, etc., and then, at a later time, control the devices on steps 4 or 7 without affecting the action on step 5. (Steps are on  $K5$  as shown in Fig. 2.)

The Responder is foolproof. It will seek a numbered step in accordance with a like number of pulses on the first round. On the second round, it will reset itself almost instantly in the presence of a single pulse. Sending up to three pulses on the second round will have the same effect as a single pulse. However, not until the stepping relay is in its 0 position can it accurately respond to a given number of pulses for a given position.

By tying steps 1 and 2 together and connecting them to the reset function ( $K4$  in Fig. 2), a certain amount of noise immunity is built into the Responder. It will not activate any control circuits unless at least three pulses are received in rapid order. This feature is especially desirable for R/C operation, or where the Responder may be accidentally pulsed.

**How It Works.** An s.p.d.t. switching mechanism, such as that shown for  $K1$  in Fig. 2, is used to connect a positive or a negative voltage as needed to  $K3$ ,  $K4$ ,  $K5$  and the base of  $Q1$ . This switch (on  $K1$ ) can be part of a relay in an R/C receiver or in any other appropriate external control device. (Note that  $K1$  is actually not considered as a part of the Responder, but rather as an integral component of whatever external control system is used.)

Relay  $K1$  (or its equivalent) switches the voltage from positive to negative and back to positive for each pulse. There-

fore, this switch should be a spring-loaded affair which always returns to an upward position (positive voltage on the normally-closed set of contacts).

Before tracing the action of the positive and negative voltages on  $Q1$ , the various diodes and relays  $K2$ ,  $K3$ ,  $K4$  and  $K6$ , you should know how  $K5$  works. Both the *Advance* and *Reset* coils of  $K5$  operate on 117 volts a.c. Since the control voltages are on the order of 6 volts d.c. in the Responder, relays  $K3$  and  $K4$  are used to switch the *Advance* and *Reset* coils, respectively.

Each time the *Advance* coil is ener-

#### PARTS LIST

- $C1, C2$ —100- $\mu F$ , 15-volt electrolytic capacitor\*
- $C3, C6$ —6- $\mu F$  (or 5- $\mu F$ ), 15-volt electrolytic capacitor\*
- $C4, C5$ —0.02- $\mu F$  ceramic or disc capacitor\*
- $D1, D2, D3, D4$ —1N4004 (or 1N4001) diode\*
- $I1, I2$ —6-volt lamp—see text
- $K1$ —See text
- $K2$ —6-volt s.p.d.t. relay
- $K3, K4$ —6-volt s.p.s.t. relay
- $K5$ —117-volt a.c. stepping relay (Guardian IR-MC, 24 contacts, or similar)
- $K6$ —6-volt power relay
- $Q1$ —2N217 transistor
- RECT 1—2-amp, 50-PIV rectifier bridge (International Rectifier 10DB2A-C, or similar)\*
- $R1, R2$ —100-ohm, 1-watt resistor\*
- $S1$ —S.p.s.t. switch
- $T1$ —Filament transformer: primary, 117 volts; secondary, 12 volts, 1 ampere, center-tapped
- 1—Printed circuit card, or 3 $\frac{1}{4}$ " x 4" perforated phenolic board—see text\*\*
- 1—Aluminum or steel cowli-type utility box
- Misc.—Indicator lamp sockets, line cord, hookup wire, spacers, solder, hardware, barrier strip, etc.

The asterisked parts are available from Southwest Technical Products Co., 219 West Rhapsody, San Antonio, Texas 78216.

\*Included in package of components for printed circuit board, \$5.

\*\*Drilled and etched fiberglass printed circuit card, \$2.



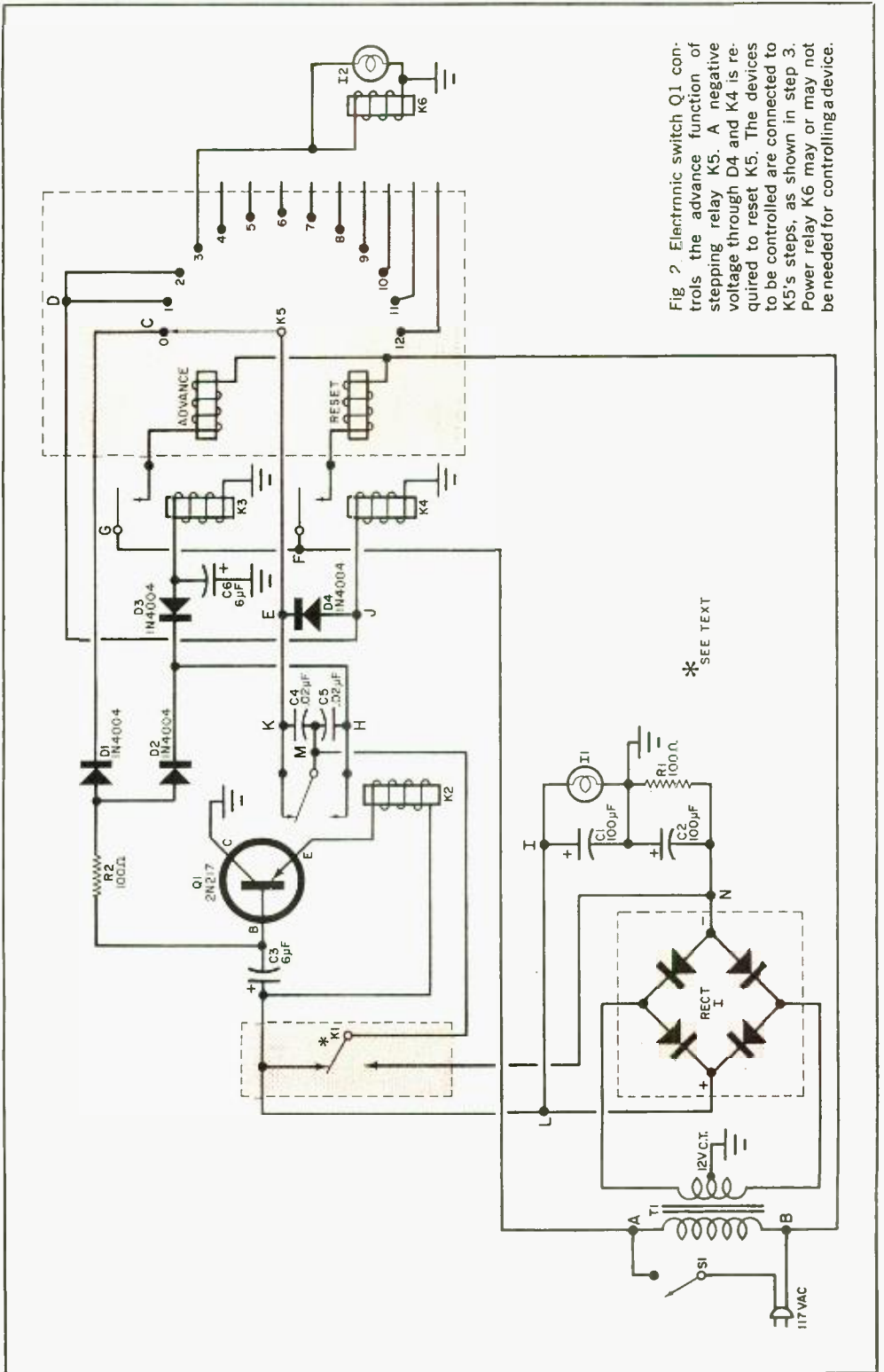

Fig 2. Electronic switch Q1 controls the advance function of stepping relay K5. A negative voltage through D4 and K4 is required to reset K5. The devices to be controlled are connected to K5's steps, as shown in step 3. Power relay K6 may or may not be needed for controlling a device.

\*SEE TEXT

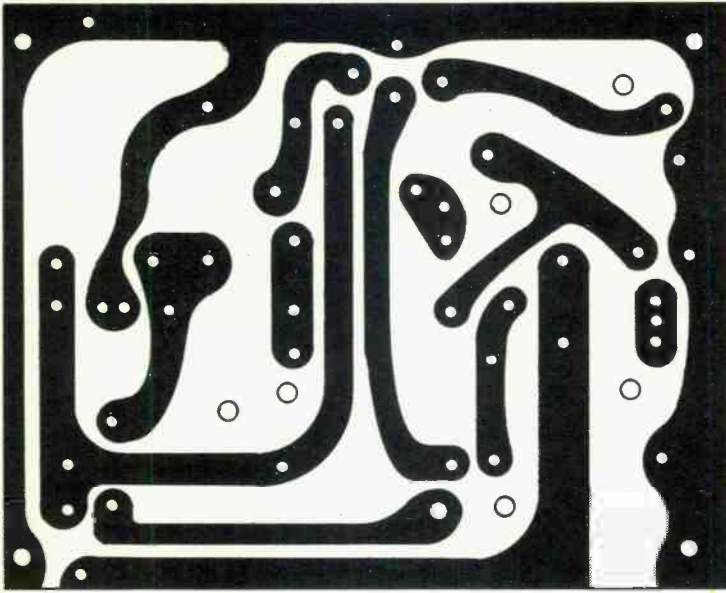

Fig. 3. If you decide to make your own printed circuit board, use this full-size drawing as a guide to proper etching of foil side of board.

gized, *K5* advances one step and holds. When the *Reset* coil is activated, *K5* is spring-returned to its 0 step.

When *S1* is closed and power is applied, the pilot lamp, *I1*, lights and the Responder is ready to go to work. In the Responder's quiescent state, *Q1* does not conduct and all relays and coils are de-energized. Note that *K6*—like *K1*—is not considered to be part of the Responder proper.

When *K1* is energized, a negative voltage is applied through the upper con-

tacts of *K2* to *D4* and the armature of *K5*. In step 0 on *K5*, the negative voltage is fed to *D1* and forward-biases *Q1* to allow it to conduct. When *Q1* conducts, *K2* becomes energized, which removes the negative voltage from the *D4-K4* circuit and applies it to the *D3-K3* circuit. Each time *K3* sees a negative pulse, it advances one step. Capacitor *C3* holds *Q1* conducting and *K2* energized to prevent the *Reset* coil from being activated. As long as *K2* is energized, no control voltage reaches any of the steps on *K5*, and no externally controlled circuits are affected until the Responder settles down to a quiescent state. The train of pulses must come in a rapid enough succession to be within the discharge time of *C3*.

If *K5* is on step 3 or higher when *K1* is energized, the negative voltage cannot get to *Q1*, and now *D4* is able to go to work and pass this voltage on to *K4* and reset *K5*. Notice that steps 1 and 2 on *K5* (the noise immunity circuits) are connected back to *K4*; if for any reason *K5* is advanced only to either step, *K5* will reset itself with a positive or a negative voltage, but not until *K1* de-energizes, *Q1* in turn stops conducting, and *K2* releases.

Transformer *T1*, full-wave bridge rectifier *RECT 1*, *C1*, *C2*, *R1* and *I1* provide suitable positive and negative voltages to

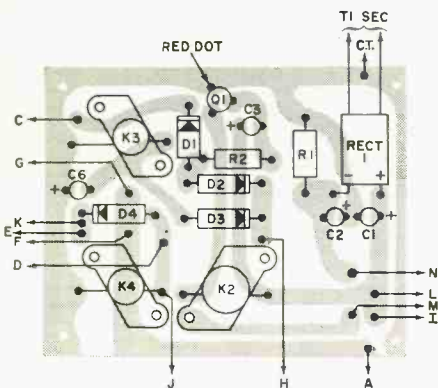

Fig. 4. Parts layout is not critical, but be careful not to confuse polarity of diodes, and the connections to the relays' frames, coils, and contacts.

operate the Responder. Pilot lamp *I1* does double duty; it helps power supply regulation as does *R1*, and it also serves as an on/off indicator. Lamp *I2* is optional. Capacitors *C4* and *C5* are used for relay contact protection; a 0.02- $\mu$ F capacitor can also be placed across the contacts on *K3* and another on *K4*, if you wish. Capacitor *C6* tends to prevent chatter and helps *K3* to perform in a more positive manner.

Circuits to be controlled having voltage and current requirements different from the 6 volts d.c. available at *K5*'s steps, or for continuous operation—once activated, require relays (*K6*, etc.) or other switching devices (SCR's) to be interposed between *K5* and the controlled circuit.

**Construction.** The Responder can be built into any 8" x 6" x 3" enclosure. Parts placement is not critical, but perhaps the most suitable layout for the small parts is on a printed circuit board or plain perforated phenolic board. If you want to make your own printed circuit board, follow the actual-size drawing shown in Fig. 3. You can buy one already etched and drilled for \$2 post-paid (see Parts List).

If you use a circuit board, you can fol-

low the same general layout for parts as shown in Fig. 4. When mounting capacitors, diodes and transistor, be careful to observe polarity. After all parts are mounted, set the circuit board aside.

Drill the mounting holes for the circuit board, power transformer, indicator lamps, switch and stepping relay, referring to Fig. 5 for the general location of these major parts. Actual location of parts is not too important provided that the parts do not interfere with the circuit board or each other. To facilitate mounting of the board and other parts, secure *T1* to the metal case last.

Use  $\frac{3}{8}$ " spacers to get adequate clearance between the board and case. Optional indicator lamps (*I1*, *I2*, etc.) should be mounted on the front part of the case.

After all parts are mounted, wire the circuit in accordance with the schematic. For your convenience, the lettered points in Fig. 4 correspond to the same lettered points in Fig. 2.

Each of the steps on stepping relay *K5* should be connected to a suitable terminal strip or set of output jacks mounted on the back of the case, such as the jack marked "TO *K6*" in Fig. 5. Because only 6 volts d.c. is available at each step at any one time, power relays or circuits to be controlled should also be able to operate on 6 volts d.c.

**Final Check.** When construction of the Responder is complete, connect the pulsing device to satisfy the switching requirements for *K1* as shown in Fig. 1. Turn the Responder on, and pulse it once. Relay *K5* should advance to step 1. After a short delay, as *C6* discharges, the stepping relay should automatically reset to step 0. The same is true when you pulse the responder twice, except that *K5* should first advance to step 2. Check each of the other steps of *K5* by pulsing the Responder the same number of times as the step number you want, but between each selection of steps, reset *K5* to step 0 with one or two pulses.

When you are satisfied that the Responder is operating properly, you can connect your power relays and circuits to be controlled. Once you work with and get to know the Responder, you will find that its applications and functions are practically limitless.

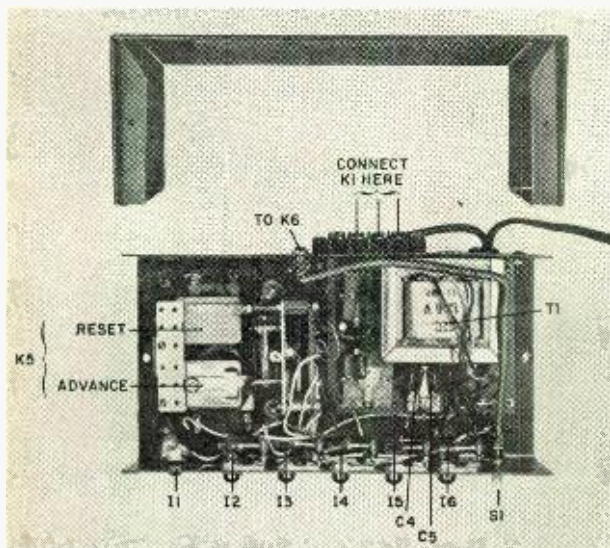

Fig. 5. Position the parts so that they do not interfere with each other or with the circuit board. Both Reset and Advance coils are 117-volt a.c.-operated and care must be exercised to keep them clear of the case. If necessary, use a larger case.





## "PRINCESS CINDERELLA"

BUILD THE UP-RATED  
VERSION OF THE  
CINDERELLA BOOK-SHELF  
HI-FI SYSTEM

By **DAVID B. WEEMS**

**T**HE HALF-CUBIC FOOT sealed enclosure called "Cinderella" described in the October 1965 **POPULAR ELECTRONICS** (p. 49) was a reasonable example of what \$10 will accomplish if you build your own hi-fi speaker system. Inside the original "Cinderella" enclosure was a 6" woofer and a miniature cone tweeter. Both speakers could be purchased for just under \$7. The 6-inch woofer had a very flexible suspension and a 5-oz. magnet.

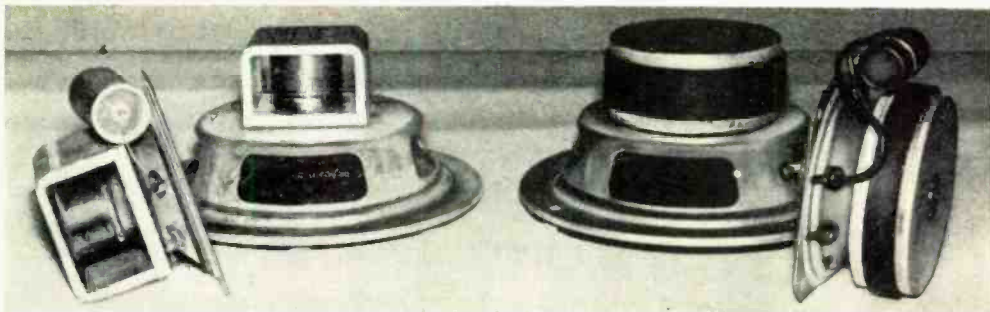

Both earlier model speakers (left) had 4.6-ounce alnico V magnets; improved model speakers (right) sport 10-ounce magnets in tweeters and 20-ounce magnets in woofers for superior damping and transient response.

During the intervening two years, an improved woofer has been developed with a 20-oz. magnet. This magnet weight is rarely found in small speakers—at least those with a diameter of less than 8 to 10". You can build a "Princess Cinderella" speaker enclosure using this new woofer for about \$15.

Although the size of the enclosure must be increased, this new system is still classified under the category of *small bookshelf systems*. The sound it can produce will compare favorably with many similar size units that sell for as high as \$40.

**New Speakers.** The really interesting characteristic of the original "Cinderella" woofer was that the cone suspension was free enough to allow a fundamental

resonance between 45 and 50 Hz. The woofer in the "Princess Cinderella" has a somewhat more rugged suspension and the free air resonance has been measured by the author to be about 60 Hz. Since this 10-15 Hz increase in fundamental resonance would be detrimental in a sealed enclosure, the author has designed the "Princess Cinderella" as a ported enclosure. Simultaneously, the use of a port has raised the efficiency of the overall system while the increased magnet weight has provided superior damping and transient response.

The top end response of the system has also been extended. Efficiency of the tweeter has been improved due to the use of a 10-oz. magnet. The roll-off at the high end of the audio spectrum appears to be around 17,000-18,000 Hz.

**The New Enclosure.** A somewhat larger enclosure is required to compensate for the greater displacement of the more massive speakers. As in the original "Cinderella" system, rigidity of the

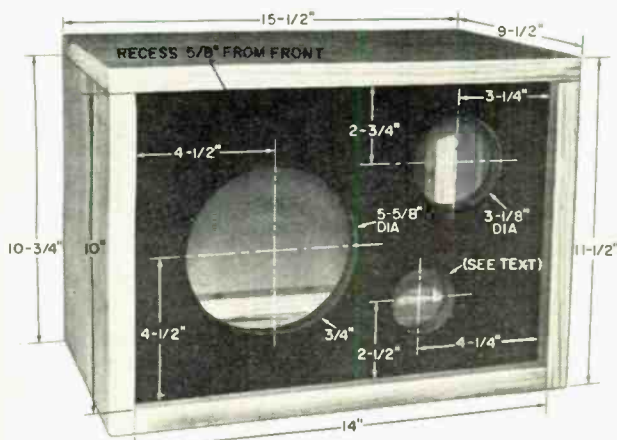

TOP, BOTTOM, SIDES— $3/4$ " x  $9\frac{1}{2}$ " PINE SHELVING

Fig. 1. Dimensioning of speaker board is critical. Speaker hole sizes are given, but outer diameter of mailing tube selected determines size of port hole.

#### PARTS LIST

- 1—Woofer (McGee Radio Co. Model SX-6071)
- 1—Tweeter (McGee Radio Co. Model TS-6070)
- 2— $10$ " x  $14$ " pieces of  $3/4$ " fir plywood for speaker and rear boards
- 1— $15\frac{1}{2}$ " x  $9\frac{1}{2}$ " piece of  $3/4$ " pine shelving for top
- 1— $14$ " x  $9\frac{1}{2}$ " piece of  $3/4$ " pine shelving for bottom
- 2— $10\frac{3}{4}$ " x  $9\frac{1}{2}$ " pieces of  $3/4$ " pine shelving for sides
- 1— $45$ " x  $3/4$ " x  $3/4$ " piece of pine for cleats
- 1— $5$ -ft. length of  $1/2$ " quarter-round molding for trim
- Misc.— $\#6$  x  $1\frac{1}{2}$ " finishing nails,  $\#8$  x  $3/4$ " sheet metal screws,  $\#8$  x  $1\frac{1}{4}$ " flathead wood screws, steel brads, grille cloth, glue, wire, etc.

structure is a prime requisite for best possible performance. Either  $\frac{3}{4}$ "-thick fir plywood or light pine shelving (sold as 1" x 10" clear pine board) can be used for the top, bottom, and sides, although pine is specified in the Bill of Materials.

The port and speaker locations and the dimensions are fairly critical. Locate the holes for the speakers exactly as shown in Fig. 1. The hole size for the port will be determined by the outer diameter of the hard cardboard mailing tube you choose for the port duct. This mailing tube should be  $2\frac{1}{2}$ " long and should preferably have an inner diameter of 2". The outer diameter is only important in that it will guide you in cutting out the right-size hole.

After the three holes are cut, insert the mailing tube into the port hole and dress it flush with the front of the speaker board so that some of the cardboard duct extends inside the enclosure. Glue the tube in place and, when dry, apply a coat of flat black paint to the front of the board, inside the cardboard duct, and inside the speaker cutouts.

**Assembly.** Set the speaker board  $\frac{5}{8}$ " back from the front edge of the enclosure's bottom board and glue and nail these two pieces together. Do the same for the top and both sides. Then sand and stain or paint all exterior surfaces—except the speaker board. When the paint or stain dries, mount the speakers over their respective cutouts and wire them according to Fig. 2.

Nail or screw  $\frac{3}{4}$ " x  $\frac{3}{4}$ " pine cleats  $\frac{3}{4}$ " in from the rear edge of the enclosure as shown in the illustrations. Now staple or tack a 2"-thick layer of cotton batting or other suitable acoustic damping material to the sides and rear wall of the enclosure near the woofer. Also staple a 2"-thick curtain of cotton batting to the inside top of the enclosure and arrange this curtain so that it drapes over the woofer but is clear of the inside mouth of the port duct.

Attach the grille cloth to the front of the speaker board and miter-cut four pieces of  $1\frac{1}{2}$ "-quarter-round molding to neatly frame the front of the enclosure and to hide the ragged edges of the grille cloth.

Finally, screw the rear board of the enclosure in place and connect the speak-

er wires to the 4-ohm output tap of your amplifier. You'll note that this is a small system which gives a special feeling of "presence," particularly in the reproduction of music from small instrumental groups. You can increase the bass output from your amplifier without adversely affecting the system (doubling). The end result will be a sound that is much

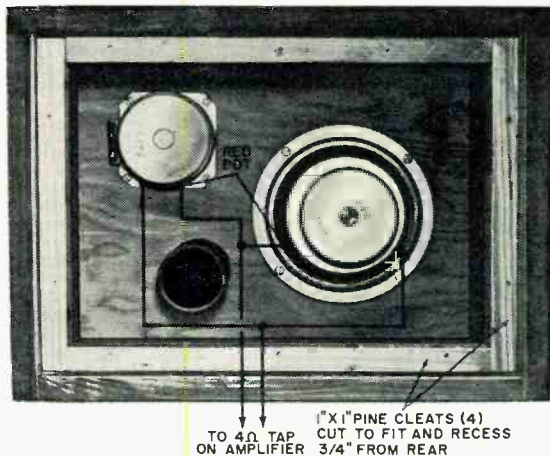

Fig. 2. Pine cleats hold rear board of enclosure in place. Proper speaker phasing is obtained only when red dots on speakers are wired common to each other.

*bigger* than would seem possible considering the physical size of the new "Princess Cinderella" enclosure.

**Construction Variations.** In place of the usual grille cloth, the author used an expanded aluminum grille on the front of the "Princess Cinderella" enclosure. For maximum attractiveness, the grille should be backed by a black cloth of open weave to hide the speakers.

Various readers of the original "Cinderella" article have asked whether the choice of enclosure material is of importance to the performance of the system. Apparently, what these readers had in mind was the possibility of using one of the new, very hard, "pressed" boards for the enclosure walls. You can use any material for the "Cinderella" systems, provided that it is inflexible, and that the enclosure can be sealed so there are no air leaks in the corners or wrap-around which fits the front and back of the enclosure.



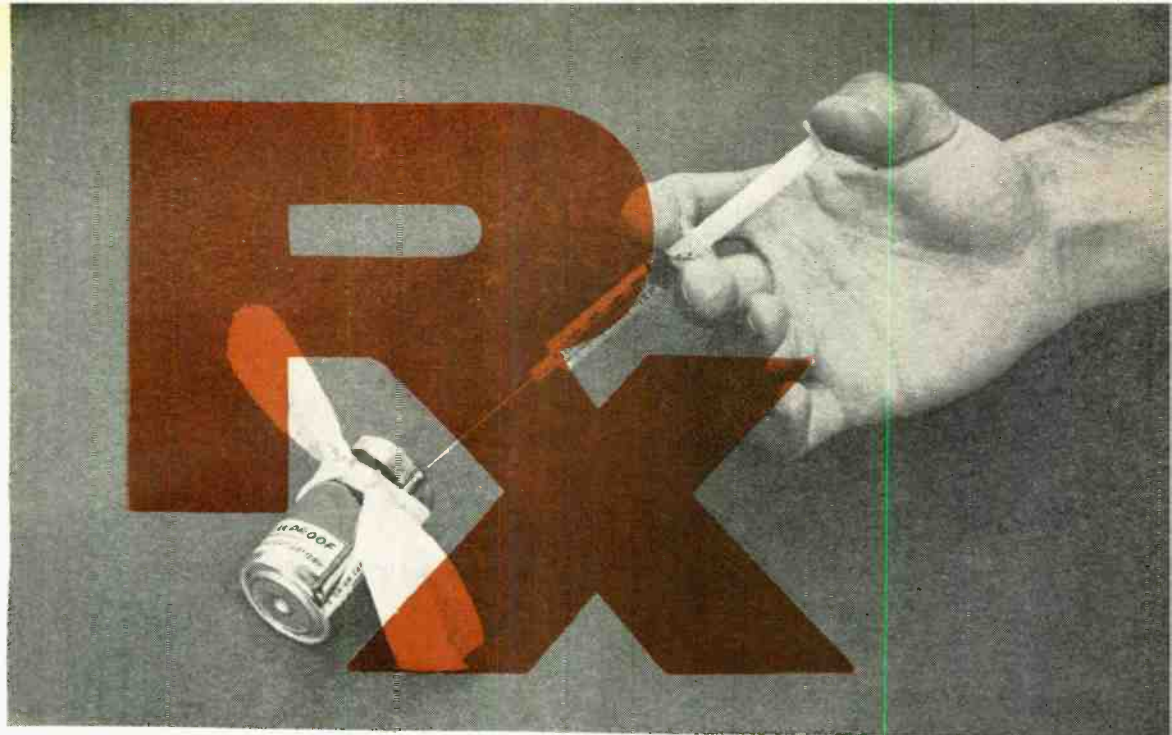

## CAN DRY CELLS BE RECHARGED?

YOU CAN GET UP TO  
20 TO 30 TIMES  
MORE LIFE OUT OF  
YOUR BATTERY

By FRED SHUNAMAN

### COMING NEXT MONTH

Plans for combination battery tester and charger that lets you control and monitor charging current and voltage as well as perform tests under desired loading conditions! Project designed and built by Harley H. Stover.

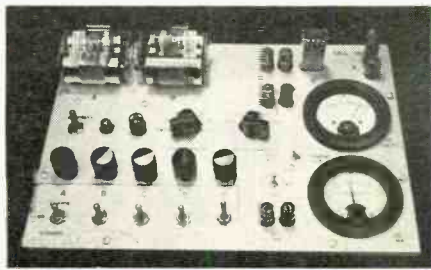

**W**AY BACK in the days when I was powering my peanut tube (Western Electric 215A to the historians) with a No. 6 dry cell, recharging a dry cell was no problem. We simply took the cardboard case off the cell, punched a few nail holes in the zinc, and dunked it in a fruit jar filled with a solution of water and sal ammoniac. The thinking was that there was still some zinc in the cell and that it probably lacked moisture. The cell's life was increased tremendously—it ran until big holes appeared in the zinc.

But charging a dry cell electrically? That was something else again. There were persistent rumors that someone had done it, but the manufacturers' instructions were explicit. "Dry cells are not designed to be recharged," they said. So the matter rested in indecision until a.c. sets came along and we forgot all about it—for a while.

Shortly after the transistor radio ap-

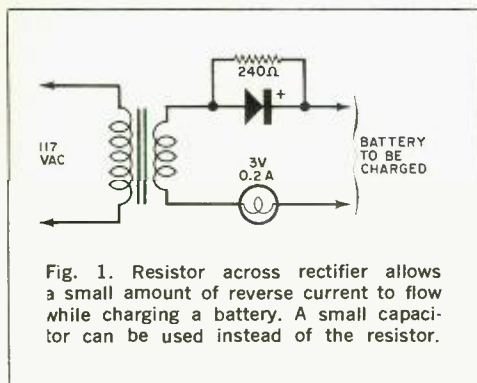

Fig. 1. Resistor across rectifier allows a small amount of reverse current to flow while charging a battery. A small capacitor can be used instead of the resistor.

peared on the market, dry battery charging began to stage a comeback. Besides the transistor sets, children's toys were using large quantities of these cells—nothing beats a stalled toy electric motor for running down a battery. A few chargers were offered to the public, usually through highly pictorial Sunday-supplement advertising.

I picked up a charger and tried it out on my collection of dry cells, some of which were nearly new. Running the cells in a flashlight until the light dimmed and turned yellow, then recharging the cells overnight or a little longer, I came to the conclusion that the life of a dry cell could be about doubled, with a large number of recharges.

Shortly afterward, I read an article by a British author, Ralph W. Hallows, in which he claimed excellent results with the help of a technique borrowed from electroplating. He used a small amount of a.c. along with the d.c. charging current—about 10% reverse current. (Half of the time, the a.c. looks like a reverse charging current.) "This technique," he said, "deposited the zinc smoothly and evenly on the inside of the can, instead of in spongy clumps." Commercial chargers using this principle (Fig. 1) were in use in Europe, according to Hallows, and he had recharged flashlight cells repeatedly for more than 18 months of

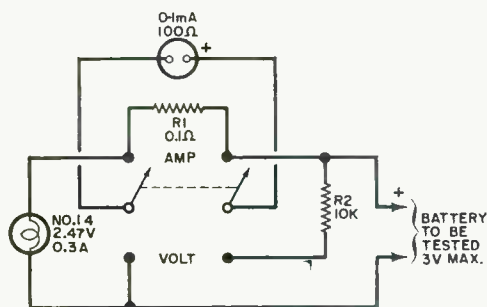

Fig. 2. Test jig made it possible to check battery voltage and current while the battery was discharged through the lamp. Open-circuit battery voltage can be measured by partially unscrewing the lamp.

Fig. 3. This inexpensive, commercially available unit, with modification, was used to charge the batteries. An interlock similar to the type used on TV sets prevents the a.c. line voltage from getting at any of the exposed battery connections while the lid is up.



service. I made a note to try the system, but just didn't get around to it. All this was more than a decade ago.

But the growing popularity and flood of transistor radios, phonographs, tape recorders and the other battery-operated devices has made the subject topical again. A number of charges are now on the market and available in department stores, hardware stores, hobby stores, electronics parts stores and in variety stores. They are available by mail order and as premium gifts. At the present rate of market penetration, there will be more battery chargers in this country than there are bathtubs, or refrigerators, within the next year or two. There are good chargers and there are bad chargers, and price is not always the best guide to quality.

I obtained an inexpensive charger, one that would handle four dry cells at a time. In spite of its low price, the appearance of the equipment inspired confidence—it was well constructed out of plastic, and looked as if it were intended for use. An ingenious shorting device made it equally easy to charge one or four cells, and the contacts immediately suggested the right way to insert the batteries. An interlock disconnected the 117-volt power line whenever the unit was open, for safety. I was almost ready to prove or disprove to myself some of the claims about charging dry batteries.

Reading up a little on the subject, I found that—among other things—a 1½-volt cell should not be allowed to drop below 1 volt. So a little test jig (circuit shown in Fig. 2) was constructed to make it easy to check the condition of the battery at any time. Either the voltage under load, or the current, could be determined at the flip of a switch. Also, unscrewing the lamp made it possible to determine open-circuit voltage.

I bought four RCA VS 036 cells: two for putting through the charger as many times as possible, and two to act as controls by using them without the benefit of being recharged. Putting a pair into the jig, and running them down, and then putting the other pair into the jig and doing the same thing, I learned an interesting fact: just how good a flashlight cell is. Both pairs discharged down to 1.8 volts, or 0.9 volt per cell, and kept

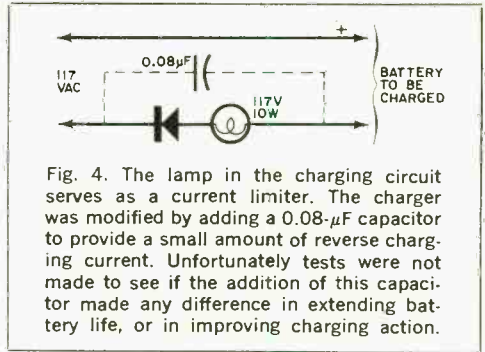

Fig. 4. The lamp in the charging circuit serves as a current limiter. The charger was modified by adding a 0.08- $\mu$ F capacitor to provide a small amount of reverse charging current. Unfortunately tests were not made to see if the addition of this capacitor made any difference in extending battery life, or in improving charging action.

the lamp lit for an identical time (3 hours and 40 minutes). "Removed from service," each cell showed 1.1 volt on open circuit.

Set 1 was placed in the commercially available charger (Fig. 3) and charged in accordance with instructions that came with the charger. The batteries were then returned to service, and "ran" nearly as long as the first time. (Incidentally, I modified the charger to supply reverse current. It seemed easier to install a capacitor than a resistor in the space I had, so I put a 0.08- $\mu$ F paper capacitor across both the "lamp-resistor" and the diode, as shown in the dashed lines in Fig. 4. Unfortunately, no comparison was made of charging batteries with and without this capacitor.)

The first three charges added an additional 9 hours to the original almost 4 hours of life. Now I learned a second interesting thing about dry cells: the ability of a run-down dry cell to recuperate. Remembering that batteries tended to recover somewhat after discharge, after two days of rest I put my control cells (set 2) back into the test jig. They again lit the lamp to full brilliancy, with a loaded voltage of 1.45 each (as against 1.5 when they were absolutely new) and "ran" for nearly three hours (170 minutes) on the second discharge. With two-day rests between each discharge, set 2 went through two additional discharges, one for 100 minutes, and the other for 90 minutes. After two more days of rest, they measured 1.5 volts open circuit, but only 0.8 volt loaded, and were considered to be at the end of their useful life. They had worked a flashlight lamp for an approximate total of 9½ hours.



The control cells were, for practical purposes, of no further use, but I thought it might be interesting to see what would happen if I tried to charge them up. After a 36-hour charge, they showed 3.7 volts (1.85 each) on open circuit, and 3.4 volts when loaded down with 350 mA of current through the lamp. The lamp stayed on for 3 hours and 40 minutes (surprisingly, the same as when the batteries were new) before the batteries dropped to 1.8 volts (under load); the light had not as yet started to dim appreciably. So I continued to put them on a regular charge-discharge cycle and was able to drain another 34 hours and 35 minutes out of those "used up" cells, for a total of 44 hours, 15 minutes.

So it appears that the story that, "You can't charge a run-down cell," needs modification. However, there seem to be a number of variables as to how much "second-life" batteries have. Much depends upon their age, state of charge while standing around and not in use, and how the batteries were used. Batteries that have been run down in a normal manner and then put on charge soon after do take and hold a charge. On the other hand, I tested two pairs of cells from flashlights as soon as they ceased to give enough light, after several months of intermittent service; neither pair would light a lamp more than momentarily after being taken off charge.

Meanwhile, set 1 was going through cycle after cycle of charge and discharge, dropping down to 180 minutes of life per

charge, from the original 220. After the first few discharges, battery life per charge continued to decline more slowly and leveled off at about 170 minutes. For more than another dozen charges, it maintained this level,  $\pm 5$  to 10 minutes. After another two dozen charge and discharge cycles, the batteries dropped to less than 120 minutes per discharge. Around the 30th cycle, no more than 60 minutes at a time of useful life was obtained. See Fig. 5.

I abandoned charging after the 31st round. The pair of cells had worked a flashlight lamp for about 68 hours, or roughly seven times the "normal" expected life. They still had potential life in them, but I didn't think it was worthwhile to charge a battery that couldn't produce more than a single hour of illumination.

My experiments were not quite up to laboratory precision. Other work interfered with the regularity of the charging and discharging cycles. It wasn't possible for me to always stop the discharge cycle at exactly 1.8 volts for the two cells. But the exceptions were indeed rule-provers and showed that the cells, under- or overdischarged, tended to return to their proper place on the "hours vs. discharges" curve. Of course, in actual use, the start and stop of a charge-discharge cycle can also be expected to take place at other than ideal times.

Authorities say that recharged cells have a shorter shelf life than new ones. It is likely that if the cells I used had

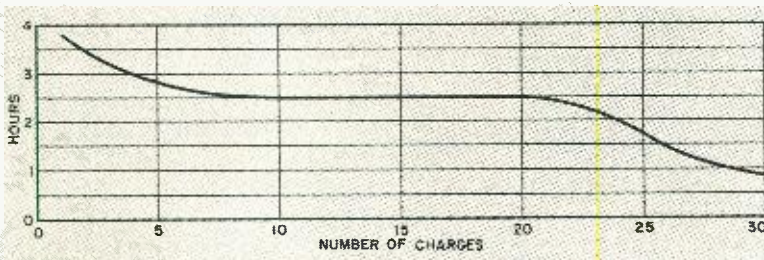

Fig. 5. Two 1.5-volt "D" cells placed in series were discharged to about 1.8 volts (0.9 volts each cell) and then charged. Graph shows number of hours it took for batteries to drain down to 1.8 volts after each charge. About  $2\frac{1}{2}$  hours of life per charge was realized between the 8th and the 21st charge. Tests were stopped when less than one hour of continuous battery operation could be expected. Shelf life was not determined.

been put in a flashlight and used intermittently for about a month until the voltage dropped to the recharge point, the cell life would have been much shorter in terms of total milliampere-hours. However, the experimental conditions more closely resembled certain industrial and law-enforcement applications, where flashlights are used every night and returned for charging every morning.

While I confined my experiments to ordinary carbon-zinc D-cells (and kept the charger tied up three months doing only that), I did get a chance to try a charge or two on some of the smaller cells. Results appeared similar. One set of AA's, in particular, was taken out of an illuminated probe, where they no longer lit the lamp. After being re-



Fig. 6. Hearing-aid battery adapter has movable slide to accommodate different-size batteries. A zener diode inside adapter regulates charging voltage. Adapter is about same size as a "D" cell and easily fits into battery charger shown in Fig. 3.

charged, they brought the lamp up to full brightness, and remained useful for about two weeks.

I did not try to charge alkaline cells, but there is sufficient reason to believe that these cells can also be recharged.

**Mercury batteries** are another story. In theory, they are highly chargeable, but in practice they come in such a variety of sizes and voltages that they can be difficult to handle. I brought leads out from my charger to one small cell. Two hours later I found the case empty. I

have not yet found the top or the contents of the cell. Could be that the battery blew up because of an excessive charging rate.

A constant-voltage charger is the only kind that will handle these batteries properly. (The charger I used would be classified as a constant current type.) When the battery approaches full charge, the charging current falls practically to zero. The current must also be limited to a safe value. There are automatically regulated mercury battery chargers on the market. And an adapter the size of a D cell is available to charge hearing-aid batteries. It fits into the charger in lieu of a battery, and it uses a zener diode to establish a constant-voltage type of charge.

While mercury batteries can be recharged, chargers built to handle more than one type of battery would have to be a bit more elaborate, because of the variety of sizes and voltages. Danger of explosion is greater than with other types of cells. You can blow up a carbon-zinc cell, but only by charging it at a grossly excessive rate. Most such blow-ups of carbon-zinc cells are due to steam, and would be impossible at a 45-mA charging rate.

**In conclusion**, dry cells can be easily recharged. If you can get about two hours or more out of a recharged cell, the job of removing, charging, and re-installing the batteries is worthwhile. The electricity cost is small—it averages out to 3.4 cents per charge. Indeed, most of the power used is consumed in the dropping resistor.

The better chargers use a transformer to deliver not more than about 3.5 volts to two cells connected in series. Overcharging is then impossible since the charge tapers off to nothing as the rising voltage of the cells approaches that of the supply. A resistor or capacitor across the rectifier to provide about a 10% reverse charging current could be desirable.

Whether adding the a.c. component made the difference between the up-to-date results above and the rather inconclusive ones of the 1950's, I don't know. I suspect that leakproof construction, now universal, may have been an important factor. Batteries don't dry out as quickly as they used to. -50-

# INTERNATIONAL ELECTRONICS QUIZ

By **ROBERT P. BALIN**

Recent technological advances in the field of electronics tend to overshadow contributions by earlier scientists from many parts of the world. For example, few students remember that the first known magnetic device—the compass—is a contribution from China, or that the theoretical groundwork in the field of atomic physics which eventually led to the splitting of the atom by the United States, was

actually laid by Albert Einstein, the German-born physicist, while doing research work in Switzerland. To test your biographical knowledge of some earlier scientists and their inventions, see how many of the common electrical devices (A-J) illustrated below you can associate with the country of origin (1-10) of their inventors.

(Answers appear on page 90)

- 1 BELGIUM \_\_\_\_\_
- 2 DENMARK \_\_\_\_\_
- 3 ENGLAND \_\_\_\_\_
- 4 FRANCE \_\_\_\_\_
- 5 GERMANY \_\_\_\_\_

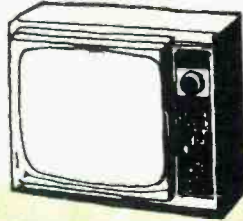

**C TV SET**

- 6 HOLLAND \_\_\_\_\_
- 7 ITALY \_\_\_\_\_
- 8 JAPAN \_\_\_\_\_
- 9 RUSSIA \_\_\_\_\_
- 10 U.S.A. \_\_\_\_\_

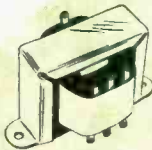

**B TRANSFORMER**



**D X-RAY TUBE**

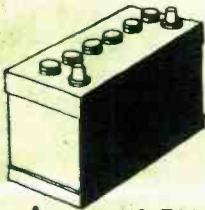

**A VOLTAIC PILE**



**E RADIO TELESCOPE**

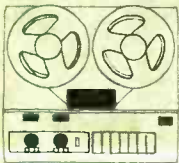

**J WIRE RECORDER**



**F DYNAMO**



**I CRYSTAL**



**G CAP. CITOR**



**H TV ANTENNA**



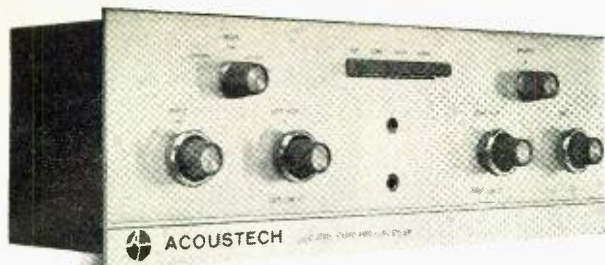

# ACOUSTECH "ADD-A-KIT" SOLID-STATE INTEGRATED HI-FI AMPLIFIER

PUT TOGETHER A TRANSFORMERLESS STEREO  
POWER OUTPUT AMPLIFIER KIT—ADD A  
PREAMPLIFIER-CONTROL CENTER KIT AT ANY TIME

**M**OST AUDIOPHILES SEEM TO AGREE that a large sum of money must be invested in order to obtain the best hi-fi equipment. But for the kit builder, this is not the case. Some of the highest quality hi-fi/stereo amplifiers can be obtained in kit form at a considerable saving over similar factory-wired units. The all-transistor power amplifier-control center (Model XI/PM) by Acoustech\* ranks among the best hi-fi kits available today.

This integrated amplifier actually consists of two kits that can be bought separately. The price tag for the stereo power amplifier (XI) is just \$129.50. For an additional \$89.50, the builder gets the stereo preamplifier section (PM) which consists of a pair of printed circuit card modules and a new front panel for the integrated amplifier-preamplifier.

Both kits have been prepared with the builder's convenience in mind. For example, all small parts come in numbered bags that correspond to the wiring steps in the assembly manual; and the bags are pinned to Acoustech's exclusive "Kit-Kloth." The "Kit-Kloth" is a feature that will be welcome to those who have to work on a kitchen or dining room table; all construction is performed on the "Kit-

Kloth," preventing any table top burns or scratches and gouges.

The critical circuitry for the power amplifier and preamplifier subsections comes already mounted on four computer-type plug-in printed circuit cards. This helps to keep construction down to a bare

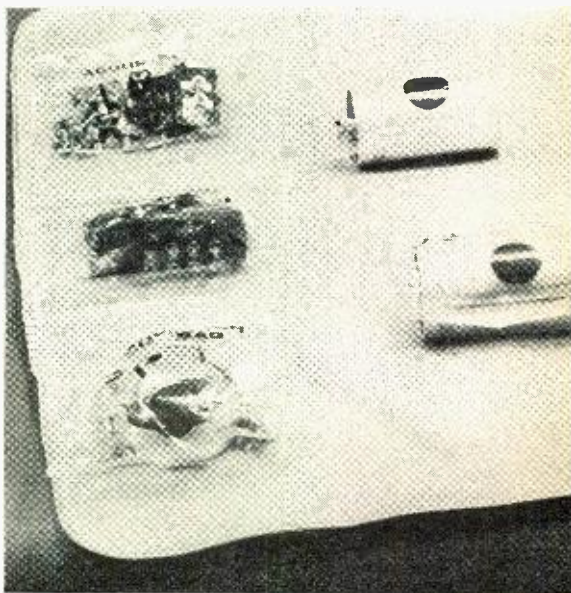

Kit includes an exclusive "Kit-Kloth" which serves as a convenient work surface covering and keeps small parts within easy reach during construction.

\*Acoustech, Inc., 139 Main St., Cambridge, Mass. 02142

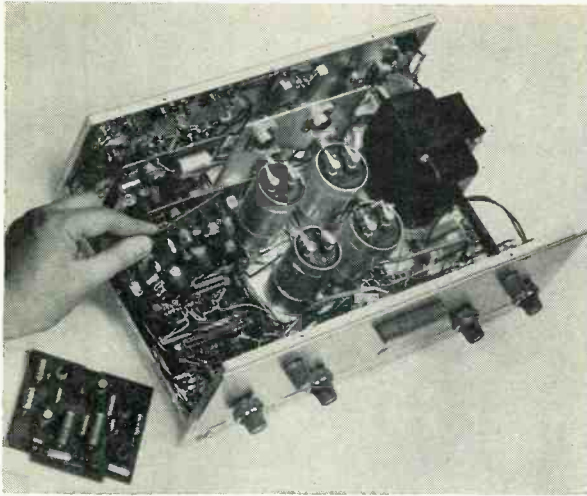

Completed integrated amplifier-preamplifier has neat, uncluttered appearance. Massive computer-quality electrolytic capacitors are used exclusively in the power supply. Four computer-type plug-in printed circuit cards come factory-wired to provide the best possible sound reproduction and low distortion—and to facilitate the construction.

minimum. All that is really left for you to do is put the mechanical parts together, assemble the power supply, and wire the interconnections.

Even if you have never built a kit before in your life, you should have no trouble in assembling the power amplifier and power supply sections. Putting the preamplifier sections together, however, is a bit more difficult. But by carefully following instructions and the full-color assembly drawings, and having a little patience, you should be able to overcome any obstacles.

Another exclusive feature of these Acoustech kits can be found at the end of the assembly instructions. A "count-down system" tells how many (and which) components should be connected

to every pin and solder lug in the part of the kit you build—added insurance against costly wiring errors.

**Subjective listening** is perhaps the best test for an amplifier. Suffice it to say that the sound reproduction from the XI/PM is crisp with unstrained vocal and instrumental clarity. If you have any idea of what the "presence" of sound is, you can be sure that the XI/PM integrated amplifier has it—from whispering sounds to the roaring finale of an orchestral piece like Tchaikovsky's *1812 Overture*.

Some hi-fi enthusiasts may feel that the 8-db boost or cut range of the tone controls is inadequate. The limited range of the controls, however, makes it virtually impossible to distort the sound—unless it's already noticeably distorted before it reaches the XI/PM. In fact, the truest sound is obtained when the bass and treble controls are not even in the circuit; to achieve this goal of the perfectionist, the amplifier's control center has a facility to switch the tone controls out of the circuit.

Whether you are looking for a good amplifier to start your system, or one to move up to, the Acoustech XI/PM should satisfy you. And if you already have a good tube-type or transistorized preamplifier, you can buy just the XI power amplifier kit. Either way, 70 watts of power (35 watts per channel) will be yours for uncompromised sound reproduction.

#### TECHNICAL DATA

Output power per channel	35 watts
Transient power per channel	90 watts
Frequency response at normal listening level	± 1 db, 5-70,000 Hz ± 3 db, 2-120,000 Hz
Harmonic distortion at 20-20,000 Hz	Less than 0.25%
Hum and noise below rated output	Phono input: 55 dB High-level: 75 dB
I.M. distortion for 2-volt equivalent output	Phono: 0.15% High-level: 0.09%
Input sensitivity	Phono: 2.5 and 10 mV
Square wave rise time	1.75 μsec
Inputs in ohms	Phono: 47,000 High-level: 250,000
Output	4-16 ohms
Tone control range	8-db boost and cut

# SENSITIVE LOW-COST INDICATORS

COMBINATION  
TRANSISTOR/PILOT LIGHT  
CIRCUITS ARE  
EASY TO ASSEMBLE

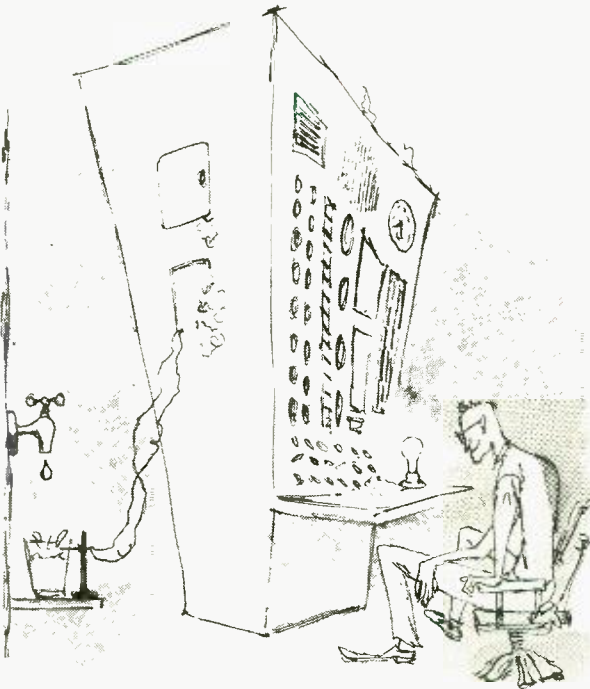

By JOHN L. BEISWENGER

**A**N "INDICATOR" is usually a small gadget that can "tell" you if a piece of equipment is on or off, if the level of a liquid is high or low, if things are hot or cold, etc. An indicator can also alert you to a situation in time to allow you to avoid a major catastrophe—or even a minor one.

Generally, an indicator must be activated by some kind of switch, transducer, or other type of detector. Detectors can be mechanical, electro-mechanical, or electronic devices. Electronic detectors are usually faster-acting, more sophisticated, and more sensitive devices than their mechanical counterparts, and are able to monitor situations that might otherwise escape detection.

Electronic indicators can be inexpensive (less than \$1), or they can be costly, complex affairs. Described here are a few low-cost units that can be put together with one or more transistors and with one or more low-current, low-voltage pilot lights. A 51-cent transistor (either a 2N1302 or a 2N1303) and a number 49 indicator lamp can be made to work with a sensor that for one reason or another cannot tolerate sufficient voltage or current to light the lamp directly. In a way, the transistor amplifies the action.

**How They Work.** A simple indicator circuit using only one transistor, an indicator lamp, and suitable resistors is shown in Fig. 1. The open pair of sensing leads



Fig. 1. Sensing leads can be replaced by any on/off switch type of transducer or detection probe. When the circuit is closed, the indicator light goes on.

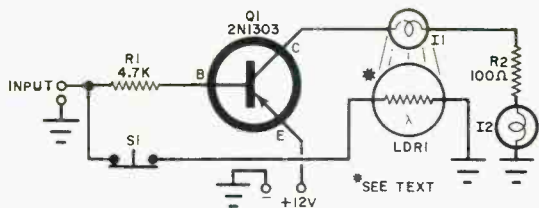
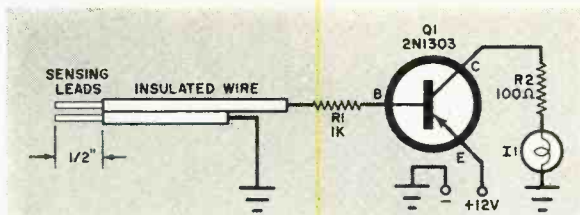

Fig. 2. Latching type of indicator circuit keeps the lamps on even after an "on" signal is removed. Lamp I1 in series with a 100-ohm resistor can be wired in parallel with I2 and R2.

can function as a liquid level indicator, just like a normally-open switch that closes when something happens. As a matter of fact, any switch that can sense a change in temperature, humidity, speed, etc., can be used.

When the sensing leads are open-circuited, no current can flow through the transistor and lamp. On the other hand, when the transistor's base circuit is completed, through the sensor, current flows and energizes the lamp.

Resistor *R1* serves as a base current limiter. Resistor *R2* drops the voltage enough to obtain safe operation of the indicator lamp. The indicator lamp remains on as long as the sensing leads form a closed circuit.

A few minor changes can be made in the basic circuit to produce an indicator that will latch on. The addition of a light-dependent resistor (*LDR1*) and another lamp connected into the circuit as well as a normally-closed, momentary-break switch, as shown in Fig. 2, are all that are needed.

Operation of the latching circuit is essentially the same as the basic indicator circuit except that *I1* illuminates *LDR1*. In the presence of light, the resistance of *LDR1* drops, effectively completes the base circuit, and keeps the transistor turned on. Once the circuit conducts, it remains on even after the sensor is returned to its open-circuit condition. The circuit can be turned off, or reset by

depressing *S1* long enough to douse the light from *I1*.

You can obtain a greater degree of sensitivity by applying enough bias to the base circuit, as shown in Fig. 3, to just keep *Q1* in a nonconducting state. Should a liquid or any other substance bridge any of the gaps in the sensor enough to increase the forward bias, the transistor will turn on, and so will the lamp. Transistor *Q2* enhances circuit sensitivity only, and could be eliminated in some applications. Potentiometer *R1* serves as a sensitivity control.

(Continued on page 98)

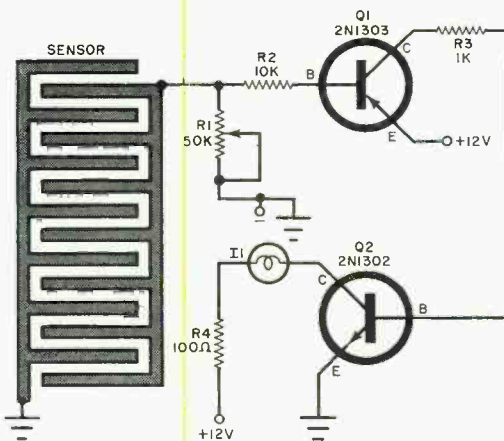

Fig. 3. Sensitivity can be increased by adjusting bias to just below *Q1*'s conducting point. Any further decrease in resistance, as by moisture bridging sensor's elements, will turn on *Q1*, *Q2*, and *I1*.



## BUILD THE QRP MIDGET

By **JIM WHITE**, W5LET

**D**O YOU STILL get a thrill out of hamming? Or is the spirit of adventure gradually disappearing? Maybe you have been considering taking up a new hobby, like chasing butterflies, or collecting stamps. Don't do it. There is nothing like switching to low power—very low power—to restore the thrill to hamming.

If you have done all of your hamming on a "store-bought" rig, maybe you should try your hand at building a transmitter—one that is really portable, with no power lines to worry about. The *QRP Midget* is a 2-tube, battery-powered transmitter that you can hold in the palm of your hand. It will work on 80-, 40-, or 20-meter CW. It can be built for less than \$10 and, when connected to a good antenna, will give a good account of itself.

**How It Works.** The circuit uses two 3S4 tubes in parallel as a crystal oscillator. The filaments are wired in series so that a 6-volt battery can be used for the filament supply. By using plug-in coils, band-changing is as simple as plugging and unplugging a tube. The coils are tuned to resonance in each band by a single variable capacitor.

In addition to the 6-volt battery, two 45-volt B batteries are wired in series to provide 90 volts for the plates and screens of the tubes. The key is connected in series with the B-minus lead to the batteries. A small coil, *L2*, couples the r.f. in the plate circuit to the antenna.

**Construction.** Since the *QRP Midget* is very small, the arrangement of parts is important. A good look at the photo-

RETURN  
TO THE DAYS OF OLD  
WITH  
2.5 WATTS INPUT

graphs will show you just where each part is located.

After all of the necessary holes are drilled and punched, install the crystal socket. Then wire *R1* across its terminals. Leave enough excess lead wire to reach pin 3 of *V1* and the ground connection of *J1*. Now install the three tube sockets, phono (*J1*) and coax (*J2*) connectors, and variable capacitor *C3*.

Following the circuit diagram, carefully wire the balance of the transmitter. All wiring, with the exception of the leads to the batteries, is done with No. 20 solid hookup wire. The battery leads are made of 18" lengths of No. 20 stranded hookup wire; it is a good idea to use different colored wire for these four leads to lessen the possibility of making a mistake when connecting them to the batteries.

The last three parts to be mounted are *S1*, *C1*, and *C2*. The two capacitors are wired across *J1* and the 4-prong coil socket, respectively. The four battery leads are connected to the switch, the ground connection of *J1*, and the "hot" side of *J1*.

**Winding The Coils.** On each of the coil forms, there are two separate windings, *L1* and *L2*, of No. 24 enameled wire. They are separated from each other by a

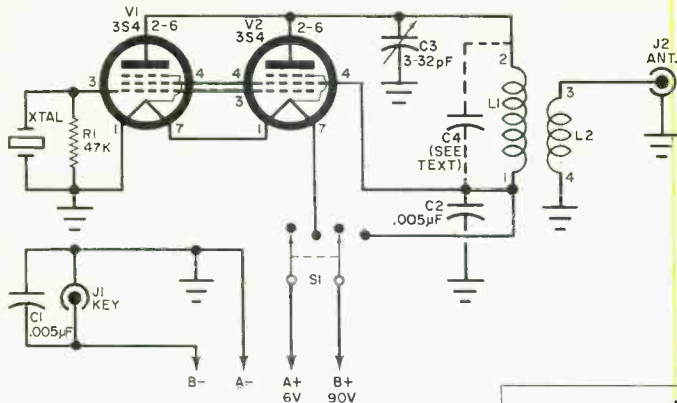

Rockbound transmitter for 80, 40, and 20 meters is small enough to fit into your glove compartment, complete with batteries. Note that pin 5 on 3S4, connected to screen grid and filament center tap, is not used, and is not shown here. Key plugged into J1 turns transmitter on and off for CW operation. Don't let the low power fool you non-hams—you must have a license to put this unit on the air.

distance of  $\frac{1}{8}$ ". For 80 meters,  $L1$  consists of 31 turns, close-wound, and  $L2$  is 8 turns, close-wound. The 40-meter coil has 21 turns on  $L1$  and 7 turns on  $L2$ , both close-wound.

The 20-meter coil has 12 turns on  $L1$ . This coil is wound so that the winding takes up about 1 inch, with the turns spaced equally to occupy this space. Coil  $L2$  on the 20-meter form consists of 3 turns, close-wound.

When you wind the 80-meter coil, be sure and solder  $C4$  in place as you solder the two wires from  $L1$  to the pins. This capacitor is mounted inside the coil form.

**Going On The Air.** Connect a key to  $J1$  and a good antenna for the band you intend to work to  $J2$ . With the power switch in the "off" position, insert the

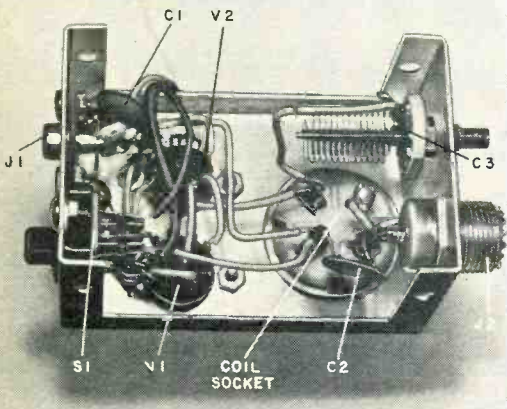

Neatness counts; proper parts location and lead dress are important for clean operation. Keep the leads short. Terminal strip to accommodate battery leads can be mounted on the other half of the box.

## PARTS LIST

- $C1, C2$ —0.005- $\mu$ F, 1000-volt disc ceramic capacitor
- $C3$ —3-32 pF midget variable capacitor (E.F. Johnson 160-130 or similar)
- $C4$ —50-pF silver mica capacitor
- $J1$ —Phono connector, female
- $J2$ —Coax connector, female
- $L1, L2$ —See text
- $R1$ —47,000-ohm,  $\frac{1}{2}$ -watt resistor
- $S1$ —D.p.s.t. slide switch
- $V1, V2$ —3S4 tube
- 3—Coil forms (J. Millen 45004)
- 1—Crystal socket (National CS-6)
- 1—Coil socket (Amphenol 49RSS4)
- Misc.—6-volt battery, 45-volt battery (2), tube sockets (3), wire, solder, nuts, bolts, etc.

two 3S4's into their sockets. Plug a crystal into the crystal socket and a coil into the coil socket (they must be for the same band). Now, using a field strength meter, or a receiver S-meter, turn the transmitter on, press the key, and slowly rotate variable capacitor  $C3$  until you get an indication that the *QRP Midget* is oscillating.

Tune  $C3$  to the peak reading. If you peak it too much, the keying may be erratic. Adjust  $C3$  for the best output consistent with good keying.

Keep in mind that you must have a good antenna when you use the *QRP Midget*. A makeshift antenna simply will not do the job with such low power. Put some time and energy into the antenna, and it will pay dividends. Also, the author has found that a few of the crystals for 20 meters are a little sluggish and do not oscillate very well; you might have to try several before you get a good one.

If you want to measure the input to the *QRP Midget*, just put a milliammeter in series with the B-plus lead. The input should be about  $2\frac{1}{2}$  watts.



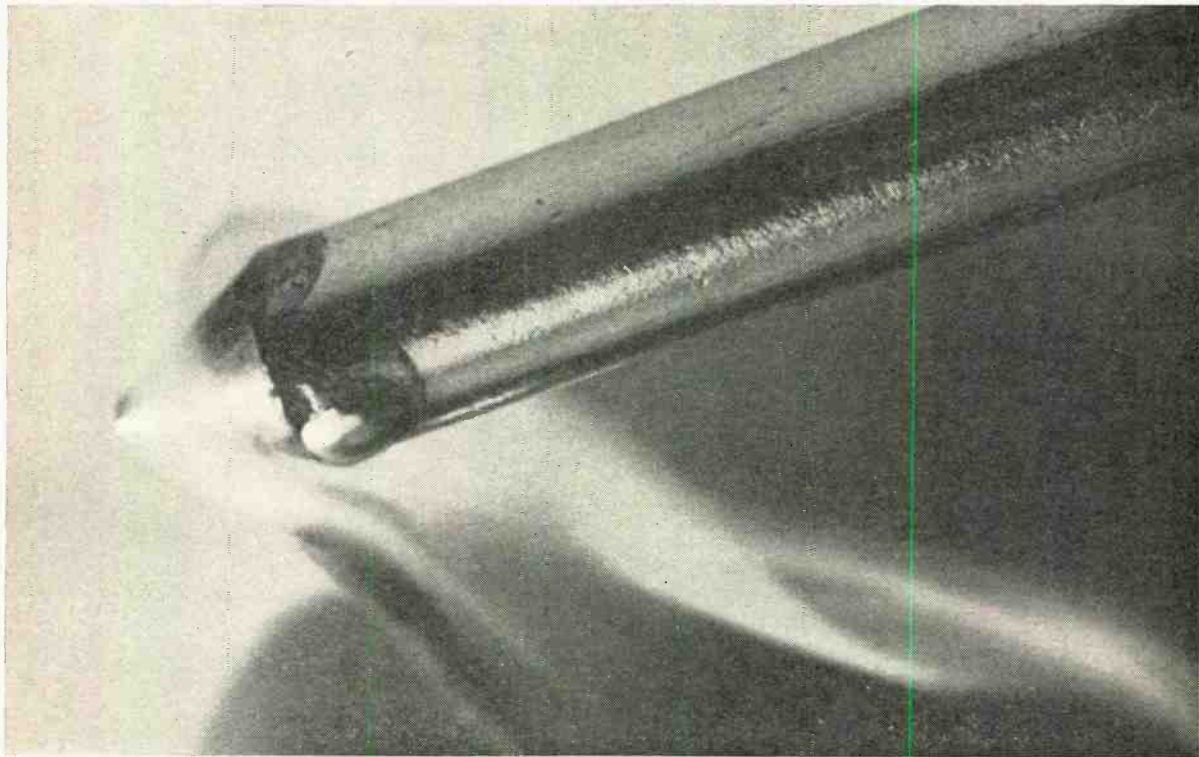

# ELECTRONIC SOLDERING

DO YOU MAKE GOOD CONNECTIONS THE FIRST TIME,  
EVERY TIME?

**T**HERE IS NOTHING DIFFICULT about soldering. Yet most kits returned to the manufacturer and many home-built projects sent to the repair shop usually suffer from little more than poor soldering. Although the bulk of all soldering troubles can be attributed to cold soldered connections, there are also other types of soldering faults; heat damage, short circuits, corrosion, etc.

Cold soldered junctions have different effects on a circuit. They can appear as open, intermittent, high resistance and normal connections. They can fool you into thinking that you have noisy and otherwise defective components.

By **JOHN McNARNEY**

It doesn't take much time or effort to learn and put into practice good soldering habits. Nor does good soldering require any expensive tools or difficult-to-master skills. If you stick to a few common sense rules, you will be able to produce well soldered connections.

**Types of Soldering Tools.** There are all kinds of non-specialized soldering tools designed for general-purpose work. There are soldering irons (including soldering pencils), soldering guns, and soldering pistols. They are all rated according to electrical power consumption. High efficiency factors make it possible to disregard losses and think of the wattage rating as heat power.

Heat power is either light duty (20 to about 50 watts), medium duty (50 to about 125 watts), or heavy duty (125 watts and higher). Manufacturers' duty ratings are often misleading, however, since their designations are based on comparisons of the same types of soldering tools. For example, some soldering guns may be designated as light-duty tools, even though few—if any—guns develop less than 100 watts of heat power.

**Soldering Irons.** Soldering irons and pencils, taken as a group, are character-

istically lightweight and compact, weighing in at less than a half-pound, (without power cord). These tools cost from as little as \$1.50 up to about \$20 for elaborate or precision units and kits complete with special attachments.

The soldering iron and pencil are designed for constant use over a long period of time and with a minimum amount of tip deterioration. As such, this type of tool is especially adapted for extensive project work and kit building.

Soldering irons and pencils have a heat-generating device (resistance element) which is electrically isolated from the soldering tip, but closely thermally coupled. The size and weight of the tip affect the tool's initial heating and heat recovery times. Different kinds of metal and a multitude of shapes and sizes are available. A simple copper tip having one or more flat faces at the pointed end is generally used.

A new type of soldering iron, constructed in such a manner as to provide a selection of different heat power ranges, has recently become popular among hobbyists. This type of tool employs a separate step-down transformer, the second-

Clockwise from bottom, pencil soldering iron, transformer soldering gun, and soldering pistol are most often used types of soldering tools. Each type of tool is available with different heat power ratings plus a variety of specialized tip configurations.

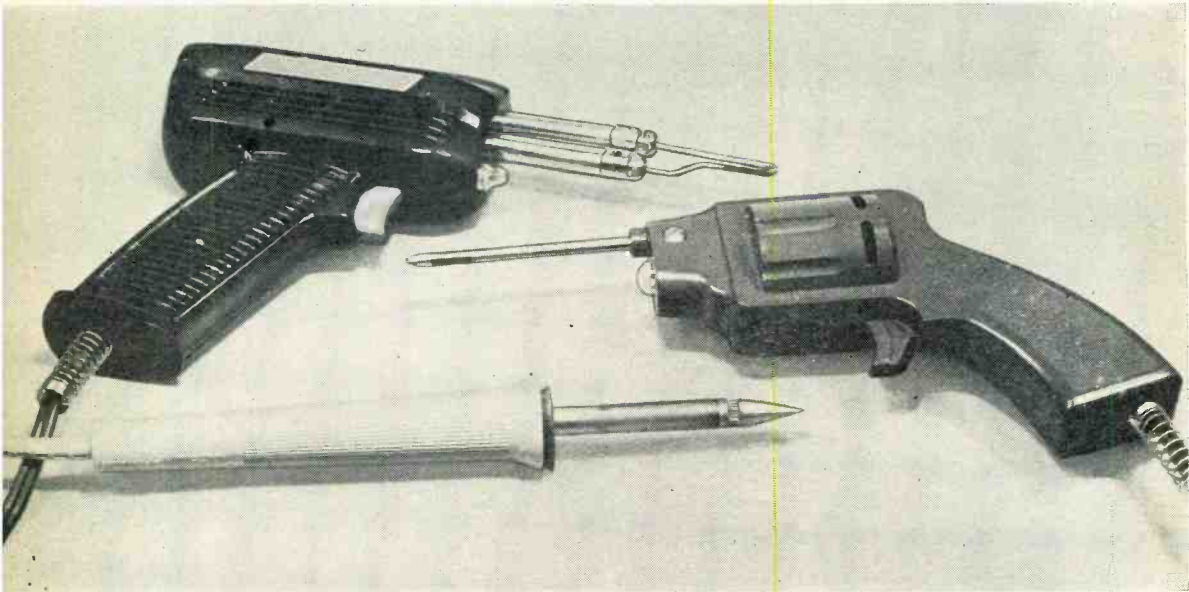

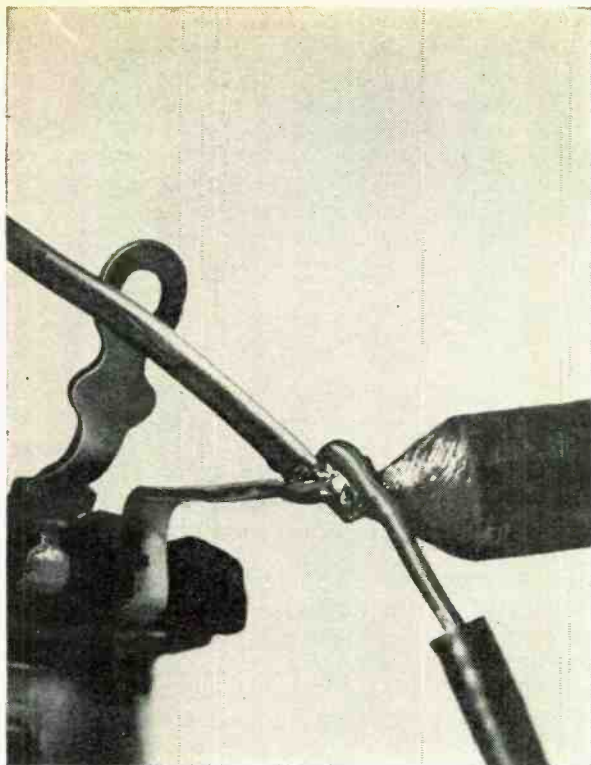

Heat and solder should be applied to opposite sides of connection for best results. This allows solder to flow properly into and around joint. Use only enough solder to insure a good, solid connection.

dary of which is tapped in several places, to provide the correct amount of low voltage and high current for the heat power range selected.

**Soldering Guns.** The soldering gun, because of its built-in transformer, is a rather heavy and bulky device, but its unique pistol-like construction makes it comfortable to use and easy to manipulate. Soldering guns can be purchased for from \$4 to about \$14.

The built-in transformer of the soldering gun provides low voltage and high current directly to the tip. The tip appears to be a short circuit across the transformer's secondary, and comes up to soldering temperature almost instantly.

Because of the instantaneous heating—and cooling—feature of the soldering gun, this type of tool is often preferred for intermittent applications. It is also used by those advocates of get in and get out fast with high heat to prevent damage to transistors and other solid-state components.

Photos below show examples of good (left) and poorly (right) soldered connections. Good connection is usually bright and smooth, while poorly soldered connection is more often than not dull and grainy due to improper application of heat and/or solder.

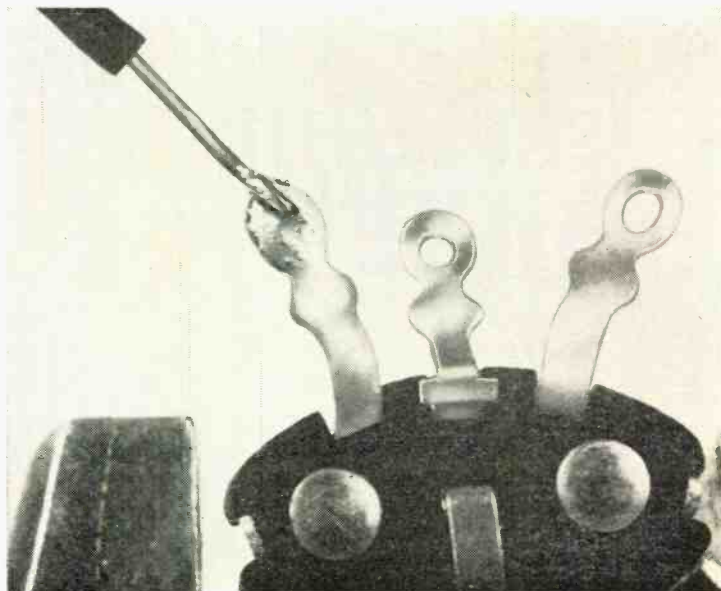



**Soldering Pistols.** The soldering pistol has about the same shape as the soldering gun. The pistol is a hybrid affair, combining features of both the soldering iron and the soldering gun. For example, this type of tool employs both a heating element and a step-down transformer, and its soldering tip resembles those found on many soldering irons.

The step-down transformer serves the same basic function as in the soldering gun; it provides a low voltage-high current source for almost instantaneous heat.

As a general rule, soldering irons and pencils are light- to medium-duty tools, soldering guns are medium- to heavy-duty, and pistols can be obtained in either light-, medium-, or heavy-duty units. Take your choice; but remember, the tool you do choose must be capable of producing enough heat power to efficiently solder the connection in the shortest possible time. This doesn't mean that the higher the power the better. On the contrary, excessively high power tools are more likely to cause more damage in the hands of a person who doesn't have experience in using them.

**Solders and Fluxes.** Solder is simply a tin-lead alloy that flows at a relatively low temperature (about 370°F). Because of this low melting temperature, solder connections can be made quickly and economically.

Most solders are identified by their tin-lead combination. A solder alloy that contains 60% tin and 40% lead is described as 60/40 solder—with the percentage of tin always shown as the first number in the ratio.

Solder is most convenient to use in 16- or 18-gauge strand form. The small cross-sectional area allows conservatively rated tools to make it flow quickly, and the quantity of solder used for each terminal can be easily controlled.

In order for solder to adhere properly to a connection, the joint must be clean, free of oxides, and properly heated. The most effective way to combat oxidation is to use an oxide-reducing flux. However, solder flux will not remove dirt, grease, paint, etc.

Acid and chloride salt fluxes are highly corrosive and have no place in electronics. Use a rosin-type flux for general-purpose soldering and an aluminum oxide-reduc-

ing flux for soldering components to aluminum. (Yes, you can solder to some types of aluminum alloys.)

Solder and fluxes are so closely related that solder manufacturers have combined the two in precisely balanced proportions for general and specialized applications by fabricating the solder so that it contains one or more cores of rosin flux.

**How To Solder.** The cardinal rule is to "keep it clean." That goes for your soldering tools as well as for the connection to be soldered. If the soldering tool you use is a pencil or iron that has a large copper tip, the tip must be coated (tinned) with a thin film of solder to prevent deterioration resulting from oxidation. Tinning also helps heat transfer from the tip to the work.

Even before you proceed to make a connection, the components and terminals to be soldered must be clean. A dirty solder lug or component lead can be quickly cleaned by rubbing it with medium-grade emery cloth or coarse steel wool.

Once the components and terminals to be soldered are cleaned, they are connected together in such a way as to form a good electrical and mechanical joint. The unsoldered connection should be electrically conductive and mechanically solid.

Heat-sink the leads of heat-sensitive components. (The heat sink can be a commercially available item, the jaws of long-nose pliers, or even a paper clip in a pinch.) The heat sink serves as a heat radiator and should be placed as close to the component as possible.

Finally, apply the heat to the connection to be soldered—not the solder! When the connection is hot enough to cause the solder to flow, apply just enough of the solder to form a thin coat. To improve the efficiency of the heat transfer from the soldering tip to the terminal, or connection, many electronics enthusiasts allow a bead of solder to form on the soldering tip. When this bead of solder "surrounds" the connection, heat flows into the joint from "all" sides.

Remove the solder feed first, then the heat, and do not allow the newly soldered connection to move while the solder is in a mobile state. That's all there is to it. —50—



# VOM + FET = TVM

**W**OULD YOU USE an ordinary low-input impedance VOM (volt-ohm-milliammeter) to make essential voltage measurements in high-impedance circuits while your VTVM (vacuum-tube voltmeter) was sitting idly on your workbench? Of course not. But what do you do if you don't have a VTVM? You can step up the input impedance of your VOM by interposing a suitable device between the circuit under test and the VOM. Such a device—a FET VOM-to-TVM converter—can be built for about \$10.00.

So long as your present VOM has a 0-50 or 0-100  $\mu\text{A}$  d.c. full-scale range, it can be made to exhibit an input impedance on the order of 10 megohms even on low d.c. voltage ranges with the aid of this converter. If you want to measure a.c., you can achieve an input resistance of about 1 megohm by simply using a rectifier probe with the converter.

Battery operation of the converter and the VOM make the combination into a portable "VTVM" independent of a 117-volt power line—an advantage most VTVM's do not have.

BUILD SIMPLE ADAPTER  
TO MAKE YOUR VOM  
ACT LIKE A  
\$200 TRANSISTORIZED  
VOLTMETER

By **JAMES RANDALL**

**How It Works.** Figure 1 shows the circuit diagram for the converter. Resistors *R1* through *R4* comprise a 10-megohm voltage divider used for range selection. The N-channel field-effect transistor (FET), *Q1*, in a source-follower configuration isolated by *R5*, acts like a high-impedance to low-impedance matching device, and also forms one leg of a bridge circuit.

The other legs of the bridge are made up of source resistor *R6*, potentiometer *R9*, and resistors *R8* and *R10*. Potentiometer *R9* zero-sets the meter (balances the bridge) to compensate for the current through *R6* and *Q1* when no voltage is applied to the test probes.

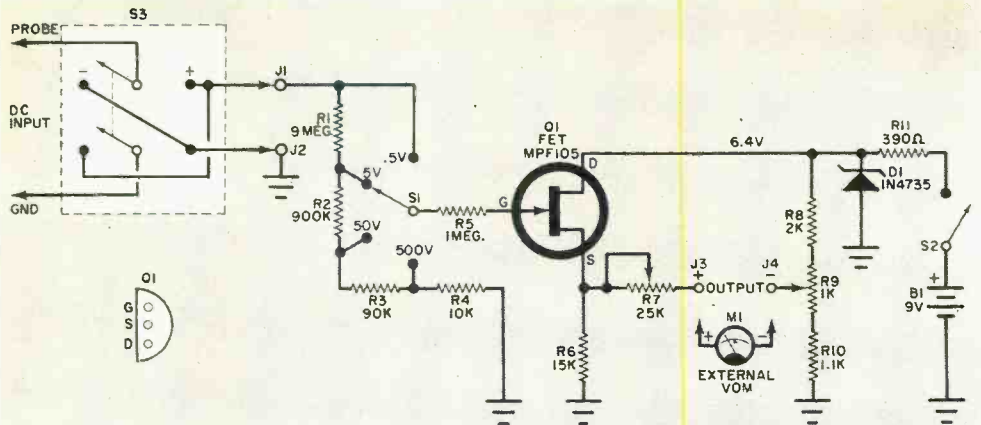

Fig. 1. High-impedance characteristic of field effect transistor permits 10-megohm voltage divider to come between the circuit under test and a VOM. Divider sets up 5 voltage ranges from 0.5 volt to 500 volts.

Operating power is supplied by *B1*, and stabilized by zener diode *D1*, to maintain calibration accuracy for a longer period during the life of the battery. Battery end voltage in this instance is about 6 volts.

To measure a.c. voltages with any d.c. instrument, it is first necessary to convert the a.c. into d.c., which is then measured by the instrument. A suitable circuit for making this conversion is shown in Fig. 2.

The r.m.s. values of a.c. voltages from power line frequencies to r.f. can be measured by using this circuit ahead of the voltage divider in the FET converter. The limit of the maximum voltage which can be measured is determined primarily by *D2*, which is used as the rectifier. Input coupling capacitor *C1* can have a 400-volt rating or higher, as desired. Resistors *R12* and *R13* should be precision 1% types, or selected from 5% resistors to obtain accurate values.

### PARTS LIST

- B1*—9-volt battery
- C1*—0.05- $\mu$ F, 600-volt capacitor
- D1*—6.2-volt,  $\frac{1}{4}$ -watt zener diode
- D2*—1N4003 diode, or similar
- J1, J2, J3, J4*—Input and output jacks or binding posts
- Q1*—Motorola MPF105 field-effect transistor
- R1*—9 megohms,  $\pm 5\%$
- R2*—900,000 ohms,  $\pm 5\%$
- R3*—90,000 ohms,  $\pm 5\%$
- R4*—10,000 ohms,  $\pm 5\%$
- R5*—1 megohm,  $\pm 20\%$
- R6*—15,000 ohms,  $\pm 5\%$
- R7*—25,000-ohm miniature potentiometer
- R8*—2000 ohms,  $\pm 5\%$
- R9*—1000-ohm miniature potentiometer
- R10*—1100 ohms,  $\pm 5\%$
- R11*—390 ohms,  $\pm 10\%$
- R12*—270,000 ohms,  $\pm 1\%$
- R13*—680,000 ohms,  $\pm 1\%$
- S1*—Single-pole, 5-position, non-shorting rotary switch
- S2*—S.p.s.t. slide switch
- S3*—D.p.d.t. slide switch—optional
- 1—3" x 4" x 5" utility cabinet—see text
- 1—2 $\frac{1}{2}$ " x 2 $\frac{1}{2}$ " perforated circuit board—see text
- Misc.—Rubber feet (4), cabinet handle, battery clip, knobs, wire, solder, "L"-brackets (2)

**Construction.** You have a number of choices in constructing the FET VOM-to-TVM converter. The unit can be built in the form of a probe, or built as a plug-in unit, or as a bench-type accessory and housed in a small utility cabinet. The choice is a matter of convenience, and depends essentially on the availability of the necessary miniature components as well as on the particular VOM with which it will be used. For example, if you can get a miniature selector switch—not over one-half inch in diameter—for *S1*, as well as miniature po-

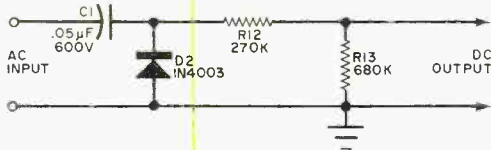

Fig. 2. This simple rectifier probe can be assembled to measure a.c. voltages. The probe's impedance (about 1 megohm) varies inversely with frequency.



tentiometers for  $R7$  and  $R9$ , then all of the components can be put in a probe case no bigger than 1" x 1" x 7".

However, the simplest, and most economical approach is to use a 3" x 4" x 5" utility cabinet in which standard components can be assembled with plenty of room to spare. Such a box will provide room for a polarity reversing switch ( $S3$ ) enabling you to measure either positive or negative voltages without physically reversing the input leads. But while this feature is handy to have, it is not really necessary.

You can duplicate the author's model by following the general layout which is shown in the photographs. Then you can mount the range switch,  $S1$ , the balance control,  $R9$ , the polarity reversing switch (optional), and the input and output jacks on the panel.

Divider resistors  $R1$  through  $R4$  are mounted directly on the range switch ( $S1$ ), which has an *off* position. However, you may find it more convenient to control the battery power with a separate slide switch ( $S2$ ).

Mount the calibration potentiometer ( $R7$ ), the zener diode, the FET ( $Q1$ ), and the remaining resistors on a 2½"-square piece of perforated phenolic circuit board, and secure the board to the rear of the front panel by means of two small L-shaped brackets. The battery can

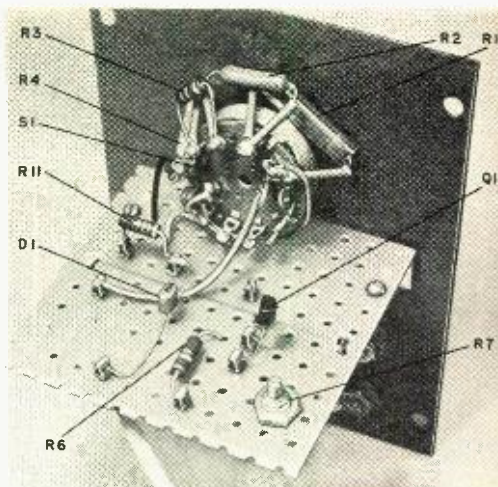

Fig. 4. Inside top view of converter shows voltage divider resistors mounted on the range-selector switch. "Breadboard" type construction can be used to hold the other components in place. A phenolic perforated board and small clips were used here.

be put in a holder and clamped to the base of the unit. Then complete the circuit wiring according to Fig. 1.

The front panel controls can be lettered, using dry transfers, and then sealed in with a clear plastic spray. If your VOM has a 0-50  $\mu\text{A}$  scale, mark the range positions from left to right as follows: OFF—0.5—5—50—500 volts. If a 0-100  $\mu\text{A}$  meter scale is used, mark the ranges: OFF—1.0—10—100—1000 volts.

**Calibration.** To calibrate the instrument, connect a pair of test leads from its output jacks to the input of the VOM, setting the VOM on its 50- $\mu\text{A}$  or 100- $\mu\text{A}$  d.c. current range. Turn switch  $S1$  to its lowest range and adjust the balance control ( $R9$ ) for zero indication on the VOM.

Apply an accurate calibrating voltage (0.5 volt for a 50- $\mu\text{A}$  meter or 1.0 volt for a 100- $\mu\text{A}$  meter) to the converter's input and adjust calibration potentiometer  $R7$  for full-scale reading (50 or 100  $\mu\text{A}$ ). To check linearity, reduce the applied voltage in small increments while observing that the VOM tracks with the calibrating voltage. Linearity and voltage divider accuracy depend upon the accuracy of the 5% resistors. Use precision 1% resistors if possible. You can also make comparison readings with a known accurate VTVM.

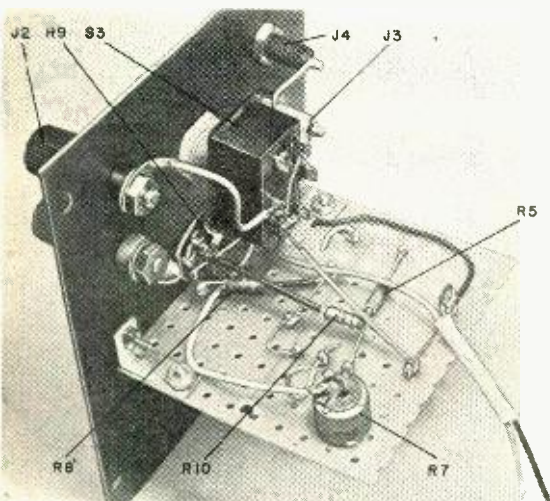

Fig. 3. All of the converter's parts can be fitted into a hand-held probe, or mounted inside a small cabinet. Parts layout and wiring are not critical.

# AAH-CHOOO! NOT ANOTHER



the original circuit. If your car has a positive ground, substitute an *npn* transistor for *Q1* and reverse the polarity of capacitor *C5*.

**Construction.** Although parts layout is not critical, the "Pepper" circuit must be shielded on all six sides. The connection to the AM radio input must be via a coaxial cable.

Drill the appropriate size holes in the box to mount *J1*, *C3* and *L1* as shown in Fig. 2. You can use a perforated phenolic board to lay out the circuit components; if you do, use 1/2" long spacers to provide adequate clearance between the circuit board and the metal box.

Run the coax cable through a rubber grommet in the side of the box, and solder the cable directly into the circuit. If possible, connect the 12-volt power lead to the on-off switch in your car radio. However, the current drain is so low that the "Pepper" circuit can be left

**Q**UITE A FEW READERS have built "Pepper," the outboard r.f. amplifier to increase the sensitivity of automobile AM broadcast band receivers. Although the "Pepper" circuit that appeared in the May 1966 issue (page 56) of *POPULAR ELECTRONICS* could add 8 to 10 dB of gain, it just didn't behave properly for many project builders. Some readers complained of increased sensitivity to ignition noise or susceptibility to motor boating.

The original "Pepper" circuit has been revised as shown in Fig. 1. In the modified circuit a coil/capacitor combination (*L1/C3*) has been added and the new design calls for installation in a metal or shielded container.

The modified "Pepper" unit need not cost more than \$5 and will obviously cost much less if you have constructed

Fig. 1. R.f. amplifier *Q1* can be tuned for best reception at any desired frequency in broadcast band by adjusting settings of *L1* and *C3*.

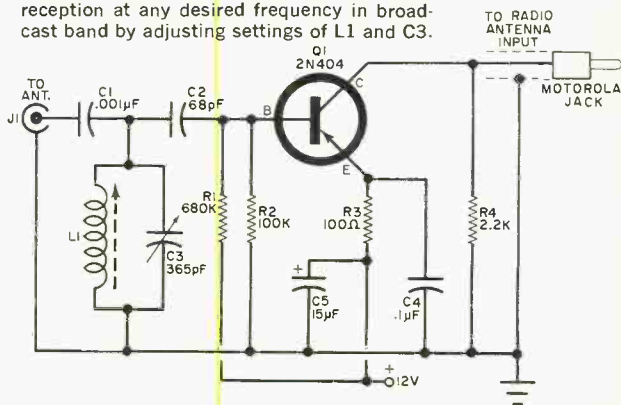



# PEPPER?

## OUTBOARD BCB PREAMP PEPS UP AUTO RECEPTION

By GARY MC CLELLAN

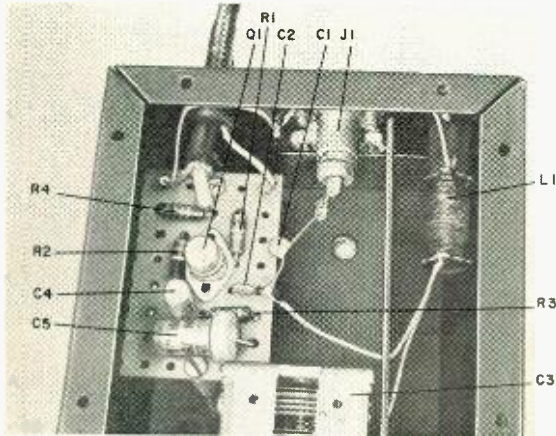

Fig. 2. Optional metal plate shields L1 from rest of circuit. Be careful not to short out trimmers on tuning capacitors. Solidly ground box to car frame.

### PARTS LIST

- C1—0.001- $\mu$ F disc capacitor
  - C2—68-pF disc capacitor
  - C3—365-pF variable capacitor
  - C4—0.1- $\mu$ F, 100-volt paper capacitor
  - C5—15- $\mu$ F, 15-volt electrolytic capacitor
  - J1—Motorola antenna jack
  - L1—Ferrite loopstick antenna coil (similar to Lafayette 32R4108)
  - Q1—2N404 transistor—see text
  - R1—680,000-ohm resistor
  - R2—100,000-ohm resistor
  - R3—100-ohm resistor
  - R4—2200-ohm resistor—see text
- } all resistors  
} 1/2-watt
- Misc.—Metal box, coaxial cable, hookup wire, perforated phenolic board, spacers, hardware, solder, rubber grommet, etc.



Fig. 3. Circuit must be built inside metal box to provide effective shield against r.f. interference that can be caused by ignition and other noises.

operating even when your radio is turned off by simply tying into the "Accessory" side of the ignition switch.

**Tuning and Use.** Disconnect the antenna from your car radio and plug it into the "Pepper" input jack, J1. Turn on the AM radio and adjust L1 until at one setting you can tune C3 through the entire AM broadcast range. Once set, L1 is not readjusted; but peaking of the circuit is left to C3. On strong local signals, additional peaking of C3 may be unnecessary and you may find that an arbitrary setting of peaking capacitor, C3, will serve your everyday needs. On long trips and when you are away from strong AM broadcasting stations, have "Pepper" positioned so that you can tune C3 for best reception.

For additional gain, try substituting a 2.5-mH radio frequency choke for the collector load resistor, R4.



# 180 SQUARE INCHES OF COLOR TV

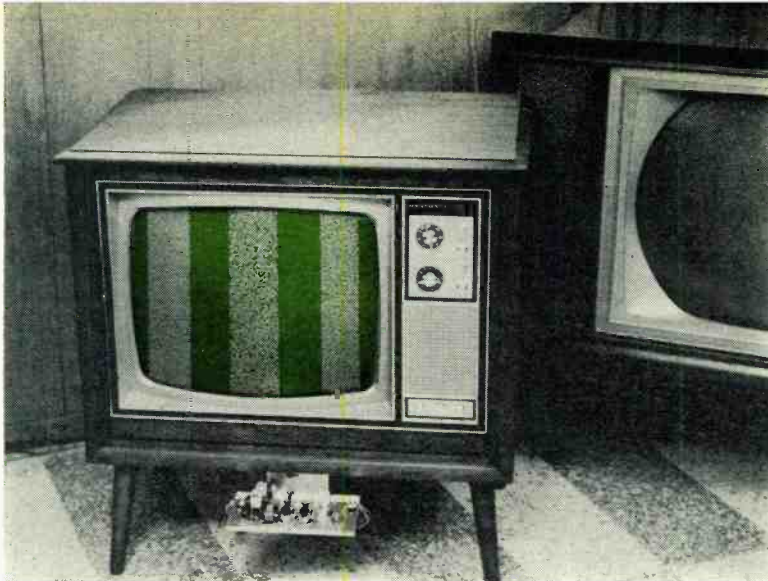

HEATHKIT "180"  
IS VAST IMPROVEMENT  
OVER ORIGINAL  
21" COLOR TV KIT

IF THE PROOF is in the doing, the Heath Company has another winner in its "180" color TV kit. By taking practically all of the essential ingredients from the huge "295" color TV kit\*, substituting a smaller picture tube, and adding an appropriate size cabinet, Heath has come up with the GR-180 kit (\$379.95, plus cabinet). Using a 19" rectangular tube (180 sq. in. of viewing area), the GR-180 replaces the first Heath color TV kit—the 1964 GR-53A.\*\*

It is natural to compare the new kit

\*POPULAR ELECTRONICS, May, 1966, page 62.

\*\**ibid.*, May, 1964, page 81.

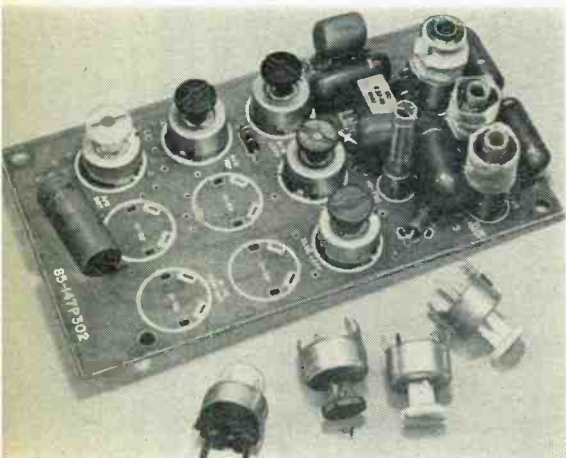

Convergence board is assembled on a printed circuit card in about 20 minutes. Each knob is color-coded.

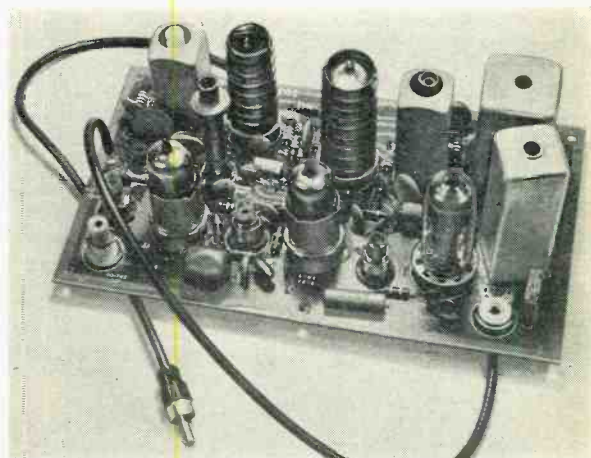

Three-stage i.f. strip is shipped to builder pre-assembled, tested, and aligned to insure best pictures.

with the older 21"-round picture tube kit. By 1967 standards, the 1964 receiver is getting near the antique category. For only a modest sacrifice of picture tube viewing area, the cabinet volume has been more than sliced in half for the "180" (see photo above, left). And the "180" is considerably sturdier—due primarily to the metal wrap-around box shield that encloses the bulb of the picture tube and screens off stray magnetic fields which upset the color purity.

It is impossible to itemize all of the circuitry changes between the "180" and the 1964 kit. However, some of the major changes are reflected in the kit assembly itself. For example, the builder now receives a completely wired, tested, and pre-aligned i.f. strip. This strip is crucial in reproducing faithful color, and the pre-wired unit eliminates a possible major trouble spot. The circuits surrounding the high voltage rectifiers have been vastly improved and all of the components associated with the horizontal output, damper, regulator, and rectifiers are delivered to the builder intact in another pre-wired package.

Two significant new circuits appear in the "180." One circuit involves automatic degaussing and the other the pin-cushion adjustments necessitated by the 90° picture tube. Degaussing occurs whenever the receiver is turned on from a cold start. Pin-cushion elimination is a minor but stable adjustment; once made, it will retain its setting indefinitely.

**Wiring It Up.** The hundreds of individual parts for the "180" flow together without a trace of trouble. Three printed circuit cards are worked up as subassemblies. Two of these, plus the pre-assembled i.f. strip, are mounted on the main chassis frame and a specially prepared cable harness is soldered in place to interconnect the boards and the operating controls.

When the picture tube is mounted and the metal shield assembled, the main chassis is swung into place (it is mounted on hinges for easy servicing). After initial degaussing, the yoke and pole pieces are positioned around the neck of the picture tube. Then you add the knobs and panel trim—total construction time should be between 23 and 24 hours.

**The Proof Is In The Viewing.** Side-by-side comparison of the older 21" receiver and the new "180" confirmed what we would have suspected—the pictures in the "180" were sharper, uniformity of color was excellent, controls were more positive in action and somewhat more flexible (greater tint and color range), and there appeared to be substantially less "noise" or "snow" on all channels.

No review of a Heath color TV kit would be complete without mentioning that each receiver has a built-in dot generator to enable the builder to converge the color without extra test equipment.

-50-

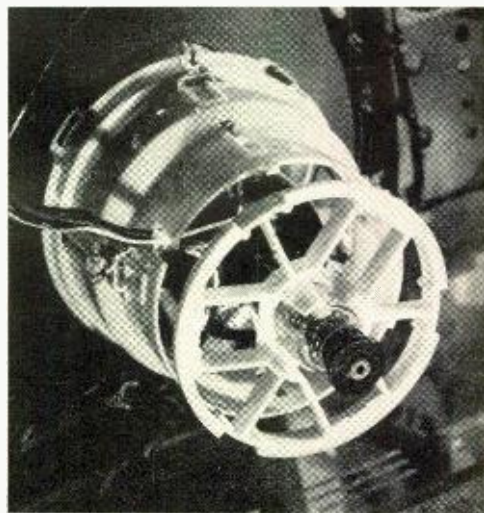
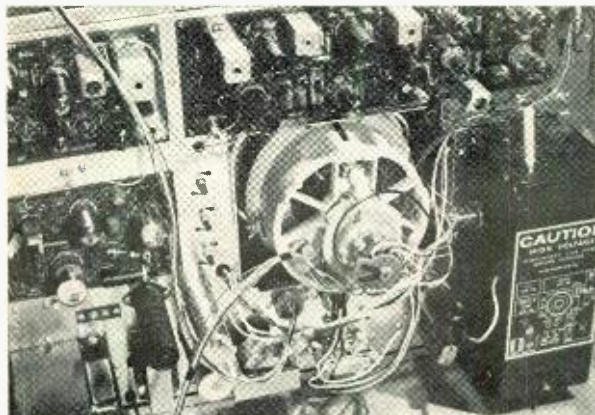

Pole piece assembly is partially fabricated by the builder. View at right shows yoke in position and the plastic pole piece retaining ring being slipped along neck. Above is overall view of rear of TV set.



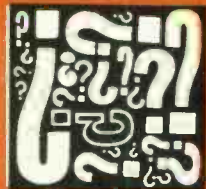

# INFORMATION CENTRAL

By CHARLES J. SCHAUERS, W6QLV

**M**OST letters and postcards from readers of POPULAR ELECTRONICS addressed to this column are brief and the questions well presented. However, many letters are too long, go into too much detail, and frequently ask too many questions—with lots of “if’s, and’s, and but’s”. Your columnist appreciates receiving short succinct communications with sufficient background electronics information to permit reasonable evaluation of the problems.

The volume of mail addressed to this column is increasing at an alarming rate. Although a percentage of the queries are now being answered on a personal basis, it may soon be impossible to continue this service. Please check your local sources of information before writing to *Information Central*. With a few electronics handbooks at your fingertips, plus all of the mail order catalogs, you’ll be surprised how many questions can be answered with a minimum of research. Also, bear in mind that there is an intrinsic delay in your mailing a question, it being routed through the magazine’s editorial offices, and finally being placed in my hands.

Time does not permit the redesign or modification of communications equipment for the benefit of an individual reader, but this column will provide such data (in print) if there is a sufficiently large number of requests for the same information. Nor can we lend instruction manuals or supply complicated wiring diagrams for ham, CB, TV, or SWL equipment. Wherever possible, however, we will tell you where the diagrams are available and how you may obtain the replacement for your construction or operating manual. In the future, we hope to establish a means of duplicating some of this “out of date” material.

**Power Line Noise.** *I am an SWL and I recently moved to a location which forces me to use a vertical antenna. A big power line near my home gives me no trouble when the weather is dry, but when it rains I hear nothing but a lot of hash on my receiver. Is there anything I can do about it?*

You can try calling the power company and ask them for help. If the power line carries high voltage, there is little that can be done if the noise spectrum is wide. However, if there is a major power leakage path

caused by dirty insulators, or other defects, the power company may want to cut their losses.

**CB To Intercom.** *My neighbor is an avid CB operator. I can tell, because I hear her on the intercom in my house. If I switch off the intercom, she does not come through, but then I have no intercom. What can I do?*

Try inserting a 75,000-ohm resistor in series with the grid of each of the first two intercom amplifier stages and bypass the grid to ground with a 0.001-uF capacitor.

**CB To Ham.** *I am a CB'er and have decided to become a radio amateur. How do I go about it?*

Contact the American Radio Relay League (ARRL), 225 Main St., Newington, Conn. 06111. Ask them to send you information on becoming a ham.

**Neon Lamp Life.** *Which small neon lamps have the longest average life? I am not too concerned about brilliance.*

The following neon lamps have an average useful life of about 25,000 hours: NE-2, NE-2D, NE-2E, NE-2H, NE-2J, NE-51H, NE-2P and NE-2M.

**Electronic Flash Problem.** *I own a Braun Hobby Model EF-3 electronic flashgun. While overseas I accidentally plugged the unit into a 220-volt outlet. Since then the gun has not worked. Would it be difficult to repair?*

It could be, but first check the 400-mA slow-blow fuse. I’ll bet a blown fuse is your only trouble.

**Indoor Reception Problems.** *I live reasonably close to FM and TV transmitting sites (within 5 miles) and use a line cord antenna for one FM receiver and a hank of wire about 3' long for the other FM set. My portable TV receiver has its own built-in antenna. Since moving to this location, I have noticed that when I walk around the room the FM sets will distort or even jump frequency, and the TV picture will always change when I walk away from the receiver. What is the cause of these effects, and is there a cure?*

Literally speaking, the cause consists of



very strong reflections and those things called "standing waves." You're probably so close to the high-powered transmitters that reflections from your body sometimes overpower the direct signal from the transmitter. The only solution is to erect a simple outdoor antenna and feed the TV set and FM receivers from a suitable splitter.

**Electric Fence Transformer.** *In your February 1967 column you gave information on an electric (transistorized) fence. The transformer recommended was referred to as the Triad F-14X. I cannot buy one in my city. What are the recommended primary and secondary voltages?*

There is nothing too critical about this transformer. Most readers duplicating the suggested circuit will find that a power transformer with a primary suited to their line voltage and with a secondary voltage of 6.3 volts will be perfectly adequate.

**National NCX-3 Improvements.** *I have just purchased a secondhand NCX-3 transceiver. Can you suggest any improvements to soup up this rig?*

I can give you three suggestions. For improving your receiver sensitivity, remove resistor *R44* (the resistor at the screen grid *V10*). Do not replace it. Secondly, for improved tracking on 80 meters, change *C18* from 240 pF to 220 pF (5% tolerance) and then repeak the 80-meter grid coil. Finally, to improve the receiver audio on SSB, change capacitor *C82* from 0.01  $\mu$ F to 0.02  $\mu$ F.

**Local AM BCB Blanking.** *My AM BCB receiver uses a loopstick for an antenna. I would like to listen to a station on 620 kHz that has a transmitter 40 miles away. Unfortunately, a local station on 970 kHz blanks it out. In fact, the local is so strong it can be picked up all over the AM dial. I have tried an outdoor antenna without success. What can I do?*

Really not too much. It sounds as though you're so close to the station on 970 kHz that you have r.f. saturation, and even the best AM receiver would have trouble. Before

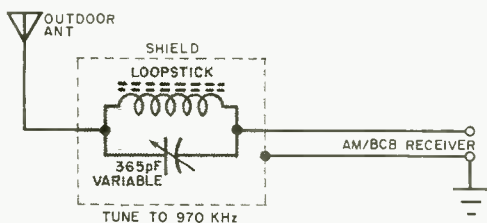

giving up, however, I would try a trap tuned for the 970 kHz station—if your receiver has a separate antenna input connection.

**Simple BCB Tuner.** *I don't have much money to spend on my hi-fi hobby, but I would sure appreciate the diagram of a simple inexpensive AM tuner that I can feed into my hi-fi amplifier. I only want to tune one of two local stations. Can I build one for about \$5?*

You certainly can, and a simple tuner that you should be able to plug into your hi-fi setup is shown in the accompanying

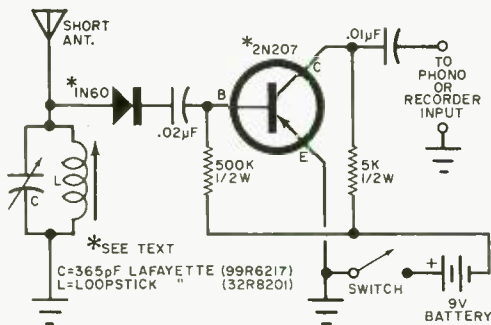

diagram. The diode can be just about anything, including a 1N34A, 1N38A, 1N54A, etc. The transistor can also be a 2N404, 2SB32, 2N217, or GE-2.

**Air Conditioner Interference.** *I have a rather large 240-volt air conditioner in my house rated for a heat exchange of 18,000 BTU. At about 6 or 10 seconds before the air conditioner shuts off, it creates an electrical interference to the FM and TV. This just doesn't seem right and I was wondering if I could do anything about it?*

Obviously the interference is coming from an improperly operating thermostat. Sometimes the thermostat contacts do not break cleanly (as they should) and there is a lingering contact that results in bounce and arcing. Try a replacement thermostat, or an arc suppressor across the contacts. This suppressor could simply be a 0.1- $\mu$ F capacitor in series with a 25-ohm, 1/2-watt resistor. If possible, you might also juggle the starting and stopping relay contact adjustments—there may not be enough tension for the stopping contact to break free at the proper temperature setting.

**Hi-Fi Speaker Quality.** *If we are to believe the ads on hi-fi loudspeakers, each manufacturer makes at least one "perfect" speaker. What determines speaker quality?*

The best article I have seen on this subject appeared in the November, 1965, issue of POPULAR ELECTRONICS (p. 47). The author pointed out that a good hi-fi speaker must have a smooth frequency response, good transient response, adequate power handling capacity, fair sensitivity, broad directivity,

and sufficient damping at the lowest resonant frequency. There is probably no "perfect" hi-fi speaker because all of the above characteristics are interdependent. When choosing a hi-fi speaker, the choice must be personal, for a speaker that may please my ear may not please yours.

**Rheostats Vs. Potentiometers.** *How do I distinguish between a rheostat and a potentiometer? Is it the resistance, physical appearance, or wattage that separates these two components?*

There is a tendency to use the terms "rheostat" and "potentiometer" interchangeably, but although these components are both variable resistors, their purpose and circuits are different. Note in the accompanying wiring diagram that the potentiometer is a continuously variable voltage divider. The rheostat is not as versatile as a potentiometer although rheostats are seen frequently in TV receivers—particularly time base circuits, height and linearity controls, etc. Potentiom-

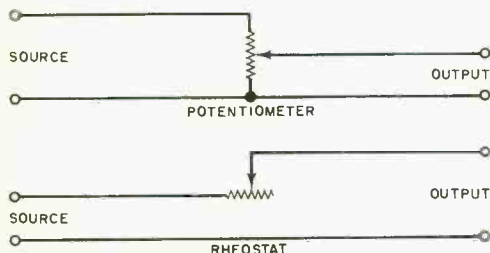

eters are simply connected as two-terminal devices and the third terminal ignored when they are used as rheostats.

The term "rheostat" was popular in the days of the antique radio receiver wherein the operator controlled the filament brightness of such tubes as the 199, 200, 201A, etc.

**Muting 75S-1 With KWS-1.** *How do I mute my Collins 75S-1 while using a KWS-1? I bought these sets secondhand and have no specific information on muting this combination.*

When you tie these two rigs together, you can mute the 75S-1 by connecting pins 5 and 6 on jack 102 (receiver disable) to mute on the 75S-1. Connect the 75S-1 antivox jack to the 500-ohm audio (pin 7) on J102 of the KWS-1.

**28-Volt Relays on 117 Volts.** *I have a number of very fine surplus 28-volt d.c. relays. It hurts not to be able to put them to use in my shack. How about suggesting a suitable power supply?*

The power supply shown here should work as long as you adjust the 10-watt resistor to secure the best relay operation. The

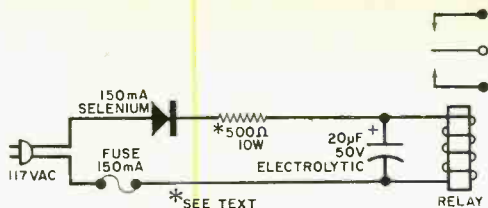

value of this resistor depends upon the coil resistance and may be anything from 500 ohms (the usual minimum) to as high as 1500 ohms. If the relay should start chattering, increase the value of the electrolytic capacitor.

**CB Splatter.** *A couple of other CB stations in my locality have told me that my signals are splattering over part of the band. Each time I have been told this, I have gone off the air and checked tubes and meter readings, but everything appears to be okay. Are these other operators putting me on?*

You didn't mention if you were using an outboard—or built-in—modulation booster. If so, you may be putting more audio into the final r.f. amplifier of your CB rig than necessary and exceeding the 100% modulation limit. Splattering results from trying to put too much modulation on too weak a carrier. The cure is simply less modulation. Also, don't scream into the mike. And you might find it advantageous to buy an EICO 715 CB tester which contains a very accurate modulation meter.

**It's Illegal.** *One of my SWL friends told me that it is illegal to repeat the radiotelephone conversations I hear on my short-wave receiver. What I am referring to are the ship-to-shore telephone conversations. Is this true?*

Yes, the Communications Act specifically prohibits the interception, use, and publication of radio communications not intended for the public. Broadcasting (AM or FM), TV, and ham radio are not included in this so-called "secrecy" act. All radiotelephone conversations that are not intended for the general public are supposedly private. You can't help hearing them, but don't divulge what you have heard. The penalty for divulging communications not intended for public use is a fine not exceeding \$10,000, or imprisonment for a term not exceeding two years, or both.

**In Closing.** My thanks to the many readers who have sent in kind comments about this department. They've gone a long way toward convincing the Editor that it is being read. Send your questions to: Information Central, % POPULAR ELECTRONICS, One Park Avenue, New York, N.Y. 10016.

-30-



# SHORT-WAVE LISTENING

By **HANK BENNETT**, W2PNA/WPE2FT  
Short-Wave Editor

## “SOUND RECORDING—DO NOT X-RAY”

IN RECENT YEARS the practice of sending tape recordings to foreign broadcasting stations in lieu of the more conventional written reception reports has been gaining increased acceptance by the stations. Many broadcasters today look for tape recordings of their transmissions. This method of reporting is the best way of letting a station know exactly how it is being received in a particular location.

However, several broadcasters have written to tell us that some tape recordings are arriving at their destinations with little or nothing on the tapes. In such cases, it would seem that the listener had done nothing more than send the station a blank roll of recording tape.

Little known by many SWL's is the fact that customs offices, both in the United States and many foreign countries, x-ray packages to partially determine their contents rather than go to the trouble of opening them. An x-ray will erase a magnetic recording.

To overcome this problem, when you send a tape recording to another country, you

should clearly label the package “Sound Recording—Do Not X-Ray.” This will enable the customs officials to avoid damaging your recording through the use of x-rays.

**Clandestine Stations In The News.** For the benefit of new readers of this column, we might explain that a clandestine broadcasting station is one that operates without a license, or at a secret location, or both. Monitors are urged to listen for any new clandestine stations and report on them. But before sending the information in to this column, please be sure that your data is correct, especially so far as the frequency, time, and identification of the stations are concerned.

The often-heard *R. Euzkadi*, which customarily broadcasts in Spanish and Basque, is now announcing as *Radio Scalli, Le Voice of the Basque Underground*, as noted from their only Eng. identification at 2200 on 15,083 kHz. However, reports should still be addressed to *Radio Euzkadi, La Voz de Basque Underground*, B.P., Paris, France. The location of this station, according to their QSL card, is on the border between Spain and France.

*Radio Portugal Livre* is another station that currently is being widely logged. Look  
(Continued on page 92)



Well-equipped listening post of Wallace Glavich, WPE6EPX, Eureka, Calif., boasts four receivers: National's HRO-50T, HFS-VHF, and RBL-5VLF, plus a Hallicrafters SX-88. Wallace has 50 countries verified out of a total of 101 countries logged.

Ted Vodde, WPE4JBE, of St. Petersburg, Fla. (at right) uses a Hallicrafters TW-1000 receiver. Ted's record is 44 countries logged, 39 verified.





**“Get more  
education  
or  
*get out of  
electronics***

**...that's my advice.”**

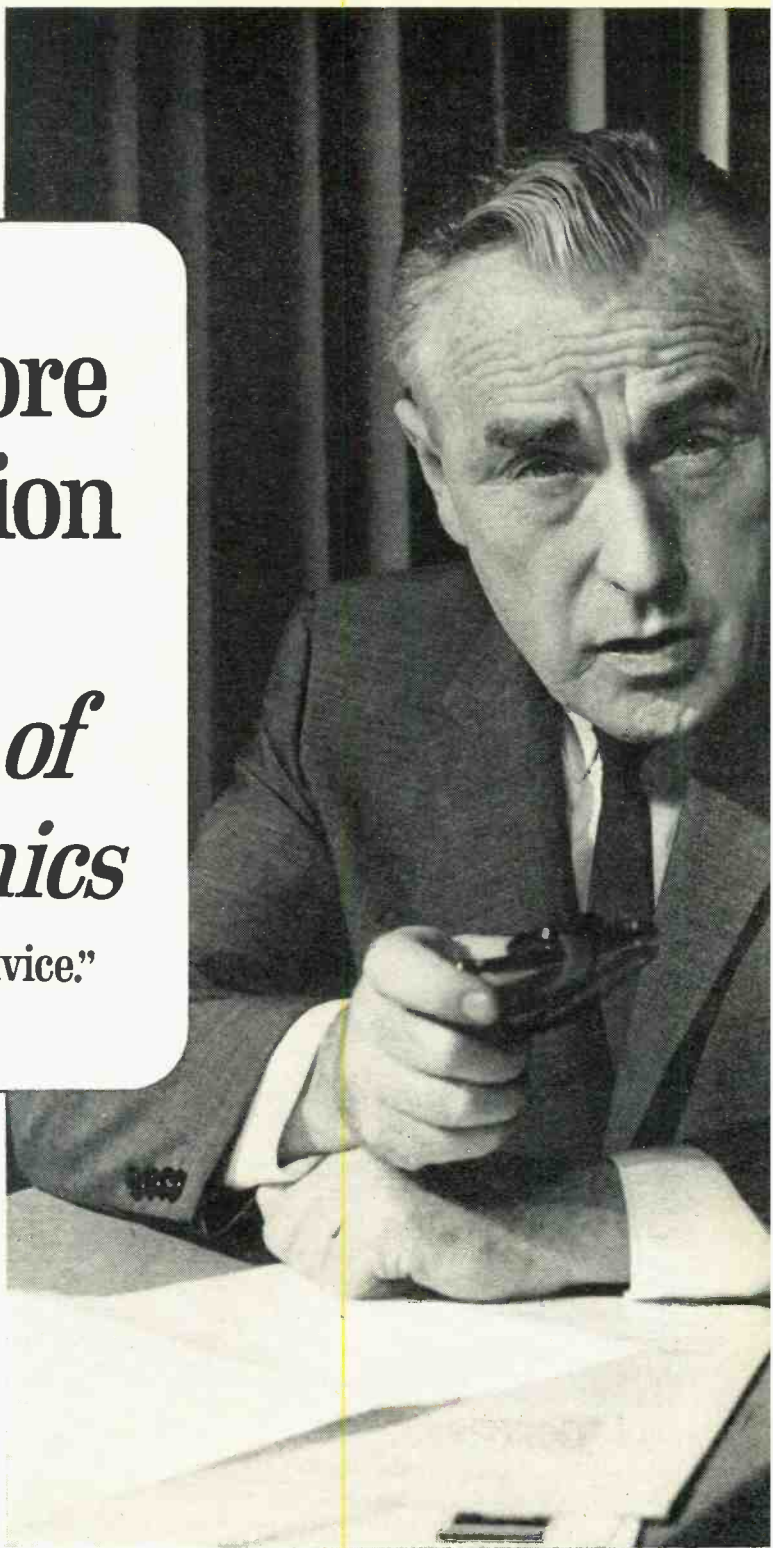



**Ask any man who really knows the electronics industry.** Opportunities are few for men without advanced technical education. If you stay on that level, you'll never make much money. And you'll be among the first to go in a layoff.

But, if you supplement your experience with more education in electronics, you can become a specialist. You'll enjoy good income and excellent security. You won't have to worry about automation or advances in technology putting you out of a job.

How can you get the additional education you must have to protect your future—and the future of those who depend on you? Going back to school isn't easy for a man with a job and family obligations.

CREI Home Study Programs offer you a practical way to get more education without going back to school. You study at home, at your own pace, on your own schedule. And you study with the assurance that what you learn can be applied on the job immediately to make you worth more money to your employer.

You're eligible for a CREI Program if you work in electronics and have a high school education. Our FREE book gives complete information. Airmail postpaid card for your copy. If card is detached, use coupon below or write: CREI, Dept. 1229 E, 3224 Sixteenth Street, N.W., Washington, D.C. 20010.



**The Capitol Radio Engineering Institute**  
 Dept. 1229 E, 3224 Sixteenth Street, N.W., Washington, D.C. 20010

Please send me FREE book describing CREI Programs. I am employed in electronics and have a high school education.

NAME \_\_\_\_\_ AGE \_\_\_\_\_

ADDRESS \_\_\_\_\_

CITY \_\_\_\_\_ STATE \_\_\_\_\_ ZIP CODE \_\_\_\_\_

EMPLOYED BY \_\_\_\_\_

TYPE OF PRESENT WORK \_\_\_\_\_  GI BILL

I am interested in  Electronic Engineering Technology  
 Space Electronics  Nuclear Engineering Technology  
 Industrial Electronics for Automation  
 Computer Systems Technology

APPROVED FOR VETERANS ADMINISTRATION TRAINING

# ENGLISH-LANGUAGE BROADCASTS TO NORTH AMERICA

## FOR THE MONTH OF JULY

PREPARED BY ROBERT LEGGE

TO EASTERN AND CENTRAL NORTH AMERICA			
TIME—EST	TIME—GMT	STATION AND LOCATION	FREQUENCIES (MHz)
7:15 a.m.	1215	Melbourne, Australia	11.71
		Montreal, Canada	9.625, 15.365
9 a.m.	1400	Stockholm, Sweden	17.84
3 p.m.	2000	Accra, Ghana	11.85
4 p.m.	2100	Hilversum, Holland	11.73, 15.425
5 p.m.	2200	London, England	15.26, 17.79
		Moscow, U.S.S.R.	9.685, 11.955, 15.15
6:30 p.m.	2330	Johannesburg, South Africa	9.705, 11.90
7 p.m.	0000	London, England	9.58, 11.78, 15.26
		Moscow, U.S.S.R.	9.685, 11.955, 15.15
		Peking, China	15.06, 17.68
		Sofia, Bulgaria	9.70
		Tirana, Albania	7.263
7:30 p.m.	0030	Budapest, Hungary	9.833, 11.91, 15.16
		Stockholm, Sweden	11.805
7:50 p.m.	0050	Vatican	9.69, 11.76, 15.285
8 p.m.	0100	Berlin, Germany	9.73, 11.89
		Havana, Cuba	6.17, 11.76
		Madrid, Spain	6.13, 9.76
		Prague, Czechoslovakia	7.345, 11.99, 15.368, 17.84
		Rome, Italy	11.81, 15.41
8:15 p.m.	0115	Berne, Switzerland	6.12, 9.535, 11.79
8:30 p.m.	0130	Bucharest, Rumania	11.94, 15.25
		Cairo, U.A.R.	9.475
		Cologne, Germany	9.64, 11.945
		Hilversum, Holland	9.59
		(via Bonaire)	
		Johannesburg, South Africa	9.705, 11.90
8:45 p.m.	0145	Copenhagen, Denmark	9.52
9 p.m.	0200	Lisbon, Portugal	6.025, 6.185, 9.68
		London, England	9.58, 11.78, 15.26
		Moscow, U.S.S.R.	9.685, 9.70, 11.955
		Stockholm, Sweden	11.805
9:30 p.m.	0230	Beirut, Lebanon	15.355
10 p.m.	0300	Bucharest, Rumania	9.57, 11.94, 15.25
		Budapest, Hungary	9.833, 11.91, 15.16
		Madrid, Spain	6.13, 9.76
TO WESTERN NORTH AMERICA			
TIME—PST	TIME—GMT	STATION AND LOCATION	FREQUENCIES (MHz)
6 p.m.	0200	Melbourne, Australia	15.32, 17.84
		Tokyo, Japan	15.135, 15.235, 17.825
7 p.m.	0300	Moscow, U.S.S.R.	15.14, 15.18, 17.76
		(via Khabarovsk)	
		Peking, China	9.457, 11.82, 15.095
		Seoul, Korea	15.43
7:30 p.m.	0330	Stockholm, Sweden	11.805
7:45 p.m.	0345	Berlin, Germany	11.875, 11.92
8 p.m.	0400	Sofia, Bulgaria	9.70
8:30 p.m.	0430	Budapest, Hungary	9.833, 11.91, 15.16
8:45 p.m.	0445	Cologne, Germany	9.735, 11.945
9 p.m.	0500	Berne, Switzerland	9.695, 11.715
		Moscow, U.S.S.R.	9.54, 11.755, 11.85



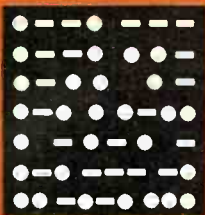

# AMATEUR RADIO

By **HERB S. BRIER**, W9EGQ  
Amateur Radio Editor

## FCC ACTION ON INCENTIVE LICENSING—WHEN?

**I**N A SHORT ADDRESS at the annual Quarter Century Wireless Club banquet in Washington, Mr. Rosel H. Hyde, Chairman of the Federal Communications Commission, stated that the Commission had not yet taken action on FCC Docket 15928, the so-called "incentive licensing" proposal. But he reported that the commission staff was in the process of preparing its recommendations on the docket to present to the commissioners, so that the latter could make their decision—in a matter of weeks (?).

Actually, of more importance than the exact date when the FCC will release its decision on Docket 15928 were Commissioner Hyde's complimentary remarks about the Eye Bank Network, the Amateur Radio

Emergency Corps, RACES, and amateur radio in general. He suggested that old-timers should do what they could to stimulate the interest of youngsters in amateur radio as a lifetime hobby which can enlarge their educational horizons, and concluded by saying, "Whatever the docket number, the objective of the Federal Communications Commission in relation to amateur radio is to improve the status of the amateur service in the public interest."

After reading Commissioner Hyde's speech, William I. Orr, W6SAI, Menlo Park, Calif., made some cogent remarks about the reduced growth rate of amateur radio in his privately published newsletter "Amateur Radio Facts." Bill noted that after a drop

## AMATEUR STATION OF THE MONTH



Henry F. O'Meara, WB2NRX, Brockport, N.Y., is one of those hams who believe that you do not need elaborate equipment to enjoy amateur radio. Using a Hallicrafters HT-40 transmitter and SX-140 receiver, and a simple antenna, Hank has worked 40 states, Canada, and Mexico on 40 meters. Also to be seen in his shack is a Hallicrafters SX-110 receiver for short-wave listening, which he has been doing—off and on—since 1940. WB2NRX will receive a one-year subscription for submitting the winner for July in our Amateur Station of the Month photo contest. To enter the contest, send a clear picture of your station with you at the controls and some details on the equipment you use and your ham career to Amateur Radio Photo Contest, c/o Herb S. Brier, Amateur Radio Editor, Box 678, Gary, Ind. 46401.

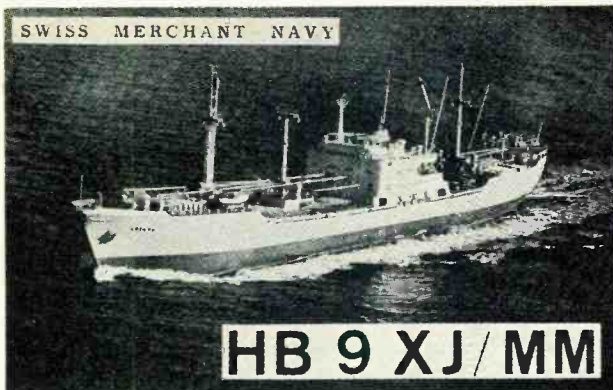

This is the QSL card (actual size, about 9¼" x 3½") of Hans Buhler, HB9XJ/MM, who operates CW, SSB, and RTTY aboard the MS "Ariana" in the Swiss Merchant Navy. His equipment includes a Hallcrafters HT-42 transmitter, a Collins 51J-4 receiver, a Model 15 teleprinter, and assorted antennas around the ship. HB9XJ/MM's biggest thrill is giving a RTTY addict a rare "maritime-mobile" contact.

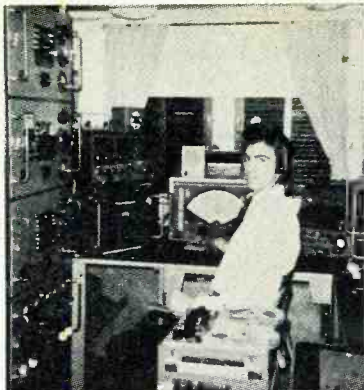

Novice Joe Bills, WN8TDN, of Delaware, Ohio, works the lower frequency bands with a Heathkit DX-60A transmitter and HR-10 receiver, and 50-MHz with a Gonset "Communicator." Joe is a member of RACES, the ARRL Emergency Corps, and Air Force Junior ROTC! He has 15 states confirmed so far.

from 252,300 to 245,100 individual amateur licenses extant between 1965 and 1966 there was a slight increase in the past year. But the increase has been in General and Extra Class licenses, not in Novice and Technician licenses, the type that most new amateurs begin with; they continue to decrease in number.\*

W6SAI places the blame for these conditions on several factors, including the Citizens Radio Service, which he says short-circuits many prospective amateurs. Bill

\*These figures are close, but not wholly accurate. During the first week of April the FCC computerized operation read out that there were 256,442 licensed hams. Of these, 11,542 were Novices and 58,409 were Technicians—a drop of 3000 in the Novice ranks, but only 300 for the Technicians. Both General Class and Extra Class licenses have climbed in the past two years.

reasons (with much truth) that the main attraction of amateur radio to prospective hams would be to work DX on phone, although many of them become interested in other facets of amateur radio—including code operation—after becoming hams. And DX phone work is obviously impossible with a Novice license; so why study for it?

In view of these facts, Bill recommended to the American Radio Relay League that it petition the FCC to authorize Novice phone operation between 29.5 and 29.7 MHz in the amateur 10-meter band. The present requirement of passing a 5-wpm code test and a simple written examination to obtain a Novice license would still be valid, and the license would continue to be issued for a limited, non-renewable term—one year at present.

Bill admits that his proposal has some bad points, but its good points may outweigh the bad. And it is a proposal that might be looked upon with considerable favor by the FCC, because—if enacted—it would relieve considerable "hobby" pressure on the CB channels. And if we amateurs cannot make a qualified, fully-licensed ham out of any Novice during his license term, his license will expire, and he will be automatically off the air.

**Simplified Station Identification.** In a surprise move, early in April, the FCC proposed that hams be permitted to simplify station identification procedures. The FCC said that this new rule would reduce the unnecessary burden for "multiple" identifications—but all DX men know that the rule would legalize the current practice of "tail-ending."

The present rule for identification requires that all calls start with the letters of the

(Continued on page 91)



# SOLID STATE

By LOU GARNER, Semiconductor Editor

**A**LTHOUGH ALL solid-state image sensors are in the developmental stage, as reported in last month's column, and solid-state operation does offer many advantages, it may well be that in the near future the TV camera tube will be a hybrid device representing a combination of both solid-state and vacuum-tube technologies. Such a device has just been developed by the Bell Telephone Laboratories (Murray Hill, N.J.).

The function of any TV image sensor is to convert an optical image into a corresponding electrical signal. This is accomplished by first changing the light image into a pattern of electrical charges that are stored on some type of mosaic structure. The pattern is then read out as a signal, either by means of a scanning electron beam or through use of digital switching techniques.

BTL's new TV camera tube, developed primarily for use in its Picturephone® visual telephone equipment, employs a target structure that is smaller than a nickel, yet contains a square array of more than a quarter-of-a-million silicon photodiodes. The diameter of each photodiode is less than one-quarter the diameter of a human hair.

The main elements of the target structure used in the new TV camera tube are illustrated in Fig. 1. P-type semiconductor islands are diffused into an n-type silicon substrate. The substrate itself is isolated from the electron scanning beam by a silicon dioxide coating. A gold overlay on each p-type island increases the effective beam landing area of the individual photodiodes. Electrical contact to the substrate is pro-

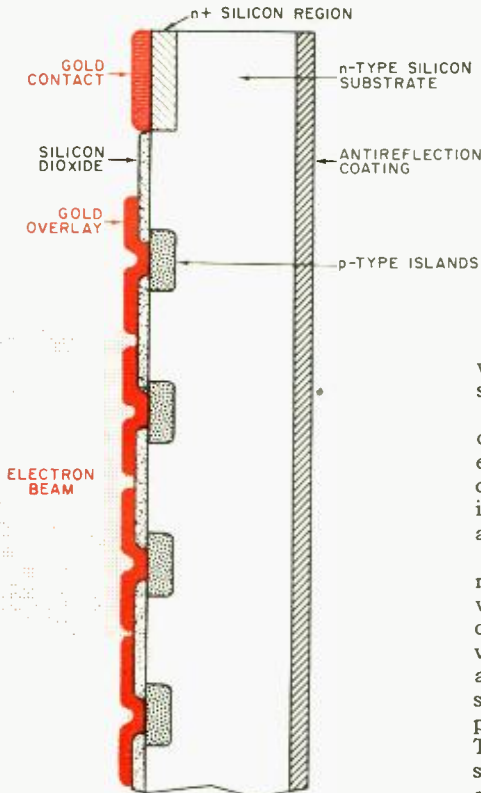
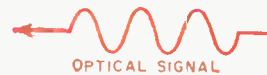

Fig. 1. Hybrid solid-state/vacuum-tube vidicon developed by Bell Labs features a semiconductor mosaic structure which is scanned by an electron beam to provide a video signal. More than 0.25 million silicon photodiodes are formed on a target smaller than a nickel. The tube operates under average light levels.



vided by a small region of heavily doped  $n+$  silicon, coated by a gold contact.

Light reflected by the object scene is focused on the solid-state target structure to effectively change the conductivity of the individual photodiodes. An output video signal is developed when the electron beam scans across these diodes.

Because BTL's new TV camera tube is much more sensitive than presently used vidicon-type tubes, less illumination is required for the scene being televised. The device produces acceptable video signals under average light levels in homes, offices, and similar locations. In addition, the unit has a potential operating lifetime of several years. The new tube, when in full production, should be comparable in price to currently available vidicons.



**Reader's Circuit.** Recognizing the low power requirement and long-operating life of the neon night light, reader Gordon Richmond (1045 Inglewood Ave., West Vancouver, B.C., Canada) decided to build a battery-powered version for camping, fishing and similar outdoor applications. Unfortunately, neon lamps require from 60 to 90 volts for operation, and thus cannot be used in ordinary low-voltage battery applications. To overcome this "high-voltage" requirement, Gordon devised the simple, but effective, night light illustrated in Fig. 2. A transistor ( $Q1$ ) is employed in a simple tickler-feedback type of circuit, and the stepped-up a.c. voltage developed by oscillator action powers the neon lamp ( $I1$ ).

Gordon built his battery-powered night

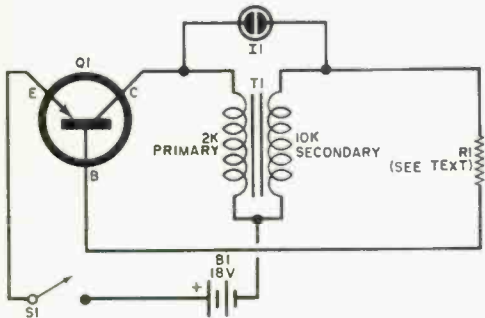

Fig. 2. Reader Gordon Richmond's simple oscillator circuit chops and hikes up the 18-volt d.c. to the more than 60 volts needed to fire the neon lamp.

light using parts salvaged from his "junk box." Transistor  $Q1$  is an International Rectifier TR-04 general-purpose audio unit, and  $T1$  is a small interstage coupling transformer having a 2000-ohm primary and a 10,000-ohm secondary winding. The neon lamp is an NE-2. Resistor  $R1$  is a half-watt, the value of which is determined experimentally; for optimum performance the value should be between 10,000 and 15,000 ohms. Power is supplied by two 9-volt transistor batteries connected in series, and  $S1$  can be any on/off switch.

Neither layout nor wiring is critical, and you can assemble the unit in a small plastic or metal box. To obtain the best value for  $R1$ , start with about 20,000 ohms and work up, until you are able to get the maximum amount of light. If the lamp does not light when  $S1$  is closed, try reversing  $T1$ 's primary or secondary connections (not both).

**Manufacturer's Circuit.** A growing number of experimenters are discovering the advantages of using integrated circuits (IC's), and the 5-to-10 MHz oscillator circuit shown in Fig. 3 should be of value to both students

and experimenters. Employing an MC1550 linear IC amplifier, this circuit is one of several featured in Vol. 4, Issue No. 4, of the "Motorola Monitor" (published by Motorola Semiconductor Products, Inc.). Other circuits described in the same issue include a 60-MHz tuned amplifier, a video amplifier, and a wide-band 45-MHz amplifier.

The components within the dashed enclosure are part of the IC amplifier; the other components are connected externally to provide a customized design. Included are transistors  $Q1$ ,  $Q2$  and  $Q3$ , diode  $D1$ , and resistors  $R1$ ,  $R2$ ,  $R3$  and  $R4$ . The numbered leads help identify connections.

When the IC is operated as a linear amplifier, the input signal is applied to  $Q1$ 's base, while the amplified output signal is obtained from  $Q3$ 's collector. Total circuit gain is proportional to the cascaded gain of  $Q1$  and  $Q3$ . Transistor  $Q2$  provides a.g.c. capabilities, and in this application  $Q1$  functions as a constant-current source with its collector current shared by  $Q2$  and  $Q3$ . Since the gain of a transistor is proportional to its emitter current,  $Q3$ 's gain can be varied by adjusting  $Q2$ 's bias. Voltage-divider  $R1$ - $R2$  determines the bias applied to  $Q2$  and  $Q3$ .

When the IC is used in an oscillator circuit, it functions as a simple regenerative temperature-stabilized high-gain amplifier. Transistor  $Q3$ 's collector load consists of a tuned circuit comprised of  $T1$ 's primary shunted by a tuning capacitor ( $Ct$ ). The feedback necessary to sustain oscillation is obtained from  $T1$ 's secondary winding, which goes to  $Q1$ 's base circuit. Capacitors designated  $C$  serve as bypass devices. Operating power is furnished by  $B1$ , and is controlled by switch  $S1$ .

Except for the IC package, standard components are used. Transformer  $T1$  is a hand-wound r.f. unit with the primary and secondary windings made up of #36 enameled wire wound on a T-12-2 ferrite core. The primary winding has 21 turns, while the secondary winding has 7 turns. Capacitor  $Ct$  is a 170-780 pF variable unit while  $C1$  and all other capacitors ( $C$ ) are 0.1- $\mu$ F disc ceramic types. Load  $RL$  is a half-watt resistor.

The circuit layout and wiring technique followed will depend on the intended application of the completed unit. For general experiments and tests, breadboard construction is preferred. On the other hand, if the completed oscillator is to be used as a signal generator or low-power transmitter, you may want to assemble the circuit in a small metal box or chassis. Regardless of the assembly technique used, good r.f. wiring practice should be followed.

According to Motorola, neither the d.c. supply voltage nor the load resistor ( $RL$ ) values are overly critical. Satisfactory per-

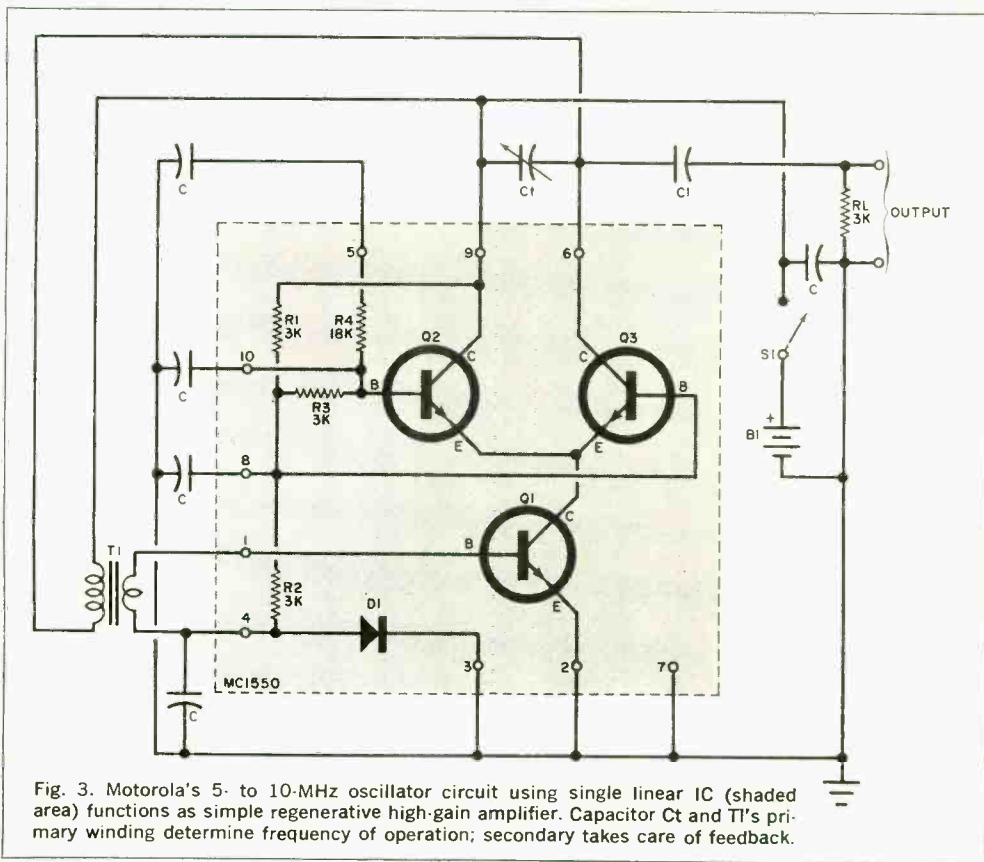

Fig. 3. Motorola's 5- to 10-MHz oscillator circuit using single linear IC (shaded area) functions as simple regenerative high-gain amplifier. Capacitor  $C_t$  and  $T_1$ 's primary winding determine frequency of operation; secondary takes care of feedback.

formance is achieved with load resistances from 1000 to 10,000 ohms and with battery potential ranging from 6.0 to 12.0 volts. Typically, the circuit can supply signals of approximately 9 volts, peak-to-peak, across a 3000-ohm load with a 10-volt d.c. source.

**Product News.** Texas Instruments, Inc. (Dallas, Texas), well known as a semiconductor manufacturer, has now entered the

power systems market with a line of sealed, rechargeable nickel-cadmium batteries and power packs. The new product line will be produced at TI's Control Products plant in Attleboro, Mass.

A unique semiconductor device capable of indicating the position of a light spot on its face through the use of X-Y voltage coordinates, has been introduced by United Detector Technology (P.O. Box 2251, Santa Monica, Calif.). The device, called PIN-SPOT/10, is essentially a sensitive silicon photodetector equipped with five output terminals; the center terminal is common, while each of the two remaining pairs provide X and Y position voltages. A typical PIN-SPOT/10 circuit is illustrated in Fig. 4. Battery  $B_1$ , between the photodetector's center terminal and circuit ground, provides operating power, and resistors  $R_1$ ,  $R_2$ ,  $R_3$ , and  $R_4$  act as output loads. Voltmeters  $M_1$  and  $M_2$  provide indications of the coordinate voltages. The device can be used in test instruments, optical inspection equipment, homing devices, machine control systems, and servo system installations.

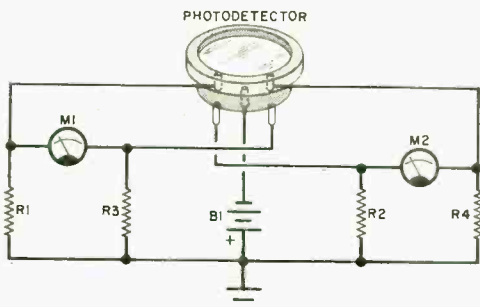

Fig. 4. Photodetector by United Detector Technology can indicate the position of a light spot on its face through the use of X-Y voltage coordinates.

(Continued on page 85)



# ON THE CITIZENS BAND

By MATT P. SPINELLO, KHC2060, CB Editor

**A**T THE HEIGHT of the Citizens Band Radio Jamboree season, when hundreds of two-way radio clubs throughout the United States and Canada sponsor get-togethers in their areas, it seems appropriate to spotlight a CB club that has annually used its jamboree celebration as a vehicle to aid the unfortunate.

The Windy City CB Radio Club, Tullahoma, Tennessee, was first organized by Franklin "Mutt" Ashby and Chuck Reeves, in October, 1962. Membership in those days totaled three. Today the club boasts 50 active participants in all projects undertaken by the club.

Following the club's first jamboree in 1964, a check for \$50 was written from the proceeds and presented to the local cerebral palsy organization. The following year, Windy City CB'ers donated \$500 to the fund from the money accumulated during a jamboree held as a memorial to the late Jim Reeves, a Grand Ole Opry entertainer who

lost his life in an airplane crash in 1964.

Last year Windy City club members drew \$700 from their jamboree proceeds to help pay for a new bus for the cerebral palsy school to transport children back and forth from Coffee, Moore, and Bedford counties, and they also presented the school with a piano. At the 1966 jamboree, the club was lauded by the then Tennessee Governor Frank Clement who stated that he was "proud to be associated with an organization that does such a fine job..." and "... it is good to know that there are people in the world like these who are willing to help those who need it the most."

The Windy City group has been equally active in emergency work. As an assistance group to the Civil Defense agency, the club has helped locate missing persons and to drag lakes in search of drowning victims. As a team attached to the Civil Air Patrol, club members have been on duty during flood emergencies and on missions in search of

## CB JAMBOREE FLASHBACK

Photo below courtesy of Tullahoma News & Guardian. Photo at right, taken by Bob Couch, courtesy of the Tullahoma News.



At the 1966 Windy City CB Radio Club Jamboree, Frank G. Clement, then governor of Tennessee (left, below) proclaimed petite Jackie Robinson queen of the jamboree. Standing next to Jackie is her brother, Marty, waiting to be crowned king. Below, Burl Shelton, past president of the club, looks over toys the group collected for distribution with food and clothing to needy children on Christmas Eve.





crashed aircraft. The group has also sponsored toy and clothing drives for distribution to needy families during the Christmas season.

Last year's Windy City jamboree drew large groups from Huntsville, Nashville, Chattanooga, Birmingham, and Memphis, as well as distant CB'ers from clubs in Arkansas, Kentucky, Texas, and California. If you expect to be within range on September 3-4, and are interested in what makes a veteran CB club "tick," we suggest that you drop in on the Windy City CB Radio Club's 1967 Jamboree to be held Labor Day weekend. The profits will undoubtedly go to a worthy cause. If you'd like the scoop in advance, drop a request in the mail to Mutt Ashby, KDD2134, vice president, WCCBRC, 316 S. Frankline St. (Box 12), Tullahoma, Tennessee. Tell Mutt "Matt sent you."

**HELP Blasted By Michigan CB'ers.** Although the Automobile Manufacturers Association petition for two additional CB channels has been dangling for nearly two years, it was only a few months ago that the Federal Communications Commission solicited comments from interested parties. The AMA petition would add the 27.235- and 27.245-MHz channels to the Citizens Band, to be used exclusively by motorists to request information or assistance en route.

The AMA calls their program HELP (Highway Emergency Locating Plan) and obviously has the support of the automotive industry. However, not everyone is convinced that HELP is all that the AMA says

Current officers of the Windy City club are (left to right): Mutt Ashby, KDD2134, vice president; Charles Haynes, KDD4690, projects officer; Jesse Ledford, KMM2821, president; Mrs. Alberta Ledford, KMM2821, secretary/treasurer; Charles Warren, KDD5140, sergeant at arms; and Clyde Hatchett, KKM1606, in charge of refreshments.



July, 1967

it could be. Some months ago the International Association of Chiefs of Police stated that they saw no good in the HELP program. And in April the Michigan Citizens Band Council and the Citizens Radiophone Association (Michigan) both told the FCC that they believed HELP to be "impractical and inoperable." Chaos and confusion could only result from implementing HELP, according to these clubs. In addition, both clubs recommended that the FCC spend more time correcting the present ills of CB instead of adding hundreds of thousands of new CB stations.

**CB Emergencies.** On an early Sunday morning last March, United REACT, Denver, Colorado, initiated an emergency transmission to alert CB'ers of a missing 16-year-old boy who was possibly suffering from a cerebral hemorrhage. The Rocky Mountain REACT team was notified and units merged to form a major search of the Denver area in conjunction with the Denver Police Department. They were ham-

*(Continued on page 85)*

### 1967 OTCB JAMBOREE CALENDAR

Planning a jamboree, get-together, banquet or picnic? Send the details to: 1967 OTCB Jamboree Calendar, POPULAR ELECTRONICS, One Park Avenue, New York, N.Y. 10016. For more information on the jamborees listed below, contact the clubs or club representatives at the addresses given.

**Tillsonburg, Ont., Canada** July 1-2  
Event: Fourth GRS-CB Campout. Sponsor: South Western General Radio Association. Contact: Gearld Inch, Campout '67 Chairman, 283 Talbot St., St. Thomas, Ont., Canada.

**Painesville, Ohio** July 29-30  
Event: CB Campout and Jamboree. Sponsor: Five Watters of Lake County. Location: Lake County Fairgrounds. Contact: Jamboree, P.O. Box 213, Painesville.

**Melbourne, Fla.** Aug. 4-6  
Event: Fourth Florida National Jamboree. Location: Civic Auditorium. Sponsor: Thunderbird Citizens Band Radio Club, Palm Bay, Fla. Contact: Mel Fender, President, P.O. Box 474, Palm Bay, Fla. 32905.

**Sydney, N.S., Canada** Aug. 19  
Event: Third Annual Nova Scotia CB Jamboree. Sponsor: Cape Breton Citizens Band Radio Club. Contact: Cape Breton CB Radio Club, P.O. Box 471, Sydney.

**Fowlerville, Mich.** Aug. 19-20  
Event: Annual Great Lakes CB Jamboree. Sponsor: Oakland Social C-Bees, Inc. Contact: Ron Hulbert, Jamboree Chairman, P.O. Box 922, Pontiac, Mich. 48056.

**Norwalk, Ohio** Aug. 19-20  
Event: Fifth Annual Weekend for CB'ers Jamboree. Location: Huron County Fairgrounds. Sponsor: Sheriff's Huron County Emergency Net, Inc. Contact: Helen L. Nestor, Publicity Chairman, 24 Townsend Ave., Norwalk 44857

# ELECTRONICS LIBRARY

## PRINCIPLES OF AMPLITUDE MODULATION

Amplitude-modulated AM radio transmission is used in almost every walk of life now, but Citizens Band radio alone accounts for the largest portion of the AM transmitter market. So CB'ers will be particularly interested in this easy-to-read, well-illustrated, simple text (it is directed towards those who have a high school education). Amateur radio operators and experimenters in general should also find this book informative. Material covered includes: types of modulation, heterodyning, bandwidth, basic modulator circuits, plate modulation, AM waves, modulation percentage, modulation systems, and checking modulation.

*Published by TechPress, Inc., Brownsburg, Ind. 46112. 78 pages. Soft cover. \$1.95.*

## DICTIONARY OF RADIO AND TELEVISION

by W. E. Pannett, M.I.E.E.

Although much of the basic information in this volume will be familiar to many of our readers, recent developments in radio-communications have resulted in a great increase in the number of terms likely to be encountered in the field. The author has brought together the well-established terms and the many new ones. Actually, this is more of a pocket encyclopaedia than a dictionary in certain respects: elementary principles are covered briefly but new and complex devices are described in detail where necessary to clarify the underlying principles or mode of operation. Also, the book is spotted throughout with illustrative diagrams. To supplement the "definitions," a list of technical abbreviations is included at the back of the book.

*Published by Philosophical Library Inc., 15 E. 40 St., New York 16, N.Y. 373 (7¼" x 4¾") pages. Hard cover. \$15.00.*

## BASIC MATHEMATICS FOR ELECTRONICS

by Frank L. Juszli, Norman Mahler, James M. Reid

The authors of this text are well qualified to be so—they have a combined experience of 20 years of teaching in technical institutes with particular emphasis on mathematics and electricity. A working knowledge of arithmetic is the only prerequisite to a thorough understanding of the material; no background in electricity is presumed (although an acquaintance with certain electrical fundamentals should be helpful). *Basic Mathematics for Electronics* provides a systematic

approach to the application of algebraic, logarithmic, exponential, and trigonometric functions in the solution of electric circuit problems, and is suitable for study concurrently with most electrical and mathematical courses.

*Published by Prentice-Hall, Inc., Englewood Cliffs, N.J. 07632. 450 pages. Hard cover. \$12.00.*

## 101 WAYS TO USE YOUR VOM AND VTVM, Second Edition

by Robert G. Middleton

In addition to explaining and illustrating the many possible uses of the versatile VOM and VTVM, this book presents procedures and tests for checking the accuracy of the equipment itself. In this new edition, the meter circuitry explanations have been expanded to show various means of protection against overload damage, and calibration procedures are detailed more extensively. Frequency-compensated multipliers in a.c. VTVM's are discussed and illustrated. Also, since semiconductor testing has become more important since this book was first released in 1959, this topic has been given greater coverage. Finally, the making of decibel measurements is thoroughly delineated.

*Published by Howard W. Sams & Co., Inc., 4300 West 62 St., Indianapolis, Ind. 46206. Soft cover. 144 pages. \$2.95.*

## FUNDAMENTALS OF VACUUM-TUBE AMPLIFIERS

While the basic fundamentals of all types of modern vacuum-tube amplifiers and circuitry are thoroughly covered in this book, the emphasis is on audio amplifiers. The four classes of audio amplifiers (A, AB, B, and C) are treated in detail, and there is a special section on decibels and their use in audio equipment. The book is a condensation of one of the U.S. Navy Training Manuals in the "Fundamentals of Electronics" series.

*Published by TechPress, Inc., Brownsburg, Ind. 46112. 305 pages. Soft cover. \$3.95.*

## RCA SILICON POWER CIRCUITS MANUAL, SP-50

Despite the fact that SP-50 is intended primarily for designers of solid-state power circuits, much of the information contained in it will be of use to students and hobbyists interested in solid-state electronics. The manual should answer just about every question that might arise concerning such silicon power devices as transistors, diodes, SCR's, etc. And it is profusely illustrated with graphs and useful circuits. Anyone who has occasion to use power transistors and diodes will find SP-50 valuable as a reference source for design hints and for a quick brushup on theory.

*Published by Electronic Components and Devices, Radio Corporation of America, Harrison, N.J. Soft cover. 416 pages. \$2.00.* —50—

# Build your own motor speed control with RCA experimenter kits

**Control Motors With Name Plate Ratings Up to 6 Amperes.  
Available from Your RCA Distributor**

Now, using two RCA Silicon Controlled Rectifier Experimenter Kits (KD2105) together with additional passive components, you can build a motor speed control for ac/dc universal motors (series wound) with name plate ratings up to 6 amperes.

RCA's twin-kit circuits offer you flexibility in that you may control any one of many individual tools or appliances such as half-inch power drills, jigsaws, buffers, floor polishers, and mixers.

The RCA Experimenter Twin-Kits are part of a complete program fully explained and illustrated in the new 136-page Experimenter's Manual KM-71 on sale at your RCA Distributor. In it you'll find detailed information on more than 24 different and useful circuits you can build including 6- and 12-Volt battery chargers, lamp dimmers, audio frequency operated switches, and heat and light-operated switches.

Check with your RCA Distributor on RCA Experimenter's Kits. Select the kit or kits for the solid-state circuits you have in mind. Do it today.



Technical Series KM-71

RCA Electronic Components and Devices, Harrison, N.J. 07029



**The Most Trusted Name in Electronics**

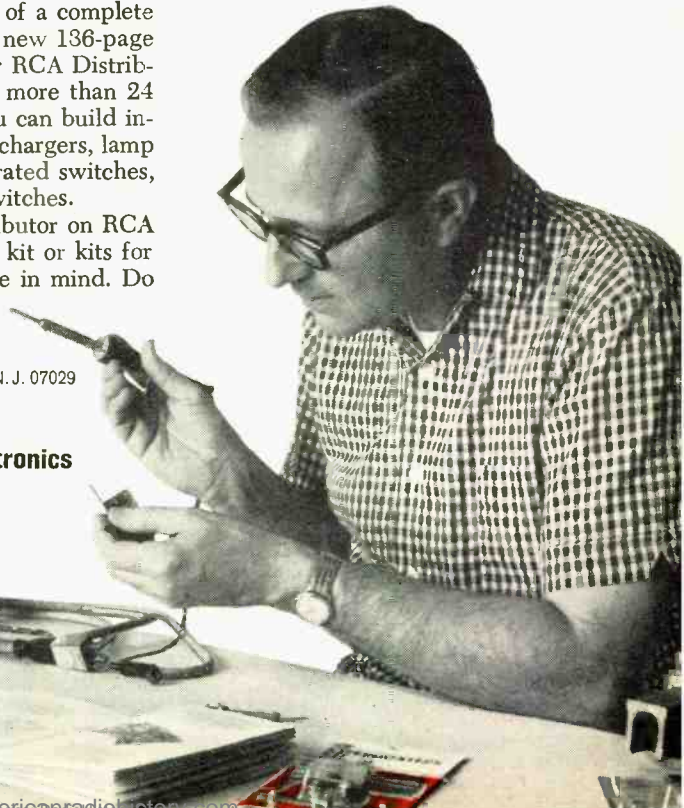
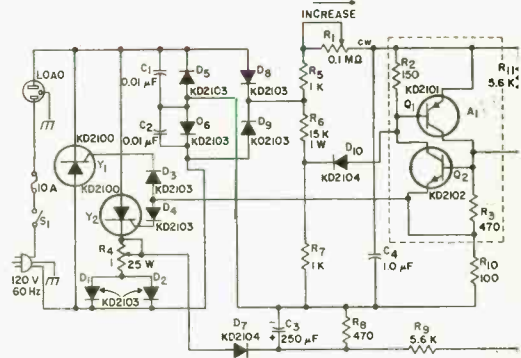



# GET MORE ACTION WITH

**MULTI-ELMAC  
PRECISION MADE,  
POPULAR PRICED  
CB UNITS!**

**\* CITI-FONE SS \$16950**

**FULL  
23 CHANNEL**

AC-DC Operation,  
Illuminated Meter  
& Channel Selector,  
Triple Tuned RF,  
"Noise Immune"  
Squelch, Double  
Tuned IF's, Ready to Operate



**\* CITI-FONE 99 \$9950**

**FULL  
8 CHANNEL**

AC-DC Operation,  
Delayed AVC,  
Electronic Switching,  
2 Stage Pre-Amp  
Illuminated "S"  
Meter, Complete  
with Crystal for 1 Channel



**\* CITI-FONE II \$4995**

**SOLID STATE  
Transmitter-Converter**

Compact 5 3/4 x  
4 3/8 x 1 1/2, 9  
Transistor, 2  
Diodes, 5 Watt  
Input (PCC Max.)  
100% Modulation, 12 VDC  
Operation. Complete with Crystal for  
1 Channel



Please send further information on Citi-Fone SS , 99 , II

**MULTI-ELMAC CO.**

21470 Coolidge • Oak Park, Michigan 48237

NAME \_\_\_\_\_

ADDRESS \_\_\_\_\_

CITY \_\_\_\_\_

STATE \_\_\_\_\_ ZONE \_\_\_\_\_

**CIRCLE NO. 19 ON READER SERVICE PAGE**

## TIPS

(Continued from page 16)

able, you can drive a nail or sheet metal screw into each cell-connecting strap. These straps are usually about 1/8" below the surface of the pitch covering the top of the battery. If in doubt about the exact location of a strap, scrape some of the pitch away; do not employ excessive force or hammer blows, and watch out for acid splatter. You can use any cell or

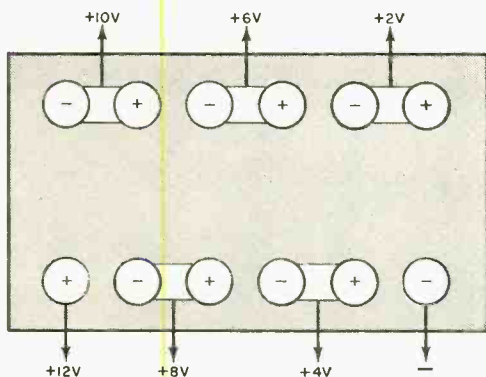

any combination of cells to achieve the desired voltage. You can even use a battery with a dead cell that is no longer suitable for car use—just avoid the dead cell in your hookup. Of course, you can recharge the battery as needed.

—Vincent F. Allen

## MAKE-IT-YOURSELF PHONE JACK FROM SCRAP PARTS

For those who like to home-brew everything for a project, here's a simple and reliable phone jack that can be added to the list. It's made from a short length of threaded iron or brass pipe, a pair of hex nuts, and a length of springy brass. The actual length of the threaded pipe depends on the thickness of the panel on which the jack is to be mounted; the thicker the panel, the longer the pipe (about 3/4" long for a 1/4"-thick panel). After the pipe is cut, secure it to the panel with the hex nuts as shown in the photo. Solder hookup wire directly to the pipe, or to a solder lug placed under the hex nut. Now bend a 3/8" wide by 2"-long (approx.) piece of springy brass strip as shown, and

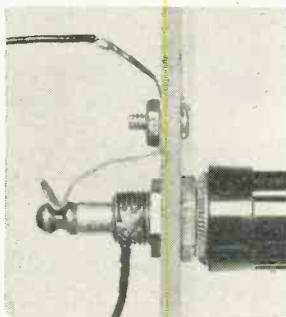

drill a hole in it for mounting on the panel. Then solder another piece of wire to the brass strip. If you mount the newly made jack on a metal panel, be sure to insulate the brass strip from the chassis by using one extruded and one flat fiber washer.

—Art Trauffer

# NOW: PACE 2-WAY RADIO IN YOUR \$ 69<sup>95</sup> CAR



USE THE NEW PACE "AUTOMATE" ALL SOLID STATE 5-WATT TRANSMITTER to call for help when you're in trouble • Receive messages over your AM car radio . . . and get assistance in a hurry • Communicate up to 10 miles even on a weak battery • Just flip on the transmitter switch, tune your car radio to 1505, pick up the microphone, and make a call • Takes no more current than an electric clock • 12 channels available for business or personal use • Write for complete information and the name of your nearest PACE dealer.

**((p)) PACE**

**COMMUNICATIONS CORP.**

24049 Frampton Ave., Harbor City, Calif. 90710

Export Div.: 64-14 Woodside Ave., Woodside, N.Y.  
Also available in Canada

**CIRCLE NO. 21 ON READER SERVICE PAGE**

July, 1967

# NEW

mobile  
performance  
hand-held  
convenience

incomparable  
**PACE**  
quality



3-channel transmit/  
receive • 2-watt  
output • 18 silicon  
transistors  
• double  
conversion  
receiver  
• automatic  
noise  
limiter  
and squelch  
• for mobile  
and portable  
use • only  
\$99.95 complete  
with antenna and  
battery. Write  
for information.

**PACE-MATE** CB transceiver

**((p)) PACE**

**COMMUNICATIONS CORP.**

24049 Frampton Ave., Harbor City, Calif. 90710

Export Div.: 64-14 Woodside Ave., Woodside, N.Y.  
Also available in Canada

**CIRCLE NO. 29 ON READER SERVICE PAGE**

83

# NEW LITERATURE

To obtain a copy of any of the catalogs or leaflets described below, simply fill in and mail the coupon on page 15.

"Goof-proof" single-post-type soldering guns are featured in a 4-page, 4-color catalog by *Wen Products, Inc.* Described and illustrated are the "slim-line" long-reaching Model 75 "pistol" for beginners (25-100 watts); the Model 222 "Hot-Rod" medium-range gun for the home craftsman (25-200 watts); and the Model 450 heavy-duty gun (25-450 watts). All three guns have a built-in working spotlight and a trigger switch for instant heating.

Circle No. 85 on Reader Service Page 15

New items in *Edmund Scientific's* Catalog 674, their 25th anniversary issue, include nickel-cadmium cells, polarizing material for experimental purposes, a 16' weather balloon, color filter sheets, and an electrical engraving pencil. There are more than 3800 items in all. This catalog is free to industrial purchasing agents who request it on a company letterhead.

Circle No. 86 on Reader Service Page 15

"What Is An Electronic Organ" is the title of a booklet published by the *Schober Organ Corporation* which explains, in nontechnical terms, what the many parts and controls of an organ are for and how they are used by the player. Photographs are keyed to the text, and a glossary of organ terms is included. Twenty-five cents.

Circle No. 87 on Reader Service Page 15

## THE "BEACHCOMBER"

(Continued from page 32)

**Operating Notes.** Do not attempt to use the Beachcomber with the two oscillators operating at zero beat (the same frequency). This will reduce sensitivity by about half, due to the slight locking action caused by stray coupling. If you note any sudden changes in pitch when the search coil bumps the ground or vegetation, check the wiring and loop mounting for loose parts. Any movement of parts or wire, inside or outside, on or near the search coil can cause changes

*World Radio Laboratories* is putting out a "first of its kind" Citizens Band catalog. Said to be one of the most complete catalogs for CB'ers that has ever been assembled, it features "everything" in equipment and accessories. Multi-color.

Circle No. 88 on Reader Service Page 15

A "Special Product Technical Bulletin," CVT-104, entitled "Small Automatic Voltage Regulating Transformers," has been published by the *Central Transformer Company*. These regulators are now available with power ratings as low as 1.0 VA (to as high as 5 kVA) and can be designed to solve specific problems.

Circle No. 89 on Reader Service Page 15

Some 200 electronic kits and factory-assembled instruments are featured in *EICO's* 1967 36-page catalog. Completely new in this edition are the "Cortina" solid-state stereo amplifier and tuner; #888 universal engine analyzer; "Nova-23" solid-state CB transceiver; and *EICOCRAFT* solid-state electronic kits.

Circle No. 90 on Reader Service Page 15

Described in the 52-page 1967 *Mallory Distributor Products Company* catalog are more than 1400 precision electronic components: batteries and flashlights, capacitors, controls, jacks and plugs, semiconductors, switches and circuit breakers, timers and vibrators. Performance charts and product diagrams are included.

Circle No. 91 on Reader Service Page 15

Issue Number 43 of "MICRO Tips," published by *MICRO SWITCH*, a division of Honeywell, describes eight cost-saving ideas in unique applications of various types of switching mechanisms. A form is provided for the reader to present an idea of his own and submit it for possible publication in future issues.

Circle No. 92 on Reader Service Page 15

in pitch. The better the construction, the more reliable the indications.

If you are primarily interested in smaller objects, coins—for instance, you can make the detector more sensitive by using a smaller-diameter search coil. A 4" loop will work nicely. The only change necessary is to add two turns to the search loop coil. Keep in mind that the smaller loop will not penetrate as deeply as a larger one.

If you are interested in finding larger objects at a greater depth than the Beachcomber's maximum range, you might look into the deep-searching metal locator described in the January 1967 issue of *POPULAR ELECTRONICS*. —30—



## ON THE CITIZENS BAND

(Continued from page 79)

pered by the extensive amount of territory that had to be covered, and by the limited use of two-way communications due to skip conditions. But finally, after some 15 hours, the boy was found and rushed to the Colorado General Hospital by his family for immediate treatment. The Rocky Mountain group and United REACT have extended their thanks to the following units for their unlimited participation: Rocky Mountain Rangers; St. Anthony's Emergency Unit; Denver Metro Auxiliary REACT; and all independent CB'ers from the Metro area who took part in the search.

Most people in the Chicago area would like to forget about the big snow that all but crippled the "Windy City" last winter. But Kenneth Shirk, KLK1186, will not forget the blizzard too soon. Ken was stranded for 12 hours while on his way home from his office at radio station WIND, Chicago. When he became bogged down in heavy snowdrifts, he kept the car motor and heater running until the gas supply gave out. His CB call for help was relayed from Willard Sutton, KPJ1052, in Aetna, to Chet

Haas, KPJ1989, in East Gary, Indiana. Haas and his three grandsons, equipped with toboggan, eventually rescued Shirk—who then became a house guest at the Haas home until the worst of the storm was over.

I'll CB'ing you!

—Matt, KHC2060

## SOLID STATE

(Continued from page 77)

A complementary unijunction transistor made in IC form is now being produced by General Electric's Semiconductor Products Department. Identified as CU-5K1, the new UJT is fabricated with a *p*-type rather than a conventional *n*-type emitter junction, and thus requires d.c. operating voltages of a polarity opposite to that employed by the more familiar types. In addition to its reverse d.c. biasing characteristics, the device has much better temperature stability than *n*-type units, and boasts an accuracy of  $\pm 5\%$  when used as an oscillator.

**Transitips.** When you are troubleshooting a multistage receiver or amplifier, the signal  
(Continued on page 90)

**NEW** Advanced  
Marine Antenna  
For **CB Radio**  
**CHANNELCAT**

IL 6307 R

Mosley the World's leading manufacturer of Quality communication antennas introduces a New Advanced CB Marine Antenna . . . **THE CHANNEL CAT** . . . another Mosley first!

#### DELUXE FEATURES:

- No ground required
- Advanced fold-over device
- Portable — for ship-or-shore
- Superior performance even on wood and fiberglass
- Stainless steel whip section
- Salt-water protected

Get all the facts! Send for FREE brochure. Write Dept. 136 . . .

Mosley Electronics Inc.  
4610 N. Lindbergh Blvd.  
Bridgeport Mo. 63042

**Mosley Electronics Inc.**

# Join "THE TROUBLESHOOTERS"

They get paid top salaries  
for keeping today's  
electronic world running

Suddenly the whole world is going electronic! And behind the microwave towers, push-button phones, computers, mobile radio, television equipment, guided missiles, etc., stand **THE TROUBLESHOOTERS**—the men needed to inspect, install, and service these modern miracles. They enjoy their work, and get well paid for it. Here's how you can join their privileged ranks—without having to quit your job or go to college in order to get the necessary training.



**J**UST THINK HOW MUCH in demand you would be if you could prevent a TV station from going off the air by repairing a transmitter...keep a whole assembly line moving by fixing automated production controls...prevent a bank, an airline, or your government from making serious mistakes by repairing a computer.

Today, whole industries depend on electronics. When breakdowns or emergencies occur, someone has got to move in, take over, and keep things running. That calls for one of a new breed of technicians—The Troubleshooters.

Because they prevent expensive mistakes or delays, they get top pay—and a title to match. At Xerox and Philco, they're called Technical Representatives. At IBM they're Customer Engineers. In radio or TV, they're the Broadcast Engineers.

What do you need to break into the ranks of The Troubleshooters? You might think you need a college diploma, but you don't. What you need is know-how—the kind a good TV service technician has—only lots more.

### Think With Your Head, Not Your Hands

The service technician, you see, "thinks with his hands." He learns his trade by taking apart and putting together, and often can only fix things he's already familiar with.

But as one of The Troubleshooters, you may be called upon to service complicated equipment that you've never seen before or *can't* take apart. This means you have to be able to take things apart "in your head." You have to know enough electronics to understand the engineering specs, read the wiring diagrams, and calculate how a circuit should test at any given point.

Now learning all this can be much simpler than you think. In fact, you can master it without setting foot in a classroom and without giving up your job!

### AUTO-PROGRAMMED™ Lessons Show You How

For over 30 years, the Cleveland Institute of Electronics has specialized in teaching electronics at home. We've developed special techniques that make learning easy, even if you've had trouble studying before.

For one thing, our AUTO-PROGRAMMED™ lessons build your knowledge as you'd build a brick wall—one brick at a time. Each piece rests securely on the one that came before it.

#### ENROLL UNDER NEW G.I. BILL

All CIE courses are available under the new G.I. Bill. If you served on active duty since January 31, 1955, or are in service now, check box on reply card for G.I. Bill information.

In addition, our instruction is personal. When your teacher goes over your assignment, no one else competes for his attention. You are the only person in his class. He not only grades your work, he analyzes it to make sure you are thinking correctly. And he returns it the day it's received so that you can read his comments and corrections while everything is fresh in your mind.

### Always Up-To-Date

To keep up with the latest developments, our courses are constantly being revised. This year CIE students are getting new lessons in Laser Theory and Application, Microminiaturization, Single Sideband Techniques, Pulse Theory and Application, and Boolean Algebra.

In addition, there is complete material on the latest troubleshooting techniques including Tandem System, Localizing through Bracketing, Equal Likelihood and Half-Split Division, and In-circuit Transistor Checking. There are special lessons on servicing two-way mobile equipment, a lucrative field in which many of our students have set up their own businesses.

### Your FCC License—or Your Money Back!

Two-way mobile work and many other types of troubleshooting call for a Government FCC License, and our training is designed to get it for you. But even if your work doesn't require a license, it's a good idea to get one. Your FCC License will be accepted anywhere as proof of good electronics training.

And no wonder. The licensing exam is so tough that two out of three non-CIE men who take it fail. But CIE training is so effective that 9 out of 10 of our graduates pass. That's why we can offer this warranty with confidence: *If you complete one of our license preparation courses, you'll get your license—or your money back.*

### Mail Card for 2 Free Books

Want to know more? Mail the postage-paid reply card bound here. We'll send our 40-page catalog describing our courses and the latest opportunities in Electronics. We'll also send a special book on how to get a Commercial FCC License. Both are free. If the card is missing, just send us your name and address.



# CIE

**Cleveland Institute of Electronics**

1776 E. 17th St., Dept. PE-56, Cleveland, Ohio 44114

Accredited Member National Home Study Council  
A Leader in Electronics Training... Since 1934



CIRCLE NO. 7 ON READER SERVICE PAGE



# POPULAR ELECTRONICS SUBSCRIBER SERVICE

Please include an address label when writing about your subscription to help us serve you promptly. Write to: Portland Place, Boulder, Colo. 80302

### Change of Address:

Please let us know you are moving at least 4 weeks in advance. Affix magazine address label in space to the right and print new address below. If you have a question about your subscription, attach address label to your letter.

### To Subscribe:

Check boxes below.

- New     Renewal  
 5 years \$20  
 3 years \$13  
 1 year \$5

### Specify

- Payment enclosed  
 —You get 1 extra issue per year as a Bonus!  
 Bill me later.

AFFIX LABEL

If you have no label handy, print OLD address here.

state	city	address	name	please print
zip-code				

Add'l postage: \$1 per year outside U.S., its possessions & Canada.

name please print 0216

---

address

---

city

---

state zip-code

Let **COYNE** Train You  
**AT HOME**  
 for Big Pay in  NOT FOR PROFIT Est. 1899

**TELEVISION** **RADIO**  
**COLOR TV**

### MAIL COUPON FOR FREE BOOK

Coyne Electronics Institute Dept. B7-C2  
 1501 W. Congress Pkwy., Chicago, Ill. 60607  
 Send FREE Book showing how I can get Coyne Quality Home Training in TV-Radio at Low Cost on Easy Terms.

Name.....  
 Address.....  
 City..... State..... Zip.....  
 Phone..... Age.....

Put X here if interested in Resident School for Associate Degree in Electronics Engineering and Technology, or shorter courses in Electricity, Radio-TV, Electronics. Approved GI Bill. Spare time employment and tuition payment plans available.

injection test technique is one of the fastest and simplest methods to use. All you need is one of the many solid-state "buzzers" now on the market which produce a harmonically rich audio signal capable of penetrating audio, i.f., and r.f. stages.

The procedure calls for applying a test signal successively to various parts of the receiver or amplifier under test, and then picking up the signal at another point. Generally, you should start at the output stage and work back to the input (or antenna, in the case of a receiver).

An output signal (a buzz or tone) should be heard in the speaker at each test point. When no output signal is obtained, the trouble has been isolated to the stage being checked. Further tests can then be made in that stage to isolate the faulty component, using an ohmmeter or voltmeter, or both.

That's it for now.

—Lou

## QUIZ ANSWERS

(Quiz appears on page 46)

- 1—F The first practical industrial dynamo was built by Zenobe Theophile Gramme of BELGIUM in 1876.
- 2—J The wire recorder was invented by Valdemar Poulsen of DENMARK in 1898.
- 3—B The principle of the transformer was discovered by Michael Faraday of ENGLAND in 1831.
- 4—I The piezoelectric effect in crystals was discovered by Pierre and Jacques Curie of FRANCE in 1880.
- 5—D The X-ray tube was invented by Wilhelm Conrad Roentgen of GERMANY in 1895.
- 6—G The Leyden jar, forerunner of the modern capacitor, was discovered by Pieter Van Musschenbroek of HOLLAND in 1746.
- 7—A The so-called voltaic pile, the earliest battery known, was invented by Count Alessandro Volta of ITALY in 1800.
- 8—H The "Yagi" antenna was invented by Hidetsu Yagi of JAPAN in the early 1900's.
- 9—C The first electronic television device was actually developed by Boris Lvovitch of RUSSIA in 1907.
- 10—E The radio telescope was invented by Karl Janski of the UNITED STATES in 1933.

## AMATEUR RADIO

(Continued from page 73)

station being called, followed by those of the caller (e.g., WA2HDQ de W9EGQ). DX men frequently delete the call of the DX station and simply rattle out, "de W9EGQ de W9EGQ." The new rule—in Docket 17377—would require full calls only at the end of an established contact.

However, RTTY men would have to sign more frequently, and mobiles would be allowed to delete present designators or location descriptions.

**Humorous Certificate Available.** If you would like to dress up your radio shack with a humorous 8½" x 11" green-bordered certificate, the Rockaway Amateur Radio Club, P.O. Box 205, Rockaway Park, N.Y. 11695, will mail you one if you send the club 25 cents—no stamps. The certificate is entitled "Notice to All Visitors," and answers facetiously various questions a non-amateur might be inclined to ask an amateur. It will not improve your position in the certificate race, but should act as a conversation piece in the shack.

The Rockaway Amateur Radio Club also has a small booklet on TVI filters which it will send to anyone who asks for it. If you want *only* the booklet, include a stamped, self-addressed envelope with your request.

### NEWS AND VIEWS

**Ted Rockwell, WA5RFH/4**, Box 1151, Station B, Vanderbilt University, Nashville, Tenn., was a Novice at nine, but with moving, and one thing or another, it was 10 years before he went for his General. With a Heathkit "Comanche" and "Cheyenne," transmitter-receiver twins, Ted has worked 18 states, mostly on CW on 15 and 20 meters; he likes CW better than phone. Living in a college dorm introduced antenna problems, which he solved with a 57-inch "Vacationeer" vertical on the roof of the dorm . . . **Mike Martz, WA8RQA**, 808

Foraker Ave., Sidney, Ohio, in nine months as a Novice and six months as a General has worked 41 states and eight foreign countries on 40-meter CW. His equipment consists of a Hallicrafters HT-40 transmitter and a S-108 receiver, plus a Hy-Gain 18V vertical antenna about 40' high . . . **Vadim, UA6PE1A**, Novoherkask-30, G.P.O. Poste Restante, Rostov Region, Ignatov V. A., U.S.S.R., is trying to figure out how to earn a "Witches Certificate" (described in the September, 1966, column) by working Pauline, WA9CNV, Yolanda WA9CCP, and Roberta, K9IVG, on CW. As Vadim is an SWL, and one of the girls has never worked a DX station, and another one doesn't own a telegraph key, he has set himself a real goal!

**Chuck Hallett, WA7EGZ**, 1609 East Turney, Phoenix, Ariz., feels that many Novices and Generals overlook the DX possibilities of the 40-meter band. As evidence, he listed 22 countries he has worked on 40 meters, half of them in the Novice band. Among the countries on the list were China, Korea, Russia, and Finland. Chuck runs 150 watts to a Heathkit DX-100 transmitter and receives on a Hallicrafters SX-140. He didn't mention what kind of an antenna he uses . . . **Doug Tabor, WN7GFB**, 1964 John St., Layton, Utah, runs 50 watts to a Gonset "Commander" transmitter feeding either a dipole antenna or an oversized inverted-V antenna and a Lafayette KT-340 receiver. He will sked anyone needing Utah on weekends on any of the three lower frequency Novice bands. As he expects to be signing a WA7 call by the time you read these words, he may even sked outside the Novice bands. Doug has 27 states worked himself . . . **Jim Andrews, WN8UYP**, 4240 Otis Dr., Dayton, Ohio, goes on 40 meters with a Heathkit DX-35 transmitter feeding a 32' antenna and a Heathkit HR-20 receiver; he has a total of 20 states worked. On 2 meters, Jim ionizes the atmosphere with a Heathkit "Twoer" exciting a halo antenna, and has made 21 contacts so far.

**Richard D. Landis, WA3FVE**, 36 Wartman Rd., Graterford, Pa., worked 18 states on 80 meters as a Novice with his Johnson "Ranger" transmitter and a National NC-109 receiver. Then he passed his General Class exam, bought a National NC-303, and an Astatic D-104 microphone. Now he has 49 states and 15 countries worked. He is usually on 75-meter phone in the daytime and 10-meter phone late evenings. But Dick must have plans, because he has a tri-band beam on the way up to supplement 75-, and 40-meter dipoles and a 10-meter ground plane antenna. He'll tape-record your signal for you on request . . . **Charles Rankin, WA2HMM**, 11 Palm Lane, Westbury, L.I., N.Y., who got out of the Army last August, has been working 20-meter phone with a Heathkit HW-32 SSE transceiver driving a pair of 843's and a Mosley TA-33 tribander. Since then, he has 70 countries and 47 states—all confirmed . . . **Robert L. Nichols**,

# Sonar SENTRY VHF MONITOR RECEIVERS

\$39<sup>95</sup>

With Battery, Earphone, & Carrying strap less Crystals \$5.00 ea.

Model	FR-103	FR-106	AR-107
	25-175 MHz	25-50 MHz	Aircraft 108-136 MHz

LISTEN TO: POLICE, FIRE, AIRCRAFT & WEATHER REPORTS!

for Industrial, Commercial, Utility & Govt. Use

2 CHANNELS • BROADCAST BAND • CRYSTAL CONTROLLED

Designed and engineered for simplicity of operation. Compact enough to fit a shirt pocket yet powerful enough to deliver a clear clean signal—it's dependable • Operates on two crystal controlled VHF channels plus broadcast band • Completely solid state for long life use • Visible battery indicator to show battery condition at all times • Built in antenna • 5/8" H x 2 1/2" W x 1 1/16" D. Wt. 11 oz.

SONAR RADIO CORP., 73 Wortman Ave., Bklyn, N.Y. 11207

Please send information on VHF Monitor Receivers.

Name \_\_\_\_\_ Dept. 549

Address \_\_\_\_\_

City \_\_\_\_\_ State \_\_\_\_\_

CIRCLE NO. 24 ON READER SERVICE PAGE

**WN4DWI**, 873 Norview Ave., Norfolk, Va., learned the code the hard way. He was in the Naval hospital with pneumonia and finally buckled down to studying the code through sheer boredom. It is hard to keep up with exactly what equipment he has in the shack from day to day, but he seems to be using a Hammarlund HQ-100-AC receiver, Hallicrafters HT-40K or EICO 720K transmitter, and a Hy-Gain 14-AVQ vertical antenna at present. Bob has 37 states and six countries to show for his efforts, with most of the DX worked on 15 meters. His General ticket is on the way.

**Arthur J. Arruda, Jr.**, **WA1GOV**, 63 Gifford Ave., North Dartmouth, Mass., uses both a transmitter and a receiver older than most of our readers. The transmitter is a Stanco 100-MB running 80 watts, and the receiver is a Hallicrafters "Sky Challenger." His antenna is a 40-meter dipole, 25' high. With the combination, Art has worked 36 states and 16 countries, all on 40-meter CW, although he does work some AM phone . . . **Thomas W. Byers**, **WA4TMC**, 3232 Wickersham Ct., Orlando, Fla., and his Dad, **WA4FKA**, share the same ham shack. Using AM, CW, and SSB on 80 through 2 meters, Tom has worked 45 states and all continents. His main gear consists of a Heathkit HX-10 transmitter, a Hallicrafters SX-115 receiver, and a 3-band beam which he uses on the lower frequencies. He didn't mention what he uses on 2-meter SSB, but a Heathkit "Twoer" takes care of AM.

Remember that the first step toward representation in "News and Views" is sending us a letter. Include a clear picture of yourself at the operating position, if you have one. Thanks for forwarding your club bulletins, and keep us informed about your code and theory classes. Address all mail to: Herb S. Brier, **W9EGQ**, Amateur Radio Editor, POPULAR ELECTRONICS, P. O. Box 678, Gary, Ind. 46401.

73, Herb, **W9EGQ**

## SHORT-WAVE LISTENING

(Continued from page 67)

for it on 7410 or 8333 kHz with talks in Portuguese around 2340-2352 s/off.

The *Voice of the People of Thailand* is being heard by West Coast monitors on 9425 kHz from 1430 s/on to 1600 s/off in Thai. This station employs an interval signal consisting of high-pitched chimes.

Also from the West Coast comes word of a Vietnamese clandestine station operating on 9433 kHz from 1400 s/on to 1545-1550 s/off. Instrumental Vietnamese folk music is used as their interval signal, and is also played periodically throughout the program. They may also use an interval signal consisting of a drum and cymbals. There is a news program at the beginning of the broadcast, and towards the end of the period they provide announcements at dictation speed.

### CURRENT STATION REPORTS

The following is a resume of current reports. At time of compilation all reports are as accurate as possible, but stations may change frequency and/or schedule with little or no advance notice. All times shown are Greenwich Mean Time (GMT) and the 24-hour system is used. Reports should be sent to **SHORT-WAVE LISTENING**, P.O. Box 333,

Squires  Sanders



23'er... THE famous TRANSCEIVER

FAMOUS for quality . . . for clear, long range communications on any of the 23 CB channels (twenty or thirty miles is a snap!). The exclusive Squires-Sanders Noise Silencer makes the 23'er a standout also . . . kills the other fellow's ignition noise as well as your own. You, too, can become famous . . . with a 23'er . . . for just \$235.

See your dealer for details or write today to **SQUIRES-SANDERS, INC.**, Box 319a, Millington, N. J. 07946  
CIRCLE NO. 25 ON READER SERVICE PAGE



### SHORT-WAVE ABBREVIATIONS

anmt—Announcement	QRM—Station interference
BBC—British Broadcasting Corporation	QSL—Verification
B/C—Broadcasting	R.—Radio
Eng.—English	s/off—Sign-off
ID—Identification	s/on—Sign-on
IS—Interval signal	V.—Voice
kHz—kilohertz	VOA—Voice of America
kW—kilowatts	xmsn—Transmission
N.A.—North America	xmtr—Transmitter

Cherry Hill, N.J., 08034, in time to reach your Short-Wave Editor by the fifth of each month; be sure to include your WPE identification, and the make and model number of your receiver.

**Bolivia**—DX'ers who need this country should try for either of these relatively easy to log stations: CP75. R. *La Cruz del Sur*, La Paz, 4985 kHz, from before 0200 to s/off with an Eng. ID just after 0240; or CP38. R. *Altiplano*, La Paz, 5045 kHz, at 0130-0500 with local music, some with French lyrics, commercials, and time checks. Reports indicate that CP38 is the easier one of the two to log.

**Cambodia**—*Radiodiffusion Nationale Khmère*, Phnom-Penh, is noted in the West on 6090 kHz around 1500 in Cambodian with both male and female speakers. Reports should go to 28 Avenue Preah, Mohaksatryany Kossomak, Phnom-Penh.

**Colombia**—Station HJZP, Bogota, is being logged on 15.330 kHz at 0305-0333 with talks, information bulletins, and operatic music, all in Spanish. This R. *Nacional* station has listed parallel frequencies of 3290 (HJAB); 4955 (HJCQ); 6030 (HJZJ); 6180 (HJWT); 9635 (HJZM); 11,795 (HJZN); 11,825 (HJZO); 17,865 (HJZQ); 21,510 (HJZR); and 25,750 kHz (HJZS). Has anyone logged any of the latter three?

**Czechoslovakia**—Prague has been noted on a new frequency of 21.740 kHz at 1530 with Eng. news in the African Service; this was followed by a commentary and music until past 1600. Two more-often logged channels are 7345 kHz at 0100-0155 and 7115 kHz at 0330-0425, both directed to N. A. and in English.

**Egypt**—A new frequency for Cairo is 12,005 kHz, replacing 11,965 kHz; a German xmsn was heard at 2145, and Eng. from 2200-2230 with news at 2210. Another outlet, on 11,915 kHz, is noted at 0415-0630 in Arabic, and 0630-0700 with Eng. dictation-speed news; listen for a clock to strike 16 times at 0600. The generally reliable 9475-kHz channel is good from 0131 to 0158 in Eng. with Arab-type music; a newscast is given at 0147.

**England**—The BBC World Service to N.A. is now on 15,260 kHz (2115-0030); 11,780 kHz (2115-0330); 9580 kHz (2245-0000); and 6110 kHz (0000-0330). News is given at 2200, 2300, 0000, 0200, and 0300.

**Formosa**—*Voice of Free China*, Taipei, is carrying Eng. to N. A. at 0250-0350 on BED7 (7130 kHz); BED69 (11,825 kHz); BED60 (15,125 kHz); BED49 (15,345 kHz); BED39 (17,720 kHz); BED52 (17,775 kHz replacing 17,780 kHz); and BED40 (17,890 kHz).

**Guatemala**—Evening (local time) reception of medium-wave station TGJ, Guatemala City, 880 kHz, has been reported by numerous readers in the South, Southwest, and West. DX'ers in the East will generally find WCBS, New York, on this channel; those in the Southeast may encounter QRM from one or more Cuban stations.

**Guyana**—R. *Demerara* has Eng. commercial programs on 5980 kHz, as noted with a poor-to-fair signal around 0930. This country was formerly known as British Guiana.

**Hawaii**—Our 50th state is needed by many DX'ers. Tune for KORL, Honolulu, 10 kW, on 650 kHz during the 0700-1000 silent period of WSM, Nashville, Tenn. This station carries the "Top Forty Rock & Roll" format.

July, 1967

# CHARTERED—PIONEER ELECTRONICS SCHOOL

(Non-Profit)

## FIVE COURSES FOR TECHNICIANS

Television Service & Repairman	10 months
Electronics Mechanic	15 months
Radio Engineer	15 months
Radiotelegraph Operator	12½ months
COMPLETE Electronics Technology	20 months

New Sessions each 10 weeks

September 5, 1967

November 13, 1967

January 12, 1968

April 1, 1968

### PORT ARTHUR COLLEGE

1500 Procter, Box 310 Port Arthur, Texas 77640

Own and operate Radio Station KPAC, 5000-watts

Main Studio on College Campus

FREE BROCHURE AVAILABLE

CIRCLE NO. 30 ON READER SERVICE PAGE

# NEW! FREE

The ONLY CB Catalog  
of its KIND!



The Most COMPLETE  
Catalog for CBers  
ever put together!

Everything in equip-  
ment and accessories  
for CBers at World  
Radio Lab's Amazing  
LOW PRICES!

Anything in the  
book on easy  
credit terms,  
TOO!

#### World Radio Laboratories

3415 West Broadway

Council Bluffs, Iowa 51501

Dept PE-W7

Please rush me your FREE 1967 CB Catalog.

I am interested in becoming a CB Dealer. At-  
tached is my business letterhead. Send Dealer  
Price List.

Name \_\_\_\_\_

Address \_\_\_\_\_

City \_\_\_\_\_

State \_\_\_\_\_

Zip \_\_\_\_\_

CIRCLE NO. 27 ON READER SERVICE PAGE

# Build your own AUTO ANALYZER —and SAVE!

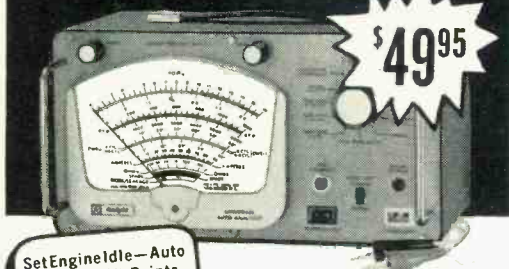

**\$49<sup>95</sup>**

Set Engine Idle—Auto Trans. Shift Points

### CHECK:

- Distributor wear
- Dwell angle
- Voltage regulator
- Condensers
- Point surfaces
- Coil resistance
- Ground circuits
- Alternator diodes
- Engine timing
- Spark output and much more!

WITH A **knight-kit**® FROM  
**ALLIED RADIO**

Headquarters for Everything in Electronics

Save double on this famous Knight-Kit Auto Analyzer. Build it yourself and save factory assembly costs. Then use it for tune-ups and trouble-shooting to hold down car upkeep.

Write for special introductory offer  
No Money Down • \$5 Monthly

## ALLIED RADIO

Dept. 3G, P.O. Box 4398, Chicago, Ill. 60680  
CIRCLE NO. 1 ON READER SERVICE PAGE



New

## Patio outdoor speaker in timeless redwood \$14.95

Audiofile net

- Silicone-treated speaker.
- 10-watt, full-range, 8-ohms.
- Handy, built-in volume control.
- Weather-resistant cane grille.
- 14" x 10½" x 3½" fits in any sheltered space.

Write for  
FREE  
CATALOG

**Argos**  
PRODUCTS COMPANY

Dept. C 600 So. Sycamore St., Genoa, Illinois 60135  
CIRCLE NO. 3 ON READER SERVICE PAGE

**Hungary**—Three new channels are in use by *R. Budapest* at press time: 5902 kHz, around 2215 with an Eng. commentary; 11,910 kHz, with Eng. to N.A. at 0430-0500; and 15,160 kHz, around 0350 with English. Some listings show the latter to be a lower-powered 15-kW outlet.

**Italy**—Rome has been found on 11,810 kHz at 2335 with sports news and a press review, and from 2340 with instrumental music. A new outlet on 15,310 kHz is being heard in Italian at 0210 with native pop music, at 0230 with a play, and in Eng. from 0400 to 0410 s/off; an Eng. amnt gave the frequencies only as 7275 and 6050 kHz, with the broadcasts beamed to Mediterranean areas. A new 16-meter outlet is on 21,560 kHz, heard at 2020-2040 with sports and music, dual to 15,400, 17,770, and 17,800 kHz.

**Jamaica**—This is another difficult country to log on the short waves. Try for medium-wave stations on 550 kHz (*Montego Bay*, 5 kW. *R. Jamaica*) around 0300; or 700 kHz (*Montego Bay*, 5 kW. *Jamaica B/C Corp.*) at 2330-0125 with American pop music. For the latter station, you will probably have to cut through a hefty signal from WLW, Cincinnati, Ohio.

**Japan**—*R. Japan's* newest schedule (with Eng. on all xmsns) reads: to N.A. at 2345-0045 on 15,135 and 17,825 kHz; to North America and Latin America at 0100-0300 on 15,135, 15,235, and 17,825 kHz; to Hawaii at 0630-0730 on 15,235 and 17,725 kHz; to Europe at 0630-0830 on 15,135 and 17,825 kHz and at 1930-2030 on 9700 and 11,965 kHz; to Australia and New Zealand at 0930-1030 on 11,875 and 15,235 kHz; to Philippines, Indonesia, and Malaysia at 1130-1300 on 9525, 11,780, and 11,940 kHz; to S. E. Asia at 1230-1530 on 9675, 11,705, and 11,875 kHz; to S. Asia at 1330-1500 on 9525, 9765, and 11,780 kHz; to Africa at 1600-1700 on 9670 and 11,780 kHz; to Middle East and N. Africa at 1730-1900 on 9525 and 11,780 kHz. The General Service is scheduled for: 0000-0030 on 9700, 15,105, and 15,425 kHz; 0100-0130 on 15,105, 15,300, and 15,425 kHz; 0200-0230, 0300-0330, 0400-0430, and 0500-0530 on 15,105, 15,195, and 15,300 kHz; 0600-0630, 0700-0730, 0800-0830, and 0900-0930 on 9505, 15,195, and 15,300 kHz; 1000-1100 on 9505, 11,815, and 15,300 kHz; 1200-1230, 1300-1330, 1400-1530, 1600-1630, 1700-1730, 1800-1830, and 1900-1930 on 9505, 9560, and 11,815 kHz; 2000-2030 on 9560, 11,815, and 15,195 kHz; 2100-2130 and 2200-2230 on 9700, 11,815, and 15,195 kHz; and 2300-0000 on 9700, 15,105, and 15,425 kHz.

**Lebanon**—*R. Lebanon*, Beirut, was on a new frequency of 11,765 kHz when noted at 0230-0300 with Eng. to N. A.; Arabic follows at 0300. The station was also noted recently on 11,715 kHz, apparently testing.

**Liberia**—Dick Reed, General Manager of ELWA, Monrovia, recently visited one of our monitors and revealed that future plans for the station include a new 20-kW xmtr local to Liberia, a 50-kW xmtr to be beamed to West Africa, and a pair of 100-kW xmtrs to be beamed to the Middle East and for Arabic service. No date has been set for completion of this expansion.

**Mexico**—Station XESG, Guadalajara, Jalisco, has been logged on 4820 kHz at 0216-0230 with a relay of the VOA program, and from 0330 with classical music. The ID is lengthy: the location is often easier to catch than the slogan.

**Netherlands**—*R. Nederland*, Hilversum, is broadcasting on three new channels: 11,730 kHz (replacing 9590 kHz) and 15,425 kHz (replacing 6085 kHz) to N. A. in Eng. at 2055-2150; and 25,610 kHz in Dutch at 1630, beginning a language newsfeed to Bonaire.

**Nigeria**—There is still considerable confusion concerning *R. Nigeria* on 4932 kHz and the *Voice of Kenya* on 4934 kHz. Both open at 0600 with a commercial service; and both stations begin with an Eng. newscast—the news from Nigeria runs to 0610, Kenya's to 0615. Recent tunings indicate that the location of the Nigerian station may be Ibadan



rather than previously thought Lagos: it parallels the National Service on 4990 kHz.

The outlet of *V. of Nigeria* on 11.920 kHz has a music program at 2145-2200 in Eng., and s/off after a frequency anmt at 2205.

**Norway**—"Norway This Week" in Eng. is beamed to East Coast N. A. at 1400-1430 on 21.730 kHz; to N. & Central America at 1600-1630 on 17.825 kHz; and to the U. S. East Coast and South America at 2200-2230 on 15.175 and 15.345 kHz; Sundays only.

**Peru**—Station OAX1A, *R. Delcar, la Voz del Norte*, Chiclayo, is still on 6700 kHz, despite a listing in some publications of 6140 kHz. This 200-watt station can be noted with typical Latin American programming around 0120-0230.

**Poland**—Warsaw is noted on 9675, 11.840, and 15.275 kHz to Australia in Polish at 0700-0730 and in Eng. to 0800. Signals usually run fair on 11.840 kHz, and poor on the other channels. *R. Warsaw* is now issuing seven new QSL cards which will form a complete map of the country.

**Portugal**—Lisbon has been found on a new channel, 9585 kHz, in Portuguese at 0030.

**Ryukyu Islands**—The VOA, Okinawa, broadcasts to the Far East from 0900 to 1930. The "Breakfast Show" is aired at 1300.

At press time, the *Voice of United Nations Command*, Deragawa, Okinawa, is on 9840 and 13.820 kHz with the Chinese and Korean Service; West Coast monitors report that both channels are usually jammed, but best reception appears to be before 1330 and after 1500. The listed 9814-kHz channel is not being heard.

**Solomon Islands**—Barry Whitehall, Broadcasting Officer for Solomon Islands B/C Service, informed us on a QSL that the power of VQ04, 3995 kHz, will be increased from its present 5000 watts around the middle of 1968—but he neglected to state how much of an increase it would be. The outlet was noted at 0945-1000 on the East Coast.

**South Africa**—The new schedule for Eng. from *R. RSA, The Voice of South Africa*, Johannesburg, in effect until Sept. 2, reads as follows: 0415-0427 to Kenya, 0430-0442 to the Middle East, and 0515-0527 to Egypt on 15.220 and 11,900 kHz; 0500-0512 to Rhodesia on 9525 and 7270 kHz; 0645-0657 to Ghana, 1600-1655 to Rhodesia, and 2100-2155 to Ghana on 11,900 and 9525 kHz; 1700-1755 to Egypt and 1800-1855 to Kenya on 21,495 and 17,805 kHz; 1900-1955 to United Kingdom on 11,785 and 9525 kHz; to N. A. (Eastern Zone) at 2330-0025, (Central Zone) 0030-0125, (Mountain Zone) 0130-0225, and (Pacific Zone) 0230-0325 on 11,900 and 9675 kHz. Other xmsns include: Dutch to Holland at 2130-2225 on 11,785 and 9720 kHz; German to Germany at 2030-2125 on 15,200 and 11,785 kHz; Portuguese to Africa at 0545-0557 on 9525 and 7270 kHz, and at 0615-0627 and 2000-2055 on 11,900 and 9525 kHz; Portuguese to Portugal at 2230-2325 on 11,785 and 9720 kHz; French to Africa at 0530-0542 on 15,220 and 11,900 kHz, at 0630-0642 on 11,900 and 9525 kHz, and at 1900-1955 on 17,805, 15,220 and 11,900 kHz; French to France at 1800-1855 on 15,245, 11,900, and 9525 kHz.

**Switzerland**—Berne has been noted with Eng. at 0220 and Italian at 0230 on 11,790 kHz, and Eng. to West Coast N. A. at 0500-0615 on 9655 kHz with a signal that is much better than the one on the previously used 5955-kHz frequency.

**Thailand**—*R. Bangkok* was noted, in a non-Eng. xmsn. at 0100 with a clock striking eight times. Tune deeply for this one: you may encounter QRM from HCJ/B, Ecuador, on 11,915 kHz and/or Rome on 11,905 kHz.

**U.S.S.R.**—Several Russian regional stations are being received well on the West Coast. One is a station on 21,475 kHz from 0300 to past 0400 with Home Service relays; s/on is at 0300 with a bell IS and a clock striking six times. A current listing indicates that this station is in Novosibirsk; the clock strike would indicate Simferopol, possibly.

**Vatican City**—Three new channels are being used by *R. Vaticano*: 11,780 kHz, in native language, at

July, 1967

# HAMS! CBERS! W9IOP PUTS THE WORLD AT YOUR FINGER TIPS!

\$1.00



NEW  
4th Edition  
"SECOND OP"

Essential DX operating aid, provides vital data like: beam headings; list of world QSL bureaus; includes logging space. See needed prefixes at a glance, increase your odds of a QSO because you have full information instantly.

\$1.00

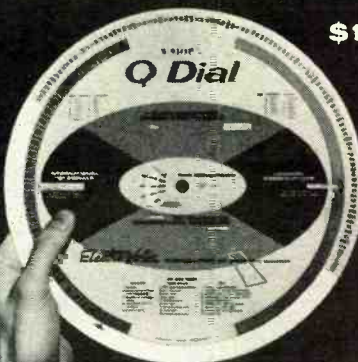

NEW "Q" DIAL

A must for every active operator, ham or C.B. Over a dozen vital information tables including: Q-signals, 10-signals, abbreviations, all U.S. radio districts and prefixes, time conversion, logging space for CW-SSB-CB. Saves time for efficient operation.

At your E-V microphone headset retailers, or send coupon.

**Electro-Voice®**

Dept. 773P, 630 Cecil Street, Buchanan, Michigan 49107  
Please send \_\_\_\_\_ Second Op, \_\_\_\_\_ Q Dial. I enclose \$1.00 for each item ordered.

Name \_\_\_\_\_

Address \_\_\_\_\_

City \_\_\_\_\_

State \_\_\_\_\_ Zip \_\_\_\_\_





# Popular SAMS BOOKS

## USE THIS HANDY ORDER FORM

- Citizens Band Radio Handbook. New Ed. 20101.....\$3.50
- 2nd-Class Radiotelephone License Handbook. 20316..... 4.75
- 101 Ways to Use Your VOM & VTVM. New Ed. 20510..... 2.95
- 101 Ways to Use Your Oscilloscope. New Ed. 20416..... 2.95
- How to Read Schematic Diagrams. 20337..... 2.25
- Tape Recorders—How They Work. New Ed. 20445..... 3.95
- TV Servicing Guide by Symptoms. 20361..... 2.50
- Color TV Servicing Made Easy. Vol. 2. 20523..... 4.50
- Color TV Training Manual. Rev. 20472..... 5.95
- Color TV Trouble Clues. Vol. 2. 20121..... 2.25
- Color TV Servicing Guide. 20358..... 3.95
- Transistor Ignition Systems Handbook. 20238..... 2.95
- Transistor Radio Servicing Made Easy. 20442..... 2.95
- Transistor Specifications Manual. Rev. 20553..... 2.95
- Tube Substitution Handbook. 10th Ed. 20534..... 1.75
- Transistor Substitution Handbook. 7th Ed. 20529..... 1.75

### FAMOUS ABC'S BOOKS

- Lasers & Masers. 20262..... \$2.25
- Computers. 20012..... \$2.50
- Tape Recording. 20395..... 1.50
- CB Radio. 20019..... 2.25
- Transistors. 20440..... 2.25
- Modern Radio. 20047..... 1.95

## HOWARD W. SAMS & CO., INC.

Order from any Electronic Parts Distributor, or mail to Howard W. Sams & Co., Inc., Dept. PE-7 4300 W. 62nd St., Indianapolis, Ind. 46268

Send books checked above. \$ \_\_\_\_\_ enclosed.

Send FREE Sams Book Catalog.

Name \_\_\_\_\_  
PLEASE PRINT

Address \_\_\_\_\_

City \_\_\_\_\_ State \_\_\_\_\_ Zip \_\_\_\_\_

CIRCLE NO. 22 ON READER SERVICE PAGE

## GET INTO ELECTRONICS

V.T.I. training leads to success as technicians, field engineers, specialists in communications, guided missiles, computers, radar, automation. Basic & advanced courses. Electronic Engineering Technology and Electronic Technology curricula both available. Associate degree in 29 months. B.S. obtainable. G.I. approved. Start September, February. Dorms, campus. High School graduate or equivalent. Catalog.

**VALPARAISO TECHNICAL INSTITUTE**  
DEPARTMENT PE, VALPARAISO, INDIANA



# SAY YOU SAW

# IT IN

# POPULAR ELECTRONICS

## LEARN Electronics Engineering AT HOME

Fix TV, design automation systems, learn transistors, complete electronics. College level Home Study courses taught so you can understand them. Earn more in the highly paid electronics industry. Computers, Missiles, theory and practical. Kits furnished. Over 30,000 graduates now employed. Resident classes at our Chicago campus if desired. Founded 1934. Catalog: "Vets—write for information about G. I. Bill Training."

**AMERICAN INSTITUTE OF ENGINEERING & TECHNOLOGY**  
1137 West Fullerton Parkway, Chicago, Illinois 60614

2205; 15.145 kHz, also in native language, from 1845 to past 1900; and 17.880 kHz in Hindi to India and S. E. Asia from 1440.

**Vietnam (North)**—R. Hanoi, on 9830 kHz (a move from 9840 kHz to avoid QRM from R. Baku and Voice of United Nations Command) has Chinese at 1430-1500, Laotian at 1500-1530, and Eng. at 1530-1600; on 11.755 kHz (a move from 11.760 kHz to avoid a Russian regional station there) at 1430 in Vietnamese—and from 1530 in Eng. dual to 9760 and 9830 kHz (prior to 1530 dual to 9760 kHz only). Another channel, believed to be used by Hanoi, on 15,044 kHz, has been tuned at 0724-0732 with Oriental music and talks.

**Unidentified**—A station has been noted irregularly on 12,000 kHz on Sundays with closing at 0248. The program consists of an exceptionally technical explanation by a non-British accented man in Eng. on the spirituality of the human soul, quite unlike the usual religious sermon programs. The signal is weak but steady; it is not believed to be Asian in origin although there is considerable S-meter "bounce."

—30—

### SHORT-WAVE CONTRIBUTORS

- R. M. Turkel (WPE1HAC), Brookline, Mass.
- Dick Grab (WPE2HYM), Woodside, N. Y.
- Eric Lebowitz (WPE2JY), Jackson Heights, N. Y.
- Kenneth Coyne (WPE2LSJ), Long Beach, N. Y.
- Robert Kaplan (WPE2MJR), Bronx, N. Y.
- Al Sauerbier (WPE2NDA), Washington, N. J.
- Roger Greene (WPE2NFC), Bronx, N. Y.
- Ira Schultz (WPE2NGG), White Plains, N. Y.
- Karl Halpern (WPE2NOB), Flushing, N. Y.
- John Zapisek (WPE2OKD), Wading River, N. Y.
- Eugene Barden (WPE2OOA), Little Ferry, N. J.
- Jeffrey Star (WPE2OZD), Franklin Square, N. Y.
- Bernard Lansing (WPE2PBA), Rochester, N. Y.
- Carl Scharwath (WPE2PEF), Santa Monica, Calif.
- Bob Eckel (WPE2PHE), Metuchen, N. J.
- John Banta (WPE2PHU), Bay Shore, N. Y.
- William Canemi (WPE2PII), Staten Island, N. Y.
- David Palfrey (WPE2PKC), Kearny, N. J.
- Gary Ohlson (WPE2PNB), Red Hook, N. Y.
- James Rivello (WPE2POK), Cherry Hill, N. J.
- Bob Huber (WPE3GUN), Wilmington, Del.
- Brian Skowron (WPE3HAL), Pittsburgh, Pa.
- Robert Longenberger (WPE3HGE), Bloomsburg, Pa.
- Robert Wilkner (WPE4ACP), Pompano Beach, Fla.
- Grady Ferguson (WPE4CB), Charlotte, N. C.
- Bruce Churchill (WPE4EVD), Chula Vista, Calif.
- William King (WPE4JY), Panama City, Fla.
- Zacky Sessions (WPE4JIN), Castle Hayne, N. C.
- Mike Kamp (WPE5EPY), Houston, Texas
- Billy Campbell (WPE5EQP), Houston, Texas
- Alex Nichols (WPE5ERG), Azle, Texas
- Stewart Mac Kenzie (WPE6AA), Huntington Beach, Calif.
- Don Kenney (WPE6AET), Westminster, Calif.
- Trev Clegg (WPE6FAF), Fresno, Calif.
- Pete Hartquist (WPE6FAY), Fairfield, Calif.
- Chris Christensen (WPE6GTG), San Bruno, Calif.
- George Chapple (WPE6GYM), Sunnyvale, Calif.
- Juris Burkevics (WPE7CLJ), Firecrest, Wash.
- George Schnabel (WPE8EMO), Brooklyn, N. Y.
- Robert French (WPE8FGH), Bellaire, Ohio
- Richard Pistek (WPE9HOA), Chicago, Ill.
- Robert Kelley (WPE9HZN), Milwaukee, Wis.
- Carl Durnavich (WPE9IFO), Riverdale, Ill.
- Bill Vogt (WPE9IND), Tinley Park, Ill.
- A. R. Niblack (WPE9KAM), Vincennes, Ind.
- John Beaver, Sr. (WPE9AE), Pueblo, Colo.
- John De Smith (WPE9EYJ), Litchfield, Minn.
- David Alpert, Morton Grove, Ill.
- Leo Alster, Rahway, N. J.
- Werner Funkenhauser, Guelpb, Ont., Canada
- Henry Gac, Detroit, Mich.
- Morey Goldstein, East Meadow, N. Y.
- Alan Guilbault, Sidney, B. C., Canada
- James Hart, Irvington, N. J.
- Bruce Henderson, Riverside, Calif.
- Bruce Horlich, Los Angeles, Calif.
- Gordon Johnston, North Surrey, B. C., Canada
- Karl Lowden, Raymondville, Texas
- Bill Siegel, St. Clair Shores, Mich.
- Joel Sinter, Jamaica, N. Y.
- William Tucker, Mission, Kan.
- Robert White, San Francisco, Calif.
- Matt Zahner, Baltimore, Md.

# SHORT-WAVE MONITOR CERTIFICATE APPLICATION

**A**LL radio listeners interested in furthering the hobby of SWL'ing—regardless of whether you DX on the BCB, VHF, TV, SW, or FM bands—are eligible to apply for a POPULAR ELECTRONICS "Certificate of Registration." You must have verified (have QSL cards from) a minimum of five radio stations, of which one was outside the borders of the United States. There is no age limit, or special equipment qualification; the only requirement is that the applicant have a sincere interest in radio communications.

All certificates are filled in and lettered before mailing; they are mailed flat and unfolded. If you want to register and receive your WPE identification sign, fill in the application blank below. Mail with 50 cents in coin (or stamps) to: MONITOR, P.O. Box 333, Cherry Hill, N.J. 08034. (Personal checks will not be acceptable). Canadians should use their own currency, and other applicants not in the U.S.A. should use 10 International Postal Reply Coupons. Allow 4-6 weeks for processing.

(Please Print)	(Do not fill out)
Name .....	
Street, City and Zone .....	
State and Zip .....	
Receivers in use	
Make .....	Model .....
Make .....	Model .....
Age .....	Occupation .....
Ham/CB call -letter assignment(s) .....	
I listen mostly to SW Broadcast      Homs      CB      BCB      VHF      VLF .....	
I use the following antennas .....	
I have      QSL cards and      countries verified.      Check if subscriber to P.E. .....	
Signature .....	Date .....



## DIRECT FREQUENCY DIALING *International Short-Wave Broadcast RECEIVER*



No more guesswork in identifying stations. Set dial at a station's frequency and if conditions permit you'll hear it everytime . . .

- Ultra-precision tuning dial accuracy; SW and standard AM Broadcast
- Crystal lattice filter for adjacent station rejection and good AF response
- Dual conversion • Solid state AF output • S-meter • Preselector gives superior sensitivity by peaking antenna and RF stages • Crystal-controlled H. F. Oscillator stability • Amplified AVC constant AF output • Price \$289.00

Write for free Brochure No. 12.

**R. L. DRAKE COMPANY • Miamisburg, Ohio 45342**

## Thinking of college and a space age career?

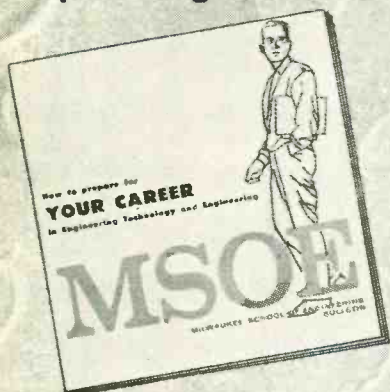

### Send for this booklet on ENGINEERING TECHNOLOGY AND ENGINEERING

Learn how you can prepare for a dynamic career as an electrical or mechanical engineering technician or engineer in such exciting, growing fields as avionics, missiles, reliability control, fluid mechanics, data processing, metallurgy, microelectronics, and advanced aerospace research.

MSOE offers residence study programs leading to these degrees in engineering technology and engineering:

2 years — Associate in Applied Science

4 years — Bachelor of Science

Also get facts about scholarships and financial aids, job placement and other student services, plus photographs of MSOE technical laboratories and student activities. Courses approved for veteran training.

For your copy, just mail the coupon — no obligation.

# MSOE

Milwaukee, Wisconsin 53201

Milwaukee School of Engineering  
Dept. PE-767, 1025 N. Milwaukee Street  
Milwaukee, Wisconsin 53201

Please send the "Your Career" booklet.  
I'm interested in

Electrical fields     Mechanical fields

Name..... Age.....

Address.....

City..... State..... ZIP.....

MS-284

CIRCLE NO. 17 ON READER SERVICE PAGE

## LOW-COST INDICATORS

(Continued from page 50)

By adding a third transistor,  $Q3$ , as shown in Fig. 4, two lamps can be activated alternately. While  $I1$  is on,  $I2$  is off, and vice versa.

**Construction.** The indicator circuits described here can be assembled on a small piece of phenolic board. Parts layout is not critical except when mounting  $LDR1$  and  $I1$  (Fig. 2). Both of these components must be closely coupled and shielded from outside light. The light from  $I1$  should shine directly on  $LDR1$ . The fully constructed indicator device—minus its power supply or battery and

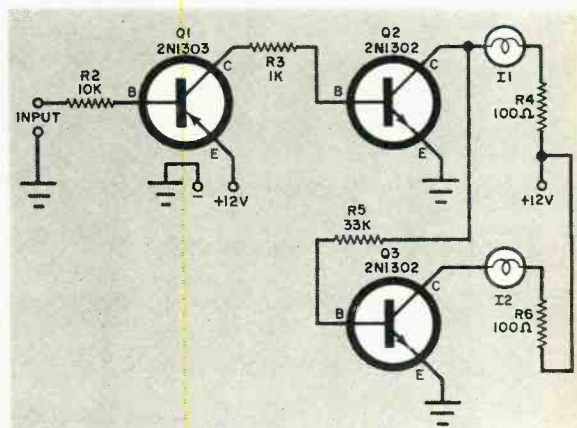

Fig. 4. Flip-flop indicator is foolproof in that it lets you know that the circuit is functioning; when lamp  $I1$  is on, lamp  $I2$  is off, and vice versa. The bias circuit shown in Fig. 3 can be included.

sensor—need not be larger than about 1" square.

Any well-filtered 12-volt d.c. power supply or a 12-volt battery will suffice to power these indicators. Note that only one 12-volt supply is needed, and that all points marked +12V on the schematic can be tied together. Power drain under the worst conditions for a one-transistor indicator circuit is about 3 milliamperes. At normal room temperatures (about 72°F), average drain can be measured in microamperes. —30—

POPULAR ELECTRONICS



# ELECTRONICS MARKET PLACE

**COMMERCIAL RATE:** For firms or individuals offering commercial products or services. \$1.00 per word (including name and address). Minimum order \$10.00. Payment must accompany copy except when ads are placed by accredited advertising agencies. Frequency discount: 5% for 6 months; 10% for 12 months paid in advance.

**READER RATE:** For individuals with a personal item to buy or sell. 60¢ per word (including name and address). No Minimum! Payment must accompany copy.

## FOR SALE

**FREE!** Giant bargain catalog on transistors, diodes, rectifiers, SCR's, zeners, parts. Poly Paks, P.O. Box 942, Lynnfield, Mass. 01940.

**GOVERNMENT Surplus Receivers, Transmitters, Snooper-scopes, Radios, Parts, Picture Catalog 25¢.** Meshna, Nahant, Mass. 01908.

**WEBBER LAB'S Police—Fire Transistorized Converter kit 30-50mc. & 100-200mc. (1 mc. spread) \$5.00 each.** 26-200mc. on broadcast band using any type radio, crystal controlled \$23.00 wired pp. tunable—crystal controlled \$11.00 kit. 72 Cottage Street, Lynn, Mass. 01905.

**JAPAN & Hong Kong Electronics Directory.** Products, components, supplies. 50 firms—just \$1.00. Ippano Kaisha Ltd., Box 6266, Spokane, Washington 99207.

**INVESTIGATORS, FREE BROCHURE, LATEST SUBMINIATURE ELECTRONIC SURVEILLANCE EQUIPMENT, ACE ELECTRONICS, 11500-L NW 7TH AVE., MIAMI, FLA. 33168.**

**CB-WPE-QLS CARDS.** Same High Quality, Beautiful, Glossy multi-color cards. New **LOW PRICES. SAMPLES, 25¢.** Dick, W8VXX, 19QA0625, Gladwin, Mich. 48624.

**R.F. CONVERTERS.** World's largest selection. Also CCTV cameras, etc. Lowest factory prices. Catalog 10¢. Vanguard 196-23 Jamaica Ave., Hollis, N.Y. 11423.

**TELEPHONE VOICE SWITCH: (LS-500). ACTUATES AUTOMATICALLY AND UNATTENDED ANY TAPE OR WIRE RECORDER. PICTORIAL INSTALLATION INSTRUCTIONS INCLUDED. \$23.75. POST PAID USA, WJS ELECTRONICS, 737 NORTH SEWARD, HOLLYWOOD, CALIF. 90038.**

**INVESTIGATORS: KEEP IN STEP WITH ADVANCEMENTS IN THE ART OF ELECTRONICS FOR THE PROFESSIONAL. SEND \$1.00 FOR EQUIPMENT BROCHURE. WJS ELECTRONICS, 737 NORTH SEWARD, HOLLYWOOD, CALIF. 90038.**

**BUG DETECTOR: WILL DETECT AND LOCATE SURREPTITIOUS TRANSMITTING DEVICES IN CONFERENCE ROOMS, HOME AND OFFICES, ETC. WRITE FOR DETAILS. WJS ELECTRONICS, 737 NORTH SEWARD, HOLLYWOOD, CALIF. 90038.**

**DETECTIVES!** Free Brochures! Electronic Surveillance Devices. SILMAR ELECTRONICS, 3476 N.W. 7th Street, Miami, Fla. 33125.

**CIRCUIT Boards, Parts for "Poptronics" projects. Free catalog. DEMCO, Box 16297, San Antonio, Texas 78216.**

**ROCKETS:** Ideal for miniature transmitter tests. New illustrated catalog, 25¢. Single and multistage kits, cones, engines, launchers, trackers, rocket aerial cameras, technical information. Fast service. Estes Industries, Penrose 18, Colorado 81240.

**LOWEST Prices Electronic Parts. Confidential Catalog Free. KNAPP, 3174 8th Ave. S.W., Largo, Fla. 33540.**

**CB-QLS CARDS.** New Designs, Record Books, Blabbermouth Awards, Gag Signs, Warning Decals, Novelties. Free Brochure. WOODY, 8474 Watson, St. Louis, Mo. 63119.

**FREE ELECTRONICS** (new and surplus) parts catalog. We repair multimeters. Bigelow Electronics, Bluffton, Ohio 45817.

**GENERAL INFORMATION:** First word in all ads set in bold caps at no extra charge. Additional words may be set in bold caps at 10¢ extra per word. All copy subject to publisher's approval. Closing Date: 1st of the 2nd preceding month (for example, March issue closes January 1st). Send order and remittance to: Hal Cymes, POPULAR ELECTRONICS, One Park Avenue, New York, New York 10016.

**SURVEILLANCE EQUIPMENT—NEW HIGH PERFORMANCE SUBMINIATURE MODELS. ELECTRONIC COUNTERMEASURE DEVICES TO PROTECT PRIVACY. FREE DATA: SECURITY ELECTRONICS-PE, 15 EAST 43RD STREET, NEW YORK, N.Y. 10017.**

**CONVERT** any television to sensitive, big-screen oscilloscope. Only minor changes required. No electronic experience necessary. Illustrated plans, \$2.00. Relco-A33, Box 10563, Houston, Texas 77018.

**MUSIC LOVERS, CONTINUOUS, UNINTERRUPTED BACKGROUND MUSIC FROM YOUR FM RADIO, USING NEW INEXPENSIVE ADAPTOR. FREE LITERATURE. ELECTRONICS, 11500-Z NW 7th AVE., MIAMI, FLORIDA 33168.**

**CLOSED-CIRCUIT TV—Industrial, educational.** Factory-direct prices. Write for particulars. **ATV RESEARCH**, Box 396P, Industrial Division, South Sioux City, Nebr. 68776.

**TV CAMERA PLANS.** Best available. Tube model, vidicon—\$3.00; transistor—\$5.00 (deductible). Flying spot scanner—\$2.50. **ATV RESEARCH**, Box 396P, So. Sioux City, Nebr. 68776.

**SEE YOURSELF ON TV!** Exciting hobby lets you televise live pictures right in your own home. Kits from \$18.95 to \$149.50. Catalog 10¢. **ATV RESEARCH**, Box 396P, Amateur Division, South Sioux City, Nebr. 68776.

**110VAC 60cy** from car generator. Powers lights, refrigerator, transmitter, receiver, etc. Simple, easy to convert. Plans, \$2.00. Tedco, Box 12098, Houston, Texas 77017.

**SUDYMONT** acoustic baffles. Plans \$5.95; Baffle \$26.95; with cabinet from \$39.95. Send speaker size. **SUDYMONT, 120 Liberty Str. NYC. 10006.**

**HOBBYISTS, EXPERIMENTERS, Amateur Scientists, Students . . . Construction Plans—All complete including drawings, schematics, parts lists, prices, parts sources . . . Laser—Build your own coherent-light optical laser. Operates in the pulsed mode, the visible light range—\$6.00 . . . Diode Laser—Invisible Light (infrared) can be continuously modulated—\$3.00 . . . Reverberator (Echo) Unit—Build your own. Use with your automobile radio, home radio or hifi, electric guitar, etc.—\$3.00 . . . Radar—Build your own ultrasonic doppler radar. Detect motion of people, automobiles, even falling rain drops. Transistorized, uses standard small 9-volt battery—\$4.00 . . . Long-Range "Sound Telescope"—This amazing device can enable you to hear conversations, birds and animals, other sounds hundreds of feet away. Very directional. Transistorized. Uses 9 V battery—\$3.00 . . . Or send 25¢ coin or stamps for complete catalogue . . . Technical Writers Group, Box 5501, State College Station, Raleigh, N.C. 27607.**

**FREE CATALOG—LOADS OF ELECTRONIC BARGAINS. R. W. ELECTRONICS, INC. 2244 So. Michigan Avenue, Chicago, Illinois 60616.**

**CRYSTALS . . . largest selection in United States at lowest prices.** 48 hr. delivery. Thousands of frequencies in stock. Types include HC6/U, HC18/U, FT-241, FT-243, FT-171, etc. Send 10¢ for catalog with oscillator circuits. Refunded on first order. Jan Crystals, 2400F Crystal Dr., Fort Myers, Fla. 33901.

**RADIO - T.V. Tubes—33¢ each.** Send for free catalog. Cornell. 4213 University, San Diego, Calif. 92105.

**JAPANESE PRODUCTS CATALOG** by air mail \$5, sea \$3. Intercontinental, CPO 1717, Tokyo, Japan.

**EXPERIMENTERS** Having trouble understanding **TRAN-SISTOR** Terminology? Our pamphlet can help you. Includes **FIELD EFFECT**. Only \$1.00. Williams, Box 2131, Lehigh Valley, Penna. 18001.

**TELEPHONE RECORDER-ACTUATOR (TWI-007). SOLID STATE MODULE AUTOMATICALLY TURNS TAPE RECORDER, AMPLIFIER, INDICATOR LIGHT ON WHEN TELEPHONE IN USE. CONNECTED ANYWHERE ON LINE. SIMPLE INSTALLATION INSTRUCTIONS INCLUDED. PREPAID \$22.85. SURVEILLANCE RECORDERS: (TWI-1000), (TWI-1010). TWILIGHT ELECTRONICS, BOX 11595-A, ST. LOUIS, MISSOURI 63105.**

**COURSES: TELEPHONE ENGINEERING, \$39.50.** Detective Electronics \$22.50. Security Electronics \$27.50. **AMAZING NEW SUPER HOBBY CATALOG 25¢.** Construction Plans: **TELEPHONE;** Answering Machines, Speaker-phones, Automatic Dialers, Central Dial Systems, Call Diverters, Voice Scramblers, Legal Connectors. **TELEVISION:** Cameras, 3DTV Converters, Color TV Converters, Video Recorders. **HOBBYIST:** Transistorized Teletypes, Electron Microscopes, Tranquilizers, Private Eye Tail Transmitter, Electronic Fingerprint Identifier. Plans \$4.95 each. Silent Listening Device Dynamiter Plans \$8.50. **KNOW YOUR TELEPHONE RIGHTS,** a study of the Telephone Tariffs \$9.50. Don Britton Enterprises, 7906 Santa Monica Blvd., Hollywood, Calif. 90046.

**POLICE RADIO.** Hear all police calls, fire departments, Sheriffs, taxis, ambulances, Highway Patrol. New 5 Band portable radio and direction finder. Free Booklet. Nova-Tech, Dept. 218, Redondo Beach, Calif. 90278.

**CBs—Hams 600 Watt Linear amplifier \$139.95.** Build yourself for less than \$40.00. Complete Illustrated Instructions. Send \$2.00. Marker Electronics Mfg., 2223 Lane Ave., Elkhart, Indiana 46514.

**NEW-ELECTRONIC PRODUCT! MAKE YOUR OWN, VARIABLE RESISTORS!** One ounce of **AIR DRYING** force paint makes **HUNDREDS** of transducers with **LITTLE** weight or volume. A **DROP** of fluid applied between conductive surfaces, will change resistance **THOUSANDS** of ohms. Operates relays; recorders; solid state circuits; **WITHOUT** amplifier. Prices \$20.00 oz. **DEAN ELECTRONICS,** Box 9265, N. Hollywood, California 91609.

**ELECTRONIC, MECHANICAL DEVICES CATALOG 10¢.** Gear Bonanza, \$2.50 **FERTIK'S,** 5249 "D," Phila., Pa. 19120.

**GUARD AGAINST ELECTRONIC BUGS.** Detect "bugs" with AM/FM and all-band radios. Exciting, interesting information. \$2.00 postpaid. Satisfaction guaranteed. M.G.N., 1128 13th Avenue, Sacramento, California 95822.

**SAVINGS on ELECTRONIC COMPONENTS, KITS, etc. CATALOG 10¢.** George Wong and Company, Box 337, Essex Station, Boston, Mass. 02112.

**SCHEMATICS FOR SURVEILLANCE EQUIPMENT—**Drawings, schematics, parts lists. Wireless room bug, Wireless telephone tap, Wireless telephone bug with battery. All three for \$23.50, any one for \$10.00. Schematics, 330 Casa Linda, Dallas, Texas 75218.

**TREASURE Hunters! Prospectors! Relco's** new instruments detect buried gold, silver, coins. Kits, assembled models. Transistorized. Weighs 3 pounds. \$19.95 up. Free catalog. Relco-A33, Box 10839, Houston, Texas 77018.

**INTEGRATED CIRCUIT** Experiment Kit, \$6.95. Others. Free catalogue. Kaye Engineering, Box 3932, Long Beach, Calif. 90803.

**UNIVAC** Computer Chassis (tubes, resistors, condensers parts) \$2.95 four for \$9.95. Send dollar for computer information, ZORMCO, Box 4444, Cleveland, Ohio 44125.

**WRIST RADIO KIT \$4.95.** Circuit boards, parts, plans for transistor projects. **FREE CATALOG.** Science Workshop, Box 393, Bethpage, N.Y. 11714.

**ALUMINUM SOLDERING HANDBOOK—**Solder aluminum with regular 50/50 wire solder, no special fluxes. Complete step by step instructions. Handbook \$1.00. Non-ferrous Metals, Box 1024, Project City, Calif. 96079.

**SEND FOR FREE CATALOG,** featuring transistors, rectifiers, zeners, SCR's, biswitches and other semiconductor devices in large and small quantities. **ALL DEVICES ARE CHECKED AND GUARANTEED. INTEGRATED CIRCUITS** (JK, SR, SRT FLIP FLOPS AND GATES) with checked inputs and diagrams are available. Solid State Sales, Box 74F, Somerville, Mass. 02143.

**LOWEST** prices. New records. All labels. Harvey's, Box 1402, Newport News, Va. 23601.

**LINEAR AMPLIFIERS:** "Hustler"—40 watts output—\$119.95; "Raider"—100 watts—\$139.95; "Maverick—250"—250 watts—\$244.95. For AM and SSB. Frequency range 20-35 megacycles (illegal) for Class D 11 meters.) Dealer inquiries invited. D & A Manufacturing Co., 1217 Avenue C, Scottsbluff, Nebraska 69361.

## CLASSIFIED ADVERTISING ORDER FORM

Please refer to heading on first page of this section for complete data concerning terms, frequency discounts, closing dates, etc.

1	2	3	4	5
6	7	8	9	10
11	12	13	14	15
16	17	18	19	20
21	22	23	24	25
26	27	28	29	30
31	32	33	34	35

Words  $\left\{ \begin{array}{l} @ 60¢ \text{ (Reader Rate)} \\ @ \$1.00 \text{ (Commercial Rate)} \end{array} \right\}$  = \$ \_\_\_\_\_

Insert \_\_\_\_\_ time(s) Total Enclosed \$ \_\_\_\_\_

NAME \_\_\_\_\_

ADDRESS \_\_\_\_\_

CITY \_\_\_\_\_ STATE \_\_\_\_\_ ZIP \_\_\_\_\_

Signature \_\_\_\_\_

**WORD COUNT:** Include name and address. Name of city (Des Moines) or of state (New York) counts as one word each. Zone or Zip Code numbers not counted. (Publisher reserves right to omit Zip Code if space does not permit.) Count each abbreviation, initial, single figure or group of figures or letters as a word. Symbols such as 35mm, COD, PO, AC, etc., count as one word. Hyphenated words count as two words.

PE-767

**JAPANESE or EUROPEAN DIRECTORY** 200 firms \$1.00. **SURVEILLANCE EQUIPMENT** Brochure 25¢. **SNOOPER MIKE** \$25.00. **SIERRATRONICS**, Box 7497, Las Vegas, Nev. 89101.

**ELECTRONIC PARTS!** Components, transistors, diodes, kits, relays, and many special items. Guaranteed. Send 25¢ for 100 page catalog. General Sales Co. P.O. Box 2031 D, Freeport, Texas 77541.

**MESHNA'S TRANSISTORIZED CONVERTER KIT.** Converts car radio to receive police and fire. 30-50MHz and 100-200MHz (one MHz Tuning). \$5.00 with easy to follow step instructions. Meshna, No. Reading, Mass. 01864.

## PLANS AND KITS

**ALLWAVE RADIO KIT.** Tube, transistor included \$5.00. Headset \$2.50. Ekeradio, Box 131, Temple City, Calif. 91780.

**SUPER SNOOPER**, printed Circuit Kit \$5.95. Others. Lectronix, Box 42, Madison Heights, Michigan 48071.

**INTEGRATED** Circuit experimenters kit. Two IC's, 2 transistors, several circuits. Kit \$12.50; Wired, \$17.00. Adams, Box 399, Hazelwood, Missouri 63042.

**"CRYSTAL EXPERIMENTER'S"** Handbook—50¢. Catalog. Laboratories, 12041-L Sheridan, Garden Grove, Calif. 92640.

**BUILD** remote reading weathervane anemometer. Directions \$2.00. Box 483, Portsmouth, N.H. 03801.

## SHORTWAVE LISTENING

**POLICE—FIRE—AIRCRAFT—MARINE—AMATEUR CALLS** on your broadcast radio with **TUNAVERTER!** Tune The Band! Economical! Guaranteed! Free Catalog! Salch Co. Dept. PE7, Woodsboro, Texas 78393.

100 **BOOKS** for SWLs, HAMS, CBers, Hobbyists. **ANTENNAS** SWL Guide, 218 Gifford, Syracuse, N.Y. 13202.

## HIGH FIDELITY

**FREE!** Send for money saving stereo catalog #P7E and lowest quotations on your individual component, tape recorder, or system requirements. Electronic Values, Inc., 200 W. 20th St., New York, N.Y. 10011.

**HI-FI** Components, Tape Recorders, at guaranteed "We Will Not Be Undersold" prices. 15-day money-back guarantee. Two-year warranty. No Catalog. Quotations Free. Hi-Fidelity Center, 239 (P) East 149th Street, New York 10451.

**"LOW**, Low quotes: all components and recorders. HiFi, Roslyn, Penna. 19001.

**TAPE RECORDERS**, Hi-Fi, components, Sleep Learning Equipment, tapes. Unusual Values Free Catalog. Dressner, 1523R, Jericho Turnpike, New Hyde Park, N. Y. 11040.

**EVERYONE** can afford **HIGH FIDELITY** components—because of our **DISCOUNT** policy. Insured guaranteed shipments—Factory sealed cartons—**FRANCHISED**. Send for our **LOW-LOW** quote today. Sound and Sight Audio, Inc. 106 West 32 Street, New York, N. Y. 10001.

## WANTED

**CASH** Paid! Unused tubes, electronic equipment. Barry, 512 Broadway, N.Y.C. 10012.

**QUICKSILVER**, Platinum, Silver, Gold. Ores Analyzed. Free Circular. Mercury Terminal, Norwood, Mass. 02062.

**WESTINGHOUSE** RA, DA, or RC Radio. Write A. Cataline, RR 4, Canton, Georgia.

## TUBES

**TUBES** "Oldies", latest. Lists free. Steinmetz, 7519 Maplewood, Hammond, Indiana 46324.

**TUBE** Headquarters of World! Send 10¢ for Catalog (tubes, electronic equipment) Barry, 512 Broadway, N.Y.C. 10012.

**FREE** Catalog. Electronic parts, tubes. Wholesale. Thousands of items. Unbeatable prices. Arcturus Electronics ZD, 502-22 St., Union City, N.J. 07087.

**RADIO & T.V.** Tubes—33¢ each. Send for free list. Cornell, 4213 University, San Diego, Calif. 92105.

**RECEIVING & INDUSTRIAL TUBES, TRANSISTORS.** All Brands—Biggest Discounts. Technicians, Hobbyists, Experimenters—Request **FREE** Giant Catalog and **SAVE!** **ZALYTRON**, 469 Jericho Turnpike, Mineola, N.Y. 11501.

**DON'T BUY TUBES**—Radio, TV-Xmitting, special-purpose types until you get our price list! Lowest prices in U.S.A. 5,000 types—Guaranteed Brand New. Send postcard for TV—Special Purpose Price List. **UNITED RADIO COMPANY**, P.O. BOX 1000, NEWARK, N.J. 07101.

## TAPE AND RECORDERS

**BEFORE** Renting Stereo Tapes try us. Postpaid both ways—no deposit—immediate delivery. Quality—Dependability—Service—Satisfaction—prevail here. If you've been dissatisfied in the past, your initial order will prove this is no idle boast. Free Catalog. Gold Coast Tape Library, Box 2262, Palm Village Station, Hialeah, Fla. 33012.

**RENT 4-TRACK STEREO TAPES**—Dependable service our keynote—**ALL MAJOR LABELS—FREE CATALOG** (48 States)—**TRIMOR** Company, P.O. Box 748, Flushing, N.Y. 11352.

**STEREO TAPES.** Save up to 60% (no membership fees, postpaid anywhere U.S.A.). Free 60 page catalog. We discount batteries, recorders, tape accessories. Beware of slogans "not undersold," as the discount information you supply our competitor is usually reported to the factory. **SAXITONE**, 1776 Columbia Road, Washington, D.C. 20009.

**AUTOMATIC** telephone connection for Concord and other transistorized recorders. **SURVEILLANCE** and Privacy Protection Devices. Free Data: Security Electronics-PER, 15 East 43rd Street, New York, N.Y. 10017.

**TAPE** transport. NAB recording studio quality. Build yourself for amazingly low cost. Detailed plans \$5.00. Free particulars. Pepke Laboratories, 309-B West 19 Street, New York, N.Y. 10011.

**TAPE RECORDER SALE.** Brand new, latest models, \$10.00 above cost. Arkay Sales, 1028-C Commonwealth Ave., Boston, Mass. 02215.

**RENT** Stereo Tapes—over 2,500 different—all major labels—free brochure. Stereo—Parti, 1616-PE Terrace Way, Santa Rosa, California 95404.

**HI-FI** Components. Tape Recorders, at guaranteed "We Will Not Be Undersold" prices. 15-day money-back guarantee. Two-year warranty. No Catalog. Quotations Free. HiFidelity Center, 239 (PT) East 149th Street, New York 10451.

**RENT** Stereo-8 **CAR TAPES.** 10¢/day. Send refundable \$10.00 deposit and name of first selection. Autotapes, Box 19086-D, Indianapolis, Ind. 46219.

**RENT STEREO TAPES—75¢ WEEK.** CATALOG. ART'S, 1442 BLAZE, SIMI, CALIF.

## PERSONALS

**INVESTIGATORS, FREE BROCHURE, LATEST SUBMINATURE ELECTRONIC SURVEILLANCE EQUIPMENT.** ACE ELECTRONICS, 11500-K NW 7th AVE., MIAMI, FLA. 33168.

**BORROW \$1,205 AIRMAIL!** Repay \$47 for 36 months. State licensed. Postal Finance, Dept. 84-N, 200 Keeline Building, Omaha, Nebraska 68102.

**BILL PROBLEMS?** Poor credit no trouble. Not a loan company. Send for free application. Nationwide Acceptance, Dept. PE, 930 F St. N. W., Washington, D. C. 20017, or 1326PE Plainfield St., Cranston, R. I. 02919.



---

## REPAIRS AND SERVICES

---

**TV Tuners rebuilt and aligned per manufacturers specification.** Only \$9.50. Any make UHF or VHF. We ship COD. Ninety day written guarantee. Ship complete with tubes or write for free mailing kit and dealer brochure. JW Electronics. Box 51C, Bloomington, Indiana 47401.

---

## INSTRUCTION

---

**LEARN While Asleep,** hypnotize with your recorder, phonograph. Astonishing details, sensational catalog free! Sleep-Learning Association, Box 24-ZD, Olympia, Wash. 98501.

**LEARN ELECTRONIC ORGAN SERVICING** at home all makes including transistors. Experimental kit—trouble-shooting. Accredited NHSC. Free Booklet. **NILES BRYANT SCHOOL,** 3631 Stockton, Dept. A, Sacramento 20, Calif. 95820.

**ASSOCIATE Degree** in Electronics Engineering earned through combination correspondence-classroom educational program. Free brochure. Grantham Technical Institute, 1505 N. Western Ave., Hollywood, Calif. 90027.

**HIGHLY**—effective home study review for FCC commercial phone exams. Free literature! **Cook's School of Electronics,** P.O. Box 36185 Houston, Texas 77036.

**HIGH SCHOOL DIPLOMA** at home. Qualified instructors. Send age, highest grade completed, for free details. No salesman. **SOUTHERN STATES ACADEMY,** Professional Bldg., Dept. 5, Decatur, Ga. 30000.

**REI** First Class Radio Telephone License in (5) weeks Guaranteed. Tuition \$295.00. Job placement free. (KAN-SAS CITY) R.E.I., 3123 Gillham Road, Kansas City, Missouri, Telephone WE1-5444. (SARASOTA) R.E.I., 1336 Main Street, Sarasota, Florida 33577. Telephone 955-6922.

**HIGHLY EFFECTIVE** home study course in Electronics Engineering Mathematics with circuit applications. Earn your Associate in Science Degree. Free Literature. **Cook's Institute of Electronics Engineering,** P.O. Box 36185 Houston Texas 77036. (Established 1945.)

**FCC** First Class License in six weeks—nation's highest success rate—approved for Veterans Training. Write **Elkins Institute,** 2603B Inwood Road, Dallas, Texas 75235.

**FCC LICENSE THROUGH TAPE RECORDED INSTRUCTION.** Bob Johnson Audio-Visual Training, 1060D Duncan, Manhattan Beach, Calif. 90266.

---

## INVENTIONS WANTED

---

**PATENT** Searches including Maximum speed, full airmail report and closest patent copies, \$6.00. Quality searches expertly administered. Complete secrecy guaranteed. Free Invention Protection forms and "Patent Information." Write Dept. 9, Washington Patent Office Search Bureau, 711 14th Street, N.W., Washington, D.C. 20005.

**INVENTORS!** Outright cash sale or royalties for your inventions. Patented. Unpatented. Active demand from our client manufacturers. Financial assistance available. Write Dept. 35, United States Invention Brokerage, 78 Wall Street, New York, N.Y. 10005.

**INVENTORS.** We will develop, help sell your idea or invention, patented or unpatented. Our national manufacturer clients are urgently seeking new items for outright cash sale or royalties. Financial assistance available. 10 years proven performances. For free information, write Dept. 41, Wall Street Invention Brokerage, 79 Wall Street, New York, N.Y. 10005.

**INVENTORS** Needing Help with any problem, financial, development, securing manufacturer, obtaining patent. Write the organization that delivers action and results—not promises. **Pioneer Invention Service,** Dept. 79, 150 Broadway, New York, N.Y. 10038.

---

**INVENTIONS** wanted. Patented; unpatented. **Global Marketing Service,** 2420-P 77th, Oakland, Calif. 94605.

**INVENTIONS—IDEAS** developed: **CASH/ROYALTY SALES.** Member: United States Chamber of Commerce. **Raymond Lee,** 130-GR West 42nd, New York City 10036.

**PATENT SEARCHES \$6.00! FREE "INVENTION RECORD"/** Information. Miss Hayward, 1029HR Vermont, District of Columbia 20005.

**INVENTORS!** Sell your invention for cash or royalties! Our client manufacturers eagerly seek new items. Patented. Unpatented. Financial assistance if needed, 25 years proven performances. For free information, write Dept. 20, Gilbert Adams, Invention Broker, 80 Wall St., New York, N.Y. 10005.

**INVENTORS!** Don't sell your invention, patented or unpatented, until you receive our offer. **Eagle Development Company,** Dept. P, 79 Wall Street, N.Y., N.Y. 10005.

**INVENTORS** Needing Help with any problem, financial, development, securing manufacturer, obtaining patent. Write the organization that delivers action and results—not promises. **Pioneer Invention Service,** Dept. 79, 150 Broadway, New York, N.Y. 10038.

---

## GOVERNMENT SURPLUS

---

**JEEPS** Typically From \$53.90 . . . Trucks From \$78.40 . . . Boats, Typewriters, Airplanes, Electronics Equipment, Photographic Equipment, used. 100,000 Bargains Direct From Government. Complete Sales Directory and Surplus Catalog \$1.00 (Deductible First \$10.00 Order). **Surplus Service,** Box 820-J, Holland, Mich. 49424.

---

## BOOKS

---

**FREE CATALOG.** Adult Books. **POSTAL PE,** 2217 Lackland, St. Louis, Missouri 63114.

**FREE** Book. Prophet Elijah Coming Before Christ. Wonderful Bible Evidence. **PE Megiddo Mission,** Rochester, New York 14619.

**FREE** catalog 950 aviation/electronic/space books, **Aero Publishers,** 329PE Aviation Road, Fallbrook, California 92028.

---

## MAGAZINES

---

"**JAPANESE Electronics Industry.**" Monthly Magazine. Sample \$1.00. Subscription \$10.00. "Oriental Electronics Directory." 200 Firms. \$2.00, **Dee,** Box 211, Beverly Hills, Calif. 90213.

---

## AUTHORS' SERVICES

---

**AUTHORS!** Learn how to have your book published, promoted, distributed. **FREE** booklet "ZD," **Vantage,** 120 West 31 St., New York 10001.

**POEMS WANTED** for new song hits and recordings by America's most popular studio. **Tin Pan Alley,** 1650-ZD Broadway, New York 10019.

---

## EMPLOYMENT OPPORTUNITIES

---

**ELECTRONIC INSTRUCTOR WANTED**—Spartan School of Aeronautics has opening for instructor to teach theory and laboratory for television and two-way communications. Call or write **Robert E. Jinkins;** Director of Electronics; Spartan School of Aeronautics; P.O. Box 51239; Dawson Station; Tulsa, Oklahoma 74151; Phone: Area Code 918, TE 5-4491.

---

## HYPNOTISM

FREE Hypnotism, Self-Hypnosis, Sleep Learning Catalog! Drawer H400, Ruidoso, New Mexico 88345.

"FEMALE HYPNOTISM" Exposed, explained! "Secret Method"—they never know! \$2, rushed. Guaranteed! Isabella Hall, Silver Springs, Florida 32688.

## RUBBER STAMPS

RUBBER ADDRESS STAMP \$1.50. SIGNATURE \$2.88. FREE CATALOG. JACKSON PRODUCTS, 1433 WINNE-MAC, CHICAGO, ILL. 60640.

## PHOTOGRAPHY—FILM, EQUIPMENT, SERVICES

MEDICAL Film—Adults Only—"Childbirth"—1 reel 8mm \$7.50—16mm \$14.95. International-E, Greenvale, L.I., New York 71548.

SCIENCE Bargains—Request Free Giant Catalog "CJ"—148 pages—Astronomical Telescopes, Microscopes, Lenses, Binoculars, Kits, Parts. War surplus bargains. Edmund Scientific Co., Barrington, New Jersey 08007.

## EDUCATIONAL OPPORTUNITIES

WANTED! TV—Radiomen to learn aircraft electronics servicing. Numerous job openings everywhere. Write: Academy Avionics, Reno/Stead Airport, Reno, Nevada 89506.

LEARN WHILE ASLEEP. Miraculously build Mind Power, achieve Self-Confidence, improve Health, gain Success. Method 92% effective. Details free. ASR Foundation. Box 7021EG Henry Clay Sta., Lexington, Kentucky 40502.

## DO-IT-YOURSELF

BUILD your own telephone intercom—complete—less battery. Write Telephones, Box PE67, Simpson, Penna. 18407.

## EMPLOYMENT INFORMATION

FOREIGN and USA job opportunities available now. Construction, all trades. Earnings to \$2,000.00 monthly. Paid overtime, travel, bonuses. Write; Universal Employment, Woodbridge, Connecticut 06525.

FOREIGN EMPLOYMENT. Construction, other work projects. Good paying overseas jobs with extras, travel expenses. Write only: Foreign Service Bureau, Dept. D, Bradenton Beach, Florida 33510.

JOBS! NATIONWIDE OPPORTUNITIES! ENGINEERS, TECHNICIANS, COMPLETE LIST. REVISED MONTHLY. \$1.00. BOX 9946, WASHINGTON, D. C. 20015.

EMPLOYMENT Resumes. Get a better job & earn more! Send only \$2.00 for expert, complete Resume Writing Instructions. J. Ross, 80-34 Kent St., Jamaica. N.Y. 11432, Dept. PE.

## REAL ESTATE

FREE!!! Illustrated 168 page catalog! Describes hundreds of farms, ranches, homes, businesses, vacation, retirement and waterfront properties coast to coast! Specify type property and location preferred. Zip code, please. UNITED FARM AGENCY, 612-EP West 47th St., Kansas City, Mo. 64112.

**CORNELL**  
**33**  
**TUBES**  
**1 YR. GUARANTEED**  
**SENSATIONAL PRICES**  
• TUBE CARTONS  
• DIODE KITS  
• TOP HATS  
• TUNER CLEANER  
**SEND FOR FREE CATALOG**  
4205 University Ave.  
San Diego, Calif. 92105

**CORNELL ELECTRONICS CO.**  
4205 University Ave., San Diego, Calif. 92105

## MOVIE FILMS

SUPER or REGULAR 8mm—SPORTS ACTION IN EXCITING COLOR! Catalog. SPORTLITE FILMS-PE, 20 North Wacker Drive, Chicago, Illinois 60606.

## PRINTING

EMBOSSED business cards, \$2.99—1,000, free samples. Gables—405T Clifton, Glenshaw, Pa. 15116.

FREE Booklet "Secrets of Cutting Printing Cost." Dept. I, 305 S. 4th, Springfield, Illinois 62701.

## STAMPS

450 FINE Mixed U.S. 15¢, Wright, Box 753-X, Hagerstown, Md. 21740.

## BUSINESS OPPORTUNITIES

INVESTIGATE ACCIDENTS: Earn up to \$1,000 and more a month in your own business. Work spare time with average earnings of \$5 to \$8 per hour. No selling. Send for Free booklet. No obligation. No salesman will call. Write: Universal Schools, CZ-7, 6801 Hillcrest, Dallas, Texas 75205.

RAISE Rabbits for us on \$500 month plan. Free details. White's Rabbitry, Mt. Vernon, Ohio 43050.

EXCELLENT Opportunity for extra income selling home burglary protection equipment. One of the fastest growing fields today. No special skills required. Dimension, Inc., 2835 Dorr Ave., Fairfax, Virginia 22030.

VENDING Machines—No Selling. Operate a route of coin machines and earn amazing profits. 32-page catalog free. Parkway Machine Corporation, 715PE Ensor Street, Baltimore, Md. 21202.

FREE CATALOGS. Repair air conditioning, refrigeration. Tools, supplies, full instructions. Doolin, 2016 Canton, Dallas, Texas 75201.

PIANO TUNING learned quickly at home. Tremendous field! Musical knowledge unnecessary. GI Approved. Information free. Empire School of Piano Tuning, Miami, Florida 33145.

ELECTROPLATING Equipment and supplies. All types for home workshops and industrial. Send \$1.00 (refundable) for equipment guide formulas, operating data, catalog. HBS Equipment Division 90, 3543 East 16th, Los Angeles, California 90023.

MAKE up to \$10,000 a year raising chinchillas, mink, rabbits or guinea pigs for us. We supply breeding stock, equipment and feed. Send \$1.00 for catalog and complete information. Keeney Brothers Farms, Dept. ZE, New Freedom, Pa. 17349.

I MADE \$40,000.00 Year by Mailorder! Helped others make money! Start with \$10.00—Free Proof. Torrey, Box 318-N, Ypsilanti, Michigan 48197.

FREE Book "990 Successful, little-known Businesses." Work home. Plymouth 145G, Brooklyn, N.Y. 11218.

**ELECTRICAL REPAIR**—Washers, dryers, motors, stoves, clocks, toasters. Free Details. Industrial Training Institute, Dept. 65098, 815 E. Rosecrans, Los Angeles 90059.

**MUSIC**

**POEMS** wanted for new songs. Nashville Music Institute, Box 532-E, Nashville, Tennessee, 37202.

**EQUIPMENT**

**FREE ELECTRONICS** Catalog. Tremendous bargains. Send postcard: Electrolab, Department C-679D, Hewlett, New York 11557.

**MISCELLANEOUS**

**WINEMAKERS:** Free illustrated catalog of yeasts, equipment. Sempex, Box 7208, Minneapolis, Minn. 55412.

**SPARE TIME OPPORTUNITY—MONEY—WE PAY \$10 hr.** for **NOTHING** but your opinions, written from home about our clients' products and publications, sent you free. Nothing to buy, sell, canvass, or learn. No **SKILL. NO GIMMICKS.** Just honesty. Details from **RESEARCH, ZD2, Box 669, Mineola, N.Y. 11501.**

**COLLAPSIBLE** farm pond fish traps. Animal traps. Bargains galore. Free catalog and trapping secrets. Sensitronix, 2225-F62 Lou Ellen, Houston, Texas 77018.

**STAMMER** — Stutter — No More. (Dr. Young.) Write: Gaucho, Box 9309-E8, Chicago 60690.

**STOP BURGLARS THE EASY WAY!!** Affix authentic "Protected by Electronic Sentry Alarm" Decals to auto windows, doors & windows of home, retail stores, vending machines, etc. Whether you have an alarm or not—thieves stay away! Only \$1.00 each set of two. J. Ross, 80-34 Kent St., Jamaica, N.Y. 11432 Dept. PE.

**MAIL ORDER OPPORTUNITIES WAITING FOR YOU!**

Classified Advertisers find more outlets for their product and service advertising in Ziff-Davis Electronics Publications than in any other media.

Whether in a monthly publication: **POPULAR ELECTRONICS, ELECTRONICS WORLD, HiFi/STEREO REVIEW . . .** or in an annual: **COMMUNICATIONS HANDBOOK, ELECTRONIC EXPERIMENTER'S HANDBOOKS, ELECTRONICS INSTALLATION AND SERVICING HANDBOOK, or TAPE RECORDER ANNUAL—**Classified Advertising is responded to regularly by an affluent audience of active electronics enthusiasts.

Prove to yourself the effectiveness of Classified Advertising in Ziff-Davis Electronics Publications. Write today for information, assistance or sample copies to:

**Hal Cymes, Classified Advertising Manager**  
**Ziff-Davis Publishing Company**  
**One Park Avenue, New York, N. Y. 10016**

**POPULAR ELECTRONICS**

**JULY 1967**

**ADVERTISERS INDEX**

READER SERVICE NO.	ADVERTISER	PAGE NO.
1	Allied Radio	94
	American Institute of Engineering & Technology	96
2	Amperex Electronic Corp	FOURTH COVER
3	Argos Products Company	94
4	B & K	23
5	Burstein-Applebee Co	8
	Capitol Radio Engineering Institute	68, 69, 70, 71
6	Cleveland Institute of Electronics	11
7	Cleveland Institute of Electronics	86, 87, 88, 89
	Cornell Electronics Co	103
8	Courier Communications, Inc	25
	Coyne Electronics Institute	90
28	Delta Products, Inc	10
	DeVry Institute of Technology	5
9	Drake Company, R.L.	97
	Electro-Voice	95
11	Hallicrafters	6
12	Heath Company	12, 13
13	International Crystal Mfg. Co., Inc	9
14	Johnson Company, E.F.	17
15	Kuhn Electronics	16
16	Lafayette Radio Electronics	16
17	Milwaukee School of Engineering	98
18	Mosley Electronics, Inc	85
19	Multi-Elmac Co	82
20	Multicore Sales Corp	8
	National Radio Institute	SECOND COVER, 1, 2, 3
	National Technical Schools	7
21	Pace Communications Corp	83
29	Pace Communications Corp	83
30	Port Arthur College	93
	RCA Electronic Components and Devices	THIRD COVER
31	RCA Electronic Components and Devices	81
	RCA Institutes, Inc	18, 19, 20, 21
22	Sams & Co., Inc., Howard W	96
23	Shure Brothers, Inc	26
24	Sonar Radio Corp	91
25	Squires-Sanders, Inc	92
26	Turner Microphone Company, The	14
	Valparaiso Technical Institute	96
27	World Radio Laboratories	93
<b>CLASSIFIED ADVERTISING 99, 100, 101, 102,</b>		<b>103, 104</b>



# Now in one handbook...the service information you need for 12 makes of color TV sets

## TABLE OF CONTENTS

- INTRODUCTION  
 HOW TO USE THIS HANDBOOK  
 ABBREVIATIONS USED IN THIS HANDBOOK
- Section 1. CHASSIS INDEX
  - Section 2. CHASSIS LAYOUTS
  - Section 3. PURITY ADJUSTMENTS
  - Section 4. CONVERGENCE ADJUSTMENTS
    - STATIC CONVERGENCE (general)
    - DYNAMIC CONVERGENCE (specific)
  - Section 5. BLACK-AND-WHITE SETUP ADJUSTMENTS
  - Section 6. PHASE AND MATRIX ADJUSTMENTS
  - Section 7. COLOR AFC FIELD ADJUSTMENTS
  - Section 8. MISCELLANEOUS ADJUSTMENTS
  - Section 9. FUSES AND CIRCUIT BREAKERS
  - Section 10. TEST EQUIPMENT FOR COLOR TV SERVICING
  - Section 11. RECEIVING TUBES FOR COLOR TV

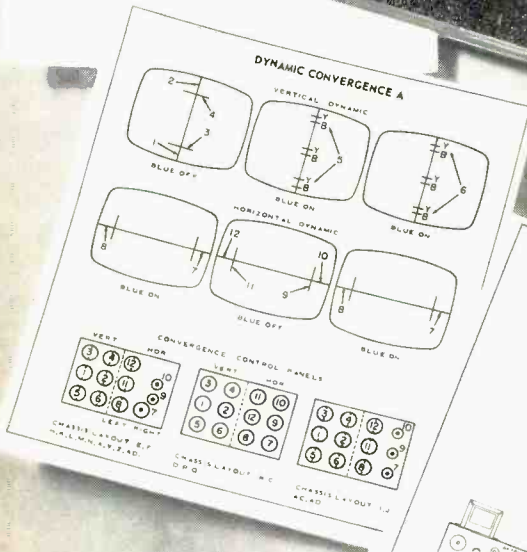

"Dynamic Convergence"

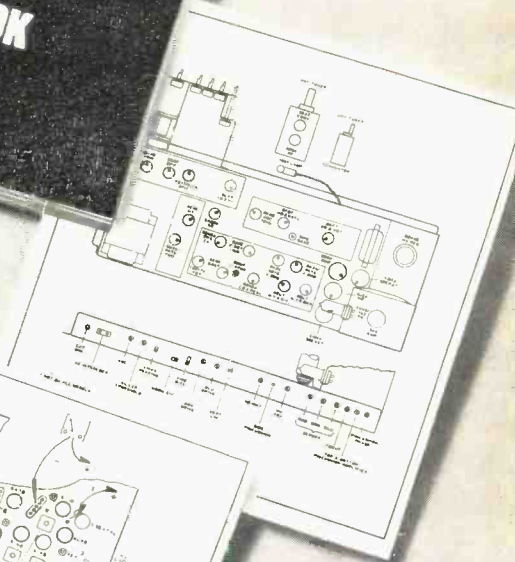

"Color AFC Field Adjustments"

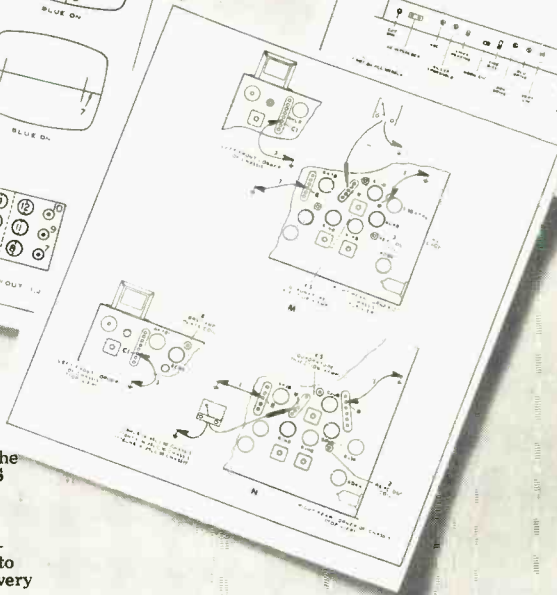

"Chassis Layouts"

Just look up the chassis number of the set you are working on in the CHASSIS INDEX and you will be guided to the proper sections of the 140-page RCA Color TV Service Handbook. All the information is based on the manufacturer's own service notes. You'll want to carry a copy in your tube caddy on every color TV service call.

**TO KEEP UP WITH COLOR, SEE YOUR RCA DISTRIBUTOR ABOUT GETTING THE RCA COLOR TV SERVICE HANDBOOK (1A1553).**

RCA ELECTRONIC COMPONENTS AND DEVICES, HARRISON, N. J.



**The Most Trusted Name in Electronics**

RCA's personal quality performance program aims for missile-type reliability in commercial receiving tubes. Under this program thousands of RCA people have pledged to strive for error-free performance so that when you replace with RCA receiving tubes you're sure of a satisfied

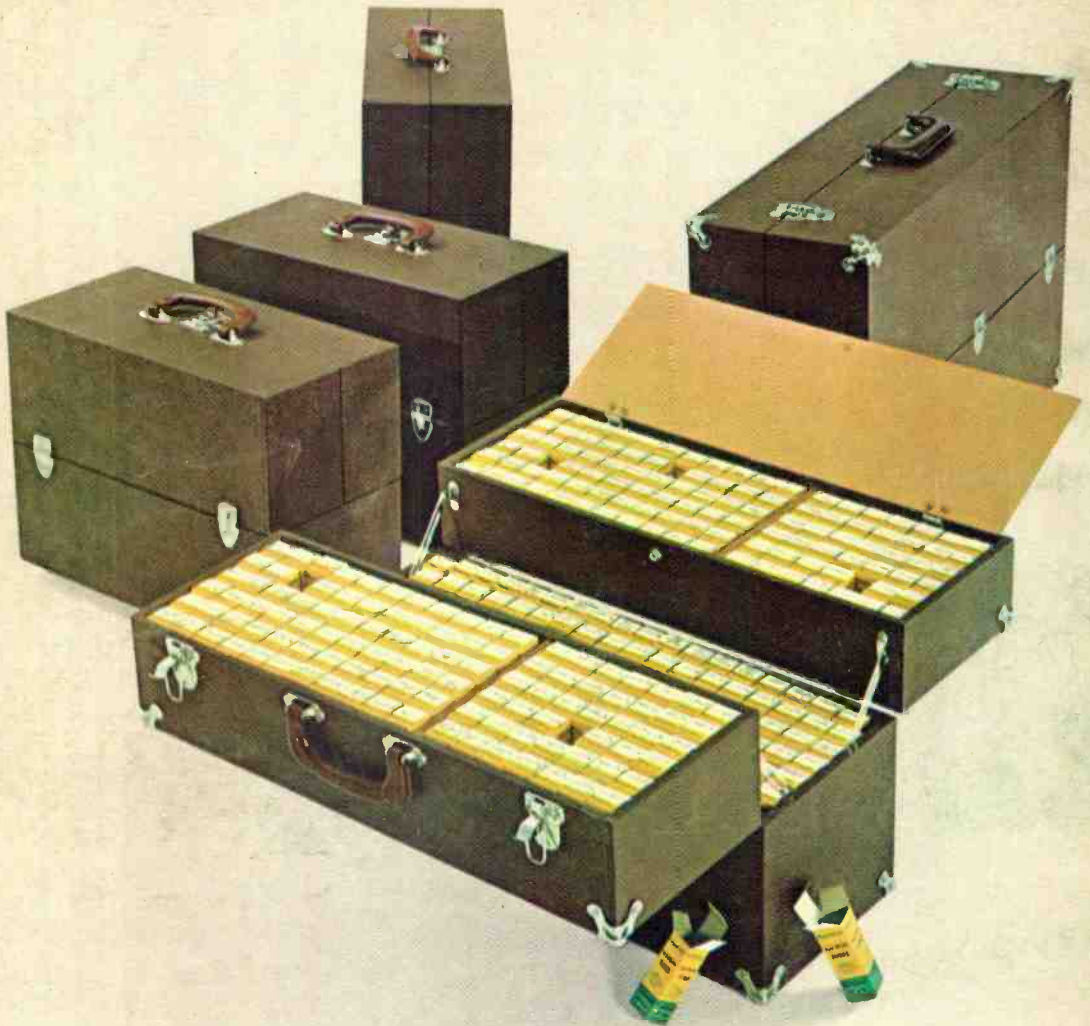

**One out of every five  
professional servicemen  
has switched to Amperex  
TV replacement tubes**

It takes a lot of quality to change the buying habits of 20% of the most knowledgeable technicians in the business. These servicemen are following the pattern set by the leading TV manufacturers, who are designing more and more of their quality lines around tubes originated by Amperex. The Amperex line of popular types is expanding all the time. Look for the green and yellow cartons at your distributor's or write: Amperex Electronic Corp., Hicksville, L. I., N.Y. 11802.

**Amperex**

TOMORROW'S THINKING IN TODAY'S PRODUCTS

