

ELECTRONICTM

Servicing & Technology

September 1995

New technology in consumer electronics

Mechanical problems in the Sanyo VHR9300



Oscilloscope Update/ Multimeter Update

U.S. \$3.00



*****2-DIGIT 448
01 000553269 9604 10000

PULL-OUT PROFAX
RCA Proscan
Color Television
Model No. CTC187

A VCR Is Like A Box Of Chocolates...

...You Never Know
What You're Gonna Get!

When that next VCR walks in your front door, you never know what kind of problem you'll be looking at. Whether the problem is heads, servos, electrical, or mechanical, you need to find the source of the problem as soon and as accurately as possible.

When you need quick, simplified, yet complete VCR analyzing help, the VC93 All Format VCR Analyzer dynamically and completely analyzes all VCR video, audio, tuner, and servo problems. You'll have everything you need the next time you're looking for an answer to a confusing VCR problem. Thousands of proud VC93 owners already give it an outstanding "thumbs up."

VCRs and the VC93 All Format VCR Analyzer go together just like troubleshooting efficiency and profits. To discover more about the VC93 All Format VCR Analyzer and how it can help your business, call your Area Representative today.



Call 1-800-SENCORE (736-2673)

Circle (1) on Reply Card

SENCORE
3200 Sencore Drive, Sioux Falls, SD 57107
Direct: (605)339-0100 Fax: (605)339-0317

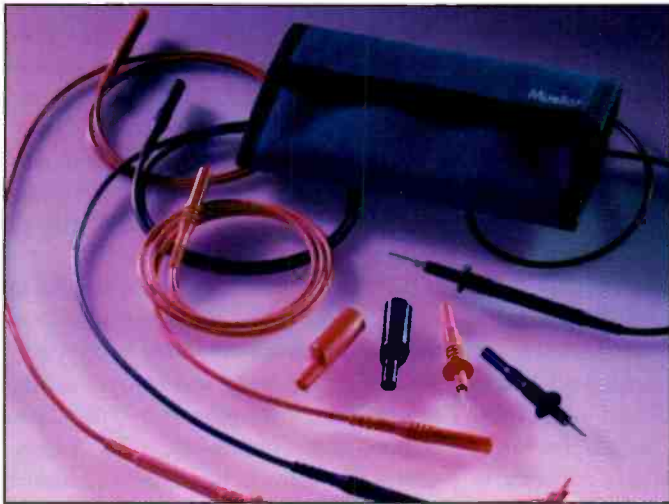

page 6

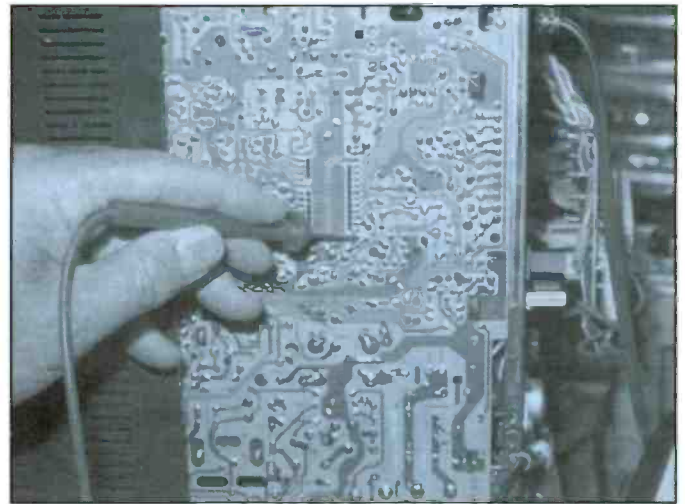

page 46

FEATURES

6 Three part multimeter update: Selecting a multimeter test probe assembly

By Matthew Dare

The choice of a probe assembly depends on application, frequency of use, environment, longevity, and safety. Refer to the guidelines given in this article the next time you are planning to buy a set of probes.

Multimeter safety standards

By The ES&T Staff

When, on a rare occasion a servicer has to make measurements on an ac power supply he must keep safety uppermost in mind. This article will help technicians become more aware of safety precautions.

Is your multimeter giving you the right information?

By The ES&T Staff

How appropriate and how effective are your measurement tools at addressing problems of distortion and overall power quality? This month the ES&T staff will help answer those questions.

12 Mechanical problems in the Sanyo VHR9300

By Steve Babbert

In this article the author discusses how to troubleshoot common problems associated with the Sanyo VHR9300 television set.

16 Oscilloscope update: Choosing an oscilloscope probe

By ES&T Staff / ITT Pomona

Here are several important factors to consider when selecting an oscilloscope probe.

26 New technology in consumer electronics

By The ES&T Staff

This article provides a recap of some of the recent developments that will one day have an effect on the lives and work of those people who work in the consumer electronics industry.

46 Troubleshooting audio circuits by the numbers

By Homer Davidson

Sound circuits can be easily serviced by the numbers. In this article the author explains this process.

35 Profax

45 Test Your Electronics Knowledge

A little of everything

52 Photofacts

55 Business Corner

Service business management

58 Literature

61 ES&T Calendar of Events

62 Computer Corner

Setting up a LAN

67 What Do You Know About Electronics?

Diodes

70 Products

74 Classified/Readers' Exchange

76 Advertisers' Index

ON THE COVER

Oscilloscopes and multimeters have been workhorses for technicians for years, displaying waveforms, voltage levels, resistances and a lot more. Somehow you wouldn't expect that manufacturers of these devices would be able to keep making them more useful, but they do. At the same time, they manage to keep making them smaller and more portable, and do all of this at bargain prices. (Photo courtesy Tenma Test Equipment)

DEPARTMENTS

2 Editorial

4 News

25 Books

THE PROFESSIONAL MAGAZINE FOR ELECTRONICS AND COMPUTER SERVICING

ELECTRONIC

Servicing & Technology

Technical students choose consumer electronics servicing

On a warm day this past June, I drove into Kansas City to attend an event at the newly expanded Bartle Hall. I was amazed at the sight that greeted me as I drove into the downtown area. Kansas City's normally quiet downtown area was alive with young people walking around, sitting on the steps of Bartle Hall, buying hot dogs, soft pretzels and soft drinks from street vendors. Also amazing was the municipal parking lot; it was full. I had to drive three blocks, park in a commercial lot and walk the three blocks back to Bartle Hall.

The event that was causing all of this activity was the 1995 Annual VICA USA Skills Championships. VICA, the Vocational and Industrial Clubs of America, is an organization to which many students who attend vocational and industrial schools, both at the secondary (high school) and post-secondary (two-year college, for example) levels belong to. There were students from every conceivable type of trade and technical occupation: diesel mechanics, jet-engine mechanics, hair dressers and more.

The reason I was attending the event, however, is that there was a contingent of students from throughout the United States there to test and demonstrate their skills in consumer electronics servicing. These were students from large schools, such as DeVry, as well as from small technical colleges, community colleges and vocational courses in high schools.

The competition consists of three parts: a written test, construction of an electronics kit and troubleshooting of a consumer product that had been deliberately bugged with a known problem.

The competition was staged by VICA, but there were representatives of the consumer electronics industry everywhere, performing the functions necessary to keep everything going and under control. There were several representatives of the Electronic Industries Association/Consumer Electronics Group (EIA/CEG), and manufacturers of consumer electronics products, manufacturers of tools and test equipment and more. See the related news item in this issue for a complete list of the individuals and companies who were in attendance at the event.

The students in this event participate because they have pride in what they're doing, and in the profession they plan to practice once they graduate. The three top

students in each school category, secondary and post-secondary, who perform the best are awarded medals: Gold, Silver or Bronze (the Skill Championships used to be called the Skill Olympics). They are also awarded prizes given by manufacturers, such as tool kits, test equipment, and other prizes coveted by budding technicians. The best of these students may go on to international competition.

The message of these competitions of interest to us is that there are students in the world who are interested in consumer electronics servicing, and who are willing to work hard to develop their skills and to be good at that profession. It also demonstrates that many companies in consumer electronics are willing to spend money for sponsorship and prizes to help develop these skilled individuals.

Skills standards

The idea of a skills championship competition brings up the question: "What does a technician need to know in order to competently service a product?" That question leads, in turn, to several other questions, such as who can or will determine the body of knowledge and other skills that a technician needs? Given the advanced state of electronics technology today, that's a big challenge.

This very question has been addressed in considerable detail by a broad-based group of industry, government and educational organizations, including representatives of the Electronics Industries Association, the Electronics Industries Foundation, consumer electronics manufacturers, other associations, schools and more.

The skills standards that have been developed include a broad range of attributes that technicians are expected to demonstrate, including Desirable Behaviors and Work Habits, Technical Skills, Test Equipment and Tools Skills, Basic and Practical Skills, and Additional Skills.

The document that sets forth these criteria includes details of each of these areas, and even provides estimates for the amount of time that will be required to teach them.

Implementation of these skills standards is ongoing. We'll keep readers posted as developments occur.

Nils Conrad Penner



BOOM!

The Digital Explosion **HAS BEGUN!**

Computer and multimedia hardware and software, online services, digital audio and video, DVD, satellite, interactive TV and home automation products are competing for consumers' spending dollars. But what is the winning product mix — and how do you sell it?

CES Orlando — The Digital Destination — showcases how digital technology and home electronics products will converge. With a complete conference and training program and an exhibit floor dedicated to digital technology, CES Orlando will be the one show that gives you it all.

For more information, call 703-907-7600.

 **CES**[®]
ORLANDO '96
The Digital Destination

May 23-25, 1996 Orange County Convention Center Orlando, Florida



Sponsored by the Electronic Industries Association's Consumer Electronics Group (EIA/CEG) and the Software Publishers Association. Produced and managed by EIA/CEG.

ELECTRONIC

Servicing & Technology

Electronic Servicing & Technology is edited for servicing professionals who service consumer electronics equipment. This includes service technicians, field service personnel and avid servicing enthusiasts who repair and maintain audio, video, computer and other consumer electronics equipment.

EDITORIAL

Nils Conrad Persson, *Editor*
 Kirstie A. Wickham, *Associate Editor*
 Richard S. Moseson, NW2L, *On-Line Coordinator*

CONSULTING EDITORS

Homer L. Davidson, *TV Servicing Consultant*
 Victor Meeldijk, *Components Consultant*
 John E. Shepler, *Audio Consultant*
 Sam Wilson, *Electronics Theory Consultant*

PRODUCTION

Elizabeth Ryan, *Art Director*
 Barbara Terzo, *Associate Art Director*
 Susan Oliveri, *Assistant Art Director*
 Edmond Pesonen, *Electronic Composition Mgr.*
 Dorothy Kehrwieler, *Production Manager*
 Emily Kreutz, *Assistant Production Manager*
 Pat Le Blanc, *Phototypographer*

BUSINESS

Richard A. Ross, *Publisher*
 John Dorr, *General Manager*
 Frank V. Fuzia, *Controller*
 Simon Schatzmann, *Circulation Director*
 Catherine Ross, *Circulation Manager*
 Melissa Nitschke, *Operations Manager*
 Carol Licata, *Data Processing*
 Denise Pyne, *Customer Service*

SALES OFFICE

Electronic Servicing & Technology
 76 N. Broadway, Hicksville, NY 11801
 516-681-2922; FAX 516-681-2926
 Diane G. Klusner, *Director of Advertising*
 Emily Kreutz, *Sales Assistant*

EDITORIAL CORRESPONDENCE:

P.O. Box 12487
 Overland Park, KS 66212
 913-492-4857

National Electronics Service

NESDA

Dealers Association, Inc.
 Member, Electronic Servicing
 Dealers Association



Electronic Servicing & Technology (ISSN 0278-9922) is published 13 times a year by CQ Communications, Inc. 76 N. Broadway, Hicksville, NY 11801. Telephone (516) 681-2922. Second class postage paid at Hicksville, NY and additional offices. Subscription prices (payable in US dollars only): Domestic—one year \$24.75, two years \$45. Foreign countries—one year \$30.75, two years \$57. Entire contents copyright 1995 by CQ Communications, Inc. Electronic Servicing & Technology or CQ Communications, Inc. assumes no responsibility for unsolicited manuscripts. Allow six weeks for delivery of first issue and for change of address. Printed in the United States of America.

Postmaster: Please send change of address notice to Electronic Servicing & Technology, 76 N. Broadway, Hicksville, NY 11801.

CQ Communications, Inc. is publisher of CQ The Radio Amateur's Journal, Popular Communications, Micro-Computer Journal, CQ Radio Amateur (Spanish CQ), CQ Amateur Radio Equipment Buyer's Guide, CQ Amateur Radio Beginner's Buyer's Guide, Popular Communications Communications Guide, and Electronic Servicing & Technology.

News

EIA/CEG publishes its 1995 edition of the U.S. Consumer Electronics Industry In Review

Sales to dealers of consumer electronic products grew nine percent after 1993 reaching \$55.9 billion according to the newly-published 1995 Edition of "The U.S. Consumer Electronics Industry In Review: Entertainment & Education Yesterday, Today & Tomorrow (The Review)." The Electronic Industries Association (EIA) expects to see an increase of almost seven percent in 1995 of factory sales for consumer electronics bringing the total to \$60 billion.

"The Review" discusses these and other growth trends in the consumer electronics industry. "The Review" provides an analysis and discussion of the historical, statistical and market trends reflected in this industry. Further, a look at 1994 reveals that:

- Sales of home theater products, inclusive of several audio and video categories, reached \$7.7 million.
- The introduction of Digital Satellite Systems (DSS) redefines analog technology for a digital video future.
- Large-screen televisions (25 inches and above) dominated sales of color TVs over 19 and 20-inch sets.
- Projection TVs gave a repeat performance, for the fifth straight year, with \$1.1 billion in sales.

"The Review" also examines other issues which faced the consumer electronics industry in 1994. Specifically, EIA/CEG Government and Legal Affairs Department's involvement in the coordination of producing an industry white paper on the National Information Infrastructure. Additionally, EIA/CEG's lobbying efforts on Capitol Hill resulted in creating Congressional opposition to a Department of Energy proposal which would have eliminated many of the enhanced features on televisions. The association was also successful in averting a mandate to equip all televisions with the v-chip technology (the integration of program content advisories over line 21 of vertical blanking during violent scenes). These and many other issues are discussed in this publication.

All data was compiled by the Electronic Industries Association's Marketing Ser-

vices Department which has developed comprehensive statistical reporting programs for over three decades.

ISCET Receives White House Recognition

The International Society of Certified Electronics Technicians (ISCET) has received congratulations from President Bill Clinton on its 25th Anniversary. ISCET, which was founded in July of 1970, celebrated its 25th Anniversary at the National Professional Electronics Convention, July 31 through August 5, at the Hyatt Regency Crystal City Hotel in Arlington, VA.

In his letter, President Clinton stated, "For twenty-five years, ISCET has worked to educate its members and promote excellence within the field of electronics. The strength of your organization today exemplifies the ongoing commitment to professionalism that inspired your founders."

There are technicians certified by ISCET in all 50 states and 41 territories and foreign countries. Based on past statistics, the 40,000th technician will be certified before the end of 1995. The program has helped assure consumers that the technician entrusted to service their product possesses the knowledge, training, and experience to perform exacting technical work with distinction.

The White House letter closed with best wishes for many years of continued success. For more information about ISCET and the CET program, contact ISCET, 2708 West Berry, Fort Worth, TX 76109, (817) 921-9101, Fax (817) 921-3741.

Appliance technicians certified

Seventeen technicians received the "Certified Appliance Technician" title and three managers became "Certified Service Managers" following examinations conducted at the annual Major Appliance Servicer Convention, held February 23 through 25, in Houston, TX.

The successful technicians, who were among a group of 32 who sat for the exam, passed a rigorous examination given by the International Society of Certified Electronics Technicians (ISCET). The exam consists of 100 multiple-choice



Winners for major appliance technology



Winners for electronic products servicing

questions covering electrical circuits and components, refrigeration systems, laundry equipment, cooking equipment, and dishwashers and trash compactors. Successful applicants receive a wall certificate designating them as Certified Appliance Technicians and are eligible for membership in ISCET.

The management exam contains 100 multiple choice questions covering financial statements, customer and labor relations, billing and pricing, and law and regulations that affect servicers.

A seminar preparing the technicians for the exam was given at the convention by Ken Krober CAT, Santaquin, UT. Krober is preparing a study guide/practice test for the exam based on his successful seminar. The management session was conducted by Randy Whitehead CSM, Salt Lake City, UT.

The Certified Appliance Technician and the Certified Service Manager exams are available from ISCET/NESDA test administrators located throughout the nation and abroad. To receive a list of test sites, persons should contact ISCET, 2708 West Berry, Fort Worth, TX 76109. (817)921-9101. Fax (817)921-3741.

Winners in Electronic Products Servicing Announced 1995 Skills USA Championships

The winners of the twenty-ninth annual Skills USA Championships (formerly called the VICA United States Skill

Olympics) in Electronic Products Servicing were announced Friday evening, June 30, at the Awards Session of the VICA National Leadership and Skills Conference. The Conference was held June 27—June 30, 1995, at the Municipal Auditorium and the H. Roe Bartle Hall in Kansas City, Missouri. More than 3,600 outstanding vocational students joined in the excitement of hands-on competition in fifty-four different trade, technical, and leadership fields.

Working against the clock and each other, the participants proved their expertise in job skills for occupations such as electronics, technical drafting, precision machining, medical assisting and culinary arts. There were also competitions in leadership skills, such as extemporaneous speaking and conducting meetings by parliamentary procedures.

The Vocational Industrial Clubs of America (VICA) is the national organization for students in trade, industrial, technical and health occupations education. It sponsors the Skills USA Championships annually to recognize the achievements of vocational students and to encourage them to strive for excellence and pride in their chosen occupations.

The contests are planned by technical committees made up of representatives of labor and management and are designed to test the skills needed for a successful entry-level performance in given occupational fields. Safety practices and pro-

cedures—an area of great concern to labor and management alike—are judged and graded and constitute a portion of a contestant's score.

Section I of the contest consisted of six individual test stations that provided a variety of challenges in servicing "state-of-the-art" consumer electronics products: personal computer, color television/monitor, VCR, audio, electronic test equipment, and digital technology. Section II activities evaluated the contestant's soldering and desoldering skills, and the student was required to assemble an electronic kit. Section III was a written safety/theory exam designed to test understanding of safety procedures, electronic concepts, and servicing procedures.

In the electronic products servicing contest, the top students were:

Mitchell Whitaker from Cynthia, KY, First Place in the Post-secondary division; Scott Templin from Valdosta, GA, Second Place in the Post-Secondary division; Carlos Lovera from Whittier, CA, Third Place in the Post-Secondary division; Philip Carmichael from Tyler, TX, First Place in the Secondary division; Peter Johnson from WValley, UT, Second Place in the Secondary division; Jean-Paul Rodrigues from Las Vegas, NV, Third Place in the Secondary division.

Each of these winners has been awarded a one-year complimentary subscription to **Electronic Servicing & Technology** magazine. ■

Selecting a multimeter test probe assembly

(Keep in mind safety and convenience)

By Matthew Dare

Multimeter probe assemblies are pretty simple: a plug to mate with the meter, a length of test lead and a prod to touch the points of interest in the circuit. In actuality, selecting a set of multimeter test probes is not as simple as it appears to be. Care taken in selecting a set of probes will be rewarded by safety in operation, accuracy of measurements, and long probe life.

At the meter end

Looking at the meter end of the connection first, some of the most often used terminations are:

- the 4mm banana jack for unshrouded banana plugs.
- the 4mm banana jack for shrouded banana plugs.
- BNC female connector.
- miniature banana jack.
- 0.080-inch pin receptacle.

For general purpose meters, the 4mm banana jack is the most common connection. The BNC connector is number two in popularity. Always check to see if the instrument can accept a shrouded test lead if you're considering buying a set of these. Not all meters can accept them.

Second, consider the voltages and current that will typically be measured. If the working voltages you'll be measuring exceeds 30V, use a probe that is fully shrouded, rated for higher voltages, and that conforms to the IEC 1010 standard.

Probes made to this standard are clearly marked with the voltage rating. Note that the measurement of very low voltages, or currents less than 1mA requires specialized leads and techniques.

Environmental considerations

Next, evaluate the environment in

Dare is manager of Quality Systems for Mueller Electric Co., Cleveland, Ohio.

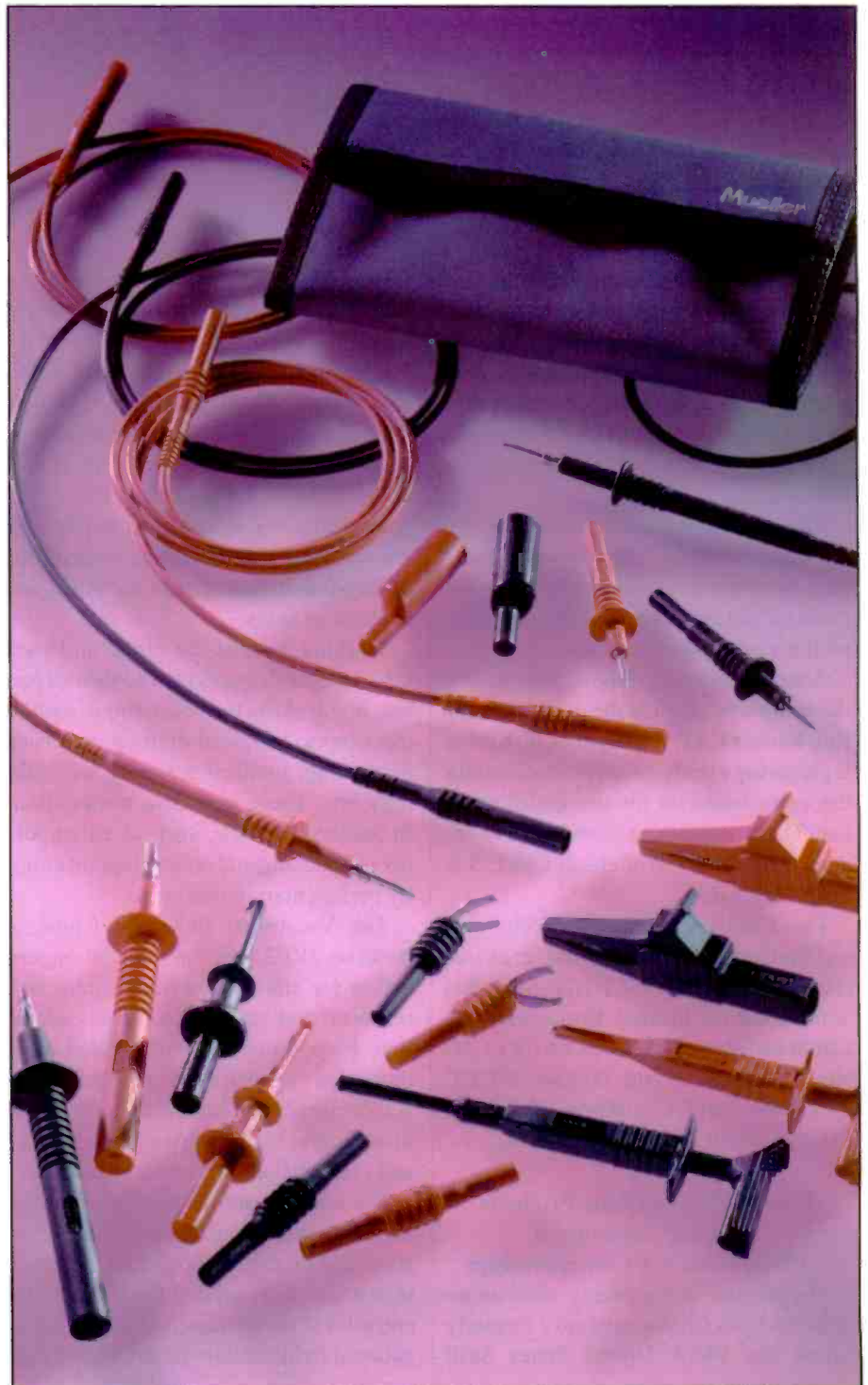

Photo courtesy of Mueller Electric Company

which the leads will ordinarily be used to determine the insulator materials that you should be looking for. In terms of safety, most probes are voltage rated at pollution category 2, defined as nonconductive pollution. The greater the amount and conductivity of pollution present, the greater the creepage and clearance distances needed to ensure operator safety. Elevated temperatures cause perspiration, along with the secretion of other body oils that are conductive pollutants.

Temperature extremes, moisture and contaminants also affect the insulator materials themselves. PVC becomes brittle at low temperatures; silicone does not, but it can pick up an electrostatic charge at low temperatures. ABS, a common test prod housing material, becomes brittle when exposed to aromatic or chlorinated hydrocarbons and lubricants.

Non-silicone based rubber can also be affected by hydrocarbons and may become brittle or crack when exposed to ozone and strong ultraviolet light (UV). Even microscopic fractures can be dangerous by virtue of the consequent reduction in creepage distance.

Some good choices

Polypropylene and nylon are good choices for high end probes. While nylon does absorb moisture, this is not a factor except where very low currents and voltages are to be measured. These materials also lend themselves well to incorporating molded strain reliefs which are desirable features on any prod portion of a probe in daily use. Silicone, when used as a wire insulation is prone to "pullback," so look for a mechanical restraint on the insulation of these probes.

In an 18AWG (American Wire Gauge) flexible wire, the number of strands can vary from 65 to 500. The most expensive and long lasting probes use a 400+ conductor sheathed in silicone. The conductor is welded or mechanically attached to a brass insert. To meet the IEC 1010 standard, this connection cannot be a part of the strain relief. The prod needle tip must be brass or stainless steel. Brass conducts better, but stainless holds a point longer and penetrates oxidation, insulation or conformal coatings.

The banana plug can have 4-leaf or 9-leaf spring construction. The 9-leaf can

rotate on its spindle and is typically good for 10,000 operations. Lifespan of a 4-leaf is variable. It doesn't rotate and can be damaged by forced rotation.

Configurability

A modular probe uses a lead with a plug at each end and variable attachments to be slipped on the ends. A multiple feature probe uses a prod with a male thread immediately behind the needle tip. Thus the operator can screw lugs, plunger clips, alligator clips or extension needles to the prod. The operator must weigh the versatility of this type of probe against the inconvenience of assembly and disassembly. A good rule is that if a specific configuration is used more than 25% of the time, it should have a dedicated assembly.

Making the choice

The choice of a probe assembly depends on application, frequency of use, environment, longevity, and safety. Refer to these guidelines the next time you're planning to buy a set of probes for your favorite multimeter.

It's Hard To Find Fault With This Fault-Finder.

The Spectris 110 10BASE-T Wiring Fault-Tester. One-button, one-person fault-finding.

- Identifies open, shorted, crossed, reversed and split pair faults
- Performs cable identification and verification
- Tests all four pairs; tests 8 remotes simultaneously

Now Only \$249.95

No other instrument of its kind is as effective or easy to use. With the Spectris 110, testing and identifying faulty wiring in 10BASE-T cabling is as quick as the push of a button. All tests are run automatically. Green LEDs indicate correctly-wired pairs. If faults are found, red LEDs indicate which cables are incorrectly wired and a large, single-digit LED identifies the type of fault. The 110 can also verify or identify up to 8 individual cables using numbered remote units. And it makes wire-mapping an effortless task. (The #1 remote identifier comes with the unit; Nos. 2-8 are additional.)

The Spectris 110. The no-fault fault tester.



For more information on our Spectris 110 or to place your order, call (800) 439-4250 or Fax (800) 234-8286.

SPECIALIZED PRODUCTS COMPANY

©1995 Specialized Products Company

Circle (73) on Reply Card

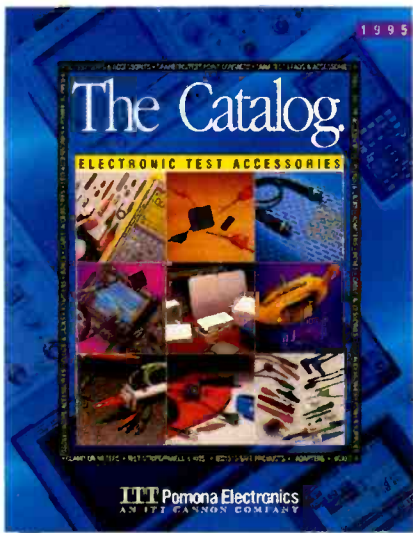

Brighten Up Your Test Life.

Using test instruments? Nothing will brighten your day more than one of these test accessories from the all-new Pomona Catalog:

- 30-450MHz monolithic Micro LC™ oscilloscope probes ■ IC test clips for MC68360 and X86 devices
- Programmable DIP IC test adapter ■ ESD service kits
- DMM test lead kits

You can put a FREE copy on your shelf today. Just visit your Pomona Distributor or contact:

ITT Pomona Electronics,
1500 E. Ninth St.,
Pomona, CA 91766-3835.
Phone: (909) 469-2900.
FAX (909) 629-3317.



FLUKE

Tektronix

ITT Pomona Electronics
AN ITC CANNON COMPANY

Multimeter safety standards

By The ES&T Staff

Electronics servicing technicians are not ordinarily required to make measurements on the ac power system, but on those occasions when the servicer suspects that power problems are contributing to equipment malfunction, there's no alternative but to take a look to see what the ac supply voltage is doing. When making such measurements, however, the technician must keep safety uppermost in mind, because transient overvoltages on today's power systems can compromise safety in troubleshooting, maintenance, and repair procedures.

Safety concerns have become paramount as occupational safety risks are recognized and businesses now take action to safeguard their employees. The safe use of test instruments is a critical matter. Fortunately, formal definitions now exist to guide users on the selection of appropriately rated test instruments for a specific overvoltage environment.

High-voltage, high-current

High-voltage and high-current environments are perhaps the greatest concern. Engineers, technicians, and electricians working on power systems must seriously consider the "overvoltage environment" in which they are performing measurements. "Overvoltage environment" refers to an installation environment in which a high transient voltage could occur on the system being measured. The level of the transient, in thousands of volts, defines the specific overvoltage category for the environment.

Typically, the farther the system is from the main distribution lines coming from the utility, the lower the potential transient level, because of inherent damping in the system. The transient alone may or may not have sufficient energy to be life-threatening, but the fact that the transient typically rides on top of a power source, such as 440V at 200A could have devastating follow-through effects. Thanks to the efforts of safety agencies in the US and Europe, definitions of installation environments and the risks inherent in each have been formalized in writing.

The International Electrotechnical Commission, or IEC, develops international general standards for safety of electrical equipment for measurement, and for control and laboratory use. IEC in 1988 voted to replace an older standard, IEC-348, with a more stringent standard, IEC-1010-1. IEC-1010-1, including amendment 1, is used as the basis for the following standards:

- US standard ANSI/ISA-S82.01-94
- Canadian standard CAN C22.2 No. 1010.1-92
- European standard EN61010-1:1993

Here are some of the commonly asked questions about IEC-1010-1, especially as it applies to electrical and electronic test equipment.

How are IEC-1010-1 and IEC-348 different?

There are many differences between these two standards. One of the main differences concerns spacing requirements. The IEC-1010-1 standard goes a step further than IEC348 in the spacing requirements for a given maximum input-voltage rating. The standard refers to these spacings as "creepage" distance (along surfaces) and "clearance" distance (shortest distance through the air). Larger clearance distances enable the meter to withstand the higher overvoltage transients that may be found on the electrical distribution system being measured.

What is an overvoltage category, and what is the significance of overvoltage category III?

IEC-1010-1 specifies overvoltage category ratings, which relate to the probability of a voltage occurring (at some location) that is significantly higher than the voltage expected. For example, an unexpected voltage transient would be considered an overvoltage. Overvoltage categories range from I to IV, in increasing order of overvoltage level expected. They are not necessarily related to the nominal voltage level of the system.

Overvoltage Category IV is typically the overhead or underground utility ser-

vice to an installation and is beyond the scope of IEC-1011. Overvoltage Category III typically refers to the main voltage feeder or branch circuit lines that are separated from the utility service by at least a single level of transformer isolation. Categories I and II are successively more isolated and distant from the utility service than Categories III and IV. Instruments designed to meet Overvoltage Category III are able to withstand overvoltage transients better than instruments designed to Overvoltage Category II.

Anyone working on the main voltage feeder or branch circuit lines up to 600V should use instruments rated for at least Overvoltage Category III.

How does IEC differ from standards such as those published by UL and CSA?

Underwriters Laboratories (UL), Canadian Standards Association (CSA), and TUV (a German standards organization) are approval/listing agencies. IEC is an international standards writing organization. Local governments may use the IEC standards to write their own national standards, complete with enhancements influenced by local needs (for example, ANSI/ISA-S82.01-94 based on IEC-1010-1 in the US). The approval/listing agencies are independent testing laboratories that test products against national standards or their own standards, such as UL3111 based on IEC-1010-1.

What is meant by "UL listed"?

A manufacturer may state that a product is designed to meet the requirements of IEC-1010-1, UL 3111, or both. However, to be UL listed, CSA-certified, or TUV certified, the manufacturer must employ the services of the approval/listing agency to test the product's conformity to the standard. Only upon successful completion of this independent testing, and receipt of authorization from the approval/listing agency, may the manufacturer display the mark of the agency on the product.

A manufacturer may claim that its product is "designed to IEC-1010-1 standards, but that does not mean the instrument has successfully passed the independent evaluation and testing of an approval/listing agency such as UL. The reverse is also true: a product with a UL listing, for example, may or may not meet

the requirements of IEC-1010-1, depending on whether Underwriters Laboratories tested the product to UL 1244 (the old standard) or UL3111 (standard based on IEC-1010-1).

How can I compare two products if one was rated according to IEC-348 and the other to IEC-1010-1?

Because IEC-1010-1 takes into account the higher voltage transients that occur in some locations, overvoltage protection in a new meter rated for 600V could be better than that of an older meter rated for 1000V under IEC-348. Here is an example. A meter rated for an input

voltage of 1000V may have been designed to meet the IEC-348 safety standard. The clearance distance for 1000V under IEC-348 is 8mm. On the other hand, a meter rated for an input voltage of 600V and developed in 1995 has been designed to meet Overvoltage Category III under IEC-1010-1. Category III specifies a clearance distance of 11.5mm for a 600V rating. Thus, the protection from overvoltage transients would actually be better in a newer 600V meter than in an earlier 1000V meter, since the increased distance will withstand a higher voltage transient before breaking down.

This article is based on information provided by Fluke

New Tool Kit™ Series

THE MOST PRACTICAL, COMPACT, INEXPENSIVE DMMs AVAILABLE

MODEL	2703A	2704A	2706	2707
DCV	●	●	●	●
RES	●	●	●	●
CAP	●	●	●	●
FREQ	●	●	●	●
LOGIC	●	●	●	●
PRICE	\$39	\$59	\$79	\$89

Models 2703A, 2704A, 2707

Measures voltage resistance and current, and lots more! 0.5% DC accuracy. Prices start at \$39.95!

New Tool Kit™ DMMs from B+K PRECISION are the industry's best values for performance, features and dependability. Compare these ruggedized testers against all comers — at up to twice the price. You'll be sold on Tool Kit.

All four Tool Kit™ DMMs measure DC current to 10 amps, have large 3½ digit LCD readouts

and a continuity beeper. The Model 2704A adds AC current, capacitance and transistor tests. The Model 2706 adds temperature measurement. The Model 2707 is similar to the 2704A with added frequency counter and logic probe functions.

See your local distributor for immediate delivery.



BK PRECISION
MAXTEC INTERNATIONAL CORP.

Domestic and International Sales
6470 W. Cortland St., Chicago, IL 60635
312-989-1448 • FAX: 312-794-9740

Circle (54) on Reply Card

Is your multimeter giving you the right information?

By The ES&T Staff

The increased use of electronic equipment in commercial and industrial installations has resulted in a consequent increase in harmonic distortion in power systems. Harmonic distortion has, in turn, increased the need to keep a critical eye on the overall health of the power system within a facility.

One result of increased harmonics is that overall power quality continues to drop. Because of this the equipment can malfunction and fail, and "low power factor" can lead to higher power costs. This chain of cause and effect raises the question about measurement tools: "How appropriate and how effective are today's measurement tools at addressing problems of distortion and power quality?"

Average-responding instruments

For years ac meters have used a technique called "average responding-rms indicating" to display the root-mean-squared (rms) value, or effective heating value, of the current being measured. Rms is the mathematical calculation on an ac waveform that gives a value equivalent to the dc level that would have the same heating value as the ac current being measured. The average responding method provided a practical and economical way to measure the rms equivalent of a sine wave without using expensive and delicate laboratory equipment. Basically, the average value of the rectified signal is measured and then multiplied by a constant that results in the rms value, as shown in Figure 1.

In order for this method of determining rms to be accurate, the waveform being measured must be a perfect sine wave. Unfortunately, there is no guarantee that an ac voltage at the wall outlet will be a perfect sine wave. On the contrary, distortion on today's typical power systems may result in errors in voltage and current readings as high as 20% to 50% when measured with an average-responding multimeter.

Signal distortion

Distortion of the power company's

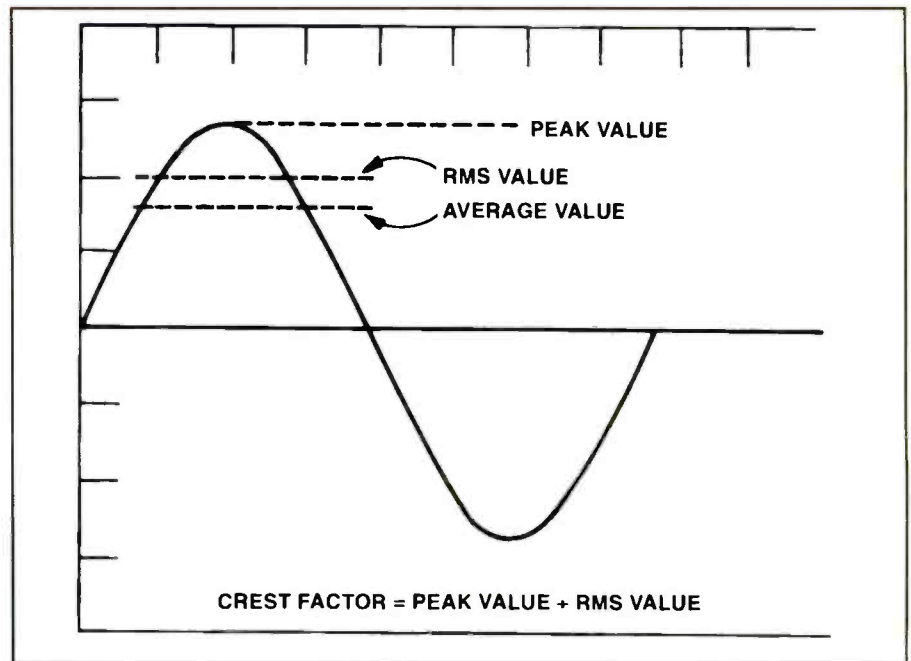

Figure 1. The average responding method of measuring ac provides a practical and economical way to measure the rms equivalent of a sine wave: the average value of the rectified signal is measured and then multiplied by a constant that results in the rms value. In order for this method to be accurate, the waveform must be a perfect sine wave.

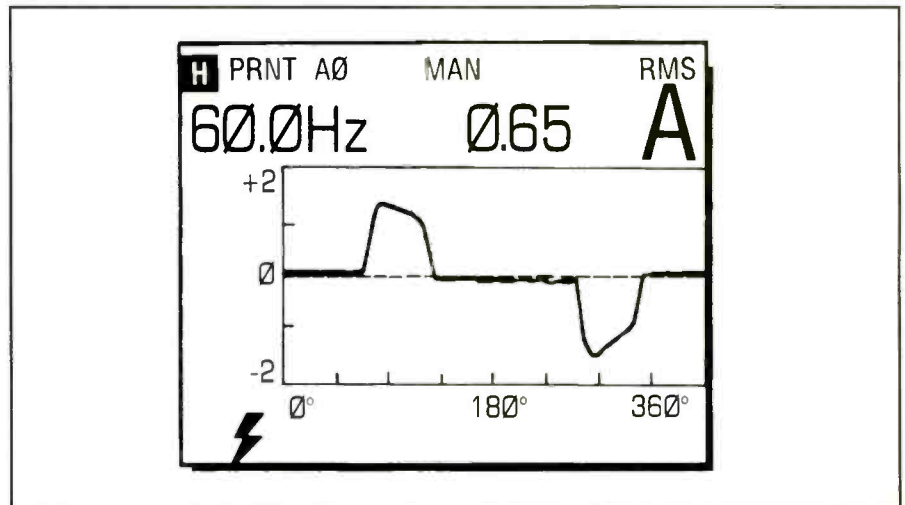

Figure 2. This is what the current waveform at the line cord of a typical monitor for a PC in an office looks like. Instead of a perfectly shaped sine wave, the monitor is drawing power from the line in an inconsistent or "nonlinear" fashion. A reading by a meter with graphical display indicates a true rms current of 0.65A. The reading of an average-responding meter measuring the same current was 0.47 amps. This is an error of nearly 28%.

sinusoidal ac waveform is common in heavy industry, commercial installations, and other facilities in which there is a great deal of electronically controlled

equipment. Every facility is different. Figure 2 shows the current waveform at the line cord of a typical monitor for a PC in an office. Instead of a perfectly shaped



TYPE OF METER	MEASURING CIRCUIT	RESPONSE TO SINE WAVE	RESPONSE TO SQUARE WAVE	RESPONSE TO DISTORTED WAVE
AVERAGE-RESPONDING	MULTIPLIES RECTIFIED AVERAGE BY 1.1			
TRUE-RMS-RESPONDING	RMS-CALCULATING CONVERTER CALCULATES HEATING VALUE	CORRECT	CORRECT	CORRECT

Figure 3. Average-responding instruments give correct readings for pure sinewave signals only. True-rms instruments give correct readings for signals of all shapes. An average-responding instrument will produce unpredictable readings-in the worst case; as much as 50% low. Waveforms containing harmonics cannot be measured accurately by average-responding instruments.

sinewave, the monitor is drawing power from the line in an inconsistent or “non-linear” fashion. The result is distortion that causes harmonics on the power system. As shown in Figure 2, a reading by a meter with graphical display indicates a true rms current of 0.65A. The reading of an average-responding meter measuring the same current was 0.47 amps. This is an error of nearly 28%.

If the magnitude of the nonlinear loads is minor compared with the magnitude of the traditional linear loads (loads that draw power in a linear fashion relative to the voltage waveform) the problems are minimal. But as more and more nonlinear loads are added (more PCs, fax machines, copy machines, lighting fixtures with electronic ballasts, etc.) the nonlinear loads begin to predominate. The results are varied, depending on the installation and the loads. Typical symptoms include overheating transformers and distribution panels, breakers that trip even when an average-responding meter indicates that the current is within the acceptable range, and products plugged into the ac outlet that do strange things.

Harmonic distortion is certainly not new; it has been a fact of life in power systems ever since the introduction of solid-state components that control and regulate power. But today, with the balance between traditional electrical equipment and electronic equipment shifting toward the non-linear loads, the full con-

sequences of harmonics are starting to come to light.

Evaluating the problem

Plant engineers typically use a “walking tour” of the plant to first get a visual reading of impending problems. On a walking tour of a facility, a plant engineer would notice an early indication of harmonics: heat. An electrical panel and a transformer are hot to the touch., another panel is emitting a humming sound. The experienced plant engineer knows that these clues may indicate the presence of harmonics. At this point, the engineer takes readings of voltage, current and frequency with a handheld digital multimeter (DMM). However, the readings obtained will be incorrect if using an average-responding meter. Let’s see why.

True rms voltage vs rms from average-responding instruments

As explained earlier, average-responding instruments give correct readings for pure sinewave signals only. On the other hand, “true-rms” instruments give correct readings for signals of all shapes. An average-responding instrument will produce unpredictable readings, in the worst case, as much as 50% low. Waveforms containing harmonics cannot be measured accurately by average-responding instruments, which still make up the vast majority of low-cost electrical measurement tools (Figure 3).

The performance of any ac meter is limited by its bandwidth and crest factor ratings. Bandwidth refers to the range of frequencies within which the meter can make accurate measurements. Distorted waveforms contain multiple frequencies that are higher than the fundamental frequencies? (typically 50Hz, 60Hz or 400-Hz in ac power systems).

Crest factor is the ratio of the peak value of a signal to its rms value. Refer back to Figure 1. The crest factor of a sinewave is 1.414; therefore, in a system with pure sinewave voltages and currents, any meter with a crest factor rating above 1.414 would be up to the task. However, systems with harmonics have higher-peaking signals, which increase the crest factor of those signals. That is why you should look for a meter with a crest factor rating of 3 or higher at full scale.

Check the specs

When evaluating true-rms instruments, be sure to consider other specifications. If you need to check the signal being provided by the power system to see how it’s affecting the equipment you service, you’ll need an instrument that is designed to handle at least 600V ac and dc signals. Crest factor specifications should be at least 3 at full scale. And be sure to demand an instrument that measures continuity, capacitance, and frequency. All of these capabilities should be available in a meter in the \$200 range.

This article based on information provided by Fluke.

Mechanical problems in the Sanyo VHR9300

By Steve Babbert

The unit that's most likely to come across my bench at any given time is the Sanyo VCR, VHR9300. I don't know if this is because it is prone to failure or if it is because a large number of them were sold. Whatever the reason, I think most service centers can expect to see a lot of them in the future.

As in many newer designs, this unit uses gears instead of the rubber "idler tire" to drive the feed and take-up reels. There are two belts associated with the main drive and loading mechanisms which seem to hold up as well as any. There are, however, two mechanical problems which account for a large number of failures. These problems may also develop in the VHR9200, which uses the same tape mechanism.

The broken front-load gear

There is a small gear in the tape loading mechanism that transfers motion from the main loading gear to the rack that controls the forward and reverse movement of the stage. This gear is fragile, and I have found many of them with a missing tooth. This fragility might be a design flaw, or it might be intended to protect more critical parts of the mechanism in the event that someone applies too much force during the loading of a tape cassette.

When this gear fails, in addition to the obvious symptoms (no loading or unloading) there can be other symptoms that might lead the technician in the wrong direction. The System Control portion of the VCR monitors various sensors to determine the position of the tape during loading and unloading. When the gears go out of sync the Syscon may get mixed messages which can cause symptoms ranging from gear-grinding to shutdown.

Stuck tape

In one VHR9300 the tape became

Babbert is an independent consumer electronics servicing technician.

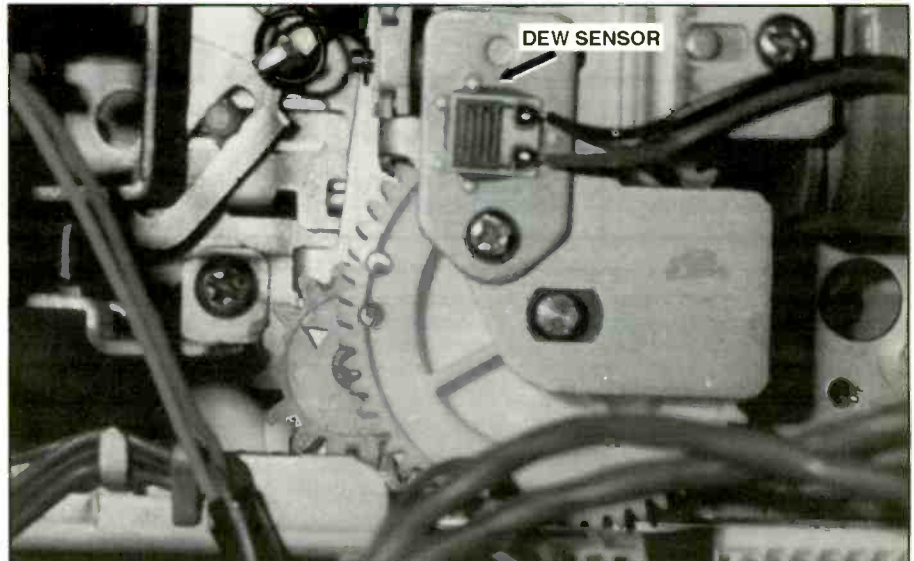

Figure 1. In the Sanyo VHR9300, in order to gain access to the loading motor and gear assembly, remove the upper bracket.

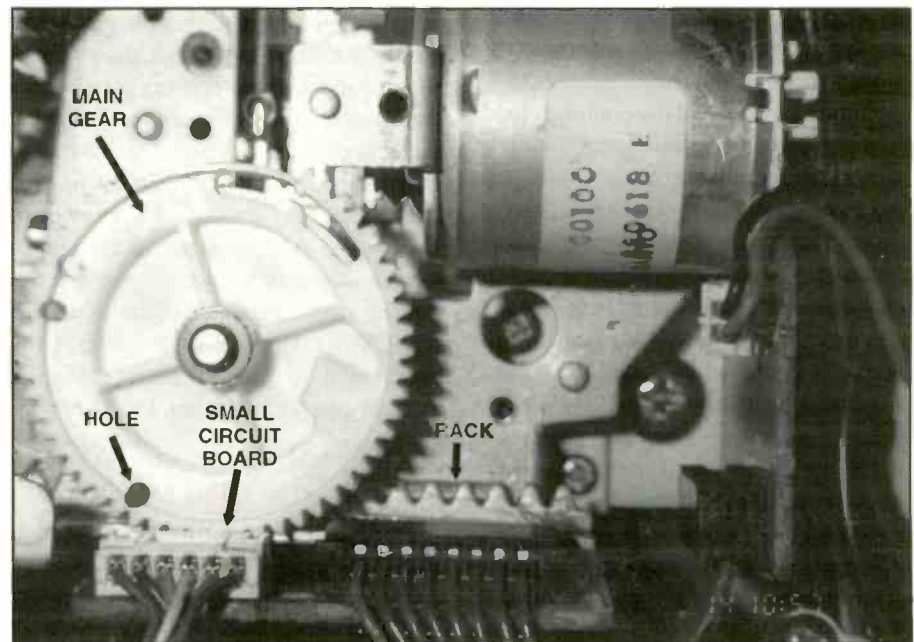

Figure 2. If possible, rotate the main gear by hand to this position before removing it. This is the normal position of the gear when a tape is fully loaded into the VCR.

stuck halfway through the loading process. Power would come on but there was no response when any of the front panel buttons were pressed. Knowing this model, the first thing I checked was the

infamous 16-tooth gear. As I suspected, a tooth was missing.

The first time I encountered this problem I didn't have service literature so I used a known-good unit as a reference.

From the known-good unit, I then made a diagram of the position of the gears in the fully loaded and unloaded position. I found that gear replacement is much easier in the loaded position and whenever the VCR is in this position, the only gear that needs to be in a specific position during reassembly is the main loading gear.

The main circuit board must be removed to uncover the loading motor and gear assembly (Figure 1). You'll have to remove three screws from the upper bracket to gain access to the gears. The screw holding the dew sensor to the bracket does not need to be removed.

When the bracket is removed the worm gear will separate from the motor pulley but will remain attached to the bracket. The bracket can then be laid to the side without unplugging the dew sensor. If possible, rotate the main gear by hand to the position shown in Figure 2 before removing. This is the normal position of the gear when a tape is fully loaded. Two screws which hold the small circuit board beside the gear assembly must be loosened, otherwise the connector will prevent removal of the main gear. At this point the broken gear can be removed from the VCR (Figure 3).

If the mechanism at the base of the main gear pin is in the position shown in Figure 3 it will need to be moved to the position shown in Figure 4. This is somewhat difficult because it is spring loaded and tends to resist any attempt to get it into position. In most cases it will be in the right position if the main gear was removed correctly.

Once the broken gear is replaced, the rack should be pushed fully forward before installing the main gear. The small single hole in the gear should be next to the first pin on the connector. Notice that the section of the gear without teeth is where the worm gear will fit. Notice also the position of the rack. At this point the housing holding the worm gear and dew sensor can be reinstalled.

Improperly installed gears can cause a variety of symptoms. One common symptom is the illumination of the "cassette in" symbol on the vacuum fluorescent display when there is no tape in the machine.

Fast forward/rewind problems

Another problem that I've found in several of these chassis is a sluggish fast

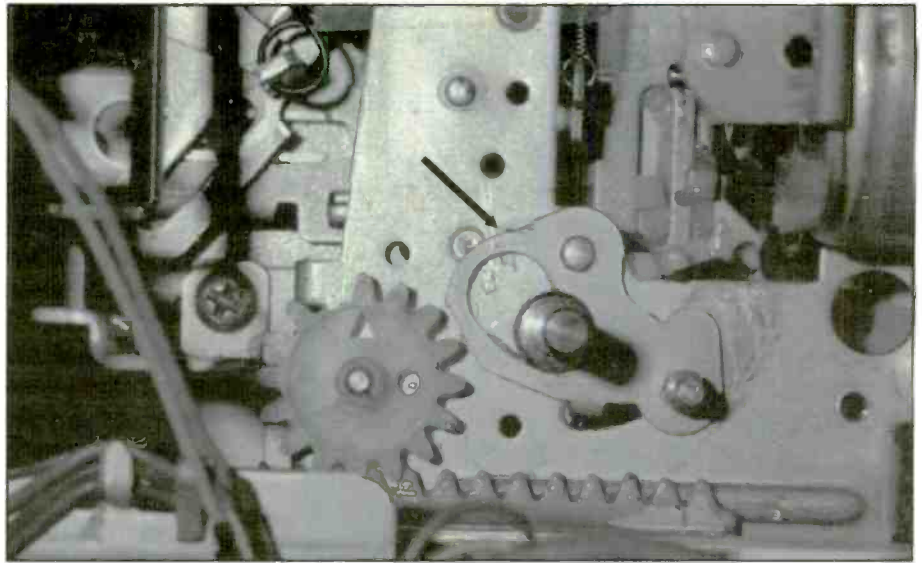

Figure 3. The cause of the failure of this VCR to load completely was this broken gear. If the mechanism at the base of the main gear pin is in this position, it will have to be moved to the position shown in Figure 4 in order to remove the broken gear.

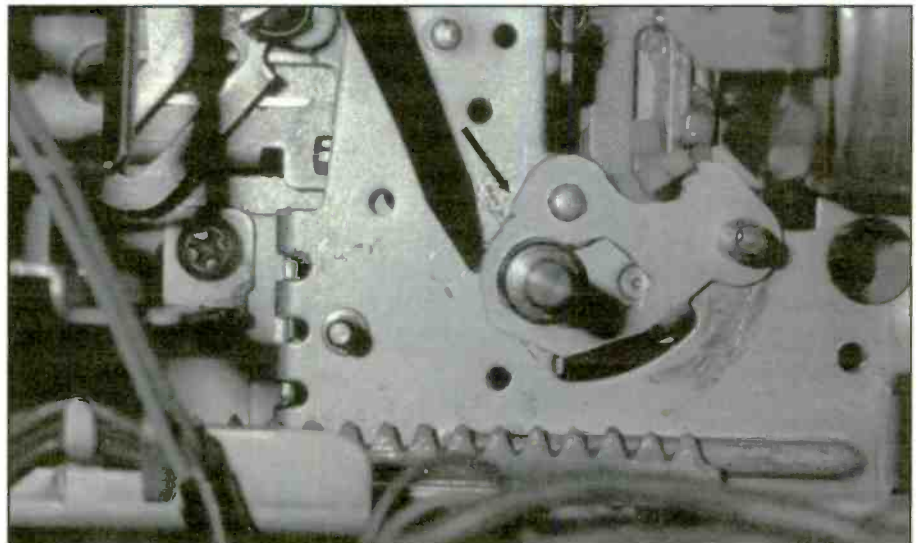

Figure 4. The mechanism at the base of the main gear pin must be in this position in order to remove the broken loading gear.

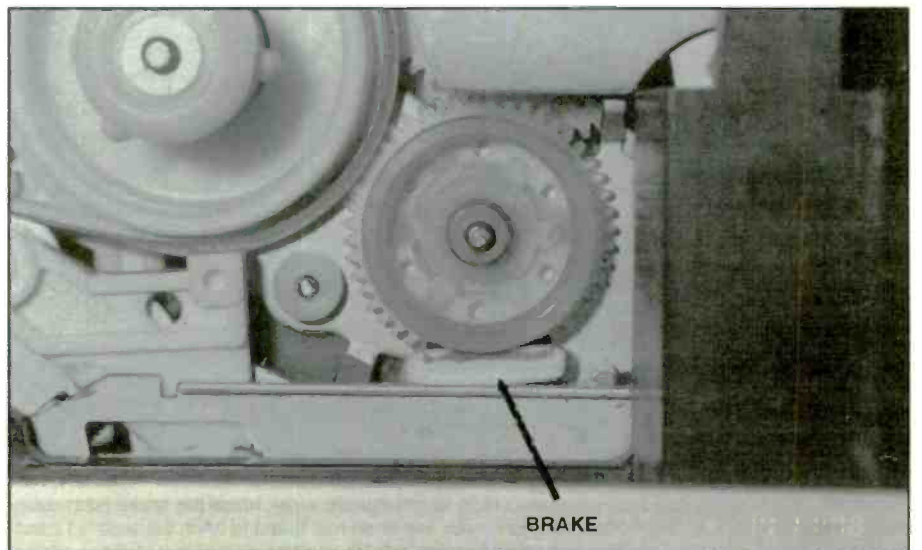

Figure 5. Black particles around the brakes made me suspect a problem in this area.

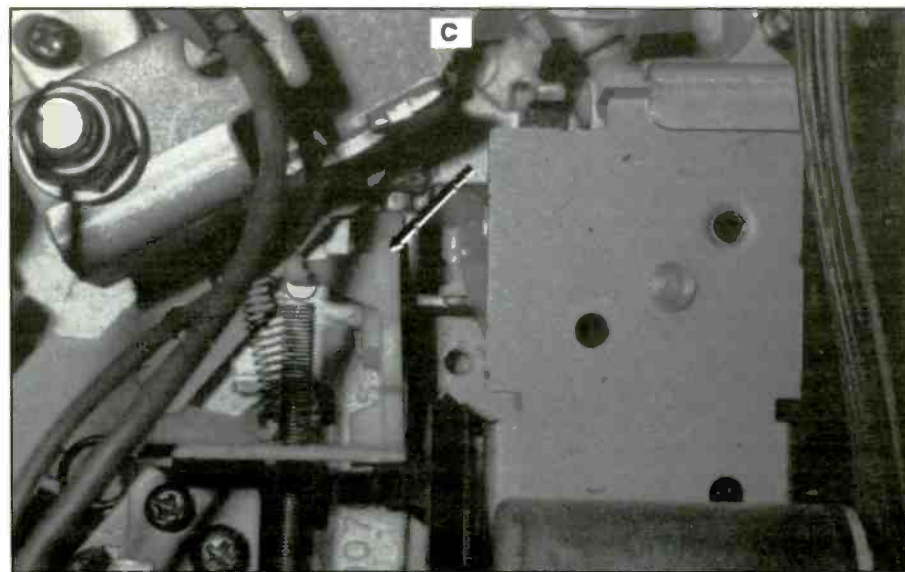
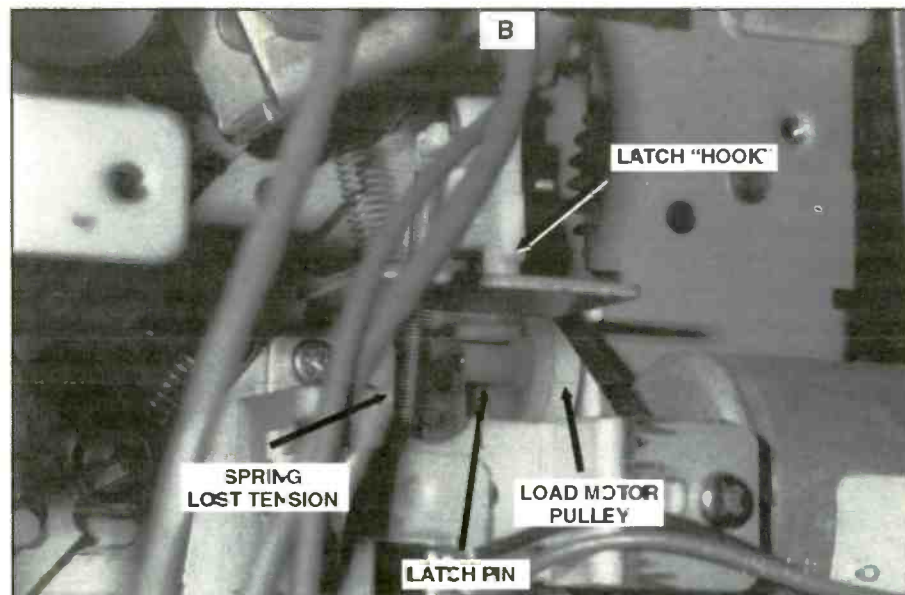
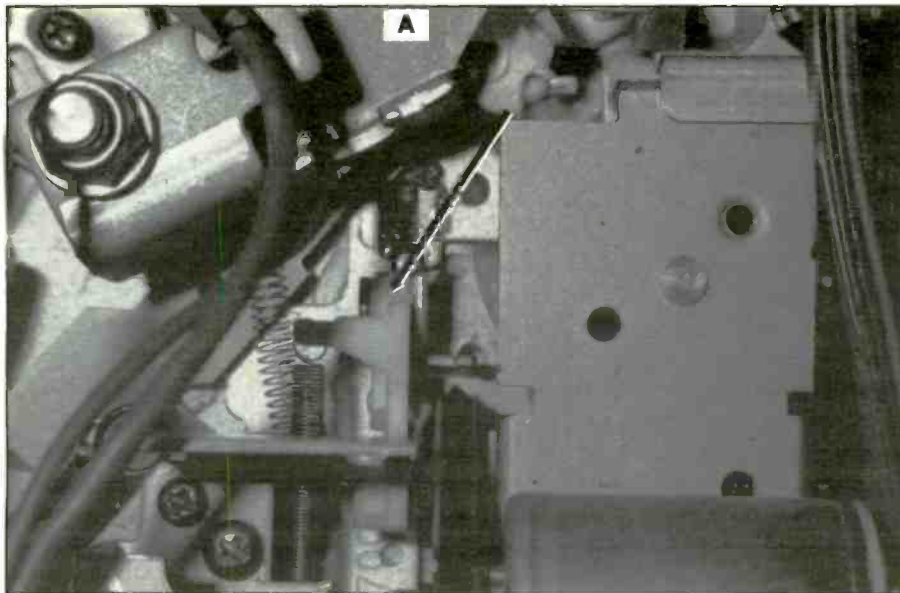

Figure 6. This latching mechanism, shown in its latched position (a), holds the brake pads away from the drive gears. In the position shown in (b), the latch has failed to latch because of insufficient spring tension. The portion of the mechanism in (c) is another view of the situation shown in (b).

forward and rewind function, or the complete absence of them. The first time I encountered this problem I suspected the usual worn idler tire. However, after removing the cover and finding that gears were used instead of an idler wheel I realized that I could be in for a difficult time.

Visual inspection revealed no problems. All of the gears seemed to turn freely and mesh properly. I installed a test jig which allowed me to see if something was slipping or binding while the machine was running. I checked the take-up and feed reels by hand while the unit was in both the fast forward and rewind modes. Both reels seemed to have insufficient torque. Torque was fine in the play and high speed search modes (in both forward and reverse directions).

Close visual inspection revealed black particles around the area where the brakes came in contact with the drive gears. The brake pads had a black covering over the felt pads. I assumed that this was where the particles came from. I wondered if this deterioration was normal (Figure 5).

I ran the machine through the various cycles once again while focusing my attention on the brakes. The brakes did not lift off of the gears in either the fast forward or the rewind mode. I felt certain that they should be releasing. I checked a known good machine which showed that they should release in all modes, only making momentary contact when stopping the mechanism.

After repeated cycling of the machine between rewind and stop I noticed that the brakes would release briefly at the beginning of the rewind cycle. As soon as the machine settled into the rewind mode the brakes would snap back as if a latching mechanism was failing.

Once again I turned my attention to the known good unit. Looking at the bottom of the unit I could see the linkage that controlled the movement of the brakes. However, it looked as though it was associated with a number of other mechanical functions. I couldn't see anything that resembled a latch. Portions of this linkage were obscured by a layered portion of the mechanism. I then returned to the top side of the machine to a point above the place where the linkage became buried underneath. Finally I found a latch that looked as though it was associated with the brakes. Returning to the defective machine I verified that the latch was indeed

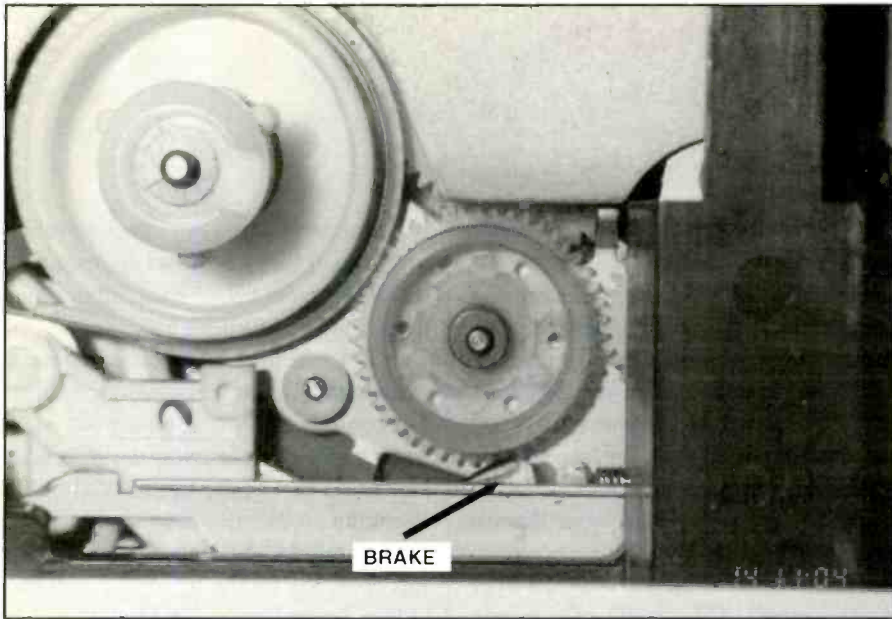

Figure 7. Once the faulty spring is replaced and the VCR is cycled, the brake will be in the position shown here.

letting go, causing the brakes to snap back to the engaged position.

The latching mechanism is very pecu-

liar. The hook catches on a pin that is concentric with and part of the load motor pulley (Figure 6). There is a spring that

keeps a downward pressure on the latch pulling it towards the pulley. When the machine stops, the pulley reverses direction causing the hook to roll up and off of the pin, releasing the brakes.

Since I could see no signs of excessive wear on the latch itself I concluded that the spring had lost tension. Replacement with a slightly tighter spring will solve the problem, but using a spring that is too tight may prevent unlatching altogether. Once the spring is replaced and the machine is cycled, the brake will be in the position shown in Figure 7.

Summary

Sometimes a known good unit can be the most valuable source of service information. In some cases, diagrams can be drawn during disassembly and reassembly for future reference. In other cases, the unit can be repeatedly cycled through its various modes in order to observe how the various parts interact. In time you will become familiar with many designs, each having their own peculiarities. ■

Come Out of the Dark.

Shed some light
On your managerial skills with the Certified Service Manager exam from NESDA, the association dedicated to sales and service dealers and technicians.

For a **FREE** practice test and some answers to *your* questions, complete and send the following to NESDA:

Name _____
Business _____
Address _____
City _____ State _____
Zip _____
Phone _____

National Electronics Service
NESDA
Dealers Association, Inc.

2708 W. Berry St.
Ft. Worth, TX 76109
(817) 921-9061

SAVE TIME, MONEY, AND FRUSTRATION WITH...

ONE-STOP SHOPPING!!!

There is **ONLY ONE** place to call!
PHONE: 800-289-0300 or FAX: 800-289-0301

WITH OVER 1/4 MILLION LINE ITEMS, ALL IN ONE LOCATION!

YOU WOULD HAVE ONLY:

- ☞ One purchase order to generate (no minimums)
- ☞ One invoice to pay
- ☞ One shipment to receive (averaging a 90+% fill-rate)
- ☞ One backorder report to reconcile (automatically mailed bi-weekly with ETA's)

FACTORY AUTHORIZED FOR 15 MAJOR BRANDS!

SONY	PANASONIC	GE*
SHARP	PROSCAN*	JVC
ZENITH	QUASAR	AIWA
TOSHIBA	SCOTT	HITACHI
TECHNICS	RCA*	EMERSON

We also offer: A **FREE** or **DISCOUNTED FREIGHT** program, **SAME DAY SHIPPING** for orders in by 2:30 P.M. (P.S.T.), **NO HANDLING CHARGES**, and the finest **RESEARCH** department anywhere!

FOR THE MOST PARTS AND THE FASTEST SERVICE...

COUNT ON **ae** andrews electronics

P.O. Box 914, Santa Clarita, CA 91380-9014
INQUIRES: 805-257-7700 or FAX 805-295-5162
* PREMIER DISTRIBUTOR

Circle (52) on Reply Card

Oscilloscope update

By The ES&T Staff

The wonders of modern electronics, including such advances as microcomputers and special-purpose integrated circuits have made it possible for manufacturers to pack unheard-of power and functionality into their products.

In the consumer area, for example, look at the CD player. Not only can you play noise-free music conveniently, but you can select tracks at random, program the unit to play them, and then have them endlessly repeated. Televisions, VCRs and other consumer electronics products offer the same kinds of convenience in modestly-priced units.

Test equipment, too

But this revolution has not escaped the notice of manufacturers of the test equipment that's used to test and service the consumer products. A quick glance at the current offerings from manufacturers of traditional as well as non-traditional test equipment will turn up some very interesting innovations. Take, for example, waveform frequency and amplitude. Gone are the days when a technician had to patiently count graticule divisions, then check the scale factors on the scope's dials, then perform some mathematical prestidigitation to determine the frequency or amplitude of a displayed waveform, and then hope he did everything right.

These days, the technician simply has to manipulate some markers on the screen, then perhaps push a button, and the desired parameter is automatically calculated by the oscilloscope and displayed, numerically, to a couple of decimal places, on the screen, or on a separate meter as display.

The computer as oscilloscope

One of the more interesting developments that has been introduced in recent years is the hardware/software combination that can turn a personal computer into an oscilloscope. This magazine has mentioned several such products in the past few years. One that has recently come to the attention of the editors is a product

called O-Scope, from Allison Technology Corporation of Carvel, TX.

As with most computer-based oscilloscopes, this one has some pretty serious limitations. If your looking for something for TV work, this is not for you. The product information sheet says that this product can handle signals up into the low ultrasonic range. That's a few tens of KHz. TV work requires a scope that can handle up to near 100MHz.

However, for someone who has a personal computer and is looking for an inexpensive oscilloscope for audio or other low-frequency work, or who just wants to experiment to see how a computer can be turned into an oscilloscope at less than \$200, this could be a useful item.

The oscilloscope module plugs into the computer's printer port via a cable that is supplied with the product. The unit also includes a dc adapter which supplies power to it. The input to the unit is a standard BNC connector to which the user can connect a standard oscilloscope probe. The monitor provides the waveform display, as well as a display of the oscilloscope's controls. The cursor keys on the computer keyboard are used to select the desired function and to adjust the values.

The oscilloscope/multimeter

Another improvement over the standard oscilloscope that provides technicians with a more useful tool is the oscilloscope/multimeter combination. With this innovation, technicians no longer need to bother with two sets of leads; one for waveform observation and one for the meter. Depending upon the manufacturer, the user can either read meter readings at the same time as he observes the waveform, or he can switch between meter and oscilloscope functions.

Automatic shift

A number of other features have gradually been incorporated into oscilloscopes over the past several years, such as automatic configuration, which eliminates the need to readjust the controls between measurements. For example,

some modern scopes can monitor changes in the input waveform and automatically select the proper time base, input range, trigger level and slope.

As these test devices continue to evolve, they assume the work of adjusting controls and interpreting the waveform parameters, leaving the technician free to do the job he has to do: troubleshoot the problem.

After telling you the basics about oscilloscopes, the following article will help you in determining what kind of oscilloscope probe would be right for you.

Choosing an oscilloscope probe

In a pinch, even a piece of wire could be used as an oscilloscope test lead. Wire is inexpensive and readily available. But the signal you're attempting to read could be severely degraded if you use a length of wire as an oscilloscope probe. The bare-wire "probe" could overload the instrument's input amplifier and, lacking any shield, could pick up stray signals. Only a true passive voltage oscilloscope probe, with compensation circuitry and shielded cabling (Figure 1) can offer signal integrity during use.

There are several important factors to consider when selecting an oscilloscope probe. By comparing these factors with your testing requirements and instrument, you should be able to select the probe best suited for your specific application.

Before we begin, review your instrument's rated bandwidth and input values; input resistance, capacitance, and interface connector. This is your initial guide to selecting a compatible probe. Quality instrument manufacturers print this information directly on the scope.

If you don't find these specifications on the scope, it is usually found in the operating instructions. Standard values of input resistance and capacitance are 1M Ω

Speed And Performance!

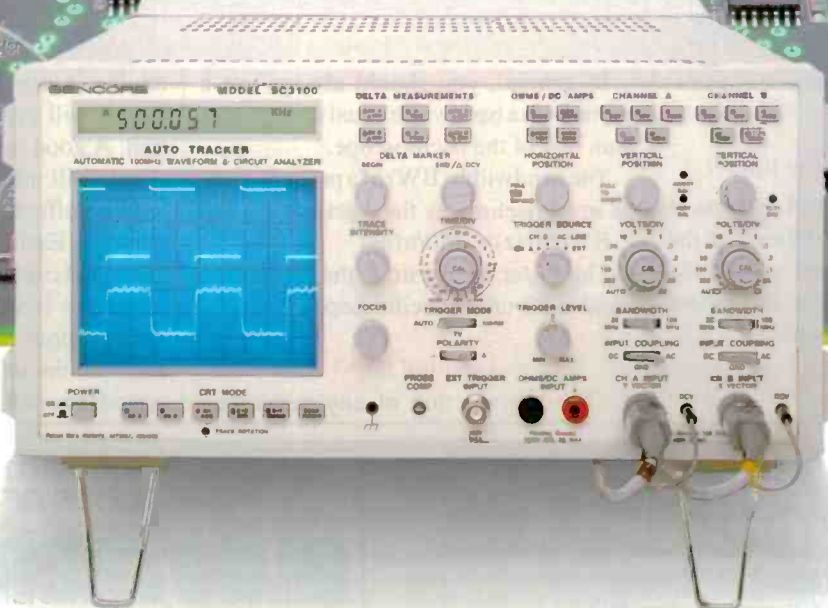

SC3100 "AUTO TRACKER"
Automatic 100 MHz Waveform & Circuit Analyzer
Patented

The Fastest Measurement To Measurement Analyzer On The Market!

One probe connection is all you need to put the SC3100 "AUTO TRACKER" into the race of electronic circuit analyzing. You can track and measure the key parameters of any waveform at the push of a button for fast, precise troubleshooting.

The easy-to-use 100 MHz, dual trace oscilloscope has autoranged time-base and vertical attenuators so you can concentrate on the circuit - not

on readjusting knobs and controls. The exclusive delta functions combined with the ohm/current meter provide you with troubleshooting performance without changing course to swap leads or meters.



To fully appreciate the speed and performance of the SC3100 "AUTO TRACKER," you need to use it on your bench - full speed ahead. Prepare yourself for high performance!

Call us for a no-obligation SC3100 "AUTO TRACKER" test drive today. You'll feel the difference in performance from the first measurement.

1-800-SENCORE (736-2673)

Circle (106) on Reply Card

SENCORE
3200 Sencore Drive, Sioux Falls, SD 57107
Direct: (605)339-0100 Fax: (605)339-0317

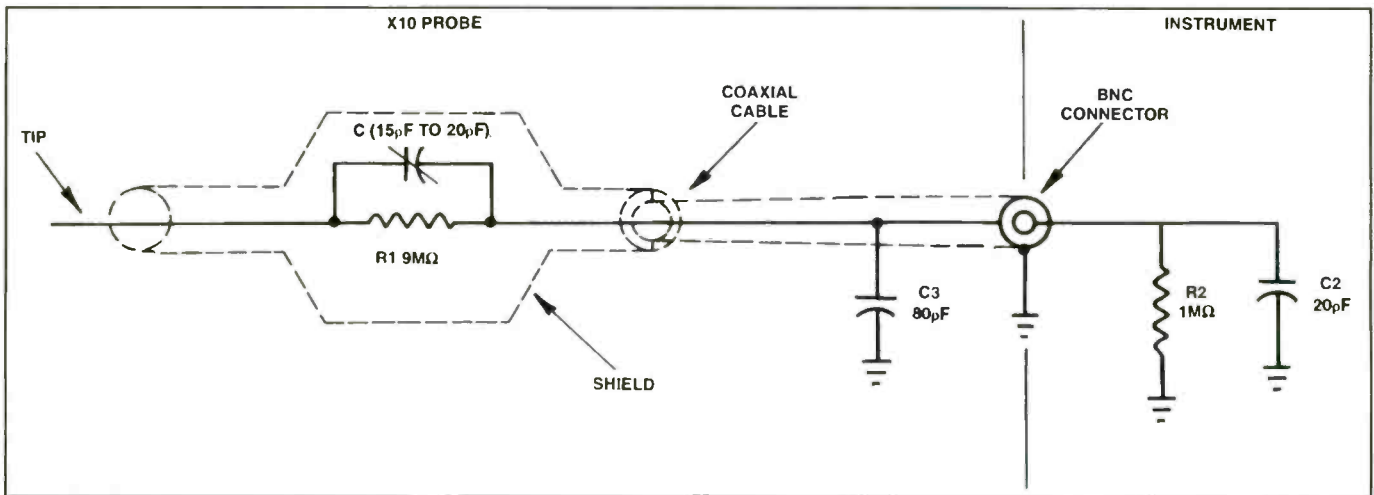

Figure 1. A true passive voltage oscilloscope probe with compensation circuitry and shielded cabling will not distort the measured signal.

and 20pF. The interface connector is usually a BNC female.

Bandwidth (BW) and rise time (t_r)

Probes are most often rated in terms of bandwidth. Bandwidth is defined as the frequency at which the amplitude of the displayed signal (voltage) is 3dB below the reference amplitude (voltage).

The equation would be:
 $\text{dB} = 20 \text{ Log}(V_{\text{out}}/V_{\text{in}})$

In general, you should always use a probe with a bandwidth equal to or greater than that of the oscilloscope.

The bandwidth (BW) of a probe is related to its risetime by the equation:

$$\text{BW}(\text{MHz}) = 350/\text{tr}(\text{ns})$$

The faster the risetime, the greater the bandwidth of the oscilloscope.

Loading effect

The introduction of any measuring

device (scope/probe combination) to a circuit will produce some signal distortion. A good quality probe, matched to a scope, will minimize this distortion, i.e., loading effect, or reduce it to a known quantity. Each probe has an input resistance and capacitance.

At low frequencies, usually less than 1MHz, input resistance is the principal factor in the loading effect. The high tip impedance of the probe, usually 1MΩ for

New and Pre-Owned Test Equipment

Sales • Rentals • Service

SUBSTANTIAL SAVINGS ON:

Fluke, Hewlett Packard, Goldstar Leader, Tektronix, and more

GoldStar Precision

Pre-Owned Oscilloscope Specials

Tektronix 465 100 MHz \$649.00
 Tektronix 465B 100 MHz \$789.00
 Tektronix 475 200 MHz \$899.00

• Professionally Refurbished
 • 90 Day Warranty

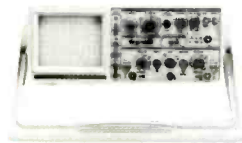

SUPER SALE!

Model OS-9100P → \$999.00!
 Full 100 MHz Bandwidth!

Model OS-904RD - 40 MHz Bandwidth
 On-Screen Measuring Cursors & Readout!
\$699.00!

- TV Synchronization Trigger
- Dual-Channel, High Sensitivity
- Calibrated Delayed Sweep
- Two Probes Included, 2 Year Warranty

Full Line of Oscilloscopes, Analyzers, Meters, and Audio & Video Test Equipment

1-800-99-METER
 1-800-996-3837

FOTRONIC CORPORATION

P.O. BOX 708, Medford, MA 02155



(617) 665-1400 FAX (617) 665-0780

ORGANIZE AND PROTECT YOUR COPIES OF

THE PROFESSIONAL MAGAZINE FOR ELECTRONICS AND COMPUTER SERVICING

ELECTRONIC

Servicing & Technology



Now there's an easy way to organized and keep copies of your favorite magazine readily available for future reference.

These custom-made titled cases and binders are ideal to protect your valuable copies from damage.

They're designed to hold a year's issues (may vary with issue sizes), constructed with reinforced board and covered with durable leather-like material in red, title is hot-stamped in gold, cases are V-notched for easy access, binders have special spring mechanism to hold individual rods which easily snap in.

Cases: 1-\$8.95 3-\$24.95 6-\$45.95

Binders: 1-\$11.25 3-\$31.85 6-\$60.75

Add \$1.50 per case/binder for postage & handling. Outside USA \$3.50 per case/binder (US funds only).

Send Name, Address (no P.O. box numbers), City, State and Zip. CHARGE ORDERS: (Minimum \$15): American Express, VISA, MC, DC accepted. Send card name, #, Exp. date. Allow 4 to 6 weeks delivery.

Send all orders to:

Electronic Servicing & Technology
 Jesse Jones Industries, Dept. 95 EST
 499 East Erie Avenue, Philadelphia, PA 19134
 PA Residents add 7% sales tax.

Call TOLL FREE 7 days, 24 hours 1-800-825-6690

Circle (62) on Reply Card

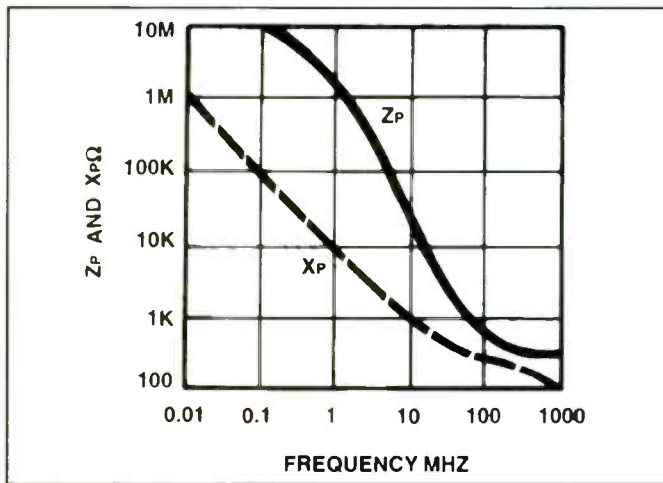

Figure 2. (above) The total input impedance (Z_p) and capacitive reactance (X_p) change with the frequency of the observed signal.

Figure 3. (upper right) Most probes derate their maximum voltages as frequency increases.

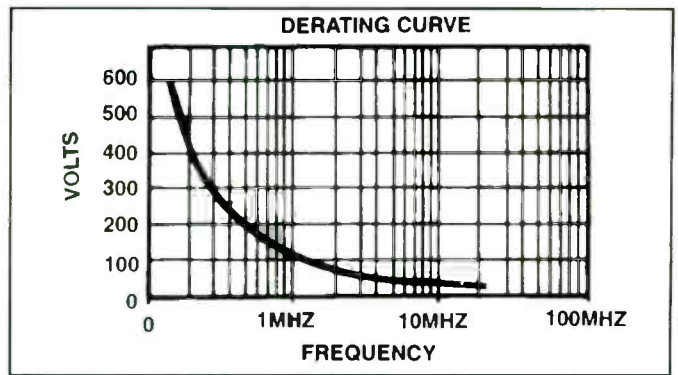
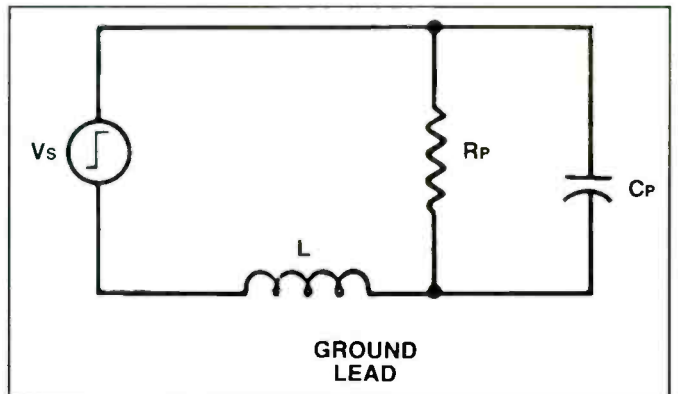

Figure 4. (right) Because the ground lead connecting the oscilloscope to the unit under test has inductance, as frequency of the measured signal increases, the inductive reactance of this lead increases, which may introduce distortions and leading-edge ringing on high-speed pulse waveforms. Keep the ground lead short.



a X1 probe and $10M\Omega$ for a X10 probe, minimizes circuit loading. As frequency increases, the probe's capacitance becomes the gating value. See the graph of

Figure 2 for an illustration of the changes of a probe's total input impedance (Z_p) and capacitive reactance (X_p) with changes in frequency.

For circuits that are sensitive to impedance loading there is the X100 probe. It has an input impedance of $100M\Omega$ and approximately $6pF$ when connected to a

HC Protek Series 6500 Scopes They Work As Good As They Look

20/40/60 MHz Oscilloscopes
With Alternate Mag
from \$559⁰⁰

Features...

- Dual Trace.
- Alt. Mag permits simultaneous display of 4 traces - 2 originals and 2 magnified types.
- Automatic focus with linear focus circuitry.
- Alternate trigger.
- Basic Sensitivity - 5mV to 5V/div, enhanceable to 1mV/div.
- Special Sync separator circuit stabilizes triggering with TV-H and TV-V signals.
- Low power consumption
- Compact, quality assured design.
- 6" wide, rectangular CRT with internal graticule.
- 2 Year Product Warranty.



Model 6506
60 MHz, \$999⁰⁰

Model 6504
40 MHz, \$890⁰⁰

Model 6502
20 MHz, \$559⁰⁰

Send For Complete Spec's and Data.

HC Protek 154 Veterans Drive, Northvale, NJ 07647
Tel: (201) 767-7242 Fax: (201) 767-7343



Circle (71) on Reply Card

To Order Back Issues



Send \$3.50 Per Issue

When ordering back issues include the following information: Name, address, city, state & zip. Please make a list of the issues you're requesting. When paying by credit card send the number along with the expiration date. Check, Money Order, Mastercard, VISA, Discover and AMEX accepted.

Complete your collection today.

1-800-853-9797

or Fax 1-516-681-2926

Electronic Servicing & Technology

76 North Broadway, Hicksville, NY 11801

TENMA™ TEST EQUIPMENT

Tested Accurate, Proven Reliable



High-Tech DMM

Technicians have come to rely on Tenma's high quality and reliability for their service needs. From simple DMMs to benchtop oscilloscopes, Tenma meets your needs with accurate, reliable products at truly competitive prices.

100MHz CRT Readout Oscilloscope



Look to MCM Electronics for the complete line of TENMA products. Call today for your free MCM catalog filled with over 21,000 service parts, tools, semiconductors and the entire line of TENMA test equipment.



For your free catalog,
call . . . **1-800-543-4330**



MCM ELECTRONICS®
650 CONGRESS PARK DR.
CENTERVILLE, OH 45459-4072
A PREMIER Company

Get fast delivery from our distribution facilities near Reno, NV and Dayton, OH!

ES83

standard oscilloscope. If a high enough signal voltage is available for the X100 attenuation, this probe would be most suitable for use in this situation.

As a general rule of thumb, choose a probe with the highest overall input impedance (highest input resistance and lowest input capacitance) for the lowest circuit loading effect. Because fast rise-time is closely related to high bandwidth, pick a probe with the lowest capacitance for best results.

Voltage input

For operator safety, always compare the voltage to be measured to the maximum input capability of the probe. Keep in mind that most probes derate their maximum voltages as frequency increases. See Figure 3 for the derating curve of a typical oscilloscope probe.

Grounding issues

The quality and accuracy of the displayed measurement is greatly affected by how the probe is grounded to the circuit under test. The ground-lead inductance is represented by Figure 4, and the inductive reactance by the equation:

$$X_L = 2\pi fL$$

Where f is the frequency and L equals the ground return path inductance. As the frequency increases, so does the inductive reactance. This reactance can cause signal distortions and leading-edge ringing on high-speed pulse waveforms. To reduce this effect, use the shortest ground lead possible (ground to the device under test) or adapters such as a BNC interface.

Fully insulated probes

This final category deals not with the probe's internal circuitry, but with its construction. Because battery-powered portable scopes may be used without earth grounding, user safety becomes a primary factor. A signal voltage may set up on the shielding circuit and, if a standard probe is used, this voltage would be present on the exposed BNC shell.

Fully-insulated probes, specifically designed for use with portable scopes, cover these exposed points with plastic insulation. The international safety standard IEC1010-1 details the design criteria for safer operation of these probes. ■

This article was adapted from the ITT Pomona Electronics pamphlet "Selecting the Right Scope Probe."

The Electronic Instrument Handbook, second edition, Hewlett-Packard Company, McGraw Hill, \$79.50.

Hewlett-Packard Company announces that the second edition of the Electronic Instrument Handbook, which sold out after only six months on bookstore shelves, now is in its second printing. The authoritative, largely HP-authored resource on electronic instrumentation was first published by McGraw Hill in 1973, and has been updated to include the latest technological advancements.

The 900-page book was edited by Clyde F. Coombs, Jr., a retired HP manufacturing manager, and written by HP engineers, students and hi-tech writers. The handbook covers everything from the basics of electronic instruments to measurement instruments to the role of software in "virtual" instruments.

The handbook is endorsed by the Electronics Book Club and Electronic Engineers Book Club. It is available at college and technical bookstores and at some larger superstores. It can be ordered directly by calling McGraw Hill at this number: 1-800-722-4726.

McGraw Hill, Inc., Blue Ridge Summit, PA 17294-0850

Instant Internet with WebSurfer, By David Sachs and Henry Stair, Prentice Hall, 320pp, \$24.95

Prentice Hall announces the publication of "Instant Internet with WebSurfer" by David Sachs and Henry Stair, a new book/software package that offers Windows PC users fast complete Internet and World Wide Web access.

With "Instant Internet with WebSurfer," new Internet users can get online in under five minutes and tour the Internet and the exciting multimedia World Wide Web with the step-by-step guidance of the author's, Internet experts, David Sachs and Henry "Pete" Stair.

This new book presents clear, hands-on instructions for using every important Internet service and comes with easy-to-use, preconfigured point-and-click connections to five leading Internet service providers. The accompanying diskettes contain the latest release of Internet Chameleon software from NetManage, the award-winning integrated Internet soft-

ware package for Windows PCs. Internet Chameleon software includes WebSurfer, a next-generation browser with full multimedia capabilities.

Sachs and Stair take readers step-by-step through every stage of getting online: installing all needed software and using the Internet's basic tools—e-mail, telnet,

ftp, and gopher. "Instant Internet with WebSurfer's" unique Instant Activities show readers how to access many of the World Wide Web's exciting new sites, and its Pointers and Tips help new users surf the Internet quickly and easily.

(Continued on page 72)

MORE FEATURES LESS COST



GoldStar brings you a variety of affordable digital multimeters to meet your test equipment needs.

- Large, easy to read 3 1/2 and 3 3/4 digit displays in Manual and Auto Ranging format
- Functions and Feature packed
- Overload protection voltage up to 600V in Resistance, Capacitance and Continuity-Ranges
- High Reliability and of course, sensibly priced
- Patent Pending wrong position 10A input jack
- Meets IEC-348 Safety Standards

Spec & Model	DM-311	DM-312	DM-313*	DM-331	DM-332*	DM-333*	DM-334
Digit	3.5	3.5	3.5	3.75	3.75	3.75	3.75
Counts	2000	2000	2000	4000	4000	3200	4000
Range (Auto/Manual)	M	M	A/M	M	M	A/M	A/M
DC/AC Voltage (1000v/750v)	*	*	*	*	*	*	*
DC/AC Current (10A)	*	*	*	*	*	*	*
Resistance (20 Meg Ohm)	*	*	*	*	*	*	*
Bar Graph	*	*	*	*	*	*	*
Data Hold	*	*	*	*	*	*	*
Battery Tester	*	*	*	*	*	*	*
Continuity/Diode Check	*	*	*	*	*	*	*
TR Hfe	*	*	*	*	*	*	*
Frequency	*	*	*	*	*	*	*
Capacitance	*	*	*	*	*	*	*
Min./Max. Recording	*	*	*	*	*	*	*
Safety Holster	*	*	*	*	*	*	*
List Price	\$49.95	\$79.95	\$59.95	\$99.95	\$119.95	\$69.95	\$99.95



LG Precision
The Sensible Source

19013 East 166th St., Cerritos, CA 90708-2226 310-404-0101 fax: 310-921-6227

New technology in consumer electronics

By The ES&T Staff

So much is happening in consumer electronics today that it's hard to keep track of it. More and more computers are being sold to consumers, and they're becoming more and more powerful and constantly offering new features, such as CD-ROM, fax software, color printing, full-motion video, stereo audio and more. Television sets continue to offer larger screens and better pictures. CD players now come in juke box configurations capable of storing and playing as many as 100 CDs.

In addition to the new products that consumers can buy, there are new technologies developing in the services that

bring information and entertainment into the home. Cable companies either have been, or soon will be offering information transmission and reception capabilities, much as the telephone company traditionally offers. The telephone companies have in some areas been offering entertainment, such as videos over the telephone lines, much as the cable companies have been traditionally offering.

Once a year we publish an article that provides a recap of some of the recent developments in consumer electronics that will one day have an effect on the lives and work of those people who work in the

consumer electronics industry. Here are some of the recent developments that we think you should be aware of.

Computer data transmission via TV cable

Home-office personal computer users can now access corporate offices, on-line services and the Internet at fast speeds, over long distances and at low cost using a personal cable TV modem designed and manufactured by LAN City Corporation. Positioned as an onramp to the information superhighway, the modem provides users of any home computer and any ca-

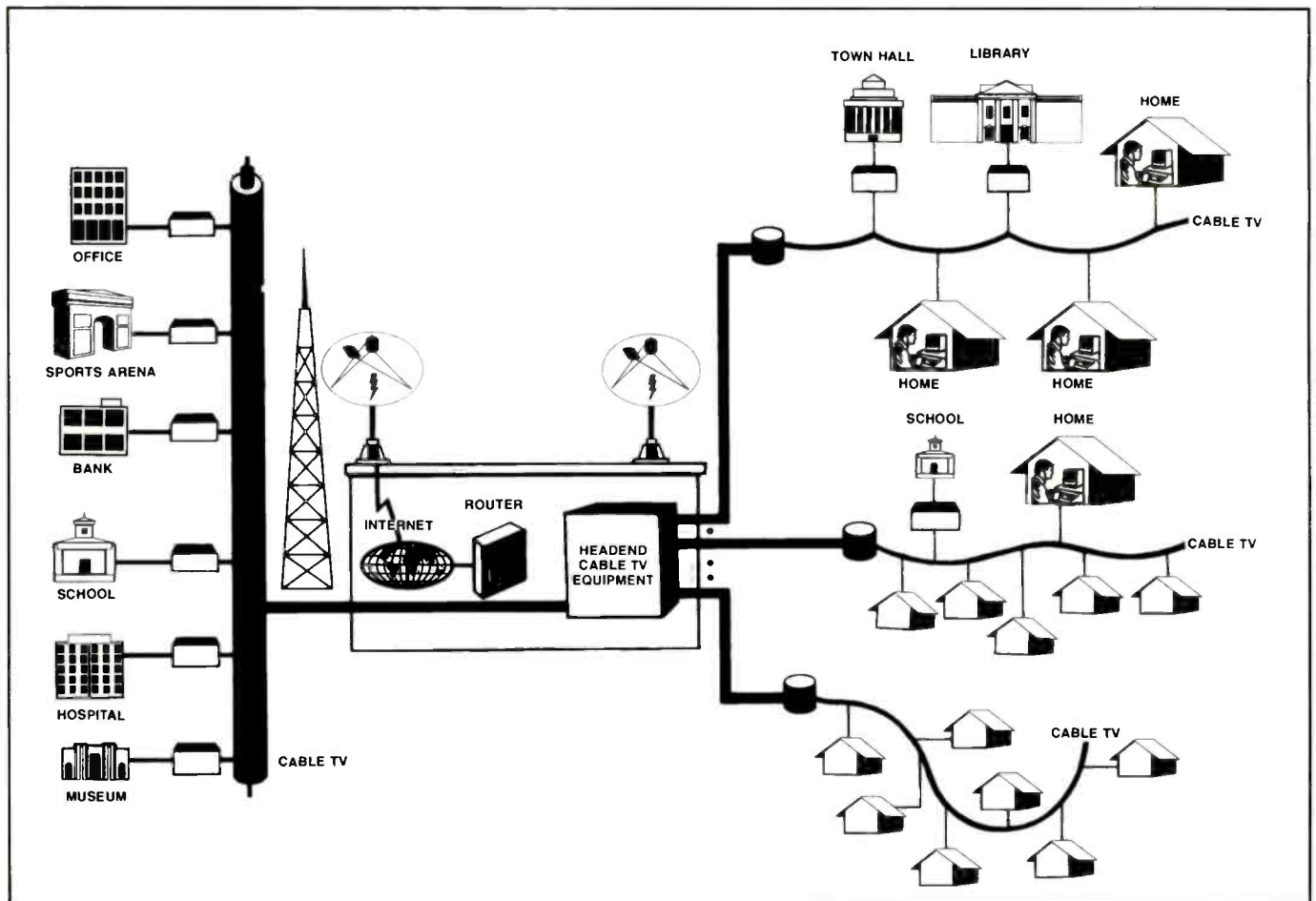

Figure 1. The cable modem is useful for home-based consultants, small businesses and telecommuters desiring city-wide connectivity to other personal computers, to on-line services and to the Internet.

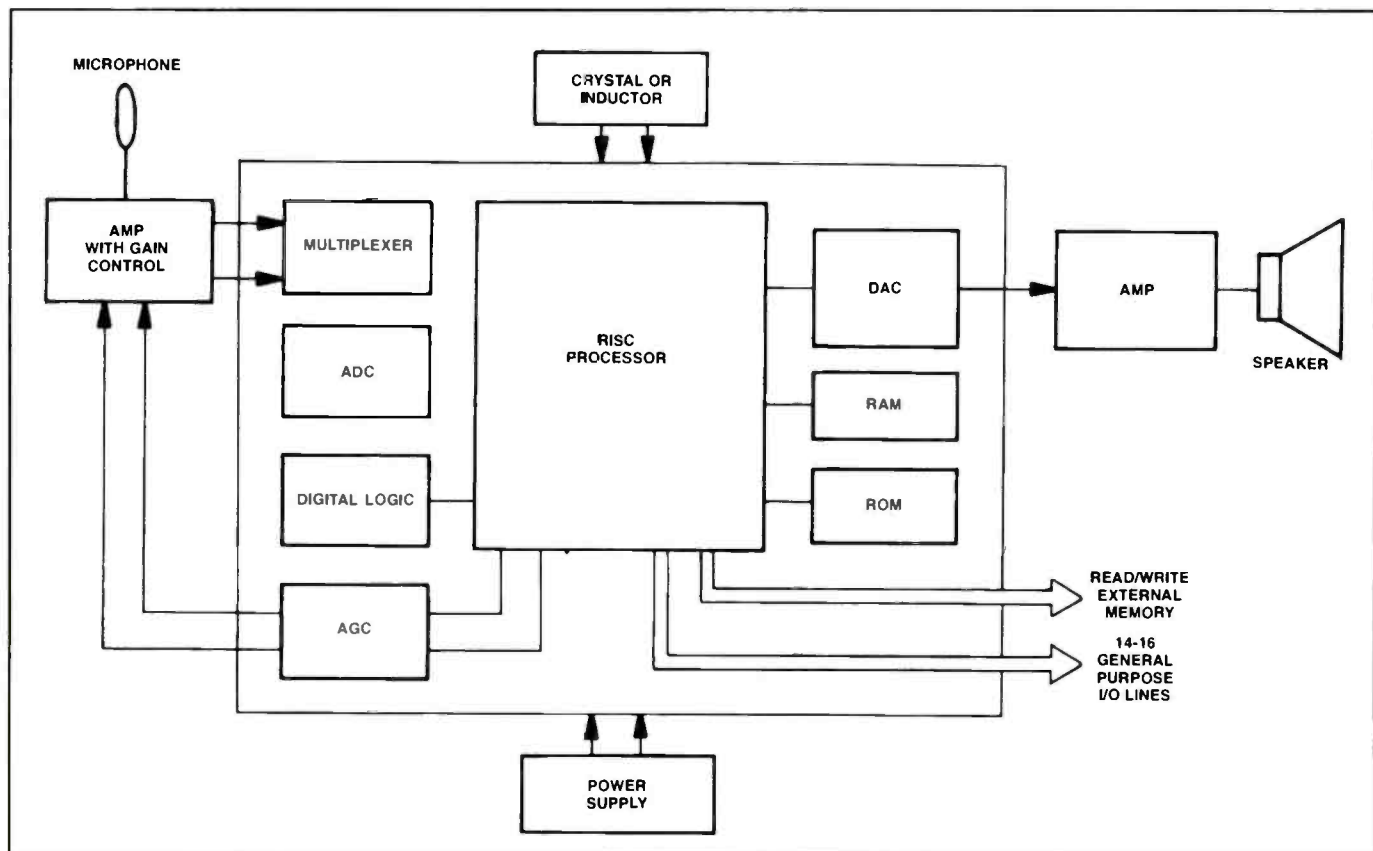

Figure 2. The RSC series utilizes a proprietary neural network based recognition technology to provide speech recognition and synthesis in cost sensitive applications such as toys, games, electronic entertainment and consumer electronics.

ble TV system in any country with two-way, 10-million-bit-per-second connectivity city-wide across 200 miles. LCP operates 1,000 times as fast as traditional telephone modems at 1/200 of the cost per bit, according to the manufacturer. The cost of the LAN City personal (LCP) cable modem is \$595.

"LCP is the first cable TV modem ever developed to operate over any commercial cable TV channel, extending the same power of corporate business networks to today's 500 million worldwide home cable TV subscribers," states Rouzbeh Yassini, LAN City's president and CEO. "And at one-half cent per 100 bits—which is a 200:1 cost advantage over typical 9,600 bit-per-second phone modems."

The cable modem sends and receives data at 10 million bits per second. For example, a typical 80-megabit graphics file requiring 2-1/4 hours to transfer via phone modem would take approximately eight seconds to transmit using LCP. This rapid connectivity speed brings the 10 megabit Ethernet LAN industry standard to home computer users, providing them high-performance on-line access to data and multimedia files.

The modem sends data farther than it has ever traveled over TV cable: 200 miles round-trip from any personal computer via any cable TV company, and worldwide over the Internet. To maintain the integrity of long-distance data communications, the modem incorporates computer-industry-standard SNMP network management, providing the cable TV operator with a high degree of network control and visibility. Additional security measures prevent unauthorized access and control of the network.

LCP is simply installed between a personal computer and a cable TV line, operating transparently. After the new product's software automatically determines the modem's operational frequencies and parameters, the unit is ready to be used. The modem can bring itself on-line only if it is authorized by the cable TV operator.

The modem is useful for home-based consultants, small businesses and telecommuters desiring city-wide connectivity to other personal computers, to on-line services and to the Internet (Figure 1). It is the culmination of the manufacturer's vision to provide a total data-over-cable-

TV solution for businesses, cable TV headends and home computers.

Rewritable optical discs

The international alliance of major hardware and software enterprises supporting the SD format for next-generation high-density optical discs (Table 1) have announced the adoption of a rewritable/erasable phase-change optical disc which it has named "SD-RAM" (super density random-access memory). The rewritable SD-RAM offers complete random access capability and a storage capacity of more than 2.6-gigabytes (GB) per side and over 5.2GB for a double-sided disc, which is sufficient to meet or exceed the requirements recently outlined by technical experts from leading companies of the personal computer industry.

The alliance also revealed that rewritable SD-RAM discs have received endorsements from Japan's Asahi Chemical Industry Company Limited, and Toray Industries, Inc., and the UK's Plasmon Plc, three leading materials manufacturers known for their expertise in phase-change optical disc technology. Such support is expected to encourage the early

Hitachi, Ltd.
 Matsushita Electric Industrial Co., Ltd.
 MCA Inc.
 Pioneer Electronic Corporation
 Thomson Multimedia
 Time Warner, Inc.
 Toshiba Corporation
 Mitsubishi Electric Corporation
 Victor Company of Japan, Ltd.
 Nippon Columbia Co. Ltd.,
 Toshiba-EMI Ltd.,
 Pioneer LDC, Inc.,
 Metro-Goldwyn-Mayer Inc.,
 Turner Home Entertainment,
 Zenith Electronics Corp.
 Samsung Electronics Co.
 SKC Ltd.

Table 1. Members of the SD alliance, the group of companies that is developing the phase-change method for rewritable optical discs.

commercialization of a rewritable disc.

The phase-change optical system adopted for SD-RAM has the following characteristics:

- it is economical, as players may be thin, with a simple structure;
- it features "direct overwrite" of non-sequential computer data that simplifies and speeds up rewriting;
- is compatible with read-only discs;
- it supports expansion of recording density in future products.

These characteristics will allow SD-RAM to be used as a portable ultra high-capacity rewritable data storage medium, just as floppy disks and magneto-optical discs are currently rerecorded.

In April, the SD alliance announced its adoption of a series of read-only SD discs, SD-ROM, that encompasses a single-sided version of the back-to-back bonded disc (SD-5), a double-sided version (SD-10), a 9GB disc that allows data recorded on both sides to be read from a single side (SD-9); a double-sided 18GB disc that bonds together two dual-layer discs (SD-18) is currently under development. The alliance has also adopted a write-once disc: SD-R.

The SD alliance's selection of the phase-change optical disc for its rewritable medium rests on the conviction that this technology meets all the requirements for future high capacity data storage recently announced by technical experts from five personal computer companies. In addition to rewritability, these

requirements include read compatibility with future read-only discs and rewritable discs, and backward read compatibility with current CD-ROMs.

The main features of the rewritable SD-RAM are as follows:

- SD-RAM uses the same disc as all SD format discs. Formed by back-to-back bonding of two 0.6mm-thick discs, the discs realize high density storage and high resistance to warping. The SD-RAM disc offers more than 2.6GB of storage capacity: this is approximately 4 times the capacity of a CD-ROM, which holds about 600-megabytes (MB), and equivalent to the capacity of 1,300 2MB floppy disks.

The double-sided version of the disc offers a capacity of over 5.2GB. Storage capacity will increase with future technological development, such as the commercialization of a blue laser diode, though even then SD-RAM will maintain backward read compatibility. (Future blue laser diode SD-RAM drives will read discs recorded by earlier generations of red-laser diode SD-RAM drives).

- The SD-RAM writes new data as it erases old data—called direct overwrite—with write/erase operations done by a single laser diode. This allows the realization of a small, light drive structure and low manufacturing costs.

- The SD-RAM uses the same retrieval mechanism to read discs as other SD-ROM discs, so as to maintain read compatibility with other SD-ROM discs. As a result, any SD-RAM drive will read all SD-ROM discs. In the same way, SD-ROM and SD-R drives will read discs written by SD-RAM drives. All SD disc drives will also read current CD-ROMs.

- Back-to-back bonding of 0.6mm-thick discs offers high reliability and efficiency in disc manufacturing because its thinness contributes to improved accuracy in the disc injection process. A shorter injection cycle time also contributes to the reduction of total manufacturing costs. The back-to-back bonding of discs used to form a single SD disc offers superior disc endurance and stability, and it offers the highest degree of resistance to warping that might occur with time, temperature and humidity.

The SD alliance companies already have abundant experience in phase-change optical disc technology, and the support from three of the leading optical disc medium manufacturers provides the

basis for the SD alliance's proposal of SD-ROM and SD-RAM as future high capacity data storage media for computers. Toward achieving this, the alliance will work with the computer industry to finalize details of the SD-RAM specification, to ensure that future rewritable optical discs fully satisfy all user needs.

See Table 2 for the main specifications.

Digital HDTV progresses

At the invitation of CBS, the seven-member Digital HDTV Grand Alliance early in June provided a special preview of its digital high-definition television (HDTV) system to executives from the network's affiliate stations (Table 3). By year's end, this HDTV system is expected to receive Federal Communications Commission (FCC) approval as the standard for the next generation of over-the-air TV broadcasting.

Ed Grebow, executive vice president of CBS Inc., and Joe Flaherty, CBS senior vice president for technology, gave the affiliates a visual update on the progress of digital HDTV featuring a variety of programming compressed through Grand Alliance prototype hardware. Among the materials shown at the CBS Affiliates Meeting, were scenes from Murphy Brown, footage from the Olympic Games and the Montreux Jazz Festival, and an automobile commercial; all in wide-screen digital HDTV.

This world-leading technology is now in its final round of laboratory evaluation at the Advanced Television Test Center in Alexandria, VA, and will undergo terrestrial and cable field testing this summer in Charlotte, NC. While the research and development effort began some eight years ago, the new system is the result of two years of research collaboration involving seven organizations: AT&T, General Instrument Corporation, the Massachusetts Institute of Technology, Philips Consumer Electronics, the David Sarnoff Research Center, Thomson Consumer Electronics and Zenith Electronics Corporation. At the urging of the FCC Advisory Committee on Advanced Television Service (ACATS), the seven joined forces in May 1993 to form the Digital HDTV Grand Alliance, whose goal was to produce a best-of-the-best system for the United States.

The demonstrations, to more than 200 representatives of CBS affiliates, mark

the first time that the Grand Alliance system has been shown at a network affiliates meeting. The CBS affiliates experienced digital HDTV images and surround sound processed through Grand Alliance prototype hardware.

CBS's Flaherty, a member of the ACATS and co-chairman of its Technical Subgroup, has been a prime mover in the eight-year industry effort to bring digital HDTV to the United States. At the National Association of Broadcasters (NAB) convention in April, where the Grand Alliance system made its industry debut, adopted in April, the influential association for Maximum Service Television (MSTV) reaffirmed its "commitment to high definition television and the use by broadcasters of their ATV (advanced television) channels substantially for HDTV."

At an NAB session on April 9, NBC Executive Vice President, Mike Sherlock predicted that NBC will broadcast some prime-time programming; as early as the fall of 1997. And Thomas Murphy, chairman of CapCities/ABC told Broadcasting & Cable (April 10) that ABC is "committed to offering television on the additional

spectrum that broadcasters expect will be set aside for that purpose by the FCC."

"The Grand Alliance system is especially well suited to the real-world needs of broadcasters," explained Jerry Pearlman, Zenith chairman, speaking on behalf of the Grand Alliance. At the technical level, he said, "Its robust digital technology ensures a broad service area, prevents interference into analog broadcasts and provides immunity from interference into the digital signal."

In the marketplace, digital HDTV will empower the nation's broadcasters to compete effectively with other delivery media, both in terms of digital programming and multimedia services.

In addition to its stunningly clear digital images and theater-like digital surround sound, the Grand Alliance system is uniquely flexible, allowing broadcasters to transmit a virtually limitless mix of video, audio and data services. New data services might include sports scores and statistics, stock quotations and even "interactive advertising."

Digital video and much more

For its seventh annual Digital Video

Storage capacity: Single sided - more than 2.6GB

Double sided - more than 5.2GB

Sector size: 2KB

Wavelength of laser diode: 650 or 680 nanometers

Track pitch: 0.74 micrometer

Recording method: zone method*

Data transmission rate: more than 10 megabits per second

*The zone method realizes high-density recording by maintaining recording density according to the distance between the pickup head and the center of the disk.

Table 2. Specifications of the SD-RAM.

Workshop, the Electronic Industries Association's Consumer Electronics Group (EIA/CEG) expanded the scope of the proceedings to include digital audio. Now renamed as the "Digital Audio & Video Workshop", the event will be held October 3 through 6, 1995, at the Marriott Hotel in Philadelphia, PA with the participation of the Consumer Electronics Society of the IEEE (Institute of Electrical and Electronic Engineers).

**NORTH AMERICA'S LARGEST AUTHORIZED
Office Equipment & Circuit Board Repair Center**

**COMPLETE
MACHINE REPAIR**

Facsimiles Laser Printers
Personal Copiers Typewriters

- ▶ FAST TURNAROUND
- ▶ GENUINE OEM PARTS
- ▶ FACTORY AUTHORIZED
- ▶ BEST PRICING AND QUALITY
- ▶ COMPONENT LEVEL REPAIR

THERMAL FAX REPAIR ONLY \$35.00 (Plus Parts)

**QUALITY
SERVICE PRODUCTS**



THE HYTEC STANDARD TOOL KIT

Choice of two case styles -
6" deep Polyethylene hard case with 2 pallets
or
5 1/2" deep large zippered case

INCLUDES THESE TOOLS:

- | | |
|--------------------------|---------------------|
| 3" Phillips Screwdriver | Soldering Iron |
| 6" Phillips Screwdriver | Solder Wick |
| 4" Phillips Screwdriver | Solder Pack |
| 1/8" Slotted Screwdriver | Metric Scale |
| 6 1/2" Mag Screwdriver | File |
| 7 mm Nutdriver | Spring Hook |
| 8 mm Nutdriver | Metric Feeler Gauge |
| Small Vise-Grips | Electrician's Knife |
| 6" Longnose Pliers | Oval Sash Brush |
| 4" Diagonal Cutters | Electrical Tape |
| External Ring Pliers | 2 oz. Oiler |
| 4 oz. Ball Peen Hammer | Pen Light |
| Metric Allen Key Set | Cable Ties |
| 3/32" Pin Punch | |

\$199.00

(Add \$36.00 for hard case pictured)

MENTION THIS AD FOR A 5% DISCOUNT



SHARP

brother

SAMSUNG

Panasonic



DEALER SERVICES, Inc.

4548 ParkBreeze Ct. Orlando, FL 32808
800-883-1001 Fax: 407-297-4310

CALL FOR OUR LATEST CATALOG AND REPAIR LISTINGS -

1-800-883-1001

Circle (63) on Reply Card

Phase-change optical disc

Magneto-optical discs are now the most widely used form of rewritable optical disc. In a phase-change optical disk drive, reading and writing data is done by converting the recording layer of the disk from an amorphous to a crystalline state and vice versa, using the heat from a laser diode. Reading data from the disk is done using the laser in a reduced power mode. Overwriting uses the beam at a higher power level to crystallize the spot where data is recorded, so as to erase it. At its highest power level, the beam transforms the crystalline material to an amorphous state, allowing new data to be written. In this way, a phase-change optical disk can carry out selective writing and rewriting while consecutively erasing data.

Full-fledged compressed digital audio is becoming more important both as a stand-alone technology and as a complement to digital video. That is why the EIA and the IEEE-CES took the step to include digital audio in this workshop.

On October 3, two audio workshop sessions will present up-to-the-minute details of digital audio development in video environments. The sessions will also bring attendees up to date on the digital testing for FM and AM radio being conducted by the National Radio Systems Committee and EIA.

In two tutorials on October 4, speakers will address the different compression schemes for digital audio systems and the new facets of video servers and video-on-demand technology. Attendees can learn which technologies are working in which applications and why. Video workshop sessions will cover a broad array of issues relating to cable, consumer electronics, computers, telecommunications and broadcasting. In the broadcast and cable areas, speakers will focus on the laboratory and field testing results of the Grand Alliance EDTV System and investigate and contrast the standards for HDTV and SDTV. Attendees also will learn how digital has impacted the cable industry and its new service opportunities.

On the personal computer front, attendees will see how digital video is being applied to teleconferencing, multimedia presentations, on-line services and cable television on the desktop. In the consumer electronics workshop, expert panelists will review: the digital video disc systems from Toshiba, Time Warner and Sony/Philips; interactive digital satellite television systems; and open-architecture, digital set-top boxes for video dial tone. While discussing the latest developments for hybrid fiber-coax transport architec-

tures, video-on-demand networks, residential access communications and modulation transport technologies, telecommunications panelists will expose the important issues involved in planning for telecommunications that will support digital video and audio.

Included in the workshop is an engaging Thursday evening panel discussion focusing on the battle for the gateway to the home. The workshop is co-chaired by George Hanover of EIA/CEG and Patrick Griffiths of the IEEE-CES.

Breakthrough in digital set-top technology

BroadBand Technologies Inc. and Thomson Consumer Electronics announced in June the signing of a Memorandum of Understanding (MOU). Under terms of the MOU, the companies are pursuing an agreement to enable Thomson to produce digital receiver/decoders (set-top boxes) with open interfaces at the set-top and on the network at a price from \$50 to \$90 less than the equivalent pass-band hybrid fiber coax (HFC) solutions.

A mutual objective is to develop cost-effective set-tops with an open standard for use by telephone companies worldwide. BroadBand Technologies reports its research has demonstrated that the products which may be developed by the two companies can be marketed at prices much lower than HFC set-tops.

Thomson, which manufactures and markets the highly successful RCA Digital Satellite System, has announced its strategy to become a leading worldwide supplier of digital set-top boxes. These set-tops will be required by telephone and cable companies for direct home delivery of movies and interactive services such as electronic shopping, ticket ordering, banking, and other electronic activities.

Both telephone and cable companies are investing heavily to set up broadband networks which could include the deployment of millions of digital set-tops over the next five years.

"Our goal is to accelerate the deployment of digital systems by facilitating cost-effective, interoperable network set-top solutions in the marketplace," said Salim A.L. Bhatia, President and CEO of BroadBand Technologies. "Thomson is a world leader in consumer electronics. They know how to sell in this competitive marketplace. With this announcement, we intend to be positioned even stronger to provide our customers with products that lead the industry in price and performance."

"We chose BroadBand Technologies because we wanted to strengthen our position in the evolving broadband distribution and set-top business," said Thomson's James E. Meyer, Senior Vice President, Product Management. "BroadBand's technology is already mature, and it would allow us to develop digital set-tops now to provide our customers with the services they need at a price point that the market demands."

The Memorandum of Understanding, which is mutually non-exclusive, brings together two industry leaders.

Thomson is the world's largest manufacturer of digital set-tops. The company's high volume and advanced digital receiver/decoder technology make it the industry's cost leader. Thomson is the largest manufacturer and marketer of color TVs in the U.S. (RCA, ProScan, GE brands), and the fourth largest consumer electronics company in the world.

BroadBand Technologies is the industry cost and performance leader in fiber to the curb (FTTC) Switched Digital Video (SDV) products and was the first to market with SDV technology-based products. BroadBand is offering its second generation product on its Fiber Loop Access (FLX platform to network operators worldwide).

According to the two companies, products that would be developed by Thomson and BroadBand Technologies under a final agreement being negotiated, would help deliver increased capacity and advanced features and services in a standard format, with a standard network interface provided by BroadBand's FLX platform.

These standards-based, network to set-

AT&T
 General Instrument
 MIT
 Philips
 Sarnoff
 Thomson
 Zenith

Table 3. Members of the HDTV Grand Alliance.

top interfaces are being provided to appropriate standards-making bodies—including the ATM Forum and DAVIC for review as part of the two companies' commitment to the speedy deployment of network set-top systems. By incorporating industry standards such as Asynchronous Transfer Mode (ATM) cell communication and 16-CAP (16 Carrierless Amplitude and Phase Modulation) encoding, the products would be designed to offer the customer the most cost-effective solution available to access digital video and interactive multimedia services.

The companies report that the new set-tops would achieve price/performance leadership over existing HFC set-tops by

Requirements by the personal computer industry

A group of technical experts representing Apple Computer, Inc., Compaq Computer Corporation, Hewlett-Packard Company International Business Machines Corporation and Microsoft Corporation recently announced their requirements for a future high-capacity compact-disc format. Their objectives are:

- a single interchange standard for both TV-based and PC-based applications;
- backward read compatibility with existing CDs;
- forward compatibility with future read/write and write-once discs;
- a single file system for all kinds of discs; *low cost;
- no mandatory container;
- reliable data storage and retrieval;
- high on-line capacity;
- high performance for sequential and non-sequential data.

simplifying the network to set-top connection. Using low frequency, baseband transmission eliminates the need for forward error correction, adaptive equalization, and demodulation. The result would be a product designed to maximize performance while using fewer components and realizing significant savings.

BroadBand Technologies, Inc., based in Research Triangle Park, NC, was founded in 1988. Its mission is to provide network operators with the systems required to bring the power of interactive

switched digital broadband technology to consumers. The company's Fiber Loop Access (FLX) System is currently being deployed by Bell Atlantic and is being trialed by Southwestern Bell. It has been in trials at most regional Bell operating companies, by GTE, and by a number of international telephone companies.

Sensory Circuits, although only a year old, announced that it is supplying its RSC-164 speech recognition ICs with the

Improve Your Form.

3/5 Part

A continuous feed form used for customer COD service, parts/accessory sales receipts, and warranty billing. Includes technician hard copy and set tag. Available in 3-part (N3CS) and 5-part (N5CS) format.

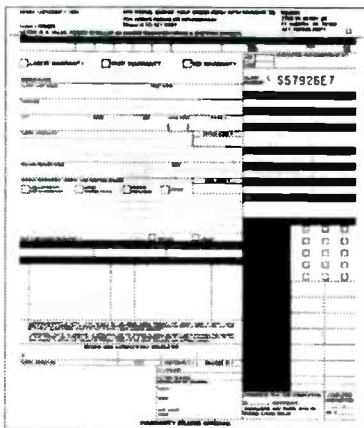

5 Part

A continuous feed 5-part (N5CN) form for warranty billing that does not include a set tag.

Discounts Carbonless NESDA Forms are available to NESDA members at additional savings. For pricing information and samples, contact Moore Business Products at the number below.

The NESDA Form
 Moore Business Products
 (800) 433-5557

Fox International
 23600 Aurora Road • Bedford Hts., Ohio 44146
 OVER 3 MILLION PARTS IN STOCK

Panasonic - Quasar - Technics

Why Call Multiple Distributors For All Your Parts Needs?
 "With One Call You Get It All"

CALL ONE NUMBER
 FOR ALL YOUR PART NEEDS
800-321-6993
 We Are Not A Broker WE STOCK PARTS
 Call Us With Your Backorder List Today!!!!

DALBANI

the ultimate saving source



*Electronic Components
is our business*

FREE CATALOG

DALBANI CORPORATION
4225 N.W. 72 ND. AVE. MIAMI, FLORIDA, 33166
TEL: (305) 716-1016 FAX: (305) 594-6588

Circle (58) on Reply Card



**Satellite
Dealers
Association**
(A not-for-profit association)

Join Us

Regional Tech Seminars

Electronics Technology School,
Satellite/Antenna/MATV, and
Business Management Schools
for small electronics service dealers

CSI Certification

Become a CSI. **Certified Satellite
Installer, or a CET, (Satellite
Journeyman)**. Join those making a pro-
fession of the business. Call for nearest
test site. (360 sites)

Training Materials

Seminar Videos, UCANDO Training
Videos, FCC and CET study materials -
books and computer disks; monographs
and a full time office to provide dealer
and technician help - when you need it.

Call for member application
317-653 4301
602 N Jackson
Greencastle, IN 46135

Circle (72) on Reply Card

Interactive Voice technology (Figure 2) to several products for release in 1995.

Two products were shown in February at the New York Toy Fair incorporating Sensory Circuits Interactive Voice technology. Both products fall into the Electronic Learning Aid category and utilize speech synthesis and recognition to teach early learning concepts to children.

Tiger Electronics has released the Talkback Phonebook under the Playskool brand. The Talkback Phonebook not only uses the RSC-164 for speech recognition and synthesis, but also as a digital recorder to record the child's name for use in interactive conversation. The product allows the child to call different people and have conversations with them.

For example, by calling the school, the child gets asked simple math problems, and the teacher can intelligently respond to what the child says; at the zoo the child learns the names of animals, etc. Tomy Electronics' Busytown Talker uses the Paramount Communications licensed Richard Scarry characters of Lowly Worm, Huckle the Cat, and Sgt. Murphy. The characters each talk in their own voices, and teach early learning concepts such as shapes, colors, words, and numbers.

The RSC-164 further allows a Karaoke mode where the chip can simultaneously synthesize 4 voice music, while amplifying the child's voice over the microphone. Busytown Talker uses over 400 words of synthesized speech, and a 36 word recognition vocabulary.

Other Products to be announced soon according to Sensory's president, Todd Mozer, "We've been overwhelmed with interest in our Interactive Voice technology. Expect to be hearing more from us over the next several months about the RSC-164 appearing in communication devices, PDA's, remote controllers, and other consumer applications."

The RSC series utilizes a proprietary neural network based recognition technology to provide speech recognition and synthesis in cost sensitive applications such as toys, games, electronic entertainment and consumer electronics. In mid 1995 Sensory will introduce the LSC-164i, a reduced cost version with the external memory bus removed.

The RSC series allows for speaker independent recognition, requiring no training by the end user. The RSC-164 is also capable of speaker dependent recog-

niton, allowing the user to customize the words to be recognized. The recognition technology can recognize an unlimited number of words broken into sets of two to ten words. Each set contains different words, and the possible number of sets is limited only by available memory. The RSC series includes digital filtering to improve recognition quality.

Speech and sound effects are synthesized by the on-chip processor from data in ROM. Synthesis uses a proprietary time domain technology that can compress speech and sound effects to 5,000 bits per second and maintain an excellent sound quality. Over 40 seconds of speech or sound effects can be stored on the chip, and external ROM can be accessed for unlimited sound storage. Additionally, the RSC164 can record to off-chip RAM at data rates of under 15,000 bits per second for custom greetings, phone answering machines, voice changers and handheld communication devices.

The 4MIPS (million instructions per second) custom processor may be programmed to execute control or logic functions associated with the operation of any product. This minimizes the amount of additional electronics required to implement the product. Less than 50% of the processor is utilized during synthesis.

The RSC series utilizes a .6 micron CMOS design with auto powerdown mode on chip for extended battery life. Selectable clock speeds include 4.7MHz, 7.2MHz, and 14.3MHz with an on-chip 32.7MHz housekeeping circuit. The automatic gain control (AGC) circuitry allows speaking at different vocal volumes or at varying distances from the microphone with little impact on recognition quality. The RSC series uses a single 3V to 6V supply, which draws less than 10µA current in standby mode, and 5mA typical operating current.

The beat goes on

As this small selection of the total effort that's taking place in consumer electronics and allied businesses suggests, the changes we have seen in consumer electronics in the past couple of decades, while amazing and impressive, are merely a prolog to the changes to come. The next few years promise to be an interesting time for consumers of electronics products as well as for those who service them. ■

Test Your Electronics Knowledge

A little of everything

By Sam Wilson

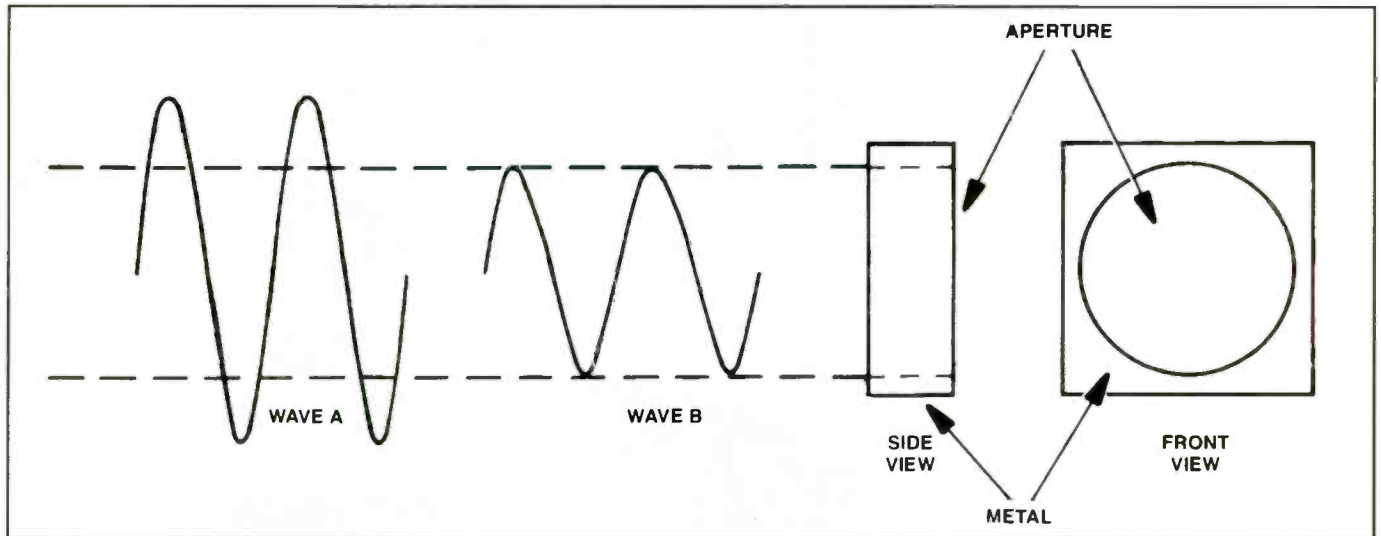

Figure 1. These two electromagnetic waves, of equal frequency but different amplitudes, are approaching an aperture. What will happen when they reach the aperture?

1. Refer to Figure 1. Two electromagnetic waves (A and B) are approaching an aperture. They both have the same frequency, but the amplitude of A is greater than the amplitude of B. Which of the following is true?

- A. Waveform B will pass through but waveform A will not.
- B. Waveform B will pass through unchanged, but, the peaks of waveform A will be clipped.
- C. Neither choice is correct.

2. The JFET connection on Figure 2 is used as a(n) _____.

3. What is the conjugate of $j16$?

4. Which of the following equations is correct for determining the percent regulation of a brute force power supply?

- A. $(V_{FL} - V_{NL})/V_{NL}$
- B. $(V_{NL} - V_{FL})/V_{FL}$
- C. Neither choice is correct.

5. The phase angle between the voltage and current in a power circuit is 45° . How

do you find the power factor of that circuit expressed as a percent value?

6. $P = V \times I$. That is an equation based on Watt's Law.

- A. True
- B. False

7. Is the following statement correct? A capacitor can be made with a capacitance value so high that it can be used to replace a battery.

- A. Correct
- B. Not Correct

8. An undesirable pulse occurs when two NAND gates change states at slightly different times. The undesired pulse is called a(n) _____.

9. What is the decimal value of the following binary coded decimal number: 0001 0011? _____.

10. Regarding an FM signal, what do you get when you divide the frequency deviation by the modulation frequency?

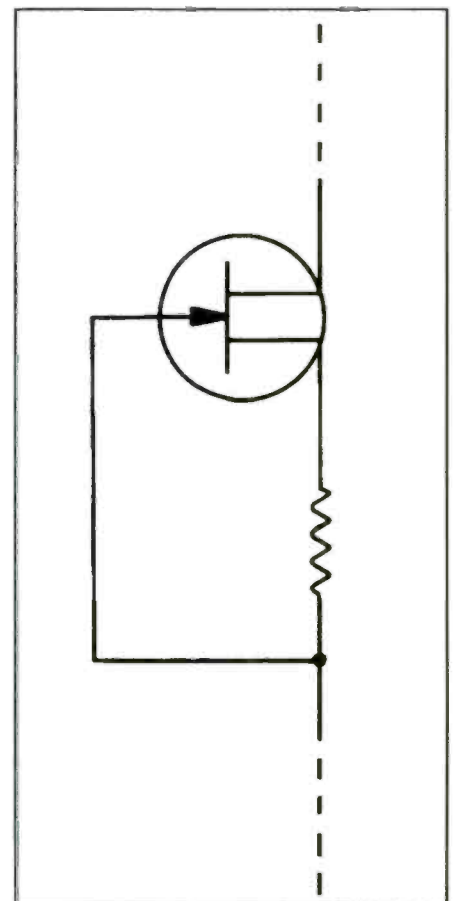

Figure 2. What is this JFET connection for?

Wilson is the electronics theory consultant for **ES&T**

(Answers on page 69)

Troubleshooting audio circuits by the numbers

By Homer Davidson

Troubleshooting the sound circuits in a TV set is usually not difficult. The cause of dead audio circuits, as with dead TV chassis, is usually easily located. Troubleshooting weak and intermittent audio problems becomes more difficult. Often the cause of distorted sound is a malfunction in the audio output circuits.

Some technicians prefer to first check the voltage output of the power supply that supplies power to the audio stages. Others try to locate the dead sound stage by checking each transistor with in-circuit tests, while other technicians signal trace the audio using an oscilloscope and an external amplifier. If the audio is extremely weak, the cause of this symptom can be located by signal tracing using the scope as a monitor. Sound circuits can easily be serviced by the numbers.

The early audio circuits

In early solid-state TV chassis, the audio circuits contained af, driver and single-ended output transistors. In later sets, the IC IF/Detector and preamp IC were introduced, then the audio output circuits of an af or driver transistor and two output transistors in push-pull operation. Transistor audio output circuits were quite popular at one time in most consumer electronic products. Later the audio output IC appeared.

IC components found in the audio stages consisted of not only the audio output circuits, but preamp and driver circuits. This same IC may also include part of the IF/SIF and discriminator sound circuits (Figure 1).

Often the IC became leaky, causing dead, intermittent or distorted audio. The audio output terminal of the output IC was coupled directly to the permanent magnet (PM) speaker. Defective speaker coupling capacitors were known to produce weak, intermittent or distorted sound, or no sound at all. Simply replacing the au-

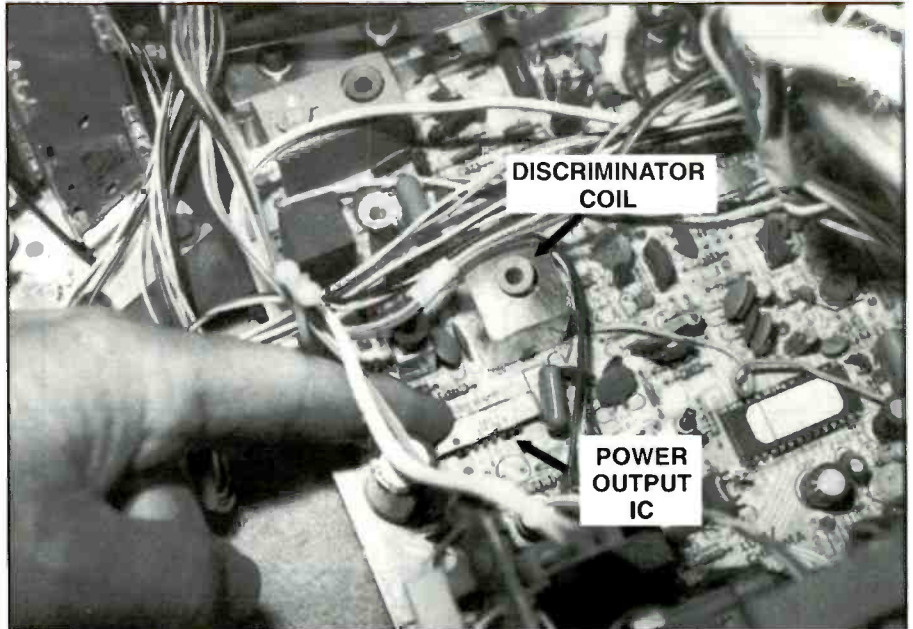

Figure 1. The audio circuits in early solid-state TV sets consisted of a single integrated circuit mounted on a heat sink.

dio output IC solved many different sound problems.

Today's sound circuits

Transistors are back in today's low

priced TV chassis. You will find the same af amp and two small output transistors in push-pull operation. Usually, these transistors are found in the small portable or table-top model TV's.

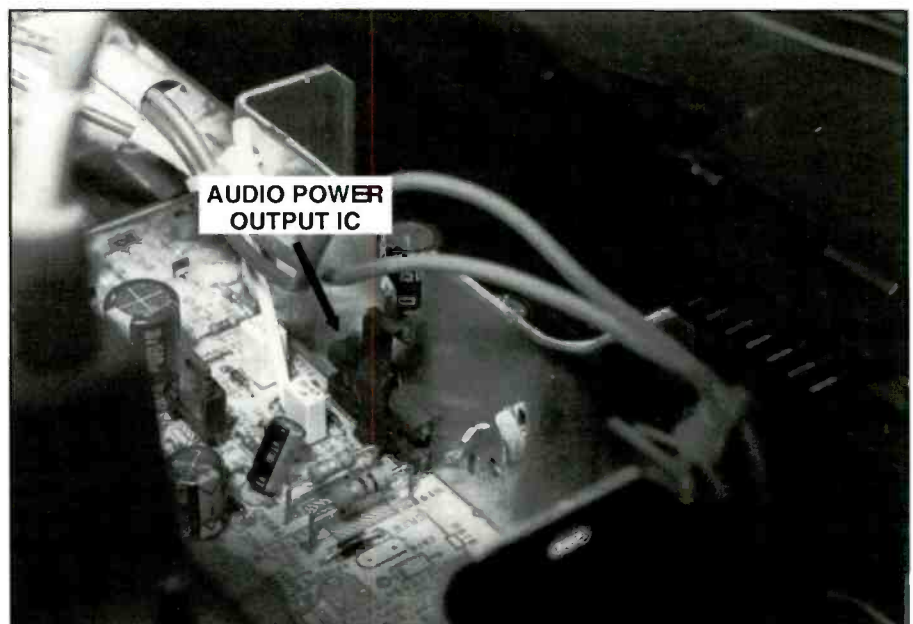

Figure 2. All of the audio output circuits in some sets are included in one IC.

Davidson is a TV servicing consultant for ES&T.

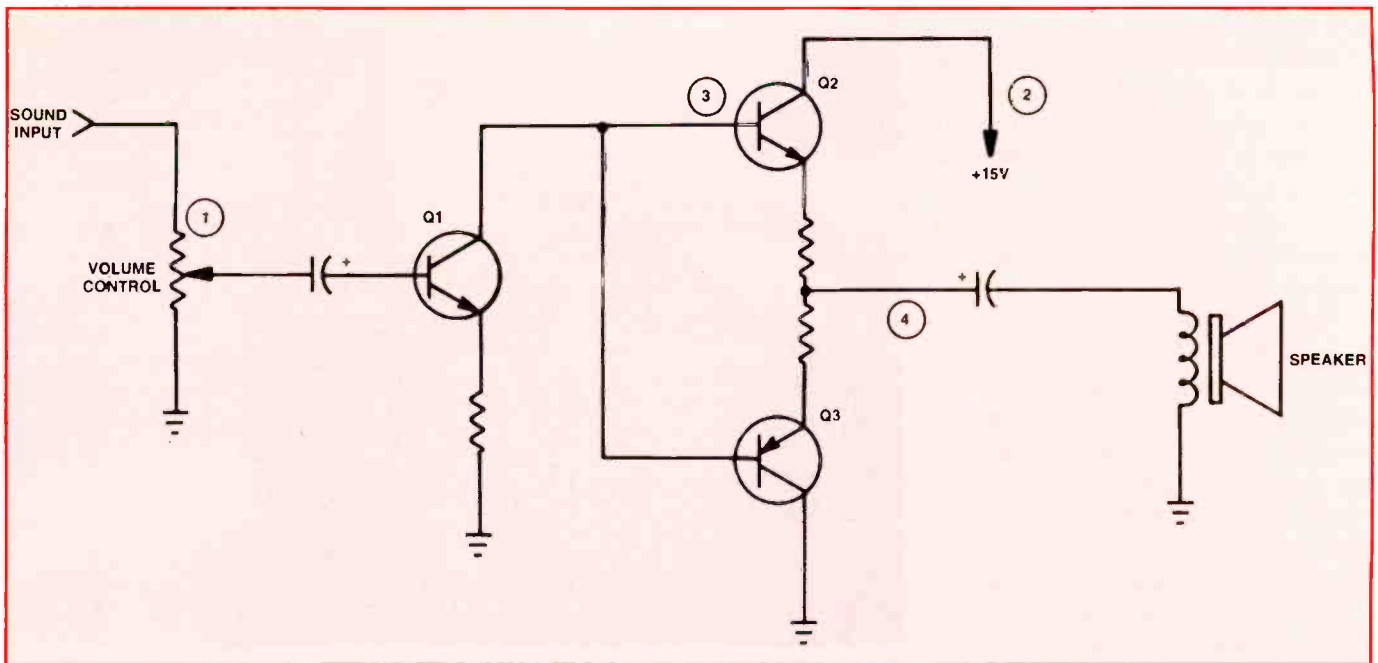

Figure 3. An orderly procedure, checking "by the numbers" using signal tracing and voltage tests can quickly lead the technician to the cause of audio circuit problems.

Monophonic TV sound circuits can consist of one large IC, sound IF detector, and preamp in the large IC with additional sweep, AGC and color circuits, or a single power IC component. The sound output IC is mounted on a separate heat sink (Figure 2).

A stereo sound system may consist of a stereo demodulator circuit, demodulator IC, matrix, audio switching IC, and dual audio output IC. In other stereo chassis, the audio is capacitance coupled to a MPX/stereo IC, with left and right audio output terminals. The stereo signal is cou-

pled to a Video/Audio control IC, dual-af amp IC, and to a dual-audio output IC.

No audio

Complete absence of sound output may be caused by almost any working component in the audio circuits. A defec-

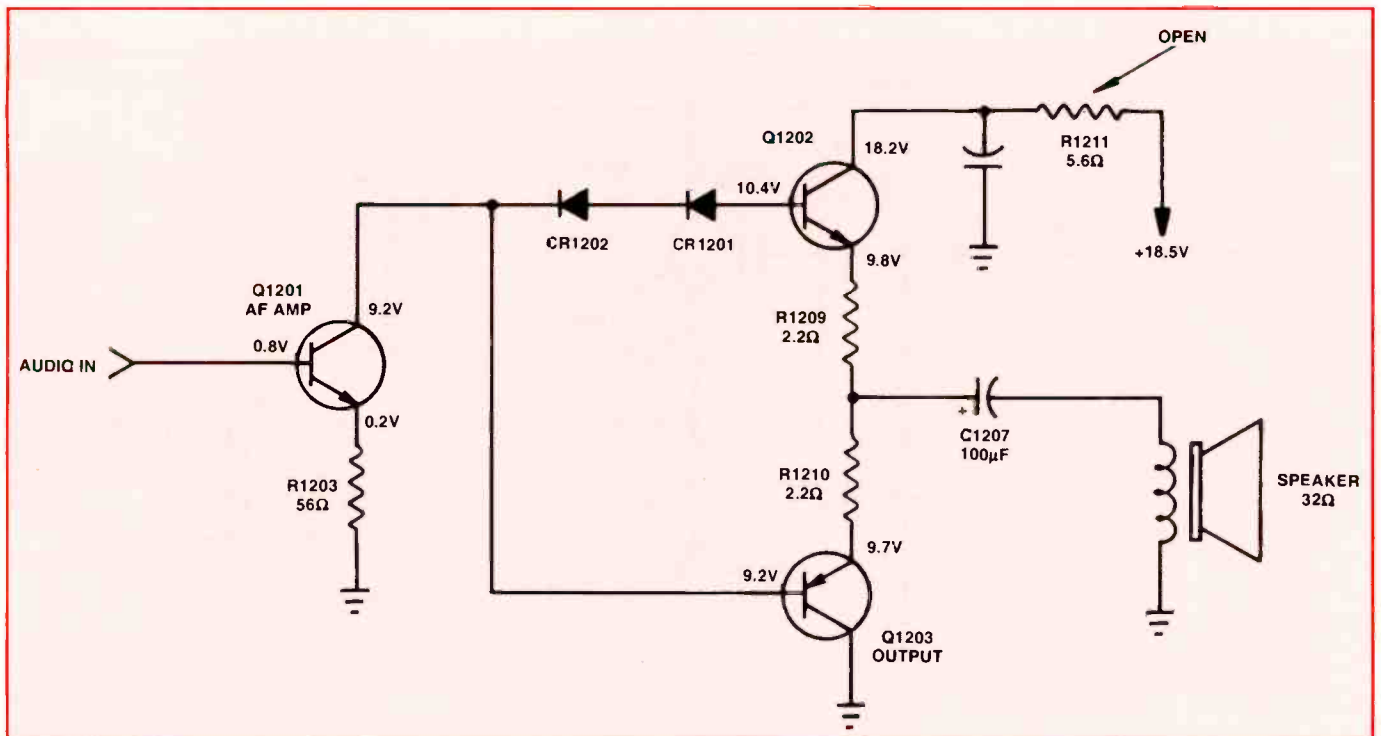

Figure 4. In one RCA CTC146E set, R1211 was open, resulting in the absence of sound.

tive relay, a blown fuse, a leaky or shorted output transistor or a leaky or shorted IC can result in the absence of sound. Open or leaky driver transistors can kill the sound, as can a leaky audio output IC or an open speaker electrolytic capacitor. Be sure to check bias resistors and diodes when trying to locate a dead transistor or integrated circuit.

Other malfunctions that can cause the absence of sound are, improper power supply voltages to the audio circuits or leaky electrolytic filter or decoupling capacitors. Check for open isolation resistors between the power source and the output transistor or IC components if there is no sound but voltage across the electrolytic filter capacitor is normal.

Weak sound is often caused by open or dried-up coupling capacitors. Especially, suspect electrolytic coupling capacitors of $1\mu\text{F}$ to $10\mu\text{F}$. Weak and garbled sound may be caused by misadjustment of the sound or discriminator coil. Open sound take-off coils can result in normal audio on local strong TV stations and weak sound on distance reception. Check the electrolytic speaker coupling capacitors for weak audio. A combination of weak and distorted sound can be caused by a leaky output transistor or IC.

Audio output transistors and IC com-

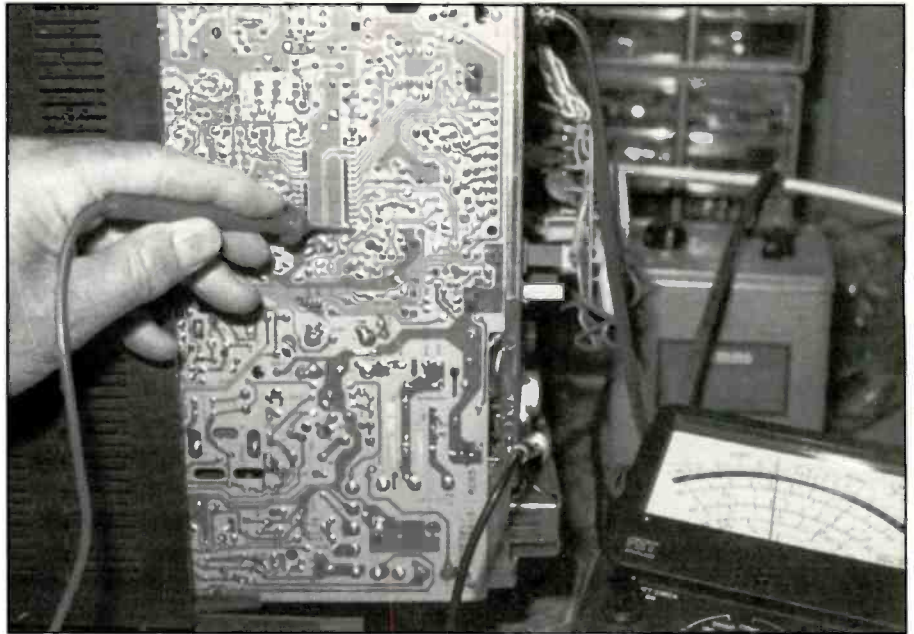

Figure 5. Careful voltage measurements at the pins of integrated circuits or transistors can help locate the defective part.

ponents are the most frequent cause of distorted sound. Sometimes leaky af or driver transistors or a leaky if/detector and preamp IC can be the cause of weak and distorted sound. Slight distortion with hum in one channel may be the result of a defective dual-output IC. Check all bias resistors and look for leaky capacitors tied to the audio output transistor or

IC. If the audio sounds garbled, don't overlook the possibility that the if or discriminator coil may be misadjusted.

Intermittent sound

Intermittent audio is the most difficult audio problem to locate and can take up a great deal of service time. A defective relay can cause intermittent sound or

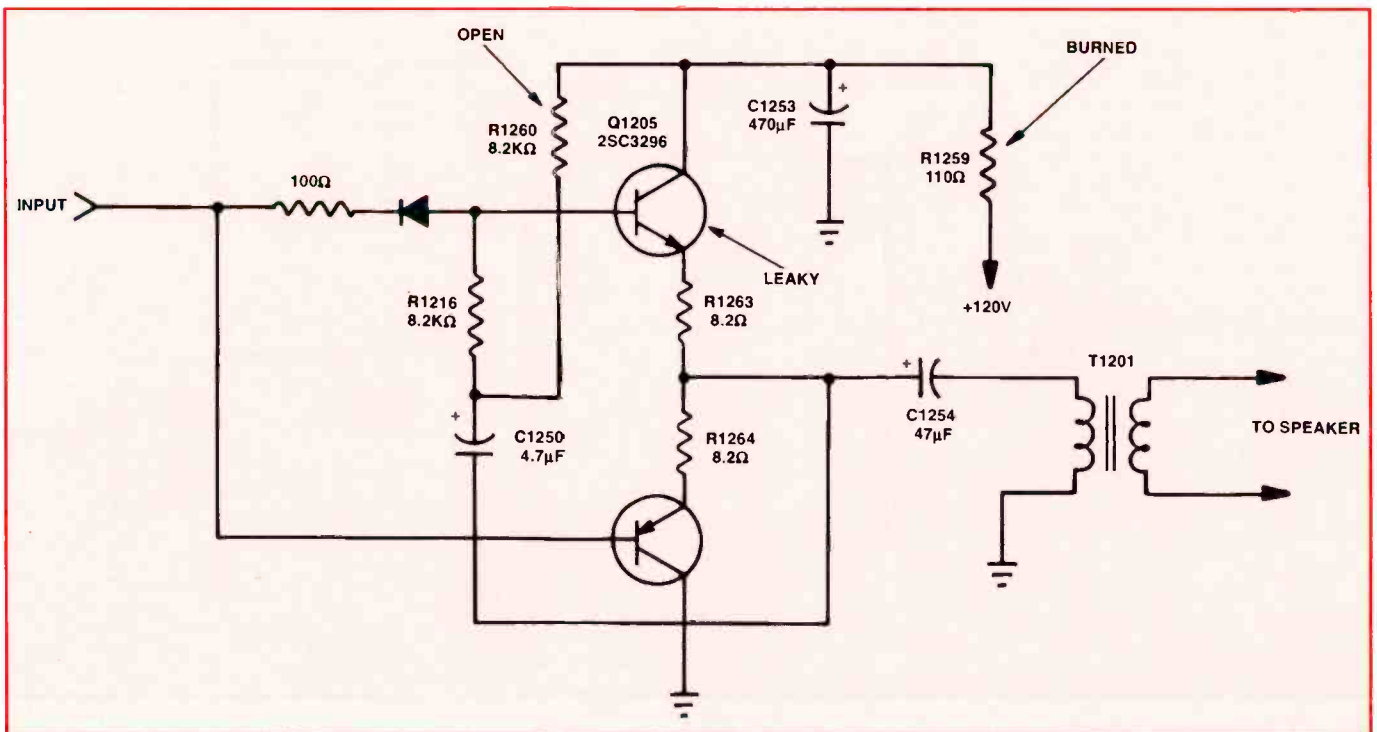

Figure 6. In an Emerson MS250 TV set, replacement of leaky Q1205, open R1260 and R1259 restored the sound.

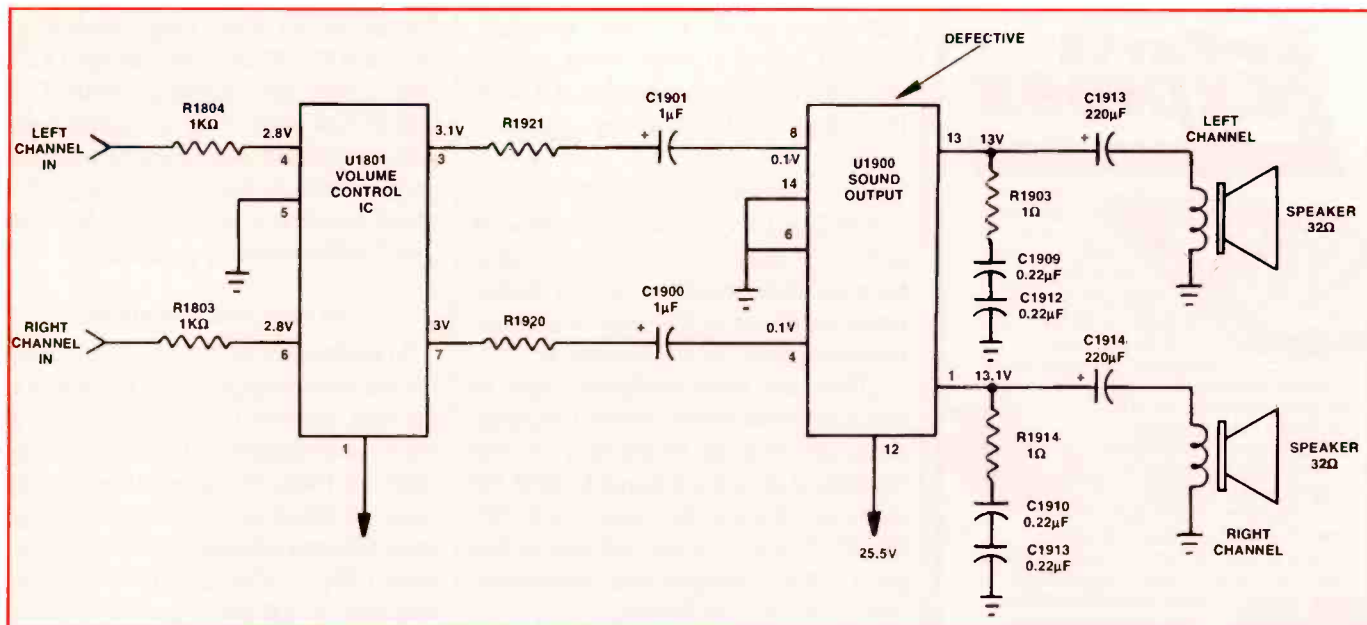

Figure 7. Integrated circuit U1900, which had a leaky right channel was replaced with an exact replacement part to solve an audio problem in this RCA CTC166 chassis.

complete absence of sound. Soldered board connections and cold solder joints cause many intermittent sound problems. Intermittent audio can be caused by poor IC or transistor terminal connections to the printed circuit board. If you suspect that this is the problem, solder all terminal connections with fresh solder. Another possible cause of intermittent sound problems is intermittent transistors or integrated circuits.

Check by the numbers

The cause of most sound problems can be located quickly using routine checks. The first test is to make sure the volume control is turned up. Place your ear close

to the speaker to determine if there are any signs of weak audio or audio hum. If hum is present, this indicates that ac voltage is possibly being applied to the audio output stage. Then, visually inspect audio circuits for burned or overheated components.

Check the audio stages by the numbers (Figure 3) to determine if the sound problem is within the audio output or in the IF/SIF, or discriminator circuits.

- Step 1: check for audio at the volume control by observing the audio waveform on the scope probe or by applying the audio from this point to the input of an external amplifier.

- Step 2: if these tests show that sound is present at the volume control, check the

voltage source at the audio output transistors or IC.

- Step 3: if source voltage is present at the audio output circuits, but there is no audio at the speaker, signal trace the audio at the base terminal of the output transistor or the input terminal of the IC.

- Step 4: check for the presence of signal output at the collector of the transistor or IC output terminal.

If no sound is found at the volume control in Step 1, proceed to the sound front-end of the IF/SIF detector and preamp IC circuits for the following tests.

- Step 1: check the audio output at the output pin terminal of the SIF IC with a scope or external amp.

- Step 2: take a critical voltage mea-

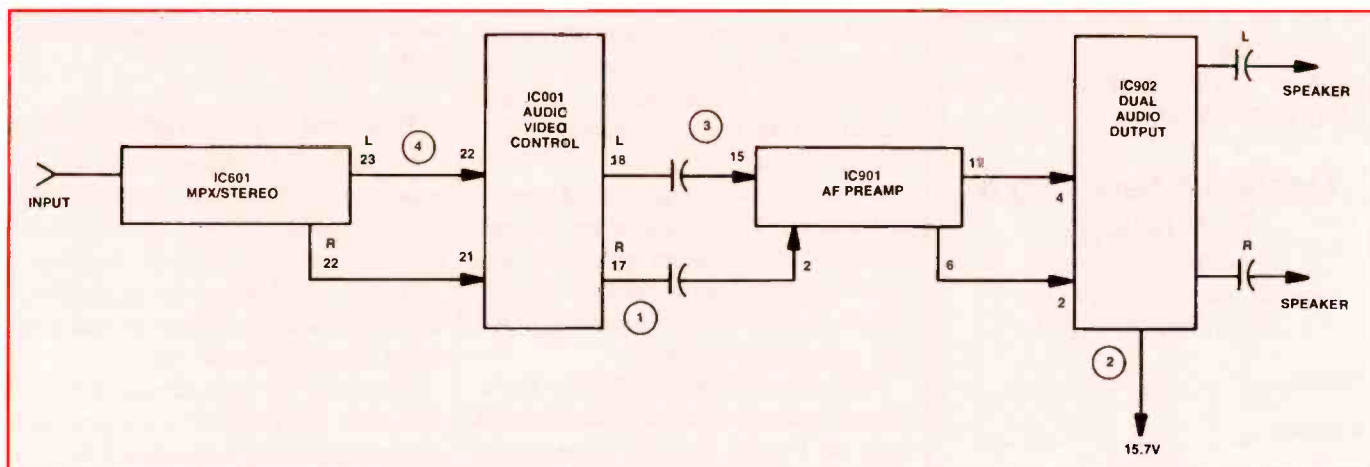

Figure 8. Block diagram of a TV MPX/Stereo sound output circuit.

Parts Express™



Parts Express is proud to announce that we now stock the NTE line of replacement semiconductors. NTE has been

supplying the electronics industry with top notch replacement parts for over 15 years. All NTE products meet or exceed industry specifications and offer an exclusive 2 year manufacturer warranty. We also offer a complete line of parts for the service repair industry. Test equipment, loudspeakers, video and audio heads, magnetrons,



belts, idler assemblies, tools, soldering equipment, just to name some of the 12,000 items we stock. Ask about our new dealer program for resellers. Call toll free for a copy of our FREE 212 page catalog. **Source Code: ESM**

**CALL TOLL FREE
1-800-338-0531**

Parts Express 340 E First St. Dayton, Ohio 45402-1257
Phone: 513-222-0173 Fax: 513-222-4644

Circle (70) on Reply Card

MOVING?

If you're planning a move in the near future, don't risk missing an issue of *Electronic Servicing & Technology*. Please give us 6-8 weeks notice if you're planning on changing your address. Just write in your new address below and mail this coupon, WITH YOUR SUBSCRIPTION MAILING LABEL, to:

Electronic Servicing & Technology

Subscriber Services
76 North Broadway
Hicksville, NY 11801

Name _____
Address _____
City _____
State _____ Zip _____

surement at the SIF IC supply terminal.
• Step 3: if the picture is normal, check the sound IF/SIF input terminal of IC with the scope demodulator probe.

Audio signal tracing

One good way to isolate the cause of audio problems in a TV set is to signal trace the audio circuits with a TV station tuned in using an oscilloscope or an external amplifier as the audio monitor.

There are many different stages to check out in the stereo circuits. Check the audio circuits by the numbers. If you find no audio at the volume control, check the audio waveform at the output pin of VIF/SIF IC. When no sound is found at this point, check voltages and components tied to the VIF/SIF circuits.

If the waveform or sound is present at the output terminal of VIF/SIF IC, proceed to the input of the MPX/stereo IC. Now check the audio output at both right and left output stereo channels. The audio amp can be used from this point on with the external amplifier. If there is no sound on either output channel, check voltage and components on the MPX/stereo IC. If one channel is dead or weak, you should suspect a defective MPX/IC.

Next, check the input audio at the preamp, af and audio control IC, if there is one in the circuit. Both channels of audio can be signal traced with an audio signal from stereo/MPX IC, through control IC, preamp, af and volume control circuits. Signal trace with a scope and an external amp. Likewise check the audio output stages by the numbers.

No sound-normal color picture

An RCA CTC146E chassis had no sound output. Step 1 of the audio checking procedure revealed that there was audio at the volume control. This suggested that the trouble was in the sound output circuits.

I measured the voltage as recommended by Step 2. The voltage at the collector terminals of the output transistors was zero (Figure 4). Absence of the 18V audio circuit source indicated problems in the low voltage power supply.

The schematic showed that the 18.5V source is taken from a low voltage derived from the flyback. A quick voltage measurement at the cathode terminal of the silicon diode CR4120 and filter capacitor C4135 (470µF) indicated normal voltage.

Further checks in this area revealed that resistor R1211 (5.6Ω) between the 18.5V source and the collector terminal of Q1202 was open. Both the output transistor and R1211 were replaced to insure proper audio to the 32Ω speaker. This sound problem was easily located with step 2 of the checking procedure.

No right channel audio

In an Emerson M250 set, the left channel was normal but there was no audio in the right channel. I checked the audio at the volume control of the right channel (Step 1). There was normal sound at the volume control, so I checked the voltage at the collector terminal of the output transistor (Step 2). The collector terminal of transistor Q1206 was at ground potential. The collector terminal of transistor Q1205 should be at around 100V, but it measured only 47.7V (Figure 5).

I brushed the dust and dirt aside and made a few observations. R1259 was running quite warm. I tested Q1205 in the circuit. It appeared to be leaky, so I removed it and tested it again out of the circuit. I decided to test all bias resistors that were checked while the output transistor was out of the circuit. The R1260, an 8.2KΩ resistor had a very high resistance reading. I disconnected one end of this suspected resistor from the circuit and tested it again. This check confirmed that this resistor was open.

I replaced transistor Q1205 (2SC3296), which operates at a higher voltage than most audio transistors, and replaced it with a universal replacement; an NTE375 output transistor. Replacing these defective components; transistor Q1205, resistor R1260, and resistor R1259 at the number 2 check point restored sound output in this set (Figure 6).

Weak and distorted right channel

An RCA CTC166 had a weak and distorted sound in the right channel. When servicing audio problems in stereo audio systems, you will generally find that it will take a little longer to locate the defective component, since there are many different circuits to check out.

Since only the right channel in this set was weak and distorted, I skipped diagnostic step number 1 and went directly to the audio output circuits. A check of the schematic diagram for this set revealed that this RCA CTC166 chassis has a vol-

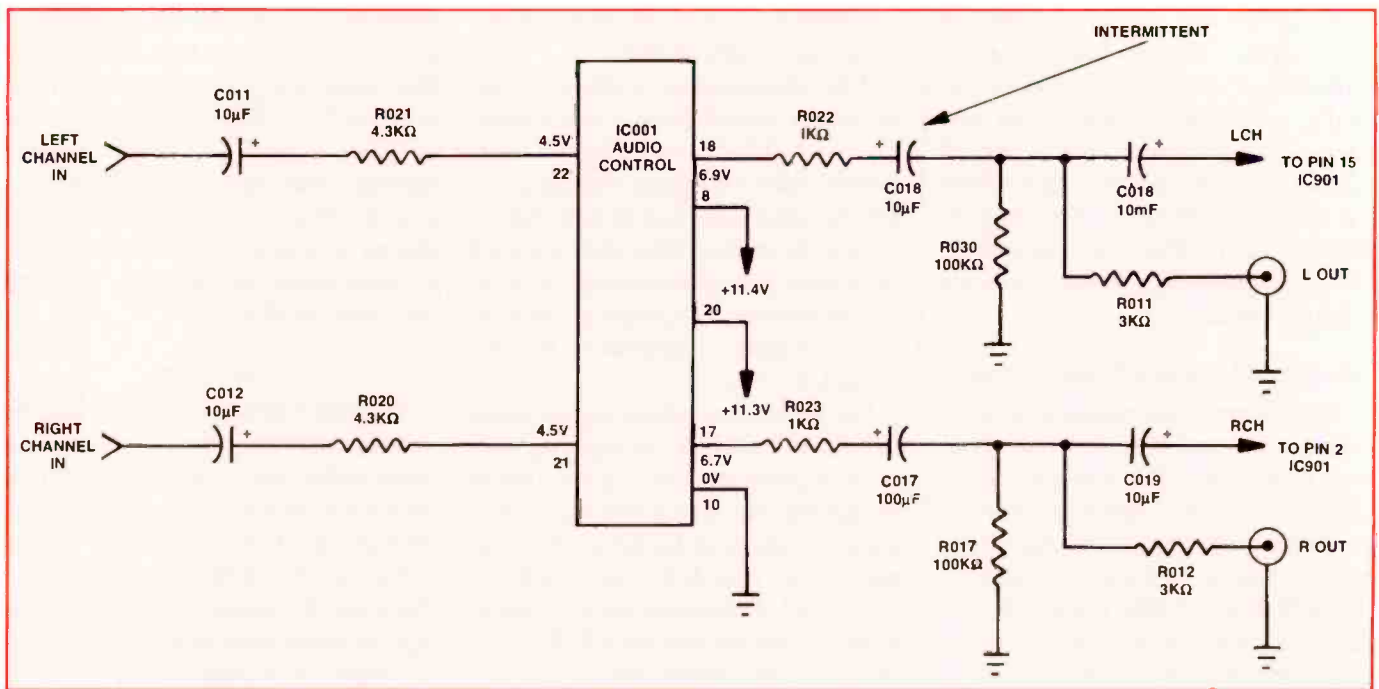

Figure 9. Replacement of an intermittent capacitor, C016 (10µF), in the left channel in a Goldstar CMT-2612 TV corrected an intermittent sound problem.

ume control IC (U1801) feeding a dual audio output IC1900.

I measured the voltage at pins 1, 12 and 13. Naturally, the supply voltage at pin 12 and left output channel 13 should be normal since the left channel audio was nor-

mal (Step 2). The voltage at pin 1 was only 7.2V, indicating a possible defective output IC (Figure 7).

I applied the input audio from pin 4 to an external amplifier, and compared it with the audio at the normal left channel

at pin 8. I found that the right channel signal produced a lower volume in the external amplifier. To make sure that the audio signal was present ahead of the output IC, U1900, I tested the right channel audio at pin 7 of U1801. Both audio channels were

Two great products. Two big ways to save.

It's almost too good to be true!

PHOTOFACT® and VCRfacts® provide the service documentation you need to repair televisions and VCRs easily and inexpensively. Available in individual sets or by monthly subscription, these proven repair tools cover numerous makes and models, cost a fraction of the price of manufacturers' data, and are available to you today. It may seem too good to be true, but it's not. Call us and see.

1-800-428-7267

fairly comparable at pins 3 and 7 of U1801. This led me to believe that the right channel circuitry of U1900 was defective. I tested all components that were connected to each pin of U1900. They all appeared normal. I ordered a replacement for U1900, an RCA 181836 exact replacement part. When this replacement was installed, it corrected the weak and distorted channel.

Intermittent sound-left stereo channel

Intermittent sound problems in stereo channels can consume a great deal of service bench time. For example, in the Goldstar CMT-2612 that I was working on, an intermittent left audio channel can be caused by problems at any point from the MPX/Stereo IC601, through the Audio/Video control IC001, preamp and AF IC901, to audio output IC902 (Figure 8). Since there were so many different audio stages, I decided to check the circuits one half at a time, monitoring the intermittent

left channel at pin 18; the output of the audio video control IC001.

After about an hour of operation, the left channel speaker became a little noisy. Pin 18 of IC001 showed no signs of intermittent audio. This meant that the intermittent component must be from pin 18 towards the speaker. Since a known-good test speaker was used in testing, the problem could not be the speaker. It had to be an intermittent component in the left channel circuitry.

I divided the remaining suspect stereo audio circuits in half. By checking with the test monitor at pin 11 of IC901, I found that the left channel was still intermittent at pin 11, indicating that the problem was between pin 18 of IC001 and output pin 11 of IC901. I connected the scope probe to pin 15 of the left channel at IC901 (Figure 9). The left channel can also be monitored at the left channel output jack that connects to the input circuits.

After several minutes, the left channel

sound began to act up. The waveform at pin 15 of IC901 reflected the problem. This meant that the intermittent part was either R022, C016 or C018 from pin 18 of IC001 to pin 15 of IC901. When I sprayed coolant on C016 (10 μ F), an electrolytic coupling capacitor, the sound cleared up. Capacitor C018 was found to be intermittent. Replacement of C018 solved the problem.

Conclusion

Sound problems can be serviced by the numbers starting at the volume control. Some technicians may prefer to start at the SIF/Detector IC and work towards the speaker. I prefer to cut the audio circuits in half and start at the volume control to determine if sound problems are in the input or output sound stages. You will find that when the problem is weak or intermittent sound, or if the audio is stereo, it will take a little longer to locate the defective component. ■

Photofacts

CROSLEY

CT1321C121	3520
CT1922C121	3522
13E605-00AA	3520
19E601-00AA	3522

GE

CTC146E	3515
CTC146L	3515
05GP005	3517
20GT425N02	3515
20GT425N04	3515

GOLDSTAR

CN-26B44	3523
CN-26B60	3523
GCT 2515S	3523
GCT 2554SN	3523
NC-44A	3523

MAGNAVOX

RJ4476	3513
RJ4910	3513
25G101-00AA	3513
25G104-00AA	3513

PANASONIC

PV-4820	VCR-266
PV-4820-K	VCR-266
PV-4822	VCR-266
PV-4822-K	VCR-266

QUASAR

AEDC167	3521
YAEDC167	3521
TT6288CE	3521
TT6288CH	3521
YTT6288CE	3521
YTT6288CH	3521

RCA

CTC187CK	3512
F31632ETFM1	3512
F31632ETJX1	3512

SEARS

NC95A	3518
580.40472090	3518
580.40472091	3518
580.42052090	3518
580.42052091	3518
580.42052092	3518

SHARP

27F-S300	3510
----------------	------

SONY

KV-27S15	3516
KV-29RS15	3516
KV-32S15	3516
SCC-F84M-A	3516
SCC-F84P-A	3516
SCC-F85H-A	3516
SCC-F85K-A	3516
SCC-F89G-A	3516

TOSHIBA

CF20D40	3511
TAC9402	3511

ZENITH

CN-100C	3519
SMS1324S	3519
SMS1324X	3519
SMS1941SG	3514

RECEIVED
Serving Technology

YES!

WHEN SEALING, PLEASE DO NOT COVER SHADED AREA.

STATE ZIP

CITY

ADDRESS

NAME

RETURN ADDRESS (Please Print)



NO POSTAGE
NECESSARY
IF MAILED
IN THE
UNITED STATES

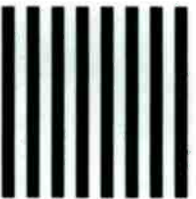

BUSINESS REPLY MAIL
FIRST CLASS MAIL PERMIT NO. 2055 HICKSVILLE, NY 11801

POSTAGE WILL BE PAID BY ADDRESSEE

ELECTRONIC
Servicing & Technology

76 North Broadway
Hicksville, NY 11801-9962

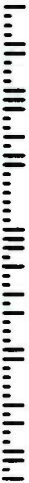

Service business management: “The Common Sense Factor”

By David Presnell



The service business can have the best technicians, the best equipment, the best benches, the best location; but the service business is a business. Like all businesses, the service business has to be managed in terms of profits from beginning to end. Without some form of accounting and business management ability, the service business suffers.

The intent of this article is to provide some common sense ideas to think about, especially if you're the sole owner/operator of your own service business. It is not my intention to teach accounting or business management. There are plenty of excellent colleges available for that. The following article is based on my opinion. Take it for what it is. You probably won't find the following information in any book, but I think you'll find it useful.

What is a business?

When one or more people develop and

organize a group of resources into a system designed to deliver a product or service to other people who need or want that product or service, we call it a business.

The business is developed through research to determine if a need exists, or if a need or demand can be created. Resources include capital, equipment, buildings, the work force, suppliers, inventory, and two other very important factors: time and the customer.

The system designed to deliver this product or service must be managed to the point that the product or service can be delivered at a profit. I call this attempt to deliver profitably “business management.”

The business must market its product or service if it is to grow. This can often be performed with little cost, but marketing is seen by some as an evil when business is slow. Marketing, however, must proceed as an ongoing process just like business management.

Why are you in business?

The next time you walk into a small

business, ask the owner “Why are you in business?” There is only one true answer, the one you're least likely to hear: “We're in business to make money!” All other reasons must be secondary to making money. I believe that being in business for any other primary reason will eventually lead to problems.

We're in business, or should be, to make money! How much money do you want to make? Take a piece of paper and write down how many total dollars you have taken in this year to date. From your financial statements subtract all expenses that you have paid this year from those total dollars, and calculate your profit for this year to date. Subtract what you think you'll pay in taxes. This leaves you with an idea of how much profit you will have this year so far, if any.

What condition is your business in?

Now, ask yourself some questions. Why is my profit or loss the way it is? Can I change it? What will I have to do to change it? If your profits are not as high as you

Presnell is owner of an independent computer servicing business and a freelance technical writer.

ES&T READER SURVEY



ES&T READER SURVEY

Associations that provide courses, seminars, service managers and owners of similar concerns with a number of leading educational opportunities, decisions and opportunities about service managers in the industry, and more. With the survey, you'll see to get an idea of what percentage of respondents, in response, and why readers are members of an organization of any kind.

1. Are you a member of any of the associations that deal for consumer electronics service?

- ETA (Electronic Technicians Association)
- ECET (International Society of Certified Electronic Technicians)
- IECIA (Professional Electronic Service Centers Association)
- ISEA (Professional Service Associates)
- ISEA (Professional Service Associates)
- ISEA (Professional Service Associates)
- ISEA (Professional Service Associates)
- Other (please specify)

2. If you are a member, what benefits of the association do you consider most important?

3. If you are not a member of an association, why not?

4. What could an association offer you that would make you want to join?

Bound into this issue is the ES&T Reader Survey card. It's located on page 33.

It's a mini survey about **you**. We would like to hear about the problems you face, the opportunities you see and the equipment you use during the course of your work day.

The postage is paid. All you have to do is fill it out and mail it.

What could be easier?

**Please fill yours out
and mail it today.**

wish or you're losing money, ask yourself why. What am I doing wrong? Is the work available? Can I get more of it? Are my employees doing the job I pay them for? If not, am I failing to manage my labor properly? Can I find better suppliers? Can I cut cost? Can I change the price I charge? Should I begin marketing my business? Answer all these questions and any others you think of, and write down your answers.

Setting goals

Now, write down your estimated sales for next year. What you think it will be? Under that number list what you think your expenses will be. Be sure to include all of your expenses. Add about 10% to your expense estimate. Also, add a marketing expense and, just for fun, a pay raise for your employees.

Calculate your estimated profit for next year. On another sheet of paper, list each income and expense item separately, but this time write what you want it to be. This will become your operating goals. Now, list specifically each step you will need to accomplish to carry out each goal.

Break the whole thing down into monthly, weekly, and daily steps. Write each daily step down on a calendar book that you can carry around with you. Make each step simple to carry out. Then do it.

If you use an accountant, start asking them questions. Numbers are the life of your business. Understand why accountants do things the way they do. You may not have time for it now, but you will have to make time if your profits start dropping. Look carefully at every piece of paper your accountant gives you. Ask him what it means to your business. Have him explain it in terms you understand. Get what you're paying for.

Who needs marketing?

Marketing is everything! If you don't believe it, try starting a business without putting up a sign or telling anyone about it. When most people hear the word marketing, they think of advertising expense. Advertising is only a small part of marketing. I define marketing this way: the

continual process of creating and maintaining a demand or desire for your product or service.

Marketing must be a continual, ongoing process. If you let marketing fall behind, your profits suffer. In the process of creating a demand or desire for a product or service, most businesses advertise. Learn where your advertising dollars are best spent. Test your advertising for results using coupons and giveaways.

When you started your business, you probably did some general advertising to let people know you were in business. This early effort should not be the end of your advertising efforts. You will be surprised to know how many people there are in your market area that have never heard of you or your business.

The importance of your image

A successful business has a good public image. Image is as much a part of marketing as anything else. You have to treat your customers fairly and courteously if you ever want their business again. Word of mouth can be your best advertising, or it can be your downfall.

Different people perceive things differently. A friend called me up complaining about how much he had to pay a certain appliance repair technician to fix his refrigerator. He stated, "I had to pay that crook 40 bucks. He was only here five minutes. I'll never call him again." I questioned him and learned that the technician was actually there about an hour, replaced a part he had in stock, and the repair was performed on a Sunday evening. I promptly informed my friend that the technician should have charged him \$200 for not only saving all his food, but working on a Sunday as well.

You and your employees have to maintain your image. One unhappy employee can cost you more lost business than you can imagine. Keep your employees happy. Determine what your employees need and do everything you can to satisfy them. A satisfied employee will market your business every time they're in public. Give them some business cards and develop a method to reward them every time

they bring in new business. You'll be surprised at the results. Give your employees the opportunity to be proud of their job and the company they work for. You will be rewarded in profits.

Promoting your business

In fact, a marketing opportunity exists every time you go into a public place. Leave your business card anywhere you can. Tell people what you do. Then, when they bring you their work, do it well.

When someone's TV goes on the blink, they usually at some point pull it out from the wall. Consider affixing an attractive label on the back of set you service with the words: "FOR SERVICE CALL YOUR COMPANY NAME." Or your might print up and distribute an emergency telephone label that lists local emergency numbers such as 911, where to call to report power outages, the poison control center, and a line at the bottom that states "FOR CONSUMER ELECTRONICS SERVICE CALL YOUR COMPANY NAME." These are examples of good marketing that will cost your company little.

How you respond to calls

I mentioned the importance of your image above. I must stress that image must not be allowed to drop due to poor service techniques. Never make the mistake of thinking that one of your customers will not mind your putting off their repair until next week because you know them personally. Friends and relatives can be good business, but they're customers too if you agree to take in their work.

I have often refused to work on computers of close friends and relatives because they often expect it free, complain more than your paying customers, and want their work put in front of your paying customers' work. They are the very ones who will run your business down when your free work doesn't satisfy them.

Customers expect professionalism from neat technicians. Let me conjure up a mental image. Your TV set breaks down. You call a technician listed in the

yellow pages (one of the best deals available). Two weeks later, a man comes to your door with beer on his breath, test leads dragging on the ground from the hip pocket of his cut-off blue jeans, wearing a sweaty T-shirt that looks like it's two sizes too small, and a baseball cap on which someone has written "TV MAN" with a magic marker. He asks, "Uh, you the guy who called 'bout your TV?" Now would you let him in your house? This technician might be one of the best in the country, but who would hire him?

The common sense factor

To be successful in the service business, you have to manage the business with profits in mind. That may sound sad to some, but it's a fact of life in the business world. Take some evening classes on accounting and general business management, if you need to. Don't be afraid to ask those who know the answers for help. Fear has caused many businesses to fail. However, fear in its rightful place has been the driving force that kept many businesses operating profitably for years.

Don't just run an ad in the newspaper and call it marketing. Ask questions. Ask why at every turn. Think about your situation. Talk to your customers. Ask them what you could do to improve service. Ask your employees for their ideas. Believe it or not, somewhere in your workforce there's a potential manager's assistant waiting to be acknowledged. Your employees may know more about how your business operates than you do. Talk to them. They know where all the problems are, and they often can tell you what the solution is.

Never forget it's a business

Many technicians and owners of small businesses in consumer electronics servicing entered the business because of their technical background. A technical background is definitely an important factor in running a successful business, but the business aspects of servicing are every bit as important. If you don't have business skills, get them, or hire someone who does have them. ■

"The SEMIANALYZER is the most complete test equipment on my bench

-R. Hohl, GMC Corp, MI



- o Traces video, audio, digital signals...from 1mv to 50V, while displaying DC volts.
- o Displays breakdown voltage of zeners, semiconductors, capacitors, LEDs, neons, etc. while measuring leakage and noise.
- o Checks semiconductor junctions in-circuit, with red LED display and audible beep tones.
- o Includes deluxe long tip stainless test probes.
- o 60 day satisfaction or money-back guarantee.

Just \$349. Includes 3 year warranty
(407) 487-6103 voice or fax

"The MICROANALYZER sure helps on those tough jobs"

-Sears Roebuck Service, IL



- o In-circuit HV stress testing of HV components: Tests diode, capacitor, transformer, magnetron.
- o Measures up to 5000 AC or DCV in two ranges.
- o Checks triacs, transistors, mosfets, and SCRs.
- o Overload and reverse-polarity protection.
- o 60 day satisfaction or money back guarantee.

Just \$349. Includes 3 year warranty
(407) 487-6103 voice or fax

YOU'RE ON A SERVICE CALL...

Here is a way to transfer only paying customers to your cellular phone while directing all other callers to your office answering machine...



STU (Selective Teletransfer Unit) will give your customers calling your office the ability to reach you immediately. Stop losing business to your competition; Save money on your cellphone bill. Installs on any phone line (uses 3-way calling).

Just \$149. Includes 3 year warranty
(407) 487-6103 voice or fax

ELECTRONIC DESIGN SPECIALISTS
4647 Appalachian St, Boca Raton, FL 33428



MONITOR REPAIR SOFTWARE

Now Only \$29!

Resolve Monitor Repair Database

Shareware Version — 700 repair details on 81 monitors & more! **\$29**

Version 1.13, 2,133 repairs/331 models **\$249**

Resolve Term

Terminal Repair Database
284 repairs/95 models **\$129**

Video Test Bench

Monitor Test Pattern
Generation Software
Patterns & Trouble-shooting
Tips for CGA, EGA, VGA &
SVGA Monitors **\$129**

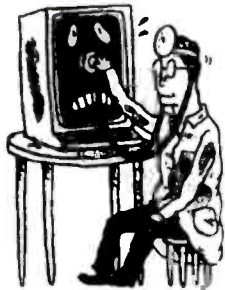

ANATEK
CORPORATION

PO Box 1200 Amherst, NH 03031

1-800-999-0304

Circle (75) on Reply Card

TECHNICAL SUPPORT PROGRAM

MAKING GOOD MONEY OR JUST GETTING BY ?

The only Full Time Tech-Tip Program in the USA that adds 2,000 repairs and re-publishes our paper bound manuals every 8 months for non-computerized centers. For those computerized we offer the most advanced system, DOS or Windows in which you may print or enter your own repairs. Starting with 12,000 Tips, 163 brands plus, a newsletter with step by step up to the minute repairs with today's techniques.

ONE-TIME MEMBERSHIP FEE

Updates are **optional** in any format.



**PAPER OR COMPUTER
TV-MAN TECH-TIPS
"PAY"**



We are **not** a one-shot deal with occasional updates at varying prices from a limited number of brands. We are the **only** company that provides a 30-day money back guarantee on our computer program and it's legal, licensed and easy to operate. Member Better Business Bureau of Palm Beach County and NESDA. Our Demo is "FREE" and so is the phone call.

800 474-3588 M-S, 9am-9pm EST.

M/C, Visa, Amex, Disc., COD, Co. Chk, P/O's

Circle (76) on Reply Card

Literature

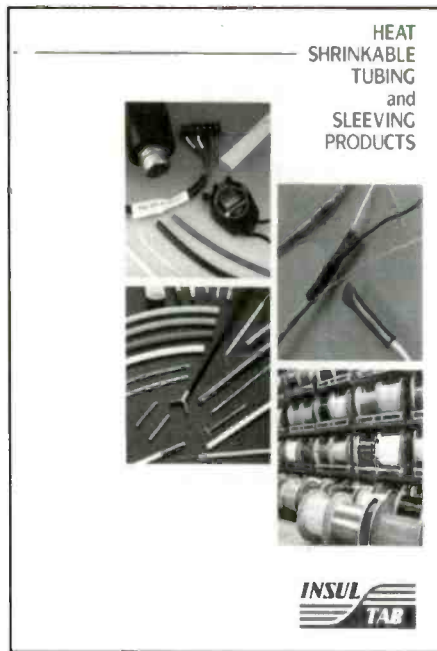

Tubing catalog

A catalog describing heat-shrinkable tubings, medical and non-toxic heat-shrinkable tubings, sleeveings extruded from different materials, and spiral cut cable wrap is being offered by Insul-Tab.

The Heat-Shrinkable Tubing and Sleeveings Products Catalog features a wide range of heat shrinkable tubings including: PVC, thin wall polyolefin, multiple wall PVC and polyolefin, tubings with special properties, PTFE and FEP, and medical and non-toxic tubings. PVC and PTFE sleeveings and spiral cut cable wrap are also included.

Circle (100) on Reply Card

On-line design center available over the world wide web (WWW)

Harris Semiconductor announces a new On-Line Design Center accessible to computer users over Internet's World Wide Web (WWW). The web site (<http://www.semi.harris.com>) features over 1,000 data sheets, application notes and tech briefs. Other features include search capability, design support with over 135 SPICE macromodels, and registration for the company's power seminar.

The on-line design center offers quick, user-friendly access to a product selection database, technical information in the form of over 1,000 technical documents, software simulation and design tools, and technical support.

The on-line information is categorized

under eight menu buttons. The What's New? button pulls up a list of press releases that can be viewed in four languages English, French, German and Italian. Under Product Information, the user navigates a product function tree to get to particular devices and any data sheets, application notes, technical briefs, or other relevant documentation. The Search button enables a search engine that performs searches based on part number (example "HA5703"), root part number (example "5703), or part function/description (example "converter").

The Attend a Power Seminar button gives information on dates and locations for the currently running power seminar and allows on-line registration for a session. Under the Design Support sub-menu are SPICE macromodels, VHDL models, simulation software, e-mail application support and more. Select Web Sites to locate other Harris Semiconductor information such as the Reliability Engineering department's on-line product and process reliability reports. The last two button options—Contact Us and Feedback—give address and phone numbers for the company's offices and allow feedback on the web site.

The heart of this on-line service is the large database of technical documentation. The hundreds of complete data sheets, application notes, technical briefs and software documentation are available in Adobe Acrobat .PDF and PostScript file formats. Users can download the viewer free of charge within the web site. The viewer yields a clear and easily readable document that can be printed or downloaded to the user's hard drive for future reference.

Key product parameters and references can be located using Acrobat's built-in search engine. Moreover, when using Microsoft Windows, sections of any document can be copied from the .PDF file (using the copy command) and pasted into other Windows software; this feature is useful when developing design review documents or internal specifications.

Circle (101) on Reply Card

Electronics catalog

MCM Electronics introduces catalog number 35. The catalog contains over 1,000 new items, including project acces-

CATALOG 33 51 87

MCM ELECTRONICS



CHECK THE MCM ADVANTAGES

- ✓ Representantes De Habla Hispana
- ✓ Toll-free Technical Hotline
- ✓ New Distribution Facility To Meet Your Needs
- ✓ Ability To Cross Reference Over 80,000 Parts
- ✓ Over 97% In Stock Availability
- ✓ Instantly Informed Sales Staff ... Guaranteed!

CALL TOLL FREE 1-800-543-4330
FAX 1-513-434-6959

sories, semiconductors, connectors, test equipment, computer products, audio, TV, VCR and appliance repair parts. This catalog also introduces Motorola 2-way radios, SL Waber power distribution products, caller identification devices from TT Systems, and Sherwood car head units and amplifiers.

Circle (102) on Reply Card

Brochure defines complete power monitoring solutions

BMI's new four-page, color brochure features concise descriptions of the company's complete product line—power monitoring systems, power monitors, harmonics analyzers, and RTUs. A comprehensive product measurements chart allows customers to easily determine the appropriate instrument for their monitoring applications.

Circle (103) on Reply Card

Plastics bonding design guide

The Loctite Design Guide for Bonding Plastics is available from Loctite. The guide has been written for design engineers, but it is also a useful reference for others requiring more information about adhesives and their use with plastics.

The guide includes 30 chapters on properties of plastics and adhesive bonding performance on them; a section on plastic surface treatments; adhesive joint design information; and a stress-cracking potential table for many combinations.

The guide also offers test methodologies, a glossary of adhesive terms, an in-

dex of adhesive trade names and other valuable information.

A typical chapter lists a specific type of plastic, its trade names and manufacturers general description, general properties and typical uses. The chapter also shows bond strengths that can be achieved using various adhesives. The effects of surface roughening and chemical treatment on bond strength are discussed along with other important information.

Circle (104) on Reply Card

LAN catalog

Jensen Tools has introduced a new 51-page LAN catalog that features selection charts, diagrams, technical data and useful illustrations.

The catalog begins with a simple illustration of common LAN topologies and the answers to the most commonly asked LAN questions.

The featured kits include everything needed to network two PCs together—cards, software and pre-made cables, with optional add-on kits for additional PCs.

Circle (105) on Reply Card

ES&T Calendar

10th Annual Networks Expo-Dallas
Networking and Interoperability
September 12-14, 1995
Blenheim Group
800-829-3976

NASM 40th Annual Meeting
National Association of Service
Managers
September 16-19, 1995
Oak Brook Hills Hotel and Resort
Oak Brook, IL
708-310-9930

PC Expo Home
Technology for Small or Home Offices
and Home Computing
September 28- October 1, 1995
Jacob Javits Convention Center
New York, NY
Blenheim Group
800-829-3976

10th Annual PC Expo-Chicago
October 3-5, 1995
McCormick Place East
Chicago, IL
800-829-3976

CES Mexico
Mexico City, Mexico
October 10-12, 1995
703-329-1380

Personal Computer and Electronics
Expo
October 19-22
Nassau Veterans Memorial Coliseum
Uniondale, NY
Expo, Inc.
800-886-8000
516-889-6000

Systems Support Expo
October 26-27, 1995
Moscone Center
San Francisco, CA
10:00 am to 5:00 pm daily
Fax: 207-846-0657

International Winter Consumer
Electronics Show
January 5-8, 1996
Las Vegas, NV

Mobile Electronics Show
April 19-21, 1996
Orlando, FL

CES Orlando '96 --The Digital
Destination
May 23-25, 1996
Orlando, FL

Setting up a LAN

By David F. Norman

In a previous issue we covered some of the advantages of local area networks for the user. For a dealer or technician, networking a customer's system offers many opportunities when it comes to making a profit. We are going to go through the procedure step-by-step with a typical small network. Take it from an expert: before you sell a system, install one of your own and get familiar with it; this is not an area for OJT at the customer's site.

The software part of the network discussed here is by Artisoft and is called Lantastic 6.0. For the hardware, we are going to use Western Digital Ethernet cards, although Lantastic supports many other cards, including their own.

When you order the software, be careful to order the proper version for the number of nodes you will be operating on. If you have two computers to use as workstations and a third machine to use as a file and print server, you need software that is suitable and legal for at least three nodes or workstations.

Speaking of legality, most single-user software is licensed to only one machine. Sharing a single-user copy of most software over a network is almost always illegal. From the standpoint of performance, some single-user software functions perfectly under multi-user network conditions; some does not. Contact the manufacturer of the specific software for information regarding licensing and upgrades to multi-user. Adding additional licenses is always less costly than buying several single-user packages.

While there are many different brands of networking software and hardware, they all have a similar purpose, tying computers, peripherals, and even other types of computer systems, together, in order to make better use of time and resources. I chose these particular products simply because I'm familiar with them and have long term confidence in them.

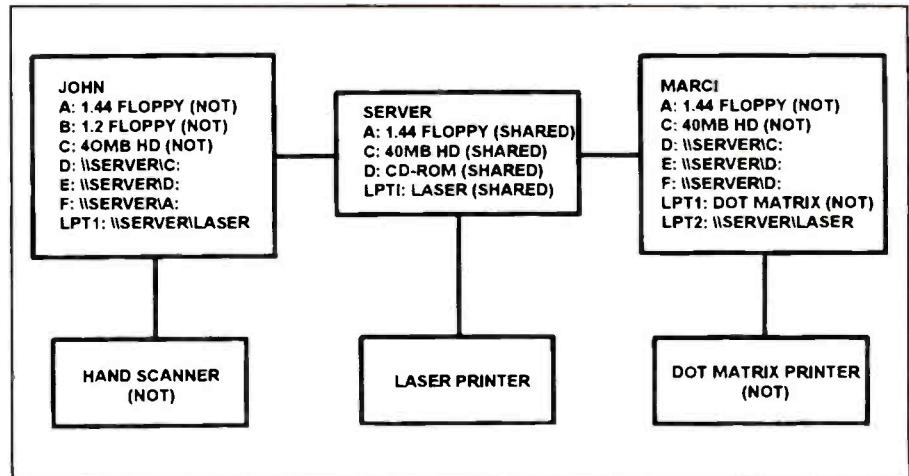

Figure 1. It is a good idea before you start to draw a simple diagram to determine which machine will share which resource.

Most of the procedures demonstrated here will apply to other systems.

Before you start the installation

Before beginning the installation, take a few minutes to check that every piece of equipment, including printers and monitors, connected to the computer is protected by a surge protector. Phone lines connected to modems or fax cards should also be protected. It may seem obvious, but if one computer on a network is not protected, none of them are.

Run diagnostics to check each unit for proper operation. If necessary, clean the floppy drives. Remove and reinsert each card plugged into the motherboard to assure a good, clean connection. In short, perform a little preventive maintenance while you have the cases open.

A quick overview of the instructions for the hardware and software only takes a few minutes and is time well spent. Both software and hardware have improved over the years, but plug-and-play can cost you a lot of time later. Pay special attention to the considerations regarding hardware interrupt conflicts. This can drive you up a wall until resolved.

Another timesaving tip is to read any

"README" files that might be on the installation disks. These text files often advise the servicer of any last minute changes, fixes, and improvements left out of the printed documentation. These files can be loaded into any word processor or simply printed to the screen with a simple "TYPE README.TXT !MORE" or similar command. You can also use the command, "TYPE README.TXT >PRN" to print a hardcopy.

Don't be reluctant to network older machines

For the purposes of this article, we will assume that you have at least three IBM compatible computers with at least two monitors (after setup, the fileserver doesn't need a monitor), with a 40MByte or larger hard disk in each computer. Most of us who have done this before like to have the same version of DOS on all the machines in a network. It is an excellent idea to clean up and defragment the hard disks on each machine before installation of any new software.

Don't get the idea that only high-end computers are worth networking. If the two workstations we will set up had no hard disks, networking would still be pos-

Norman is an independent computer consultant.

sible, but the software installation would be made to floppy disks. The savings realized by not having a hard disk in each workstation tends to cost in terms of overall flexibility but may be unavoidable for other reasons.

Nowadays, you couldn't buy a simple 80286 (AT-type) computer if you tried, from a new computer dealer. However, there are a lot of them available at low cost from used computer dealers. For word processing, text-based databases and accounting software, and small spreadsheets, the inexpensive machines still work fine. Even an old 8088 or 8086 (XT-type) without a hard disk can be used for that occasional letter or proposal, storing the file on the server and printing perfect copy on the laser printer. One of these old step-child machines will work great for network maintenance.

Normal workstation operation will be no different after the network is installed. Slow machines are still slow no matter how fast the server might be. The difference is that instead of being limited to a floppy drive, the old machines can now

load programs over the network and store created files on the server. A letter printed from an old machine looks the same when it is printed on a laser printer as it would coming from the newest dream machine. If you plan ahead with reasonable expectations, you can continue to use existing equipment until it quits. Just use it for a job it can handle.

A couple of hints: as a rule, the fastest, biggest hard disk should be in the fastest computer. That computer should have at least a couple of megabytes of RAM for use as a server. If you work with large, high-resolution graphics such as in desktop publishing operations, plan on using a fast computer (386 or above) as the workstation for those applications. There is a lot of sorting that goes on when printing high-resolution graphics and this work is handled at the workstation—not at the server.

Before you go any further, make a copy of the AUTOEXEC.BAT and CONFIG.SYS files on each machine. Use easy to remember file names such as OLD.AXB and OLD.CFG. If something goes

wrong during the installation, it is always nice to be able to get back to where you were when you started.

Creating the network

Okay, we have our equipment checked out and now we are ready to begin. If there are peripheral cards in any of the proposed workstations which will be shared from the server, install them in the server at this time, using standard antistatic procedures. We will resolve any conflicts later.

Now install the network cards in each computer. Until you have done this a few times, it is also a good idea to have all the computers in the same place. Use the same cabling that you will use to connect them when they are in place.

Note: if the network ever gives a message such as "Connection to Server broken," first check the connections on the cabling. For some reason, the coax used to connect Ethernet cards over short runs seems to acquire loose connectors over time. Check this before you panic.

Ethernet cards using coax (50Ω) also require a terminator at each end of the bus.

Repair PCs, Printers, and Macs for about \$10 average per unit.

If this sounds hard to believe, that's okay. What we at NAC find hard to believe is what most companies spend on computer and peripheral repair. If you would like to learn how to save up to 80% or more on maintenance parts call us at NAC for more information about our Advanced Repair Seminars. Or you can go on spending what you are currently spending and try to convince yourself you're working efficiently.



National Advancement Corporation

2730 S. Harbor, Suite J
Santa Ana, CA 92704
(800) 832-4787
(714) 754-7110

Circle (69) on Reply Card

Computer Monitor Tester



Price:
\$295.00
+\$5.00 S&H

Includes battery, AC adapter, Mac adapter and 120 day warranty

Finally, a low cost way of getting into the monitor repair business. Test and repair computer monitors with speed and accuracy. The "Checker 12" is an *easy to operate*, hand held, battery, or AC operated computer color monitor pattern generator. With its support of CGA (15.75khz), EGA (22khz), MACII (35khz), and VGA modes 1,2,3 (31.5khz) 800X600 (35khz, 1024X768 interlaced (35khz), 1024X768 non-interlaced & 1024X768NI with sync on Green (48khz), you can easily checkout a monitor in all of its' modes. With its' single mode switch, you know exactly what type of monitor you are testing. Its' front panel pictures show just what you should be seeing on the monitor under test. You can quickly tell if the monitor is a VGA, SVGA, or a SVGA/NI. The "Checker 12" provides various test patterns for VGA monitors. X-hatch, for size and linearity and convergence set-up. White screen, for purity and CRT burn evaluation. Color bars and 8 step gray scale for color tracking and balance. There is also a single color mode that allows for single color channel operation.

Computer and Monitor Maintenance



1-800-466-4411 404-662-5633



We also have the Checker VI, a six port stand-alone VGA (640X480) test pattern generator. **No computer required.** Just \$249.95.

Circle (57) on Reply Card

If you don't order these terminators when you order the cards you will have to make them from a BNC connector and a 50Ω resistor. However, you must have them in place or, at best, network operation will be highly erratic. Where a station is physically located on the bus doesn't matter, but we will assume the above configuration for this discussion.

Plan your system

The Lantastic network is peer-to-peer, meaning that assets of any computer may be shared by any other computer on the network. In real life, having every computer share all of its resources is neither desirable nor possible. For example, you might have a hand scanner or sound card attached to Workstation One. Obviously, it is impractical to attempt to "share" these resources from another room.

Printers and CD-ROM's, on the other hand, lend themselves nicely to sharing, as long as basic common sense is followed. Print queues are an integral part of any network software, so you don't have to worry about print jobs being mixed up. You can even set the system up to send a banner page, (a blank divider) between jobs, but that wastes a lot of paper.

And, of course, you don't want to send a print job requiring card stock or labels without first putting the proper paper in the printer, and you can't look up a parts list on the CD-ROM if a telephone directory is in the slot. A lot of managing a LAN is just common sense.

It is a good idea before you start to draw a simple diagram such as Figure 1, to determine which machine will share which resource. Also bear in mind that heavy network operations invariably slow down local operation. So "Keep It Simple, Stupid" (KISS), is always a good rule to follow in computing. If a machine gets heavy usage, especially if it is used with large, high-resolution graphics, it is probably not a good idea to use it as a file or print server; make it a workstation only.

Study the circuit cards in the system

After you have designed your system and moved the peripherals and their cards around, take a few minutes to look over the documentation on each card, including the network cards, installed in each machine on the network.

Most newer cards give you several choices as to interrupts and addresses (Hex). Check each machine for possible conflicts. If your network card and a scanner card share addresses or hardware interrupts, you can bet you will have a problem. Resolve these conflicts by changing interrupts and addresses as per the documentation. For future reference, write down the configurations; you may need to include these as parameters when you install the various drivers. This seems more confusing than it is in most cases.

For example, you may need to modify the batch file which loads the network software with a line such as: `WD8003 IRQ=3D3 IOBASE=3D280 RAMBASE=3DD000`. Depending on whether the card is software programmable, you may need to physically move switches on the card. Follow the documentation or call the manufacturer for technical support.

Installing the software

If you see no obvious conflicts, proceed with your software installation. At least when you get a message advising you of a conflict, you will know where to start looking. In most cases, a machine won't boot properly if there are conflicts among the cards installed and that will be your first clue. Just take your time and fix one thing at a time.

When you begin the installation process, Lantastic will check out your system and then ask you a series of questions. For the first time around, you should probably accept the defaults wherever possible. The exception would be as noted above, not making certain machines servers. For our purposes, make one machine named SERVER a file and print server. You can reconfigure a workstation as a server later if desired.

Let's say that you name the first machine SERVER because that's what you want it to do. The second is named JOHN, because he usually operates it, and the third is named MARCI for the same reason. There is no reason, in our example, for JOHN to share anything with either MARCI or SERVER. MARCI doesn't share anything with JOHN or SERVER. JOHN and MARCI share the disk drives, CD-ROM and printer belonging to SERVER. This is only the simplest of all

configurations. All machines could be made servers if necessary.

Each installation will require several megabytes of disk space on your hard disk. Later, you can go back and remove the unneeded files, such as text files and options you don't need or use. Refer to your diagram when the program asks which resources you intend to share. Don't worry if you don't get everything just right the first time; if you can't straighten things out, you can always delete all the files and directories on your hard disk carefully using the DELTREE command and start over.

Repeat this procedure for each machine and your network is installed. The program will make changes to each AUTOEXEC.BAT and CONFIG.SYS files. Reboot them all at once and you have a network. Right? Wrong.

When it doesn't work

When MARCI or JOHN comes up, each machine looks for SERVER. If SERVER isn't up and running, you get a warning that the login has failed and JOHN and MARCI work normally, except that they have network software loaded that isn't doing them a bit of good.

First things first. Boot SERVER and let it come up. This may take a couple of minutes and is one reason why many network servers are left running day and night. Since we don't have a monitor attached to SERVER, be certain that if the power goes off and back on, the machine will boot back up and load network software without human intervention. An uninterruptible power supply for SERVER and either JOHN or MARCI or both is also a good investment.

When SERVER is up and running, JOHN and MARCI will boot up and automatically log onto the network, assuming that everything is as it should be. But let's say things are not just right. What then?

Start at the server

When things aren't working correctly, start troubleshooting at the server. Hook up a monitor and boot the server without letting the network software load. A simple boot disk will accomplish this. Make certain that the resources you want the server to share work properly without the network operating. If not, troubleshoot as

```

AUTOEXEC.BAT
echo off
SET TEMP=3Dc:\temp
SET CDPATHP=3DH
PATH=C:\C:\WINDOWS;C:\DOS;C:\batch\C\norton;D:\converts;D:\ANY
WHERE=c:\nantasti;C:\wp60 prompt=3D$p$g
LH /L:1,22096 LANCACHE /CACHE_SIZE=3D1024
LH /L:3,56928 mouse.COM /Y
echo: DO YOU WANT TO START THE NETWORK AS SERVER386
CHOICE
IF ERRORLEVEL 2 GOTO :MENU
LH /L:0:2,27936;1,3088;3,56016 /S COMMAND /E:256
/CC:\LANTASTI\STARTNET.BAT :MENU

CONFIG.SYS
DEVICE=3DC:\DOS\HIMEM.SYS
DEVICE=3DC:\DOS\EMM386.EXE NOEMS I=3DB000-B7FF X=3DD000-D1FF
BUFFERS=3D10,0
FILES=3D60
dos=3DUMB
LASTDRIVE=3DDM
FCBS=3D16,0
dos=3DHIGH
DEVICEHIGH /L:1,12048 =3DC:\DOS\SETVER.EXE
DEVICEHIGH /L:1,5888 =3DC:\DOS\RAMDRIVE.SYS 512 512 512 /E
DEVICEHIGH /L:1,1824 =3DC:\DOS\TANSI.SYS
SHELL=3DC:\DOS\COMMAND.COM C:\DOS\p
STACKS=3D9,256

STARTNET.BAT
echo off
rem LANtastic Version 6.00 installed 94/07/29 23:06:22
C:
cd C:\LANTASTI
SET LAN_CFG=3DC:\LANTASTI
rem If LANtastic is disabled, skip everything.
IF EXIST DISABLED GOTO :STARTNET_DONE
@echo =3D=3D=3D=3D Begin LANtastic configuration
=3D=3D=3D=3D=3D
SET LAN_DIR=3DC:\LANTASTI.NET
LOADHIGH SHARE
LOADHIGH WD8003
LOADHIGH AILANBIO @STARTNET.CFG
LOADHIGH REDIR SERVER386 @STARTNET.CFG
LOADHIGH SERVER C:\LANTASTI.NET @STARTNET.CFG
NET LOGIN \SERVER386
call CONNECT.BAT
@echo =3D=3D=3D=3D=3D End LANtastic configuration
=3D=3D=3D=3D=3D
cd \

CONNECT.BAT
NET MESSAGE/ENABLE BEEP
NET MESSAGE/ENABLE POP
NET MESSAGE/ENABLE SPEAK
NET LPT/DISABLE NOTIFY
NET LPT TIMEOUT 10
NET USER SERVER386=20
NET LOGIN \SERVER386
NET LOGIN \286
NET USE C: \SERVER386\C-DRIVE
NET USE D: \SERVER386\D-DRIVE
NET USE E: \SERVER386\E-DRIVE
NET USE F: \286\C-DRIVE
NET USE G: \286\A-DRIVE
NET USE H: \286\CROM
NET USE LPT1 \286\@PRINTER

```

← **Figure 2.** Batch and Configuration programs on a typical LAN system.

you would any other computer problem. If they are working properly, load NET_MGR. This file is found in the network software subdirectory.

Check "Shared Resources" to make sure the disks, CD-ROM, and printers are listed. If all is not as it should be, check the manual for directions and add the resources desired. Check the "Server Start-up Parameters" next. Printing should be enabled and there should be one "Printer Task" for each printer connected to the server. Leave everything else alone for now. Exit and reboot the server, starting the network.

Boot one workstation and watch the loading procedure for any potential problems. Then type SETNET. A batch file will load, which will then load NET. NET lets you login to SERVER and select the drives and printers you want to use. When you exit, the program will write or update a batch file called CONNECT.BAT. This file contains the login procedure that STARTNET.BAT, which loads the network, looks for. Of course, this is all confusing. When it works right, however, everything is done for you.

A network in operation

Now when you reboot the workstation, everything should work. The program will ask you for a password. Editing the CONNECT.BAT file will eliminate that requirement. Hit the ENTER key and you are running. Besides your normal drives, you will have other drives, which are really on SERVER. For example, on a typical workstation with two internal hard disks (C: and D:) connected to a server with two internal disks, you will now have E: and F: as well.

If you also made the server's floppy drives available, there will be other drives added to the workstation. Actually you can have up to twenty-six drives available on the workstation (A: through Z:). One of the advantages of networking is that you can use a subdirectory on a server and call it a drive letter on a workstation. Thus "C:\DOC\LETTER" on SERVER might be designated drive "L:" on the workstation. Experimentation will show you how easy this is to set up.

Printing from a workstation is the same as always, with one exception. Instead of printing to a local printer (a printer physically attached to a workstation), print jobs are sent to a print queue on the server and from there to the printer. This is usually a transparent operation, although you may note that very short jobs take a little longer to reach the printer. So do very long jobs, but the program from which you are printing may actually "free up" quicker as the queue takes the print job. The server does the waiting instead of your workstation.

Fine tuning

Repeat the SETNET process on the second workstation and you are in business. Then you can begin the process of

fine tuning. If your workstations are 80386 or 80486 computers, you can load the network software into the "high memory" area between 640K and 1000K. If you are running this type of machine, you have probably already had to add an exclusion for the network card address (something like X=3DD000-DFFF) to your EMM386 or equivalent memory manager.

Now you can go back to the server and increase the size of different buffers to speed up the operation. You might also install LANCACHE in place of SMARTDRV or other disk caching program.

If you do increase the size of server buffers and tasks to maximum, the network will work faster and more efficiently, but you will have to bring the network down to adjust it since you won't

have enough free memory to load NET-MGR or much of anything else. As a final touch on the server, add the command ALONE to the CONNECT.BAT file on the server. This dedicates all server processing to the network, increasing the efficiency of the system.

Learn your stuff and cash in

Don't be afraid to experiment with the various parameters. Before you sell a system like this, at least one of your people should be pretty proficient in setting it up and adjusting it. There are many more bells and whistles included. You may select several layers of security, pop up messaging, mail services, remote server control, and much more. All in all, you will find the documentation including on-line help, quite thorough and easy to understand. If all else fails, look up error messages in the manual or call for technical assistance.

While setting up the first system and getting it configured will probably take you a couple of days, with a little experience you can install this network on a system of five nodes in three or four hours. Planning ahead and keeping successful copies of AUTOEXEC.BAT, CONFIG.SYS, STARTNET.BAT, and CONNECT.BAT files will speed up the process considerably.

Figure 2 shows samples of actual files in use on an operating network. Your files will probably be simpler. Some of the "odd" parameters were added by MEMMAKER. Even with network software loaded, this particular computer has 629K of free memory for running programs.

As you gain enough experience to understand the effect of each line in these files on the system, it is a very simple matter to copy them onto a computer and edit them as necessary for a particular configuration.

As with most of the skills you have learned for your business, you must pay to learn. Sell only a few networks and you will quickly turn the cost of your training into profit. This is an excellent product to package with a maintenance agreement. Your customers need networks; they also need training and ongoing service. Don't miss out on your piece of the action. ■

MicroComputer JOURNAL

The new print forum for the exchange of ideas and techniques among computer professionals.

If you're involved in installing, upgrading, enhancing or experimenting with the leading edge of small computer technology, you need MicroComputer Journal.

If your special interest is in CD ROM, or virtual reality, or robotics, or artificial intelligence, or SBC's, you need MicroComputer Journal.

If your computing needs are anything but ordinary, you need MicroComputer Journal.



BEST OFFER: Subscribe for two years and receive six additional issues (ONE FULL YEAR) absolutely FREE!

Please check one:

- Eight bi-monthly issues for the price of six only \$29.70
- Eighteen bi-monthly issues for the price of twelve only \$59.40

Get your copy of **MicroComputer Journal** delivered to your home or business and receive extra issues.

All prices in U.S. dollars: Canada/Mexico - Eight bi-monthly issues \$36.00; eighteen bi-monthly issues \$69.00. Foreign - Eight bi-monthly issues \$38.00; eighteen bi-monthly issues \$73.00. Foreign Air Mail - Eight bi-monthly issues \$95.00; Eighteen bi-monthly issues \$206.00.

(Please Print Clearly)

Name _____

Address _____

City _____ State _____ Zip _____

Check or Money Order Enclosed

Bill to: MasterCard Visa American Express Discover

Account #: _____ Exp. date: _____

Signature _____

1-800-853-9797
or FAX: 516-681-2926

MicroComputer Journal
76 N. Broadway
Hicksville, NY 11801

What Do You Know About Electronics?

Diodes

By Sam Wilson

There was a time when the subject of diodes was dispensed with once you knew about diode tubes, selenium rectifiers, and copper oxide rectifiers. Now I have books on the subject. As far as I'm concerned troubleshooting is not getting any easier. What do you think?

In the next issue we will look at Gunn diodes, IMPATT diodes and a few others you may not have run into in your daily servicing routine.

$$f_r = \frac{1}{2\pi\sqrt{LC}}$$

Figure 1. This equation for resonance expresses a complex relationship among frequency, inductance, and capacitance. It makes this relationship a lot easier to grasp than if it were expressed in an ordinary sentence.

Mathematics of electronics— Once more

In the last issue I talked about calculus. I made the statement that any calculus problem can be solved by using a graphical procedure. Before I go any further with that statement I want to answer a question I have been asked many times. Why does a technician need to know mathematics? Also, I have heard *this* statement many times: "I have been an electronics technician for ten years and I have never had to use any mathematics."

The answer to the question and the reply to the statement are the same. As a technician you do not need mathematics for the same reason an engineer or physicist needs it. They are involved in a completely different field. I think it is unfortunate that engineers don't spend some time learning the job of a technician but that's another story.

When you first began learning about electronics you were given some training in Ohm's law. You learned three very ba-

Wilson is the electronics theory consultant for ES&T

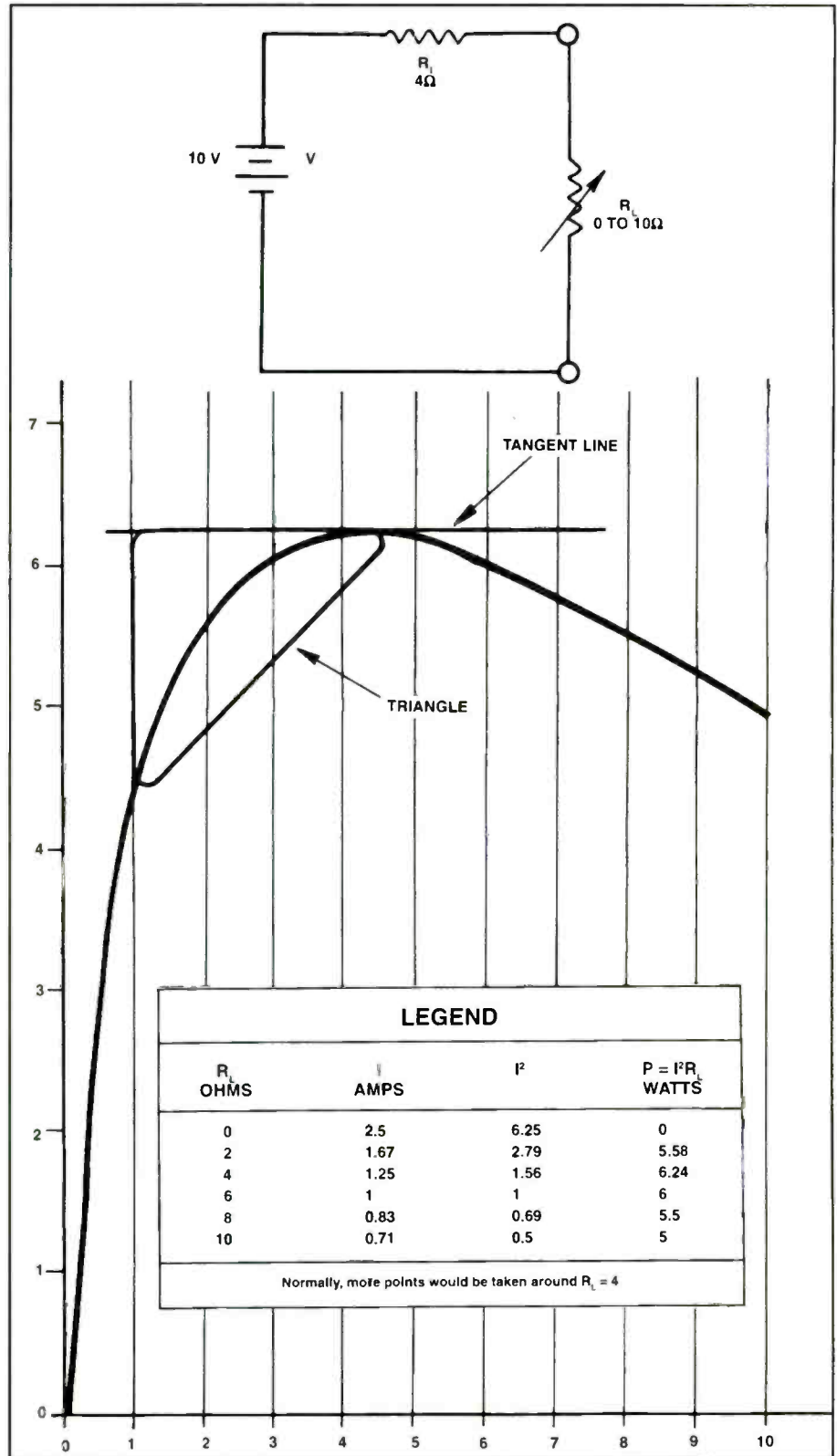

Figure 2. Show that the maximum power dissipated by R_L in this circuit occurs when the resistances are equal: $R_L = R_i$.

$$I^2 = \frac{V^2}{(R_i + R_L)^2}$$

Figure 3. The current in the circuit of Figure 2 is equal to the voltage of the source divided by the total resistance: $R_L + R_i$.

$$P_L = \frac{V^2}{(R_i + R_L)^2} \times R_L$$

Figure 4. Substituting the equation for the current shown in Figure 3 into the equation for Joule's Law ($P = I^2 R_L$) gives this equation.

sic versions of an equation that related current, voltage and resistance. If you had to learn the relationships between parameters in words instead of by the simple equations you might have had to stay in school an extra year.

The math is a kind of shorthand

Think about learning the simple equation of Figure 1 for resonant frequency. Suppose you had to learn the relationship between f , L and C in this way: "The resonant frequency of a series inductive/capacitive circuit is inversely related to two constants: the number 2 and the constant π . It is also inversely related to the square root (Whoa!— that is a math term! Let's avoid it) which is inversely related to a number when multiplied by itself, is equal to the product of the inductance in henries and the capacitance in farads."

Using only that statement, you would have to do a lot of mental gymnastics to answer this question: "If you move the plates of a capacitor in a series LC circuit closer together, will the resonant frequency increase or decrease?"

Refer again, to the equation in Figure 1. Remember that anything you do to increase the value of the denominator will decrease the value of the fraction. Moving the plates closer together increases the capacitance, and therefore, decreases the resonant frequency.

Knowing equations helps to understand relationships

Just by knowing the equations you

know the relationships between the parameters in a circuit. If the voltage you measure across a resistor is too high, you automatically know that the resistance is high or the current is high. You know that because voltage (V) equals $I \times R$. Those are the only parameters you normally deal with. Of course, if you need to throw in the effect of temperature you need to throw in another math equation.

Technicians sometimes forget how much their knowledge of electronics is dependent upon learning the relationships between parameters. When you worked problems using equations the answers were not as important as the practice you got in studying relationships.

A little more calculus

Actually that statement I made about solving calculus problems graphically is not really that bold if you know where calculus came from. Rene Descartes (my teacher pronounced his name "day cart") combined algebra and geometry into a (then) new mathematics called analytic geometry. Later, Newton and Leibnitz invented calculus based upon that analytic geometry which, in turn, was based upon algebra and geometry. Differential calculus is a study of how one thing varies in relationship with another. That is what a graph in analytic geometry tells you.

Your oscilloscope gives a graphical display based upon analytics. It is a graph showing how one thing changes with respect to another. For example, a sine wave display shows how the voltage changes with respect to time.

So, let's work a problem in differential calculus. You can find this problem in just about any applied calculus book. I am purposely choosing a problem whose answer you already know.

A calculus problem

Refer to the circuit in Figure 2. Show that the maximum power dissipated by R_L occurs when $R_L = R_i$. You know that the power dissipated by R_L is equal to the square of the current multiplied by R_L :

$$P = I^2 R_L \text{ (Joule's Law)}$$

You also know that the current is equal to the voltage divided by the total resistance (Figure 3). Substituting that for I^2 gives the equation found in Figure 4. Substitute known values for V and R_i and you get the equation in Figure 5.

That is how you get an equation for

$$P_L = \frac{100^2}{(4 + R_L)^2} \times R_L$$

Figure 5. Substitute known values for V and R_i into Figure 4 and you get this equation.

power in terms of the load resistance. The next step is to substitute values for R_L . The legend on the curve of R_L vs P_L shows the results of the substitution. The corresponding values of R_L and P_L are entered on the graph. Observe that the curve goes through maximum at the point where $R_L = R_i$. A plastic triangle (shown with a heavy line) was laid along the left edge to draw a line parallel to the X axis at the maximum point.

Don't look for any actual calculus in the solution. The reason that this is considered a differential calculus problem is because in this problem you have to determine the point at which something is at a maximum; in this case power dissipation. Differential calculus, which deals with rates of change allows us to determine where the rate of change of that parameter, in this case power, has become zero. When a parameter has reached its maximum (or minimum) value, it has stopped changing. By finding the value of the quantity in question we have solved the problem. In this case we did the job using a graphical solution.

In some future article I will work a problem in integral calculus using the graphical method.

What? They don't understand voltage? There's a surprise!

Every once in a while I feel it is important to thank readers who send articles and even magazines. Sometimes they get here a little worse for the wear, but, the information is still intact. I recently received an important letter from a reader who wishes to have (his/her) name withheld. It contained a copy of a letter to an IEEE publication called Spectrum.

Spectrum is one of my favorite publications—not nearly as favorite as ES&T though. (I know where the money comes from!). The individual who wrote to IEEE Spectrum was Vincent Biancomano of Long Valley, NJ. I am sorry to say that no address is available. I would have liked to correspond with him.

His point is that Radio Amateurs are not necessarily people with a knowledge of electronics (I watered that down a little). Listen to what he says.

"The end result of buying versus building,—amateur equipment—and the rote exams, is predictable: today's typical ham cannot even master fundamentals. In a limited study of 205 hams I did six years ago (multiple-choice exam), only 13 percent could correctly define the term voltage as work needed to move an electric charge from one point in an electric field to another. Most hams still think voltage is a unit of force or pressure (one young fellow thought it was 'pressure in a pipe')."

He ends his letter with this: "You cannot just throw money at education and technology and hope the problem will be solved." If I could have written to him I would have sent him copies of some WDYKAE? articles and a few ES&T magazines. If he is looking for technically aware technicians he is apparently looking in all the wrong places.

Also, don't forget that there are some top technicians who are hams and who also subscribe to ES&T. Also, I happen

to know some top technicians who are hams and who belong to ETA and IS CET. Even if it is true that they are a minority they need to be recognized.

**From Hal Thomas—
syndicated columnist**

But the problem isn't confined to electronics. In one of his columns, Hal Thomas quotes Hillsdale College President George Roche—"In spite of the massive infusion of money, tens of thousands of college seniors do not know when Columbus sailed to the New World, who wrote the Declaration of Independence or why the Civil War was fought."

I could tell them how to get that Columbus thing straight. In school we were taught the following saying:

"Columbus sailed the deep blue sea, in fourteen hundred ninety three."

Just kidding.

Definitions

Here are the definitions of some terms used in electronics. Fill in the names of the terms. Answers are given below.

1. A transparent material that can store electrical energy and later release it as visible light. _____
2. Another name for Esaki diode. _____
3. The frequency range from 30,000 MHz to 300,000MHz. _____
4. Change in the length of a ferromagnetic material when placed in a magnetic field. _____
5. The name of a negative ion is: _____

ANSWERS

1. ELECTROFLUOR
2. TUNNEL DIODE
3. EHF (EXTREMELY-HIGH FREQUENCY)
4. MAGNETOSTRICTION
5. ANION

Test Your Electronics Knowledge

Answers to test

(from page 45)

1. C. It is the frequency—not the amplitude—that determines whether an electromagnetic wave can pass through an aperture. For example, the dimensions of a waveguide determine the frequency of the microwave signal (not the amplitude) that will pass through.
2. constant-current diode. That is one way of making a constant current diode.
3. Write it as: $0 + j16$. The conjugate is $0 - j16$, or, $-j16$.
4. Choice A is correct by definition.
5. % Power Factor = $(\text{Cos } 45^\circ) \times 100$.

In this example the power factor is 70.7 percent.

6. B. It is Joule's Law.
7. Correct! It is called a "capattery".
8. It is called a glitch and it can really mess up your logic system!
9. 13 each of the binary combinations is equal to a decimal digit.
10. It is called the modulation index and it is often represented by the Greek letter Beta.

Use your free Reader Service card for more information on companies advertising in this issue.

Is there a long lasting solution for improving the performance and reliability of switches and connectors?

See DeoxIT on page 71

VCR REPLACEMENT PARTS

VXPO521 Panasonic Idler Orig.	\$2.99ea (10 min)
164113 RCA Idler Original	\$2.99ea (10 min)
NPLY0111GEZZ Idler Original	\$8.95ea
613-022-2534 Sanyo/Fisher Gear	\$6.69ea (10 min)
199347 RCA Replacement Belt Kit	\$1.99ea
VTK-1 Video Tool Kit (15 Pc) w/case	\$39.95ea
VENAS0099 Panasonic Motor	\$8.95ea



POPULAR SEMICONDUCTORS

25D1427	\$2.50ea (10 min)
25D1555	\$1.99ea
SDA-3202-3	\$6.95ea
25C4664	\$3.50ea 10/up \$2.95ea
STK563F	\$8.95ea 5/up \$8.50ea
STK4273	\$9.95ea 5/up \$8.95ea
STR30130	\$2.95ea Any Quantity!
STR30135	\$2.95ea Any Quantity!

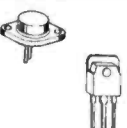

POPULAR REPLACEMENT FLYBACKS

2434391	Hitachi	\$24.95ea
1-439-357-11	Sony	\$26.95ea
FO014	Sharp	\$19.95ea
FO015	Sharp	\$19.95ea
FO016	Sharp	\$19.95ea
F1588	Sharp	\$29.95ea
TLF14401F	Panasonic	\$29.95ea
TLF14423F	Panasonic	\$29.95ea
TLF14530	Panasonic	\$26.95ea



POPULAR REPLACEMENT PARTS

NCS-1 NINTENDO GAME SOCKET	\$7.95ea
340313-5 NAP TUNER	\$34.95ea
4835-1539-7006 NAP SAW FILTER	\$5.50ea
1-228-482-00 SONY FOCUS RESISTOR	\$49.95ea
4835-1163-7005 NAP THERMISTOR	\$3.95ea
KSS-210A ORIGINAL PICKUP HEAD	\$49.95ea



FREE 92 PAGE CATALOG!

MATELECTRONICS

400 Pike Road
Huntingdon Valley, PA 19006-1610

CALL TOLL FREE 1-800-628-1118
FAX TOLL FREE 1-800-628-1005



Circle (67) on Reply Card

ISCET VCR

Cross Reference

VCR Model Number Cross Reference and VCR Parts Cross Reference

- 5th Edition.** Contains both model- and parts- number cross references for more than 1,700 models and almost 5,000 parts. **\$29.95** Plus shipping \$3.00
- One 3 1/2" disk, or**
- Two 5 1/4" discs.** Version 6.0, for IBM PC AT/XT or compatibles. Requires hard drive and DOS 2.1 or greater. **\$69.95** Plus shipping \$3.00
- Special Combo Offer.** Your choice of discs, plus 5th Edition VCR Cross Reference. **\$95.00** Plus shipping \$3.00

Allow 4-5 weeks delivery when using personal checks or VISA and MasterCard. Money orders and cashiers checks processed immediately.

Amount _____ VISA MasterCard
Card No. _____ Exp. _____
Name _____
Business _____
Address _____
City _____ State _____ Zip _____
Phone _____ Member ISCET NESDA

Texas residents multiply dollar value x 7 1/4% for taxes.
Foreign shipments please add International postage.
Send ISCET, 2708 W. Berry St., Ft. Worth TX 76109

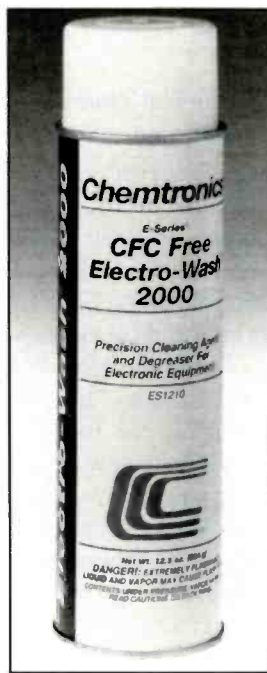

CFC-free products line

Chemtronics offers a line of products that contain no CFCs or other ozone depleting compounds. CFC-free cleaners include Electrowash 2000, Tun-O-Wash, Head Cleaner II, Flux-Off 2000, Super Bio-Wash, and CFC Free 70 PSI. Testing products include Freez-It 2000, and protective products include a line of static dissipative products and lubricants.

Circle (10) on Reply Card

Battery operated universal counter-timer

The Global Specialties Model 5002 is an American built and designed intelligent bench-top 1.3 GHz universal counter-timer. This counter combines the company's frequency counter experience with microprocessor technology. Features include, wide frequency range, from 5Hz to 1.3GHz, measurement functions including frequency, time interval, period, ratio, pulse width and event counting. The unit has gate times of 0.1, 1, and 10 seconds and uses a high resolution recip-



rocal measurement technique giving 7 significant digits of accuracy. The LCD read-out displays the measurement value and operating modes. Trigger level controls and a low pass filter are provided along with both internal and external timebase input capabilities.

Circle (11) on Reply Card

Portable oscilloscope/meter

Fluke introduces a new 100MHz ScopeMeter Series II, the Model 105. This new handheld instrument puts the high bandwidth of a benchtop digital storage oscilloscope and a true-rms digital multimeter into the hands of any user who needs a portable, battery-powered tool at the job site. Offering 100MHz bandwidth, the product allows troubleshooting of the



high-frequency signals found in video equipment, maintenance of medical equipment, or other high frequency applications. The unit is easy to operate, offering menu-driven operation and one-button access to over 30 measurements.

The device allows the user to switch quickly between meter and scope functions. Whether functioning as an oscilloscope or multimeter, it provides both numeric readings and a waveform display of the measured signal.

Circle (12) on Reply Card

Frequency counter

Global Specialties introduces the Model 6002, 8.5-digit, 1.3GHz counter for measurements from 5Hz to 1.3 GHz.

Features include period measurements from 1µs to 200ms and a 10MHz crystal oven oscillator timebase that assures +0.5-



ppm(10C to 40C), 1+ppm/year stability. The easy-to-read, 8.5 digit 0.43-inch display features leading zero blanking and a contrast enhancement filter. LED indicators for gate open, oven ready, and overflow provide additional convenience.

Circle (13) on Reply Card

Multimeter with PC interface

Extech's new data acquisition system offers a multimeter with a built-in optically isolated RS-232C serial interface and data acquisition software compatible with Microsoft Windows. The meter features a large 1999 count 3 1/2 digit display (LCD), data hold, an overload warning, and is equipped with a 9-pin serial port and cable (DB9-F connector) for direct connection to a PC. Easy to use Windows based software permits automatic data collection, audible alarms, and a variety of PC displays to choose from (analog/digital, meter, graph, and data list).



Data can be saved as an ASCII file for importing into Lotus, Excel, or other spreadsheet programs. MultiMeter measures ac/dc current and voltage, frequency, capacitance, resistance, and temperature. Additional low cost plug-in modules monitor current (via clamp-on), airflow, humidity, light level, and RPM. An optional datalogger module captures readings at 1 to 10 minute intervals. The datalogger stores up to 1800 readings and up to 10,000 readings using the memory expansion module. The data acquisition system includes MultiMeter, spare fuse, battery, temperature probe and leads, data acquisition software, RS-232 serial cable, and case.

Circle (14) on Reply Card

Function generator/frequency counter

The new Model B-803, 0.02Hz to 2MHz Function Generator from HC Prottek, features a 4 digit LED readout for continuous display of generator output frequency and can now be used as a frequency counter to measure an external signal frequency.



The combination function generator frequency counter produces square, triangle, or sine waves. It has plus or minus dc offset, 20dB attenuation and sweep output of 0.5Hz to 50Hz continuously variable. Output frequency is controlled via seven push button switches from X1 to X1MHz and a continuously tunable frequency dial.

Circle (15) on Reply Card

Chemical circuit protector

A newly formulated product that protects computers and electronics from moisture, static and corrosion has been announced by Circuit Guard International. Circuit Guard was originally developed for the aerospace industry to protect sensitive microcircuits from exposure to harsh environments.

The product forms an atmospheric barrier around electronic components. This barrier actively encapsulates and chemically neutralizes all ion transferring electrolytes (such as moisture, pollutants, salt, and dust) which cause corrosion leading to circuit failure. The chemical will also safely discharge harmful static by neutralizing charged particles.

The spray on liquid is compatible with the plastics, epoxies and various metals used in electronic systems. It has a dielectric strength in excess of 38,000V and does not alter resistive, capacitive, or inductive circuits. It is emulsifiable in water, and is nontoxic and nonirritating to the skin and eyes.

Circle (16) on Reply Card

[Continued from page 69]

CONTACT CLEANERS ARE NOT CREATED EQUAL

DeoxIT™

- Improves Conductivity
- Reduces Noise & Distortion
- Deoxidizes, Cleans & Protects
- Reduces Intermittents
- Reduces RFI, Wear & Abrasion

Even the finest equipment cannot guarantee noise-free operation. One "dirty" connection anywhere in the signal path can cause unwanted noise, distortion and signal loss. Considering the hundreds (if not thousands) of connections in electronic equipment today, it's only a matter of time before they begin to fail.

Use what the Manufacturers Use!



Available in Environmentally-Safe Spray, Wipes, Pen, Precision Dispensers & Bulk Containers

Some film deposits are effectively removed with "wash-type" cleaners such as contact/tuner cleaners, degreasers, alcohols and other solvents. Oxides and sulfides, however, become an integral part of the contact surface and cannot be removed by ordinary contact cleaners.

DeoxIT dissolves oxides and sulfides that form on metal surfaces, removing these sources of resistance. This restores the contact's integrity and leaves a thin (organic) layer that coats and protects the metal.

DeoxIT's advanced formula contains deoxidizers, preservatives, conductivity enhancers, arcing and RFI inhibitors and anti-tarnishing compounds that significantly increase the performance and reliability of electrical components and equipment.

DeoxIT provides long-lasting (1-10 years) protection, reducing the expense of repeated cleaning with expensive and aggressive ozone-depleting solvents.

DeoxIT outperforms & outlasts all other contact cleaners.

Non-flammable, Safe on Plastics & Environmentally-safe.

CAIG PRODUCTS...USED BY THOSE WHO DEMAND THE BEST!

Ampex	Federal Express	Honeywell	Switchcraft
Boeing	General Electric	McIntosh Labs	Tektronix
Diebold Inc.	John Fluke Mfg.	Mctrolia	Texas Inst.
Dolby Lab.	Hewlett Packard	Nakamichi	Xerox Corp.

CAIG LABORATORIES, INC. 16744 West Bernardo Drive San Diego, CA 92127-1904
TEL: (619) 451-1799 FAX: (619) 451-2799

1-800-CAIG-123

Circle (55) on Reply Card

Instant Internet with WebSurfer is ideal for any Internet user with a Windows PC:

- Beginners who want a quick and easy way to connect to the Internet
- Internet users with terminal accounts who want easier, more powerful access.
- Experienced Internet users looking for better software.

"Instant Internet with WebSurfer" enables users to establish any type of Internet connection they choose including SLIP, CSLIP, PPP and even high-speed ISDN connections—in five minutes or less. These connections allow users to access all Internet services such as the World Wide Web. All five participating service providers—CERFnet, Portal, PSI InterRamp, AlterNet (UUNET Technologies Inc.), and IBM Internet Connection (Advantis)—offer special money-saving offers to those who buy the book.

Internet Chameleon software won the John Dvorak Telecommunications Excellence Award for Outstanding Internet Front End. WebSurfer, Internet Chameleon's exciting new World Wide Web browser, includes advanced features such as automatic dial-up line speed optimization, local file caching, WYSIWYG styles, and support for 16 million colors.

Prentice Hall, Englewood Cliffs, NJ 07632

Technician's Guide to Industrial Electronics: How to Troubleshoot and Repair Automated Equipment, McGraw-Hill, By Robert S. Carrow, 400 pages, \$45.00 hardcover.

The Technician's Guide to Industrial Electronics serves as a useful handbook for industrial machine operators, electronics technicians, and plant managers who are interested in learning more about today's rapidly evolving electronic industrial automation technologies.

Author Robert S. Carrow walks readers step by step through a typical automation project, from concept to installation. Providing practical, hands-on examples, Carrow describes the components and subcomponents used in robots, computerized machine tools, and other types of automated equipment. He also discusses the many applications of these machines.

Topics include power transmission, in-

dustrial computers, process controllers and PLCs, electric motors, and motion control, with an emphasis on AC, DC, and servo drivers. Other subjects covered: sensors and feedback devices, "Machine vision" and image processing basics, total quality management and ISO 9000 standard, robotics and system integration, and industrial safety.

Each chapter in this comprehensive manual contains its own bibliography for those readers interested in additional information on an area. Carrow also provides numerous forms and logs for charting machine downtime data, I/O logging, preliminary ISO 9000 auditing, and more.

McGraw-Hill, Inc., Blue Ridge Summit, PA 17294-0850

Consumer Electronics Source Book, The Electronic Industries Association/Consumer, \$5.00.

If you desire the best, most up-to-date information on sources for replacement electronic parts and technical literature, go right to the source: "The 1995 Consumer Electronics Replacement Parts Source Book."

This valuable annual publication, created by the Consumer Electronics Group of the Electronic Industries Association, is the electronics manufacturing industry's most complete directory for obtaining replacement parts from product manufacturers. Includes information on obtaining the parts you need and where to find the current technical service literature that will help you better serve your customers. It's a manual no servicer can afford to be without.

Electronic Industries Association, 2500 Wilson Blvd., Arlington, VA 22201

The Downloader's Companion for Windows, Prentice Hall, 190 pages, \$19.95

Millions of people are retrieving online "souvenirs"—games, pictures, sounds, movies, programs and data of all kinds. When they "unwrap" these gifts and try to use them, however, the files often aren't in usable form. The Downloader's Companion for Windows, a new book/disk package from Prentice Hall PTR, shows users how to translate downloaded files into useful formats, and gives them all the

Windows software they'll need to do it.

Authors Scott Meyers and Catherine Pinch walk through every procedure Windows users may need to successfully use files they've obtained from online commercial services such as America Online, CompuServe and Prodigy, or from the Internet. Readers learn exactly how to:

- Decompress compressed files.
- Unarchive multiple files that were bundled into a single file.
- "Decode" files that were "uencoded" for posting on e-mail, bulletin boards or Usenet newsgroups.
- Convert image files from "GIF" or "JPEG" to formats their computers use.

The Downloader's Companion for Windows collects all the insider's information Meyers and Pinch have accumulated in decades of working with computer networks. It also includes all the Windows-based software downloaders need—an extensive collection of shareware and freeware. Without this book, users would have to search for these programs on-line, at great expense—and then the software itself might need to be converted before it could be used!

The Downloader's Companion for Windows offers all this software on one 3.5" high-density diskette:

- WinZip provides an easy-to-use Windows interface for working with downloaded file archives in any of these popular formats: ZIP, LZH, ARJ and ARC.
- Lview Pro allows users to view and edit images in several formats, including GIF and JPEG, the Net's two most well-known image formats.
- MPEGView plays movies stored in the standard MPEG format.
- WPLAny plays sound files in any of five different data formats.
- XferPro decodes files that have been encoded in any of 16 different mailing formats.
- ARJ and LHA are efficient, high-quality compression and archiving programs.

Downloading files is one of the primary reasons people use the Net. With The Downloader's Companion for Windows, using those downloaded treasures is finally as easy as it ought to be.

Prentice Hall, Englewood Cliffs, NJ 07632

Classified

Classified advertising is available by the word or per column inch.

By-the word. \$1.65 per word, per insertion, pre-paid Minimum charge is \$35 per insertion. Initials and abbreviations count as full words. Indicate free category heading (For Sale, Business Opportunities, Miscellaneous, Wanted). Blind ads (replies sent to ES&T for forwarding) are \$40 additional. No agency discounts are allowed for classified advertising by the word. Contact Kirstie Wickham at 516-681-2922 to place your classified ad (by-the-word). Mastercard, VISA, American Express and Discover are accepted for FAX or mail orders.

Per column inch (classified Display): \$235 per column inch, per insertion, with frequency discounts available, 1" minimum, billed at 1/4" increments after that 10" maximum per ad. Blind ads are \$40 addition. Reader Service Number \$25 additional to cover processing and handling costs. (Free to 4-inch or larger ads.) For more information regarding classified display advertising please call 516-681-2922. Optional color (determined by magazine) \$150 additional per insertion.

Send your order, materials and payments to:

Electronic Servicing & Technology, 76 North Broadway, Hicksville, New York 11801 Attn: Classified Department
Phone: 516-681-2922 FAX: 516-681-2926

FOR SALE

BULLETIN * IT'S OFFICIAL-THE LARGEST TIP DATABASE *OVER 17,300* VALUABLE , TIME-SAVING REPAIRS** for servicing TV's, VCR's, Projection TV's, CAMCORDERS & other electronics, organized in an easy-to-use computer program—**The TIP REPAIR Program. PROFESSIONAL BOARD/COMPONENT LEVEL REPAIRS from Technicians like yourself.** ADD your own tips. **PRINT** tips. **BACKUP** & save the tips that you have Added/Revised. Owners of our **COMPUTERIZED TIP PROGRAM** say this is the *BEST**** technical tip program on the market today. Works on **ANY** IBM compatible computer. **NEW VERSION—works in DOS and WINDOWS. Only \$200.00 and *NO* COPY PROTECTION!!!**
> Don't be fooled by other cheaper tip programs > that are copy protected with limited installs (now that's a gimmick) and still other programs that are more expensive with less tips & a database that never gets any bigger >. **FREE** shipping for Prepaid orders (U.S.A.) ****FREE** Demo!** Have your own tips? Ask about our **TIP EXCHANGE** policy with **FREE Updates!** **CALL 1-800-215-5081/ 1-516-643-7740. HIGHER INTELLIGENCE SOFTWARE, 60 Farmington Lane, Melville, NY 11747.**

**** DON'T BE LEFT OUT EVEN IF YOU DON'T OWN A COMPUTER **** ELECTRONIC SOFTWARE DEVELOPERS NOW OFFERS 1,926 SERVICE TIPS IN BOOK FORM COVERING COLOR & PROJECTION TV'S, AND VCR'S FOR EMERSON, GOLDSTAR, NEC, SAMSUNG AND ZENITH **FOR THE LOW PRICE of \$59.95.** TO ORDER Mail Check or Money Order for \$59.95 to: ELECTRONIC SOFTWARE DEVELOPERS INC. 826 SO MAIN ST, SOUTH FARMINGDALE, NY 11735 or call 1-516-221-6403.

TV CASE HISTORIES: Booklet with 2,440+ histories. Satisfaction assured. Only \$49 (plus \$3.00 for priority mail). **Mike's Repair Service,** P.O. Box 217, Aberdeen Proving Ground, MD 21005. Same mailing address 31 years. Send SASE for samples. 410-272-4984, 1-800-2-FIX TVS 11am-9pm.

TEST EQUIPMENT BOUGHT & SOLD: OSCILLOSCOPES, ETC. 1-408-738-4206. FAX 1-408-736-6946.

FURTHER PRICE REDUCTION. Diehl Mark III \$49, Diehl Mark V Horizontal circuit tester \$169. New. Conductive coating for remote control keypads \$9.99 ppd. **WEEC,** 2411 Nob Hill Road, Madison, WI 53713. (608)-238-4629, (608)-273-8585.

SERVICE DATA & HARD TO FIND PARTS previously-owned SAMs, manufacturers data, books, **FREE** catalog. **AG Tannenbaum,** Box 386, Ambler, PA 19002, (215) 540-8055, fax (215) 540-8327.

Tektronix 500MHz scope system, 7904, 7A26, 7A24, 7B80, 7B85, \$1100; Tektronix, 200MHz scope system, 7704A, 7A26, 7A26, 7B80, 7B92A, \$1000.00; Tektronix 7603, 7A26, 7A26 , 7B53A, 100MHz scope system, \$650.00, **A-Comm Electronics** 303- 290-8012.

Test Equipment For Sale. Send for Test Equipment Sales list, A-Comm Electronics, 7198 S. Quince St. Englewood, Colorado 80112. 303- 290-8012.

FOR SALE

SERVICE TIPS NOW CONTAINS OVER 17,185 TECHNICAL TIPS. Due to the **TREMENDOUS RESPONSE FROM OUR CUSTOMERS, SERVICE TIPS IS NOW ONE OF THE LARGEST AND MOST CURRENT DATABASE'S AVAILABLE TODAY.** **SERVICE TIPS** is organized in **ALPHABETICAL ORDER** by Brand Model/Chassis & Symptom with 3 lines for Symptom and 8 for Solution. **YOU CAN REVISE and EDIT or PRINT** any service tip in our database, **AND YOU CAN ADD YOUR OWN INFORMATION** and it will automatically be alphabetized and sorted. **SERVICE TIPS HAS MULTIPLE WAYS TO BACK UP ALL OR PART OF THE DATA.** The program contains **ACTUAL TECHNICIANS FINDINGS** on TV's, Projection TV's, VCR's, Camcorders and other consumer electronic equipment. **UNLIKE SOME OTHER PROGRAMS, WE HAVE NO GIMMICKS. ATTENTION ALL 1ST TIME BUYERS - CALL US FOR A SPECIAL BONUS OFFER.** **SERVICE TIPS is available for \$149.95 plus s&h.** For more information **CALL US at 1-800-621-8477** (from US & Canada). Demo Disk and Quarterly Updates available.

TV shop closing after 45 years, owner retiring. Collection of parts and service literature for Emerson, Goldstar, RCA, Samsung, Sharp, Philips, Sylvania, Philco, Magnavox, lots of RCA parts many no longer available from RCA. Lots of Sams, Test Equipment Sencore VA48, VA62A, NT64, SC61, PR57, LC53, 10J107 Test Jig, B&K 1479 scope, B&K 415 Generator, 2 Holiday HI 1800 Survey meters. Many other tools and equipment and parts. Best offer can have all including parts bins and cabinets. For information write Mervin Meyer Electronics, 27894 Jewell Road, PO Box 32, Jewell, Ohio 43530, or call 419-497-2451.

******12,000 CURRENT SERVICE CENTER Tech-Tips, 163 Brands - 2,000 New Repairs Every 8 Months-3" Published Manual for NON-COMPUTERIZED Centers or Choose THE ONLY COMPUTER PROGRAM With a MONEY-BACK GUARANTEE. Want to Computerize Your Complete Service Center With a Proven User Friendly Ready to Operate Fully Licensed Program? All Books and Warranty Included, Network or Single User. For "FREE" DEMONSTRATIONS ****See Page 58******

!!! AT LAST !!! the most comprehensive FCC to MODEL CROSS REFERENCE GUIDE BOOK available. With equivalent model numbers listed in alpha-numerical order it enables you to cross reference **73 brands with over 1,000 model numbers** on VCR's, Camcorders and Computer Monitors that are the same or similar. **THIS ELIMINATES UNNECESSARY ORDERING OF PARTS AND SERVICE LITERATURE AND THAT'S IMPORTANT** because **IT SAVES YOU TIME AND MONEY ON THE REPAIR.** To order send check or money order for **\$19.95 plus \$3.00 Shipping** to Electronic Software Developers Inc. 826 South Main Street, South Farmingdale NY 11735 or phone 1-800-621-8477.

******* FREE ZENITH CURES *******
Earn \$\$\$ Repair Zenith TV modules found in over 1000 models, 1983-1993. Symcure manual shows you how. \$89.95 or send SASE for **FREE** samples. **ZMEX,** 807 Queen Palm Lane, Sarasota, FL 34243.

Leader 3100 multichannel TV sound Generator, \$300.00; **Leader LSW-480;** 480-U71, 480-U77, 480-U80, \$900.00 **A-Comm Electronics** 303-290-8012.

FOR SALE

Computer Monitor Test Pattern Generator. Generates color bars & cross hatch. Seven sync rates. Service monitors without a computer. From \$199. INDEPENDENCE ELECTRONICS, 119 South Main, Independence, Missouri, 816-836-1094.

Sencore Electronic Testing Equipment models VA62A, SC61, PR57, VC63, CR70, LC102, TE46, and SCR250 all for \$7000.00. Will Sell Separately. Includes all books, manuals, video tapes. Call 217-794-5131.

BUSINESS OPPORTUNITIES

TV & Video Service Business for sale or lease. Est. 30 year, same good location in Moreno Valley California, 92556. Call 909-242-4794, ask for Peter.

**To Advertiser in
Electronic Servicing & Technology's
Classified Section Call 516-681-2922**

Readers' Exchange

Readers' Exchange is a free service.

The following restrictions apply to Readers' Exchange:

- Only individual readers may use Readers' Exchange, and items must be restricted to those that are ordinarily associated with consumer electronics as a business or hobby. If you're in business to sell the item(s) you want to offer for sale, the appropriate place for your message is in a paid advertisement, not Readers' Exchange.

- Readers' Exchange items must be restricted to no more than three items each for wanted and for sale, and may be no more than approximately four magazine column lines in length (about 20 words).

- All submissions must be typed or printed clearly!

Send your Readers' Exchange submissions to:

Readers' Exchange

Electronic Servicing & Technology, 76 N. Broadway, Hicksville, NY 11801

FOR SALE

Weller EC1002 micro soldering station adj temp - \$180.00, Pace PC20A, desoldering station, \$350.00. Both in excellent condition. *Contact: Tri State Service, PO Box 170, Staten Island, NY 10306.*

Sencore Equipment, LC102, VA62A, VC93, and others. Retiring. *Contact: Barbara Purvis, 317-546-7738.*

Sencore VC93 and all accessories \$1500.00, TV and VCR test instruments in excellent condition. Send large s.a.s.e. or call for complete listing. *Contact: Clarence G. McKee, 9516 Zion Rd., Rives Jct., MI 49277, 517-569-3139.*

Complete Sencore Tech Choice video test equipment, 8 pcs. Less than 1 1/2 years old, Like new. Bought for \$16K, asking \$8.7K. Call for information. *Contact: 919-365-5993 (leave message)*

B&K analyst 1077 + book. Jackson cathode ray oscilloscope CR3. *Contact: Ann Bichanich, 15 1/2 W. Lake St., Chisholm, Minn 55719, 218-254-4421.*

Sencore CR70 CRT tester/restorer, excellent condition. \$600.00. *Contact: Bob, RGM Electronics, 71 Saranac Avenue, Lake Placid, NY 12946, 518-523-3801.*

Sencore CVA94, used twice, \$2700.00, Sencore VR940, used twice, \$500.00, Sencore VC93, never used, \$2600.00. With cables and manuals. Will pay shipping. *Contact: Gordon Wilmot, 12 Putnam Road, Hyde Park, NY 12538, 914-229-0478, 5-6 PM, EST M-F.*

Sencore VA62A with NT64, ST65, RG67, and EX231, Sencore SC80 scope (upgrade). All excellent condition, \$2600.00. *Contact: Mike Arnold, 610-691-3767 (evening).*

Sencore SC3100 auto tracker oscilloscope. New, in box with accessory cable kit. \$2800.00 or offer plus shipping. *Contact: Jeremy, 916-723-9769.*

HP model 400L VTVM. Tektronix model 551 dual beam oscilloscope with one type A, one type B plug-ins. Eico model 460 oscilloscope. Conar model 281 signal generator. Conar model 231 tuned signal tracer. *Contact: Martin Eich, 1141 Glen Shaw Road, Edmonton, KY.*

Sencore VA62A, ST65, CR70, VC93, SC3080. Complete Tentel gauge package. All equipment in excellent condition. All cables, manuals, and original boxes included. \$6000.00 or best offer. *Contact: Bruce Dorson 603-878-2815.*

Sony video camera DXC 1800 bodies only, no lenses. Used, untested one lot of 5. \$200.00 plus shipping. *Contact: 916-686-6306 (evenings).*

WANTED

KNIGHT KG-686, RF Generator and B&K 1077B Analyst. *Contact: Charles T. Huth, 229 Melmore Street, Tiffin, OH 44883, 419-448-0007.*

Sharp copy machine, model SF8200, need service manual and schematics. *Contact: John Destroyer, 13405 Burt Road, Riley, MI 48041.*

Eico model 950-A, resistance-capacitance comparator bridge schematic. *Contact: H.L. Hemken, 183 Glover Avenue, Chula Vista, CA 91910-2515, 619-691-0576.*

Colorado tape backup 250, motor drive IC marked A9223 or board with. *Contact: Pat 215-661-9107.*

Service manuals for: Technovox 20 inch TV TX-2020, plus parts sources, Zenith 20 inch SE5273S, Janel SP2000 stereo processor, Toshiba Fax TF111 plus parts sources, Mita copier DC-121 plus parts sources, Canon copier NP-210 plus parts sources. *Contact: Mr. Rejean Mathieu, 819-874-1049(phone), 819-874-0704 (fax).*

Used test equipment, service manuals for TV, VCRs, stereos and camcorders. Need Curtis Mathes TV manual. *Contact: Beri, 803-882-6593 (fax).*

Emerson VCR964, complete faceplate and remote control, Sanyo 19 inch TV model 91C615A, flyback transformer, picture tube for a Sony model KV2870 (tube no. 710AB22), HV transformer, Orion 3214003 for a 13 inch Brooksonic model CTV-4509YL. *Contact: John's Repair Center, 142 Jackson Street, Philadelphia, PA 19148.*

Zenith model 23GC45 TV or Zenith p/n 95-3176 or Thordarson FLY-564, need flyback transformer. Also need schematic for Curtis Mathes model D555(or CMC-62). *Contact: John Smith, 803-665-5333.*

To buy Texas Instruments A/D - ICs # TLC548 which was sold by Radio Shack catalog # 276-1796. Also to buy owner's manual (photocopy O.K) for IBM printer #5152, and schematic for Honda car stereo #CM3306. *Contact: John Augustine, 3129 Earl Street, Lauderdale, PA 19605, 610-929-8850.*

AIWA model TP-50R record-play head for reel-to-reel recorder (could probably use any make head). *Contact: Don Hicke, 4131 Mt. Everest BLVD, San Diego, CA 92111.*

Educational materials, training courses, videos, etc. relating to TV, VCR repair, etc. Also Riders manuals. *Contact: S. Fogel, 87 Sandra Drive, Parsippany, NJ 07054, 201-316-8424.*

Sony model KV-1520R and 400DNB22 picture tubes. *Contact: Bob Oserkis, 17320 Burma Street, Encino, CA 91316, 818-996-3390 (after 10 A.M. west coast) or fax 818-772-1651.*

TUBES • TUBES • TUBES
World's Largest Range
 Over 2,000 Types, Domestic & Foreign

 **UP TO 85% OFF** Ask for price list

 **International Components Corporation**
 Toll Free 800-645-9154 • N.Y. State 516-293-1500
 105 Maxess Road, Melville, New York 11747

Circle (74) on Reply Card

Tech's Guide To Pricing **NEW**

"Sperry Tech's Pricing Guide"
 Updated new 6th edition...a framework for setting rates that apply to Hi-Tech products...a formula that guarantees SUCCESS!
 Call Toll Free for details 1-800-228-4338

Circle (64) on Reply Card

NEW AUTO RADIO VIBRATORS PLUS:
 6 to 12 VOLT POWER INVERTERS, SPEAKERS, TRANSFORMERS, DIAL GLASS, MORE!
 If you repair older car radios...YOU NEED OUR **FREE CATALOG!**

ANTIQUA AUTOMOBILE RADIO INC.
 700 Tampa Rd., Palm Harbor, FL 34683
 1 (800) WE FIX AM or FAX (813) 789-0283

Circle (53) on Reply Card

ELECTRONIC SOFTWARE DEVELOPERS, INC.
 826 South Main St., South Farmingdale, NY 11735

17,250 Service Tips \$149.95

THE MOST CURRENT TECHNICAL TIPS COMPUTER PROGRAM AVAILABLE TODAY.

CALL 1-800-621-8477

Circle (60) on Reply Card

GEnie® The most fun you can have with your radio on!



No other online service serves the radio hobbyist like GEnie's Radio & Electronics RoundTable does. Scanning, shortwave, ham radio, even an online callsign database so you can look up QSL info in an instant! And we have it all at one of the lowest connect time rates of all the major online services

To sign up for GEnie with your computer & modem, dial toll free in the U.S. or Canada 1-800-638-8369.

At the U#= prompt, type JOINGENIE

And for a special introductory offer, At the key/offer code prompt type BWH528

Circle (78) on Reply Card

Advertiser's Index

Company	Page Number	Reader Service Number	Advertiser Hotline
AnaTek Corporation.....	58	75	800/999-0304
Andrews Electronics.....	15	52	800/289-0300
Antique Automobile Radio, Inc.	76	53	800/WE FIX AM
B & K Precision.....	9	54	312/889-1448
CES Orlando '96.....	3	56	703/907-7600
Caig Laboratories.....	69,71	55	800/CAIG-123
Computer & Monitor Maintenance.....	63	57	800/466-4411
Dalbani Corporation.....	32	58	305/716-1016
Electronic Design Specialists.....	57	59	407/487-6103
Electronic Software Developers.....	76	60	800/621-8477
Fluke Corporation.....	BC	106	800/59-FLUKE
Fox International.....	31	61	800/321-6993
Fotronic.....	20	62	800/996-3837
GEnie Radio & Electronics Roundtable.....	76	78	800/638-8369
HC Protek.....	21	71	201/767-7242
Hytec Dealer Services, Inc.....	29	63	800/883-1001
ISCET.....	70		817/921-9101
ITT Pomona.....	8	65	909/469-2900
International Components Corp.	76	64	800/645-9154
LG Precision.....	25	66	310/404-0101
MAT Electronics.....	70	67	800/628-1118
MCM Electronics.....	22	68	800/543-4330
NESDA.....	15,31		800/433-5557
National Advancement Corp.....	63	69	800/832-4787
Parts Express.....	50	70	800/338-0531
Sams, Howard & Company.....	51	77	800/428-7267
Satellite Dealers Association.....	32	72	317-653-4301
Sencore.....	IFC,19	1,111	800/SENCORE
Specialized Products.....	7	73	800/439-4250
Sperry Tech.....	76	74	800/228-4338
TV Man Tech Tips, Inc.....	58	76	800/474-3588
Thomson Consumer Elec.....	IBC	93	

We'd like to see your company listed here too. Call Diane Klusner at 516/681-2922 to work out an advertising program tailored to suit your needs.



SALES OFFICE
PHONE (516) 681-2922
FAX (516) 681-2926



Save time...make more money

...with the new

SOURCE BOOK

by Thomson

VCR/Camcorder SOURCE BOOK

VCR/Camcorder

RCA



PROSCAN

SK Series

KEY ITEMS CROSS REFERENCE

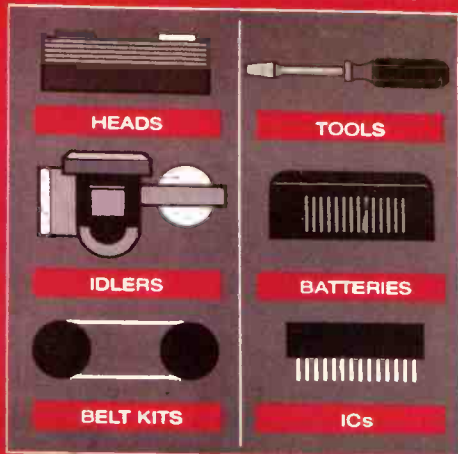

Exact Replacement Semiconductors
OEM Replacement Parts
Universal Replacement Parts

THOMSON CONSUMER ELECTRONICS

Now available...a single guide to help you find your exact or universal parts...fast!

Our new cross reference source book for VCRs and camcorders combines our most popular cross reference information into one easy-to-use volume.

One book...filled with 320 information packed pages on VCR and camcorder key items, universal parts ...and much more.

The Technician's New Friend

Contact your TCE Parts Distributor for your complimentary copy. Order Publication Number 1J9780

Here's what the new guide contains:

- OEM Replacement Parts
- Universal Replacement Parts
- Exact Replacement Semiconductors
- Camcorder Batteries
- Flameproof Resistors
- and much more

THOMSON CONSUMER ELECTRONICS

Circle (93) on Reply Card

True-rms. True values.

NEW

Do you troubleshoot non-linear circuits or loads? If so, you need true-rms capability to ensure accurate measurements. Now you can get this capability without having to compromise on quality or safety to stay within your budget.

Priced at just \$199.00*, the new Fluke Model 76 true-rms DMM is the latest in the long line of true-rms values from Fluke. You can use the Model 76 to easily measure true-rms ac current and volts, dc current and volts, ohms, capacitance, continuity, and frequency. And, the Model 76 is the only DMM in its class that meets UL, CE, CSA, and TÜV certification standards and conforms to the IEC 1010-1 product safety standard for Overvoltage Category III.⁽¹⁾

You'll find that kind of true value all the way down the line with Fluke test tools. See your local Fluke distributor to select a true-rms meter that fits whatever your job or budget demands.



Fluke 32
\$149*



Fluke 33
\$269*



Fluke 76
\$199*



Fluke 87
\$335*



Fluke 8060A
\$459*

* U.S. list price. Prices subject to change without notice.

(1) Approvals/Listing pending

© 1995 Fluke Corporation P. O. Box 9090, M/S 250E, Everett, WA USA 98206-9090. U.S. (206) 356-5400. Canada (905) 890-7600. Europe (31 40) 644200. Other countries (206) 356-5500. All rights reserved. Ad no. 00768



FLUKE

Circle (111) on Reply Card