

# ELECTRONIC<sup>TM</sup>

**Service & Technology**

MAY 1988/\$2.50

Quick tests for B&W TVs • Battery problems in electronic equipment

Circuit analysis and troubleshooting quiz—Part II

## Hand-soldering surface-mount components





# Easier Testing. By Comparison.

*Scopemate 2.<sup>TM</sup> With Your Scope Or Ours,  
Still The Best Price Solution  
For Good/Bad IC and Component Testing.*

Now you can economically test all types of analog, digital and hybrid components—including resistors, capacitors, diodes and ICs with up to 40 pins—using a simple X-Y oscilloscope. In the field or on the bench, in-circuit or out-of-circuit. Without tedious pin-by-pin or contact-by-contact testing.

It's made possible by Scopemate 2<sup>TM</sup> from Beckman Industrial. All it does is plot voltage vs. current. Just a lot easier. A lot faster.

Scopemate 2 compares components known to be good with those to be tested, giving you a very accurate and fast way to identify bad devices. The voltage vs. current plot from a known good device is compared to the device under test. In fact, since there's no complex numerical test data to interpret, Scopemate 2 is ideal for less experienced personnel.

And, at \$395 it doesn't take too long to figure that Scopemate 2 may pay for itself in saved testing time. Real soon. Scopemate 2 comes with a simple yet comprehensive operator's manual, a complete set of leads, interconnect cables and plug-in transformer.

Although Scopemate 2 will work with just about any X-Y oscilloscope,

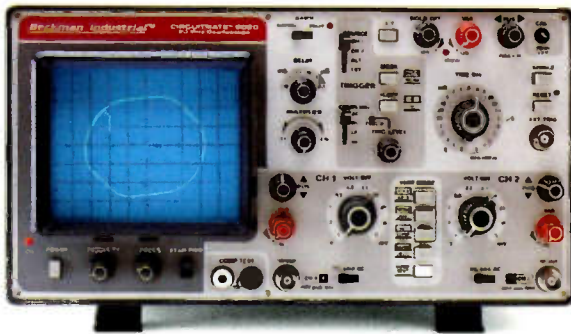

## 9020 20MHz Delayed Sweep Oscilloscope \$589.00

Vertical Accuracy:	±3%
Time-based accuracy:	±3%
Input Impedance:	1M ohm 35pF (2%)
Input Max. Voltage:	400V (DC + pos. peak AC)
Sweep Delay Ranges:	10, 1.0, 1ms; 10, 1.0, 1μs
Mode:	Normal, search, delay

Beckman Industrial Circuitmate<sup>TM</sup> Model 9020 offers capabilities seldom found on other scopes costing less than \$600.

Proven capabilities such as **delayed sweep** for easy bandwidth analysis, zoom-in for short-duration events, a variable holdoff function for a stable display of non-periodic signals—even beam finding to

locate and return trace to view regardless of control settings. And switchable X1/X10 probes give you more sensitivity for low frequency measurements, less circuit loading for high frequency measurements.

For real value, combine the 9020 and Scopemate 2 for performance and flexibility unmatched by systems costing \$1,500 or more.

Both Scopemate 2 and our Circuitmate Model 9020 illustrate a simple commitment by Beckman Industrial—to provide service test instruments that meet your needs. Whether through advanced technology or value-oriented applications of proven technology, Beckman Industrial gives you the right features at the right price, with service test instruments built to rigorous standards of quality and reliability.

Visit your Beckman Industrial distributor today and find out how the ruggedly reliable Scopemate 2 and the 9020 Oscilloscope can meet your needs. And why they offer the best value around. By comparison.

## Scopemate 2<sup>TM</sup> IC/Component Tester \$395.00

Test Method: Direct Visual Comparison (known good vs. device under test)

Test Sockets/Interface: 20 and 40-pin ZIF IC sockets, banana jacks

Power: 120 or 220VAC, 50/60Hz, 5VA max. (specify)

Circuit Test Voltage/Current: 14VAC RMS (voltage, approx.); 300μA AC RMS (current, approx.)

Pin Test selection: Push-button switch per pin.



*In Service  
Instruments,  
We're The One.*

**Beckman Industrial<sup>TM</sup>**

Beckman Industrial Corporation  
Instrumentation Products Division  
A Subsidiary of Emerson Electric Company  
3883 Ruffin Road, San Diego, CA 92123-1898  
(619) 495-3200 · FAX (619) 268-0172 · Tlx 249031

Circle (1) on Reply Card

© 1987 Beckman Industrial Corporation







# SEEK PROFESSIONAL HELP

Servicing electronic equipment isn't always easy, especially if you're doing it in the field. At Chemtronics we can help with over 200 specially engineered products for the maintenance, repair and production of high technology equipment. Call today for our latest problem solving catalog.

Circle (3) on Reply Card

**Chemtronics**  
Keeping pace with advanced technology

Chemtronics, Inc. 631 Old Willets Path, Hauppauge, NY 11788 800-645-5244 In NY 516-582-3322 Telex 968567





Page 8

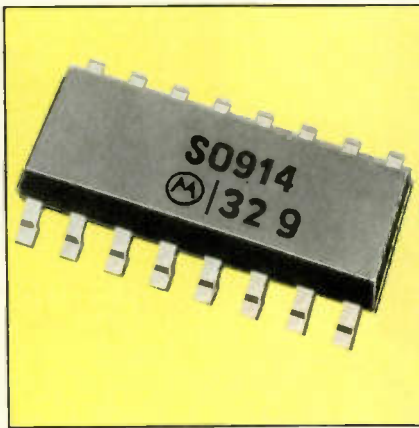

Page 18



Page 22

## FEATURES

### 10 Battery problems in electronic equipment

*By Joseph J. Carr, CET*  
Maybe you wouldn't automatically think *batteries* if someone mentioned electronics servicing, but take a look at some of the newest high-tech gadgetry, such as wristwatch TVs and portable TVs. Battery-powered devices are going where no electronics have gone before, and it's up to the electronics servicer to keep them running wherever the user needs them.

### 18 Hand soldering surface-mount components

*By Christopher H. Fenton*  
Have you ever noticed how much empty space is under the cover of today's TVs? What used to require all that space is now being downsized to tiny, SMD-encrusted circuit boards that do much more than their simpler predecessors. When you need to service these complex devices, knowing a few tricks of the trade can help you do it faster and with less chance of damaging those delicate surface-mount components.

The how-to magazine of electronics...

**ELECTRONIC**  
Servicing & Technology

### 22 Quick tests for B&W TVs

*By Homer L. Davidson*  
B&Ws may not be the hottest news in electronics, but there are occasions when you may want to keep one running. However, you have to be careful not to allow the cost of the repairs to exceed the cost of the TV itself. Here are some quick tests that can speed up the job of locating typical problems in B&W TVs.

### 42 Circuit analysis and troubleshooting quiz—Part II

*By Bert Huneault, CET*  
Here it is, the second circuit analysis quiz, guaranteed to give the canniest electronics servicer pause. If you got burned on the last one, now's your chance to show how much you've improved your servicing know-how.

## DEPARTMENTS

#### 4 Editorial

Pass it along...

#### 6 News

#### 8 Technology

Sound and image—from one flat screen

#### 31 Profax

#### 47 Literature

### 48 Test your electronics knowledge

### 50 What do you know about electronics?

Backward transistors—An update

### 53 Products

### 54 Troubleshooting tips

### 56 Symcure

### 58 Books

### 60 Audio corner

CD channel frames

### 62 Computer corner

Those mysterious glitches

### 64 Video corner

The playback story

### 66 Readers' exchange

### 68 Advertisers' index

## ON THE COVER

Hand-soldering surface-mount components doesn't require any special tools, just a little know-how. One of the most important factors in any soldering job is choosing the best iron for the particular job at hand. (Photo courtesy of Ungar.)



# LEADER

## NOW Battery Powered!

Choose the New LBO-315 for ac/dc,  
or the current LBO-325 for ac only.

## Sometimes it's hard to go back for a scope!

**60-MHz full-function field-service Attache Case Oscilloscope is so light and small it will be taken everywhere, every time.**

LBO-325 packs all the power and performance of a cumbersome, backbreaking, 60-MHz workbench oscilloscope into an easy-to-carry, ultra-compact, featherweight unit. Although its 3½-inch CRT is as big and clear as screens on large field-service scopes—LBO-325 weighs only 9 lbs. So it won't weigh field-technicians down, no matter how far afield they go! LBO-325 is so small it fits inside a 3-inch deep attache case with room to spare for a multimeter, service manuals and some tools. The ideal full-function scope for a cramped work area or crowded bench.

### Reduces the cost of service calls.

Time is money. A scope left in the vehicle takes time to retrieve. One kept in the shop causes repeat service calls. The LBO-325

Attache Case Oscilloscope is so easy to carry and use, techs will take it everywhere, every time. And the time saved translates into extra profits for years to come.

### Outperforms all other portables:

- 60 MHz • Dual channel • ALT TIME BASE simultaneously displays main waveform and any expanded portion
- ALT TRIG for stable display of 2 asynchronous signals • Bright, sharp 12-kV trace • Large 3½-inch PDA CRT • Illuminated graticule
- Comprehensive triggering • TV-V and TV-H sync separators • Variable trigger hold-off • Delay line shows sharp leading edges • CH-1 output drives low-sensitivity instruments
- Measures only 3 x 9 x 11½ inches • Weighs 9 lbs.

### Two-year warranty.

Built tough to provide long use, LBO-325 is backed by Leader's 30-year reputation for reliability and by factory service depots on both coasts.

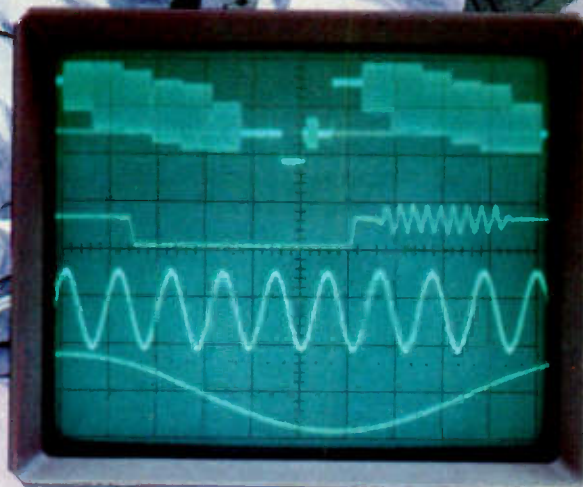

LBO-325 CRT is shown actual size.

Call toll-free  
**(800) 645-5104**  
In NY State  
**(516) 231-6900**

Request an evaluation sample, our latest Test Instrument Catalog with over 100 outstanding products, the name and address of your nearest "Select" Leader Distributor, or additional information.

For professionals  
who know  
the difference.

**LEADER**  
Instruments Corporation

380 Oser Avenue  
Hauppauge, New York 11788  
Regional Offices: Chicago, Dallas  
Los Angeles, Boston, Atlanta  
In Canada call Omnitrnix Ltd.  
(514) 337-9500

For Demonstration Circle (36) on Reply Card





# Pass it along...

Servicing consumer electronics products is a difficult job at best. The products needing servicing are complex devices, based on principles that are not easy to comprehend, and good servicing literature frequently is not available. In many cases, solving a servicing problem would be far easier if only the servicer had more experience with the particular make and model.

If you don't have the literature or the experience, you can still make diagnosing and correcting problems easier by consulting another servicing technician who is an expert on a particular set. In other words, sharing servicing information can yield great benefits in servicing.

Sharing information takes place through a number of avenues. In a servicing facility where there are several technicians, sharing may take place informally. One technician, in chatting with another, describes a set of symptoms on a particular set and the other technician responds with "I had one just like that last week..." He describes precisely the procedure he used to fix that set, and it works for the problem at hand.

Manufacturers also help by gathering information on servicing problems. They keep track of warranty claims and analyze servicing help that their experts provide to servicing technicians. When they determine that this information is of general enough interest, they publish it and furnish it to servicing facilities that subscribe to their servicing literature.

Other vehicles for exchanging servicing experiences, which are accessible to all technicians, are the Sycmures and Troubleshooting Tips in *ES&T*. These departments serve as clearing-houses for servicing information. Technicians provide us with this information, and we publish it as a service to other interested technicians.

To make this service work, we need information from working servicing technicians like you, so we're trying to make it easier for you to send it in.

Here's a brief description of what

we're looking for and how to submit items.

### Sycmure

For an idea of what Sycmure is all about, see this month's installment on page 56. Each symptom/cure is one of those problems that keeps cropping up on a particular TV set—the kind that, when someone says, "Hey, I've got a Tyrannosaurus Rex model XYZ 235 with green lines in the picture," you know that replacing C2355690 will almost certainly solve the problem. We pay \$60.00 per page (six sycmures) we publish.

### Troubleshooting tips

See pages 54 and 55 for an idea of what Troubleshooting Tips are all about. What we want for this department are the problems that give you a little trouble, make you think and apply a logical troubleshooting procedure. The difference between these and Sycmures is that we want not only the symptom and cure, but also a description of what your thinking process was and how it led you to a solution. We pay \$25 for each Troubleshooting Tip we publish.

### Send for a kit

At the bottom of this page is an application blank. If you're interested in submitting Sycmures or Troubleshooting Tips, drop us a note or send the form below to:

Sycmure/TTips Editor

**Electronic Servicing & Technology**

P.O. Box 12901

Overland Park, KS 66212

We'll send you a kit with detailed guidelines on what Sycmure and Troubleshooting Tips should consist of, along with blank forms that you can use to quickly and easily make your submissions.

Help yourself to a little extra money, and help your fellow technicians to some of your servicing know-how.

*Mike Conrad Person*

I would like to submit some of my experiences to be used as Sycmures/Troubleshooting Tips. Please send me a kit.

Name: \_\_\_\_\_

Address: \_\_\_\_\_

City/State: \_\_\_\_\_ Zip: \_\_\_\_\_





PHILIPS

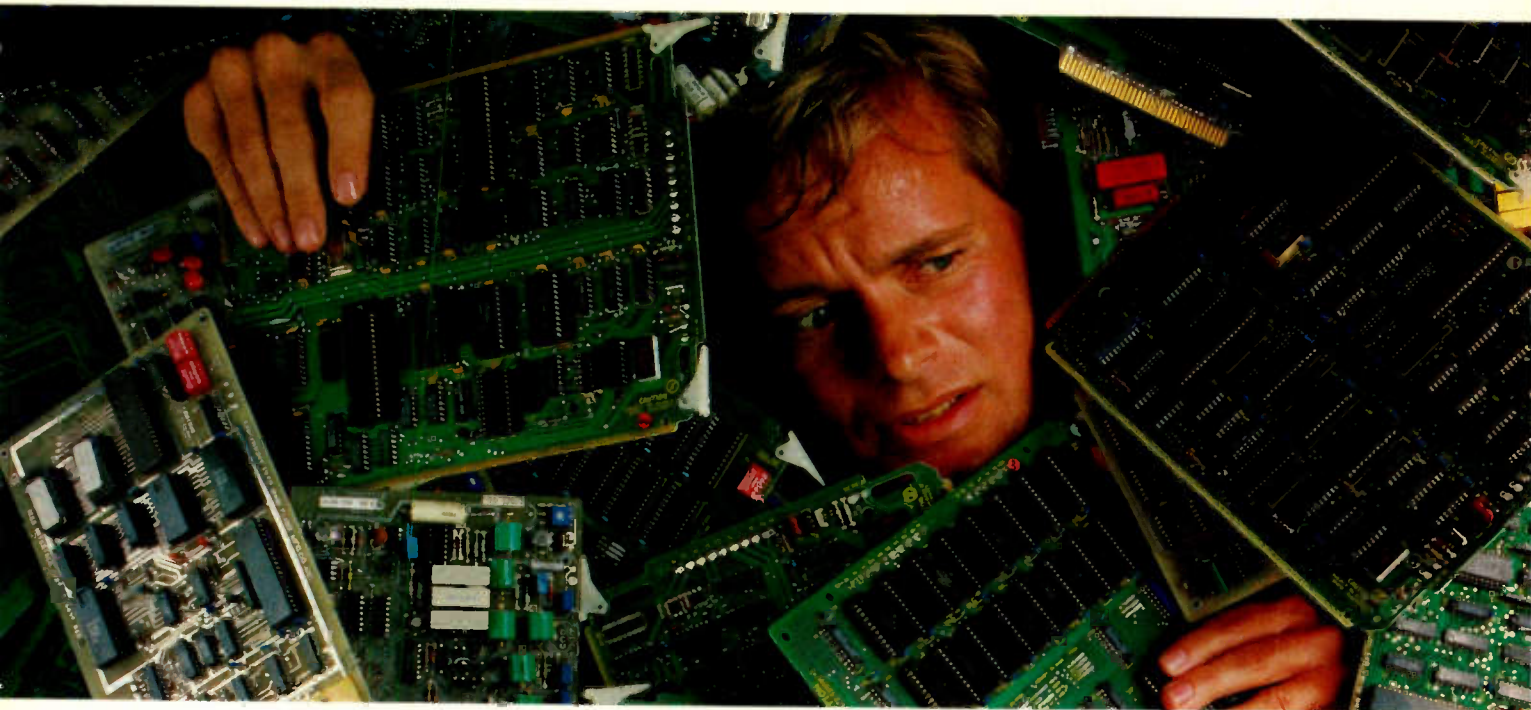

# How to rescue yourself from a landslide of microprocessor board failures.

**Complementing traditional troubleshooting tools, the Fluke 9010A can help decrease your board repair times by 55-80%.**

You've got your oscilloscopes, your logic analyzers and your signature analyzers. But Fluke offers a better way to troubleshoot: the tool you'll reach for most. It's the 9010A Troubleshooter, a versatile board tester that's so easy to use, you can start testing the very first day.

The Fluke 9010A has a proven track record in saving repair time and substantially reducing board float. In fact, it has become the microprocessor repair tool of choice for over 2800 companies worldwide, including the leading computer and electronics manufacturers.

**Test the easy way: from the microprocessor socket.**

To begin board repair, remove the microprocessor from its socket and insert the interface ped connector in its place. Each

element of the microprocessor kernel (the bus, ROM, RAM and I/O) can be tested with a few simple commands.

Fluke's patented emulation technology offers real time testing and complete visibility throughout the circuit. This lets you test even the tough problem areas, including DMA, disk, video, communications and peripheral controllers. All diagnostic messages are presented in simple-to-understand English.

### Comprehensive support from Fluke.

The 9010A supports over 50 microprocessors (including 180X, 6502, 680X, 680XX, 803X, 804X, 805X, 808X, 874X, 80X86, 9900, Z80, Z800X, 8751). And it is backed by Fluke's complete support network, which offers training courses nationwide on test strategy, basic operation and even  $\mu$ P fundamentals.

In addition to the 9010A, the leader in emulative board test technology also offers the 9100A Digital Test System for a fully automated repair solution; plus the 90 Series, a compact inexpensive troubleshooting solution for 6809, Z80 and 8085  $\mu$ Ps.

*To learn how you can escape the landslide, get your free video brochure "The 9010A  $\mu$ P Board Repair Solution."*

**Call 1-800-44-FLUKE, EXT. 88 today.**

John Fluke Mfg. Co., Inc. P.O. Box C9090,  
M/S 250C, Everett, WA 98206.  
U.S.: 206-356-5400 CANADA: 416-890-7600.  
OTHER COUNTRIES: 206-356-5500.

© Copyright 1988 John Fluke Mfg. Co., Inc.  
All rights reserved. Ad No 0181-F9010.



The 9010A Microsystems Troubleshooter

See us at  
Electro, Booth #364-373





## EIA releases final sales figures

According to figures released by the Electronic Industries Association's Consumer Electronics Group (EIA/CEG), sales to dealers of consumer electronics totaled \$30,277,000 in 1987, up more than 2% from 1986. The more modest growth is attributed in part to the stock market drop. The EIA reports that of the 24 categories for which they report, 14 showed growth, two were unchanged and two were slightly behind their 1986 pace.

The EIA is estimating a 7% growth for 1988. Early figures for 1988 show that most categories except projection TV were down from 1987 month-to-date and year-to-date. Notable exceptions

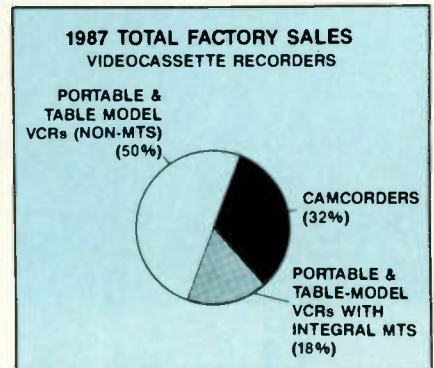
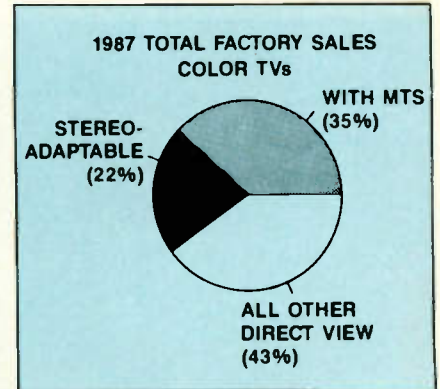
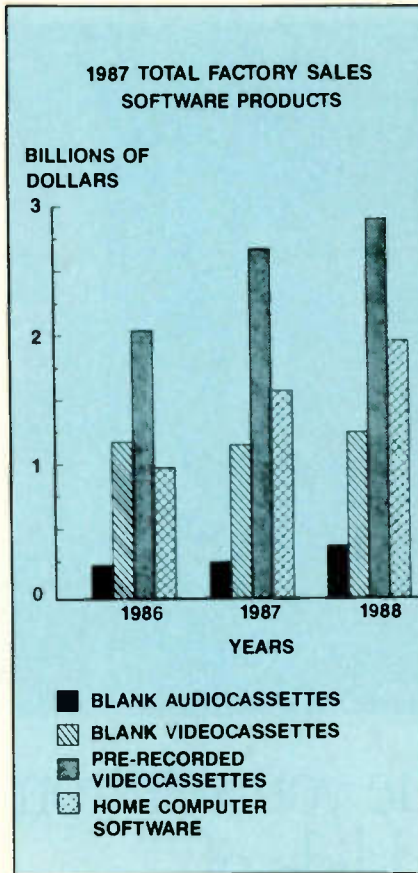
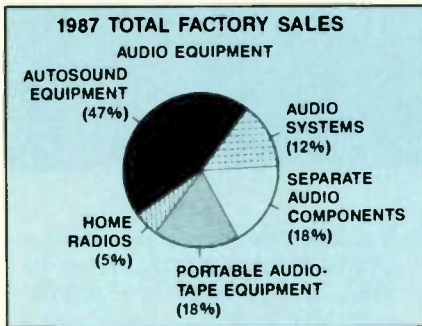

were camcorders, up 11% year-to-date, and stereo TV, up 20% in January 1988 compared to January 1987.

The how-to magazine of electronics

## ELECTRONIC

*Servicing & Technology*

**Electronic Servicing & Technology** is the "how-to" magazine for technicians who service consumer electronics equipment. This includes service technicians, field service personnel and avid servicing enthusiasts who repair and maintain audio, video, computer and other consumer electronics equipment.

### EDITORIAL

Nils Conrad Persson, *Editor*  
 Carl Babcoke, *Consumer Servicing Consultant*  
 Tom Cook, *Senior Managing Editor*  
 Alisa Carter, *Associate Editor*  
 Kathy Mickelson, *Editorial Assistant*

### CONSULTING EDITORS

Homer L. Davidson, *TV Servicing Consultant*  
 Christopher H. Fenton, *Circuit Fabrication Consultant*  
 Victor Meeldijk, *Components Consultant*  
 Kirk G. Vistain, *Audio Consultant*  
 Sam Wilson, *Electronics Theory Consultant*

### ART

Kevin Callahan, *Creative Director*  
 Barbara Miles, *Graphic Designer*

### BUSINESS

Cameron Bishop, *Group Vice President*  
 Eric Jacobson, *Publisher*  
 Greg Garrison, *Sales Manager*  
 Stephanie Hanaway, *Promotions Manager*  
 Kelly Hawthorne, *Promotions Coordinator*  
 Dee Unger, *Advertising Business Manager*  
 Catherine Grawe, *Advertising Coordinator*

### ADVERTISING

Regional advertising sales offices are listed in classified pages.

### ADMINISTRATION

R.J. Hancock, *President*  
 Doug Riemer, *Circulation Vice President*  
 Jane J. Powell, *Circulation Director*  
 Jo Ann DeSmet, *Fulfillment Manager*  
 Barbara Clare, *Reader Correspondent*



Member, Audit Bureau of Circulation



Member, American Business Press



Member, Electronic Servicing Dealers Association

### CORRESPONDENCE

Editorial, advertising and circulation correspondence should be addressed to: P.O. Box 12901, Overland Park, KS 66212-9981 (a suburb of Kansas City, MO); 913-888-4664.  
 Home office fax: 913-888-7243.  
 Home office telex: 42-4156 INTERTEC OLPK

**SUBSCRIPTION PRICES:** one year, \$19.49; two years, \$32.98 in the USA and its possessions. Foreign countries: one year, \$23.49; two years, \$36.98. Single copy price: \$2.50; back copies, \$3.00. Adjustment necessitated by subscription termination to single copy rate. Allow 6 to 8 weeks for new subscriptions.

**PHOTOCOPY RIGHTS:** Permission to photocopy for internal or personal use is granted by Intertec Publishing Corp. for libraries and others registered with Copyright Clearance Center (CCC), provided the base fee of \$2 per copy of article is paid directly to CCC, 21 Congress St., Salem, MA 01970. Special requests should be addressed to Eric Jacobson, publisher.  
 ISSN 0278-9922 \$2.00 + 0.00



© 1988 All rights reserved.



**IDS offers data-comm seminar**  
International Data Sciences is presenting a series of seminars titled, "Techniques and Trends in Data Communications Testing." The seminars will reinforce the basics and will teach skills required to maintain both today's networks and those of the future. For more information on seminar schedules, contact Jack Simpson, International Data Sciences, 7 Wellington Road, Lincoln, Rhode Island 02865; 800-IDS-DATA or 401-333-6200.

**ISCET offers video exam**  
Technicians can now be certified as video specialists with a new exam developed by the International Society of Certified Electronics Technicians (ISCET). Video is now the ninth professional option technicians may select for their journeyman specialty of the CET test. For more information, contact ISCET at 2708 West Berry St., Fort

Worth, TX 76109; 817-921-9101.

**UL proposes standard**  
Underwriters Laboratories (UL) is proposing two updated standards for recognition as American National Standards: the Standard for Safety for Wire Connectors and Soldering Lugs for Use With Copper Conductors, UL 486A; and the Standard for Safety for Wire Connectors for Use With Aluminum conductors, UL 486B.

Both standards cover terminal-type wire connectors. UL 486A covers connectors intended for use with number 22 AWG (0.32mm<sup>2</sup>) or larger copper conductors. UL 486B covers connectors intended for use with number 12 AWG (3.3mm<sup>2</sup>) or larger aluminum or copper-clad aluminum wire, including those designated for number 18 AWG (0.82mm<sup>2</sup>) or larger copper wire. Both standards cover connectors for use at 600V or less, for use with conductors

in accordance with the National Electrical Code, ANSI/NFPA 70. Splicing-type wire connectors intended for use with number 4 AWG (21.2mm<sup>2</sup>) or larger copper conductors are also covered. For a free copy of the revised standards, contact Bill Bird at UL, 333 Pfingsten Road, Northbrook IL 60062; 312-272-8800, ext. 2501.

**NESDA/ISCET set convention date**  
The National Professional Electronics Convention of sales/service dealers and technicians will be held Aug. 1-6 at the Pheasant Run Resort, St. Charles, IL.

The convention, which is sponsored by the National Electronics Sales and Service Dealers Association (NESDA) and the International Society of Certified Electronics Technicians (ISCET), will feature management and technical seminars, in-depth sessions with manufacturers, annual meetings of NESDA

*Continued on page 17.*

# GUARANTEED PERFORMANCE!!



## METERS



- 73 3 1/2" digit, DMM **\$67**
- 75 3 1/2" digit, DMM 99.
- 77 3 1/2" digit, DMM 119.
- 8060A 4 1/2" digit-true RMA 323.
- 8062A 4 1/2" digit-true RMA 260.
- 37 Bench portable DMM 217.
- 8010A Bench/portable true RMS 255.
- 8012A Bench/portable true RMS 318.
- 8050A Bench/portable true RMS 349.

## BECKMAN

*Beckman Industrial*

- DM15B 3 1/2" digit, 26 ranges, beeper **\$51.98**
- DM25L 3 1/2" digit, 29 ranges, logic probe, cap measure 94.50
- DM850 4 1/2" digit, frequency counter, data hold 207.83
- Tech300 Diode Test 113.00
- Tech330 True RMS, Diode Test 206.00
- DM73 Probe-Auto-ranging, beeper, data hold 55.00
- CC6 Clamp-on meters (measure up to 600 amps) 68.18

## SCOPES



3 Years Manufacturers Warranty parts & labor

## HITACHI Special

- V-212 20 MHz dual trace scope **\$365.**
- V-222 20 MHz dual trace scope 550.
- V-423 40 MHz dual trace, delayed sweep scope 795.
- V-660 60 MHz dual trace scope 999.
- V-665 60 MHz dual trace cursor readout scope 1245.
- V-1060 100 MHz dual trace scope 1294.
- V-1065 100 MHz/ cursor readout scope 1544.
- V-6020 20 MHz digital storage scope 1745.

- 9020 20 MHz dual trace scope, component tester, delay sweep **468.**

- B&K**
- 2120 20 MHz dual trace scope **385.**

## IWATSU

- DS-6411 40 MHz digital storage scope **Call For Prices**
- DS-6612 60 MHz digital storage scope **Call For Prices**
- SS-5706 30 MHz 3 channel scope

- SS-5705 40 MHz 3 channel scope
- SS-5710 60 MHz 4 channel scope
- SS-5712 200 MHz 4 channel scope
- SS-6122 100 MHz 4 channel scope/ CRT readout & cursor

Iwatsu  
Call For Prices

## POWER SUPPLIES

### Viz

- WP-702A Dual 0-20VDC (r 0-200MA, dual meter) **\$190.**
- WP-703A Single 0-20VDC (r 0-500MA, single meter) 146.
- WP-704A Single 0-40VDC (r 0-250MA, single meter) 146.
- WP-705A Single 0-50VDC (r 0-2A, digital meter) 349.
- WP-706A Single 0-25VDC (r 0-4A, digital meter) 370.
- WP-707A Dual 0-25VDC (r 0-2A, digital meter) 465.
- WP-31A Isolation transformer 1.5KVA, 3 fixed 350VA outputs 223.78

- B&K**
- 1610 Power supply 0-30VDC, 0-1A **\$ 147.**
- 1630 Power supply 0-30VDC, 0-3A 220.
- 3011 Function generator 0.2 HZ - 2MHZ 205.

## IC TESTER

- B&K**
- 560 Programmable IC tester **\$2970.**
- 541 Component tester 364.
- 550 T.T.L. IC comparator 364.
- 552 CMOS I.C. comparator 364.

## SOLDERING SUPPLIES

### Ungar

- UTC 100 Temperature controlled soldering system **\$67**

- 4024 De-soldering service station 414.
- 9000 Temperature controlled soldering station 208.
- 6970 HD Heat gun (gives 1000 watts) 72.
- 1095 Heat gun (gives 1000 watts) 35.
- 1100 Soldering gun 100/140 watts 20.

## WELLER

- WTCPR Control output soldering station **\$119.**
  - 8200 All purpose soldering gun 21.
  - D550 28.58
- Kester solder and multicore solder available CALL!*



**"I GUARANTEE YOUR SATISFACTION!"**  
For 43 years professionals have counted on KELVIN, for the lowest prices and immediate delivery, from our huge inventory. Count on KELVIN!"

Lisa S. Hadar  
Executive V.P., C.P.A.

**WE CARRY**  
Panavise, Xcelite Tools, Vaco Tools, X-Acto, Kester Solder, Sellstrom Safety Equipment

- Electronic Parts
  - Electrical Parts
  - Large Selection of State of the Art Educational Kits.
- Not Responsible For Typographical Errors.

# KELVIN

**FREE CATALOG**

# 1-800-645-9212

ELECTRONICS 7 FAIRCHILD AVE., PLAINVIEW, N.Y. 11803 (516)349-7620 FAX:516-349-7830



# Sound and image-- from one flat screen

Matsushita Electric Industrial Company, Ltd., has developed the Audio Flat Panel Screen (AFP-S), a video projection TV screen with a built-in flat speaker.

Incorporating the company's audio flat-panel speaker, the 70-inch (142.2cm x 106.7cm) screen allows high-fidelity sound to be reproduced from the screen surface.

The completely flat screen allows wide-angle viewing without distortion when used with the recently introduced S-VHS-compatible projector.

The screen uses a large-area vibrating plate, which maintains a low vibration level even under high sound pressure, and a new twin-cabinet speaker system. This design allows the flat-panel

speakers to reproduce more powerful bass sound despite the screen's cabinet thickness of only 3 inches.

The wide viewing angle and lenticular reflection, which has high luminance,

creates a more vivid picture. The screen also uses large-area plates that function as woofers, which are placed in a coaxial arrangement with the midrange speakers and tweeters. **ES&T**

**Table 1  
Specifications**

Speaker system:	3-way speakers in a twin-cabinet system
Speakers used:	Woofers: 142.2cm x 106.7cm flat square unit Midrange: 13cm x 6cm cone unit by four Tweeters: 2.5cm dome unit by two
Maximum input:	100W
Output sound level:	90dB/Wm
Crossover frequency:	200Hz, 4kHz
Frequency range:	30Hz to 20,000Hz
Dimensions (WxHxD):	174cm x 168.1cm x 7.5cm
Screen size:	70 inches (142.2dm x 106.7cm)
Weight:	100kg

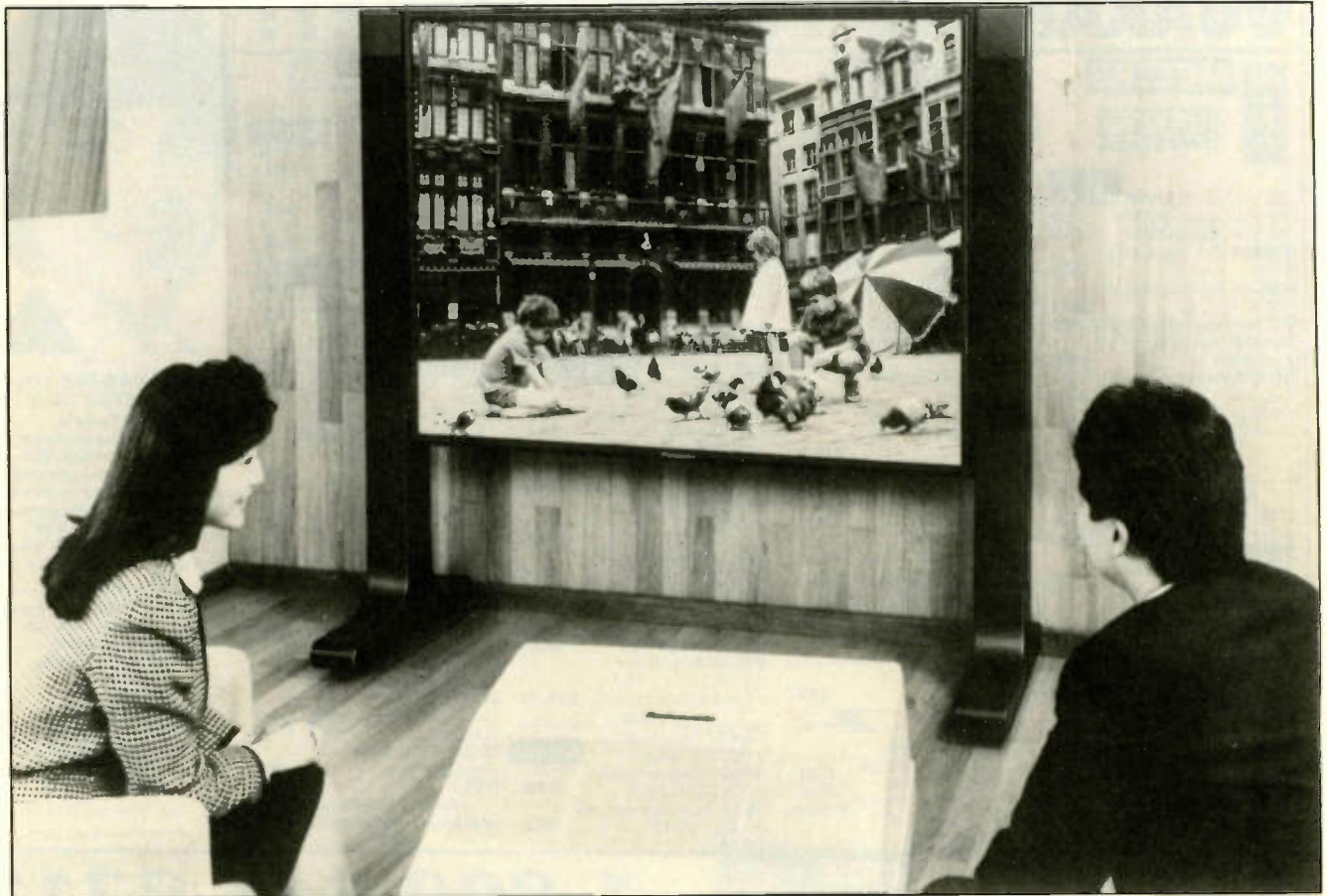

A flat screen allows wide-angle viewing without distortion.





PHILIPS

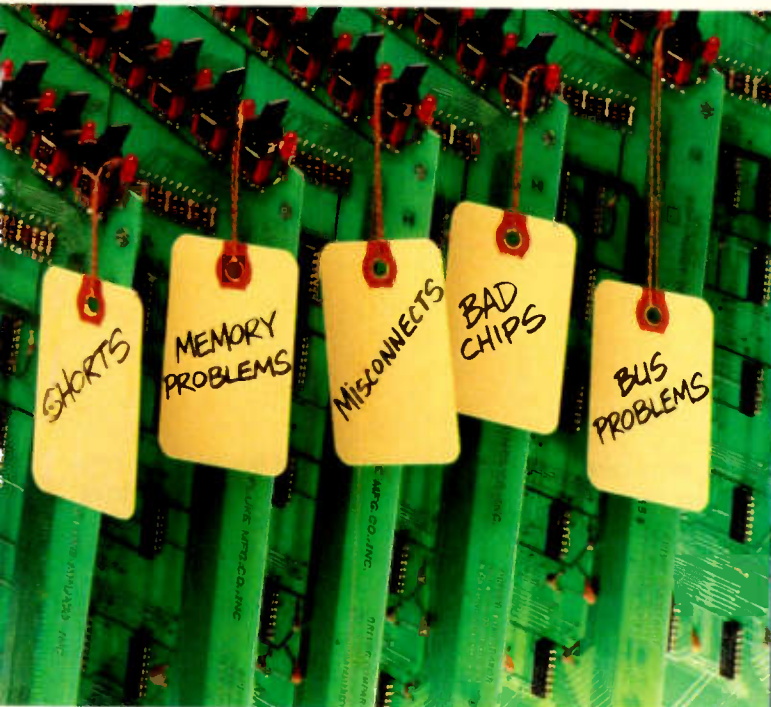

## Multiple Problems.

**For microprocessor board troubleshooting and service, nothing expands your diagnostic capabilities — and simplifies your operation — like the new Fluke 90 Series.**

This unique  $\mu$ P board tester gives you a complete range of test functions:

- Bus Tests
- Memory Tests
- I/O Tests
- QuickTrace™ Probe Test, to automatically identify and display unknown nodes.

QUICKTRACE  
A02

- In all, 16 different preprogrammed tests make the 90 Series a powerful stand-alone troubleshooting instrument.

### Add the power of a PC.

Connect the 90 Series' RS-232 port to a PC or terminal and access advanced troubleshooting functions, such as Break-Point and Frame-Point capabilities, memory upload and download, plus external trigger functions. You can save both test sequences and results, building documentation on different boards as you go.

### Designed for real-time testing.

The 90 Series consists of three units, each designed for one of the three most commonly used 8-bit processors (Z80, 6809 or 8085).

Each tester clips directly onto the microprocessor, including soldered-in processors. Power is supplied by the Unit Under Test. The UUT continues to operate while diagnostics are executed, so you can even locate intermittent problems.

### Easy on the technician, easy on the budget.

The 90 Series is small enough (11" x 6" x 3") to find a home on every service bench. Test results are fast and presented in English. Each diagnostic function is selected from a simple-to-follow menu, which greatly reduces training time.

The Fluke 90 Series is ideal for service and repair operations, as well as engineering prototype testing and technician training. And it's ideally priced at \$1395 (suggested U.S. list), available from leading electronic distributors.

To find out more about the Fluke 90 Series, or the products that made Fluke the leader in emulative board testing, the 9000

## One Solution.

Micro-System Troubleshooter or 9100 Digital Test System, call today at **1-800-44-FLUKE ext. 33.**

The Fluke 90 Series. A single instrument for a multitude of problems.



### The 90 Series $\mu$ P Board Tester

John Fluke Mfg. Co., Inc., P.O. Box C9090, M/S 250C, Everett, WA 98206.  
U.S.: 206-356-5400 CANADA: 416-890-7600.  
OTHER COUNTRIES: 206-356-5500.

© Copyright 1987 John Fluke Mfg. Co., Inc. All rights reserved. Ad No. 1173-F90.

See us at Electro, Booth 363-374





# Battery problems in electronic equipment

By Joseph J. Carr, CET

With the proliferation of new battery-operated equipment—televisions the size of radios, radios even smaller than that—a lot of the electronics servicer's time can be spent troubleshooting battery-related problems. However, entertainment electronics are not the only devices that are battery-operated. There are other applications in which battery failure is not just an inconvenience, and knowing how to get these devices up and running can help you fill a critical servicing niche.

One area that relies heavily on battery-operated equipment is biomedical electronics. I was once employed by a university medical center that relied on batteries for different reasons. Some equipment was battery-powered for portability. A defibrillator, for example, might be needed almost anywhere—heart attacks don't always occur near an electrical outlet. Although most of our defibrillators were ac-powered (or dual-powered), we also had a number of purely battery-powered models. Still other devices used batteries for reasons of patient safety. A cardiac output computer, for example, makes measurements based on a thermistor inserted into the heart. Small amounts of ac leakage current could be fatal, so batteries are used to completely isolate the instrument from the ac power line.

## Terminology

To be linguistically precise, a *cell* is the most basic element and has the minimum voltage for that sort of device. Additional voltage is gained when the cells

are connected in series; extra current is gained when the cells are connected in parallel. To be strict, we would refer to single entities as cells and multiple-cell entities as *batteries*. In common usage, it is usually acceptable to be less than precise, so all cells and batteries are called *batteries*.

## NiCd batteries

This article will focus mainly on the nickel-cadmium (NiCd) batteries used in portable electronics equipment. These batteries have a nominal 1.2V terminal voltage at full charge, except immediately before turn-on after a fresh charge, at which time the *open-terminal* voltage is 1.4V.

Shortly after turn-on, however, the open-terminal voltage drops to the nominal value of 1.2V for the duration of the operation. As the stored energy is used, the terminal voltage drops.

NiCd batteries are rechargeable and typically will sustain a charge-discharge cycle lifetime of 1,000 times before they become unusable. In most cases, manufacturers rate a battery as unusable when the capacity of the battery drops below 80% of its original specified value.

The capacity of a battery is measured in ampere-hours (Ah)—that is, the product of current load (in amperes) and time required to reach the officially designated discharge state. The NiCd battery is capable of delivering some tremendous currents. For example, the size-D (4Ah) and size-F (7Ah) can deliver short-duration current of 50A or more. That is why we used them in defibrillators and why certain medium-power radio transmitters can use them.

Because of their ability to deliver

huge currents, NiCd batteries are best fused in order to protect printed wiring tracks, wires and other conductors. I have seen copper-foil PC tracks and an on/off switch smoked by a shorted capacitor across the dc line.

The amount of time that a battery will last is a function of the discharge time, which, in turn, is determined by the amount of current drawn. Figure 1 shows two different discharge scenarios: one for a current of one-tenth the Ah rating and one for a current equal to the Ah rate. In Figure 1A, the battery will be fully discharged in 10 hours, while in Figure 1B discharge occurs in one hour. This particular chart is derived from the data published for a size-D cell rated at 4Ah.

## Rating games

The standard cell ratings for NiCd batteries are as follows:

Battery size	ampere-hour rating
AA	0.4/0.5/0.7
C	2
D	4
F	7

As you can see in the chart above, the AA cells are found in three ratings from 400mAh to 700mAh, depending upon the manufacturer and style. You will find a lot of variation from this chart, especially among consumer-product NiCd batteries. I have seen size-C rated at both 1Ah and 1.2Ah, and I have seen size-D rated at 2Ah. I suspect these are actually lesser cells dressed in size-C and size-D packages. One manufacturer's representative actually admitted to me that the consumer "D-cells" are ac-

Carr is an electronics engineer who has contributed frequently to *ES&T* and has published many books on electronics.



Figure 1. The amount of time that a battery will last is a function of the discharge time, which, in turn, is determined by the amount of current drawn. For a current of one-tenth the Ah rating (Figure 1A), the battery will be fully discharged in 10 hours. For a current equal to the Ah rate (Figure 1B), discharge occurs in one hour.

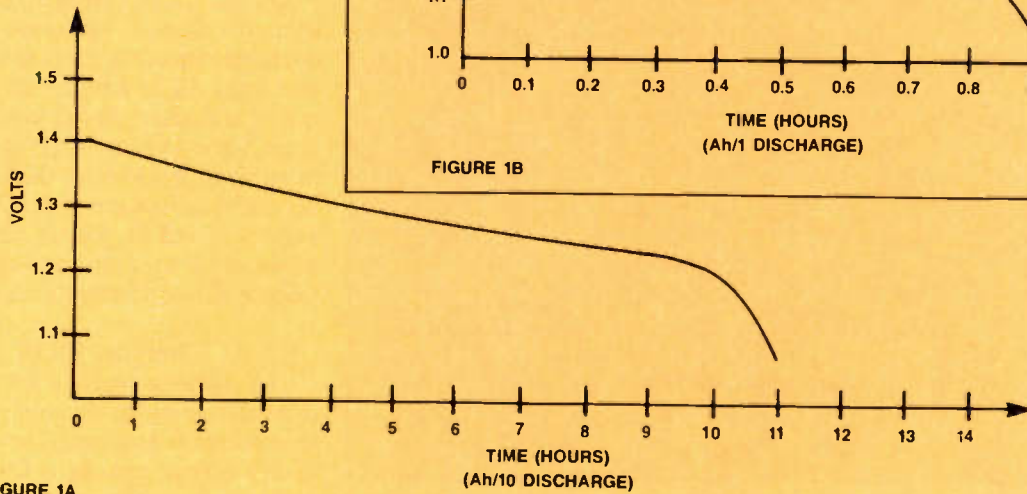
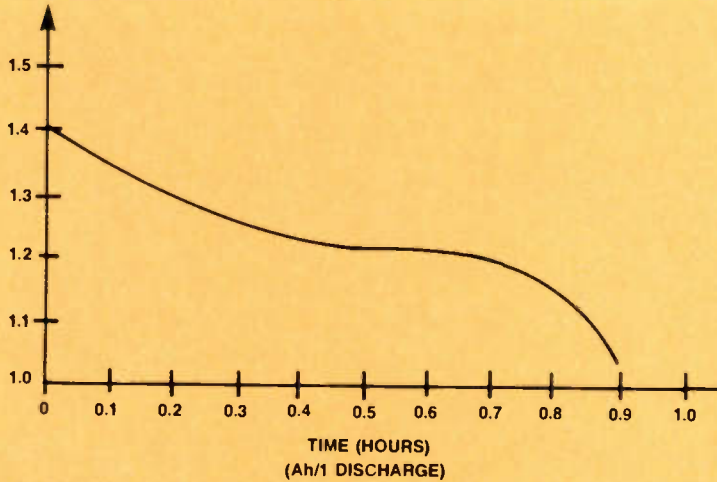
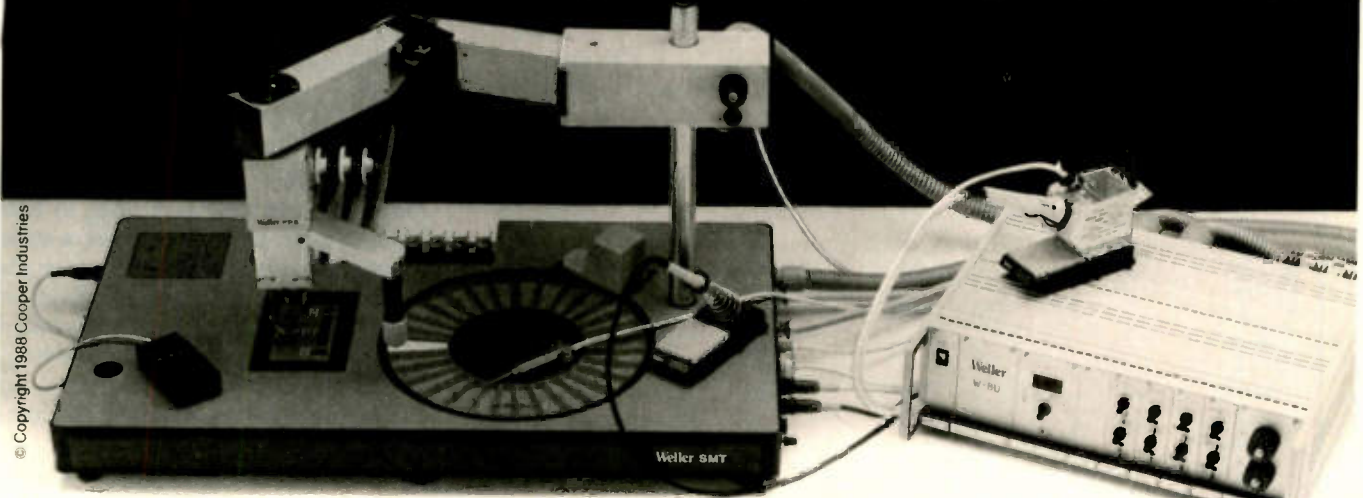

FIGURE 1B



# Weller® PPS. The unique answer to SMD re-work.



Weller, the undisputed leader in soldering technology, is proud to introduce a unique piece of equipment, specifically designed for the repair, re-work and prototyping of circuit boards with lead-less and hybrid components and also for small production runs.

The Weller Pick-Place-Solder system is a self contained manual work station for the application of glue or solder paste and for the removal, positioning, soldering and desoldering of SMD's by means of temperature controlled inert gas. Call today for the full, state-of-the-art details.



The difference between work and workmanship.

BREWER-TITCHENER™ CAMPBELL® COVERT® CRESCENT® LUFKIN® MERRILL NICHOLSON® PLUMB® H.K. PORTER™ TURNER® WELLER® WIRE-WRAP® WISS® XCELITE®  
 CooperTools PO Box 728 Apex NC, 27502 USA Tel (919) 362-7510 Telex 579497  
 A division of Cooper Industries

Circle (37) on Reply Card



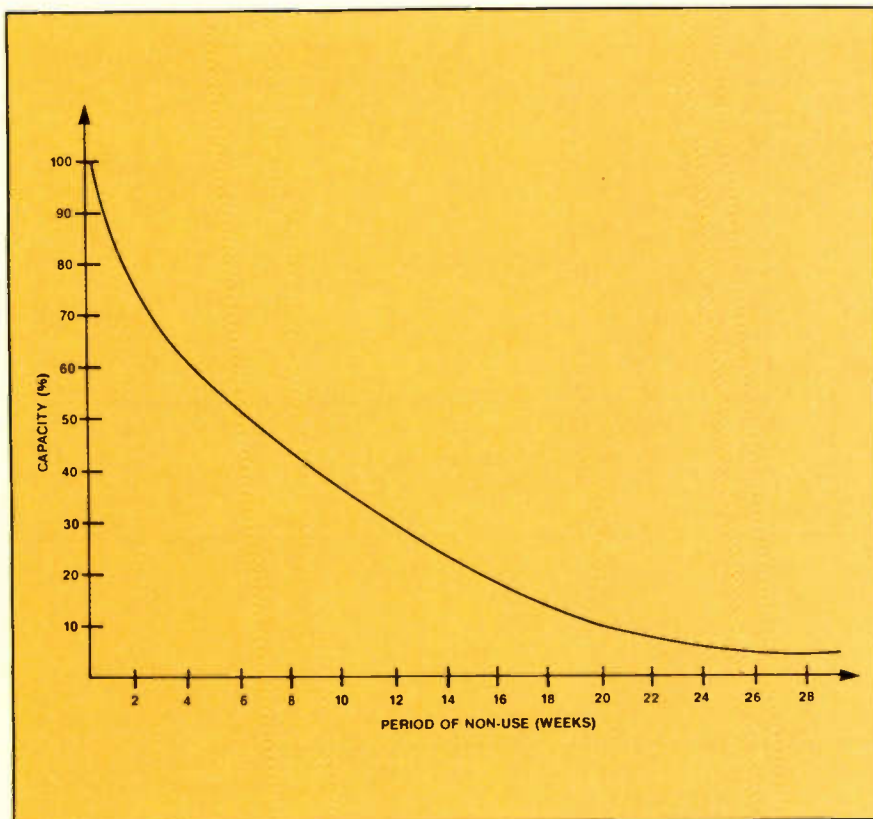

**Figure 2.** NiCd batteries also can lose energy from merely sitting. This storage discharge curve for a typical NiCd battery shows that a battery or cell will be of doubtful use after only a few weeks of storage.

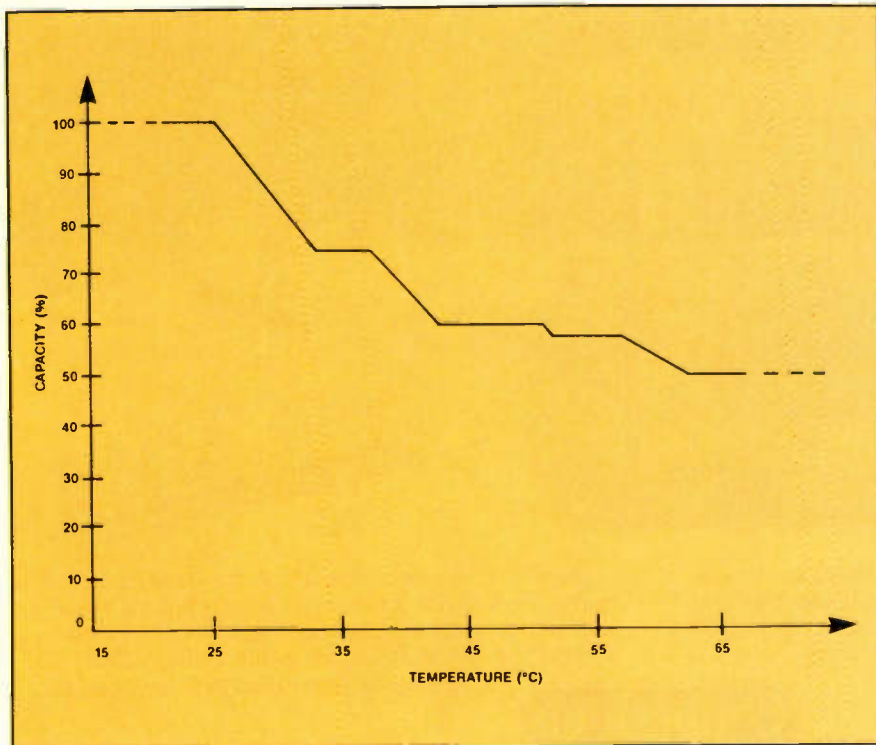

**Figure 3.** Because the available current capacity is a function of temperature, the operating temperature can diminish the battery's available capacity. As the temperature increases above room temperature (25°C), the available capacity diminishes.

tually size-C cells inside a D-package.

This chicanery is of little consequence to most consumer electronics users and actually results in a lower cost product. But make sure that you get the correct ampere-hour rating. I would not want to be the guy who reduces a heart patient's chance of survival by replacing 4Ah NiCd cells in the defibrillator with a collection of 2Ah consumer replacements.

Another rating game is played by some distributors who quote different discharge rates. One standard method of measuring Ah capacity is the current required to discharge a cell to 1.0V in one hour. Some makers, however, define it in terms of the 10-hour discharge rate normalized to ampere-hours. Analyzing Figures 1A and 1B, you can see how this might result in a false feeling of confidence in your battery's capacity.

### Charging NiCds

The charging protocol for the NiCd depends somewhat on application and manufacturer. In general, however, the charge current must be at least Ah/20, and in many commercial chargers it is Ah/15. For most applications where you can control the charge rate, it is safe to use a charge rate of Ah/10. That is, charge the battery at a current not greater than one-tenth the ampere-hour rating. The battery also must be charged to 140% of capacity, so a charge time of 14 hours is mandatory. The general rule is to charge at one-tenth ampere-hour rating for 14 hours.

Some chargers are designed to fast-charge the battery in as little as an hour, although most charge in three to four hours. Fast-charging should not be done unless the battery maker recommends it. Even then, I am a little cautious about fast-charging, having once seen a size-D cell explode from too-fast charging. NiCd batteries can be dangerous, so don't ad-lib: Follow the maker's recommendations religiously.

NiCd batteries also can lose energy from merely sitting. Some users find that if an instrument is charged up and then stored, it may be unusable at the time when it is eventually turned on. Figure 2 shows a storage discharge curve for a typical NiCd battery. As you can see, the battery or cell will be of doubtful use after only a few weeks of storage. I can recall many times when nurses in our neonatal intensive care unit complained bitterly about an instrument (and my ability to keep it fixed),



when the instrument actually was never plugged into the charger. The cure for this type of problem is a trickle charge at a rate between Ah/30 and Ah/50. Some commercial battery chargers have a switch that allows either an Ah/10 regular charge rate or an Ah/30 trickle charge.

Another problem with NiCds is the effect of the operating temperature on available capacity. As shown in Figure 3, the available current capacity is a function of temperature: As the temperature increases above room temperature (25°C), the available capacity diminishes.

#### NiCd "memory"

You will hear a running debate that NiCds do/do not have a memory problem. *Memory* means that a battery will not allow deep discharge after repeated shallow discharges. For example, if a battery routinely is discharged to only 80% of capacity, after a while it will "remember" the 80% level as the full-discharged point. The battery will then exhibit the fully discharged potential

when the charge level is only 80% of fully charged. That makes the battery look like a premature failure.

A NiCd battery suffering memory problems can sometimes be reformed by repeatedly fully charging it, then immediately deep discharging it. After a while, the memory phenomena would work itself out.

The best "cure" for the memory phenomena is to avoid it altogether. I have a friend who lives in constant pain and uses an electronic pulse generator called a Transcutaneous Electronic Nerve Stimulator (TENS) to keep the pain at a manageably low level. This physician-prescribed device runs on small NiCd batteries. My friend complained that the \$90 battery pack lasted only a few weeks. Questioning him, I found that he routinely placed the TENS unit in the charger every night, even though he didn't use it all the time. Hence, the TENS unit battery was routinely shallow-cycled and developed memory.

I instructed him to keep two battery packs available. One was kept in an in-

sulated bag in his brief case and was used when the other one went dead; the other was installed in the unit. When the TENS unit battery was low, it didn't work as well, so my friend would swap battery packs. He used one battery pack for two years, and has found the average battery life to be at least a year—compare that to the six-week use he used to get.

#### Maintaining NiCds

When equipment is subject to routine maintenance, it is possible to keep the batteries healthy by following a certain routine. In most of the equipment I have serviced, the manufacturer recommended that the batteries be periodically discharged and then re-charged. The protocol for most is as follows:

- Fully charge the battery or cell.
- Discharge it fully with a resistor that draws a current of Ah/10 for about eight to nine hours for multicell batteries and 10 hours for single cells.
- Recharge the battery at the Ah/10 rate for 14 to 16 hours.

# PACESETTER PRODUCTIVITY

100 MHz TEK 2246A/2245A

Smart scopes, perfect setup! Tek sets the new, fast pace for frequent measurements with automatic front panel setup. Nonvolatile memory for up to 20 front-panel setups (2246A). Time and voltage cursors. Exclusive SmartCursors™ track waveform changes for voltage measurements. All backed by Tek's 3-year warranty.

\$1795/\$2395

NEW

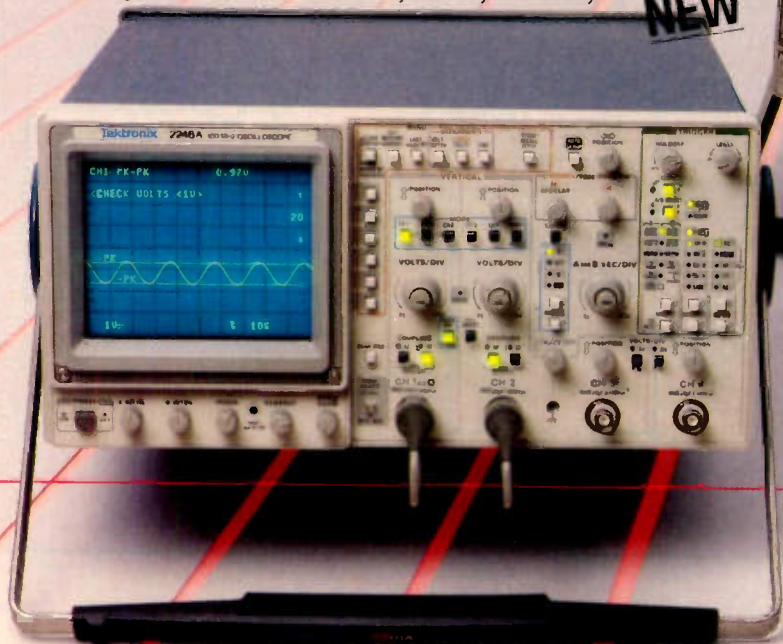

Call Tek direct  
for PaceSetter specs!  
**1-800-426-2200**

Prices subject to change without notice.

Copyright ©1988, Tektronix, Inc. All rights reserved. TTA 906-A

**Tektronix**  
COMMITTED TO EXCELLENCE

Circle (38) on Reply Card



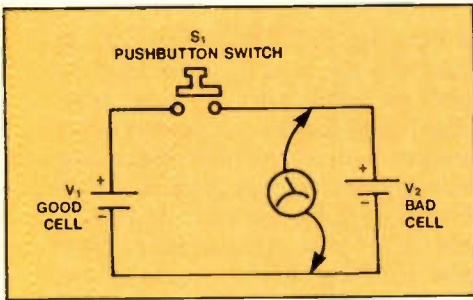

Figure 4. A revitalization circuit for shorted NiCd cells uses a known-good cell of the same type to vaporize the internal dendrites that short the plates together.

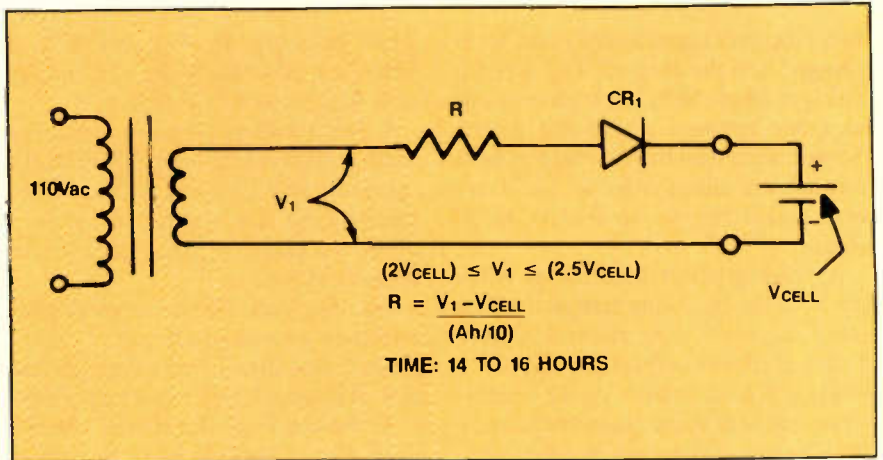

Figure 5. In this basic circuit for a constant-current charger, a resistor in series with the rectifier has a value that limits the output current under short-circuit conditions to the official Ah/10 charging rate. The transformer secondary voltage should be 2.5 times the cell or battery voltage.

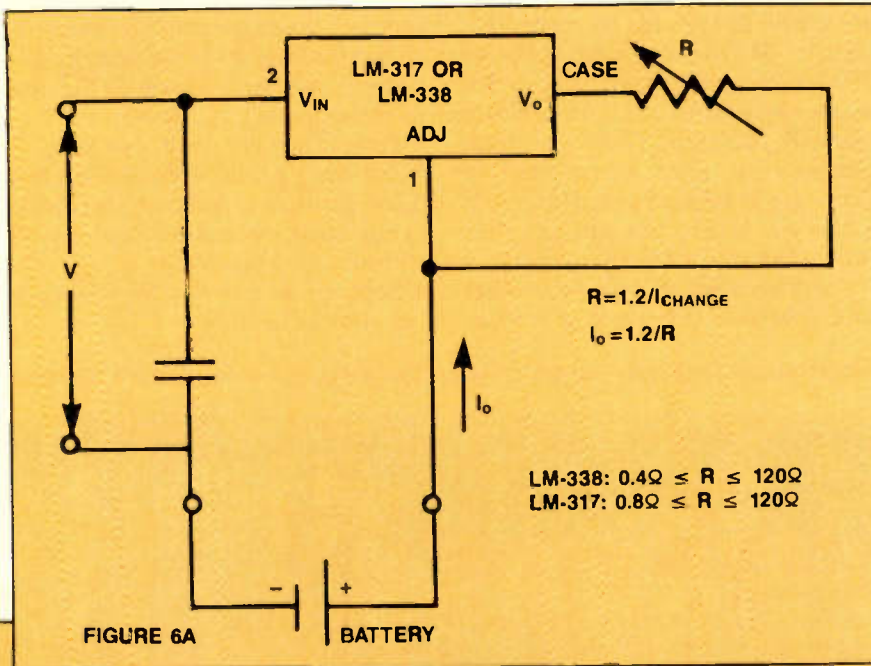
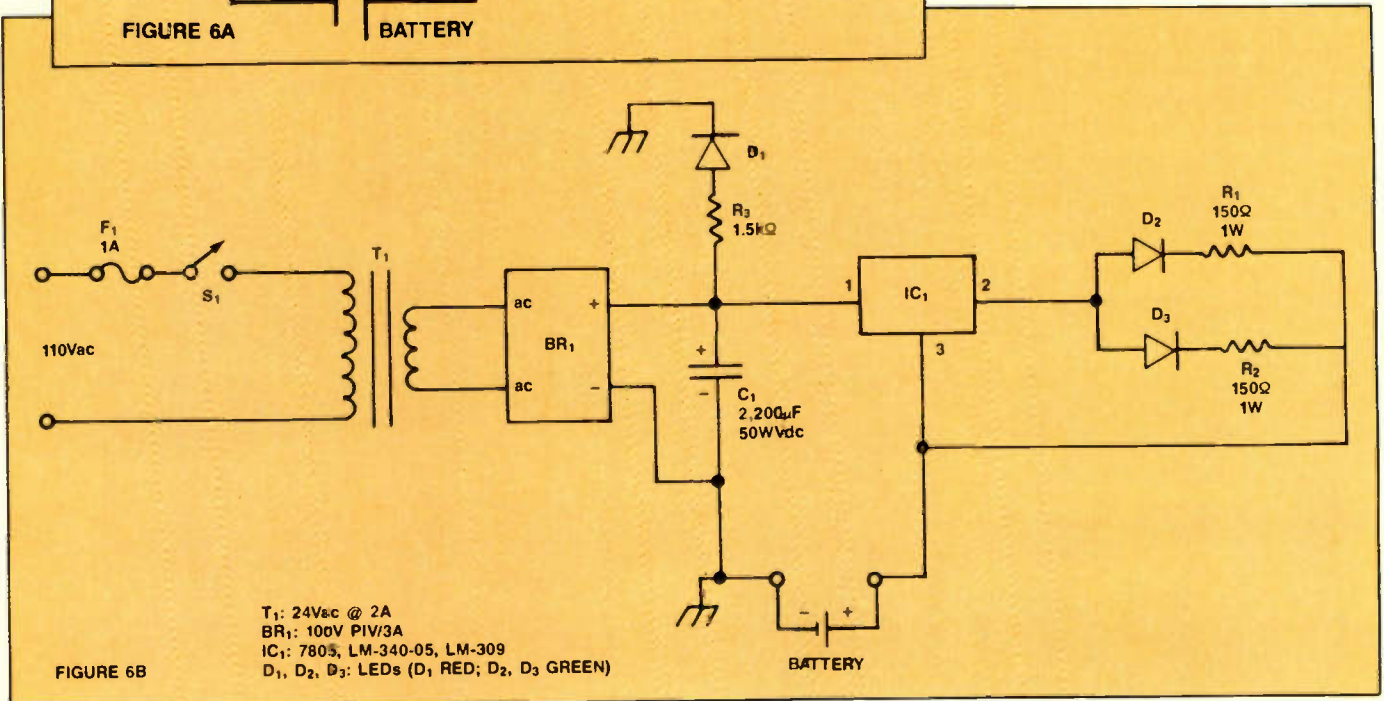

Figure 6. These electronic CI chargers are based on 3-terminal IC voltage regulators. The variable circuit (Figure 6A) is based on the LM-317 (up to 1A) and the LM-338 (up to 5A). The charge current can be set down to 10mA by the value of resistor R. The circuit in Figure 6B will charge batteries up to 4Ah with terminal voltages up to 12Vdc. It is based on the 5V fixed regulator such as the LM-309, LM-340-05 or 7805 devices.





A phenomena called *polarity reversal* might result if the battery is fully discharged. The cause of this problem is that not all cells have the same terminal voltage at any given time. One cell may be charged backward by the others in the series chain. For this reason, multicell batteries are only discharged to between 10% and 20% of capacity.

Do not leave the battery in a discharged condition for a lengthy period of time. The battery may then develop interelement shorts. Little whiskers called *dendrites* grow from plate to plate and cause a short circuit. The cell potential drops to zero or near-zero, and the cell will refuse to accept a charge. In some cases, you would have to regard the cell as lost and replace it. There are, however, some cells that can be salvaged from short circuits.

Figure 4 shows a revitalization circuit for shorted NiCd cells. It works by vaporizing the internal dendrites that short the plates together. A known-good cell of the same type is placed across the shorted cell through a push-button

or spring-loaded toggle switch. It is important to use this type of switch instead of a regular switch—you don't want to keep the circuit closed for too long (battery explosion could result). Press the switch several times in succession, then measure the terminal voltage. If the current from  $V_1$  successfully vaporizes the dendrites inside of  $V_2$ , then the terminal voltage will rise.

**CAUTION:** *If you use this method, be sure to wear safety goggles or glasses.* NiCd batteries have been known to explode under high current, and it could conceivably happen when de-shortening a cell. I have never seen it happen under this circumstance, but I wouldn't bet my eyesight on it never happening.

#### Charging NiCd batteries

There are two basic forms of chargers for NiCd batteries: constant-current (CI) and constant-voltage (CV). Regardless of the type, it is important that you don't use a charging current greater than Ah/10 unless you are specifically instructed to do so by the battery manufac-

turer (not the equipment maker, by the way). The Ah/10 rate is one-tenth of the ampere-hour rating. For a 500mAh AA cell, for example, a charging current of 50mA is used. Use 200mA for a 2Ah size-C cell and 400mA for the 4Ah size-D cell. Incidentally, don't overcharge batteries using other Ah ratings.

Figure 5 shows the basic circuit for a constant-current charger of simple design. The transformer secondary voltage should be 2.5 times the cell or battery voltage. A resistor in series with the rectifier has a value that limits the output current under short-circuit conditions to the official Ah/10 charging rate. This circuit is the basic circuit for most low-cost chargers.

Figure 6 shows two electronic CI chargers based on 3-terminal, IC voltage regulators. A variable circuit, shown in Figure 6A, is based on the LM-317 (up to 1A) and LM-338 (up to 5A).

Both circuits require a filtered dc input voltage several volts higher than that battery or cell potential. The actual value is not critical as long as it is high

# PACESETTER PERFORMANCE

100 MHz TEK 2236/2235

100 MHz scope, counter, timer, DMM—just \$2795

The ultra-versatile Tek 2236 makes measuring everything from frequency, period and width to delay time and  $\Delta$  time push-button easy—in addition to CRT display, you get digital readout display accurate to 0.001% and beyond. PaceSetter performance on a modest budget? Look at the 100 MHz, dual-trace Tek 2235 with the best of the basics—just \$1575!

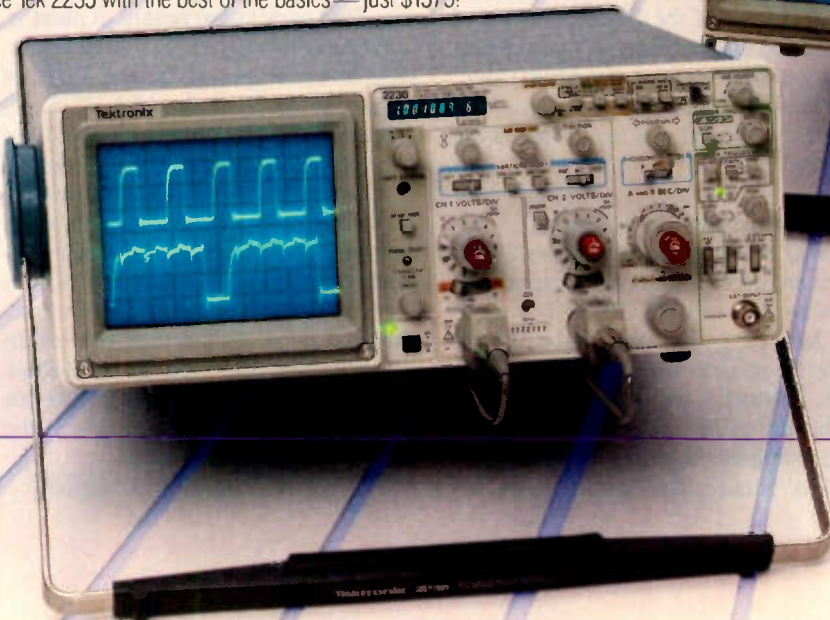
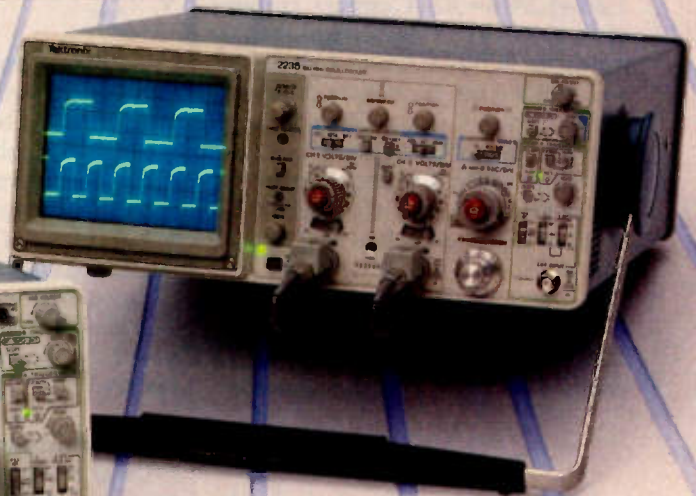

Call Tek direct  
for PaceSetter specs!

**1-800-426-2200**

Prices subject to change without notice.

Copyright ©1988, Tektronix, Inc. All rights reserved. TTA 906-B

**Tektronix**  
COMMITTED TO EXCELLENCE

Circle (9) on Reply Card



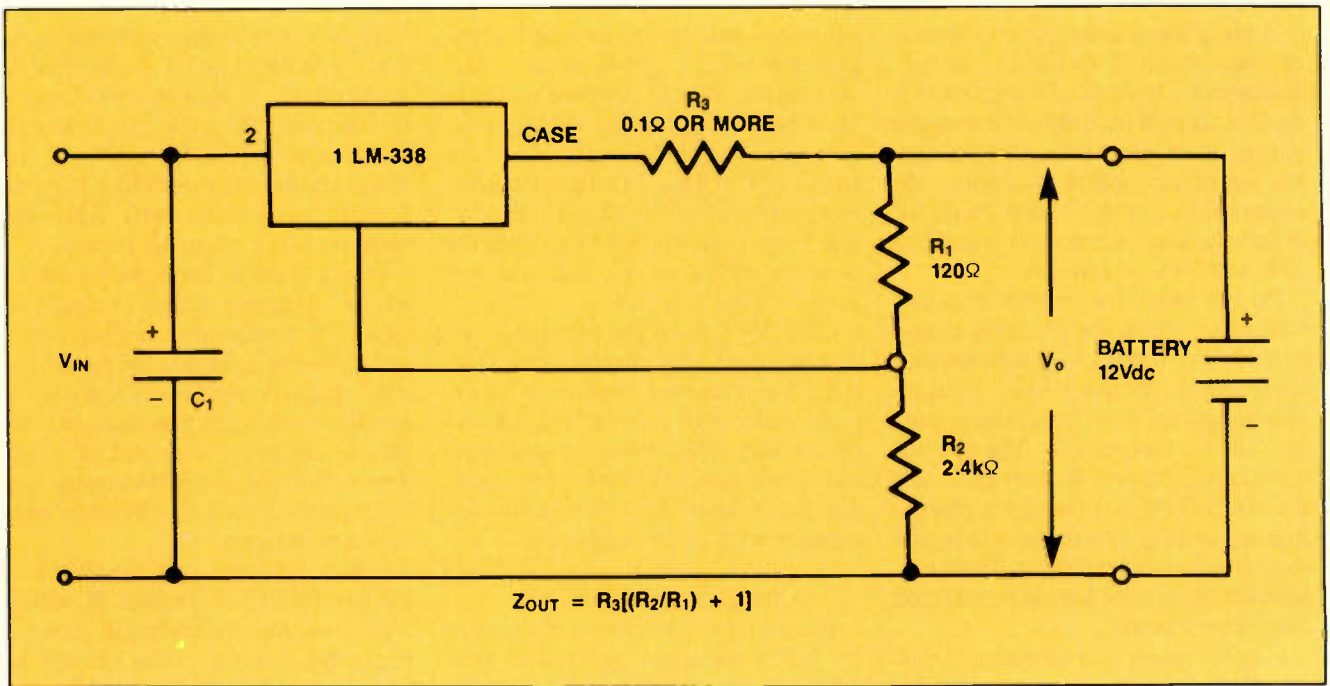

Figure 7. In this constant-voltage charger, the output voltage is set by the ratio of  $R_1$  and  $R_2$ .

enough to turn on the circuit. (In general,  $V_{in}$  is greater than  $V_{batt} + 3V$ .) You can set the charge current by setting the value of resistor  $R$ . For example, for a 400mA charger for a 4Ah size-D cells, use a resistor value of  $1.2/I = 1.2/0.4 = 3\Omega$ . Charging currents down to 10mA can be accommodated by the circuit of Figure 6A, so both regular and trickle chargers can be designed.

The circuit in Figure 6B will charge batteries up to 4Ah with terminal voltages up to 12Vdc. It is similar to the circuit in Figure 6A, but it is based on the 5V fixed regulator such as the LM-309, LM-340-05 or 7805 devices.

A constant-voltage charger is shown in Figure 7. The output voltage of the charger is set by the ratio of  $R_1$  and  $R_2$ , and is determined by the equation:

$$V_o = 1.25(R_2/R_1) + 1$$

A series resistor,  $R_3$ , prevents the current from exceeding the Ah/10 value and is set to allow the short-circuit current to that value. The required charger output impedance must be the resistance  $V_o/I_{max}$ , where  $V_o$  is the open-terminal battery voltage and  $I_{max}$  is the maximum permissible charging current. For

a 12V, 4Ah battery, for example, the required impedance is  $12/(4/10) = 12/0.4 = 30\Omega$ . Solve the equation in the figure for  $R_3$  and place that resistor value in series with the output of the regulator. The power rating of the resistor must be  $V_o \times I_{max}$ .

#### Using bench power supplies

A bench power supply should not be used to charge NiCd batteries unless it has both a variable output-voltage control and a current-limiting control. Set the output voltage to exactly the full terminal voltage of the NiCd battery and adjust the current-limiter for a short-circuit current equal to the Ah/10 value. Disconnect the output short from the power supply and connect it across the battery.

#### Multiple-cell batteries

Large numbers of multiple-cell batteries are used in electronic equipment. Most are typically 6V, 12V or 24V models. In most cases, these batteries are made up of individual AA, C, D or F cells. I found it possible to take apart the battery packs and replace individual cells to restore the battery to normal operation. Some battery packs are put to-

gether with screws or snaps; others are glued together.

My friend (mentioned earlier) who uses a TENS unit paid \$90 each for the battery packs. One afternoon we took apart one of the "bad" packs using an X-acto knife and a lot of care. We found that the pack consisted of three AA cells connected in series. We went to a store that sold commercial solder-tab AA cells and returned with \$18 worth of cells to make a "new" battery. I showed him how to solder them in and then used super-glue to re-close the plastic package. That pack lasted nearly 18 months.

When selecting cells for replacement, keep in mind several factors. First, of course, is the right size (AA, C, D, F) and the right Ah rating (not all C and D cells are created equal). Also keep in mind whether regular cells or solder-tab cells are needed. I have found that some consumer NiCd cells are in non-standard packages. One brand of AA cells is a millimeter or so shorter than standard AA cells. This sometimes results in intermittent operation. To avoid shimming these cells or re-tensioning the contact spring, I avoid buying them and use the standards instead.

**ES&T**



Continued from page 7.

and IS CET, golf and tennis tournaments, and the Professional Electronics Trade Show featuring consumer products, test equipment, service aids and accessories. For more information, contact NPEC, 2708 West Berry, Fort Worth, TX 76109; 817-921-9061.

**SBCA establishes telephone hotlines**

In an effort to promote home satellite-TV ownership and to educate and assist dealers and consumers, the Satellite Broadcasting and Communications Association (SBCA), assisted by General Instrument, has established two national, toll-free hotlines.

Two hotlines are available: a dealer hotline (800-356-3160) and a consumer hotline (800-533-4584). The hotlines may also be used to report (anonymously, if desired) individuals or companies involved in the manufacture, modification and sale of illegal descramblers.



## SYMCURE/Troubleshooting Tips guidelines

ES&T is now paying \$60 per page (six different cases of symptoms and their solutions) for accepted S ymcure submissions.

The term *S ymcure* is a contraction of two words: symptom/cure. Problems that are published in the S ymcure department are those that have occurred more than once.

This is the kind of problem you can solve without even a second thought because you've already seen so many of that particular brand and model of set with those symptoms; in almost every case, it will be the same component that fails or the same solder joint that opens.

ES&T is also paying \$25 per item for accepted Troubleshooting Tips.

A Troubleshooting Tip describes a procedure used to diagnose, isolate and correct an actual instance of a specific problem in a specific piece of equipment. Its value, however, lies in the general methods described.

A good Troubleshooting Tip has the following elements:

- It should be a relatively uncommon problem.
- The diagnosis and repair should present something of a challenge to a competent technician.
- It should include a detailed, step-by-step description of why you suspected the cause of the problem and how you confirmed your suspicions—anything that caused you to follow a false trail also should be included.
- It should describe how the repair was performed and any precautions about the possibility of damage to the set or injury to the servicer.

For S ymcures and Troubleshooting Tips, please also include:

- the manufacturer's name;
- the model and chassis number;
- the Sams Photofact number;
- a sketch of the schematic area where the fault was found.

(Include a major component such as a transformer or transistor to provide a landmark.)

# PACESETTER PRICE

50 MHz TEK 2210/2225

Best-of-class performance at

**\$995/\$2195**

Get the PaceSetter start in digital storage with Tek's NEW 50 MHz 2210. Featuring 20 MS/s per channel digitizing, 4K record length per channel plus familiar, full-bandwidth analog operation for just \$2<sup>95</sup>. And for pure and simple analog performance with unmatched economy, look at the popular, 2-channel Tek 2225—just \$995!

**NEW 2210**  
20 MS/s per channel

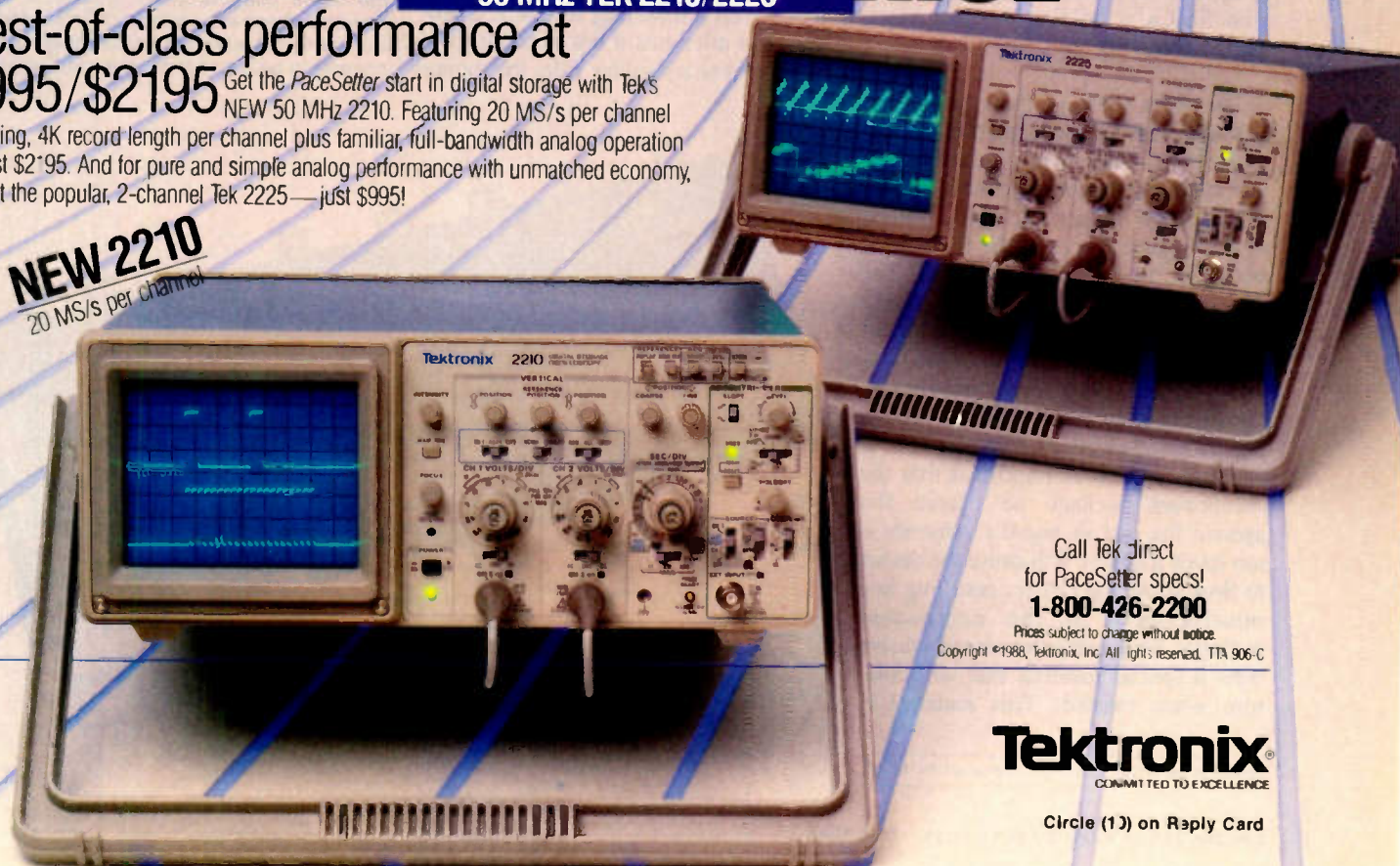

Call Tek direct  
for PaceSetter specs!  
**1-800-426-2200**

Prices subject to change without notice.

Copyright ©1988, Tektronix, Inc. All rights reserved. TTA 906-C

**Tektronix**  
COMMITTED TO EXCELLENCE

Circle (13) on Reply Card



# Hand-soldering surface-mount components

By Christopher H. Fenton

Replacing surface-mount components (SMCs) can be a real problem if you don't have all the right tools. With just the everyday tools of the trade, a technician who occasionally comes across the odd SMC can do the job effectively without investing in expensive, specialized tools or sacrificing the quality of the repair.

The major difference between soldering an SMC and a standard DIP package is the leads. Instead of through-hole wire leads, which form the electrical and mechanical connections to a circuit board, SMCs have small lead tabs that are soldered to the same side of a circuit board as the circuit pattern. Without the through-hole wire leads to hold the component in place, the major problem with SMCs is holding them in place during soldering.

## Keeping them in their places

You can use a wide range of adhesives to secure a component in place before you solder it. A non-corrosive, quick-setting glue should be used, and it should be placed only on the component package, not on the lead tabs. The adhesive should be applied sparingly (with a toothpick or something similar) after the component's leads and the footprint pattern have been pre-tinned. Grasp the component with a pair of tweezers and place it square against the footprint tabs. It is important that the component package be placed flat against the circuit board's substrate—too much adhesive will cause the device to float above the circuit, resulting in a misalignment of the component package. Some adhesive manufacturers offer a special material that will fracture when twisted. This material is

preferred to make subsequent removal easier.

Masking tape also can be used to secure SMCs to a circuit board. You can tack a component to a circuit board by taping one side of it to the circuit board and then soldering the opposite side. Then remove the tape and solder the other side.

The best way to attach an SMC is with *reflow soldering*. Before the adhesive is applied, the lead tabs of the SMC and the board footprint should be pretinned. When heat is applied, the solder will reflow around the lead tab and form a solder fillet. Because no additional solder is used, it is important that the tinned surfaces have enough solder on them to form a good solder fillet. A light touch with a soldering iron will reflow the joint after just a few seconds. The result is a shiny solder fillet that bonds

the component to the surface of the circuit board and minimizes the risk of damaging a component by over-exposing it to heat.

As with any new skill, it takes a little practice to master all the nuances. Always inspect a completed solder fillet with a magnifying glass to check its integrity. Flux should be cleaned off with a solvent, and excess solder and solder bridges should be removed with a soldering braid or other desoldering method. Solder fillets with too little solder also should be repaired by adding more solder to the fillet.

*Continued on page 20.*

Surface-mount components have small lead tabs that are soldered onto the same side of the board that the circuit pattern is on. Because there are no through-hole leads, surface-mount technology allows more components to be packed into the same space.

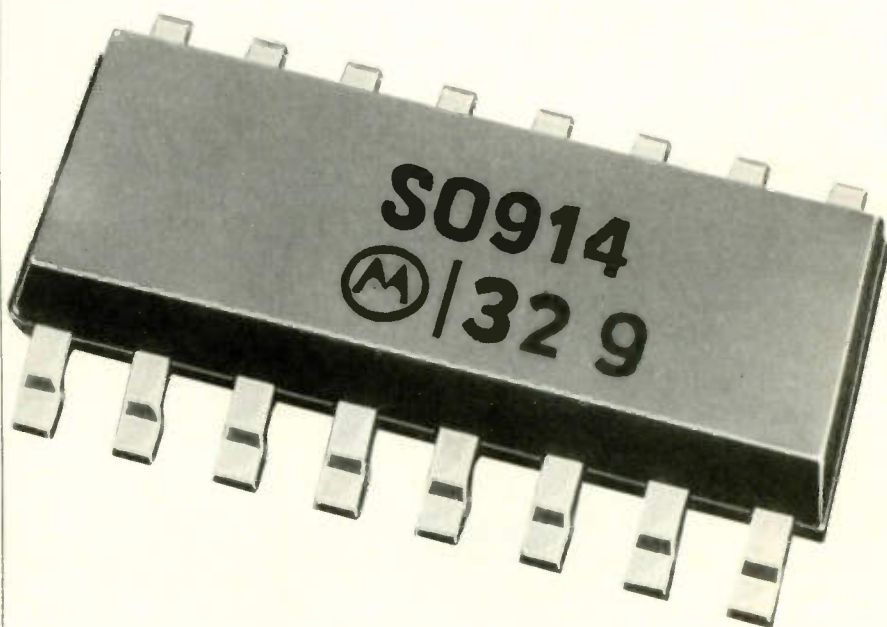

Fenton is the circuit fabrication consultant for ES&T.



## Choosing a soldering iron

Maybe its the one the Mrs. gave you for Christmas last year. But is the soldering iron you are currently using the right one for the job? Using the wrong iron can wreak havoc on a printed circuit and severely compromise the reliability of the repair. How do you evaluate what kind of iron is best-suited for your workbench? By keeping a few basic facts in mind, you can effectively choose the right soldering iron for the job.

The majority of soldering irons are sold on the basis of heating-element wattage. This is, unfortunately, a major misconception. The wattage only indicates the potential heat an iron can produce. The amount of heat that actually reaches the tip of the soldering iron will be considerably less than the iron's rated heat. The amount of heat produced directly corresponds to the heat transfer efficiency of the iron, the shape of the soldering tip, the distance between the heating element and the work and the type of work being done. (The type of work being done affects the rate at which heat is being lost from the iron during soldering—the larger the solder joint, the greater the heat needed for reflow.)

In most electronics applications, 650°F is the minimum of heat required to reflow a solder joint. However, this doesn't take into account the heat lost from the tip. A heat reserve also must be figured into the choice of an iron. But be careful: Too much heat can ruin components and carbonize the flux before it has a chance to do its job. In general, most connections require about 800°F. Large wire connections, such as braided wire grounds or heavy-gauge wire, might require around 1,000°F. A special iron should be used to make these types of connections.

### The importance of the tip

The type of soldering to be done determines what type of iron you should use. Once you choose the iron, you have to consider which tip you need. The basic idea of all soldering theory is to transfer the greatest amount of heat to the connection in the shortest amount of time. The shape and condition of the tip will affect how well the iron does this. For soldering non-solid-state circuits and other large components, a 100W standard iron with a 3/8-inch-diameter, chisel-shaped tip is best. However, this kind of iron is too awkward and generates far too much heat to be used on circuit boards.

A 30W to 40W iron with a 3/16-inch-diameter, chisel-shaped tip should be used to solder connections on printed circuits. Fine connections, such as soldering to trace widths, requires a 20W iron with a 1/16-inch-diameter, conical tip.

In the old days, most tips were made from copper because it was such a good conductor of heat. However, the tips frequently had to be redressed and retinned because copper corrodes very quickly. Today's tips, which usually have a copper center plated with a thick iron or nickel coating, are less susceptible to corrosion. *They must never be redressed* because filing or grinding will destroy the tip. Coated tips also need to be retinned less often than traditional copper tips.

Tinning the tip is, however, the best way to create a quick and efficient solder joint. A thin layer of bright solder should always be present on the area of the tip used to make contact with the joint. Wipe the iron on a wet sponge if there is too much solder on the iron. If the iron is going to sit for awhile, extra hot solder should be applied to the tip to compensate for the solder that will oxidize off while you're not using the iron.

Corrosion is the worst enemy of a soldering tip because it prevents the effective transfer of heat to the solder joint. When they become corroded, clad tips should be sanded lightly with a piece of emery cloth and then retinned. An iron should never be retinned while it is hot. Let the iron cool, then warm it up for about a minute and a half and apply flux-core solder. If it doesn't reflow right away, don't worry; keep applying the solder. After a few seconds, the solder will begin to reflow. Because corrosion is faster at higher temperatures, the idea is to tin the tip at the lowest possible temperature. Wipe off all excess solder on the wet sponge. Clad tips should be replaced when corrosion has eaten through the plating.

Ideally, the best iron to use is the smallest, shortest and lightest iron with the thermal capacity to do the job. Excessive iron weight promotes fatigue. Excessive tip or iron length will cause the iron to be unbalanced and will keep the technician's hand too far away from the work for adequate control. Pistol-grip soldering irons are well balanced and allow the technician's hands to be close to the work, with the arm in a natural position. Pistol-gripped irons also have the advantage of

*Continued on page 20.*

## THE ONLY ESD-SAFE STATION WITH 20 OUT OF THE TOP 20 FEATURES.

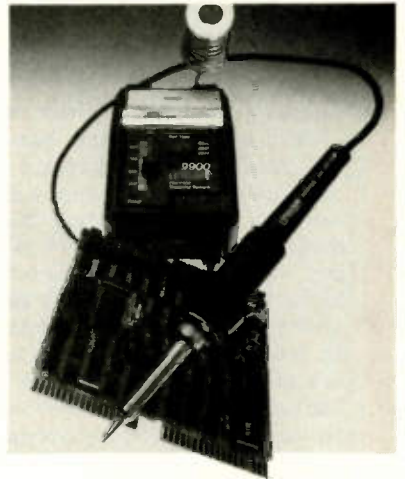

## THE UNGAR 9900AS.

Make a wish list of all the features you'd want in a soldering station. Chances are, you'll find them all on the Ungar 9900.

The 9900 soldering system meets military specifications, has the best temperature stability and offers a choice of four quick-connect soldering irons. Topping this unique combination of features is a competitive price and two-year warranty on the power base.

For the other 15 features, call or write us today.



## UNGAR®

Division of Eldon Industries, Inc.

100 W. Manville St.

Compton, CA 90220

Phone (213) 774-5950

FAX (213) 631-7568

Circle (11) on Reply Card



Continued from page 19.

minimizing handle heat. However, they can be difficult to operate in tight spaces.

The color of the handle also should be considered. Recent studies have shown that certain colors are more visible than others on the edge of a person's peripheral vision. Multiple handle colors promote safety and efficiency, reducing the chances of missing an iron pick-up. The iron's handle should have an adequate flare to prevent a technician's hands from sliding forward onto the iron.

#### Soldering standard dip circuit boards

When soldering resistors, capacitors and other discrete components to a printed-circuit board, make sure you use an iron with the proper wattage. In most electronics applications, a 20W to 40W iron with a chisel tip will do the job. Higher wattage irons will reflow the solder, but they may get too hot and damage the substrate or the component. A heat sink should be clamped onto the wire lead between the component and the solder joint, usually on the component side of the substrate.

Devices that are large and unaffected by heat should be soldered with a 40W iron with a triangular tip. The iron should be capable of maintaining enough heat to reflow the solder freely around the annular connector. It should be able to maintain sufficient heat to solder multiple connections.

The shape of the soldering tip depends on the size, thickness, heat retention and area of the solder joint. A shorter or long-

er soldering tip may be required to reach a specific soldering area. A pointed, spade or other shape of point may have to be used depending on the type of device being soldered and the size of the annular connector. For example, a pointed tip puts solder neatly in a specific area; a spade-shaped tip puts more heat and solder into a much wider area.

Solder connection should be composed of a minimum of solder. Excess solder does not guarantee a better connection. In fact, it often indicates that too much heat was applied to the solder joint for too long a time. More important, using too much solder costs more because additional labor must be put into correcting the solder joint.

Another great danger of soldering is not using enough heat. If the solder connection is not heated long enough, a *rosin joint* will result. Although a rosin joint looks nearly identical to a solder joint, the flux resins in a rosin joint insulate the component's lead from making a good contact, which will eventually cause a loose connection. After the circuit board has been soldered, it should be cleaned of all flux residues and then inspected for rosin joints. A good solder joint should be smooth and shiny; a rosin joint is a dull gray and is full of pin holes.

A standard wire-component's leads need only enough solder to firmly attach them to the annular connector perpendicular to the board's substrate. With the majority of components, it is usually sufficient to pre-tin the component's leads and then insert the pre-tinned components in-

to their proper holes. When the iron is applied to the connection, the solder from the pre-tinned components reflow to form the solder joint.

The amount of time the iron should be in contact with the solder joint is a matter of seconds. Contact should be just long enough for the solder flux to melt and for the solder from the pre-tinned leads to reflow and make the connection. It takes a little time and practice to master this skill because there are so many variables. With a little patience and practice, you can make good solder joints that will increase the reliability of your work.

When soldering a number of connections on the same circuit board, follow the same principle of single joints: Pre-tin all component leads and then reflow the connections. If the connection looks as if it needs more solder to make it a good connection, a little more can be added from a strand of solder wire. With multiple joints, you have used the right amount of solder if the solder flows in the form of peaks and valleys. A continuous flat surface indicates that you used too much solder. Excess solder in multiple joints sometimes occurs if you use too large a solder strand.

The size of the solder strand depends on the type of connections being soldered. For printed circuit boards, use a small-diameter solder strand, such as 1/16-inch-diameter, flux-cored solder. Small-sized solder strands melt fast and lose less heat, which allows better control of the amount of solder applied to a circuit board.

Continued from page 18.

This method, however, has a major drawback—it may be ineffective with soldering multilead chip packages. Because only one lead can be soldered at a time, the radiant heat will melt adjoining fillets and float the component off its footprint. Constant exposure to heat also may ruin the component before it can be put into use. Another way of replacing an SMC doesn't even involve using a soldering iron at all.

Solder paste is probably the best method of attaching multilead chip packages because all the lead connections are made at the same time. A thin coating of solder paste is applied to the footprint pads and to the component tabs. The component is placed into its proper position on the printed circuit board with a pair of tweezers. The paste will hold the component in place until

the joint can be reflowed.

Before the joint can be reflowed, the circuit board must be preheated to burn off the solvents in the solder paste and to minimize the risk of thermal shock to the circuit board. Curing times vary widely depending on which brand of solder paste is being used. Read the manufacturer's spec sheet carefully for curing and mixing instructions. Solder paste is typically packaged in a syringe, and it is usually necessary to mix the paste. A typical curing spec is 10 minutes in a convection oven at 200°F.

Remove the board after it has cured and turn up the temperature of the oven to the reflow temperature. Place the board in the oven just long enough for the solder to reflow and attach the replacement component to the surface of the circuit board—reflow should oc-

cur almost instantly. It is very important to remove the board as soon as the solder has reflowed because overexposure to heat can ruin components. Most components can withstand the temperature of molten solder for about 10 seconds. Solder paste is a dull, gray color and becomes very shiny once it has reflowed. Check the alignment of the component package to make sure that it has remained in the proper position.

It is possible to replace SMCs without investing in a lot of expensive equipment. As use of surface-mount components increases, the tools designed specifically for the task will become more economical and more widely available. Until then, a savvy technician can make do with what's on hand—and do the job well.

ES&T



# Analyze Any Waveform To 100 MHz, 10 Times Faster, 10 Times More Accurately, Absolutely Error Free ... Or Your Money Back



SC61 Waveform Analyzer  
\$3295 Patented

## Analyze Waveforms Easily

- Accurate waveform display — 60 MHz bandwidth (usable to 100 MHz) to test the latest digital circuits
- Rock-solid sync — ECL logic circuits and differential amplifiers give fiddle-free operation
- Four times the measuring range — Measure from 5 mV to 2000 volts (3000 volt protection) for expanded signal handling
- Easy to use — Human engineered controls and virtually no graticule counting or calculations

## AUTOTRACKING™ Digital Readings Analyze The Whole Signal

- Autoranging DC volts through single probe
- Automatic Peak-to-Peak Volts — even if variable control is "out of cal"
- Automatic frequency measurements without sensitivity adjustment or range switching

## Delta Digital Tests Analyze Any Part Of The Signal

- Delta Peak-to-Peak Volts — Peak-to-Peak volts of any part of the signal
- Delta Time for any time reading — including delay between traces
- 1/Delta Time — or frequency of part of the signal — finds sources of interference or ringing
- Frequency Ratio Test — Tests multiplier and divider circuits

With the SC61's waveform analyzing power, you can measure any part of even the most difficult waveform at the push of a button.

Waveform analyzing is easy with the SC61; just connect the probe to any point in the circuit and push a button; DC volts, peak-to-peak volts, or frequency readings snap onto the easy-to-read LCD.

You get direct digital readings without the confusing menus or cursors that digital readout scopes require. Readings are accurate even if the signal isn't on the CRT or knobs are left "out of cal".

The SC61's clean front panel and human engineered controls take the confusion out of scope operation.

Try an SC61 Waveform Analyzer. You'll quickly discover how the power at your fingertips reduces your toughest troubleshooting challenge at the push of a button.

Ready to order? Need more information? Call your area Sales Engineer 1-800-843-3338. Ask him about the SC61 video tape.

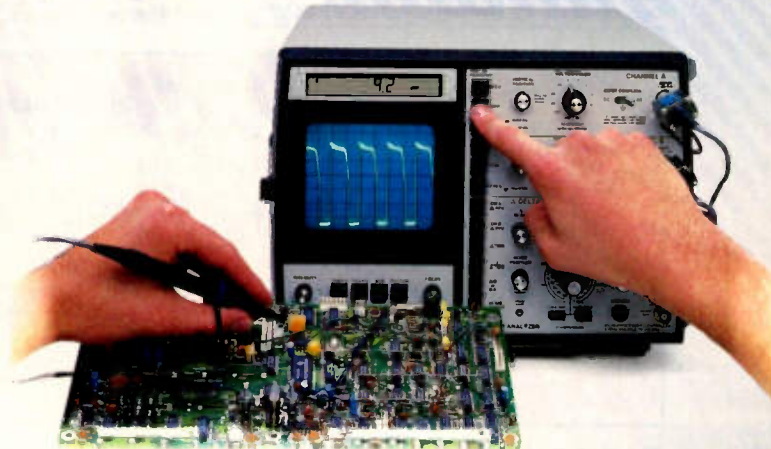

**Call 1-800-843-3338**

**SENCORE**

Circle (35) on Reply Card



# Quick tests for B&W TVs

By Homer L. Davidson

Servicing any small, black-and-white TV receiver ordinarily must be finished very quickly, or the value of the repair work could easily exceed the worth of the set. Many TV technicians refuse to work on any B&W set, for various reasons, but there may be reasons why you should. Sometimes, a portable TV is brought in by someone to whom you feel a sense of obligation. Or someone might have private reasons for wanting to keep a B&W set operating. Because a repair often will cost more than the original price of a B&W set, it's a good idea to come up with an accurate estimate before you begin.

Following are some tips to help you make repairs on B&W sets more quickly.

## No sound, no picture

When both sound and picture are missing, a major power-supply problem is likely. First, test for dc voltage at the collector of the horizontal-output transistor. If the reading is zero or a very low positive dc voltage, it's almost certainly a power-supply problem. Take a look at the two fuses in Figure 1. One is in the ac circuit; the other is in the rectified dcV circuit. Check and replace them if they are open.

Very low voltage at the horizontal-

output's collector might indicate a leaky output transistor or a defective regulated power supply. Measure the low voltage as you rotate the B+ control. A high or low dc voltage that changes little from rotation of the B+ control is the symptom of a defective power supply.

If the dc voltage at the output of the regulated supply is low and cannot be varied with the B+ control, remove the dc fuse. With ac power on, measure the dcV at the dc fuse, the common cathodes of the bridge, and the large filter capacitor. These three voltages should be identical and should measure between +11.5V and +19.5V for combination battery/ac operation. But for acV-only models, this voltage might measure +115V to +165V. Note: The large filter capacitor might be connected to either side of the dc fuse.

In normal service, some fuses are blown by leaky or shorted silicon diodes in the bridge. These diodes can be ruined by lightning or line noise and fluctuations. If the dc voltage is correct (or slightly high) at the output of the diode bridge rectifier (two cathodes connected to the large filter capacitor), the voltage supply source probably is normal. Therefore, any problems must be in the voltage regulator.

Check the two regulator transistors and the two diodes in-circuit for leak-

age. (See Figure 1.) The large regulator transistor is often leaky or open. If there is any sign of in-circuit leakage, disconnect one lead of the transistor or diode and use this lead to check for out-of-circuit leakage.

Remember, the large regulator transistor tends to break down under load, but not during tests. Replace it. Your time is too valuable to waste.

Rotation of the B+ control often has no effect on the power-supply output B+ voltage unless the secondary fuse or the horizontal-output transistor has been replaced to make the TV operate. The only explanation I have is that the regulation circuit was not designed for operation with zero-load current.

## Set does not operate on battery

Most malfunctions during battery operation are caused by corroded battery connections, open dc fuses, broken battery plugs or corroded battery switches. When the TV operates normally on ac but not on dc, check the battery fuse and its circuits (Figure 2). Apply anticorrosion liquid or paste to all switch and battery connections. Buff the switch contacts with a soft cloth (if the contacts can be seen). The battery switch is sometimes located on the volume control. In other TVs, the switch is located where the +12V battery cable plugs into the chassis.

Suspect incorrect battery polarity when the auto-battery fuse continues to blow each time the cable is plugged into the cigarette lighter. Check the auto, van or truck for battery voltage and polarity. If the car battery is normal, examine the 12V cable for previous repairs or miswiring.

## Horizontal sweep is dead

A dc voltage that is too low and scope pulses that are barely perceptible at the collector terminal of the horizontal-output transistor indicate a serious HV-component defect or a non-functioning horizontal-output stage.

Hold the scope probe near the collector terminal during the waveform anal-

Davidson is the TV servicing consultant for ES&T.

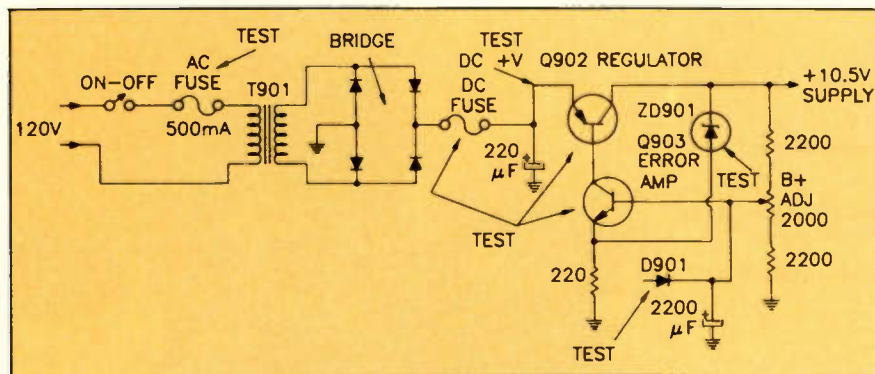

Figure 1. If preliminary tests indicate power-supply problems, check the ac and dc fuses (with the power off) and replace any open fuses. With ac power on, measure the collector and emitter voltages of Q902, the regulator transistor, and compare them with the schematic. If the emitter voltage is low, check the bridge rectifiers and the 2,200µF electrolytic. If the emitter voltage is correct, check the regulator circuit, beginning with Q902, Q903, zener ZD901, and the resistors. If nothing tests defective, replace Q902.



ysis. A leaky or shorted horizontal-output transistor or damper diode can cause the dc fuse to blow. Low dc voltage measured at the horizontal-output transistor's collector might result from a leaky output transistor or from incorrect dc voltage coming from the low-voltage power supply. Improper voltages at the CRT anode can cause both sides of the raster to pull in from the sides. Use an HV probe and test the HV at the CRT. Also, scope the base terminal of the horizontal-output transistor and look for any abnormal waveforms.

Next, check the waveform and dc voltage at the collector of the horizontal-driver transistor. Low dc voltage along with an incorrect waveform might indicate a leaky horizontal transistor or a loss of drive signal. Insufficient drive voltage might cause the driver transistor (and its collector load resistor) to run warm. Scope the horizontal-oscillator stage and look for normal horizontal sawteeth. If there are none, the horizontal oscillator is obviously dead.

Inspect the horizontal hold-control coil for visible opens and broken wire connections. The oscillator coil has a very long adjustment rod, which protrudes far enough out of the rear of the chassis so that the viewer can adjust the horizontal locking. But several problems can arise. The rod can warp and move the coil laterally when it is rotated. This coil movement can break some of the wires.

With some defects, the horizontal cannot be locked by any adjustment of the rod and coil. Viewers have been known to use a pair of pliers on the rod end while attempting to rotate the rod just a bit more. For this and other reasons, check the condition of the coil in all receivers that have them. The rod and coil have caused more than their fair share of troubles.

Test the oscillator, driver and output transistors in-circuit. If there is any doubt about forward tests or leakage, remove that transistor and check it out-of-circuit. When any transistor is suspected of being intermittent, replace it.

Do not waste time with more transistor tests, which might take hours. B&W servicing demands quick repairs.

A horizontal-frequency test signal should be injected into the horizontal-oscillator stage to determine the performance of the oscillator and driver stages and the transistors.

If the test signal doesn't have the same waveform that the input has during normal operation, it is best to remove the horizontal-output transistor to avoid possible damage. However, almost any waveform and approximate horizontal frequency will pass through the driver stage for testing.

In one RCA KCS-206A chassis, the horizontal-driver transistor was excessively warm and a check with the scope showed that base and collector waveforms were absent. The collector dc voltage at the Q501 oscillator transistor was too high. Resistance measurement showed a high reading to ground because L501 was open, broken at two contacts and pushed back onto the chassis.

### One horizontal line

One white, horizontal line across the

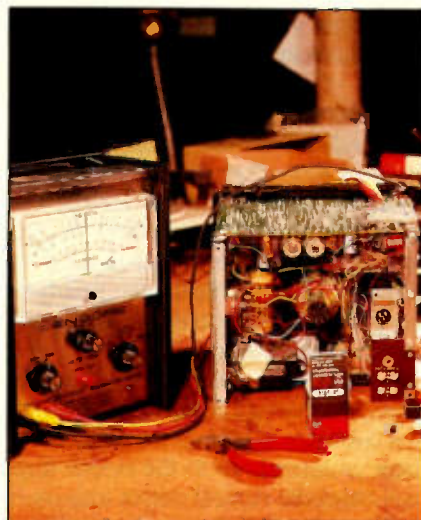

One of the first steps in determining the cause of the problem is testing transistors in-circuit.

center of the screen is an indication that the vertical-deflection system is not operating. Although the most common cause of zero vertical sweep is shorted or open vertical-output transistors, there are other possibilities, such as faulty resistors. Always test the bias or emitter resistors in the transistor output circuits. Next, test all other resistors in the final two or three vertical stages.

Locate the vertical-output transistors on the small TV chassis (see photograph). Measure dc voltage at the collector heat sinks. One collector usually is connected to a B+ source while the other collector and heat sink connect through a low-value resistor to ground. (See Figure 3.) These are two valuable

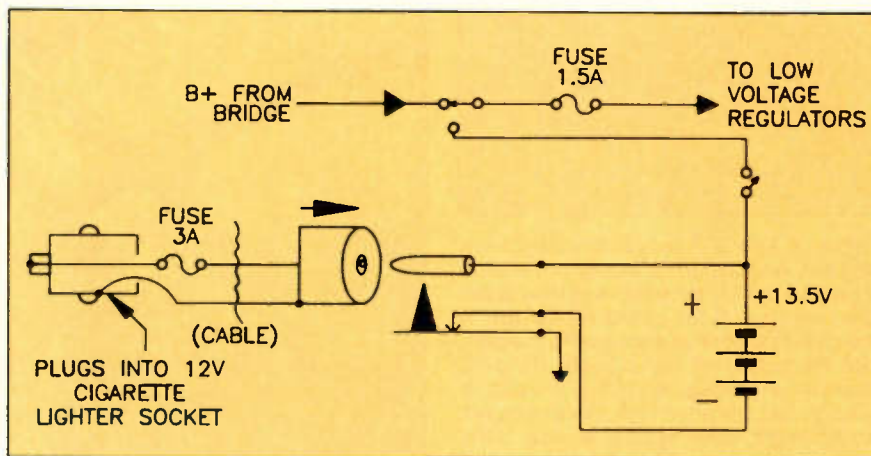

Figure 2. Notice that this B&W TV has three possible power sources: +13.5V from a power transformer, a bridge and a capacitor; +13.5V from internal batteries; or +12V to +13V from a car battery. The selected voltage is sent to the voltage regulators. Switching the cigarette-lighter voltage (and ground) in or out of the circuit is accomplished simply by mechanical motion of the female end of the lighter plug into the receiver. Inserting the female plug brings in the voltage and switches the ground away from the internal battery. Removing the plug takes the lighter cable out of the circuit, so ac or internal battery operation can be selected by another switch.



test points for use during analysis, and the results should determine your next steps.

Scope the large coupling capacitor that feeds the vertical signal to the yoke coils. A lack of vertical waveform there indicates problems in the vertical circuits, but a normal waveform of high amplitude points to trouble in the yoke circuits. Other vertical/yoke problems are possible, but these two examples will cover most repairs.

To start at the beginning, scope the vertical drive (if countdown is used) or the oscillator output. If the 60Hz oscillator is normal, go to the output stage and check the vertical-output transistors and associated diodes in-circuit. Measure the smaller base and emitter resistors for opens and values that have been changed by overloads. Check each electrolytic capacitor using a capacitance meter. Remember, most vertical problems are located in the vertical-output stages.

#### Insufficient vertical height

On one B&W TV set I serviced, the picture was not tall enough. I scoped pins 8 and 1 of IC31 (the vertical oscillator, amplifier and vertical-output amplifier in a JCPenney 685-1036), which indicated weak vertical sweep. All the important transistor functions for

the usual three stages are contained in IC31. The voltage between pins 9 and 12 was lower than normal, indicating a leaky IC or a problem in the low-voltage power supply.

I checked the schematic and noticed that the +11.5V source also supplied the horizontal-output circuits. Although the white horizontal line was shorter than usual, correction of the vertical height had priority. I assumed a component in the vertical circuit was reducing the dc voltage. To determine whether the power supply was normal, I switched the combination portable to AM radio and found that the +11.5V source was normal when a local station was tuned in.

I then used desoldering braid to desolder IC31 pin 12 from the circuit. The low-voltage source returned to normal and the horizontal line increased to normal length. Evidently, IC31 was leaky. Any resistance reading below 1,000Ω from IC31 pin 12 to chassis ground indicates a leaky IC. When IC31 was replaced by another AN7562 IC, normal vertical and horizontal sweeps were restored.

#### Snow with poor vertical sync

Locating defective components in AGC and sync circuits can be difficult. Defective AGC circuits can cause snow, rolling pictures, pulling pictures and/or

out-of-lock pictures. Horizontal and vertical sync are processed together by the sync-separator circuits, so these should be among the first items tested.

First, adjust the AGC control to determine whether the problem can be minimized or eliminated by this adjustment. If the control has some effect on the picture, you can assume that the AGC circuits are operating. Check the AGC voltage applied to the tuner and IF stages. Look for AGC test points. When there is no IF AGC test point, measure the dc voltages at bases of the IF transistors. With the antenna disconnected and no other signal applied, vary the AGC control and compare the range of voltages obtained against those on the schematic. By the way, picture-pulling can be caused by dried electrolytic capacitors in the AGC circuits. Substitute new ones when there is doubt.

With a color-bar generator connected to the antenna terminals, scope the video signal at the base of the AGC gating transistor. Sometimes a strong local station can be used for the test. However, most video and AGC waveforms on schematics are from color bars. Some B&W portable TVs combine video and AGC functions in one transistor. Scope the input and output waveforms of the sync circuits to determine whether poor vertical or horizontal sync is caused in

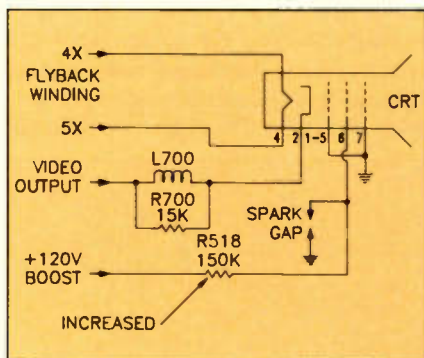

**Figure 3.** The CRT base's dc voltages are primarily responsible for picture brightness. If cathode pin 2 is too positive relative to the grid pins 1 and 5, the picture will be dark. If the grid is too positive compared to the cathode, the picture will be too bright. If the G2 (screen grid) voltage is too low, the picture will be dark. If it is too high, the picture will be too bright. Other symptoms occur if the filament has too much or too little current. If all of the CRT voltages are similar to those on the schematic, but the picture is very dim and the TV must be warmed up before any picture can be seen, it is likely the CRT is weak and needs replacement. In this schematic, the increased 150kΩ resistance reduced the G2 voltage and darkened the picture.

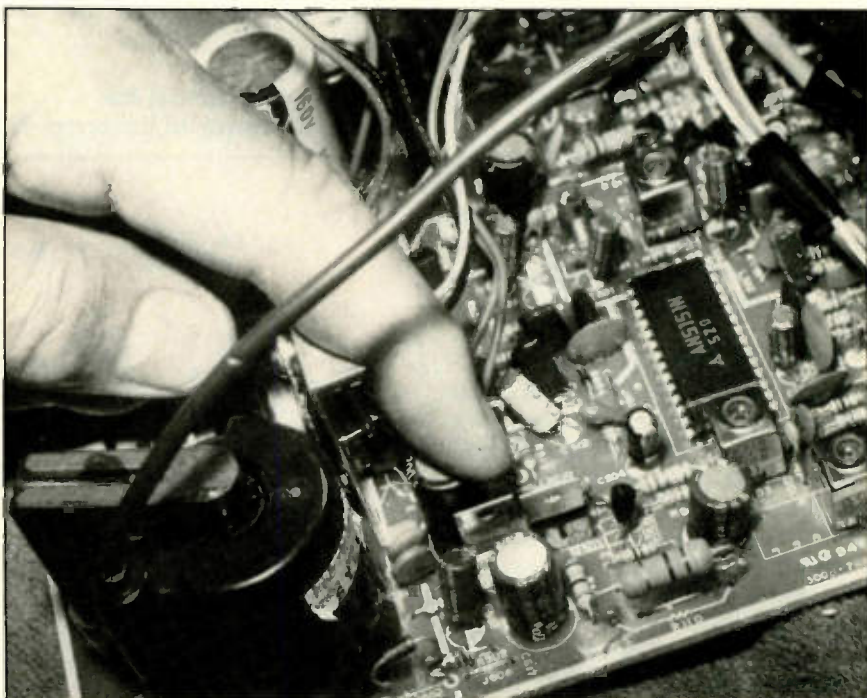

Measuring the dc voltages at the collectors of the vertical-output transistors is one of the first steps in vertical-circuit servicing. Two vertical-output transistors usually are easy to locate because they are very large and each has a metal plate protruding from the top. This metal plate/heat sink is connected to the collector in type TO-220 transistors.



This rear view of a combination radio/TV and audiocassette player shows the crowded areas inside. The audio-circuit board is in the upper left corner (from the point of view of the viewer). The cassette player is at the far left and slightly below center. Along the bottom and next to the tape player is the radio chassis. A larger chassis from about the center to the right side holds the TV components, including those four adjustable controls. The base of the CRT is slightly to the left of center. The CRT base is one important area where dc voltages should be measured with a DMM.

the sync-separator stage. While no signal is being received, measure the voltage at the transistor or IC AGC and sync terminals and compare them with those on the schematic. Make your analysis from these various tests.

**Normal sound—flashing raster**

A defective video component might produce any of these symptoms: no raster, brightness that cannot be reduced enough, wavy lines, flashes in the raster, or several retrace lines at the top of the raster. These symptoms also can be produced by the picture tube. If the sound is normal, the signal must be satisfactory at the first video amplifier. There-

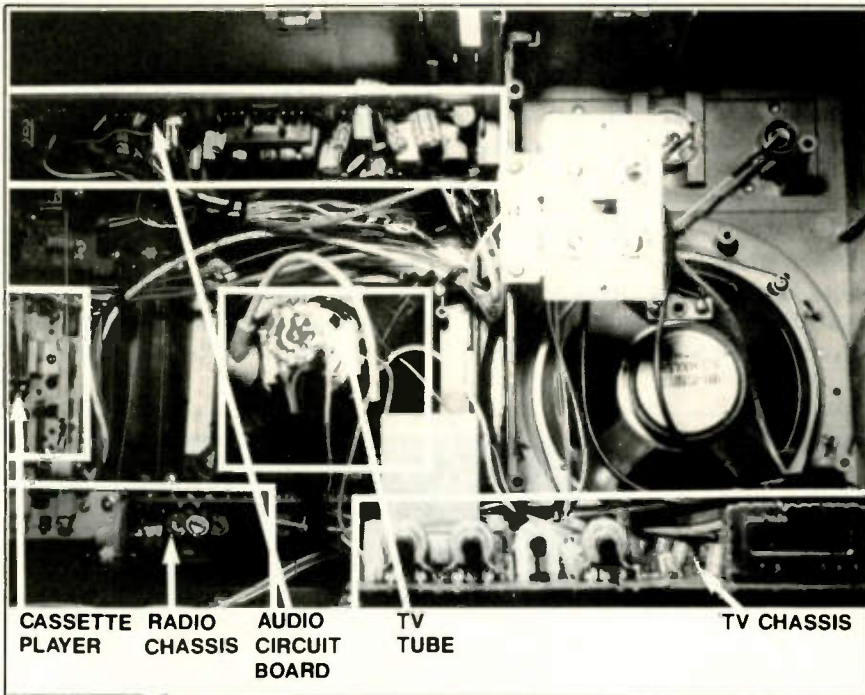

fore, troubleshoot the video-output circuits as you would the sound stages. First, measure dc voltages of the video-output transistor and compare them with the schematic. Test in-circuit both

the video amplifier and the blanking transistors. Any transistor that shows signs of leakage must be removed and tested out-of-circuit. Connect a color-bar generator to the antenna terminals

**INTRODUCTION TO VCR REPAIR ON VHS VIDEO TAPE**

This new release by Ucando explains how the VCR works from the tuner to the RF modulator.

**YOU WILL LEARN:**

- How the chroma signal is processed
- How the luminance signal is processed
- How the audio signal is processed
- How the video drum servo works
- How the capstan servo works
- How the control head works
- How to clean the tape path
- Professional troubleshooting techniques

**SAVE TIME AND MONEY**

After viewing this program you will have a better understanding of how the VHS VCR functions. **To save time and money on your VCR repairs order your own VHS VCR tape now!** Simply call (513) 548-6113 and have your Master Card or Visa ready.

**Price \$59.95**

Please allow 2-4 weeks for delivery.

**10 Day Money Back Guarantee!**



VCR EDUCATIONAL PRODUCTS CO.  
P.O. BOX 386  
GREENVILLE, OHIO 45331

Circle (13) on Reply Card

**INTRODUCING THE AR-100 MAXI-PROBE™**

*The World's First Pen-Style DMM with Built-in 10MHz Logic Probe*

**INNOVATION, NOT IMITATION**

The AR-100 Maxi Probe. Unheard of features and performance in one small package. Volts, Ohms, Audible continuity, Data Hold. Then add a full-function, TTL/CMOS logic probe. Screw on accessory tips. Diode Test. Test Leads. And a storage case.

Result: All the functions you need for both analog and digital testing in one small package, at one low price.

So visit your local ARI distributor and take hold of the future, today. The AR-100 Maxi Probe. All others pale by comparison.

- Measure:
- Volts •Ohms •Diodes
  - Audible Continuity
- And:
- TTL & CMOS Logic To 10MHz!
- Features:
- Screw-On Accessory Tips
  - Data Hold



**AMERICAN RELIANCE INC.**  
VALUE BEYOND MEASURE

9241E VALLEY BLVD. ROSEMEAD, CA 91770  
(800)654-9838

ARI manufactures a complete line of electronic test equipment, including EPROM, EEPROM, and PLD programmers, IC testers, Cable testers, DPMs, DMMs, and Logic testing devices. Call or write today for your free Brochure.

Circle (14) on Reply Card



and observe the waveforms through the video-output circuits. Remember the possibility of a defective vertical blanking stage. Go directly to the picture tube if the video stage appears to be normal.

### Testing the picture tube

A defective picture tube can exhibit failure in many different ways: a dim picture, brightness that cannot be turned down completely, an out-of-focus picture, no raster or a dark raster, or retrace

lines near the top of the raster. If the picture tube is defective, the B&W portable probably is worth less than it would cost to repair it.

When you suspect a defective picture tube, be certain of the diagnosis and estimate. Check the CRT with your CRT tester. If your CRT tester won't test these small-necked picture tubes, as many will not, perform whatever additional tests you can to be certain whether the CRT is defective. Are the filaments

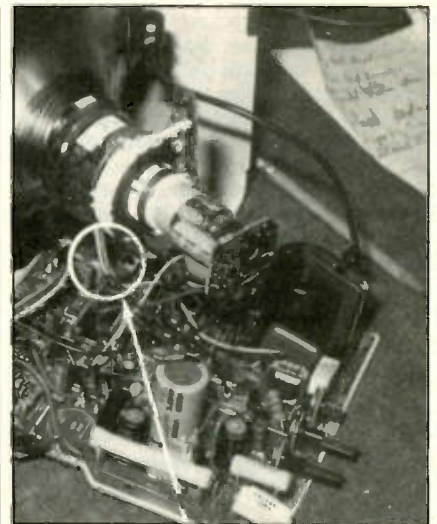

SOUND IC

In some B&W receivers, a large and complex IC includes all of the sound stages and other stages, such as video, as well. It usually is the largest IC on the chassis.

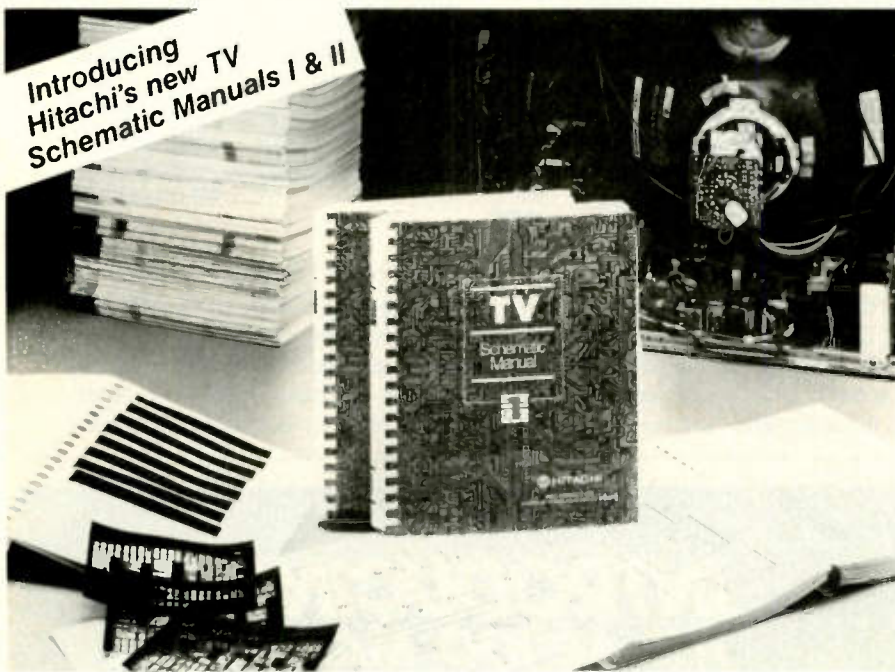

## All the technical data of 83 Hitachi TV Manuals—in just two volumes



Our new Hitachi TV Schematic Manuals give you the best of both worlds—

With the compact storage of 32X microfiche and full-view hard copies of the items you use the most. Organized by year and model number in both formats, these volumes give you everything you need—83 models from 1975–1981. They're neatly packaged, easy to use, and economically priced.

You'll get hard copies of:

- Schematic Diagrams • Block Diagrams
- Printed-Circuits Board Layouts • Part Lists • Mechanical Part Exploded Views

And get the works on microfiche:

- Service Manuals with Technical Data and Information • Troubleshooting Tips • Revised or Supplemental Manuals • Instruction

Manuals • Parts and Service Bulletins

**Volume I covers:** 54 models from 1975–1978.

**Volume II covers:** 29 models from 1979–1981.

That's a lot of service data for a low \$54.95 per volume! About what you would expect to pay for information on only two models. Or save even more by getting both volumes for just \$104.00. Take advantage of these savings now. It's a simple, cost-effective way to increase proficiency and increase profit. Also available are our VCR Volumes I, II and III.

Call toll-free 1-800-447-2882 for your nearest Authorized Hitachi Distributor

### HSC Service Company

division of Hitachi Sales Corporation of America

Circle (12) on Reply Card

lighting near the socket? If not, check the continuity. Any resistance higher than about 50Ω might indicate a high-resistance filament that cannot heat. Follow the filament leads to their next connections in the circuits. One wire will go to ground. The other probably will connect with a dc power source. In other models, the filament power might be taken from a winding on the flyback transformer.

Measure the high voltage at the CRT anode connection, observing the proper methods and precautions. Then check all dc voltages of the CRT base socket. A low HV causes focusing and brightness problems. A dark or dim picture can be caused by reduced B+ boost or the CRT grid voltages. When possible, check the schematic for details.

### A dark picture

One problem I encountered with an AOC model TIL7-3A5 portable B&W receiver was a very dark picture with lines around some parts of the picture. After I checked the CRT emission (good), I carefully tested all dc voltages on the CRT socket. A reading of only +21.2V was measured at pin 6; this reading is much lower than the normal +109V (Figure 3). The HV was average at 10.7kV.

However, during tests of the B+ boost circuit, I found that 150kΩ R518 had greatly increased in resistance, thus reducing the pin-6 dc voltage and restricting the brightness. Replacement of the





PHILIPS

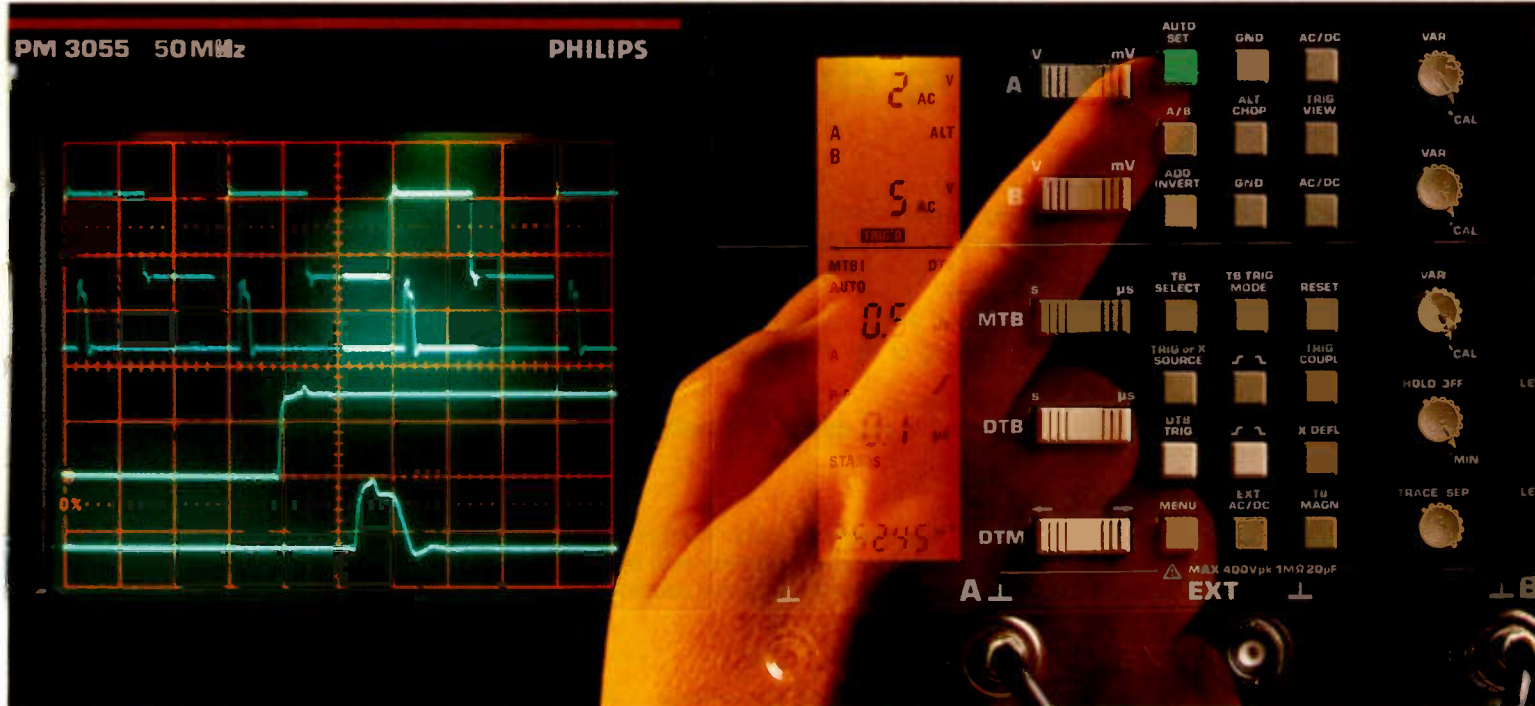

# The smart scope for people who hate to wait

**The Philips microcomputer-controlled PM 3050 Series. The only 50 MHz scopes in the world smart enough to find and display the signal—automatically.**

#### SMART PERFORMANCE

- **Autoset finds the signal at the touch of a button.** Philips' intelligent beamfinder automatically selects amplitude, timebase and triggering for error-free instant display of any input signal on any channel.
- **16kV CRT for optimum viewing.** When it comes to brilliance, clarity and spot quality, nothing in its class shines brighter.
- **LCD Panel for confident, at-a-glance operation.** A valuable information center, it instantly displays all instrument settings and parameter values. With no mistakes.

- **Auto-Triggering "thinks for you".** This built-in intelligence provides fast, accurate, properly-triggered signals up to 100 MHz.
- **IEEE Compatibility.** The PM 3050 Series is the only family of 50 MHz scopes with an add-on IEEE-488 interface option for fast computer hook-up.
- **Choice of Models.** Single timebase or delayed sweep versions are available.

#### SMART SUPPORT

Philips PM 3050 Series also comes with a 3-year warranty and all the technical and service assistance you need. From Fluke—the people who believe that extraordinary technology deserves extraordinary support.

#### SMART BUY

For about what you'd pay for the next-best scope you get innovative engineering that's

more productive and easier to use. You get plug-in modularity and IC microelectronics for reliability you've never seen in this class before. Plus, for a limited time, you get a no-risk, no-questions-asked, 30-day money-back guarantee. So why wait any longer?

#### TEST THE DIFFERENCE

So call Fluke today at **800-44-FLUKE ext. 77**. And find out how smart your next oscilloscope buy can be.

John Fluke Mfg. Co., Inc., P.O. Box C9090, M/S 250C, Everett, WA. 98206  
U.S.: 206-356-5400 CANADA: 416-890-7600  
OTHER COUNTRIES 206-356-5500

© Copyright 1987 John Fluke Mfg. Co., Inc.  
All rights reserved. Ad No. 1075-P305X



PM 3050/55 • 50 MHz • OSCILLOSCOPES

See us at Electro,  
Booth 363-374



Circle (15) on Reply Card



## B&W servicing checklist

**SYMPTOM:** No sound, picture is normal.

**ANALYSIS:** Test the sound IF, sound discriminator, audio stages and speaker until the defect is located and sound is restored.

**SYMPTOM:** No picture, raster is normal.

**ANALYSIS:** In this order, check the video IF stages, video detector, video amplifier and the tuner. Use signal-tracing or signal-injection.

**SYMPTOM:** One horizontal line in the center.

**ANALYSIS:** The vertical-deflection system is not operating. Check the vertical circuit using DMM and scope.

**SYMPTOM:** Picture is unstable or rolling.

**ANALYSIS:** Check adjustments of AGC and horizontal hold. The problem might be caused by a simple loss of vertical sync. The defect also might be more subtle, affecting both vertical and horizontal. Use the scope; don't guess.

**SYMPTOM:** No sound and no picture.

**ANALYSIS:** First, test the power supply (none of the TV's systems operate without dc). If the various voltages measure within tolerance, scope the outputs of the vertical- and horizontal-deflection systems. If the supply voltages are correct, the major faults usually are in the horizontal-output/high-voltage stage. Again, use the DMM and scope, following the circuit diagram.

**SYMPTOM:** Sound is normal, but the picture is not.

**ANALYSIS:** Perhaps the picture is flashing off and on, is very dim or is too bright. The problem first requires a power-off visual examination of the CRT socket and its wiring. Then, with power on, use a DMM to measure the dc voltage at each CRT pin. Compare the readings with those on the schematic. All major deviations are proof of a malfunction, and additional tests should be made to pinpoint the defective component.

resistor solved the problem. Since that time, I have found several more of these sets with the same symptom and cause.

### Weak or distorted sound

There are several defects that can cause sound problems. Burned bias resistors or electrolytic emitter-bypass capacitors with dried out electrolyte can cause weak sound. A defective electrolytic coupling capacitor to the speaker can cause weak or intermittent sound. All sound might be eliminated by an open speaker-coupling capacitor. A warped cone and other speaker defects can simulate audio distortion. Weak or distorted sound might result from a leaky coupling capacitor to the output

transistors or the output transistors. Also, certain defects in audio-output transistors cause popping sounds in the speaker.

Many variations of circuits and components are designed into B&W receivers, just as they are in color receivers. Some of the latest sound circuits in B&W models have driver and audio-output transistors in a single IC. Another variation has one IC performing all sound functions. Or perhaps all the sound stages are included in one IC with the luminance, video and AGC circuits. When these complex ICs are employed, troubles in other circuits may or may not affect the sound.

Here are two quick tests to find the

origin of distorted or mushy audio sound. The first is to check the response to a reduction in volume. A dragging voice coil caused by a warped cone sounds nearly normal at loud volume, but it sounds more distorted as the volume is reduced (the reverse of most amplifier distortion). At very soft volume, the sound is all distortion. The second test is to disconnect one lead of the TV speaker and clip a test-speaker across the audio-output terminals. If the test speaker plays well at both high and low volume, it is certain that the TV speaker is defective. It is best to use the test speaker whenever possible, but the first test (listening) can be done without even removing the cabinet back.

A quick test for dead or intermittent sound is to parallel another electrolytic capacitor across the speaker-coupling capacitor. Normal sound without intermittents proves the original capacitor is defective. Measure the IC B+ dc voltage at the correct voltage-source terminal. Use the schematic to locate the desired terminal number. Do not go on to the next step until this voltage has been verified as correct or until it can be brought into tolerance by minimum repairs.

Use a scope or an external audio amplifier to signal-trace the audio from the volume control through the transistors or ICs. With the external audio amplifier, check the signal input and output of the audio IC for weak, distorted or intermittent audio. Perhaps only a slight adjustment of the discriminator or ratio-detector sound coil might be needed to eliminate a buzz in the sound and to slightly increase the volume.

Before making a repair on a B&W TV set, make sure that the cost of repairs will not exceed the worth of the set. If the cause of failure cannot be located and corrected within an hour or so, the total charges might exceed the value of the receiver. Usually, the B&W TV should not be repaired when a picture tube, flyback transformer or other expensive component tests defective. Excessive damage from lightning or power-line surges totals the entire B&W chassis. Also, the smaller B&W TVs contain some very small components, and any defectives must be replaced by the manufacturer's original part numbers. These facts and other conditions affect the estimated cost to repair.

On the average, however, most B&W TV problems are not too difficult to locate, and many of the components are moderate in cost.

**ESU**



**CHASSIS SCHEMATIC  
RCA PVM050**

Product safety should be considered when component replacement is made in any area of a receiver. A star (★) next to a component symbol designate components that have special safety characteristics. Only the exact manufacturer's specified parts should be used as replacements. Use of substitute replacement parts that do not have the same safety characteristics as recommended in factory service information may create shock, fire, excessive x-radiation or other hazards.

This schematic is for the use of qualified technicians only. This instrument contains no user-serviceable parts.

The other portions of this schematic may be found on other Profax pages.

All integrated circuits and many other semiconductors are electrostatically sensitive and therefore require special handling techniques.

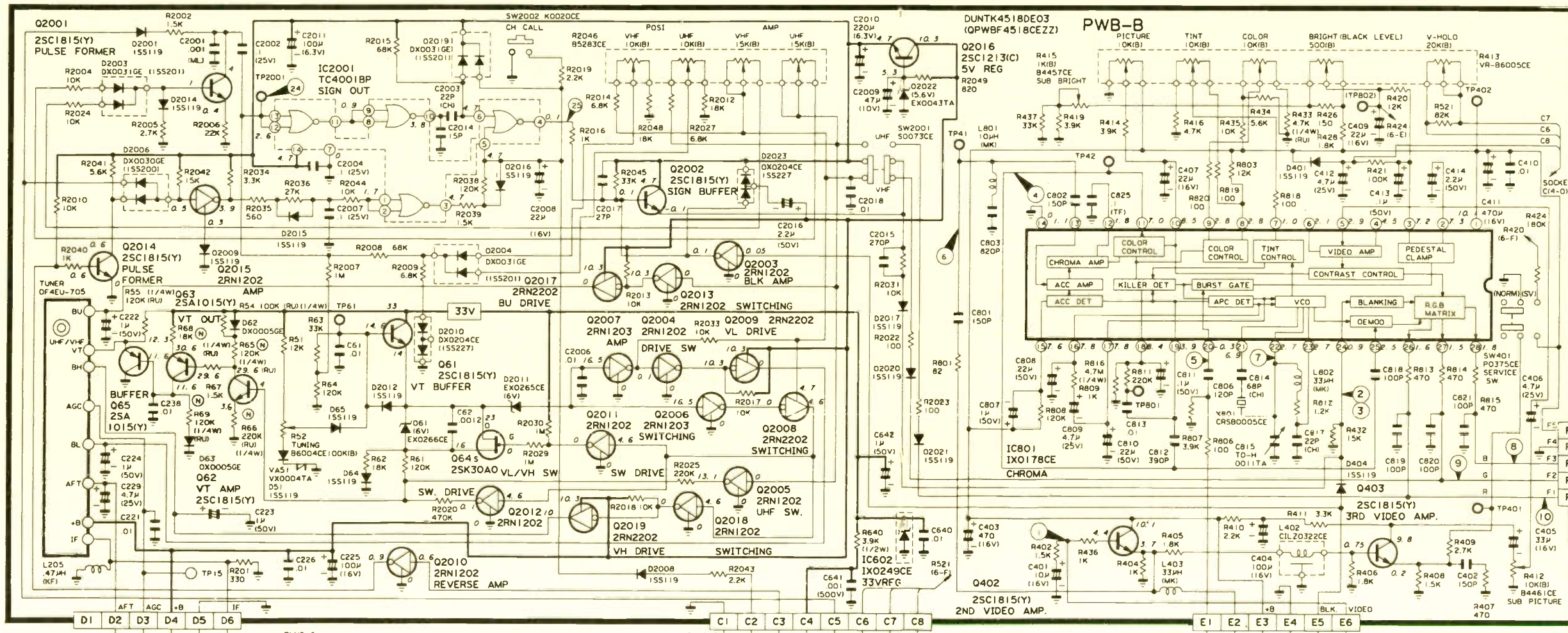
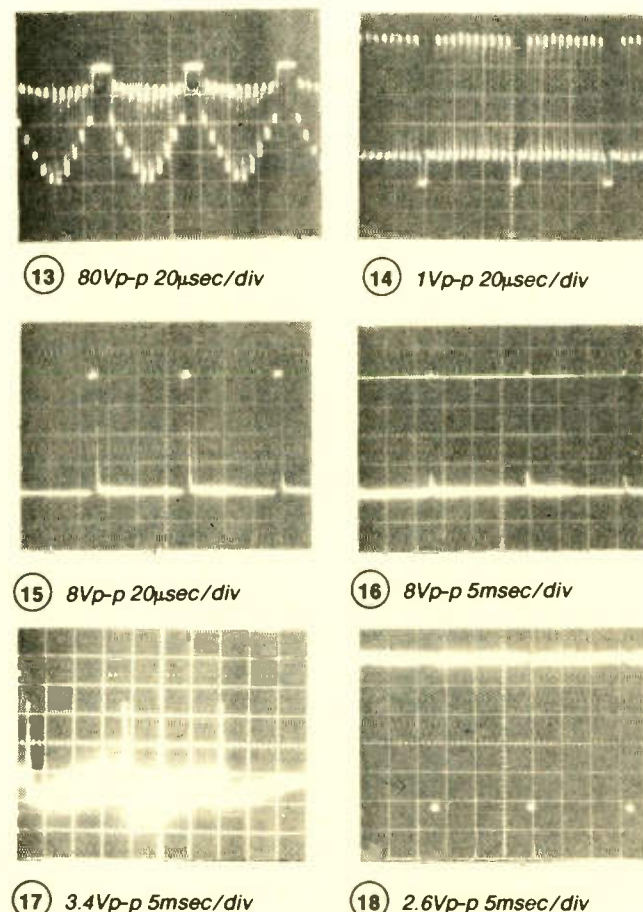
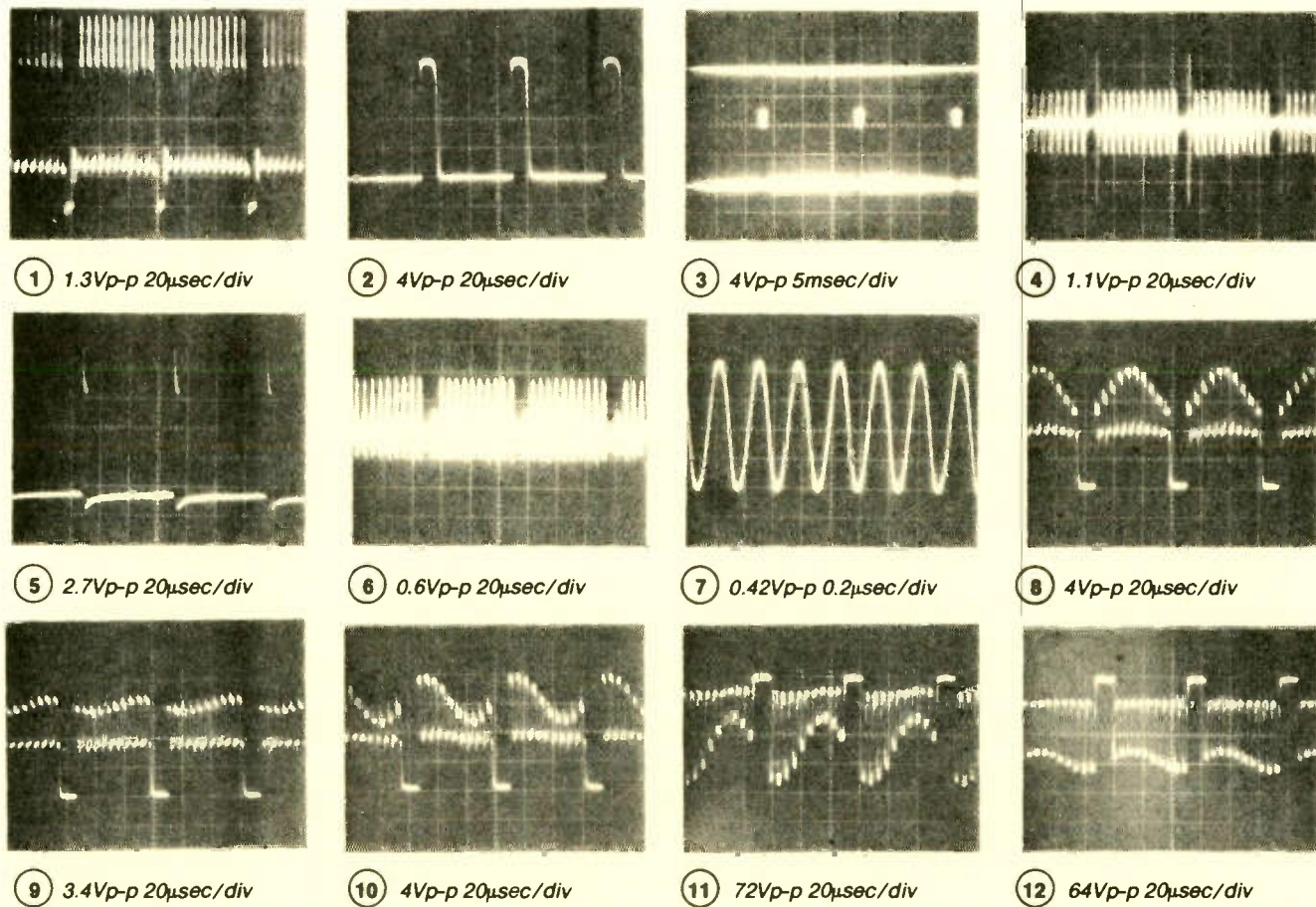



MAIN CIRCUIT DIAGRAM HITACHI CT2652, CT2653

MAIN CIRCUIT DIAGRAM HITACHI CT2652, CT2653

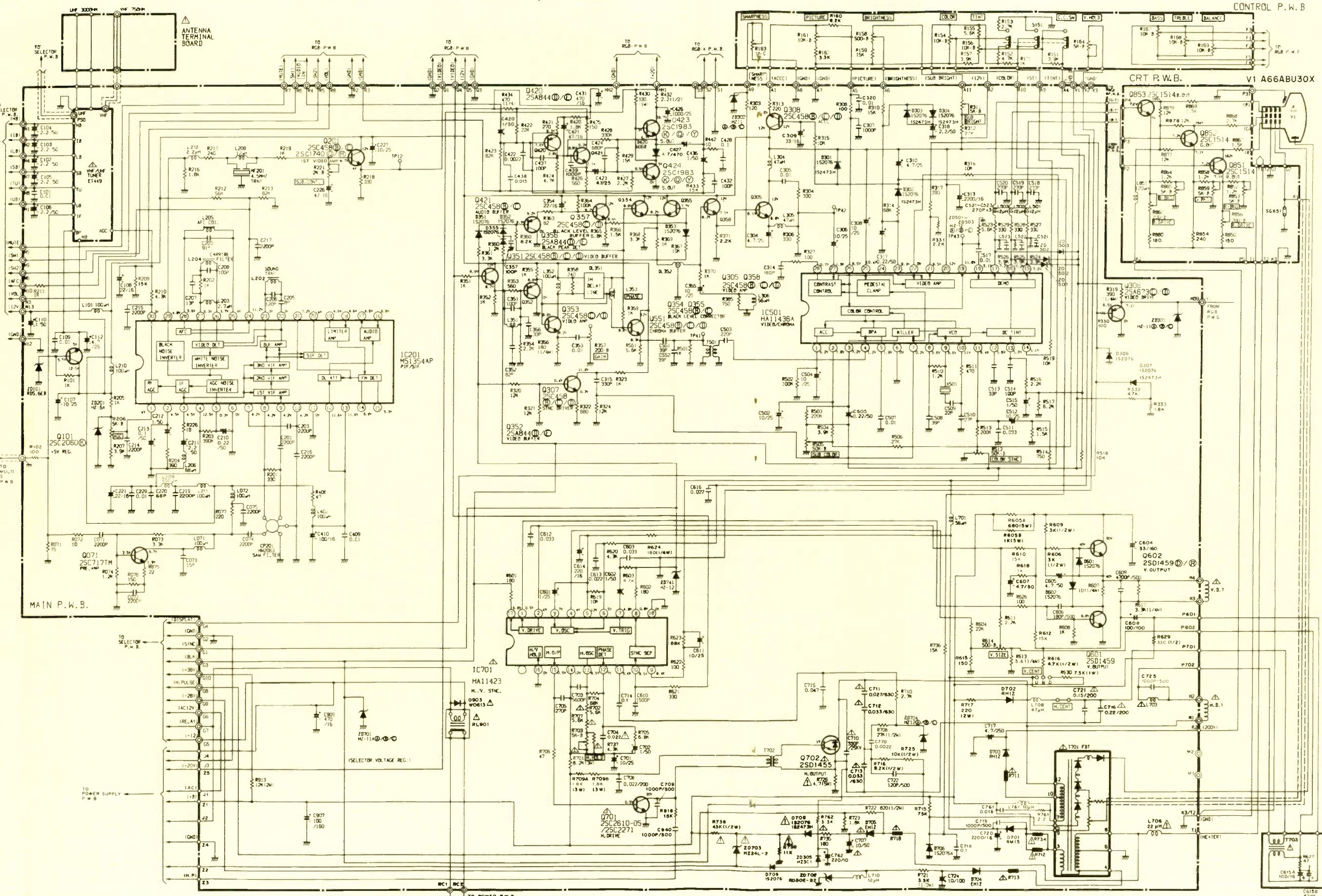

Product safety should be considered when component replacement is made in any area of a receiver. Components marked with a Δ and shaded areas of the schematic diagram designate sites where safety is of special significance. It is recommended that only exact cataloged parts be used for replacement of these components.

Use of substitute replacement parts do not have the same safety characteristics as recommended in factory service information may create shock, fire, excessive x-radiation or other hazards.

This schematic is for the use of qualified technicians only. This instrument contains no user-serviceable parts.

The other portions of this schematic may be found on other Profax pages.



### CHASSIS SCHEMATIC RCA PVM050

Product safety should be considered when component replacement is made in any area of a receiver. A star (\*) next to a component symbol number and a star on or surrounding schematic symbols designate components that have special safety characteristics. Only the exact manufacturer's specified parts should be used as replacements. Use of substitute replacement parts that do not have the same safety characteristics as recommended in factory service information may create shock, fire, excessive x-radiation or other hazards.

This schematic is for the use of qualified technicians only. This instrument contains no user-serviceable parts.

The other portions of this schematic may be found on other Profax pages.

All integrated circuits and many other semiconductors are electrostatically sensitive and therefore require special handling techniques.

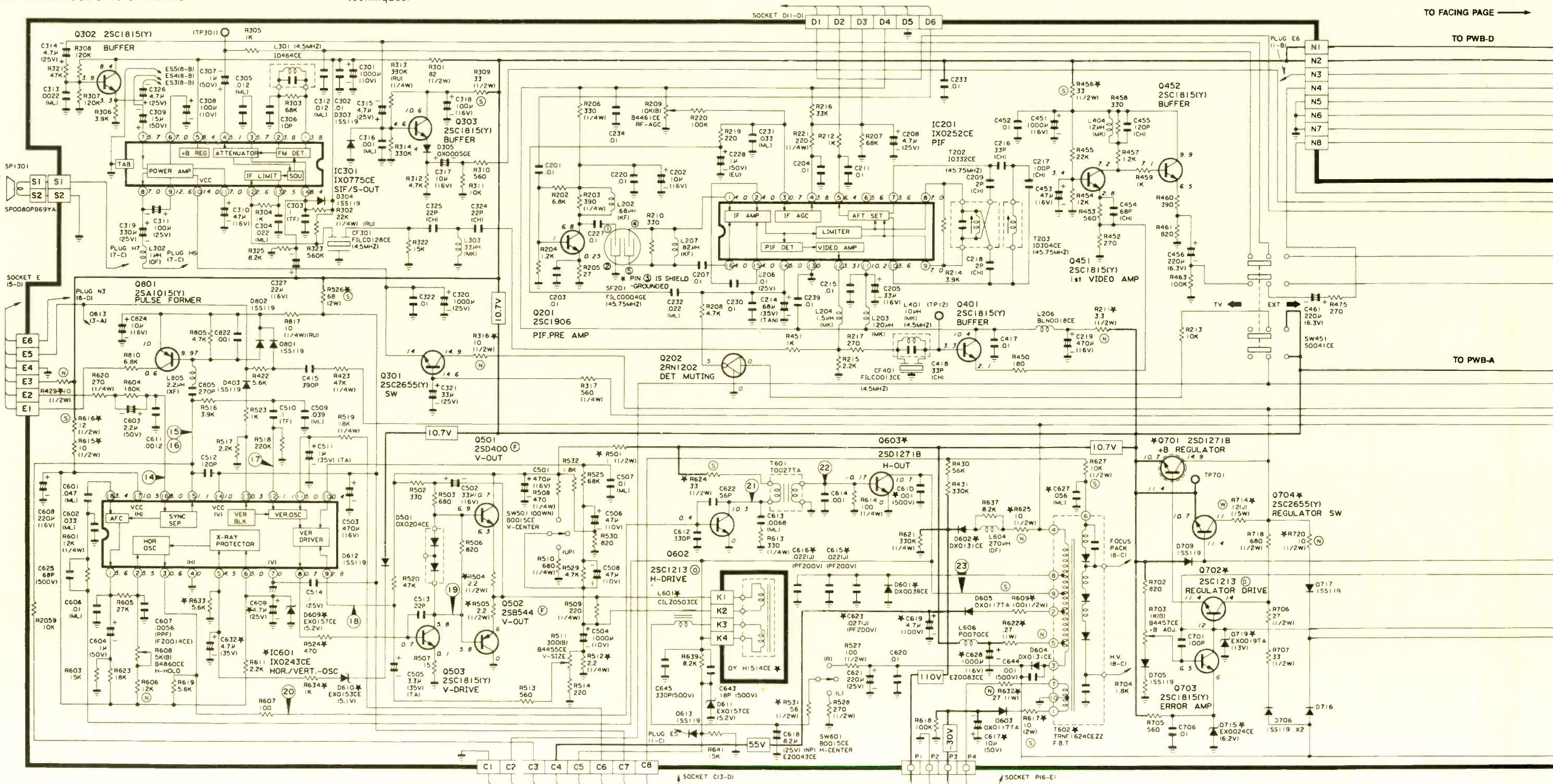

### CHASSIS SCHEMATIC RCA PVM050

Product safety should be considered when component replacement is made in any area of a receiver. A star (\*) next to a component symbol number and a star on or surrounding schematic symbols designate components that have special safety characteristics. Only the exact manufacturer's specified parts should be used as replacements. Use of substitute replacement parts that do not have the same safety characteristics as recommended in factory service information may create shock, fire, excessive x-radiation or other hazards.

This schematic is for the use of qualified technicians only. This instrument contains no user-serviceable parts.

The other portions of this schematic may be found on other Profax pages.

All integrated circuits and many other semiconductors are electrostatically sensitive and therefore require special handling techniques.



**CHASSIS SCHEMATIC  
RCA PVM050**

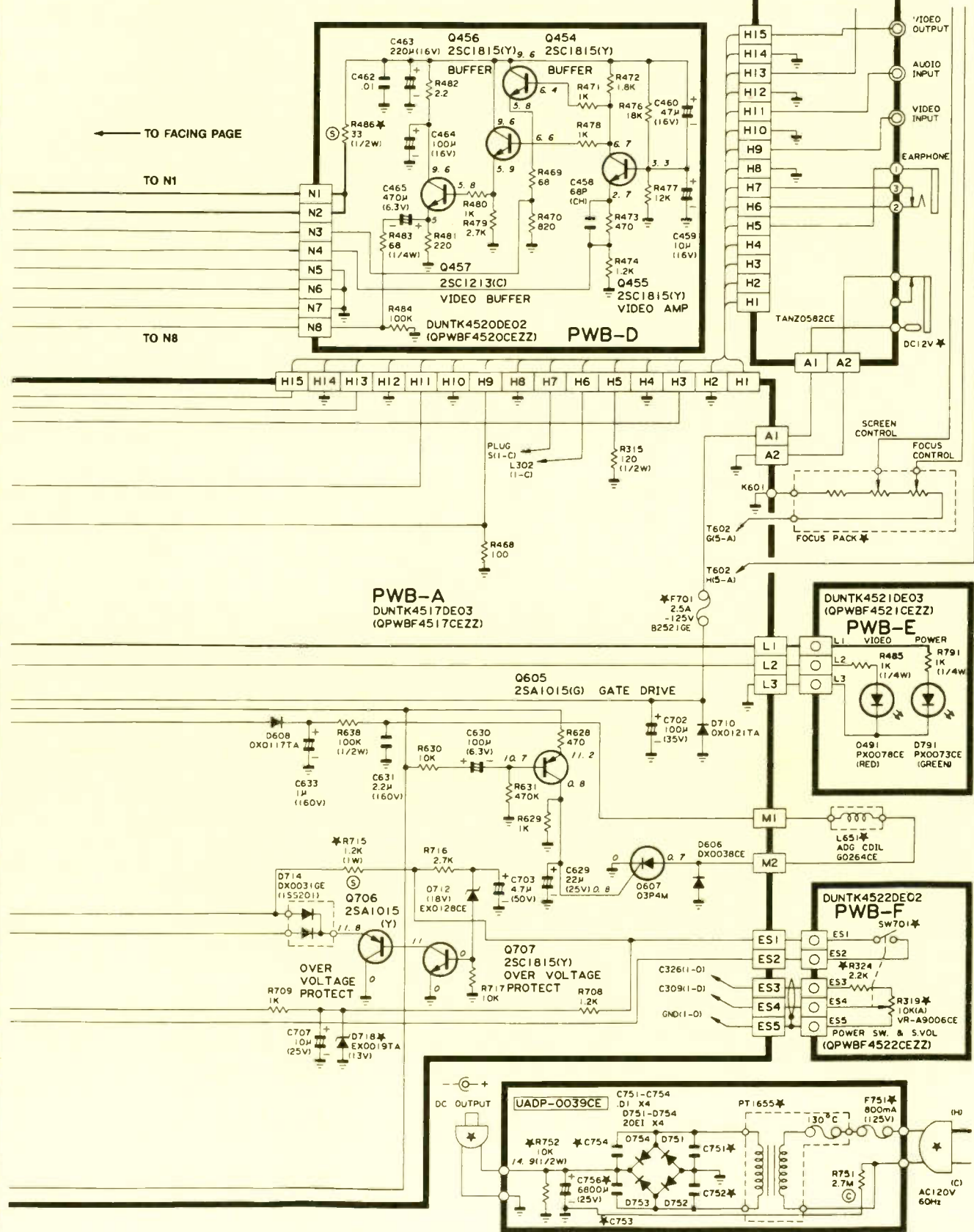

**CHASSIS SCHEMATIC  
RCA PVM050**

Product safety should be considered when component replacement is made in any area of a receiver. A star (\*) next to a component symbol number and a star on or surrounding schematic symbols designate components that have special safety characteristics. Only the exact manufacturer's specified parts should be used as replacements. Use of substitute replacement parts that do not have the same safety characteristics as recommended in factory service information may create shock, fire, excessive x-radiation or other hazards.

This schematic is for the use of qualified technicians only. This instrument contains no user-serviceable parts.

The other portions of this schematic may be found on other Profax pages.



May 1988

Schematic

RCA	Color TV, PVM050.....	3023
Hitachi	Color TV, CT2652, CT2653.....	3024

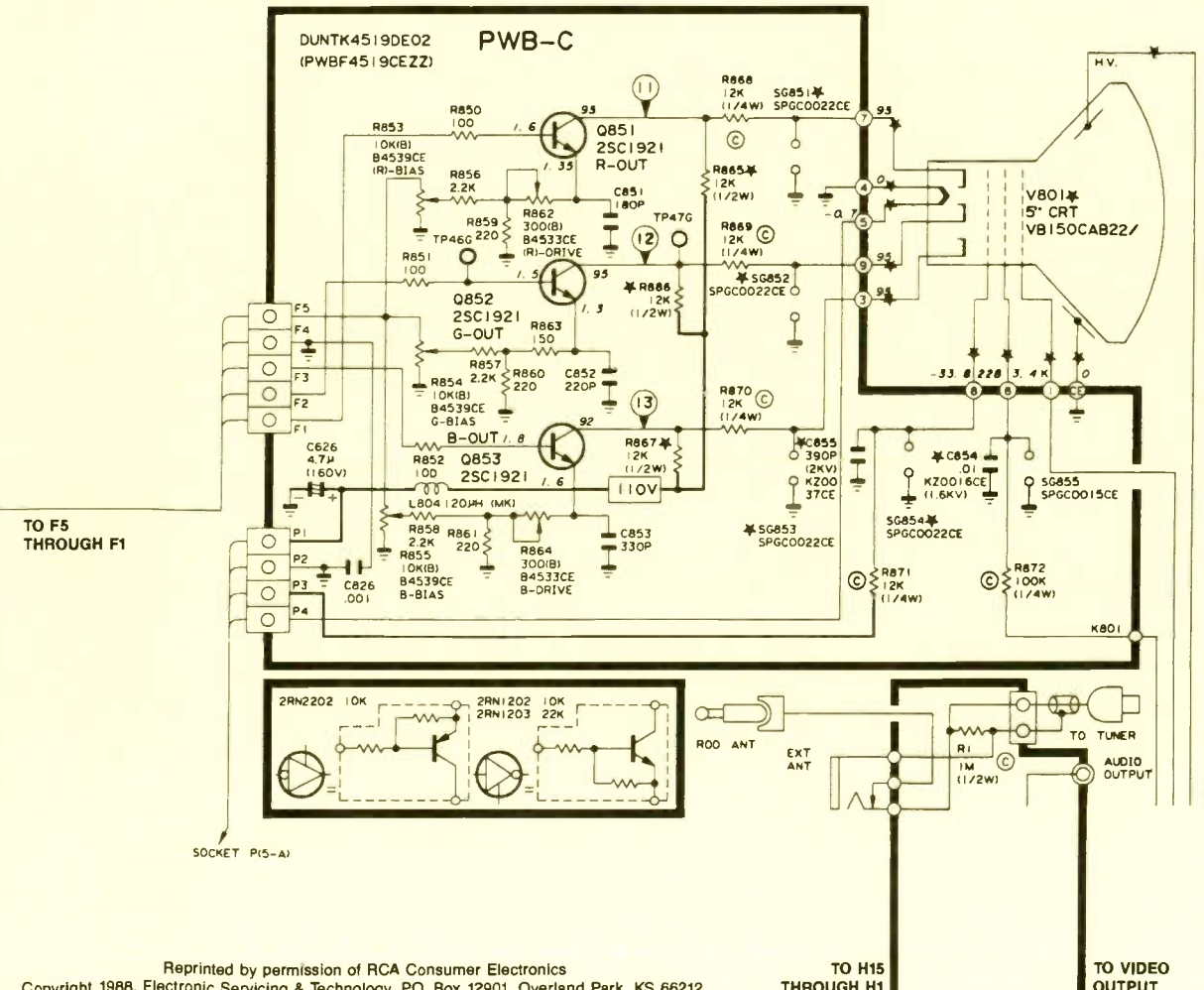



# Put them to the test

## Mini-Meters with Maxi-Specs

5" L x 2 3/4" W x 1 1/4" H    5 1/4" L x 2 1/2" W x 7/8" H    5 3/4" L x 2 1/4" W x 1 1/4" H



### SCOPE 3 1/2 Digit LCD Meter

- 0.5% Accuracy • DC Voltage • AC Voltage • DC Current • Resistance • Diode Test • Battery Life 300 Hrs • Overload Protection: DC 500V, AC 350V, ohms 250V DC/AC.

Model DVM-630  
Our Price **\$2995**  
Zippered carrying case CC-30 \$4.50

### NEW! SCOPE 3 1/2 Digit, LCD 8 Function w/ Transistor Tester

- 0.5% Accuracy • Audible continuity and diode test • 10 Amp measurement • Resistance • DC/AC Voltage.

Model DVM-632  
Reg. \$80.00  
Our Price **\$4495**  
Zippered carrying case CC-30 \$4.50

### SCOPE 3 1/2 Digit LCD w/ Autoranging

- 0.5% Accuracy • Auto/Manual range selection • DC Voltage • AC Voltage • AC Current • DC Current • Resistance.

*Special*  
Model DVM-631  
Our Price **\$4995**  
Deluxe carrying case CA-92 \$9.95

## SCOPE Digital Capacitance Meter

1 pf to 2000 µf



- Digital LCD display • LSI-circuit • High accuracy: 100 PPM 0.5% • Broad test range • Fast sampling time • Capacitor discharge protection • Compact, lightweight design • One-hand operation.

Model DCM-602  
Our Price **\$5995**

## SCOPE Digital Multimeters

- Overload protection • Auto-decimal LCD readout • Polarity indication • 300 hr. 9V battery life • Low battery indicator • 5% DC accuracy



Model DVM-636  
Our Price **\$6750**

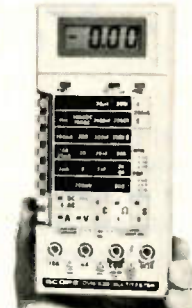

Model DVM-638  
Our Price **\$8750**

- 8 Functions, 37 Ranges including Transistor and Capacitance measurements

- 11 Function, 38 ranges including Logic Level Detector, Audible and Visual Continuity, Capacitance and Conductance measurements

CA-92 Deluxe Padded Case for DVM meters ..... \$9.95  
TL-216 Transistor and Capacitance Test Leads ..... \$9.90



### NEW! SCOPE Frequency Counters

- 8-digit LED • Compact • lightweight • Automatic range and Hold function • High stability in reference oscillator.

Model FC-7011  
100 MHz Our Price **\$16995**

Model FC-7051  
550 MHz Our Price **\$24995**



### FORDHAM Frequency Counter

- 10 Hz - 150 MHz Range • 7-digit LED display • VHF/HF selection • Gate time 1 sec., 5 sec. • ±1 count accuracy.

Model FC-150  
Our Price **\$13990**



### NEW FORDHAM Function Generator

- 0.5 Hz - 500 KHz in 6 ranges • Sine, square & triangle wave forms • VCA and VCF inputs • Accuracy ±5% of full scale.

Model FG-202  
Our Price **\$14990**

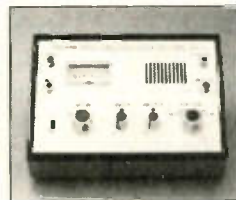

### FORDHAM Signal Tracer/Injector

- Easy to operate • VU meter • Two LED mode indicators • 1 KHz test tone • 8 ohm speaker • Test leads.

Model SE-610  
Our Price **\$11990**

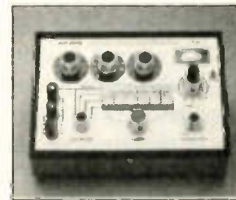

### FORDHAM LCR Bridge Meter

- Fully transistorized • 1 KHz signal generator • Measures resistance, inductance, capacitance • High mechanical and electrical stability • Battery operated.

Model LC-340  
Our Price **\$14995**



### B&K Precision 20 MHz Dual Trace

- Dual/Single trace operation • 1 mV/div sensitivity • Auto/Norm triggered sweep operation with AC, TVH, TVV and Line coupling • Calibrated 18 step time base with 10X magnifier.

Model 2120  
Our Price **\$39995**

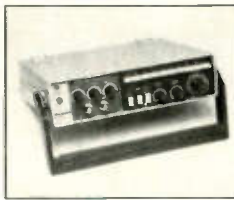

### FORDHAM Sweep Function Generator

- Frequency range 0.2 Hz to 2 MHz • Sine, triangle, square, pulse TTL, wave forms • Frequency accuracy ±5% of length scale • Test leads included.

Model FG-801  
Our Price **\$21995**

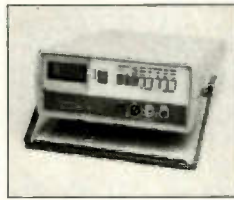

### SCOPE 4 1/2 Digit Bench Digital Multimeter

- 4 1/2 Digit LCD • Automatic (-) negative polarity • Six 1.5V "D" batteries • Low battery indication • Overload protection • Test lead set, batteries, spare fuse incl.

Model DVM-6005  
Our Price **\$21995**



### Hitachi 35 MHz Dual Trace Oscilloscope

- Frequency bandwidth DC to 35 MHz • 6 inch CRT with % calibrations • Autofocus • Scale illumination and photographic bezel • Lightweight, compact • Probes incl.

Model V-355  
Our Price **\$59995**

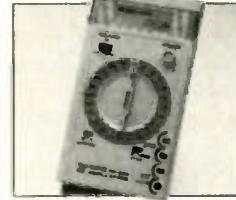

### SCOPE Pocket Sized Audio Signal Generator

- Sine/square wave patterns • 20 Hz to 150 KHz • Battery operation • Freq. accuracy ±3% or less • Output 1.2V rms max. (no load) • Low battery indicator • Test leads / 9V battery incl.

Model RC-555  
Our Price **\$5995**

Telephone Orders Now! Mon. - Fri. 8 a.m. - 6 p.m. EST. Sat. 9 a.m. - 3 p.m. EST

ASK FOR FREE CATALOG. Money orders, checks accepted. C.O.D.'s require 25% deposit

# Fordham

260 Motor Parkway, Hauppauge, NY 11788

Toll Free **800-645-9518**

In NY State 800-832-1446

### Service & Shipping Charge Schedule Continental U.S.A.

FOR ORDERS	ADD
\$25-100	\$4.50
\$101-250	\$6.00
\$251-600	\$8.00
\$601-750	\$10.50
\$751-1,000	\$12.50
\$1,001-1,500	\$16.50
\$1,501-2,000	\$20.00
\$2,001 and up	\$25.00



# Circuit analysis and troubleshooting quiz

## --Part II

By Bert Huneault, CET

Our first "Circuit Analysis and Troubleshooting Quiz" (June 1987) dealt with an audio amplifier circuit. This second multiple-choice quiz will give you an opportunity to test your knowledge of—and apply your troubleshooting skills to—an audiotape recorder circuit.

For the sake of variety, the schematic chosen for this article features PNP transistors and a transformer type of push-pull output circuit rather than the more popular OTL (output-transformerless, or totem pole) circuitry used in the June quiz. This portable tape recorder operates from either batteries or the ac line. The normal dc voltages (relative to ground) shown on the schematic are for ac operation from 117V line voltage.

As in the previous quiz, the answer section doesn't just list the correct answers. It also explains the reasons behind the answers, thus providing useful information.

Huneault is an electronics instructor and head of the REE department at St. Clair College of Applied Arts & Technology.

For readers not thoroughly familiar with tape-recorder circuitry, the answer to question 1 includes a brief circuit description that traces the signal path from the microphone input to the recording head in the record mode, and from the playback head to the loudspeaker in the playback mode. That information might help novices answer some of the subsequent questions.

Go to it now, and score 5 points for each correct answer. Good luck!

### Circuit analysis questions

1. With multiple-section switch  $S_1$  in the position shown on the schematic, the tape recorder is in the:

- (a) record mode.
- (b) playback mode.

2. What is the function of  $30\mu\text{F}$  capacitor  $C_2$  in the first AF amplifier stage?

- (a) It provides dc negative feedback for  $Q_1$ .
- (b) It prevents degeneration.
- (c) It couples the audio signal to  $Q_1$ .

(d) It protects  $Q_1$  from thermal runaway.

3. What is the function of  $33\text{k}\Omega$  resistor  $R_7$  connected between  $Q_1$  and  $Q_2$ ?

- (a) It provides ac positive feedback from  $Q_2$  to  $Q_1$  in order to increase gain.
- (b) It provides dc negative feedback between  $Q_2$  and  $Q_1$ .
- (c) It provides base bias for  $Q_1$ .
- (d) Both (b) and (c) above.

4. What is the function of diode  $D_1$ ?

- (a) It provides protection for output transistors  $Q_4$  and  $Q_5$ .
- (b) It provides protection for the loudspeaker.
- (c) It rectifies the audio signal for the level indicator.
- (d) It prevents excessive audio signal amplitude during recording (peak limiter).

5. This tape recorder features:

- (a) ac erase.
- (b) dc erase.

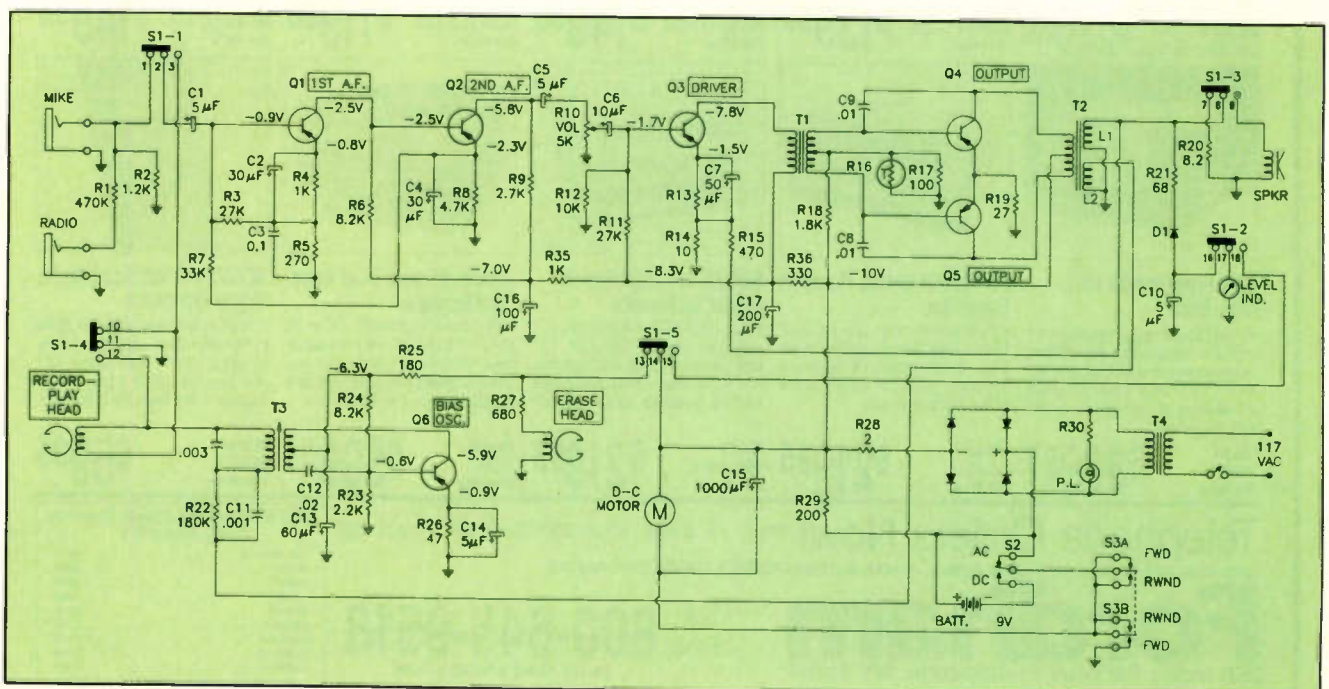



6. What is the function of  $100\mu\text{F}$  electrolytic capacitor  $C_{16}$  (below  $Q_2$ )?

- (a) It reduces 60Hz ripple in the dc voltage supplying  $Q_1$  and  $Q_2$  during ac line operation.
- (b) It decouples stages  $Q_1$  and  $Q_2$  from the  $V_{cc}$  line supplying transistor  $Q_3$ .
- (c) It filters the AGC voltage.
- (d) None of the above.

7. The collector current in transistor  $Q_2$  is:

- (a) between 0.25mA and 0.5mA.
- (b) between 0.5mA and 1mA.
- (c) between 1mA and 2mA.
- (d) more than 2mA.

8. What is the function of audio transformer  $T_1$ ?

- (a) It improves the impedance match between the base circuitry of the output stage and the collector circuitry of the driver.
- (b) It provides split-phase signals for the output stage.
- (c) Both (a) and (b) above.
- (d) None of the above.

9. The  $R_{14}$ - $R_{15}$  resistor network results in:

- (a) reduced amplitude distortion.
- (b) reduced frequency distortion.
- (c) both (a) and (b) above.
- (d) none of the above.

10. The schematic diagram shows that the normal electrode voltages of the  $Q_6$  bias oscillator transistor are  $-0.6\text{V}$  on the base and  $-0.9\text{V}$  on the emitter. Which of the following statements is true?

- (a) These dc voltages are correct.
- (b) Somebody goofed! These dc voltages are wrong because they indicate that the emitter-base junction of PNP transistor  $Q_6$  is reverse-biased.
- (c) The symbol is wrong.  $Q_6$  should be an NPN transistor.
- (d) The base voltage is correct, but the emitter voltage should be  $+0.9\text{V}$  instead of  $-0.9\text{V}$ .

#### Troubleshooting questions

11. Switch  $S_{3B}$ 's ground connection becomes broken (unsoldered) just below the RWND label on the schematic diagram. Which is the most likely symptom?

- (a) The tape recorder records properly, but it cannot play back.

# PANAVISE PRODUCTS FOR TODAY'S TECHNOLOGIES

For over 30 years, PanaVise has made work holding devices for a variety of industries. Our newest line is created specifically for the electronics professional! PanaVise experience and made-in-USA quality ensure years of reliable, long-lasting service.



**STANDARD PANAVISE:** The original "tilt it, turn it, hold it anywhere you want it" vise with the patented split ball. A single control knob lets you position work in three planes—without removing it from the unit! Opens to  $2\frac{1}{4}"$  and comes standard with tough, yet gentle nylon jaws for improved grip. Steel, brass, Teflon® and grooved nylon accessory jaws sold separately. Model #301. Suggested retail \$33.95.

#### IDC BENCH ASSEMBLY PRESS:

For low volume mass termination of IDC connectors on flat (ribbon) cable, choose this quick, economical  $\frac{1}{4}$  ton manual IDC Assembly Press. Select interchangeable base plates for female socket transition connectors, card edge connectors, standard DIP plugs, D-Subs, etc. Ribbon cable and strip header (IDC) cutters also available. Perfect for short run production, R&D centers, MRO's and service technicians. Model #505. Suggested retail \$139.95.

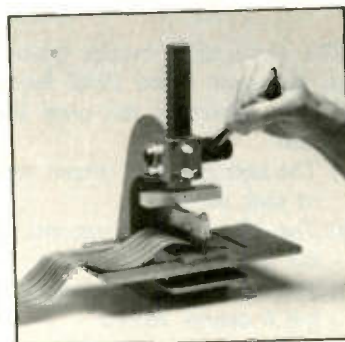

**MULTI-PURPOSE WORK CENTER:** Self-Centering Extra Wide Opening Head (opens to 9") is combined with our famous "split ball" Standard Base to create a versatile work station. Reversible (serrated or "V" groove) neoprene jaw pads gently hold a variety of round or difficult to hold items with ease! Convenient Tray Base Mount (with parts wells) completes the package. Model #350. Suggested retail \$52.95.

**CIRCUIT BOARD HOLDER:** Eight-position rotation, tilt-angle and height adjustments plus six positive-lock positions in the vertical plane mean convenience and versatility! Spring-loaded arm holds circuit boards securely, but allows quick, easy removal and replacement. Perfect for component insertion and soldering: a must for maximum work efficiency. Model #333. Suggested retail \$49.95.

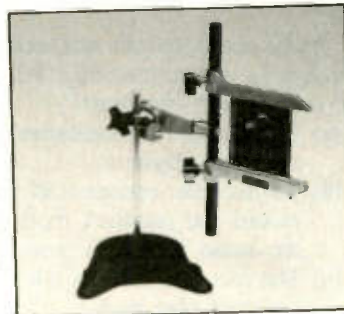

## PANAVISE

See your local electronic equipment supplier or contact PanaVise for the source nearest you.  
PanaVise Products, Inc.; 2850 E. 29th Street;  
Long Beach, CA 90806; (213) 595-7621.



- (b) The tape-transport mechanism works correctly in the forward mode, but it cannot rewind.
- (c) The electronics operate normally, but the motor does not run.
- (d) None of the above.
12. Resistor  $R_{28}$  ( $2\Omega$ ) becomes open (in the power supply). Which is the most likely symptom?
- (a) The tape recorder works OK on batteries but is inoperative on ac line voltage.
- (b) The tape recorder is dead in both modes (battery and ac line).
- (c) The electronics operate normally, but the motor does not run.
- (d) None of the above.
13. The connection breaks open between terminals 3 and 10 of function switch  $S_1$ . Which is the most likely symptom?
- (a) The tape recorder cannot record or play back.
- (b) The tape recorder records OK, but it does not play back.
- (c) The tape recorder plays back OK, but it cannot record.
- (d) Performance is not affected on either record or playback.
14. Resistor  $R_7$  ( $33k\Omega$ ) becomes open. During playback of a prerecorded tape, what is the most likely symptom?
- (a) weak volume
- (b) distorted sound
- (c) no sound (no voice or music heard out of the loudspeaker)
- (d) audible oscillations (squeaks or whistles)
15. Audio output-transformer secondary winding  $L_2$  opens internally. Which is the most likely symptom?
- (a) The recorder is inoperative on record and playback.
- (b) The recorder operates OK in both record and playback modes, but the audio fidelity is reduced.
- (c) The recorder records OK, but it does not play back.
- (d) The recorder does not record, but plays back prerecorded tapes.
16. The dc voltage on all three electrodes of bias oscillator transistor  $Q_6$  measures 0V relative to ground. Which is the most likely defect?
- (a) Transistor  $Q_6$  is defective.
- (b) Resistor  $R_{26}$  is open.
- (c) Capacitor  $C_{13}$  is shorted.
- (d) Capacitor  $C_{14}$  is shorted.
17. The level indicator indicates power-supply voltage during playback but is inoperative during record. Which is the most likely fault?
- (a) a defective meter
- (b) a shorted capacitor  $C_{10}$
- (c) the volume control is turned all the way down
- (d) either (b) or (c) above
18. During playback of a prerecorded tape, no voice or music is heard from the loudspeaker. The volume control is turned up, and signal tracing reveals that the audio signal is present at the collector of  $Q_2$  but absent at the base of  $Q_3$ . What is the most likely defect?
- (a) Capacitor  $C_3$  is shorted.
- (b) Resistor  $R_9$  is open.
- (c) Capacitor  $C_6$  is open.
- (d) Resistor  $R_{12}$  is open.
19. Although the tape-transport mechanism runs OK, the machine does not record or play back. Signal tracing reveals an audio signal at  $Q_3$ 's base but not at its collector.  $Q_3$ 's dc electrode voltages (relative to ground) are as follows: base is  $-2.3V$ , emitter is 0V, collector is more than  $-8V$ . What is the most likely defect?
- (a)  $R_{12}$  is open.
- (b)  $C_7$  is shorted.
- (c)  $R_{14}$  is open.
- (d)  $Q_3$  has an open emitter-base junction.
20. Music and voice reproduction suffers from amplitude distortion. What is the most likely defect?
- (a)  $R_{18}$  is open.
- (b)  $R_{19}$  is open.
- (c)  $C_4$  is open.
- (d) Any of the above.

### Answers

1—(a). In this recording mode, the input signal from the microphone or radio jack passes through switch  $S_{1-1}$  (contacts 1 and 2 closed) and through coupling capacitor  $C_1$  to the base of the first audio amplifier transistor. After amplification by  $Q_1$ , the audio signal is direct-coupled to the base of  $Q_2$  for further amplification. It is then RC-coupled through  $C_5$ ,  $R_{10}$  and  $C_6$  to the base of the driver transistor. Note that in this mode,  $R_{10}$  acts as a *recording level control*. Used in conjunction with the level indicator, the recording level con-

rol prevents overdriving the tape.

The amplified signal at the collector of  $Q_3$  is transformer-coupled to the bases of push-pull output transistors  $Q_4$  and  $Q_5$ . Push-pull output transformer  $T_2$  features two secondary windings,  $L_1$  and  $L_2$ . The audio output signal induced into the  $L_2$  secondary is coupled through a frequency compensation network ( $R_{22}$ - $C_{11}$ ) and through the secondary winding of oscillator transformer  $T_3$  to the high side of the recording head.

Note that in this mode, the low side of the head is returned to ground through closed contacts 10 and 11 of function switch  $S_{1-4}$ , thus completing the circuit. The secondary of  $T_3$  adds the high-frequency bias signal to the audio signal applied to the recording head. The resulting shift in operating point prevents distortion that otherwise would be caused by the non-linear characteristics of the magnetic tape's B&H curve.

While this recording action is taking place, an audio signal is also induced into transformer  $T_2$ 's  $L_1$  secondary. This signal is fed through closed contacts 8 and 7 of switch  $S_{1-3}$  to 8.2 $\Omega$  dummy load resistor  $R_{20}$ , as well as through series resistor  $R_{21}$  to the level indicator circuitry consisting of  $\frac{1}{2}$ -wave rectifier  $D_1$ , filter capacitor  $C_{10}$ , closed contacts 16 and 17 of switch  $S_{1-2}$ , and a dc voltmeter.

Note that in this recording mode, the loudspeaker is switched out of circuit by switch  $S_{1-3}$ . Finally, note that switch section  $S_{1-5}$  applies dc voltage from the power supply (through closed contacts 13 and 14) to the erase head as well as to the high-frequency bias oscillator, energizing both circuits.

When we switch over to the playback mode, the multiple poles of switch  $S_1$  slide over to the right, closing contacts that were previously open and opening contacts that were previously closed. As a result, closed contacts 11 and 12 ( $S_{1-4}$ ) ground one side of the playback head, while the audio signal at the opposite terminal of the head is coupled through closed contacts 3 and 2 ( $S_{1-1}$ ) and through coupling capacitor  $C_1$  to the first AF amplifier.

Following amplification by the various stages, the audio output signal induced into the  $L_1$  secondary of  $T_2$  is applied through closed contacts 8 and 9 ( $S_{1-3}$ ) to the loudspeaker, while dummy load resistor  $R_{20}$  is switched out of circuit. During this playback action, variable resistor  $R_{10}$  is adjusted for the



desired volume. Switch  $S_{1,2}$  disconnects the voltmeter from the audio circuitry and connects it through closed contacts 17 and 18 to the dc power supply, giving the user a handy indication of the battery condition during portable operation.

Finally, note that in this playback mode, switch  $S_{1,5}$  disables the erase head and bias oscillator circuits by removing dc power from terminal 13.

2—(b).  $C_2$  is a bypass capacitor across emitter resistor  $R_4$ . Its reactance is negligible at audio frequencies, thus preventing  $R_4$  from producing ac negative feedback (degeneration). Incidentally,  $R_4$  does produce dc negative feedback, which stabilizes the bias and protects  $Q_1$  from thermal runaway.

3—(d). Note the absence of the usual connection from the base of  $Q_1$  to the power supply. So how is the base of  $Q_1$  biased? The  $33k\Omega$  resistor is the answer. Along with  $R_3$  and  $R_5$ , resistor  $R_7$  forms a voltage-divider network that supplies  $-0.9V$  bias voltage to  $Q_1$ 's base, but the source of this dc voltage is the emitter of  $Q_2$  ( $-2.3V$ ) rather than the power supply. This connection between  $Q_2$  emitter and  $Q_1$  base also constitutes a dc negative feedback loop that provides bias stabilization of the direct-coupled  $Q_1$  and  $Q_2$  transistors. For example, if heat makes the  $Q_2$  collector current rise (increased leakage current), the dc voltage at  $Q_2$ 's emitter would likewise increase, i.e., become more negative than  $-2.3V$ . This would apply more forward bias (through  $R_7$ ) to the base of  $Q_1$ , making  $Q_1$  conduct a little more heavily, thus causing a reduction of its collector voltage to something less than  $-2.5V$ . Because  $Q_1$  is direct-coupled to the base of  $Q_2$ , this decreasing negative voltage reduces the forward bias on the N-type base of  $Q_2$ . This reduces the latter's collector current, offsetting the initial rise in collector current caused by heat.

4—(c). The answer to this one was just about given away in the circuit description relating to question 1. The level indicator is a dc voltmeter, but the audio signal from secondary winding  $L_1$  is an ac voltage. Diode  $D_1$  simply rectifies the audio signal, and filter capacitor  $C_{10}$  charges up to the average level of the pulsating dc voltage; the latter varies with signal fluctuations and is indicated by the voltmeter. Recording level con-

# NEW SERVICES FROM PTS

## TUNERS



Varactor  
Front ends  
Standard

## MODULES



Mother boards  
Single function  
Manufacturer's Updates

## VCR



VHS  
Beta  
Portables

## TVRO

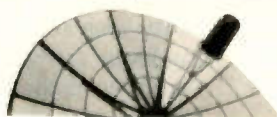

Receivers  
Actuators & Arms  
Down converters

■ PTS wants your repair business. And they have made some big changes at servicenters nationwide. New test equipment. New quality assurance programs. Even faster express service! And a new 800 number to serve you better. Call PTS today.

## THE NEW

# PTS

## 1-800-441-2371

Ask for the servicenter or distributor nearest you.

PTS Corporate Headquarters  
P.O. Box 272  
Bloomington, Indiana 47402

Circle (18) on Reply Card



trol  $R_{10}$  is adjusted so that the loudest audio peaks do not exceed the 0dB red line on the voltmeter scale.

5—(b). As pointed out in the circuit description, dc voltage from the power supply is applied to the erase head (through resistor  $R_{27}$ ) during recording. As the tape moves by the erase head, previously recorded magnetic patterns are erased before reaching the vicinity of the record head. Although erasing with dc is acceptable in low-cost tape recorders, better-quality machines generally feature ac erase, which applies high-frequency current from the bias oscillator to the erase head.

6—(b). With  $1k\Omega$  resistor  $R_{35}$ ,  $C_{16}$  forms an RC-decoupling network that eliminates unwanted coupling between  $Q_3$  and the first two stages via the common impedance of their  $V_{cc}$  supply. If you were tempted to answer (a), keep in mind that the power supply features a *full-wave* bridge rectifier. Therefore, any ripple not fully filtered by  $C_{15}$  and  $C_{17}$  would be 120Hz ripple, not 60Hz.

7—(a). Here, Ohm's law comes to our rescue. As indicated on the schematic, the normal dc voltage is  $-5.8V$  at the collector and  $-7.0V$  at the bottom of the  $2.7k\Omega$  collector load resistor. Therefore,  $R_9$  drops 1.2V. Hence, the collector current must be  $1.2V/2,700\Omega = 0.44mA$ .

8—(c). Driver transformer  $T_1$  provides the proper impedance match between the relatively low input impedance of the output transistors and the higher output impedance of driver transistor  $Q_3$ . At the same time,  $T_1$  also provides (because of its center-tapped secondary) opposite phase signals for the bases of the push-pull output transistors.

9—(c). The  $R_{14}$ - $R_{15}$  voltage divider network constitutes an ac negative feedback loop between the secondary ( $L_1$ ) of the audio output transformer and the driver's emitter circuit; negative feedback reduces both amplitude distortion and frequency distortion in the audio output signal.

10—(a). If  $Q_6$  were a Class-A amplifier, those voltages would be wrong. But  $Q_6$  is an oscillator and, as is commonly the case, it features *signal bias* (*grid-leak* bias for you old-timers).

Although the transistor does require

forward base-emitter bias to get it started—and more than 1V is indeed provided by the  $R_{23}$ - $R_{24}$  voltage divider network—the base current produced by negative peaks of the oscillating signal charges  $C_{12}$  positively on the base side; during the rest of each cycle,  $C_{12}$  discharges through  $R_{23}$ . This *base-leak* action reduces the average base voltage to  $-0.6V$ , making it appear as if the  $Q_6$  base-emitter junction is permanently reverse-biased. However, remember that periodically it becomes *forward biased* because of those negative signal peaks. This is what keeps the transistor switching back on.

11—(d). The forward/rewind switch normally returns the positive terminal of the power supply to ground in the forward mode (record or play), thus completing the  $V_{cc}$  supply circuit for the electronics. When the rewind button is depressed, this power-supply ground return becomes disconnected, effectively disabling the transistor circuitry. Thus, you don't hear Mickey Mouse or Alvin the Chipmunk during the fast-rewind operation. With an open-ground defect, the audio circuitry obviously is dead during both record and playback. However, note that the tape-transport mechanism continues to operate normally because the switch  $S_{3A}/S_{3B}$  wiring keeps the motor connected across the power supply even when the ground connection is broken.

12—(a). This one is a giveaway! Incidentally, in this machine, ac/dc switch  $S_2$  is mechanically activated by either inserting the ac line cord into or pulling the cord out of its receptacle at the side of the cabinet.

13—(b). With that connection broken, the audio signal from the head is prevented from reaching the base circuit of the first AF transistor during playback. Record operation is unaffected.

14—(c). The most likely symptom would be no sound because transistor  $Q_1$  is cut off in the absence of base bias normally applied through  $R_7$  from the emitter of  $Q_2$  (see answer 3). The weak signal from the playback head has insufficient amplitude to turn on  $Q_1$ , even on its most negative peaks.

15—(d).  $L_2$  is only used to supply the audio signal to the head during record

applications. Playback is unaffected.

16—(c). With  $C_{13}$  shorted, the  $-6.3V$  supply voltage for the base and collector circuits of  $Q_6$  drops to zero. So does the emitter voltage because current stops flowing through  $R_{26}$ . Incidentally, if the  $180\Omega$  decoupling resistor  $R_{25}$  is rated at 0.5W or less, it will likely go up in smoke because of excessive current caused by the short.

17—(d). With  $C_{10}$  shorted, obviously no voltage is applied to the voltmeter during record. Likewise, if the volume control is turned fully down, no audio reaches the output stage and diode  $D_1$  has no signal to rectify.

18—(c). An open  $C_6$  prevents the audio signal from reaching the base of  $Q_3$ . A shorted  $C_5$  would lower the  $Q_2$  collector voltage somewhat, but it would not kill the signal. Neither would an open  $R_{12}$ , which would only shift the base bias of  $Q_3$  slightly.

19—(d). With an open emitter-base junction, the transistor cuts off. With no current flow, the emitter voltage drops to zero and the collector voltage increases to the full supply value. With only bleeder current flowing through  $R_{11}$ ,  $Q_3$ 's base voltage increases to the value determined by the  $R_{12}$ - $R_{11}$  voltage divider ratio, i.e., about  $-2.3V$ .

20—(a). An open  $R_{18}$  would remove forward bias from the output transistor bases. This shift in operating point would result in Class-B operation and crossover distortion. An open  $R_{19}$  would, of course, kill the audio completely. An open  $C_4$  would introduce degeneration in the second AF amplifier. This, if anything, would tend to *reduce* distortion, not increase it.

#### The moment of truth

Well, now that all of this hard work is over, how did you make out? If you scored 5 points for each correct answer, the following "truth table" will give you the good (or bad?) news:

90-100: Super technician  
75-85 : Promising technician  
60-70 : Brush up a bit on tape recorders and/or troubleshooting techniques  
Under 60: You definitely need to study previous and future articles in this series of circuit analysis and troubleshooting quizzes.



## Literature

### Publication catalog

*Lynco Publications* has published a 12-page catalog listing its service management publications. The company specializes in publications designed to help improve efficiency and profitability in service operations. Subjects covered include technician productivity, service marketing, effective advertising, profitable repair-parts management and cost control.

Circle (125) on Reply Card

### Test equipment catalog

*A.W. Sperry Instruments* is offering its 27-page MC-600—Issue A catalog. The catalog features the company's line of products and includes all specifications and accessories. New additions include a non-contact voltage detector and redesigned Snap-Around volt-ohm-ammeters with expanded ranges.

Circle (126) on Reply Card

### Testing and prototyping catalog

A 28-page catalog of electronic testing and prototyping equipment is available from *Global Specialties*. Included in the Spring 1988 catalog are breadboarding and educational products, logic test equipment, power supplies, test instruments and accessories.

Circle (127) on Reply Card

### Electronics instruments catalog

The Winter/Spring 1988 catalog from *Genstar REI Sales Company* lists thousands of like-new instruments. The catalog includes analyzers, desktop computers, printers, recorders, oscilloscopes, generators and more. Prices, warranties and illustrations are provided.

Circle (128) on Reply Card

### Test and measurement catalog

A catalog featuring the test and measurement product line from *John Fluke Mfg.* and *N.V. Phillips* is now available. The 512-page catalog includes descriptions of more than 600 products. New sections cover oscilloscopes, logic analyzers and GPIB instrument systems. The catalog includes expanded signal generator and counter/timer sections, plus a new introduction section that describes 13 new products.

Circle (129) on Reply Card

### New/used equipment catalog

*Lectronic Research Labs* has released its 224-page catalog for 1988. Detailed descriptions and prices are included for 6,000 items of new and used electronic equipment and microwave components. All pre-owned equipment is reconditioned and calibrated to meet original manufacturers' specifications and is warranted for 120 days.

Circle (130) on Reply Card

### Test equipment catalog

The AAD-38 36-page catalog from *Amprobe Instrument* has complete specifications for the company's analog and digital clamp-on volt-amp-ohmmeters and multimeters, capacitor analyzers, digital tachometers, pyrometers and thermometers, circuit tracers, megohmmeters and more.

Circle (131) on Reply Card

**ES&T**

# NEW

## "FOR ZENITH T.V. SERVICERS"

For Zenith models V, Z, A, B and C send us all modules, leaving tuner control, picture tube, yoke in set, and we will repair your modules with full warranty for only \$39.95 —that's right 39.95\* ... Look:

### All you need to do is this:

1. Tell us the problem.
2. Send us all modules (except tuner control, picture tube and yoke.)
3. Do not remove chips and transistors from their position.
4. If you wish mark chips, and modules.

### We will:

1. Repair your modules.
2. Provide full warranty for 6 months, including flyback and chips.
3. Return your modules with no service charge if found in proper working order.
4. Provide tips for reinstallation of modules.
5. Work done and supervised by Certified Electronic Technician.

### WHAT ARE THE BENEFITS TO YOU?

- No inventory
  - No guess work
  - Fast turn around
  - Lower cost per service
- For free technical assistance call: 1-800-759-6767  
9-6 Eastern Standard Time  
\* Free Return Shipping  
\* IC'S Extra

# SERA SERVICE

## INDEPENDENT ELECTRONIC REBUILDER

2343 N.W. 20 Street  
Miami, Florida 33142  
(305) 642-4000

EXCELLENCE IS FOUND WITH SPECIALIZATION  
WE SPECIALIZE IN ZENITH

Circle (19) on Reply Card



# Test your electronics knowledge

By Sam Wilson, CET

1. Refer to the crystal radio circuit in Figure 1. Which of the following is correct regarding the circuit composed of L and C?

- A. They form a series-tuned circuit.
- B. They form a parallel-tuned circuit.

2. Which of the following diodes would work best in the circuit in Figure 1?

- A. a gallium arsenide (GaAs) diode
- B. a silicon rectifier diode
- C. a constant-current diode
- D. a hot-carrier diode

3. Which of the following best describes the purpose of j in the expression  $10-j6$ ?

- A. It shows that 6 is to be subtracted from 10.

B. It shows that 6 is the value of inductive reactance.

C. It shows that 10 and 6 are at right angles.

D. It shows that 6 is an imaginary number that cannot be defined.

4. What is the capacitive reactance of the series capacitor combination in Figure 2?

5. An oscilloscope display shows five cycles of sine wave voltage. Increase the sweep speed to see:

- A. more cycles.
- B. fewer cycles.

6. Increasing the bandwidth of an amplifier will:

- A. increase the noise.

B. decrease the noise.

7. Convert the following BCD number to a decimal number: 100100110010.

8. Shot noise is present whenever dc current flows through a resistance. It is an alternating current that exists only where there is dc current and is present in both tubes and transistors. What is another name for shot noise?

9. What is the name of the component that has the symbol shown in Figure 3?

10. Given  $x = 10 \log P_2/P_1$ , what is the name for x?

Answers are on page 52.

Wilson is the electronics theory consultant for ES&T.

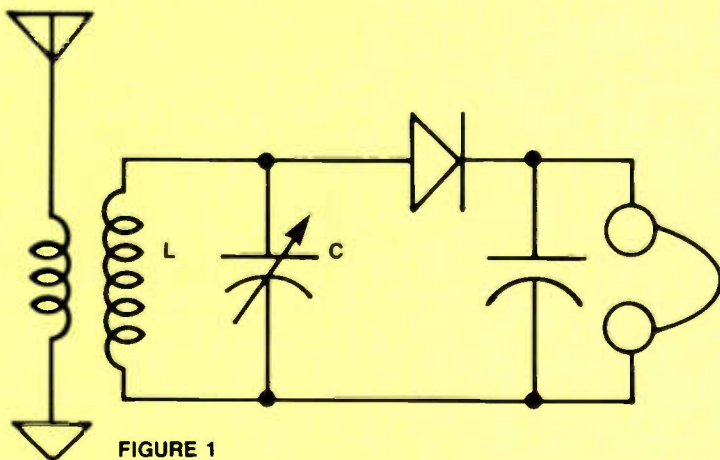

FIGURE 1

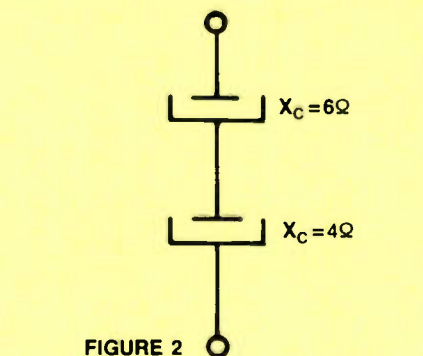

FIGURE 2



FIGURE 3



# Don't make your customers hate their VCR's guts.

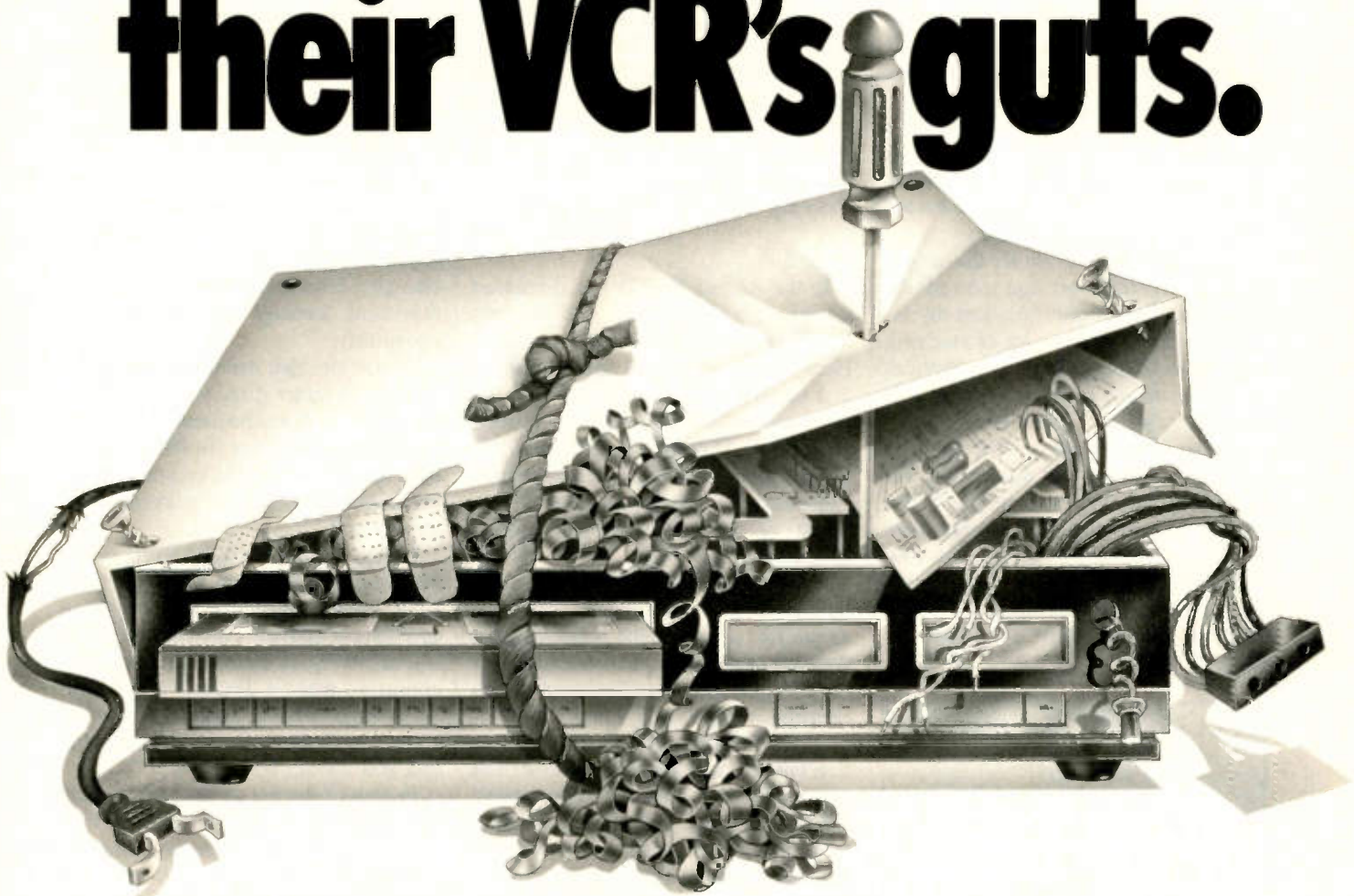

## Use authentic RCA/GE brand exact replacement parts.

The last thing your customers want to see after having their VCRs repaired is an instant replay of the original problem.

But that's what can happen when you use off-brand replacement parts. Mailings from unknown discounters may offer incredibly low prices. Brochures from unproven aftermarket manufacturers may look very attractive, too. But that second-rate quality and service may also cost you your customers.

That's why you should depend on RCA/GE exact replacement parts for VCRs. No one in the industry offers a wider, more reliable product line. With RCA/GE parts you'll not only keep your customers happy, you'll also keep them loving their VCRs — inside and out.

To learn more, see your local RCA/GE Parts Distributor. Or write: Thomson Consumer Electronics, Sales Promotion Services, Distributor and Special Products, 2000 Clements Bridge Road, Deptford, N.J. 08096-2088.



**VCR Replacement Parts**

Circle (20) on Reply Card



# What do you know about electronics--

## Backward transistors:

## An update

By Sam Wilson, CET

When I was a young technician at Hughes Aircraft, an instructor in that company gave me some good advice: A sure way of understanding electronic circuits is to learn all you can about vacuum tubes, especially about what goes on *inside* those devices.

At that time, the transistor had been invented, but I had never seen one, so he didn't explain that the same advice holds true for all semiconductor devices.

Lately, I've come to realize the importance of carrying over that tube advice to all solid-state amplifiers and thyristors. I've been doing a lot of studying about what happens inside the devices as well as what's going on outside. It is starting to make a difference.

Letters from readers, like the one from Robert Knupp in this article, are helpful in rounding out the study. His letter is so important that I want to share it (and some of his enclosures) with you.

The article that triggered Knupp's response described an experience that a reader named John Justice reported. He

Wilson is the electronics theory consultant for ES&T.

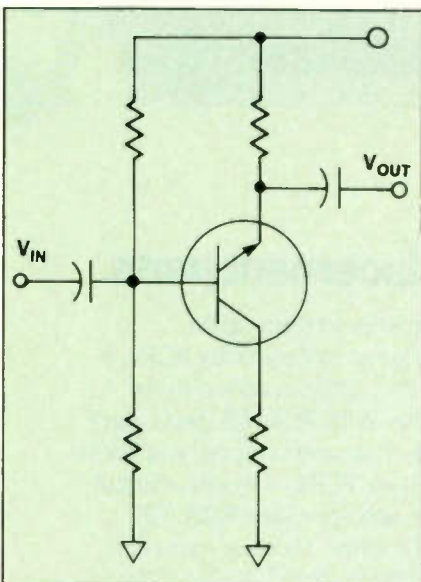

Figure 1. When connected upside-down, this transistor worked, but with reduced gain.

connected a transistor upside-down as shown in Figure 1. The transistor worked but with reduced gain. (See "What Do You Know About Electronics?" in the August 1987 issue.)

My concern was that this would be an easy mistake to make. The result: The circuit would work, but not as well as it should. That, in turn, would introduce an additional (unnecessary) troubleshooting problem. Here is his letter:

Dear Sir:

In the August ES&T, you discussed interchanging collector and emitter leads in bipolar transistor circuits. Here's some additional information.

A transistor that behaves in nearly the same way in either direction is termed *symmetric*. Most practical devices are highly *asymmetric* because the forward characteristics are optimized at the expense of the *backward* or inverse connection.

As you noted, inverse beta is usually far smaller than the forward value. This means that inverse alpha is also smaller than forward alpha. The tendency for the collector current to increase with increasing voltage (the *Early effect*) is often unnoticeable in the forward direction but becomes severe in reverse. The common-base forward breakdown  $BV_{CBO}$  for a small-signal silicon transistor may easily exceed 100V, whereas the inverse value  $BV_{EBO}$  is less than a dozen volts. The collector junction should withstand current-limited breakdown; the emitter may not. Operation in inverse avalanche mode can permanently damage a transistor's characteristics.

In general, operating a transistor in reverse offers poorer performance, with one small exception. Near the origin, the common-emitter inverse characteristic curves are slightly more ideal than normal. This can be desirable for low-level switching. Naturally, the lower beta requires that you supply a larger base current to ensure saturation.

Symbols for parameters such as alpha and beta are given subscripts to distinguish between the two modes of operation. So, forward or *normal* alpha is denoted  $\alpha_F$  or  $\alpha_N$ , and inverse or *reverse* alpha is  $\alpha_R$  or  $\alpha_I$ . Typically,  $\alpha_F$  is near unity, while  $\alpha_R$  ranges from 0.2 to 0.7. Both alphas are used extensively in large-signal modeling. An important example is the equation relating reverse saturation currents for the collector and emitter junctions:  $\alpha_R I_{CS} = \alpha_F I_{ES}$ . Actually, a transistor's parameters vary under changing circuit conditions. *Constants* represent average values in most equations.

Transistors that are manufactured to be used in either direction often go by the name *choppers* because of their use in chopper amplifiers. In this case, the data sheet provides information on inverse operation, including inverse beta, shown as  $h_{FE(INV)}$ .

Notice that *inverse* is the fourth possible region of operation for a transistor (thus: cutoff, saturation, forward active and inverse active). This possibility for two active region connections can cause confusion when a device with unidentified leads is being tested. Choose the hookup with the highest measured beta and you should be safe.

In manufacturing a transistor, a good collector makes a poor emitter and vice versa, so a decent transistor cannot be completely symmetric. An efficient emitter is heavily doped and has a small junction area. By contrast, efficient collection requires a large collector junction area and a lightly doped collector, which also raises the forward breakdown voltage. Furthermore, in modern transistors, in addition to the base being very thin, the doping varies gradually across the base (called *grading*). In the forward direction, this helps to steer charge carriers toward the collector and also curbs the Early effect. However, in reverse it makes things much worse.

If nothing else, the inverse mode might provide some interesting student



experiments of just how bad it can get when you use poor-quality devices.

One last item. In the "Justice differential amplifier," the transistors are effectively connected backward and are also changed from common-emitter to common-collector. As a result, phase-splitter action causes the small-signal characteristics to be inverted.

I have enclosed some related articles of interest.

**Robert Knupp**  
Mesa, AZ

Figure 2 shows how the collector current changes as the collector-emitter voltage of a bipolar transistor is increased. The emitter of the NPN tran-

sistor is positive with respect to the collector.

At the point marked with an X, the beta value is 2. John Mulvey discusses this curve in *Measurement Concepts—Semiconductor Measurements* (Tektronix, 1968).

He says that under certain conditions, the characteristic of the reverse-connected transistor is favorable for circuit-design considerations. His specific example is in the saturation region (where switching transistors operate).

In *Electronic Engineering* magazine (August 1973), L.S. Cornish discusses the problem of reverse base-emitter breakdown. (Note: This breakdown occurs when a transistor is connected up-

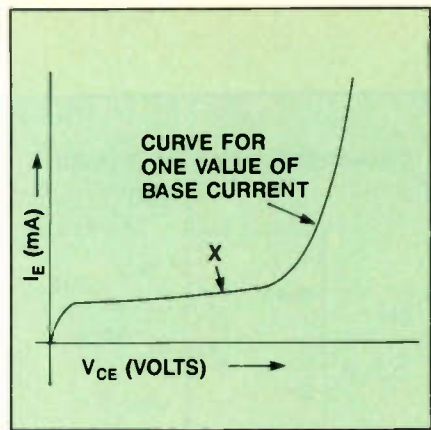

**Figure 2.** This curve shows how the collector current changes as the collector-emitter voltage of a bipolar transistor is increased. The emitter of the NPN transistor is positive with respect to the collector.

side-down in a circuit.)

He says that when the emitter-base junction is reverse-biased, there can be a 40% to 60% reduction of beta. When the circuit was left unpowered, there was a slight recovery of the beta. That recovery occurs more quickly when a slight forward current is applied at the junction.

The degradation of the emitter-base junction and the low value of beta limit the applications of reverse-connected transistors. However, there are some ad-

# NEW RUGGEDIZED SCOPE PROBES

Just a phone call away.

**\$35** P6103

50 MHz 10x  
Compensation Range  
15 to 35 pF

**\$58** P6109

150 MHz 10x  
Compensation Range  
18 to 22 pF

These new passive voltage probes can be used with any oscilloscopes having matching compensation ranges.

Screw in tips mean easy repair, no downtime.

To order call toll free **1-800-426-2200**

VISA and MasterCharge accepted.

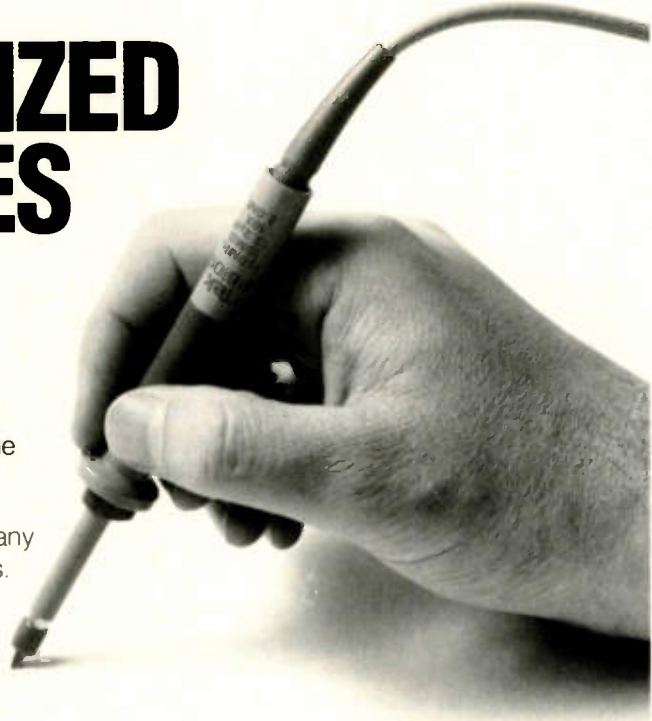

**Tektronix**  
COMMITTED TO EXCELLENCE



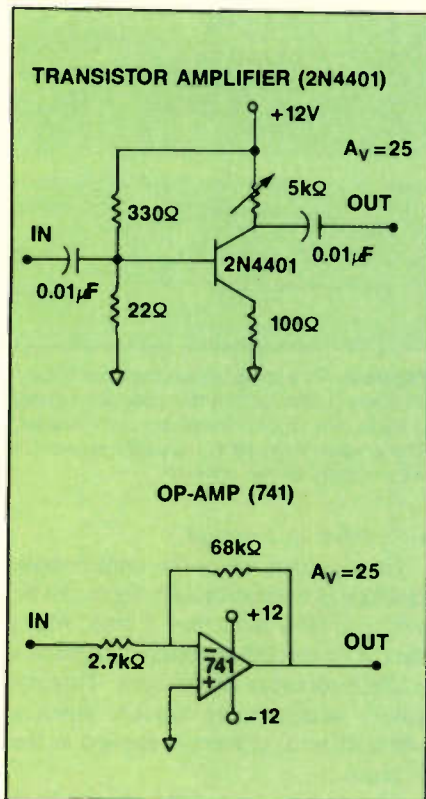

vantages to the reverse-connected transistor in switching circuits where the transistor operates in the saturation region.

#### Discrete vs. IC (op-amp)

Glen Langley of West Palm Beach, FL, has sent the results of an experiment he performed comparing a discrete transistor amplifier with a 741 op-amp circuit. Both had gains of about 25. Figure 3 shows the circuits.

He expected to prove the op-amp to be superior. Surprisingly, it was no match for the discrete circuit. The 2N4401 circuit provided an output with less distortion *and did it at a lower cost.*

His conclusion is that the op-amp is favored because it is easy to use, not because it is a better circuit.

Of course, the 741 op-amp is not the

**Figure 3.** A comparison of a discrete transistor amplifier and an op-amp circuit, both with gains of about 25, showed one reader that the transistor provided an output with lower distortion and lower cost.

best choice for an amplifier face-off, but the 2N4401 is probably not the best transistor in the business.

I would be interested in hearing from any readers who want to defend the op-amp.

#### Gamma

Dear Sir:

During 1986, you discussed the use of the symbol *gamma* in transistor work. It has indeed been used to represent common-collector current gain, but the most widely accepted usage has always been for emitter efficiency. An efficient emitter readily injects carriers into the base (which then participate in transistor action) while accepting very few carriers from the base (which contribute only to the total base current). The emitter doping is very heavy relative to the base, so that the emitter has vastly more majority-charge carriers. This makes *gamma*, the ratio of carriers injected to the total that flow, close to unity.

**Robert Knupp**  
Mesa, AZ

**ES&T**

## Quiz answers

1. A—series tuned. Although the inductor and capacitor look as if they are in parallel, the induced secondary voltage is in series with the inductor. Therefore, it is a series-tuned circuit.

2. D. You want a diode that has practically no forward breakover voltage, so you want a hot carrier diode.

3. C—The purpose of *j* in the equation is to show that 10 and 6 are at right angles. The *j* operator says turn right (for negative values) and turn left (for positive values).

4. 10Ω. Capacitive reactances add when they are in series.

5. B—fewer cycles. The equation for the number of cycles displayed is:

the number of cycles displayed = sweep time of scope/time for one cycle of signal being measured.

For a given input signal, increase the sweep speed (numerator).

6. A—increase noise. Both shot noise and thermal agitation noise increase as bandwidth increases.

7. 932. Separate the number into groups of four:

1001	0011	0010
9	3	2

8. Schottky noise. (The question describes shot noise.)

9. A *diac* or 3-layer diode. It is used to prevent an SCR or triac from conducting until the gate reaches a certain minimum value.

10. *x* is the value of decibels.

**ES&T**



## Circuit repair kit

A.P.E. has introduced a combat circuit repair kit that includes everything required to repair, rework, modify, cannibalize and install engineering changes to circuit boards, including multilayer and multiwire boards. The kit is designed for facilities that are isolated from normal supply routes.

Circle (75) on Reply Card

## Regulated dc power supplies

A line of regulated dc power supplies is available from the *Brunelle Commander Series*. These units feature short-circuit protection and both automatic constant-current and constant-voltage output with low ripple. Sixteen models, including four dual-tracking units, are available in six voltage ranges between 0Vdc and 18Vdc and 0Vdc and 150Vdc with current levels from 2A to 20A.

Circle (76) on Reply Card

## Workbench tools

Desco Industries has introduced several new tools to help with production of electronic assemblies. Tools in-

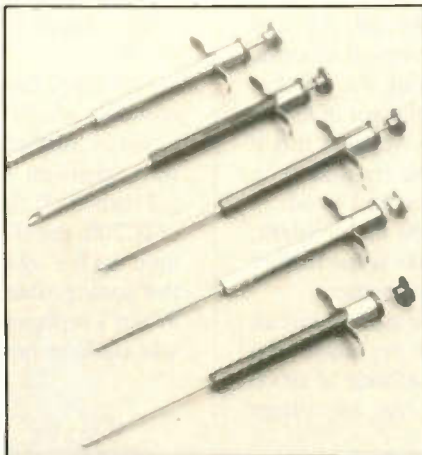

clude a line of lead extractors for removing the center conductor from shielded and coaxial cables.

Circle (77) on Reply Card

## Spool holder

Wybar Electronics has announced the model SA-1 Spool Aid for holding small spools of wire and solder. The holder accommodates a standard, 5-pound reel of solder and holds small reels of wire. Reels up to 3 inches wide and 4 inches in diameter with a minimum arbor hole diameter of 1/4 inch can be used with the holder.

Circle (78) on Reply Card

## Tool kit

The JTK-6 compact tool collection from Jensen includes 24 electronic tools: seven screwdrivers, a 4-inch adjustable wrench, two pair of pliers, a wire stripper, a knife, an alignment tool, a rule, a hex-key set, scissors, a bur-nisher, a soldering-iron, a solder aid, and a fork and hook. The case also will hold a probe meter.

Circle (79) on Reply Card

Continued on page 57.

# Self-Contained Bench-Top Desoldering

“The Solution for any demanding through-hole application”

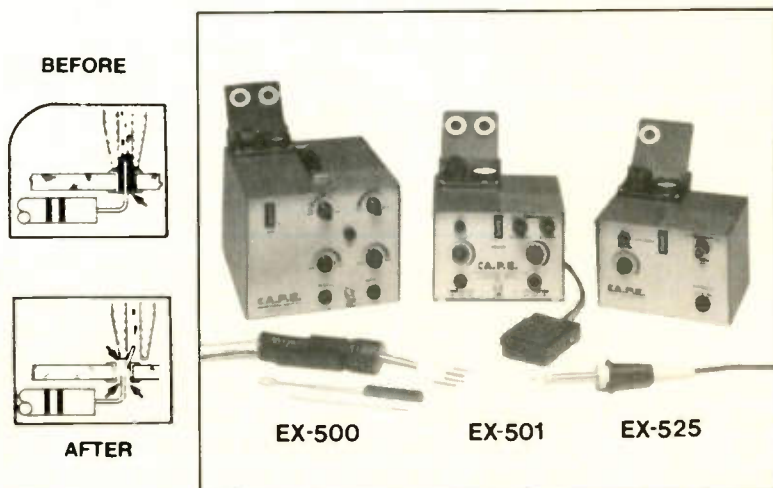

A.P.E. introduces the most efficient spike-free method for multi-lead component removal.

To ensure high reliability, repair, quality and consistency, our new generation model EX-500, EX-501, and EX-525 systems have the following new features:

- Zero voltage switching and localize grounding for CMOS safety
- Low voltage heating elements and accessories for operators safety
- Microprocessor controlled temperature regulation
- Self-contained pumps produce the highest vacuum force

Contact your local  
Authorized A.P.E. Representative  
for a no-obligation product demonstration.

or write:

**A.P.E.**

ent

le (22) on Reply Card

See us in Booth #629

NATIONAL ELECTRONIC PACKAGING AND PRODUCTION CONFERENCE  
**NEPCON**  
EAST '88

June 14-16, 1988  
Bayside Exposition Center  
Boston, Massachusetts







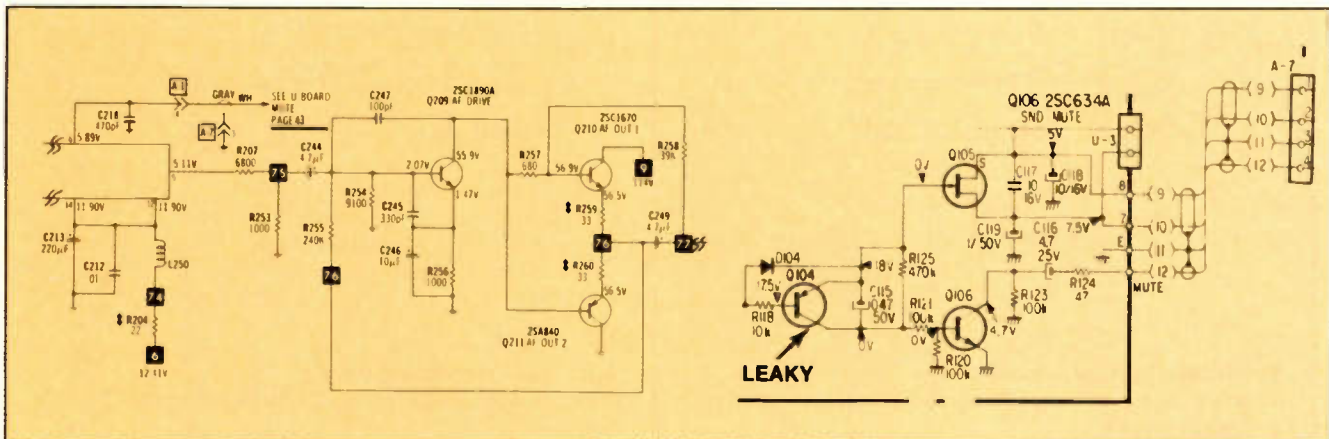

Figure 1. The first step in troubleshooting this TV was to inject a 1kHz signal through the coupling capacitor, C244.

Figure 2. A leaky mute drive transistor (Q104) was turning on Q106, the sound-mute transistor.

feature had not been selected.

Working backward from the base of Q106, I checked Q104, the mute drive transistor. It proved to be leaky and exhibited a voltage of 0.6V at its collector, which was forward bias-

ing Q106. Replacement of Q104 restored normal sound to the set.

**Garbis Saatjian**  
Los Angeles

## BOARD REPAIR DEPOT 1 YEAR GUARANTEE!

### BOARD REPAIR:

Exceptional Quality & Reliability

\* Advance Exchanges Available

\* IBM PC, XT, AT

AT&T 6300

\* COMPAQ

EPSON

TI

### TESTING:

100% Functional test

12 hour Burn-in @ 115°F

Outgoing final test and inspection

**1-800-BOARDFX**

*D. S. Walker & Associates, Inc.*  
11210 Steeplecrest Suite #300 Houston, Texas 77065 (713) 890-2257

Circle (23) on Reply Card

*Free Catalog!*

**Tool Kits,  
Cases, Tools,  
Test Equipment,  
Telco,  
Clean Room,  
Static Control,  
MRO Products**



Techni-Tool's latest **FREE CATALOG** includes the biggest and best selection of top-quality items to be found anywhere! The catalog presents more than 16,000 items from over 800 fine manufacturers. You will find tools and accessories for electro-mechanical assembly and maintenance, electronics, telecommunications, field service, and computer maintenance, plus ESD products, clean room supplies and tools for SMT applications. And you get **ONE-STOP SHOPPING** and convenient **24-HOUR SERVICE**. Call, FAX, Telex or write for your free copy.

**TECHNI-TOOL inc.**

5 Apollo Road, P.O. Box 368  
Plymouth Meeting, PA 19462 USA  
(215) 825-4990 Telex 83-4763  
FAX 215-828-5623

Circle (24) on Reply Card



This SYMCURE is reprinted from Electronic Servicing magazine.

Chassis—Zenith 19GC45 and 19GC48  
PHOTOFACT—None

1

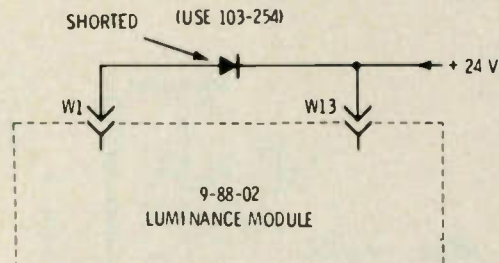

**Symptom**—Low brightness  
**Cure**—If not luminance module, check for shorted diode, as shown.

Chassis—Zenith 13GC10  
PHOTOFACT—1540-2

4

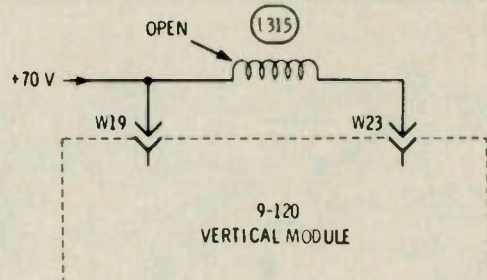

**Symptom**—No vertical height  
**Cure**—If not vertical module, check for open L315

Chassis—Zenith 17EC45 and 19EC45  
PHOTOFACT—1377-3

2

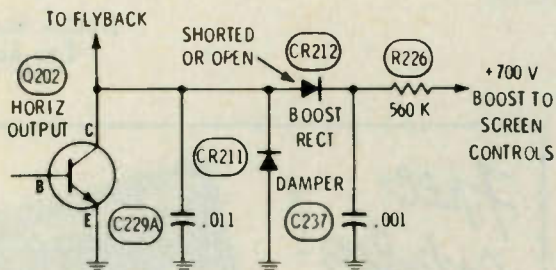

**Symptom**—Low brightness  
**Cure**—If there is no line with setup switch, check for defective CR212 boost diode.

Chassis—Zenith 17FC45 and 19FC45  
PHOTOFACT—1466-3

5

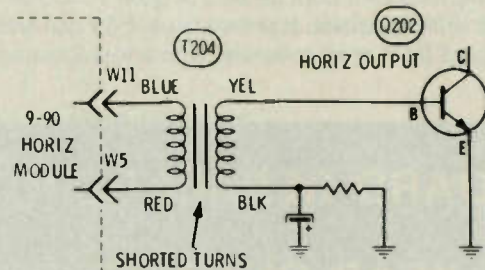

**Symptom**—Narrow picture with foldover  
**Cure**—Replace driver transformer, T204

Chassis—Zenith 17FC45 and 19FC45  
PHOTOFACT—1466-3

3

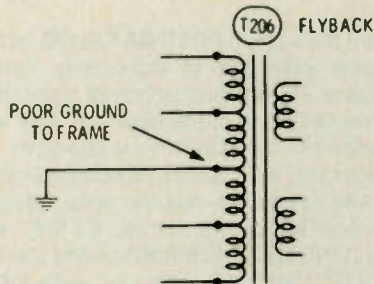

**Symptom**—Out-of-sync-color at edges; no color at center of screen.  
**Cure**—Check for poor ground at the frame of T206 flyback.

Chassis—Zenith 19GC45 with zoom  
PHOTOFACT—None

6

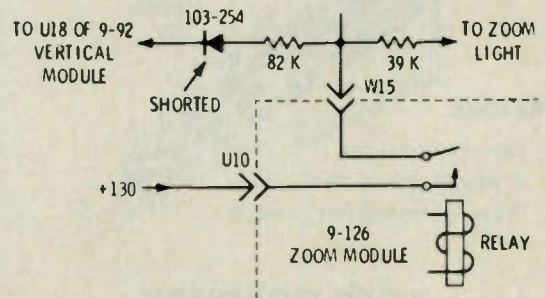

**Symptom**—Height excessive without zoom; normal with zoom  
**Cure**—Check for shorted diode, as shown.



## Products

Continued from page 53.

### Miniature DMM

The Circuitmate DM79 from *Beckman Industrial* is a hand-held DMM the size of a credit card. It offers automatic shut-off, auto-ranging and 3,200-count display. Functions include 5Vdc, 4Vac



and six resistance ranges, as well as continuity and diode checks. A 320mV range offers greater than 100MΩ input impedance. Other features include 2,000V case insulation, 700V overvoltage protection and 0.35% dc accuracy.

Circle (80) on Reply Card

### Soldering station, hot tweezer

*O.K. Industries* has introduced two soldering tools. The SA-10 Tri-Temperature soldering station, which now meets military specifications, has three temperature-indicator display lights; temperature repeatability to  $\pm 8^\circ\text{F}$ ; and tip-to-ground potential of less than 2mV. The station includes a 115V or 230V controller and a 24V/48W iron.

The SMT-W2, a hot tweezer for removing surface-mount components, fea-



tures an ergonomically designed hand-piece and two 8W ceramic heating elements for temperature stability.

Circle (81) on Reply Card

### VCR idler tire kit

*Parts Express* has introduced a VCR idler tire kit, which includes a free

cross-reference that lists more than 80 manufacturer assembly parts for more than 200 models. The kit includes 150 tires (10 each of 15 different sizes).

Circle (82) on Reply Card

### Logic monitor

The AR-80LM logic monitor from *American Reliance* provides autodetection of power and ground pins and both TTL and CMOS logic levels. The monitor provides indications for logic high, low and pulsing inputs. For pulses with repetition rates of more than 8Hz, the unit flashes the LED at an 8Hz rate, which allows the unit to be used at clock rates up to 40MHz.

Circle (83) on Reply Card

### Voltage reference

*Sibex* has announced the VR-1, a battery-powered, hand-held voltage refer-



ence. Output is selectable from 10mV to 10V in a 1-2-5 sequence. Both positive and negative voltages are available at the output terminals, and power is supplied by a standard 9V battery. A low-battery indicator is provided on the front panel.

Circle (84) on Reply Card

### Contact connector tool kits

*Jonard Industries* has introduced a new line of contact connector insertion and removal tool kits. The KA-260 and KR-260 kits contains tools for insertion and removal, respectively, of #12, #16 and #20 connector contacts. The kits have color-coded dielectric handles and conform to military standards.

Circle (85) on Reply Card

ES&T

**REDUCE  
YOUR COSTS...  
INCREASE  
YOUR  
PROFITS...**

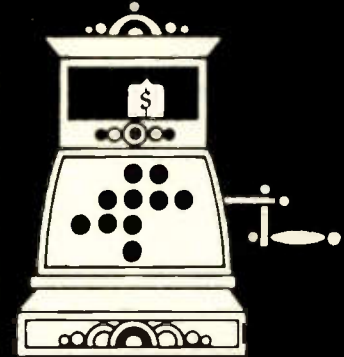

**WITH THE PRB  
BELT SYSTEM**

**PROJECTOR-RECORDER BELT** offers you the world's most complete inventory of replacement belts for all types of electronic equipment including...

- VIDEO RECORDERS
- COMPUTER PERIPHERALS
- TURNTABLES
- CASSETTE RECORDERS
- PROJECTORS
- 8-TRACKS
- 145 VIDEO BELT KITS

PRB has the replacement belt you need in just the right shape and size. PLUS the PRB system helps you find your replacement belt easily and fast for maximum convenience that assures profitable returns.

**PRB...THE SOURCE FOR  
OVER 10,000 ELECTRONIC  
COMPONENTS**

We stock a wide variety of electronic components. These are all high quality electronic components at everyday low prices backed by service you can depend on.

For details on our profitable belt system and a FREE copy of our Catalog just write or call toll free...

NATIONAL 1-800-558-9572  
IN WISCONSIN 1-800-242-9553  
BUSINESS NUMBER 1-414/473-2151  
IN CANADA CALL COLLECT: 1-613/225-5003  
TLX 4994411 PRB USA FAX: 414/473-4727

**PROJECTOR-  
RECORDER  
BELT  
CORPORATION**

P.O. Box 176 Whitewater, WI 53190

Circle (25) on Reply Card



## Books/Photofact

*Editor's Note: Please direct inquiries and orders to the publisher at the address given rather than to ES&T.*

**Radio Manufacturers of the 1920's**, by Alan Douglas;  
The Vestal Press Ltd.; 256 pages;  
\$19.95 paperback, \$29.95 hardbound.

This chronicle of the leading makers of the radio era is designed for antique radio and nostalgia buffs. The first of three volumes, volume 1 is arranged alphabetically, by company, to examine every company of significance to the radio era.

The Vestal Press Ltd., P.O. Box 97, 320 N. Jensen Road, Vestal, NY 13850; 607-797-4872.

**1988-89 Technical Guide and Cross Reference Manual**;  
NTE Electronics; \$3.25.

This manual lets you find the semiconductor replacement parts for more than 230,000 original devices. All parts are quality tested and backed by a 2-year warranty.

NTE, 44 Farrand St., Bloomfield, NJ 07003; 800-631-1250 (800-624-2624 in New Jersey).

**IBM PC Advanced Troubleshooting & Repair**, by Robert Brenner;  
Howard W. Sams, 300 pages; \$24.95.

This advanced version of *IBM PC Advanced Troubleshooting and Repair* features step-by-step troubleshooting methods and detailed circuit descriptions. Troubleshooting programs and oscilloscope screen photos and drawings help identify problems. The book presents a system overview and discusses detailed system operation, troubleshooting techniques, preliminary service checks and detailed circuit troubleshooting/analysis.

Howard W. Sams & Company, 4300 W. 62nd St., Indianapolis, IN 46268; 800-428-SAMS.

**How to Test Almost Everything Electronic, 2nd Edition**; by Jack Darr and Delton T. Horn;  
TAB Books; 190 pages;  
\$8.70 paperback, \$15.95 hardbound.

This revised and updated version covers the changes that have taken place in the world of electronics in the twenty years since the first edition was published. This book describes how to perform tests and measurements and how to interpret results. Included are descriptions of the various pieces of test equipment and the necessary electronics

fundamentals. New sections cover the basics of digital electronics and introduce some simple test analyzer circuits readers can build.

TAB Books, P.O. Box 40, Blue Ridge Summit, PA 17214; 717-794-2191.

**Electronic Display Devices**, by Richard A. Perez;  
TAB Professional and Reference Books; 416 pages;  
\$39.95, hardbound.

This book provides a comprehensive technical overview of the electronic display field, comparing basic information on a variety of display types. The author describes how each display works, how it is made, what its operating characteristics are, and what its strong and weak points are. A number of sample applications are included for each.

TAB Professional and Reference Books, P.O. Box 40, Blue Ridge Summit, PA 17214; 717-794-2191.

**IC User's Casebook**, by Joseph J. Carr;  
Howard W. Sams; \$12.95.

The author shows how to construct more than 100 projects and circuits, including linear and digital devices, timers and general devices. Projects range from linear ICs to CMOS.

Howard W. Sams, 4300 W. 62nd St., Indianapolis, IN 46268; 800-428-SAMS.

**Digital Electronics Troubleshooting, 2nd Edition**, by Joseph J. Carr;  
TAB Books, 434 pages;  
\$17.95 paperback, \$25.95 hardbound.

This updated and expanded guide to digital electronics covers not only the basics of digital circuitry but also several forms of clock circuits, including oscillators and multivibrators, and the latest microprocessors used in cassette players, VCRs, televisions and other consumer products. The guide includes more than 300 diagrams, schematics and charts, along with problems and answers.

TAB Books, P.O. Box 40, Blue Ridge Summit, PA 17214; 717-794-2191.

**Using the Triggered Sweep Oscilloscope**, by Robert L. Goodman;  
TAB Books; 308 pages;  
\$23.95, hardbound.

The wideband triggered sweep oscilloscope is one of the most essential

pieces of equipment for servicing microprocessors and ICs that require scope test performance ability beyond that of a narrow-band scope. The author shows how to use the scope and provides troubleshooting tips for TV/video systems, VCRs, stereos, 2-way radios, broadcasting equipment, microprocessors and microcomputers.

TAB Books, P.O. Box 40, Blue Ridge Summit, PA 17214; 717-794-2191.

**Electronic Conversions, Symbols and Formulas, 2nd edition**, by Rufus P. Turner and Stan Gibilisco;  
TAB Books; 280 pages;  
\$14.60 paperback, \$21.95 hardbound.

This guide covers the most necessary mathematical relations, functions, tables, symbols, formulas and conversion factors. The book includes fundamental information on impedance, imaginary numbers, vectors, longwire antennas and feedlines, line and standing wave-ratio losses, polar coordinates, significant digits, complex numbers and more.

TAB Books, P.O. Box 40, Blue Ridge Summit, PA 17214; 717-794-2191.

**Troubleshooting with the Oscilloscope, Fifth Edition**, by Robert Middleton, revised by Joseph J. Carr;  
Howard W. Sams, 225 pages;  
\$16.95.

The author uses a step-by-step guide to advise readers of the latest advancement in technology and to show them how to use the oscilloscope to perform diagnostic tests and repairs more quickly. This new edition emphasizes digital troubleshooting and applications as well as the time- and data-domain analyzers and logic-state analyzer.

Howard W. Sams & Company, 4300 W. 62nd St., Indianapolis, IN 46268; 800-428-SAMS.

**The Benchtop Electronics Reference Manual**, by Victor F.C. Veley;  
TAB Books, 620 pages;  
\$24.60 paperback, \$34.95 hardbound.

This data book serves as a reference for electronics and communications technicians on more than 160 electronics topics, divided into a 3-stage exploration: *basic principles*, which explains basic concepts to newcomers in electronics; *mathematical derivations*, which provides relevant equations to help more advanced electronics practi-



tioners; and *practical examples*, which gives interested readers concrete illustrations of each topic.

TAB Books, P.O. Box 40, Blue Ridge Summit, PA 17214; 717-794-2191.

**Amplifiers Simplified, With 40 Projects, by Delton T. Horn;**  
TAB Books, 210 pages;  
\$10.60 paperback, \$16.95 hardbound.

The author provides an electronics experimenter with the practical information needed to amplify audio, radio and video signals. Forty projects and experiments guide readers through the circuits involved with inverting and non-inverting amplifiers, a ceramic cartridge phono amplifier and tape recorder, high-power amplifiers and voltage-controlled amplifiers.

TAB Books, P.O. Box 40, Blue Ridge Summit, PA 17214; 717-794-2191.

**44 Power Supplies For Your Electronic Projects, by Robert J. Traister and Jonathan L. Mayo;**  
TAB Books, 256 pages;  
\$15.60 paperback, \$23.95 hardbound.

This do-it-yourself reference book is a complete introduction to power-supply theory and design. Covered are all necessary instructions needed to build power-supply circuits using breadboards, perfboards and printed circuits of individual design.

TAB Books, P.O. Box 40, Blue Ridge Summit, PA 17214; 717-794-2191.

**Beyond The Transistor: 133 Electronics Projects, by Rufus P. Turner and Brinton L. Rutherford;**  
TAB Books, 240 pages;  
\$9.70 paperback, \$16.95 hardbound.

This book was written to help readers learn to use several special-purpose digital and analog integrated circuits and to increase their understanding of solid-state devices. The novice can learn tips for soldering, breadboarding and troubleshooting electronics projects. Projects include a dual LED flasher and an audible continuity checker.

TAB Books, P.O. Box 40, Blue Ridge Summit, PA 17214; 717-794-2191.

**Meters and Scopes: How to Use Test Equipment, by Robert J. Traister;**  
TAB Books; 322 pages;  
\$14.60 paperback, \$23.95 hardbound.

This guide to electronic tests and

measurements is intended as an introduction for beginners and as a reference for the practicing technician. The author describes the function and use of various test instruments and explains how to connect the devices to electronic circuits under test.

TAB Books, P.O. Box 40, Blue Ridge Summit, PA 17214; 717-794-2191.

**The Illustrated Home Electronics Fix-It Book—2nd Edition, by Homer L. Davidson;**  
TAB Books, 480 pages;  
\$16.60 paperback, \$25.95 hardbound.

This do-it-yourself book offers tips for repair on about every piece of electronic equipment found in the home. There are 377 detailed illustrations to help with following directions. A chapter is also devoted to how and where to locate replacement parts.

TAB Books, P.O. Box 40, Blue Ridge Summit, PA 17214; 717-794-2191.

#### PHOTOFACT

##### EMERSON

2572-1 ..... ECR214A, ECR214D,  
ECR214(SUFFIX A/C/D/E/F)  
2573-1 ..... ECR139A  
2574-1 ..... EC101R, EC102W  
2575-1 ..... MSR199R  
2576-1 ..... MS250R, MS250RA  
2577-1 ..... MS30RBK (SUFFIX A),  
MS30RB/RBK  
2578-1 ..... MS25R

##### GENERAL ELECTRIC

2577-2 ..... 8-0904, 8-0955

##### RCA

2572-2 .... FLR520WR/25ER/26SR/  
30TR/35WR/36SR/40SR/50ER,  
GLR841TR/45FR/45HR/49PR  
(CH. CTC120D SUB1)  
2574-2 .... FMR560ER/60TR/75TR,  
FMR722ER/TR, FMR725TR,  
GMR891TR/93ER/95HR/99PR  
(CH. CTC130C)

##### SEARS

2573-2 ..... 564.48122650/51,  
564.48123650  
2578-2 ..... 564.49078650/51/52

##### TOSHIBA

2575-2 ..... CF907, CT907C  
(CH. TAC8721/26)  
2576-2 ..... CF317, CT317C

ES&T

## VCR IDLER TIRES



Now you can do VCR repairs faster and easier than ever before. **Parts Express** is now offering the most comprehensive idler tire kit available. With this kit in your stock room you can do over 90% of idler assembly repair jobs without waiting for parts deliveries.



The kit includes a **FREE** cross-reference listing over 80 manufacturer assembly numbers and over 200 model numbers. 150 tires total, 10 each of 15 different sizes in a high quality storage case with separate compartments for each size. Worth over \$400 retail value.

#400-900 **\$55<sup>00</sup>**

#### VCR IDLER ASSEMBLIES

Part #	Replacement for	(1-9)	(10-up)
430-010	Sharp NIDL0006	4.15	3.70
430-020	Sharp NIDL0005	4.35	3.90
430-030	Sharp NPLY-V0051	4.15	3.70
430-050	Pana VXPO329	1.40	.95
430-052	Pana VXPO344	1.40	.95
430-055	Pana VXPO401	1.95	1.55
430-060	Pana VXPO521	4.50	3.90
430-100	Fisher 4204-00300	7.80	6.90
430-105	Fisher 4804-00100	1.50	1.25
430-110	Fisher 4904-00900	7.50	6.75
430-120	RCA 164113	3.75	2.95
430-125	RCA 150614	3.95	3.25
430-130	HIT 6413111	5.20	4.65

**FREE  
CATALOG**

**Parts  
Express**  
International Inc.

CALL TOLL FREE

**1-800-338-0531**

340 E. First St., Dayton OH 45402  
Local—1-513-222-0173

Circle (26) on Reply Card



# Audio Corner

## CD channel frames

By Kirk Vistain

It's time to byte the bit stream again. You didn't think we could take care of it in only two columns, did you? Let's get our bearings. We're in the *channel* domain, meaning the data is still in 14-bit format. We'll talk about two kinds of frames. A *frame* is a block of data with a marker at the beginning. Information is processed one frame at a time. This allows the circuitry to grab a bunch of bits, send them to the processor and let it crunch away while the optics and RF-amp are busy getting another frame off the disc.

### Small frame

Figure 1 shows the contents of a small channel frame, usually represented with a lower-case f to distinguish it from a large frame, represented by a capital F. Remember that the only difference between this frame before and after 14-to-8 demodulation is that 8-bit bytes (also loosely referred to as *words*) are represented by 14-bit bytes. The actual information is the same (if everything is working correctly). You can see that each small frame begins with a 24-bit sync signal followed by the ubiquitous trio of merging bits, which separates words. For those of you who think in binary, the unique sync pattern is 100000000001000000000010.

First in the line-up is a control signal. After demodulation, the control signal is an 8-bit value whose bits are labeled

P through W starting with the most significant bit (MSB). Most current CD-player production uses only one bit, the Q. All the same, CD manufacturers typically encode the P bit as well to indicate the lead-out groove and the space between selections. The rest are there for expansion.

So what good is one bit? It can represent only one of two values. The trick is this: Q bits are accumulated until the assemblage equals 98 bits. This block of data can pass some real information about disc contents, length of tracks, type of pre-emphasis, etc. More on that later. Back to the small frame.

After the control word comes the digitized audio, 12 words in all, consisting of alternate pairs of right- and left-channel words. Next comes their CRCC (error correction) data, then another block of 12 audio and four CRCC words. This adds up to 588 bits in the channel domain.

### Large frame

As mentioned a moment ago, a CD player needs to assemble 98 small frames to build a usable block of control data. The repetition rate of a small frame is 7.35kHz (WFCK); the repetition rate of a large frame is 75Hz. In the data domain (after 14-to-8 demodulation), the control data block consists of eight words of 98 bits each. Only the Q word is commonly used. Figure 2 shows its structure. The two leading sync bits identify the beginning of a con-

trol word. Next comes a 4-bit code indicating the format of the recorded audio:

0000	2-channel, no pre-emphasis
0001	2-channel, with pre-emphasis
1000	4-channel, no pre-emphasis
1001	4-channel, with pre-emphasis

Virtually all CDs are coded 0001 for pre-emphasized stereo. The next four address bits identify which of the eight possible control words (P through W) follows. For Q, this is always 0001.

The majority of the Q word (data-Q) contains information about the selections on the disk, such as playing time and location. It occurs in two formats, one for TOC (table of contents) and the other for normal play. You'll remember that TOC is placed on the inner part of a CD. (CDs play from the inside out.) Because information in the table of contents is critical for reproduction, it is recorded with triple redundancy.

Figure 3 breaks down the structure of data-Q. In the TOC, data-Q keeps track of music number (MNR, identifying a particular selection) and running time in minutes, seconds and frames (big ones), all in binary coded decimal (BCD) format. P<sub>MIN</sub>, P<sub>SEC</sub> and P<sub>FRAME</sub> contain the starting time of the selection (MNR). An MNR of hexadecimal AA indicates the lead-out track.

After TOC, in the data (music) area of the CD, Q-data contains the music number and, if implemented, an index

Vistain is the audio consultant for ES&T.

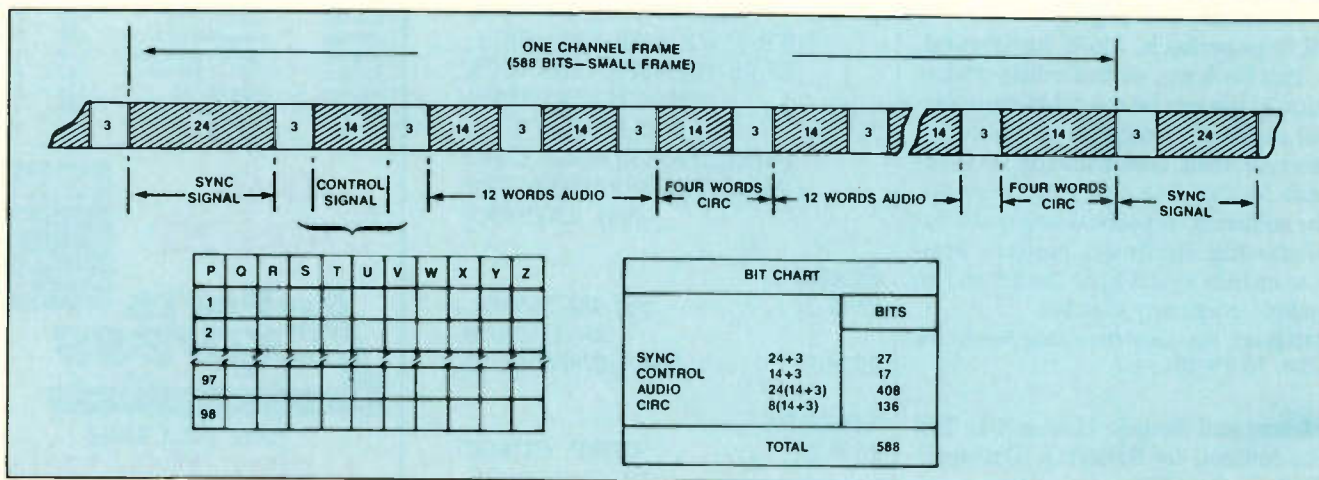

Figure 1. After 14-to-8 demodulation there are eight 1-bit control words per small frame. 98 frames are stored to get eight 98-bit control words. Only Q is extensively used.



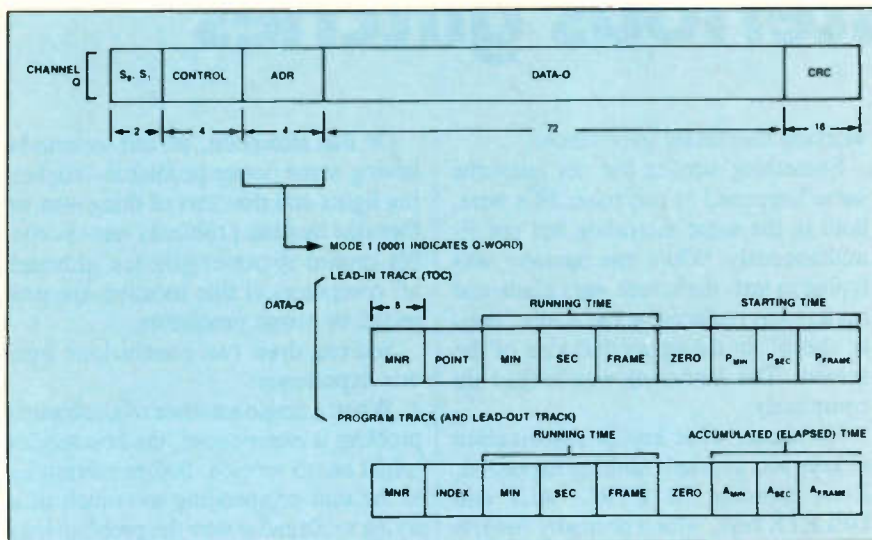

Figure 2. This breakdown shows the structure of the control word (Q-data) from one large frame. The two leading sync bits identify the beginning of a control word. The next 4-bit code indicates the format of the recorded audio.

number, which is just another subdivision used by some CDs to speed access to particular information. The index value will be 01 if unused. The first block of time data mimics that in the TOC. The second contains elapsed (accumulated) time. This information is not redundantly recorded.

### Troubleshooting

So what good are all these digital details when it comes to slapping a CD player into shape? Frankly, not much. After all, even the CD player doesn't care much about TOC when it comes to normal play, or at least the optics, servos and DA converter don't. Some units, when in a test mode that disables shutdown, will reproduce music normally. But direct access to tracks is not usually possible because the microprocessor is ignorant of the starting locations of each one. This is why most CDs will not play a disc if TOC reading fails. The guy who designed the software for the micro planned it that way.

Some processing circuits have a *window* to the Q-word sync bits. Thanks to poor documentation, the window might be difficult to locate, however. Check the inputs to the microprocessor. There may be a pin labeled SCOR, which is the product of logically ORing the subcode sync bits. It makes a good trigger for the scope. The rest of the Q control word also feeds the micro, at an input often termed SUBQ.

In any case, if you trigger on the sync

bits, you can watch the subcode data. The first eight bits after sync should remain constant for a given disk. If so, the servos are probably OK, and most of the digital processing circuitry up to the SUBQ take-off point is probably all right as well.

### Tracking tips

It has been my experience that tracking gain is one of the least critical adjustments on a CD player. Well, experience doesn't dole out all of the facts at once. It seems tracking gain has a huge effect on playability of warped discs.

You'd think a focus adjustment would be more significant, but actually a warp produces a radial error, too. Focus doesn't seem to have a problem keeping up with it, but small adjustments of tracking gain make a significant difference. You can simulate warpage by gluing a small piece of metal or plastic near the center hole of a CD on the bottom. This will prevent it from seating properly on the spindle, simulating a warp. Panasonic sells one, but they call it a balance disc.

Another good tip for tracking gain adjustment came to me from some factory-service techs. Put the player in pause mode and observe the tracking error (TE) signal. You'll see a large excursion where the optics "skip" over the track, then a section of normal TE. With gain properly adjusted, there will be minimal overshoot or undershoot in the transition area.

**ES&T**

## HITACHI SCOPES

15-25% Discount



V1060  
100MHz  
\$1285

V660 60MHz Dual Trace \$899  
V422 40MHz Dual Trace \$699  
V212 20MHz Dual Trace \$379

## ELENCO PRODUCTS AT DISCOUNT PRICES!



\$498  
MO-1252

### Scopes

MO-1253 40MHz Dual Trace \$595  
Delayed Sweep 12KV HV, More  
MO-1252 35MHz Dual Trace \$498  
MO-1251 20MHz Dual Trace \$349  
w/ Two 1x, 10x 100MHz probes, manual  
S-3000 10MHz fully calibrated \$239

### GF-8016 Function Generator with Freq. Counter



\$239.95

Sine, Square, Triangle  
Pulse, Ramp, .2 to 2MHz  
Frequency .1 thru 10MHz

GF-8015 without Freq. Meter \$179

### Digital Triple Power Supply

Model XP-765 \$239.95

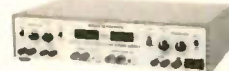

0-20V @ 1A  
0-20V @ 1A  
5V @ 5A

Fully Regulated, Short Circuit Protected  
with 2 Limit Cont. 3 Separate Supplies  
XP-660 w/ Analog Meters \$169.95

### Color Convergence Generator



SG-200

\$69.95

Finest in the Industry  
10 rock steady patterns

### Digital LCR Meter

\$138.95

Model  
LC-1800

Measures  
Inductors,  
Capacitors,  
Resistors



### Multimeter with Cap. and Trans. Tester

\$59.95

Model  
CM-1500A

8 Functions  
with Case



C&S Sales Inc., 1245 Rosewood  
Deerfield, IL 60015 (312) 541-0710  
800-292-7711 ASK FOR CATALOG

15 Day Money Back Guarantee  
2 Year Limited Guarantee  
Add 5% for Postage (\$10 max)  
IL Res., 7% Tax



Circle (27) on Reply Card



# Those mysterious glitches

By Conrad Persson

My office has installed a number of IBM PC XTs, and one of the things we have gotten used to is some degree of strange behavior in otherwise normal machines. For example, at least twice, my PC made a strange crackling noise, and then the screen went blank. All attempts to recover from this situation were fruitless. The only remaining option was to make sure the floppy disk drive was empty and turn the machine off. After the hard-disk whine disappeared, I turned the computer on again. It came back up and worked perfectly—until it happened the second time.

I went through the same steps again with exactly the same results. Shutting down and restarting the PC put it back in service. The computer has been

working flawlessly ever since.

Something similar but not quite the same happened to two other PCs here, both in the same afternoon but not simultaneously. While one operator was typing in text, the screen went blank and his text was replaced by the words "parity check" in the upper left side of the screen. The keyboard was locked up completely.

No matter what key or combination of keys was pressed, nothing happened. Even pressing the CTRL, ALT and DELETE keys, which normally restarts the computer without the ON/OFF switch, did nothing. In both of these cases, the operator turned off the power switch, waited to make sure the hard disk was stopped, then turned on the power again. This returned the computer to normal operation, and the problem has not reoccurred in either PC.

On that afternoon, we did seem to be having some power problems—flickering lights and that sort of thing—so we theorize that the problems were probably caused by power glitches, although all computers at this location are protected by surge protectors.

You can draw two conclusions from this experience:

1. When a single instance of a computer problem is experienced, the best service might be no service. Before tearing into the unit or spending too much time trying to diagnose why the problem happened, just try operating the computer normally and see if the problem recurs.
2. Unexplainable glitches do occur from time to time, leaving the operator with an inoperable computer and no recourse but to turn it off and lose everything in memory. Encourage the operator to save frequently to disk so that the amount of

Persson is editor of ES&T.

## ATTENTION CAMERA TECHS! Equipment you need at prices you can afford!

**\$688**

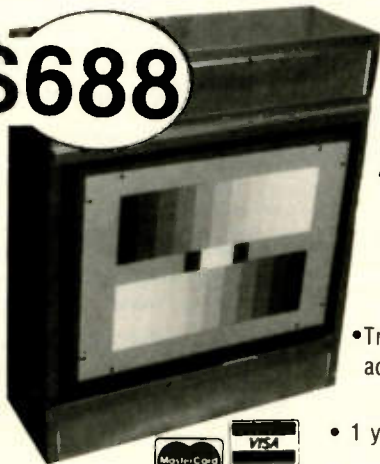

Model TR100 CB  
Camera Light Box  
with transparencies

- Stainless steel
- (2) 3200° Kelvin Lamps (meets mfr. spec.)
- 7-Bar color transparency
- 11-step gray scale transparency
- Transparencies mounted in acrylic with optical scratch-resistant surface.
- 1 year conditional guarantee

(313) 939-2740

Fax #(313) 939-6040

**TRONIX** inc.

31148 Lund, Warren, MI 48093

The method most  
manufacturers  
recommend

Circle (28) on Reply Card

## Learn how to repair VCRs...

Read

**Video Corner**

each month  
in **ELECTRONIC**

Servicing & Technology



information lost is minimal.

### Drive alignment problems

After a floppy disk drive has been in service for some time, the head may be far enough out of alignment to cause read or write problems. When a misaligned head is directed either by the computer or the intelligence in the drive to move to a certain location and read or write the data, its position, because of wear and mechanical shock from banging against its stops, is not quite correct. This might cause the head to write data on the disk in the wrong location, or to be unable to read data that is in the correct location.

The solution to this problem is to follow the manufacturer's directions and realign the head. The problem is, when you've realigned the head and everything's back to spec, data that was written when the head was grossly out of alignment may not be readable.

In the April 1988 issue of *MSM* magazine (formerly *Microservice Manage-*

*ment*), a Tech Tip by Noor S. Khalsa of Computer Clinic, Santa Fe, NM, describes how to recover data that is inaccessible because of this situation.

1. Connect a disk drive to an oscilloscope and look at the analog signal from the head. Use the test points that are used for radial alignment. Put the problem diskette in the drive and adjust the head alignment for maximum amplitude.

Connect the drive to a computer, read the data, then write the data to a properly aligned drive.

If you encounter intermittent read errors, further tweaking of the alignment may be necessary. When making the adjustments, move the head only slightly, and mark the positioner first so that the alignment may be moved back to where it was. Otherwise, you may lose it altogether, and another trip to the scope will be necessary.

2. If the computer is not able to read any of the data recorded on the drive that needed realignment, the index sensor was probably too far advanced when

the data was written. Try adjusting the index-to-data burst to about 100 per second instead of 200 per second. Trial-and-error-adjustment may be necessary. Again, make only small adjustments, first one way and then the other. If the sensor is moved too far, no index will be sensed and the drive will become *not ready*. The disk drive used to read the data will then have to be realigned after the data has been recovered.

A better approach to this problem would be to perform some checks before you realign a disk drive. Take a few of the disks that were most recently recorded on the drive to be realigned and try to read them on a properly aligned drive. If they can be read on this drive with no problem, then they should be readable on the faulty drive once it's realigned. If they can't be read on the properly aligned drive, read them from the faulty drive and transfer the data to disks written on the properly aligned drive *before* you realign the drive.

**ES&T**

## NESDA Computer Group

COMPUTER SALES AND SERVICE DEALERS  
WORKING TOGETHER



**NESDA**

- Service training.
- Assistance in selecting in-house equipment and software.
- Specialized software for service management.

- Factory contacts for service literature and parts.
- Involvement in a stable and productive national trade association.

FOR MORE INFORMATION SEND BUSINESS CARD TO:  
NESDA COMPUTER GROUP, 2708 WEST BERRY STREET  
FORT WORTH, TEXAS 76109; PHONE (817) 921-9061

### Hang in there — until you receive your new MCM ELECTRONICS Catalog!

It's FREE...and its 168 pages contain nearly 11,000 in-stock items that can be promptly shipped — with extremely flexible payment terms.

**Quality** is controlled by multiple preshipment inspections under our stringent standards.

**Competitive prices** let you enjoy increased profit margins on every job.

**Quick, TOLL-FREE ordering** helps you get the items you need...when you need them.

**Get your copy TODAY!**



For your **FREE** copy, call **TOLL-FREE!**  
**1-800-543-4330**  
In Ohio, call  
1-800-762-4315  
In Alaska or Hawaii, call  
1-800-858-1849



**MCM ELECTRONICS**  
858 E. CONGRESS PARK DR.  
CENTERVILLE, OH 45459-4072  
A PREMIER Company

SOURCE NO. ES-33

Circle (29) on Reply Card



## The playback story

By Conrad Persson

This is the last of a 3-part series on high-fidelity audio circuits used in VCRs. Part I described how the audio and video signals are recorded. Part II discussed the audio circuits themselves. (Adapted from the GE technical training manual, VCRs and Video Cameras, 1985 Line.)

The block diagram of the audio playback circuitry is shown in Figure 1. Signals from the audio heads are applied to the head amplifier (IC4201), where

the head in contact with the tape is selected by a delayed head-switching pulse (delayed in order to compensate for the 120° offset location of the audio heads). The output of the head amplifier contains both right- and left-channel signals, which must be separated by bandpass filters FL4203 and FL4204.

IC4203 contains the FM demodulator, which converts the audio back to an amplitude-modulated signal by essentially reversing the process of FM modulation. The 100kHz low-pass filter removes high-frequency noise from the demodulated signal and routes it to the audio dropout compensator.

The audio dropout compensator combats the effects of momentary loss of the playback audio RF signal, which will result in noise. This dropout noise can be caused by a defective spot on the tape, a tracking control error or naturally occurring head-switching point noise.

If the dropout detector sees a missing or severely attenuated RF signal, it will activate the dropout hold stage. Refer to Figure 2, the timing chart for the audio dropout compensator. The chart gives an example of tape-defect dropout (case 1) and compensation for normal head-switching point noise (case 2). In either case, the dropout detector

Persson is editor of ES&T.

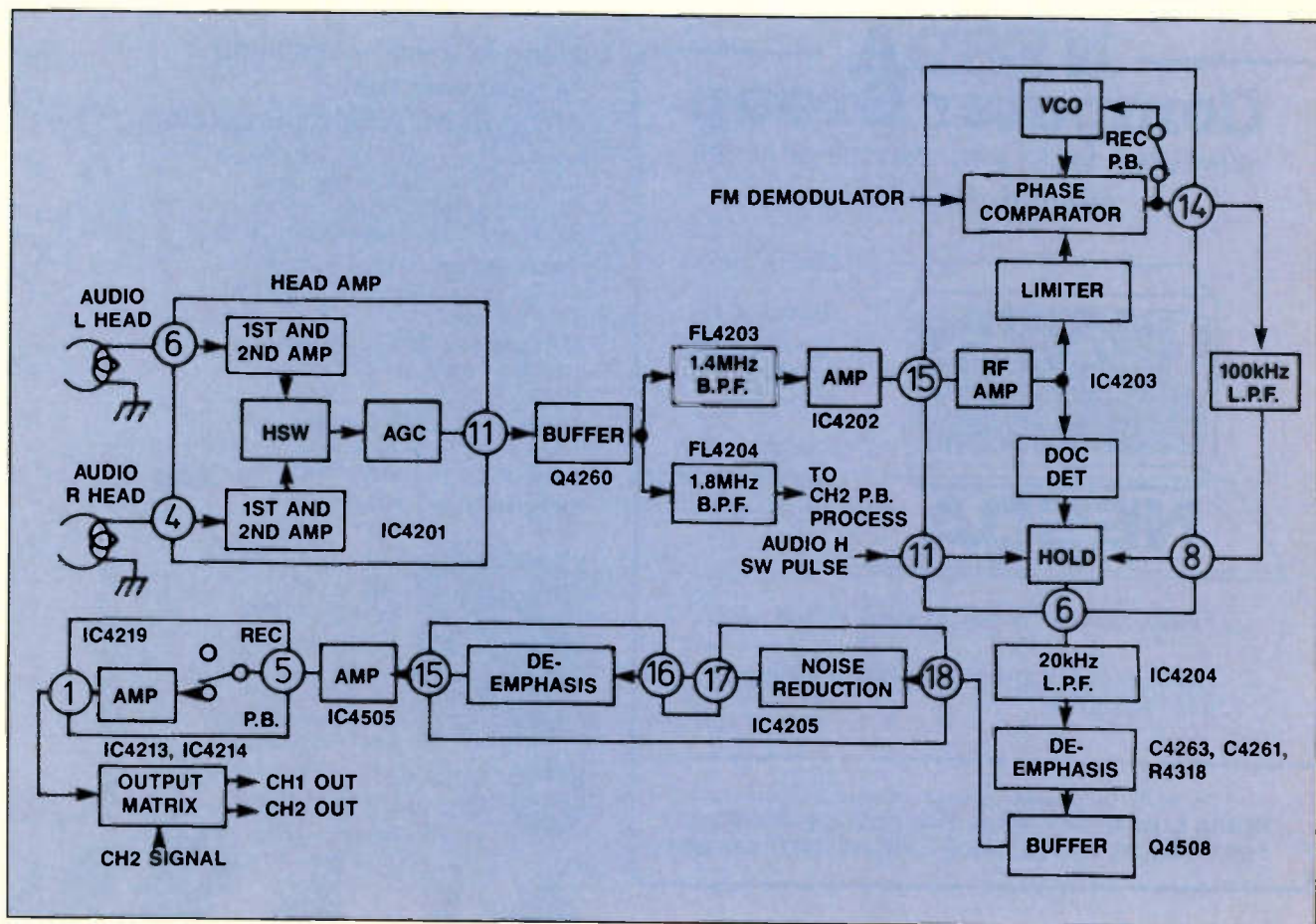

Figure 1. Simplified block diagram of the VHS High Fidelity audio playback circuitry (left channel).



and hold circuits maintain demodulator output signal level at the point where it was when the dropout occurred. If the dropout lasts for any appreciable length of time (more than 10 to 12 lines), the linear (normal) audio signal output will be substituted for the lost high-fidelity signal.

From pin 6 or IC4203, the signal is further processed in stages that reverse the effect of emphasis and noise reduction. In the output stages, combinations of linear track and high-fidelity audio can be selected through a switching matrix stage.

**BS&T**

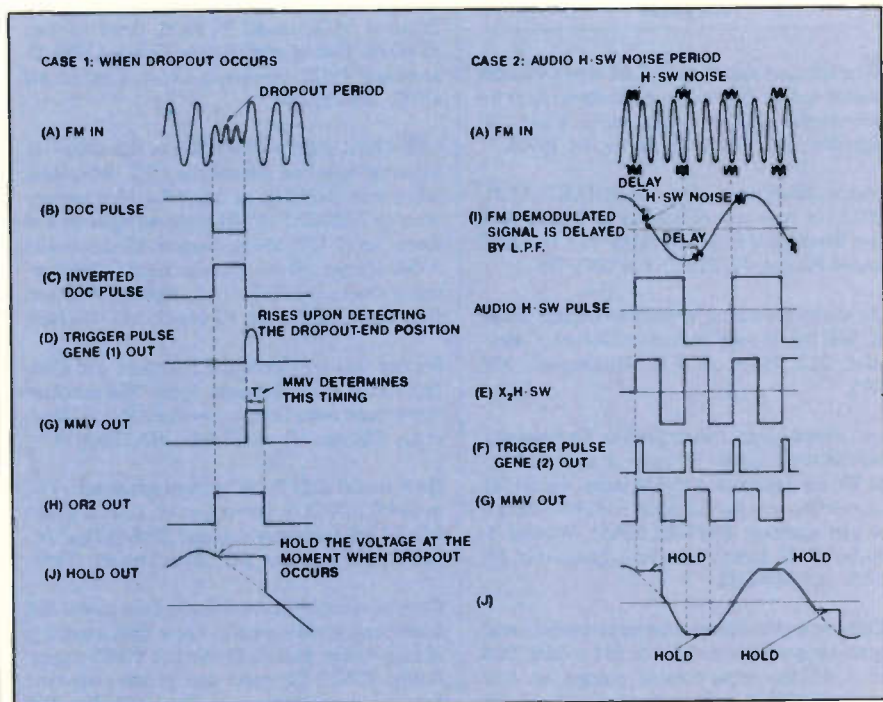

Figure 2. The timing chart for the audio dropout compensator gives an example of tape defect dropout (case 1) and compensation for normal head-switching point noise (case 2).

Technicians,  
Get Serious  
About Your  
Profession



Being a certified electronics technician lets people know that you are a professional in your field. It tells them that you are serious about your work and can perform up to CET standards.

Now you can order the "Study Guide for the Associate-Level CET Test" from the International Society of Certified Electronics Technicians. It includes material covering the most often missed questions on the Associate CET exam. 8 1/2" x 11", paperback, 60 pages.

For More Information Contact:

IS CET, 2708 W. Berry, Fort Worth, TX 76109; (817) 921-9101

NAME \_\_\_\_\_

ADDRESS \_\_\_\_\_

CITY \_\_\_\_\_ STATE \_\_\_\_\_

ZIP \_\_\_\_\_

copies @ \$5 (+ \$1 postage.)

send material about IS CET and becoming certified.

## ATTENTION TECHNICIANS

- ★ JOB OPENINGS
- ★ MONTHLY TECHNICAL TRAINING PROGRAM
- ★ BUSINESS MANAGEMENT TRAINING
- ★ LOW COST INSURANCE
- ★ CERTIFICATION
- ★ TECHNICAL SEMINARS

All of this in a nonprofit international association for technicians

FIND OUT MORE:



604 N. Jackson St.  
Greencastle, IN 46135

**CONSOLIDATED**  
ELECTRONICS

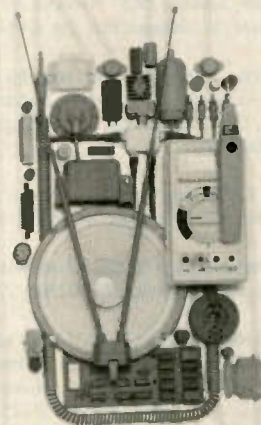

CONSUMER & INDUSTRIAL ELECTRONICS CATALOG • 17TH EDITION

## THE ULTIMATE ELECTRONICS CATALOG.

Order your 260 page catalogue packed with over 10,000 money saving electronic parts and equipment. Send \$3.00 check or money order, or call 1-800-543-3568 today and use your Mastercard or Visa.  
Consolidated Electronics, Incorporated  
705 Watervliet Ave., Dayton, Ohio 45420-2599

NAME \_\_\_\_\_

ADDRESS \_\_\_\_\_

CITY \_\_\_\_\_

STATE \_\_\_\_\_

ZIP \_\_\_\_\_

Circle (30) on Reply Card



# Readers' Exchange

## WANTED

Schematics and parts lists for CRT type fish/depth locaters and trolling motor controllers. Also for Pace model P5430 2-way radio tester. *W. Stegmiller, P.O. Box 2025, Butler, PA 16003.*

Service information for CAPEHART SKTC 401/13P or type and availability of 8-track deck drive motor used in it. *Ulo Vilms, P.O. Box 1437, Lanark Village, FL 32323; 904-697-3796.*

Tube-testing chart for a Mercury tube tester, model 103. Will buy or copy and return. *Joseph F. Marciniak, 2211 Wilson St. N.E., Minneapolis, MN 55418.*

New or used battery (plastic) holder for Panasonic AM/FM radio, model 725; new or used dual VC and SW for Panasonic AM/FM stereo, model 761 (Sams 960)—new part number: EVG765U40A53, old part number: EVFK12L50A53. *William J. Maida, 274 W. Sabal Palm Place, Longwood, FL 32779; 305-869-6138.*

Schematic and/or information on precision visual alignment generator for TV & FM model 7008 Philco. Will buy or pay copying, postage, etc. *Paul L. Jones, 10595 Vista Valle Drive, San Diego, CA 92131.*

Wow and flutter meter, new or used with reasonable price. *T. Davis, General Television, 3056 Old Shell Road, Mobile, AL 36607; 205-478-1148.*

Schematic for Sony MR-9700W radio, VCR repair manuals, Sencore PR57 Powerite. *Ed Herbert, 410 N. Third St., Minersville, PA 17954.*

Sequerra model FMI tuner; parts for Marantz 10B tuner—any condition. *Mike Zuccaro, Voice & Video, 5038 Ruffner St., San Diego, CA 92111; 619-560-1166.*

8NP4 CRTs, new or used. *Sunrise Consultants, P.O. Box 807, Chewelah, WA 99109; 509-935-8517.*

Admiral flyback #79A197-1. *Bob Nister, 3407 Arlington Ave., Riverside, CA 92506; 714-684-9393.*

Used socket CR-23, CR-24, CR-25 and CR-26 for a B&K 466 tester/rejuvenator. *Fernand Plourde, 2189 rue Honore-Beaugrand, Montreal, P. Quebec, H1L 5X6, Canada; 514-351-1257.*

Schematic and/or information on Precision visual alignment generator for TV & FM model 7008 Philco. Will buy or pay copying, postage, etc. *Paul L. Jones, 10595 Vista Valle Drive, San Diego, CA 92131.*

Diehl technician/shop owners' newsletters or copies, issue 4 through 14 or higher. *J. Hillrick, 732 Queen St., Regina, Saskatchewan, Canada, S4T 4A3.*

Tektronix 585 scope tube (T581 TEK); manuals or copies for Rhode & Schwarz Polyskope II sweep generator and display, type SWOB BN 4245/50; Marconi TF 1066B/6 FM signal generator; Genrad GR-1003 signal generator. *F. Jestaedt, 13300 Forest Drive, Bowie, MD 20715; 301-464-8513.*

Service information and schematic diagram for an Emerson VCR, model VCR650, serial number 41080091. Date of manufacture: October 1984. *D. Mancha, 43672 Gatehouse Court, Canton, MI 48187; 313-455-2801.*

CRT 470NGB22 or 470PHB22 or substitute—or someone who can rebuild my CRT. Also need schematics (will buy or copy) for Montgomery Ward GGV12989C TV; KLH model eighteen FM tuner (Sams: 1273 SED); Harman-Kardon model A 500 (Sams: 579-9); Marantz model 2285B receiver (Sams: MHF-144). *C. Bufano, 16 Green Hills Drive, Shelburne, VT 05482; 802-985-2419.*

Service info for Concept 6.5 receiver and Concept ELC-1, ELC-2 cassette decks. Will purchase or pay copy cost. *Urszula Lweczek, 1615 W. Montrose, Chicago, IL 60613-1213; 312-528-2658.*

B&K model 1251 NTSC pattern generator; VIZ model WP-705A dc power supply; Leader model LDC-823S frequency counter. *Marvin Paul Jr., Marv's TV, P.O. Box 282, Herndon, PA 17830.*

Copy of assembly manual for an Eico model 465 wide-band scope—need to know final assembly of high-voltage section; Electrotech TO-60 scopes, Robyn T240D CB radio and Maico body-type hearing aids, working or not. *Stanley Chalker, 1176 Smithsonian Ave., Youngstown, OH 44505.*

Panasonic ECXB1070B tripler block for CT-905 TV; service manual or schematic for Knight model KG-895 stereo amp (will buy photocopy); Panasonic flyback TLF80824. *Dan Schafer, 4215 Buechner Ave., Cleveland, OH 44109; 216-351-4555.*

KRK 237A tuner, flyback and Sams Photofact for CTC93A-L12—reasonable price. *4366 Eastport Drive, Bridgeport, MI 48722.*

Heathkit IT-5235 yoke/flyback tester, like new, \$50; VIZ WP-28 Isoltap isolation transformer, \$20; Heathkit IG-72 audio generator, \$20. With manuals. *Joe Dinger, RRI Box 87-D, Bringham, IN 46913; 317-566-3269 after 4 p.m. EST.*

CRT for Tektronix 422 scope or parts scope; manual for 422 with battery option; manual for old Micronta (Radio Shack) transistorized, hand-held signal tracer; manual for Heath IM-5210 HV probe. *E. Francik, 104 Chapel St., Pittston, PA 18640; 717-654-6271.*

## FOR SALE

Around 60 books on radio repair and TV repair, \$50 plus shipping. *T.W. Benson, 204 Riverside Ave., Tallahassee, AL 36078; 205-283-4266.*

219 assorted Sams, #229 to #1952, \$175 plus shipping or best offer. *Weeden's Television Rental, 14450 N.E. 29th Place, #118, Bellevue, WA; 206-881-7626.*

B&K model 820 capacitance meter, very good condition, \$85; Sencore S.S. 137 sweep analyzer, \$65 or will exchange for B&K isolated variable ac meter supply, model 1653. *Lurry, 619-462-7445.*

Sencore VA62 universal video analyzer, VC63 VCR test accessory, AD232 banana/scope adapter, TP225 sure-hold alligator clip adapter probe and ST65 video analyzer stereo TV adapter, like new, with manuals, \$3,000.; CREI electronic engineering technology base program (50 assignments) with a major in communication engineering (20 assignments), outline furnished upon request, \$150; and more. All items in excellent condition. Send large SASE for complete list. *Clarence G. McKee, 9516 Zion Road, Rives Junction, MI 49277; 517-569-3139.*

B&K 1076 analyst, \$75; Accurate Instruments model 156 genometer, \$35; Radio City Products model 750 Do-All TV signal generator, \$35; Eico model 378 audio generator, \$35; Eico model 232 VTVM, \$20; Eico high-voltage probe, \$10; Viz WR50C RF signal generator, \$100 (transistor model, almost new); Eico 666 tube tester without chart or roller, \$25. Postage required on all. *Stanley Chalker, 1176 Smithsonian Ave., Youngstown, OH 44505.*

NRI complete VCR home-study course, 11 volumes plus training tape (excellent condition), \$60. *Douglas R. Zook, 320 Bellis Court S.E., Palm Bay, FL 32909; 305-723-9226.*

Fluke #27 yellow used once, with leads, warranty card, instructions, \$210 or best offer; FE-20, used, recently recalibrated, \$75 or best offer. *Stanley Todorow, G8468 Belle Bluff Drive, Grand Blanc, MI 48439; 313-695-0271.*

Sencore VA48, SG165, LC-53 Z-meter, many other items. All in good to excellent condition. Send SASE for complete list. *Paul Jensen, P.O. Box 512, Viborg, SD 57070.*

NRI stereo and TV course with working kits, Discovery Lab, \$300; NTS communications course with AM experiment radio, bench DMM, Heathkit transceiver, \$300; B&K E2000 signal generator, \$195. Add UPS. *Orland Lynd, 2300 Harvard Way #124F, Reno, NV 89502; 702-825-6157.*

500 radio and TV tubes, new, in factory cartons, 90% off list price; A.B. Dick mimeograph machine with service manual, \$35 plus shipping; manuals, books, magazines, parts. Send large SASE for list. *M. Seligsohn, 1455 55th St., Brooklyn, NY 11219.*

Sencore LC-75 Z-meter 2 with SCR 250, \$650; Sencore DVM 37, \$175; EICO 150 signal tracer, \$75. All in excellent condition, in original boxes. *Howie Frix, III Cordele Road, Albany, GA 31705; 912-436-8575.*

Sencore YF33 yoke and flyback tester, with instructions, in mint condition, \$75. *McFarland TV, 220 Norman Ridge Drive, Bloomington, MN 55437; 612-835-3759.*

PC boards, fly and HV mult for GE K chassis, \$50; 47 Sams, #53-591, \$0.65 each; 7- and 8-pin jan tubes in white boxes, \$0.75 to \$1.50. Will consider trade. Send SASE for list. *Robert Morrison, 1640 Mill Oak Drive, Virginia Beach, VA 23464.*

More than 5,000 service diagrams, including Sams, TV, AR, Sony, Panasonic, Sharp,



Magnavox, Emerson, Portland, Toshiba, Admiral, AOC and others, \$2,500 for all. *Thomas Piacenti, 141 W. Thirwell Ave., Hazleton, PA 18201; 717-455-7355.*

Three Heath electronics courses with all parts and trainer, never used, \$300; 10-volume DeVry electronics course, excellent condition, \$120 plus UPS. *Daniel Seidler, 3721 W. 80th St., Chicago, IL 60652.*

Tequipment S54 scope, single-channel, dc to 10MHz, solid-state, with manual, \$100; B&K 1076 TV analyst with leads and manual, \$80. Add shipping. *Paul Kort, 6136 John St., Loves Park, IL 61111; 815-633-7509.*

Heath-Zenith ET-3400-A microprocessor trainer, excellent condition, assembled, \$195. Make offer. *Donald Pidcock, 18 Rocktown Road, Lambertville, NJ 08530; 609-397-3560.*

Sencore PR57 Powerite variable isolation transformer and safety analyzer, plus a Simpson 2100 portable ac voltmeter, \$400; Sencore DVM56A microranger digital voltmeter with probes, \$500; and more. Send large SASE for list. *Clarence G. McGee, 9516 Zion Road, Rives Junction, MI 49277; 517-569-3139.*

117 ETD Telefax; SCR 221 electrified frequency meter; Atwater Kent 2-stage amp, type TA; color

test jig with Telematic adaptors; QST magazines from 1971, 1972 and 1973. Make offer. *William J. Maida, 274 W. Sabal Palm Place, Longwood, FL 32779; 305-869-6138.*

Sencore VA-48 TV analyst with test leads, manuals, schematics, \$700. *Kenneth L. Schultz, 1045 Heavenridge, Essexville, MI 48732; 517-893-5918.*

Sencore VA-48, \$650; PR-57 power isolator, \$175; LC-53 Z-meter, \$450, includes manuals. All like new, never used commercially. *Lewis Smith, 2154 Warnlands Ave., Vista, CA 92084; 619-726-8059.*

Like-new Lectrotech color generator and vector scope with manuals, \$250. *Tri-City TV, Route 3, Box 186, Birch Tree, MO 65438; 314-292-3281.*

Sencore equipment, ten pieces, never been used, still in warranty, currently selling for more than \$10,000. Will take considerably less. Will sell package or individually. *Kenneth H. DeBord, Route 1, Mooresburg, TN 37811.*

B&K model 162 transistor/FET tester, test in circuit or out, in mint condition, with batteries, test cables and manual, \$75. Will ship UPS collect. *C.A. Caputo, 7 Donna St., Peabody, MA 01960; 617-535-1091.*

A.B. Dick mimeograph machine with manual, \$35

plus shipping; test books; service manuals; radio and TV parts; 600 new, standard-brand tubes in factory cartons, 90% off list price. Send large SASE for list. *M. Seligsohn, 1455 55th St., Brooklyn, NY 11219.*

Sencore VA-62 video analyzer with VC-63 accessory, test leads, manuals and probes, including TP212 HV probe. Perfect condition, \$2,900, or will trade for Sencore SC-61 scope. *Michael E. Carter, NCS Box 7, FPO NY 09539.*

50 unused B&W picture tubes, \$50 for all if picked up or \$10 each plus shipping. FREE if picked up: truckload of used TV sets and TV parts. *Jim Farago, P.O. Box 65701, St. Paul, MN 55165; 612-722-0708.*

Model E34-18 Sylvania (1984) complete chassis, yoke, video module controls and tuners, assembly and switch-volume control, \$65 plus shipping. *M.E. Andrews, Jr., Box 91, Exeter, RI 02822.*

CRTs: 25XP22 substitutes for many part numbers; 205P4; 17DLP4. Make offer for any or all. *C. Bufano, 16 Green Hills Drive, Shelburne, VT 05482; 802-985-2419.*

Sencore VA-48 video analyzer, like new, very little use, \$700 or best offer. *Ken Harnly, RD #1, Box 461, Manheim, PA 17545; 717-898-7731.*

**ES&T**

## Classified

Advertising rates in the Classified Section are \$1.55 per word, each insertion, and must be accompanied by payment to insure publication.

Each initial or abbreviation counts as a full word.

Minimum classified charge \$30.00.

For ads on which replies are sent to us for forwarding (blind ads), there is an additional charge of \$35.00 per insertion to cover department number, processing of replies, and mailing costs.

Classified columns are not open to advertising of any products regularly produced by manufacturers unless used and no longer owned by the manufacturer of distributor.

### FOR SALE

**TV TOUGH DOGS:** 300 symptoms and cures. Send \$7.95 to DAVIS TV, 11772 Old Fashion Way, Garden Grove, CA 92640. 10-87-tfn

**AUTOMOBILE RADIO, TAPE** and amplifier repairs most manufacturers. Quick turn around time. Send your units to us at, Laran Auto Electronics, 188 W. Lincoln Avenue, Mount Vernon, New York 10550. Inquiries: P.O. Box 466, Bronx, New York 10475. 914-664-8025, 800-223-8314. 5-88-tfn

**INTEGRATED CIRCUITS:** Lowest prices on Admiral, GE, NAP, Philco, RCA, Sears, Sylvania, and Zenith types. Write P.E.C. Box 894 Union, NJ 07083. 03-88-61

**TV TROUBLESHOOTING:** 156 Problems-Solutions on models/chassis in service today. Nothing old listed. Complete narrative on each solution. Also, 15 effective steps to easier repairs, \$12.00. Jones, Box 702, Niceville, FL 32578. 2-88-61

**"UNCLE JON'S SEMICONDUCTOR CRISS-CROSS"** 1000's of TV, VCR, and audio ICs and transistors cross referenced FROM General Purpose Replacement Part Numbers (ECG, NTE, and others) TO RCA, Zenith, GE and many Japanese part numbers. If you need a type 712 TV sound IF/Detector, don't order an expensive replacement, check your stock for EP84x73(GE), HA1124(Hitachi), or AN240(Matsushita). Pays for itself the first time you use it. \$8.95 Ea. Uncle Jon's Video Service Co., 12871 Briarwest Circle, Houston, Texas 77077. (\*Phillips ECG, \*\*NTE). 4-88-31

**UNIVERSAL CRT REFERENCE BOOK** now available from Dandy Mfg. Co., 2323 Gibson, Muskogee, OK 74403. A valuable service aid which details basing/pinout sequence for heaters, cathodes, G1's & G2's for all Color CRT's, Projection, Camera and Oscilloscope, (Asian, European & domestic from 1949 to 1988). Chargecards/cash/checks/MO's. No COD's. \$10.00 Toll free 1-800-331-9658. 2-88-11

**LAMPKIN 107B COMMUNICATIONS** Service Monitor—\$400.00. Standard Deviation Meter—\$200.00. Helper Sinadder Meter—\$90.00. Pathcom Pro-1 Prom Programmer—\$100.00. R.F. Communications Phone—(414) 835-1793. 5-88-11

**VHS REPAIR HISTORIES OVER 100 SOLUTIONS \$10.95.** How to Set Up a VCR Service Facility \$9.95. Western Hemisphere Enterprises, Box 673, Comrack, NY 11725. 5-88-11

**PHOTOFACTS:** Individual folders #1 to #1400 \$3.00. Above #1400 \$5.00. Sent same day first-class postpaid. Loeb, 414 Chestnut Lane, East Meadow, NY 11554. 12-87-61

**VHS-VCR REPAIR SOLUTIONS VOLUMES I, II, III.** Each contains 150 symptoms and cures, cross reference chart, free assistance. Each \$11.95, any two \$19.95, all \$29.95. Eagle Electronics, 52053 Locks Lane, Granger, IN 46530. 5-88-11

**SONY-TRINITRON** Rebuilt Picture Tubes are now available. All tubes shipped U.P.S. No Charge. We buy all Sony duds. Rochester Kinescope, 716-235-0750. 11-87-tfn

### WANTED TO BUY

**WANTED:** B&K 747 or similar tube tester. We buy receiving tubes. Submit your list for our offer. Antique Electronic Supply, 688 W. First St., Tempe, AZ 85281, 602-894-9503. 5-88-11

### BUSINESS OPPORTUNITIES

**TV/VCR SALES & SERVICE;** well established, fully equipped. Located in northern Virginia, highest growth area in U.S. Retiring because of health reasons. Call 703-972-7027 after 7:00 PM EST. 12-87-tfn

**TV/ELECTRONICS SALES and SERVICE;** Well established, fully equipped with inventory and large VIDEO RENTAL business. 1,200 SF owners apartment above and new garage. Good figures. High traffic count in fastest growing area of Western Main Lakes Region. Roosevelt Trail Business Brokers—Fred Packard 2071647-2172. 5-88-11

### POSITION WANTED

**SITUATION WANTED** Tech heavily experienced in VCR, Camcorders, TV's, Computers etc. seeks high pay, good benefits, etc., with firm desiring to venture into the future of servicing, and remain! Have extremely fast troubleshooting skills to component level, and management experience. Factory trained, tech schooled, 20 years on the bench, and ready to relocate. Write to Video Tech, 103 Montleau Ave., Salisbury, MD 21801. 03-88-1FN



## NTSC VECTOR ANALYZER



MODEL 300

ONLY \$375

Turns your oscilloscope into an NTSC vectorscope for video camera and camcorder alignment. Currently in use by independent servicers, factory service centers, and factory service training schools.

**GREENTRON INC** P.O. BOX 6805 GREENVILLE SC 29606 (803) 232-3889

Circle (34) on Reply Card

### TV "TECH'S" DREAM

TEST & RESTORE EVERY CRT on the market.... without every buying another adaptor socket for your CRT tester. Fits ALL makes & models. MONEY BACK GUARANTEE. Over 12,000 sold. Complete Patented Kit, with Sockets & Setup Book.... Only \$63.95 ppd. A one-time investment for life!! Visa/MC/COD's/Checks.

**FREE CALL 1-800-331-9658**

**DANDY MFG. CO.**

2323 Gibson Street Muskogee, OK 74403

Circle (31) on Reply Card

Tech's Guide To Pricing

### "Tech's Guide To Pricing"

updated new 5th edition... a framework for setting rates that apply to Hi-Tech products... a formula that guarantees SUCCESS!

Call Toll Free for details **1-800-228-4338** 8/5 CST

Circle (33) on Reply Card

## In our continuing efforts to serve you...

From time to time, Intertec Publishing Corp. makes its subscriber lists available to carefully screened companies or organizations whose products, services or information may be of interest to you. In every case, list users must submit their promotional material for approval. They may use the list only once.

No information other than name and address is ever divulged although names may be selected by segment to which the particular offer might appeal.

We are confident that the majority of our readers appreciate the controlled use of mailing lists. A few people may prefer their names not be used.

If you wish to have your name removed from any lists that we make available to others, please send your request together with your mailing address label to:

**ELECTRONIC**  
Servicing & Technology

Direct Mail Mgr.  
Intertec Publishing Corp.  
P.O. Box 12901  
Overland Park, KS 66212

## Ad Index/Hotline

Company	Page Number	Reader Service Number	Advertiser Hotline
American Reliance	25	14	800/654-9838
Automated Production Equipment Corp.	53	22	516/654-1197
Beckman Industrial Corp.	IFC	1	619/495-3200
C + S Sales	61	27	800/292-7711
Chemtronics, Inc.	1	3	800/645-5244
Consolidated Electronics Inc.	65	30	800/543-3568
Cooper Group	11	37	919/362-7510
Dandy Mfg. Co.	68	31	800/331-9658
Eta	65		
Fluke, John Mfg. Co., Inc.	5,9,27,8A&8B	5,7,15	800/44-FLUKE
Fordham Radio Supply Co.	41	16	800/645-9518
Greentron Inc.	68	34	803/232-3889
Hitachi Sales Corp. of America	26	12	516/921-7200
Iscet	65		
JDR Instruments	IBC	2	800/538-5000
Kelvin Electronics	7	6	800/645-9212
Laguardia Enterprises	68	32	714/579-1276
Leader Instrument Corp.	3	4,36	800/645-5104
MCM Electronics	63	29	800/543-4330
NESDA	63		817/921-9061
Panavise Products Inc.	43	17	213/595-7621
Parts Express Int'l. Inc.	59	26	513/222-0173
Projector Recorder Belt Corp.	57	25	800/558-9572
PTS Corp.	45	18	812/824-9331
RCA Distributor and Special Products	49	20	
Sencore, Inc.	21	35	800/843-3338
Sera Service	47	19	305/642-4000
Sperry Tech, Inc.	68	33	800/228-4338
Techni-Tool	55	24	215/825-4990
Tektronix, Inc.	13,15,17,51	38,9,10,21	800/433-2323
Tektronix, Inc.	16A-B		800/433-2323
Tronix, Inc.	62	28	313/939-4710
U-Can-Do VCR Educational Products Co.	25	13	513/548-6113
Ungar Div./Eldon Industries	19	11	
Walker, D.S. & Associates	55	23	713/890-2257
Zenith	BAC		

**HAND REMOTE REPAIR**  
**LA GUARDIA ENT**  
5882 Rich Hill Way  
Yorba Linda, CA 92686  
(714) 579-1276

90 Day Warranty New Batteries Included

- Call for pricing
- 24 hr. turnaround time
- Return freight pre-paid

Circle (32) on Reply Card

**ELECTRONIC SERVICING & TECHNOLOGY** Volume 8, No. 5 (USPS 462-050) is published monthly by Intertec Publishing Corp., 9221 Quivira Road, P.O. Box 12901, Overland Park, KS 66212. Second Class Postage paid at Shawnee Mission, KS, and additional mailing offices. POSTMASTER: Send address changes to ELECTRONIC SERVICING & TECHNOLOGY, P.O. Box 12952, Overland Park, KS 66212-9981.

### ADVERTISING SALES OFFICES

## ELECTRONIC

Servicing & Technology

#### ALL U.S. TERRITORIES

Greg Garrison, Sales Manager

P.O. Box 12901

Overland Park, KS 66212

Phone: (913) 888-4664

Fax: (913) 888-7243

Telex: 42-4156 INTERTEC OLPK

#### NORWOOD, AUSTRALIA

Hastwell, Williamson, Rouse PTY. LTD.

P.O. Box 419

Norwood, S.A. 5067

Phone: 332-3322

Telex AA 87113

#### OXFORD, ENGLAND

Nicholas McGeachin

Roseleigh House, New Street

Deddington, Oxford OX5 4SP

Phone: (0869) 38794

Telefax: (0869) 38040

Telex: 837469 BES G

#### TOKYO, JAPAN

Haruki Hirayama,

EMS, Inc.

Sagami Bldg., 4-2-21, Shinjuku,

Shinjuku-ku, Tokyo 160, Japan

(03) 350-5666

Telex: 2322520 EMSINCJ

Cable: EMSINCPERIOD



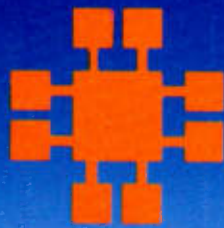

# JDR INSTRUMENTS™

Complete customer satisfaction... superior service... friendly, knowledgeable personnel... quality merchandise... providing the best values in leading edge technology.



FULLY OVERLOAD PROTECTED

TRANSISTOR TESTER

9 FUNCTIONS 34 RANGES

CONDUCTANCE TESTER ADDS VERSATILITY

TEMPERATURE TESTER TO 2000° F

## Our DMM-300

A remarkable value!

# 79.95

This full function 3.5 digit DMM offers highly accurate performance and a host of added features to help you do the job—fast. Capacitance, transistor, temperature, conductance and audible continuity in addition to the ranges you'd expect from a DMM of this quality. Temperature probe, test leads and battery included. Input impedance: 10M ohm. Basic DC accuracy: plus/minus 0.25%. Approx. 7" x 3 1/2" x 1 3/4" Wt. 13 1/2 ozs.

DC VOLTAGE TO 1000 VOLTS

AC/DC CURRENT 200µA TO 10A

CAPACITANCE TESTER 2000pF TO 20µF

### DPM-1000 \$54.95

3.5 DIGIT PROBE TYPE DMM

Custom 80 pin LSI chip provides accuracy and reliability in such a compact size. Autoranging, audible continuity and data hold feature help you pinpoint the problem quickly. Case and batteries included.

- Basic DC accuracy: plus/minus 1%
- DC voltage: 2v-500v, autoranging
- AC voltage: 2v-500v, autoranging
- Resistance: 2k ohms-2M ohms, autoranging
- Fully over-load protected
- Input impedance: 11M ohm
- Approx. 6 1/2" x 1" x 3/4" Under 3 ozs.



- ★ 2 YEAR REPLACEMENT WARRANTY
- ★ 30 DAY MONEY BACK GUARANTEE
- ★ TOLL FREE TECHNICAL SUPPORT
- ★ NEXT DAY AIR SHIP AVAILABLE

### MODEL 2000 \$389.95

20 MHz DUAL TRACE OSCILLOSCOPE

Model 2000 makes frequency calculation and phase measurement quick and easy. The component tester aids in fast troubleshooting. Service technicians appreciate the TV Sync circuits for viewing TV-V and TV-H and accurate synchronization of the video signal. Blanking, VITS, and V/H sync pulses.

- Exceptionally bright 5" CRT
- Built-in component tester
- TV Sync filter
- X-Y operation • 110/220 volts

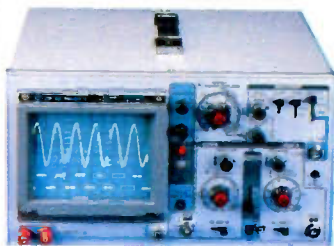

### MODEL 3500 \$499.95

35 MHz DUAL TRACE OSCILLOSCOPE

Wide bandwidth and exceptional 1mV/DIV sensitivity make the Model 3500 a powerful diagnostic tool for engineers or technicians at a remarkable price. Delayed triggering allows any portion of a waveform to be isolated and expanded for closer inspection. Variable Holdoff allows stable viewing of complex waveforms.

- Exceptionally bright 5" CRT
- Delayed and single sweep modes
- Z axis intensity modulation
- X-Y operation • TV sync filter
- Fast 10ns rise time



### DMM-200 \$49.95

3.5 DIGIT FULL FUNCTION DMM

Get highly accurate performance at a very affordable price. Rugged construction, 20 amp current capability and 22 ranges make it a perfect choice for serious field or bench work. Low battery indicator and tilt-stand. Probes and 2000 hour battery included.

- Basic DC accuracy: plus or minus 0.25%
- DC voltage: 200mv-1000V, 5 ranges
- AC voltage: 200mv-750V, 5 ranges
- Resistance: 200 ohms-20M ohms, 6 ranges
- AC/DC current: 200µA-20A, 6 ranges
- Input impedance: 10M ohm
- Fully overload protected
- Approx. 7" x 3 1/2" x 1 1/2" Wt. 11 ozs.



### DMM-100 \$29.95

3.5 DIGIT POCKET SIZE DMM

Perfect for the field service technician. Shirt pocket size without compromising features or accuracy. Large, easy to read 1/2" LCD display. Fully overload protected for safety, 2000 hour battery life with standard 9v cell. Probes and battery included.

- Basic DC accuracy: plus/minus 0.5%
- DC voltage: 2v-1000v, 4 ranges
- AC voltage: 200v-750v, 2 ranges
- Resistance: 2k ohms-2M ohms, 4 ranges
- DC current: 2mA-2A, 4 ranges
- Input impedance: 10M ohm
- Fully overload protected
- Approx. 5" x 3" x 1". Under 7 ozs.

COPYRIGHT 1987 JDR MICRODEVICES

JDR INSTRUMENTS, 110 KNOWLES DRIVE, LOS GATOS, CA 95030  
RETAIL STORE: 1256 SOUTH BASCOM AVE, SAN JOSE, CA (408) 947-8881



# ORDER TOLL FREE 800-538-5000

Circle (2) on Reply Card



**For your own reputation  
and in your customers' best interest  
always insist on**

**Genuine Zenith**

---

**Remanufactured Replacement Parts**

---

**Reconditioned and Serviced for Reliability**

---

**by Zenith People**

---

**as Knowledgeable and Dedicated as**

---

**Those Who Made the Originals!**

---

One of the easiest, fastest, and surest ways for you to preserve the pedigree and maintain the quality of the Zenith products you service is with genuine Zenith replacement parts.

And at no time is this more critical than when you replace the more sophisticated components like modules, tuners, channel selectors and sub-assemblies.

Your participating Zenith parts distributor will supply you with a replacement remanufactured, reconditioned and serviced for reliability by Zenith people as dedicated and knowledgeable as those who made the original.

Equally important, the replacement module or sub-assembly you receive in exchange from your Zenith parts distributor

will most likely incorporate any Zenith factory-made modifications in effect at the time of remanufacture.

And nowhere else but in a participating Zenith parts distributor's Exchange Program can you get assurance that a replacement incorporates Zenith factory up-dates!

To learn the location of the Zenith R&R Exchange Counter in your area, write on your company letterhead and we will help you locate one that's nearby.

Risking an exchange for a Zenith replacement anywhere else doesn't make sense. Not when factory-fresh replacement modules and sub-assemblies are so readily available thru a Zenith parts distributor's Exchange Program! Write now!



The quality goes in before the name goes on.®