

ELECTRONICTM

Service & Technology

NOVEMBER 1987/\$2.25

Troubleshooting startup circuits

Service microwave oven panels • The meter said ...what?

Power conditioning

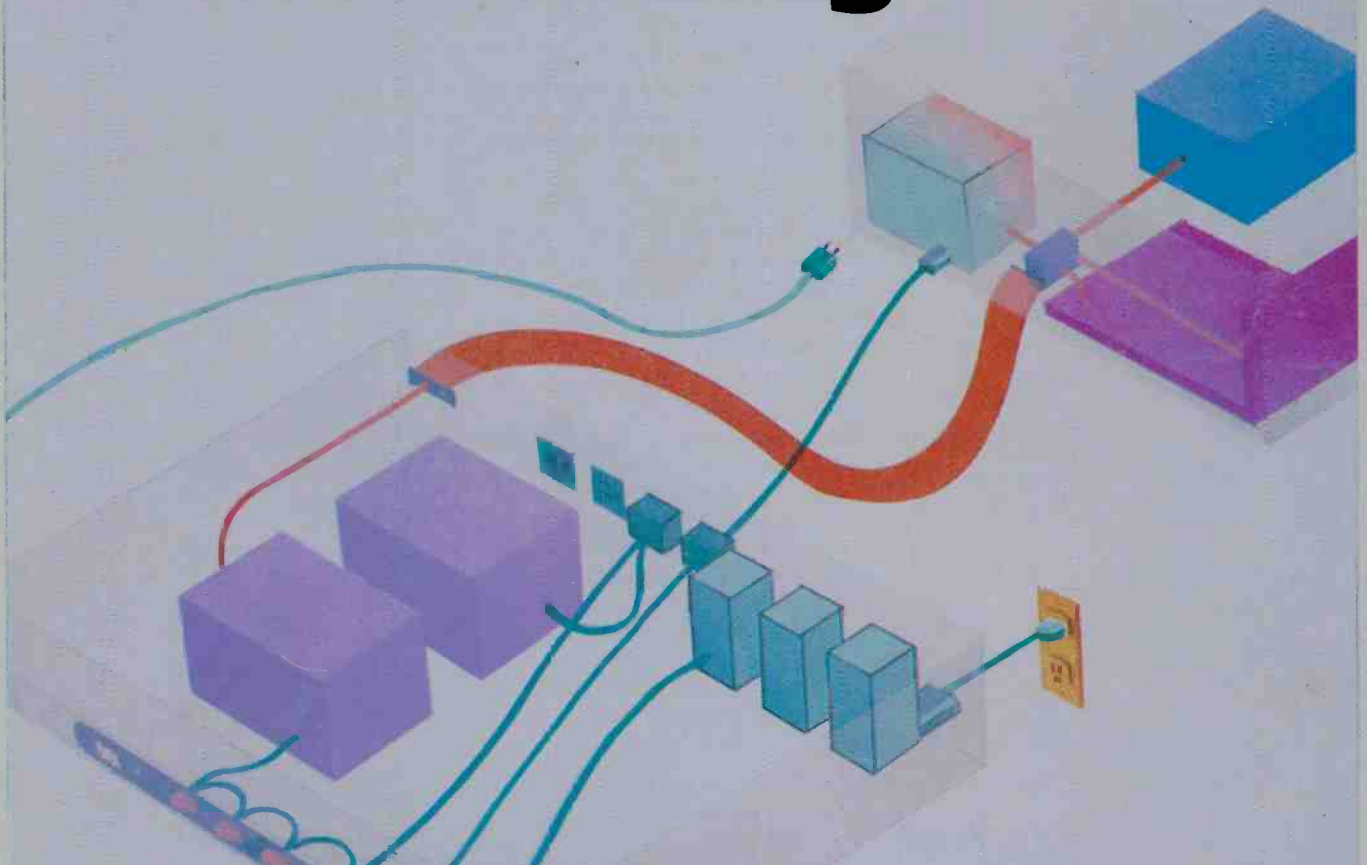

A14111-----FLTCA9421 OCT88 ESQ
R10906851052886121 EE 1
BRAD FELTZ ES
*
1942 CAIN RD
NORTH COLLINS NY 14111

Oops Proof. Now Even Better.

*Industry's Most Popular Heavy-Duty DMMs...
Now Even Better With Dual-Fuse Protection
And A Tougher Case.*

The tough just got tougher. When Beckman Industrial introduced heavy-duty DMMs tough enough to withstand accidental drops, input overloads and destructive environments, they quickly became the industry's most popular.

Now they're even tougher, thanks to the best dual-fuse protection you can buy and a new case. Covered by a one-year, no-fault guarantee against damage to the meter other than gross abuse.

For overloads, all voltage ranges can withstand transients up to 6KV. Resistance ranges are protected to 600 volts. Current ranges are protected by a 2 amp/600 volt fuse. The 10 amp range is protected by a 15 amp, 600 volt high energy fuse with 100,000 amp interrupt rating.

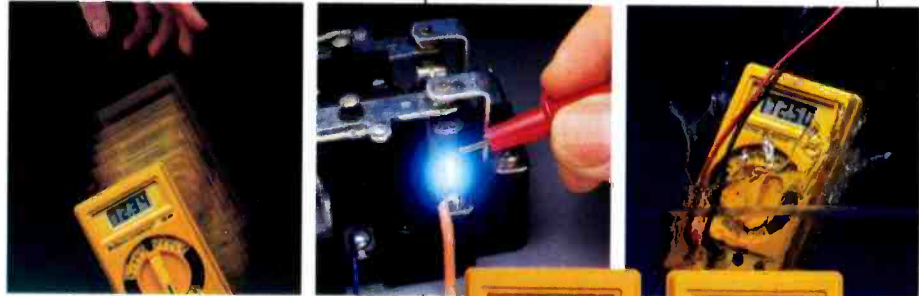

Our heavy-duty DMMs can withstand accidental drops, literally bouncing back for more, thanks to a new case made of Valox[®], one of the most impact and corrosive chemical resistant thermoplastics around. Sensitive components are shock mounted for impact protection.

Even oil, water and industrial grime can't keep our heavy-duty DMMs away from the action. *Everything* is sealed with o-rings for maximum protection.

Of course, even the toughest DMM isn't much good if it can't deliver accuracy and the right combination of capabilities at the right price.

Check the HD DMM specs for yourself: Maximum voltage rating of 1500 volts DC, 1000 volts AC; tested to 40KHz; diode test function; and exclusive INSTA-Ohm[®] capability, now with an audible beeper, to make your HD even easier to use.

What's more, you can select just the model you need without paying extra. Start with the economical HD-100 at \$169.00 for solid, all-around meter performance. Choose the HD-110 with continuity beeper. Or, the HD-110T that lets you select Fahrenheit or Celsius temperature measurement with a simple field adjustment, accurately measuring from -4°F to +1999°F, and works with any K-type thermocouple. It also has a measurement range of 32°F to 392°F with the thermocouple provided.

You can even get the true RMS capability on the HD-130,



or with a 4 1/2 digit display required by the HD-140's accuracy.

HEAVY DUTY DMMS	HD100	HD110	HD110T	HD130	HD140
Digits		3 1/2			4 1/2
Accuracy (Vdc)		0.25%		0.1%	0.05%
Input Impedance	22 Megohms			10 Megohms	
AC Conversion Type	Average			True RMS	
Bandwidth (AC Volts)	10KHz		40KHz	10KHz	
Current Range	0.1µA				0.01µA
Min. Reading					
Max. Reading	2A	10A (20A for 30 Seconds)			
Continuity Beeper		✓			
Battery Life (Alkaline type)	2000 Hours				100 Hours

Visit your local Beckman Industrial distributor today. Compare. And discover why the toughest are tougher than ever.

*In Service
Instruments,
We're The One.*

Beckman Industrial™

Beckman Industrial Corporation, Instrumentation Products Division
A Subsidiary of Emerson Electric Company
3883 Ruffin Road, San Diego, CA 92123-1898
(619) 495-3200 • FAX: (619) 268 0172 • T1.X. 249031

© 1987 Beckman Industrial Corporation

Valox[®] is a registered trademark of General Electric.

Circle (1) on Reply Card

NEW FROM TEK AT JUST \$995!

Light weight makes the 2225 easy to carry even to remote servicing sites.

Fully segmented graticule lines ease the way for quick, accurate voltage and time measurements.

Bright, full-size CRT with minimal geometric distortion and crisp, small spot size delivers sharp trace definition.

One-button beam finder locates off-screen signals, even when intensity is turned down.

Proven design and rugged construction offer reliability at its best. And the Tek reputation for meeting rigid environmental requirements means confidence in your measurements—and in knowing that his scope is built to last.

Sweep speeds to 5 ns/div are fast enough for making accurate pulse and timing measurements on most digital logic families, with good resolution.

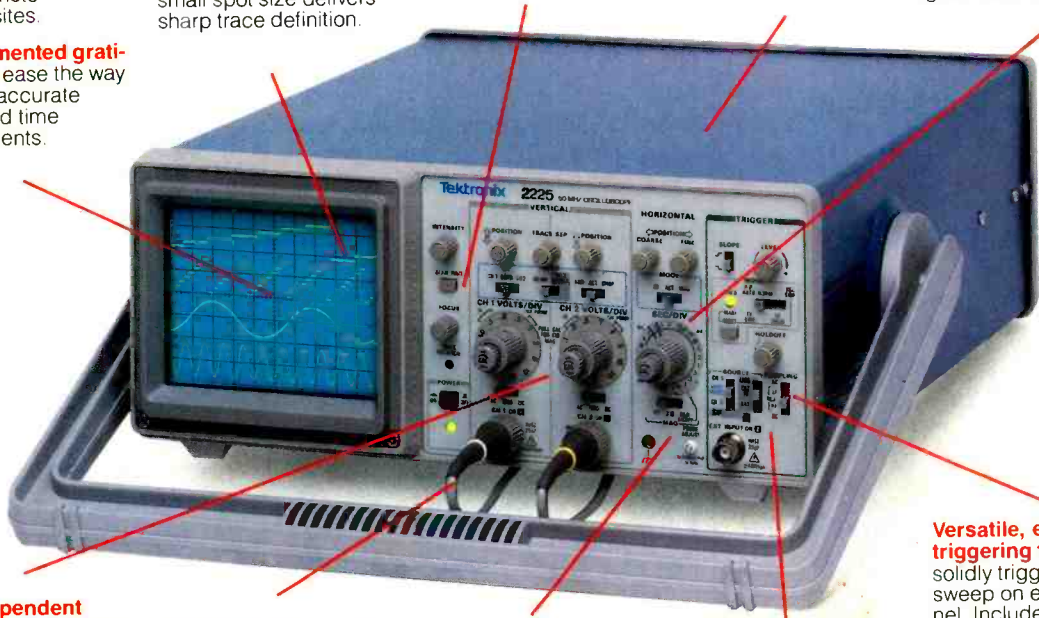

Two independent channels with 50 MHz bandwidth and independent bandwidth limiting on each channel to 5 MHz, 500 μ V/div sensitivity for low-level signal measurements and differential applications.

New low-cost probes (with nearly unbreakable tips) complement the rugged scope design. Compensation adjustments in the probe body itself eliminate the bulky compensation box at the front panel. Scope and probes are a perfect match!

Fast, accurate alternate horizontal magnification lets you choose any of three expansion levels to magnify any part of the normal waveform display—including the trigger point and end of sweep.

Now for the first time! Two vertical-channel inputs and an external Z-axis input all on the front panel. An excellent combination for manufacturing test stations and rackmount applications. And at the simple flip of a switch you can trigger on the Z-axis signal.

Versatile, easy-to-use triggering functions solidly trigger the sweep on either channel. Included are asynchronous triggering capability; flexible coupling via DC, AC, HF and LF reject filtering; hands-free triggering from virtually any signal; plus independent selection of either TV line or TV field triggering regardless of time-base setting.

Now, the professional quality and performance you expect from Tektronix... at an unexpected price: \$995 for scope, probes, 3-year warranty and 30-day free trial on approved credit. No portable in its class can match the Tek 2225 for features, versatility, convenience and value. It's the easy, economical answer to scope needs at bench and field sites, on the manufacturing floor and in the classroom. Call Tek to order, for application assistance or to get the name of your nearest Tek representative or distributor.



Call Tek direct: 1-800-426-2200



Tektronix
COMMITTED TO EXCELLENCE

ELECTRONIC

Servicing & Technology

Volume 7, No. 11 November 1987

12 Report from the test lab: the Semianalyzer transistor/junction tester

By Carl H. Babcoke, CET
The EDS Semianalyzer, intended primarily for testing diode and transistor junctions, uses a combination of passive testing and a breakdown mode with noise testing.

16 Test your electronics knowledge

By Sam Wilson, CET
This month's quiz asks some basic questions about oscilloscopes and VCRs.

18 Servicing microwave oven panels

By Homer L. Davidson
It's like magic—cooking without heat, with just the touch of a button. It doesn't take magic, however, to service the microwave's control panel, just some basic servicing skills.

26 Power conditioning

By Conrad Persson
If you're like most modern consumers, you have a home full of electronic equipment—televisions, VCRs, computers, even devices you might not think of, like the water bed heater. Yet without power conditioning, you could find yourself back in the pre-electronic era with just one bolt of lightning.

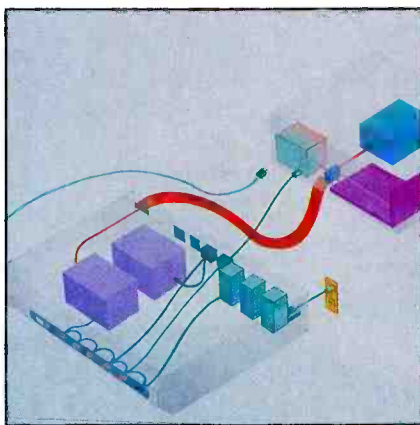

page 26
This uninterruptible power system provides emergency power to a personal computer when the ac-line power fails. (Photo courtesy of Applied Research and Technology)

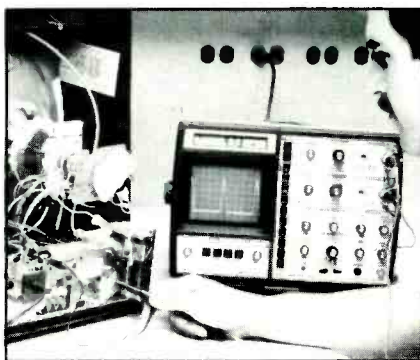

page 42
To see whether you've got a shutdown problem or a startup problem, monitor the collector of the horizontal output transistor. If you don't see pulses build up, you have a startup problem.

Departments:

- 4 Editorial
- 6 Feedback
- 7 Photofact
- 8 News
- 11 Technology
- 41 Books
- 52 Products
- 58 Audio Corner
- 62 Computer Corner
- 63 Literature
- 64 Video Corner
- 66 Readers' Exchange
- 68 Advertisers' Index

42 Troubleshooting startup circuits

By Gregory D. Carey, CET
This second part in a three-part series on horizontal output circuits helps you differentiate between startup problems and shutdown problems.

48 What do you know about electronics?—Model behavior

By Sam Wilson, CET
Sometimes you need to resort to a model to visualize how electronic components work. This month, take a fantastic journey into a semiconductor model to understand its behavior.

54 The meter said ...what?

By Joseph J. Carr, CET
If you've ever done a double-take at a meter reading, you know that what the meter says isn't always the entire answer. This article shows four cases of misleading meter readings, and explains how the technicians found the correct answer.

On the cover...

This uninterruptible power system provides emergency power to a personal computer when the ac-line power fails or when the voltage drops below the required level. The unit provides dc directly to the computer, bypassing the computer's power supply, thus eliminating the inefficiencies of converting the UPS battery supply to ac, then converting it back to dc in the computer.



Portable Problem Solver

Ultra-compact Digital Storage Oscilloscope-Multimeter.

Easily carried in a tool kit or attache case—powered by batteries or supplied ac adaptor—this 2-in-1 lightweight is always ready for hand-held action.

Multi-function, 200-kHz DSO.

Just flip the switch from DMM to SCOPE and the performance of a professional Digital Storage Oscilloscope is at your fingertips. Lets you capture and analyze single-shot and very slow phenomena. Stores up to three waveforms, and has such top-of-the-line features as auto-ranging time base setting, pre-trigger, roll mode, and on-screen readout of setting conditions. Low-power indicator

alerts you when batteries need recharging, while a separate back-up system protects memory.

Full-function, 3½-digit DMM.

Precise measurement of ac/dc voltage, current and resistance is easy to see on the large, high-contrast, display. Automatically selects range which provides greatest accuracy and resolution.

Perfect for many applications.

LCD-100 is a unique combination instrument that can confirm that its DMM is measuring a desired signal. Better by far than a DMM alone... more useful in the field than any benchtop DSO in this bandwidth, LCD-100 is ideal for servic-

ing a broad range of electromechanical, electrical and electronic systems.

Call toll-free
1-800-645-5104
 In NY State
(516) 231-6900

Ask for an evaluation unit, our latest Catalog, more information, or the name of your "Select" Leader Distributor.

For professionals
 who know
 the difference.
LEADER
 Instruments Corporation

380 Oser Avenue, Hauppauge, New York 11788
 Regional Offices:
 Chicago, Dallas, Los Angeles, Boston, Atlanta
 In Canada call Omnitronix Ltd. (416) 828-6221

For Information Circle (4) on Reply Card
 For Demonstration Circle (5) on Reply Card

Protecting your investment

Our society has become increasingly safety conscious. The use of seat belts in automobiles has been demonstrated to save many lives. In fact, seat belts have been shown to be so effective that many states have passed mandatory seat belt laws. The same is true of smoke detectors in the home. At first, just a few pioneering individuals were installing them. Then, as a result of the number of lives saved because of the beep of a smoke detector, more and more people saw the wisdom of having an alarm to alert them in the event of a fire.

This consciousness of safety has been carried over into other areas. Modern electronics products have become so sensitive to a number of environmental factors that efforts to eliminate, or at least minimize, damage caused by these factors has increased. Two examples of these damaging factors are electrostatic discharge (ESD) damage and damage caused by power-line disturbances such as surges and spikes.

The electronics community, along with materials and packaging manufacturers, has come up with a number of answers to these problems. For example, the ESD problem has been attacked on a number of fronts: wrist straps, conductive bench tops, portable conductive work surfaces and other products alleviate the problem.

Likewise, manufacturers have come up with a number of ways to deal with the problem of power-line disturbances. These range from simple plug-in devices that feature minimal protection from spikes and surges, all the way up to uninterruptible power supplies that not only provide attenuation or elimination of spikes, but will provide from a few minutes to several hours of battery power in the event of a power outage.

All of this protection comes, of course, at a price. First, it costs money. Sometimes a lot of money. In some cases proper use of the protection is inconvenient. Who wants to be tied to a workbench by a length of conductor? What field technician wants to have to unwrap and lay out and find a ground for a complete ESD protective package? But if you want that protection, you have to use it every time.

But wait, there's a worse problem.

Some of the products that are supposed to provide protection don't. Or at least they have never been *tested* to prove that they provide the protection they are claimed to have. As was pointed out in the static protection article in the October issue of *ES&T*, some of the so-called static protective bags are least effective when protection is needed most. And when it comes to protection from power-line disturbances, it's definitely "Let the buyer beware."

For example, in talking to a source for this month's article on power conditioning, I learned that some manufacturer's sell "power conditioning" equipment that doesn't necessarily offer that protection. A little personal investigation with minimal effort confirmed this. I simply went into the personal computer department of a local discount store and lifted the first self-proclaimed spike suppressor off the rack. It was not only called a spike suppressor, it was UL listed.

However, after I opened the package and took a look at the disclaimer on the back of the unit, I found that the product had never been tested as a spike suppressor. The UL listing attested to the product's safety as an *electrical wiring device*, but said nothing about its ability to protect a device plugged into it from damage caused by power-line disturbances. The manufacturer's packaging was misleading at best. I'm sure that lots of people have their computers, VCRs and TVs plugged into similar devices, content that they have provided adequate protection for them.

Someone once said, "It's not what you don't know that will hurt you. It's what you know for sure that isn't so." Likewise, it's not so much the *unprotected* electronics products you own that will suffer damage—you can just unplug them during an electrical storm. It's the equipment you have "protected" using inadequate protection that will most likely be damaged or destroyed.

Don't leave protection of electronics equipment to chance. Study the market. Make sure that the protection you provide has been tested and found to be effective.

Mike Conrad Pearson



PHILIPS

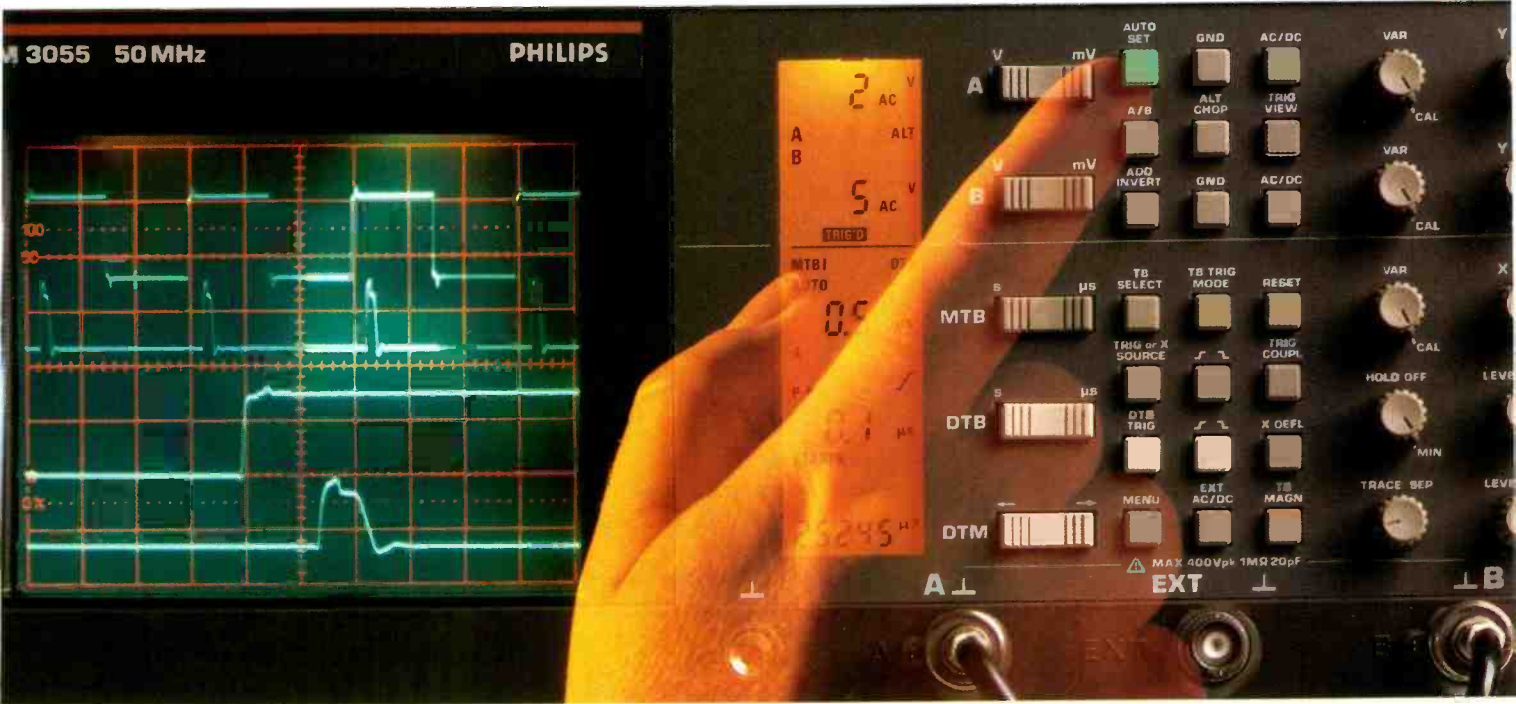

The smart scope for people who hate to wait

The Philips microcomputer-controlled PM 3050 Series. The only 50 MHz scopes in the world smart enough to find and display the signal—automatically.

SMART PERFORMANCE

- *Autoset finds the signal at the touch of a button.* Philips' intelligent beamfinder automatically selects amplitude, timebase and triggering for error-free instant display of any input signal on any channel.
- *16kV CRT for optimum viewing.* When it comes to brilliance, clarity and spot quality, nothing in its class shines brighter.
- *LCD Panel for confident, at-a-glance operation.* A valuable information center, it instantly displays all instrument settings and parameter values. With no mistakes.

- *Auto-Triggering "thinks for you".* This built-in intelligence provides fast, accurate, properly-triggered signals up to 100 MHz.
- *IEEE Compatibility.* The PM 3050 Series is the only family of 50 MHz scopes with an add-on IEEE-488 interface option for fast computer hook-up.
- *Choice of Models.* Single timebase or delayed sweep versions are available.

SMART SUPPORT

Philips PM 3050 Series also comes with a 3-year warranty and all the technical and service assistance you need. From Fluke—the people who believe that extraordinary technology deserves extraordinary support.

SMART BUY

For about what you'd pay for the next-best scope you get innovative engineering that's

Circle (11) on Reply Card

more productive and easier to use. You get plug-in modularity and IC microelectronics for reliability you've never seen in this class before. Plus, for a limited time, you get a no-risk, no-questions-asked, 30-day money-back guarantee. So why wait any longer?

TEST THE DIFFERENCE

So call Fluke today at **800-44-FLUKE ext. 77**. And find out how smart your next oscilloscope buy can be.

John Fluke Mfg. Co., Inc., P.O. Box C9090, M/S 250C.
Everett, WA, 98206
U.S.: 206-356-5400 CANADA: 416-890-7600
OTHER COUNTRIES 206-356-5500

© Copyright 1987 John Fluke Mfg. Co., Inc.
All rights reserved. Ad No. 1075-P305X



PM 3050/55 • 50 MHz • OSCILLOSCOPES



Feedback

Letter to Sam Wilson

In the "Test Your Electronic Knowledge" feature in the July 1987 issue of *ES&T*, the correct answer to question 10 should be A. According to the schematic diagram, if the resistor marked R is open, the transistor will be saturated, because I_b and I_c still flow to ground through the transistor through V_{ce} . Therefore the formula $I_e = I_b + I_c$ still applies.

Moe Myint
Washington, DC

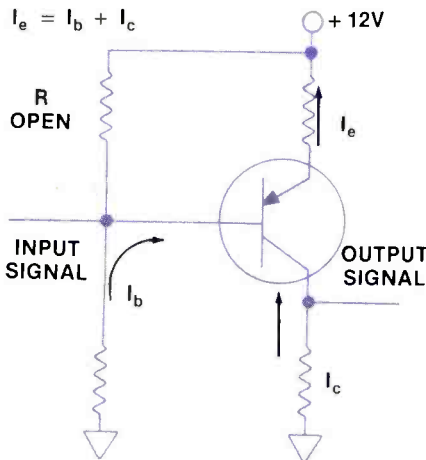

So many people have written about this error that I felt it necessary to give a detailed explanation of the correct answer.

As you know, the correct answer is that the resistor will be saturated. It is sometimes easier to visualize the purpose of R in a right-side-up NPN transistor circuit, so I am enclosing Figure A.

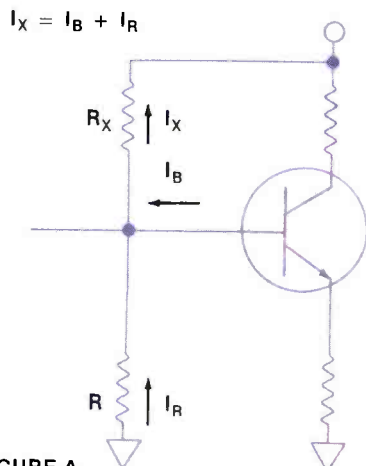

FIGURE A

The question states, "If the resistor marked 'R' is open, the transistor will be (saturated or cut off)." As shown by the arrows, the current through R_x is a combination I_b plus I_c . If R is open, only I_b flows through R_x . That greatly reduces the drop across R_x and causes the base voltage to go very high. The resulting increase in base current drives the transistor into heavy conduction (usually saturation). The same situation occurs in the PNP transistor circuit in Figure 5 in the July 1987 quiz.

Thanks again for writing. Your letters are very important to us.
Sam Wilson

Interest in electronic organ repair

In reference to the August 1987 Feedback letter about electronic organs, I would like to see a series concentrating on the theory and troubleshooting of these pieces of equipment, especially the smaller keyboards. I feel more people have these because of their inexpensiveness, and they tend to need servicing more often because of their portable nature, which makes them prone to disaster (from moisture, dust, fumble fingers, etc.)

Ray Tweedale, Jr., CET
Milwaukee, WI

From our readers' responses, it does seem that a series of articles on servicing electronic articles would be useful to *ES&T* readers. If any of our readers would be interested in writing such an article, please contact the editor at Intertec Publishing, P.O. Box 12901, Overland Park, KS 66212.

In the August feedback a reader requested an article on electronic organs. Perhaps this is a subject to be covered, perhaps not, as it is a rather specialized field and is slowly dying as companies, one by one, cease to produce product or have them designed and built overseas.

I have been servicing organs (or keyboards as they are called today) for almost 30 years. I have always tried to help techs from other locations who get themselves into an organ and find that it is a world of its own. (I get lost in a TV chassis.)

At one time the organ industry was very large, but at this time there appear to be only four companies left that are producing organs in this country. Many of the others are now just service organizations.

The modern-day organ or keyboard is actually a computer that plays music. Digital technology using PCM and MIDI interfacing is now the thing. While most instruments are similar on the outside and can do many of the same things, each company does it differently. If technicians have a good electronics background with some basic computer or digital training, along with some musical knowledge, they should be able to service the newer products. Most of the remaining companies will supply service information for a fee; however, one must usually be affiliated with a dealer in order to get parts or be willing to accept COD shipments with some sort of minimum order.

If you are not already aware, there is an organization for organ technicians that is growing every day. It is known as MITA International (Musical Instrument Technicians Association) and is based in St. Louis, MO. It puts out a monthly newsletter to its members, and is running service seminars throughout the country, now that the companies do not. Membership is \$25 a year for a tech, and it is fast becoming a clearinghouse for information as to what is happening in the industry. Contact Ken Gurler, Editor, MITA News, 8216 Audrain Drive, St. Louis, MO 63121-4504; 314-389-3290.

There have also been many super service companies springing up that are sources for parts for the older instruments that the individual companies no longer wish to keep in inventory. Keyboard Systems puts out a parts cross-reference for solid-state items used by the organ companies, and also lists all the present company service addresses. The company's address is 3637 East 7800 South, Salt Lake City, UT 84121. They are also a good source for older organ tubes.

Richard M. Johnson
Wakefield, MA

ES&T

Photofact

These Photofact folders for TV receivers have been released by Howard W. Sams since ES&T's last report.

GENERAL ELECTRIC 7-7650A	2531-1	RCA EMR295E (CH. CTC125E)	2536-2
GENERAL ELECTRIC 13PF6500WA01, 13PF6504WA01 (CH. NF-A)	2533-1	SEARS 564.42351650/51/52	2534-1
HITACHI CT1371	2530-1	TOSHIBA CF2046, CX2046C	2530-2
PANASONIC CTH-1463R, CTJ-1463R	2536-1	TOSHIBA CX2056	2531-2
QUASAR TT5947AW/48AW, WT5946AW (CH. ADC139, DC139)	2532-1	TOSHIBA CX2675, CX2800C, CX2875C	2533-2
QUASAR TL9951AK, TU9940AK/48AK (CH. AEMQDC110)	2535-1	ZENITH B1908WB/08WC/08W2/20W/20WC/26W/92W/92WC/ 92WC5/92W5/96W, B3932W/32WC/36W/52W, S1906B/10W, V3906Y/30W	2532-2
RCA EMR330E, EMR330W (CH. CTC123A)	2535-2	ZENITH C0920A/20D/20K/20U/30S/30S2	2534-2

ES&T
m

NEW RUGGEDIZED SCOPE PROBES

Just a phone call away.

\$35 P6103

50 MHz 10x
Compensation Range
15 to 35 pF

\$58 P6109

150 MHz 10x
Compensation Range
18 to 22 pF

These new passive voltage probes can be used with any oscilloscopes having matching compensation ranges.

Screw in tips mean easy repair, no downtime.

To order call toll free **1-800-426-2200**

In Oregon, call collect (503) 627-9000.

VISA and MasterCharge accepted.

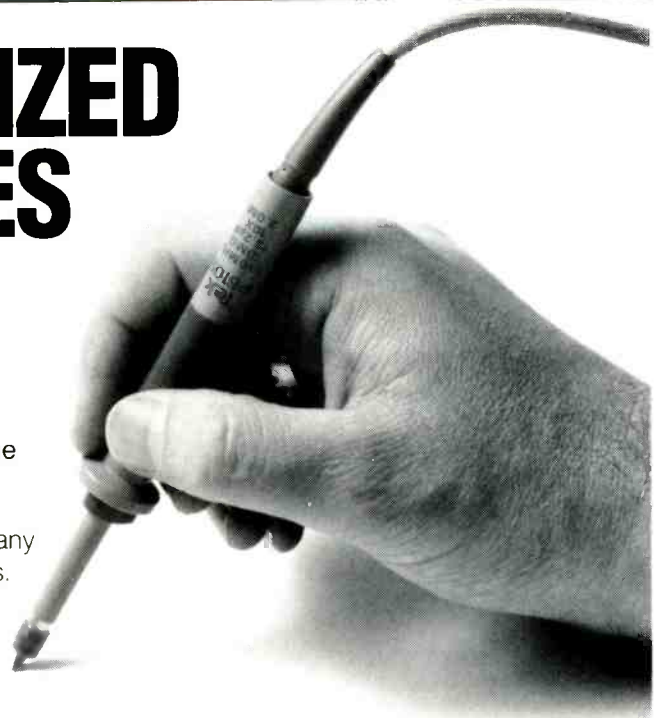

Tektronix
COMMITTED TO EXCELLENCE

NAPCEC expands education program

N.A.P. Consumer Electronics Corporation (NAPCEC) has announced an expanded format for its Successful Service Training (SST) program, a series of technically oriented educational programs aimed primarily at technicians, engineers and service professionals.

Program courses are continually updated. The current listing includes courses on VCRs, VCR product technology, wide-screen projection television, B1 and C9 television chassis, fundamentals of color cameras, and compact disc digital audio players.

NAPCEC also plans to introduce a basic digital technology program using a digital logic training system.

Individual SST courses range from two to five days and are offered at six NAPCEC training facilities and in major cities across the country. For more information, contact: Lisa Cole, N.A.P.

Product Services, P.O. Box 555, Jefferson City, TN 37760; 615-475-0044.

Pace offers surface mount class

Pace has announced that its PCT-400 course on surface mount rework and repair will be conducted at its facilities on the following dates: Nov. 9-13 at both the Tustin, CA, and Laurel, MD, locations; and Dec. 7-11 at the Tustin, CA, location only. For more information, contact Pace at 9893 Brewers Court, Laurel, MD 20707; 301-490-9860.

VCR and camcorder sales increase

Sales of VCRs and camcorders advanced in July, according to the Washington-based Electronic Industries Association (EIA). Sales of camcorders topped 116,000 units, a 22% gain compared with July 1986. VCR sales expanded 10% to about 916,000 units.

Fluke services Philips products

John Fluke Manufacturing Company and N.V. Philips of the Netherlands have announced a new service arrangement in the United States and Canada. Fac-

tory authorized service for Philips Test & Measurement products will now be performed at Fluke Technical Centers throughout the United States and Canada. Products covered include oscilloscopes, logic analyzers, counters, function and pulse generators, multimeters and GPIB/IEEE-488 system components.

The agreement has produced several service enhancements for owners of Philips instruments:

- Automatic upgrades – Fluke service personnel will bring Philips instruments up to current specifications whenever they are serviced;
- 90-day warranty – On all repairs, Fluke will warrant the total performance of the instrument, not just the repair, for 90 days;
- Pick-up/delivery – Instrument pick-up and delivery and on-site calibration will be offered in many locations;
- Genuine parts – Only factory authorized Philips parts will be used in all repairs.

Fluke has also entered into a global alliance with N.V. Philips to market and support its test and measurement instruments in North America.

The how-to magazine of electronics

ELECTRONIC

Servicing & Technology

Editorial, advertising and circulation correspondence should be addressed to: P.O. Box 12901, Overland Park, KS 66212-9981 (a suburb of Kansas City, MO); (913) 888-4664. Home office fax: 913-888-7243; Home office telex: 42-4156 INTERTEC OLPK

EDITORIAL

Nils Conrad Persson, *Editor*
 Carl Babcoke, *Consumer Servicing Consultant*
 Tom Cook, *Senior Managing Editor*
 Alisa Carter, *Associate Editor*
 Joy Culver, *Editorial Assistant*
 Darryll Fortune, *Editorial Assistant*
 Darren Sextro, *Editorial Assistant*

CONSULTING EDITORS

Homer L. Davidson, *TV Servicing Consultant*
 Christopher H. Fenton, *Circuit Fabrication Consultant*
 Victor Meeldijk, *Components Consultant*
 Kirk G. Vistain, *Audio Consultant*
 Sam Wilson, *Electronics Theory Consultant*

ART

Kevin Callahan, *Art Director*
 Barbara Miles, *Graphic Designer*

BUSINESS

Cameron Bishop, *Group Vice President*
 Eric Jacobson, *Publisher*
 Greg Garrison, *Sales Manager*
 Stephanie Hanaway, *Promotions Manager*
 Kelly Hawthorne, *Promotions Coordinator*
 Dee Unger, *Advertising Supervisor*
 Catherine Grawe, *Advertising Coordinator*

ADVERTISING

Regional advertising sales offices are listed in classified pages.

ADMINISTRATION

R. J. Hancock, *President*
 Doug Riemer, *Circulation Vice President*
 Jo Ann DeSmet, *Fulfillment Manager*
 Janey Powell, *Circulation Manager*
 Dee Manies, *Reader Correspondent*



Member, Audit Bureau of Circulation



Member, American Business Press



Member, Electronic Servicing Dealers Association

ELECTRONIC SERVICING & TECHNOLOGY is the "how-to" magazine for technicians who service consumer electronics equipment. This includes service technicians, field service personnel and avid servicing enthusiasts who repair and maintain audio, video, computer and other consumer electronics equipment.

SUBSCRIPTION PRICES: one year \$18, two years \$30 in the USA and its possessions. Foreign countries: one year \$22, two years \$34. Single copy price \$2.25; back copies \$3.00. Adjustment necessitated by subscription termination to single copy rate. Allow 6 to 8 weeks for new subscriptions.

PHOTOCOPY RIGHTS: Permission to photocopy for internal or personal use is granted by Intertec Publishing Corp. for libraries and others registered with Copyright Clearance Center (CCC), provided the base fee of \$2 per copy of article is paid directly to CCC, 21 Congress St., Salem, MA 01970. Special requests should be addressed to Eric Jacobson, publisher. ISSN 0278-9922 \$2.00 + 0.00

INTERTEC
 PUBLISHING CORPORATION

1987 All rights reserved



**Jumbo size
plus sharp
resolution
-- all in one**

Matsushita Electric Industrial Company, Ltd, maker of National, Panasonic, Technics and Quasar products, has introduced the world's largest CRT color television featuring a 41-inch direct-view screen. The television combines the jumbo-size screen of a projection TV with the sharp picture resolution of a CRT television. A stand with built-in speakers will also be available.

The television offers three sets of stereo audio/video input jacks and two sets of audio/video output jacks. The set also has a special S-video input terminal for Super-VHS. Variable audio output jacks allow easy connection to an external hi-fi system.

The company used computer

modeling and analysis techniques to reduce the weight inherent in large-size CRTs to 88.2lb, while virtually eliminating deflection distortion.

The TV tube's design, having a 30.6mm neck with a 110° deflection angle, represents a significant improvement over the 40-inch CRTs with 36.5mm neck and 90° deflection angle introduced several years ago.

The television has a flat hyperbolic screen with improved overlapping field lens, aberration-reducing triode and an impregnated cathode that allow the color CRT to accommodate 6mA of current and reduce dot size from 8mm to 5mm. The impregnated cathode can withstand high current with-

out burning out. In addition, the back of the CRT's shadow mask has a special coating to increase electron reflectivity and thermal emission, which further reduces local doming.

The television has 560 lines of horizontal resolution and adopts the newly developed comb filters for greater detail by electronically processing the incoming color signals. Also added are newly developed black-level retention and dynamic aperture controls. The television features surround sound capability and Dolby surrounding circuit, and has a 2-way, 4-speaker sound system. Overall, output power is 30W (20W in the television and 10W in the surround rear speaker).

ES&T

The Semianalyzer transistor/junction tester

This month, the report is about the model 59C Semianalyzer transistor/junction tester from Electronic Design Specialists. Model 59C is a combination of passive testing and breakdown voltages with noise testing. The two are not compatible, so they are not done together; instead, they are completely separated—an interesting concept that works fine.

The 59C is intended primarily for testing diode and transistor junctions, although tests can be made on a few other components. Physically, the unit is moderately small, except for the outside-type handle that functions as a tilt stand. Width and depth are 9 inches (plus the handle); depth is only 3 inches. Power is supplied by 120Vac only.

The digital readout appears to have 2½-digit operation with automatic range selection and ½-inch red LED digits. During the various tests, red LED words such as OPEN, PNP, SHORT or any of six others can be flashed on the screen to indicate the conditions.

There are only two basic test positions: JUNCT with the switch out (condition of the junction), or BRKDN (breakdown mode) when the switch is locked in. The breakdown mode measures leakage of the junction. That switch is next to the power switch.

At the right side of the panel above the two switches is a grille that resembles a giant salt shaker; the various sounds originate here. Two jacks for the test probes are located at the center bottom.

Testing silicon junctions

Here are the simple steps for testing the junctions of an average silicon transistor:

1. With the black lead at the base, touch the collector with the red lead. The screen should read: SINGLE JUNCT NPN. If it does, the first test has been passed. A defective junction might have read OPEN, LEAKY or SHORT. Any of these conditions reject that junction.

2. With the black lead on the base, touch the emitter with the red lead. The screen should read: SINGLE JUNCTION NPN (the same as for the collector test). This indicates a normal base/emitter junction.

3. Touch the red and black test leads to the emitter and collector. The reading should be OPEN JUNCTION. If so, reverse the test lead polarity and touch the emitter and collector again. This reading should also be OPEN JUNCTION. These open emitter/collector readings are normal, and any deviation probably indicates the transistor is defective.

Of course, these previous tests were all made with the mode switch in the junction position. Before using the breakdown voltage, you should know that this voltage can shock you, because it might be any dc voltage up to about 180Vdc. Of course, the current is limited to 10mA, but that much can really shock you. And any shock is worse when you are not expecting it. Use care when handling the test leads during the breakdown mode.

There are some problems. Do not leave the breakdown switch activated (switch locked in) but switch it off to the JUNCT position after each use. Otherwise, you might accidentally place the probes across a sensitive circuit, causing damage. But there is more. The dcv/dcv converter that supplies the breakdown voltage should not be

operated for longer periods of time. Be on the safe side for both reasons and *turn off the breakdown voltage after each use.*

Testing voltage breakdown

With an NPN transistor, touch the red test lead to the collector and the black lead to the emitter. If the junction is good, the avalanche voltage will be less than 150V, and the speaker will have some faint hiss without popping or crackling. That is the *avalanche* or *breakdown voltage* of the collector/emitter junction. One test transistor showed 51.1V, which is the top voltage limit for its operation. The same test can be performed with the red probe touching the emitter and the black probe touching the base. Of course, this is reverse bias for the junction, which then acts as a zener to limit the voltage drop. With the test transistor that voltage was 5.6V.

Miscellaneous

Bias diode for a power transistor often has a box with two, three or four diodes in series. Any or all of these can fail. Use the basic transistor C/E method and the readout will show the number of junctions that are working.

Darlington or high-gain transistors show the usual single junction between base and collector, but usually will show dual junctions when measuring base to emitter.

In-circuit junction testing

The 59C is said to be very rapid and accurate when used for in-circuit tests. Of course, the breakdown test would not be used unless that transistor was disconnected temporarily from the circuit.

According to the instruction

By Carl H. Babcoke



manual, circuit loads as low as 10Ω will not affect the readings, although the LEAKY sign might be lighted at times. I tested a silicon base/emitter junction, obtaining SINGLE JUNCT NPN normal reading. A 96Ω resistor was connected between base and emitter, then the test was repeated. This time the readout was LEAKY SINGLE JUNCT NPN. No attempt was made to find the effects of lower resistances because transistor junctions that light the NPN or PNP legend usually are not defec-

tive (just obscured by circuit load). But if a transistor shows LEAKY JUNCT *without* the PNP or NPN flag, it probably is defective. Remove it from the circuit for more testing.

Testing zener diodes

When the diode is out of circuit, the 59C will show the correct zener

dc voltage. Connect it the same as any diode breakdown test (red probe to the anode, black probe to the cathode) and read the zener voltage on the screen. The 10mA of regulated current makes this possible for zeners of all voltages.

Testing capacitor leakage

Out-of-circuit film and alumi-

VIDEO WONDERBOX™

"The ultimate solution to TV/VCR repair"



- NTSC color pattern generator-16 standard patterns
- Lightweight-weighs less than 2.5 pounds
- RGB outputs-IBM PC monitor compatible
- Modulated RF and video outputs
- 4.5 MHz intercarrier frequency with 1 KHz internal modulation (switchable)
- Affordable

Call or Write for Your
Video Wonderbox Today!



ncm electronics

1500 Wyatt Drive
Santa Clara, CA 95054
(408) 496-0290

Circle (7) on Reply Card

POWER PROBLEM?

The Solution!
KALGLO Computer Grade Power Protection Products

TRANSIENT VOLTAGE SURGE SUPPRESSORS
POWER LINE FILTERS • POWER LINE CONDITIONERS
STANDBY UNINTERRUPTIBLE POWER SYSTEMS
1-800-524-0400, in PA 215-837-0700
CALL TODAY FOR FREE LITERATURE

Kalglo Electronics Co., Inc.
6584 Ruch Road
Bethlehem, PA 18017-9359

DEALER-VAR-OEM
INQUIRIES INVITED

Circle (8) on Reply Card

num-electrolytic capacitors up to 1,000 μ F can be tested for leakage and the maximum voltage that each can endure, using the voltage-breakdown mode.

As the capacitor charges, the voltage reading races upward, slows down, levels off and then begins to go down. Because this is the voltage-breakdown point, notice what the voltage reads, then instantly disconnect the capacitor from the 59C test leads.

All capacitors produce noises when the voltage is near the breakdown point. Look for a capacitor that is breaking down at a lower voltage than the marked value (or the working peak voltage in the receiver). Thumping noises or wildly varying voltage readings are valid reasons to reject that capacitor.

Noise tests of transistors are performed exactly as leakage tests are, except attention is focussed on the volume and quality of the noise. Good semiconductor junctions will show a stable voltage and have a steady hissing sound

(pink noise). Intermittent or noisy junctions produce an erratic voltage reading along with all varieties of popping noises. Leaky semiconductors often do not have excessive noise, but always will show a voltage lower than the rating.

Testing neon and LED lamps

With the instrument switched for the *breakdown* mode, touch the test leads to the LED or neon lamp (observing polarity when LEDs are tested) and the voltmeter will show the correct voltage for that LED or neon. In many cases the test can be made in-circuit with good accuracy. This is possible because of the regulated (constant-current) voltage supply.

Remember, for all these tests the machine being tested must be unplugged and without ac or dc power.

Note: Do *not* test the voltage breakdown of any tantalum capacitor. Tantalum capacitors have very low leakage but they have a tendency to short on any voltage

beyond their rated limits. Do not test them.

Model 59C is not intended for testing germanium junctions. However, most germanium junctions can be tested with reduced accuracy. One germanium tested single junction with a breakdown voltage of 129V.

One red and one black test lead are furnished with the machine. They have no resistances, capacitances or inductances in series or parallel with the test leads, but the operating manual seems to indicate some important characteristics. The operating manual says: "The junction tester portion of the EDS-59C has been calibrated to sharp stainless-steel probes with exactly 36-inch long leads. If you use any test leads other than the ones recommended, the tester may give inaccurate circuit conditions." I have no comment.

Audible signals

Audio tones that accompany some transistor junction tests are not mentioned in the operating instructions and owner's manual that details all the other tests. Perhaps the manual I have was one of the early ones that was intended for revisions as needed. Anyway, the machine produces a pleasant low tone for normal junctions, a slightly higher tone for Darlington base readings or bias-diode junctions, a shrill high tone for shorted junctions, or a low buzz for leaky circuits. Of course, the audible signals cannot be used during breakdown tests because the audio channel is busy with noise analysis.

It has been said that after using the 59C instrument while noticing the various audio tones for each read-out, a technician should have no difficulty in using the junction analyzer by listening for the various tones, rather than by watching the read-outs. Of course, this can be a time-saver.

Comments

Every item of test equipment has limits on the things that safely can be done with or to it.

The junction mode of the 59C supplies all necessary signals for the tests; no outside power is needed or desired. Therefore, the ma-

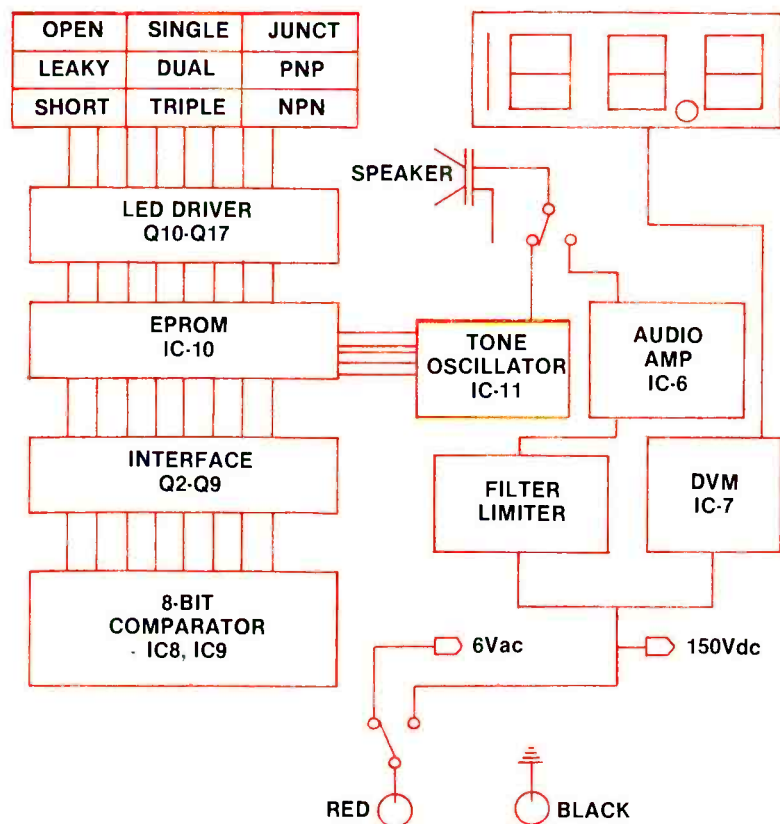

Figure 1. Block diagram of the unit. The first part of the unit probes semiconductors in circuit to indicate condition, type and number of junctions. The second part finds the component's breakdown voltage and amplifies junction noise.

chine being used for in-circuit tests *must* be unplugged from the 120Vac power. Further, all B+ lines near the test site should be grounded for a few seconds each to ensure that no B+ is stored there.

Do not switch to the breakdown mode and leave it there, even after the test has been made. One reason is the danger of shocks. The pointed test probes have up to 180Vdc between them (although limited to 10mA). I haven't been able to check out the following statement, so it is printed verbatim: "Besides, the DC/DC converter consumes a lot of power, and leaving the 59C in the VB mode for more than a few minutes at a time will shorten its life considerably." It is recommended, therefore, that you use the breakdown mode for the test or tests and then move the switch to *junction* position until the breakdown mode is again needed.

Incidentally, the only clue about how the instrument operates was found in a press release that said, in part: "sends out a special current-limited sine wave through its test leads to the circuit under test; the circuit and the component under test will distort the sine wave in a certain way. This distorted sine wave is converted by an 8-bit analog-to-digital converter, and the 8-bit word is presented to a 16K PROM, which has been programmed to recognize and display the results of just about any situation it may encounter."

Sample readings

The EDS-59C Semianalyzer is said to display up to 25 different combinations of circuit parameters. These will be self-explanatory.

Shorted junction—the reading is less than 0.6V (one junction) in both directions.

Leaky junction—readings under 0.6V in one direction, and one or more junctions in the other direction.

These will give you two samples of the screen readouts possible on the 59C.

Comments

During the time I have examined the EDS 59C, I have grown fond of

it. At first, I was not enthusiastic because I had samples of almost every commercial transistor tester ever made and a few I had hand-built. But I particularly like the breakdown and noise tests, which are unique. Each technician will have a different preference. Another might like the panel readouts best; there is something for everyone.

The EDS 59C has several highly

unusual features, and merits a thorough evaluation. After all, it is the equivalent of two testers in one with almost all functions automated. The only adjustment on the front panel is the junction/breakdown switch, and it is the one that changes from one type of testing to another. (EDS is located at 951 SW 82 Ave., North Lauderdale, FL 33068.)

ES&T

CALL TOLL FREE
Include work address and
phone number for Free Catalog.

800-824-2873

DIGITAL MULTIMETERS

BECKMAN

Beckman Industrial!

- All 300, HD, and Circuitmate series
- All accessories in stock

MODEL	PRICE
HD100	\$169
HD110	\$199
HD130	\$259
HD140	\$279
300	\$179
310	\$145
320	\$179
330	\$219
350	\$229
360	\$289
4410	\$239

FLUKE

- Autorange Analog display
- Touchhold function
- 0.3% accuracy Heavy duty

MODEL	PRICE	MODEL	PRICE
21	\$ 99	75	\$109
23	\$145	77	\$145
25	\$229	8010A	\$289
27	\$259	8012A	\$359
37	\$215	8020B	\$199
52	\$189	8024B	\$249
73	\$ 79	8050A	\$399

FLUKE 77  Digital Multimeter

SALE \$119

LIST \$145

WAYNE KERR

MODEL	PRICE
4210	\$2200
4225	\$1500

SCOPES

HITACHI

 Hitachi
Denshi America, Ltd.

- All 20 models in stock
- 2-3 year warranties
- 20-100 MHz

MODEL	PRICE
VC6041	\$3900
V209	\$798
V222	\$575
1050	\$1299
1100A	\$2490
422	\$740
425	\$845
680	\$1275

HITACHI V-509

Portable Dual Trace Scope

SALE \$1199

LIST \$1445

IWATSU



- All 14 models in stock
- 2-3 year warranties
- 20-250 MHz

IWATSU (CONT.)

MODEL	PRICE
5702	\$ 535
5705	\$ 899
5706	\$ 749
5710	\$1245
5711	\$1695
5712	\$2999

POWER SOURCES

POWER DESIGNS

- Low and high voltage power sources
- 1-5 year warranties

MODEL	PRICE
TP340	\$750
TP343A	\$795
TW347	\$590
TW5005W	\$505
TW6050A	\$748
2K20	\$695
2020B	\$750
4050	\$560
6150	\$615

SOLA POWER

MODEL	PRICE
SPS800	\$ 873
63-13-114	\$ 237
63-13-150	\$ 456
63-13-175	\$ 580
63-13-210	\$ 672
750VAUPS	\$1976
750VAUPSI	\$2580

USED TEST EQUIPMENT, TOO!—OVER 3,000 MODELS AVAILABLE AT HUGE DISCOUNTS WITH WARRANTIES!

■ Quantity Discounts Available ■ Dealers Welcome ■ Freight and Tax Extra ■ Immediate Availability of Equipment

**US United States
Instrument Rentals, Inc.**

A U.S. Leasing Company
2988 Campus Drive
San Mateo, CA 94403

Circle (9) on Reply Card

November 1987 *Electronic Servicing & Technology* 15

Test your electronics knowledge

By Sam Wilson, CET

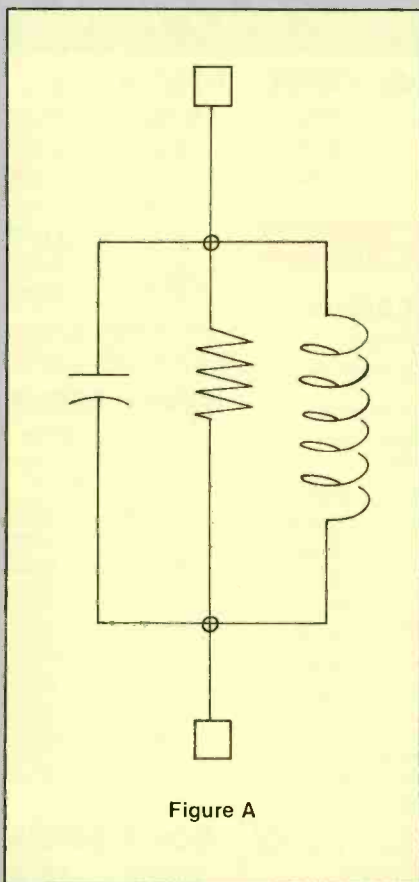

- Which of the following would you expect to find in a digital storage oscilloscope?
 - A PIN diode
 - A D/A converter
 - A special CRT
 - A video enhancement circuit
- The Z-axis input terminal of any oscilloscope—including the digital storage oscilloscope—controls the
 - angular movement of the CRT beam.
 - vertical deflection of the beam.
 - horizontal deflection of the beam.
 - None of these choices is correct.
- What type of diode is used to convert infrared remote signals into electrical impulses?
 - Tunnel diode *FAST SWITCH*
 - Hot carrier diode *LOW FORWARD RESISTANCE*
 - PIN diode
 - Four-layer diode
- The gap in a VCR head is about
 - 14 thousandths of an inch wide.
 - 1.4 thousandths of an inch wide.
 - 25 millionths of an inch wide.
 - 217 millionths of an inch wide.
- In a VHS VCR the adjacent tracks overlap. To prevent signals from being affected by overlapping tracks,
 - a different index of modulation is used for each head.
 - the azimuth is different for each head.
 - the elevation is different for each head.
 - the direction of motion for each head, with respect to the tape, is reversed for each adjacent track.
- The most common problem involving circuit board rework or repair is
 - removing and replacing components.
 - removing fungus protection.
 - reconnecting cracked foil.
 - re-applying fungus protection.
- The resistor in Figure A is called a
 - swamping resistor *LOWERS Q OF TUNED CIRCUIT*
 - equalizing resistor.
 - temperature compensating resistor.
 - bleeder resistor.
- Should one of the heads in a VCR system become inoperative, the resulting picture will be a combination of bad IM and SNOW.
- Is the following statement correct? The recommended way to clean the video heads in a VCR is to use a lintless swab, a recommended solvent and a gentle up and down motion.
 - Correct
 - Not correct *NOT UP AND DOWN*
- An audio equalizer is really just
 - a variable-frequency active filter.
 - a bass boost tone control.
 - an op-amp with a linear roll off.
 - an elaborate set of tone controls.

Answers are on page 61.

DIAGNOSTICS

for Personal Computers from Windsor Technologies

Windsor Technologies offers a family of diagnostic products for IBM PC, PC XT, PC AT and compatible computers. Originally designed for and used by service industry professionals, **Windsor's** products are well suited for anyone involved in the management and maintenance of personal computers.

PC-Technician™

Professional Level Personal Computer Diagnostic System

PC-Technician is an 'advanced' type diskette-based diagnostic system that provides comprehensive testing for each individual system component. Information about the testing and the results are presented via text and graphics on the system's display. **PC-Technician** provides on-line help displays and information about the system's configuration.

PC-Technician is ideal for service personnel, manufacturers, OEM's, and users who need detailed information about the status of their computer's hardware.

PC-Technician is available in the following configurations:

- Product Code T01 (for PC, PC XT) **\$195.00**
- Product Code T51 (for PC AT) **\$245.00**
- Product Code T90 (for PC, PC XT, PC AT—
T01 and T51 in the same carrying case) **\$395.00**

A FREE Evaluation Diskette is available—see the coupon below.



T90—PC, PC XT, PC AT

WindsorPOST™

Personal Computer Diagnostic ROM Module

WindsorPOST is designed to be used when the system is malfunctioning such that its 'power-on-self-test' (commonly called POST) does not complete satisfactorily and a diskette-based diagnostic product, such as **PC-Technician**, cannot be loaded and used for troubleshooting.

WindsorPOST temporarily replaces the system's BIOS ROM module. When installed, its LED indicates if the proper amount of power is at the BIOS ROM socket. It then performs 36 tests on the circuits and electrical components on the system board, the system memory up to 640K, and the color or monochrome video display memory. Errors are identified down to the module (chip) level in three full displays of information on the system's video display unit.

WindsorPOST is intended for those service operations where specific identification of failing components is required and where soldered components are removed and replaced. **WindsorPOST** has been in use in the field for over one year and performance data indicates that it properly identifies the failing component at least 70% of the time.

WindsorPOST is currently available for use on IBM PC's and PC XT's (a PC AT type product is under development) and those compatible systems where the system board circuitry and components are extremely similar to the IBM standard. **WindsorPOST** comes with a 30-day money back guarantee.

- Product Code P01 (PC, PC XT) **\$295.00**



P01—PC, PC XT

For immediate ordering, contact **Windsor Technologies** at (415) 456-2209, 8:30 AM-5:00 PM Pacific Coast time. VISA, Mastercard, American Express and COD orders accepted.



Volume discounts and reseller discounts are available.

Windsor Technologies, Inc.

130 Alto Street
San Rafael, CA 94901
(415) 456-2200

PC-Technician and WindsorPOST are trademarks of Windsor Technologies, Inc., and IBM PC, PC XT, PC AT are trademarks of International Business Machines Corporation.

Windsor Technologies, Inc.

130 Alto Street, San Rafael, CA 94901 · (415) 456-2200

Please Send A Free **PC-Technician** Evaluation Diskette

Please Send Info About **PC-Technician** **WindsorPOST**

NAME _____ TITLE _____

COMPANY _____ (TELEPHONE) _____

ADDRESS _____

CITY _____ STATE _____ ZIP _____

SERVICE CO OEM MANUFACTURER DEALER VAR/VAD

IN-HOUSE SERVICE USER OTHER _____

ES&T 1187

Circle (10) on Reply Card

Servicing microwave oven panels

By Homer Davidson

Modern microwave ovens may be operated by a touch of the finger – simply touch the buttons or pads of the control panel and the oven will automatically take over the cooking process. Like all other electronic devices, the control panel may break down and need repairs, but servicing the microwave oven control panel is not as difficult as it may seem at first. In fact, the defective control unit is rather easy to spot after making a few simple tests.

The touch-control panel

Many of the new microwave ovens have a front control panel that allows you to enter the cooking data with just a few buttons. Besides the number pads for cooking time, there are a number of other function keys used to control the cooking operation, such as the AUTO START CLOCK, TIMER, VARIABLE COOKING CONTROL, CLEAR, STOP and COOK pads. (See Figure 1.)

The keyboard assembly contains

all the touch pads that control the microwave oven. (See Figure 2.) These touch pads are constructed somewhat like those of the calculator or computer system. When the touch pad is pressed, contact is made through a flexible cable to the control unit. This flat cable plugs into a large pin connector at the control board.

When an oven malfunctions, try operating the controls. If you press the proper sequence of keys and you don't hear audible signals, suspect a defective keyboard. Another symptom of a defective keyboard is the illumination of two or more figures on the display at the same time. Erratic oven operation and improper sign display may be caused by a corroded ribbon cable or dirty pin connector. A simple fix for this problem in some ovens is to cut off the corroded end of the cable, which will start a new set of contacts.

Testing the keyboard

Many microwave ovens feature a

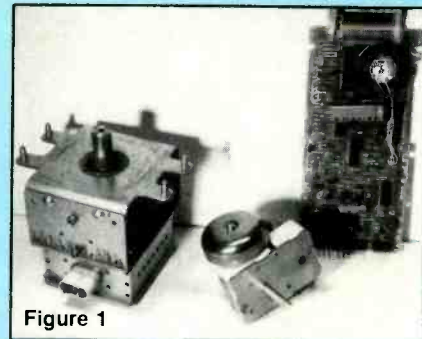

Figure 1

Figure 1. The heart of any microwave oven is the magnetron tube and control unit. Here an electronic control unit is contrasted with an older manual timer.

Figure 2. The touch pad or keyboard connects directly to the control board via a large, flat ribbon cable.

Figure 3. Here the control unit provides a controllable gate voltage applied to the triac switch assembly. If there is no gate voltage at the triac, suspect a defective control unit.

set of test-mode connections that allow a servicing technician to bypass the keyboard and force the oven into the cook cycle. When the test points of an inoperative oven are shorted together and the oven goes into a normal cooking cycle, suspect a defective keyboard. If the oven does not start cooking with the test terminals shorted, use the high setting of an ohmmeter to check each wire connection of the cable between the keyboard and the control unit for broken wires.

The control unit

The control unit controls the entire cooking process when the cook key is pressed. As Figure 3 shows, a voltage from the unit energizes a cook relay or turns on a triac, which supplies power-line voltage

to the primary winding of the high-voltage power transformer. The fan motor may be controlled by the control unit. In some of Sharp's touch-control circuits, the turntable motor also operates from the control board. If the oven features a temperature probe, it plugs directly into the control unit.

These symptoms suggest a defective control panel:

- Absence of signal when a key or a group of keys is pressed
- Failure of digit segments or indicator lights
- Appearance of incorrect figures on the display
- Flickering or erratic illumination of the display digits
- Erratic or improper clock operation
- Absence of sound from the annunciator, or continuous sound

after cooking is complete

- Improper temperature control with the temperature probe in use
- Erratic cooking or no cooking at all

Digital display problems

A digital clock with LED display may be found in some microwave ovens. Other models have a lighted display panel with a display window of various function indicators. The digital display panel lights up when the power cord is plugged in. (See Figure 4.)

The digital display assembly may contain a fluorescent display tube that receives its filament voltage from a small power transformer mounted on the control unit. Suspect an open filament or no ac voltage (3V) if the filament of the tube

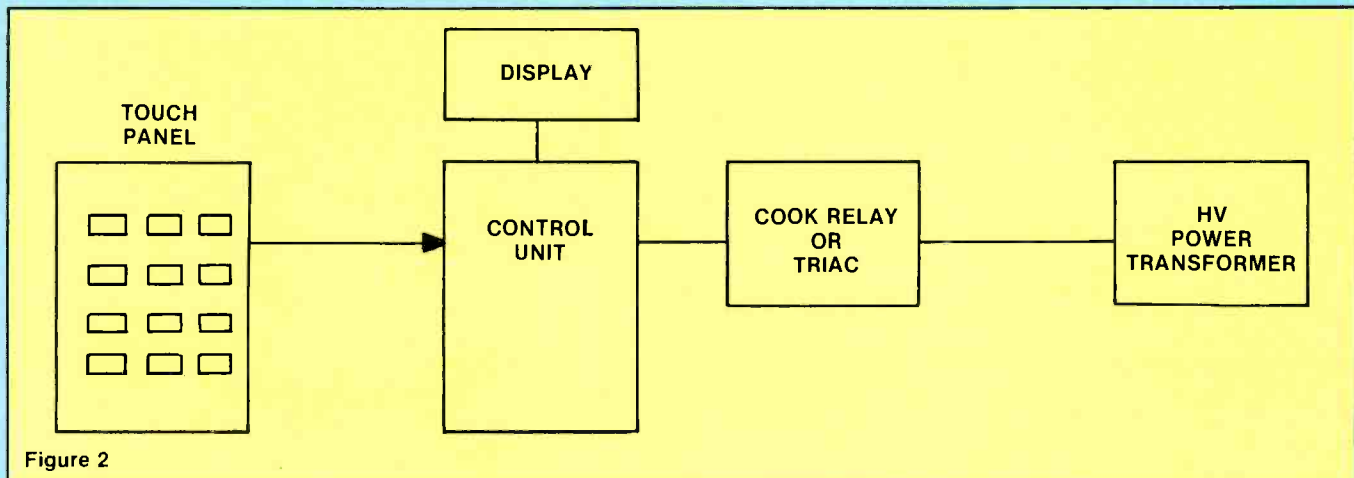

Figure 2

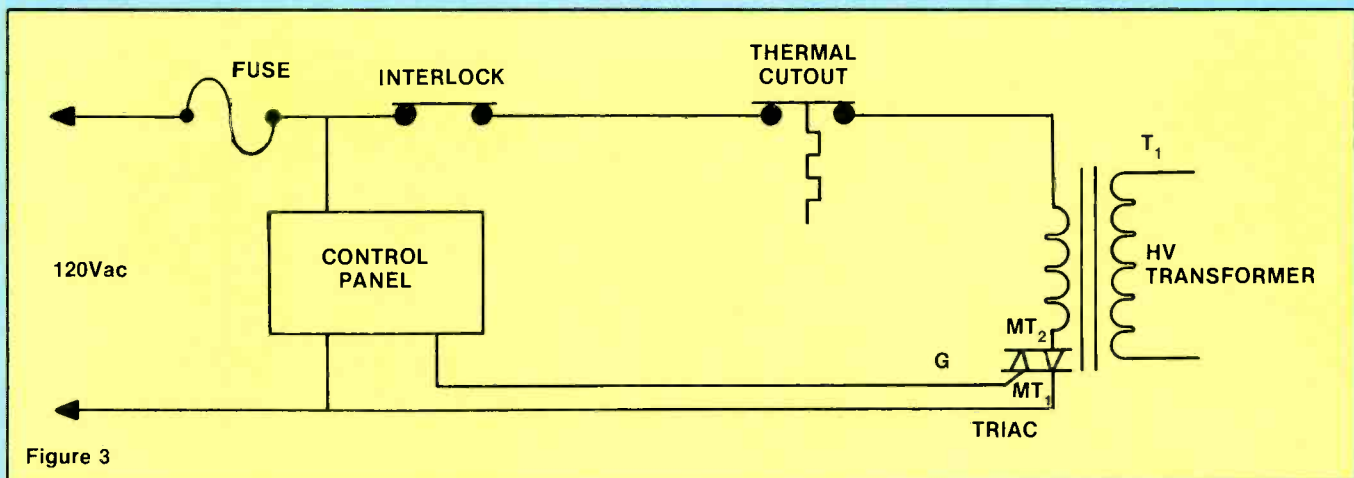

Figure 3

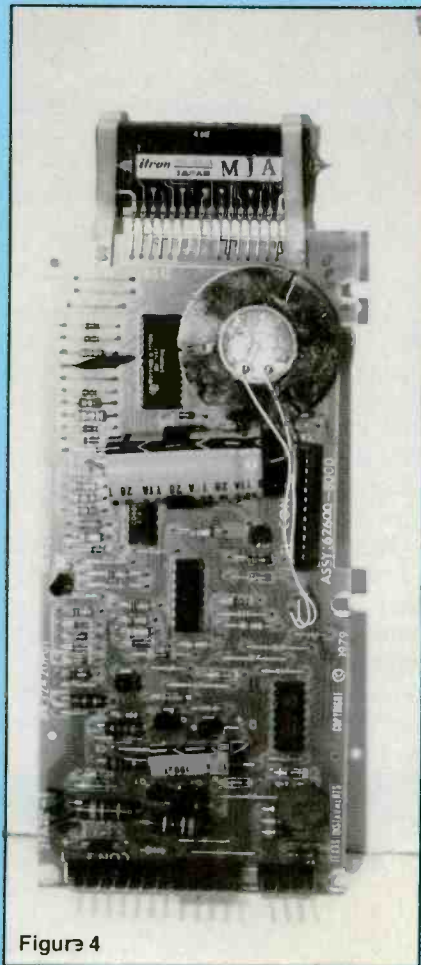

Figure 4

Figure 4. The digital display is found at the top of the control board. The round object below it is a ceramic annunciator for signalling.

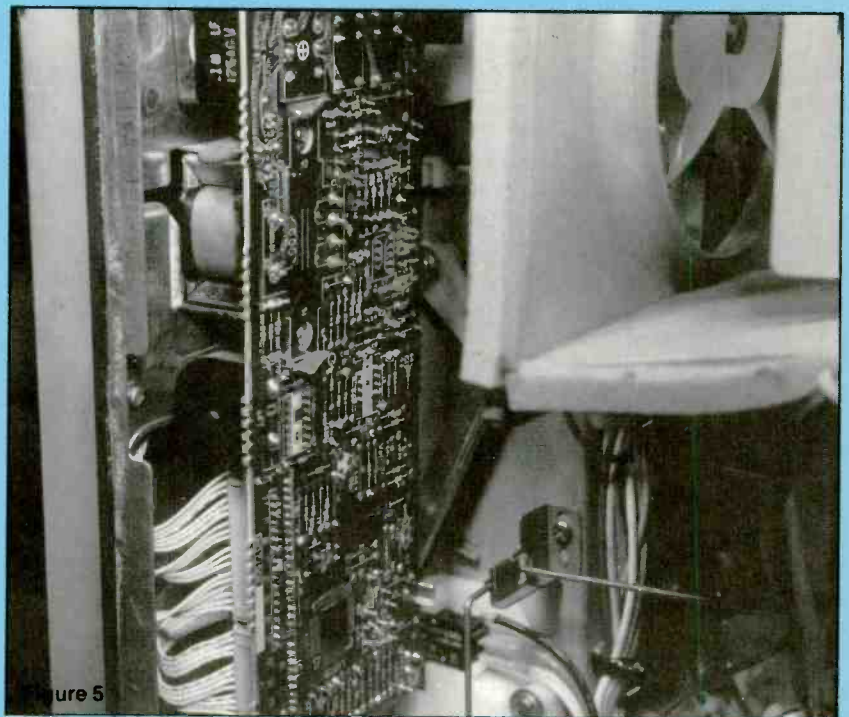

Figure 5

Figure 5. In some ovens the small power transformer of the low-voltage supply is mounted on the control unit. If you suspect that oven failure is due to lightning damage or some other kind of power surge or spike, check this transformer.

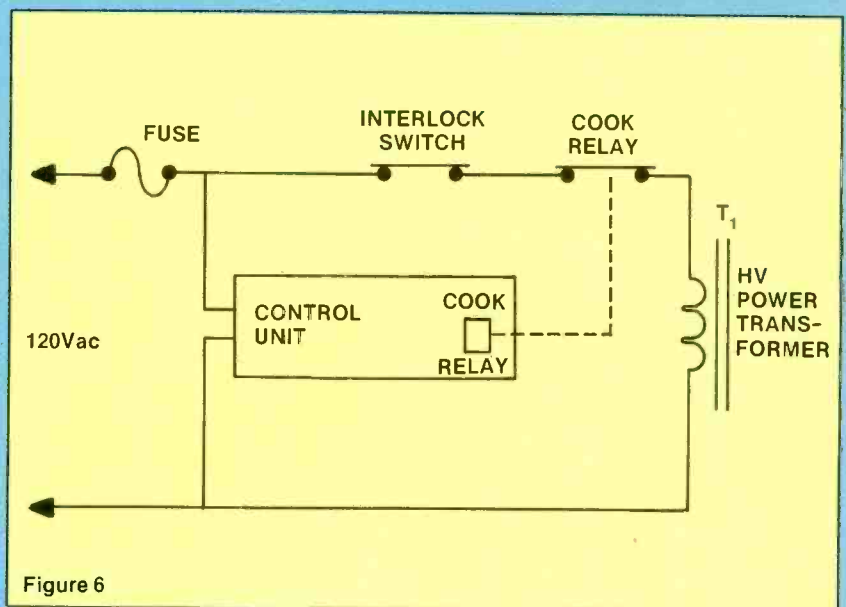

Figure 6

Figure 6. In some models the control unit operates the cook relay assembly. The relay may be mounted on the control unit or separately in the oven.

Figure 7. Measure the gate voltage at the triac assembly to see if it is receiving a signal from the control unit. In this example the smallest space terminal is the gate connection.



Figure 7

does not light up. (See Figure 5.) The plate and grid voltage for the display tube are supplied by the control board. Check the oven fuse when the digital display does not light up and the oven doesn't operate. If you replace the fuse and the display still doesn't light, suspect a defective control unit.

The temperature probe

Some microwave ovens have a removable temperature probe, which is plugged into a jack found on the oven cavity wall. To use the temperature probe, you insert it into the food to be cooked, then press the appropriate buttons to input the final temperature that the cooked food is to reach. The oven will turn off automatically when the food reaches the programmed temperature.

When the temperature probe is plugged into the oven jack, it connects the probe directly to the control board. A probe sense switch may be activated at the same time in some ovens. This sense switch disables all regular cook operations and the oven will only operate on the sensing temperature probe. The probe sense switch is also connected to the control panel. The oven should never be operated with the temperature probe lying in the oven cavity. Most oven temperature probes are not interchangeable with other makes and models.

A defective temperature probe may cause improper program temperature operation: temperature does not update, final food temperature is wrong and the unit shuts off too soon. You can determine whether the problem is caused by the control board or by the probe by making the appropriate tests as discussed below.

For example, the temperature probe in a Norelco S7500 model can be checked with the ohmmeter. A thermistor in its tip has a resistance that decreases as its temperature increases. The probe shows a resistance of 55,000 Ω at room temperature. Other temperature probes may have a resistance of 42,500 Ω to 59,000 Ω .

The temperature of a Sharp R-7350 model may be checked at 200°F. Here's how to do it. Put nine ounces of water in a 2-cup

measuring cup and place the temperature probe in the water. Place the container and probe in the center of the oven and plug the probe into the oven receptacle.

Set the cooking temperature at 200°F and touch the COOK pad. In approximately 4 minutes the temperature of the water should be about 200°F and the oven should shut off. Disconnect the probe and measure the resistance at once, while the probe is still hot. The resistance should be 37,000 Ω to 41,000 Ω at 200°F. If the resistance differs greatly from this range of values, the probe is defective and should be replaced.

Servicing the control circuits

When you're faced with an oven that doesn't operate, the first step is to determine if it's caused by the power circuits or the control circuits. Determine if the oven relay or triac assembly is activated by the control unit. (See Figure 6.) Although the control panel selects time, temperature and clock operation, its main function is to turn the oven on and off. In ovens with the cook relay, you can hear and see the contacts close if the control panel is normal. Because the triac is silent in operation, you'll have to take a voltage reading to see if the gate voltage is present.

Before touching any of the circuits in the oven, carefully discharge the high-voltage capacitor. Clip the DMM test probe to the gate terminal of the triac. Clip the ground probe to the bottom or ground side of the high-voltage capacitor; sometimes just clipping the ground probe to the oven chassis may not make a good ground. Start the oven and measure the gate voltage. (See Figure 7.) A normal 5V is found at the Norelco triac assembly. No gate voltage indicates a defective control unit. A cook relay and triac assembly are both found in a Sharp SKR-9105 model.

Ovens with cook relays may be checked by measuring the voltage across the relay solenoid winding. Again, clip the leads of a DMM across the solenoid winding terminals after discharging the HV capacitor. Start the oven and measure the dc voltage across the relay terminals. No voltage here may in-

Performance Tools.

Our AR-130A is always ready— thanks to intelligent Auto-Power-Off circuitry.

- Ideal multi-purpose meter.
- 20 Amp AC/DC capability
- Transistor hFE measurement
- Gold plated PC board reliability



AR-130 A

Our AR-170 NL sets new standards—

in telecommunications & audio equipment testing.

- Direct dBm reading (600 ohms) of systems noise level measurement
- True RMS AC measurement
- High accuracy: 20 mV, 20 μ A and 20 ohm range
- .1% DC accuracy



AR-170 NL

Our AR-690 LP conserves precious bench top space— ideal for PC, CD and VCR service.

- 25 MHz TTL logic probe with multiple audible tones
- Special Peak Hold feature measures voltage and current



AR-690 LP

THE American Reliance line of Test and Measurement Equipment has been getting the job done all over the world for nearly a decade. Contact us for more information.

800-654-9838

American Reliance Inc., 9241 E. Valley Blvd.
Rosemead, CA 91770 • FAX: (818) 287-8855



ARI / THE MEASURE OF QUALITY

SEE US AT WESCON
BOOTH #4519-4521

Circle (12) on Reply Card

AMERICAN RELIANCE INC.

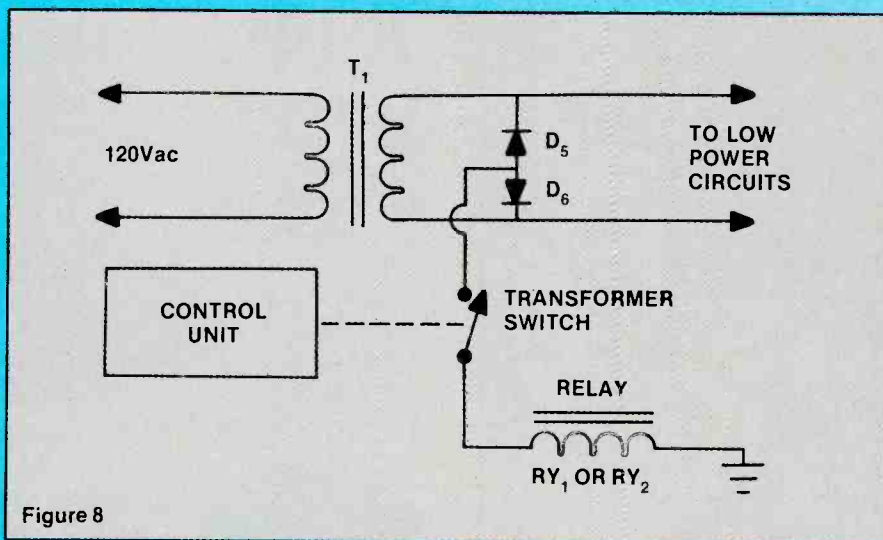

Figure 8

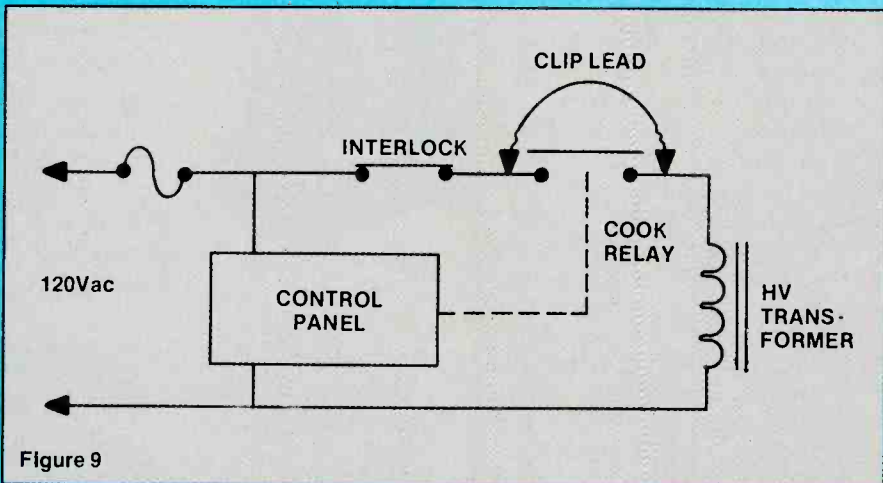

Figure 9

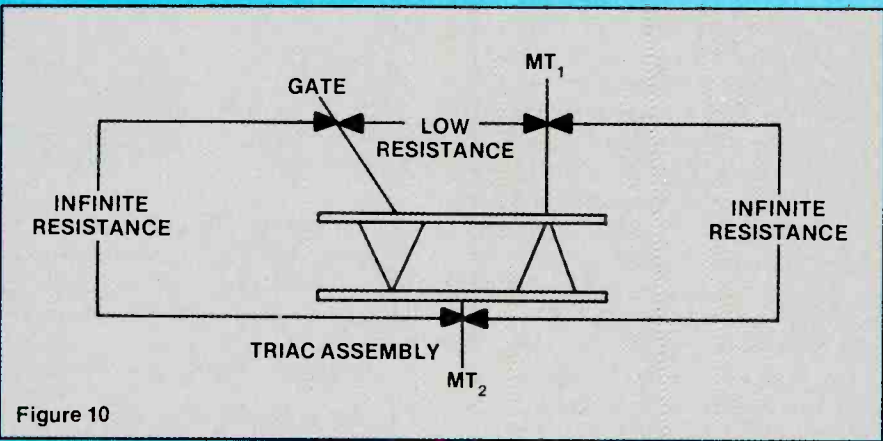

Figure 10

Figure 8. In a Sharp R-7350, a transistorized switch of the control unit controls the cook relay.

Figure 9. Placing a clip lead across the cook relay terminals will establish whether an inoperative oven is caused by the control circuits or if it's the power circuits. Always be sure that the HV capacitor is discharged before touching anything in the oven.

Figure 10. If you suspect that the triac is leaky, check it with the high ohms scale of the ohmmeter. You should measure infinite resistance in both directions between MT₁ and MT₂ if the triac is normal.

indicate a defective control unit.

If the proper control voltage appears at the relay terminals, the relay may be defective: for example, it may have an open solenoid winding. Check the continuity of the relay winding with the ohmmeter. The resistance should be somewhere between 100Ω and 150Ω.

In a Sharp R-7350 model, the cook relay is activated by a transistor switch located in the control unit. Actually, the solenoid winding of the cook relay is in series with the transistor turn-on switch and ground return of diodes D₅ and D₆ of power transformer T₁. (See Figure 8.) These components are all located on the control board.

To check out the relay in this case, disconnect wire lead terminals 3 and 5 and connect the ohmmeter leads to the relay terminals. The meter should read infinite with the power off, and display a low reading when the cook pad is touched. Replace the control unit if improper operation is found.

If the relay is energized and the oven still doesn't cook, suspect poor relay contacts. You may check the contacts with the ohmmeter, or simply shunt a clip wire across the solenoid terminals feeding ac to the primary winding of the high-voltage transformer. (See Figure 9.) The oven should come on at once if the high-voltage circuits and the magnetron tube are normal. Replace the oven relay if it is defective.

Oven starts when on/off pushed

A problem encountered in some microwave ovens is that the oven will begin to operate immediately when the on/off button is pressed, instead of remaining inoperative until you enter the desired cooking time and press the START or COOK button. In some cases this problem indicates a faulty control unit. In other cases, however, a leaky triac located in the primary winding of the high-voltage transformer may be at fault. To isolate the cause of this problem, simply discharge the high-voltage capacitor, pull the gate wire off the triac and start again. If the oven begins to cook, the triac is conducting with no gate voltage present,

which suggests that the triac is leaky. In some ovens, you may find two different triac assemblies, one for the browner element and the other for the primary winding of the power transformer.

The suspected triac may be checked with the high-resistance range of a VOM or DMM. Resistance measurements between gate and T_2 on a good triac are infinite in both forward and reverse directions. (See Figure 10.) Likewise, the resistance measurement between MT_1 and MT_2 of a normal triac is infinite. A normal low-resistance measurement may be found in either direction between gate and MT_1 . Suspect a leaky triac if the resistance measurements between gate and MT_2 or between MT_1 and MT_2 in any direction are low.

Blowing the fuse

In some ovens the fuse may blow when the on/off switch is pressed, indicating a short in the oven components. If the fuse blows when the cook pad is touched, do not change the control unit. Check for a shorted fan motor, magnetron or high-voltage rectifier.

Carefully discharge the HV capacitor and disconnect the high-voltage lead from the magnetron. Clip a 100W bulb across the primary winding of the transformer. Now, reset the control panel and touch the cook pad. If the light is bright and the oven fuse doesn't blow, the leaky component is in the high-voltage circuits. If the fuse blows at once, check the magnetron fan motor and stirrer motor for a short circuit.

Control unit power-supply

In cases where the control panel is found to be defective, most manufacturers would like to have the control unit replaced with a new one. This is especially true if the control panel is in warranty. Although replacing the control panel is quick and easy, a few voltage tests on the power supply of the control panel may reveal a few simple defective components; replacing just those will place the oven back into operation. Standard components in the power-supply circuits may be obtained locally or from the manufacturer.

DO NOT DISTURB:

When it comes to AC power, computers need peace and quiet....

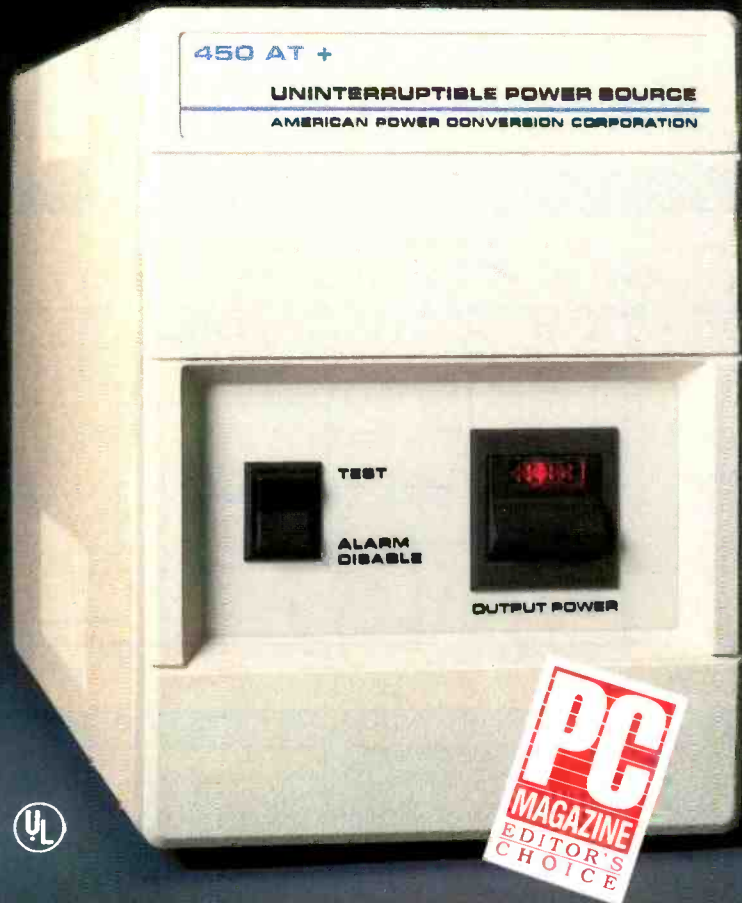

Shield your computer and irreplaceable data from all forms of power disturbances including blackouts, brownouts, sags, surges, spikes and noise with the continuous protection provided by UPS systems from American Power.

- For file servers, UNIX, CAD and PC applications
- Ultra-compact desktop design for easy placement
- Phase-synchronous transfers for the smoothest and most consistent switchover possible
- Models available from 300 to 1200 Volt Amps for computers from micros and supermicros to minis

American Power Conversion Corporation

89 Cambridge Street • Burlington, MA 01803 • 617-273-1570

Unix is a trademark of AT&T Bell Labs

Circle (13) on Reply Card

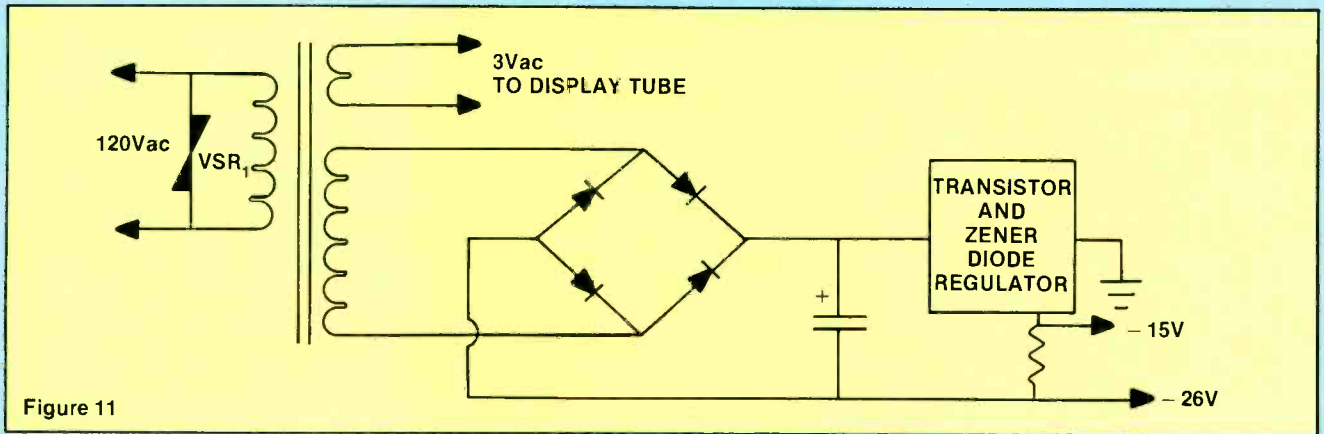

Figure 11

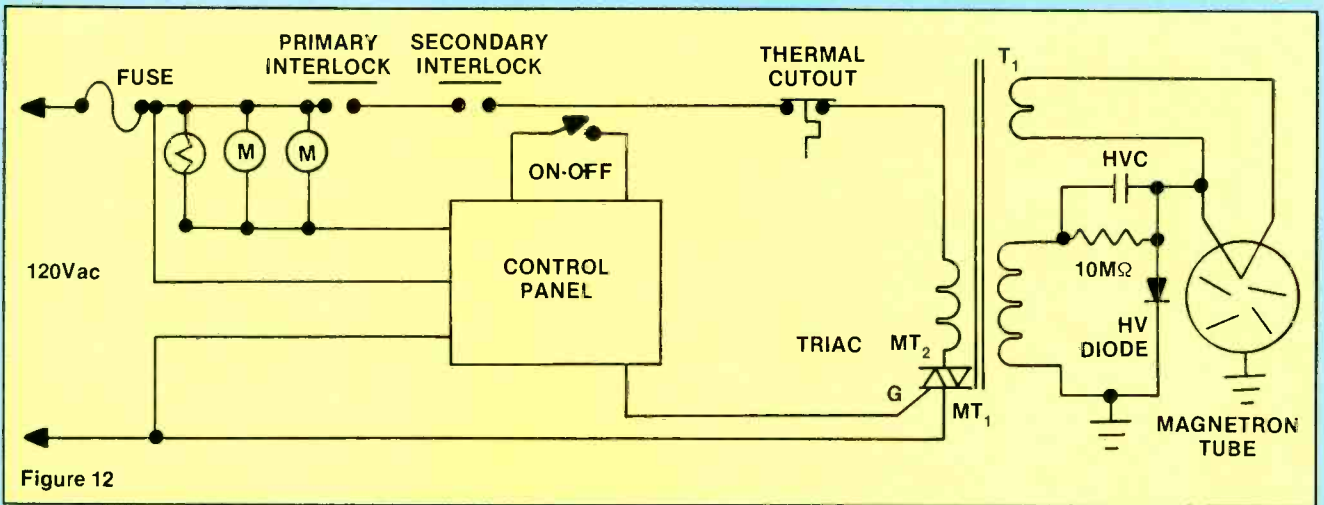

Figure 12

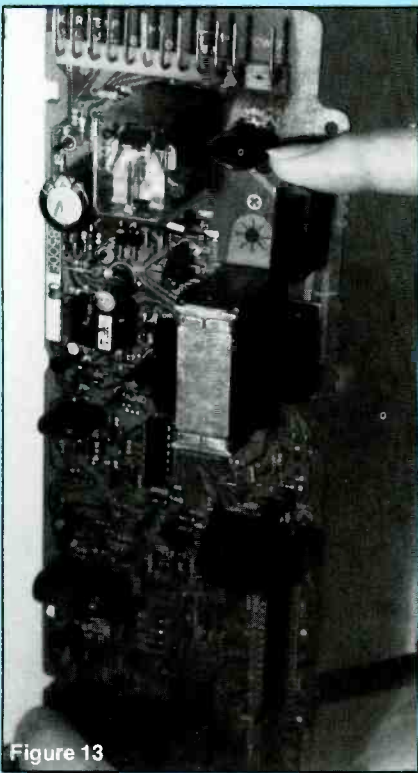

Figure 13

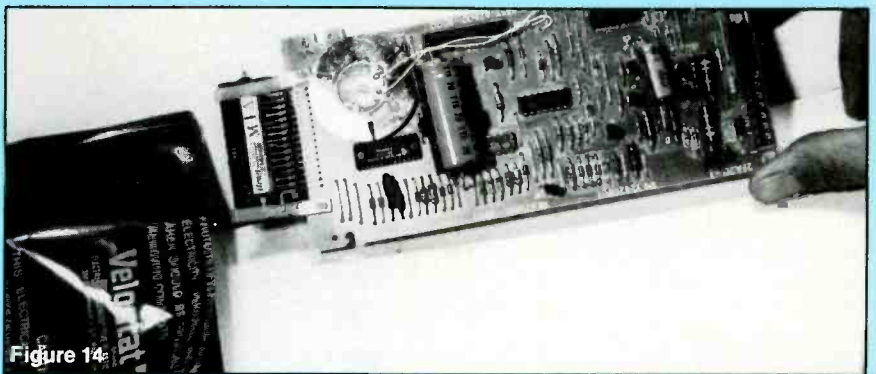

Figure 14

Figure 11. Check the low-voltage power supply of the control unit, just as you would do with a TV or audio system. Voltage measurements and leakage tests of diodes turn up most defective power supplies.

Figure 12. Before you take the drastic step of replacing the control unit, check other components. Poor interlock primary and secondary switches cause many oven problems.

Figure 13. A varistor across the incoming ac line protects the power transformer and other control components when lightning or power-line problems exist. Here the inside of the varistor was blown open after lightning struck the incoming ac line.

Figure 14. If the control board is susceptible to electrostatic discharge (ESD) damage, the replacement will come in a package that protects against static electricity. Be sure to take precautions against causing ESD damage, or you could destroy the new board before it's installed.

The power supply may be a full-wave bridge circuit with zener diodes, IC and transistor regulator circuits. (See Figure 11.) Check for correct voltage at the different voltage sources with the DMM. Improper voltage or absence of voltage may indicate a leaky or open component in the power supply. The control unit may be removed from the oven to check transistors, diodes and zener diodes for leakage. Check the transistors and diodes in the circuit with the diode test of a DMM. The windings of T_1 may be checked with the low ohms scale.

Last minute checks

Before replacing the front panel, make sure other components are not defective, or that problems elsewhere in the oven are not the cause of the trouble. Check for a good ground system at the receptacle the oven is plugged into. Make sure the ac operating voltage is between 110Vac and 120Vac. Sometimes, if the receptacle ground is defective, the panel may skip numbers, giving incorrect readings, or it may become difficult to program or erratic in operation.

Make sure all interlocks of the oven are operating properly. (See Figure 12.) Check each interlock action with the ohmmeter. Besides the primary and secondary interlock switches, check the door interlock sense switch found in some models. You may be able to program the control panel with a defective door interlock sense switch, but the unit will not start. This symptom may be confused with a defective control panel.

A defective on/off sense switch may prevent the fan blower, light and stirrer from operating. In this case the display will only show 88.88 on the display. When the oven comes on as the start or cook button is pressed, suspect a shorted triac rather than a defective control board. If the oven blows a fuse as soon as the start or cook button is pressed, check the oven for a leaky magnetron tube or high-voltage diode, not a defective control unit. Make sure the control panel is operated according to the manufacturer's directions, and check that other components are

not defective before you replace the control panel.

Lightning damage

Often the control board is damaged by lightning strikes on the power line entering the house or by surges caused by power outages or shorting of high-powered ac lines during electrical storms. If you suspect damage as a result of power-line transients, check for burn marks near the control board. Notice that there is a varistor placed across the line to protect the control-board circuits. (See Figure 13.)

Replace the control board if it is excessively damaged by the lightning strike. If the damage doesn't appear to be excessive, you may find that other components are normal and only the varistor needs replacement. Clean off all burn marks and repair any damaged wiring. Re-install the repaired board in the oven and give the oven a test run. If everything is operating properly, replace the varistor across the ac input.

Some final precautions

Always discharge the HV capacitor before you touch any of the oven circuitry. Make sure that the control panel is defective before you replace it. Take precautions against electrostatic discharge damage when handling the control board. (You will probably find that it comes in an antistatic package for protection—see Figure 14.) Handle the control unit by the edges when you mount it in the oven. Once it is in place and the oven is back in operation, take gate or relay voltage readings to make sure everything is operating properly. Finally, making sure that you are familiar with the control panel, test the operation of the oven to ensure that it is completely restored to normal.

As was pointed out in the body of the article, there are some simple repairs that the technician in the field can make to the control board. In most cases it makes more sense to replace the entire board in order to eliminate lengthy diagnostic procedures to troubleshoot down to the component level.

ES&T

OK
Electronics
Division

Have a 'Short' Problem that needs a Long Term Solution?

Retractable Safety-Shield Test Leads from OK

These silicone rubber banana leads are ultra supple, heat resistant, tangle free and compatible with any meter.

Even more...

Adding a retractable safety shield protecting you and the D.U.T. makes OK's safety silicone banana leads clearly the most superior "short" solution.

But wait, there's still more...

The safety shielded test lead are part of a broad range of test instrument accessories from OK including oscilloscope probes, test lead kits, BNC cable assemblies, attenuators and terminations.



CALL OK TODAY

800 523-0667

IN NEW YORK STATE DIAL (914) 969-6800
BEING THE BEST IS A MATTER OF BEING OK.

OK
Industries
Inc.

4 Executive Plaza, Yonkers, New York 10701 USA
Telex 125091 OK NYK, Telex 232395 OK NY UR
Phone (914) 969-6800
Fax (914) 969-6650

Circle (14) on Reply Card

Power conditioning

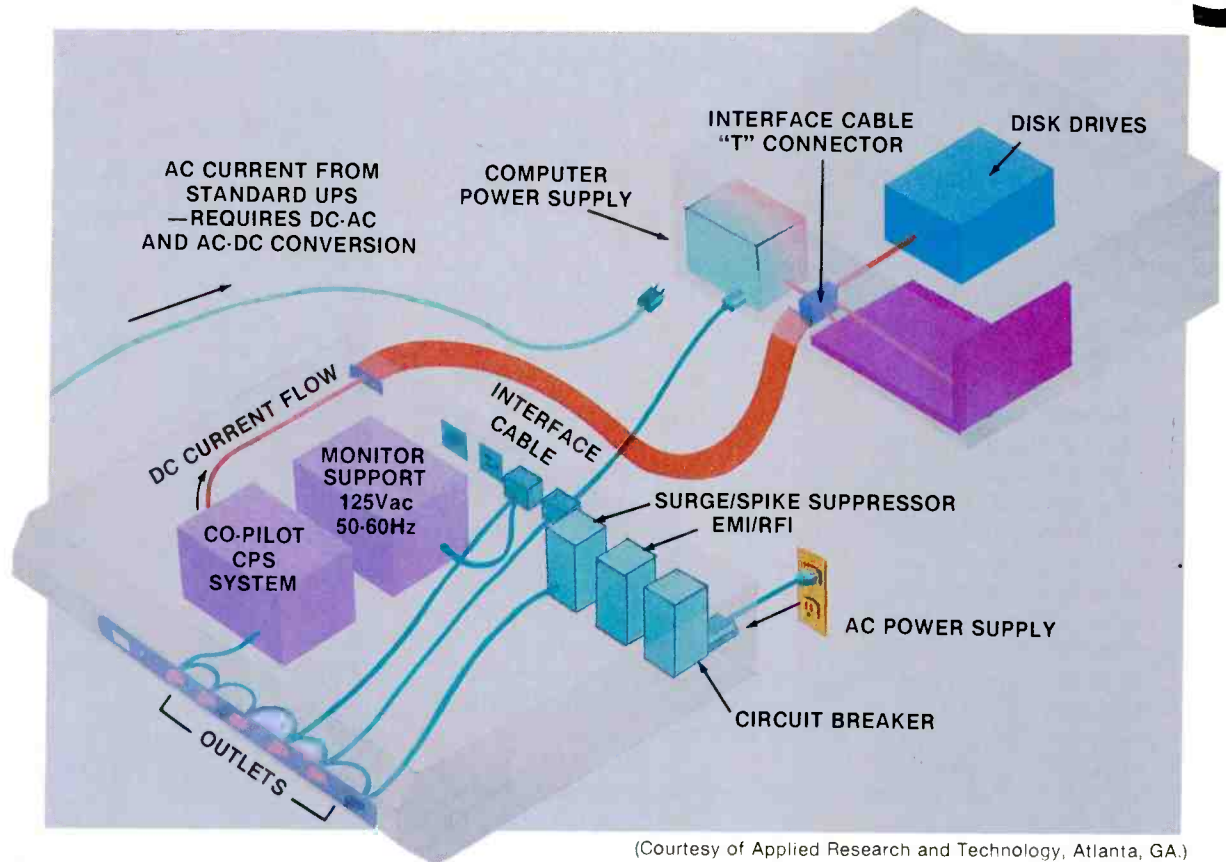

(Courtesy of Applied Research and Technology, Atlanta, GA.)

By Conrad Persson

Late last winter, a relative asked me what I thought about the need for power conditioning. He had received a flyer from the local power company announcing a program of power conditioning for its customers. For a fee, the company would send an electrician to his house to install a lightning arrester, to protect the power line coming in, and a surge suppressor at the point where the most sensitive equipment is connected to the home's electrical wiring.

My response was that it's like buying insurance. His house might never be hit by lightning, making the investment worthless. On the other hand, if he didn't have it done and lightning hit the house, some equipment would be damaged.

About a month later he told me that the house had been hit by lightning, he had not had any of the power protection equipment installed, and the garage door opener, the TV and a cordless phone had been damaged.

Not long after that, a friend at work told me that her house had been hit by lightning and some of her consumer electronics equipment, notably her television, had been damaged.

These are, unquestionably, spectacular failures caused by disturbances on the power line. Whether or not it is economically feasible to protect the incoming power line of any one home against what is still an unlikely occurrence is still a moot point. However, it has been demonstrated that power lines inside and outside homes are subject to disturbances that can cause damage to delicate electronics equipment. The cumulative effect may be degradation of performance or outright failure of the product.

The nature of power-line disturbances

Much of the following information is excerpted from a paper titled "Power Line Problems—An Introduction," by Charles F.

Kerchner, Jr., P.E., President of Kalglo Electronics Company of Bethlehem, PA.

To understand what power-line disturbances are all about, you need to understand some terms and definitions.

- **Steady-state voltage**—This term describes steady-state rms voltage values that stay constant for 10 seconds or longer.
- **Nominal or normal voltage**—The normal, planned voltage for a system. For most purposes in consumer electronics this is 110Vac to 125Vac.
- **Power failure**—A condition in which the power-line voltage drops to zero for more than one cycle (1/60 of a second) on any one of the three phases used to transmit the power.
- **Blackout**—A total power failure lasting from several seconds to hours or more.
- **Brownout**—A reduction in the steady-state utility power-line voltage below its nominal value.

The term *brownout* ordinarily means a low-voltage condition that is planned and announced beforehand to users, and is usually done to compensate for heavy electrical consumption.

- **Undervoltage**—A continuous reduction in the steady-state voltage to below the nominal voltage. This condition is similar to brownout but ordinarily refers to unplanned reductions by the utility or a localized condition on a particular circuit.

- **Overvoltage**—A situation where the steady-state voltage of the power line exceeds the nominal voltage.

- **Sag**—A decrease in the power-line voltage for a number of cycles of the power waveform on any of the three phases. The duration of a sag is determined by the number of cycles of the 60Hz frequency that the disturbance lasts.

- **Dip**—A brief decrease in the power-line voltage. This is similar to a sag, but lasts a shorter amount of time.

- **Surge**—An increase in power-line voltage above normal that lasts for a number of cycles. A surge is the overvoltage equivalent of a sag.

- **Impulse**—A very short-term disturbance, increase or decrease, superimposed on the ac sine wave, that typically lasts between 0.5 μ s and 100 μ s. Impulses that increase the instantaneous voltage are called *spikes*, while those that decrease the instantaneous voltage are called *notches*.

- **Spike**—An overvoltage impulse ranging from 400V to 5,600V or more, superimposed onto the ac sine wave. Any spike of more than 600V can be highly damaging.

- **Notch**—An undervoltage impulse similar to a spike, but of opposite polarity to the instantaneous value of the ac sine wave. It is called a *notch* because the effect is to cause a notch in the sine wave. A notch typically lasts about as long as does a spike, but it may last up to several milliseconds. Spikes and notches ordinarily occur in pairs or in an oscillating series. For every notch there is usually a spike that follows because of power-line inductances and capacitances.

- **Transient**—Any short-term, abnormal event on the power line. All power-line disturbances are transient by definition.

- **EMI**—An abbreviation for *electromagnetic interference*. In terms of power-line problems, this is broad spectrum, electromagnetic noise that is either impressed on the power line directly from the source, or is radiated to the power line and then conducted to susceptible equipment.

- **RFI**—Electromagnetic noise in the radio frequency spectrum.

- **TVI**—Electromagnetic noise in the television spectrum.

- **EMP**—The abbreviation for *electromagnetic pulse*; EMP describes the powerful pulse of electromagnetic energy, generated by a thermonuclear explosion, that may damage or destroy sensitive electronic devices and interfere with electronic telecommunications.

- **Differential mode**—Power-line disturbances that occur across the normal current-carrying wires of the power line, from the hot wire to the neutral.

- **Common mode**—Power-line disturbances that occur between both of the current-carrying wires and ground.

- **MOV**—The abbreviation of the term *metal oxide varistor*. This is a

2-terminal device with a voltage-dependent resistance: When the voltage across the device increases above a specified value, its resistance decreases abruptly (1ns to 5ns). When connected from a line to ground, for example, if a large transient occurs, it switches from a very large value of resistance (essentially an open circuit) to a very low value and absorbs the potentially damaging voltage increase. MOVs are most effective when used in groups of three (line to ground, neutral to ground, line to neutral) to provide both common-mode and differential-mode protection.

- **Silicon avalanche zener diodes**—A fast-acting, solid-state junction device, but with low energy-handling capacity. With switching speeds in the picosecond range, they operate by shunting the surge or spike to ground before it can enter the protected circuit.

- **Gas discharge tube**—A calibrated spark gap in a gas-filled chamber. These devices are relatively slow, operating in microseconds, but they can handle very large energy surges. They operate by shunting the surge or spike to ground before it reaches the protected unit. These devices are frequently placed at the service entrance and are used to provide protection for the wiring in an entire building.

- **EMI/RFI filter**—A circuit or device that contains series-inductive (load-bearing) and parallel-capacitive (non-load bearing) components that provide a low-impedance path around the protected circuit for high-frequency noise. Filters also attenuate impulses, because a Fourier analysis of a spike will reveal that a spike is composed of high-frequency sinusoidal components. Because of this, filters and surge suppressors used together act synergistically; that is, the two together provide better protection than the sum of the individual protection factors.

- **UPS**—Abbreviation for *uninterruptible power system*. Provides a steady source of power at or near the nominal line voltage to a piece of equipment, regardless of power-line disturbances such as sags, dips, brownouts or blackouts.

- **Voltage-regulating transformer**

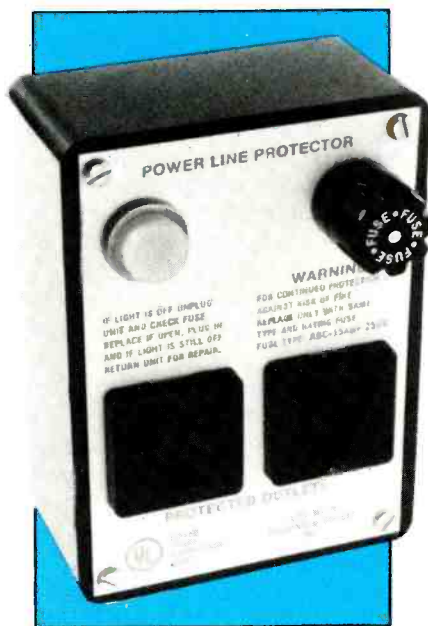

This unit, the Mini-II, plugs directly into any properly grounded outlet, provides transient-voltage surge protection and is available with EMI/RFI filtering.



This unit, the Co-Pilot by Applied Research and Technology, is designed to be placed directly on the computer. The computer monitor is then placed on top of it. The unit provides surge and spike protection and EMI/RFI protection. In addition, according to the manufacturer, its internal battery will provide two hours of operating time for a fully loaded IBM PC AT in the event of a blackout or brownout.



mer—A continuous acting transformer, usually ferroresonant, that instantaneously regulates the output voltage to normal levels despite wide swings in the input voltage.

- **Power-line conditioner**—A combination of a voltage-regulating transformer with a super isolation transformer that provides smooth, regulated, noise-free ac voltage with no ohmic connection between input and output. This kind of unit will correct most power problems other than complete power failure.

How often do problems occur?

Mr. Kerchner's paper cites studies by three organizations that indicate that power-line problems occur regularly. For example, one study by members of the Institute

of Electrical and Electronic Engineers (IEEE) shows that surges and impulse voltage spikes can occur as frequently as twice per hour in a typical residence, with peak values as high as 1,500V to 2,500V. During thunderstorms, peaks as high as 5,600V were observed.

A study by IBM in 29 different locations throughout the United States showed that an average of around 50 voltage spikes occur per month. This represented almost 40% of the total disturbances they observed.

A 2-year study by Bell Laboratories showed that most locations will experience approximately 25 power-line disturbances in a year, 87% of which were sags below 96V. Sags of this magnitude can

cause the power supply in electronic equipment to malfunction.

While these studies don't agree completely on the nature of power-line disturbances, there is correlation that power-line disturbances are indeed a problem.

Solving the problem

Part of the solution is in the hands of the engineers who design the products. Where the quality of the product warrants, they must design or specify power supplies that will operate over a wider range of power-line voltages. They can include power-line disturbance suppression circuitry in the products they design.

For products that do not have adequate protection from power-line disturbances, which includes

most if not all electronics products found in the average home (TVs, stereos, microwave ovens, VCRs, personal computers and so forth), the answer is to connect some kind of protection device in the power line to intercept spikes and surges before they enter the unit.

Mr. Kerchner makes an interesting point regarding external protection. Even in cases where internal protection is provided, it may make sense to use external protection. No matter how good a job the design engineer does of designing in protection, those protection components usually take some finite, even if very short, time to turn on and provide their protection. And some kinds of faults can find their way around or through some kinds of power-line disturbance. If protection is provided external to the unit, the wiring between the protection device and the unit being protected provides a kind of delay line, giving the external protection device time to work fully before the disturbance reaches the equipment.

How power-protection devices work

Power protection comes in a number of shapes, sizes and degrees of effectiveness. One of the most familiar is the simple 6-outlet power strip with built-in components to intercept sags and spikes coming down the line *before* they get into your expensive and sensitive VCR or personal computer. Other power-protection devices are simply plugged directly into the wall outlet. Sensitive electronic equipment is then plugged into the power protection device.

There are some power-protection devices that are made for specific brands of computers. These include delayed turn-on of some of the outlets so that the computer will be turned on before the peripherals, such as the printer or external disk drive. Some manufacturers even provide a current sensor on one of the outlets in the box, so that all of the other outlets remain inoperative until current is drawn from one main receptacle. This gives the user the ability to use the on/off switch of one piece of equipment plugged into the device as a master switch to turn on all the

equipment plugged into the device at once.

The sidebar accompanying this article shows schematic diagrams of some of the kinds of power-line conditioning products available and describes how they work.

How good are they?

Power line conditioning products available for consumer electronics range from the almost worthless to the very effective. For starters, you can get some idea of the effectiveness of a given product by checking its UL listing. A good guide is to check to see if the device carries a label that says that it is UL Listed under Classification 1449 or 1283. UL classification 1449 is the classification for transient-voltage surge protection, and this listing indicates that the device has been tested and found to provide this type of protection.

UL classification 1283 indicates that the device has been tested and shown to provide transient-voltage surge suppression and also provides RFI/EMI noise protection.

If a device is listed under some other classification, it might have only been tested and found to be safe under the standard for an ex-



This device is designed to protect the entire building and all electric/electronic equipment in it from large, high-voltage surges coming from outside the building. Considered primarily a lightning surge arrester, this device would be installed by an electrician at the service entrance. It consists of a gas tube that dissipates larger surges to ground, then restores itself.

ELENCO PRODUCTS AT DISCOUNT PRICES!

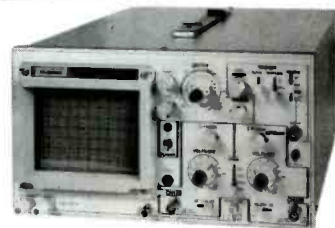

20 MHz Dual Trace Oscilloscope \$359.95 MO-1251

Two 1x, 10x 100 MHz probes, diagrams and manual included. Write for specs.

35 MHz \$499.95 MO-1252



GF-8016 Function Generator with freq. counter

\$239.95

Sine, Square, Triangle Pulse, Ramp, .2 to 2 MHz Frequency .1 thru 10 MHz

GF-8015 without freq. meter \$179

Triple Power Supply XP-660

0-20V @ 1A
0-20V @ 1A
5V @ 5A

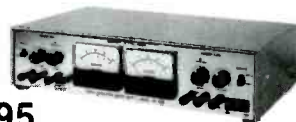

\$159.95

Fully regulated, short circuit protected with 2 limit cont. 3 separate supplies

3 Amp Power Supply XP-650

0-40V @ 1.5A
0-20V @ 3A



\$129.95

Fully regulated, short circuit protected current limit control

Color Convergence Generator



SG-200 \$69.95

Finest in the industry 10 rock steady patterns

Multimeter with Capacitance and Transistor Tester

Model CM-1500A with case

\$64.95

Reads volts, ohms, current, capacitors, transistors, diodes



Digital LCR Meter \$148.95



Model LC-1800 Measures: Inductors Capacitors, Resistors Inductors 1uH to 200H Capacitor .1Pf to 200uF Resistor .01 Ohms to 20M Ohms Ranges 6 Ind, 7 cap, 7 res

C + S Sales, Inc., 1245 Rosewood Dr., Deerfield, IL 60015. 800-292-7711, 312-459-9040. ASK FOR CATALOG. Add 5% P&H (\$10 max. per item) IL Res., add 7% sales tax



Circle (15) on Reply Card

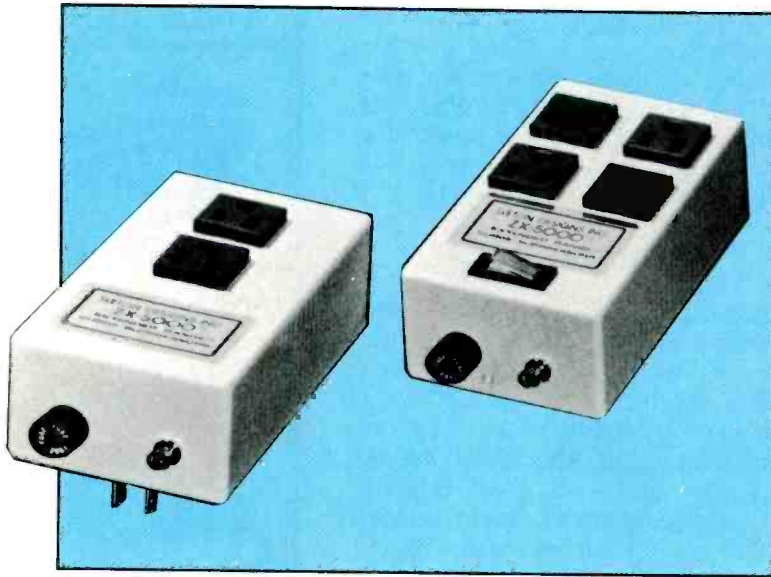

According to the manufacturer, this unit, the Sutton Designs ZX-5000 Extended Range series of surge-spike-noise suppressors, contains advanced protection circuitry designed for computer protection in military, space and heavy-duty commercial applications. Voltage withstand capability of the units is 25,000V, the dynamic short-term current rating is 20,000A, and clamping voltage is 195V.

tension outlet or multi-outlet plug, with no indication of whether it protects against transients.

I like to think transient-voltage surge suppressors are a little like seat belts: For the most part, you probably don't need one, but it's a

Continued on page 39

Here is a schematic diagram of a transient-voltage protection device with EMI/RFI noise protection. When the neon lamp is lit, it merely means that the device is connected to the line. It doesn't imply that the protection components are working.

The three MOVs provide transient-voltage surge suppression, and the capacitors and coils provide EMI/RFI noise suppression. As discussed in the text, however, the transient protection and noise suppression act together synergistically so that the total protection offered by

the combination is greater than the sum of the individual circuits.

The three MOVs are voltage-dependent resistors. The two MOVs connected from hot to ground and from neutral to ground protect against common-mode transients: those that are impressed on both the neutral and hot lines. The MOV connected from hot to neutral protects against differential-mode voltage transients.

Although the legend indicates that the MOVs used are rated between 130V and 150V, Kerch-

ner says that 150V units are adequate to provide protection. Attempting to clamp the device's output too close to nominal line voltage might cause damage to the protection device in the event of a prolonged rise in line voltage to at or slightly above the rating of the MOVs.

The arrangement of capacitors and coils attenuates smaller-voltage anomalies that would not activate the MOVs, but would appear as noise at the input of the electronic product plugged into the line if they were not attenuated.

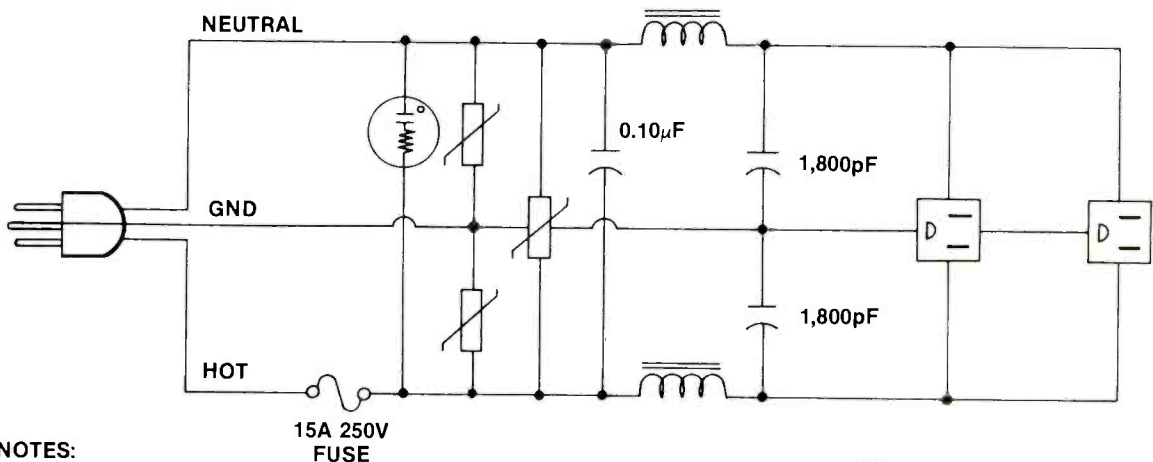

NOTES:



ARE 130V-TO-150V MOVs



ARE 10µH-TO-50µH HASH COILS, RATED 15A



IS A STATUS LIGHT-NEON ASSEMBLY

Continued from page 30

good idea to have it on and working in case you ever do need it. And just as with seat belts, they will protect you up to a point. If you drive head-on at 65 miles per hour into a semi going 65 miles an hour in the opposite direction, no seat belt is going to save you. Just so with power protection devices: If your VCR is plugged into the ac line when a lightning bolt strikes the power line a few feet from your house, the spike coming through will probably destroy any power-protection device and the equipment it was installed to protect as well.

And if the unit it was designed to protect is your personal computer and you're sitting at the keyboard, you just might experience catastrophic failure as well.

Once again, caution is urged. If there are thunderstorms in the area, unplug any sensitive electronic products (do this well before the electrical activity gets too close, lest you have your hand on

Sources of power conditioning equipment

Acme Electric Corporation
125 S. Union St.
Olean, NY 14760
716-373-3255

BEHA Corporation
13191 56th Court, Unit 101
Clearwater, FL 33520
813-576-6074

Advanced Electronics Systems
2005 Lincoln Way East
Chambersburg, PA 17201
717-263-5681

CPS Electronics
4151-112th Terrace N.
P.O. Box 2460
Pinellas Park, FL 34290-2460
813-578-1600

Applied Research and Technology
The Pavilion, Suite 210
5770 Powers Ferry Road N.W.
Atlanta, GA 30327-4390
512-259-3403

Clary Corporation
320 W. Clary Ave.
San Gabriel, CA 91776
818-287-6111

ATTENTION! ELECTRONICS TECHNICIANS

EARN YOUR
**B.S.E.E.
DEGREE**



THROUGH HOME STUDY

Our New and Highly Effective Advanced-Placement Program for experienced Electronic Technicians grants credit for previous Schooling and Professional Experience, and can greatly reduce the time required to complete Program and reach graduation. No residence schooling required for qualified Electronic Technicians. Through this Special Program you can pull all of the loose ends of your electronics background together and earn your B.S.E.E. Degree. Upgrade your status and pay to the Engineering Level. Advance Rapidly! Many finish in 12 months or less. Students and graduates in all 50 States and throughout the World. Established Over 40 Years! Write for free Descriptive Literature.

COOK'S INSTITUTE
OF ELECTRONICS ENGINEERING



347 RAYMOND ROAD
P.O. BOX 20345
JACKSON, MISSISSIPPI 39209

Circle (18) on Reply Card

Uninterruptible Power Systems



Read what the experts say;

"Clary Corp.'s OnGuard 600VA has the makings of the perfect UPS: it's functionally invisible. Whether or not line voltage is available, it constantly supplies up to 600VA of nearly pure sine-wave power at an almost unvarying 120 volts. No UPS is more unobtrusive than the OnGuard."

-WINN L. ROSCH



ONGUARD SERIES I & II (400VA to 3KVA)

ONGUARD is the first UPS designed specifically for the non-linear power supplies found in all of today's micro and minicomputers. It can support more non-linear computer load than any other equally rated UPS.

- WORLD'S SMALLEST 3KVA—PLUG COMPATIBLE WITH IBM S/36 OR EQUAL
- RACK MOUNTABLE (UP TO 3KVA)
- ON-LINE, SINEWAVE OUTPUT
- UNIVERSAL VOLTAGE & FREQUENCY CONVERTER
- OVER 100 VARIETIES TO CHOOSE FROM
- SMALLEST & QUIETEST

3 KVA .97 Lbs. of
Quiet Power for
Only \$5,355⁰⁰ (dlv.)

OTHER SYSTEMS AVAILABLE TO 37.5 KVA

CLARY CORPORATION

320 West Clary Avenue
San Gabriel, CA 91776 (818) 287-6111 Ext. 684

ONGUARD

Circle (33) on Reply Card

Controlled Power

1955 Stephenson Hwy.
Troy, MI 48083
313-528-3700

Current Technology

1400 S. Sherman, Suite 202
Richardson, TX 75081
214-238-5300

Cuesta Systems

3440 Roberto Court
San Luis Obispo, CA 93401
805-541-4160

Dränetz

P.O. Box 4019
Edison, NJ 08818-4019
201-287-3680

Ecos Electronics Corporation

205 W. Harrison St.
Oak Park, IL 60304
312-383-2505

Electronic Specialists

171 South Main St.
Natick, MA 01760
617-655-1532

Elgar Corporation

9250 Brown Deer Road
San Diego, CA 92121
619-450-0085

General Power Systems

1400 N. Baxter St.
Anaheim, CA 92806
714-956-9321

Kalglo Electric

6584 Ruch Road
Bethlehem, PA 18017
800-524-0400

Lakontek

2385 South Clinton Ave.
South Plainfield, NJ 07080
201-755-7680

PMC Industries

9353 Activity Road
San Diego, CA 92126
619-695-3520

PTI Industries

320 River St.
Santa Cruz, CA 95060
408-429-6881

Panamax

150 Mitchell Road
San Rafael, CA 94903
415-499-3900

Para Systems

11425 Mathis St.
Suite 404
Dallas, TX 75234
214-869-1688

Perma Power Electronics

5615 West Howard Ave.
Chicago, IL 60648
312-647-9414

Philips ECG

100 First Ave.
Waltham, MA 02254
617-890-6107

Pilgram Electric Co.

105 Newtown Road
Plainview, NY 11803
516-420-8990

Power Integrity Corporation

1840 Pembroke Road
Greensboro, NC 27429-0682
919-379-9773

RCA Distributor and Special Products Division

200 Clements Bridge Road
Deptford, NJ 08096
609-853-2243

Safe Power Systems

528 W. 21st. St.
Tempe, AZ 85282
602-894-6864

Shape Magnetronics

901 Dupage Ave.
Lombard, IL 60148
312-620-8394

Sola

1717 Busse Road
Elk Grove Village, IL 60007
312-439-2800

Sun Research

Old Bay Road, Box 210
New Durham, NH 03855
800-443-1922

Superior Electric

383 Middle St.
Bristol, CT 06010
203-582-9561

Sutton Designs

Computer Security Division
300 N. Tioga St.
Ithaca, NY 14850
607-277-4301

Technipower

P.O. Box 222
Commerce Park
Danbury, CT 06810
203-748-7001

Tripp Lite

500 N. Orleans
Chicago, IL 60610
312-329-1777

Tycor Electronic Products Ltd.

6107 Sixth St.
SE Calgary, Alberta T2H 1L9
Canada
403-259-3200

Ultima Electronics

21 Central Drive
Farmingdale, NY 11735
516-752-0144

the plug when the surge comes down the line), and don't go near any wiring that comes into the house from outside: antenna, cable, telephone.

Which brings me to one final point: When you're thinking about

transient-voltage surge suppressors, you might also give a thought to suppressors for the telephone line if there's a modem for the computer, and consider some kind of protection for any other wiring coming into the house from outside.

For a list of sources of power-conditioning equipment, see "Dealing with Power Line Problems" in the November 1986 issue of ES&T.

ES&T

Books

Editor's note: Periodically *Electronic Servicing & Technology* features books dealing with subjects of interest to our readers. Please direct inquiries and orders to the publisher at the address given, rather than to us.

Standards Glossary; Underwriters Laboratories; \$18.75.

Underwriters Laboratories' new Standards Glossary is a complete listing of terms and definitions taken from the glossary sections of more than 500 UL Standards for Safety.

The word "current" alone has more than a dozen listings, ranging from "breakaway current" to "threshold current." Distinctions are drawn between identical terms for different applications, such as rated current for products in general and rated current as it applies specifically to protectors. Each definition is followed by at least one UL standard to which the defined term applies.

Published by Underwriters Laboratories, 333 Pfingsten Road, Northbrook, IL 60062; 312-272-8800 ext. 2612.

Product Index; Underwriters Laboratories; \$8.

The new edition of Underwriters Laboratories' Product Index includes several new categories. The index has also been updated to include references to the latest published and proposed UL safety standards, now covering more than 12,000 products under more than 500 product categories.

Published by Underwriters Laboratories, 333 Pfingsten Road, Northbrook, IL 60062; 312-272-8800 ext. 2612.

Communications Electronics: Systems, Circuits, and Devices, by Forest Barker; Prentice- Hall, 676 pages, \$36.95, hardbound.

Written for new entrants into

the field of electronic communications, this book provides basic information on the systems, circuits and devices used in communications systems. An opening discussion of modulation and a basic AM broadcast-band receiver (including troubleshooting and alignment) introduce the reader to a basic communication system. The more complex FM, 2-way radio, digital and light-wave carrier systems are also covered. The author discusses

transmission lines and antennas, noise control, transmission and propagation and basic information on TV stations and receivers. Example calculations, tables and graphs enhance the physical, not mathematical explanations, and glossaries, reviews and quizzes are included after each chapter. Appendices explain the use of the decibel and government regulations.

Published by Prentice-Hall, Englewood Cliffs, NJ 07632; 800-223-2336.

ES&T



Because Your Customers Deserve the Best



Hitachi Original Replacement Parts

Quality, reliability, service...they're the touchstones of the Hitachi tradition, as recognizable as our trademark. And now those same standards that have earned us our reputation as a technological leader in consumer products, back up our new line of **Hitachi Original Replacement Parts**.

We know that for the service professional, time wasted is profit lost. Which is why Hitachi makes it easy for you. With our complete line of parts, we provide you with a single source for all your repair needs—and a profitable addition to your business. From VCR kits, IC chips and

diodes—to battery packs, video, audio accessories and technical publications.

What's more, our nationwide network of distribution centers means that you can get the parts and accessories you need, when you need them. And, of course, **Hitachi Original Replacement Parts** are included in our total service support program...because your customers deserve the best.

For more information, call toll-free
1-800-447-2882.

HSC SERVICE COMPANY
division of Hitachi Sales Corporation of America

401 W. Artesia Blvd.
Compton, CA 90220
(213) 537-8383

Circle (19) on Reply Card

November 1987 *Electronic Servicing & Technology* 41

Troubleshooting startup circuits

By Gregory D. Carey, CET

We started this series by discussing shutdown problems because some technicians blame the safety shutdown circuits any time they are missing high voltage in a TV receiver. Let's start disarming this myth with a very simple axiom: *You cannot have a shutdown without startup.* This rule may be so important that you will want to hang it above your workbench.

The reason I am stressing this point so hard is that you use different methods to isolate *startup* problems than you use to isolate *shutdown* problems. For shutdown troubles, you want to reduce the voltage so that you can monitor the response of the safety sensors as you gradually increase the supply voltage. You isolate startup problems by helping some circuits along while monitoring a key test point. But you need to understand the startup circuits before the troubleshooting processes really make sense. For the most part, you need to remember that the circuits form a closed loop.

The closed startup loop

Figure 1 shows a general block diagram of a modern horizontal circuit. Raw ac voltage is applied directly to a rectifier—usually a full-wave bridge. The output is filtered with a large electrolytic capacitor and then fed to a regulator. (The different types of regulators will be covered in part III.) The regulator feeds one end of the primary of the flyback, which in turn

This is the second of a three-part series dealing with the horizontal output circuits of modern TV receivers. Part I explained how shutdown circuits operate and the best way to find the cause of shutdown. This time, we will see what happens if the circuits never get started in the first place. Part III will explain how to isolate troubles related to the power supply and regulator circuits. Combining all three should help you isolate any problem related to the output stages.

feeds to the collector of the horizontal output transistor.

The output transistor receives its signal from a driver transistor feeding a step-down transformer. The transformer increases the current fed to the output stage to make up for the relatively low gain of the power-output transistor (beta generally runs under 10). The driver transistor gets its signal from the horizontal oscillator. The oscillator and driver, in turn, receive power from a scan-derived power supply connected to one of the secondary windings of the flyback transformer.

If you study this diagram for a moment, you'll soon discover it won't work. The horizontal oscillator cannot run without power from the flyback. But the flyback can't receive power unless the output transistor is being driven by

the oscillator. Turning on the power switch gets everything ready, but the horizontal circuit can't get started without a push. That's why you need a startup circuit.

The startup circuit gives the horizontal oscillator and drive circuits the little push they need to start running. When the output transistor begins to conduct, a voltage begins to build in the secondary, feeding the scan-derived power supply. This, in turn, begins to power the oscillator and the driver to provide more drive for the output. After a few cycles everything has built to maximum, and the closed loop is ready to sustain its own operation.

Most receivers use one of two types of startup circuits. The type used generally depends on whether the entire chassis has a single *hot* ground (referenced directly to the ac line), or whether the chassis has a *hot* and a *cold* (isolated) ground. The two circuits are the *trickle* and the *kick* start circuits.

The trickle starter

The trickle starter, shown in Figure 2, is more common and less complicated than the kick starter. In its simplest form, the trickle starter uses a high-value resistor connected between the unregulated power-supply output and the horizontal oscillator and driver. This resistor lets enough current leak through from the raw B+ circuits to let the horizontal circuits start, but does not provide enough

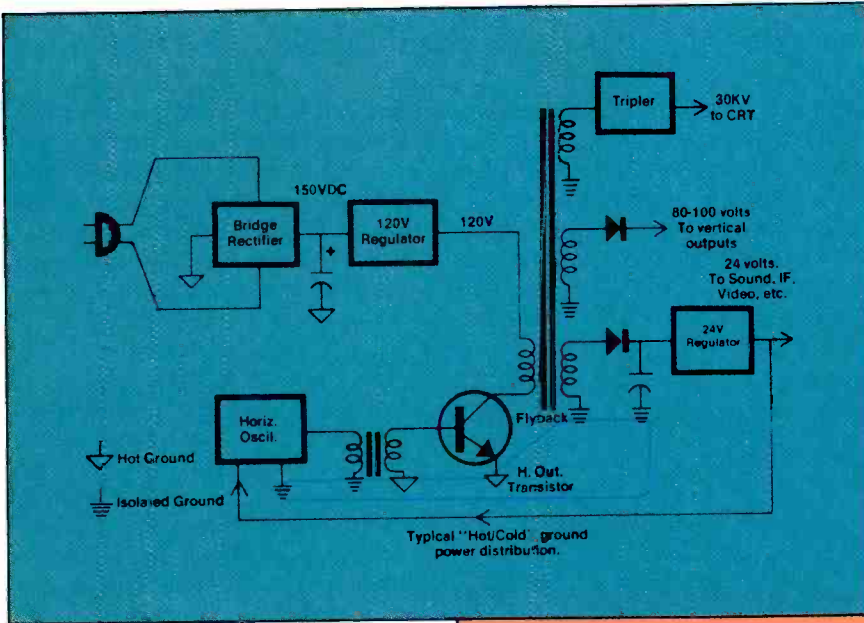
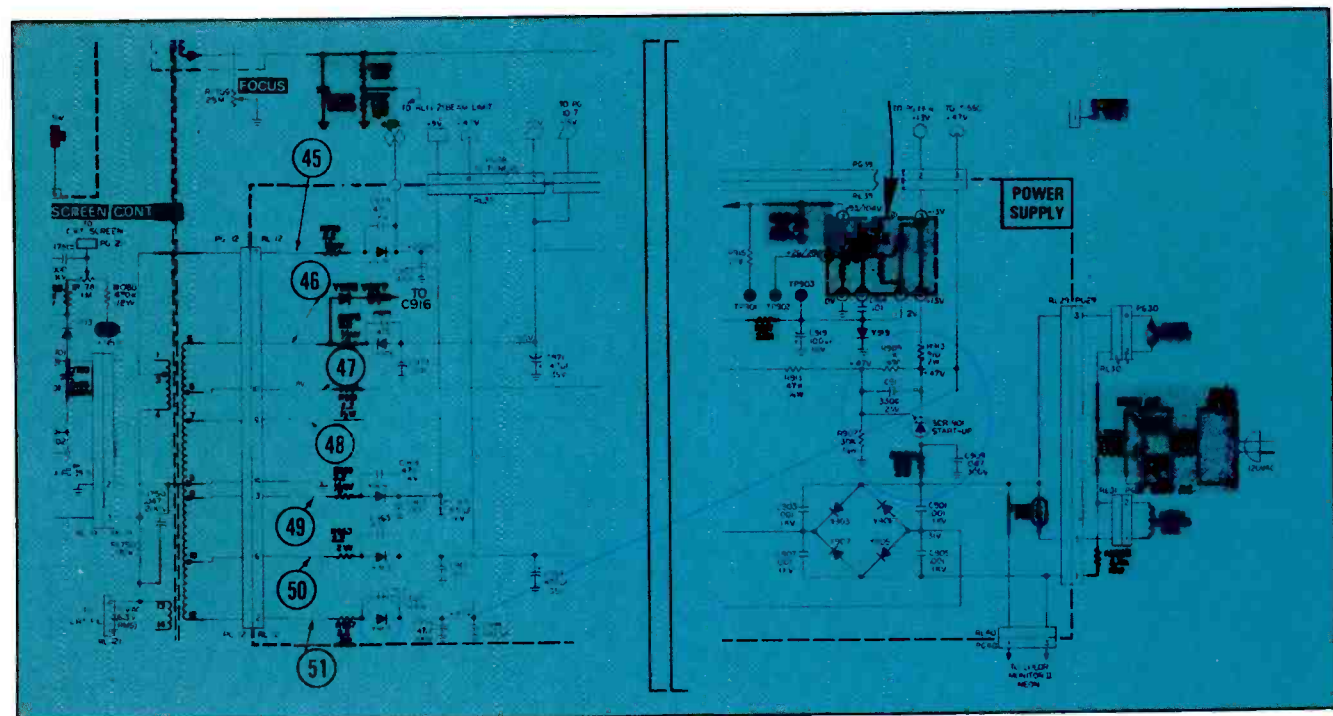
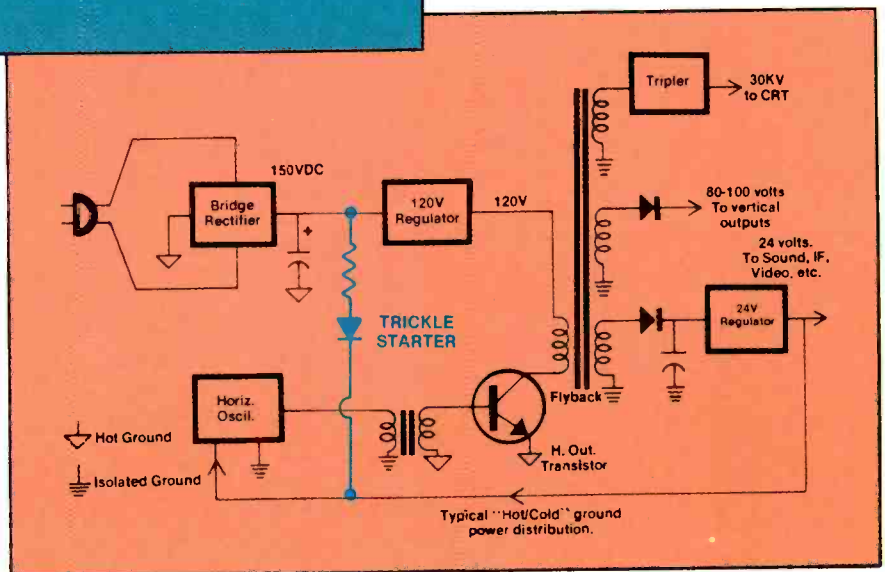

Figure 1. The scan-derived power supply and the horizontal oscillator form a closed loop; the flyback cannot generate power until the oscillator is running. (Courtesy of Sencore)

Figure 2. A trickle starter provides a small amount of unregulated voltage until the scan-derived power supply develops enough power to operate the horizontal circuits. (Courtesy of Sencore)

Figure 3. The current through the startup SCR (SCR-901) and the current-limiting resistor (R-905) provide power to the 47V line until the scan-derived voltage coming through the diode on the flyback (Y957) produces adequate power. (Courtesy of GE)



current to sustain operation. When the scan-derived power supply develops enough power, it takes over from the trickle circuit to operate the horizontal circuits.

You might wonder why the designer even bothers with the scan-derived feedback power. Why not

reduce the value of the startup resistor and allow the oscillator and driver to be powered directly from the raw power supply? The answer is that this supply is not regulated. Line voltage fluctuations, perhaps caused by the refrigerator starting or by a motor kicking in at a fac-

tory down the road, could throw the horizontal oscillator off frequency. If flyback power is used, these surges are eliminated by the output stage regulator. Figure 3 shows an actual trickle startup circuit used in a General Electric set.

Kick starters

The startup voltage only needs to be present for the few milliseconds needed for the horizontal circuits to start. The kick starter provides these few milliseconds of power, and that's all.

The popularity of kick starters comes and goes, depending on circuit grounds. The circuit is usually found in receivers that have most of the circuits isolated from the ac line by the flyback transformer. These receivers still have a hot ground in the output stage. The trickle starter cannot be used in these receivers because the raw B+ is on the hot side and the horizontal oscillator is on the cold side of the flyback. The kick starter bridges between the hot and the cold sides of the flyback transformer without defeating the isolation.

A common example of the kick starter is found in RCA chassis from the CTC85 through the CTC101. These receivers have a startup transformer between the bridge rectifier and the main power-supply capacitor, as Figure 4 shows. This transformer mystifies some technicians because dc flows through its primary, and we all know that a transformer cannot be used with dc. Yet the transformer produces enough voltage to start the horizontal circuits. How is this possible?

To solve the mystery, you have to think of the circuit *before* the power is turned on, not after the set has run for a while. At this time the main filter capacitor will be discharged. The starting pulse forms as the capacitor is charging. The secondary voltage drops to zero when the capacitor is fully charged and dc current is flowing through the primary winding.

The diode at the output of the secondary serves two purposes. It acts as a rectifier while the starting pulse is formed. It then be-

Figure 4. This simplified schematic of a circuit used by RCA shows how a kick starter develops an output. The start transformer produces an output, but only during the time that the main filter capacitor (C₁) is charging.

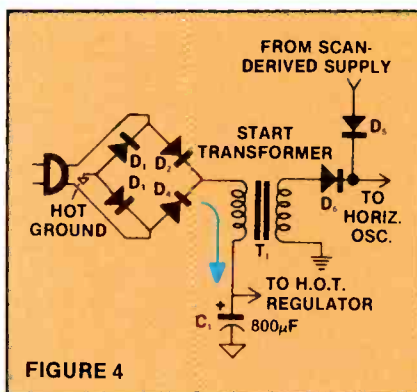
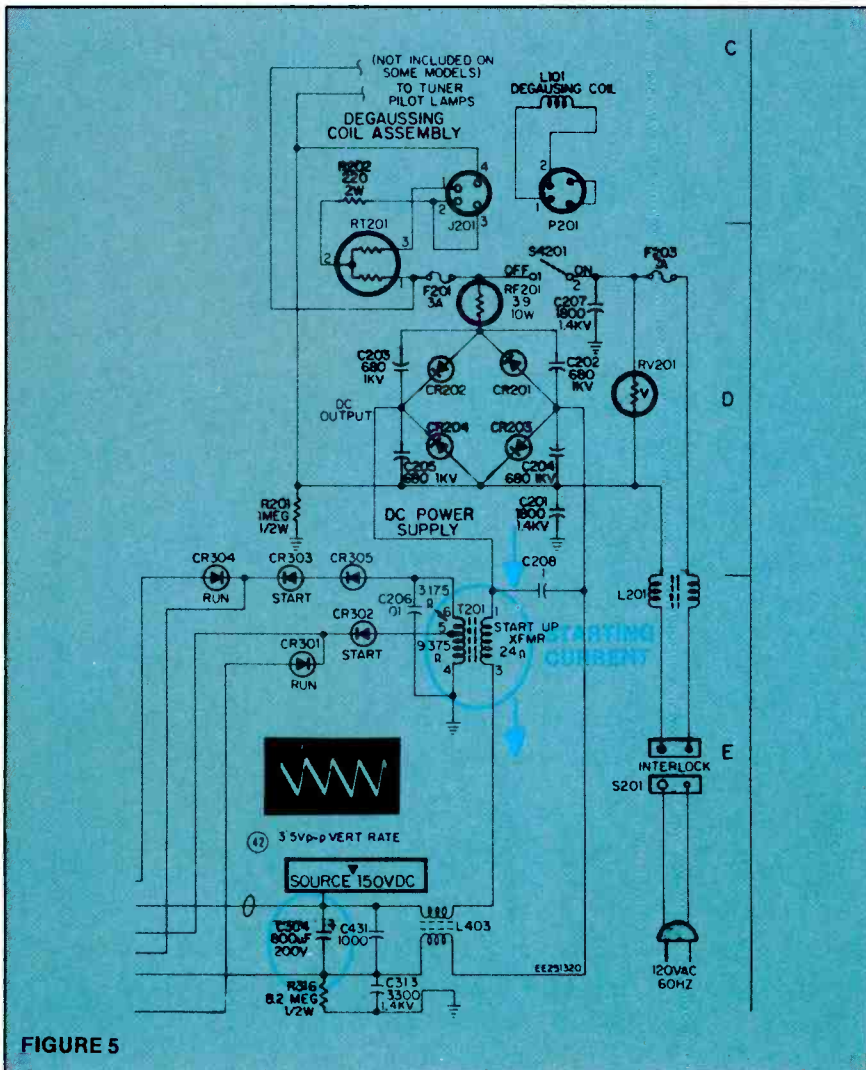

Figure 5. Here is the actual startup circuit used in RCA models from the CTC85 through the CTC101. The start diodes (CR302 and CR305) rectify the output during startup, and then block the flow backwards through the secondary when the output circuits are running. (Courtesy of RCA)



Discover How The World's Only 100% Automatic, Dynamic, & Portable LC Analyzer Gives You Total Confidence In Your Cap/Coil Testing . . . Call 1-800-843-3338 Today!

comes reverse-biased as the scan-derived voltage builds, preventing the transformer from loading the scan-derived supply. (See Figure 5 for an actual kick-start circuit used in an RCA CTC85 chassis.)

The kick starter creates one particularly annoying problem for the servicer: It only fires one time. This gives you only one chance to determine what took place. And it must be reset by discharging the capacitor before it can fire again. The capacitor may take several seconds to discharge because a dead output stage does not draw normal current. It's a good idea to measure the dc voltage at the capacitor and wait until the voltage drops to about 20V before turning on the set again. That way you know the starting circuits can produce the starting pulse.

Circuits that prevent startup

It should be pretty clear that the receiver cannot start if the startup circuits are defective. However, the startup voltage can be present, but may not have enough energy to get the output circuits up and running. In still other cases the startup circuits work correctly, but a problem in some other circuit prevents the set from starting. These defects are also correctly labeled "startup" problems.

A defective horizontal oscillator, for example, prevents startup. The oscillator may be dead, or it may simply be too far off frequency. Sometimes a bad capacitor or mis-adjusted hold control can cause intermittent startup.

A set is more likely to have startup problems when it is connected to an isolation transformer. The core of the transformer softens the starting surge and shortens the time the kick starter circuit supplies voltage. The oscillator may be just far enough off frequency that it cannot get started during the shortened starting pulse.

A defect in any other part of the feedback loop also prevents startup. Common defects are in flyback transformers, output transistors or driver transformers. The receiver will also not start if the primary power supply is defective.



LC77 AUTO-Z™
Automatic Capacitor and Inductor Analyzer
Double Patented \$1,895



The first cap/coil analyzer guaranteed to reliably test anywhere, without calculations, look-up tables, or error — 100% automatically so you're confident of your accuracy.

Do you want to eliminate doubt from your cap/coil testing? The LC77 AUTO-Z tests all key parameters with results *anyone* can understand. Automatic good/bad results eliminate the guesswork for error-free analysis. Touch-sensitive keypad and one-two-three setup makes your AUTO-Z the easiest and fastest LC analyzer on the market.

Are you frustrated trying to test the new high-tech caps/coils used in modern electronics? Only the LC77 AUTO-Z allows you to test them all. Test capacitors from 1 pf to 20 farads, with leakage tests to 1000 V and ESR to 2000 ohms for locating failures other testers miss. Inductor value from 1 uh to 20 H and a patented ringing test for dependable, error-free coil testing every time.

Do you need the freedom of a battery-operated portable LC meter? The LC77 is 100% battery portable for use in the field or factory. The full power and potential of the LC77 AUTO-Z is packed into a light-weight, portable package. The AUTO-Z puts the complicated electronics on the inside for ease of operation on the outside.

Do you want maximum efficiency with a bus compatible LC testing system? Your LC77 AUTO-Z is IEEE 488 compatible for automated cap/coil analysis for data collection, incoming inspection, and quality assurance tests.

Be satisfied that you can meet all the challenges new technology brings. Call WATS Free 1-800-843-3338 today and tell your Area Sales Engineer you want to "try before you buy" with Sencore's exclusive 10 Day Self Demo.

AUTO-Z is a trademark of Sencore, Inc.

WATS Free 1-800-843-3338 In Canada WATS Free 1-800-851-8866



SENCORE

Means Success In Electronic Servicing

3200 Sencore Drive, Sioux Falls, South Dakota 57107

Call Collect 605-339-0100 In SD & AK

Circle (20) on Reply Card

WARNING

Always use an isolation transformer when servicing startup problems to prevent death or injury to the servicer or damage to the circuits. TV receivers that use startup circuits almost always have hot chassis, in which some or all the circuits are referenced directly to the ac line. NEVER plug more than one unit into an isolation transformer simultaneously. Doing so may defeat the isolation.

Identifying the problems

The first step to fixing a problem is deciding whether the receiver has trouble in the startup or in the shutdown circuits. You need to know if the horizontal output circuit operated even for a few milliseconds. If some kind of signal appears, you know that the circuits started up and were then shut down. If there is no signal, you treat it as a startup problem.

Some technicians depend on the crackle of high voltage building on the CRT to make this decision. If you hear the high voltage come up, you know that the circuits ran for at least a moment. But the opposite does not always confirm a startup problem because there may be no crackle if the CRT cath-

odes don't conduct or if the CRT already has high voltage on it from a prior startup. (Note: The flybacks in many modern receivers do not have a high-voltage bleeder resistor, so high voltage may remain on the CRT for a long time.)

A better way to tell whether the circuits started is to monitor a test point when you first apply power. The collector of the horizontal output transistor gives the best information if you have an oscilloscope capable of measuring more than 1,000 volts. As an alternative, you can connect a high-voltage probe to the CRT high-voltage connector to see whether any high voltage develops. We will cover the test at the output transistor because it provides more information.

WARNING

Use extreme caution when making any measurements around high voltage. Remove the power before making connections. Make certain none of the test leads can come loose during a reading. Be especially careful to properly ground your test equipment to the circuit.

Turn off the set and connect your scope probe to the collector of the horizontal output transistor. Be sure to securely attach the

ground lead so it cannot come loose during the test. Preset your scope to measure the flyback pulse from the output transistor. This pulse normally runs between 700V_{pp} and 1,200V_{pp}, so set the input attenuator to its highest voltage level. Set the sweep to the horizontal video rate. Use your "horizontal preset" function if your scope has one, or else set the timebase switch to the 10 microsecond per division rate. (See Figure 6.)

Now, watch the scope's CRT as you turn on the set. If you see pulses build—even briefly—you know the circuits started and were then shut down. Follow the procedures in part I of this series to find the exact cause.

If you don't see pulses, switch your scope to measure dc (either by pressing a digital readout button or by going through the steps needed to make a dc measurement with the CRT). If the voltage shows zero, your "startup" problem is really a power-supply problem. Move back through the regulator and supply circuits to find its cause.

If dc is present, the rest of the circuits may be waiting for the startup pulse. You need to test the startup circuits next. One way to do this is to substitute for the startup voltage.

Give the set a little help

An effective way to check the startup circuits and scan-derived power supply is to substitute for the startup voltage with an external power supply. This is especially important when working with the more complicated kick starters. If the circuits start, you will disconnect the external voltage to see if the circuits continue to operate.

Monitor the collector of the output transistor (or the high voltage) to see if the circuits respond. Adjust your external power supply for the dc voltage normally found

Figure 6. The best place to monitor, when confirming whether the set started, is the collector of the horizontal output transistor. If you see pulses build and then collapse, you know that the set started and was then shut down by a safety circuit.

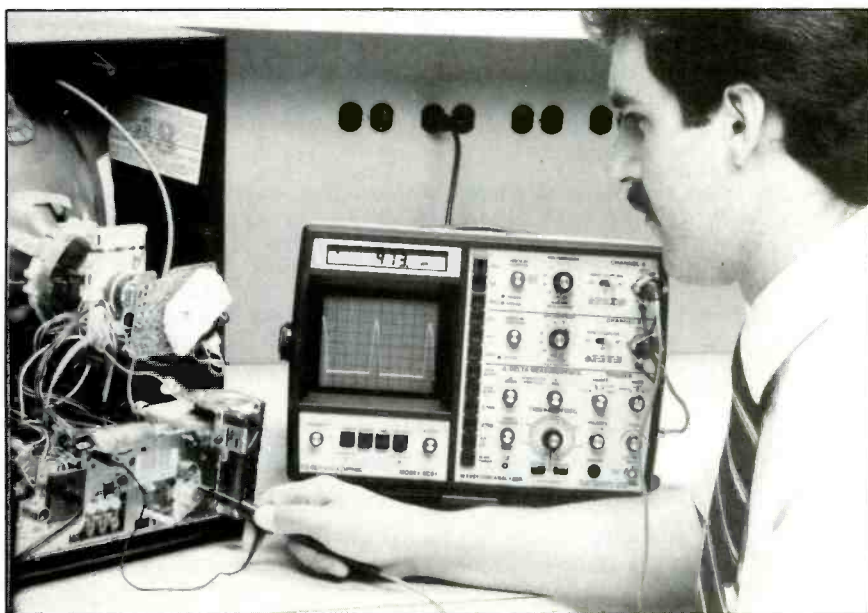

Analyze defective waveforms faster, more accurately, and more confidently — every time or your money back

at the scan-derived supply that feeds the horizontal oscillator. Connect the ground lead to the circuit ground. Turn on the power to the TV receiver and touch the positive lead of the external power supply to the test point in the receiver.

If nothing happens, the startup circuit is not the trouble. You will now need to track down the problem. The output stage is often damaged by power-line surges or nearby lightning strikes, so start there. Use a transistor tester to check the output transistor, and use a reliable yoke/flyback tester to test the flyback. If the output components test good, suspect a problem in the horizontal oscillator or the driver circuits.

If the receiver starts and runs with the external power supply connected, you're almost finished. But you still have to see if the set will continue to run. Disconnect the external power-supply lead. If the set still runs, you know that the closed loop functions correctly, but cannot get started. Test the items mentioned earlier: the startup circuits and the horizontal oscillator's free-running frequency. (Don't forget that you will have to wait for the filter capacitor to discharge to re-check the operation of a kick starter.)

If the set shuts down with the external supply disconnected, you have confirmed that the scan-derived power supply is not delivering enough power. Check the rectifier diode. If it is bad, be certain that you replace the diode with the correct type, because diodes designed for 60Hz supplies often don't work correctly when rectifying the 15kHz signals from the flyback. If the diode is good, suspect an open flyback winding or a component or connection between the flyback and the horizontal circuits.

Separating startup problems from shutdown problems will help you get to the real cause of a high-voltage problem faster. When you're certain you have a startup problem, the correct troubleshooting procedures help you quickly isolate its cause.

ES&T

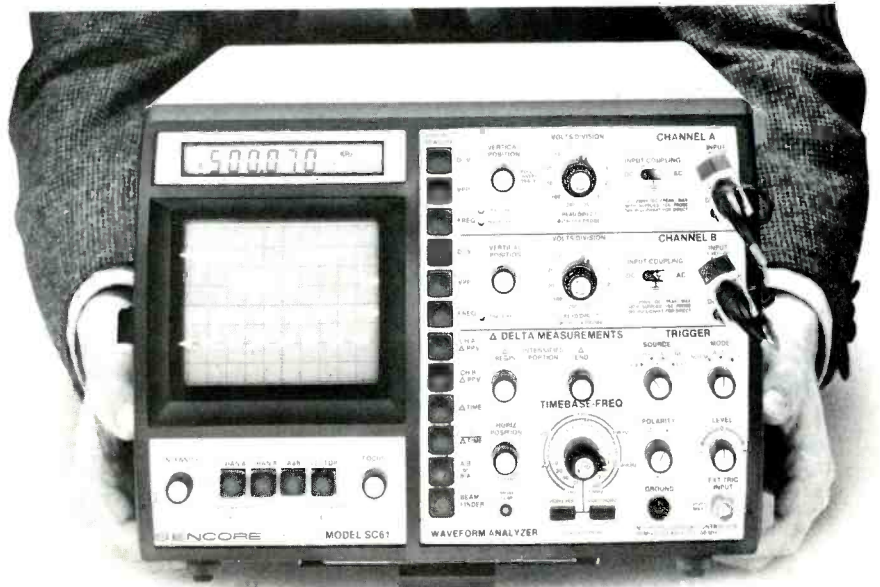

with the SC61 Waveform Analyzer™
Patented \$3,295

If you value your precious time, you will really want to check out what the exclusively patented SC61 Waveform Analyzer can do for you — 10 times faster, 10 times more accurately, with zero chance of error.

End frustrating fiddling with confusing controls. Exclusive ultra-solid ECL balanced noise cancelling sync amplifiers, simplified controls, and bright blue dual trace CRT help you measure signals to 100 MHz easier than ever.

Accurately measure waveforms from a tiny 5 mV all the way to a whopping 2,000 V, without hesitation, with patented 3,000 VPP input protection — eliminates expensive "front end" repairs and costly equipment downtime.

Make only one circuit connection and push one button for each circuit parameter test: You can instantly read out DC volts, peak-to-peak volts and frequency 100% automatically with digital speed and accuracy. It's a real troubleshooting confidence builder.

Confidently analyze complex waveforms faster and more easily. Exclusive Delta measurements let you intensify any waveform portion. Analyze glitches, interference signals, rise or fall times or voltage equivalents between levels; direct in frequency or microseconds.

Speed your digital logic circuit testing. Analyzing troublesome divide and multiply stages is quicker and error free — no time-consuming graticule counting or calculations. Simply connect one test lead to any test point, push a button, for test of your choice, for ERROR-FREE results.

To see what the SC61 can do for your troubleshooting personal productivity and analyzing confidence, CALL TODAY, WATS FREE, 1-800-843-3338, for a 10 Day Self Demo or a full color brochure.

Waveform Analyzer is a trademark of Sencore, Inc.



WATS Free 1-800-843-3338 In Canada WATS Free 1-800-851-8866

SENCORE

Means Success In Electronic Servicing

3200 Sencore Drive, Sioux Falls, South Dakota 57107

In SD Call Collect 605-339-0100

Circle (21) on Reply Card

What do you know about electronics?

Model behavior

By Sam Wilson, CET

Some time ago I wrote about the models that are used for teaching about capacitors. It is necessary to resort to models in order to give beginning students an idea about capacitors that they can visualize.

As far as I'm concerned, the hardest course to teach is beginning electronics. You have to start everywhere at once. It is neces-

sary to get the beginning student into the subject even though that student may have no background knowledge. Models make it possible to get the student into the subject in a short period of time.

There is the danger that students learning by models will get married to them. That gets in the way of their learning more ad-

vanced concepts as they come to the point where the model doesn't work. It can easily be avoided by letting the students know they are being given a concept that will have to be modified as they advance in their studies.

This month I'm going to start by reviewing the procedure for charging a capacitor when there is nothing connected to its leads. This procedure doesn't fit with the model that is usually used for teaching capacitors. I'm also going to talk about the voltage across resistors that have nothing connected to their leads. As with the capacitor discussion, this doesn't fit the model usually used for resistors. However, that voltage is very important for making certain types of measurements.

Charging capacitors without using their leads

A popular way of teaching about charging and discharging capacitors is actually a model for that operation. Students are told that capacitors become charged by forcing electrons into one plate of the capacitor and sucking them out of the other plate. The capacitor is supposed to be charged when the excess electrons are trapped on the negative plate and electrons are prevented from getting into the other plate.

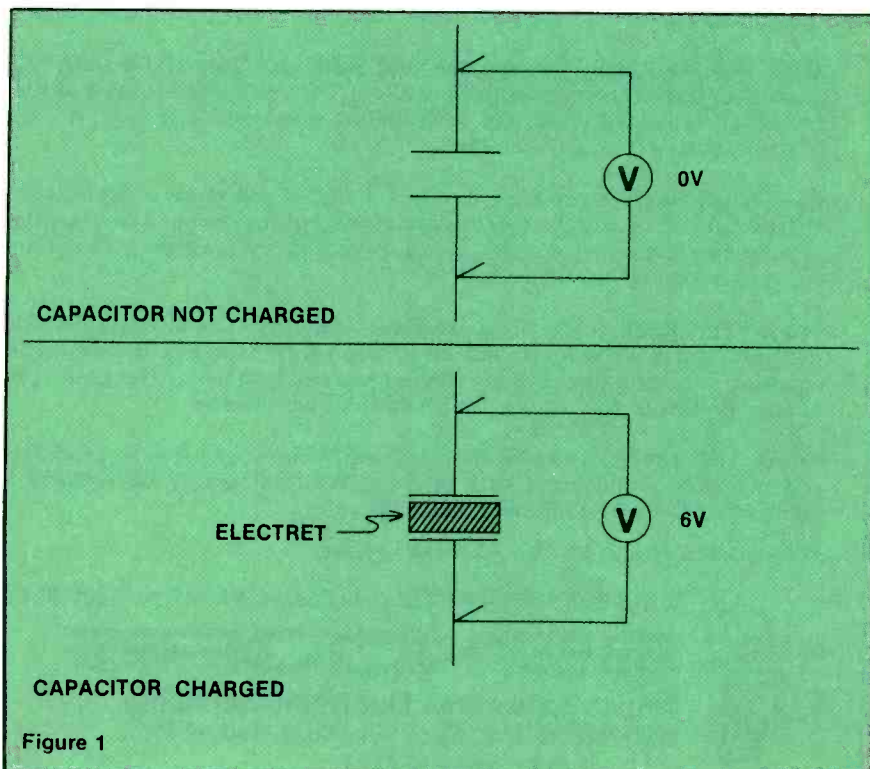
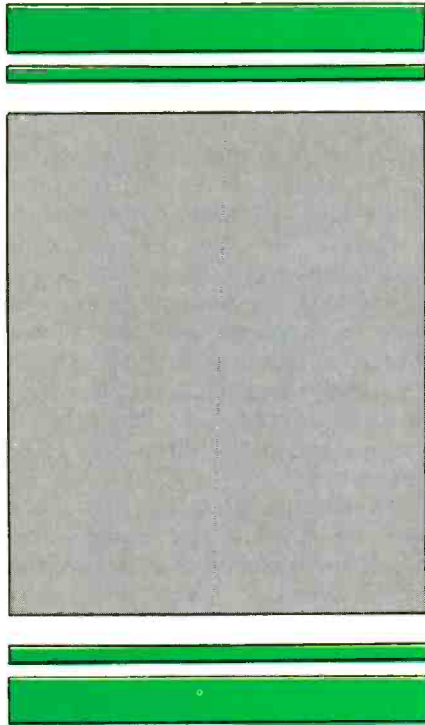

Figure 1



That concept of charging a capacitor disregards the very important role played by the dielectric. As a matter of fact, a capacitor can be charged and discharged *without* using its leads, but not without using its dielectric. (See Figure 1.)

An *electret* is a permanently charged dielectric. At one time electrets were nothing more than a lab curiosity. Today they are used in speakers, microphones and other electronic devices. When used as a permanent (read-only) memory, they are guaranteed to hold their charge for 99 years.

You can make a simple electret by placing melted wax between two large plates that form a capacitor. Connect a very large voltage across the capacitor and keep it there while the wax cools and hardens. The wax will be an electret. (This experiment was described in a previous issue.)

The voltmeter in Figure 1 shows that there is no voltage across the capacitor at the start of the experiment. Placing the electret between the capacitor plates produces a voltmeter reading, showing that the capacitor is charged.

The idea of that experiment is to show that the *dielectric* actually stores the energy in the capacitor.

Before discussing the voltage across resistors that have no connections to their leads, it would be

Now test and restore every CRT on the market . . . without ever buying another adaptor socket or coming up embarrassingly short in front of your customer . . . or your money back



**with the new improved CR70 "BEAM BUILDER"™
Universal CRT Tester and Restorer
\$1,295**

Have you ever?

Thrown away a good TV CRT, data display CRT, or scope CRT that could have been used for another two or three years because you had no way to test or restore it?

Lost valuable customers because you advised them that they needed a new CRT when another technician came along and restored the CRT for them?

Lost the profitable extra \$35 or more that you could have gotten for restoring a CRT while on the job and locked in the profitable CRT sale later?

Avoided handling profitable trade-ins or rentals because you were afraid you'd have to replace the picture tube when you could have restored it?

Had a real need to test a CRT on the job, but didn't have the right adaptor socket or setup information in your setup book?

If any of these things have happened to you, **CALL TODAY, WATS FREE, 1-800-843-3338**

WATS Free 1-800-843-3338 In Canada WATS Free 1-800-851-8866



SENCORE

Means Success In Electronic Servicing

3200 Sencore Drive, Sioux Falls, South Dakota 57107
Call Collect 605-339-0100 in SD

Circle (22) on Reply Card

a good idea to take a fantastic voyage.

A semiconductor trip

I once saw a movie titled "Fantastic Voyage" (or something like that). People were put into a space ship and reduced in size. Then they were injected into the veins of a man. As I remember, they had to make their way to his brain. The plot may not be too solid, but the movie was a complete course in the operation of a human as a system.

We're going to borrow that space ship and travel inside a semiconductor material. That way, we can see for ourselves what Brownian motion and intrinsic currents are all about. It will help to review these things before we talk about

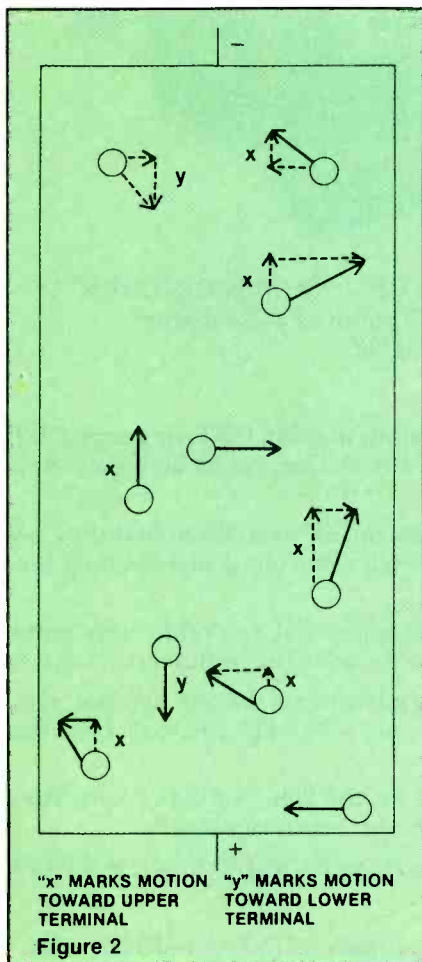

that voltage across resistors. We're going inside a small block of germanium, but we would see the same thing in other semiconductor materials.

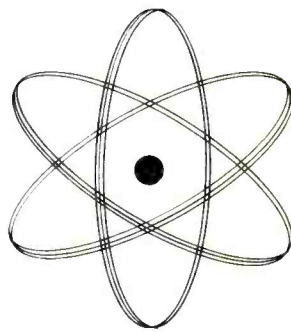

This time we will just journey to a point that is barely inside the surface. In the next issue, we will travel through the material and stop at such tourist attractions as grain boundaries, interstitial atoms and other deathnium traps.

Some of the people who are with us are not prepared for the first inside view of the material. They are not technically trained people. The geometric arrangement of the atoms is perfect and orderly. It looks like some kind of man-made work of modern art.

Every atom is perfectly positioned, and each atom is in a violent vibrating motion. We explain to the non-technical passengers that this is called *Brownian* motion. We would see this regardless of the type of material we had entered. At a special command, the people outside apply a small increase in heat and we see the motion increase.

Occasionally we see a small particle thrown off a vibrating atom. It looks like a tiny space ship as it moves between the atoms and lands at a distant atom. Those particles are electrons, and their motion through the material is actually a form of electric current, called *intrinsic current*.

When the temperature of the material is increased, the number of electrons traveling between atoms is also increased. It is this motion of electrons that we came to see, so we end the journey.

Noise voltage

You know that at room temper-

ature there are electrons that gain enough energy to escape from an atom or molecule. The motion of those electrons—called *intrinsic current*—is in random directions.

Except for the few electrons moving at right angles to the resistor axis, the motion of electrons can be resolved into two vector motions. This is shown in Figure 2. One is the horizontal vector, which is of no interest here. The other is the vector in the direction of the leads.

At any one instant in time there will be more vector motions toward one terminal than toward the other terminal. *That terminal is very slightly negative with respect to the other terminal for the instant in time being considered.*

During the next instant in time there will be more vector motions in the opposite direction and the voltage across the resistor will reverse.

The overall result is that there is a very small amount of ac voltage across the resistor when it is lying on a bench with nothing connected to its terminals. That is called the *noise voltage* of the resistor. The noise is called *Johnson noise* or thermal agitation noise (sometimes just thermal noise).

If you like your theory laced with a little bit of math, the noise voltage can be calculated from the equation

$$V_{\text{noise}} = \sqrt{4kT\Delta fR}$$

where

k is Boltzman's constant (I'll discuss this later),

T is the temperature in Kelvin (that is, degrees C + 273°),

Δf is the band of frequencies of interest, and

R is the resistance of the resistor.

Applications

How does this affect the everyday work of a technician? Well, you can't do anything to change Boltzman's constant or the number four. However, you can see the advantage of cooling resistors in noise-sensitive circuits.

Also, the bandwidth of the circuit involved affects the noise, so it is important not to have a wider bandwidth than is needed for the

job. Remember, *noise and bandwidth are tradeoffs.*

Actually, the noise equation doesn't tell the whole story. It is for use with copper wire. (It is a long time between times when we see copper-wire resistors.) For practical resistors the amount of noise is greater than indicated by the equation. Table 1 shows how practical resistors compare.

**Table 1.
Resistors and noise**

Type of resistor	Noise problem
carbon	worst
film	better
wirewound	best

Use of noise in evaluating amplifiers

When you connect a resistance across the input terminals of an amplifier, you have injected noise into that amplifier. For example, connecting an antenna to the RF amplifier of a TV receiver injects noise because of the antenna resistance. As another example, a resistive transducer (such as a photoreistor) connected to an amplifier injects noise.

The semiconductor amplifying devices (bipolar transistors, JFETs and MOSFETs) are made with semiconductor materials, so they produce Johnson noise.

Manufacturers sometimes give a noise rating for a device or for amplifiers, stating its *equivalent noise resistance*. That is the resistance of an imaginary resistor that produces the same amount of noise as the device (or amplifier) being rated. A low value of equivalent noise resistance is preferred in most cases.

Equivalent noise temperature is another way of evaluating noise. It makes use of the noise *power* equation for resistance:

$$P_{\text{noise}} = kT\Delta f$$

where *k*, *T* and Δf have the same meanings as in the equation for noise voltage.

ES&T

Walk "Tough Dog" Troubles Out Of Any TV & VCR In Half The Time . . . Guaranteed!



with the exclusive, patented
VA62 Universal Video Analyzer™ . . . \$3,495

Would you like to . . .

Reduce your analyzing time? Isolate any problem to one stage in any TV or VCR in minutes, without breaking a circuit connection, using the tried and proven signal substitution method of troubleshooting.

Cut costly callbacks and increase customer referrals by completely performance testing TVs and VCRs before they leave your shop? Own the only analyzer that equips you to check all standard and cable channels with digital accuracy. Check complete, RF, IF, video and chroma response of any chassis in minutes without taking the back off the receiver or removing chassis, plus set traps dynamically and easily right on the CRT.

Reduce costly inventory from stocking yokes, flybacks, and other coils and transformers for substitution only, with the patented Ringing Test? Run dynamic proof positive test on any yoke, flyback, and integrated high voltage transformer.

Protect your future by servicing VCRs for your customers before they go to your competition? Walk out "tough dog" troubles in any VCR chrominance or luminance circuit to isolate problems in minutes. Have proof positive tests of the video record/play heads before you replace the entire mechanism.

Have one piece of test equipment that doesn't need replacing every time technology changes? Be able to service Stereo TVs & VCRs profitably, and get in on the ground floor of this growing market with exclusive phase-locked accessories.

Find out how the VA62 Universal Video analyzer will make servicing easier and more profitable in your shop? Call WATS Free 1-800-843-3338 and ask your area Sales Engineer for a "Try before you buy" 10 Day Self Demo or a full color brochure and join the many servicers already on the road to more profitable servicing with the VA62.

Universal Video Analyzer is a trademark of Sencore, Inc.

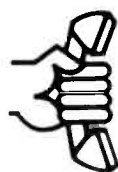

WATS Free 1-800-843-3338 In Canada WATS Free 1-800-851-8866

SENCORE

Means Success In Electronic Servicing

3200 Sencore Drive, Sioux Falls, South Dakota 57107

Call Collect 605-339-0100 In SD & AK

Circle (23) on Reply Card

November 1987 *Electronic Servicing & Technology* 51

**Technicians,
Get Serious
About Your
Profession**



Being a certified electronics technician lets people know that you are a professional in your field. It tells them that you are serious about your work and can perform up to CET standards.

Now you can order the "Study Guide for the Associate-Level CET Test" from the International Society of Certified Electronics Technicians. It includes material covering the most often missed questions on the Associate CET exam. 8 1/2" x 11", paperback, 60 pages.

For More Information Contact:

ISCET, 2708 W. Berry, Fort Worth, TX 76109; (817) 921-9101

NAME _____
ADDRESS _____
CITY _____ STATE _____
ZIP _____
_____ copies @ \$5 (+ \$1 postage.)
_____ send material about ISCET
and becoming certified.

VCR Maintenance and Repair on Video Tape

There is no other tape like ours on the market. This VHS tape is loaded with one hour and forty-seven minutes of expert information. This new tape takes you step-by-step through four different VCRs and shows you the similarities and differences of each.

The only hand tool required is a Phillips head screwdriver. That's right! There is no test equipment or special tools required. Also, you need no special schooling to perform the simple tasks on our video.

Save time and money

After viewing this program you will be able to do the most common repair jobs on all VCRs. To save time and money on your VCR repairs order your own VHS VCR tape NOW! Simply call:

(513) 548-6113 or
1-800-323-0826 (Ohio only)

and have your Master Card or Visa ready.

The tape is only \$29.95 + 3.00 (postage and handling). Please allow 6-8 weeks for delivery.

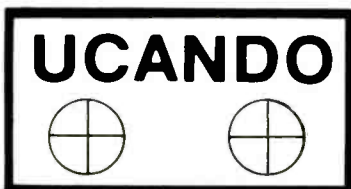

VCR EDUCATIONAL PRODUCTS
P.O. BOX 386
GREENVILLE, OHIO 45331

Circle (17) on Reply Card



Compressed gas dusters

Chemtronics has introduced a line of high-purity Ultrajet compressed gas dusters ultra-filtered to less than 0.2 microns. The dusters deliver a jet of microscopically pure, moisture-free inert gas that removes particulates from inaccessible areas without contaminating, scratching or leaving a residue.

The dusters are available in 3-, 8- and 14-ounce cans, as well as in a reusable chrome valve assembly for high-volume users.

Circle (75) on Reply Card

Digital storage oscilloscopes

Iwatsu Instruments has introduced two new models to its line of digital storage oscilloscopes.

The DS-6612 offers a 60MHz analog bandwidth, a 60MHz digital storage bandwidth for repetitive signals, dual 20 megasamples/second analog-to-digital converters and deep 16K waveform memory. The DS-6411 has a 40MHz analog bandwidth plus dual 10 megasamples/second analog-to-digital converters.



Both scopes feature phase, peak-to-peak and ground reference, averaging, pre-trigger and post-trigger, GO/NO GO judgment modes and roll mode.

Circle (76) on Reply Card

Solder extraction systems

Automated Production Equipment Corporation has introduced three self-contained solder extraction systems, the models EX-500, EX-501 and EX-525. The systems feature zero voltage switching and localized grounding for CMOS

safety, a finger switch/foot switch option, low-voltage heating elements and accessories, microprocessor-controlled temperature regulation, and locking DIN connectors.

Circle (77) on Reply Card

Telecommunications service tool kit

Contact East introduces its telecommunications service kit T27, specifically designed for the telecommunications specialist. A full selection of optional accessories and a choice of carrying case is available.

Circle (78) on Reply Card

ESD work station kits

Desco Industries has released several series of complete work station kits for proper grounding and usage in EOS/ESD-sensitive areas. Each series is available with five different standard benchtop soft mats in sizes from 18"x24" to 60"x24" Some series include complete work stations, including floor mats, wrist straps and all necessary ground cords. Others include only the benchtop mats or bench mats and wrist straps.

Circle (79) on Reply Card

Training materials

The "70 Series Solutions" training product from *John Fluke Manufacturing* is designed to maximize the usefulness and safety of the company's 70 Series of hand-held digital multimeters.

The product includes a 15-minute videotape, overhead transparencies, a 100-page instructors' guide and 25 student workbooks. Training emphasizes hands-on exercises rather than theory.

Among the subject matter covered is how to measure current, resistance, ac/dc voltages, sine wave, non-sine wave and composite voltage.

Circle (80) on Reply Card

Power regulators

The Datagard spike and noise suppressor from *SL Waber* is available in a wall plug-in unit, model DG315-P, or as a 16-inch strip for multiple plug-in, model DG315-S. Both feature maximum spike energy dissipation of 80J one

time, 25J repeated usage, self-restoring. Maximum spike voltage is 7,000V, and clamping spike voltage is 55V above line.

The company's Linegard 600 uninterruptible power supply (UPS) protects against computer data loss in a power emergency. Engineered for multi-user PCs and mini-computers, the unit can provide up to two hours of power during an outage. The UPS features an internal battery, built-in voltage regulation, and overload capacity handling of up to a 200% load starting surge.

Circle (81) on Reply Card

Temperature controller

Hot Tools' Dial-Temp controller is compatible with any soldering iron, woodburning tool or other de-



vice that uses a heating element from 15W to 1,600W. The device is plugged into the controller and the controller plugs into any 110Vac outlet. The controller has a 15A capacity.

Circle (82) on Reply Card

Monitor tester

Network Technologies has introduced the MONTEST-VGA portable pattern generator, designed for operation with the new VGA monitors used with the PS/2 personal computer line. The tester verifies monitor operation in all modes as well as checks monitor alignment, convergence and color balance.

The unit generates four video patterns at eight scan formats. At 31.5kHz, it provides line formats

of 350, 400 and 480. The 35.5kHz scan format is supported, exercising the full range of capabilities of the new display. The generator can also test TTL monitors compatible with the MD, CGD and EGD standards.

Circle (83) on Reply Card

Electronic power conditioner

Sola has introduced a series of microprocessor-based electronic power conditioners (EPC) with output capacities of 500VA, 1,000VA and 2,000VA. The units' overload capacity ranges from 300% for 600 cycles to 1,400% for one cycle. Output voltage is measured continuously and corrected every 16ms. The EPC holds output voltage to $\pm 5\%$ for input voltage variations up to $+15\%$ and down to -25% . The 60Hz EPC is UL-listed, CSA-certified and conforms to FCC Class B requirements. The 50Hz models available are built to VDE and IEC requirements.

Circle (85) on Reply Card

Hot air tool

The Brian R. White Company has introduced the Leister Hot-Jet hot air tool, which provides contactless desoldering and soldering of surface-mount device (SMD) and dual-inline package (DIP) components between 20°C and 600°C using hot air. The electronically controlled air volume produced is 30 liters/minute and is adjustable in 3 steps.



The double-insulated tool is available in 100V, 120V and 220V 50Hz to 60Hz. A variety of nozzles and reflectors is available.

Circle (87) on Reply Card

ES&T

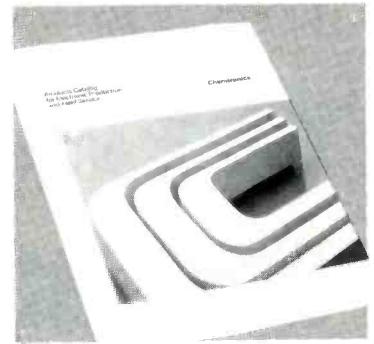

CHEMICAL SOLUTIONS

FREE CHEMTRONICS CATALOG!

Comprehensive new source for over 200 products used in electronic manufacturing and field service. Precision cleaning agents, flux removers, bulk solvents, circuit refrigerants, precision dusters, non-residual wipers, foam swabs, premoistened pads/swabs, antistatic compounds, conformal coatings, lubricants, adhesives, desoldering braids, rosin core solder and solder masking agents. Complete with technical specifications and application guide.



Chemtronics Inc.
681 Old Willets Path
Hauppauge, N.Y. 11788
516-582-3322

Circle (26) on Reply Card

Your integrity is on the line.

Monitron™ 2000

Don't let power line disturbances hang you up or threaten your professional integrity. The new **Monitron 2000** power line monitor will increase your productivity and cost-effectiveness.



MONITRON 2000 FEATURES:

- 5 fault detection levels: spike, high volt., low volt., dropout, power failure; self-test circuit
- ANSI standard trigger points
- Total compatibility
- Compact; mounts on terminal, peripheral or its own stand
- Easy to install & use

Contact: Mendon Electronics
3800 Monroe Ave.
Pittsford, NY 14534
(716) 248-8480

Circle (24) on Reply Card

The meter said ... what?

By Joseph J. Carr, CET

An English gentleman left his office in London and went to his club for an evening of convivial fellowship with other gentlemen. When it came time to leave he went to the cloak room and found the porter standing there with his coat already in hand. The startled gentleman asked, "How did you know it was mine without the claim check?" The dignified porter retorted, "I didn't, sir. All I knew was that it's the coat you came in with...who *owns* it is another question entirely."

That dignified gentleman's club porter *refused to speculate on any fact not actually in evidence*. That advice is good not just for cloak-room porters, but electronic servicers as well. Sometimes, the meters and oscilloscopes give us a bum steer and thereby lead us unprofitably astray. Let's take a look at several situations where the evidence of our senses and instruments gives us false results.

Case No. 1

A customer brought in an AM car radio. The complaint was that sometimes it whistled and sometimes it was distorted, but other times it played OK. The problem sounded at first like a classical intermittent—probably a loose connection or busted PC board. When the radio was turned on, the technician found that it worked and, in fact, on first blush appeared quite normal. He was about to assume it was just another NFF (no fault found), which happens quite often when customers work on their own sets without letting an expert check it out in the car.

But the technician was sharp,

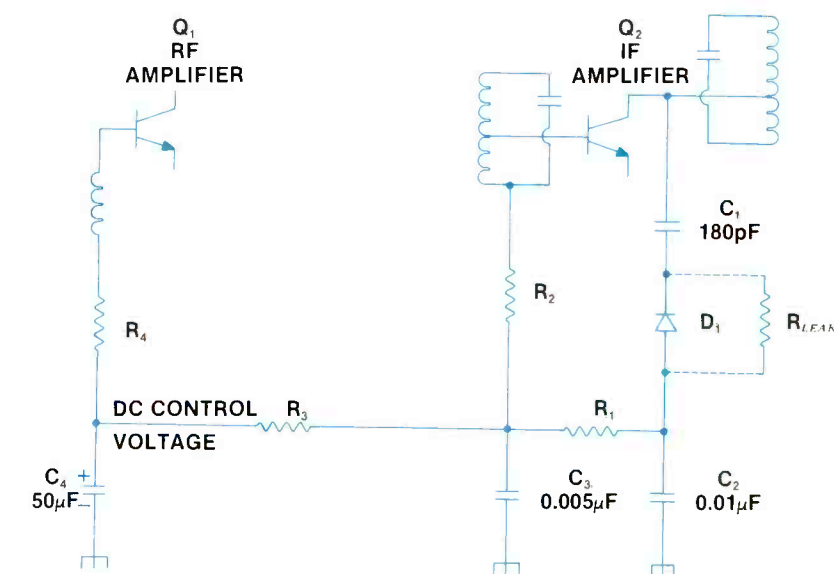

Figure 1

and he noted that the announcer tended to lisp a little on "S" and "P" sounds. Paying a little closer attention, he concluded that the lisping was due to the fact that the set was hyper-sensitive and was therefore on the verge of oscillation all the time.

The first place one might look in a radio with tunable oscillations (or lisping) is the automatic gain control (AGC) circuit. (See Figure 1.) The AGC samples the IF amplifier output signal, rectifies it and filters it to dc, and then uses the dc to control the gain of the IF and RF amplifier stages, so it forms a potential feedback loop if the decoupling is not working well. Hence, the AGC is always suspect in such cases.

Most AGC loops in AM radios contain a large-value electrolytic capacitor (C_4) that filters the dc control voltage, and if it is open oscillation will result. This capacitor is probably the classical cause of AGC oscillations. The technician bridged C_4 with a known good capacitor, but it produced no change. He next suspected the power supply decoupling capacitors. Again, bridging a known good electrolytic capacitor of the proper value across the set's capacitors did no good at all. Next the tech pulled one end of AGC-rectified D_1 loose and measured both the forward and reverse resistances. The ratio was 5:1, and the "conventional wisdom" told him that diode was OK, so he soldered it back in.

After a certain amount of head scratching and chin rubbing, he remembered that the customer claimed that the radio was sometimes distorted and at other times it was OK. Tapping the circuit board with an insulated probe didn't show any intermittents. Because the shop was too far from any AM station to receive a really strong signal, he connected the AM signal generator and tuned it to the radio dial frequency.

Sure enough, on strong AM signals (even though well within the normal permissible signal-strength range) the radio became distorted, while on weaker levels of RF input signal the distortion disappeared. It was also found that the radio tended to oscillate a little as the dial was rocked on and off the signal generator frequency. On a hunch he replaced the AGC rectifier diode (D_1), and the problem went away. The oscillation disappeared, the distortion disappeared, the announcer didn't lisp and the radio responded to the full dynamic range of input signals.

The root problem was leakage resistance across diode D_1 (R_{leak} in Figure 1). The confusion was two-fold. First, diodes are normally open or shorted; only rarely do they exhibit leakage or a *partial* short. Second, the "conventional wisdom" misled the technician. It seems that 5:1 (or even 10:1, the alternate conventional wisdom) is bum advice for high-impedance circuits. An order of 100:1 or even greater is more reasonable for real diodes in real AGC circuits.

Another confusion was that the technician was in a single location where signal strengths did not

reach the levels required to drive the set into trouble. Installed in a car, however, the situation was different because the driver frequently had to drive close to the station. The same scenario could conceivably result on table-model or portable radios that play OK in the basement (where signal levels are small), but distort in the second-floor bedroom where signal levels are higher. It also shows that the technician should not depend on a quick or cursory check of any equipment; the problem might be subtle.

Case No. 2

Fresh from spending 15 minutes too long on Case No. 1, the same technician picked up another car radio and tossed it on the bench. This model was an older, solid-state AM radio from the early 1970s. Turning it on, he found the same symptoms. "AHA!" he thought to himself, "Another bad AGC rectifier diode!" After replacing D_1 , he found the problem persisted. In this case, collector-to-base leakage in the RF amplifier transistor caused a symptom similar to the symptom in Case No. 1. Although not a big problem today, it was common in the "olden days" when AM RF amplifier transistors were all germanium. (Note: The problem can exist on silicon transistors but it is a lot rarer than on Ge devices.)

Case No. 3

A Cable-TV/MATV maintenance repair installation organization (MRIO) had a technician who checked out equipment before giving it to field installers, and who

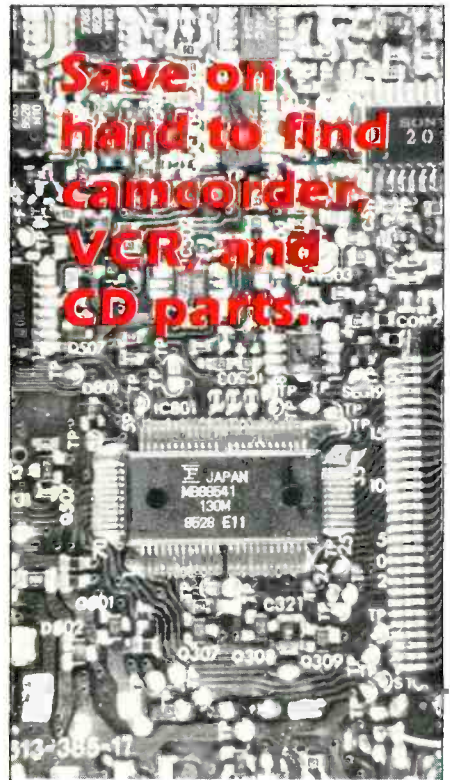

- SURFACE MOUNT DEVICES
- IDLER ASSEMBLIES
- BELTS
- LAMPS/SENSORS
- MOTORS
- INTEGRATED CIRCUITS
- CLEANERS/SOLVENTS
- CONNECTORS/CABLES

CALL TOLL FREE
1-800-338-0531



**FREE
CATALOG**



340 E. First Street; Dayton, OH 45402
Local Phone: 513-222-0173
FAX: 513-461-3391

Circle (25) on Reply Card

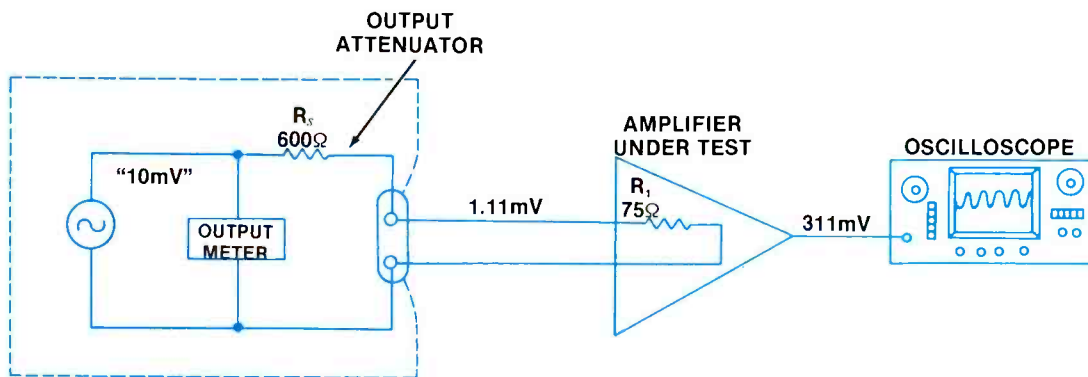

FIGURE 2

also repaired defective equipment. The technician was required to service both VHF/UHF channelized RF gear as well as baseband video amplifiers. Being frugal, the manager gave her a function generator to supplement the VHF/UHF TV generator, with the idea that the 0.01Hz to 11MHz function generator could service the 100Hz to 6MHz video baseband equipment. The function generator was a bright, gleaming new model that produced square waves, sine waves, triangular waves and variable duty-cycle pulses. It was truly a quality piece of test equipment.

The technician set up the function generator to make gain checks on the baseband video amplifiers prior to issuing them to field people. These amplifiers were specified to 40dB voltage gain (X100) and could accept high-level inputs to 25mV without overloading. Knowing these specs, she set the signal generator output frequency to about 1MHz and dialed up an output level of 10mV rms (well within overload spec). A 40dB voltage amplifier has a gain of X100, so she expected an output of 10mV x 100, or 1,000mV (1V). Because her output indicator was an ac-coupled wideband oscilloscope, which reads peak-to-peak (p-p) voltage, she expected to see about 2.82 x 1,000mV, or 2,820mV on the CRT screen. Unfortunately, the reading was only slightly more than 300mV. It was obviously a defective amplifier, so she put it aside for repair later. Because the impatient field crew needed an amplifier, she grabbed another and checked its gain. It too had an out-

put voltage around 300mVp-p.

Two new amplifiers in a row with the same symptoms? Unlikely, for the brand was good quality and had a long record of working properly. So, being a bright young lady from a good technical school, she figured that something was wrong with the test setup. She first looked at the function generator operator's manual, and there she found the difficulty. Function generators, despite their wide frequency range, are *designed like audio generators* and thus have a 600Ω output impedance. Furthermore, the output level meter is *ahead* of the stepped output attenuator that sets both the level and the constant 600Ω output impedance. (See Figure 2.) As a result, the output level is accurate only when the signal generator output terminal is terminated in a 600Ω impedance. The video amplifier, on the other hand, has a 75Ω input impedance. In this circuit, the *actual* output voltage, V_o , as opposed to the meter reading, is:

$$V_o = \frac{(10\text{mV})(R_i)}{(R_i + R_s)}$$

$$V_o = \frac{(10\text{mV})(75)}{(75 + 600)}$$

$$V_o = 750\text{mV}/675 = 1.11\text{mV}$$

As a result of an incorrectly specified signal generator, despite the fact that it worked on the right frequency, the good 40dB amplifiers output 1.11mV x 100 = 111mV, or 313mVp-p...exactly what Brenda measured.

In past times, that type of error was unlikely because audio generators, with their 600Ω output impedances, rarely worked above either 20kHz or 100kHz at the highest. But today the technology finds it easy to provide multiwaveform function generators with low-end frequencies in the subhertz range and high-end frequencies in ranges that were clearly "RF" a decade ago. One expects RF generators to have a 50Ω output impedance unless specifically designed for TV/video applications, in which case it is 75Ω...not 600Ω!

Case No. 4

A building's cable system is designed around 75Ω equipment, which is standard for TV/video systems. By error, an installer uses 50Ω coaxial cable to wire a section of the building. When signal levels are measured, it is found that slight anomalies exist. Some gains are too high, and others are too low. Can we find the answer to the mystery? Consider Figure 3.

Whenever an RF or video amplifier is mismatched as regards input and/or output impedances, a *standing wave ratio* (SWR) exists. The SWR will cause a mismatch loss of:

$$ML = -10 \text{ LOG} \left(1 - \frac{\text{SWR} - 1}{\text{SWR} + 1} \right)^2$$

For example, when the SWR is 2:1, the gain mismatch loss is about 0.51dB. If there are two SWRs working with or against each other, the multiple reflected and incident waves bounce around

$$SWR_1 = R_1/Z_0 = 75/50 = 1.5:1$$

$$SWR_2 = R_2/Z_0 = 75/50 = 1.5:1$$

$$MISMATCH LOSS = 20 \text{ LOG} \left[1 \pm \left(\frac{SWR_1 - 1}{SWR_1 + 1} \right) \times \left(\frac{SWR_2 - 1}{SWR_2 + 1} \right) \right]$$

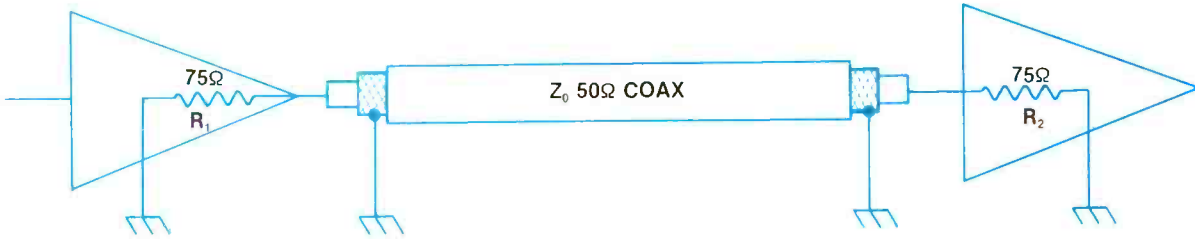

FIGURE 3

the coax, adding and subtracting to signal levels, and produce a mismatch loss of:

$$ML = -20 \text{ LOG} \left[1 \pm \left(\frac{SWR_1 - 1}{SWR_1 + 1} \right) \times \left(\frac{SWR_2 - 1}{SWR_2 + 1} \right) \right]$$

In the system of Figure 3, we have two SWRs involved:

$$R_1/Z_0 = 75/50 = 1.5:1$$

$$R_2/Z_0 = 75/50 = 1.5:1$$

In other words, we have a pair of 1.5:1 SWRs. When these SWRs are cranked through the formula, we have a pair of possible gain errors of +0.34dB or -0.35dB. In other words, a 10dB gain amplifier might ordinarily measure either 10.34dB or 9.65dB. While this variation might seem inconsequential (there are places where it is not!), it serves to illustrate a prob-

lem that becomes much worse with a larger mismatch.

Not everything is as it seems, a fact that points up the necessity for the technician to be more than a potted plant at the back of the shop. Some technicians I have known over the years always want a "cookbook" service guide that says, "When you see this, replace (or do) that." In real life it sometimes pays to think.

ES&T

ATTENTION TECHNICIANS

- ★ JOB OPENINGS
- ★ MONTHLY TECHNICAL TRAINING PROGRAM
- ★ BUSINESS MANAGEMENT TRAINING
- ★ LOW COST INSURANCE
- ★ CERTIFICATION
- ★ TECHNICAL SEMINARS

All of this in a nonprofit international association for technicians

FIND OUT MORE:



604 N. Jackson St.
Greencastle, IN 46135

Test VCR Mechanics Fast and Easy!

Take the guesswork and hassles out of VCR
mechanical problem diagnosis!

Four Universal, Powerful Tools for VCR Service

Tape Tension Gauge: The Tentelometer® is the world's most universal method of measuring hold back tension. Calibration can easily be checked

in the "field". Merely slide the probes over tape to measure tape tension directly in grams. Illustrated instruction manual included. This is the back tension gauge referenced by many of the VCR service manuals, and it will work on all VCRs.

T2-H7-UM \$295



Video Head Protrusion Gauge: Universal, fast, safe method of measuring the amount of video head tip wear. Measures in microns and ten-thousandths of an inch. Allows accurate predictions of remaining head life. Head wear provides useful information regarding VCR condition and wear on other components. Stop guessing about head wear. Accessory "S1" stand allows use on any VCR.

HPG-1 \$479 S1 \$95



Spindle/Elevator Gauge: The TSH gauge inserts into the VCR just like a cassette. The new TSH-V5 performs 6 critical measurements to eliminate tape binding and edge damage. This gauge quickly locates problems that can't even be detected by other methods. Fully illustrated instruction manual is included.

TSH-V5 for VHS: \$395



Torque Gauge: A universal, inexpensive, accurate torque gauge for VHS and Beta VCRs. Calibrated in Gram-Centimeters both clockwise and counterclockwise. Complete with easy-to-follow, detailed instruction manual for VHS recorders. Includes a modified VHS cassette for ease-of-use.

Complete System
TQ-600 \$139

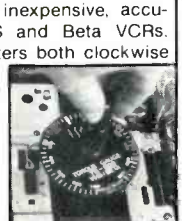

Tentel® provides the most powerful, easy-to-use, field calibrateable, universal VCR test equipment available for various mechanical tests. Call our application engineers today for answers to your questions. Ask about the combination discount when ordering all 4 gauges.

Tentel Corp.

1506 Dell Avenue
Campbell, CA 95008

(800) 538-6894
(408) 379-1881
in California

Circle (32) on Reply Card

November 1987 *Electronic Servicing & Technology* 57

Using a technical help line

The complexity of the products we service increases every year. Technological change is so rapid that what you knew just a few years ago is already obsolete. New home entertainment equipment is tougher than ever to fix, yet the selling prices are so low that many customers simply junk any defective unit that cost them less than \$200. Among Japanese manufacturers, the plunging dollar has had a relatively minor effect on retail prices, but parts cost is turbo-thrusting into the stratosphere. There has never been a time when scoring a direct hit on the defective part has been more difficult or more essential.

Ten years ago, I would have said that calling a manufacturer's technical help line was about as useful as a 250W soldering gun in a microcassette recorder. Now that's changing. With all the large-scale integration (LSI) in equipment, much of the "circuit sense" we had with analog, discrete designs is missing, simply because we often don't know what's inside some \$80, 80-pin chip. Add to this the fact that microprocessor control means that two otherwise identical units with different codes burned into their controllers may exhibit significantly different symptoms for the same failure.

Just to spray a little more gasoline on the fire, programmers are notorious perfectionists who may make several changes in a given model's program code throughout its production. These are, for the most part, not documented. So, sooner or later you'll probably need to call the manufacturer's tech help line, like it or not.

Be prepared

The varying commitment to support among companies means that the person on the other end of the help line could be anything from a glorified switchboard operator, with a prepared text on several broad product categories, to a technical help specialist, whose only job is to supply servicers with the information they need for effective servicing. Regardless of the type of help available, you can maximize the results by following a few simple rules.

First of all, you can probably avoid a call altogether by searching through all the updates, supplements and bulletins the major players provide. This is a basic requirement of intelligent servicing in the 1980s. Most techs I know would rather replace the tip on a hot soldering iron with their bare hands than keep a bulletin file updated, but the fact is that a 700° burn will cripple them less than shoddily maintained service information.

In the big shop, file maintenance should be considered a high priority, with the responsible individual reporting directly to the service manager. In a small shop, the technician may have to take care of it himself. You should need little coaxing if you're on commission or quota. Having that information organized and handy always pays off. The only thing I like less than filing service bulletins and supplements is not being able to find one when I need it.

Be sure you've done some troubleshooting first. Fishing expeditions shouldn't be necessary if your information is in order. In most instances, if you haven't used a scope, you're not prepared to call for help.

Next, have the manufacturer's service manual (schematic) in front of you. How can you and the technical adviser talk about circuitry over the phone if you're not both "singing off the same song sheet"? If you've had training on a unit, it would be smart to keep the training manual handy too. After all, you want to be on and off the phone as quickly as possible.

Make sure you have a clear understanding of the symptoms. You are going to be the eyes and ears of the tech adviser, and the more accurate your description, the better your chance of getting an answer. One of the fundamental drawbacks of telephone troubleshooting is that you're often missing a key symptom. That's why you're stuck. Of course, then you can't convey this symptom to the adviser because you're not aware of it. This is the cause of many "impossible" failures. The only remedy is more thorough troubleshooting.

Don't expect miracles. You're a trained, productive technician who works on the equipment every day. You have the defective unit in front of you, with all the visual and auditory clues available. If you can't fix the thing, how is somebody a few hundred miles away on the other end of a telephone line supposed to do it? The best you can expect is that the adviser has heard of the problem before, there's a late-breaking bulletin not yet in the shops, or perhaps just talking it over will trigger a solution in your mind.

Avoiding technical help

Most "dogs" are the result of either a mental block, inaccurate service information or physical inaccessibility of components. Of these, the mental block is the most common detriment to effective repair. If you ever want to be a class A technician, you'll have to deal with the problem daily. The answer is to be well informed. Study the current literature on the subject, attend manufacturers' training, and yes, you probably should even do some *homework* if you want to stay competitive. Information is what you need, and at the rate it's coming, it takes special effort just to avoid falling behind.

On the bench, if you haven't pinpointed the defective component in an hour, you better put the unit aside and get a few successful repairs logged out before continuing. Otherwise, you'll get "dog-headed," an unproductive state of mind in which you expect every simple problem to have a sinister, senseless, impossible cause. With that kind of attitude, you'll be lucky to fix anything.

When you finally put the pup back on the bench, re-examine the symptoms, assess the validity of the assumptions you're making, and repeat your test procedures. You'll probably get it this time.



Answers: to the quiz

Questions are on page 16.

1. B. Unlike the earlier storage oscilloscope, the digital storage oscilloscope does not require a special CRT. The waveform to be stored is converted into digits by an analog/digital converter, and those digits are stored in a memory. To retrieve the waveform, a digital/analog converter is used. (For more information, see "The Oscilloscope: The Eyes of the Technician" by Conrad Persson in the April 1987 issue.)
2. D. A signal at the Z-axis input terminal controls the beam intensity.
3. C. Does anyone remember when diodes were just used for detecting and rectifying? Tunnel diodes are used as fast switches and oscillators. Hot carrier diodes have

a low forward breakover. Infrared diodes are used to generate infrared signals. The PIN (positive intrinsic negative) diodes convert the infrared signals into electric impulses. (See "What Do You Know About Electronics?" in the April 1987 issue.)

4. C. By comparison, the thickness of a human hair is about 250 times the width of a VHS VCR head gap. (See the April 1987 Video Corner.)

5. B. One video head is installed with an azimuth of $+6^\circ$, and the other is installed with an azimuth of -6° . This ensures that alternate tracks are recorded at an angle of -12° to each other, so little signal is generated by overlapping tracks.

6. A. A vacuum desoldering sys-

tem reduces this problem considerably. (See "Desoldering Components" by James K. Bausell in the May 1987 issue.)

7. A. The swamping resistor lowers the Q of the tuned circuit so the bandwidth is greater. See "Test Your Electronics Knowledge" in the May 1987 issue.)

8. Bad image and lots of snow. (See "Maintenance and Cleaning of VCRs" by Victor Meeldijk in the May 1987 issue.)

9. Absolutely NO! The swab and solvent parts of the statement are OK, but the up and down motion *may damage fragile heads!*

10. D. The equalizer divides the audio spectrum into a large number of bands—usually ten or so. (See the May 1987 Audio Corner.)

ES&T

Learn how to repair VCRs...

Read

Video Corner

each month
in **ELECTRONIC**
Servicing & Technology

NESDA Computer Group

COMPUTER SALES AND SERVICE DEALERS
WORKING TOGETHER

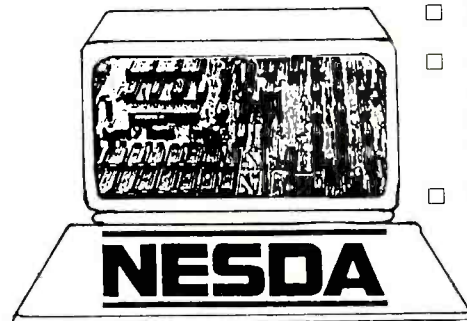

- Service training.
- Assistance in selecting in-house equipment and software.
- Specialized software for service management.
- Factory contacts for service literature and parts.
- Involvement in a stable and productive national trade association.

FOR MORE INFORMATION SEND BUSINESS CARD TO:
NESDA COMPUTER GROUP, 2708 WEST BERRY STREET
FORT WORTH, TEXAS 76109; PHONE (817) 921-9061

Reading and writing with PROMs

This is the second part of a 4-part series on non-volatile memories. Part one covered the basic read-only memory (ROM), which is mask-programmed at the factory and cannot be erased.

Although the basic read-only memory is useful for purposes where you do not want any chance of the contents being erased, there are uses for which a programmable ROM is more convenient. For one thing, the ordinary mask-programmed ROM is very expensive, and is therefore not cost-effective in small production batches. In low-volume applications, it is more economical to use fusible-link ROMs that are user-programmable. These programmable read-only memories (PROMs) are not programmed during the IC manufacturing process, but are custom programmed by the user. Once programmed, however, the PROM is like an ordinary ROM—it can't be erased or reprogrammed. Thus, if the program in a PROM is faulty or the user decides to alter instructions or data, the PROM must be thrown away.

PROM ICs generally feature blown-junction transistor (BJT) technology, with transistor leads comprising fusible links. These links come intact from the manufacturer. By applying a suitably high voltage to specific addresses, the user can selectively blow any of these fuse links to produce the desired data storage. Connections left intact can represent a binary 1, while those burned open store a binary 0.

PROMs are field-programmable devices, and the equipment used to program them is called a PROM programmer (or PROM burner), a machine that permits keyboard entry of the desired program or data. During the programming process, the chip's address pins and data pins determine which memory cells will get their fuse links burned out.

As already mentioned, ROMs and PROMs are neither erasable nor reprogrammable. A more versatile category of read-only memories are both erasable and reprogrammable.

Erasable PROMs

The erasable programmable read-only memory, or EPROM, is a device that can not only be programmed by the user, but can also be erased and reprogrammed as often as desired. Once programmed, the EPROM is a non-volatile memory that can hold its stored data practically indefinitely.

The memory cells in an EPROM are field effect transistors (FETs) that feature a floating gate, an insulated gate with no electrical connections. By applying a relatively high-voltage programming pulse to the device (25V to 50V between source and drain for about 50ms per address location), electrons are injected into the insulated floating gate and remain trapped there once the pulse is removed because there is no discharge path. Thus, programming places a charge on the MOS transistor, and the MOSFET is such a good "capacitor" that it retains the charge for years.

Of course, there can be thousands of MOS transistors on the chip, each one representing a binary digit—bit 1 or bit

0, depending on whether it stores a charge or not. Naturally, during programming operations the IC's address and data pins are used to determine which memory cells get a charge and which don't.

The charge is erasable by means of ultraviolet (UV) light. A transparent quartz window is built into the top of the EPROM case (DIP package) for this purpose. High-intensity UV light is concentrated through this window onto the memory chip inside, causing a photocurrent to flow from the floating gate back to the silicon substrate; this neutralizes the trapped electrical charge. All the stored bit patterns are thus erased simultaneously.

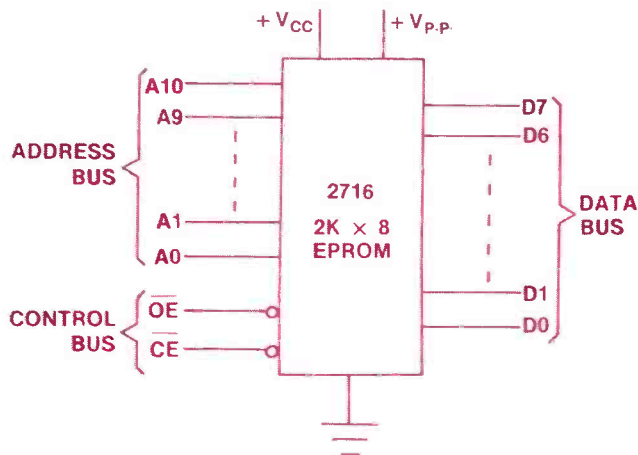

Figure 1. The EPROM can not only be custom programmed by the user, but can be erased and reprogrammed as often as desired. Like the ROM, the EPROM has eight data lines, but its eleven address lines (compared to 10 in the ROM) gives it a storage capacity of 2,048 eight-bit words, or 2Kbytes. Although both have a CE (chip enable) pin, the EPROM also has an OE (output enable) pin that allows it to write as well as read.

A main disadvantage of the EPROM is the long time (15 to 30 minutes) it takes to erase. Once the erasing operation is completed, an opaque label is placed over the clear window to prevent stray UV (from fluorescent lights or sunlight) from gradually erasing the new contents of the EPROM.

The EPROM can then be reprogrammed by means of a PROM programmer. Note that for both erasing and programming operations, the EPROM must be removed from the printed circuit board in which it is used.

EPROMs are very useful in design and development of computer systems. They allow the designer to try out a new program and debug it by erasing and reprogramming as often as necessary until it works perfectly. When the design is finalized, the data can be burned into PROMs for small production runs, or it can be sent to an IC manufacturer who produces a ROM mask for mass production.

Literature

Products catalog

The 52-page, full-color catalog from *Beckman Industrial* describes the company's line of digital multimeters, oscilloscopes, telecommunications test equipment, function generators and frequency counters. In addition to providing specifications and photographs on each product, the catalog also includes a section displaying the new line of temperature measuring instruments, consisting of hand-held thermometers and temperature calibrators.

Circle (125) on Reply Card

Battery size checker

Batt-tronic offers a 1988 universal battery size checker with a slot size for every popular watch and calculator battery. The sizer features silver oxide and mercury referencing, as well as lithium information.

Circle (126) on Reply Card

Products catalog

L-Com Data Products' 60-page interconnection products catalog contains over 2,000 line items, including RS232 devices and testers, multiplexers, rack panels, surge protection systems, cable and accessories. The catalog lists not only basic data communications products, but also hard-to-find and state-of-the-art devices. Information provided includes unit/quantity pricing, specifications, illustrations and photographs.

Circle (127) on Reply Card

Rental catalog

The 1987-88 rental catalog from *Genstar Rental Electronics* features electronic test equipment available from the company under rental terms. New equipment listings from major instrumentation manufacturers are included. Product categories include analyzers, meters, generators, oscilloscopes, desktop computers and telecommunications. Rental terms and conditions are listed, as are toll-free numbers of inventory centers.

Circle (128) on Reply Card

Electronic components catalog

Mouser Electronics is offering a 176-page catalog featuring 16,000 items stocked in depth. The catalog provides product data and pricing of standard stocked industrial electronic components, including capacitors, potentiometers, resistors, transformers, lamps, switches, batteries, holders, jacks, plugs, speakers, knobs, fuses, semiconductors, hardware, tools, test equipment and more.

Circle (129) on Reply Card

BSI
m

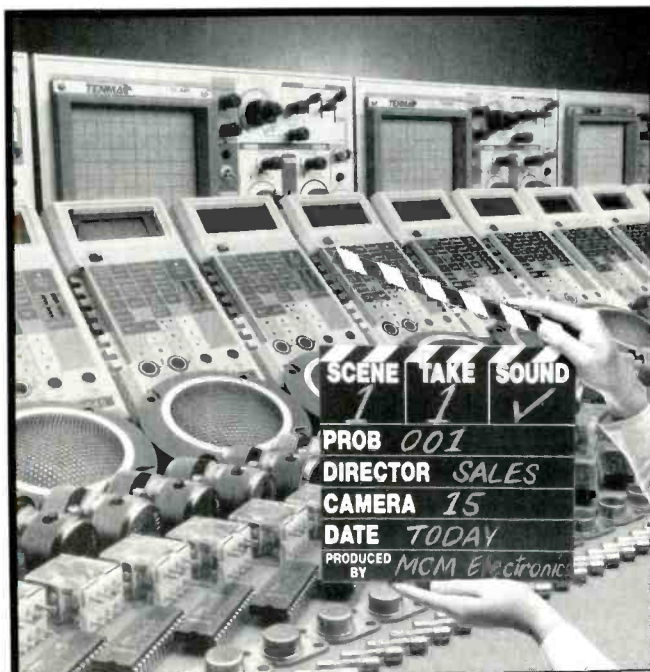

"TAKE ONE"

Take one look at the new MCM catalog and you'll discover...

- An unbeatable line-up of parts and products
- Many new items that are hard to find
- Great values that save you money

You'll also discover convenient ordering with our TOLL-FREE lines, fast and friendly service, plus quick shipment on the items you need.

All of this is in the new MCM catalog — and we invite you to "Take One." For your copy — with no obligation to buy — call TODAY!

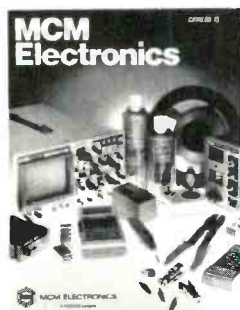

TOLL-FREE
1-800-543-4330
In Ohio, 1-800-762-4315
In Alaska and Hawaii,
1-800-858-1849



MCM ELECTRONICS
858 E. CONGRESS PARK DR.
CENTERVILLE, OH 45459
A PREMIER Company

SOURCE NO. ES-27

Circle (27) on Reply Card

Advanced electronics for remote control

One of the interesting—and frightening—things about taking a close look at today's TV sets is coming face to face with the incredible complexity you'll find there. But not only are today's televisions complex, the circuitry you'll find inside represents the state of the art in circuit design and construction.

For example, a look inside the model CTC 140, recently introduced by RCA and showcased in ES&T's Technology department in October, reveals a cornucopia of advanced electronics:

1. A digital control system that contains
 - a system control microprocessor (U3100),
 - an analog interface unit (U3300),
 - an EEPROM (U3200),
 - a keyboard matrix and indicators,
 - a band switching IC (U3600), and
 - the Dimensia microcomputer (U3501—in Dimensia models).
2. Surface-mounted devices (SMDs), many of which are electrostatically sensitive
3. A switching power supply

In other words, you don't have to get involved in computers or industrial electronics to be besieged by the latest electronic technology; it will come to you.

Why advanced electronics?

These advances have been introduced for a variety of

reasons, including smaller size, lighter weight, lower production costs, greater efficiency and improved reliability.

The CTC 140 service manual has some interesting things to say about the reasons for using the circuitry that is found in the unit, and also about the servicing aspects of the set. "Some of the new and innovative CTC 140 features are made possible using a few unique and different circuits. Most CTC 140 circuit designs are derived from previous RCA color television chassis designs. These proven circuit designs help ensure a reliable product.

"The functional block diagram of the CTC 140 chassis contains a few blocks that are similar to those found in videocassette recorders and may be unfamiliar to some TV service technicians. Similar circuits have been used in high-end color television receivers for many years. These circuits often were designed to be modules and were rarely serviced. Because the CTC 140 chassis has most circuits unitized on one circuit board, it is necessary to service these circuits to the component level."

The digital control system

Systems control microcomputer U3100 scans the front-panel keys and monitors for a key press. When a key press is detected, U3100 checks to see which key has been pressed and initiates the appropriate program sequence. Scanning of the front-panel keys or buttons is also used to drive the front-panel indicators. The serial data bus carries

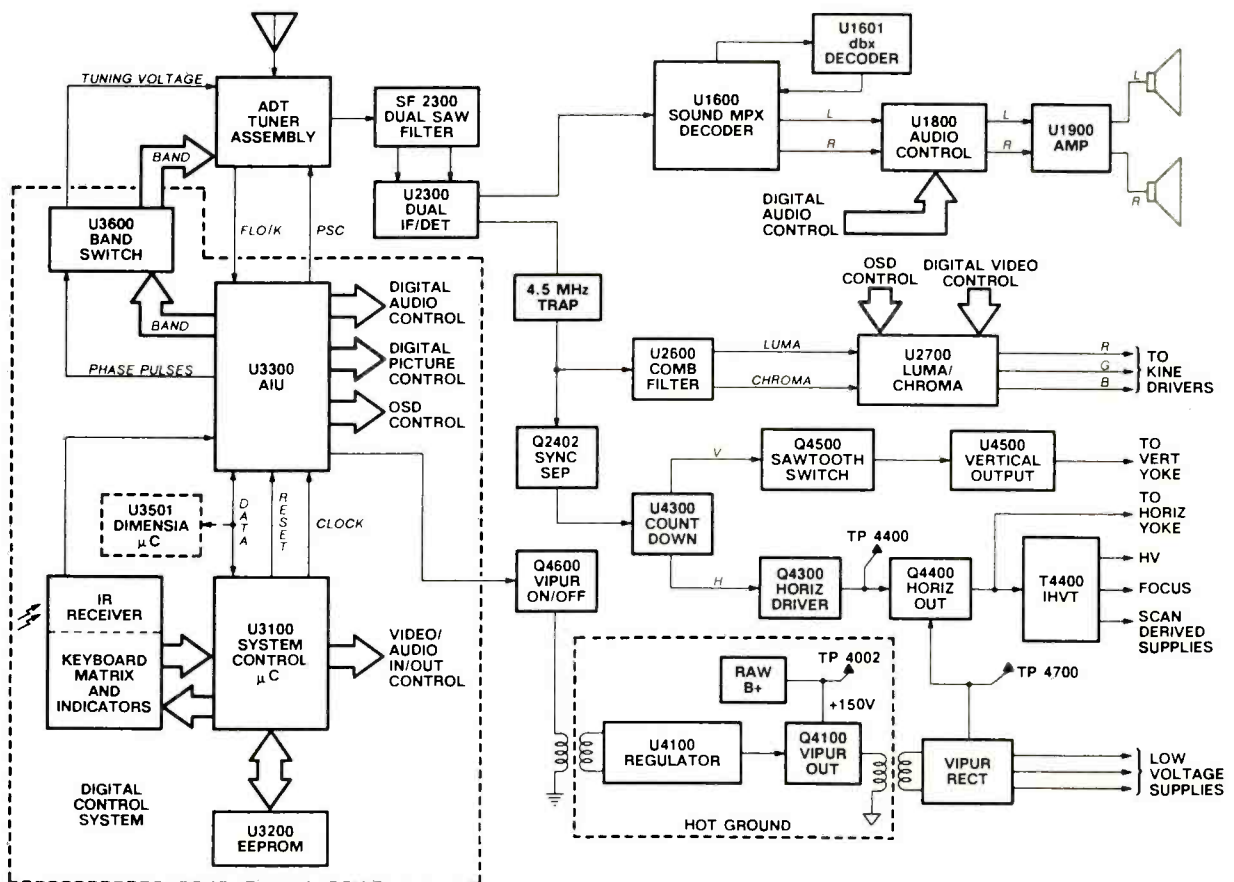

communications to and from the analog interface unit (AIU), the system control microprocessor and the Dimensia microcomputer (only in Dimensia models).

A 4MHz crystal is used to generate a clock for timing the AIU and system control microcomputer. However, the serial data bus runs at 125kHz, this frequency generated by the system control microcomputer dividing down the 4MHz clock signal. The bus transmits local and remote-control function commands, along with Dimensia commands (only in Dimensia models).

The system control also communicates with the EEPROM via a separate serial data bus. EEPROM U3200 stores the channel tuning data for the scan list, the factory and customer picture/audio setup data (levels) and the menu data. A replacement part EEPROM comes preprogrammed with factory setup levels. The system control microcomputer stores and retrieves data in the EEPROM via the serial data bus.

The analog interface unit provides:

- power on/off control to the power supply via transistor Q4600,
- digital control of the picture and audio circuits,
- OSD control, and tuning control.

The set is turned on when the AIU supplies a 32kHz signal to transistor Q4600. When the 32kHz signal is removed from Q4600, the receiver is turned off.

Control of the picture and audio is provided by supplying pulses that are low-pass filtered to generate a dc control voltage. The dc control voltage is then applied to the video and audio circuits. As the number of pulses in a given time frame is varied, the dc control voltage is also varied and control of picture or audio is accomplished.

On-screen display is controlled by the AIU IC supplying control signals to the video processing circuits. The video processing circuits use these control signals turning off and on the picture guns to generate the OSD.

The AIU IC U3300 controls the tuning operation using the pulse-swallowing technique of most phase-locked loops. Band switching information is supplied to the band switch or band decoder U3600 from the AIU. Monitoring a divided-down version of the tuner's local oscillators frequency, known as FLO/K, the AIU generates the tuning voltage. The AIU also generates prescaler control (PSC) pulses to change the division ratio of the prescaler.

ES&T

**"ES&T
is always
great."**

**"Especially Trouble-
shooting Tips and
Profax are extreme-
ly helpful. Keep
them coming."**

**Tony Bernier, Owner
Tony's TV Service
St. Croix, VI**

ELECTRONIC
Servicing & Technology

Practical techniques for today's servicing professional

Plug in!
To the NESDA system.

YOUR BUSINESS is in the world's fastest changing industry. If you're not careful, you could find your business in the dark.

But, you don't have to stay there.

Through a system of local, state, and regional groups, the National Electronics Sales & Service Dealers Assn. (NESDA) keeps members up-to-date with the fast pace of advancing technology while offering:

- ◆ Managerial and technical training.
- ◆ Business contacts.
- ◆ Technical and management certification.
- ◆ Information on new products.
- ◆ Legislative activities that affect the industry.

Don't be left in the dark. Let the NESDA system work **FOR YOU!**

For more information and an application, write to:
NESDA, 2708 W. Berry St., Ft. Worth, TX 76109; Ph (817) 921-9061

Name _____

Bus. Name _____

Address _____

State _____ Zip _____ Phone _____

Member of State Local Assn. _____

**ELECTRONIC SERVICING & TECHNOLOGY
STATEMENT OF OWNERSHIP**

Statement of Ownership, Management and Circulation (Act of August 12, 1970; Section 3685, Title 39, United States Code).

- 1A. Title of publication: Electronic Servicing & Technology
- 1B. 462-050
2. Date of filing: Sept. 25, 1987
3. Frequency of issue: Monthly
- 3A. Number of issues published annually: 12
- 3B. Annual subscription price: \$18
4. Location of known office of publication (Street, city, county, state, zip code): 9221 Quivira Rd., Overland Park, Johnson County, Kansas 66215.
5. Location of the headquarters or general business offices of the publishers (not printers): 9221 Quivira Rd., Overland Park, Johnson County, Kansas 66215.
6. Names and complete addresses of publisher, editor, and managing editor. Publisher (Name and Address): Eric Jacobson, 9221 Quivira Rd., Overland Park, KS 66215. Editor (Name and Address): Conrad Persson, 9221 Quivira Rd., Overland Park, Kansas 66215. Managing Editor (Name and Address): Tom Cook, 9221 Quivira Rd., Overland Park, Kansas 66215.
7. Owner (If owned by a corporation, its name and address must be stated and also immediately thereunder the names and addresses of stockholders owning or holding 1 percent or more of total amount of stock. If not owned by a corporation, the names and addresses of the individual owners must be given. If owned by a partnership or other unincorporated firm, its name and address, as well as that of each individual must be given. If the publication is published by a nonprofit organization, its name and address must be stated.) Intertec Publishing Corp., a Macmillan company, 9221 Quivira Rd., Overland Park, Kansas 66215.
8. Known bondholders, mortgagees, and other security holders owning or holding 1 percent or more of total amount of bonds, mortgages or other securities (If there are none, so state): Macmillan, Inc., 866 Third Ave., New York, NY 10022.
9. Paragraphs 7 and 8 include, in cases where the stockholder or security holder appears upon the books of the company as trustee or in any other fiduciary relation, the name of the person or corporation for whom such trustee is acting, also the statements in the two paragraphs show the affiant's full knowledge and belief as to the circumstances and conditions under which stockholders and security holders who do not appear upon the books of the company as trustees, hold stock and securities in a capacity other than that of a bona fide owner. Names and addresses of individuals who are stockholders of a corporation which itself is a stockholder or holder of bonds, mortgages or other securities of paragraphs 7 and 8 when the interests of such individuals are equivalent to 1 percent or more of the total amount of the stock or securities of the publishing corporation.
10. This item must be completed for all publications except those that do not carry advertising other than the publisher's own and are named in sections 132.231, 132.232 and 132.233, postal manual (Sections 4355a, 4354b, and 4356 of Title 39, United States Code.)

	Average No. Copies Each Issue During Preceding 12 Months	Single Issue Nearest To Filing Date
A. Total No. Copies Printed (Net Press Run)	51,217	46,000
B. Paid Circulation		
1. Sales through dealers and carriers, street vendors and counter sales	-	-
2. Mail subscriptions	47,575	43,855
C. Total Paid Circulation	47,575	43,855
D. Free Distribution (including samples) by mail, carrier delivery or other means	1,127	1,287
E. Total Distribution (Sum of C and D)	48,702	45,142
F. Office use, left-over, unaccounted spoiled after printing	2,515	858
G. Total (Sum of E and F should equal net press run shown in A)	51,217	46,000

I certify that the statements made by me above are correct. (Signature of editor, publisher, business manager, or owner.)

ERIC JACOBSON
Publisher

Readers' Exchange

No ad requests will be accepted for Readers' Exchange without a full, verifiable name, address AND phone number. This information is necessary for ES&T files. Phone numbers will not be published, if so requested.

Wanted:

Schematic for Sony stereo amplifier, model TA-1010; Flyback #95-3148-05, or Fly #599 for Zenith television, model G3410C. *Fredrick B. Smith, 8682 Auburn, Detroit, MI 48228; 313-582-9677, leave message.*

IC number 56A24-1 (or 56D24-1) used in Admiral model 25C631 color television. *Henry Sievers, 6819 Willamette Drive, Austin, TX 78723; 512-926-7479.*

Original factory service manuals for McMurdo Silver and E.H. Scott radios of the '30s; new or used parts—complete units; tubes 913 and 3KP4. *Wilford D. Wilkes, Box 103, Brishin, PA 16620.*

High-voltage tripler (number on tripler is 561B026-1) for MGA color television model CS196, please send price. *John Augustine, 530 N. 9th St., Reading, PA 19604; 215-372-5438.*

Old RCA modules and service literature for classic CTC48-CTC92. Send asking price and module numbers. *Mike Shelton, 2708 May Drive, Burlington, NC 27215; 919-227-2908 after 8 p.m.*

B&K solid-state 3050 audio signal generator with manual; Heathkit model IM 4180 FM deviation meter with manual; Heathkit solid-state distortion meter. All items must be in excellent condition. *Lloyd Spivey, WLLS AM/FM, Highway 281 South, Hartford, KY 42347; 502-298-3268.*

Usable 7-inch B&W CRT #CT-537 to fit Sony model TV-790. Will pay cash or possible trade. *Leon Tebis, 434 4th St., Brooklyn, NY 11215; 718-693-7311.*

A power amplifier of 400+400W with many outputs. *Arnell Electronics, P.O. Box 247, 33 Abb, Gregoire POINTE-A-PITRE, GUADELOUPE.*

Marantz model 10B tuner, must be intact. Any condition. Will buy or trade. *Mike Zuccaro, Voice & Video, 5038 Ruffner St., San Diego, CA 92111; 619-560-1166 days or 619-271-8294 nights and weekends.*

Diehl technician/shop owners newsletters, issues #4 to #14 (or higher). *J. Hilbrich, 732 Queen St., Regina, Saskatchewan, Canada, S4T 4A3.*

K.L.H. model 7 speaker. *Frank Beckerle, 313 Woodcrest Drive, Buffalo 14220; NY 716-823-1571.*

Knight 83YX137 AF generator with manual; 83Y135 signal tracer manual only. *C.T. Huth, 229 Melmore St., Tiffin, OH 44883.*

Used scopes, generators, tube testers. Riders books. Will sell two pr sound powered phones. B&K 1076. Webster Tele-talk 2076. *Bob's Band Instrument, P.O. Box 92, Marion, MI 49665.*

Head drum assembly A-6050.009-A (or -066-A) for Sony SLP-300 player. *Don Hicke Video, 4642 Oregon St., #2, San Diego, CA 92116; 619-291-3932.*

Schematic/service data, original or copy. Tek oscilloscope model 545. *Scott Tanenbaum, 4 Jarvis Court, Erial, NJ 08081.*

For sale:

Sencore DVM 37 digital multimeter, \$125; B&K Analyst 1077R, \$225; Sencore LC53 Z-Meter. All equipment like new, with manuals and in original cartons. *Paul Cecil, Paul's TV, 260 Main Cross, Charlestown, IN 47111; 812-256-3119.*

Digital 11/34 computer with two RKO56J drives and 22 discs, \$1,000. Simpson capacohmmeter model 383-A, \$40. Beltron CRT tester, \$100. RCA oscilloscope, model W33A, \$50. B&K Dyna Sweep 1070, \$20. *Robert Blanchard, Pinehill Road, Warren, NH 03279.*

B&K Precision model 1248 digital I.C. color generator, excellent condition, \$250. *Michael Rowell, Gohmert Audio/Visual, Start Route Box 38A, Meyersville, TX 77974; 512-275-8951.*

TV sets for parts—Admiral 1M30, M25; Magnavox T809, T995, T979; Philco 22QT80, 3CR41; RCA CTC 40P, CTC 91, CTC 97, CTC 108; Quasar TS919; Zenith 19DC12, 25CC50. Also for sale, two excellent picture tubes—19VLPN22 and 25VFHP22, Knight 6/10 meter, model T-175 linear amp; two Litton oven parts: model 70/42 menu master and model 56-4888-10 11/78; Sony TC-580 reel-to-reel recorder. *D.J. Ajala, 50 Fir Circle, Babbitt, MN 55706.*

DeVry Institute model 34 oscilloscope, \$75; EICO model 147 signal tracer, \$25; Sencore FE-20 hi-lo multimeter, \$75. Will consider trades. *B.L. Deck, 122 Fourth Ave. South, Algood, TN 38501.*

Heath IB-2A impedance bridge, \$45; Heath IT-3120 transistor tester, \$35. Both in good condition, with manuals. *Bob Kramer, 919 Grove St., Aurora, IL 60505; 312-898-8946.*

Large quantity of tubes, transistors, ICs, yokes, flies, test equipment. *SAMS, H. Weymouth, P.O. Box 6292, Ruritan Center, Edison, NJ 08837; 201-248-1176.*

Working B&K 1076, original carton, manuals, slides, \$125 shipped; 400BK22 color CRT, \$20; approx. 50 new B&W CRTs—4 to 24-inch, \$50 for all, picked up; approx. 50 B&W TV sets, free if picked up; 50 B&W TV sets, solid state, \$2 each take all, picked up; Conrac AV-12 professional TV tuner, \$50. *Jim Farago, P.O. Box 65701, St. Paul, MN 55165; 612-722-0708.*

B&K 3010 function generator, \$110; Heathkit hand-held frequency counter, \$80, and charger, \$5; B&K VTVM #177-B, \$150. All with manuals. *Jim Dums, 125 Pike St., Port Carbon, PA 17965; 717-622-4254 after 4 p.m.*

Good HO transformer, RCA 113382, \$10; BA, BK, HA, ZA, CA and FA Quasar panels, all \$50; back issues of PF Reporter, Electronic Servicing, Electronic World and others (send s.a.s.e. for list). All items plus UPS shipping. *Clark Trissell, 3530 Purnee St., Lincoln, NE 68506; 402-488-5263.*

Sencore LC53 Z-meter, brand new, w/SCR and triac tester, never used, \$575. *Richard Larnder, 16744 Kenmore Road, Kendall, NY 14476; 716-659-2247.*

Tubes, 25¢ and up, new and used, rare, old and current. Send list for quote. *Ted Youngman, 2225 Vigo St., Lake Station, IN 46305.*

NRI communications course (older version) with experiments, \$200; NRI A-V course (latest version) with trainer and experiments, \$400; Heath ET-3100B trainer (never used), \$100; Heath IM-2400 frequency counter (unassembled), \$100. Prices don't include shipping. *Roy LaFrance, 1334 Walnut Drive, Eureka, CA 95501; 707-442-3677.*

Scencore VA62 universal video analyzer, VC63 VCR tester accessory, with manual and cables, \$2,100. *Ronald MacKenzie, 41 Wheelwright Lane, Levittown, Long Island, NY 11756; 516-579-8546.*

Yokes: 95-2501-95-2780-S89633-294-7215; 361380-1-36138004247; 24D68592B01 (2 in stock); RCA yokes from bonded tubes; 51-33657-2-51-33657-2 (2 in stock); A03317 RCA; 1456605-502, \$9 each plus shipping. *Zenith Vert 9-92, \$8.50 each plus shipping. M.E. Andrews, Jr., Box 91, Exeter, RI 02822.*

Scencore equipment: VA62 video analyzer; VC63 VCR test accessory; SC61 waveform analyzer; LC53 Z-meter; PR57 Powerite. Like new, best offer. *Jack K. Sweeney, P.O. Box 206, New Harmony, IN 47631; 812-326-7555 days or 812-682-3119 after 6 p.m.*

Scencore SC61 waveform analyzer, \$2,200; Scencore VA48 video analyzer, \$475; plus shipping. *UPS COD only. Albert Hunter, 911 Rockport Road, Janesville, WI 53545; 608-754-5664.*

Zenith modules 9-86 up to 9-155, several dozen of each. Asking dud price. *G. Stuart, 503 Sunnyside Lane, Hopkins, MN 55343.*

Tekfax ETD: 1623 to 1770, trade or make offer; two operating instruction manuals for Hickok model 209-A multimeter, both for \$5. *William J. Maida, 271 W. Sabal Palm Pl., Longwood, FL 32779; 395-869-6138.*

SAMs photo fact POMs, from #1 thru #2459 with filing cabinets; about 50 SAMs radio repair manuals; \$3,000 for all. *Alan Flesherman, Box 253, Midway, WV 25878; 304-683-5420.*

Hickok 610A universal TV-FM alignment signal generator, with manuals, \$75; Philco 8300 wide-band oscilloscope amplifier, \$10; SAMs photofact sets no. 69 through 496, 75¢ each or all 275 sets for \$150 (or best offer); Bell & Howell TV and radio repair course, 11 complete volumes, \$75. All good condition, plus shipping. *John Bronzakis, 247 Valley Circle, Charleroi, PA 15022; 412-483-3072.*

Scencore FE-20 high/low meter with two high-voltage probes, \$95; two new 20k/V VOMs, one with carrying case for \$25, one with temperature scale for \$30; used digital B&K DMM, operational, \$15; Heathkit IG5280 RF generator, IT-5283 signal tracer, \$30 each; B&K 1805 80MHz, 8-digit frequency counter, used once, \$200. COD and shipping charges extra or best offer. *Stanley Todorow, 68368 Belle Bluff Drive, Grand Blanc, MI 48439; 313-695-0271.*

Chips: 200+ digital, unused, marked, surplus grade, \$35; 100 LM381AN, purchased from distributor, prime, \$150; 5,000-foot telephone extension cord, flat line, 4-conductor stranded, \$150; Sears digital exercise/pulse monitor with instructions, never used, cost \$100, sell for \$70. Best offer on any. *Marchand Electronics, 10614 80th Ave., Puyallup, WA 98373.*

RCA 10J016 universal test jig with 40 adapters, \$150 plus shipping. *Bruce B. Fuller, 5072 Country Club Way S.E., Port Orchard, WA 98366, c/o Bruce Electronics; 206-871-4723.*

NLS digital meter, \$35; Conar resistor-capacitor tester, signal generator, signal tracer, transistor tester, tube tester, \$35 each; B&K CRT rejuvenator/restorer, \$200, and #290 meter, \$125. All include manuals, prices do not include shipping. All calls after 5 p.m. — by appointment only. *Len Elgart, 1811 Quentin Road, Brooklyn, NY 11229; 718-375-3640.*

TV transformers and coils: Merit horizontal oscillators, deflection yokes, width/lin coils, radio detector, Stancore vertical block oscillators, RAM, horizontal oscillator, vertical output, vertical block oscillator. Sell or trade. Send s.a.s.e. for complete list. *R.P. Morrison, 1640 Mill Oak Drive, Virginia Beach, VA 23464; 804-467-8605 after 6 p.m. EST.*

VTVM with probe, transistor/FET tester, temperature tester, harmonic generator, tube/continuity tester, transistor tester, signal injector. Sams photofacts and books. Send s.a.s.e. for details. Buy separately or all for \$572.75 (free shipping for one week only), COD only. Call first day received, only \$450 — you pay shipping. *David Lehmann, R.R. 2, Box 104, Mansfield, MO 63704; 417-924-3350.*

Sams Photofacts, series 100 to 1000; old MHF & AR TSM and CB. No reasonable offer refused. Also old test equipment, tubes, transistors, etc. Will sell or trade. *Tom Giacinto, H.M. Electronics, 198 South Middletown Road, Nanuet, NY 10954; 914-623-2612.*

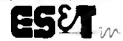

Advertising rates in the Classified Section are 85 cents per word, each insertion, and must be accompanied by payment to insure publications.

Each initial or abbreviation counts a full word. Minimum classified charge is \$20.00.

For ads on which replies are sent to us for forwarding (blind ads), there is an additional charge of \$30.00 per insertion to cover department number, processing of replies, and mailing costs.

Classified columns are not open to advertising of any products regularly produced by manufacturers unless used and no longer owned by the manufacturer or distributor.

FOR SALE

AUTOMOBILE RADIO and tape replacement parts. Delco, Chrysler, Philco-Ford, Motorola, Panasonic and many others. Large inventory. *Laran Electronics, Inc., 3768 Boston Road, Bronx, NY 10469. (212) 881-9600. National (800) 223-8314, NY State (800) 446-4430.* 1-85-tfn

VCR REPAIR SOLUTIONS FOR VHS MODELS. Volume I—150 Symptoms and cures—\$11.95. Volume II—\$11.95. All 300, \$19.95. *Eagle Electronics, 52053 Locks Lane, Granger, IN 46530.* 7-87-61

SERVICE MANUALS. Large Shop has 18 yr. collection of duplicates. All original manufacturer. All new. Audio \$1.00, video \$5.00. Send SASE for list. *Tape Recorder Clinic, 4850 E. Speedway, Tucson, Arizona 85712.* 11-86-tfn

TV/VCR "Tuff Tips" listed by mfg. and model. 1st edition—200 TV/VCR tips \$10.95. 2nd edition—200 TV/VCR tips \$10.95 both editions \$19.95. For TV tips only—1st or 2nd edition \$5.95, both editions \$10.95. For VCR tips only—1st or 2nd edition \$6.95, both editions \$12.95. *TECH CURES, 4825 Fredericksburg Road, San Antonio, Texas 78229.* 11-87-21

TV/VCR FAILURE HISTORIES—Multiple cures for most problem areas. Send \$6.95 with mfg. and model number to *TECH CURES, 4825 Fredericksburg Road, San Antonio, Texas 78229.* Money will be refunded with free sample, if model is not on database. 11-87-21

VCR CROSS-REFERENCE LISTINGS for the following electronically similar manufacturers: RCA Sharp, Sylvania, Panasonic, Quasar, Magnavox, Philco, Hitachi and J.C. Penney. Each \$13.95, any 2 or more \$10.95 each. *TECH CURES, 4825 Fredericksburg Road, San Antonio, Texas 78229.* 11-87-21

TV TROUBLESHOOTING: 130 Problems-Solutions plus 12 steps to easier repairs. \$12.00. Remarkable Diagnostic tool, measure high voltage performance, no mistakes. \$5.00. *Jones, Box 702, Niceville, FL 32578.* 11-87-3t

SERVICE MANUALS—AUDIO: Akai, Marantz, Sansui, Sharp, Rotel, etc. Sell all make offer. *Parts Boxes, TEAC 4 channel reel Tweeters & Horns 205-988-5037.* 11-87-11

SCENCORE VA62 universal video analyzer, VC63 VCR tester accessory. Complete with manual & cables \$2,100.00 firm. *Ronald MacKenzie, 42 Wheelwright Lane, Levittown, Long Island, New York 11756. (516) 579-8546.* 11-87-11

"THE WORKBENCH COMPANION"—Over 200 pages of Tough Dogs and troubleshooting notes from 20 years in the business. Partial contents: *Symcure Index 1970-1987, Radio Elec. Clinic 1969-1987, ETD Index ColorFax 1969-1982, Testing HV Diodes, Int. Flybacks, Zenors, etc. Important note on capacitors and much more. Price: \$29.95 + \$2.50 shipping and handling. FARRELL ELECTRONICS, Hi-Teck, Larry Gribbin, Chief Engineer, 127 Providence Avenue, SOUTH PORTLAND, MAINE 04106.* 10-87-3t

SCENCORE SC61 Dual Trace Scope and Scencore VA48 Video Analyzer. Each comes with leads and manuals. Excellent condition. Plus much more! Asking \$2800.00. (312) 289-0056. 10-87-2t

T.V. SALES & SERVICE. Well established business located northern Virginia. Owner retiring and will help with financing. Call 703-972-7027 after 7:00 p.m. EST. 6-85-tfn

TV TOUGH DOGS: 300 symptoms and cures. Send \$7.95 to *DAVIS TV, 11772 Old Fashion Way, Garden Grove, CA 92640.* 10-87-tfn

SONY-TRINITRON Rebuilt Picture Tubes are now available. All tubes shipped U.P.S. No Charge. We buy all Sony tubes. *Rochester Kinescope, 716-235-0750.* 11-87-tfn

BUSINESS OPPORTUNITIES

NORTH SHORE OF MASSACHUSETTS. Established appliance, TV, and VCR repair service with new and used sales opportunity. Real estate package available. Call for details (617) 281-1006 days. 8-87-4t

TV/VCR REPAIR SHOP. For Sale. Parts. Equipment. Established, good lease & location. Nice shop. \$25,000.00. 713-541-0260. *Houston, Texas.* 11-87-2t

EDUCATION

CABLE TV TRAINING—Training in Cable Television Technology. Learn construction, installation, and maintenance. *Cable Correspondence Courses, Inc., P.O. Box 1319, St. Charles, MO 63302.* 7-87-tfn

SERVICES

CREDIT REPAIR. Business and Commercial Loans Brokered. Small Business Consultant. Free details. *Commercial Financial Group, P.O. Box 920957, Dept. 241, Houston, Texas 77292-0957.* 11-87-11

**PERSONALIZED 24-HOUR SERVICE
ON OVER 10,000 ELECTRONIC
COMPONENTS & PRODUCTS...**

CALL TOLL FREE

IN
1-800-558-9572 WIS 1-800-242-9553
24 HOUR ORDERING: FAX: 414/473-4727



PROJECTOR-RECORDER BELT CORP.
P.O. Box 176 • Whitewater, WI 53190
TLX 4994411 PRBUSA

Circle (31) on Reply Card

A MUST FOR THE TV TECHNICIAN

UNIVERSAL CRT ADAPTER. Don't buy another socket for your CRT Tester! Join 10,000 satisfied buyers & WIN the Socket War! GUARANTEED to fit your tester. Test/clean/restore ALL Color, B/W, Projection. \$63.95ppd w/Set up book, Visa, MC, COD.



1-800-331-9658

DANDY MFG. CO.

2323 Gibson, Muskogee, Oklahoma 74403

Circle (28) on Reply Card

**HAND REMOTE REPAIR
LA GUARDIA ENT.**

5882 Rich Hill Way
Yorba Linda, CA 92686
(714) 579-1276

90
Day
Warranty
New Battery
Included

- Call for pricing
- 24 hr. turnaround time
- Return freight pre-paid

Circle (29) on Reply Card

Tech's
Guide
To
Pricing

NEW

**"Tech's Guide To
Pricing"**

updated new 5th edition... a framework for setting rates that apply to Hi-Tech products... a formula that guarantees SUCCESS!

Call Toll Free for details 8/5
1-800-228-4338 CST

Circle (34) on Reply Card

ELECTRONIC SERVICING & TECHNOLOGY Volume 7, No. 11 (USPS 462-050) is published monthly by Intertec Publishing Corp., 9221 Quivira Road, P.O. Box 12901, Overland Park, KS 66212. Second Class Postage paid at Shawnee Mission, KS, and additional mailing offices. POSTMASTER: Send address changes to ELECTRONIC SERVICING & TECHNOLOGY, P.O. Box 12952, Overland Park, KS 66212-9981

Ad Index/Hotline

Company	Page Number	Reader Service Number	Advertiser Hotline
American Power Conversion	23	13	617/273-1570
American Reliance	21	12	800/654-9838
Beckman Industrial Corp.	IFC	1	619/495-3200
C + S Sales	29	15	800/292-7711
Chemtronics, Inc.	53	26	800/645-5244
Clary Corporation	39	33	818/287-6111
Cooks Inst. Elec. Engrg.	39	18	601/371-1351
Dandy Mfg. Co.	68	28	800/331-9658
ETA	57		
Fluke, John Mfg. Co., Inc.	5	11	800/227-3800
Hitachi Sales Corp. of America	41	19	516/921-7200
Iscet	52		
Kalglo	13	8	800/524-0400
Laguardia Enterprises	68	29	714/579-1276
Leader Instrument Corp.	3	4,5	514/337-9500
MCM Electronics	63	27	800/543-4330
Mendon Electronics	53	24	716/248-8480
NCM Electronics	13	7	408/496-0290
NESDA	61,65		
OK Industries, Inc.	25	14	800/523-0667
Parts Express Int'l Inc.	55	25	513/222-0173
Projector Recorder Belt Corp.	68	31	800/558-9572
Sencore, Inc.	45,47,49,51	20,21,22,23	800/843-3338
Sola Electric	IBC	2	800/243-8160
Sperry Tech, Inc.	68	34	800/228-4338
Tektronix, Inc.	1,7	3,6	800/433-2323
Tentel	57	32	800/538-6894
U.S. Instrument Rentals	15	9	800/824-2873
U-Can-Do VCR Educational Products Co.	52	17	513/548-6113
Windsor Technologies, Inc.	17	10	415/456-2200
Zenith	BC		

ADVERTISING SALES OFFICES

ELECTRONIC
Servicing & Technology

ALL U.S. TERRITORIES

Greg Garrison, Sales Manager

P.O. Box 12901

Overland Park, KS 66212

Phone: (913) 888-4664

Fax: (913) 888-7243

Telex: 42-4156 INTERTEC QLPK

NORWOOD, AUSTRALIA

Hastwell, Williamson, Rouse PTY. LTD.

P.O. Box 419

Norwood, S.A. 5067

Phone: 332-3322

Telex AA 87113

LONDON, ENGLAND

Nicholas McGeachin

Roseleigh House, New Street

Deddington, Oxford OX5 4SP

Phone: (0869) 38794

Telefax: (0869) 38040

Telex: 837469 BES G

TOKYO, JAPAN

Haruki Hirayama,

EMS, Inc.

Sagami Bldg., 4-2-21, Shinjuku,

Shinjuku-ku, Tokyo 160, Japan

(03) 350-5666

Telex: 2322520 EMSINCJ

Cable: EMSINCPERIOD

**USE ES&T
classified
ads**

PROTECT YOUR SYSTEM AGAINST ADVERSE VOLTAGE CONDITIONS.



It doesn't take a storm to shock your sensitive computer and upset the business that depends on it. Over ninety per cent of computer problems are due to irregular power. Just the slightest surge or dip in electricity can trigger costly errors, memory loss or a complete system shutdown. And anything from an air conditioner turning off to a nearby appliance starting up can make it happen.

But you and your computer can easily weather the constant and devastating onslaught of voltage irregularities with the sure Sola solution. Our full line of economical, UL-listed regulators is designed to protect computers and other sensitive electronic equipment against unwelcome AC disturbances, including brown-outs, voltage surges and dips,

voltage transients and transverse or common mode noise. Even the most minimal voltage variations are tightly controlled. And Sola offers a complete line of regulators to fit your particular need — from portables to hard wire to rack mount construction. Sola Regulators are maintenance-free, and installation is as easy as plugging in a lamp. So why not

take a load off your mind, when you can take the load off your line with voltage regulators from Sola.

COMPUTER REGULATORS FROM SOLA.

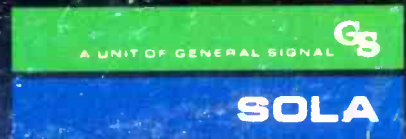

1717 Busse Rd.
Elk Grove Village, IL 60007
(312) 433-2800
1-(800)-243-8160

Write for free literature.

Circle (2) on Reply Card

Zenith remanufactured and reconditioned replacement modules and sub-assemblies factory-fresh from Exchange Counters throughout the U.S.

There's no sense risking an exchange anywhere else!

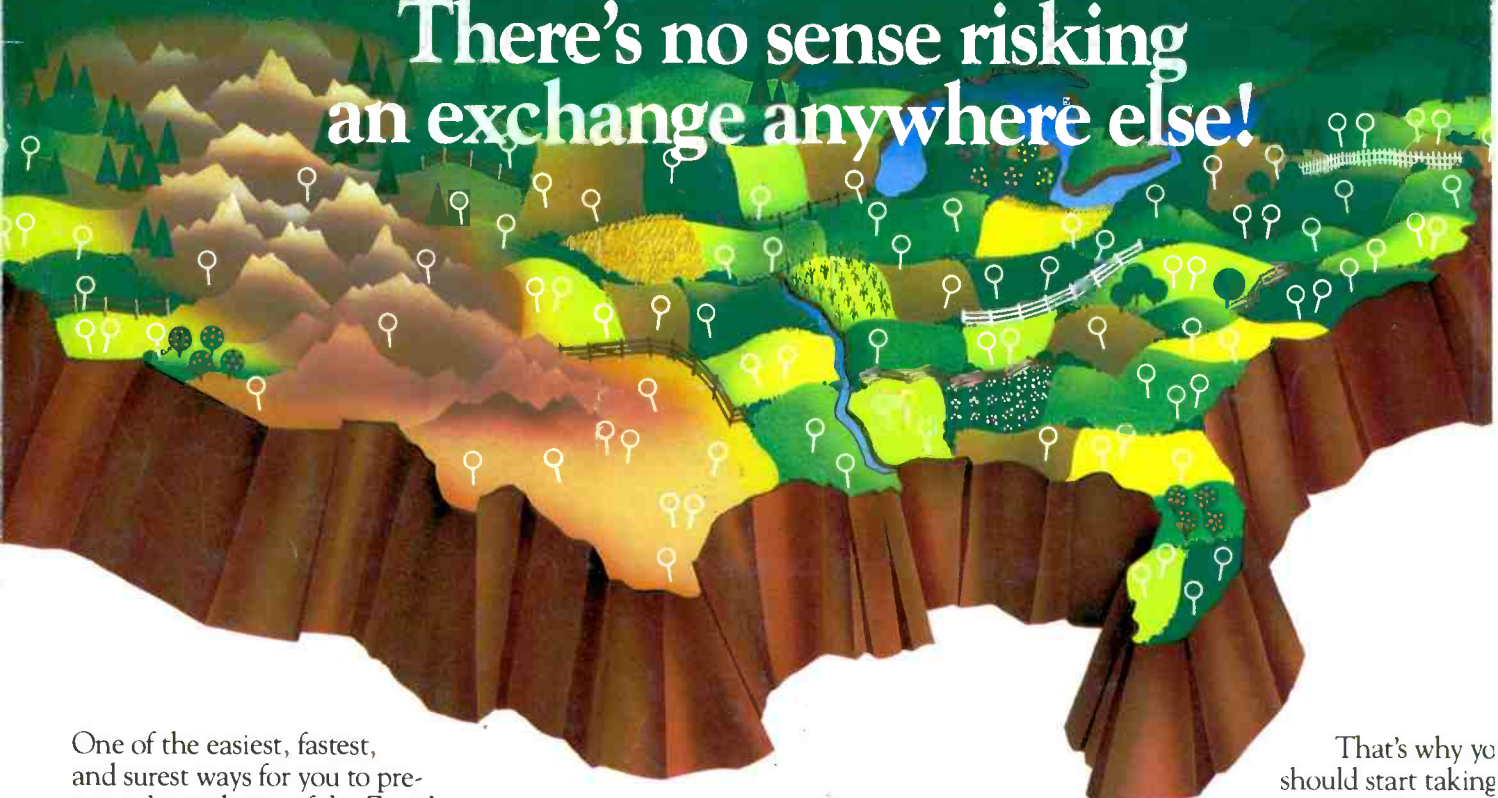

One of the easiest, fastest, and surest ways for you to preserve the pedigree of the Zenith products you service and maintain is with genuine Zenith replacement parts.

And at no time is this more critical than when you replace the more sophisticated components like modules, tuners, channel selectors and sub-assemblies.

Your participating Zenith parts distributor will supply you with a replacement remanufactured, reconditioned and serviced for reliability by Zenith people as dedicated and knowledgeable as those who made the original.

Equally important, the replacement module or sub-assembly you receive in exchange from your Zenith parts distributor will most likely incorporate Zenith factory modifications, if any, in effect at the time of remanufacture.

And nowhere else but in a participating Zenith parts distributor's Exchange Program can you get assurance that a replacement incorporates a Zenith factory up-date if one exists!

ZENITH

The quality goes in before the name goes on.®

That's why you should start taking advantage of your

Zenith parts distributor's R&R Exchange Program now.

We'll help you locate the Zenith R&R Exchange Counters in your area if you'll write on your company letterhead with your complete address element and Zip Code.

Chances are there's an Exchange Counter for Zenith factory-fresh replacement modules and sub-assemblies closer than you realize.

Write, if you don't know, and we'll tell you where it is! There's no sense risking an exchange for a Zenith replacement anywhere else!